



3 1761 06705941 0

CAMBRIA
SHEL

TO THE HONORABLE SECRETARY OF THE
NAVY
WASHINGTON, D. C.

RE: [Illegible]

[Illegible]

[Illegible]

77

S/A 77

CONSOLIDATED STEEL CORPORATION
MEMPHIS, TENN.

CAMBRIA STEEL COMPANY'S WORKS

JOHNSTOWN, PA.

CAMBRIA PLANT

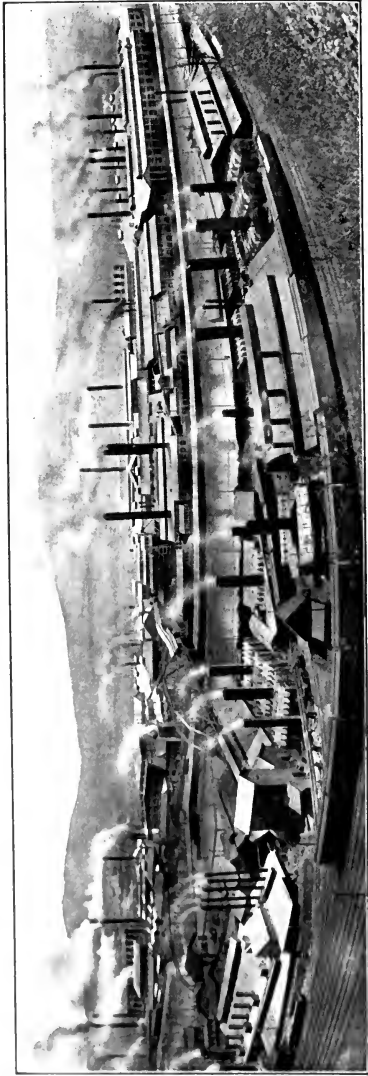

← ONE MILE →

- BLAST FURNACES 1-4
- FOUNDRY
- PAINT, CAR REPAIR AND PATTERN SHOPS
- ROLL SHOP
- MACHINE SHOP
- AXLE SHOP
- RAIL AND SHAPE MILLS
- COAL STORAGE
- COAL BRIDGE
- BLAST FURNACES 5 AND 6
- BLOOMING, BILLET AND BEAM MILLS
- BESSEMER STEEL WORKS
- O. H. STEEL WORKS

L

0

#

COAL BRIDGE

GAUTIER PLANT

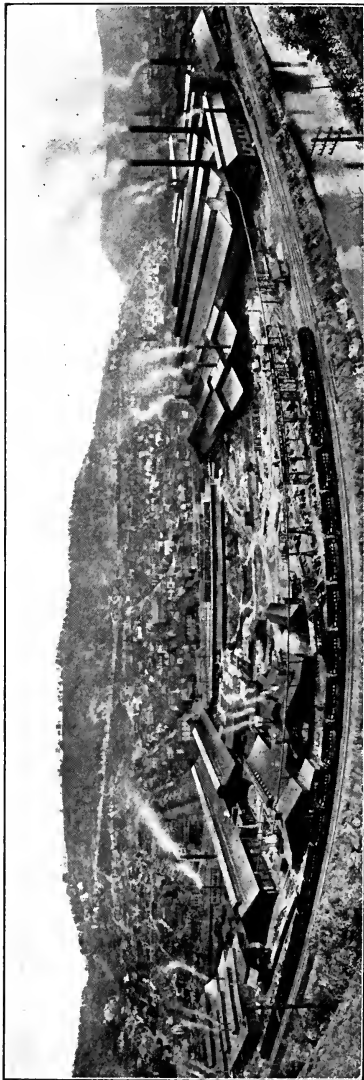

COLD ROLL SHOP

9" MILL

BAR MILL

PLATE MILLS

RAKE SHOP

MACHINE SHOP

DISC SHOP

UNIVERSAL PLATE MILL

14" MILL

8" MILL

10" MILL

ROLL SHOP

FRANKLIN PLANT

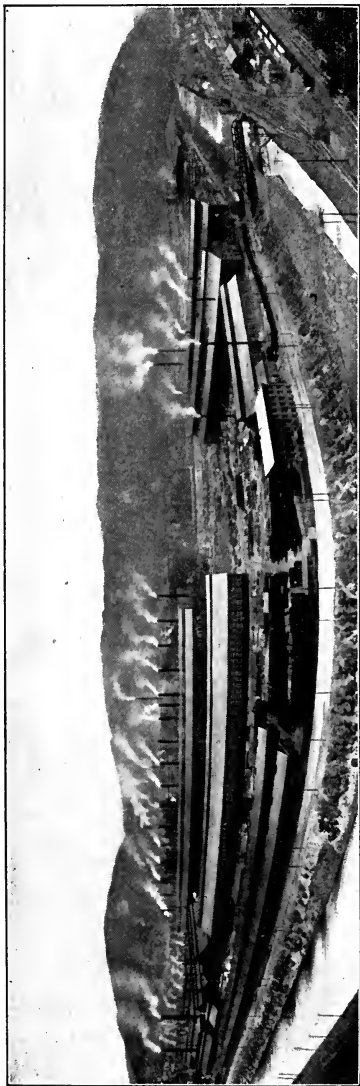

BLOOMING MILLS
SLABBING MILL
CAR PAINT SHOP

COKE PLANT
BLAST FURNACES 7 AND 8
O. H. STEEL WORKS
134" PLATE MILL

POWER PLANT

STRUCTURAL SHOP
BEAM YARD

CAR SHOP
FORGE SHOP
BOLT SHOP

GENERAL SALES OFFICES: PHILADELPHIA, PA., U. S. A.

PA.

PA.

ZY

F

Z

F

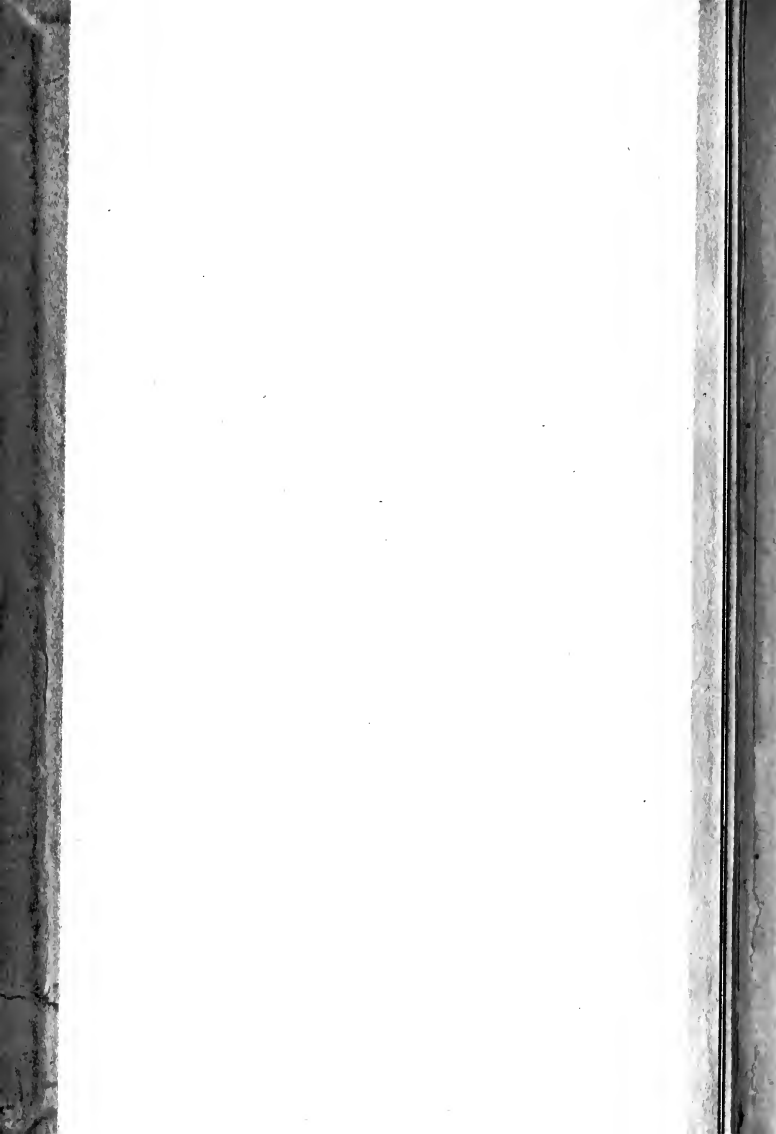

CAMBRIA STEEL

A HANDBOOK OF INFORMATION
RELATING TO

STRUCTURAL STEEL

MANUFACTURED BY THE
CAMBRIA STEEL COMPANY

CONTAINING USEFUL TABLES, RULES,
DATA, AND FORMULÆ FOR
THE USE OF

ENGINEERS, ARCHITECTS,
BUILDERS AND MECHANICS

PREPARED AND COMPILED BY
GEORGE E. THACKRAY, C. E.
SPECIAL ENGINEER, CAMBRIA STEEL CO.

GENERAL OFFICES: PHILADELPHIA, PA. #
WORKS AT JOHNSTOWN, PA.
U. S. A.

2) 1919

Copyright, 1919, by Cambria Steel Company

Price, \$1.50



PREFACE TO TWELFTH EDITION.

This edition introduces much new matter thought useful, and revises, to a considerable extent, the data of the prior edition, to conform to current practice and a wider range of structural products.

The table of steel ingots is greatly amplified by the addition of more sizes and styles.

Cuts and properties of many new sections are introduced, among which are bulb angles, top-guard bulb angles, 3-inch and 4-inch channels for cars, 12-inch ship channels, and some seventeen T-bars of considerable range in dimensions.

Three sizes of rolled steel car stakes are also included.

Drawings and tabulations of standard ship sections including ship channels, bulb angles and one Z-bar hatch section, together with the equal leg and unequal leg angles selected as standards for ship building, which were adopted on November 20, 1918, are now given.

Rolled safety floor plates and buckle plates are newly listed in most convenient sizes.

In view of well-recognized practice, the standard connection angles formerly shown have been superseded by new standards and all tables relating thereto are correspondingly modified.

Additional new tables believed of value have been incorporated. These refer to Flat and Corrugated Steel Sheeting; Roof Truss Dimensions and Stresses; Moments of Inertia of Rectangles; Sizes of Wrought Spikes and Wood Screws; Wire Gauges shown in Combined Table; Decimal Equivalents of Non-Binary Fractions; Square Roots and Cube Roots of Fractions; Weights of Circular Steel Plates; Trigonometrical Formulæ; Squares and Cubes of Numbers and Fractional Intervals; Combinations and Factors of π ; Relations in Circular Segments; Volumes and Surfaces of Solids; Minutes and Seconds expressed in Decimals of a Degree and vice versa; Metric and Customary Measure Conversions, etc.

The tables of weights for various substances and materials have been considerably augmented.

Specifications for Structural and Boiler Steel have undergone slight revision to bring these up to date.

CONTENTS.

	PAGE
General Information.....	VI-X
Sections of I-Beams and Channels.....	2-16
" Angles, Bulb Angles and Top Guard Angles....	17-23
" Hatch Z-Bar and Car Side Stakes.....	23
" T-Bars, Crane Rail and Door Spreader.....	24-26
Method of Increasing Sectional Areas.....	26
Proportions of Standard Beams and Channels.....	27
Diagram for Minimum Standard Beams and Channels....	28, 29
Pressed Steel Car Parts and Car Forgings.....	30, 31
Sizes of Ingots.....	32
Sizes of Squares, Rounds and Flats.....	33
Sizes of Billets, Blooms and Slabs.....	34, 35
Square Billets and Sheet and Tin Bars.....	36
Sizes of Plates and Thin Sheared Sheets.....	37-39
Weights and Dimensions of I-Beams and Channels.....	40-45
" " " Bulb Angles, Top Guard....	45, 46
Weights and Dimensions of T-Bars and Angles.....	47-51
References to Beam Tables, Beams as Girders, Connection Angles and Live Loads for Floors.....	52
Standard Construction Details.....	53-67
Materials and Construction for Fireproof Floors.....	68-77
Notes on Lateral Strength of Beams.....	78-83
Approximate Weights of Various Roof Coverings.....	84
Weights, Dimensions and Data for Steel Sheeting.....	85
Formulae for Dimensions and Stresses of Roof Trusses...	86-89
Buckle Plates and Safety Floor Plates.....	90
Reinforced Concrete Floor Slabs.....	91-93
Limiting Spans and Maximum Loads of Beams and Channels	94-97
Coefficients of Deflection of Beams.....	98, 99
Explanation of Tables of Safe Loads.....	100-105
Tables of Safe Loads for I-Beams and Channels.....	106-123
" Spacing of I-Beams.....	124-135
" Maximum Bending Moments for I-Beams and Chan- nels.....	136, 137
" Safe Loads for Angles.....	138-159
General Formulae for Flexure and Bending Moments.....	160-165
Formulae for Moments of Inertia of Standard Sections....	166, 167
Properties of Various Sections.....	168-175
Explanation of Tables of Properties.....	176-181
Tables of Properties of I-Beams, Channels and Hatch Z-Bar	182-191
" " Bulb Angles, Car Side Stakes and Door Spreader Bar.....	192-195
" " T-Bars and Angles.....	196-209
Moments of Inertia of Rectangles.....	210-213
Properties of Standard T-Rails.....	214
Radii of Gyration for Two Angles Placed Back to Back....	215-217
Strength of Steel Columns or Struts.....	218-221
Example of the Use of Tables on pages 215-217 and 218-221.	222

	PAGE
Explanations of Tables Relating to Steel Columns.....	222, 223
Dimensions and Properties of Plate and Angle Columns...	224-228
Spacing of Channels for Equal Moments of Inertia.....	229
Dimensions and Properties of Latticed Channel Columns..	230, 231
Dimensions and Properties of Plate and Channel Columns.	232-242
Typical Details of Plate Girders, Column Bases, and Steel Columns.....	243
Safe Loads for I-Beam Columns.....	244-247
Safe Loads for Plate and Angle Columns.....	248-267
Safe Loads for Latticed Channel Columns.....	268-271
Lattice Bars and Stay Plates for Latticed Channel Columns	272, 273
Safe Loads for Channel and Plate Columns.....	274-301
Cast Iron Columns.....	302-304
Explanations of Safe Loads for Beam Box Girders and Plate Girders.....	305
Safe Loads for Beam Box Girders.....	306-316
Safe Loads for Plate Girders.....	317-326
Grillage Beams.....	327
Allowable Unit Stresses and Loads in Accordance with Building Laws of Various Cities.....	328-349
Tables and Information Pertaining to Rivets and Pins....	350-361
Weights and Dimensions of Bolts and Nuts.....	362-371
Upset Screw Ends, Eye Bars and Turn Buckles.....	372-378
Right and Left Nuts and Clevises.....	379, 380
Dimensions of Rivet Heads After Driving.....	380
Weights, Dimensions and Safe Loads of Chains.....	381
Bridge Pins, Nuts and Pilot Nuts, and Lateral Pins.....	382, 383
Counter and Lateral Rods.....	383-385
Nails and Spikes.....	386-389
Dimensions, Weights and Properties of Standard Pipe....	390-392
Standard Specifications.....	393-402
Notes and Tables on Wooden Beams and Columns.....	403-423
Specific Gravity and Weight of Various Substances.....	424-433
Standard Gauges and Weights of Sheets and Plates of Various Metals.....	434-443
Square Roots and Cube Roots of Fractions.....	444
Decimal Equivalents of Non-Binary Fractions.....	444, 445
Decimal Parts of Foot and Inch.....	446-450
Weights and Areas of Square and Round Bars.....	451-463
Weights of Circular Plates.....	464-467
Areas of Flat Rolled Steel Bars.....	468-473
Weights of Flat Rolled Strips and Bars.....	474-486
Areas and Circumferences of Circles.....	487-509
Logarithms of Numbers.....	510, 511
Trigonometrical Functions and Formulae.....	512-522
Squares, Cubes, Reciprocals, Square and Cube Roots....	523-547
Values for Combinations of π	548, 549
Mensuration.....	550-556
Relations Between Decimals of a Degree and Minutes and Seconds.....	557
Weights and Measures.....	558-561
Metric Conversion Tables.....	562-590

(For Complete details of Contents, see Index)

GENERAL INFORMATION.

Our products are principally steel, made by the Bessemer or Open Hearth process, as required, and of all qualities from the softest rivet stock to high carbon special spring material.

Our Beams and Channels are made to conform to the American Standards, adopted January, 1896, in which the flanges have a uniform slope of one to six, and the dimensions, proportions and weights are determined by a regular schedule, as shown on the diagrams on pages 28 and 29. The standard proportions of beams and channels are further shown on page 27.

The principal structural angles now made are limited in number to conform to the American Standards, as revised May 21, 1910, and include eight base, or a total of fifty-four sizes for equal leg angles, and nine base, or a total of fifty-seven sizes of unequal leg angles, all varying in thickness by one-sixteenth inch, as shown on pages 17 and 18 and tables herein. It is believed that these standard angles include a sufficient range of sizes to meet all usual structural requirements, but, at the same time, we will continue the manufacture of angles of special sizes and proportions for those who require them, as shown on page 19.

The weights of angles, now given, are those adopted as American Standards in May, 1910.

The standard ship sections adopted November 20, 1918, comprising ship channels, bulb angles and one Z-bar hatch section are now shown and tabulated herein for the first time, and these standards also include certain equal leg and unequal leg angles, which were adopted on the same date, as standards for ship building, all of which are shown and indicated herein by a dagger. Although the drawings of standard structural sections herein show the minimum sizes, the drawings of standard bulb angles and ship channels are made to indicate the sizes of the British standard sections, which form the basis of these ship section standards.

During the time when rolls are being prepared for the new ship channels and bulb angles, our older sections of these shapes shown herein will be furnished, but as the new rolls become ready, the standard sections will be supplied and the prior shapes will be obsolete.

The method of increasing the sectional area of shapes from the minimum or base sizes to intermediate and maximum sizes, is

shown approximately on page 26. For beams and channels the increase from the minimum adds equally to the web thickness and flange width, the weight of the increase being equal to that of a plate of the same depth as the section, and of a thickness equal to the increase of the dimensions stated.

The method of increasing the thickness of angles from the minimum has the effect of adding to the length of the legs, as shown on page 26, so that for intermediate and maximum sizes the legs will be somewhat longer than the minimum or nominal dimensions, except in the cases for which we have finishing grooves. The plates of drawings of sections, pages 2 to 26 inclusive, show the minimum or base sizes of the various shapes, except in cases of standard ship channels and bulb angles as heretofore noted. Sections shown on the plates or lists for which more than one weight is stated can be rolled of different thicknesses to produce the stated weights. Others for which only one weight is given cannot be varied. Each section shown herein is numbered, both in the plates and tables, for convenience in reference and ordering.

I-Beams and Channels should be ordered of weights shown in the tables. Orders and inquiries concerning 12 in. 40 lb., 15 in. 60 lb., and 15 in. 80 lb. I-Beams should also specify these by Section Number.

Orders for angles and plates should specify either the thickness or the weight, but not both.

Orders for universal or edged plates should specify the width and thickness in inches and the length in feet and inches, whereas orders for sheared plates should give all the dimensions in inches.

All weights are stated in pounds per lineal foot of section, except in the table of rails on page 214, in which the weights are given in pounds per yard, as is customary. Weights of rolled sections are calculated on the basis of 489.6 pounds per cubic foot of steel, and 3.4 times the sectional area in square inches equals the weight in pounds per lineal foot. In calculating the weights, areas, and properties of I-Beams, Channels, and Angles for the lists and tables herewith, the fillets and smaller rounded corners were not considered.

The dimensions of all steel material herein are theoretical, as they are subject to customary rolling variations.

Structural Angles, I-Beams and Channels, unless otherwise ordered, will be cut to length with variation not to exceed $\frac{3}{8}$ inch more or less than that specified. For cutting to exact lengths, or with less variation than $\frac{3}{8}$ inch, an extra price will be charged.

All sections shown herein are steel.

**OFFICES FOR SALE OF
CAMBRIA STEEL COMPANY PRODUCTS.**

**GENERAL OFFICES: WIDENER BUILDING,
PHILADELPHIA, PA., U. S. A.**

- ATLANTA.....Candler Building, 129 Peachtree Street.
BOSTON.....Scollay Building, 40 Court Street.
CHICAGO.....McCormick Building, Corner of Michigan
Avenue and Van Buren Street.
CINCINNATI.....Union Trust Building, Corner of Fourth and
Walnut Streets.
CLEVELAND.....Swetland Building, 1010 and 1012 Euclid
Avenue.
DETROIT.....Penobscot Building, 45 Fort Street, West.
NEW YORK.....City Investing Building, 165 Broadway.
PHILADELPHIA.....Widener Building, Chestnut and Juniper
Streets.
PITTSBURGH.....Oliver Building, Smithfield Street.
ST. LOUIS.....Chemical Building, Corner of Eighth and
Olive Streets.
SALT LAKE CITY....Newhouse Building, Corner of Main Street
and Exchange Place.
SAN FRANCISCO....Monadnock Building, 681 Market Street.
SEATTLE.....Colman Building, Corner of First Avenue
and Marion Street.
WASHINGTON, D. C..Woodward Building, Corner of Fifteenth
and H Streets, N. W.

**WORKS AT
JOHNSTOWN, PA.
U. S. A.**

CAMBRIA STEEL COMPANY PRODUCTS.

STRUCTURAL STEEL WORK.

Finished Steel Work for Buildings, including Beams, Girders, Columns, Roof Trusses, etc., fitted complete and ready for erection.

STEEL CARS.

Gondola, Hopper-Gondola, Hopper, Flat, Tank, Mine, etc., Underframes and Trucks.

Freight, Passenger, Electric and Industrial Car Wheels. Draft Gears, Forged and Pressed Steel Car Parts.

STEEL RAILS.

Steel T-Rails, 12 lbs. to 150 lbs. per yard.

Angle, Plain and Special Type Splice Bars.

Standard and Special Track Bolts and Nuts.

For detailed information, see Rail and Splice Catalogue.

STEEL AXLES.

Passenger Car, Freight Car, Tender Truck, Engine Truck, Driving, Electric Car, Street Car, Mine Car, etc.

CRANK PINS, PISTON RODS, BRIDGE PINS.

Made to any requirement.

MACHINE BOLTS, NUTS, RIVETS, AND PIPE OR TANK BANDS WITH ROLLED THREADS.

FORGINGS.

Axles, Crank Pins, Piston Rods and Forgings in general furnished of carbon steel, annealed, or treated by our Coffin toughening process (patented) as specified.

Crank Pins and Piston Rods also furnished oil-tempered and annealed; other small Forgings will be, if desired.

For small car forgings and pressed steel parts, see list on pages 30 and 31 herein.

ANNULAR ROLLED SECTIONS.

Car Wheels, Crane Track Wheels, Blanks for Cylindrical Wheels, Gears, Sprockets, Band Wheel Flanges, Pipe Flanges, Bevel Rollers, and Automobile Fly Wheels, etc.

MERCHANT BAR STEEL.

Including Tire, Toe Calk, Machinery, Automobile Spring, Carriage Spring, Baby Carriage Spring, Railroad Spring, Hoe, Rake, Fork, Forging, Bolt, Rivet, etc.
Special Sections.
Automobile and Motor Truck Rim Sections.

STEEL SPECIALTIES.

Mine Ties, Fence Posts, Reinforcing Bars, etc.

AGRICULTURAL STEEL AND SHAPES.

Finger Bars, Knife Backs, Rake Teeth, Bundle Carrier Teeth, Tedder Forks and Springs, Spring Harrow Teeth, Harrow (Drag) Teeth, Seat Springs, etc.

PLOW STEEL.

Bars and Slabs (Pen and Pernot), Flat Plow Shapes, Digger Blades, Hammered Lay, Rolled Lay, etc.

COLD ROLLED AND COLD DRAWN STEEL.

Rounds, Squares, Hexagons, Flats, Shafting and Special Shapes.

STEEL DISCS WITH ROLLED BEVEL.

10" to 20" diameter dished for Harrows, Drills, Cultivators, etc.
23" to 28 $\frac{1}{4}$ " diameter dished for Plows.
8" to 26" diameter flat for Rolling Coulters.

PRESSED STEEL SEATS FOR AGRICULTURAL IMPLEMENTS.**WIRE RODS, WIRE AND WIRE PRODUCTS.**

Wire Rods. Bolt, Screw and Rivet Wire.
Bright and Annealed Wire.
Galvanized Coiled Steel Spring Wire.
Barbed Wire, Galvanized or Painted.
Wire Nails, Bright or Galvanized.
Cement Coated Nails.
Fence Wire and Wire Fence. Fence and Poultry Netting Staples.
Bale Ties—Single Loop.

NON-STEEL PRODUCTS.

Cinder, Slag and Coal Derivatives.
Limestone Ballast and Screenings.

FOR PRODUCTS NOT LISTED HEREIN, SEE SPECIAL CATALOGUES.

SECTIONS
OF
STRUCTURAL STEEL SHAPES
MANUFACTURED BY
CAMBRIA STEEL COMPANY

STANDARD BEAMS.

B. 5

WT. 5.5, 6.5 AND 7.5 LBS.

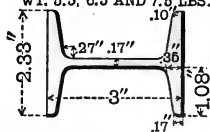

B. 9

WT. 7.5, 8.5, 9.5 AND 10.5 LBS.

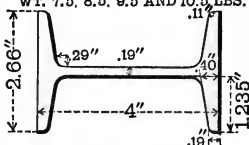

B. 13

WT. 9.75, 12.25 AND 14.75 LBS.

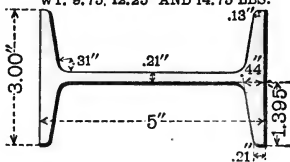

B. 17

WT. 12.25, 14.75 AND 17.25 LBS.

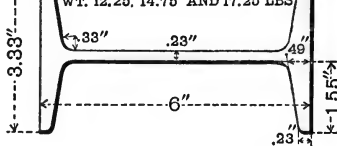

B. 21

WT. 15, 17.5 AND 20 LBS.

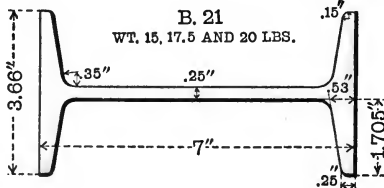

STANDARD BEAMS.

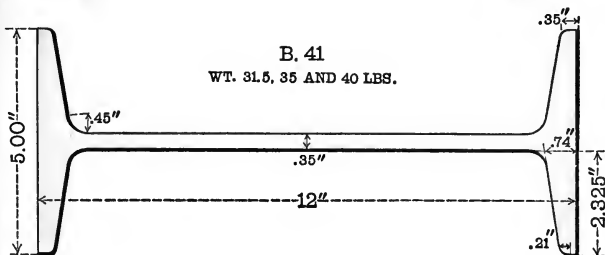
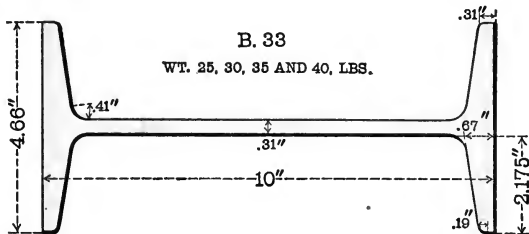
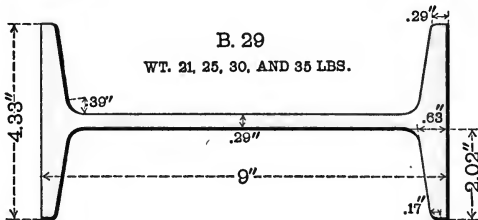
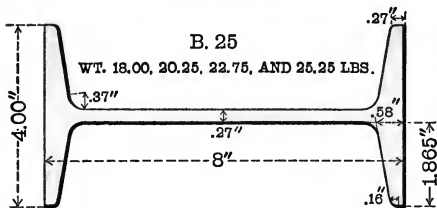

BEAMS.

SPECIAL 12" BEAM.

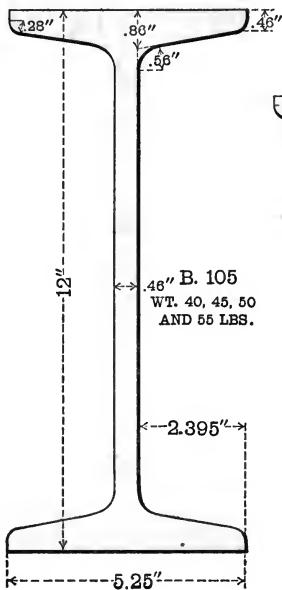

STANDARD 15" BEAM.

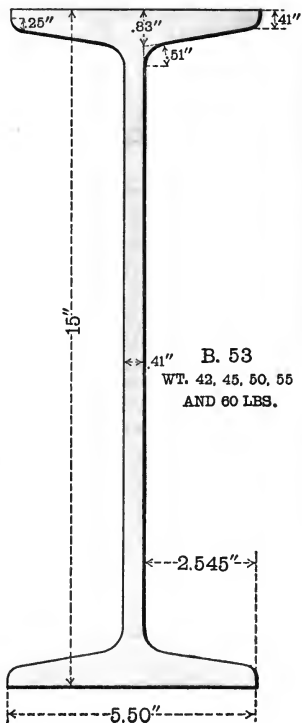

SPECIAL BEAMS.

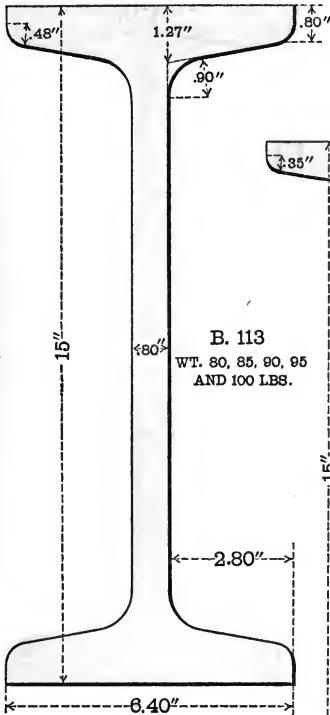

B. 113
 WT. 80, 85, 90, 95
 AND 100 LBS.

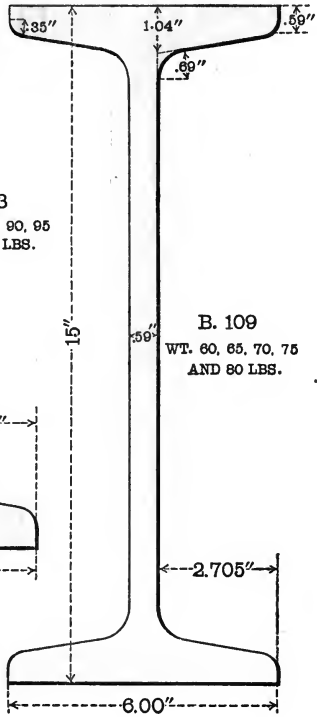

B. 109
 WT. 60, 65, 70, 75
 AND 80 LBS.

STANDARD BEAMS.

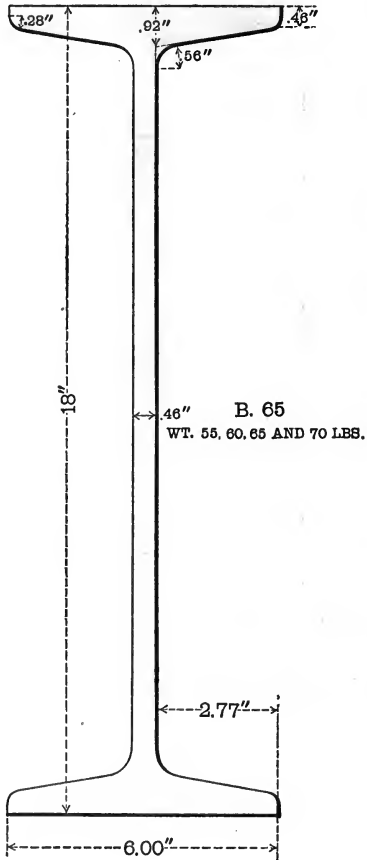

BEAMS.

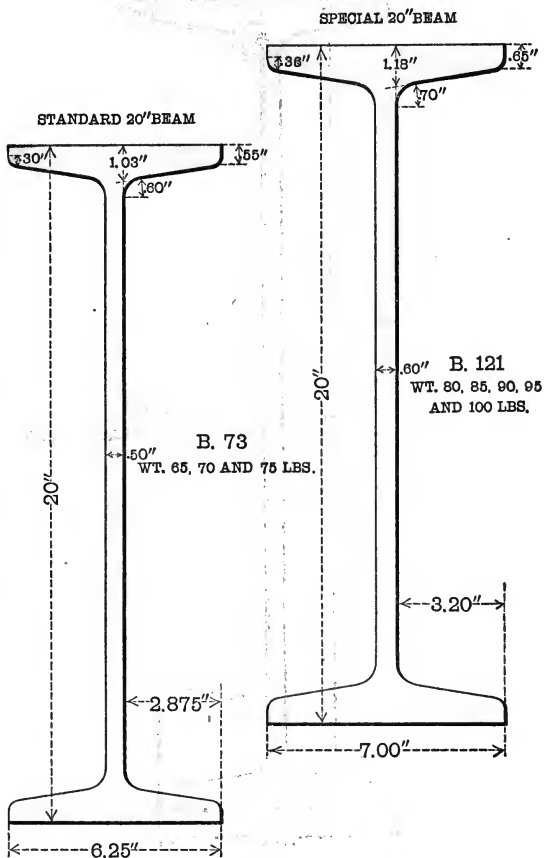

STANDARD BEAMS.

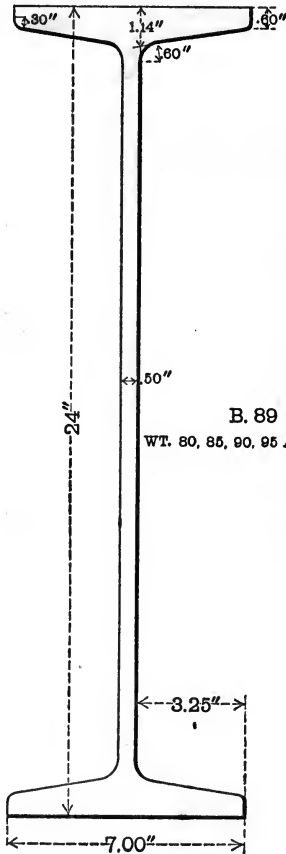

B. 89

WT. 80, 85, 90, 95 AND 100 LBS.

SPECIAL BEAMS.

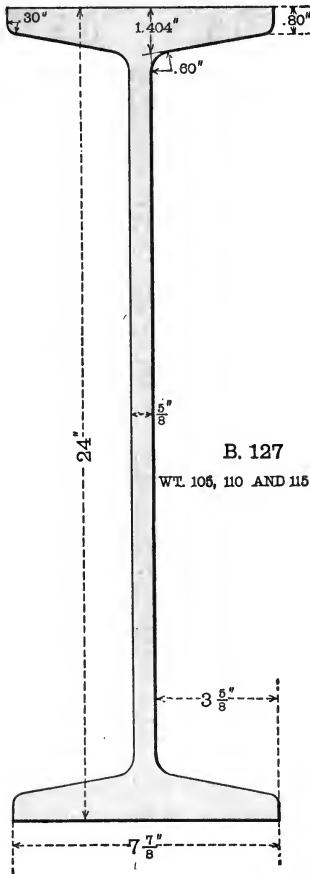

B. 127

WT. 106, 110 AND 115 LBS.

STANDARD CHANNELS.

C. 5

WT. 4, 5 AND 6 LBS.

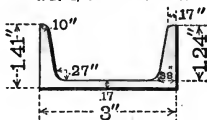

C. 9

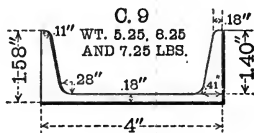
WT. 5.25, 6.25
AND 7.25 LBS.

C. 13

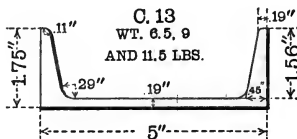
WT. 6.5, 9
AND 11.5 LBS.

C. 17

WT. 8, 10.5, 13 AND 15.5 LBS.

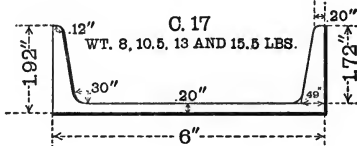

C. 21

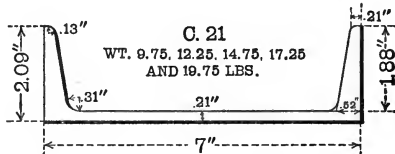
WT. 9.75, 12.25, 14.75, 17.25
AND 19.75 LBS.

C. 25

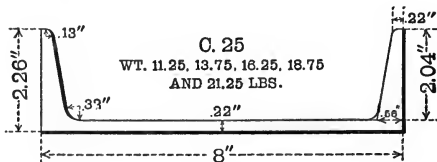
WT. 11.25, 13.75, 16.25, 18.75
AND 21.25 LBS.

STANDARD CHANNELS.

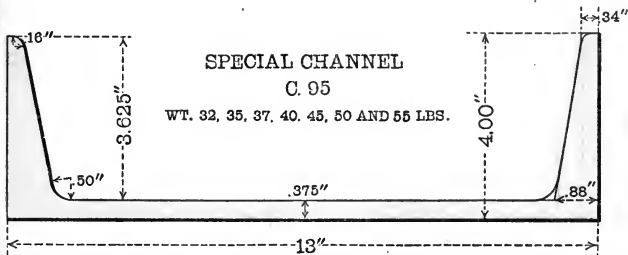
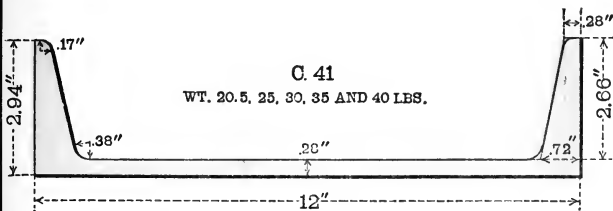
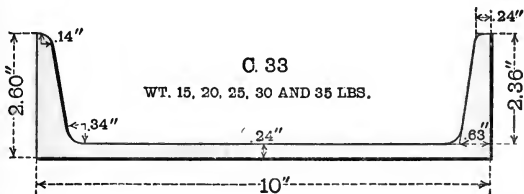
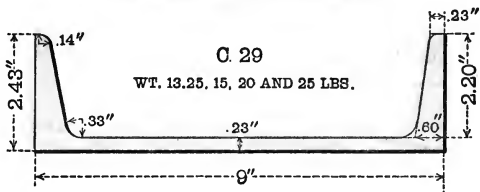

CHANNELS.

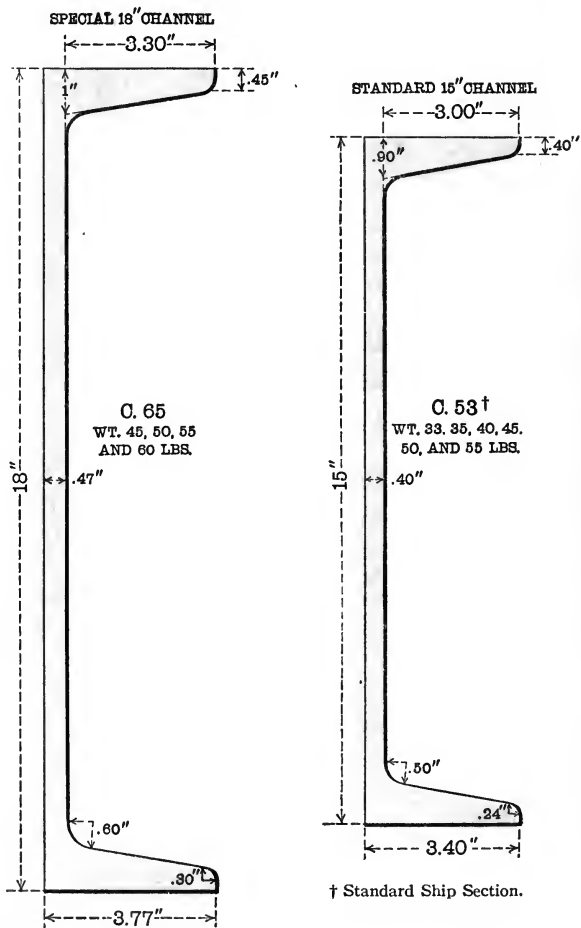

SPECIAL AND SHIP CHANNELS.

BRAKE BEAM CHANNEL.

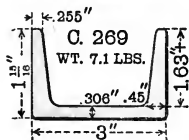

CAR CHANNEL.

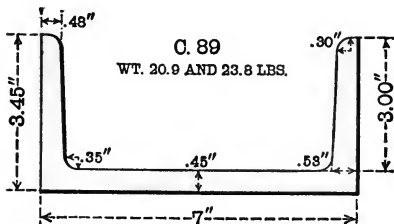
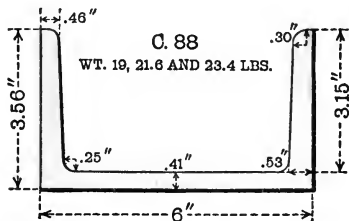
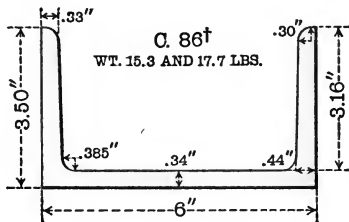
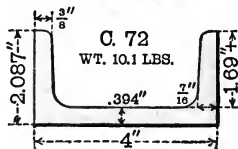

† Standard Ship Channel.

SHIP CHANNELS.

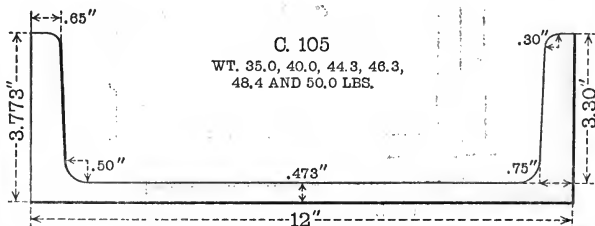
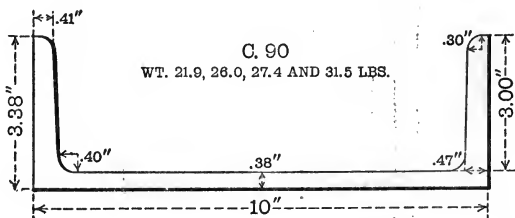
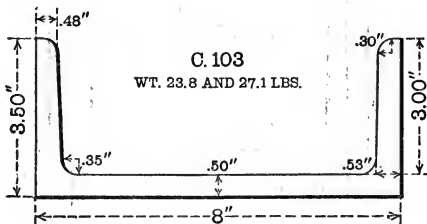
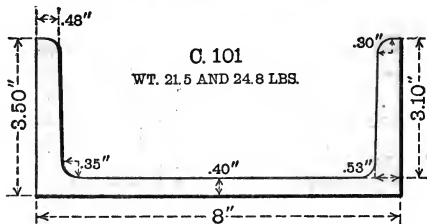

STANDARD SHIP CHANNELS.

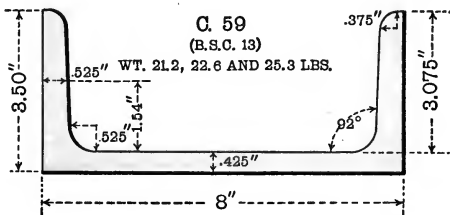
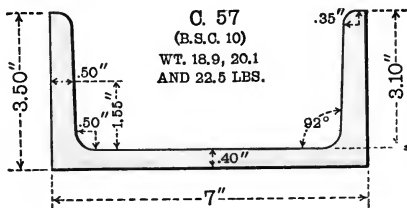
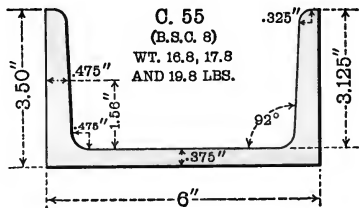

STANDARD SHIP CHANNELS.

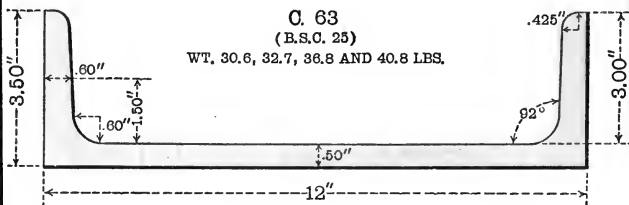
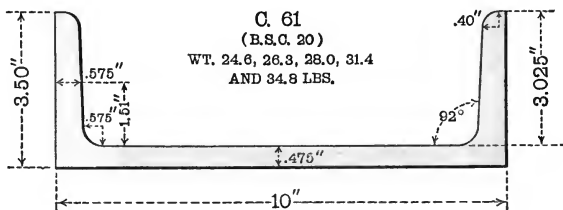
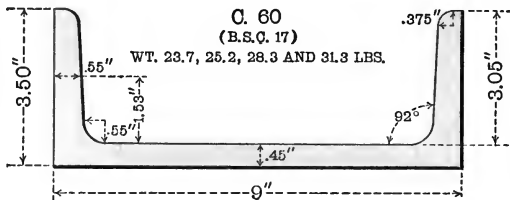

STANDARD ANGLES WITH EQUAL LEGS.

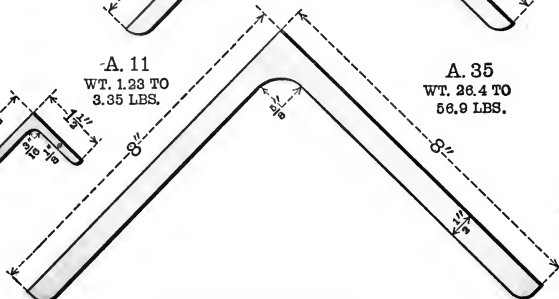
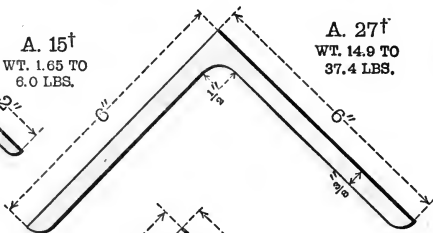
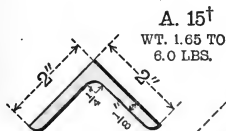
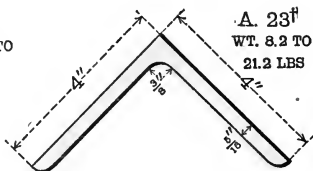
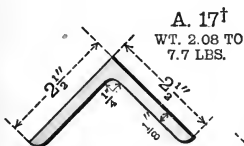
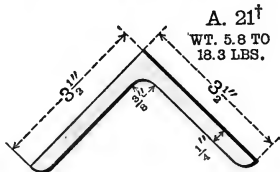
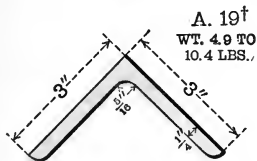

† Standard Ship Section.

STANDARD ANGLES WITH UNEQUAL LEGS.

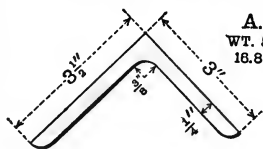

A. 97†
WT. 5.4 TO
18.8 LBS.

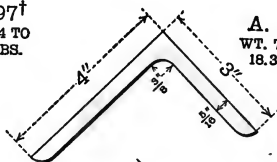

A. 99†
WT. 7.2 TO
18.3 LBS.

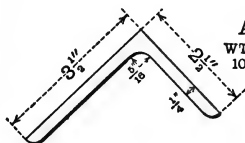

A. 95
WT. 4.9 TO
10.4 LBS.

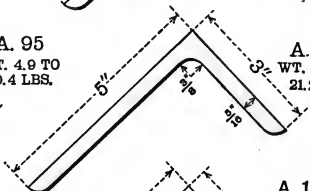

A. 101†
WT. 8.2 TO
21.2 LBS.

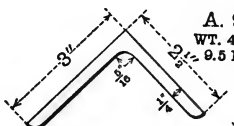

A. 93†
WT. 4.5 TO
9.5 LBS.

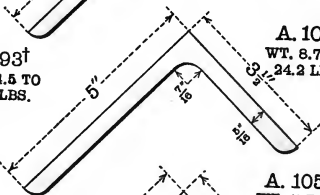

A. 103
WT. 8.7 TO
24.2 LBS.

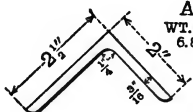

A. 91
WT. 2.75 TO
6.8 LBS.

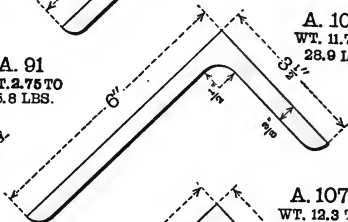

A. 105†
WT. 11.7 TO
28.9 LBS.

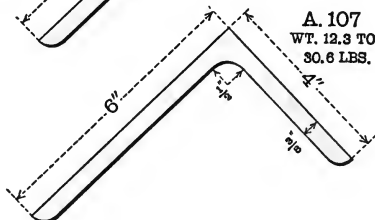

A. 107
WT. 12.3 TO
30.6 LBS.

† Standard Ship Section.

SPECIAL ANGLES.

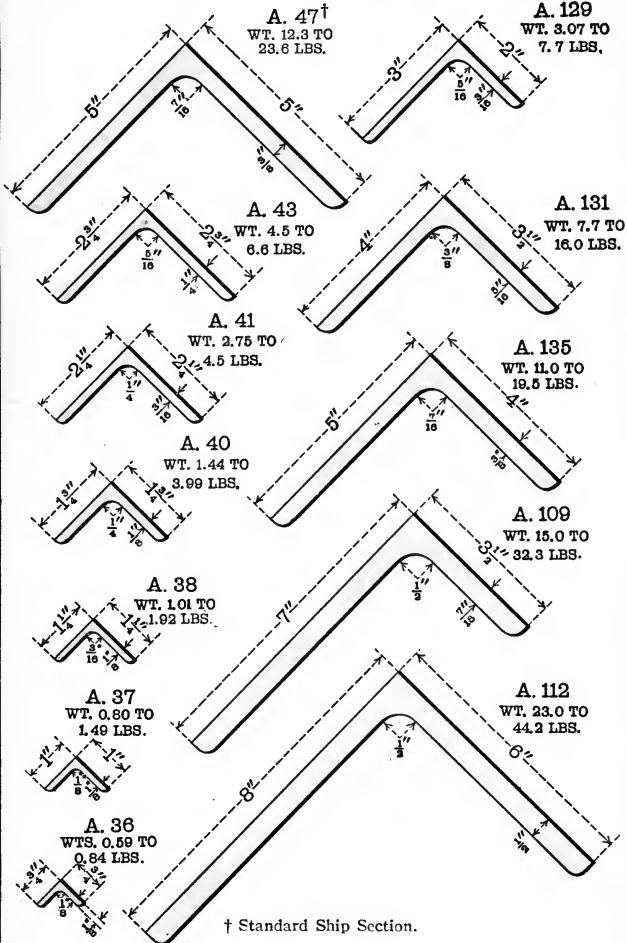

BULB ANGLES.
TOP GUARD ANGLES.

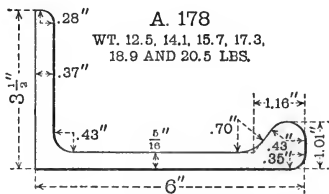
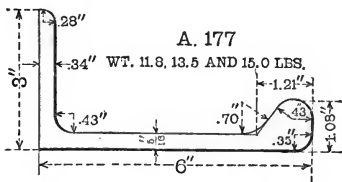
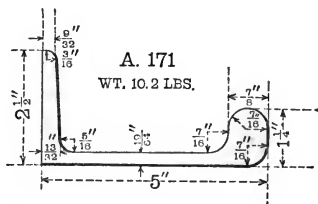
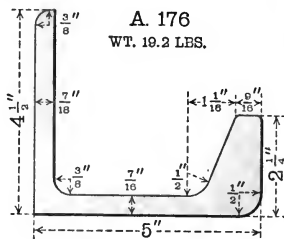
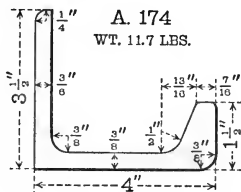

BULB ANGLES.

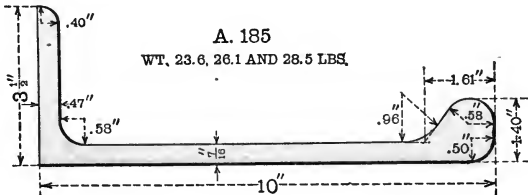
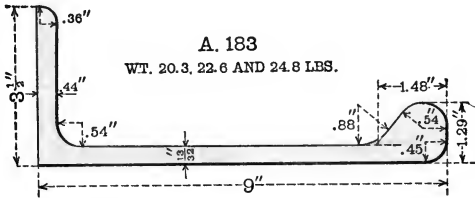
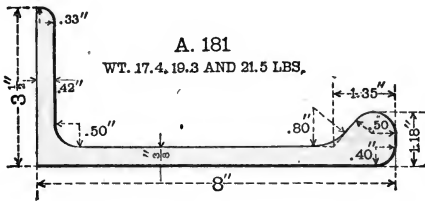
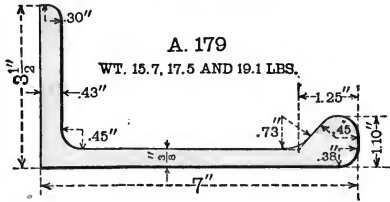

STANDARD BULB ANGLES.

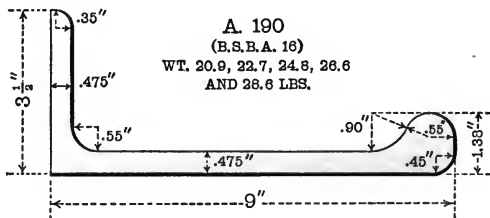
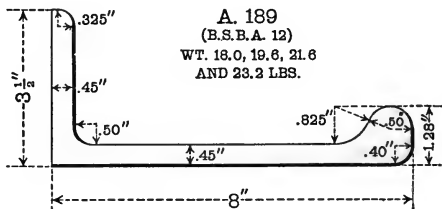
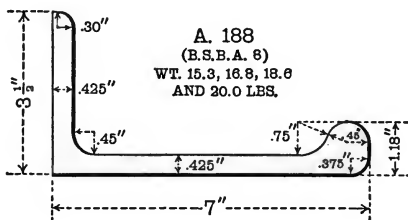
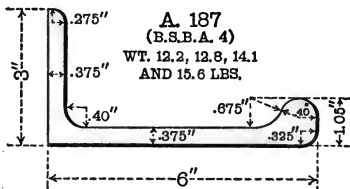

STANDARD BULB ANGLES.

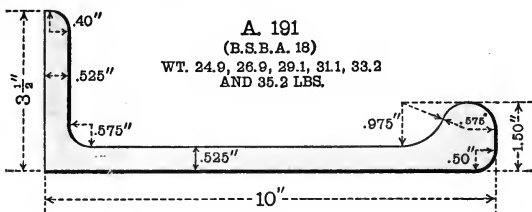
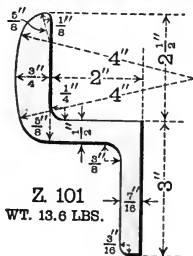
Z-BAR HATCH SECTION.
STANDARD SHIP SECTION.

CAR SIDE STAKE SECTIONS.

L. 2
WT. 7.2, 8.7 AND 11.7 LBS.

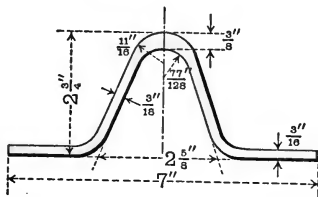

T-BARS WITH EQUAL LEGS.

T. 5

WT. .89 LBS.

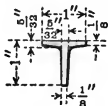

T. 183

WT. 1.51 LBS.

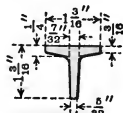

T. 181

WT. 1.37 LBS.

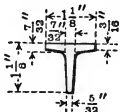

T. 187

WT. 1.60 LBS.

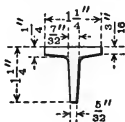

T. 191

WT. 1.94 LBS.

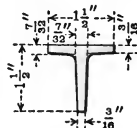

T. 188

WT. 1.70 LBS.

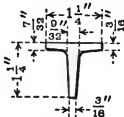

T. 193

WT. 2.47 LBS.

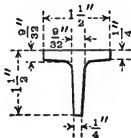

T. 37

WT. 3.56 LBS.

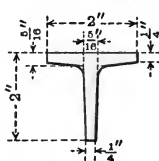

T. 194

WT. 3.09 LBS.

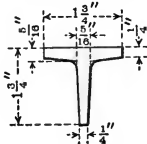

T-BARS WITH EQUAL LEGS.

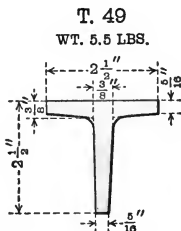
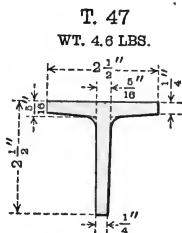
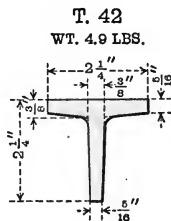
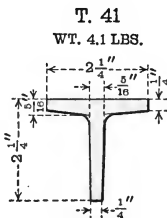
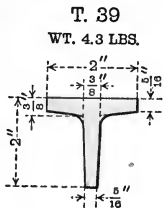

T-BARS WITH UNEQUAL LEGS.

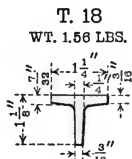
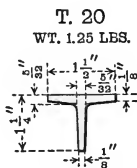
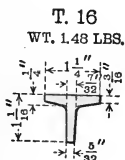

DOOR-SPREADER.

C. 250
WT. 19.8 LBS.

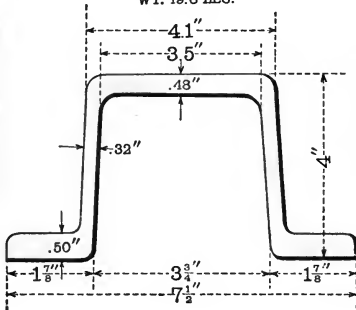

CRANE RAIL.

NQ. 539
WT. 50 LBS. (PER FOOT)

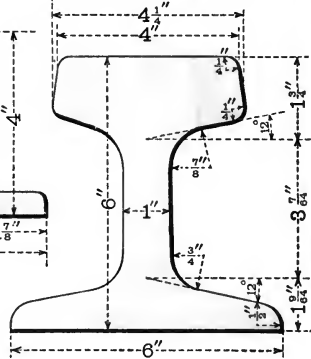

METHOD OF INCREASING SECTIONAL AREA.

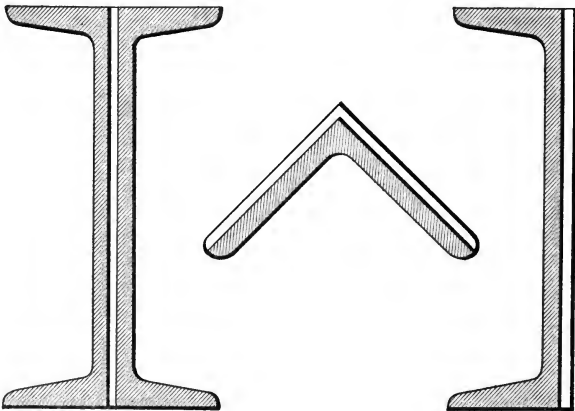

STANDARD BEAMS AND CHANNELS.

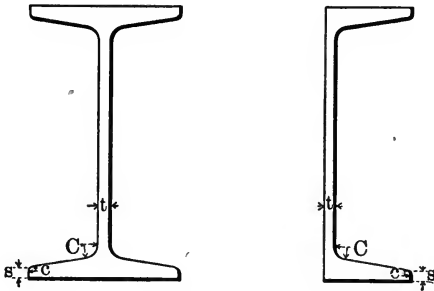

The following data are common to all Standard I-Beams and Channels, with the exceptions stated:

$$c = \frac{6}{10} \text{ Minimum Web.}$$

$$C = \text{Minimum Web} + \frac{1}{10} \text{ inch.}$$

s = Minimum Thickness of Web = t Minimum for all Channels and Beams, except 20" I and 24" I.

For 20" Standard I, $s = .55''$, t Minimum = $.50''$.

For 24" Standard I, $s = .60''$, t Minimum = $.50''$.

The Slope of Flange of all Standard Beams and Channels is $16\frac{2}{3}\%$
 $= 9^\circ - 27' - 44'' = 2''$ per foot.

STANDARD BEAMS.

The following Formulas and Diagram relate to the Properties of I-Beams:

$$\text{Weight per foot} = \text{Area} \times 3.4.$$

$$\text{Area} = td + 2s(b-t) + \frac{(b-t)^2}{12}.$$

$$\text{Section Modulus} = s = \frac{2I}{d}$$

$$\text{Slope of Flange} = g = \frac{h-1}{b-t} = \frac{1}{6} \text{ for Standard Beams.}$$

$I =$ Moment of Inertia, Neutral Axis (1-1) parallel to flange.

$$I = \frac{1}{12} [bd^3 - 4g(h^4 - 1^4)] \text{ or } \frac{1}{12} (h^4 - 1^4) \text{ for Standard Beams.}$$

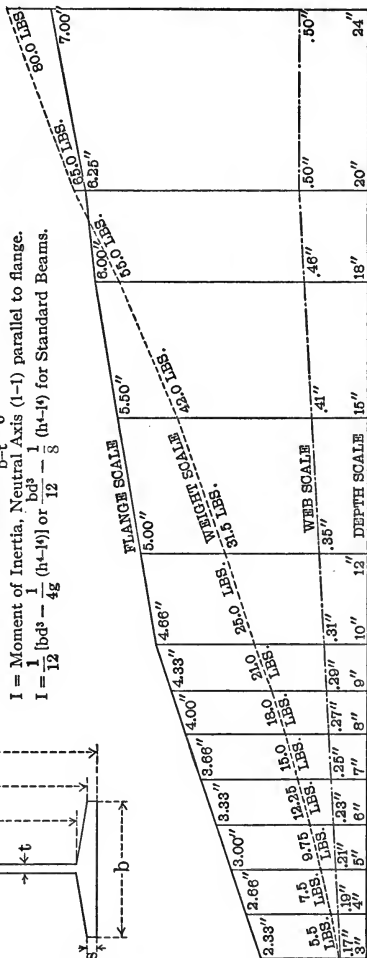
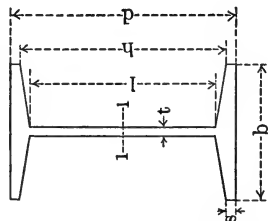

DIAGRAM FOR MINIMUM STANDARD BEAMS.

STANDARD CHANNELS

The following Formulas and Diagram relate to the Properties of Channels:

Weight per foot = Area X 3.4.

Area = $td + 2s(b-t) + \frac{(b-t)^2}{6}$.

Section Modulus = $s = \frac{2I}{d}$.

Slope of Flange = $g = \frac{h-1}{2(b-t)}$, or $\frac{1}{6}$ for Standard Channels.

I = Moment of Inertia, Neutral Axis (1-1) parallel to flange.

$I = \frac{1}{12} [bd^3 - 8g(h-1)^3]$ or $\frac{bd^3}{12} - \frac{h^3-1^3}{16}$ for Standard Channels.

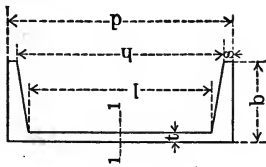

FLANGE SCALE	1.41"	1.68"	1.75"	1.92"	2.09"	2.26"	2.43"	2.60"	2.84"	3.40"
WEB SCALE	17"	18"	6.5	8.0	9.75	11.25	13.25	15.0	20.5	35.0
WEIGHT SCALE	4.0 LBS	6.26 LBS	19"	20"	.21"	.23"	.23"	.24"	.28"	.40"
DEPTH SCALE	3"	4"	5"	6"	7"	8"	9"	10"	12"	15"

DIAGRAM FOR MINIMUM STANDARD CHANNELS.

PRESSED STEEL OR FLANGED CAR PARTS.

Truck Bolsters.	Drop Doors.
Side Sills.	Longitudinal Ridge Stiffeners.
Center Sills.	Cross Ridge Supports.
End Sills.	Cross Body Ties.
Draft Sills.	Diagonal Braces.
Draft Lugs.	Door Spreaders.
Sub-Side Sills.	Air Reservoir Supports.
Side Stakes.	Push Pole Pockets.
End Stakes.	Body Corner Caps.
Corner Stakes.	Door Hinge Butts.
Outside Hopper Plates.	Bolster Diaphragms.
Inside Hopper Plates.	Wheel Diaphragms.
Side Plates.	Cross Bearer Diaphragms.
End Plates.	Hopper Diaphragms.
Floor Plates.	Door Diaphragms.
Longitudinal Ridge Plates.	Center Diaphragms.
Cross-Ridge Plates.	Center Sill Diaphragms.
End-Plate Stiffeners.	Bolster Center Diaphragms.
Hopper Doors.	

FORGINGS FOR CAR WORK.

Air Cylinder Push Rod.	Chain Hook.
Air Reservoir Release Rod.	Chain Link.
Arch Bars.	Corner Bands
Bottom Follower Guide.	Column Bolt Nut Lock.
Bottom Side Bearing.	Coupler Yokes.
Bracket for Brake Shaft.	Coupling Links.
Brake Beam Hanger.	Coupling Pins.
Brake Beam Hanger Carrier.	Cylinder Lever Connecting Rod.
Brake Connection Rod Carrier.	Cylinder Lever Fulcrum.
Brake Levers.	Door Chain U-Bolt.
Brake Mast.	Door Hinge.
Brake Mast Yoke.	Door Hinge Pins.
Brake Pins.	Door Operating Lever.
Brake Rods with Clevises.	
Brake Step Bracket.	

FORGINGS FOR CAR WORK (CONTINUED).

Door Safety Chain Support.	Lever Guides.
Door Shaft Pawl.	Live Truck Lever Guide.
Door Tumbling Link.	Main Follower Sprocket Wheel
Draft Cylinder Support.	Shaft.
Draw Bar Carrier.	Operating Shaft.
Draw Bar Liner.	Operating Shaft Cam.
Draw Bar Yoke.	Operating Shaft Cam Stops.
Door Clevises.	Operating Ratchet Pawl.
Door Tumbling Lever.	Operating Ratchet Pawl Guard.
End Sill Pipe Clamp.	Pipe Clamp.
Eye-Bolts.	Pipe Clamp and Support.
Floating Lever.	Pushrod Carrier.
Floating Lever Carrier.	Ratchet Wrench Dog.
Floating Lever Connecting	Roping Staple.
Rod.	Sheave and Link Pin.
Floating Lever Fulcrum.	Side Stake Pockets.
Grab Irons.	Sill Step Suspension Spring.
Hand Brake Lever Carrier.	Suspension Spring.
Hand Brake Lever Fulcrum.	Suspension Spring Hanger.
Hand Brake Lever Guide.	Tie Bars with Upset Ends or
Hand Brake Rod.	Plain.
Hand Brake Rod Guide.	Top Body Tie Angle.
Hand Brake Rod Stop.	Top Side Bearing.
Hand Brake Rod with Threaded	Truck and Body Center Plates.
Connection for Malleable	Truck Bolster Tie Bar.
Stop.	Truck Door Stop, Chain
Hook Bolts.	Clamp Hooks.
Inside Body Step.	Truck Levers.
Journal Bearing Wedges.	Truck Side Bearing.
King Bolt.	U-Bolt Clamp for Angle Valve.
King Pin Support.	Uncoupling Lever.

A large variety of small forgings not listed above can be furnished to order.

STEEL INGOTS.

Style of Mold (See Foot-note)	Mold Dimensions			Approximate Ingot Weight	Grade
	Bottom	Top	Height		
	Inches	Inches	Ft.-Ins.	Pounds	
O,X.	20 $\frac{1}{8}$ x 23 $\frac{3}{8}$	18 $\frac{1}{2}$ x 20 $\frac{1}{2}$	6-1 $\frac{1}{2}$	7300	Open Hearth or Bessemer
O,F.	21 x 21	19 x 19	6-3	7300	
B,F.	21 x 21	19 x 19	6-3	7100	
I,F,S.	21 x 21	25 x 25	6-0	8800	Open Hearth
O,F.	20 x 22 $\frac{1}{2}$	18 x 20 $\frac{1}{2}$	6-5 $\frac{1}{2}$	7300	
I,F,S.	16 $\frac{1}{2}$ x 20 $\frac{1}{4}$	20 $\frac{1}{2}$ x 23 $\frac{3}{4}$	6-2	7800	"
*I,F,S.	16 $\frac{1}{2}$ x 20 $\frac{1}{4}$	20 $\frac{1}{2}$ x 23 $\frac{3}{4}$	6-2	7900	"
O,F.	22 $\frac{3}{4}$ x 26	20 $\frac{3}{4}$ x 24	6-5 $\frac{1}{2}$	10400	"
O,F.	25 $\frac{1}{2}$ x 30	23 $\frac{1}{2}$ x 28 $\frac{1}{2}$	6-2	13500	"
O,F.	30 x 30	28 x 28	6-2	15500	"
I,F,S.	27 x 27	30 x 30	6-0	16300	"
O,X.	25 x 36	23 x 35	6-0	14000	"
O,X.	25 $\frac{1}{2}$ x 40	22 $\frac{5}{8}$ x 38 $\frac{1}{2}$	6-2	15500	"
O,X.	26 x 53	23 x 51 $\frac{1}{2}$	6-2	20500	"
O,X.	25 $\frac{1}{2}$ x 56	23 $\frac{3}{4}$ x 54 $\frac{1}{2}$	6-3	25500	"
O,F.	32 $\frac{1}{2}$ x 36	30 $\frac{1}{2}$ x 35	6-0	19500	"
I,V.	26 x 30	30 x 34	6-2	18600	"
O,F.	30 $\frac{1}{2}$ x 30 $\frac{1}{2}$	28 $\frac{1}{2}$ x 28 $\frac{1}{2}$	8-0	20400	"
O,F.	32 $\frac{1}{4}$ x 38	30 $\frac{1}{4}$ x 36	8-0	25000	"
O,F,X.	32 x 52 $\frac{1}{2}$	29 $\frac{1}{2}$ x 50	8-0	35000	"
O,X.	32 x 56	30 x 54	6-3	30000	"
I,B,F,S.	21 x 21	25 x 25	6-0	10200	"
I,B,F,S.	26 x 26	30 x 30	6-0	15700	"
C,G.	22 $\frac{1}{2}$ diam.	20 diam.	18-0	23800	"
C,G.	26 "	23 $\frac{1}{2}$ "	18-0	29100	"
C,G.	28 $\frac{1}{4}$ "	26 "	18-0	33800	"
C,G.	31 $\frac{1}{4}$ "	29 "	18-0	41800	"
C,G.	38 "	34 "	18-0	55000	"
G,R.	18 x 30	16 x 28	18-0	27500	"
B,F.	22 x 38	20 x 36	18-0	36500	"
K,G,S.	16 $\frac{3}{8}$ { short diam.	19 { short diam.	8-4	8300	"

B = Bottle-Necked; C = Circular; F = Ingot Sides Flat; G = Corrugated; I = Inverted; K = Octagonal; O = Open Top; R = Rectangular or Slab Style; V = Ingot Sides Concave; X = Ingot Sides Rounded or Convex; S = With Sinkhead; * = Irregular Taper.

Sizes of Hot and Cold Ingots will vary slightly from above dimensions.

STEEL SQUARES.

All sizes from $\frac{3}{16}$ " to $2\frac{1}{16}$ " increasing by $\frac{1}{64}$ "
 All sizes from $2\frac{1}{16}$ " to $3\frac{3}{8}$ " increasing by $\frac{1}{32}$ "
 All sizes from $3\frac{1}{2}$ " to $5\frac{1}{2}$ " increasing by $\frac{1}{8}$ "
 Plinished squares from $\frac{7}{32}$ " to $2\frac{1}{2}$ "

STEEL HAND ROUNDS.

All sizes from $1\frac{1}{8}$ " to $2\frac{7}{8}$ " increasing by $\frac{1}{64}$ "
 All sizes from $2\frac{7}{8}$ " to $3\frac{3}{16}$ " increasing by $\frac{1}{16}$ "
 All sizes from $3\frac{1}{4}$ " to $7\frac{1}{4}$ " increasing by $\frac{1}{8}$ "
 All sizes from $7\frac{1}{4}$ " to 8 " increasing by $\frac{1}{4}$ "

STEEL GUIDE ROUNDS.

All sizes from $\frac{1}{4}$ " to $2\frac{5}{16}$ " increasing by $\frac{1}{64}$ "

LARGE STEEL ROUNDS.

DIAMETER Inches	MINIMUM LENGTHS Sheared with Rough Ends. Inches	MAXIMUM LENGTH Feet
11	6 to 36	25
15	6 to 36	10 $\frac{1}{2}$
16	6 to 36	9 $\frac{1}{2}$

Other lengths shorter than maximum can only be furnished by special arrangement.

REGULAR FLATS.

WIDTH Inches	THICKNESS. Inches	WIDTH Inches	THICKNESS Inches
$\frac{1}{4}$ to 1	$\frac{3}{16}$ to $\frac{9}{16}$	$2\frac{1}{4}$ to 3	$\frac{3}{16}$ to $2\frac{1}{4}$
1 to $1\frac{1}{8}$	$\frac{3}{16}$ to $\frac{3}{4}$	3 to 4	$\frac{3}{16}$ to $2\frac{3}{4}$
$1\frac{1}{8}$ to $1\frac{1}{2}$	$\frac{3}{16}$ to $\frac{7}{8}$	4 to $4\frac{1}{2}$	$\frac{3}{16}$ to $1\frac{1}{2}$
$1\frac{1}{2}$ to $2\frac{1}{4}$	$\frac{3}{16}$ to $1\frac{1}{4}$	$4\frac{1}{2}$ to 6	$\frac{3}{16}$ to $2\frac{3}{16}$

Variation for intermediate widths less than $1'' = \frac{1}{64}''$.

Variation for intermediate widths over $1'' = \frac{1}{16}''$, or less by special arrangement.

THIN FLATS OR LIGHT BANDS.

WIDTH	THICKNESS
$\frac{3}{8}''$ to $\frac{1}{2}''$ increasing by $\frac{1}{16}''$	$\frac{1}{8}''$ (.125'') to $\frac{5}{32}''$ (.156'')
$\frac{1}{2}''$ to $12''$ increasing by $\frac{1}{16}''$	$\frac{1}{16}''$ (.063'') to $\frac{5}{32}''$ (.156'')

MAXIMUM LENGTHS OF

Thickness in Inches.	WIDTH IN INCHES.																					
	4½	5	5½	6	7	8	9	10	11	12	13	14	15	16	17	18	19	20	21	22	23	
	LENGTH IN FEET.																					
2					10	30	30	30	30	30												
2½				10	30	30	30	30	30	30	30	30	30	30	30	30	30	30	30	30	30	
3				30	30	30	30	30	30	30	30	30	30	30	30	30	30	30	30	30	30	
3½				30	30	30	30	30	30	30	30	30	30	30	30	30	30	30	30	30	30	
4	30	30	30	30	30	30	30	30	30	30	30	30	30	30	30	30	30	30	30	30	30	
4½	30	30	30	30	30	30	30	30	30	30	30	30	30	30	30	30	30	30	30	30	30	
5		30	30	30	30	30	30	30	30	30	30	30	30	30	30	30	30	30	30	30	30	
5½			30	30	30	30	30	30	30	30	30	30	30	30	30	30	30	30	30	30	30	
6				30	30	30	30	30	30	30	30	30	30	30	30	30	30	30	30	30	30	
7					30	30	30	30	30	30	30	30	30	30	30	30	30	30	30	30	28	
8						30	30	30	30	30	30	30	30	30	30	30	30	30	28	27	26	25
9							30	30	30	30	30	30	30	30	30	30	30	25	24	23	22	
10								30	30	30	30	30	30	30	30	30	30	23	21	20	20	
11									30	30	30	30	30	30	30	29	28	20	19	19	18	
12										30	30	30	30	30	28	27	25	19	18	17	16	
13											30	30	30	28	26	25	23	17	16	16	15	
14												30	28	26	24	23	22	16	15	14	14	
15													26	24	23	21	20	15	14	13	13	
16														22	21	20	19	14	13	13	12	
17															20	19	18	15	13	12	12	
18																18	17	12	12	11	11	
19																	16	12	12	11	11	
20																		11	10	10	10	
21																			10	10	9	
22																				9	9	

Minimum Length for sizes included by heavy lines = 1½ feet.

Minimum Length other sizes = 3 feet.

Under certain conditions other sizes than those listed

BILLETS, BLOOMS AND SLABS.

WIDTH IN INCHES.																				Thickness in Inches.		
24	25	26	27	28	29	30	31	32	33	34	35	36	37	45	46	47	48	49	50		51	
LENGTH IN FEET.																						
30	30	30	30	30	30	30	30	30	30	30	30	30	30	30	30	30	30	30	30	30	2	
30	30	30	30	30	30	30	30	30	29	29	30	29	28	27	30	30	29	28	27	27	30	2½
30	30	30	30	30	28	27	27	26	25	30	25	24	24	30	30	25	25	24	24	28	4	
30	30	30	30	30	25	24	24	23	22	30	22	22	21	30	30	22	22	21	21	25	4½	
30	30	30	30	30	23	22	21	20	20	30	20	19	19	30	30	20	19	19	19	22	5	
30	30	30	30	29	21	20	19	19	18	30	18	18	17	28	28	18	18	17	17	20	5½	
30	30	29	28	27	19	18	18	17	16	27	17	16	16	26	25	16	16	16	16	18	6	
27	26	25	24	23	16	15	15	14	14	23	14	14	13	22	21	14	14	13	13	16	7	
24	23	22	21	20	14	13	13	13	12	20	12	12	12	19	19	12	12	12	12	14	8	
21	20	19	19	18	12	12	11	11	11	18	11	11	10	17	17	11	11	10	10	12	9	
19	18	17	17	16	11	11	10	10	10	16	10	9	9	15	15	10	10	9	9	11	10	
17	16	16	15	15	10	10	9	9	9	14	9	9	8	14	14	9	9	8	8	10	11	
15	15	14	14	13	9	9	9	8	8	13	8	8	8	13	12	8	8	8	8	9	12	
14	13	13	13	12	8	8	8	8	7	12	7	7	7	12	11	7	7	7	7	8	13	
13	13	12	12	11	8	8	7	7	7	11	7	7	6	11	11	7	7	6	6	8	14	
12	12	11	11	11	7	7	7	7	6	11	6	6	6	10	10	6	6	6	6	7	15	
12	11	11	10	10	7	7	6	6	6	10	6	6	6	10	9	6	6	6	6	7	16	
11	11	10	9	9	7	6	6	6	6	9	6	6	5	9	9	6	6	5	5	6	17	
10	10	9	9	9	6	6	6	6	5	9	5	5	5	9	8	5	5	5	5	6	18	
10	10	9	8	8																	19	
9	9	8	8	8																	20	
9	9	8	8	8																	21	
8	8	8	7	7																	22	

Minimum Length = 3 feet.

herein might be furnished by special arrangement.

**SQUARE BILLETS.
WITH ROUND CORNERS.**

Size.	Maximum Length.	Minimum Length.
Inches.	Feet.	Feet.
$1\frac{3}{4} \times 1\frac{3}{4}$	30	24
2 x 2	30	24
$2\frac{1}{4} \times 2\frac{1}{4}$	30	24
3 x 3	30	24
4 x 4	16	$1\frac{1}{2}$
$4\frac{1}{2} \times 4\frac{1}{2}$	16	$1\frac{1}{2}$
5 x 5	16	$1\frac{1}{2}$
$5\frac{1}{2} \times 5\frac{1}{2}$	16	$1\frac{1}{2}$
6 x 6	16	$1\frac{1}{2}$

SHEET AND TIN BARS.

Width.	Weight per Foot Length.	Maximum Length.	Minimum Length.
Inches.	Pounds.	Feet.	Feet.
8	8	30	25
8	9	30	25
8	10	30	25
8	11	30	$20\frac{1}{2}$
8	12	30	$20\frac{1}{2}$
8	13	30	$20\frac{1}{2}$
8	14	30	$16\frac{1}{2}$
8	15	30	$16\frac{1}{2}$
8	16	30	$16\frac{1}{2}$
8	17	30	$16\frac{1}{2}$
8	18	30	13
8	19	30	13
8	20	30	13
8	21	30	13
8	22	30	13
8	23	30	13
8	24	30	$9\frac{1}{2}$
8	25	30	$9\frac{1}{2}$

SHEARED PLATES.

Width in Inches.	THICKNESS IN INCHES								
	$\frac{3}{16}$	$\frac{1}{4}$	$\frac{5}{16}$	$\frac{3}{8}$	$\frac{7}{16}$	$\frac{1}{2}$	$\frac{9}{16}$	$\frac{5}{8}$	$\frac{11}{16}$
	MAXIMUM LENGTH IN INCHES								
24	400	525	575	600	600	600	600	600	
25-30	375	525	500	600	600	625	625	625	
31-36	375	475	525	550	550	575	575	575	575
37-42	450	525	550	575	610	600	600	600	575
43-48	450	525	575	600	600	600	600	600	600
49-54	450	525	550	600	600	625	625	625	600
55-60	400	525	550	600	600	625	625	625	600
61-66	350	475	500	575	575	600	600	600	600
67-72	325	450	500	540	550	575	575	575	575
73-78		425	475	440	540	540	540	540	540
79-84		400	475	440	540	540	540	540	540
85-90		350	375	400	450	450	450	450	450
91-96		300	325	350	400	400	400	400	400
97-102		275	300	325	375	375	375	375	375
103-108		250	275	300	350	350	350	350	350
109-114		175	200	225	275	275	275	300	300
115-120			175	200	250	250	250	250	250
121-126				180	180	180	180	180	180
Maximum Diam. of Heads.	72	115	124	127	127	127	127	127	127

Minimum Diameter of Heads (Circular Plates) = 30 inches.

SHEARED PLATES.

THICKNESS IN INCHES.										Width in Inches.
$\frac{3}{4}$	$\frac{13}{16}$	$\frac{7}{8}$	$\frac{15}{16}$	1	$1\frac{1}{8}$	$1\frac{1}{4}$	$1\frac{1}{2}$	$1\frac{3}{4}$	2	
MAXIMUM LENGTH IN INCHES.										
										24
										25- 30
550	525	500	475	475	450	425	400	375	350	31- 36
575	525	500	500	500	475	425	400	375	350	37- 42
575	550	550	525	525	500	450	400	375	350	43- 48
575	550	550	525	525	500	450	400	375	350	49- 54
575	550	550	525	525	475	425	400	375	325	55- 60
575	550	550	525	525	475	425	375	350	325	61- 66
575	550	525	500	500	475	425	375	350	300	67- 72
525	500	475	450	450	425	375	325	300	280	73- 78
500	450	450	425	425	375	350	325	300	280	79- 84
425	400	400	375	375	350	325	280	270	260	85- 90
400	375	375	350	325	300	275	260	260	250	91- 96
375	350	350	325	300	275	250	250	240	240	97-102
350	325	325	300	275	250	250	180	175	160	103-108
300	275	275	250	250	225	200	175	160	150	109-114
275	250	250	225	225	200	200	175	160	150	115-120
180	200	200	175	175	160	160	150	144	144	121-126
127	126	126	126	126	126	125	125	125	125	Maximum Diam. of Heads.

Larger sizes up to 4 inch thickness, finished weight not exceeding 12,000 pounds, will be considered.

WEIGHTS AND DIMENSIONS OF STANDARD I-BEAMS.

Section Number.	Depth of Beam.	Weight per Foot.	Area of Section.	Thickness of Web.	Width of Flange.	Page Number of Section.
	Inches.	Pounds.	Sq. In.	Inch.	Inches.	
B 5	3	5.5	1.63	.17	2.33	2
"	"	6.5	1.91	.26	2.42	"
"	"	7.5	2.21	.36	2.52	"
B 9	4	7.5	2.21	.19	2.66	2
"	"	8.5	2.50	.26	2.73	"
"	"	9.5	2.79	.34	2.81	"
"	"	10.5	3.09	.41	2.88	"
B 13	5	9.75	2.87	.21	3.00	2
"	"	12.25	3.60	.36	3.15	"
"	"	14.75	4.34	.50	3.29	"
B 17	6	12.25	3.61	.23	3.33	2
"	"	14.75	4.34	.35	3.45	"
"	"	17.25	5.07	.47	3.57	"
B 21	7	15.0	4.42	.25	3.66	2
"	"	17.5	5.15	.35	3.76	"
"	"	20.0	5.88	.46	3.87	"
B 25	8	18.0	5.33	.27	4.00	3
"	"	20.25	5.96	.35	4.08	"
"	"	22.75	6.69	.44	4.17	"
"	"	25.25	7.43	.53	4.26	"
B 29	9	21.0	6.31	.29	4.33	3
"	"	25.0	7.35	.41	4.45	"
"	"	30.0	8.82	.57	4.61	"
"	"	35.0	10.29	.73	4.77	"
B 33	10	25.0	7.37	.31	4.66	3
"	"	30.0	8.82	.45	4.80	"
"	"	35.0	10.29	.60	4.95	"
"	"	40.0	11.76	.75	5.10	"
B 41	12	31.5	9.26	.35	5.00	3
"	"	35.0	10.29	.44	5.09	"
"	"	40.0	11.76	.56	5.21	"
B 53	15	42.0	12.48	.41	5.50	4
"	"	45.0	13.24	.46	5.55	"
"	"	50.0	14.71	.56	5.65	"
"	"	55.0	16.18	.66	5.75	"
"	"	60.0	17.65	.75	5.84	"

Orders and inquiries concerning 12 in. 40 lb., 15 in. 60 lb., and 15 in. 80 lb. I-Beams should also specify by Section Number.

WEIGHTS AND DIMENSIONS OF STANDARD I-BEAMS.

Section Number.	Depth of Beam.	Weight per Foot.	Area of Section.	Thickness of Web.	Width of Flange.	Page Number of Section.
	Inches.	Pounds.	Sq. In.	Inch.	Inches.	
B 65	18	55.0	15.93	.46	6.00	6
"	"	60.0	17.65	.56	6.10	"
"	"	65.0	19.12	.64	6.18	"
"	"	70.0	20.59	.72	6.26	"
B 73	20	65.0	19.08	.50	6.25	7
"	"	70.0	20.59	.58	6.33	"
"	"	75.0	22.06	.65	6.40	"
B 89	24	80.0	23.32	.50	7.00	8
"	"	85.0	25.00	.57	7.07	"
"	"	90.0	26.47	.63	7.13	"
"	"	95.0	27.94	.69	7.19	"
"	"	100.0	29.41	.75	7.25	"

WEIGHTS AND DIMENSIONS OF SPECIAL I-BEAMS.

Section Number.	Depth of Beam.	Weight per Foot.	Area of Section.	Thickness of Web.	Width of Flange.	Page Number of Section.
	Inches.	Pounds.	Sq. In.	Inch.	Inches.	
B 105	12	40.0	11.84	.46	5.25	4
"	"	45.0	13.24	.58	5.37	"
"	"	50.0	14.71	.70	5.49	"
"	"	55.0	16.18	.82	5.61	"
B 109	15	60.0	17.67	.59	6.00	5
"	"	65.0	19.12	.69	6.10	"
"	"	70.0	20.59	.78	6.19	"
"	"	75.0	22.06	.88	6.29	"
"	"	80.0	23.53	.98	6.39	"
B 113	15	80.0	23.57	.80	6.40	5
"	"	85.0	25.00	.90	6.50	"
"	"	90.0	26.47	.99	6.59	"
"	"	95.0	27.94	1.09	6.69	"
"	"	100.0	29.41	1.19	6.79	"
B 121	20	80.0	23.73	.60	7.00	7
"	"	85.0	25.00	.66	7.06	"
"	"	90.0	26.47	.74	7.14	"
"	"	95.0	27.94	.81	7.21	"
"	"	100.0	29.41	.88	7.28	"
B 127	24	105.0	30.98	.63	7.88	9
"	"	110.0	32.48	.69	7.94	"
"	"	115.0	33.98	.75	8.00	"

Orders and inquiries concerning 12 in. 40 lb., 15 in. 60 lb., and 15 in. 80 lb. I-Beams should also specify by Section Number.

WEIGHTS AND DIMENSIONS OF STANDARD CHANNELS.

Section Number.	Depth of Channel.	Weight per Foot.	Area of Section.	Thickness of Web.	Width of Flange.	Page Number of Section.
	Inches.	Pounds.	Sq. In.	Inch.	Inches.	
C 5	3	4.0	1.19	.17	1.41	10
"	"	5.0	1.47	.26	1.50	"
"	"	6.0	1.76	.36	1.60	"
C 9	4	5.25	1.55	.18	1.58	10
"	"	6.25	1.84	.25	1.65	"
"	"	7.25	2.13	.33	1.73	"
C 13	5	6.50	1.95	.19	1.75	10
"	"	9.00	2.65	.33	1.89	"
"	"	11.50	3.38	.48	2.04	"
C 17	6	8.00	2.38	.20	1.92	10
"	"	10.50	3.09	.32	2.04	"
"	"	13.00	3.82	.44	2.16	"
"	"	15.50	4.56	.56	2.28	"
C 21	7	9.75	2.85	.21	2.09	10
"	"	12.25	3.60	.32	2.20	"
"	"	14.75	4.34	.42	2.30	"
"	"	17.25	5.07	.53	2.41	"
"	"	19.75	5.81	.63	2.51	"
C 25	8	11.25	3.35	.22	2.26	10
"	"	13.75	4.04	.31	2.35	"
"	"	16.25	4.78	.40	2.44	"
"	"	18.75	5.51	.49	2.53	"
"	"	21.25	6.25	.58	2.62	"
C 29	9	13.25	3.89	.23	2.43	11
"	"	15.00	4.41	.29	2.49	"
"	"	20.00	5.88	.45	2.65	"
"	"	25.00	7.35	.61	2.81	"
C 33	10	15.0	4.46	.24	2.60	11
"	"	20.0	5.88	.38	2.74	"
"	"	25.0	7.35	.53	2.89	"
"	"	30.0	8.82	.68	3.04	"
"	"	35.0	10.29	.82	3.18	"
C 41	12	20.5	6.03	.28	2.94	11
"	"	25.0	7.35	.39	3.05	"
"	"	30.0	8.82	.51	3.17	"
"	"	35.0	10.29	.64	3.30	"
"	"	40.0	11.76	.76	3.42	"

WEIGHTS AND DIMENSIONS OF STANDARD CHANNELS.

Section Number.	Depth of Channel.	Weight per Foot.	Area of Section.	Thickness of Web.	Width of Flange.	Page Number of Section.
	Inches.	Pounds.	Sq. Ins.	Inch.	Inches.	
C 53	15	33 †	9.90	.40	3.40	12
"	"	35 †	10.29	.43	3.43	"
"	"	40 †	11.76	.52	3.52	"
"	"	45 †	13.24	.62	3.62	"
"	"	50 †	14.71	.72	3.72	"
"	"	55 †	16.18	.82	3.82	"

WEIGHTS AND DIMENSIONS OF SHIP AND SPECIAL CHANNELS.

Section Number	Depth of Channel.	Weight per Foot.	Area of Section.	Thickness of Web.	Width of Flange.	Increase in Web and Flange for each Pound Increase of Weight.	Page Number of Section.
	Inches.	Pounds.	Sq. In.	Inch.	Inches.	Inch.	
C 269	3	7.1	2.07	.306	1 $\frac{1}{8}$.098	13
C 72	4	10.1	2.95	.394	2.09	.074	13
C 86	6	15.3 †	4.47	.34	3.50	.049	13
"	"	17.7	5.19	.46	3.62	"	"
C 88	6	19.0	5.58	.41	3.56	.049	13
"	"	21.6	6.36	.54	3.69	"	"
"	"	23.4	6.87	.63	3.78	"	"
C 89	7	20.9	6.15	.45	3.45	.042	13
"	"	23.8	6.99	.57	3.57	"	"
C 101	8	21.5	6.30	.40	3.50	.037	14
"	"	24.8	7.26	.52	3.62	"	"
C 103	8	23.8	7.00	.50	3.50	.037	14
"	"	27.1	7.96	.62	3.62	"	"
C 90	10	21.9	6.44	.38	3.38	.029	14
"	"	26.0	7.64	.50	3.50	"	"
"	"	27.4	8.04	.54	3.54	"	"
"	"	31.5	9.24	.66	3.66	"	"
C 105	12	35.0	10.30	.47	3.77	.0245	14
"	"	40.0	11.76	.60	3.90	"	"
"	"	44.3	13.02	.70	4.00	"	"
"	"	46.3	13.62	.75	4.05	"	"
"	"	48.4	14.22	.80	4.10	"	"
"	"	50.0	14.70	.84	4.14	"	"

† Standard Ship Section

WEIGHTS AND DIMENSIONS OF STANDARD SHIP CHANNELS.

Dimensions of standard 6-inch, 15.3 lb. ship channel on page 43.

Section Number.	Depth of Channel.	Weight per Foot.	Area of Section.	Thickness of Web.	Width of Flange.	Increase in Web and Flange for each Pound increase of Weight.	Page Number of Section.
	Inches.	Pounds.	Sq. Ins.	Inch.	Inches.	Inch.	
C 55	6	16.8	4.92	.325	3.45	.049	15
“ (BSC 8)	“	17.8	5.22	.375	3.50	“	“
“	“	19.8	5.82	.475	3.60	“	“
C 57	7	18.9	5.55	.350	3.45	.042	15
“ (BSC 10)	“	20.1	5.90	.400	3.50	“	“
“	“	22.5	6.60	.500	3.60	“	“
C 59	8	21.2	6.23	.375	3.45	.037	15
“ (BSC 13)	“	22.6	6.63	.425	3.50	“	“
“	“	25.3	7.43	.525	3.60	“	“
C 60	9	23.7	6.96	.400	3.45	.033	16
“ (BSC 17)	“	25.2	7.41	.450	3.50	“	“
“	“	28.3	8.31	.550	3.60	“	“
“	“	31.3	9.21	.650	3.70	“	“
C 61	10	24.6	7.23	.375	3.40	.029	16
“	“	26.3	7.73	.425	3.45	“	“
“ (BSC 20)	“	28.0	8.23	.475	3.50	“	“
“	“	31.4	9.23	.575	3.60	“	“
“	“	34.8	10.23	.675	3.70	“	“
C 63	12	30.6	9.00	.450	3.45	.0245	16
“ (BSC 25)	“	32.7	9.60	.500	3.50	“	“
“	“	36.8	10.80	.600	3.60	“	“
“	“	40.8	12.00	.700	3.70	“	“

General slope of flange, $2^\circ = .035$.

WEIGHTS AND DIMENSIONS OF SHIP AND SPECIAL CHANNELS.—Continued.

Section Number.	Depth of Channel.	Weight per Foot.	Area of Section.	Thickness of Web.	Width of Flange.	Increase in Web and Flange for each Pound increase of Weight.	Page Number of Section.
	Inches.	Pounds.	Sq. Ins.	Inch.	Inches.	Inch.	
C 95	13	32	9.30	.38	4.00	.023	11
"	"	35	10.29	.45	4.08	"	"
"	"	37	10.88	.50	4.12	"	"
"	"	40	11.76	.56	4.19	"	"
"	"	45	13.24	.68	4.30	"	"
"	"	50	14.71	.79	4.42	"	"
"	"	55	16.18	.90	4.53	"	"
C 65	18	45	13.25	.47	3.77	.016	12
"	"	50	14.71	.55	3.85	"	"
"	"	55	16.18	.63	3.93	"	"
"	"	60	17.65	.72	4.02	"	"

WEIGHTS AND DIMENSIONS OF BULB ANGLES.

Section Number	Size	Weight per Foot	Area of Section	Thickness Plain Leg	Thickness Bulb Leg	Length of Bulb	Width of Bulb	Page Number of Section
	Inches	Pounds	Sq. Ins.	Inches	Inches	Inches	Inches	
A174	4 x 3½	11.7	3.42	⅜	⅜	57/64	1½	20
A176	5 x 4½	19.2	5.64	7/16	7/16	1 9/32	2¼	"
A171	5 x 2½	10.2	3.00	9/32-13/32	19/64	7/8	1¼	"
A177	6 x 3	11.8	3.47	.34	5/16	1.21	1.08	"
"	"	13.5	3.95	.39	3/8	"	1.14	"
"	"	15.0	4.41	.43	7/16	"	1.20	"
A178	6 x 3½	12.5	3.66	.37	5/16	1.16	1.01	"
"	"	14.1	4.13	.41	3/8	"	1.08	"
"	"	15.7	4.60	.45	7/16	"	1.14	"
"	"	17.3	5.07	.49	1/2	"	1.20	"
"	"	18.9	5.53	.53	9/16	"	1.26	"
"	"	20.5	6.02	.58	5/8	"	1.33	"
A179	7 x 3½	15.7	4.61	.43	3/8	1.25	1.10	21
"	"	17.5	5.13	.46	7/16	"	1.16	"
"	"	19.1	5.60	.48	1/2	"	1.23	"
A181	8 x 3½	17.4	5.09	.42	3/8	1.35	1.18	"
"	"	19.3	5.64	.44	7/16	"	1.24	"
"	"	21.5	6.30	.50	1/2	"	1.30	"
A183	9 x 3½	20.3	5.96	.44	13/32	1.48	1.29	"
"	"	22.6	6.62	.48	15/32	"	1.35	"
"	"	24.8	7.27	.52	7/16	"	1.41	"
A185	10 x 3½	23.6	6.91	.47	7/16	1.61	1.40	"
"	"	26.1	7.64	.51	1/2	"	1.46	"
"	"	28.5	8.35	.55	9/16	"	1.53	"

WEIGHTS AND DIMENSIONS OF STANDARD BULB ANGLES.

Section Number.	Size.	Weight per Foot.	Area of Section.	Thickness Plain Leg.	Thickness Bulb Leg.	Width of Bulb.	Page Number of Section.
	Ins.	Lbs.	Sq. In.	Ins.	Ins.	Ins.	
A 187	6 x 3	12.2	3.58		.350	1.025	22
" (BSBA 4)	"	12.8	3.76	.375	.375	1.050	"
"	"	14.1	4.14		.425	1.100	"
"	"	15.6	4.58		.475	1.150	"
A 188	7 x 3½	15.3	4.50		.375	1.125	22
" (BSBA 8)	"	16.8	4.94	.425	.425	1.175	"
"	"	18.6	5.46		.475	1.225	"
"	"	20.0	5.90		.525	1.275	"
A 189	8 x 3½	18.0	5.29		.400	1.225	22
" (BSBA 12,	"	19.6	5.78	.450	.450	1.275	"
"	"	21.6	6.34		.500	1.325	"
"	"	23.2	6.83		.550	1.375	"
A 190	9 x 3½	20.9	6.14		.425	1.325	22
" (BSBA 16)	"	22.7	6.68	.475	.475	1.375	"
"	"	24.8	7.29		.525	1.425	"
"	"	26.6	7.82		.575	1.475	"
"	"	28.6	8.41		.625	1.525	"
A 191	10 x 3½	24.9	7.32		.475	1.450	23
" (BSBA 18)	"	26.9	7.90	.525	.525	1.500	"
"	"	29.1	8.55		.575	1.550	"
"	"	31.1	9.14		.625	1.600	"
"	"	33.2	9.77		.675	1.650	"
"	"	35.2	10.35		.725	1.700	"

WEIGHTS AND DIMENSIONS OF CAR SIDE STAKES.

Section Number.	Extreme Width.	Depth.	Weight per Foot.	Area of Section.	Base Thickness.	Apex Thickness.	Groove Width.	Page Number of Section.
	Ins.	Ins.	Lbs.	Sq. In.	Ins.	Ins.	Ins.	
L 2	7	2¾	7.2	2.10	¾	¾	2⅝	23
"	"	2⅓	8.7	2.54	⅞	⅞	"	"
"	"	2⅓	11.7	3.42	⅞	⅞	"	"

WEIGHTS AND DIMENSIONS OF REGULAR T-BARS. EQUAL LEGS.

Section Number.	Width of Flange.	Depth of Bar.	Thickness of Flange.	Thickness of Stem.	Weight per Foot.	Area of Section.	Page Number of Section.
	Inches.	Inches.	Inch.	Inch.	Pounds.	Sq. Ins.	
T 5	1	1	$\frac{1}{8}$ to $\frac{5}{32}$	$\frac{1}{8}$ to $\frac{5}{32}$.89	.26	24
T 181	$1\frac{1}{8}$	$1\frac{1}{8}$	$\frac{3}{16}$ " $\frac{7}{32}$	$\frac{5}{32}$ " $\frac{7}{32}$	1.37	.40	"
T 183	$1\frac{3}{16}$	$1\frac{3}{16}$	$\frac{3}{16}$ " $\frac{1}{4}$	$\frac{5}{32}$ " $\frac{7}{32}$	1.51	.44	"
T 187	$1\frac{1}{4}$	$1\frac{1}{4}$	$\frac{3}{16}$ " $\frac{1}{4}$	$\frac{5}{32}$ " $\frac{7}{32}$	1.60	.47	"
T 188	$1\frac{1}{4}$	$1\frac{1}{4}$	$\frac{3}{16}$ " $\frac{7}{32}$	$\frac{3}{16}$ " $\frac{9}{32}$	1.70	.50	"
T 191	$1\frac{1}{2}$	$1\frac{1}{2}$	$\frac{3}{16}$ " $\frac{7}{32}$	$\frac{3}{16}$ " $\frac{7}{32}$	1.94	.57	"
T 193	$1\frac{1}{2}$	$1\frac{1}{2}$	$\frac{1}{4}$ " $\frac{9}{32}$	$\frac{1}{4}$ " $\frac{9}{32}$	2.47	.73	"
T 194	$1\frac{3}{4}$	$1\frac{3}{4}$	$\frac{1}{4}$ " $\frac{5}{16}$	$\frac{1}{4}$ " $\frac{5}{16}$	3.09	.91	"
T 37	2	2	$\frac{1}{4}$ " $\frac{5}{16}$	$\frac{1}{4}$ " $\frac{5}{16}$	3.56	1.05	"
T 39	2	2	$\frac{5}{16}$ " $\frac{3}{8}$	$\frac{5}{16}$ " $\frac{3}{8}$	4.3	1.26	25
T 41	$2\frac{1}{4}$	$2\frac{1}{4}$	$\frac{1}{4}$ " $\frac{5}{16}$	$\frac{1}{4}$ " $\frac{5}{16}$	4.1	1.19	"
T 42	$2\frac{1}{4}$	$2\frac{1}{4}$	$\frac{5}{16}$ " $\frac{3}{8}$	$\frac{5}{16}$ " $\frac{3}{8}$	4.9	1.43	"
T 47	$2\frac{1}{2}$	$2\frac{1}{2}$	$\frac{1}{4}$ " $\frac{5}{16}$	$\frac{1}{4}$ " $\frac{5}{16}$	4.6	1.33	"
T 49	$2\frac{1}{2}$	$2\frac{1}{2}$	$\frac{5}{16}$ " $\frac{3}{8}$	$\frac{5}{16}$ " $\frac{3}{8}$	5.5	1.60	"

WEIGHTS AND DIMENSIONS OF REGULAR T-BARS. UNEQUAL LEGS.

Section Number.	Width of Flange.	Depth of Bar.	Thickness of Flange.	Thickness of Stem.	Weight per Foot.	Area of Section.	Page Number of Section.
	Inches.	Inches.	Inch.	Inch.	Pounds.	Sq. Ins.	
T 16	$1\frac{1}{4}$	$1\frac{1}{16}$	$\frac{3}{16}$ to $\frac{1}{4}$	$\frac{5}{32}$ to $\frac{7}{32}$	1.48	.43	25
T 18	$1\frac{1}{4}$	$1\frac{1}{8}$	$\frac{3}{16}$ " $\frac{7}{32}$	$\frac{3}{16}$ " $\frac{1}{4}$	1.56	.46	"
T 20	$1\frac{1}{2}$	$1\frac{1}{4}$	$\frac{1}{8}$ " $\frac{5}{32}$	$\frac{1}{8}$ " $\frac{5}{32}$	1.25	.37	"

WEIGHTS AND DIMENSIONS OF STANDARD ANGLES. EQUAL LEGS.

Sizes not specially marked were adopted as standard, May 21, 1910, by the Association of American Steel Manufacturers, for bridge, car, ship and general building construction. Sizes marked * are of special thickness and are not A. A. S. M. Standard.

Section Number.	Dimensions.	Thick-ness.	Weight per Foot.	Area of Section.	Section Number.	Dimensions.	Thick-ness.	Weight per Foot.	Area of Section.
	Inches.					Inch.			
A 11	1½ x 1½	⅜	1.23	.36	A 23	4 x 4	⅝	8.2	2.40
"	1½ x 1½	⅜	1.80	.53	"	4 x 4	⅜	9.8	2.86
"	1½ x 1½	¼	2.34	.69	"	4 x 4	⅜	11.3	3.31
"	1½ x 1½	⅝	2.86	.84	"	4 x 4	⅜	12.8	3.75
* " "	1½ x 1½	⅜	3.35	.98	"	4 x 4	⅝	14.3	4.18
* A 15	2 x 2	⅜	1.65	.48	"	4 x 4	⅝	15.7	4.61
"	2 x 2	⅜	2.44	.72	"	4 x 4	⅝	17.1	5.03
"	2 x 2	⅜	3.19	.94	"	4 x 4	⅝	18.5	5.44
"	2 x 2	⅜	3.92	1.15	* " "	4 x 4	⅝	19.9	5.84
"	2 x 2	⅜	4.7	1.36	* " "	4 x 4	⅝	21.2	6.23
* " "	2 x 2	⅜	5.3	1.56					
* " "	2 x 2	⅜	6.0	1.75					
* A 17	2½ x 2½	⅜	2.08	.61	A 27	6 x 6	⅜	14.9	4.36
"	2½ x 2½	⅜	3.07	.90	"	6 x 6	⅜	17.2	5.06
"	2½ x 2½	¼	4.1	1.19	"	6 x 6	⅜	19.6	5.75
"	2½ x 2½	⅝	5.0	1.47	"	6 x 6	⅝	21.9	6.43
"	2½ x 2½	⅝	5.9	1.73	"	6 x 6	⅝	24.2	7.11
"	2½ x 2½	⅝	6.8	2.00	"	6 x 6	⅝	26.5	7.78
* " "	2½ x 2½	⅝	7.7	2.25	"	6 x 6	⅝	28.7	8.44
A 19	3 x 3	¼	4.9	1.44	"	6 x 6	⅝	31.0	9.09
"	3 x 3	⅝	6.1	1.78	"	6 x 6	⅝	33.1	9.73
"	3 x 3	⅝	7.2	2.11	"	6 x 6	⅝	35.3	10.37
"	3 x 3	⅝	8.3	2.43	"	6 x 6	1	37.4	11.00
"	3 x 3	⅝	9.4	2.75					
* " "	3 x 3	⅝	10.4	3.06	A 35	8 x 8	½	26.4	7.75
* A 21	3½ x 3½	¼	5.8	1.69	"	8 x 8	⅝	29.6	8.68
"	3½ x 3½	⅝	7.2	2.09	"	8 x 8	⅝	32.7	9.61
"	3½ x 3½	⅝	8.5	2.48	"	8 x 8	⅝	35.8	10.53
"	3½ x 3½	⅝	9.8	2.87	"	8 x 8	⅝	38.9	11.44
"	3½ x 3½	⅝	11.1	3.25	"	8 x 8	⅝	42.0	12.34
"	3½ x 3½	⅝	12.4	3.62	"	8 x 8	⅝	45.0	13.23
"	3½ x 3½	⅝	13.6	3.98	"	8 x 8	⅝	48.1	14.12
* " "	3½ x 3½	⅝	14.8	4.34	"	8 x 8	1	51.0	15.00
* " "	3½ x 3½	⅝	16.0	4.69	"	8 x 8	1	54.0	15.87
* " "	3½ x 3½	⅝	17.1	5.03	"	8 x 8	1	56.9	16.73
* " "	3½ x 3½	⅝	18.3	5.36					

Standard Angles vary only by ⅛ inch. Sections shown on page 17.

† Standard Ship Section.

**WEIGHTS AND DIMENSIONS OF STANDARD ANGLES.
UNEQUAL LEGS.**

Sizes not specially marked were adopted as standard, May 21, 1910, by the Association of American Steel Manufacturers, for bridge, car, ship and general building construction. Sizes marked * are of special thickness and are not A. A. S. M. standard.

Section Num-ber.	Dimensions.	Thick-ness.	Weight per Foot.	Area of Section.	Section Num-ber.	Dimensions.	Thick-ness.	Weight per Foot.	Area of Section.
	Inches.					Inch.			
A 91	2½ x 2	3/16	2.75	.81	A 99	4 x 3	5/16 †	7.2	2.09
"	2½ x 2	1/4	3.62	1.06	"	4 x 3	3/8 †	8.5	2.48
"	2½ x 2	5/16	4.5	1.31	"	4 x 3	7/16 †	9.8	2.87
"	2½ x 2	3/8	5.3	1.55	"	4 x 3	1/2 †	11.1	3.25
* "	2½ x 2	7/16	6.1	1.78	"	4 x 3	9/16	12.4	3.62
* "	2½ x 2	1/2	6.8	2.00	"	4 x 3	5/8	13.6	3.98
A 93	3 x 2½	1/4 †	4.5	1.31	* "	4 x 3	11/16	14.8	4.34
"	3 x 2½	5/16 †	5.6	1.62	* "	4 x 3	3/4	16.0	4.69
"	3 x 2½	3/8 †	6.6	1.92	* "	4 x 3	13/16	17.1	5.03
"	3 x 2½	7/16	7.6	2.22	"	4 x 3	7/8	18.3	5.36
* "	3 x 2½	1/2	8.5	2.50	A101	5 x 3	5/16 †	8.2	2.40
* "	3 x 2½	9/16	9.5	2.78	"	5 x 3	3/8 †	9.8	2.86
A 95	3½ x 2½	1/4 †	4.9	1.44	"	5 x 3	7/16 †	11.3	3.31
"	3½ x 2½	5/16	6.1	1.78	"	5 x 3	1/2 †	12.3	3.75
"	3½ x 2½	3/8	7.2	2.11	"	5 x 3	9/16	14.3	4.18
"	3½ x 2½	7/16	8.3	2.43	"	5 x 3	5/8	15.7	4.61
"	3½ x 2½	1/2	9.4	2.75	* "	5 x 3	11/16	17.1	5.03
* "	3½ x 2½	9/16	10.4	3.06	* "	5 x 3	3/4	18.5	5.44
*A 97	3½ x 3	1/4 †	5.4	1.56	* "	5 x 3	13/16	19.9	5.84
"	3½ x 3	5/16 †	6.6	1.93	* "	5 x 3	7/8	21.2	6.23
"	3½ x 3	3/8 †	7.9	2.30	A103	5 x 3½	5/16	8.7	2.56
"	3½ x 3	7/16 †	9.1	2.65	"	5 x 3½	3/8	10.4	3.05
"	3½ x 3	1/2 †	10.2	3.00	"	5 x 3½	7/16	12.0	3.53
"	3½ x 3	9/16	11.4	3.34	"	5 x 3½	1/2	13.6	4.00
* "	3½ x 3	5/8	12.5	3.67	"	5 x 3½	9/16	15.2	4.47
* "	3½ x 3	11/16	13.6	4.00	"	5 x 3½	5/8	16.8	4.92
* "	3½ x 3	3/4	14.7	4.31	"	5 x 3½	11/16	18.3	5.37
* "	3½ x 3	13/16	15.8	4.62	* "	5 x 3½	3/4	19.8	5.81
* "	3½ x 3	7/8	16.8	4.92	* "	5 x 3½	13/16	21.3	6.25
					* "	5 x 3½	7/8	22.7	6.67
					* "	5 x 3½	15/16	24.2	7.09

Standard Angles vary only by 1/16 inch. Sections shown on page 18.

† Standard Ship Section.

WEIGHTS AND DIMENSIONS OF STANDARD ANGLES. UNEQUAL LEGS.—CONTINUED.

Sizes not specially marked were adopted as standard, May 21, 1910, by the Association of American Steel Manufacturers, for bridge, car, ship and general building construction. Sizes marked * are of special thickness and are not A. A. S. M. standard.

Section Number.	Dimensions.	Thick-ness.	Weight per Foot.	Area of Section.	Section Number.	Dimensions.	Thick-ness.	Weight per Foot.	Area of Section.
	Inches.	Inch.	Pounds.	Sq. Ins.		Inches.	Inch.	Pounds.	Sq. Ins.
A105	6 x 3 $\frac{1}{2}$	$\frac{3}{8}$ †	11.7	3.42	A107	6 x 4	$\frac{3}{8}$	12.3	3.61
"	6 x 3 $\frac{1}{2}$	$\frac{7}{16}$ †	13.5	3.97	"	6 x 4	$\frac{7}{16}$	14.3	4.18
"	6 x 3 $\frac{1}{2}$	$\frac{1}{2}$ †	15.3	4.50	"	6 x 4	$\frac{1}{2}$	16.2	4.75
"	6 x 3 $\frac{1}{2}$	$\frac{9}{16}$ †	17.1	5.03	"	6 x 4	$\frac{9}{16}$	18.1	5.31
"	6 x 3 $\frac{1}{2}$	$\frac{5}{8}$ †	18.9	5.55	"	6 x 4	$\frac{5}{8}$	20.0	5.86
"	6 x 3 $\frac{1}{2}$	$\frac{11}{16}$ †	20.6	6.06	"	6 x 4	$\frac{11}{16}$	21.8	6.40
"	6 x 3 $\frac{1}{2}$	$\frac{3}{4}$ †	22.4	6.56	"	6 x 4	$\frac{3}{4}$	23.6	6.94
"	6 x 3 $\frac{1}{2}$	$\frac{13}{16}$	24.0	7.06	"	6 x 4	$\frac{13}{16}$	25.4	7.47
"	6 x 3 $\frac{1}{2}$	$\frac{7}{8}$	25.7	7.55	"	6 x 4	$\frac{7}{8}$	27.2	7.98
* "	6 x 3 $\frac{1}{2}$	$\frac{15}{16}$	27.3	8.03	* "	6 x 4	$\frac{15}{16}$	28.9	8.50
* "	6 x 3 $\frac{1}{2}$	1	28.9	8.50	* "	6 x 4	1	30.6	9.00

WEIGHTS AND DIMENSIONS OF SPECIAL ANGLES. EQUAL LEGS.

Section Number.	Dimensions.	Thick-ness.	Weight per Foot.	Area of Section.	Section Number.	Dimensions.	Thick-ness.	Weight per Foot.	Area of Section.
	Inches.	Inch.	Pounds.	Sq. Ins.		Inches.	Inch.	Pounds.	Sq. Ins.
A 36	$\frac{3}{4}$ x $\frac{3}{4}$	$\frac{1}{8}$.59	.17	A 41	2 $\frac{1}{4}$ x 2 $\frac{1}{4}$	$\frac{3}{16}$	2.75	.81
"	$\frac{3}{4}$ x $\frac{3}{4}$	$\frac{1}{16}$.84	.25	"	2 $\frac{1}{4}$ x 2 $\frac{1}{4}$	$\frac{1}{4}$	3.62	1.06
					"	2 $\frac{1}{4}$ x 2 $\frac{1}{4}$	$\frac{5}{16}$	4.5	1.31
A 37	1 x 1	$\frac{1}{8}$.80	.23					
"	1 x 1	$\frac{3}{16}$	1.16	.34	A 43	2 $\frac{3}{4}$ x 2 $\frac{3}{4}$	$\frac{1}{4}$	4.5	1.31
"	1 x 1	$\frac{1}{4}$	1.49	.44	"	2 $\frac{3}{4}$ x 2 $\frac{3}{4}$	$\frac{5}{16}$	5.6	1.62
					"	2 $\frac{3}{4}$ x 2 $\frac{3}{4}$	$\frac{3}{8}$	6.6	1.92
A 38	1 $\frac{1}{4}$ x 1 $\frac{1}{4}$	$\frac{1}{8}$	1.01	.30	A 47	5 x 5	$\frac{3}{8}$ †	12.3	3.61
"	1 $\frac{1}{4}$ x 1 $\frac{1}{4}$	$\frac{3}{16}$	1.48	.43	"	5 x 5	$\frac{7}{16}$ †	14.3	4.18
"	1 $\frac{1}{4}$ x 1 $\frac{1}{4}$	$\frac{1}{4}$	1.92	.56	"	5 x 5	$\frac{1}{2}$ †	16.2	4.75
A 40	1 $\frac{3}{4}$ x 1 $\frac{3}{4}$	$\frac{1}{8}$	1.44	.42	"	5 x 5	$\frac{9}{16}$ †	18.1	5.31
"	1 $\frac{3}{4}$ x 1 $\frac{3}{4}$	$\frac{3}{16}$	2.12	.62	"	5 x 5	$\frac{5}{8}$ †	20.0	5.86
"	1 $\frac{3}{4}$ x 1 $\frac{3}{4}$	$\frac{1}{4}$	2.77	.81	"	5 x 5	$\frac{11}{16}$ †	21.8	6.40
"	1 $\frac{3}{4}$ x 1 $\frac{3}{4}$	$\frac{5}{16}$	3.39	1.00	"	5 x 5	$\frac{3}{4}$ †	23.6	6.94
"	1 $\frac{3}{4}$ x 1 $\frac{3}{4}$	$\frac{3}{8}$	3.99	1.17					

Standard Angles vary only by $\frac{1}{16}$ inch. Sections shown on pages 18 and 19.

† Standard Ship Section.

**WEIGHTS AND DIMENSIONS OF SPECIAL ANGLES.
UNEQUAL LEGS.**

Section Number	Dimensions	Thick-ness	Weight per Foot	Area of Section	Section Number	Dimensions	Thick-ness	Weight per Foot	Area of Section
	Inches	Inch	Pounds	Sq. Ins.		Inches	Inch	Pounds	Sq. Ins.
A129	3 x 2	$\frac{3}{16}$	3.07	.90	A109	7 x 3 $\frac{1}{2}$	$\frac{7}{16}$	15.0	4.40
"	3 x 2	$\frac{1}{4}$	4.1	1.19	"	7 x 3 $\frac{1}{2}$	$\frac{1}{2}$	17.0	5.00
"	3 x 2	$\frac{5}{16}$	5.0	1.47	"	7 x 3 $\frac{1}{2}$	$\frac{9}{16}$	19.1	5.59
"	3 x 2	$\frac{3}{8}$	5.9	1.73	"	7 x 3 $\frac{1}{2}$	$\frac{5}{8}$	21.0	6.17
"	3 x 2	$\frac{7}{16}$	6.8	2.00	"	7 x 3 $\frac{1}{2}$	$\frac{11}{16}$	23.0	6.75
"	3 x 2	$\frac{1}{2}$	7.7	2.25	"	7 x 3 $\frac{1}{2}$	$\frac{3}{4}$	24.9	7.31
A131	4 x 3 $\frac{1}{2}$	$\frac{5}{16}$	7.7	2.25	"	7 x 3 $\frac{1}{2}$	$\frac{13}{16}$	26.8	7.87
"	4 x 3 $\frac{1}{2}$	$\frac{3}{8}$	9.1	2.67	"	7 x 3 $\frac{1}{2}$	$\frac{7}{8}$	28.7	8.42
"	4 x 3 $\frac{1}{2}$	$\frac{7}{16}$	10.6	3.09	"	7 x 3 $\frac{1}{2}$	$\frac{15}{16}$	30.5	8.97
"	4 x 3 $\frac{1}{2}$	$\frac{1}{2}$	11.9	3.50	"	7 x 3 $\frac{1}{2}$	1	32.3	9.50
"	4 x 3 $\frac{1}{2}$	$\frac{9}{16}$	13.3	3.90	A112	8 x 6	$\frac{1}{2}$	23.0	6.75
"	4 x 3 $\frac{1}{2}$	$\frac{5}{8}$	14.7	4.30	"	8 x 6	$\frac{9}{16}$	25.7	7.56
"	4 x 3 $\frac{1}{2}$	$\frac{11}{16}$	16.0	4.68	"	8 x 6	$\frac{5}{8}$	28.5	8.36
A135	5 x 4	$\frac{3}{8}$	11.0	3.23	"	8 x 6	$\frac{11}{16}$	31.2	9.15
"	5 x 4	$\frac{7}{16}$	12.8	3.75	"	8 x 6	$\frac{3}{4}$	33.8	9.94
"	5 x 4	$\frac{1}{2}$	14.5	4.25	"	8 x 6	$\frac{13}{16}$	36.5	10.72
"	5 x 4	$\frac{9}{16}$	16.2	4.75	"	8 x 6	$\frac{7}{8}$	39.1	11.48
"	5 x 4	$\frac{5}{8}$	17.8	5.23	"	8 x 6	$\frac{15}{16}$	41.7	12.25
"	5 x 4	$\frac{11}{16}$	19.5	5.72	"	8 x 6	1	44.2	13.00

Sections shown on page 19.

BEAM TABLES.

Tables of safe loads for beams and channels and spacings of I-Beams for floors are given with explanatory notes on pages 100 to 135.

BEAMS AS GIRDERS.

In some cases two or more beams may be bolted together side by side to form a girder, in which case cast iron separators with bolts should be used to hold the various members together. Separators should be placed at each end of the girder, at points of concentrated loading, and for uniform loading should be located at distances apart not greater than twenty times the width of the smallest beam flange, in order to laterally support the upper flanges which are in compression and prevent their failure by buckling. The separators should preferably fit closely between the beam flanges so as to unite the beams forming the girder and thereby cause them to act together in resisting the load. Tables of Standard and Special Separators are given on pages 66 and 67.

CONNECTION ANGLES.

When beams are coped or fitted together at right angles, connection angles are generally used, standards for which, covering usual cases, are shown on pages 53, 54 and 55. Explanations and tables of limiting spans for which these standards may be used are given on pages 56 to 59. Beams may be fitted together thus with flush tops or bottoms or in intermediate positions, as required in cases where the girder or trimmer beam is the larger. In cases where the girder or trimmer beam is the smaller, special stirrups or other connections are required.

LIVE LOADS FOR FLOORS.

The following loads per square foot, exclusive of weight of floor materials, show the range assumed in usual practice:

Dwellings	70 lbs. per sq. ft.
Offices	70 to 100 lbs. per sq. ft.
Buildings for public assembly.	120 to 150 lbs. per sq. ft.
Stores, warehouses, etc.	150 to 250 lbs. and upwards per sq. ft.

On page 328 are given in detail the safe loads for which floors should be designed in accordance with the building laws of various cities.

**STANDARD CONNECTION ANGLES
FOR I-BEAMS AND CHANNELS.**

FOR 3" AND 4"
BEAMS AND CHANNELS

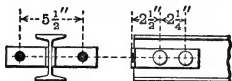

2- 6" x 4" x $\frac{3}{8}$ " ANGLES-2" LONG
WEIGHT 4.1 LBS.

FOR 5", 6" AND 7"
BEAMS AND CHANNELS

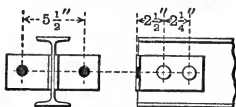

2- 6" x 4" x $\frac{3}{8}$ " ANGLES-3" LONG
WEIGHT 6.2 LBS.

FOR 8", 9" AND 10"
BEAMS AND CHANNELS

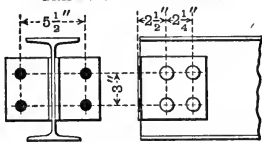

2- 6" x 4" x $\frac{3}{8}$ " ANGLES-5 $\frac{1}{2}$ " LONG
WEIGHT 11.3 LBS.

FOR 12"
BEAMS AND CHANNELS

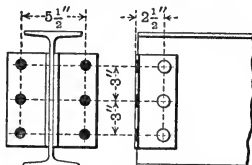

2- 4" x 4" x $\frac{7}{16}$ " ANGLES-8 $\frac{1}{2}$ " LONG
WEIGHT 16.1 LBS.

FOR 15", 18" AND 20"
BEAMS AND CHANNELS

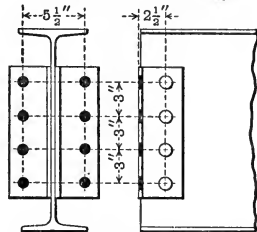

2- 4" x 4" x $\frac{7}{16}$ " ANGLES-11 $\frac{1}{2}$ " LONG
WEIGHT 21.7 LBS.

FOR 24" BEAMS

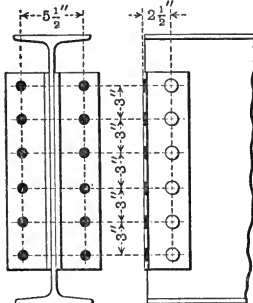

2- 4" x 4" x $\frac{1}{2}$ " ANGLES-17 $\frac{1}{2}$ " LONG
WEIGHT 37.4 LBS.

All rivets and bolts to be $\frac{3}{4}$ " diameter; all open holes $\frac{13}{16}$ " diameter.

**LOCATION OF CONNECTION ANGLES FOR
STANDARD BEAMS OF THE SAME OR DIFFERENT
SIZES FRAMING OPPOSITE,
BOTTOMS OR TOPS FLUSH.**

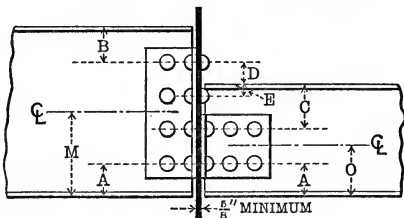

Depth of Beams		M	O	A	B	C	D	E
Inches								
Main Beam	Opposite Beam	Inches	Inches	Inches	Inches	Inches	Inches	Inches
3	3	1½	1½	1½	1½	1½
4	3	1½	1½	1½	2½	1½
4	4	2	2	2	2	2
5	4	2⅛	2⅛	2⅛	2⅞	1⅞
5	5	2½	2½	2½	2½	2½
6	4	2⅜	2⅜	2⅜	3⅝	1⅝
6	5	2½	2½	2½	3½	2½
6	6	3	3	3	3	3
7	4	2⅜	2⅜	2⅜	4⅝	1⅝
7	5	2½	2½	2½	4½	2½
7	6	2½	2½	2½	4½	3½
7	7	3½	3½	3½	3½	3½
8	4	3⅝	2⅛	2⅛	2⅞	1⅞	1⅛
8	5	4	2½	2½	2½	3½	½
8	6	4	2½	2½	2½	3½	½
8	7	4	2½	2½	2½	4½	½
8	8	4	4	2½	2½	2½
9	5	4	2½	2½	3½	2½	½
9	6	4	2½	2½	3½	3½	½
9	7	4	2½	2½	3½	4½	1½
9	8	4	4	2½	3½	2½
9	9	4½	4½	3	3	3
10	5	4	2½	2½	4½	2½	½
10	6	4	2½	2½	4½	3½	½
10	7	4	2½	2½	4½	4½	1½
10	8	4	4	2½	4½	2½
10	9	4	4	2½	4½	3½
10	10	5	5	3½	3½	3½

**LOCATION OF CONNECTION ANGLES FOR
STANDARD BEAMS OF THE SAME OR DIFFERENT
SIZES FRAMING OPPOSITE,
BOTTOMS OR TOPS FLUSH.**

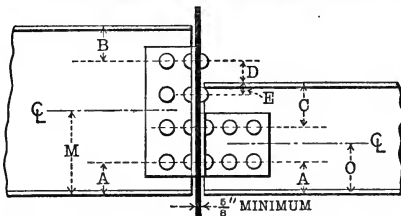

Depth of Beams		M	O	A	B	C	D	E
Inches								
Main Beam	Opposite Beam	Inches	Inches	Inches	Inches	Inches	Inches	Inches
12	8*	5 $\frac{3}{4}$	4 $\frac{1}{4}$	2 $\frac{3}{4}$	3 $\frac{1}{4}$	2 $\frac{1}{4}$	$\frac{3}{4}$
12	9*	5 $\frac{3}{4}$	4 $\frac{1}{4}$	2 $\frac{3}{4}$	3 $\frac{1}{4}$	3 $\frac{1}{4}$	$\frac{1}{4}$
12	10	5 $\frac{3}{4}$	4 $\frac{1}{4}$	2 $\frac{3}{4}$	3 $\frac{1}{4}$	4 $\frac{1}{4}$	1 $\frac{1}{4}$
12	12	6	6	3	3	3
15	8*	7 $\frac{1}{4}$	4 $\frac{1}{4}$	2 $\frac{3}{4}$	3 $\frac{1}{4}$	2 $\frac{1}{4}$	$\frac{3}{4}$
15	9*	7 $\frac{1}{4}$	4 $\frac{1}{4}$	2 $\frac{3}{4}$	3 $\frac{1}{4}$	3 $\frac{1}{4}$	2 $\frac{3}{4}$	$\frac{1}{4}$
15	10	7 $\frac{1}{4}$	4 $\frac{1}{4}$	2 $\frac{3}{4}$	3 $\frac{1}{4}$	4 $\frac{1}{4}$	1 $\frac{3}{4}$	1 $\frac{1}{4}$
15	12*	7 $\frac{1}{2}$	6	3	3	3	0	0
15	15	7 $\frac{1}{2}$	7 $\frac{1}{2}$	3	3	3
18	8*	7 $\frac{1}{4}$	4 $\frac{1}{4}$	2 $\frac{3}{4}$	6 $\frac{1}{4}$	2 $\frac{1}{4}$	$\frac{3}{4}$
18	9*	7 $\frac{1}{4}$	4 $\frac{1}{4}$	2 $\frac{3}{4}$	6 $\frac{1}{4}$	3 $\frac{1}{4}$	2 $\frac{3}{4}$	$\frac{1}{4}$
18	10	7 $\frac{1}{4}$	4 $\frac{1}{4}$	2 $\frac{3}{4}$	6 $\frac{1}{4}$	3 $\frac{1}{4}$	1 $\frac{3}{4}$	1 $\frac{1}{4}$
18	12*	7 $\frac{1}{2}$	6	3	6	3	0	0
18	15	7 $\frac{1}{2}$	7 $\frac{1}{2}$	3	6	3
18	18	9	9	4 $\frac{1}{2}$	4 $\frac{1}{2}$	4 $\frac{1}{2}$
20	8*	7 $\frac{3}{8}$	4 $\frac{3}{8}$	2 $\frac{7}{8}$	8 $\frac{1}{8}$	2 $\frac{1}{8}$	$\frac{7}{8}$
20	9*	7 $\frac{1}{2}$	4 $\frac{1}{2}$	3	8	3	0	0
20	10*	8	5	3 $\frac{1}{2}$	7 $\frac{1}{2}$	3 $\frac{1}{2}$	2 $\frac{1}{2}$	0 $\frac{1}{2}$
20	12*	7 $\frac{1}{2}$	6	3	8	3	0	0
20	15	7 $\frac{1}{2}$	7 $\frac{1}{2}$	3	8	3
20	18	9	9	4 $\frac{1}{2}$	6 $\frac{1}{2}$	4 $\frac{1}{2}$
20	20	10	10	5 $\frac{1}{2}$	5 $\frac{1}{2}$	5 $\frac{1}{2}$
24	8*	10 $\frac{3}{8}$	4 $\frac{3}{8}$	2 $\frac{7}{8}$	6 $\frac{1}{8}$	2 $\frac{1}{8}$	$\frac{7}{8}$
24	9*	10 $\frac{1}{2}$	4 $\frac{1}{2}$	3	6	3	0	0
24	10*	11	5	3 $\frac{1}{2}$	5 $\frac{1}{2}$	3 $\frac{1}{2}$	2 $\frac{1}{2}$	0 $\frac{1}{2}$
24	12*	10 $\frac{1}{2}$	6	3	6	3	0	0
24	15*	10 $\frac{1}{2}$	7 $\frac{1}{2}$	3	6	3	0	0
24	18	12	9	4 $\frac{1}{2}$	4 $\frac{1}{2}$	4 $\frac{1}{2}$	1 $\frac{1}{2}$	1 $\frac{1}{2}$
24	20	13 $\frac{1}{2}$	10 $\frac{1}{2}$	6	3	5	1	2
24	24	12	12	4 $\frac{1}{2}$	4 $\frac{1}{2}$	4 $\frac{1}{2}$

*Opposite beam must be set back one inch to clear rivet heads.

STANDARD CONNECTION ANGLES FOR I-BEAMS AND CHANNELS.

Standard connection angles for all sizes of beams and channels are shown on page 53. These are of sufficient strength for all usual connections of the various sizes shown, figured on the basis of $\frac{3}{4}$ inch rivets or bolts and the following allowable unit stresses in pounds per square inch.

Stress.	Shop Rivets.	Field Rivets or Turned Bolts.	Field Rough Bolts.
Single Shear.....	12000	10000	8000
Bearing—One Side...	24000	20000	16000
“ —Enclosed...	30000	20000	16000

In cases where beams frame opposite, the web between outstanding legs of standard connection angles should not be less than $\frac{5}{8}$ inch thick.

When beams of very short spans are loaded to their full capacity, the end shear or reaction which has to be transmitted through the connections becomes so great that stronger connections than the standard should be used.

The following tables give the limits of length below which the standard connections do not apply and for which special designs should be made. For all lengths greater than those given in the tables the standard connections are sufficiently strong.

MINIMUM SPANS OF CHANNELS FOR LIMITING VALUES OF STANDARD CONNECTION ANGLES.

Channel.			Web Con- nec- tion.	Outstanding Legs Connection.			
				Field Rivets.		Field Bolts.	
Section Number.	Depth.	Weight per Foot.	Enclosed Bearing Shop Rivets.	Single Shear Rivets or Turned Bolts.	Minimum Span.	Single Shear Rough Bolts.	Minimum Span.
	Inches.	Pounds.	Pounds.	Pounds.	Feet.	Pounds.	Feet.
C 5	3	4.0	7650	8840	.8	7070	.9
“	“	5.0	11700	“	.8	“	1.0
“	“	6.0	16200	“	.9	“	1.1
C 9	4	5.25	8100	8840	1.3	7070	1.5
“	“	6.25	11250	“	1.3	“	1.6
“	“	7.25	14850	“	1.4	“	1.8
C 13	5	6.5	8550	8840	1.9	7070	2.3
“	“	9.0	14850	“	2.2	“	2.7
“	“	11.5	21600	“	2.6	“	3.2

MINIMUM SPANS OF CHANNELS FOR LIMITING VALUES OF STANDARD CONNECTION ANGLES.

Channel.			Web Connection.	Outstanding Legs Connection.			
Section Number.	Depth.	Weight per Foot.		Enclosed Bearing Shop Rivets.	Field Rivets.		Field Bolts.
	Inches.	Pounds.	Pounds.		Single Shear Rivets or Turned Bolts.	Minimum Span.	Single Shear Rough Bolts.
				Pounds.	Feet.	Pounds.	Feet.
C 17	6	8.0	9000	8840	2.7	7070	3.3
"	"	10.5	14400	"	3.1	"	3.8
"	"	13.0	19800	"	3.5	"	4.4
"	"	15.5	25200	"	4.0	"	5.0
C 21	7	9.75	9450	8840	3.7	7070	4.6
"	"	12.25	14400	"	4.2	"	5.3
"	"	14.75	18900	"	4.7	"	5.9
"	"	17.25	23850	"	5.2	"	6.5
"	"	19.75	28350	"	5.8	"	7.2
C 25	8	11.25	19800	17670	2.5	14140	3.1
"	"	13.75	27900	"	2.8	"	3.4
"	"	16.25	36000	"	3.1	"	3.8
"	"	18.75	44100	"	3.4	"	4.2
"	"	21.25	52200	"	3.6	"	4.5
C 29	9	13.25	20700	17670	3.2	14140	4.0
"	"	15.00	26100	"	3.5	"	4.3
"	"	20.00	40500	"	4.1	"	5.1
"	"	25.00	54900	"	4.8	"	6.0
C 33	10	15.0	21600	17670	4.1	14140	5.1
"	"	20.0	34200	"	4.8	"	6.0
"	"	25.0	47700	"	5.5	"	6.9
"	"	30.0	61200	"	6.3	"	7.8
"	"	35.0	73800	"	7.0	"	8.8
C 41	12	20.5	18900	26510	6.1	21210	6.1
"	"	25.0	26320	"	4.9	"	6.1
"	"	30.0	34420	"	5.5	"	6.8
"	"	35.0	43200	"	6.0	"	7.6
"	"	40.0	51300	"	6.6	"	8.3
C 53	15	33.0	36000	35340	6.3	28280	7.9
"	"	35.0	38700	"	6.5	"	8.1
"	"	40.0	46800	"	7.0	"	8.8
"	"	45.0	55800	"	7.6	"	9.5
"	"	50.0	64800	"	8.1	"	10.2
"	"	55.0	73800	"	8.7	"	10.9

MINIMUM SPANS OF I-BEAMS FOR LIMITING VALUES OF STANDARD CONNECTION ANGLES.

I-Beam.			Web Con- nec- tion.	Outstanding Legs Connection.			
Section Number.	Depth.	Weight per Foot.		Enclosed Bearing Shop Rivets.	Field Rivets.		Field Bolts.
	Inches.	Pounds.	Pounds.		Single Shear Rivets or Turned Bolts.	Minimum Span.	Single Shear Rough Bolts.
				Pounds.	Feet.	Pounds.	Feet.
B 5	3	5.5	7650	8840	1.2	7070	1.3
"	"	6.5	11700	"	1.1	"	1.4
"	"	7.5	16200	"	1.2	"	1.5
B 9	4	7.5	8550	8840	1.8	7070	2.3
"	"	8.5	11700	"	2.0	"	2.4
"	"	9.5	15300	"	2.1	"	2.6
"	"	10.5	18450	"	2.2	"	2.7
B 13	5	9.75	9450	8840	3.0	7070	3.7
"	"	12.25	16200	"	3.3	"	4.2
"	"	14.75	22500	"	3.7	"	4.6
B 17	6	12.25	10350	8840	4.4	7070	5.5
"	"	14.75	15750	"	4.9	"	6.1
"	"	17.25	21150	"	5.3	"	6.6
B 21	7	15.00	11250	8840	6.3	7070	7.9
"	"	17.50	15750	"	6.8	"	8.5
"	"	20.00	20700	"	7.3	"	9.1
B 25	8	18.00	24300	17670	4.3	14140	5.4
"	"	20.25	31500	"	4.6	"	5.7
"	"	22.75	39600	"	4.9	"	6.1
"	"	25.25	47700	"	5.2	"	6.5
B 29	9	21.0	26100	17670	5.7	14140	7.2
"	"	25.0	36900	"	6.2	"	7.8
"	"	30.0	51300	"	6.9	"	8.6
"	"	35.0	65700	"	7.5	"	9.4
B 33	10	25.0	27900	17670	7.4	14140	9.3
"	"	30.0	40500	"	8.1	"	10.2
"	"	35.0	54000	"	8.9	"	11.1
"	"	40.0	67500	"	9.6	"	12.0
B 41	12	31.5	23625	26510	8.2	21210	9.1
"	"	35.0	29700	"	7.7	"	9.6
"	"	40.0	37800	"	8.3	"	10.4
B 105	12	40.0	31050	26510	9.1	21210	11.3
"	"	45.0	39150	"	9.6	"	12.0
"	"	50.0	47250	"	10.2	"	12.8
"	"	55.0	48600	"	10.8	"	13.5

MINIMUM SPANS OF I-BEAMS FOR LIMITING VALUES OF STANDARD CONNECTION ANGLES.

I-Beam.		Web Connection.	Outstanding Legs Connection.				
Section Number.	Depth.		Weight per Foot.	Enclosed Bearing Shop Rivets.	Field Rivets.		Field Bolts.
	Inches.	Pounds.			Pounds.	Single Shear Rivets or Turned Bolts.	Minimum Span.
				Pounds.	Feet.	Pounds.	Feet.
B 153	15	42.0	36900	35340	8.9	28280	11.2
"	"	45.0	41400	"	9.2	"	11.5
"	"	50.0	50400	"	9.8	"	12.2
"	"	55.0	59400	"	10.3	"	12.9
"	"	60.0	67500	"	10.9	"	13.6
B 109	15	60.0	53100	35340	12.3	28280	15.4
"	"	65.0	62100	"	12.8	"	16.0
"	"	70.0	70200	"	13.4	"	16.7
"	"	75.0	79200	"	14.0	"	17.4
"	"	80.0	88200	"	14.5	"	18.1
B 113	*15	80.0	72000	35340	15.9	28280	19.9
"	"	85.0	81000	"	16.5	"	20.6
"	"	90.0	89100	"	17.0	"	21.3
"	"	95.0	98100	"	17.6	"	22.0
"	"	100.0	107100	"	18.1	"	22.6
B 65	18	55.0	41400	35340	13.4	28280	16.7
"	"	60.0	50400	"	14.2	"	17.7
"	"	65.0	57600	"	14.8	"	18.5
"	"	70.0	64800	"	15.5	"	19.4
B 73	20	65.0	45000	35340	17.7	28280	22.1
"	"	70.0	52200	"	18.5	"	23.0
"	"	75.0	58500	"	19.2	"	24.0
B 121	20	80.0	54000	35340	22.2	28280	27.7
"	"	85.0	59400	"	22.8	"	28.5
"	"	90.0	66600	"	23.6	"	29.4
"	"	95.0	72900	"	24.3	"	30.3
"	"	100.0	79200	"	25.0	"	31.3
B 89	24	80.0	67500	53020	17.6	42410	21.9
"	"	85.0	76950	"	18.2	"	22.8
"	"	90.0	85050	"	18.8	"	23.5
"	"	95.0	93150	"	19.4	"	24.2
"	"	100.0	101250	"	20.0	"	25.0
B 127	24	105.0	85050	53020	23.6	42410	29.5
"	"	110.0	93150	"	24.2	"	30.3
"	"	115.0	101250	"	24.8	"	31.0

*Interior web edges of standard connection angles must be chamfered to avoid interference with beam web fillets.

STANDARD SPACING OF RIVET AND BOLT HOLES THROUGH FLANGES AND CONNECTION ANGLES OF I-BEAMS, AND TANGENT DISTANCES BETWEEN FILLETS MEASURED ALONG THE WEB.

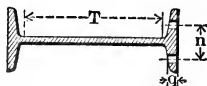
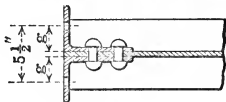

Depth of Beam Ins.	Wt. per Ft. Lbs.	n	g	q	T	Depth of Beam Ins.	Wt. per Ft. Lbs.	n	g	q	T
		Ins.	Ins.	In.	Ins.			Ins.	Ins.	Ins.	In.
3	5.5	$1\frac{7}{16}$	$2\frac{3}{8}$	$\frac{1}{4}$	$1\frac{11}{16}$	15	42.0	3	$2\frac{3}{8}$	$\frac{5}{8}$	$12\frac{1}{8}$
"	6.5	"	$2\frac{5}{8}$	"	"	"	45.0	"	$2\frac{1}{2}$	"	"
"	7.5	"	$2\frac{3}{4}$	"	"	"	50.0	"	$2\frac{1}{2}$	"	"
"	"	"	"	"	"	"	55.0	"	$2\frac{3}{8}$	"	"
4	7.5	$1\frac{1}{2}$	$2\frac{3}{8}$	$\frac{5}{16}$	$2\frac{11}{16}$	"	60.0	"	$2\frac{3}{8}$	"	"
"	8.5	"	$2\frac{5}{8}$	"	"	"	"	"	"	"	"
"	9.5	"	$2\frac{1}{2}$	"	"	15	60.0	$3\frac{1}{4}$	$2\frac{3}{8}$	$\frac{7}{8}$	$11\frac{3}{4}$
"	10.5	"	$2\frac{1}{2}$	"	"	"	65.0	"	$2\frac{3}{8}$	"	"
"	"	"	"	"	"	"	70.0	"	$2\frac{3}{8}$	"	"
"	"	"	"	"	"	"	75.0	"	$2\frac{1}{4}$	"	"
5	9.75	$1\frac{3}{4}$	$2\frac{5}{8}$	$\frac{5}{16}$	$3\frac{9}{16}$	"	80.0	"	$2\frac{1}{4}$	"	"
"	12.25	"	$2\frac{9}{16}$	"	"	"	"	"	"	"	"
"	14.75	"	$2\frac{1}{2}$	"	"	"	"	"	"	"	"
6	12.25	2	$2\frac{5}{8}$	$\frac{3}{8}$	$4\frac{7}{16}$	15	80.0	$3\frac{3}{4}$	$2\frac{1}{2}$	$1\frac{1}{8}$	$10\frac{11}{16}$
"	14.75	"	$2\frac{9}{16}$	"	"	"	85.0	"	$2\frac{1}{8}$	"	"
"	17.25	"	$2\frac{1}{2}$	"	"	"	90.0	"	$2\frac{1}{4}$	"	"
"	"	"	"	"	"	"	95.0	"	$2\frac{3}{8}$	"	"
"	"	"	"	"	"	"	100.0	"	$2\frac{3}{8}$	$1\frac{1}{8}$	"
7	15.00	$2\frac{1}{4}$	$2\frac{5}{8}$	$\frac{3}{8}$	$5\frac{5}{16}$	"	"	"	"	"	"
"	17.50	"	$2\frac{9}{16}$	"	"	"	"	"	"	"	"
"	20.00	"	$2\frac{1}{2}$	"	"	18	55.0	$3\frac{1}{4}$	$2\frac{1}{2}$	$\frac{1}{2}$	$15\frac{3}{16}$
"	"	"	"	"	"	"	60.0	"	$2\frac{1}{2}$	"	"
8	18.00	$2\frac{1}{4}$	$2\frac{5}{8}$	$\frac{7}{16}$	$6\frac{3}{16}$	"	65.0	"	$2\frac{1}{8}$	"	"
"	20.25	"	$2\frac{9}{16}$	"	"	"	70.0	"	$2\frac{3}{8}$	"	"
"	22.75	"	$2\frac{1}{2}$	"	"	"	"	"	"	"	"
"	25.25	"	$2\frac{1}{2}$	"	"	"	"	"	"	"	"
9	21.0	$2\frac{1}{2}$	$2\frac{1}{2}$	$\frac{1}{2}$	$7\frac{1}{16}$	20	65.0	$3\frac{1}{2}$	$2\frac{1}{2}$	$\frac{1}{2}$	$16\frac{7}{8}$
"	25.0	"	$2\frac{1}{2}$	"	"	"	70.0	"	$2\frac{1}{2}$	"	"
"	30.0	"	$2\frac{1}{2}$	"	"	"	75.0	"	$2\frac{1}{2}$	"	"
"	35.0	"	$2\frac{3}{8}$	"	"	20	80.0	4	$2\frac{1}{8}$	$\frac{1}{2}$	$16\frac{1}{8}$
"	"	"	"	"	"	"	85.0	"	$2\frac{1}{8}$	"	"
10	25.0	$2\frac{5}{8}$	$2\frac{1}{2}$	$\frac{1}{2}$	$7\frac{15}{16}$	"	90.0	"	$2\frac{3}{8}$	"	"
"	30.0	"	$2\frac{1}{2}$	"	"	"	95.0	"	$2\frac{1}{2}$	"	"
"	35.0	"	$2\frac{1}{8}$	"	"	"	100.0	"	$2\frac{5}{16}$	"	"
"	40.0	"	$2\frac{3}{8}$	"	"	"	"	"	"	"	"
12	31.5	$2\frac{3}{4}$	$2\frac{1}{8}$	$\frac{1}{2}$	$9\frac{11}{16}$	24	80.0	4	$2\frac{1}{2}$	$\frac{7}{8}$	$20\frac{11}{16}$
"	35.0	"	$2\frac{1}{8}$	"	"	"	85.0	"	$2\frac{1}{8}$	"	"
"	40.0	"	$2\frac{1}{8}$	"	"	"	90.0	"	$2\frac{1}{8}$	"	"
"	"	"	$2\frac{1}{2}$	"	"	"	95.0	"	$2\frac{1}{2}$	"	"
"	"	"	"	"	"	"	100.0	"	$2\frac{3}{8}$	"	"
12	40.0	3	$2\frac{1}{2}$	$\frac{1}{2}$	$9\frac{5}{16}$	"	80.0	4	$2\frac{1}{2}$	$\frac{7}{8}$	$20\frac{11}{16}$
"	45.0	"	$2\frac{1}{2}$	"	"	"	85.0	"	$2\frac{1}{8}$	$1\frac{1}{8}$	$20\frac{1}{8}$
"	50.0	"	$2\frac{1}{2}$	"	"	24	105.0	4	$2\frac{1}{2}$	"	"
"	55.0	"	$2\frac{1}{2}$	"	"	"	110.0	"	$2\frac{1}{2}$	"	"
"	"	"	"	"	"	"	115.0	"	$2\frac{3}{8}$	"	"

**STANDARD SPACING OF RIVET AND BOLT HOLES
IN FLANGES AND CONNECTION ANGLES OF
CHANNELS, AND TANGENT DISTANCES BE-
TWEEN FILLETS MEASURED ALONG THE WEB.**

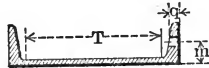
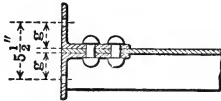

Depth of Channel	Wt. per Ft.	m	g	q	T	Depth of Channel	Wt. per Ft.	m	g	q	T
Ins.	Lbs.	Ins.	Ins.	In.	Ins.	Ins.	Lbs.	Ins.	Ins.	In.	Ins.
3	4.0	$\frac{13}{16}$	$2\frac{21}{32}$	$\frac{1}{4}$	$1\frac{13}{16}$	10	15.0	$1\frac{1}{2}$	$2\frac{5}{8}$	$\frac{7}{16}$	$8\frac{1}{16}$
"	5.0	"	$2\frac{5}{8}$	$\frac{3}{32}$	"	"	20.0	$2\frac{1}{16}$	$2\frac{1}{2}$	"	"
"	6.0	"	$2\frac{1}{16}$	"	"	"	25.0	2	$2\frac{1}{2}$	"	"
"	"	"	"	"	"	"	30.0	"	$2\frac{1}{2}$	"	"
4	5.25	1	$2\frac{21}{32}$	$\frac{5}{16}$	$2\frac{11}{16}$	"	35.0	"	$2\frac{1}{2}$	"	"
"	6.25	"	$2\frac{5}{8}$	"	"	"	"	"	$2\frac{1}{2}$	"	"
"	7.25	"	$2\frac{1}{2}$	"	"	"	"	"	$2\frac{1}{2}$	"	"
"	"	"	"	"	"	12	20.5	$1\frac{3}{4}$	$2\frac{5}{8}$	$\frac{1}{2}$	$9\frac{11}{16}$
"	"	"	"	"	"	"	25.0	"	$2\frac{1}{16}$	"	"
5	6.5	1	$2\frac{21}{32}$	$\frac{5}{16}$	$3\frac{5}{8}$	"	30.0	2	$2\frac{1}{2}$	"	"
"	9.0	$1\frac{1}{4}$	$2\frac{1}{2}$	"	"	"	35.0	"	$2\frac{1}{16}$	"	"
"	11.5	"	$2\frac{1}{2}$	"	"	"	40.0	"	$2\frac{3}{8}$	"	"
"	"	"	"	"	"	"	"	"	"	"	"
6	8.0	$1\frac{1}{8}$	$2\frac{31}{32}$	$\frac{3}{8}$	$4\frac{1}{2}$	"	"	"	"	"	"
"	10.5	"	$2\frac{1}{2}$	"	"	13	32.0	$2\frac{3}{4}$	$2\frac{9}{16}$	$\frac{9}{16}$	$10\frac{3}{8}$
"	13.0	$1\frac{3}{8}$	$2\frac{1}{2}$	"	"	"	35.0	"	$2\frac{1}{2}$	"	"
"	15.5	"	$2\frac{1}{2}$	"	"	"	37.0	3	$2\frac{1}{2}$	"	"
"	"	"	"	"	"	"	40.0	"	$2\frac{1}{2}$	"	"
7	9.75	$1\frac{1}{4}$	$2\frac{5}{8}$	$\frac{3}{8}$	$5\frac{7}{16}$	"	45.0	"	$2\frac{1}{2}$	"	"
"	12.25	"	$2\frac{1}{2}$	"	"	"	50.0	"	$2\frac{1}{2}$	"	"
"	14.75	"	$2\frac{1}{2}$	"	"	"	55.0	"	$2\frac{1}{2}$	"	"
"	17.25	$1\frac{1}{2}$	$2\frac{1}{2}$	"	"	"	"	"	$2\frac{1}{2}$	"	"
"	19.75	"	$2\frac{7}{16}$	"	"	"	"	"	"	"	"
"	"	"	"	"	"	15	33.0	$1\frac{7}{8}$	$2\frac{9}{16}$	$\frac{5}{8}$	$12\frac{3}{8}$
"	"	"	"	"	"	"	35.0	"	$2\frac{1}{2}$	"	"
8	11.25	$1\frac{1}{4}$	$2\frac{5}{8}$	$\frac{3}{8}$	$6\frac{5}{16}$	"	40.0	"	$2\frac{1}{2}$	"	"
"	13.75	"	$2\frac{1}{2}$	"	"	"	45.0	"	$2\frac{1}{16}$	"	"
"	16.25	$1\frac{1}{2}$	$2\frac{1}{16}$	"	"	"	50.0	$2\frac{1}{4}$	$2\frac{3}{8}$	"	"
"	18.75	"	$2\frac{1}{2}$	"	"	"	55.0	"	$2\frac{1}{2}$	"	"
"	21.25	"	$2\frac{1}{2}$	"	"	"	"	"	$2\frac{1}{2}$	"	"
"	"	"	"	"	"	"	"	"	"	"	"
9	13.25	$1\frac{3}{8}$	$2\frac{5}{8}$	$\frac{7}{16}$	$7\frac{1}{4}$	18	45.0	$2\frac{1}{4}$	$2\frac{1}{2}$	$\frac{7}{8}$	15
"	15.00	"	$2\frac{1}{2}$	"	"	"	50.0	"	$2\frac{1}{2}$	"	"
"	20.00	$1\frac{3}{4}$	$2\frac{1}{2}$	"	"	"	55.0	"	$2\frac{1}{16}$	"	"
"	25.00	"	$2\frac{7}{16}$	"	"	"	60.0	"	$2\frac{3}{8}$	"	"

MAXIMUM SIZE OF RIVETS IN FLANGES OF BEAMS AND CHANNELS.

I-BEAMS.						CHANNELS.		
Depth of Beam.	Weight.	Diameter of Rivets.	Depth of Beam.	Weight.	Diameter of Rivets.	Depth of Channel.	Weight.	Diameter of Rivets.
Inches.	Lbs. per Ft.	Inch.	Inches.	Lbs. per Ft.	Inch.	Inches.	Lbs. per Ft.	Inch.
3	5.50	$\frac{3}{8}$	15	42.0	$\frac{3}{4}$	3	4.00	$\frac{1}{2}$
4	7.50	$\frac{1}{2}$	15	60.0	"	4	5.25	"
5	9.75	"	15	80.0	$\frac{7}{8}$	5	6.50	"
6	12.25	$\frac{5}{8}$	18	55.0	"	6	8.00	$\frac{3}{8}$
7	15.00	$\frac{3}{4}$	20	65.0	"	7	9.75	"
8	18.00	$\frac{3}{4}$	20	80.0	"	8	11.25	$\frac{3}{4}$
9	21.00	"	24	80.0	"	9	13.25	"
10	25.00	"	24	105.0	"	10	15.00	"
12	31.50	"				12	20.50	$\frac{7}{8}$
12	40.00	"				15	33.00	"

STANDARD SPACING OF RIVET AND BOLT HOLES IN ANGLES, WITH MAXIMUM

RIVETS IN SIZE OF RIVETS TO BE USED.

CRIMPED ANGLES

CLEARANCE
FOR RIVETING

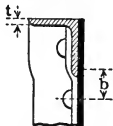

$$b = 2t + 1\frac{1}{2}''$$

MINIMUM 2''

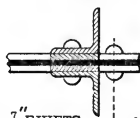
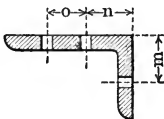

FOR $\frac{7}{8}''$ RIVETS $\rightarrow 1\frac{1}{4}''$
 .. $\frac{3}{4}''$.. $\rightarrow 1\frac{1}{8}''$

ANGLES.

Length of Leg.	m	Diam. of Rivet.	Length of Leg.	m	Diam. of Rivet.	Length of Leg.	m	n	o	Diam. of Rivet.
Ins.	Ins.	Ins.	Ins.	Ins.	Ins.	Ins.	Ins.	Ins.	Ins.	Ins.
$\frac{3}{4}$	$\frac{1}{2}$	$\frac{1}{4}$	2	$1\frac{1}{8}$	$\frac{5}{8}$	4	$2\frac{1}{2}$	$\frac{7}{8}$
1	$\frac{5}{8}$	"	$2\frac{1}{4}$	$1\frac{1}{4}$	$\frac{3}{4}$	$4\frac{1}{2}$	"	2	$1\frac{1}{2}$	"
$1\frac{1}{4}$	$\frac{3}{4}$	$\frac{3}{8}$	$2\frac{1}{2}$	$1\frac{3}{8}$	"	5	3	"	$1\frac{3}{4}$	"
$1\frac{3}{8}$	$\frac{7}{8}$	"	$2\frac{3}{4}$	$1\frac{5}{8}$	"	6	$3\frac{1}{2}$	$2\frac{1}{2}$	$2\frac{1}{4}$	"
$1\frac{1}{2}$	"	"	3	$1\frac{3}{4}$	$\frac{7}{8}$	7	"	"	3	1
$1\frac{3}{4}$	1	$\frac{1}{2}$	$3\frac{1}{2}$	2	"	8	$4\frac{1}{2}$	3	"	$1\frac{1}{8}$

BEARING PLATES FOR SHAPES USED AS BEAMS.

Shapes used as beams resting on masonry walls or piers will generally require bearing plates of steel or their equivalents, set in or upon the masonry to properly distribute the load thereon with due regard to the allowable safe pressures for the class of stonework or brickwork in question.

A table of bearing plates is given on page 65, which gives the bearing values in pounds for plates of various sizes based on the safe unit pressure allowable for different classes of masonry. As the strength of masonry varies largely according to the qualities of the material used, the workmanship and age, it is impossible to give absolute figures for safe unit pressures for all classes of work, but the values given on page 64 are believed to fairly represent these for the usual kinds of ordinary architectural masonry. The strength of ordinary masonry generally depends upon the crushing value of the mortar or cement used and does not bear any fixed relation to the ultimate strength of the brick or stone entering into the construction.

The table of bearing plates gives the bearing values of various sizes of plates when used with different classes of masonry, but the thickness of the plate should be computed for each case.

For a plate of given length and breadth the thickness depends upon the allowable load and unit stress, and the width of the flange of the beam or channel resting upon it.

The thickness may be determined by the following formula

$$t = .866 (l - b) \sqrt{\frac{R}{pb^2l}}$$

t = thickness of plate in inches.

l = length of plate in inches, in a direction perpendicular to the axis of the beam or channel.

b = width of flange of beam or channel in inches.

R = reaction at point of support in pounds.

For uniformly distributed loads, R = one-half of the load given in Tables of Safe Loads, pages 106 to 123 inclusive.

p = allowable stress in pounds per square inch on extreme fibre of plate.

b' = width of plate in the direction of the axis of the beam or channel; *i. e.*, bearing on wall in inches.

If $p = 16\ 000$ lbs. for steel we have

$$t = .00685 (l - b) \sqrt{\frac{R}{b^2l}}$$

EXAMPLE.

What is the proper size of steel bearing plate to be used in a wall of brick laid in cement mortar to support the end of a 10-inch standard I-Beam, weighing 40 pounds per foot, of 10 foot span, subjected to its safe load uniformly distributed?

On page 109 in the Table of Safe Loads Uniformly Distributed for Cambria I-Beams, the total load is found to be 33 850 pounds, and half of this, or 16 925 pounds, will be the reaction at each end.

On referring to the Table of Bearing Plates, on page 65, the proper size for this load on the class of masonry in question is found to be 6" x 10". The width of flange of a 10-inch 40 lb. standard beam is 5.10 inches.

Substituting these values in the formula for thickness gives

$$t = .00685 (10 - 5.10) \sqrt{\frac{16\ 925}{6 \times 10}} = .562$$

The nearest commercial size above this is $\frac{5}{8}$ inch, which is the thickness required.

If a shorter plate would suit the location better it may be seen from the table that a plate 8" x 8" will give the necessary bearing value and the thickness of this would be

$$t = .00685 (8 - 5.10) \sqrt{\frac{16\ 925}{8 \times 8}} = .323$$

and the nearest commercial size above this is $\frac{3}{8}$ ", which is the thickness required.

STANDARD BEARINGS AND BEARING PLATES.

Size of Beams and Channels.	Bearing.	Bearing Plate.		
		Dimensions.	Weight.	Area.
Inches.	Inches.	Inches.	Pounds.	Sq. Inches.
3	6	6 x 6 x $\frac{3}{8}$	3.9	36
4	6	6 x 6 x $\frac{3}{8}$	"	36
5	6	6 x 6 x $\frac{3}{8}$	"	36
6	6	6 x 6 x $\frac{3}{8}$	"	36
7	8	8 x 8 x $\frac{1}{2}$	9.1	64
8	8	8 x 8 x $\frac{1}{2}$	"	64
9	8	8 x 8 x $\frac{1}{2}$	"	64
10	12	12 x 12 x $\frac{3}{4}$	30.6	144
12	12	12 x 12 x $\frac{3}{4}$	"	144
15	12	12 x 15 x $\frac{3}{4}$	38.3	180
18	15	15 x 15 x $\frac{7}{8}$	55.8	225
20	15	15 x 18 x 1	76.5	270
24	15	15 x 18 x 1	"	270

SAFE BEARING VALUES OF WALL PLATES FOR VARIOUS STYLES OF MASONRY.

Material.	Pounds per Sq. In.	Tons per Sq. Ft.
Rubble Masonry in Cement Mortar.	250	18.0
Brickwork " " "	300	21.6
First Class Sandstone (Dimension Stone) . .	400	28.8
" " Limestone	500	36.0
" " Granite	600	43.2
Portland Cement Concrete 1 : 2 : 4	600	43.2
" " " 1 : 2 : 5	500	36.0

BEARING PLATES FOR I-BEAMS AND CHANNELS.

Bearing on Wall.	Size of Plate.	Safe Bearing Value of Plate in 1000 Pounds.						
		Rubble in Cement	Brick in Cement	Sand-stone.	Lime-stone.	Granite.	Concrete. 1:2:4.	Concrete. 1:2:5.
		250 lbs. per sq. in.	300 lbs. per sq. in.	400 lbs. per sq. in.	500 lbs. per sq. in.	600 lbs. per sq. in.	600 lbs. per sq. in.	500 lbs. per sq. in.
Ins.	Ins.							
4	4 x 4	4.0	4.8	6.4	8.0	9.6	9.6	8.0
4	4 x 6	6.0	7.2	9.6	12.0	14.4	14.4	12.0
4	4 x 8	8.0	9.6	12.8	16.0	19.2	19.2	16.0
6	6 x 6	9.0	10.8	14.4	18.0	21.6	21.6	18.0
6	6 x 8	12.0	14.4	19.2	24.0	28.8	28.8	24.0
6	6 x 10	15.0	18.0	24.0	30.0	36.0	36.0	30.0
8	8 x 8	16.0	19.2	25.6	32.0	38.4	38.4	32.0
8	8 x 10	20.0	24.0	32.0	40.0	48.0	48.0	40.0
8	8 x 12	24.0	28.8	38.4	48.0	57.6	57.6	48.0
10	10 x 10	25.0	30.0	40.0	50.0	60.0	60.0	50.0
10	10 x 12	30.0	36.0	48.0	60.0	72.0	72.0	60.0
10	10 x 14	35.0	42.0	56.0	70.0	84.0	84.0	70.0
12	12 x 12	36.0	43.2	57.6	72.0	86.4	86.4	72.0
12	12 x 14	42.0	50.4	67.2	84.0	100.8	100.8	84.0
12	12 x 15	45.0	54.0	72.0	90.0	108.0	108.0	90.0
12	12 x 16	48.0	57.6	76.8	96.0	115.2	115.2	96.0
12	12 x 18	54.0	64.8	86.4	108.0	129.6	129.6	108.0
14	14 x 14	49.0	58.8	78.4	98.0	117.6	117.6	98.0
14	14 x 16	56.0	67.2	89.6	112.0	134.4	134.4	112.0
14	14 x 18	63.0	75.6	100.8	126.0	151.2	151.2	126.0
14	14 x 20	70.0	84.0	112.0	140.0	168.0	168.0	140.0
15	15 x 15	56.2	67.5	90.0	112.5	125.0	135.0	112.5
15	15 x 18	67.5	81.0	108.0	135.0	162.0	162.0	135.0
16	16 x 16	64.0	76.8	102.4	128.0	153.6	153.6	128.0
16	16 x 18	72.0	86.4	115.2	144.0	172.8	172.8	144.0
16	16 x 20	80.0	96.0	127.0	160.0	192.0	192.0	160.0
16	16 x 22	88.0	105.6	139.8	176.0	211.2	211.2	176.0
18	18 x 18	81.0	97.2	129.6	162.0	194.4	194.4	162.0
18	18 x 20	90.0	108.0	144.0	180.0	216.0	216.0	180.0
18	18 x 22	99.0	118.8	158.4	198.0	237.6	237.6	198.0
18	18 x 24	108.0	129.6	172.8	216.0	259.2	259.2	216.0
20	20 x 20	100.0	120.0	160.0	200.0	240.0	240.0	200.0
20	20 x 22	110.0	132.0	176.0	220.0	264.0	264.0	220.0
20	20 x 24	120.0	144.0	192.0	240.0	288.0	288.0	240.0
20	20 x 26	130.0	156.0	208.0	260.0	312.0	312.0	260.0

Safe Bearing Value of Plate = Area of Plate (in square inches) X Allowable Safe Bearing Value (per square inch) on the Masonry.

STANDARD CAST IRON SEPARATORS FOR I-BEAMS.

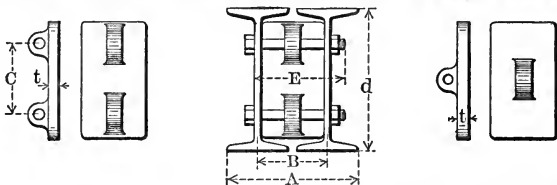

Section Number.	Beams.				Separators.			Bolts, Square Heads and Hex. Nuts.				
	Depth.	Weight per Foot.	Out to Out of Flanges of Beams.	Center to Center of Beams.	Thickness.	Weight.	Increase of Weight for each inch additional spread of Beams.	Diameter.	Center to Center of Bolts.	Length.	Weight of Bolts and Nuts.	Increase of Weight of Bolts for each in. additional spread of Beams.
	d		A	B	t			C	E			
	Ins.	Pounds.	Inches.	Inches.	In.	Pounds.	Pounds.	In.	Ins.	Ins.	Pounds.	Pound.

SEPARATORS WITH ONE BOLT.

B 5	3	5.5	5 $\frac{5}{8}$	3	$\frac{3}{8}$	1.0	.17	$\frac{3}{8}$		4	.95	.123
B 9	4	7.5	5 $\frac{7}{8}$	3 $\frac{1}{4}$	"	1.3	.26	"		4 $\frac{1}{2}$	1.01	"
B 13	5	9.75	6 $\frac{1}{2}$	3 $\frac{1}{2}$	"	1.8	.36	"		4 $\frac{3}{4}$	1.04	"
B 17	6	12.25	7 $\frac{5}{8}$	4	$\frac{1}{2}$	3.0	.59	"		5 $\frac{1}{4}$	1.11	"
B 21	7	15.0	7 $\frac{7}{8}$	4 $\frac{1}{4}$	"	3.3	.65	"		5 $\frac{1}{2}$	1.14	"
B 25	8	18.0	8 $\frac{1}{2}$	4 $\frac{1}{2}$	"	3.8	.72	"		5 $\frac{3}{4}$	1.17	"
B 29	9	21.0	9 $\frac{5}{16}$	5	"	5.0	.85	"		6 $\frac{1}{4}$	1.23	"
B 33	10	25.0	9 $\frac{7}{8}$	5 $\frac{1}{4}$	"	7.0	.98	"		6 $\frac{1}{2}$	1.26	"
B 41	12	31.5	10 $\frac{3}{4}$	5 $\frac{3}{4}$	"	7.5	1.14	"		7	1.32	"
B 105	12	40.0	11 $\frac{1}{8}$	6	"	7.5	1.14	"		7 $\frac{1}{2}$	1.38	"

SEPARATORS WITH TWO BOLTS.

B 41	12	31.5	10 $\frac{3}{4}$	5 $\frac{3}{4}$	$\frac{1}{2}$	7.8	1.20	$\frac{3}{4}$	6 $\frac{1}{2}$	7	2.64	.246
B 105	12	40.0	11 $\frac{1}{8}$	6	"	7.8	1.20	"	"	7 $\frac{1}{2}$	2.76	"
B 53	15	42.0	11 $\frac{3}{4}$	6 $\frac{1}{4}$	"	11.5	1.50	"	7	7 $\frac{3}{4}$	2.82	"
B 109	15	60.0	12 $\frac{1}{2}$	6 $\frac{1}{2}$	"	11.5	1.50	"	"	8 $\frac{1}{4}$	2.95	"
B 113	15	80.0	13	6 $\frac{3}{4}$	"	11.5	1.50	"	"	9	3.13	"
B 65	18	55.0	12 $\frac{3}{4}$	6 $\frac{3}{4}$	$\frac{5}{8}$	16.5	2.38	"	9	8 $\frac{1}{2}$	2.95	"
B 73	20	65.0	13 $\frac{1}{4}$	7	"	17.5	2.60	"	10	8 $\frac{3}{2}$	3.01	"
B 121	20	80.0	14 $\frac{1}{8}$	7 $\frac{1}{4}$	"	17.5	2.60	"	"	9 $\frac{1}{4}$	3.19	"
B 89	24	80.0	14 $\frac{3}{4}$	7 $\frac{3}{4}$	"	25.5	3.25	"	12	9 $\frac{1}{4}$	3.19	"
B 127	24	105.0	16	8 $\frac{1}{8}$	"	25.5	3.25	"	"	9 $\frac{1}{2}$	3.26	"

Lengths and weights of separator bolts in above table are for girders composed of two beams of minimum section as shown. Lengths of bolts for intermediate and maximum sizes of beams may be obtained by adding twice the increase of web thickness to the lengths given.

SPECIAL CAST IRON SEPARATORS FOR I-BEAMS.

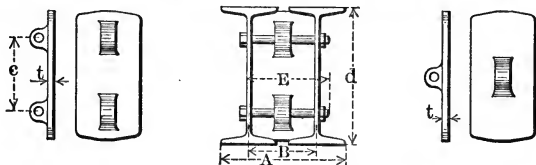

Beams.				Separators.			Bolts, Square Heads and Hex. Nuts.					
Section Number.	Depth. d	Weight per Foot.	Out to Out of Flanges of Beams.	Center to Center of Beams.	Thickness. t	Weight.	Increase of Weight for each inch additional spread of Beams.	Diameter.	Center to Center of Bolts.	Length.	Weight of Bolts and Nuts.	Increase of Weight of Bolts for each in. additional spread of Beams.
			A	B					C			
	Ins.	Pounds.	Inches.	Inches.	In.	Pounds.	Pounds.	In.	Ins.	Ins.	Pounds.	Pound

SEPARATORS WITH ONE BOLT.

B 5	3	5.5	5 ⁵ / ₁₆	3	3 ³ / ₈	1.1	.29	3 ⁴ / ₈		4	.95	.123
B 9	4	7.5	5 ⁷ / ₈	3 ¹ / ₄	"	1.6	.33	"		4 ¹ / ₂	1.01	"
B 13	5	9.75	6 ² / ₂	3 ¹ / ₂	"	2.0	.49	"		4 ³ / ₄	1.04	"
B 17	6	12.25	7 ⁵ / ₁₆	4	1 ¹ / ₂	3.3	.78	"		5 ¹ / ₄	1.11	"
B 21	7	15.0	7 ⁷ / ₈	4 ¹ / ₄	"	3.9	.92	"		5 ¹ / ₂	1.14	"
B 25	8	18.0	8 ¹ / ₂	4 ¹ / ₂	"	4.7	1.06	"		5 ³ / ₄	1.17	"
B 29	9	21.0	9 ⁵ / ₁₆	5	"	5.9	1.20	"		6 ¹ / ₂	1.23	"
B 33	10	25.0	9 ⁷ / ₈	5 ¹ / ₄	"	6.8	1.33	"		6 ¹ / ₂	1.26	"
B 41	12	31.5	10 ³ / ₄	5 ³ / ₄	"	8.8	1.61	"		7	1.32	"
B 105	12	40.0	11 ¹ / ₄	6	"	8.9	1.53	"		7 ¹ / ₂	1.38	"

SEPARATORS WITH TWO BOLTS.

B 41	12	31.5	10 ³ / ₄	5 ³ / ₄	1 ¹ / ₂	9.5	1.61	3 ⁴ / ₈	6 ¹ / ₂	7	2.64	.246
B 105	12	40.0	11 ¹ / ₄	6	"	9.5	1.58	"	"	7 ¹ / ₂	2.76	"
B 53	15	42.0	11 ³ / ₄	6 ¹ / ₄	"	12.5	2.02	"	7	7 ³ / ₄	2.82	"
B 109	15	60.0	12 ³ / ₄	6 ³ / ₄	"	13.0	1.97	"	"	8 ¹ / ₄	2.95	"
B 113	15	80.0	13 ⁵ / ₈	7 ¹ / ₄	"	13.2	1.91	"	"	9	3.13	"
B 65	18	55.0	12 ³ / ₄	6 ³ / ₄	5 ⁵ / ₈	19.8	2.41	"	9	8 ¹ / ₄	2.95	"
B 73	20	65.0	13 ¹ / ₄	7	"	22.9	3.37	"	10	8 ³ / ₂	3.01	"
B 121	20	80.0	14 ³ / ₄	7 ³ / ₄	"	24.6	3.34	"	"	9 ¹ / ₄	3.19	"
B 89	24	80.0	14 ³ / ₄	7 ³ / ₄	"	30.3	4.07	"	12	9 ¹ / ₄	3.19	"
B 127	24	105.0	16 ¹ / ₂	8 ⁵ / ₈	"	32.5	4.07	"	"	9 ¹ / ₂	3.26	"

Lengths and weights of separator bolts in above table are for girders composed of two beams of minimum section as shown. Lengths of bolts for intermediate and maximum sizes of beams may be obtained by adding twice the increase of web thickness to the lengths given.

FIREPROOF CONSTRUCTION.

Buildings of fireproof construction consist essentially of a steel frame or skeleton to support the floors, and in the case of high buildings, the outside walls also are carried by the steel framing. All parts of the steel work are enclosed and protected by some fire-resisting material, which should be of such quality and arrangement as not to disintegrate or fall away when heated to high temperatures and at the same time exposed to a stream of cold water. The fireproofing for the floors, in addition to its ability to afford a fireproof protection to the steel beams, must be capable of supporting the load and distributing it to the floor beams, which in turn transmit it to the columns and thence to the foundations.

One of the earlier forms of floors consists of brick arches built between and supported by the bottom flanges and lower portions of the web of iron or steel I-Beams, but this style has considerable dead weight and, as ordinarily constructed, does not provide fireproof protection for the bottom flanges of the beams. Another of the earlier forms of floor is composed of sheets of corrugated iron arched between the beams, on which a concrete filling is placed, and this also, as ordinarily constructed, does not provide protection for the bottom flanges of the beams, besides, it is quite heavy.

A later style of floor is the hollow tile system, which is composed of flat or segmental arches constructed of moulded blocks of hard burned clay, specially shaped, and of various depths to suit different loads and the sizes of the I-Beams supporting them. In the hollow tile system, the blocks may also be of porous terra-cotta which is lighter than hard clay.

Various other systems of fireproofing are now in use, the most usual forms of which consist of cement, concrete or other material used alone or deposited or arranged about a strengthening or supporting framework of steel shapes, bars, rods, wire, wire-cloth, etc.

Column or girder fireproofing may be accomplished by the use of hard clay or porous terra-cotta blocks shaped to fit and enclose the steel work, or the steel may be wrapped with wire, wire-cloth, metal lath, etc., and a concrete or plastered coating applied to it.

Fireproof partitions may be constructed of hollow tile composed of hard clay or porous terra-cotta to which the plaster finish may be directly applied, or they may be composed of suitable metal studding on which is secured the wire-cloth or metal lath that serves to support the concrete or other fireproofing, the surface then being plastered in the usual manner.

The dead weights of fireproof floors vary between wide limits dependent upon the system employed, the load to be carried and the distance between the supporting beams.

**WEIGHTS OF HOLLOW TILE FLOOR ARCHES
AND FIREPROOF MATERIALS.**

END CONSTRUCTION, FLAT ARCH.

Width of Span between Beams.	Depth of Arch.	Weight per Square Foot.
5 feet to 6 feet.	8 inches.	27 pounds.
6 " 7 "	9 "	29 "
7 " 8 "	10 "	33 "
8 " 9 "	12 "	38 "

HOLLOW BRICK FOR FLAT ARCHES.

(SIDE CONSTRUCTION.)

Width of Span between Beams.	Depth of Arch.	Weight per Square Foot.
3 feet 6 inches to 4 feet 0 inches.	6 inches.	27 pounds.
4 " 0 " 4 " 6 "	7 "	29 "
4 " 6 " 5 " 0 "	8 "	32 "
5 " 6 " 6 " 0 "	9 "	36 "
6 " 0 " 6 " 6 "	10 "	39 "
6 " 6 " 7 " 0 "	12 "	44 "

PARTITIONS.

	Thickness.	Weight per Square Foot.
Hollow Brick (Clay) Partitions.	2 inches.	11 pounds.
" " " "	3 "	14 "
" " " "	4 "	15 "
" " " "	5 "	19 "
" " " "	6 "	20 "
" " " "	8 "	27 "
Porous Terra-Cotta Partitions.	3 "	16 "
" " " "	4 "	19 "
" " " "	5 "	22 "
" " " "	6 "	23 "
" " " "	8 "	33 "

FURRING, ROOFING AND CEILING.

	Thickness.	Weight per Square Foot.
Porous Terra-Cotta Furring.	2 inches.	8 pounds.
" " " Roofing.	2 "	12 "
" " " "	3 "	14 "
" " " "	4 "	18 "
" " " Ceiling.	2 "	11 "
" " " "	3 "	14 "
" " " "	4 "	18 "

6-inch Segmental Arches, 26½ pounds per square foot.

8- " " " " 32 " " " " "

2- " Porous Terra-Cotta Partition, 8 pounds per square foot.

8'' x 3¼'' x 2¼'' Hollow Brick, 3000 lbs. per 1000.

TABLES OF SAFE LOADS—TERRA COTTA FLOOR ARCHES.

The Table of Safe Loads for Flat Arches, page 71, is applicable to all shapes of blocks. The areas given are obtained by passing a plane through the blocks at right angles to all the webs and are the areas for 1-foot width of arch. Generally speaking, end construction blocks of various shapes, but of the same depth and cross sectional area, have equal strength. The weight of the arch has not been deducted in Table of Safe Loads for Flat Arches. Therefore, this and other dead loads must be deducted to obtain the net safe live load for any arch and span.

EXAMPLE.—What load will an 8-inch arch carry (using a Factor of Safety of 5), for a span of 5 feet 6 inches, the blocks having a sectional area parallel to the beams, of 44.25 square inches?

Area of 8-inch block in Table = 37 sq. ins.

$44.25 \div 37 = 1.19$, Ratio of Actual Area to Tabular Area.

Safe Load in Table = 228, $\times 1.19 = 271$ pounds = Safe Load for Actual Area.

Weight of Arch = $44.25 \times 12 = 531$ cu. in. $\times .06 = 32$ lbs. per sq. ft.

$271 - 32 = 239$ lbs. = Safe Load in lbs. per sq. ft. for S. F. of 7.

$271 \times 7 \div 5 = 379$, $- 32 = 347$ lbs., Safe Load for S. F. of 5.

Tables of Safe Loads for Segmental Arches in spans up to 10 feet are given on pages 72 and 73. The areas of the blocks for which the safe loads are given are the areas per foot of arch parallel with beams. The weight of the arch blocks has been deducted in the Table, so that only the dead load of concrete fill, plastering, etc., must be deducted to obtain net live load.

Segmental arch construction is cheaper than flat arch construction, and is the stronger of the two. Where for any reason a flat arch is not deemed necessary, this is an admirable floor construction to use.

Even with this type of construction, the flat ceiling may be secured by suspending a metal lath ceiling below the arch from the bottom of the beams. To do this, however, adds so much to the cost that it is generally cheaper to use the Flat Arch.

Segmental Arches can also be built with a raised skew. This flattens the arch and reduces the amount and consequently the expense of the cinder concrete fill, but it also reduces the strength of the arch.

In Segmental Arches, the thrust on the beams (particularly at the bottom of beams) is very great, and where there is any doubt of the beams' sustaining the thrust, it is desirable to use steel tie rods. These tie rods may be fireproofed or left unprotected, the best practice being to protect them.

SAFE LOADS FOR FLAT FLOOR ARCHES OF SEMI-POROUS TERRA COTTA.

As given by manufacturers of this material.

Safety Factor 7.

ARCHES.	6 ins.	7 ins.	8 ins.	9 ins.	10 ins.	12 ins.	15 ins.
AREAS.	Square Inches.						
	31	34	37	40	43	49	58
SPANS.	Pounds per Square Foot.						
1 Ft. 6 In.	1928	2468	3069	3733	4459	6097	9022
2 " 0 "	1085	1388	1726	2100	2508	3430	5075
2 " 6 "	694	888	1104	1344	1605	2195	3248
3 " 0 "	482	617	767	933	1114	1524	2255
3 " 3 "	410	525	650	795	950	1299	1922
3 " 6 "	354	453	563	685	819	1120	1657
3 " 9 "	308	394	491	597	713	975	1443
4 " 0 "	271	347	431	525	627	857	1268
4 " 3 "	240	307	382	465	555	759	1124
4 " 6 "	214	274	341	414	495	677	1002
4 " 9 "	192	246	306	372	444	608	900
5 " 0 "	<u>173</u>	222	276	336	401	548	812
5 " 3 "	157	201	250	304	364	497	736
5 " 6 "	143	183	228	277	331	453	671
5 " 9 "	131	<u>168</u>	208	254	303	415	614
6 " 0 "	120	154	191	233	278	381	563
6 " 3 "	111	142	176	215	256	351	519
6 " 6 "		131	163	198	237	324	480
6 " 9 "		121	<u>151</u>	184	220	301	445
7 " 0 "		113	140	<u>171</u>	204	280	414
7 " 6 "			122	<u>149</u>	<u>178</u>	243	360
8 " 0 "			107	131	156	214	317
8 " 6 "				116	138	190	281
9 " 0 "				103	123	<u>169</u>	250
9 " 6 "					111	<u>152</u>	225
10 " 0 "					100	137	<u>203</u>
10 " 6 "						124	<u>184</u>
11 " 0 "						113	167
11 " 6 "						103	153
12 " 0 "						95	141

Above Safe Loads include weight of arch blocks and other dead load. Average weight of arch blocks (lbs. per sq. ft. of arch) = Sectional Area \times 12 \times .06.
Below heavy lines, spans should be used for ceiling arches only.

SAFE LOADS FOR TERRA COTTA SEGMENTAL FLOOR ARCHES.

As given by manufacturers of this material.

Weight of Arch Blocks not included.

Factor of Safety 7.

ARCHES.		4 ins.	6 ins.	8 ins.	10 ins.
AREAS.		Square Inches.			
		28	36	43	47
SPANS.	RISE.	Pounds per Square Foot.			
Ft.-ins.	Inches.				
4-0	$\frac{3}{4}$	702	902	1078	1178
	1	920	1148	1414	1545
	$1\frac{1}{4}$	1155	1485	1774	1939
	$1\frac{1}{2}$	1353	1740	2079	2272
	$1\frac{3}{4}$	1545	1986	2373	2593
	2	1736	2233	2667	2915
4-6	$\frac{3}{4}$	616	792	946	1034
	1	812	1044	1247	1363
	$1\frac{1}{4}$	1020	1313	1568	1713
	$1\frac{1}{2}$	1196	1539	1833	2009
	$1\frac{3}{4}$	1381	1775	2121	2318
	2	1536	1975	2359	2578
5-0	$\frac{3}{4}$	551	709	847	926
	1	744	951	1143	1249
	$1\frac{1}{4}$	911	1172	1400	1530
	$1\frac{1}{2}$	1072	1379	1647	1800
	$1\frac{3}{4}$	1238	1592	1902	2078
	2	1379	1773	2118	2315
5-6	$\frac{3}{4}$	499	641	766	837
	1	672	864	1032	1128
	$1\frac{1}{4}$	826	1062	1269	1387
	$1\frac{1}{2}$	984	1266	1512	1652
	$1\frac{3}{4}$	1119	1439	1719	1879
	2	1258	1619	1933	2118
6-0	$\frac{3}{4}$	455	585	699	764
	1	612	788	941	1028
	$1\frac{1}{4}$	753	969	1157	1265
	$1\frac{1}{2}$	898	1154	1379	1507
	$1\frac{3}{4}$	1022	1315	1570	1716
	2	1148	1476	1763	1927
6-6	$\frac{3}{4}$	428	551	658	719
	1	562	724	864	944
	$1\frac{1}{4}$	701	902	1077	1177
	$1\frac{1}{2}$	823	1058	1264	1382
	$1\frac{3}{4}$	947	1218	1455	1590
	2	1055	1358	1622	1772
7-0	$\frac{3}{4}$	394	508	606	662
	1	520	669	799	873
	$1\frac{1}{4}$	648	834	996	1089

SAFE LOADS FOR TERRA COTTA SEGMENTAL FLOOR ARCHES.

As given by manufacturers of this material.

Weight of Arch Blocks not included.

Factor of Safety 7.

ARCHES.		4 ins.	6 ins.	8 ins.	10 ins.
AREAS.		Square Inches.			
		28	36	43	47
SPANS.	RISE.	Pounds per Square Foot.			
Ft.-ins.	Inches.				
7-0	1½	762	981	1171	1280
	1¾	876	1127	1346	1471
	2	983	1264	1510	1650
7-6	¾	366	471	563	615
	1	482	621	741	810
	1¼	602	774	925	1011
	1½	715	920	1099	1201
	1¾	815	1049	1253	1369
2	915	1176	1405	1536	
8-0	¾	341	439	525	573
	1	457	588	703	768
	1¼	562	724	864	944
	1½	668	859	1026	1122
	1¾	767	987	1179	1288
2	854	1099	1312	1434	
8-6	¾	319	411	491	536
	1	428	551	658	719
	1¼	527	678	810	885
	1½	626	806	963	1052
	1¾	719	926	1106	1208
2	807	1037	1239	1354	
9-0	¾	300	386	461	504
	1	408	518	619	677
	1¼	501	645	770	842
	1½	590	758	906	990
	1¾	677	871	1041	1137
2	759	977	1167	1276	
9-6	¾	283	364	435	475
	1	380	489	584	638
	1¼	472	608	726	793
	1½	561	721	862	942
	1¾	639	823	983	1074
2	717	923	1102	1204	
10-0	¾	267	344	411	449
	1	359	462	552	603
	1¼	447	576	688	751
	1½	531	683	816	892
	1¾	610	784	937	1024
2	683	879	1050	1147	

TESTS OF FLOOR ARCHES.

A summary of the principal data and results of tests which were the subject of a paper entitled "Tests of Fire-proof Flooring Material," published in the *Transactions of the American Society of Civil Engineers*, Vols. xxxiv and xxxv, is given in the following table:

BREAKING LOAD OF HOLLOW TILE ARCHES.

Depth of Arch.	Rise.	Span.	Length.	Total Load.	Load per Sq. Foot.	Total Horizontal Thrust.	Horizontal Thrust per Ft. of Arch.	BLOCKS.		Character of Load.	Manner of Laying Joints.
								Style.	Material.		
Ins.	Ins.	Ins.	Ins.	Lbs.	Lbs.	Lbs.	Arch.				
6.	3.5	60	48.	13750	688	29474	7369	E	Hard	Dis.	Port.
7.5	5.	46	11.5	9000	2452	10367	10818	"	"	"	N.M.
7.5	5.	60	35.2	11250		33750	11505	"	"	Cen.	Port.
7.5	5.	60	36.5	13000		39000	12822	"	Porous	"	"
8.	7.	60	38.25	14500		31071	9747	"	"	"	"
8.	7.	60	38.25	15750		33750	10588	"	Hard	"	"
12.	10.	60	41.	16400		24600	7200	"	"	"	"
12.	8.75	60	10.	3100		5314	6377	"	"	"	N.M.
12.	9.	60	10.	5000		8333	10000	"	"	"	"
12.	9.	60	10.	15100	3630	12583	15100	"	"	Dis.	"
12.	9.5	60	10.	2500		3947	4736	"	"	Cen.
8.	5.5	46	11.5	2500	681	2614	2727	S	"	Dis.	N.M.
8.	5.	45	11.5	1300	362	1463	1526	"	"	"	"
8.	6.	60	36.	10000		25000	8333	"	"	Cen.	Port.
8.	5.	60	36.	5700	380	8550	2850	"	"	Dis.	"
8.	5.	60	12.	3500	700	5250	5250	"	"	"	N.M.
8.	5.5	60	12.	10000	2000	13636	13636	"	"	"	"
8.	5.5	60	12.	2500		6818	6818	"	"	Cen.	"
8.	5.5	60	24.	9950	995	13568	6784	"	"	Dis.	"
8.	5.5	60	24.	2500		6818	3209	"	"	Cen.	"
10.	7.5	60	36.	13500	900	13500	4500	"	"	Dis.	Port.
10.	8.	60	37.	14500	940	13594	4408	"	"	"

NOTE.—In the above table the following abbreviations are used: "E," End Construction; "S," Side Construction; "Hard," Hard Clay; "Porous," Porous Terra-Cotta; "Dis.," Distributed Load; "Cen.," Concentrated Load at Center; "Port.," Portland Cement, and "N. M.," No Mortar.

The Loads per Sq. Foot in the above table were obtained in all cases by dividing the Total Load by the superficial area of the arch in square feet. The Horizontal Thrust for Distributed and Central Loads was obtained by formulæ similar to those given therefor on the following page, and for Central Loads this is double that for a Distributed Load of the same weight.

THRUST OF ARCHES.

The horizontal thrust of segmental floor arches, on the assumption of uniform loading, may be found by the following formula:

$$T = \frac{3WL^2}{2R}$$

in which

T = pressure or thrust in pounds per lineal foot of arch.

W = load on arch in pounds per square foot, uniformly distributed.

L = span of arch in feet.

R = rise of segmental arch in inches.

For a concentrated load at the center, of weight P, the thrust

$$T = \frac{3PL}{R}$$

For arches with flat tops and bottoms, such as are used in floors, the voussoir joints on each side of the central key are usually laid out on parallel lines, and in these cases the thrust may be determined approximately by using for R, in the above formula, the effective depth of the arch, which is somewhat less than the nominal depth, as indicated on page 77.

For segmental arches the rise R is the vertical distance from the highest part of the intrados to the plane of the springing line. If the radius of the intrados for segmental arches is r, the rise may be obtained from the following formula:

$$R = r - \sqrt{r^2 - \frac{L^2}{4}}$$

$$\text{conversely, } r = \frac{R}{2} + \frac{L^2}{8R}$$

TIE RODS.

Although in the completed structure the horizontal thrusts of adjoining arches may counterbalance each other, the tie rods should be so proportioned and spaced as to withstand the entire thrust of the arches, thus tying the structure together and facilitating the construction.

SPACING OF TIE RODS FOR TILE ARCHES.

The table on the next page was computed from the following formula, which was obtained from that giving the thrust of arches on page 75.

$$B = \frac{A \times R \times 10\,000}{WL^2}$$

in which

B = spacing of tie rods in feet.

A = net area of rod in square inches.

R = rise of arch in inches.

W = load in pounds per square foot of the arch.

L = span of arch in feet.

The above formula gives the spacing of tie rods corresponding to a tensile stress in the rods of 15 000 pounds per square inch, without considering the flexure of the beams.

In spacing tie rods, the lateral strength of beams, for flexure due to the thrust of the arches, should be taken into consideration, explanations for which are given on pages 78 to 81 inclusive.

Spacings for other loads than that of the table may be found by proportion, thus:

Required spacing =

$$\frac{100 + \text{weight of arch in pounds per square foot}}{\text{New load in lbs. per sq. ft.} + \text{weight of arch in lbs. per sq. ft.}} \times \text{spacing from table.}$$

Weights of tile arches per square foot are given on page 69.

As noted under the heading "Lateral Strength of Beams," on pages 82 and 83, care should be taken that the spacing of tie rods is not greater than twenty times the least flange width, otherwise the safe loads should be reduced to compensate for the strains produced by flexure of the upper flange considered as a column in compression.

SPACING OF TIE RODS FOR TILE ARCHES IN FEET.

For a uniform load of 100 lbs. per square foot in addition to the weight of the arch.

Span of Arch.	Diameter of Tie Rods.	Nominal Depth of Arch. Inches.					
		6	7	8	9	10	12
		Effective Depth or Rise of Arch. Inches.					
Feet.	Inch.	3.6	4.6	5.6	6.6	7.6	9.6
3	$\frac{5}{8}$	6.4	8.0	9.5	10.9	12.3	15.0
"	$\frac{3}{4}$	9.5	12.0	14.2	16.3	18.3	22.4
"	$\frac{7}{8}$	13.2	16.6	19.8	22.6	25.5	31.1
4	$\frac{5}{8}$	3.6	4.5	5.4	6.1	6.9	8.4
"	$\frac{3}{4}$	5.4	6.7	8.0	9.2	10.3	12.6
"	$\frac{7}{8}$	7.4	9.4	11.1	12.7	14.3	17.5
5	$\frac{5}{8}$	2.3	2.9	3.4	3.9	4.4	5.4
"	$\frac{3}{4}$	3.4	4.3	5.1	5.9	6.6	8.0
"	$\frac{7}{8}$	4.8	6.0	7.1	8.1	9.2	11.2
6	$\frac{5}{8}$..	2.0	2.4	2.7	3.1	3.7
"	$\frac{3}{4}$..	3.0	3.6	4.1	4.6	5.6
"	$\frac{7}{8}$..	4.2	4.9	5.7	6.4	7.8
7	$\frac{5}{8}$	2.0	2.3	2.8
"	$\frac{3}{4}$	3.0	3.4	4.1
"	$\frac{7}{8}$	4.2	4.7	5.7
8	$\frac{5}{8}$	1.7	2.1
"	$\frac{3}{4}$	2.6	3.1
"	$\frac{7}{8}$	3.6	4.4

Spacings below heavy lines apply to greater spans than are recommended for that depth of arch.

LATERAL STRENGTH OF BEAMS TO RESIST FLEXURE DUE TO THRUST OF ARCHES, ETC.

In special cases where the thrust of a floor arch is exerted against a beam, channel, angle or other shape without other lateral support than the tie rods, or braces, this will produce lateral flexure and stresses in addition to those caused by the vertical loading. Throughout the body of the floor the thrusts of the adjoining arches, when completed, will usually counterbalance each other, but in the outer beams around shafts or elsewhere, if unsupported sideways, the stresses due to the lateral forces should be considered.

The total allowable stress per square inch for the extreme fibres of beams has been placed at 16 000 pounds per square inch, and in order that this may not be exceeded owing to lateral stresses, the stress due to vertical loading should be correspondingly reduced so that the resultant intensity shall not exceed the allowable limit. This may be calculated by considering the beam as continuous and laterally supported at intervals by the tie rods, the spans being equal to the spacing of the rods.

In this case the fibre stress due to the lateral forces is:

$$p' = \frac{wx_1B^2}{I'} \quad (1)$$

in which

p' = fibre stress in pounds per square inch due to lateral forces.

w = lateral load or thrust in pounds per lineal foot of section used as a beam.

x_1 = distance of the extreme fibre from the neutral axis in inches.

B = distance between tie rods or lateral supports in feet.

I' = moment of inertia about the vertical axis of the section or that one at right angles to the line of application of the lateral forces.

For I-Beams with the web placed vertically, as usual, x_1 becomes equal to $\frac{b}{2}$, where b is the width of the flange in inches.

In this case the above formula for intensity of unit stress due to lateral load becomes:

$$p' = \frac{wbB^2}{2I'} \quad (2)$$

In order that the total resultant intensity of unit stress shall not exceed the allowable limit of 16 000 pounds per square inch, the stress due to vertical loading must be reduced by the amount of the intensity of stress due to the horizontal thrust of the arch, as determined by formula (2).

If p' represents the intensity of unit stress due to the horizontal thrust of the arch, and p the corresponding allowable intensity of unit stress due to the vertical loading, then

$$* p = 16\,000 - p'$$

Having thus obtained the reduced vertical stress p , the safe vertical load of the tables corresponding to this stress should accordingly be reduced by multiplying it by the ratio $\frac{p}{16\,000}$ and similarly for other stresses and corresponding loads, thus making proper allowance for the additional stresses produced by the lateral forces.

If the reduction of the safe loads on this account is a considerable proportion of the original amount due to vertical loading only, it would be more economical to provide lateral braces or tie rods at shorter intervals, thus avoiding the use of an excessive amount of material in the beam.

As the stresses due to vertical forces for usual cases of loading are a maximum at the center of the span it will ordinarily be sufficient to space the tie rods or braces at shorter intervals near the center in order to allow for the combined stresses due to vertical loading and horizontal thrusts.

The above method of calculation is not exact when considering the lateral thrust of arches, or loads from similar materials which do not exert a uniform pressure throughout their surfaces of contact with the sustaining beam on account of the friction and bond of their component parts, but this analysis of the stresses may serve as a guide in designing.

The above formulæ should be used in connection with the tables and formula given on pages 82 and 83 relating to the lateral strength of beams, due to compression of the upper flange figured as a column between points of lateral support.

* This method of treatment gives approximate results which are on the side of safety.

The correct determination can be secured by the use of the section modulus polygon. (See Transactions of the American Society of Civil Engineers, Vol. LVI, 1906, page 169, *et seq.*)

EXAMPLE.

What is the proper size of I-Beam without other lateral support than the usual tie rods, corresponding to a total fibre stress of 16 000 pounds per square inch under the following conditions? The beam is 18 feet between end supports and carries a tile arch on one side having a nominal depth of 9 inches, effective depth of 6.6 inches, a span of 5 feet, designed to carry a superimposed load of 75 pounds per square foot in addition to the weight of the arch and other floor materials. The hollow tile arch weighs 36 pounds per square foot and the other materials, including plastering, weigh 14 pounds, making a total load, exclusive of the weight of the beam, equal to 125 pounds per square foot.

For tie rods of $\frac{3}{4}$ " diameter the spacing between them would be 5.9 feet, as shown by the table of Spacing of Tie Rods on page 77 in which the safe stresses in the rods only are considered.

Substituting the proper values in the formula for lateral thrust of arches, given on page 75, this will be

$$T = \frac{3 \times 125 \times 5^2}{2 \times 6.6} = 710 \text{ lbs. per lineal foot.}$$

Substituting this value for w in formula (2) page 78 and assuming a 10" beam 25 lbs. per foot, the moment of inertia of which is 6.89, as given in the Tables of Properties of I-Beams, page 182, we have

$$p' = \frac{710 \times 4.66 \times 5.9^2}{2 \times 6.89} = 8\,358 \text{ lbs. per sq. in.}$$

Therefore $p = 16\,000 - 8\,358 = 7\,642$ lbs. per sq. in.

Hence the safe load as determined by the consideration of vertical loads only, should be reduced to $\frac{7\,642}{16\,000}$, or approximately .48 of the amount given by the Tables of Safe Loads in case the spacing of the tie rods is not changed.

The safe vertical load for a 10" beam, weighing 25 lbs. per foot, 18 feet long between supports, for fibre stress of 16 000 lbs. per square inch, is 14 470 lbs. uniformly distributed, including the weight of the beam as given in the Tables of Safe Loads, on page 109, or 14 020 exclusive of the weight of the beam, and .48 of this is 6 730 lbs., which is the vertical load it can safely carry in order that the total stress due to it and the lateral thrust shall not exceed 16 000 lbs. per square inch.

The actual vertical load on the beam under consideration is as follows:

$$\frac{5}{2} \times 18 \times 125 = 5\,625 \text{ lbs.,}$$

which is less than the allowable amount, 6 730 lbs., as figured above, so that a smaller beam may suffice.

Therefore, assume a 9-inch beam, weighing 21 lbs. per foot, the moment of inertia of which about an axis coincident with center line of web is found in the Table of Properties, on p. 182, to be 5.16.

In this case

$$p' = \frac{710 \times 4.33 \times 5.9^2}{2 \times 5.16} = 10\,370 \text{ lbs. per sq. in.}$$

Substituting this in the formula for p we have

$$p = 16\,000 - 10\,370 = 5\,630 \text{ lbs. per sq. in.}$$

Therefore the safe vertical load will be $\frac{5\,630}{16\,000}$, or approximately .35 of the tabular safe load.

The safe vertical load for a 9" 21 lb. beam, 18 feet long, for a fibre stress of 16 000 lbs. per square inch is 11 180 lbs., as given in the Table of Safe Loads, on page 109, and .35 of this, after deducting weight of the beam, is 3 781 lbs., which is less than the actual amount, 5 625 lbs., as calculated above, so that the 9" 21 lb. beam will not suffice.

If the spacing of the tie rods at the center be reduced from 5.9 feet to 3.25 feet, it may be found, in a manner similar to that used in the above calculations, that the safe vertical load for an 8" I-Beam, weighing 18.0 lbs. per foot, is reduced to .74 of its tabular value of 8 430 lbs., or 6 328 lbs., and as this amount is greater than the actual load as above, namely, 5 625 lbs., the 8" beam would answer the purpose, under the changed conditions as to spacing of tie rods. As this beam might deflect beyond the limit for plastered ceilings, it should be examined in accordance with the rule or formula given for obtaining safe deflections in the explanation of the Tables of Safe Loads, and elsewhere herein.

Calculating this by the rule given on page 102, the safe load for the allowable limit of deflection is

$$W = \frac{9\,480 \times 16^2}{18^2} = 7\,491 \text{ lbs.,}$$

which is greater than the actual amount, 5 625 lbs., so that the 8" beam is sufficient and proper if the spacing of central tie rods be changed to 3.25 feet, as assumed in the last case.

**LATERAL STRENGTH OF BEAMS,
WITHOUT LATERAL SUPPORT.**

The Tables of Safe Loads for Cambria I-Beams and Channels and Tables of Spacing of Cambria I-Beams, on pages 106 to 135, are calculated on the assumption that proper provision is made for preventing lateral deflection by means of tie rods or other braces. In order to prevent undue strains in the compression flange, considered as a column, the beams should be supported laterally at distances not exceeding twenty times the flange width, this ratio being determined by the following formula, which gives the safe load for solid columns of soft steel:

$$P = \frac{18000}{1 + \frac{l^2}{3000b^2}}$$

in which

p = allowable stress in pounds per square inch.

l = length between lateral supports in inches.

b = width of flange in inches.

Substituting 16 000 for p in the above formula, which is the allowable unit stress of the safe load tables, it is found that the ratio $\frac{l}{b} = 19.37$, from which it may be seen that the compression flange should be supported laterally at distances not exceeding twenty times the flange width as stated above.

Beams which are not thus supported laterally should not be loaded to their full transverse capacity. The allowable fibre stresses and proportions of their full loads which they can safely carry when laterally supported at various distances is given in the following table:

**REDUCTION IN VALUES OF ALLOWABLE FIBRE
STRESS AND SAFE LOADS FOR SHAPES
USED AS BEAMS DUE TO LATERAL
FLEXURE.**

Ratio of Span or Distance between Lateral Supports to Flange Width.	Allowable Unit Stress for Direct Flexure in Extreme Fibre.	Proportion of Tabular Safe Load to be Used.	Ratio of Span or Distance between Lateral Supports to Flange Width.	Allowable Unit Stress for Direct Flexure in Extreme Fibre.	Proportion of Tabular Safe Load to be Used.
$\frac{l}{b}$	P		$\frac{l}{b}$	P	
19.37	16000	1.0	65	7474	.47
20	15882	.99	70	6835	.43
25	14897	.93	75	6261	.39
30	13846	.87	80	5745	.36
35	12781	.80	85	5281	.33
40	11739	.73	90	4865	.30
45	10746	.67	95	4491	.28
50	9818	.61	100	4154	.26
55	8963	.56	105	3850	.24
60	8182	.51	110	3576	.22

The above table should be used in connection with the Tables of Safe Loads Uniformly Distributed for Cambria I-Beams and Channels, on pages 106 to 123 inclusive, and limits the values found therein under the conditions given above.

EXAMPLE.

Required the safe load for a 15-inch standard I-Beam weighing 42 pounds per foot for a span of 30 feet without lateral supports:

From the data the ratio $\frac{l}{b} = \frac{30 \times 12}{5.5} = 65$.

From the above table the proportion of the safe load which the beam can safely support under these conditions is .47. From the Table of Safe Loads for I-Beams, page 111, the safe load for this beam when properly supported laterally is 20 940 pounds, which multiplied by .47 gives 9 842 pounds as the safe load uniformly distributed under the conditions given, including the weight of the beam, or 8 582 pounds superimposed load.

APPROXIMATE WEIGHTS OF VARIOUS ROOF COVERINGS.

In Pounds per Square Foot.

Copper Sheeting, B. W. G. No. 22.....	1¼
Corrugated Iron, B. W. G. Nos. 26 to 16.....	1-3¼
Felt, two Layers.....	½
Felt and Asphalt.....	2
Felt and Gravel, ⅝ inch thick.....	6½
Galvanized Iron, B. W. G. Nos. 26 to 16.....	1-3
Lath and Plaster Ceiling, Ordinary.....	6-8
Sheathing, 1 inch thick, Hemlock.....	2
" " " White Pine or Spruce.....	2½
" " " Yellow Pine.....	4
Shingles, 16 inch, laid 5½ inch to weather.....	2
Skylight Glass, ⅜ to ½ inch thick.....	2½-7
Slates, ⅜ to ⅝ inch thick, 3 inch double lap.....	4-7
Slag Roofing, 4-ply, with cement and sand.....	4
Steel Sheeting (See next page).....	¾-3
Tiles (See Page 69).....	8-20
Tin.....	¾-1
Zinc, B. W. G. No. 20.....	1½

APPROXIMATE WEIGHT OF ROOFS INCLUDING FRAMING:

Corrugated Sheets.....	8-10
Shingle.....	6-10
Slate.....	12-15
Tar and Gravel.....	10-12
Tin.....	6-8
Tile.....	20-30
If roof is plastered underneath, add to values given above.....	6

Weight of Roof Truss with span of 75 feet or less..... 5
 Snow Load—25 lbs. per horizontal square foot of roof for all slopes up to 20°, reduced 1 lb. for each degree of slope in excess of 20°. No snow load to be considered for slope of 45° or more.

WIND PRESSURE ON ROOFS.

Based on 20 Lbs. per Sq. Ft. on a Vertical Plane.

1.84 cos α - 1.

FORMULA.—Normal Pressure per sq. ft. = P sin α

Pitch of Roof.	Angle of Slope (α) with Horizontal.	Rise of Roof per Foot.	Normal Wind Pressure.
	Degrees. Minutes.	Inches.	Pounds per Sq. Ft.
1 6 4 4 3 3 2 2 3 3 4 1	18 - 25	4	8.4
	26 - 33	6	11.9
	33 - 41	8	14.6
	45 - 0	12	18.1
	53 - 7	16	19.4
	56 - 20	18	19.7
	63 - 27	24	20.0

STEEL SHEETING.

Weights given (U. S. Standard) are based on 480 lbs. per cu. ft.

Gauge Number U. S. Std.	Thickness Inch	Weight—Lbs. per Sq. Ft.				Spacing of Supports	
		Flat		Corrugated		Roof	Sides
		Black	Galvanized	BlackPainted	Galvanized	Not Over Ft.—Ins.	Not Over Ft.—Ins.
16	.0625	2.50	2.66	2.75	2.81	5 - 9	7 - 8
28	.05	2.00	2.16	2.20	2.36	5 - 9	7 - 8
20	.0375	1.50	1.66	1.65	1.82	4 - 9	6 - 8
22	.03125	1.25	1.41	1.38	1.54	3 - 9	5 - 8
24	.025	1.00	1.16	1.11	1.27	2 - 9	3 - 10
26	.01875	.75	.91	.84	.99		
28	.015625	.63	.79	.69	.86		

Standard Flat and Corrugated Sheets furnished in lengths 48, 60, 72, 84, 96, 108 and 120 inches.

Standard Flat Sheets in widths 24, 26, 28, 30 and 32 inches.

Standard Corrugated Sheets in widths as follows:

For	Width of Sheet Flat	Width of Sheet Corrugated	Width of Corrugation	Depth of Corrugation	Corrugation in Lap	Edges Laid	
	Ins.	Ins.	Ins.	Ins.		Up	Down
	Roofing ..	30	27 1/2	2 1/2		5/8	1 1/2
Roofing ..	28	26	"	"	2	2
Siding ...	28	26	"	"	1	2

Sheets should preferably be ordered in even ft. lengths to span 2 purlin spaces.

End Lap:

6 inches for Roofing, roof pitch 6 inches.

8 inches for Roofing, roof pitch 4 inches.

8 inches for Roofing, roof pitch less than 4 inches, when laid with slater's cement.

4 inches for Roofs in snowless climates and for Siding.

Ridge Roll:—No. 24 Gauge; 96-inch lengths; 3-inch end lap, standard diameter 2 1/2 inches; apron 6 inches.

Flashing:—No. 24 Gauge; 30-inch lengths; 3-inch end lap.

Corner Capping:—48-inch lengths; 4-inch end lap.

FASTENINGS.

Straps:—No. 18 U. S. Gauge Steel 3/4-inch wide; 1 strap and 2 rivets or bolts for each lineal foot of purlin or girts; 1 bundle (400 lin. ft.) straps weighs 50 pounds; 1000 rivets weigh 6 pounds.

Clinch Rivets:—Should clinch at least 1 inch; 2 rivets to each lineal foot of purlin or girt.

Purlin leg	2 inches;	2 1/2 to 3 inches;	3 1/2 inches;	4 to 4 1/2 inches.
Length	4 inches;	5 inches;	6 inches;	7 inches.
Number per pound	48	38	33	27

Clips and Bolts:—For fastening sheeting to purlins other than angle purlins when asbestos lining is used under sheeting. No. 16 steel slightly crimped. 2 clips and 2 bolts for each lineal foot of purlin or girt; 500 clips in one box. Hole for bolt 1/16" x 1".

Closing Rivets:—1/16-inch diameter; 3/8, 1/2, 5/8 and 3/4-inch lengths; 1000=61bs. For side laps, 1 rivet for each lineal foot. For fastening flashing, etc., to sheeting, 2 for each lineal foot.

Nails:—For fastening sheeting to wooden purlins: 10d. clinch nails for roofing, one for each lineal foot (for both end and side laps), 50=1 pound. 8d. clinch nails for siding, one for each lineal foot (for both end and side laps), 70=1 pound. For sheeting on wooden sheathing in end laps and in the body of the sheets in rows about 3 or 4 feet apart, same as if purlins or girts occurred at these lines. For fastening flashing, etc., to wood use tinner's nails, 2 per foot. For fastening flashing, etc., to brick wall use 8d. nails, 2 per foot.

ROOF TRUSSES

(PRATT.)

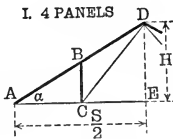

$$n = S + H = 2 \cot \alpha$$

P = Panel Load.

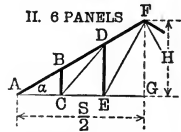

Heavy lines in diagrams indicate Compression Members.

I—4 Panels.

Member	Length	Stress = P x	n =						
			3	$\frac{24}{7}$	2 cot 30°	4	$\frac{24}{5}$	5	6
AB, BD	$S \sec \alpha + 4$	$\frac{3}{4} \sqrt{n^2 + 4}$	2.70	2.98	3.00	3.35	3.90	4.04	4.74
AC	$S + 4$	$\frac{3}{4} n$	2.25	2.57	2.60	3.00	3.60	3.75	4.56
CE	$S + 2$	$\frac{1}{2} n$	1.50	1.71	1.73	2.00	2.40	2.50	3.00
BC	$H + 2$	1	1.00	1.00	1.00	1.00	1.00	1.00	1.00
CD	$\sqrt{S^2 + 16 H^2} + 4$	$\frac{1}{4} \sqrt{n^2 + 16}$	1.25	1.32	1.32	1.41	1.56	1.60	1.80

II—6 Panels.

Member	Length	Stress = P x	n =						
			3	$\frac{24}{7}$	2 cot 30°	4	$\frac{24}{5}$	5	6
AB, BD	$S \sec \alpha + 6$	$\frac{5}{4} \sqrt{n^2 + 4}$	4.51	4.96	5.00	5.59	6.50	6.73	7.91
DF	$S \sec \alpha + 6$	$\sqrt{n^2 + 4}$	3.61	3.97	4.00	4.47	5.20	5.39	6.32
AC	$S + 6$	$\frac{5}{4} n$	3.75	4.29	4.33	5.00	6.00	6.25	7.50
CE	$S + 6$	n	3.00	3.43	3.46	4.00	4.80	5.00	6.00
EG	$S + 3$	$\frac{3}{4} n$	2.25	2.57	2.60	3.00	3.60	3.75	4.50
BC	$H + 3$	1	1.00	1.00	1.00	1.00	1.00	1.00	1.00
DE	$2H + 3$	$\frac{3}{2}$	1.50	1.50	1.50	1.50	1.50	1.50	1.50
CD	$\sqrt{S^2 + 16 H^2} + 6$	$\frac{1}{4} \sqrt{n^2 + 16}$	1.25	1.32	1.32	1.41	1.56	1.60	1.80
EF	$\sqrt{S^2 + 36 H^2} + 6$	$\frac{1}{4} \sqrt{n^2 + 36}$	1.68	1.73	1.73	1.80	1.92	1.95	2.12

COEFFICIENTS FOR CALCULATING TRUSS MEMBERS.

n.....	3	$\frac{24}{7}$	2cot30°	4	$\frac{24}{5}$	5	6
α	33°41.4'	30°15.4'	30°	26°33.9'	22°37.2'	21°48.1'	18°26.1'
Sec α	1.2018	1.1577	1.1547	1.1180	1.0833	1.0770	1.0541
Sec ² α	1.4444	1.3403	1.3333	1.2500	1.1736	1.1600	1.1111
Sec α tan α8012	.6753	.6667	.5590	.4514	.4308	.3514
Sec $\alpha \sqrt{9 \sec^2 \alpha - 8}$	2.6874	2.3334	2.3094	2.0156	1.7342	1.6824	1.4907

**ROOF TRUSSES
(PRATT).**

$n = S \div H = 2 \cot \alpha.$

$P =$ Panel Load.

Heavy lines in diagrams indicate compression members.

IV. 10 PANELS

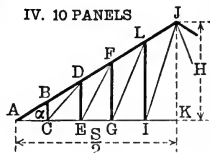

III. 8 PANELS

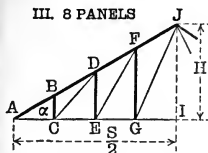

III—8 Panels.

Member	Length	Stress = P x	n =						
			3	24 7	2 cot 30°	4	24 5	5	6
AB, BD	S sec $\alpha \div 8$	$7/4 \sqrt{n^2 + 4}$	6.31	6.95	7.00	7.83	9.10	9.47	11.07
DF	S sec $\alpha \div 8$	$3/2 \sqrt{n^2 + 4}$	5.41	5.95	6.00	6.71	7.80	8.08	9.49
FJ	S sec $\alpha \div 8$	$5/4 \sqrt{n^2 + 4}$	4.51	4.96	5.00	5.59	6.50	6.73	7.91
AC	S+8	$7/4 n$	5.25	6.00	6.06	7.00	8.40	8.75	10.50
CE	S+8	$3/2 n$	4.50	5.14	5.20	6.00	7.20	7.50	9.00
EG	S+8	$5/4 n$	3.75	4.29	4.33	5.00	6.00	6.25	7.50
GI	S+4	n	3.00	3.43	3.46	4.00	4.80	5.00	6.00
BC	H+4	1	1.00	1.00	1.00	1.00	1.00	1.00	1.00
DE	H+2	$3/2$	1.50	1.50	1.50	1.50	1.50	1.50	1.50
FG	$3H \div 4$	2	2.00	2.00	2.00	2.00	2.00	2.00	2.00
CD	$\sqrt{S^2 + 16 H^2} \div 8$	$1/4 \sqrt{n^2 + 16}$	1.25	1.32	1.32	1.41	1.56	1.60	1.80
EF	$\sqrt{S^2 + 36 H^2} \div 8$	$1/4 \sqrt{n^2 + 36}$	1.68	1.73	1.73	1.80	1.92	1.95	2.12
GJ	$\sqrt{S^2 + 64 H^2} \div 8$	$1/4 \sqrt{n^2 + 64}$	2.14	2.18	2.18	2.24	2.33	2.36	2.50

IV—10 Panels.

Member	Length	Stress = P x	n =						
			3	24 7	2 cot 30°	4	24 5	5	6
AB, BD	S sec $\alpha \div 10$	$9/4 \sqrt{n^2 + 4}$	8.11	8.93	9.00	10.06	11.70	12.12	14.23
DF	S sec $\alpha \div 10$	$2 \sqrt{n^2 + 4}$	7.21	7.94	8.00	8.94	10.40	10.77	12.65
FL	S sec $\alpha \div 10$	$7/4 \sqrt{n^2 + 4}$	6.31	6.95	7.00	7.83	9.10	9.42	11.07
LJ	S sec $\alpha \div 10$	$3/2 \sqrt{n^2 + 4}$	5.41	5.95	6.00	6.71	7.80	8.08	9.49
AC	S+10	$9/4 n$	6.75	7.71	7.79	9.00	10.80	11.25	13.50
CE	S+10	2 n	6.00	6.86	6.93	8.00	9.60	10.00	12.00
EG	S+10	$7/4 n$	5.25	6.00	6.06	7.00	8.40	8.75	10.50
GI	S+10	$3/2 n$	4.50	5.14	5.20	6.00	7.20	7.50	9.00
IK	S+5	$5/4 n$	3.75	4.29	4.33	5.00	6.00	6.25	7.50
BC	H+5	1	1.00	1.00	1.00	1.00	1.00	1.00	1.00
DE	$2H \div 5$	$3/2$	1.50	1.50	1.50	1.50	1.50	1.50	1.50
FG	$3H \div 5$	2	2.00	2.00	2.00	2.00	2.00	2.00	2.00
LI	$4H \div 5$	$5/2$	2.50	2.50	2.50	2.50	2.50	2.50	2.50
CD	$\sqrt{S^2 + 16 H^2} \div 10$	$1/4 \sqrt{n^2 + 16}$	1.25	1.32	1.32	1.41	1.56	1.60	1.80
EF	$\sqrt{S^2 + 36 H^2} \div 10$	$1/4 \sqrt{n^2 + 36}$	1.68	1.73	1.73	1.80	1.92	1.95	2.12
GL	$\sqrt{S^2 + 64 H^2} \div 10$	$1/4 \sqrt{n^2 + 64}$	2.14	2.18	2.18	2.24	2.33	2.36	2.50
IJ	$\sqrt{S^2 + 100 H^2} \div 10$	$1/4 \sqrt{n^2 + 100}$	2.61	2.64	2.65	2.69	2.77	2.80	2.92

ROOF TRUSSES (FINK).

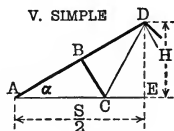

$$n = S + H = 2 \cot \alpha$$

$$P = \text{Panel Load.}$$

Heavy lines in diagrams indicate compression members.

V—Simple.

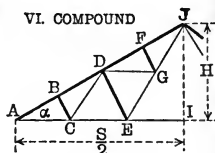

Member	Length	Stress = $\frac{P}{x}$	n =						
			3	$\frac{24}{7}$	$2 \cot 30^\circ$	4	$\frac{24}{5}$	5	6
AB	$S \sec \alpha \div 4$	$\frac{3}{4} \sqrt{n^2 + 4}$	2.70	2.98	3.00	3.35	3.90	4.04	4.74
BD	$S \sec \alpha \div 4$	$\frac{3n^2 + 4}{4 \sqrt{n^2 + 4}}$	2.15	2.47	2.50	2.91	3.52	3.67	4.43
AC	$S \sec^2 \alpha \div 4$	$\frac{3}{4} n$	2.25	2.57	2.60	3.00	3.60	3.75	4.50
CE	$S (1 - \frac{1}{2} \sec^2 \alpha)$	$\frac{1}{2} n$	1.50	1.71	1.73	2.00	2.40	2.50	3.00
BC	$S \sec \alpha \tan \alpha \div 4$	$\frac{n}{\sqrt{n^2 + 4}}$	0.83	0.86	0.87	0.89	0.92	0.93	0.95
CD	$S \sec^2 \alpha \div 4$	$\frac{1}{4} n$	0.75	0.86	0.87	1.00	1.20	1.25	1.50

VI—Compound.

Member	Length	Stress = $\frac{P}{x}$	n =						
			3	$\frac{24}{7}$	$2 \cot 30^\circ$	4	$\frac{24}{5}$	5	6
AB	$S \sec \alpha \div 8$	$\frac{7}{4} \sqrt{n^2 + 4}$	6.31	6.95	7.00	7.83	9.10	9.42	11.07
BD	$S \sec \alpha \div 8$	$\frac{7n^2 + 20}{4 \sqrt{n^2 + 4}}$	5.76	6.44	6.50	7.38	8.72	9.05	10.75
DF	$S \sec \alpha \div 8$	$\frac{7n^2 + 12}{4 \sqrt{n^2 + 4}}$	5.20	5.94	6.00	6.93	8.33	8.68	10.44
FJ	$S \sec \alpha \div 8$	$\frac{7n^2 + 4}{4 \sqrt{n^2 + 4}}$	4.65	5.43	5.50	6.48	7.95	8.31	10.12
AC	$S \sec^2 \alpha \div 8$	$\frac{7}{4} n$	5.25	6.00	6.06	7.00	8.40	8.75	10.50
CE	$S \sec^2 \alpha \div 8$	$\frac{3}{2} n$	4.50	5.14	5.20	6.00	7.20	7.50	9.00
EI	$S (1 - \frac{1}{2} \sec^2 \alpha)$	n	3.00	3.43	3.46	4.00	4.80	5.00	6.00
BC, FG	$S \sec \alpha \tan \alpha \div 8$	$\frac{n}{\sqrt{n^2 + 4}}$	0.83	0.86	0.87	0.89	0.92	0.93	0.95
DE	$S \sec \alpha \tan \alpha \div 4$	$\frac{2n}{\sqrt{n^2 + 4}}$	1.66	1.73	1.73	1.79	1.85	1.86	1.90
CD, DG	$S \sec^2 \alpha \div 8$	$\frac{1}{4} n$	0.75	0.86	0.87	1.00	1.20	1.25	1.50
EG	$S \sec^2 \alpha \div 8$	$\frac{1}{2} n$	1.50	1.71	1.73	2.00	2.40	2.50	3.00
GJ	$S \sec^2 \alpha \div 8$	$\frac{3}{4} n$	2.25	2.57	2.60	3.00	3.60	3.75	4.50

ROOF TRUSSES
(FAN).

$n = S + H = 2 \cot \alpha$
 $P = \text{Panel Load.}$

Heavy lines in diagrams indicate compression members.

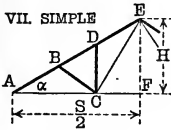

VII—Simple.

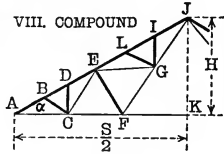

Member	Length	Stress = P x	n =						
			3	$\frac{24}{7}$	2 cot 30°	4	$\frac{24}{5}$	5	6
AB	S sec $\alpha + 6$	$\frac{5}{4} \sqrt{n^2 + 4}$	4.51	4.96	5.00	5.59	6.50	6.73	7.91
BD	S sec $\alpha + 6$	$\frac{13(n^2 + 36)}{12 \sqrt{n^2 + 4}}$	3.54	3.96	4.00	4.55	5.38	5.59	6.64
DE	S sec $\alpha + 6$	$\frac{5n^2 + 4}{4 \sqrt{n^2 + 4}}$	3.40	3.95	4.00	4.70	5.73	5.99	7.27
AC	S sec ² $\alpha + 4$	$\frac{5}{4} n$	3.75	4.29	4.33	5.00	6.00	6.25	7.50
CF	S (1 - $\frac{1}{2}$ sec ² α)	$\frac{3}{4} n$	2.25	2.57	2.60	3.00	3.60	3.75	4.50
BC, CD	S sec $\alpha \sqrt{9 \sec^2 \alpha - 8}$	$n \sqrt{n^2 + 36} \div$	0.93	1.00	1.00	1.08	1.18	1.21	1.34
CE	S sec ² $\alpha + 4$ [+12]	$\frac{1}{2} n [6 \sqrt{n^2 + 4}]$	1.50	1.71	1.73	2.00	2.40	2.50	3.00

VIII—Compound.

Member	Length	Stress = P x	n =						
			3	$\frac{24}{7}$	2 cot 30°	4	$\frac{24}{5}$	5	6
AB	S sec $\alpha + 12$	$\frac{11}{4} \sqrt{n^2 + 4}$	9.92	10.92	11.00	12.30	14.30	14.81	17.39
BD	S sec $\alpha + 12$	$\frac{31n^2 + 108}{12 \sqrt{n^2 + 4}}$	8.95	9.92	10.00	11.26	13.18	13.66	16.13
DE	S sec $\alpha + 12$	$\frac{11n^2 + 28}{4 \sqrt{n^2 + 4}}$	8.81	9.91	10.00	11.40	13.53	14.07	16.76
EL	S sec $\alpha + 12$	$\frac{11n^2 + 20}{4 \sqrt{n^2 + 4}}$	8.25	9.40	9.50	10.96	13.15	13.70	16.44
LI	S sec $\alpha + 12$	$\frac{31n^2 + 36}{12 \sqrt{n^2 + 4}}$	7.28	8.41	8.50	9.91	12.02	12.55	15.18
IJ	S sec $\alpha + 12$	$\frac{11n^2 + 4}{4 \sqrt{n^2 + 4}}$	7.14	8.40	8.50	10.06	12.38	12.95	15.81
AC	S sec ² $\alpha + 8$	$\frac{11}{4} n$	8.25	9.43	9.53	11.00	13.20	13.75	16.50
CF	S sec ² $\alpha + 8$	$\frac{9}{4} n$	6.75	7.71	7.79	9.00	10.80	11.25	13.50
FK	S (1 - $\frac{1}{2}$ sec ² α)	$\frac{3}{2} n$	4.50	5.14	5.20	6.00	7.20	7.50	9.00
BC, CD GL, GI	S sec $\alpha \sqrt{9 \sec^2 \alpha - 8}$ [+24]	$n \sqrt{n^2 + 36} \div$ $[6 \sqrt{n^2 + 4}]$	0.93	1.00	1.00	1.08	1.18	1.21	1.34
EF	S sec $\alpha \tan \alpha + 4$	$\frac{3n}{\sqrt{n^2 + 4}}$	2.50	2.59	2.60	2.68	2.77	2.79	2.85
CE, EG	S sec ² $\alpha + 8$	$\frac{1}{2} n$	1.50	1.71	1.73	2.00	2.40	2.50	3.00
FG	S sec ² $\alpha + 8$	$\frac{3}{4} n$	2.25	2.57	2.60	3.00	3.60	3.75	4.50
GJ	S sec ² $\alpha + 8$	$\frac{5}{4} n$	3.75	4.29	4.33	5.00	6.00	6.25	7.50

CAMBRIA STANDARD BUCKLE PLATES.

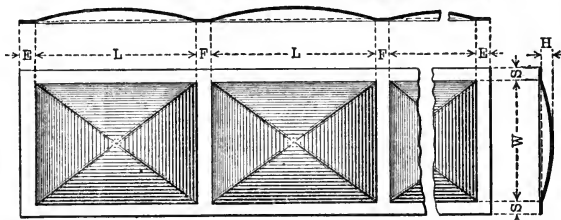

No.	SIZE OF BUCKLES.		RISE OF BUCKLE (H). Ins.	PLATE THICKNESS. Ins.	NUMBER OF BUCKLES PER PLATE.	WIDTH OF FLANGES AND FILLETS.
	Side (L).	Side (W).				
	Ft. Ins.	Ft. Ins.				
1	2-8	2-8	2	$\frac{1}{4}$, $\frac{5}{16}$ or $\frac{3}{8}$	1 to 10	END FLANGES (E) Preferably made alike, from 2 to 18 ins. wide. If wider than 18 ins., use angles riveted across the plates for stiffeners. SIDE FLANGES (S) Preferably made alike, from 2 to 6 ins. wide. Best not to exceed 4 ins. FILLETS (F) From 2 to 6 ins. wide. Best not to exceed 4 ins.
2	2-8	3-8	2	"	1 " 10	
3	3-8	2-8	2	"	1 " 8	
4	3-1	3-2	3	"	1 " 9	
5	3-2	3-1	3	"	1 " 9	
6	3-1	3-9	3	"	1 " 9	
7	3-9	3-1	3	"	1 " 8	
8	4-0	4-0	3	"	1 " 7	
9	4-6	3-11	$3\frac{1}{2}$	"	1 " 6	
10	3-11	4-6	$3\frac{1}{2}$	"	1 " 7	
11	3-6	5-6	$3\frac{1}{2}$	"	1 " 2	
12	5-6	3-6	$3\frac{1}{2}$	"	1 " 2	

ROLLED STEEL SAFETY FLOOR PLATES.

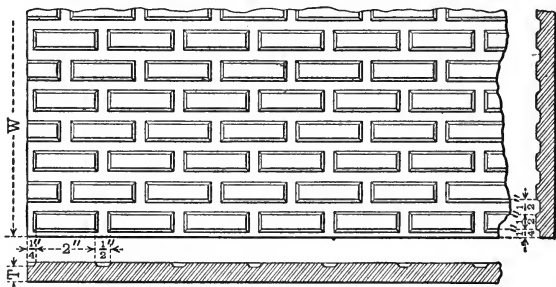

WIDTH (W).	THICKNESS (T).	MAXIMUM LENGTH.
Inches.	Inches.	Feet.
18 to 25	$\frac{5}{16}$ to $\frac{3}{4}$	50
25 " 36	$\frac{5}{16}$ " $\frac{1}{2}$	50

FIREPROOFING—REINFORCED CONCRETE.

The actual fire tests of reinforced concrete have been limited, but experience, together with the results of tests so far made, indicates that concrete may be safely used for fireproofing purposes. It is in itself incombustible and proof against ordinary fire when composed of the best materials properly mixed, applied and anchored in place. For a fireproof filling or deadening layer in floors, these same materials without reinforcement may be used or clean hard burned cinders may be substituted for this purpose. The low rate of heat conductivity is one reason of its value for fireproofing and the concrete actually affected by fire, remains in position and affords protection to the concrete beneath it. The thickness of protective coating required, depends upon the probable duration of a fire, which is likely to occur in the structure. However, for ordinary conditions, it is recommended, as a general rule, that the metal in girders and columns be protected by a minimum of 2 inches, beams $1\frac{1}{2}$ inches, and floor slabs, the different minimum values, as indicated in the accompanying table.

A properly designed combination of protected steel framework with reinforced concrete floor slabs, if well executed is particularly safe and effective in fireproof building construction, and the use of concrete and steel in the floor slab is especially advantageous, affording both strength and rigidity.

In reinforced concrete design, the following assumptions are recommended and considered by almost all authorities, and are, therefore, used as the basis for the formulæ and tables of pages 92 and 93, but it must be noted that all these ideal conditions cannot be had in practice and if possible allowance should be made accordingly.

(1) Calculations should be made with reference to working stresses and safe loads, rather than to ultimate strengths and ultimate loads.

(2) A section, plane before bending remains plane after bending.

(3) The modulus of concrete in compression within the usual limits of working stresses is constant. The distribution of compressive forces in slabs is therefore rectilinear.

(4) The tensile stresses in the concrete shall be neglected in calculating the reinforced slab resistance.

(5) Perfect adhesion between concrete and reinforcement is assumed.

(6) Initial stresses in the reinforcement due to contraction or expansion in the concrete may be neglected.

These above assumptions, while not entirely borne out by experimental data, are recommended and used by various authorities on this subject in the interest of simplicity and uniformity.

REINFORCED CONCRETE FLOOR SLABS.

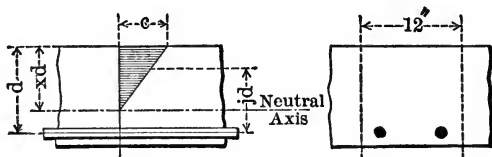

NOTATION.

- w = Total weight in lbs. per sq. ft. including slab weight.
 L = Span in feet c. to c. of beam supports.
 M = Bending Moment for 12" width of slab (inch pounds).
 E_c = Modulus of Elasticity for concrete.
 E_s = " " " " steel.
 r = Ratio. $E_s \div E_c$.
 C = Extreme fibre stress of concrete in compression.
 S = " " " " steel in tension.
 K = Constant for a given steel and concrete.
 d = Effective depth of slab in inches.
 p = Ratio of steel area to effective slab area.
 x = Distance, Top of slab to Neutral Axis $\div d$.
 j = " between centers of stress $\div d$.
 V = Maximum Shear, 12" width of slab.
 v = Unit shear.
 u = Unit bond stress.
 Σo = Sum of perimeters of bars (in 12" width of slab).

FORMULÆ.

$M = 1.5 wL^2$ —for slabs freely supported.

$= 1.2 wL^2$ — " " continuous over supports.

$$p = \frac{C^2 r}{2 S (Cr + S)} \quad x = rp \left(\sqrt{1 + \frac{2}{rp}} - 1 \right)$$

$$K = \frac{Sp}{3} \left(\frac{2Cr + 3S}{Cr + S} \right) \quad j = 1 - \frac{x}{3}$$

$$d = \sqrt{\frac{M}{12 K}} \quad \text{Steel Area (12" width of slab)} = 12 dp$$

$$v = \frac{V}{12 jd} \quad (\text{not to exceed 60 lbs. for stone or 25 lbs. for cinder concrete}).$$

$$u = \frac{V}{jd \Sigma o} \quad (\text{not to exceed 60 lbs. for stone or 30 lbs. for cinder concrete}).$$

For Square and Round Bars, refer to pages 451-457.

NOTE.—Best practice indicates that Spans of Floor Slabs should not exceed seven feet between steel beams or steel girders. Generally speaking, the span should in no case exceed 10 feet for ordinary work.

REINFORCED CONCRETE FLOOR SLABS.

Values deduced from formulæ, page 92, using unit stresses based on modern safe practice.

Concrete.	Weight per cu. ft. Pounds.	C	S	$r = \frac{r}{E_s \div E_c}$	P	K	x	j
Stone. 1:2:4.	150	500	16000	15	.0050	71.5	.320	.893
Cinder. 1:2:4.	110	185	16000	30	.0015	21.8	.258	.914

THICKNESS OF CONCRETE BELOW STEEL.

Depth of Slab "d" (inches).	$2\frac{1}{2}$ to 4	$4\frac{1}{2}$ to $8\frac{1}{2}$	9 to 12	13 to 18	19 to 20	Above 20
Thickness of Concrete below Lower Surface of Steel Rods (inches).	$\frac{3}{4}$	1	$1\frac{1}{4}$	$1\frac{1}{2}$	$1\frac{3}{4}$	2

SPACING OF REINFORCING BARS.

The lateral spacing of parallel bars should not be less than two and one-half diameters, center to center, nor greater than $2\frac{1}{2} \times$ thickness of slab; nor should the distance from edge of slab to center of nearest bar be less than one and one-half diameters. The clear spacing between two layers of bars should not be less than one-half inch.

Cross reinforcement of steel rods of small diameter ($\frac{1}{4}$ "") laid parallel to the principal beams upon which the slab rests, should be used to prevent shrinkage and temperature cracks and to give added strength. They should be spaced about two feet, center to center.

DISTRIBUTION OF LOAD FOR SLABS OF FOUR SIDES SUPPORT.

Where length of slab exceeds 1.5 width, the entire load should be carried by transverse reinforcement. Slabs of smaller ratio of dimension may well be reinforced in both directions. Distribution of the load may be determined by use of the formula

$$r = \frac{l^4}{l^4 + b^4}$$

in which r = proportion of load carried by transverse reinforcement, l = length and b = breadth of slab.

Using values thus determined, each set of reinforcement is to be calculated as in slabs having two supports only.

NOTE.—In all cases of two-way reinforcement, intersections of rods should be securely tied with heavy wire.

LIMITING SPANS AND MAXIMUM LOADS OF I-BEAMS AND CHANNELS DUE TO CRIPPLING OF THE WEB.

I-Beams and Channels, when used as beams for very short spans in which the ratio of length of span to depth of beam is small, should be examined for safe strength of the web considered as a column, subjected to crippling due to the shearing strains.

The Tables of Safe Loads of Beams and Channels are computed with regard to the safe unit stresses due to flexure, and, with one or two exceptions, as indicated by dotted lines and accompanying foot-notes, the lengths of spans tabulated are such that the limitation due to web crippling does not appear. The shearing stresses acting in the web of a beam may be considered to consist of two stresses of equal intensity acting at right angles to each other, and at angles of 45 degrees with the neutral axis. The intensity of each of these stresses is equal to the intensity of the vertical shear, which is a maximum at the points of support for uniform loading, and uniform throughout from the point of loading to the supports for a superimposed concentrated load at the center.

The vertical shears for different systems of loading may be obtained by the use of moments in the usual way, and these are given for various cases on pages 162 to 165 inclusive.

The shearing stresses which act at angles of 45 degrees with the neutral axis are equivalent to compressive and tensile forces, and the former will tend to buckle the web, which should therefore be figured as composed of a series of columns of a length equal to its diagonal depth.

If c is the vertical depth of the web in the clear between the fillets which connect it with the flanges, the square of the length of the column to be considered will be $2c^2$.

Substituting this value for l^2 in the formula for long columns

$$P = \frac{12000}{1 + \frac{l^2}{3000 t^2}}$$

we have

$$P = \frac{12000}{1 + \frac{c^2}{1500 t^2}}$$

in which

p = intensity of vertical shear, in pounds per square inch =

$$\frac{\text{Total shear in pounds}}{dt.}$$

c = depth of web in clear between fillets in inches.

t = thickness of web in inches.

d = depth of beam in inches.

This formula is also applicable for computing the safe shearing stress in the webs of plate girders, in which case the length, l , is the vertical distance between centers of upper and lower rows of rivet holes connecting the webs and flanges.

The webs of plate girders should be reinforced by stiffening angles at points of support and concentrated loading, and in cases where the intensity of shear exceeds that given by the above formula the web should be provided with stiffeners.

The following tables have been prepared based upon the above formula for safe unit shearing stress in the webs of beams and channels.

**MAXIMUM SAFE LOADS FOR I-BEAMS OF ANY
LENGTH AND CORRESPONDING MINIMUM
SAFE SPANS BASED UPON CRIPPLING
OF THE WEB.**

For loads in pounds uniformly distributed including weight of beam.

Section Number.	Depth of Beam.	Weight per Foot.	Maximum Safe Load.	Minimum Span.	Section Number.	Depth of Beam.	Weight per Foot.	Maximum Safe Load.	Minimum Span.
	Inches.	Pounds.	Pounds.	Feet.		Inches.	Pounds.	Pounds.	Feet.
B 5	3	5.5	10900	1.7	B 53	15	42	86530	7.3
		6.5	17790	1.1			45	106100	6.2
		7.5	25230	.9			50	146260	4.8
B 9	4	7.5	15330	2.1	B109	15	55	186740	4.0
		8.5	22670	1.6			60	222970	3.6
		9.5	30820	1.2			60	160940	5.5
		10.5	37820	1.1			65	201330	4.6
B 13	5	9.75	20050	2.6	B113	15	70	237380	4.1
		12.25	39730	1.5			75	276990	3.7
		14.75	57400	1.2			80	316160	3.4
B 17	6	12.25	25130	3.1	B 65	18	80	247900	4.6
		14.75	44320	2.0			85	287290	4.2
		17.25	62890	1.6			90	322350	3.9
B 21	7	15	30510	3.7	B 73	20	95	361780	3.6
		17.5	49320	2.5			100	399220	3.4
		20	69540	1.9			B 73	20	65
B 25	8	18	36310	4.2	70	169980			7.3
		20.25	53560	3.1	75	206910			6.7
		22.75	72760	2.4	B121	20	80	182710	8.7
25.25	91590	2.1	85	214600			7.7		
B 29	9	21	42450	4.8			90	257610	6.6
		25	71530	3.1	95	295400	6.0		
		30	109620	2.3	100	333150	5.5		
		35	146670	1.9	B 89	24	80	127540	14.7
B 33	10	25	48960	5.4			85	166820	11.8
		30	86630	3.4			90	202450	10.1
		35	126460	2.6			95	239330	8.8
		40	165320	2.2	100	277070	7.9		
B 41	12	31.5	62890	6.2	B127	24	105	203800	12.3
		35	91730	4.5			110	243290	10.6
		40	130540	3.5			115	281900	9.4
		B105	12	40			99380	4.9	
45	138110			3.8					
50	176250			3.2					
55	213760			2.8					

MAXIMUM SAFE LOADS FOR STANDARD CHANNELS OF ANY LENGTH AND CORRESPONDING MINIMUM SAFE SPANS BASED UPON CRIPPLING OF THE WEB.

For loads in pounds uniformly distributed including weight of channel.

Section Number.	Depth of Channel	Weight per Foot.	Maximum Safe Load.	Minimum Span.	Section Number.	Depth of Channel	Weight per Foot.	Maximum Safe Load.	Minimum Span.
	Inches.	Pounds.	Pounds.	Feet.		Inches.	Pounds.	Pounds.	Feet.
C 5	3	4	10970	1.1	C 25	8	18.75	83150	1.5
		5	17830	0.8			21.25	101800	1.3
		6	25260	.6					
C 9	4	5.25	14300	1.4	C 29	9	13.25	28120	4.0
		6.25	21660	1.1			15	42250	2.9
		7.25	29830	.9			20	80980	1.8
C 13	5	6.5	17390	1.6	C 33	10	15	30570	4.7
		9	35900	1.1			20	67420	2.6
		11.5	54920	.9			25	107670	1.9
C 17	6	8	20280	2.3	C 33	10	30	147010	1.6
		10.5	39580	1.4			35	182940	1.4
		13	58300	1.1			C 41	12	20.5
15.5	76540	1.0	25	75440	3.5				
			30	114230	2.6				
C 21	7	9.75	22950	2.8	C 41	12	35	156000	2.1
		12.25	43660	1.7			40	193920	1.9
		14.75	62200	1.4			C 53	15	33
17.25	82110	1.2	35	95070	4.9				
19.75	99880	1.1	40	130940	4.3				
C 25	8	11.25	25560	3.4	C 53	15	45	171400	3.2
		13.75	44800	2.2			50	211750	2.8
		16.25	64140	1.7			55	251710	2.5

**COEFFICIENTS FOR DEFLECTION IN INCHES FOR
CAMBRIA SHAPES, USED AS BEAMS SUBJECTED
TO SAFE LOADS UNIFORMLY DISTRIBUTED.**

Distance between Supports in Feet.	Coefficient for Fibre Stress of 16 000 lbs. per Square Inch.	Coefficient for Fibre Stress of 12 500 lbs. per Square Inch.	Distance between Supports in Feet.	Coefficient for Fibre Stress of 16 000 lbs. per Square Inch.	Coefficient for Fibre Stress of 12 500 lbs. per Square Inch.
L	H	H'	L	H	H'
4	.265	.207	23	8.756	6.841
5	.414	.323	24	9.534	7.448
6	.596	.466	25	10.345	8.082
7	.811	.634	26	11.189	8.741
8	1.059	.828	27	12.066	9.427
9	1.341	1.047	28	12.977	10.138
10	1.655	1.293	29	13.920	10.875
11	2.003	1.565	30	14.897	11.638
12	2.383	1.862	31	15.906	12.427
13	2.797	2.185	32	16.949	13.241
14	3.244	2.534	33	18.025	14.082
15	3.724	2.909	34	19.134	14.948
16	4.237	3.310	35	20.276	15.841
17	4.783	3.737	36	21.451	16.759
18	5.363	4.190	37	22.659	17.703
19	5.975	4.668	38	23.901	18.672
20	6.621	5.172	39	25.175	19.668
21	7.299	5.703	40	26.483	20.690
22	8.011	6.259			

The above coefficients are for use in obtaining the deflection of steel shapes subjected to transverse strain, under their uniformly distributed safe loads for extreme fibre stresses of 16 000 pounds and 12 500 pounds per square inch; the modulus of elasticity being 29 000 000.

To find the deflection of any shape that is symmetrical about its neutral axis under the above conditions of loading when used as a beam, such as I-Beams, Channels, etc., divide the coefficient in the table corresponding to the given span and fibre stress, by the depth of the beam in inches. The result will be the deflection in inches.

To find the deflection of any shape that is unsymmetrical about its neutral axis when used as a beam, under the above conditions of loading, such as Angles, etc., divide the coefficient in the table corresponding to the given span and fibre stress by twice the distance of the most remote fibre from the neutral axis, expressed in inches.

If, in construction, the beam is placed in position in the usual manner upon its end supports without special scaffolding or falsework between them, it will deflect somewhat by reason of its own weight, and upon the addition of external loading a further deflection will occur.

The deflections obtained as above described are the total deflections due to the weight of the beam itself and the superimposed safe load uniformly distributed.

Thus, to find, from the preceding table, the deflection in inches for Cambria shapes used as Beams under their safe loads uniformly distributed including the weight of the beam :

Let D = deflection in inches,

L = length between supports in feet.

H = coefficient for deflection from table for fibre stress of 16 000 pounds per square inch.

H' = coefficient for deflection from table for fibre stress of 12 500 pounds per square inch.

d = depth of beam in inches for symmetrical sections.

x_1 = distances in inches from neutral axis to most remote fibre for unsymmetrical sections.

FOR SYMMETRICAL SECTIONS.

For fibre stress of 16 000 pounds per square inch $D = \frac{H}{d}$

For fibre stress of 12 500 pounds per square inch $D = \frac{H'}{d}$

FOR UNSYMMETRICAL SECTIONS.

For fibre stress of 16 000 pounds per square inch $D = \frac{H}{2x_1}$

For fibre stress of 12 500 pounds per square inch $D = \frac{H'}{2x_1}$

EXAMPLES.

Case I.—To find the deflection of a 9'' I-Beam weighing 30 pounds per foot, for a span of 15 feet and a maximum fibre stress of 16 000 pounds per square inch, under its safe load uniformly distributed.

From the above table the deflection coefficient for this case is found to be 3.724 which divided by 9, the depth of the beam in inches, gives .414, which is the required deflection in inches.

The safe load for this beam under the conditions named is 16 100 pounds including the weight of the beam itself as stated in the Tables of Safe Loads for Cambria I-Beams on page 109.

Case II.—To find the deflection of a 6'' \times 4'' \times $\frac{1}{2}$ '' angle, supported at the ends on its short leg as a horizontal base, for a span of 9 feet and a maximum fibre stress of 16 000 pounds per square inch under its safe load uniformly distributed including its own weight.

From the table of "Properties of Angles" on page 207 the distance x' from the neutral axis to the back of the shorter leg is found to be 1.99 inches, which subtracted from the length of long leg, 6 inches, gives 4.01 as the distance x_1 from the neutral axis to the most remote fibre. From the above table the deflection coefficient for this case is found to be 1.341, which divided by 8.02, twice x_1 , gives .167, which is the required deflection in inches.

NOTE.—For deflections of Beams and Channels due to any central or uniform load see coefficients of deflection N and N' in the Tables of Properties relating to these sections and the accompanying explanations.

For deflections of any symmetrical beams due to various systems of loading, see general formulæ and diagrams on pages 160 to 165 inclusive.

TABLES OF SAFE LOADS FOR CAMBRIA SECTIONS USED AS BEAMS, AND SPACING FOR CAMBRIA I-BEAMS.

Pages 106 to 159 inclusive.

TABLES OF SAFE LOADS AND SPACINGS.

The Tables of Safe Loads for Cambria I-Beams, Channels, and Angles, give the safe loads in pounds uniformly distributed for all usual spans based upon extreme fibre stresses of 16 000 pounds per square inch.

These loads include the weight of the steel shape itself, which should be deducted in order to obtain the external load that it will safely carry. In case the shape is used to support a floor, the weight of the steel, together with that of the other portions of the floor construction, must be deducted in order to obtain the net live load which can be safely sustained. Weights of hollow tile floor arches and fireproofing material are given on page 69. to which should be added the weight of plastering, filling on top of arches and the weight of the material forming the surface of the floor, in order to obtain the dead load of materials in figuring fireproof floors, in addition to the weight of the steel.

A table of superimposed loads per square foot, exclusive of the weights of materials, in accordance with the usual practice for different classes of buildings, is given on p. 52.

The Tables of Safe Loads for Cambria sections used as beams and the Tables for Spacing of Cambria I-Beams are calculated on the assumption that proper provision has been made for preventing lateral deflection by means of tie-rods or other braces spaced at suitable distances apart; which for beams and channels should not exceed twenty times the flange width. In cases where intermediate lateral support is not provided, the safe loads shown in the tables must be reduced, and for beams and channels the

amount of this reduction can be determined by reference to the explanations and tables therefor on pages 82 and 83.

The thrust of floor arches, which is considerable, particularly in the case of long spans or distances between tie-rods, should be taken into account where it tends to produce lateral flexure of the floor beams.

Explanations of this and a formula for reducing the unit stresses from vertical loading, on account of the additional stresses caused by horizontal forces, are given on pages 78 to 81 inclusive.

In some instances the allowable deflection will govern the design rather than the transverse strength, as in the case of beams carrying plastered ceilings, in which the deflection should be limited to $\frac{1}{375}$ inch per foot of span, or $\frac{1}{375}$ of the distance between supports in order to avoid cracking the plaster.

This limit of deflection is indicated in the tables by full horizontal lines, the figures below which correspond to loads or spacings for the given spans that will produce greater deflections than the allowable limit for plastered ceilings.

The deflection limits of the Tables of Safe Loads have been calculated for the total loads, including the weight of the section used as a beam. The superimposed live load will not produce all of this deflection, and therefore the deflection limit of the tables includes an element of safety for the reason that the beams will be deflected, after being put in place, by their own weight and that of the floor materials before the plastering is applied.

In cases where the deflection limits the use of the beam for the safe loads corresponding to the fibre stresses of the tables, the beam may be used with a less load such as to produce only the allowable deflection. The lesser load corresponding to the limit of deflection may be obtained for any span from the Table of Safe Loads as follows:

$$W = \frac{W_s \times L^2}{L_1^2}$$

in which

W = safe load in pounds for the limit of deflection for plastered ceilings = $\frac{1}{360}$ of the span.

W_s = safe load of tables next above the line giving the limit of deflection.

L = length of span in feet corresponding to W_s from the table

L_1 = length of span for the case under consideration.

This may also be expressed by the following—

RULE.

Multiply the safe load next above the heavy line of the tables by the square of the corresponding span in feet and divide the product by the square of the required span. The result will be the required load corresponding to the limit of allowable deflection for plastered ceilings.

A Table of Deflections for Cambria shapes used as beams, subjected to their safe loads uniformly distributed, and accompanying explanations with examples, are given on pages 98 and 99.

TABLES OF SAFE LOADS FOR I-BEAMS AND CHANNELS.

Tables of Safe Loads for all sizes and weights of Cambria I-Beams and channels for the usual spans, expressed in feet, are given on pages 106 to 123 inclusive.

TABLES FOR SPACING OF CAMBRIA I-BEAMS.

Tables for Spacing of Cambria I-Beams for a total load of 100 pounds per square foot including the weight of the beam, corresponding to spans from 4 to 48 feet, are given on pages 124 to 135 inclusive.

For any given size of beam the spacing or distances from centers to centers for different intensities of loading varies inversely as the load, so that the spacing for any intensity of loading may be found from the tabular spacing by proportion as stated in the notes at the foot of the tables.

TABLES OF SAFE LOADS FOR ANGLES.

Tables of uniformly distributed safe loads for the usual sizes of angles, are given on pages 138 to 159. In these tables the safe loads for equal leg angles are given on the assumption that one of the legs of the angle is horizontal and the other leg vertical. In the case of angles with unequal legs the safe loads are given for both positions, that is, with the long leg vertical and with the short leg vertical.

EXAMPLES OF APPLICATION OF TABLES OF SAFE LOADS AND TABLES OF SPACING.

EXAMPLE I.

What is the proper size of beam with a clear span of 24 feet to carry a superimposed load of 30 000 pounds uniformly distributed, the deflection to be such as not to crack a plastered ceiling?

From the Tables of Safe Loads for Cambria I-Beams, page 111, it is found that a 15-inch standard beam of this length, weighing 60 pounds per foot, will carry a gross load of 31 910 pounds, and the weight of the beam itself is $60 \times 24 = 1440$ pounds. Thus the net load may be 30 470 pounds, so that this is the proper size for the conditions named, as its deflection is within the allowable limit, which is shown to be at a span of 30 feet as indicated by the horizontal line on the table.

Similarly it may be found from page 112, that a 15-inch special beam, of 60 pounds per foot, will more than suffice, but as this section is not regularly kept in stock the standard 15-inch 60-pound beam should be ordered if prompt delivery is wanted.

It may also be found from page 114, that an 18-inch 55-pound beam will amply suffice, and as this is both stiffer and lighter than the 15-inch 60-pound beams, it could be used with economy if otherwise suitable for the location.

EXAMPLE II.

What is the safe load for an 8-inch standard I-Beam weighing 18.0 pounds per foot for a span of 20 feet, the deflection to be such as not to crack a plastered ceiling?

From the Tables of Safe Loads, page 108, it is found that the safe load for the beam in question is 7 580 pounds, but this value is below the line which indicates the span corresponding to the allowable limit of deflection.

Substituting the proper values in the formula for obtaining the reduced load corresponding to the allowable deflection, as given on page 101, we have

$$W = \frac{W_s \times L^2}{L_1^2} = \frac{9\,480 \times 16^2}{20^2} = 6\,067 \text{ pounds.}$$

which is the safe load required.

EXAMPLE III.

Required the best arrangement of beams for the floor system of a building 40 feet wide x 88 feet deep to safely support a live load of 100 pounds per square foot, using 10-inch tile arches resting on 12-inch I-Beams.

The weight of the floor materials will be about 50 pounds per square foot, allowing 39 pounds for the arch and 11 pounds for the other materials, or a total load of 150 pounds per square foot to be carried by the beams.

From the Table of Spacing for I-Beams for a uniform load of 100 pounds per square foot, page 128, it is seen that 12'' standard I-Beams weighing $31\frac{1}{2}$ pounds per foot and spaced 9.6 feet apart from center to center can be used with a span of 20 feet, and for a load of 150 pounds per square foot the spacing will be

$$\frac{9.6 \times 100}{150} = 6.4 \text{ feet.}$$

This will require one row of interior columns lengthwise of building.

To support the beams at the center of the building will require a line of girder beams resting on the columns. Assume the columns 22 feet apart, thus dividing the building into 8 bays, four on each side of the center.

The load on each girder will be

$$\frac{40}{2} \times 22 \times 150 = 66\,000 \text{ pounds.}$$

From the Table of Safe Loads, page 111, it is found that this will require two 15-inch standard I-Beams, each weighing 60 pounds per foot.

On account of the advisability of spacing the floor beams equally, the arrangement outlined above would reduce their distances to $\frac{22}{4} = 5.5$ feet center to center, so that 10-inch I-Beams, weighing 40 pounds per foot, might be used for the body of the floor, as may be determined by referring to the Table of Spacings of Cambria I-Beams, page 127, and calculating as before, with the result that the allowable spacing for these conditions is found to be 5.7 feet. The 10-inch 40-pound beam under these conditions, will, however, deflect almost to the allowable limit for plastered ceilings, besides, they are heavier than the 12-inch 31.5-pound beams first considered, so that the latter will be the stiffer and more economical.

Although the load on the girder is not uniformly distributed, but concentrated at three points between the supports, the bending moment in this case will be the same as if the load were figured to be distributed uniformly, and for similar cases with different spacings the moments would be very nearly identical.

TABLES OF MAXIMUM BENDING MOMENTS.

The Tables of Maximum Bending Moments for beams and channels given on pages 136 and 137 are useful in determining the proper section required to support one or more irregularly located concentrated loads or various arrangements of loads to which the tables of safe loads uniformly distributed will not apply.

The method used consists in computing the maximum bending moment in foot pounds resulting from the specified loading, the proper section corresponding to a fibre stress of 16 000 or 12 500 lbs. per square inch, being taken directly from the tables without further computation.

SAFE LOADS IN POUNDS UNIFORMLY DISTRIBUTED FOR CAMBRIA I-BEAMS.

Safe loads below are figured for fibre stress of 16 000 pounds per square inch and include weight of beam.

Distance between supports in feet.	STANDARD I-BEAMS.						
	3 Inch No. B 5.			4 Inch No. B 9.			
	5.5 lbs.	6.5 lbs.	7.5 lbs.	7.5 lbs.	8.5 lbs.	9.5 lbs.	10.5 lbs.
4	4410	4780	5180	7950	8470	9000	9520
5	3530	3830	4140	6360	6780	7200	7610
6	2940	3190	3450	5300	5650	6000	6350
7	2520	2730	2960	4540	4840	5140	5440
8	2210	2390	2590	3980	4240	4500	4760
9	1960	2130	2300	3530	3770	4000	4230
10	1770	1910	2070	3180	3390	3600	3810
11	1600	1740	1880	2890	3080	3270	3460
12	1470	1590	1730	2650	2820	3000	3170
13	1360	1470	1590	2450	2610	2770	2930
14	1260	1370	1480	2270	2420	2570	2720
15	1180	1280	1380	2120	2260	2400	2540
16	1100	1200	1290	1990	2120	2250	2380
17	1040	1130	1220	1870	1990	2120	2240
18	980	1060	1150	1770	1880	2000	2120
19	930	1010	1090	1670	1780	1890	2000
20	880	960	1040	1590	1690	1800	1900
21	840	910	990	1510	1610	1710	1810

For safe loads below the heavy lines, the deflections will be greater than the allowable limit for plastered ceilings = $\frac{1}{360}$ span.

SAFE LOADS IN POUNDS UNIFORMLY DISTRIBUTED FOR CAMBRIA I-BEAMS.

Safe loads below are figured for fibre stress of 16 000 pounds per square inch and include weight of beam.

Distance between supports in feet.	STANDARD I-BEAMS.					
	5 Inch No. B 13.			6 Inch No. B 17.		
	9.75 lbs.	12.25 lbs.	14.75 lbs.	12.25 lbs.	14.75 lbs.	17.25 lbs.
4	12900	14520	16160	19370	21320	23280
5	10320	11620	12930	•15490	•17050	18620
6	8600	9680	10770	12910	14210	•15520
7	7370	8300	9230	11070	12180	13300
8	6450	7260	8080	9680	10660	11640
9	5730	6460	7180	8610	9470	10350
10	5160	5810	6460	7750	8530	9310
11	4690	5280	5880	7040	7750	8460
12	4300	4840	5390	6460	7110	7760
13	3970	4470	4970	5960	6560	7160
14	3680	4150	4620	5530	6090	6650
15	3440	3870	4310	5160	5680	6210
16	3220	3630	4040	4840	5330	5820
17	3030	3420	3800	4560	5020	5480
18	2870	3230	3590	4300	4740	5170
19	2720	3060	3400	4080	4490	4900
20	2580	2900	3230	3870	4260	4660
21	2460	2770	3080	3690	4060	4480
22	2340	2640	2940	3520	3880	4230
23	2240	2530	2810	3370	3710	4050
24	2150	2420	2690	3230	3550	3880
25	2060	2320	2590	3100	3410	3720
26	1980	2230	2490	2980	3280	3580
27	1910	2150	2390	2870	3160	3450
28	2770	3050	3330

For safe loads below the heavy lines, the deflections will be greater than the allowable limit for plastered ceilings = $\frac{1}{360}$ span.

Above single dot, safe loads are too great for standard connections.

SAFE LOADS IN POUNDS UNIFORMLY DISTRIBUTED FOR CAMBRIA I-BEAMS.

Safe loads below are figured for fibre stress of 16 000 pounds per square inch and include weight of beam.

Distance between supports in feet.	STANDARD I-BEAMS.						
	7 Inch No. B 21.			8 Inch No. B 25.			
	15 lbs.	17.5 lbs.	20 lbs.	18.00 lbs.	20.25 lbs.	22.75 lbs.	25.25 lbs.
4	27600	29850	32140
5	22080	23880	25710	30330	32100	34190	36290
6	18400	19900	21430	25280	26750	28500	•30240
7	•15770	•17060	18370	21670	22930	24420	25920
8	13800	14930	•16070	18960	20060	21370	22680
9	12270	13270	14280	16850	17830	19000	20160
10	11040	11940	12860	15170	16050	17100	18140
11	10040	10860	11690	13790	14590	15540	16490
12	9200	9950	10710	12640	13380	14250	15120
13	8490	9190	9890	11670	12350	13150	13960
14	7890	8530	9180	10830	11470	12210	12960
15	7360	7960	8570	10110	10700	11400	12100
16	6900	7460	8030	9480	10030	10690	11340
17	6490	7020	7560	8920	9440	10060	10670
18	6130	6630	7140	8430	8920	9500	10080
19	5810	6280	6770	7980	8450	9000	9550
20	5520	5970	6430	7580	8030	8550	9070
21	5260	5690	6120	7220	7640	8140	8640
22	5020	5430	5840	6890	7300	7770	8250
23	4800	5190	5590	6590	6980	7430	7890
24	4600	4980	5360	6320	6690	7120	7560
25	4420	4780	5140	6070	6420	6840	7260
26	4250	4590	4940	5830	6170	6580	6980
27	4090	4420	4760	5620	5940	6330	6720
28	3940	4260	4590	5420	5730	6110	6480
29	3810	4120	4430	5230	5530	5900	6260

For safe loads below the heavy lines, the deflections will be greater than the allowable limit for plastered ceilings = $\frac{1}{360}$ span.

Above single dot, safe loads are too great for standard connections.

SAFE LOADS IN POUNDS UNIFORMLY DISTRIBUTED FOR CAMBRIA I-BEAMS.

Safe loads below are figured for fibre stress of 16 000 pounds per square inch and include weight of beam.

Distance between supports in feet.	STANDARD I-BEAMS.							
	9 Inch No. B 29.				10 Inch No. B 33.			
	21 lbs.	25 lbs.	30 lbs.	35 lbs.	25 lbs.	30 lbs.	35 lbs.	40 lbs.
8	25160	27240	30180	33120
9	22370	24210	26830	29440
10	20130	21790	24150	26500	26050	28620	31240	33850
11	18300	19810	21950	24090	23680	26020	28400	30780
12	16770	18160	20120	22080	21710	23850	26030	28210
13	15480	16760	18570	20380	20040	22020	24030	26040
14	14380	15570	17250	18930	18610	20450	22310	24180
15	13420	14530	16100	17670	17360	19080	20830	22570
16	12580	13620	15090	16560	16280	17890	19520	21160
17	11840	12820	14200	15590	15320	16840	18380	19910
18	11180	12110	13410	14720	14470	15900	17350	18810
19	10590	11470	12710	13950	13710	15070	16440	17820
20	10064	10900	12070	13250	13020	14310	15620	16930
21	9590	10380	11500	12620	12400	13630	14880	16120
22	9150	9910	10980	12050	11840	13010	14200	15390
23	8750	9480	10500	11520	11320	12450	13580	14720
24	8390	9080	10060	11040	10850	11930	13020	14110
25	8050	8720	9660	10600	10420	11450	12500	13540
26	7740	8380	9290	10190	10020	11010	12020	13020
27	7460	8070	8940	9810	9650	10600	11570	12540
28	7190	7780	8620	9460	9300	10220	11160	12090
29	6940	7510	8330	9140	8980	9870	10770	11670
30	6710	7260	8050	8830	8680	9540	10410	11280
31	6490	7030	7790	8550	8400	9230	10080	10920
32	8140	8950	9760	10580
33	7890	8670	9470	10260

For safe loads below the heavy lines, the deflections will be greater than the allowable limit for plastered ceilings = $\frac{1}{300}$ span.

SAFE LOADS IN POUNDS UNIFORMLY DISTRIBUTED FOR CAMBRIA I-BEAMS.

Safe loads below are figured for fibre stress of 16 000 pounds per square inch and include weight of beam.

Distance between supports in feet.	STANDARD I-BEAMS.			SPECIAL I-BEAMS.			
	12 Inch No. B 41.			12 Inch No. B 105.			
	31.5 lbs.	35 lbs.	40 lbs.	40 lbs.	45 lbs.	50 lbs.	55 lbs.
10	38370	40580	43720	47810	50790	53930	57070
11	34880	36890	39740	43470	46180	•49030	•51880
12	31970	33820	36430	39840	42330	44940	47560
13	29510	31220	33630	36780	39070	41480	43900
14	27400	28990	31230	34150	36280	38520	40760
15	25580	27050	29140	31880	33860	35950	38040
16	23980	25360	27320	29880	31750	33710	35670
17	22570	23870	25720	28130	29880	31720	33570
18	21310	22540	24290	26560	28220	29960	31700
19	20190	21360	23010	25160	26730	28380	30040
20	19180	20290	21860	23910	25400	26960	28530
21	18270	19320	20820	22770	24190	25680	27170
22	17440	18450	19870	21730	23090	24510	25940
23	16680	17640	19010	20790	22080	23450	24810
24	15990	16910	18220	19920	21160	22470	23780
25	15350	16230	17490	19130	20320	21570	22830
26	14760	15610	16810	18390	19540	20740	21950
27	14210	15030	16190	17710	18810	19970	21140
28	13700	14490	15610	17080	18140	19260	20380
29	13230	13990	15070	16490	17510	18600	19680
30	12790	13530	14570	15940	16930	17980	19020
31	12380	13090	14100	15420	16380	17400	18410
32	11990	12680	13660	14940	15870	16850	17830
33	11630	12300	13250	14490	15390	16340	17290
34	11280	11940	12860	14060	14940	15860	16780
35	10960	11590	12490	13660	14510	15410	16300

For safe loads below the heavy lines, the deflections will be greater than the allowable limit for plastered ceilings = $\frac{1}{360}$ span.

Above single dot, safe loads are too great for standard connections.

SAFE LOADS IN POUNDS UNIFORMLY DISTRIBUTED FOR CAMBRIA I-BEAMS.

Safe loads below are figured for fibre stress of 16 000 pounds per square inch and include weight of beam.

Distance between supports in feet.	STANDARD I-BEAM.				
	15 Inch No. B 53.				
	42 lbs.	45 lbs.	50 lbs.	55 lbs.	60 lbs.
10	62830	64830	68750	72670	76600
11	57120	58940	62500	•66070	•69630
12	52360	54030	57290	60560	63830
13	48330	49870	52890	55900	58920
14	44880	46310	49110	51910	54710
15	41880	43220	45840	48450	51060
16	39270	40520	42970	45420	47870
17	36960	38140	40440	42750	45060
18	34900	36020	38200	40370	42550
19	33070	34120	36190	38250	40310
20	31410	32420	34380	36340	38300
21	29920	30870	32740	34610	36470
22	28530	29470	31250	33030	34820
23	27320	28190	29890	31600	33300
24	26130	27010	28650	30280	31910
25	25130	25930	27500	29070	30640
26	24160	24940	26440	27950	29460
27	23270	24010	25460	26920	28370
28	22440	23150	24550	25960	27360
29	21660	22360	23710	25060	26410
30	20940	21610	22920	24220	25530
31	20270	20910	22180	23440	24710
32	19630	20260	21490	22710	23940
33	19040	19650	20830	22020	23210
34	18480	19070	20220	21370	22530
35	17950	18520	19640	20760	21880

For safe loads below the heavy lines, the deflections will be greater than the allowable limit for plastered ceilings = $\frac{1}{360}$ span.

Above single dot, safe loads are too great for standard connections.

SAFE LOADS IN POUNDS UNIFORMLY DISTRIBUTED FOR CAMBRIA I-BEAMS.

Safe loads below are figured for fibre stress of 16 000 pounds per square inch and include weight of beam.

Distance between supports in feet.	SPECIAL I-BEAM.				
	15 Inch No. B 109.				
	60 lbs.	65 lbs.	70 lbs.	75 lbs.	80 lbs.
10	86610	90470	94390	98310	102230
11	78740	82240	85810	89370	92940
12	72180	75390	78660	81920	85190
13	•66630	•69590	72610	75620	78640
14	61870	64620	•67420	•70220	73020
15	57740	60310	62920	65540	•68150
16	54130	56540	58990	61440	63890
17	50950	53220	55520	57830	60140
18	48120	50260	52440	54620	56790
19	45590	47610	49680	51740	53810
20	43310	45230	47190	49150	51120
21	41240	43080	44950	46810	48680
22	39370	41120	42900	44690	46470
23	37660	39330	41040	42740	44450
24	36090	•37690	39330	40960	42600
25	34650	36190	37750	39320	40890
26	33310	34790	36300	37810	39320
27	32080	33510	34960	36410	37860
28	30930	32310	33710	35110	36510
29	29870	31200	32550	33900	35250
30	28870	30160	31460	32770	34080
31	27940	29180	30450	31710	32980
32	27070	28270	29500	30720	31950
33	26250	27410	28600	29790	30980
34	25470	26610	27760	28910	30070
35	24750	25850	26970	28090	29210

For safe loads below the heavy lines, the deflections will be greater than the allowable limit for plastered ceilings = $\frac{1}{360}$ span.

Above single dot, safe loads are too great for standard connections.

SAFE LOADS IN POUNDS UNIFORMLY DISTRIBUTED FOR CAMBRIA I-BEAMS.

Safe loads below are figured for fibre stress of 16 000 pounds per square inch and include weight of beam.

Distance between supports in feet.	SPECIAL I-BEAM.				
	15 Inch No. B 113.				
	80 lbs.	85 lbs.	90 lbs.	95 lbs.	100 lbs.
10	112230	116030	119960	123880	127800
11	102030	105490	109050	112620	116180
12	93520	96700	99960	103230	106500
13	86330	89260	92270	95290	98310
14	80160	82880	85680	88480	91280
15	74820	77360	79970	82580	85200
16	•70140	72520	74970	77420	79870
17	66020	•68260	•70560	72870	75180
18	62350	64460	66640	•68820	71000
19	59070	61070	63130	65200	•67260
20	56110	58020	59980	61940	63900
21	53440	55250	57120	58990	60860
22	51010	52740	54530	56310	58090
23	48800	50450	52150	53860	55560
24	46760	48350	49980	51620	53250
25	44890	46410	47980	49550	51120
26	43170	44630	46140	47650	49150
27	41570	42980	44430	45880	47330
28	40080	41440	42840	44240	45640
29	38700	40010	41360	42720	44070
30	37410	38680	39990	41290	42600
31	36200	37430	38700	39960	41230
32	35070	36260	37490	38710	39940
33	34010	35160	36350	37540	38730
34	33010	34130	35280	36430	37590
35	32070	33150	34270	35390	36510

For safe loads below the heavy lines, the deflections will be greater than the allowable limit for plastered ceilings = $\frac{1}{360}$ span.

Above single dot, safe loads are too great for standard connections.

SAFE LOADS IN POUNDS UNIFORMLY DISTRIBUTED FOR CAMBRIA I-BEAMS.

Safe loads below are figured for fibre stress of 16 000 pounds per square inch and include weight of beam.

Distance between supports in feet.	STANDARD I-BEAMS.						
	18 Inch No. B 65.				20 Inch No. B 73.		
	55 lbs.	60 lbs.	65 lbs.	70 lbs.	65 lbs.	70 lbs.	75 lbs.
14	67350	71260	74620	77990	89110	92940	96670
15	62860	•66510	•69650	72790	83170	86740	90230
16	58930	62360	65300	•68240	77970	81320	84590
17	55460	58650	61460	64220	73380	76540	79610
18	52380	55430	58040	60660	•69310	72280	75190
19	49630	52510	54990	57460	65660	•68480	71230
20	47140	49880	52240	54590	62370	65060	•67670
21	44900	47510	49750	51990	59400	61960	64450
22	42860	45350	47490	49360	56700	59140	61520
23	40990	43380	45420	47470	54240	56570	58840
24	39290	41570	43530	45490	51980	54210	56390
25	37720	39910	41790	43670	49900	52040	54140
26	36260	38370	40180	41990	47980	50040	52050
27	34920	36950	38690	40440	46200	48190	50130
28	33670	35630	37310	38990	44550	46470	48340
29	32510	34400	36030	37650	43020	44870	46670
30	31430	33260	34820	36390	41580	43370	45110
31	30420	32180	33700	35220	40240	41970	43660
32	29460	31200	32650	34120	38980	40660	42290
33	28570	30230	31660	33080	37800	39430	41010
34	27730	29340	30730	32110	36690	38270	39810
35	26940	28510	29850	31190	35640	37170	38670
36	<u>26190</u>	<u>27710</u>	<u>29020</u>	<u>30330</u>	34650	36140	37590
37	25480	26960	28240	29510	33720	35160	36580
38	24810	26250	27490	28730	32830	34240	35620
39	24180	25580	26790	27990	31990	33360	34700
40	23570	24940	26120	27290	31190	32530	33830

For safe loads below the heavy lines, the deflections will be greater than the allowable limit for plastered ceilings = $\frac{1}{360}$ span.

Above single dot, safe loads are too great for standard connections.

SAFE LOADS IN POUNDS UNIFORMLY DISTRIBUTED FOR CAMBRIA I-BEAMS.

Safe loads below are figured for fibre stress of 16 000 pounds per square inch and include weight of beam.

Distance between supports in feet.	SPECIAL I-BEAM.				
	20 Inch No. B 121.				
	80 lbs.	85 lbs.	90 lbs.	95 lbs.	100 lbs.
16	97750	100570	103840	107100	110370
17	92000	94650	97730	100800	103880
18	86890	89390	92300	95200	98110
19	82320	84690	87440	90190	92950
20	78200	80460	83070	85680	88300
21	74480	76620	79110	81600	84090
22	71090	73140	75520	77890	80270
23	•68000	•69960	72230	74510	76780
24	65170	67050	•69220	71400	73580
25	62560	64360	66460	•68550	•70640
26	60160	61890	63900	65910	67920
27	57930	59600	61530	63470	65410
28	55860	57470	59340	61200	63070
29	53930	55490	57290	59090	60900
30	52140	53640	55380	57120	58870
31	50450	51910	53590	55280	56970
32	48880	50280	51920	53550	55190
33	47400	48760	50350	51930	53510
34	46000	47330	48860	50400	51940
35	44690	45970	47470	48960	50460
36	43450	44700	46150	47600	49050
37	42270	43490	44900	46320	47730
38	41160	42340	43720	45100	46470
39	40100	41260	42600	43940	45280
40	39100	40230	41530	42840	44150

Above single dot, safe loads are too great for standard connections.

SAFE LOADS IN POUNDS UNIFORMLY DIS- TRIBUTED FOR CAMBRIA I-BEAMS.

Safe loads below are figured for fibre stress of 16 000 pounds per square inch and include weight of beam.

Distance between supports in feet.	STANDARD I-BEAM.				
	24 Inch No. B 89.				
	80 lbs.	85 lbs.	90 lbs.	95 lbs.	100 lbs.
18	103070	107050	110540	114020	117510
19	97650	•101420	•104720	108020	111330
20	92770	96350	99480	•102620	•105760
21	88350	91760	94750	97740	100720
22	84330	87590	90440	93290	96140
23	80670	83780	86510	89240	91960
24	77300	80290	82900	85520	88130
25	74210	77080	79590	82100	86410
26	71360	74110	76530	78940	81350
27	68720	71370	73690	76020	78340
28	66260	68820	71060	73300	75540
29	63980	66450	68610	70770	72940
30	61840	64230	66320	68410	70510
31	59850	62160	64180	66210	68230
32	57980	60220	62180	64140	66100
33	56220	58390	60290	62200	64100
34	54570	56680	58520	60370	62210
35	53010	55060	56850	58640	60430
36	51540	53530	55270	57010	58760
37	50140	52080	53780	55470	57170
38	48820	50710	52360	54010	55660
39	47570	49410	51020	52630	54240
40	46380	48170	49740	51310	52880
41	45280	47000	48530	50060	51590
42	44170	45880	47370	48870	50360
43	43150	44810	46270	47730	49190
44	42170	43790	45220	46650	48070
45	41230	42820	44220	45610	47000
46	40330	41890	43250	44620	45980
47	39470	41000	42330	43670	45000
48	38650	40140	41450	42760	44070

Above single dot, safe loads are too great for standard connections.

SAFE LOADS IN POUNDS UNIFORMLY DISTRIBUTED FOR CAMBRIA I-BEAMS.

Safe loads below are figured for fibre stress of 16 000 pounds per square inch and include weight of beam.

Distance between supports in feet.	SPECIAL I-BEAM.		
	24 Inch No. B 127.		
	105 lbs.	110 lbs.	115 lbs.
18	138840	142390	145950
19	131530	134890	138270
20	124950	128150	131350
21	119000	122050	125100
22	113590	116500	119410
23	108660	111440	114220
24	• 104130	• 106790	• 109460
25	99960	• 102530	• 105080
26	96120	98580	101040
27	92560	94930	97300
28	89250	91540	93830
29	86170	88380	90590
30	83300	85440	87570
31	80620	82680	84740
32	78100	80100	82100
33	75730	77670	79610
34	73500	75380	77270
35	71400	73230	75060
36	69420	71200	72970
37	67540	69270	71000
38	65770	67450	69130
39	64080	65720	67360
40	62480	64080	65680
41	60950	62510	64080
42	59500	61030	62550
43	58120	59610	61090
44	56800	58250	59710
45	55530	56960	58380
46	54330	55720	57110
47	53170	54530	55890
48	52060	53400	54730

Above single dot, safe loads are too great for standard connections.

SAFE LOADS IN POUNDS UNIFORMLY DISTRIBUTED FOR CAMBRIA CHANNELS.

Safe loads below are figured for fibre stress of 16 000 pounds per square inch and include weight of channel.

Distance between supports in feet.	STANDARD CHANNELS.								
	3 Inch No. C 5.			4 Inch No. C 9.			5 Inch No. C 13.		
	4	5	6	5.25	6.25	7.25	6.5	9	11.5
	lbs.	lbs.	lbs.	lbs.	lbs.	lbs.	lbs.	lbs.	lbs.
4	2910	3290	3680	5060	5570	6090	7910	9460	11100
5	2330	2630	2940	4050	4450	4870	6330	7570	8880
6	1940	2190	2450	3370	3710	4060	5270	6310	7400
7	1660	1880	2100	2890	3180	3480	4520	5410	6340
8	1450	1640	1840	2530	2780	3050	3960	4730	5550
9	1290	1460	1630	2250	2470	2710	3520	4210	4930
10	1160	1310	1470	2020	2230	2440	3160	3790	4440
11	1060	1190	1340	1840	2020	2210	2880	3440	4040
12	970	1100	1230	1690	1860	2030	2640	3150	3700
13	890	1010	1130	1560	1710	1870	2430	2910	3410
14	830	940	1050	1440	1590	1740	2260	2700	3170
15	780	880	980	1350	1480	1620	2110	2520	2960
16	730	820	920	1260	1390	1520	1980	2370	2770
17	680	770	870	1190	1310	1430	1860	2230	2610
18	650	730	820	1120	1240	1350	1760	2100	2470
19	610	690	770	1060	1170	1280	1670	1990	2340
20	580	660	740	1010	1110	1220	1580	1890	2220
21	550	630	700	960	1060	1160	1510	1800	2110
22	530	600	670	920	1010	1110	1440	1720	2020
23	510	570	640	880	970	1060	1380	1650	1930
24	480	550	610	840	930	1020	1320	1580	1850
25	470	530	590	810	890	970	1270	1510	1780

For safe loads below the heavy lines, the deflections will be greater than the allowable limit for plastered ceilings = $\frac{1}{330}$ span.

SAFE LOADS IN POUNDS UNIFORMLY DISTRIBUTED FOR CAMERIA CHANNELS.

Safe loads below are figured for fibre stress of 16 000 pounds per square inch and include weight of channel.

Distance between supports in feet.	STANDARD CHANNELS.									
	6 Inch No. C 17.				7 Inch No. C 21.					
	8 lbs.	10.5 lbs.	13 lbs.	15.5 lbs.	9.75 lbs.	12.25 lbs.	14.75 lbs.	17.25 lbs.	19.75 lbs.	
4	11550	13440	15400	17360	16070	18410	20700	22990	25280	
5	9240	10750	12320	13890	12850	•14730	•16560	18390	20220	
6	7700	8960	10270	11570	10710	12280	13800	•15330	•16850	
7	6600	7680	8800	9920	9180	10520	11830	13140	14440	
8	5780	6720	7700	8680	8030	9210	10350	11490	12640	
9	5130	5970	6840	7720	7140	8180	9200	10220	11230	
10	4620	5380	6160	6940	6430	7370	8280	9200	10110	
11	4200	4890	5600	6310	5840	6700	7530	8360	9190	
12	3850	4480	5130	5790	5360	6140	6900	7660	8430	
13	3550	4130	4740	5340	4940	5670	6370	7070	7780	
14	3300	3840	4400	4960	4590	5260	5910	6570	7220	
15	3080	3580	4110	4630	4280	4910	5520	6130	6740	
16	2890	3360	3850	4340	4020	4600	5180	5750	6320	
17	2720	3160	3620	4080	3780	4330	4870	5410	5950	
18	2570	2990	3420	3860	3570	4090	4600	5110	5620	
19	2430	2830	3240	3650	3380	3880	4360	4840	5320	
20	2310	2690	3080	3470	3210	3680	4140	4600	5060	
21	2200	2560	2930	3310	3060	3510	3940	4380	4810	
22	2100	2440	2800	3160	2920	3350	3760	4180	4600	
23	2010	2340	2680	3020	2790	3200	3600	4000	4400	
24	1930	2240	2570	2890	2680	3070	3450	3830	4210	
25	1850	2150	2460	2780	2570	2950	3310	3680	4040	

For safe loads below the heavy lines, the deflections will be greater than the allowable limit for plastered ceilings = $\frac{1}{360}$ span.

Above single dot, safe loads are too great for standard connections.

SAFE LOADS IN POUNDS UNIFORMLY DISTRIBUTED FOR CAMBRIA CHANNELS.

Safe loads below are figured for fibre stress of 16 000 pounds per square inch and include weight of channel.

Distance between supports in feet.	STANDARD CHANNELS.									
	8 Inch No. C 25.					9 Inch No. C 29.				
	11.25	13.75	16.25	18.75	21.25	13.25	15	20	25	
lbs.	lbs.	lbs.	lbs.	lbs.	lbs.	lbs.	lbs.	lbs.	lbs.	
4	21530	24000	26610	29230	31840	28040	30130	36020	41900	
5	17230	19200	21290	23380	25470	22430	24110	28810	33520	
6	14360	16000	17740	19480	21230	18690	20090	24010	27930	
7	12310	13710	15210	16700	18200	16020	17220	20580	23940	
8	10770	12000	13310	14610	15920	14020	15070	18010	20950	
9	9570	10670	11830	12990	14150	12460	13390	16010	18620	
10	8610	9600	10650	11690	12740	11220	12050	14410	16760	
11	7830	8730	9680	10630	11580	10200	10960	13100	15240	
12	7180	8000	8870	9740	10610	9350	10040	12010	13970	
13	6630	7380	8190	8990	9800	8630	9270	11080	12890	
14	6150	6860	7600	8350	9100	8010	8610	10290	11970	
15	5740	6400	7100	7790	8490	7480	8040	9600	11170	
16	5380	6000	6650	7310	7960	7010	7530	9000	10470	
17	5070	5650	6260	6880	7490	6600	7090	8470	9860	
18	4790	5330	5910	6490	7080	6230	6700	8000	9310	
19	4530	5050	5600	6150	6700	5900	6340	7580	8820	
20	4310	4800	5320	5850	6370	5610	6030	7200	8380	
21	4100	4570	5070	5570	6070	5340	5740	6860	7980	
22	3920	4360	4840	5310	5790	5100	5480	6550	7620	
23	3750	4170	4630	5080	5540	4880	5240	6260	7290	
24	3590	4000	4440	4870	5310	4670	5020	6000	6980	
25	3450	3840	4260	4680	5090	4490	4820	5760	6700	

For safe loads below the heavy lines, the deflections will be greater than the allowable limit for plastered ceilings = $\frac{1}{360}$ span.

Above single dot, safe loads are too great for standard connections.

SAFE LOADS IN POUNDS UNIFORMLY DISTRIBUTED FOR CAMBRIA CHANNELS.

Safe loads below are figured for fibre stress of 16 000 pounds per square inch and include weight of channel.

Distance between supports in feet.	STANDARD CHANNEL.				
	10 Inch No. C 33.				
	15 lbs.	20 lbs.	25 lbs.	30 lbs.	35 lbs.
10	14270	16790	19410	22020	24640
11	12970	15270	17640	20020	22400
12	11890	14000	16170	18350	20530
13	10980	12920	14930	16940	18950
14	10190	12000	13860	15730	17600
15	9510	11200	12940	14680	16430
16	8920	10500	12130	13760	15400
17	8390	9880	11420	12950	14490
18	7930	9330	10780	12240	13690
19	7510	8840	10220	11590	12970
20	7130	8400	9700	11010	12320
21	6790	8000	9240	10490	11730
22	6490	7630	8820	10010	11200
23	6200	7300	8440	9580	10710
24	5940	7000	8090	9180	10270
25	5710	6720	7760	8810	9860
26	5490	6460	7460	8470	9480
27	5280	6220	7190	8160	9130
28	5100	6000	6930	7870	8800
29	4920	5790	6690	7590	8500
30	4760	5600	6470	7340	8210

For safe loads below the heavy lines, the deflections will be greater than the allowable limit for plastered ceilings = $\frac{1}{360}$ span.

SAFE LOADS IN POUNDS UNIFORMLY DISTRIBUTED FOR CAMBRIA CHANNELS.

Safe loads below are figured for fibre stress of 16 000 pounds per square inch and include weight of channel.

Distance between supports in feet.	STANDARD CHANNEL.				
	12 Inch No. C 41.				
	20.5 lbs.	25 lbs.	30 lbs.	35 lbs.	40 lbs.
10	22780	25600	28740	31870	35010
11	20700	23270	26120	28980	31830
12	18980	21330	23950	26560	29180
13	17520	19690	22110	24520	26930
14	16270	18290	20530	22770	25010
15	15180	17070	19160	21250	23340
16	14230	16000	17960	19920	21880
17	13400	15060	16900	18750	20600
18	12650	14220	15970	17710	19450
19	11990	13470	15120	16780	18430
20	11390	12800	14370	15940	17510
21	10850	12190	13680	15180	16670
22	10350	11640	13060	14490	15910
23	9900	11130	12490	13860	15220
24	9490	10670	11970	13280	14590
25	9110	10240	11490	12750	14000
26	8760	9850	11050	12260	13470
27	8440	9480	10640	11810	12970
28	8130	9140	10260	11380	12500
29	7850	8830	9910	10990	12070
30	7590	8530	9580	10620	11670

For safe loads below the heavy lines, the deflections will be greater than the allowable limit for plastered ceilings = $\frac{1}{360}$ span.

SAFE LOADS IN POUNDS UNIFORMLY DISTRIBUTED FOR CAMBRIA CHANNELS.

Safe loads below are figured for fibre stress of 16 000 pounds per square inch and include weight of channel.

Distance between supports in feet.	STANDARD CHANNEL.					
	15 Inch No. C 53.					
	33 lbs.	35 lbs.	40 lbs.	45 lbs.	50 lbs.	55 lbs.
10	44450	45500	49420	53350	57270	61190
11	40410	41370	44930	48500	52060	55630
12	37040	37920	41190	44460	47720	50990
13	34190	35000	38020	41040	44050	47070
14	31750	32500	35300	38100	40910	43710
15	29630	30340	32950	35560	38180	40790
16	27780	28440	30890	33340	35790	38240
17	26150	26770	29070	31380	33690	35990
18	24700	25280	27460	29640	31820	33990
19	23400	23950	26010	28080	30140	32210
20	22230	22750	24710	26670	28630	30590
21	21170	21670	23540	25400	27270	29140
22	20210	20680	22470	24250	26030	27810
23	19330	19780	21490	23190	24900	26600
24	18520	18960	20590	22230	23860	25500
25	17780	18200	19770	21340	22910	24480
26	17100	17500	19010	20520	22030	23530
27	16460	16850	18310	19760	21210	22660
28	15880	16250	17650	19050	20450	21850
29	15330	15690	17040	18400	19750	21100
30	14820	15170	16470	17780	19090	20400

SPACING OF CAMBRIA I-BEAMS FOR UNIFORM LOAD OF 100 LBS. PER SQUARE FOOT.

Proper distance in feet, center to center of Beams.

Maximum fibre stress 16 000 pounds per square inch.

Distance between supports in feet.	STANDARD I-BEAMS.						
	3 Inch No. B 5.			4 Inch No. B 9.			
	5.5 lbs.	6.5 lbs.	7.5 lbs.	7.5 lbs.	8.5 lbs.	9.5 lbs.	10.5 lbs.
4	11.0	12.0	12.9	19.9	21.2	22.5	23.8
5	7.1	7.7	8.3	12.7	13.6	14.4	15.2
6	4.9	5.3	5.8	8.8	9.4	10.0	10.6
7	3.6	3.9	4.2	6.5	6.9	7.3	7.8
8	2.8	3.0	3.2	5.0	5.3	5.6	5.9
9	2.2	2.4	2.6	3.9	4.2	4.4	4.7
10	1.8	1.9	2.1	3.2	3.4	3.6	3.8
11	1.5	1.6	1.7	2.6	2.8	3.0	3.1
12	1.2	1.3	1.4	2.2	2.4	2.5	2.6
13	1.0	1.1	1.2	1.9	2.0	2.1	2.3
14	1.0	1.1	1.6	1.7	1.8	1.9
15	1.4	1.5	1.6	1.7
16	1.2	1.3	1.4	1.5
17	1.1	1.2	1.2	1.3
18	1.0	1.0	1.1	1.2
19	1.0	1.1
20	1.0

For spacings below the heavy lines the deflections will be greater than the allowable limit for plastered ceilings = $\frac{1}{325}$ span.

Spacings for other intensities of loading may be obtained from those in tables as follows:

$$\text{Required spacing} = \frac{\text{Intensity of loading from table}}{\text{New intensity of loading}} \times \text{Computed spacing from table.}$$

SPACING OF CAMBRIA I-BEAMS FOR UNIFORM LOAD OF 100 LBS. PER SQUARE FOOT.

Proper distance in feet, center to center of Beams.
Maximum fibre stress 16 000 pounds per square inch.

Distance between supports in feet.	STANDARD I-BEAMS.					
	5 Inch No. B 13.			6 Inch No. B 17.		
	9.75 lbs.	12.25 lbs.	14.75 lbs.	12.25 lbs.	14.75 lbs.	17.25 lbs.
4	32.2	36.3	40.4	48.4	53.3	58.2
5	20.6	23.2	25.9	•31.0	•34.1	37.2
6	14.3	16.1	18.0	21.5	23.7	•25.9
7	10.5	11.9	13.2	15.8	17.4	19.0
8	8.1	9.1	10.1	12.1	13.3	14.5
9	6.4	7.2	8.0	9.6	10.5	11.5
10	5.2	5.8	6.5	7.7	8.5	9.3
11	4.3	4.8	5.3	6.4	7.0	7.7
12	3.6	4.0	4.5	5.4	5.9	6.5
13	3.1	3.4	3.8	4.6	5.0	5.5
14	2.6	3.0	3.3	4.0	4.4	4.8
15	2.3	2.6	2.9	3.4	3.8	4.1
16	2.0	2.3	2.5	3.0	3.3	3.6
17	1.8	2.0	2.2	2.7	3.0	3.2
18	1.6	1.8	2.0	2.4	2.6	2.9
19	1.4	1.6	1.8	2.1	2.4	2.6
20	1.3	1.5	1.6	1.9	2.1	2.3
21	1.2	1.3	1.5	1.8	1.9	2.1
22	1.1	1.2	1.3	1.6	1.8	1.9
23	1.0	1.1	1.2	1.5	1.6	1.8
24	1.0	1.1	1.3	1.5	1.6
25	1.0	1.2	1.4	1.5
26	1.0	1.1	1.3	1.4
27	1.1	1.2	1.3
28	1.0	1.1	1.2

For spacings above single dot the safe loads are too great for standard connections.

For spacings below the heavy lines the deflections will be greater than the allowable limit for plastered ceilings = $\frac{1}{325}$ span.

Spacings for other intensities of loading may be obtained from those in tables as follows:

$$\text{Required spacing} = \frac{\text{Intensity of loading from table}}{\text{New intensity of loading}} \times \text{Computed spacing from table.}$$

SPACING OF CAMBRIA I-BEAMS FOR UNI-FORM LOAD OF 100 LBS. PER SQUARE FOOT.

Proper distance in feet, center to center of Beams.
Maximum fibre stress 16 000 pounds per square inch.

Distance between supports in feet.	STANDARD I-BEAMS.						
	7 Inch No. B 21.			8 Inch No. B 25.			
	15 lbs.	17.5 lbs.	20 lbs.	18.00 lbs.	20.25 lbs.	22.75 lbs.	25.25 lbs.
4	69.0	74.6	80.3
5	44.2	47.8	51.4	60.7	64.2	68.4	72.6
6	30.7	33.2	35.7	42.1	44.6	47.5	•50.4
7	•22.5	•24.4	26.2	31.0	32.8	34.9	37.0
8	17.3	18.7	•20.1	23.7	25.1	26.7	28.3
9	13.6	14.7	15.9	18.7	19.8	21.1	22.4
10	11.0	11.9	12.9	15.2	16.1	17.1	18.1
11	9.1	9.9	10.6	12.5	13.3	14.1	15.0
12	7.7	8.3	8.9	10.5	11.1	11.9	12.6
13	6.5	7.1	7.6	9.0	9.5	10.1	10.7
14	5.6	6.1	6.6	7.7	8.2	8.7	9.3
15	4.9	5.3	5.7	6.7	7.1	7.6	8.1
16	4.3	4.7	5.0	5.9	6.3	6.7	7.1
17	3.8	4.1	4.4	5.2	5.6	5.9	6.3
18	3.4	3.7	4.0	4.7	5.0	5.3	5.6
19	3.1	3.3	3.6	4.2	4.4	4.7	5.0
20	2.8	3.0	3.2	3.8	4.0	4.3	4.5
21	2.5	2.7	2.9	3.4	3.6	3.9	4.1
22	2.3	2.5	2.7	3.1	3.3	3.5	3.7
23	2.1	2.3	2.4	2.9	3.0	3.2	3.4
24	1.9	2.1	2.2	2.6	2.8	3.0	3.1
25	1.8	1.9	2.1	2.4	2.6	2.7	2.9
26	1.6	1.8	1.9	2.2	2.4	2.5	2.7
27	1.5	1.6	1.8	2.1	2.2	2.3	2.5
28	1.4	1.5	1.6	1.9	2.0	2.2	2.3

For spacings above single dot the safe loads are too great for standard connections.

For spacing above the dotted line the safe load for bending is greater than the safe load for web crippling, as explained and shown on pages 82 to 84 inclusive.

For spacings below the heavy lines the deflections will be greater than the allowable limit for plastered ceilings = $\frac{1}{360}$ span.

Spacings for other intensities of loading may be obtained from those in tables as follows:

$$\text{Required spacing} = \frac{\text{Intensity of loading from table}}{\text{New intensity of loading}} \times \text{Computed spacing from table.}$$

SPACING OF CAMBRIA I-BEAMS FOR UNIFORM LOAD OF 100 LBS. PER SQUARE FOOT.

Proper distance in feet, center to center of Beams.
Maximum fibre stress 16 000 pounds per square inch.

Distance between supports in feet.	STANDARD I-BEAMS.							
	9 Inch No. B 29.				10 Inch No. B 33.			
	21 lbs.	25 lbs.	30 lbs.	35 lbs.	25 lbs.	30 lbs.	35 lbs.	40 lbs.
8	31.5	34.1	37.7	41.4
9	24.9	26.9	29.8	32.7
10	20.1	21.8	24.1	26.5	26.0	28.6	31.2	33.9
11	16.6	18.0	20.0	21.9	21.5	23.7	25.8	28.0
12	14.0	15.1	16.8	18.4	18.1	19.9	21.7	23.5
13	11.9	12.9	14.3	15.7	15.4	16.9	18.5	20.0
14	10.3	11.1	12.3	13.5	13.3	14.6	15.9	17.3
15	8.9	9.7	10.7	11.8	11.6	12.7	13.9	15.0
16	7.9	8.5	9.4	10.4	10.2	11.2	12.2	13.2
17	7.0	7.5	8.4	9.2	9.0	9.9	10.8	11.7
18	6.2	6.7	7.5	8.2	8.0	8.8	9.6	10.4
19	5.6	6.0	6.7	7.3	7.2	7.9	8.7	9.4
20	5.0	5.4	6.0	6.6	6.5	7.2	7.8	8.5
21	4.6	4.9	5.5	6.0	5.9	6.5	7.1	7.7
22	4.2	4.5	5.0	5.5	5.4	5.9	6.5	7.0
23	3.8	4.1	4.6	5.0	4.9	5.4	5.9	6.4
24	3.5	3.8	4.2	4.6	4.5	5.0	5.4	5.9
25	3.2	3.5	3.9	4.2	4.2	4.6	5.0	5.4
26	3.0	3.2	3.6	3.9	3.9	4.2	4.6	5.0
27	2.8	3.0	3.3	3.6	3.6	3.9	4.3	4.6
28	2.6	2.8	3.1	3.4	3.3	3.7	4.0	4.3
29	2.4	2.6	2.9	3.2	3.1	3.4	3.7	4.0
30	2.2	2.4	2.7	2.9	2.9	3.2	3.5	3.8
31	2.1	2.3	2.5	2.8	2.7	3.0	3.3	3.5
32	2.5	2.8	3.1	3.3
33	2.4	2.6	2.9	3.1

For spacings below the heavy lines the deflections will be greater than the allowable limit for plastered ceilings = $\frac{1}{325}$ span.

Spacings for other intensities of loading may be obtained from those in tables as follows:

$$\text{Required spacing} = \frac{\text{Intensity of loading from table}}{\text{New intensity of loading}} \times \text{Computed spacing from table.}$$

SPACING OF CAMBRIA I-BEAMS FOR UNIFORM LOAD OF 100 LBS. PER SQUARE FOOT.

Proper distance in feet, center to center of Beams.
Maximum fibre stress 16 000 pounds per square inch.

Distance between supports in feet.	STANDARD I-BEAM.			SPECIAL I-BEAM.			
	12 Inch No. B 41.			12 Inch No. B 105.			
	31.5 lbs.	35 lbs.	40 lbs.	40 lbs.	45 lbs.	50 lbs.	55 lbs.
10	38.4	40.6	43.7	47.8	50.8	53.9	57.1
11	31.7	33.5	36.1	39.5	42.0	•44.6	•47.2
12	26.6	28.2	30.4	33.2	35.3	37.5	39.6
13	22.7	24.0	25.9	28.3	30.1	31.9	33.8
14	19.6	20.7	22.3	24.4	25.9	27.5	29.1
15	17.1	18.0	19.4	21.3	22.6	24.0	25.4
16	15.0	15.9	17.1	18.7	19.8	21.1	22.3
17	13.3	14.0	15.1	16.5	17.6	18.7	19.7
18	11.8	12.5	13.5	14.8	15.7	16.6	17.6
19	10.6	11.2	12.1	13.2	14.1	14.9	15.8
20	9.6	10.1	10.9	12.0	12.7	13.5	14.3
21	8.7	9.2	9.9	10.8	11.5	12.2	12.9
22	7.9	8.4	9.0	9.9	10.5	11.1	11.8
23	7.3	7.7	8.3	9.0	9.6	10.2	10.8
24	6.7	7.0	7.6	8.3	8.8	9.4	9.9
25	6.1	6.5	7.0	7.7	8.1	8.6	9.1
26	5.7	6.0	6.5	7.1	7.5	8.0	8.4
27	5.3	5.6	6.0	6.6	7.0	7.4	7.8
28	4.9	5.2	5.6	6.1	6.5	6.9	7.3
29	4.6	4.8	5.2	5.7	6.0	6.4	6.8
30	4.3	4.5	4.9	5.3	5.6	6.0	6.3
31	4.0	4.2	4.5	5.0	5.3	5.6	5.9
32	3.7	4.0	4.3	4.7	5.0	5.3	5.6
33	3.5	3.7	4.0	4.4	4.7	5.0	5.2
34	3.3	3.5	3.8	4.1	4.4	4.7	4.9
35	3.1	3.3	3.6	3.9	4.1	4.4	4.7

For spacings above single dot the safe loads are too great for standard connections.

For spacings below the heavy lines the deflections will be greater than the allowable limit for plastered ceilings = $\frac{1}{325}$ span.

Spacings for other intensities of loading may be obtained from those in tables as follows:

$$\text{Required spacing} = \frac{\text{Intensity of loading from table}}{\text{New intensity of loading}} \times \text{Computed spacing from table.}$$

SPACING OF CAMBRIA I-BEAMS FOR UNIFORM LOAD OF 100 LBS. PER SQUARE FOOT.

Proper distance in feet, center to center of Beams.
Maximum fibre stress 16 000 pounds per square inch.

Distance between supports in feet.	STANDARD I-BEAM.				
	15 Inch No. B 53.				
	42 lbs.	45 lbs.	50 lbs.	55 lbs.	60 lbs.
10	62.8	64.8	68.8	72.7	76.6
11	51.9	53.6	56.8	•60.1	•63.3
12	43.6	45.0	47.7	50.5	53.2
13	37.2	38.4	40.7	43.0	45.3
14	32.0	33.1	35.1	37.1	39.1
15	27.9	28.8	30.6	32.3	34.0
16	24.5	25.3	26.9	28.4	29.9
17	21.7	22.4	23.8	25.1	26.5
18	19.4	20.0	21.2	22.4	23.6
19	17.4	18.0	19.0	20.1	21.2
20	15.7	16.2	17.2	18.2	19.1
21	14.2	14.7	15.6	16.5	17.4
22	13.0	13.4	14.2	15.0	15.8
23	11.9	12.3	13.0	13.7	14.5
24	10.9	11.3	11.9	12.6	13.3
25	10.1	10.4	11.0	11.6	12.3
26	9.3	9.6	10.2	10.8	11.3
27	8.6	8.9	9.4	10.0	10.5
28	8.0	8.3	8.8	9.3	9.8
29	7.5	7.7	8.2	8.6	9.1
30	7.0	7.2	7.6	8.1	8.5
31	6.5	6.7	7.2	7.6	8.0
32	6.1	6.3	6.7	7.1	7.5
33	5.8	6.0	6.3	6.7	7.0
34	5.4	5.6	5.9	6.3	6.6
35	5.1	5.3	5.6	5.9	6.3

For spacings above single dot the safe loads are too great for standard connections.

For spacings below the heavy lines the deflections will be greater than the allowable limit for plastered ceilings = $\frac{1}{380}$ span.

Spacings for other intensities of loading may be obtained from those in tables as follows:

$$\text{Required spacing} = \frac{\text{Intensity of loading from table}}{\text{New intensity of loading}} \times \text{Computed spacing from table.}$$

SPACING OF CAMBRIA I-BEAMS FOR UNIFORM LOAD OF 100 LBS. PER SQUARE FOOT.

Proper distance in feet, center to center of Beams.
Maximum fibre stress 16 000 pounds per square inch.

Distance between supports in feet.	SPECIAL I-BEAM.				
	15 Inch No. B 109.				
	60 lbs.	65 lbs.	70 lbs.	75 lbs.	80 lbs.
10	86.6	90.5	94.4	98.3	102.2
11	71.6	74.8	78.0	81.2	84.5
12	60.1	62.8	65.5	68.3	71.0
13	•51.3	•53.5	55.9	58.2	60.5
14	44.2	46.2	•48.2	•50.2	52.2
15	38.5	40.2	41.9	43.7	•45.4
16	33.8	35.3	36.9	38.4	39.9
17	30.0	31.3	32.7	34.0	35.4
18	26.7	27.9	29.1	30.3	31.6
19	24.0	25.1	26.1	27.2	28.3
20	21.7	22.6	23.6	24.6	25.6
21	19.6	20.5	21.4	22.3	23.2
22	17.9	18.7	19.5	20.3	21.1
23	16.4	17.1	17.8	18.6	19.3
24	15.0	15.7	16.4	17.1	17.7
25	13.9	14.5	15.1	15.7	16.4
26	12.8	13.4	14.0	14.5	15.1
27	11.9	12.4	12.9	13.5	14.0
28	11.0	11.5	12.0	12.5	13.0
29	10.3	10.8	11.2	11.7	12.2
30	9.6	10.1	10.5	10.9	11.4
31	9.0	9.4	9.8	10.2	10.6
32	8.5	8.8	9.2	9.6	10.0
33	8.0	8.3	8.7	9.0	9.4
34	7.5	7.8	8.2	8.5	8.8
35	7.1	7.4	7.7	8.0	8.3

For spacings above single dot the safe loads are too great for standard connections.

For spacings below the heavy lines the deflections will be greater than the allowable limit for plastered ceilings = $\frac{1}{325}$ span.

Spacings for other intensities of loading may be obtained from those in tables as follows:

$$\text{Required spacing} = \frac{\text{Intensity of loading from table}}{\text{New intensity of loading}} \times \text{Computed spacing from table.}$$

SPACING OF CAMBRIA I-BEAMS FOR UNI-FORM LOAD OF 100 LBS. PER SQUARE FOOT.

Proper distance in feet, center to center of Beams.
Maximum fibre stress 16 000 pounds per square inch.

Distance between supports in feet.	SPECIAL I-BEAM.				
	15 Inch No. B 113.				
	80 lbs.	85 lbs.	90 lbs.	95 lbs.	100 lbs.
10	112.2	116.0	120.0	123.9	127.8
11	92.8	95.9	99.1	102.4	105.6
12	77.9	80.6	83.3	86.0	88.7
13	66.4	68.7	71.0	73.3	75.6
14	57.3	59.2	61.2	63.2	65.2
15	49.9	51.6	53.3	55.1	56.8
16	•43.8	45.3	46.9	48.4	49.9
17	38.8	•40.2	•41.5	42.9	44.2
18	34.6	35.8	37.0	•38.2	39.4
19	31.1	32.1	33.2	34.3	•35.4
20	28.1	29.0	30.0	31.0	31.9
21	25.4	26.3	27.2	28.1	29.0
22	23.2	24.0	24.8	25.6	26.4
23	21.2	21.9	22.7	23.4	24.2
24	19.5	20.1	20.8	21.5	22.2
25	18.0	18.6	19.2	19.8	20.4
26	16.6	17.2	17.7	18.3	18.9
27	15.4	15.9	16.5	17.0	17.5
28	14.3	14.8	15.3	15.8	16.3
29	13.3	13.8	14.3	14.7	15.2
30	12.5	12.9	13.3	13.8	14.2
31	11.7	12.1	12.5	12.9	13.3
32	11.0	11.3	11.7	12.1	12.5
33	10.3	10.7	11.0	11.4	11.7
34	9.7	10.0	10.4	10.7	11.1
35	9.2	9.5	9.8	10.1	10.4

For spacings above single dot the safe loads are too great for standard connections.

For spacings below the heavy lines the deflections will be greater than the allowable limit for plastered ceilings = $\frac{1}{360}$ span.

Spacings for other intensities of loading may be obtained from those in tables as follows:

$$\text{Required spacing} = \frac{\text{Intensity of loading from table}}{\text{New intensity of loading}} \times \text{Computed spacing from table.}$$

SPACING OF CAMBRIA I-BEAMS FOR UNIFORM LOAD OF 100 LBS. PER SQUARE FOOT.

Proper distance in feet, center to center of Beams.
Maximum fibre stress 16 000 pounds per square inch.

Distance between supports in feet.	STANDARD I-BEAMS.						
	18 Inch No. B 65.				20 Inch No. B 73.		
	55 lbs.	60 lbs.	65 lbs.	70 lbs.	65 lbs.	70 lbs.	75 lbs.
14	48.1	50.9	53.3	55.7	63.6	66.4	69.1
15	41.9	•44.3	•46.4	48.5	55.4	57.8	60.2
16	36.8	39.0	40.8	•42.6	48.7	50.8	52.9
17	32.6	34.5	36.2	37.8	43.2	45.0	46.8
18	29.1	30.8	32.2	33.7	•38.5	40.2	41.8
19	26.1	27.6	28.9	30.2	34.6	•36.0	37.5
20	23.6	24.9	26.1	27.3	31.2	32.5	•33.8
21	21.4	22.6	23.7	24.8	28.3	29.5	30.7
22	19.5	20.6	21.6	22.6	25.8	26.9	28.0
23	17.8	18.9	19.7	20.6	23.6	24.6	25.6
24	16.5	17.3	18.1	19.0	21.7	22.6	23.5
25	15.1	16.0	16.7	17.5	20.0	20.8	21.7
26	13.9	14.8	15.5	16.2	18.5	19.2	20.0
27	12.9	13.7	14.3	15.0	17.1	17.8	18.6
28	12.0	12.7	13.3	13.9	15.9	16.6	17.3
29	11.2	11.9	12.4	13.0	14.8	15.5	16.1
30	10.5	11.1	11.6	12.1	13.9	14.5	15.0
31	9.8	10.4	10.9	11.4	13.0	13.5	14.1
32	9.2	9.7	10.2	10.7	12.2	12.7	13.2
33	8.7	9.2	9.6	10.0	11.5	11.9	12.4
34	8.2	8.6	9.0	9.4	10.8	11.3	11.7
35	7.7	8.1	8.5	8.9	10.2	10.6	11.0
36	7.3	7.7	8.1	8.4	9.6	10.0	10.4
37	<u>6.9</u>	<u>7.3</u>	<u>7.7</u>	<u>8.0</u>	9.1	9.5	9.9
38	6.5	6.9	7.2	7.6	8.6	9.0	9.4
39	6.2	6.5	6.8	7.2	8.2	8.5	8.9
40	5.9	6.2	6.5	6.8	7.8	8.1	8.4

For spacings above single dot the safe loads are too great for standard connections.

For spacings below the heavy lines the deflections will be greater than the allowable limit for plastered ceilings = $\frac{1}{360}$ span.

Spacings for other intensities of loading may be obtained from those in tables as follows:

$$\text{Required spacing} = \frac{\text{Intensity of loading from table}}{\text{New intensity of loading.}} \times \text{Computed spacing from table.}$$

SPACING OF CAMBRIA I-BEAMS FOR UNIFORM LOAD OF 100 LBS. PER SQUARE FOOT.

Proper distance in feet, center to center of Beams.
Maximum fibre stress 16 000 pounds per square inch.

Distance between supports in feet.	SPECIAL I-BEAM.				
	20 Inch No. B 121.				
	80 lbs.	85 lbs.	90 lbs.	95 lbs.	100 lbs.
16	61.1	62.9	64.9	66.9	69.0
17	54.1	55.7	57.5	59.3	61.1
18	48.3	49.7	51.3	52.9	54.5
19	43.3	44.6	46.0	47.5	48.9
20	39.1	40.2	41.5	42.8	44.1
21	35.5	36.5	37.7	38.9	40.0
22	32.3	33.2	34.3	35.4	36.5
23	•29.6	•30.4	31.4	32.4	33.4
24	27.2	27.9	•28.8	29.8	30.7
25	25.0	25.7	26.6	•27.4	28.3
26	23.1	23.8	24.6	25.4	•26.1
27	21.5	22.1	22.8	23.5	24.2
28	19.9	20.5	21.2	21.9	22.5
29	18.6	19.1	19.8	20.4	21.0
30	17.4	17.9	18.5	19.0	19.6
31	16.3	16.7	17.3	17.8	18.4
32	15.3	15.7	16.2	16.7	17.2
33	14.4	14.8	15.3	15.7	16.2
34	13.5	13.9	14.4	14.8	15.3
35	12.8	13.1	13.6	14.0	14.4
36	12.1	12.4	12.8	13.2	13.6
37	11.4	11.8	12.1	12.5	12.9
38	10.8	11.1	11.5	11.9	12.1
39	10.3	10.6	10.9	11.2	11.6
40	9.8	10.0	10.4	10.7	11.0

For spacings above single dot the safe loads are too great for standard connections.

Spacings for other intensities of loading may be obtained from those in tables as follows:

$$\text{Required spacing} = \frac{\text{Intensity of loading from table}}{\text{New intensity of loading}} \times \text{Computed spacing from table.}$$

SPACING OF CAMBRIA I-BEAMS FOR UNIFORM LOAD OF 100 LBS. PER SQUARE FOOT.

Proper distance in feet, center to center of Beams.
Maximum fibre stress 16 000 pounds per square inch.

Distance between supports in feet.	STANDARD I-BEAM.				
	24 Inch No. B 89.				
	80 lbs.	85 lbs.	90 lbs.	95 lbs.	100 lbs.
18	57.3	59.5	61.4	63.3	65.3
19	51.4	•53.4	•55.1	56.9	58.6
20	46.4	48.2	49.7	•51.3	•52.9
21	42.1	43.7	45.1	46.5	48.0
22	38.3	39.8	41.1	42.4	43.7
23	35.1	36.4	37.6	38.8	40.0
24	32.2	33.5	34.5	35.6	36.7
25	29.7	30.8	31.8	32.8	33.8
26	27.4	28.5	29.4	30.4	31.3
27	25.5	26.4	27.3	28.2	29.0
28	23.7	24.6	25.4	26.2	27.0
29	22.1	22.9	23.7	24.4	25.2
30	20.6	21.4	22.1	22.8	23.5
31	19.3	20.1	20.7	21.4	22.0
32	18.1	18.8	19.4	20.0	20.7
33	17.0	17.7	18.3	18.8	19.4
34	16.0	16.7	17.2	17.8	18.3
35	15.1	15.7	16.2	16.8	17.3
36	14.3	14.9	15.4	15.8	16.3
37	13.5	14.1	14.5	15.0	15.4
38	12.8	13.3	13.7	14.2	14.6
39	12.2	12.6	13.1	13.5	13.9
40	11.6	12.0	12.4	12.8	13.2
41	11.0	11.5	11.8	12.2	12.6
42	10.5	10.9	11.3	11.6	12.0
43	10.0	10.4	10.8	11.1	11.4
44	9.6	9.9	10.3	10.6	10.9
45	9.2	9.5	9.8	10.1	10.4
46	8.7	9.1	9.4	9.7	10.0
47	8.4	8.7	9.0	9.3	9.6
48	8.0	8.3	8.6	8.9	9.2

For spacings above single dot, the safe loads are too great for standard connections.

Spacings for other intensities of loading may be obtained from those in tables as follows:

$$\text{Required spacing} = \frac{\text{Intensity of loading from table}}{\text{New intensity of loading}} \times \text{Computed spacing from table.}$$

SPACING OF CAMBRIA I-BEAMS FOR UNIFORM LOAD OF 100 LBS. PER SQUARE FOOT.

Proper distance in feet, center to center of Beams.
Maximum fibre stress 16 000 pounds per square inch.

Distance between supports in feet.	SPECIAL I-BEAM.		
	24 Inch No. B 127.		
	105 lbs.	110 lbs.	115 lbs.
18	77.1	79.1	81.1
19	69.2	71.0	72.8
20	62.5	64.1	65.7
21	56.7	58.1	59.6
22	51.6	53.0	54.3
23	47.2	48.4	49.6
24	• 43.4	• 44.5	• 45.6
25	40.0	• 41.0	• 42.0
26	37.0	37.9	38.8
27	34.3	35.1	36.0
28	31.9	32.7	33.5
29	29.7	30.5	31.2
30	27.8	28.5	29.2
31	26.0	26.7	27.3
32	24.4	25.0	25.6
33	22.9	23.5	24.1
34	21.6	22.2	22.7
35	20.4	20.9	21.4
36	19.3	19.8	20.3
37	18.3	18.7	19.2
38	17.3	17.7	18.2
39	16.4	16.8	17.2
40	15.6	16.0	16.4
41	14.9	15.2	15.6
42	14.2	14.5	14.9
43	13.5	13.8	14.2
44	12.9	13.2	13.6
45	12.3	12.6	13.0
46	11.8	12.1	12.4
47	11.3	11.6	11.9
48	10.8	11.1	11.4

For spacings above single dot the safe loads are too great for standard connections.

Spacings for other intensities of loading may be obtained from those in tables as follows:

$$\text{Required spacing} = \frac{\text{Intensity of loading from table}}{\text{New intensity of loading}} \times \text{Computed spacing from table.}$$

MAXIMUM BENDING MOMENTS IN FOOT POUNDS FOR CAMBRIA I-BEAMS.

Section Num- ber.	Depth of Beam.	Weight per Foot.	Maximum Bending Moment.		Section Num- ber.	Depth of Beam.	Weight per Foot.	Maximum Bending Moment.	
			Foot Pounds.					Foot Pounds.	
	Inches.	Pounds.	Fibre Stress 16 000 lbs. per Sq. In.	Fibre Stress 12 500 lbs. per Sq. In.		Fibre Stress 16 000 lbs. per Sq. In.	Fibre Stress 12 500 lbs. per Sq. In.		
B 5	3	5.5	2270	1770	B 53	15	42	78530	61350
"	"	6.5	2400	1880	"	"	45	81070	63330
"	"	7.5	2530	1980	"	"	50	86000	67190
B 9	4	7.5	4000	3130	"	"	55	90800	70940
"	"	8.5	4270	3330	"	"	60	95730	74790
"	"	9.5	4530	3540	B109	15	60	108270	84580
"	"	10.5	4800	3750	"	"	65	113070	88330
B 13	5	9.75	6400	5000	"	"	70	118000	92190
"	"	12.25	7200	5630	"	"	75	122930	96040
"	"	14.75	8130	6350	"	"	80	127730	99790
B 17	6	12.25	9730	7600	B113	15	80	140270	109580
"	"	14.75	10670	8330	"	"	85	145070	113330
"	"	17.25	11600	9060	"	"	90	150000	117190
B 21	7	15	13870	10830	"	"	95	154800	120940
"	"	17.5	14930	11670	"	"	100	159730	124790
"	"	20	16130	12600	B 65	18	55	117870	92080
B 25	8	18	18930	14790	"	"	60	124670	97400
"	"	20.25	20000	15630	"	"	65	130530	101980
"	"	22.75	21330	16670	"	"	70	136530	106670
"	"	25.25	22670	17710	B 73	20	65	156000	121880
B 29	9	21	25200	19690	"	"	70	162670	127080
"	"	25	27200	21250	"	"	75	169200	132190
"	"	30	30130	23540	B121	20	80	195470	152710
"	"	35	33070	25830	"	"	85	201200	157190
B 33	10	25	32530	25420	"	"	90	207730	162290
"	"	30	35730	27920	"	"	95	214270	167400
"	"	35	39070	30520	"	"	100	220800	172500
"	"	40	42270	33020	B 89	24	80	231870	181150
B 41	12	31.5	48000	37500	"	"	85	240930	188230
"	"	35	50670	39580	"	"	90	248670	194270
"	"	40	54670	42710	"	"	95	256530	200420
"	"	"	"	"	"	"	100	264400	206560
B105	12	40	59730	46670	B 89	24	80	231870	181150
"	"	45	63470	49580	"	"	85	240930	188230
"	"	50	67470	52710	"	"	90	248670	194270
"	"	55	71330	55730	"	"	95	256530	200420
					"	"	100	264400	206560
B105	12	40	59730	46670	B127	24	105	312380	244050
"	"	45	63470	49580	"	"	110	320380	250300
"	"	50	67470	52710	"	"	115	328380	256550
"	"	55	71330	55730	"	"	115	328380	256550

MAXIMUM BENDING MOMENTS IN FOOT POUNDS FOR CAMBRIA CHANNELS.

Section Number.	Depth of Channel.	Weight per Foot.	Maximum Bending Moment.		Section Number.	Depth of Channel.	Weight per Foot.	Maximum Bending Moment.	
			Foot Pounds.					Foot Pounds.	
	Inches.	Pounds.	Fibre Stress	Fibre Stress		Inches.	Pounds.	Fibre Stress	Fibre Stress
			16 000 lbs. per Sq. In.	12 500 lbs. per Sq. In.				16 000 lbs. per Sq. In.	12 500 lbs. per Sq. In.
C 5	3	4	1470	1150	C29	9	13.25	14000	10940
"	"	5	1600	1250	"	"	15	15070	11770
"	"	6	1870	1460	"	"	20	18000	14060
					"	"	25	20930	16350
C 9	4	5.25	2530	1980					
"	"	6.25	2800	2190	C33	10	15	17870	13960
"	"	7.25	3070	2400	"	"	20	20930	16350
					"	"	25	24270	18960
C13	5	6.5	4000	3130	"	"	30	27470	21460
"	"	9	4670	3650	"	"	35	30800	24060
"	"	11.5	5600	4380					
					C41	12	20.5	28530	22290
C17	6	8	5730	4480	"	"	25	32000	25000
"	"	10.5	6670	5210	"	"	30	35870	28020
"	"	13	7730	6040	"	"	35	39870	31150
"	"	15.5	8670	6770	"	"	40	43730	34170
C21	7	9.75	8000	6250	C53	15	33	55600	43440
"	"	12.25	9200	7190	"	"	35	56930	44480
"	"	14.75	10400	8130	"	"	40	61730	48230
"	"	17.25	11470	8960	"	"	45	66670	52080
"	"	19.75	12670	9900	"	"	50	71600	55940
					"	"	55	76530	59790
C25	8	11.25	10800	8440					
"	"	13.75	12000	9380	C65	18	45	86530	67600
"	"	16.25	13330	10420	"	"	50	92310	72130
"	"	18.75	14670	11460	"	"	55	98070	76620
"	"	21.25	15870	12400	"	"	60	104190	81410

SAFE LOADS IN POUNDS UNIFORMLY DISTRIBUTED FOR CAMBRIA ANGLES.

EQUAL LEGS.

NEUTRAL AXIS PARALLEL TO EITHER LEG.

Safe loads below are figured for fibre stress of 16 000 pounds per square inch and include weight of angle.



Distance between supports in feet.	Section No. A 11.				
	$1\frac{1}{2}'' \times 1\frac{1}{2}''$				
	$\frac{1}{8}''$	$\frac{3}{16}''$	$\frac{1}{4}''$	$\frac{5}{16}''$	$\frac{3}{8}''$
	1.23 lbs. per ft.	1.80 lbs. per ft.	2.34 lbs. per ft.	2.86 lbs. per ft.	3.35 lbs. per ft.
2	390	560	720	860	1010
3	260	370	480	580	670
4	190	280	360	430	500
5	150	220	290	350	400
6	130	190	240	290	340
7	110	160	200	250	290
8	100	140	180	220	250
9	90	120	160	190	220

Distance between supports in feet.	Section No. A 40.				
	$1\frac{3}{4}'' \times 1\frac{3}{4}''$				
	$\frac{1}{8}''$	$\frac{3}{16}''$	$\frac{1}{4}''$	$\frac{5}{16}''$	$\frac{3}{8}''$
	1.44 lbs. per ft.	2.12 lbs. per ft.	2.77 lbs. per ft.	3.39 lbs. per ft.	3.99 lbs. per ft.
2	530	770	990	1200	1400
3	350	510	660	800	940
4	260	380	500	600	700
5	210	310	400	480	560
6	170	260	330	400	470
7	150	220	280	340	400
8	130	190	250	300	350
9	110	170	220	270	310
10	100	150	200	240	280

Distance between supports in feet.	Section No. A 15.						
	$2'' \times 2''$						
	$\frac{1}{8}''$	$\frac{3}{16}''$	$\frac{1}{4}''$	$\frac{5}{16}''$	$\frac{3}{8}''$	$\frac{7}{16}''$	$\frac{1}{2}''$
	1.65 lbs. per ft.	2.44 lbs. per ft.	3.19 lbs. per ft.	3.92 lbs. per ft.	4.7 lbs. per ft.	5.3 lbs. per ft.	6.0 lbs. per ft.
2	690	1020	1320	1600	1870	2130	2380
3	460	680	880	1070	1250	1420	1590
4	340	510	660	800	940	1070	1190
5	270	410	530	640	750	850	950
6	230	340	440	530	620	710	790
7	190	290	380	460	540	610	680
8	170	250	330	400	470	530	600
9	150	230	290	360	420	470	530
10	130	200	260	320	370	430	480

For safe loads below heavy lines the deflections will be greater than the allowable limit for plastered ceilings = $\frac{1}{325}$ span.

SAFE LOADS IN POUNDS UNIFORMLY DISTRIBUTED FOR CAMBRIA ANGLES.

EQUAL LEGS.

NEUTRAL AXIS PARALLEL TO EITHER LEG.

Safe loads below are figured for fibre stress of 16 000 pounds per square inch and include weight of angle.



Distance between supports in feet.	Section No. A 41		
	$2\frac{1}{4}'' \times 2\frac{1}{4}''$		
	$\frac{3}{16}''$	$\frac{1}{4}''$	$\frac{5}{16}''$
	2.75 lbs. per ft.	3.62 lbs. per ft.	4.5 lbs. per ft.
2	1300	1690	2060
3	870	1120	1370
4	650	840	1030
5	520	670	820
6	430	560	690
7	370	480	590
8	320	420	510
9	290	380	460
10	260	340	410
11	240	310	370
12	220	280	340

Distance between supports in feet.	Section No. A 17.						
	$2\frac{1}{2}'' \times 2\frac{1}{2}''$						
	$\frac{1}{8}''$	$\frac{3}{16}''$	$\frac{1}{4}''$	$\frac{5}{16}''$	$\frac{3}{8}''$	$\frac{7}{16}''$	$\frac{1}{2}''$
	2.08 lbs. per ft.	3.07 lbs. per ft.	4.1 lbs. per ft.	5.0 lbs. per ft.	5.9 lbs. per ft.	6.8 lbs. per ft.	7.7 lbs. per ft.
2	1060	1610	2100	2570	3020	3450	3860
3	710	1080	1400	1710	2010	2300	2580
4	530	810	1050	1290	1510	1720	1930
5	420	650	840	1030	1210	1380	1550
6	350	540	700	860	1010	1150	1290
7	300	460	600	730	860	990	1100
8	260	400	530	640	760	860	970
9	230	360	470	570	670	770	860
10	210	320	420	510	600	690	770
11	190	290	380	470	550	630	700
12	170	270	350	430	500	580	640

For safe loads below heavy lines the deflections will be greater than the allowable limit for plastered ceilings = $\frac{1}{325}$ span.

SAFE LOADS IN POUNDS UNIFORMLY DISTRIBUTED FOR CAMBRIA ANGLES.

EQUAL LEGS.

NEUTRAL AXIS PARALLEL TO EITHER LEG.

Safe loads below are figured for fibre stress of 16 000 pounds per square inch and include weight of angle.



Distance between supports in feet.	Section No. A 43.		
	$2\frac{3}{4}'' \times 2\frac{3}{4}''$		
	$\frac{1}{4}''$	$\frac{5}{16}''$	$\frac{3}{8}''$
	4.5 lbs. per ft.	5.6 lbs. per ft.	6.6 lbs. per ft.
2	2570	3140	3700
3	1710	2090	2460
4	1280	1570	1850
5	1030	1260	1480
6	860	1050	1230
7	730	900	1060
8	640	790	920
9	570	700	820
10	510	630	740
11	470	570	670
12	430	520	620

Distance between supports in feet.	Section No. A 19.					
	$3'' \times 3''$					
	$\frac{1}{4}''$	$\frac{5}{16}''$	$\frac{3}{8}''$	$\frac{7}{16}''$	$\frac{1}{2}''$	$\frac{9}{16}''$
	4.9 lbs. per ft.	6.1 lbs. per ft.	7.2 lbs. per ft.	8.3 lbs. per ft.	9.4 lbs. per ft.	10.4 lbs. per ft.
2	3080	3770	4440	5090	5720	6320
3	2050	2510	2960	3390	3810	4210
4	1540	1890	2220	2540	2860	3160
5	1230	1510	1780	2040	2290	2530
6	1030	1260	1480	1700	1910	2110
7	880	1080	1270	1450	1630	1810
8	770	940	1110	1270	1430	1580
9	680	840	990	1130	1270	1410
10	620	750	890	1020	1140	1260
11	560	690	810	930	1040	1150
12	510	630	740	850	950	1050

For safe loads below heavy lines the deflections will be greater than the allowable limit for plastered ceilings = $\frac{1}{320}$ span.

SAFE LOADS IN POUNDS UNIFORMLY DISTRIBUTED FOR CAMBRIA ANGLES.

EQUAL LEGS.

NEUTRAL AXIS PARALLEL TO EITHER LEG.

Safe loads below are figured for fibre stress of 16 000 pounds per square inch and include weight of angle.



Section No. A 21.

Distance between supports in feet.	3 1/2" x 3 1/2"										
	1/4"	5/16"	3/8"	7/16"	1/2"	9/16"	5/8"	11/16"	3/4"	13/16"	7/8"
	5.8 lbs. per ft.	7.2 lbs. per ft.	8.5 lbs. per ft.	9.8 lbs. per ft.	11.1 lbs. per ft.	12.4 lbs. per ft.	13.6 lbs. per ft.	14.8 lbs. per ft.	16.0 lbs. per ft.	17.1 lbs. per ft.	18.3 lbs. per ft.
2	4210	5200	6140	7050	7940	8800	9630	10440	11230	12010	12760
3	2810	3470	4100	4700	5290	5860	6420	6960	7490	8000	8510
4	2110	2600	3070	3530	3970	4400	4810	5220	5620	6000	6380
5	1680	2080	2460	2820	3180	3520	3850	4180	4490	4800	5110
6	1400	1730	2050	2350	2650	2930	3210	3480	3740	4000	4250
7	1200	1490	1760	2020	2270	2510	2750	2980	3210	3430	3650
8	1050	1300	1540	1760	1980	2200	2410	2610	2810	3000	3190
9	940	1160	1370	1570	1760	1950	2140	2320	2500	2670	2840
10	840	1040	1230	1410	1590	1760	1930	2090	2250	2400	2550
11	770	950	1120	1280	1440	1600	1750	1900	2040	2180	2320
12	700	870	1020	1180	1320	1470	1600	1740	1870	2000	2130
13	650	800	950	1090	1220	1350	1480	1610	1730	1850	1960
14	600	740	880	1010	1130	1260	1380	1490	1610	1720	1820
15	560	690	820	940	1060	1170	1280	1390	1500	1600	1700
16	530	650	770	880	990	1100	1200	1310	1400	1500	1600

Section No. A 23.

Distance between supports in feet.	4" x 4"										
	5/16"	3/8"	7/16"	1/2"	9/16"	5/8"	11/16"	3/4"	13/16"	7/8"	
	8.2 lbs. per ft.	9.8 lbs. per ft.	11.3 lbs. per ft.	12.8 lbs. per ft.	14.3 lbs. per ft.	15.7 lbs. per ft.	17.1 lbs. per ft.	18.5 lbs. per ft.	19.9 lbs. per ft.	21.2 lbs. per ft.	
2	6870	8120	9340	10530	11690	12810	13910	14980	16030	17060	
3	4580	5420	6230	7020	7790	8540	9270	9990	10690	11370	
4	3430	4060	4670	5270	5840	6410	6960	7490	8020	8530	
5	2750	3250	3740	4210	4670	5130	5560	5990	6410	6820	
6	2290	2710	3120	3510	3900	4270	4640	4990	5340	5690	
7	1960	2320	2670	3010	3340	3660	3970	4280	4580	4870	
8	1720	2030	2340	2630	2920	3200	3480	3740	4010	4260	
9	1530	1810	2080	2340	2600	2850	3090	3330	3560	3790	
10	1370	1620	1870	2110	2340	2560	2780	3000	3210	3410	
11	1250	1480	1700	1910	2130	2330	2530	2720	2910	3100	
12	1140	1350	1560	1760	1950	2140	2320	2500	2670	2840	
13	1060	1250	1440	1620	1800	1970	2140	2300	2470	2620	
14	980	1160	1340	1500	1670	1830	1990	2140	2290	2440	
15	920	1080	1250	1400	1560	1710	1860	2000	2140	2270	
16	860	1020	1170	1320	1460	1600	1740	1870	2000	2130	

For safe loads below heavy lines the deflections will be greater than the allowable limit for plastered ceilings = 1/160 span.

SAFE LOADS IN POUNDS UNIFORMLY DISTRIBUTED FOR CAMBRIA ANGLES.

EQUAL LEGS.

NEUTRAL AXIS PARALLEL TO EITHER LEG.

Safe loads below are figured for fibre stress of 16 000 pounds per square inch and include weight of angle.



Distance between supports in feet.	Section No. A 47.						
	5" x 5"						
	$\frac{3}{8}$ "	$\frac{7}{16}$ "	$\frac{1}{2}$ "	$\frac{9}{16}$ "	$\frac{5}{8}$ "	$\frac{11}{16}$ "	$\frac{3}{4}$ "
	12.3 lbs. per ft.	14.3 lbs. per ft.	16.2 lbs. per ft.	18.1 lbs. per ft.	20.0 lbs. per ft.	21.8 lbs. per ft.	23.6 lbs. per ft.
2	12910	14900	16830	18720	20570	22380	24160
3	8610	9930	11220	12480	13710	14920	16110
4	6460	7450	8410	9360	10280	11190	12080
5	5170	5960	6730	7490	8230	8950	9660
6	4310	4960	5610	6240	6860	7460	8050
7	3690	4260	4810	5350	5880	6390	6900
8	3230	3720	4210	4680	5140	5600	6040
9	2870	3310	3740	4160	4570	4970	5370
10	2580	2980	3370	3740	4110	4480	4830
11	2350	2710	3060	3400	3740	4070	4390
12	2150	2480	2800	3120	3430	3730	4030
13	1990	2290	2590	2880	3160	3440	3720
14	1850	2130	2400	2670	2940	3200	3450
15	1720	1990	2240	2500	2740	2980	3220
16	1610	1860	2100	2340	2570	2800	3020
17	1520	1750	1980	2200	2420	2630	2840
18	1440	1660	1870	2080	2290	2490	2680

Distance between supports in feet.	Section No. A 27.										
	6" x 6"										
	$\frac{3}{8}$ "	$\frac{7}{16}$ "	$\frac{1}{2}$ "	$\frac{9}{16}$ "	$\frac{5}{8}$ "	$\frac{11}{16}$ "	$\frac{3}{4}$ "	$\frac{13}{16}$ "	$\frac{7}{8}$ "	$\frac{15}{16}$ "	1"
	14.9 lbs. per ft.	17.2 lbs. per ft.	19.6 lbs. per ft.	21.9 lbs. per ft.	24.2 lbs. per ft.	26.5 lbs. per ft.	28.7 lbs. per ft.	31.0 lbs. per ft.	33.1 lbs. per ft.	35.3 lbs. per ft.	37.4 lbs. per ft.
2	18820	21720	24610	27420	30170	32880	35540	38150	40720	43240	45720
3	12550	14480	16400	18280	20120	21920	23690	25430	27150	28830	30480
4	9410	10860	12300	13710	15090	16440	17770	19080	20360	21620	22860
5	7530	8690	9840	10970	12070	13150	14220	15260	16290	17300	18290
6	6270	7240	8200	9140	10060	10960	11850	12720	13570	14410	15240
7	5380	6210	7030	7830	8620	9390	10150	10900	11630	12360	13060
8	4700	5430	6150	6850	7540	8220	8890	9540	10180	10810	11430
9	4180	4830	5470	6090	6710	7310	7900	8480	9050	9610	10160
10	3760	4340	4920	5480	6030	6580	7110	7630	8140	8650	9140
11	3420	3950	4470	4990	5490	5980	6460	6940	7400	7860	8310
12	3140	3620	4100	4570	5030	5480	5920	6360	6790	7210	7620
13	2900	3340	3790	4220	4640	5060	5470	5870	6260	6650	7030
14	2690	3100	3520	3920	4310	4700	5080	5450	5820	6180	6530
15	2510	2900	3280	3660	4020	4380	4740	5090	5430	5770	6100
16	2350	2720	3080	3430	3770	4110	4440	4770	5090	5410	5720
17	2210	2560	2900	3230	3550	3870	4180	4490	4790	5090	5380
18	2090	2410	2730	3050	3350	3650	3950	4240	4520	4810	5080
19	1980	2290	2590	2890	3180	3460	3740	4020	4290	4550	4810
20	1880	2170	2460	2740	3020	3290	3550	3820	4070	4320	4570
21	1790	2070	2340	2610	2870	3130	3390	3630	3880	4120	4350
22	1710	1970	2240	2490	2740	2990	3230	3470	3700	3930	4160

For safe loads below heavy lines the deflections will be greater than the allowable limit for plastered ceilings = $\frac{1}{300}$ span.

SAFE LOADS IN POUNDS UNIFORMLY DISTRIBUTED FOR CAMBRIA ANGLES.

EQUAL LEGS.

NEUTRAL AXIS PARALLEL TO EITHER LEG.

Safe loads below are figured for fibre stress of 16 000 pounds per square inch and include weight of angle.



Section No. A 35.

Distance
between

8" x 8"

sup- ports	1/2"	9/16"	5/8"	11/16"	3/4"	13/16"	7/8"	15/16"	1"	1 1/16"	1 1/8"
	in feet.	26.4 lbs. per ft.	29.6 lbs. per ft.	32.7 lbs. per ft.	35.8 lbs. per ft.	38.9 lbs. per ft.	42.0 lbs. per ft.	45.0 lbs. per ft.	48.1 lbs. per ft.	51.0 lbs. per ft.	54.0 lbs. per ft.
4	22310	24910	27470	30000	32490	34950	37370	39760	42120	44450	46750
5	17850	19920	21980	24000	25990	27960	29900	31810	33700	35560	37400
6	14880	16600	18310	20000	21660	23300	24920	26510	28080	29630	31160
7	12750	14230	15700	17140	18570	19970	21360	22720	24070	25400	26710
8	11160	12450	13740	15000	16250	17480	18690	19880	21060	22220	23370
9	9920	11070	12210	13330	14440	15530	16610	17670	18720	19760	20780
10	8930	9960	10990	12000	13000	13980	14950	15910	16850	17780	18700
11	8110	9060	9990	10910	11820	12710	13590	14460	15320	16160	17000
12	7440	8300	9160	10000	10830	11650	12460	13250	14040	14820	15580
13	6870	7660	8450	9230	10000	10750	11500	12240	12960	13680	14380
14	6380	7120	7850	8570	9280	9990	10680	11360	12030	12700	13360
15	5950	6640	7330	8000	8660	9320	9970	10600	11230	11850	12470
16	5580	6230	6870	7500	8120	8740	9340	9940	10530	11110	11690
17	5250	5860	6460	7060	7650	8220	8790	9360	9910	10460	11000
18	4960	5530	6100	6670	7220	7770	8310	8840	9360	9880	10390
19	4700	5240	5780	6320	6840	7360	7870	8370	8870	9360	9840
20	4460	4980	5490	6000	6500	6990	7470	7950	8420	8890	9350
21	4250	4740	5230	5710	6190	6660	7120	7570	8020	8470	8900
22	4060	4530	4990	5450	5910	6350	6800	7230	7660	8080	8500
23	3880	4330	4780	5220	5650	6080	6500	6920	7330	7730	8130
24	3720	4150	4580	5000	5420	5830	6230	6630	7020	7410	7790
25	3570	3980	4400	4800	5200	5590	5980	6360	6740	7110	7480
26	3430	3830	4230	4620	5000	5380	5750	6120	6480	6840	7190
27	3310	3690	4070	4440	4810	5180	5540	5890	6240	6590	6930
28	3190	3560	3920	4290	4640	4990	5340	5680	6020	6350	6680
29	3080	3440	3790	4140	4480	4820	5160	5480	5810	6130	6450
30	2980	3320	3660	4000	4330	4660	4980	5300	5620	5930	6230

For safe loads below heavy lines the deflections will be greater than the allowable limit for plastered ceilings = 1/320 span.

SAFE LOADS IN POUNDS UNIFORMLY DISTRIBUTED FOR CAMBRIA ANGLES.

UNEQUAL LEGS.

NEUTRAL AXIS PARALLEL TO LONG LEG.

Safe loads below are figured for fibre stress of 16 000 pounds per square inch and include weight of angle.

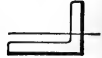

Distance between supports in feet.	Section No. A 91.						Section No. A 129.					
	2½" x 2"						3" x 2"					
	3/16"	1/4"	5/16"	3/8"	7/16"	1/2"	3/16"	1/4"	5/16"	3/8"	7/16"	1/2"
2	2.75	3.62	4.5	5.3	6.1	6.8	3.07	4.1	5.0	5.9	6.8	7.7
3	700	900	1100	1290	1470	1640	710	920	1120	1320	1510	1690
4	520	680	830	970	1100	1230	530	690	840	990	1130	1260
5	420	540	660	770	880	990	430	550	670	790	900	1010
6	350	450	550	640	730	820	360	460	560	660	750	840
7	300	390	470	550	630	700	310	400	480	570	650	720
8	260	340	410	480	550	620	270	350	420	500	560	630
9	230	290	360	420	480	540	240	310	370	440	500	560
10	210	260	330	380	430	490	210	280	340	400	450	510
11	190	240	300	340	390	440	190	250	310	360	410	460
12	170	220	270	320	360	400	180	230	280	330	380	420

Distance between supports in feet.	Section No. A 93.					
	3" x 2½"					
	1/4"	5/16"	3/8"	7/16"	1/2"	9/16"
	4.5 lbs. per ft.	5.6 lbs. per ft.	6.6 lbs. per ft.	7.6 lbs. per ft.	8.5 lbs. per ft.	9.5 lbs. per ft.
2	2160	2640	3100	3540	3970	4380
3	1440	1760	2060	2360	2650	2920
4	1080	1320	1550	1770	1980	2190
5	860	1050	1240	1420	1590	1750
6	720	880	1030	1180	1320	1460
7	620	750	880	1010	1130	1250
8	540	660	770	890	990	1100
9	480	590	690	790	880	970
10	430	530	620	710	790	880
11	390	480	560	640	720	800
12	360	440	520	590	660	730

For safe loads below heavy lines the deflections will be greater than the allowable limit for plastered ceilings = $\frac{1}{360}$ span.

SAFE LOADS IN POUNDS UNIFORMLY DISTRIBUTED FOR CAMBRIA ANGLES.

UNEQUAL LEGS.

NEUTRAL AXIS PARALLEL TO LONG LEG.

Safe loads below are figured for fibre stress of 16 000 pounds per square inch and include weight of angle.



Distance between supports in feet.	Section No. A 95.					
	3 1/2" x 2 1/2"					
	1/4"	5/16"	3/8"	7/16"	1/2"	9/16"
	4.9 lbs. per ft.	6.1 lbs. per ft.	7.2 lbs. per ft.	8.3 lbs. per ft.	9.4 lbs. per ft.	10.4 lbs. per ft.
2	2200	2690	3160	3610	4050	4480
3	1460	1790	2110	2410	2700	2990
4	1100	1340	1580	1810	2030	2240
5	880	1080	1260	1450	1620	1790
6	730	900	1050	1200	1350	1490
7	630	770	900	1030	1160	1280
8	550	670	790	900	1010	1120
9	490	600	700	800	900	1000
10	440	540	630	720	810	900
11	400	490	570	660	740	810
12	370	450	530	600	680	750

Distance between supports in feet.	Section No. A 97.										
	3 1/2" x 3"										
	1/4"	5/16"	3/8"	7/16"	1/2"	9/16"	5/8"	11/16"	3/4"	13/16"	7/8"
	5.4 lbs. per ft.	6.6 lbs. per ft.	7.9 lbs. per ft.	9.1 lbs. per ft.	10.2 lbs. per ft.	11.4 lbs. per ft.	12.5 lbs. per ft.	13.6 lbs. per ft.	14.7 lbs. per ft.	15.8 lbs. per ft.	16.8 lbs. per ft.
2	4160	3850	4540	5200	5840	6460	7070	7660	8230	8790	9350
3	2770	2570	3030	3470	3900	4310	4710	5110	5490	5860	6230
4	2080	1930	2270	2600	2920	3230	3530	3830	4120	4400	4670
5	1660	1540	1820	2080	2340	2590	2830	3060	3290	3520	3740
6	1390	1280	1510	1730	1950	2150	2360	2550	2740	2930	3120
7	1190	1100	1300	1490	1670	1850	2020	2190	2350	2510	2670
8	1040	960	1130	1300	1460	1620	1770	1910	2060	2200	2340
9	920	860	1010	1160	1300	1440	1570	1700	1830	1950	2080
10	830	770	910	1040	1170	1290	1410	1530	1650	1760	1870
11	750	700	830	950	1060	1180	1290	1390	1500	1600	1700
12	690	640	760	870	970	1080	1180	1280	1370	1470	1560
13	640	590	700	800	900	990	1090	1180	1270	1350	1440
14	590	550	650	740	830	920	1010	1090	1180	1260	1340

For safe loads below heavy lines the deflections will be greater than the allowable limit for plastered ceilings = $\frac{1}{385}$ span.

SAFE LOADS IN POUNDS UNIFORMLY DISTRIBUTED FOR CAMBRIA ANGLES.

UNEQUAL LEGS.

NEUTRAL AXIS PARALLEL TO LONG LEG.

Safe loads below are figured for fibre stress of 16 000 pounds per square inch and include weight of angle.



Distance between supports in feet.	Section No. A 99.									
	4" x 3"									
	$\frac{5''}{16}$	$\frac{3''}{8}$	$\frac{7''}{16}$	$\frac{1''}{2}$	$\frac{9''}{16}$	$\frac{5''}{8}$	$\frac{11''}{16}$	$\frac{3''}{4}$	$\frac{13''}{16}$	$\frac{7''}{8}$
	7.2 lbs. per ft.	8.5 lbs. per ft.	9.8 lbs. per ft.	11.1 lbs. per ft.	12.4 lbs. per ft.	13.6 lbs. per ft.	14.8 lbs. per ft.	16.0 lbs. per ft.	17.1 lbs. per ft.	18.3 lbs. per ft.
2	3920	4620	5290	5950	6580	7200	7810	8400	8980	9550
3	2610	3080	3530	3960	4390	4800	5200	5600	5980	6360
4	1960	2310	2650	2970	3290	3600	3900	4200	4490	4770
5	1570	1850	2120	2380	2630	2880	3120	3360	3590	3820
6	1310	1540	1760	1980	2190	2400	2600	2800	2990	3180
7	1120	1320	1510	1700	1880	2060	2230	2400	2560	2730
8	980	1150	1320	1490	1650	1800	1950	2100	2240	2390
9	870	1030	1180	1320	1460	1600	1730	1870	1990	2120
10	780	920	1060	1190	1320	1440	1560	1680	1800	1910
11	710	840	960	1080	1200	1310	1420	1530	1630	1740
12	650	770	880	990	1100	1200	1300	1400	1500	1590
13	600	710	810	910	1010	1110	1200	1290	1380	1470
14	560	660	760	850	940	1030	1120	1200	1280	1360

Distance between supports in feet.	Section No. A 131.						
	4" x 3½"						
	$\frac{5''}{16}$	$\frac{3''}{8}$	$\frac{7''}{16}$	$\frac{1''}{2}$	$\frac{9''}{16}$	$\frac{5''}{8}$	$\frac{11''}{16}$
	7.7 lbs. per ft.	9.1 lbs. per ft.	10.6 lbs. per ft.	11.9 lbs. per ft.	13.3 lbs. per ft.	14.7 lbs. per ft.	16.0 lbs. per ft.
2	5300	6260	7190	8090	8970	9760	10650
3	3530	4170	4790	5390	5980	6510	7100
4	2650	3130	3590	4040	4480	4880	5320
5	2120	2500	2870	3240	3590	3900	4260
6	1770	2090	2400	2700	2990	3250	3550
7	1510	1790	2050	2310	2560	2790	3040
8	1320	1560	1800	2020	2240	2440	2660
9	1180	1390	1600	1800	1990	2170	2370
10	1060	1250	1440	1620	1790	1950	2130
11	960	1140	1310	1470	1630	1770	1940
12	880	1040	1200	1350	1490	1630	1770
13	820	960	1110	1240	1380	1500	1640
14	760	890	1030	1160	1280	1390	1520

For safe loads below heavy lines the deflections will be greater than the allowable limit for plastered ceilings = $\frac{1}{320}$ span.

SAFE LOADS IN POUNDS UNIFORMLY DISTRIBUTED FOR CAMBRIA ANGLES.

UNEQUAL LEGS.

NEUTRAL AXIS PARALLEL TO LONG LEG.



Safe loads below are figured for fibre stress of 16 000 pounds per square inch and include weight of angle.

Distance between supports in feet.	Section No. A 101.									
	5" x 3"									
	5/16"	3/8"	7/16"	1/2"	9/16"	5/8"	11/16"	3/4"	13/16"	7/8"
	8.2 lbs. per ft.	9.8 lbs. per ft.	11.3 lbs. per ft.	12.8 lbs. per ft.	14.3 lbs. per ft.	15.7 lbs. per ft.	17.1 lbs. per ft.	18.5 lbs. per ft.	19.9 lbs. per ft.	21.2 lbs. per ft.
2	4020	4740	5430	6110	6770	7410	8040	8660	9270	9870
3	2680	3160	3620	4070	4510	4940	5360	5770	6180	6580
4	2010	2370	2720	3060	3380	3710	4020	4330	4630	4940
5	1610	1900	2170	2440	2710	2960	3220	3460	3710	3950
6	1340	1580	1810	2040	2260	2470	2680	2890	3090	3290
7	1150	1350	1550	1750	1930	2120	2300	2470	2650	2820
8	1000	1180	1360	1530	1690	1850	2010	2160	2320	2470
9	890	1050	1210	1360	1500	1650	1790	1920	2060	2190
10	800	950	1090	1220	1350	1480	1610	1730	1850	1970
11	730	860	990	1110	1230	1350	1460	1570	1690	1790
12	670	790	910	1020	1130	1240	1340	1440	1540	1650
13	620	730	840	940	1040	1140	1240	1330	1430	1520
14	570	680	780	870	970	1060	1150	1240	1320	1410

Distance between supports in feet.	Section No. A 103.										
	5" x 3 1/2"										
	5/16"	3/8"	7/16"	1/2"	9/16"	5/8"	11/16"	3/4"	13/16"	7/8"	15/16"
	8.7 lbs. per ft.	10.4 lbs. per ft.	12.0 lbs. per ft.	13.6 lbs. per ft.	15.2 lbs. per ft.	16.8 lbs. per ft.	18.3 lbs. per ft.	19.8 lbs. per ft.	21.3 lbs. per ft.	22.7 lbs. per ft.	24.2 lbs. per ft.
2	5450	6430	7400	8320	9230	10110	10980	11820	12650	13450	14270
3	3630	4290	4930	5550	6150	6740	7320	7880	8430	8970	9510
4	2720	3220	3700	4160	4610	5060	5490	5910	6330	6730	7130
5	2180	2570	2960	3330	3690	4050	4390	4730	5060	5380	5710
6	1820	2140	2470	2770	3080	3370	3660	3940	4220	4490	4760
7	1560	1840	2110	2380	2640	2890	3140	3380	3610	3850	4080
8	1360	1610	1850	2080	2310	2530	2740	2960	3160	3370	3570
9	1210	1430	1640	1850	2050	2250	2440	2630	2810	2990	3170
10	1090	1290	1480	1660	1850	2020	2200	2360	2530	2690	2850
11	990	1170	1340	1510	1680	1840	2000	2150	2300	2450	2590
12	910	1070	1230	1390	1540	1690	1830	1970	2110	2240	2380
13	840	990	1140	1280	1420	1560	1690	1820	1950	2070	2190
14	780	920	1060	1190	1320	1440	1570	1690	1810	1920	2040

For safe loads below heavy lines the deflections will be greater than the allowable limit for plastered ceilings = $\frac{1}{360}$ span.

SAFE LOADS IN POUNDS UNIFORMLY DISTRIBUTED FOR CAMBRIA ANGLES.

UNEQUAL LEGS.

NEUTRAL AXIS PARALLEL TO LONG LEG.

Safe loads below are figured for fibre stress of 16 000 pounds per square inch and include weight of angle.



Distance between supports in feet.		Section No. A 135.					
		5" x 4"					
		$\frac{3}{8}$ "	$\frac{7}{16}$ "	$\frac{1}{2}$ "	$\frac{9}{16}$ "	$\frac{5}{8}$ "	$\frac{11}{16}$ "
	11.0 lbs. per ft.	12.8 lbs. per ft.	14.5 lbs. per ft.	16.2 lbs. per ft.	17.8 lbs. per ft.	19.5 lbs. per ft.	
2	8370	9630	10860	12050	13220	14360	
3	5580	6420	7240	8030	8810	9570	
4	4180	4810	5430	6030	6610	7180	
5	3350	3850	4340	4820	5290	5740	
6	2790	3210	3620	4020	4410	4790	
7	2390	2750	3100	3440	3780	4100	
8	2090	2410	2710	3010	3300	3590	
9	1860	2140	2410	2680	2940	3190	
10	1670	1930	2170	2410	2640	2870	
11	1520	1750	1970	2190	2400	2610	
12	1390	1600	1810	2010	2200	2390	
13	1290	1480	1670	1850	2030	2210	
14	1200	1380	1550	1720	1890	2050	
15	1120	1280	1450	1610	1760	1910	
16	1050	1200	1360	1510	1650	1790	

Distance between supports in feet.		Section No. A 105.									
		6" x 3½"									
		$\frac{3}{8}$ "	$\frac{7}{16}$ "	$\frac{1}{2}$ "	$\frac{9}{16}$ "	$\frac{5}{8}$ "	$\frac{11}{16}$ "	$\frac{3}{4}$ "	$\frac{13}{16}$ "	$\frac{7}{8}$ "	$\frac{15}{16}$ "
	11.7 lbs. per ft.	13.5 lbs. per ft.	15.3 lbs. per ft.	17.1 lbs. per ft.	18.9 lbs. per ft.	20.6 lbs. per ft.	22.4 lbs. per ft.	24.0 lbs. per ft.	25.7 lbs. per ft.	27.3 lbs. per ft.	28.9 lbs. per ft.
2	6570	7550	8500	9430	10340	11230	12100	12960	13800	14640	15470
3	4380	5030	5670	6290	6890	7480	8070	8640	9200	9760	10310
4	3280	3770	4250	4720	5170	5610	6050	6480	6900	7320	7730
5	2630	3020	3400	3770	4140	4490	4840	5180	5520	5850	6190
6	2190	2520	2830	3140	3450	3740	4030	4320	4600	4880	5160
7	1880	2160	2430	2690	2950	3210	3460	3700	3940	4180	4420
8	1640	1890	2120	2360	2580	2810	3020	3240	3450	3660	3870
9	1460	1680	1890	2100	2300	2490	2690	2880	3070	3250	3440
10	1310	1510	1700	1890	2070	2250	2420	2590	2760	2930	3090
11	1190	1370	1550	1710	1880	2040	2200	2360	2510	2660	2810
12	1090	1260	1420	1570	1720	1870	2020	2160	2300	2440	2580
13	1010	1160	1310	1450	1590	1730	1860	1990	2120	2250	2380
14	940	1080	1210	1350	1480	1600	1730	1850	1970	2090	2210

For safe loads below heavy lines the deflections will be greater than the allowable limit for plastered ceilings = $\frac{1}{360}$ span.

SAFE LOADS IN POUNDS UNIFORMLY DISTRIBUTED FOR CAMBRIA ANGLES.

UNEQUAL LEGS.

NEUTRAL AXIS PARALLEL TO LONG LEG.

Safe loads below are figured for fibre stress of 16 000 pounds per square inch and include weight of angle.



Distance between supports in feet.	Section No. A 107.										
	6" x 4"										
	3/8"	7/16"	1/2"	9/16"	5/8"	11/16"	3/4"	13/16"	7/8"	15/16"	1"
	12.3 lbs.	14.3 lbs.	16.2 lbs.	18.1 lbs.	20.0 lbs.	21.8 lbs.	23.6 lbs.	25.4 lbs.	27.2 lbs.	28.9 lbs.	30.6 lbs.
	per ft.	per ft.	per ft.	per ft.	per ft.	per ft.	per ft.	per ft.	per ft.	per ft.	per ft.
2	8550	9840	11100	12320	13520	14690	15840	16970	18070	19160	20230
3	5700	6560	7400	8220	9020	9800	10560	11310	12050	12770	13490
4	4280	4920	5550	6160	6760	7350	7920	8480	9040	9580	10120
5	3420	3940	4440	4930	5410	5880	6340	6790	7230	7660	8090
6	2850	3280	3700	4110	4510	4900	5280	5660	6020	6390	6740
7	2440	2810	3170	3520	3860	4200	4530	4850	5160	5470	5780
8	2140	2460	2770	3080	3380	3670	3960	4240	4520	4790	5060
9	1900	2190	2470	2740	3010	3270	3520	3770	4020	4260	4500
10	1710	1970	2220	2460	2700	2940	3170	3390	3610	3830	4050
11	1550	1790	2020	2240	2460	2670	2880	3080	3290	3480	3680
12	1430	1640	1850	2050	2250	2450	2640	2830	3010	3190	3370
13	1320	1510	1710	1900	2080	2260	2440	2610	2780	2950	3110
14	1220	1410	1590	1760	1930	2100	2260	2420	2580	2740	2890
15	1140	1310	1480	1640	1800	1960	2110	2260	2410	2550	2700
16	1070	1230	1390	1540	1690	1840	1980	2120	2260	2400	2530

Distance between supports in feet.	Section No. A 109.										
	7" x 3 1/2"										
	7/16"	1/2"	9/16"	5/8"	11/16"	3/4"	13/16"	7/8"	15/16"	1"	
	15.0 lbs.	17.0 lbs.	19.1 lbs.	21.0 lbs.	23.0 lbs.	24.9 lbs.	26.8 lbs.	28.7 lbs.	30.5 lbs.	32.3 lbs.	
	per ft.	per ft.	per ft.	per ft.	per ft.	per ft.	per ft.	per ft.	per ft.	per ft.	
2	7670	8640	9590	10520	11430	12320	13210	14090	14950	15810	
3	5110	5760	6390	7010	7620	8220	8810	9390	9960	10540	
4	3840	4320	4790	5260	5710	6160	6600	7040	7470	7900	
5	3070	3460	3840	4210	4570	4930	5280	5630	5980	6320	
6	2560	2880	3200	3510	3810	4110	4400	4700	4980	5270	
7	2190	2470	2740	3010	3270	3520	3770	4020	4270	4520	
8	1920	2160	2400	2630	2860	3080	3300	3520	3740	3950	
9	1700	1920	2130	2340	2540	2740	2940	3180	3320	3510	
10	1530	1730	1920	2100	2290	2460	2640	2820	2990	3160	
11	1390	1570	1740	1910	2080	2240	2400	2560	2720	2870	
12	1280	1440	1600	1750	1900	2050	2200	2350	2490	2630	
13	1180	1330	1480	1620	1760	1900	2030	2170	2300	2430	
14	1100	1230	1370	1500	1630	1760	1890	2010	2140	2260	
15	1020	1150	1280	1400	1520	1640	1760	1880	1990	2110	
16	960	1080	1200	1320	1430	1540	1650	1760	1870	1980	

For safe loads below heavy lines the deflections will be greater than the allowable limit for plastered ceilings = $\frac{1}{300}$ span.

SAFE LOADS IN POUNDS UNIFORMLY DISTRIBUTED FOR CAMBRIA ANGLES.

UNEQUAL LEGS.

NEUTRAL AXIS PARALLEL TO LONG LEG.

Safe loads below are figured for fibre stress of 16 000 pounds per square inch and include weight of angle.



Section No. A 112.									
Distance between supports in feet.	8" x 6"								
	1/2"	9/16"	5/8"	11/16"	3/4"	13/16"	7/8"	15/16"	1"
	23.0 lbs. per ft.	25.7 lbs. per ft.	28.5 lbs. per ft.	31.2 lbs. per ft.	33.8 lbs. per ft.	36.5 lbs. per ft.	39.1 lbs. per ft.	41.7 lbs. per ft.	44.2 lbs. per ft.
4	12770	14230	15670	17080	18460	19830	21170	22490	23790
5	10210	11380	12530	13660	14770	15860	16930	17990	19030
6	8510	9480	10440	11380	12310	13220	14110	14990	15860
7	7290	8130	8950	9790	10550	11330	12090	12850	13590
8	6380	7110	7830	8540	9230	9910	10580	11240	11890
9	5670	6320	6960	7590	8200	8810	9400	9990	10570
10	5100	5690	6260	6830	7380	7930	8460	8990	9510
11	4640	5170	5690	6210	6710	7210	7690	8170	8650
12	4250	4740	5220	5690	6150	6610	7050	7490	7930
13	3920	4370	4820	5250	5680	6100	6510	6920	7320
14	3640	4060	4470	4880	5270	5660	6040	6420	6790
15	3400	3790	4170	4550	4920	5280	5640	5990	6340
16	3190	3550	3910	4270	4610	4950	5290	5620	5940
17	3000	3340	3680	4010	4340	4660	4980	5290	5590
18	2830	3160	3480	3790	4100	4400	4700	4990	5280
19	2680	2990	3290	3590	3880	4170	4450	4730	5000
20	2550	2840	3130	3410	3690	3960	4230	4490	4750
21	2430	2710	2980	3250	3510	3770	4030	4280	4530
22	2320	2580	2840	3100	3350	3600	3840	4090	4320
23	2220	2470	2720	2970	3210	3440	3680	3910	4130
24	2120	2370	2610	2840	3070	3300	3520	3740	3960

For safe loads below heavy lines the deflections will be greater than the allowable limit for plastered ceilings = $\frac{1}{300}$ span.

SAFE LOADS IN POUNDS UNIFORMLY DISTRIBUTED FOR CAMBRIA ANGLES.

UNEQUAL LEGS.

NEUTRAL AXIS PARALLEL TO SHORT LEG.



Safe loads below are figured for fibre stress of 16 000 pounds per square inch and include weight of angle.

Distance between supports in feet.	Section No. A 91.					
	2½" x 2"					
	¾"	¼"	⅝"	⅜"	⅞"	½"
	2.75 lbs. per ft.	3.62 lbs. per ft.	4.5 lbs. per ft.	5.3 lbs. per ft.	6.1 lbs. per ft.	6.8 lbs. per ft.
2	1560	2030	2490	2920	3330	3730
3	1040	1360	1660	1940	2220	2480
4	780	1020	1240	1460	1660	1860
5	620	810	990	1170	1330	1490
6	520	680	830	970	1110	1240
7	450	580	710	830	950	1070
8	390	510	620	730	830	930
9	350	450	550	650	740	830
10	310	410	500	580	670	750
11	280	370	450	530	610	680
12	260	340	410	490	560	620

Distance between supports in feet.	Section No. A 129.					
	3" x 2"					
	¾"	¼"	⅝"	⅜"	⅞"	½"
	3.07 lbs. per ft.	4.1 lbs. per ft.	5.0 lbs. per ft.	5.9 lbs. per ft.	6.8 lbs. per ft.	7.7 lbs. per ft.
2	2210	2890	3540	4170	4770	5350
3	1470	1930	2360	2780	3180	3570
4	1110	1440	1770	2080	2380	2670
5	880	1160	1420	1670	1910	2140
6	740	960	1180	1390	1590	1780
7	630	830	1010	1190	1360	1530
8	550	720	890	1040	1190	1340
9	490	640	790	930	1060	1190
10	440	580	710	830	950	1070
11	400	530	640	760	870	970
12	370	480	590	690	800	890

For safe loads below heavy lines the deflections will be greater than the allowable limit for plastered ceilings = ⅓¹⁶/₈ span.

SAFE LOADS IN POUNDS UNIFORMLY DISTRIBUTED FOR CAMBRIA ANGLES.

UNEQUAL LEGS.

NEUTRAL AXIS PARALLEL TO SHORT LEG.

Safe loads below are figured for fibre stress of 16 000 pounds per square inch and include weight of angle.



Distance between supports in feet.	Section No. A 93.					
	3" x 2½"					
	¼"	⅝"	⅜"	⅞"	½"	⅞"
	4.5 lbs. per ft.	5.6 lbs. per ft.	6.6 lbs. per ft.	7.6 lbs. per ft.	8.5 lbs. per ft.	9.5 lbs. per ft.
2	2990	3670	4320	4950	5560	6140
3	2000	2450	2880	3300	3700	4090
4	1500	1840	2160	2470	2780	3070
5	1200	1470	1730	1980	2220	2460
6	1000	1220	1440	1650	1850	2050
7	860	1050	1230	1410	1590	1760
8	750	920	1080	1240	1390	1540
9	670	820	960	1100	1230	1360
10	600	730	860	990	1110	1230
11	540	670	790	900	1010	1120
12	500	610	720	820	930	1020
13	460	560	660	760	850	940
14	430	520	620	710	790	880

Distance between supports in feet	Section No. A 95.					
	3½" x 2½"					
	¼"	⅝"	⅜"	⅞"	½"	⅞"
	4.9 lbs. per ft.	6.1 lbs. per ft.	7.2 lbs. per ft.	8.3 lbs. per ft.	9.4 lbs. per ft.	10.4 lbs. per ft.
2	4020	4940	5830	6690	7530	8330
3	2680	3300	3890	4460	5020	5560
4	2010	2470	2920	3350	3760	4170
5	1610	1980	2330	2680	3010	3330
6	1340	1650	1940	2230	2510	2780
7	1150	1410	1670	1910	2150	2380
8	1010	1240	1460	1670	1880	2080
9	890	1100	1300	1490	1670	1850
10	800	990	1170	1340	1510	1670
11	730	900	1060	1220	1370	1520
12	670	820	970	1120	1250	1390
13	620	760	900	1030	1160	1280
14	570	710	830	960	1080	1190
15	540	660	780	890	1000	1110
16	500	620	730	840	940	1040

For safe loads below the heavy lines, the deflections will be greater than the allowable limit for plastered ceilings = $\frac{1}{333}$ span.

SAFE LOADS IN POUNDS UNIFORMLY DISTRIBUTED FOR CAMBRIA ANGLES.

UNEQUAL LEGS.

NEUTRAL AXIS PARALLEL TO SHORT LEG.



Safe loads below are figured for fibre stress of 16 000 pounds per square inch and include weight of angle.

		Section No. A 97.										
		$3\frac{1}{2}'' \times 3''$										
Distance between supports in feet.		$\frac{1}{4}''$	$\frac{5}{16}''$	$\frac{3}{8}''$	$\frac{7}{16}''$	$\frac{1}{2}''$	$\frac{9}{16}''$	$\frac{5}{8}''$	$\frac{11}{16}''$	$\frac{3}{4}''$	$\frac{13}{16}''$	$\frac{7}{8}''$
		5.4 lbs. per ft.	6.6 lbs. per ft.	7.9 lbs. per ft.	9.1 lbs. per ft.	10.2 lbs. per ft.	11.4 lbs. per ft.	12.5 lbs. per ft.	13.6 lbs. per ft.	14.7 lbs. per ft.	15.8 lbs. per ft.	16.8 lbs. per ft.
2		3090	5090	6010	6890	7750	8590	9400	10190	10960	11710	12440
3		2060	3390	4000	4600	5170	5730	6270	6790	7300	7800	8290
4		1550	2540	3000	3450	3880	4290	4700	5090	5480	5850	6220
5		1240	2040	2400	2760	3100	3440	3760	4080	4380	4630	4980
6		1030	1700	2000	2300	2580	2860	3130	3400	3650	3900	4150
7		880	1450	1720	1970	2220	2450	2690	2910	3130	3340	3550
8		770	1270	1500	1720	1940	2150	2350	2550	2740	2930	3110
9		690	1130	1330	1530	1720	1910	2090	2260	2430	2600	2760
10		620	1020	1200	1380	1550	1720	1880	2040	2190	2340	2490
11		560	930	1090	1250	1410	1560	1710	1850	1990	2130	2260
12		520	850	1000	1150	1290	1430	1570	1700	1830	1950	2070
13		480	780	920	1060	1190	1320	1450	1570	1690	1800	1910
14		440	730	860	980	1110	1230	1340	1460	1570	1670	1780
15		410	680	800	920	1030	1150	1250	1360	1460	1560	1660
16		390	640	750	860	970	1070	1180	1270	1370	1460	1550

		Section No. A 99.									
		$4'' \times 3''$									
Distance between supports in feet.		$\frac{5}{16}''$	$\frac{3}{8}''$	$\frac{7}{16}''$	$\frac{1}{2}''$	$\frac{9}{16}''$	$\frac{5}{8}''$	$\frac{11}{16}''$	$\frac{3}{4}''$	$\frac{13}{16}''$	$\frac{7}{8}''$
		7.2 lbs. per ft.	8.5 lbs. per ft.	9.8 lbs. per ft.	11.1 lbs. per ft.	12.4 lbs. per ft.	13.6 lbs. per ft.	14.8 lbs. per ft.	16.0 lbs. per ft.	17.1 lbs. per ft.	18.3 lbs. per ft.
2		6580	7780	8940	10070	11170	12240	13280	14300	15290	16260
3		4390	5180	5960	6710	7450	8160	8860	9530	10190	10840
4		3290	3890	4470	5040	5590	6120	6640	7150	7650	8130
5		2630	3110	3580	4030	4470	4900	5310	5720	6120	6500
6		2190	2590	2980	3360	3720	4080	4430	4770	5100	5420
7		1880	2220	2550	2880	3190	3500	3800	4090	4370	4650
8		1640	1940	2240	2520	2790	3060	3320	3580	3820	4060
9		1460	1730	1990	2240	2480	2720	2950	3180	3400	3610
10		1320	1560	1790	2010	2230	2450	2660	2860	3060	3250
11		1200	1410	1630	1830	2030	2230	2420	2600	2780	2960
12		1100	1300	1490	1680	1860	2040	2210	2380	2550	2710
13		1010	1200	1380	1550	1720	1880	2040	2200	2350	2500
14		940	1110	1280	1440	1600	1750	1900	2040	2180	2320
15		880	1040	1190	1340	1490	1630	1770	1910	2040	2170
16		820	970	1120	1260	1400	1530	1660	1790	1910	2030

For safe loads below heavy lines the deflections will be greater than the allowable limit for plastered ceilings = $\frac{1}{160}$ span.

SAFE LOADS IN POUNDS UNIFORMLY DISTRIBUTED FOR CAMBRIA ANGLES.

UNEQUAL LEGS.

NEUTRAL AXIS PARALLEL TO SHORT LEG.

Safe loads below are figured for fibre stress of 16 000 pounds per square inch and include weight of angle.



Distance between supports in feet.	Section No. A 131.						
	4" x 3 1/2"						
	5/16"	3/8"	7/16"	1/2"	9/16"	5/8"	11/16"
	7.7	9.1	10.6	11.9	13.3	14.7	16.0
	lbs.	lbs.	lbs.	lbs.	lbs.	lbs.	lbs.
	per ft.	per ft.	per ft.	per ft.	per ft.	per ft.	per ft.
2	6740	7970	9160	10320	11450	12550	13630
3	4490	5310	6110	6880	7640	8370	9080
4	3370	3980	4580	5160	5730	6280	6810
5	2690	3190	3660	4130	4580	5020	5450
6	2250	2660	3050	3440	3820	4180	4540
7	1920	2280	2620	2950	3270	3590	3890
8	1680	1990	2290	2580	2860	3140	3410
9	1500	1770	2040	2290	2550	2790	3030
10	1350	1590	1830	2060	2290	2510	2730
11	1220	1450	1670	1880	2080	2280	2480
12	1120	1330	1530	1720	1910	2090	2270
13	1040	1230	1410	1590	1760	1930	2100
14	960	1140	1310	1470	1640	1790	1950
15	900	1060	1220	1380	1530	1670	1820
16	840	1000	1150	1290	1430	1570	1700

Distance between supports in feet.	Section No. A 101.									
	5" x 3"									
	5/16"	3/8"	7/16"	1/2"	9/16"	5/8"	11/16"	3/4"	13/16"	7/8"
	8.2	9.8	11.3	12.8	14.3	15.7	17.1	18.5	19.9	21.2
	lbs.	lbs.	lbs.	lbs.	lbs.	lbs.	lbs.	lbs.	lbs.	lbs.
	per ft.	per ft.	per ft.	per ft.	per ft.	per ft.	per ft.	per ft.	per ft.	per ft.
2	10060	11920	13740	15510	17240	18930	20580	22190	23770	25310
3	6710	7950	9160	10340	11490	12620	13720	14790	15850	16870
4	5030	5960	6870	7760	8620	9470	10290	11100	11880	12660
5	4020	4770	5500	6210	6900	7570	8230	8880	9510	10120
6	3350	3970	4580	5170	5750	6310	6860	7400	7920	8440
7	2870	3410	3930	4430	4930	5410	5880	6340	6790	7230
8	2520	2980	3440	3880	4310	4730	5140	5550	5940	6330
9	2240	2650	3050	3450	3830	4210	4570	4930	5280	5620
10	2010	2380	2750	3100	3450	3790	4120	4440	4750	5060
11	1830	2170	2500	2820	3130	3440	3740	4030	4320	4600
12	1680	1990	2290	2590	2870	3160	3430	3700	3960	4220
13	1550	1830	2110	2390	2650	2910	3170	3410	3660	3890
14	1440	1700	1960	2220	2460	2700	2940	3170	3400	3620
15	1340	1590	1830	2070	2300	2520	2740	2960	3170	3370
16	1260	1490	1720	1940	2160	2370	2570	2770	2970	3160
17	1180	1400	1620	1830	2030	2230	2420	2610	2800	2980
18	1120	1330	1530	1720	1920	2100	2290	2470	2640	2810

For safe loads below heavy lines the deflections will be greater than the allowable limit for plastered ceilings = $\frac{1}{360}$ span.

SAFE LOADS IN POUNDS UNIFORMLY DISTRIBUTED FOR CAMBRIA ANGLES.

UNEQUAL LEGS.

NEUTRAL AXIS PARALLEL TO SHORT LEG.

Safe loads below are figured for fibre stress of 16 000 pounds per square inch and include weight of angle.



Distance between supports in feet.	Section No. A 103.										
	5" x 3 1/2"										
	5/16"	3/8"	7/16"	1/2"	9/16"	5/8"	11/16"	3/4"	13/16"	7/8"	15/16"
	8.7 lbs. per ft.	10.4 lbs. per ft.	12.0 lbs. per ft.	13.6 lbs. per ft.	15.2 lbs. per ft.	16.8 lbs. per ft.	18.3 lbs. per ft.	19.8 lbs. per ft.	21.3 lbs. per ft.	22.7 lbs. per ft.	24.2 lbs. per ft.
2	10320	12240	14100	15930	17710	19450	21150	22810	24440	26030	27590
3	6880	8160	9400	10620	11810	12970	14100	15210	16290	17350	18400
4	5160	6120	7050	7960	8850	9720	10570	11410	12220	13020	13800
5	4130	4890	5640	6370	7080	7780	8460	9120	9780	10410	11040
6	3440	4080	4700	5310	5900	6480	7050	7600	8150	8680	9200
7	2950	3500	4030	4550	5060	5560	6040	6520	6980	7440	7880
8	2580	3060	3530	3980	4430	4860	5290	5700	6110	6510	6900
9	2290	2720	3130	3540	3940	4320	4700	5070	5430	5780	6130
10	2060	2450	2820	3190	3540	3890	4230	4560	4890	5210	5520
11	1880	2220	2560	2900	3220	3540	3850	4150	4440	4730	5020
12	1720	2040	2350	2650	2950	3240	3520	3800	4070	4340	4600
13	1590	1880	2170	2450	2720	2990	3250	3510	3760	4000	4240
14	1470	1750	2010	2280	2530	2780	3020	3260	3490	3720	3940
15	1380	1630	1880	2120	2360	2590	2820	3040	3260	3470	3680
16	1290	1530	1760	1990	2210	2430	2640	2850	3050	3250	3450
17	1210	1440	1660	1870	2080	2290	2490	2680	2880	3060	3250
18	1150	1360	1570	1770	1970	2160	2350	2530	2720	2890	3070

Distance between supports in feet.	Section No. A 135.					
	5" x 4"					
	3/8"	7/16"	1/2"	9/16"	5/8"	11/16"
	11.0 lbs. per ft.	12.8 lbs. per ft.	14.5 lbs. per ft.	16.2 lbs. per ft.	17.8 lbs. per ft.	19.5 lbs. per ft.
2	12500	14410	16280	18100	19880	21620
3	8330	9610	10850	12070	13250	14420
4	6250	7200	8140	9050	9940	10810
5	5000	5760	6510	7240	7950	8650
6	4170	4800	5430	6030	6630	7210
7	3570	4120	4650	5170	5680	6180
8	3120	3600	4070	4520	4970	5410
9	2780	3200	3620	4020	4420	4810
10	2500	2880	3260	3620	3980	4320
11	2270	2620	2960	3290	3610	3930
12	2080	2400	2710	3020	3310	3600
13	1920	2220	2500	2780	3060	3330
14	1790	2060	2330	2590	2840	3090
15	1670	1920	2170	2410	2650	2880
16	1560	1800	2030	2260	2490	2700
17	1470	1700	1910	2130	2340	2540
18	1390	1600	1810	2010	2210	2400

For safe loads below heavy lines the deflections will be greater than the allowable limit for plastered ceilings = $\frac{1}{320}$ span.

SAFE LOADS IN POUNDS UNIFORMLY DISTRIBUTED FOR CAMBRIA ANGLES.

UNEQUAL LEGS.

NEUTRAL AXIS PARALLEL TO SHORT LEG.

Safe loads below are figured for fibre stress of 16 000 pounds per square inch and include weight of angle.



Section No. A 105.											
Distance between sup- ports in feet.	6" x 3½"										
	¾"	7/16"	½"	9/16"	5/8"	11/16"	¾"	13/16"	7/8"	15/16"	1"
	11.7 lbs. per ft.	13.5 lbs. per ft.	15.3 lbs. per ft.	17.1 lbs. per ft.	18.9 lbs. per ft.	20.6 lbs. per ft.	22.4 lbs. per ft.	24.0 lbs. per ft.	25.7 lbs. per ft.	27.3 lbs. per ft.	28.9 lbs. per ft.
2	17300	19980	22600	25160	27670	30130	32550	34910	37230	39510	41630
3	11540	13320	15060	16770	18450	20090	21700	23270	24820	26340	27750
4	8650	9990	11300	12580	13840	15070	16270	17460	18620	19760	20810
5	6920	7990	9040	10060	11070	12050	13020	13960	14890	15800	16650
6	5770	6660	7530	8390	9220	10040	10850	11640	12410	13170	13880
7	4940	5710	6460	7190	7910	8610	9300	9970	10640	11290	11890
8	4330	4990	5650	6290	6920	7530	8140	8730	9310	9880	10410
9	3850	4440	5020	5590	6150	6700	7230	7760	8270	8780	9250
10	3460	4000	4520	5030	5530	6030	6510	6980	7450	7900	8330
11	3150	3630	4110	4570	5030	5480	5920	6350	6770	7180	7570
12	2880	3330	3770	4190	4610	5020	5420	5820	6210	6590	6940
13	2660	3070	3480	3870	4260	4640	5010	5370	5730	6080	6400
14	2470	2850	3230	3590	3950	4300	4650	4990	5320	5640	5950
15	2310	2660	3010	3350	3690	4020	4340	4650	4960	5270	5550
16	2160	2500	2820	3150	3460	3770	4070	4360	4650	4940	5200
17	2040	2350	2660	2960	3260	3550	3830	4110	4380	4650	4900
18	1920	2220	2510	2800	3070	3350	3620	3880	4140	4390	4630
19	1820	2100	2380	2650	2910	3170	3430	3680	3920	4160	4380
20	1730	2000	2260	2520	2770	3010	3250	3490	3720	3950	4160
21	1650	1900	2150	2400	2640	2870	3100	3320	3550	3760	3960
22	1570	1810	2050	2290	2520	2740	2960	3170	3380	3590	3780

For safe loads below heavy lines the deflections will be greater than the allowable limit for plastered ceilings = $\frac{1}{360}$ span.

SAFE LOADS IN POUNDS UNIFORMLY DISTRIBUTED FOR CAMBRIA ANGLES.

UNEQUAL LEGS.

NEUTRAL AXIS PARALLEL TO SHORT LEG.



Safe loads below are figured for fibre stress of 16 000 pounds per square inch and include weight of angle.

Section No. A 107.											
Distance between sup- ports in feet.	6" x 4"										
	3'' 8	7'' 16	1/2''	9'' 16	5'' 8	11'' 16	3'' 4	13'' 16	7'' 8	15'' 16	1''
	12.3 lbs. per ft.	14.3 lbs. per ft.	16.2 lbs. per ft.	18.1 lbs. per ft.	20.0 lbs. per ft.	21.8 lbs. per ft.	23.6 lbs. per ft.	25.4 lbs. per ft.	27.2 lbs. per ft.	28.9 lbs. per ft.	30.6 lbs. per ft.
2	17700	20430	23120	25750	28320	30850	33330	35760	38140	40480	42780
3	11800	13620	15410	17160	18880	20570	22220	23840	25430	26990	28520
4	8850	10230	11560	12870	14160	15420	16660	17880	19070	20240	21390
5	7080	8170	9250	10300	11330	12340	13330	14300	15260	16190	17110
6	5900	6810	7710	8580	9440	10280	11110	11920	12710	13490	14260
7	5060	5840	6600	7360	8090	8810	9520	10220	10900	11570	12220
8	4420	5110	5780	6440	7080	7710	8330	8940	9540	10120	10700
9	3930	4540	5140	5720	6290	6860	7410	7950	8480	9000	9510
10	3540	4090	4620	5150	5660	6170	6670	7150	7630	8100	8560
11	3220	3720	4200	4680	5150	5610	6060	6500	6930	7360	7780
12	2950	3410	3850	4290	4720	5140	5550	5960	6360	6750	7130
13	2720	3140	3560	3960	4360	4750	5130	5500	5870	6230	6580
14	2530	2920	3300	3680	4050	4410	4760	5110	5450	5780	6110
15	2360	2720	3080	3430	3780	4110	4440	4770	5090	5400	5700
16	2210	2550	2890	3220	3540	3860	4170	4470	4770	5060	5350
17	2080	2400	2720	3030	3330	3630	3920	4210	4490	4760	5030
18	1970	2270	2570	2860	3150	3430	3700	3970	4240	4500	4750
19	1860	2150	2430	2710	2980	3250	3510	3760	4020	4260	4500
20	1770	2040	2310	2570	2830	3080	3330	3580	3810	4050	4280
21	1690	1950	2200	2450	2700	2940	3170	3400	3630	3860	4070
22	1610	1860	2100	2340	2570	2800	3030	3250	3470	3680	3890

For safe loads below heavy lines the deflections will be greater than the allowable limit for plastered ceilings = $\frac{1}{328}$ span.

SAFE LOADS IN POUNDS UNIFORMLY DISTRIBUTED FOR CAMBRIA ANGLES.

UNEQUAL LEGS.

NEUTRAL AXIS PARALLEL TO SHORT LEG.

Safe loads below are figured for fibre stress of 16 000 pounds per square inch and include weight of angle.



Distance between supports in feet.	Section No. A 109.									
	7" x 3½"									
	7" 16"	1" 2"	9" 16"	5" 8"	11" 16"	3" 4"	13" 16"	7" 8"	15" 16"	1"
	15.0 lbs. per ft.	17.0 lbs. per ft.	19.1 lbs. per ft.	21.0 lbs. per ft.	23.0 lbs. per ft.	24.9 lbs. per ft.	26.8 lbs. per ft.	28.7 lbs. per ft.	30.5 lbs. per ft.	32.3 lbs. per ft.
4	13360	15140	16900	18570	20260	21910	23530	25110	26670	28210
5	10690	12120	13520	14850	16210	17530	18830	20090	21340	22560
6	8910	10100	11270	12380	13510	14600	15690	16740	17780	18800
7	7640	8650	9660	10610	11580	12520	13450	14350	15240	16120
8	6680	7570	8450	9280	10130	10950	11770	12560	13340	14100
9	5940	6730	7510	8250	9010	9740	10460	11160	11850	12540
10	5340	6060	6760	7430	8100	8760	9410	10050	10670	11280
11	4860	5510	6150	6750	7370	7970	8560	9130	9700	10260
12	4450	5050	5630	6190	6750	7300	7840	8370	8890	9400
13	4110	4660	5200	5710	6230	6740	7240	7730	8210	8680
14	3820	4330	4830	5310	5790	6260	6720	7180	7620	8060
15	3560	4040	4510	4950	5400	5840	6280	6700	7110	7520
16	3340	3790	4230	4640	5070	5480	5880	6280	6670	7050
17	3140	3560	3980	4370	4770	5150	5540	5910	6280	6640
18	2970	3370	3760	4130	4500	4870	5230	5580	5930	6270
19	2810	3190	3560	3910	4270	4610	4950	5290	5620	5940
20	2670	3030	3380	3710	4050	4380	4710	5020	5330	5640
21	2550	2880	3220	3540	3860	4170	4480	4780	5080	5370
22	2430	2750	3070	3380	3680	3980	4280	4570	4850	5130
23	2320	2630	2940	3230	3520	3810	4090	4370	4640	4910
24	2230	2520	2820	3090	3380	3650	3920	4190	4450	4700

For safe loads below heavy lines the deflections will be greater than the allowable limit for plastered ceilings = $\frac{1}{325}$ span.

SAFE LOADS IN POUNDS UNIFORMLY DISTRIBUTED FOR CAMBRIA ANGLES.

UNEQUAL LEGS.

NEUTRAL AXIS PARALLEL TO SHORT LEG.



Safe loads below are figured for fibre stress of 16 000 pounds per square inch and include weight of angle.

		Section No. A 112.								
Distance between supports in feet.		8" x 6"								
		1/2"	9/16"	5/8"	11/16"	3/4"	13/16"	7/8"	15/16"	1"
		23.0 lbs. per ft.	25.7 lbs. per ft.	28.5 lbs. per ft.	31.2 lbs. per ft.	33.8 lbs. per ft.	36.5 lbs. per ft.	39.1 lbs. per ft.	41.7 lbs. per ft.	44.2 lbs. per ft.
4		21370	23860	26310	28730	31110	33450	35770	38040	40290
5		17090	19090	21050	22980	24890	26760	28610	30430	32230
6		14250	15900	17540	19150	20740	22300	23840	25360	26860
7		12210	13630	15040	16410	17770	19110	20440	21740	23020
8		10680	11930	13150	14360	15550	16720	17880	19020	20140
9		9500	10600	11690	12770	13820	14860	15890	16900	17900
10		8550	9540	10520	11490	12440	13380	14300	15210	16110
11		7770	8670	9570	10440	11310	12160	13000	13830	14650
12		7120	7950	8770	9570	10370	11150	11920	12680	13430
13		6570	7340	8090	8840	9570	10290	11000	11700	12390
14		6100	6810	7510	8200	8880	9550	10220	10870	11510
15		5700	6360	7010	7660	8290	8920	9540	10140	10740
16		5340	5960	6570	7180	7770	8360	8940	9510	10070
17		5020	5610	6190	6760	7320	7870	8410	8950	9480
18		4750	5300	5840	6380	6910	7430	7950	8450	8950
19		4500	5020	5540	6040	6550	7040	7530	8010	8480
20		4270	4770	5260	5740	6220	6690	7150	7600	8050
21		4070	4540	5010	5470	5920	6370	6810	7240	7670
22		3880	4330	4780	5220	5650	6080	6500	6910	7320
23		3710	4150	4570	4990	5410	5810	6220	6610	7000
24		3560	3970	4380	4780	5180	5570	5960	6340	6710
25		3420	3810	4210	4590	4970	5350	5720	6080	6440
26		3280	3670	4040	4420	4780	5140	5500	5850	6190
27		3160	3530	3890	4250	4600	4950	5300	5630	5960
28		3050	3410	3760	4100	4440	4780	5110	5430	5750

For safe loads below heavy lines the deflections will be greater than the allowable limit for plastered ceilings = $\frac{1}{180}$ span.

GENERAL FORMULÆ FOR FLEXURE OF BEAMS.**NOTATION.**

- A** = Area of Section in square inches.
d = Depth of Cross Section in inches.
l = Length of Span in inches.
L = Length of Span in feet.
p = Stress in extreme fibre of section in pounds per square inch.
X₁ = Distance of Center of Gravity of Section from extreme fibre in inches.
W = Total Load, in pounds, Uniformly Distributed, including the Weight of Beam.
W₁ = Total Superimposed or Live Load, in pounds, Uniformly Distributed.
W₂ = Total Weight of Beam, in pounds, Uniformly Distributed.
W_s = Total Safe Load, in pounds, Uniformly Distributed.
P = Load, in pounds, concentrated at any point.
F = Coefficient of Strength of the Tables of Properties = Safe Load, in pounds, for a fibre stress of 16 000 pounds per square inch for a span of one foot.
F' = Coefficient of Strength of the Tables of Properties = Safe Load, in pounds, for a fibre stress of 12 500 pounds per square inch for a span of one foot.
D = Total Deflection of Beam, in inches, due to weight **W**.
D_{w1} and **D_p** = Deflections of Beams, in inches, due to the weights **W₁** and **P** respectively.
N = Coefficient of Deflection of the Tables of Properties = Deflection, in inches, due to a total load of 1 000 pounds uniformly distributed for a span of one foot.
N' = Coefficient of Deflection of the Tables of Properties = Deflection, in inches, due to a superimposed load of 1 000 pounds, concentrated at the middle of a Beam with a span of one foot.
H = Coefficient of Deflection, in inches, for fibre stress of 16 000 pounds per square inch, for any section used as a Beam subjected to its safe load Uniformly Distributed. (See table, page 98.)
H' = Coefficient of Deflection, in inches, for fibre stress of 12 500 pounds per square inch for any section used as a Beam subjected to its safe load Uniformly Distributed. (See table, page 98.)
M = Total Bending Moment, in inch pounds, due to the Weight of Beam and Superimposed Load.
I = Moment of Inertia, in inches⁴, Axis through Center of Gravity.
I₁ = Moment of Inertia, in inches⁴, Axis parallel to above but not through Center of Gravity.
v = Distance, in inches, between these Axes.
S = Section Modulus in inches³.
r = Radius of Gyration in inches.
E = Modulus of Elasticity, in pounds, per square inch (Steel = 29 000 000).

GENERAL FORMULÆ.

$$S = \frac{I}{X_1} \quad I_1 = I + Av^2 \quad r = \sqrt{\frac{I}{A}}$$

$$M = \frac{pI}{X_1} = pS \therefore p = \frac{MX_1}{I} = \frac{M}{S} \quad \text{Or for Symmetrical Section } M = \frac{2pI}{d}$$

For Beam supported at both ends and Uniformly Loaded:

$$M = \frac{Wl}{8} = \frac{(W_1 + W_2)l}{8} \therefore W = (W_1 + W_2) = \frac{8M}{l} = \frac{8pI}{lX_1} = \frac{8pS}{l}$$

SAFE LOADS.

$$F = \frac{8pS}{l} \text{ where } p = 16\,000 \text{ pounds and } l = 12' \text{ therefore } F = \frac{2}{3} 16\,000 S$$

$$F' = \frac{8pS}{l} \text{ where } p = 12\,500 \text{ pounds and } l = 12' \text{ therefore } F' = \frac{2}{3} 12\,500 S$$

To obtain the Safe Load for any span in feet, for fibre stress of 16 000 pounds per square inch:

$$\text{Safe Load} = W_s = \frac{2}{3} \frac{16\,000 S}{L} = \frac{F}{L}$$

To obtain the Safe Load for any span in feet, for fibre stress of 12 500 pounds per square inch:

$$\text{Safe Load} = W_s = \frac{2}{3} \frac{12\,500 S}{L} = \frac{F'}{L}$$

GENERAL FORMULÆ FOR FLEXURE OF BEAMS.

(CONTINUED.)

DEFLECTIONS.

- (1) Beam supported at both ends and Uniformly Loaded:

$$\text{Deflection for Total Load} = D = \frac{5}{384} \frac{Wl^3}{EI} = \frac{5}{384} \frac{(W_1 + W_2) l^3}{EI}$$

$$\text{Deflection for Superimposed Load} = Dw_1 = \frac{5}{384} \frac{W_1 l^3}{EI}$$

- (2) Beam supported at both ends with load concentrated at the middle:

$$\text{Deflection for Total Load} = D = \frac{Pl^3}{48EI} + \frac{5}{384} \frac{W_2 l^3}{EI}$$

$$\text{Deflection for Superimposed Load} = D_p = \frac{Pl^3}{48EI}$$

- (3) Beam fixed at one end, unsupported at the other, and Uniformly Loaded:

$$\text{Deflection for Total Load} = D = \frac{Wl^3}{8EI} = \frac{(W_1 + W_2) l^3}{8EI}$$

$$\text{Deflection for Superimposed Load} = Dw_1 = \frac{W_1 l^3}{8EI}$$

- (4) Beam fixed at one end, and unsupported at the other, with load concentrated at the unsupported end:

$$\text{Deflection for Total Load} = D = \frac{Pl^3}{3EI} + \frac{W_2 l^3}{8EI}$$

$$\text{Deflection for Superimposed Load} = D_p = \frac{Pl^3}{3EI}$$

$$N = \frac{5}{384} \frac{Wl^3}{EI} = \frac{5}{384} \frac{(W_1 + W_2) l^3}{EI}, \text{ where } W = (W_1 + W_2) = 1000 \text{ pounds and } l = 12'$$

$$N' = \frac{Pl^3}{48EI}, \text{ where } P = 1000 \text{ pounds and } l = 12'$$

$$\text{Total Deflection, in inches, due to a Beam Uniformly Loaded for any span in feet} = D = \frac{NWL^3}{1000} = \frac{N(W_1 + W_2)L^3}{1000}$$

$$\text{Total Deflection, in inches, due to a Superimposed Load } P \text{ and the Weight of Beam } W_2, \text{ for any span in feet} = D = \frac{N'PL^3}{1000} + \frac{N W_2 L^3}{1000}$$

$$H = \frac{12}{725} L^3 \qquad H' = \frac{3}{232} L^3$$

FOR SYMMETRICAL SECTIONS.

$$\text{Total Deflection, in inches, for a fibre stress of 16 000 lbs. per square inch} = D = \frac{H}{d}$$

$$\text{Total Deflection, in inches, for a fibre stress of 12 500 lbs. per square inch} = D = \frac{H'}{d}$$

FOR UNSYMMETRICAL SECTIONS.

$$\text{Total Deflection, in inches, for a fibre stress of 16 000 pounds per square inch} = D = \frac{H}{2X_1}$$

$$\text{Total Deflection, in inches, for a fibre stress of 12 500 pounds per square inch} = D = \frac{H'}{2X_1}$$

BENDING MOMENTS AND DEFLECTIONS FOR BEAMS OF UNIFORM SECTION.

W = Total Load, in lbs., uniformly distributed, including the weight of beam.

W_1 = Total Superimposed or Live Load, in lbs., uniformly distributed,

W_2 = Total Weight of Beam or Dead Load, in lbs., uniformly distributed.

P, P_1, P_2, P_3 = Loads, in lbs., concentrated at any points.

The ordinates in diagrams give the bending moments for corresponding points on beam. For superimposed load only, make W_2 in formulae equal to zero.

M = Total Bending Moment, in inch-lbs.

M_w, M_p = Bending Moments, in inch-lbs., due to Weights W_1 and P respectively.

I = Moment of Inertia, in inches⁴.

l = Length of Span, in inches.

E = Modulus of Elasticity, in lbs. per square inch = 29 000 000 for steel.

W_s = Total Safe Load, in lbs., uniformly distributed, including weight of beam = Total Safe Load of Tables.

(1) Beam Supported at both ends and Uniformly Loaded.

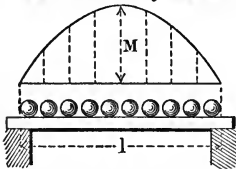

Diagram for Total Load:—

Draw parabola having $M = \frac{Wl}{8}$

Safe Superimposed Load, in lbs., uniformly distributed, $W'_s = W_s - W_2$.

Maximum Bending Moment at middle of beam = $M = \frac{Wl}{8} = \frac{(W_1 + W_2)l}{8}$.

Maximum Shear at points of support = $\frac{W}{2} = \frac{W_1 + W_2}{2}$.

Maximum deflection = $\frac{5}{384} \frac{Wl^3}{EI} = \frac{5}{384} \frac{(W_1 + W_2)l^3}{EI}$.

(2) Beam Supported at both ends with Load Concentrated at the Middle.

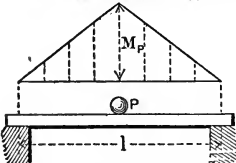

Diagram for Superimposed Load:—

Draw triangle having $M_p = \frac{Pl}{4}$

Diagram, Dead Load, similar to Case (1)

Safe Superimposed Load, in lbs., concentrated, $P_s = \frac{W_s - W_2}{2}$.

Maximum Bending Moment at middle of beam = $M = \frac{Pl}{4} + \frac{W_2 l}{8}$.

Maximum Shear at points of support = $\frac{P + W_2}{2}$.

Max. Deflection = $\frac{Pl^3}{48EI} + \frac{5}{384} \frac{W_2 l^3}{EI}$.

(3) Beam fixed at one end, Unsupported at the other and Uniformly Loaded.

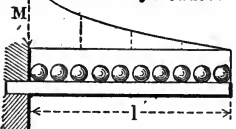

Diagram for Total Load:—

Draw Parabola having $M = \frac{Wl^2}{2}$

Safe Superimposed Load, in lbs., uniformly distributed, $W'_s = \frac{W_s}{4} - W_2$.

Maximum Bending Moment at point of support = $\frac{Wl}{2} = \frac{(W_1 + W_2)l}{2}$.

Maximum Shear at point of support = $W = W_1 + W_2$.

Max. Deflection = $\frac{Wl^3}{8EI} = \frac{(W_1 + W_2)l^3}{8EI}$.

BENDING MOMENTS AND DEFLECTIONS FOR BEAMS OF UNIFORM SECTION.

W = Total Load, in lbs., uniformly distributed, including the weight of beam.

W_1 = Total Superimposed or Live Load, in lbs., uniformly distributed.

W_2 = Total Weight of Beam or Dead Load, in lbs., uniformly distributed.

P, P_1, P_2, P_3 = Loads, in lbs., concentrated at any points.

The ordinates in diagrams give the bending moments for corresponding points on beam. For superimposed load only, make W_2 in formulæ equal to zero.

- (4) **Beam fixed at one end, and Unsupported at other, with Load Concentrated at the free end.**

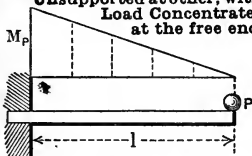

Diagram for Superimposed Load:—
Draw triangle having $M_p = Pl$.
Diagram, Dead Load, similar to Case (3)

- (5) **Beam Supported at both ends with Load Concentrated at any point.**

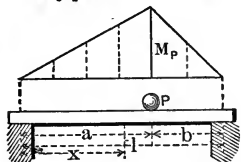

Diagram for Superimposed Load:—
Draw triangle having $M_p = \frac{Pab}{l}$.
Diagram, Dead Load, similar to Case (1)

- (6) **Beam Supported at both ends with two Symmetrical Loads.**

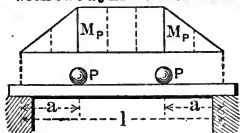

Diagram for Superimposed Load:—
Draw trapezoid having $M_p = Pa$.
Diagram, Dead Load, similar to Case (1)

M = Total Bending Moment, in inch-lbs.

M_w, M_p = Bending Moments, in inch-lbs., due to Weights W_1 and P respectively.

I = Moment of Inertia, in inches⁴.

l = Length of Span, in inches.

E = Modulus of Elasticity, in lbs. per square inch = 29 000 000 for steel.

W_s = Total Safe Load, in lbs., uniformly distributed, including weight of beam = Total Safe Load of Tables.

Safe Superimposed Load, in lbs., concentrated, $P_s = \frac{W_s - 4W_2}{8}$.

Maximum Bending Moment at point of support = $Pl + \frac{W_2 l}{2}$.

Maximum Shear at point of support = $P + W_2$.

Maximum Deflection = $\frac{Pl^2}{3EI} + \frac{W_2 l^2}{8EI}$.

Safe Superimposed Load, in lbs., concentrated, $P_s = \frac{W_2 l^2 - 4aW_2(1-a)}{8ab}$.

Maximum Bending Moment under load = $\frac{2Plb + W_2 l^2 - W_2 a^2}{2}$.

Max. Shear at Sup. near a = $\frac{Pb}{l} + \frac{W_2}{2}$.

Max. Shear at Sup. near b = $\frac{Pa}{l} + \frac{W_2}{2}$.

Deflection at distance x from left support = $\frac{1}{3EI} \left[\frac{2al - a^2}{3} \right]^{\frac{3}{2}}$.

$\left[Pb + \frac{W_2}{8} \left(\sqrt{\frac{2al - a^2}{3}} + \frac{3l^2}{2al - a^2} - 2l \right) \right]$

$x = \sqrt{\frac{2al - a^2}{3}}$ = Distance, from left support, of point of maximum deflection for superimposed load.

Safe Superimposed Load, in lbs., concentrated, each, $P_s = \frac{W_2 l - W_2 l}{8a}$.

Maximum Bending Moment at center of beam = $Pa + \frac{W_2 l}{8}$.

Maximum Shear at points of support = $\frac{2P + W_2}{2}$.

Maximum Deflection = $\frac{Pa}{24EI} (3l^2 - 4a^2) + \frac{5}{384} \frac{W_2 l^2}{EI}$.

BENDING MOMENTS AND DEFLECTIONS FOR BEAMS OF UNIFORM SECTION.

W = Total Load, in lbs., uniformly distributed, including the weight of beam.

W_1 = Total Superimposed or Live Load, in lbs., uniformly distributed.

W_2 = Total Weight of Beam or Dead Load, in lbs., uniformly distributed.

P, P_1, P_2 = Loads, in lbs., concentrated at any points.

M = Total Bending Moment, in inch-lbs.
 M_w, M_p = Bending Moments, in inch-lbs., due to Weights W_1 and P respectively.

I = Moment of Inertia, in inches⁴.

l = Length of Span, in inches.

E = Modulus of Elasticity, in lbs., per square inch = 29 000 000 for steel.

W_s = Total Safe Load, in lbs., uniformly distributed, including the weight of beam = Total Safe Load of Tables.

The ordinates in diagrams give the bending moments for corresponding points on beam. For superimposed load only, make W_2 in formulæ equal to zero.

(7) Beam Supported at both ends with Loads Concentrated at various Points.

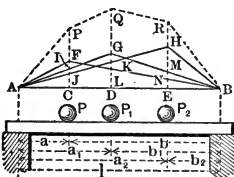

The total bending moment at any point produced by all the weights is equal to the sum of the moments at that point produced by each of the weights separately.

Diagram for Dead Load similar to Case (1).

The Maximum Bending Moment occurs at the point where the vertical shear equals zero and will be at one of the loads P, P_1 , or P_2 depending upon their amounts and spacing if W_2 is neglected.

Let R = Reaction at Left Support.

Bending Moment at P =

$$M_p = Ra - \frac{W_2 a^2}{2l}$$

Bending Moment at P_1 =

$$M_{p1} = Ra_1 - \left[\frac{W_2 a_1^2}{2l} + P(a_1 - a) \right]$$

Bending Moment at $P_2 = M_{p2} = Ra_2 -$

$$\left[\frac{W_2 a_2^2}{2l} + P_1(a_2 - a_1) + P(a_2 - a) \right]$$

$$\text{Shear or Reaction at Left Support} = \frac{P_2 b_2 + P_1 b_1 + Pb + \frac{W_2}{2}}{1}$$

$$\text{Shear or Reaction at Right Support} = \frac{P_2 a_2 + P_1 a_1 + Pa + \frac{W_2}{2}}{1}$$

Diagram for Superimposed Load:— Draw as in Case (5) the Ordinates FC, GD and HE representing the bending moments due to loads P, P_1 and P_2 respectively. Produce FC to P , making $PC = FC + IC + JC$; GD to Q , making $QD = GD + KD + LD$; and HE to R , making $RE = HE + ME + NE$. Join the points A, P, Q, R and B , then the ordinates between AB and polygon $APQRB$ will represent the bending moments for corresponding points on beam.

BENDING MOMENTS AND DEFLECTIONS FOR BEAMS OF UNIFORM SECTION.

W = Total Load, in lbs., uniformly distributed, including the weight of beam.

W_1 = Total Superimposed or Live Load, in lbs., uniformly distributed.

W_2 = Total Weight of Beam or Dead Load, in lbs., uniformly distributed.

P, P_1, P_2, P_3 = Loads, in lbs., concentrated at any points.

The ordinates in diagrams give the bending moments for corresponding points on beam. For superimposed load only, make W_2 in formulæ equal to zero.

M = Total Bending Moment in inch-lbs.

M_w, M_p = Bending Moments, in inch-lbs., due to Weights W_1 and P respectively.

I = Moment of Inertia, in inches⁴.

l = Length of Span, in inches.

E = Modulus of Elasticity, in lbs., per square inch = 29 000 000 for steel.

W_s = Total Safe Load, in lbs., uniformly distributed, including the weight of beam = Total Safe Load of Tables.

(8) Beam Fixed at both ends and Uniformly Loaded.

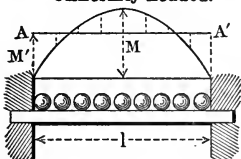

Diagram for Total Load:—Draw parabola having $M = \frac{Wl}{8}$. Also $A A'$ parallel to base and at a distance $M' = \frac{Wl}{12}$. The Vertical distances between the parabola and line $A A'$ are the moments for corresponding points on beam.

Safe Superimposed Load, in lbs., uniformly distributed, $W'_s = \frac{2}{3} W_s - W_2$.

Distance of points of contra-flexure from supports = .2113l.

Maximum Bending Moment at points of support = $\frac{Wl}{12} = \frac{(W_1 + W_2)l}{12}$.

Bending Moment at middle of beam = $\frac{Wl}{24} = \frac{(W_1 + W_2)l}{24}$.

Maximum Shear at points of support = $\frac{W_1 + W_2}{2}$.

Maximum Deflection = $\frac{Wl^3}{384EI} = \frac{(W_1 + W_2)l^3}{384EI}$.

(9) Beam Fixed at both ends with Load Concentrated at the Middle.

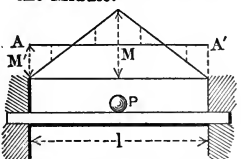

Diagram for Superimposed Load:—Draw triangle having $M = \frac{Pl}{4}$. Also $A A'$ parallel to base and at a distance $M' = \frac{Pl}{8}$. The Vertical distances between the triangle and line $A A'$ are the moments for corresponding points on beam.

Diagram for Dead Load similar to Case (8).

Safe Superimposed Load, in lbs., concentrated, $P_s = W_s - \frac{3}{2} W_2$.

Distance of points of contra-flexure from supports = $\frac{1}{4}l$.

Maximum Bending Moment at points of support = $\frac{Pl}{8} + \frac{W_2 l}{12}$.

Bending Moment at middle of beam = $\frac{Pl}{8} + \frac{W_2 l}{24}$.

Maximum Shear at points of support = $\frac{P + W_2}{2}$.

Maximum Deflection = $\frac{Pl^3}{192EI} + \frac{W_2 l^3}{384EI}$.

VALUES OF MOMENTS OF INERTIA FOR STAND- ARD AND CAMBRIA SECTIONS.

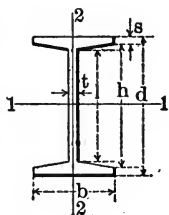

$$A = td + 2s(b-t) + \frac{(b-t)^2}{12}$$

$$I, \text{ Axis 1-1} = \frac{bd^3}{12} - \frac{h^4 - l^4}{8}$$

$$I', \text{ Axis 2-2} = \frac{b^2s}{6} + \frac{lt^3}{12} + \frac{b^4 - t^4}{288}$$

$$\text{Slope of flange} = g = \frac{h-1}{b-t} = \frac{1}{6} \text{ for standard sections.}$$

$$h = d - 2s.$$

$$l = h - g(b-t).$$

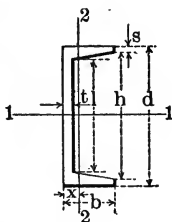

$$A = td + 2s(b-t) + \frac{(b-t)^2}{6}$$

$$x = \left[b^2s + \frac{ht^2}{2} + \frac{(b-t)^2(b+2t)}{18} \right] \div A.$$

$$I, \text{ Axis 1-1} = \frac{bd^3}{12} - \frac{h^4 - l^4}{16}$$

$$I', \text{ Axis 2-2} = \frac{1}{3} \left[2sb^3 + lt^3 + \frac{b^4 - t^4}{12} \right] - Ax^2.$$

$$\text{Slope of flange} = g = \frac{h-1}{2(b-t)} = \frac{1}{6} \text{ for standard sections.}$$

$$h = d - 2s.$$

$$l = h - 2g(b-t).$$

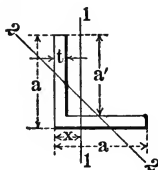

$$A = t(2a - t).$$

$$x = \frac{a^2 + at - t^2}{2(2a - t)}$$

$$I, \text{ Axis 1-1} = \frac{t(a-x)^3 + ax^3 - (a-t)(x-t)^3}{3}$$

$$I', \text{ Axis 2-2} = \frac{2x^4 - 2(x-t)^4 + t \left[a - \left(2x - \frac{t}{2} \right) \right]^3}{3}$$

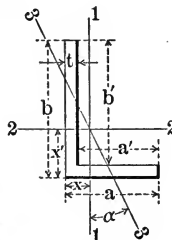

$$A = t(a + b - t).$$

$$x = \frac{t(2a'+b) + a'^2}{2(a'+b)}, \quad x' = \frac{t(2b'+a) + b'^2}{2(b'+a)}$$

$$\text{Tan. } 2\alpha = + \frac{[(2x'-t)b(b-2x') + (2x'-t)(a-t)(a+t-2x)]t}{2(I' - I)}$$

$$I, \text{ Axis 1-1} = \frac{t(a-x)^3 + bx^3 - (b-t)(x-t)^3}{3}$$

$$I', \text{ Axis 2-2} = \frac{t(b-x')^3 + ax'^3 - (a-t)(x'-t)^3}{3}$$

$$I'', \text{ Axis 3-3} = \frac{I \cos^2 \alpha - I' \sin^2 \alpha}{\cos 2\alpha}$$

VALUES OF MOMENTS OF INERTIA FOR STANDARD AND CAMBRIA SECTIONS.

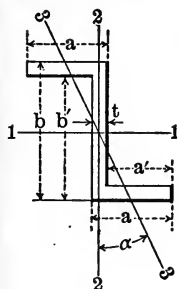

$$A = [b + 2(a - t)] t.$$

$$\text{Tan. } 2\alpha = + \frac{(bt - t^2)(a^2 - at)}{I - I'}$$

$$I, \text{ Axis } 1 - 1 = \frac{ab^3 - a'(b - 2t)^3}{12}$$

$$I', \text{ Axis } 2 - 2 = \frac{b(a + a')^3 - 2a'^3b' - 6a'a^2b'}{12}$$

$$I' \text{ Minimum, Axis } 3 - 3 = \frac{I' \cos^2\alpha - I \sin^2\alpha}{\cos 2\alpha}$$

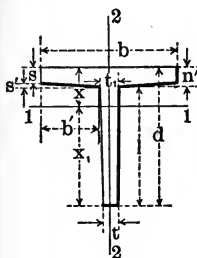

$$A = \frac{l(t + t_1)}{2} + n't_1 + b'(s + n')$$

$$x = \frac{3s^2(b - t_1) + 2b's'(s' + 3s) + 3t_1d^2 - l(t_1 - t)(3d - l)}{6A}$$

$$I, \text{ Axis } 1 - 1 = \frac{l^3(3t + t_1) + 4bn^3 - 2b's'^3}{12} - A(x - n')^2$$

$$I', \text{ Axis } 2 - 2 = \frac{sb^3 + s't_1^3 + lt^3}{12} + \frac{s'b'[2b'^2 + (2b' + 3t_1)^2]}{36} + \frac{l(t_1 - t)[(t_1 - t)^2 + 2(t_1 + 2t)^2]}{144}$$

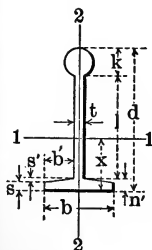

e = Area of head.

$$A = e + t(d - k) + (b - t) \left(s + \frac{s'}{2} \right).$$

$$x = \frac{e(2d - k) + t(d - k)^2 + (b - t) \left(s^2 + ss' + \frac{s'^2}{3} \right)}{2A}$$

$$I, \text{ Axis } 1 - 1 = e \left[\frac{k^2}{16} + \left(d - \frac{2s + k}{2} \right)^2 \right] + \frac{t(1 + s')^3}{3} + \frac{b's'^3 + 2bs^3}{6} - A(x - s)^2.$$

$$I', \text{ Axis } 2 - 2 = \frac{ek^2}{16} + \frac{t^3(1 + s') + sb^3}{12} + \frac{s'b'[2b'^2 + (2b' + 3t)^2]}{36}$$

PROPERTIES OF VARIOUS SECTIONS.

Sections.	Area of Section. A	Distance from Neutral Axis to Extremities of Section. x and x ₁
	a^2	$x_1 = \frac{a}{2}$
	a^2	* $x_1 = a$
	$a^2 - a_1^2$	$x_1 = \frac{a}{2}$
	a^2	$x_1 = \frac{a}{\sqrt{2}} = .707a$
	bd	$x_1 = \frac{d}{2}$
	bd	* $x_1 = d$
	$bd - b_1d_1$	$x_1 = \frac{d}{2}$
	bd	$x_1 = \frac{bd}{\sqrt{b^2 + d^2}}$

*Not the neutral axis.

PROPERTIES OF VARIOUS SECTIONS.

Moment of Inertia.	Section Modulus.	Radius of Gyration.
I	$S = \frac{I}{x_1}$	$r = \sqrt{\frac{I}{A}}$
$\frac{a^4}{12}$	$\frac{a^3}{6}$	$\frac{a}{\sqrt{12}} = .289a$
$\frac{a^4}{3}$	$\frac{a^3}{3}$	$\frac{a}{\sqrt{3}} = .577a$
$\frac{a^4 - a_1^4}{12}$	$\frac{a^4 - a_1^4}{6a}$	$\sqrt{\frac{a^2 + a_1^2}{12}}$
$\frac{a^4}{12}$	$\frac{a^3}{6\sqrt{2}} = .118a^3$	$\frac{a}{\sqrt{12}} = .289a$
$\frac{bd^3}{12}$	$\frac{bd^2}{6}$	$\frac{d}{\sqrt{12}} = .289d$
$\frac{bd^3}{3}$	$\frac{bd^2}{3}$	$\frac{d}{\sqrt{3}} = .577d$
$\frac{bd^3 - b_1d_1^3}{12}$	$\frac{bd^3 - b_1d_1^3}{6d}$	$\sqrt{\frac{bd^3 - b_1d_1^3}{12(bd - b_1d_1)}}$
$\frac{b^2d^3}{6(b^2 + d^2)}$	$\frac{b^2d^2}{6\sqrt{b^2 + d^2}}$	$\frac{bd}{\sqrt{6(b^2 + d^2)}}$

PROPERTIES OF VARIOUS SECTIONS.

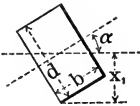
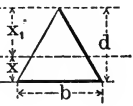
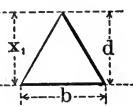
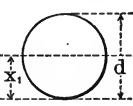
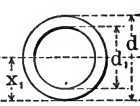
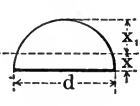
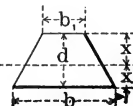
Sections.	Area of Section. A	Distance from Neutral Axis to Extremities of Section. x and x ₁
	bd	$x_1 = \frac{d \cos \alpha + b \sin \alpha}{2}$
	$\frac{bd}{2}$	$x = \frac{d}{3}$ $x_1 = \frac{2d}{3}$
	$\frac{bd}{2}$	* x ₁ = d
	$\frac{\pi d^2}{4} = .785d^2$	x ₁ = $\frac{d}{2}$
	$\frac{\pi(d^2 - d_1^2)}{4} = .785(d^2 - d_1^2)$	x ₁ = $\frac{d}{2}$
	$\frac{\pi d^2}{8} = .393d^2$	$x = \frac{2d}{3\pi} = .212d$ $x_1 = \frac{(3\pi - 4)d}{6\pi} = .288d$
	$\frac{b + b_1}{2} \cdot d$	$x = \frac{b + 2b_1}{b + b_1} \cdot \frac{d}{3}$ $x_1 = \frac{b_1 + 2b}{b + b_1} \cdot \frac{d}{3}$ *Not the neutral axis.

PROPERTIES OF VARIOUS SECTIONS.

Moment of Inertia. I	Section Modulus. $S = \frac{I}{x_1}$	Radius of Gyration. $r = \sqrt{\frac{I}{A}}$
$\frac{bd}{12} (d^2 \cos^2 a + b^2 \sin^2 a)$	$\frac{db}{6} \left(\frac{d^2 \cos^2 a + b^2 \sin^2 a}{d \cos a + b \sin a} \right)$	$\sqrt{\frac{d^2 \cos^2 a + b^2 \sin^2 a}{12}}$
$\frac{bd^3}{36}$	$\frac{bd^3}{24}$	$\frac{d}{\sqrt{18}} = .236d$
Axis through base; $\frac{bd^3}{12}$ Axis through apex; $\frac{bd^3}{4}$	$\frac{bd^2}{12}$ $\frac{bd^2}{4}$	$\frac{d}{\sqrt{6}} = .408d$ $\frac{d}{\sqrt{2}} = .707d$
$\frac{\pi d^4}{64} = .049d^4$	$\frac{\pi d^3}{32} = .098d^3$	$\frac{d}{4}$
$\frac{\pi(d^4 - d_1^4)}{64} = .049(d^4 - d_1^4)$	$\frac{\pi}{32} \frac{(d^4 - d_1^4)}{d} = .098 \frac{(d^4 - d_1^4)}{d}$	$\frac{\sqrt{d^2 + d_1^2}}{4}$
$\frac{9\pi^2 - 64}{1152\pi} \cdot d^4 = .007d^4$	$\frac{9\pi^2 - 64}{192(3\pi - 4)} \cdot d^3 = .024d^3$	$\frac{\sqrt{9\pi^2 - 64}}{12\pi} \cdot d = .132d$
$\frac{b^2 + 4bb_1 + b_1^2}{36(b + b_1)} \cdot d^3$	$\frac{b^2 + 4bb_1 + b_1^2}{12(b_1 + 2b)} \cdot d^3$	$\frac{d}{6(b + b_1)} \sqrt{2(b^2 + 4bb_1 + b_1^2)}$

PROPERTIES OF VARIOUS SECTIONS.

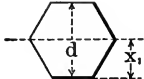
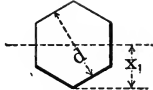
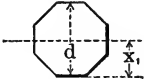
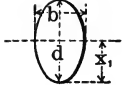
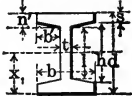
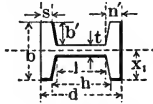
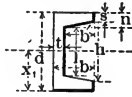
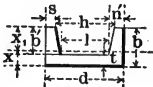
Sections.	Area of Section. A	Distance from Neutral Axis to Extremities of Section. x and x ₁
	$\frac{3}{2} d^2 \tan. 30^\circ = .866d^2$	$x_1 = \frac{d}{2}$
	$\frac{3}{2} d^2 \tan. 30^\circ = .866d^2$	$x_1 = \frac{d}{2 \cos 30^\circ} = .577d$
	$2d^2 \tan. 22\frac{1}{2}^\circ = .828 d^2$	$x_1 = \frac{d}{2}$
	$\frac{\pi bd}{4} = .785 bd$	$x_1 = \frac{d}{2}$
	$td + 2b' (s + n')$	$x_1 = \frac{d}{2}$
	$td + 2b' (s + n')$	$x_1 = \frac{b}{2}$
	$td + b' (s + n')$	$x_1 = \frac{d}{2}$
	$td + b' (s + n')$	$x = [b^2s + \frac{ht^2}{2} + \frac{g}{3}(b-t)^2 (b+2t)] \div A$ $x_1 = b - x$

PROPERTIES OF VARIOUS SECTIONS.

Moment of Inertia. I	Section Modulus. $S = \frac{I}{x_1}$	Radius of Gyration. $r = \sqrt{\frac{I}{A}}$
$\frac{A}{12} \left[\frac{d^2 (1 + 2 \cos^2 30^\circ)}{4 \cos^2 30^\circ} \right]$ = .06d ⁴	$\frac{A}{6} \left[\frac{d(1+2\cos^2 30^\circ)}{4 \cos^2 30^\circ} \right] = .12d^3$	$\frac{d}{4 \cos 30^\circ} \sqrt{\frac{1 + 2 \cos^2 30^\circ}{3}}$ = .264d
$\frac{A}{12} \left[\frac{d^2 (1 + 2 \cos^2 30^\circ)}{4 \cos^2 30^\circ} \right]$ = .06d ⁴	$\frac{A}{6} \left[\frac{d (1 + 2 \cos^2 30^\circ)}{4 \cos 30^\circ} \right]$ = .104d ³	$\frac{d}{4 \cos 30^\circ} \sqrt{\frac{1 + 2 \cos^2 30^\circ}{3}}$ = .264d
$\frac{A}{12} \left[\frac{d^2 (1 + 2 \cos^2 22\frac{1}{2}^\circ)}{4 \cos^2 22\frac{1}{2}^\circ} \right]$ = .055d ⁴	$\frac{A}{6} \left[\frac{d (1 + 2 \cos^2 22\frac{1}{2}^\circ)}{4 \cos 22\frac{1}{2}^\circ} \right]$ = .109d ³	$\frac{d}{4 \cos 22\frac{1}{2}^\circ} \sqrt{\frac{1 + 2 \cos^2 22\frac{1}{2}^\circ}{3}}$ = .257d
$\frac{\pi b d^3}{64} = .049 b d^3$	$\frac{\pi b d^2}{32} = .098 b d^2$	$\frac{d}{4}$
$\frac{1}{12} \left[b d^3 - \frac{1}{4g} (h^4 - t^4) \right]$ where $g = \frac{h-1}{b-t}$	$\frac{2I}{d}$	$r = \sqrt{\frac{I}{A}}$
$\frac{1}{12} \left[b^3 (d-h) + t^3 + \frac{g}{4} (b^4 - t^4) \right]$ where $g = \frac{h-1}{b-t}$	$\frac{2I}{b}$	$r = \sqrt{\frac{I}{A}}$
$\frac{1}{12} \left[b d^3 - \frac{1}{8g} (h^4 - t^4) \right]$ where $g = \frac{h-1}{2(b-t)}$	$\frac{2I}{d}$	$r = \sqrt{\frac{I}{A}}$
$\frac{1}{3} \left[2sb^3 + t^3 + \frac{g}{2} (b^4 - t^4) - \frac{Ax^2}{h-1} \right]$ where $g = \frac{h-1}{2(b-t)}$	$\frac{I}{b-x}$	$r = \sqrt{\frac{I}{A}}$

PROPERTIES OF VARIOUS SECTIONS.

Sections.	Area of Section. A	Distance from Neutral Axis to Extremities of Section. x and x ₁
	$bd - h(b - t)$	$x_1 = \frac{d}{2}$
	$bd - h(b - t)$	$x_1 = \frac{b}{2}$
	$bd - h(b - t)$	$x_1 = \frac{d}{2}$
	$bd - h(b - t)$	$x = \frac{2b^2s + ht^2}{2A}$ $x_1 = b - x$
	$td + s(b - t)$	$x_1 = \frac{d}{2}$
	$bs + ht$	$x = \frac{d^2t + s^2(b - t)}{2A}$ $x_1 = d - x$
	$bs + ht + b_1s$	$x = \frac{td^2 + s^2(b - t) + s(b_1 - t)(2d - s)}{2A}$ $x_1 = d - x$
	$bs + \frac{h(t + t_1)}{2}$	$x = \frac{3bs^2 + 3th(d + s) + h(t_1 - t)(h + 3s)}{6A}$ $x_1 = d - x$

PROPERTIES OF VARIOUS SECTIONS.

Moment of Inertia.	Section Modulus.	Radius of Gyration.
I	$S = \frac{I}{x_1}$	$r = \sqrt{\frac{I}{A}}$
$\frac{bd^3 - h^3(b-t)}{12}$	$\frac{bd^3 - h^3(b-t)}{6d}$	$\sqrt{\frac{bd^3 - h^3(b-t)}{12[bd - h(b-t)]}}$
$\frac{2sb^3 + ht^3}{12}$	$\frac{2sb^3 + ht^3}{6b}$	$\sqrt{\frac{2sb^3 + ht^3}{12[bd - h(b-t)]}}$
$\frac{bd^3 - h^3(b-t)}{12}$	$\frac{bd^3 - h^3(b-t)}{6d}$	$\sqrt{\frac{bd^3 - h^3(b-t)}{12[bd - h(b-t)]}}$
$\frac{2sb^3 + ht^3}{3} - Ax^3$	$\frac{I}{b-x}$	$\sqrt{\frac{I}{A}}$
$\frac{td^3 + s^3(b-t)}{12}$	$\frac{td^3 + s^3(b-t)}{6d}$	$\sqrt{\frac{td^3 + s^3(b-t)}{12[td + s(b-t)]}}$
$\frac{tx_1^3 + bx^3 - (b-t)(x-s)^3}{3}$	$\frac{I}{d-x}$	$\sqrt{\frac{tx_1^3 + bx^3 - (b-t)(x-s)^3}{3(bs+ht)}}$
$\frac{bx^3 + b_1x_1^3 - (b-t)(x-s)^3}{3} - \frac{(b_1-t)(x_1-s)^3}{3}$	$\frac{I}{d-x}$	$\left[\frac{bx^3 + b_1x_1^3 - (b-t)(x-s)^3}{3(bs+ht+b_1s)} - \frac{(b_1-t)(x_1-s)^3}{3(bs+ht+b_1s)} \right]^{\frac{1}{2}}$
$\frac{4bs^3 + h^3(3t+t_1)}{12} - A(x-s)^3$	$\frac{I}{d-x}$	$\sqrt{\frac{I}{A}}$

EXPLANATIONS OF THE TABLES OF PROPERTIES OF STANDARD AND SPECIAL I-BEAMS, STANDARD AND SPECIAL CHANNELS, AND STANDARD AND SPECIAL ANGLES WITH EQUAL AND UNEQUAL LEGS.

PROPERTIES OF I-BEAMS.

PAGES 182 TO 185 INCLUSIVE.

The figures or values in the various columns give the section numbers, dimensions, weights, areas and properties of the sections as noted in the different headings.

The columns which require special explanation are as follows:

SECTION MODULUS—Column 8.

This is obtained from the moment of inertia in column 7 by dividing it by the distance from the neutral axis to the most remote fibre, which in this case is one-half the depth of the beam.

COEFFICIENTS OF STRENGTH—Columns 13 and 14.

The coefficients of strength F and F' have been computed for fibre stresses of 16 000 and 12 500 pounds per square inch respectively, as stated in the headings of the columns, and are the safe loads in pounds uniformly distributed, including its own weight, for a beam one foot long. Thus the safe load for any span may be obtained by dividing the proper coefficient by the length of the span in feet.

The coefficients of strength were obtained from the following formulæ:

$$F = \frac{2}{3} \times 16\,000 \times S$$

$$F' = \frac{2}{3} \times 12\,500 \times S$$

in which S is the section modulus.

COEFFICIENTS OF DEFLECTION—Columns 15 and 16.

The Coefficients of Deflection N and N' for uniform and center loads, respectively, were obtained from the following formulæ:

$$N = \frac{Wl^3}{76.8EI} \qquad N' = \frac{Pl^3}{48EI}$$

in which

P and W = 1 000 pounds.

l = 12 inches.

E = 29 000 000.

I = moment of inertia about axis 1-1.

These coefficients are, therefore, the deflections in inches of a beam one foot long with a load of 1 000 pounds, hence, the deflection of a beam for any load and span may be obtained by multiplying the proper coefficient by the cube of the span in feet, and by the number of 1 000-pound units in the given load.

PROPERTIES OF STANDARD AND SPECIAL CHANNELS.

PAGES 186 TO 191 INCLUSIVE.

The various columns in the Tables of Properties of Standard Channels are similar to those in the Tables of Properties of I-Beams, as explained above, with the addition of column 11, which gives the Section Modulus about an axis through the center of gravity parallel to the web, and column 13, which gives the distance of the center of gravity from the outside of the web.

In this case the Section Modulus $S' = \frac{I'}{b - x}$ the notation being as given at the heads of the columns.

PROPERTIES OF ANGLES.

The values in the Tables of Properties of Standard and Special Angles, with Equal Legs, pages 198 to 203, are those stated in the headings, and those in the Tables of Properties of Standard and Special Angles, with Unequal Legs, on pages 204 to 209, are similar, but with the addition of values for I'' , S'' and r'' about the inclined axis 3-3, the position of which, in order to give the minimum values, was determined by the formula on page 166 or the value of the tangent of $2a$. After determining the position of the inclined axis, the properties corresponding thereto were obtained by the formula on page 166.

MOMENTS OF INERTIA OF RECTANGLES.

Tables of Moments of Inertia of Rectangles, about a transverse axis through the center of gravity, are added on pages 210 to 213 for convenience in calculating the Moments of Inertia, Section Moduli, and Radii of Gyration for compound shapes in which plates are used.

Table I is more convenient when depth of rectangle is expressed without fraction, and is directly applicable to rectangles of various widths, $\frac{1}{4}$ to 1 inch, varying by $\frac{1}{16}$ ths. Table II gives values for 1 inch widths of rectangle only, but for all depths from $\frac{1}{8}$ to $50\frac{1}{8}$ inches, varying by $\frac{1}{16}$ ths. Value for any other width may be obtained from Table II by direct multiplication of tabular value by that other width.

GENERAL FORMULÆ FOR PROPERTIES AND FLEXURE.

Formulæ for obtaining the Properties of Standard Sections are given on pages 166 and 167, and for various usual sections on pages 168 to 175 inclusive.

General formulæ for Flexure of Beams, Bending Moments, and Deflections for various cases of loading are given on pages 160 to 165 inclusive.

EXAMPLES OF APPLICATION OF THE TABLES OF PROPERTIES.

EXAMPLE I.

What is the proper size of I-Beam to carry a load of 35 000 pounds concentrated at the center of a span of 25 feet, the fibre stress not to exceed 16 000 pounds per square inch?

In the Tables of Properties of Standard I-Beams, the column headed F gives the coefficient of strength for a uniform load corresponding to a fibre stress of 16 000 pounds per square inch.

The coefficient of strength for a concentrated load at the center is twice that for the same load uniformly distributed, hence the coefficient necessary to meet the conditions is $35\ 000 \times 25 \times 2 = 1\ 750\ 000$. From the Table of Properties of Standard I-Beams, page 185, column 13, the coefficient F for a 24-inch 80-pound beam is found to be 1 855 310. The weight of the beam itself is $80 \times 25 = 2000$ pounds, which corresponds to a coefficient of $2000 \times 25 = 50\ 000$, which deducted from 1 855 310 gives a net coefficient of 1 805 310. A 24-inch beam weighing 80 pounds per foot is, therefore, the proper size.

EXAMPLE II.

What is the deflection of the beam in the preceding example under the given load?

In the Table of Properties of Standard I-Beams, pages 182 to 185 inclusive, the coefficient of deflection for beams with center loads is given in column 16. To obtain the required deflection it is only necessary to multiply the coefficient by the cube of the span and the number of 1 000 pounds units contained in the load.

Thus for the given example the deflection in inches =

$$.0000006 \times 25^3 \times \frac{35\ 000}{1\ 000} = .328 \text{ inch.}$$

EXAMPLE III.

What is the safe load uniformly distributed that can be placed on an 8-inch standard channel weighing 11.25 pounds per foot, with a clear span of 15 feet for a maximum fibre stress of 12 500 pounds per square inch, the web to be placed vertically?

From the table of Properties of Standard Channels, page 187, column 16, the coefficient of strength F' for the given channel under the conditions named, is found to be 67 300. Hence, the total load may be $67\ 300 \div 15 = 4487$ pounds, and, as the channel itself weighs 169 pounds, the net superimposed load which is can safely carry under the given conditions is 4318 pounds.

EXAMPLE IV.

What is the fibre stress in a 5" x 3" angle weighing 8.2 pounds per foot if loaded at the center with a weight of 1500 pounds, used as a beam with a span of 6 feet, the 5-inch leg to be placed vertically?

The bending moment at the center will be

$$\frac{W_1 l}{4} + \frac{W_2 l}{8} = \frac{1\ 500 \times 72}{4} + \frac{8.2 \times 6 \times 72}{8} = 27\ 443 \text{ inch pounds.}$$

Referring to the Table of Properties of Standard Angles, Unequal Legs, on page 207, the Section Modulus for this angle, corresponding to the axis 2—2, is found to be 1.89.

The maximum fibre stress is obtained by dividing the bending moment by the section modulus, thus: $\frac{27\ 443}{1.89} = 14\ 520$, which is

the maximum fibre stress in pounds per square inch at the point most remote from the neutral axis, which in this case is the extremity of the longer leg of the angle.

The second term in the above expression for the bending moment is that due to the weight of the angle itself and is inconsiderable, so that in practice it might be neglected for short spans, but should be taken into consideration for the longer ones.

PROPERTIES OF COMPOUND SHAPES.

The moments of inertia, section moduli, and radii of gyration of compound sections used as beams or columns, composed of plates and angles, channels, beams, or any combination of these, may be obtained with the aid of the Tables of Properties as follows:

The first step is to find the center of gravity of the proposed section, which in the case of symmetrical sections is at the center of the figure

For unsymmetrical sections the position of the center of gravity may be determined by multiplying the areas of the component parts by the distances of their centers of gravity from any convenient line, taken as an axis, and dividing the sum of these products by the sum of the areas, which will give the distance of the center of gravity of the compound section from the assumed axis.

The position of the center of gravity for all sizes of angles and channels, is given in the Tables of Properties for these shapes, and is given for various geometrical sections on pages 168 to 175 inclusive, in connection with their other properties.

After determining the position of the center of gravity of a compound section, as explained above, the moment of inertia about an axis through its center of gravity may be found by taking the sum of the moments of inertia of each component part about an axis through its own center of gravity, parallel to the axis of the compound section, and adding thereto the sum of products obtained by multiplying the area of each component part by the square of the distance of its center of gravity from the axis of the compound section.

Having thus obtained the moment of inertia of the compound section, the section modulus may be obtained by dividing this moment of inertia by the distance from the neutral axis to the most remote extremity of the section.

The square of the radius of gyration for the compound section may be obtained by dividing the moment of inertia by the total area.

The moment of inertia of a compound section about any axis other than that through its center of gravity may be found in a manner similar to that above described.

PROPERTIES OF STANDARD I-BEAMS.

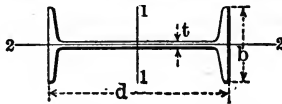

Section Number.	Depth of Beam.	Weight per Foot.	Area of Section.	Thick-ness of Web.	Width of Flange.	Moment of Inertia Axis 1-1.	Section Modulus Axis 1-1.	Radius of Gyration Axis 1-1.	Moment of Inertia Axis 2-2.	Radius of Gyration Axis 2-2.									
											d	A	t	b	I	S	r	I'	r'
											Inches.	Sq. Ins.	Inch.	Inches.	Inches. ⁴	Inches. ³	Inches.	Inches. ⁴	Inch.
B 5	3	5.50	1.63	.17	2.33	2.5	1.7	1.23	.46	.53									
"	"	6.50	1.91	.26	2.42	2.7	1.8	1.19	.53	.52									
"	"	7.50	2.21	.36	2.52	2.9	1.9	1.15	.60	.52									
B 9	4	7.50	2.21	.19	2.66	6.0	3.0	1.64	.77	.59									
"	"	8.50	2.50	.26	2.73	6.4	3.2	1.59	.85	.58									
"	"	9.50	2.79	.34	2.81	6.7	3.4	1.54	.93	.58									
"	"	10.50	3.09	.41	2.88	7.1	3.6	1.52	1.01	.57									
B13	5	9.75	2.87	.21	3.00	12.1	4.8	2.05	1.23	.65									
"	"	12.25	3.60	.36	3.15	13.6	5.4	1.94	1.45	.63									
"	"	14.75	4.34	.50	3.29	15.1	6.1	1.87	1.70	.63									
B17	6	12.25	3.61	.23	3.33	21.8	7.3	2.46	1.85	.72									
"	"	14.75	4.34	.35	3.45	24.0	8.0	2.35	2.09	.69									
"	"	17.25	5.07	.47	3.57	26.2	8.7	2.27	2.38	.68									
B21	7	15.00	4.42	.25	3.66	36.2	10.4	2.86	2.67	.78									
"	"	17.50	5.15	.35	3.78	39.2	11.2	2.76	2.94	.76									
"	"	20.00	5.88	.46	3.87	42.2	12.1	2.68	3.24	.74									
B25	8	18.00	5.33	.27	4.00	56.9	14.2	3.27	3.78	.84									
"	"	20.25	5.96	.35	4.08	60.2	15.0	3.18	4.04	.82									
"	"	22.75	6.69	.44	4.17	64.1	16.0	3.10	4.36	.81									
"	"	25.25	7.43	.53	4.26	68.0	17.0	3.03	4.71	.80									
B29	9	21.00	6.31	.29	4.33	84.9	18.9	3.67	5.16	.90									
"	"	25.00	7.35	.41	4.45	91.9	20.4	3.54	5.65	.88									
"	"	30.00	8.82	.57	4.61	101.9	22.6	3.40	6.42	.85									
"	"	35.00	10.29	.73	4.77	111.8	24.8	3.30	7.31	.84									
B35	10	25.00	7.37	.31	4.66	122.1	24.4	4.07	6.89	.97									
"	"	30.00	8.82	.45	4.80	134.2	26.8	3.90	7.65	.93									
"	"	35.00	10.29	.60	4.95	146.4	29.3	3.77	8.52	.91									
"	"	40.00	11.76	.75	5.10	158.7	31.7	3.67	9.50	.90									
B41	12	31.50	9.26	.35	5.00	215.8	36.0	4.83	9.50	1.01									
"	"	35.00	10.29	.44	5.09	228.3	38.0	4.71	10.07	.99									
"	"	40.00	11.76	.56	5.21	245.9	41.0	4.57	10.95	.96									
B53	15	42.00	12.48	.41	5.50	441.8	58.9	5.95	14.62	1.08									
"	"	45.00	13.24	.46	5.55	455.8	60.8	5.87	15.09	1.07									
"	"	50.00	14.71	.56	5.65	483.4	64.5	5.73	16.04	1.04									
"	"	55.00	16.18	.66	5.75	511.0	68.1	5.62	17.06	1.03									
"	"	60.00	17.65	.75	5.84	538.6	71.8	5.52	18.17	1.01									

PROPERTIES OF STANDARD I-BEAMS.

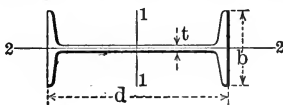

12	13	14	15	16	1
Increase of Thickness of Web for each Pound Increase in Weight.	Coefficient of Strength.		Coefficient of Deflection.		Section Number.
	For Fibre Stress of 16000 Pounds per Square Inch for Buildings.	For Fibre Stress of 12500 Pounds per Square Inch for Bridges.	Uniform Load.	Center Load.	
	f	F	F'	N	
.098	17650	13790	.00031253	.00050006	B 5
	19140	14950	.00028827	.00046124	"
	20710	16180	.00026644	.00042630	"
.074	31810	24850	.00013009	.00020815	B 9
	33890	26480	.00012209	.00019535	"
	35980	28110	.00011500	.00018400	"
	38070	29750	.00010868	.00017389	"
.059	51590	40300	.00006417	.00010267	B13
	58100	45390	.00005698	.00009117	"
	64630	50490	.00005122	.00008195	"
.049	77460	60520	.00003561	.00005698	B17
	85270	66610	.00003235	.00005177	"
	93110	72740	.00002963	.00004741	"
.042	110410	86260	.00002142	.00003427	B21
	119400	93290	.00001980	.00003168	"
	128560	100430	.00001839	.00002943	"
.037	151660	118490	.00001364	.00002183	B25
	160510	125400	.00001289	.00002062	"
	170970	133570	.00001210	.00001936	"
	181430	141740	.00001140	.00001825	"
.033	201300	157260	.00000914	.00001462	B29
	217930	170260	.00000844	.00001350	"
	241460	188640	.00000762	.00001219	"
	264990	207020	.00000694	.00001110	"
.029	260470	208500	.00000635	.00001017	B33
	286250	228630	.00000578	.00000925	"
	312390	244050	.00000530	.00000848	"
	338530	264480	.00000489	.00000782	"
.025	383670	299740	.00000360	.00000575	B41
	405800	317030	.00000340	.00000544	"
	437170	341540	.00000316	.00000505	"
.020	628270	490840	.00000176	.00000281	B53
	648310	506490	.00000170	.00000272	"
	687530	537130	.00000161	.00000257	"
	726740	567770	.00000152	.00000243	"
	765960	598410	.00000144	.00000231	"

PROPERTIES OF STANDARD I-BEAMS.

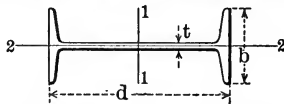

Section Number.	2	3	4	5	6	7	8	9	10	11
	Depth of Beam.	Weight per Foot.	Area of Section.	Thick-ness of Web.	Width of Flange.	Moment of Inertia Axis 1-1.	Section Modulus Axis 1-1.	Radius of Gyration Axis 1-1.	Moment of Inertia Axis 2-2.	Radius of Gyration Axis 2-2.
	d		A	t	b	I	S	r	I'	r'
	Inches.	Pounds.	Sq. Ins.	Inch.	Inches.	Inches. ⁴	Inches. ³	Inches.	Inches. ⁴	Inch.
B 65	18	55.0	15.93	.46	6.00	795.6	88.4	7.07	21.19	1.15
"	"	60.0	17.65	.56	6.10	841.8	93.5	6.91	22.38	1.13
"	"	65.0	19.12	.64	6.18	881.5	97.9	6.79	23.47	1.11
"	"	70.0	20.59	.72	6.26	921.2	102.4	6.69	24.62	1.09
B 73	20	65.0	19.08	.50	6.25	1169.5	117.0	7.83	27.86	1.21
"	"	70.0	20.59	.58	6.33	1219.8	122.0	7.70	29.04	1.19
"	"	75.0	22.06	.65	6.40	1268.8	126.9	7.58	30.25	1.17
B 89	24	80.0	23.32	.50	7.00	2087.2	173.9	9.46	42.86	1.36
"	"	85.0	25.00	.57	7.07	2167.8	180.7	9.31	44.35	1.33
"	"	90.0	26.47	.63	7.13	2238.4	186.5	9.20	45.70	1.31
"	"	95.0	27.94	.69	7.19	2309.0	192.4	9.09	47.10	1.30
"	"	100.0	29.41	.75	7.25	2379.6	198.3	8.99	48.55	1.28

PROPERTIES OF SPECIAL I-BEAMS.

B 105	12	40.0	11.84	.46	5.25	268.9	44.8	4.77	13.81	1.08
"	"	45.0	13.24	.58	5.37	285.7	47.6	4.65	14.89	1.06
"	"	50.0	14.71	.70	5.49	303.4	50.6	4.54	16.12	1.05
"	"	55.0	16.18	.82	5.61	321.0	53.5	4.45	17.46	1.04
B 109	15	60.0	17.67	.59	6.00	609.0	81.2	5.87	25.96	1.21
"	"	65.0	19.12	.69	6.10	636.1	84.8	5.77	27.42	1.20
"	"	70.0	20.59	.78	6.19	663.7	88.5	5.68	29.00	1.19
"	"	75.0	22.06	.88	6.29	691.2	92.2	5.60	30.68	1.18
"	"	80.0	23.53	.98	6.39	718.8	95.8	5.53	32.46	1.17
B 113	15	80.0	23.57	.80	6.40	789.1	105.2	5.79	41.31	1.32
"	"	85.0	25.00	.90	6.50	815.9	108.8	5.71	43.46	1.32
"	"	90.0	26.47	.99	6.59	843.4	112.5	5.64	45.79	1.32
"	"	95.0	27.94	1.09	6.69	871.0	116.1	5.58	48.25	1.31
"	"	100.0	29.41	1.19	6.79	898.6	119.8	5.53	50.84	1.31
B 121	20	80.0	23.73	.60	7.00	1466.3	146.6	7.86	45.81	1.39
"	"	85.0	25.00	.66	7.06	1508.5	150.9	7.77	47.25	1.37
"	"	90.0	26.47	.74	7.14	1557.5	155.8	7.67	48.98	1.36
"	"	95.0	27.94	.81	7.21	1606.6	160.7	7.58	50.78	1.35
"	"	100.0	29.41	.88	7.28	1655.6	165.6	7.50	52.65	1.34
B 127	24	105.0	30.98	.63	7.88	2811.5	234.3	9.53	78.90	1.60
"	"	110.0	32.48	.69	7.94	2883.5	240.3	9.42	81.04	1.58
"	"	115.0	33.98	.75	8.00	2955.5	246.3	9.33	83.23	1.56

PROPERTIES OF STANDARD I-BEAMS.

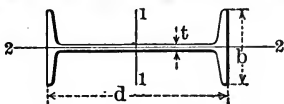

12	18	14	15	16	1
Increase of Thickness of Web for each Pound Increase in Weight.	Coefficient of Strength.		Coefficient of Deflection.		Section Number.
	For Fibre Stress of 16 000 Pounds per Square Inch for Buildings.	For Fibre Stress of 12 500 Pounds per Square Inch for Bridges.	Uniform Load.	Center Load.	
	<i>f</i>	<i>F</i>	<i>F'</i>	<i>N</i>	
.016	942880	786620	.00000098	.00000156	B 65
	997680	779440	.00000092	.00000148	"
	1044740	816200	.00000088	.00000141	"
	1091800	852970	.00000084	.00000135	"
.015	1247490	974600	.00000066	.00000106	B 73
	1301110	1016490	.00000064	.00000102	"
	1353400	1057340	.00000061	.00000098	"
.0123	1855310	1449460	.00000037	.00000060	B 89
	1926950	1505430	.00000036	.00000057	"
	1989700	1554450	.00000035	.00000056	"
	2052440	1603470	.00000034	.00000054	"
	2115190	1652490	.00000033	.00000052	"

PROPERTIES OF SPECIAL I-BEAMS.

.025	478130	373540	.00000288	.00000462	B 105
	507930	396820	.00000272	.00000435	"
	539300	421320	.00000256	.00000409	"
	570670	445830	.00000242	.00000387	"
.020	866130	676670	.00000127	.00000204	B 109
	904680	706770	.00000122	.00000195	"
	943870	737400	.00000117	.00000187	"
	983090	768040	.00000112	.00000180	"
.020	1022300	798670	.00000108	.00000173	"
	1122290	876790	.00000098	.00000157	B 113
	1160340	906520	.00000095	.00000152	"
	1199550	937150	.00000092	.00000147	"
.020	1238770	967790	.00000089	.00000143	"
	1277930	998420	.00000086	.00000138	"
	1564060	1221920	.00000053	.00000085	B 121
	1609100	1257110	.00000051	.00000082	"
.015	1661390	1297960	.00000050	.00000080	"
	1713670	1338810	.00000048	.00000077	"
	1765960	1379660	.00000047	.00000075	"
	2499090	1952420	.00000028	.00000044	B 127
.0123	2563090	2002420	.00000027	.00000043	"
	2627090	2052420	.00000026	.00000042	"

PROPERTIES OF STANDARD CHANNELS.

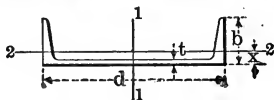

1	2	3	4	5	6	7	8	9	10	11	12
Section Number.	Depth of Channel.	Weight per Foot.	Area of Section.	Thick-ness of Web.	Width of Flange.	Moment of Inertia Axis 1-1.	Section Mod-ulus Axis 1-1.	Radius of Gyration Axis 1-1.	Moment of Inertia Axis 2-2.	Section Mod-ulus Axis 2-2.	Radius of Gyration Axis 2-2.
	d										
	Inches.	Pounds.	Sq. Ins.	Inch.	Inches.	Inches. ⁴	Ins. ³	Inches.	Inches. ⁴	Ins. ³	Inch.
C 5	3	4.00	1.19	.17	1.41	1.6	1.1	1.17	.20	.21	.41
"	"	5.00	1.47	.26	1.50	1.8	1.2	1.12	.25	.24	.41
"	"	6.00	1.76	.36	1.60	2.1	1.4	1.08	.31	.27	.42
C 9	4	5.25	1.55	.18	1.58	3.8	1.9	1.56	.32	.29	.45
"	"	6.25	1.84	.25	1.65	4.2	2.1	1.51	.38	.32	.45
"	"	7.25	2.13	.33	1.73	4.6	2.3	1.46	.44	.35	.46
C13	5	6.50	1.95	.19	1.75	7.4	3.0	1.95	.48	.38	.50
"	"	9.00	2.65	.33	1.89	8.9	3.5	1.83	.64	.45	.49
"	"	11.50	3.38	.48	2.04	10.4	4.2	1.75	.82	.54	.49
C17	6	8.00	2.38	.20	1.92	13.0	4.3	2.34	.70	.50	.54
"	"	10.50	3.09	.32	2.04	15.1	5.0	2.21	.88	.57	.53
"	"	13.00	3.82	.44	2.16	17.3	5.8	2.13	1.07	.65	.53
"	"	15.50	4.56	.56	2.28	19.5	6.5	2.07	1.28	.74	.53
C21	7	9.75	2.85	.21	2.09	21.1	6.0	2.72	.98	.63	.59
"	"	12.25	3.60	.32	2.20	24.2	6.9	2.59	1.19	.71	.57
"	"	14.75	4.34	.42	2.30	27.2	7.8	2.50	1.40	.79	.57
"	"	17.25	5.07	.53	2.41	30.2	8.6	2.44	1.62	.87	.56
"	"	19.75	5.81	.63	2.51	33.2	9.5	2.39	1.85	.96	.56
C25	8	11.25	3.35	.22	2.26	32.3	8.1	3.10	1.33	.79	.63
"	"	13.75	4.04	.31	2.35	36.0	9.0	2.98	1.55	.87	.62
"	"	16.25	4.78	.40	2.44	39.9	10.0	2.89	1.78	.95	.61
"	"	18.75	5.51	.49	2.53	43.8	11.0	2.82	2.01	1.02	.60
"	"	21.25	6.25	.58	2.62	47.8	11.9	2.76	2.25	1.11	.60
C29	9	13.25	3.89	.23	2.43	47.3	10.5	3.49	1.77	.97	.67
"	"	15.00	4.41	.29	2.49	50.9	11.3	3.40	1.95	1.03	.66
"	"	20.00	5.88	.45	2.65	60.8	13.5	3.21	2.45	1.19	.65
"	"	25.00	7.35	.61	2.81	70.7	15.7	3.10	2.98	1.36	.64
C33	10	15.00	4.46	.24	2.60	66.9	13.4	3.87	2.30	1.17	.72
"	"	20.00	5.88	.38	2.74	78.7	15.7	3.66	2.85	1.34	.70
"	"	25.00	7.35	.53	2.89	91.0	18.2	3.52	3.40	1.50	.68
"	"	30.00	8.82	.68	3.04	103.2	20.6	3.32	3.99	1.67	.67
"	"	35.00	10.29	.83	3.18	115.5	23.1	3.35	4.66	1.87	.67
C41	12	20.50	6.03	.28	2.94	128.1	21.4	4.61	3.91	1.75	.81
"	"	25.00	7.35	.39	3.05	144.0	24.0	4.43	4.53	1.91	.78
"	"	30.00	8.82	.51	3.17	161.6	26.9	4.28	5.21	2.09	.77
"	"	35.00	10.29	.64	3.30	179.3	29.9	4.17	5.90	2.27	.76
"	"	40.00	11.76	.76	3.42	196.9	32.8	4.09	6.63	2.46	.75
C53	15	33.00	9.90	.40	3.40	312.6	41.7	5.62	8.23	3.16	.91
"	"	35.00	10.29	.43	3.43	319.9	42.7	5.57	8.48	3.22	.91
"	"	40.00	11.76	.52	3.52	347.5	46.3	5.44	9.39	3.43	.89
"	"	45.00	13.24	.62	3.62	375.1	50.0	5.32	10.29	3.63	.88
"	"	50.00	14.71	.72	3.72	402.7	53.7	5.23	11.22	3.85	.87
"	"	55.00	16.18	.82	3.82	430.2	57.4	5.16	12.19	4.07	.87

PROPERTIES OF STANDARD CHANNELS.

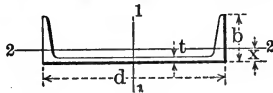

13	14	15		16	17		18	1	
Distance of Center of Gravity from Outside of Web.	Increase of Thickness of Web for each Pound Increase in Weight.	Coef. of Strength.		Fibre Stress 12500 Pounds per Sq. Inch for Bridges.	Coef. of Deflection.		Center Load.		
		Fibre Stress 16000 Pounds per Sq. Inch for Buildings.	F		F'	Uniform Load.			N'
		x	f		N	N'			
Inch.	Inches.								
.44	.098	11680	9090	.0004743	.0007589	C 5			
.44		13140	10270	.0004199	.0006718	"			
.46		14710	11490	.0003751	.0006001	"			
.46	.074	20230	15800	.0002046	.0003273	C 9			
.46		22270	17400	.0001858	.0002973	"			
.46		24360	19030	.0001698	.0002717	"			
.49	.059	31640	24720	.0001046	.0001674	C13			
.48		37860	29570	.0000875	.0001399	"			
.51		44390	34680	.0000746	.0001193	"			
.52	.049	46210	36100	.0000597	.0000855	C17			
.50		53750	42000	.0000513	.0000821	"			
.52		61600	48120	.0000448	.0000717	"			
.55		69440	54250	.0000397	.0000636	"			
.55	.042	64270	50210	.0000368	.0000588	C21			
.53		73650	57540	.0000321	.0000514	"			
.53		82740	64690	.0000286	.0000457	"			
.55		91950	71840	.0000257	.0000411	"			
.58		101100	78990	.0000234	.0000374	"			
.58	.037	86140	67300	.0000240	.0000384	C25			
.56		95990	75000	.0000216	.0000345	"			
.56		106450	83170	.0000194	.0000311	"			
.57		116910	91340	.0000177	.0000283	"			
.59		127370	99510	.0000162	.0000260	"			
.61	.033	112170	87630	.0000164	.0000262	C29			
.59		120540	94170	.0000153	.0000244	"			
.58		144070	112550	.0000128	.0000204	"			
.62		167590	130930	.0000110	.0000176	"			
.64	.029	142680	111470	.0000116	.0000186	C33			
.61		167940	131210	.0000099	.0000158	"			
.62		194090	151630	.0000085	.0000136	"			
.65		220230	172060	.0000075	.0000120	"			
.69		246380	192480	.0000067	.0000107	"			
.70	.025	227750	177930	.0000061	.0000097	C41			
.68		256000	200000	.0000054	.0000086	"			
.68		287370	224510	.0000048	.0000077	"			
.69		318750	249020	.0000043	.0000069	"			
.72		350120	273530	.0000039	.0000063	"			
.79	.020	444520	347280	.0000025	.0000040	C53			
.79		455030	355500	.0000024	.0000039	"			
.78		494250	386130	.0000022	.0000036	"			
.79		533470	416770	.0000021	.0000033	"			
.80		572680	447410	.0000019	.0000031	"			
.82		611900	478050	.0000018	.0000029	"			

PROPERTIES OF SHIP AND SPECIAL CHANNELS.

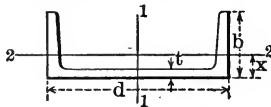

1	2	3	4	5	6	7	8	9	10	11	12	13
Section Number	Depth of Channel.	Wght per Foot.	Area of Section.	Thick-ness of Web.	Width of Flange	Thick-ness of Flange.	Slope of Flange.	Moment of Inertia Axis 1-1.	Section Modulus Axis 1-1.	Radius of Gyration Axis 1-1.	Moment of Inertia Axis 2-2.	Section Modulus Axis 2-2.
	d											
	Ins.	Lbs.	Sq. Ins.	Inch.	Ins.	In.	Ins. ⁴	Ins. ³	Ins.	Ins. ⁴	Ins. ³	
C 269	3	7.1	2.07	.306	1.94	.26	.12	2.72	1.81	1.15	.66	.52
C 72	4	10.1	2.95	.394	2.09	.38	.004	6.54	3.27	1.49	1.12	.79
C " 86	6	15.3	4.47	.34	3.50	.33	.035	25.3	8.4	2.38	5.14	2.13
		17.7	5.19	.46	3.62	"	"	27.5	9.2	2.30	5.95	2.31
C " 88	6	19.0	5.58	.41	3.56	.46	.02	31.1	10.4	2.36	6.79	2.85
		21.6	6.36	.54	3.69	"	"	33.4	11.1	2.29	7.85	3.10
		23.4	6.87	.63	3.78	"	"	34.9	11.6	2.25	8.53	3.25
C " 89	7	20.9	6.15	.45	3.45	.48	.02	44.6	12.7	2.69	6.74	2.81
		23.8	6.99	.57	3.57	"	"	48.0	13.7	2.62	7.63	3.02
C " 101	8	21.5	6.30	.40	3.50	.48	.02	60.7	15.2	3.07	7.20	2.94
		24.7	7.26	.52	3.62	"	"	65.8	16.4	3.01	8.25	3.17
C " 103	8	23.8	7.00	.50	3.50	.48	.02	63.6	15.7	3.01	7.42	2.96
		27.1	7.96	.62	3.62	"	"	68.7	17.2	2.94	8.41	3.18
C " 90	10	21.9	6.44	.38	3.38	.41	.02	92.0	18.4	3.78	6.29	2.51
		26.0	7.64	.50	3.50	"	"	102.0	20.4	3.66	7.17	2.70
		27.4	8.04	.54	3.54	"	"	105.4	21.1	3.62	7.45	2.76
		31.5	9.24	.66	3.66	"	"	115.4	23.1	3.54	8.30	2.94
C " 105	12	35.0	10.30	.47	3.77	.65	.03	215.7	36.0	4.58	12.98	4.79
		40.0	11.76	.60	3.90	"	"	233.3	38.9	4.45	14.61	5.13
		44.3	13.02	.70	4.00	"	"	248.4	41.4	4.37	15.99	5.41
		46.3	13.62	.75	4.05	"	"	255.6	42.6	4.33	16.64	5.55
		48.4	14.22	.80	4.10	"	"	262.8	43.8	4.30	17.31	5.68
		50.0	14.70	.84	4.14	"	"	268.6	44.8	4.27	17.84	5.79
C " 95	13	32.0	9.30	.38	4.00	.34	.15	237.5	36.5	5.05	11.54	3.86
		35.0	10.29	.45	4.08	"	"	251.5	38.7	4.94	12.54	4.06
		37.0	10.88	.50	4.12	"	"	259.8	40.0	4.89	13.10	4.17
		40.0	11.76	.56	4.19	"	"	272.2	41.9	4.81	13.94	4.33
		45.0	13.24	.68	4.30	"	"	292.9	45.1	4.70	15.32	4.59
		50.0	14.71	.79	4.42	"	"	313.7	48.3	4.62	16.71	4.86
		55.0	16.18	.90	4.53	"	"	334.4	51.4	4.55	18.14	5.14
C " 65	18	45.0	13.25	.47	3.77	.45	.17	584.3	64.9	6.64	12.89	4.40
		50.0	14.71	.55	3.85	"	"	623.1	69.2	6.51	13.90	4.61
		55.0	16.18	.63	3.93	"	"	662.0	73.6	6.40	14.93	4.82
		60.0	17.65	.72	4.02	"	"	703.3	78.1	6.31	15.96	5.03

PROPERTIES OF SHIP AND SPECIAL CHANNELS.

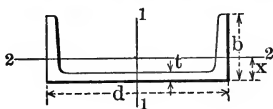

14	15	16	17	18	19	20	1
Radius of Gyration Axis 2-2.	Distance of Center of Gravity from Outside of Web.	Increase of Thickness of Web for each Lb. Increase in Weight.	Coef. of Strength.		Coef. of Deflection.		Section Number.
			Fibre Stress 16 000 Lbs. per Sq. Inch. for Buildings.	Fibre Stress 12 500 Lbs. per Sq. Inch. for Bridges.	Uniform Load.	Center Load.	
r'	x	f	F	F'	N	N'	
Inch.	Inch.	Inch.					
.50	.65	.098	19310	15090	.0002857	.0004571	C 269
.62	.67	.074	34880	27250	.0001186	.0001898	C 72
1.07	1.08	.049	89160	69660	.0000307	.0000491	C 86
1.07	1.04	"	97680	76310	.0000283	.0000452	"
1.10	1.18	.049	110450	86290	.0000250	.0000400	C 88
1.11	1.16	"	118770	92790	.0000232	.0000372	"
1.11	1.15	"	124270	97080	.0000222	.0000356	"
1.05	1.05	.042	135950	106210	.0000174	.0000278	C 89
1.05	1.04	"	146350	114330	.0000162	.0000259	"
1.07	1.05	.037	161930	126510	.0000128	.0000204	C 101
1.07	1.02	"	174930	136670	.0000118	.0000189	"
1.03	.99	.037	167470	130830	.0000122	.0000195	C 103
1.03	.98	"	183470	143330	.0000113	.0000181	"
.99	.87	.029	196310	153360	.0000085	.0000135	C 90
.97	.84	"	217650	170030	.0000077	.0000123	"
.96	.84	"	224760	175580	.0000074	.0000118	"
.95	.84	"	246100	192250	.0000068	.0000108	"
1.12	1.07	.0245	383550	299650	.0000036	.0000058	C 105
1.11	1.05	"	414790	324060	.0000033	.0000053	"
1.11	1.05	"	441670	345060	.0000031	.0000050	"
1.11	1.05	"	454470	355060	.0000030	.0000049	"
1.10	1.05	"	467270	369750	.0000030	.0000047	"
1.10	1.06	"	477510	373060	.0000029	.0000046	"
1.11	1.01	.023	389710	304460	.0000033	.0000052	C 95
1.10	.99	"	412750	322460	.0000031	.0000049	"
1.10	.98	"	426340	333080	.0000030	.0000048	"
1.09	.97	"	446740	349010	.0000029	.0000046	"
1.08	.97	"	480720	375560	.0000027	.0000042	"
1.07	.98	"	514710	402120	.0000025	.0000040	"
1.06	1.00	"	548700	428670	.0000023	.0000037	"
.99	.84	.016	692270	540830	.0000014	.0000022	C 65
.97	.83	"	738520	576970	.0000012	.0000020	"
.96	.83	"	784600	612970	.0000012	.0000019	"
.95	.85	"	833560	651220	.0000011	.0000018	"

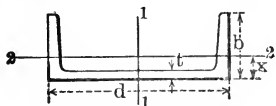

PROPERTIES OF STANDARD SHIP CHANNELS.

General slope of flange = 2° or .035.

Section Number.	Depth of Channel.	W'ght per Foot.	Area of Section.	Thick-ness of Web.	Width of Flange.	Thick-ness at Mid Flange.	Moment of Inertia Axis 1-1.	Section Mod-ulus Axis 1-1.	Radius of Gyra-tion Axis 1-1.	Moment of Inertia Axis 2-2.	Section Mod-ulus Axis 2-2.									
												d	A	t	b	I	S	r	I'	S'
												Ins.	Lbs.	Sq. Ins.	Inch.	Ins.	Inch.	Ins. ⁴	Ins. ³	Ins.
C 55	6	16.8	4.92	.325	3.45	.475	28.5	9.5	2.41	5.69	2.49									
" (BSC8)	"	17.8	5.22	.375	3.50	"	29.4	9.8	2.38	6.09	2.58									
"	"	19.8	5.82	.475	3.60	"	31.2	10.4	2.32	6.86	2.77									
C 57	7	18.9	5.55	.350	3.45	.500	42.8	12.2	2.78	6.31	2.69									
" (BSC10)	"	20.1	5.90	.400	3.50	"	44.2	12.6	2.74	6.73	2.73									
"	"	22.5	6.60	.500	3.60	"	47.1	13.5	2.67	7.54	2.98									
C 59	8	21.2	6.23	.375	3.45	.525	61.2	15.3	3.13	6.92	2.89									
" (BSC13)	"	22.6	6.63	.425	3.50	"	63.3	15.8	3.09	7.36	2.98									
"	"	25.3	7.43	.525	3.60	"	67.6	16.9	3.02	8.21	3.18									
C 60	9	23.7	6.96	.400	3.45	.550	84.3	18.7	3.48	7.52	3.08									
" (BSC17)	"	25.2	7.41	.450	3.50	"	87.3	19.4	3.43	7.97	3.17									
"	"	28.3	8.31	.550	3.60	"	93.4	20.7	3.35	8.85	3.38									
"	"	31.3	9.21	.650	3.70	"	99.4	22.1	3.29	9.71	3.57									
C 61	10	24.6	7.23	.375	3.40	.575	108.6	21.7	3.88	7.62	3.15									
"	"	26.3	7.73	.425	3.45	"	112.7	22.5	3.82	8.10	3.25									
" (BSC20)	"	28.0	8.23	.475	3.50	"	116.9	23.4	3.77	8.56	3.37									
"	"	31.4	9.23	.575	3.60	"	125.2	25.0	3.69	9.47	3.60									
"	"	34.8	10.23	.675	3.70	"	133.6	26.7	3.61	10.37	3.80									
C 63	12	30.6	9.00	.450	3.45	.600	181.8	30.3	4.50	8.89	3.48									
" (BSC25)	"	32.7	9.60	.500	3.50	"	189.0	31.5	4.44	9.37	3.58									
"	"	36.8	10.80	.600	3.60	"	203.4	33.9	4.34	10.31	3.80									
"	"	40.8	12.00	.700	3.70	"	217.8	36.3	4.26	11.26	4.01									

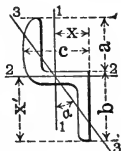

PROPERTIES OF Z-BAR HATCH SECTION.

STANDARD SHIP SECTION.

Section Number.	Size a × b × c.	Weight per Foot.	Area of Section.	THICKNESS.			Moment of Inertia Axis 1-1.	Section Modulus Axis 2-2.
				Web.	Plain Leg.	Rounded Leg.		
				Ins.	Ins.	Ins.		
Z 101	2 1/2 x 3 x 2 3/4	13.6	3.98	1/2	1/16	3/4	3.57	2.52

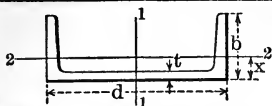

PROPERTIES OF STANDARD SHIP CHANNELS.

General slope of flange = 2° or .035.

13	14	15	16		17	18		19	1
Radius of Gyration Axis 2-2.	Distance of Center of Gravity from Outside of Web.	Increase of Thickness of Web for each Lb. Increase in Weight.	Coefficient of Strength.		Coefficient of Deflection.				Section Number.
			Fibre Stress 16 000 Lbs per Sq. Inch. for Buildings.	Fibre Stress 12 500 Lbs. per Sq. Inch. for Bridges.	Uniform Load.	Center Load.			
			F	F'	N	N'			
r'	x	f							
Inch	Inch.	Inch.							
1.08	1.17	.049	101500	79300	.0000271	.0000434			C 55
1.08	1.15	"	104700	81800	.0000264	.0000422			" (BSC 8)
1.09	1.13	"	111000	86800	.0000249	.0000398			"
1.07	1.11	.042	130410	101880	.0000182	.0000290			C 57
1.07	1.09	"	134770	105290	.0000176	.0000281			" (BSC 10)
1.07	1.07	"	143480	112090	.0000165	.0000264			"
1.05	1.05	.037	163080	127410	.0000127	.0000203			C 59
1.05	1.04	"	163770	131850	.0000123	.0000196			" (BSC 13)
1.05	1.02	"	180150	140740	.0000115	.0000184			"
1.04	1.01	.033	199730	156040	.0000092	.0000148			C 60
1.04	1.00	"	206930	161660	.0000089	.0000142			" (BSC 17)
1.03	.98	"	221330	172910	.0000083	.0000133			"
1.03	.98	"	235730	184160	.0000078	.0000125			"
1.03	.98	.029	231610	180940	.0000072	.0000115			C 61
1.02	.97	"	240500	187890	.0000069	.0000111			"
1.02	.96	"	249390	194830	.0000067	.0000107			" (BSC 20)
1.01	.95	"	267160	208720	.0000062	.0000100			"
1.01	.95	"	284940	222610	.0000058	.0000093			"
.99	.90	.025	323290	252570	.0000044	.0000070			C 63
.99	.89	"	336090	262570	.0000041	.0000066			" (BSC 25)
.98	.89	"	361690	282570	.0000039	.0000061			"
.97	.89	"	387290	302570	.0000036	.0000057			"

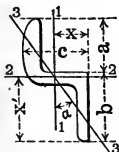

PROPERTIES OF Z-BAR HATCH SECTION.

STANDARD SHIP SECTION.

Radius of Gyration Axis 1-1.	Distance of Center of Gravity x	Moment of Inertia Axis 2-2.	Section Modulus Axis 2-2.	Radius of Gyration Axis 2-2.	Distance of Center of Gravity x'	Tangent of Angle α	Least Radius of Gyration Axis 3-3.	Section Number.
Ins.	Ins.	Ins. ⁴	Ins. ³	Ins.	Ins.		Ins.	
.95	1.42	6.98	2.39	1.33	2.93	1.560	.55	Z-101

PROPERTIES OF BULB ANGLES.

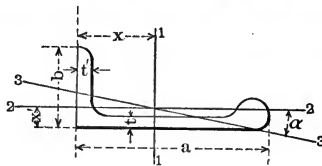

1	2	3	4	5	6	7	8
Section Number.	Size.	Weight per Foot.	Area of Section.	Thickness of Bulb Leg.	Thickness of Plain Leg.	Moment of Inertia Axis 1-1.	Section Modulus Axis 1-1.
	$a \times b$		A	t	t'		
	Inches.	Lbs.	Sq. Ins.	Ins.	Ins.	Ins. ⁴	Ins. ³
* A174	4 x 3½	11.7	3.42	⅜	⅜	7.7	3.25
* A176	5 x 4½	19.2	5.64	⅞	⅞	20.7	7.89
A 171	5 x 2½	10.2	3.00	⅜	⅜ to ⅝	10.4	4.05
A 177	6 x 3	11.8	3.47	⅞	.34	16.8	5.10
"	"	13.5	3.95	⅜	.39	18.5	5.56
"	"	15.0	4.41	⅞	.43	20.1	6.02
A 178	6 x 3½	12.5	3.66	⅞	.37	18.0	5.16
"	"	14.1	4.13	⅜	.41	19.6	5.62
"	"	15.7	4.60	⅞	.45	21.3	6.11
"	"	17.3	5.07	½	.49	22.8	6.53
"	"	18.9	5.53	⅞	.53	24.4	6.97
"	"	20.5	6.02	⅝	.53	25.9	7.42
A 179	7 x 3½	15.7	4.61	⅜	.43	29.3	7.21
"	"	17.5	5.13	⅞	.46	31.6	7.79
"	"	19.1	5.60	½	.48	33.7	8.36
A 181	8 x 3½	17.4	5.09	⅜	.42	42.8	9.54
"	"	19.3	5.64	⅞	.44	45.3	10.15
"	"	21.5	6.30	½	.50	50.1	11.14
A 183	9 x 3½	20.3	5.96	⅝	.44	62.6	12.78
"	"	22.6	6.62	⅝	.48	68.0	13.81
"	"	24.8	7.27	⅝	.52	72.7	14.75
A 185	10 x 3½	23.6	6.91	⅞	.47	88.6	16.62
"	"	26.1	7.64	½	.51	95.6	17.81
"	"	28.5	8.35	⅞	.55	102.2	19.00

*Top Guard Angle.

PROPERTIES OF BULB ANGLES.

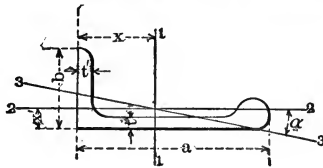

9	10	11	12	13	14	15	16	1
Radius of Gyration Axis 1-1.	Distance Center of Gravity from back of Plain Leg.	Moment of Inertia Axis 2-2.	Section Modulus Axis 2-2.	Radius of Gyration Axis 2-2.	Distance Center of Gravity from back of Bulb Leg.	Tangent of Angle.	Least Radius of Gyration Axis 3-3.	Section Number.
r	x	I'	S'	r'	x'	α	r''	
Ins.	Ins.	Ins. ⁴	Ins. ³	Ins.	Ins.		Ins.	
1.50	1.73	3.07	1.19	.95	.94	.398	.81	A174*
1.92	2.38	7.96	2.41	1.19	1.19	.385	1.01	A176*
1.86	2.43	3.47	1.81	1.08	.59	.198	1.03	A171
2.20	2.70	1.88	.79	.74	.63	.161	.65	A177
2.16	2.67	2.11	.90	.73	.65	.161	.65	"
2.14	2.66	2.33	1.00	.73	.67	.159	.65	"
2.22	2.51	3.27	1.21	.95	.80	.250	.79	A178
2.18	2.50	3.60	1.33	.93	.80	.247	.79	"
2.15	2.52	3.92	1.46	.92	.81	.244	.78	"
2.12	2.50	4.21	1.57	.91	.82	.239	.78	"
2.10	2.51	4.50	1.69	.90	.84	.238	.77	"
2.08	2.50	4.85	1.84	.90	.86	.236	.77	"
2.52	2.94	3.70	1.35	.90	.75	.193	.77	A179
2.48	2.94	3.99	1.46	.88	.76	.190	.76	"
2.45	2.97	4.16	1.52	.86	.76	.183	.75	"
2.90	3.52	3.73	1.33	.86	.70	.143	.76	A181
2.83	3.54	3.95	1.42	.84	.71	.133	.75	"
2.82	3.50	4.41	1.59	.83	.73	.136	.75	"
3.24	4.10	4.00	1.42	.82	.68	.110	.73	A183
3.20	4.08	4.37	1.56	.81	.70	.109	.73	"
3.16	4.07	4.71	1.69	.80	.71	.108	.73	"
3.58	4.67	4.34	1.53	.79	.67	.087	.73	A185
3.54	4.63	4.73	1.68	.79	.68	.087	.73	"
3.50	4.61	5.09	1.82	.78	.70	.086	.72	"

*Top Guard Angle.

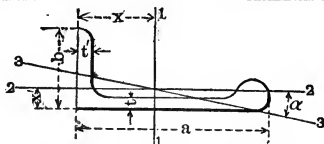

PROPERTIES OF STANDARD BULB ANGLES.

Section Number.	Size.	Weight per Foot.	Area of Section.	Thickness of Bulb Leg.	Thickness of Plain Leg.	Moment of Inertia Axis 1-1.	Section Modulus Axis 1-1.					
								A	t	t'	I	S.
								Sq. Ins.	Ins.	Ins.	Ins. ⁴	Ins. ³
A 187	6 x 3	12.2	3.58	.350		16.6	4.9					
" (BSBA 4)	"	12.8	3.76	.375	.375	17.4	5.1					
"	"	14.1	4.14	.425		18.8	5.5					
"	"	15.6	4.58	.475		20.2	5.9					
A 188	7 x 3 1/2	15.3	4.50	.375		28.6	7.2					
" (BSBA 8)	"	16.8	4.94	.425	.425	30.9	7.7					
"	"	18.6	5.46	.475		33.2	8.2					
"	"	20.0	5.90	.525		35.5	8.8					
A 189	8 x 3 1/2	18.0	5.29	.400		43.8	9.8					
" (BSBA 12)	"	19.6	5.78	.450	.450	47.1	10.6					
"	"	21.6	6.34	.500		50.4	11.2					
"	"	23.2	6.83	.550		53.7	11.9					
A 190	9 x 3 1/2	20.9	6.14	.425		63.8	13.1					
" (BSBA 16)	"	22.7	6.68	.475	.475	68.4	13.9					
"	"	24.8	7.29	.525		73.1	14.8					
"	"	26.6	7.82	.575		77.6	15.6					
"	"	28.6	8.41	.625		81.8	16.4					
A 191	10 x 3 1/2	24.9	7.32	.475		92.1	17.2					
" (BSBA 18)	"	26.9	7.90	.525	.525	98.2	18.3					
"	"	29.1	8.55	.575		104.3	19.2					
"	"	31.1	9.14	.625		110.4	20.3					
"	"	33.2	9.77	.675		115.9	21.2					
"	"	35.2	10.35	.725		122.0	22.3					

PROPERTIES OF CAR SIDE STAKE AND DOOR

SPREADER BAR SECTIONS.

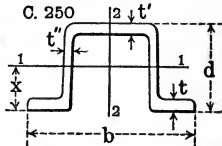
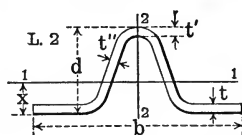

Section Number.	Size b x d	Weight per Foot.	Area of Section.	THICKNESS			Moment of Inertia. Axis 1-1.
				Base t	Top t'	Sides t"	
				Ins.	Ins.	Ins.	
L 2	7 x 2 3/4	7.2	2.10	3/16	3/8	3/16	1.99
"	7 x 2 13/16	8.7	2.54	1/4	7/16	3/16	2.90
"	7 x 2 15/16	11.7	3.41	3/8	9/16	3/16	4.55
C 250	7 1/2 x 4	19.8	5.81	1/2	.483	.320	11.78

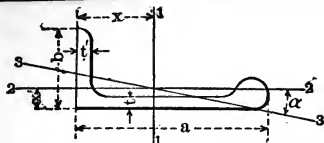

PROPERTIES OF STANDARD BULB ANGLES.

9	10	11	12	13	14	15	16	1
Radius of Gyration Axis 1-1.	Distance Center of Gravity from back of Plain Leg.	Moment of Inertia Axis 2-2.	Section Modulus Axis 2-2.	Radius of Gyration Axis 2-2.	Distance Center of Gravity from back of Bulb Leg.	Tangent of Angle.	Least Radius of Gyration Axis 3-3.	Section Number.
r	x	I'	S'	r'	x'	α	r''	
Ins.	Ins.	Ins. ⁴	Ins. ³	Ins.	Ins.		Ins.	
2.16	2.59	1.9	.83	.74	.63	.173	.65	A 187
2.15	2.60	2.1	.87	.74	.64	.174	.65	" (BSBA 4)
2.13	2.60	2.3	.96	.75	.66	.176	.65	"
2.10	2.55	2.5	1.1	.74	.67	.178	.66	"
2.52	2.99	3.4	1.2	.87	.72	.177	.75	A 188
2.50	3.00	3.7	1.4	.87	.74	.178	.76	" (BSBA 8)
2.47	2.94	4.1	1.5	.88	.75	.180	.76	"
2.45	2.95	4.5	1.6	.87	.77	.182	.77	"
2.88	3.54	3.7	1.3	.83	.70	.136	.74	A 189
2.85	3.54	4.0	1.4	.84	.71	.136	.75	" (BSBA 12)
2.82	3.48	4.4	1.6	.83	.73	.138	.75	"
2.81	3.49	4.8	1.7	.84	.75	.139	.76	"
3.22	4.10	3.9	1.4	.80	.68	.105	.73	A 190
3.20	4.10	4.3	1.5	.81	.70	.106	.74	" (BSBA 16)
3.17	4.03	4.7	1.7	.80	.71	.107	.74	"
3.15	4.03	5.1	1.8	.81	.73	.108	.75	"
3.12	3.98	5.4	2.0	.80	.74	.110	.75	"
3.55	4.63	4.4	1.6	.78	.68	.085	.72	A 191
3.53	4.62	4.8	1.7	.78	.69	.085	.72	" (BSBA 18)
3.49	4.56	5.1	1.9	.77	.70	.086	.73	"
3.48	4.56	5.6	2.0	.78	.72	.087	.74	"
3.44	4.52	5.8	2.1	.77	.74	.089	.74	"
3.43	4.53	6.3	2.3	.78	.76	.090	.75	"

PROPERTIES OF CAR SIDE STAKE AND DOOR SPREADER BAR SECTIONS.

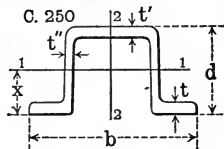
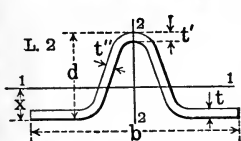

Section Modulus Axis 1-1.	Radius of Gyration Axis 1-1.	Distance to Center of Gravity x .	Moment of Inertia Axis 2-2.	Section Modulus Axis 2-2.	Radius of Gyration Axis 2-2.	Section Number.
Ins. ³	Ins.	Ins.	Ins. ⁴	Ins. ³	Ins.	
1.16	.97	1.04	5.45	1.56	1.61	L 2
1.53	1.07	.91	7.23	2.07	1.69	"
2.12	1.15	.79	10.81	3.09	1.78	"
5.77	1.42	2.04	26.2	7.00	2.12	C 250

PROPERTIES OF T-BARS.

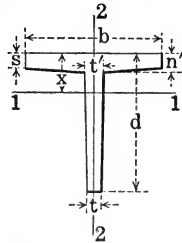

EQUAL LEGS.

Section Number	Dimensions				Weight per Foot	Area of Section	Distance of Center of Gravity from Outside of Flange	Moment of Inertia Axis 1-1
	Width of Flange	Depth of Bar	Thickness of Flange	Thickness of Stem				
	b	d	s to n'	t to t'				
	Inches	Inches	Inch	Inch				
	A	x	I	Pounds	Sq. Ins.	Inch	Inches ⁴	
T 5	1	1	$\frac{1}{8}$ to $\frac{5}{32}$	$\frac{1}{8}$ to $\frac{5}{32}$.89	.26	.29	.02
T181	$1\frac{1}{8}$	$1\frac{1}{8}$	$\frac{3}{16}$ " $\frac{3}{32}$	$\frac{3}{16}$ " $\frac{3}{32}$	1.37	.40	.33	.04
T183	$1\frac{3}{16}$	$1\frac{3}{16}$	$\frac{3}{16}$ " $\frac{1}{4}$	$\frac{3}{16}$ " $\frac{7}{32}$	1.51	.44	.34	.05
T187	$1\frac{1}{4}$	$1\frac{1}{4}$	$\frac{3}{16}$ " $\frac{1}{4}$	$\frac{3}{16}$ " $\frac{7}{32}$	1.60	.47	.36	.06
T188	$1\frac{1}{4}$	$1\frac{1}{4}$	$\frac{3}{16}$ " $\frac{7}{16}$	$\frac{3}{16}$ " $\frac{9}{32}$	1.70	.50	.40	.07
T191	$1\frac{1}{2}$	$1\frac{1}{2}$	$\frac{3}{16}$ " $\frac{7}{16}$	$\frac{3}{16}$ " $\frac{7}{32}$	1.94	.57	.44	.11
T193	$1\frac{1}{2}$	$1\frac{1}{2}$	$\frac{1}{4}$ " $\frac{3}{32}$	$\frac{1}{4}$ " $\frac{9}{32}$	2.47	.73	.47	.15
T194	$1\frac{3}{4}$	$1\frac{3}{4}$	$\frac{1}{4}$ " $\frac{5}{16}$	$\frac{1}{4}$ " $\frac{5}{16}$	3.09	.91	.54	.23
T 37	2	2	$\frac{1}{4}$ " $\frac{5}{16}$	$\frac{1}{4}$ " $\frac{5}{16}$	3.56	1.05	.59	.37
T 39	2	2	$\frac{1}{4}$ " $\frac{5}{16}$	$\frac{1}{4}$ " $\frac{5}{16}$	4.3	1.26	.61	.44
T 41	$2\frac{1}{4}$	$2\frac{1}{4}$	$\frac{1}{4}$ " $\frac{5}{16}$	$\frac{1}{4}$ " $\frac{5}{16}$	4.1	1.19	.65	.52
T 42	$2\frac{1}{4}$	$2\frac{1}{4}$	$\frac{1}{4}$ " $\frac{5}{16}$	$\frac{3}{8}$ " $\frac{5}{16}$	4.9	1.43	.68	.65
T 47	$2\frac{1}{2}$	$2\frac{1}{2}$	$\frac{1}{4}$ " $\frac{5}{16}$	$\frac{1}{4}$ " $\frac{5}{16}$	4.6	1.33	.71	.74
T 49	$2\frac{1}{2}$	$2\frac{1}{2}$	$\frac{1}{4}$ " $\frac{5}{16}$	$\frac{3}{8}$ " $\frac{5}{16}$	5.5	1.60	.74	.88

UNEQUAL LEGS.

T 16	$1\frac{1}{4}$	$1\frac{1}{16}$	$\frac{3}{16}$ to $\frac{1}{4}$	$\frac{5}{32}$ to $\frac{7}{32}$	1.48	.43	.30	.04
T 18	$1\frac{1}{4}$	$1\frac{1}{8}$	$\frac{3}{16}$ " $\frac{7}{32}$	$\frac{3}{16}$ " $\frac{1}{4}$	1.56	.46	.34	.05
T 20	$1\frac{1}{2}$	$1\frac{1}{4}$	$\frac{1}{8}$ " $\frac{5}{32}$	$\frac{1}{8}$ " $\frac{5}{32}$	1.25	.37	.33	.05

PROPERTIES OF T-BARS.

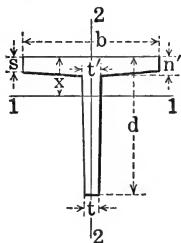

EQUAL LEGS.

10	11	12	13	14	15	16	1
Section Modulus Axis 1-1	Radius of Gyration Axis 1-1	Moment of Inertia Axis 2-2	Section Modulus Axis 2-2	Radius of Gyration Axis 2-2	Coef. of Strength		Section Number
					For Fibre Stress of 16 000 Lbs. per Square Inch.	For Fibre Stress of 12 500 Lbs. per Square Inch.	
S	r	I'	S'	r'	F	F'	
Inches ³	Inch	Inches ⁴	Inches ³	Inch			
.03	.30	.01	.02	.21	320	250	T 5
.05	.31	.02	.04	.24	530	410	T181
.06	.33	.03	.05	.26	610	480	T183
.06	.35	.03	.05	.27	680	530	T187
.08	.37	.03	.05	.26	820	640	T188
.11	.45	.06	.08	.32	1170	910	T191
.14	.45	.08	.10	.32	1490	1160	T193
.19	.51	.12	.14	.37	2020	1580	T194
.26	.59	.18	.18	.42	2770	2160	T 37
.31	.59	.23	.23	.43	3300	2580	T 39
.32	.66	.25	.22	.46	3410	2660	T 41
.41	.67	.33	.29	.48	4370	3410	T 42
.42	.75	.34	.27	.51	4420	3450	T 47
.50	.74	.44	.35	.52	5330	4160	T 49

UNEQUAL LEGS.

.05	.29	.03	.05	.28	500	390	T 16
.06	.32	.03	.05	.27	640	500	T 18
.05	.37	.04	.05	.32	530	410	T 20

**PROPERTIES OF STANDARD ANGLES.
EQUAL LEGS.**

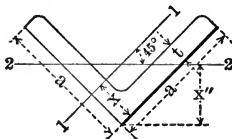

1	2	3	4	5	6	7	8
Section Number.	Dimensions.	Thickness.	Weight per Foot.	Area of Section.	Distance of Center of Gravity from Back of Leg.	Moment of Inertia Axis 1-1.	Section Modulus Axis 1-1.
	a x a	t		A	x	I	S
	Inches.	Inch.		Pounds.	Sq. Ins.	Inch.	Inches. ⁴
A11	1½ x 1½	⅛	1.23	.36	.42	.08	.072
"	"	⅜	1.80	.53	.44	.11	.104
"	"	¼	2.34	.69	.47	.14	.134
"	"	⅝	2.86	.84	.49	.16	.162
"	"	⅜	3.35	.98	.51	.19	.188
A15	2 x 2	⅛	1.65	.48	.55	.19	.13
"	"	⅜	2.44	.72	.57	.27	.19
"	"	¼	3.19	.94	.59	.35	.25
"	"	⅝	3.92	1.15	.61	.42	.30
"	"	⅜	4.7	1.36	.64	.48	.35
"	"	⅞	5.3	1.56	.66	.54	.40
"	"	½	6.0	1.75	.68	.59	.45
A17	2½ x 2½	⅛	2.08	.61	.67	.38	.20
"	"	⅜	3.07	.90	.69	.55	.30
"	"	¼	4.1	1.19	.72	.70	.39
"	"	⅝	5.0	1.47	.74	.85	.48
"	"	⅜	5.9	1.73	.76	.98	.57
"	"	⅞	6.8	2.00	.78	1.11	.65
"	"	½	7.7	2.25	.81	1.23	.72
A19	3 x 3	¼	4.9	1.44	.84	1.24	.58
"	"	⅝	6.1	1.78	.87	1.51	.71
"	"	⅜	7.2	2.11	.89	1.76	.83
"	"	⅞	8.3	2.43	.91	1.99	.95
"	"	½	9.4	2.75	.93	2.22	1.07
"	"	⅞	10.4	3.06	.95	2.43	1.19

**PROPERTIES OF STANDARD ANGLES.
EQUAL LEGS.**

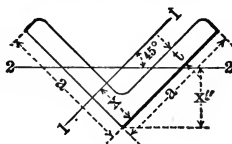

9	10	11	12	13	1
Radius of Gyration Axis 1-1.	Distance of Center of Gravity from External Apex.	Least Moment of Inertia Axis 2-2.	Section Modulus Axis 2-2.	Least Radius of Gyration Axis 2-2.	Section Number.
r	\bar{x}	I	S	\bar{r}	
Inch.	Inches.	Inches. ⁴	Inches. ³	Inch.	
.47	.60	.031	.053	.30	A11
.46	.63	.045	.072	.29	"
.45	.66	.058	.088	.29	"
.44	.69	.070	.101	.29	"
.44	.72	.082	.114	.29	"
.63	.78	.08	.10	.40	A15
.62	.80	.11	.14	.39	"
.61	.84	.14	.17	.39	"
.60	.87	.17	.20	.39	"
.59	.90	.20	.22	.39	"
.59	.93	.23	.25	.38	"
.58	.96	.26	.27	.38	"
.79	.95	.15	.16	.50	A17
.78	.98	.22	.22	.49	"
.77	1.01	.29	.28	.49	"
.76	1.05	.35	.33	.49	"
.75	1.08	.41	.38	.48	"
.75	1.11	.46	.42	.48	"
.74	1.14	.52	.46	.48	"
.93	1.19	.50	.42	.59	A19
.92	1.22	.61	.50	.59	"
.91	1.26	.72	.57	.58	"
.91	1.29	.82	.64	.58	"
.90	1.32	.92	.70	.58	"
.89	1.35	1.02	.76	.58	"

PROPERTIES OF
STANDARD ANGLES.
EQUAL LEGS.

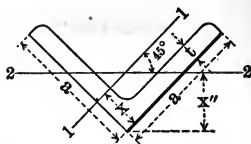

1	2	3	4	5	6	7	8
Section Number.	Dimensions.	Thickness.	Weight per Foot.	Area of Section.	Distance of Center of Gravity from Back of Leg.	Moment of Inertia Axis 1-1.	Section Modulus Axis 1-1.
	a x a	t		A	x	I	S
	Inches.	Inch.	Pounds.	Sq. Ins.	Inches.	Inches. ⁴	Inches. ³
A21	3½ x 3½	¼	5.8	1.69	.97	2.01	.79
"	"	⅜	7.2	2.09	.99	2.45	.98
"	"	½	8.5	2.48	1.01	2.87	1.15
"	"	⅝	9.8	2.87	1.04	3.26	1.32
"	"	¾	11.1	3.25	1.06	3.64	1.49
"	"	⅞	12.4	3.62	1.08	3.99	1.65
"	"	1	13.6	3.98	1.10	4.33	1.81
"	"	1¼	14.8	4.34	1.12	4.65	1.96
"	"	1½	16.0	4.69	1.15	4.96	2.11
"	"	1¾	17.1	5.03	1.17	5.25	2.25
"	"	1⅞	18.3	5.36	1.19	5.53	2.39
A23	4 x 4	¼	8.2	2.40	1.12	3.71	1.29
"	"	⅜	9.8	2.86	1.14	4.36	1.52
"	"	½	11.3	3.31	1.16	4.97	1.75
"	"	⅝	12.8	3.75	1.18	5.56	1.97
"	"	¾	14.3	4.18	1.21	6.12	2.19
"	"	⅞	15.7	4.61	1.23	6.66	2.40
"	"	1	17.1	5.03	1.25	7.17	2.61
"	"	1¼	18.5	5.44	1.27	7.66	2.81
"	"	1½	19.9	5.84	1.29	8.14	3.01
"	"	1¾	21.2	6.23	1.31	8.59	3.20
A27	6 x 6	⅜	14.9	4.36	1.64	15.39	3.53
"	"	½	17.2	5.06	1.66	17.68	4.07
"	"	⅝	19.6	5.75	1.68	19.91	4.61
"	"	¾	21.9	6.43	1.71	22.07	5.14
"	"	⅞	24.2	7.11	1.73	24.16	5.66
"	"	1	26.5	7.78	1.75	26.19	6.17
"	"	1¼	28.7	8.44	1.78	28.15	6.66
"	"	1½	31.0	9.09	1.80	30.06	7.15
"	"	1¾	33.1	9.73	1.82	31.92	7.63
"	"	1⅞	35.3	10.37	1.84	33.72	8.11
"	"	1	37.4	11.00	1.86	35.46	8.57
A35	8 x 8	½	26.4	7.75	2.19	48.65	8.37
"	"	⅝	29.6	8.68	2.21	54.09	9.34
"	"	¾	32.7	9.61	2.23	59.43	10.30
"	"	⅞	35.8	10.53	2.25	64.64	11.25
"	"	1	38.9	11.44	2.28	69.74	12.18
"	"	1¼	42.0	12.34	2.30	74.72	13.11
"	"	1½	45.0	13.23	2.32	79.58	14.02
"	"	1¾	48.1	14.12	2.34	84.34	14.91
"	"	1	51.0	15.00	2.37	88.98	15.80
"	"	1⅞	54.0	15.87	2.39	93.53	16.67
"	"	1⅞	56.9	16.73	2.41	97.97	17.53

PROPERTIES OF
STANDARD ANGLES.
EQUAL LEGS.

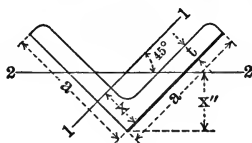

9	10	11	12	13	1
Radius of Gyration Axis 1-1.	Distance of Center of Gravity from External Apex.	Least Moment of Inertia Axis 2-2.	Section Modulus Axis 2-2.	Least Radius of Gyration Axis 2-2.	Section Number.
r	x''	I''	S''	r''	
Inches.	Inches.	Inches. ⁴	Inches. ³	Inch.	
1.09	1.37	.80	.59	.69	A21
1.08	1.40	.99	.71	.69	"
1.07	1.43	1.16	.81	.68	"
1.07	1.46	1.33	.91	.68	"
1.06	1.50	1.50	1.00	.68	"
1.05	1.53	1.66	1.09	.68	"
1.04	1.56	1.82	1.17	.68	"
1.04	1.59	1.97	1.24	.67	"
1.03	1.62	2.13	1.31	.67	"
1.02	1.65	2.28	1.38	.67	"
1.02	1.68	2.43	1.45	.67	"
1.24	1.58	1.50	.95	.79	A23
1.23	1.61	1.77	1.10	.79	"
1.23	1.64	2.02	1.23	.78	"
1.22	1.67	2.28	1.36	.78	"
1.21	1.71	2.52	1.48	.78	"
1.20	1.74	2.76	1.59	.77	"
1.19	1.77	3.00	1.70	.77	"
1.19	1.80	3.23	1.80	.77	"
1.18	1.83	3.46	1.89	.77	"
1.17	1.86	3.69	1.99	.77	"
1.88	2.32	6.19	2.67	1.19	A27
1.87	2.34	7.13	3.04	1.19	"
1.86	2.38	8.04	3.37	1.18	"
1.85	2.41	8.94	3.70	1.18	"
1.84	2.45	9.81	4.01	1.17	"
1.83	2.48	10.67	4.31	1.17	"
1.83	2.51	11.52	4.59	1.17	"
1.82	2.54	12.35	4.86	1.17	"
1.81	2.57	13.17	5.12	1.16	"
1.80	2.60	13.98	5.37	1.16	"
1.80	2.64	14.78	5.61	1.16	"
2.51	3.09	19.56	6.33	1.59	A35
2.50	3.12	21.79	6.98	1.58	"
2.49	3.16	23.97	7.60	1.58	"
2.48	3.19	26.13	8.20	1.58	"
2.47	3.22	28.24	8.77	1.57	"
2.46	3.25	30.33	9.33	1.57	"
2.45	3.28	32.38	9.86	1.56	"
2.44	3.32	34.40	10.38	1.56	"
2.44	3.35	36.40	10.88	1.56	"
2.43	3.38	38.38	11.36	1.56	"
2.42	3.41	40.33	11.83	1.55	"

PROPERTIES OF SPECIAL ANGLES.
EQUAL LEGS.

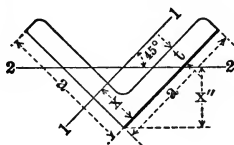

1	2	3	4	5	6	7	8
Section Number.	Dimensions.	Thickness	Weight per Foot.	Area of Section.	Distance of Center of Gravity from Back of Leg.	Moment of Inertia Axis 1-1.	Section Modulus Axis 1-1.
	a x a	t	A	x	I	S	
	Inches.	Inch.	Pounds.	Sq. Ins.	Inch.	Inches. ⁴	Inches. ³
A36	$\frac{3}{4} \times \frac{3}{4}$	$\frac{1}{8}$.59	.17	.23	.009	.017
"	"	$\frac{1}{8}$.84	.25	.25	.012	.024
A37	1 x 1	$\frac{1}{8}$.80	.23	.30	.022	.031
"	"	$\frac{3}{16}$	1.16	.34	.32	.030	.044
"	"	$\frac{1}{4}$	1.49	.44	.34	.037	.056
A38	$1\frac{1}{4} \times 1\frac{1}{4}$	$\frac{1}{8}$	1.01	.30	.36	.044	.049
"	"	$\frac{3}{16}$	1.48	.43	.38	.061	.071
"	"	$\frac{1}{4}$	1.92	.56	.40	.077	.091
A40	$1\frac{3}{4} \times 1\frac{3}{4}$	$\frac{1}{8}$	1.44	.42	.48	.13	.10
"	"	$\frac{3}{16}$	2.12	.62	.51	.18	.14
"	"	$\frac{1}{4}$	2.77	.81	.53	.23	.19
"	"	$\frac{5}{16}$	3.39	1.00	.55	.27	.23
"	"	$\frac{3}{8}$	3.99	1.17	.57	.31	.26
A41	$2\frac{1}{4} \times 2\frac{1}{4}$	$\frac{1}{8}$	2.75	.81	.63	.39	.24
"	"	$\frac{1}{4}$	3.62	1.06	.65	.50	.32
"	"	$\frac{5}{16}$	4.5	1.31	.68	.61	.39
A43	$2\frac{3}{4} \times 2\frac{3}{4}$	$\frac{1}{4}$	4.5	1.31	.78	.95	.48
"	"	$\frac{5}{16}$	5.6	1.62	.80	1.15	.59
"	"	$\frac{3}{8}$	6.6	1.92	.82	1.33	.69
A47	5 x 5	$\frac{3}{8}$	12.3	3.61	1.39	8.74	2.42
"	"	$\frac{7}{16}$	14.3	4.18	1.41	10.02	2.79
"	"	$\frac{1}{2}$	16.2	4.75	1.43	11.25	3.16
"	"	$\frac{5}{8}$	18.1	5.31	1.46	12.44	3.51
"	"	$\frac{5}{8}$	20.0	5.86	1.48	13.58	3.86
"	"	$\frac{11}{16}$	21.8	6.40	1.50	14.68	4.20
"	"	$\frac{3}{4}$	23.6	6.94	1.52	15.74	4.52

PROPERTIES OF SPECIAL ANGLES.
EQUAL LEGS.

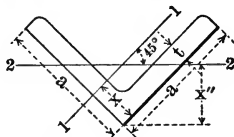

9	10	11	12	13	1
Radius of Gyration Axis 1-1.	Distance of Center of Gravity from External Apex.	Least Moment of Inertia Axis 2-2.	Section Modulus Axis 2-2.	Least Radius of Gyration Axis 2-2.	Section Number.
r	x"	I"	S"	r"	
Inch.	Inch.	Inches. ⁴	Inches. ³	Inch.	
.22	.33	.004	.011	.14	A36
.22	.36	.005	.014	.14	"
.30	.42	.009	.021	.19	A37
.30	.45	.013	.028	.19	"
.29	.48	.016	.034	.19	"
.38	.51	.018	.035	.24	A38
.38	.54	.025	.047	.24	"
.37	.57	.033	.057	.24	"
.55	.68	.051	.076	.35	A40
.54	.72	.073	.10	.34	"
.53	.75	.094	.13	.34	"
.52	.78	.113	.15	.34	"
.51	.81	.133	.16	.34	"
.70	.89	.16	.18	.44	A41
.69	.92	.21	.22	.44	"
.68	.96	.25	.26	.44	"
.85	1.10	.38	.35	.54	A43
.84	1.13	.47	.41	.54	"
.83	1.17	.55	.47	.53	"
1.56	1.96	3.53	1.79	.99	A47
1.55	2.00	4.05	2.03	.98	"
1.54	2.03	4.56	2.25	.98	"
1.53	2.06	5.06	2.46	.98	"
1.52	2.09	5.55	2.66	.97	"
1.51	2.12	6.03	2.84	.97	"
1.50	2.15	6.53	3.04	.97	"

PROPERTIES OF
STANDARD ANGLES.
UNEQUAL LEGS.

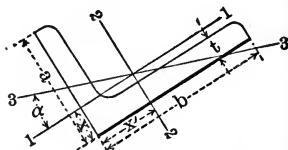

1	2	3	4	5	6	7	8
Section Number.	Dimensions.	Thickness	Weight	Area	Distance of Center of Gravity from Back of Longer Leg.	Moment of Inertia Axis 1-1.	Section Modulus Axis 1-1.
			per Foot.	Sq. Ins.			
	$b \times a$	t	Pounds.	A	x	I	S
	Inches.	Inch.			Inch.	Inches. ⁴	Inches. ³
A91	2½ x 2	¼	2.75	.81	.51	.29	.20
"	"	⅜	3.62	1.06	.54	.37	.25
"	"	½	4.5	1.31	.56	.45	.31
"	"	⅝	5.3	1.55	.58	.51	.36
"	"	¾	6.1	1.78	.60	.58	.41
"	"	⅞	6.8	2.00	.63	.64	.46
A93	3 x 2½	¼	4.5	1.31	.66	.74	.40
"	"	⅜	5.6	1.62	.68	.90	.49
"	"	½	6.6	1.92	.71	1.04	.58
"	"	⅝	7.6	2.22	.73	1.18	.66
"	"	¾	8.5	2.50	.75	1.30	.74
"	"	⅞	9.5	2.78	.77	1.42	.82
A95	3½ x 2½	¼	4.9	1.44	.61	.78	.41
"	"	⅜	6.1	1.78	.64	.94	.50
"	"	½	7.2	2.11	.66	1.09	.59
"	"	⅝	8.3	2.43	.68	1.23	.68
"	"	¾	9.4	2.75	.70	1.36	.76
"	"	⅞	10.4	3.06	.73	1.49	.84
A97	3½ x 3	¼	5.4	1.56	.79	1.30	.58
"	"	⅜	6.6	1.93	.81	1.58	.72
"	"	½	7.9	2.30	.83	1.85	.85
"	"	⅝	9.1	2.65	.85	2.09	.98
"	"	¾	10.2	3.00	.88	2.33	1.10
"	"	⅞	11.4	3.34	.90	2.55	1.21
"	"	1	12.5	3.67	.92	2.76	1.33
"	"	1¼	13.6	4.00	.94	2.96	1.44
"	"	1½	14.7	4.31	.96	3.15	1.54
"	"	1¾	15.8	4.62	.98	3.33	1.65
"	"	2	16.8	4.92	1.00	3.50	1.75
A99	4 x 3	⅝	7.2	2.09	.76	1.65	.73
"	"	¾	8.5	2.48	.78	1.92	.87
"	"	½	9.8	2.87	.80	2.18	.99
"	"	⅝	11.1	3.25	.83	2.42	1.12
"	"	¾	12.4	3.62	.85	2.66	1.23
"	"	⅞	13.6	3.98	.87	2.87	1.35
"	"	1	14.8	4.34	.89	3.08	1.46
"	"	1¼	16.0	4.69	.92	3.28	1.57
"	"	1½	17.1	5.03	.94	3.47	1.68
"	"	1¾	18.3	5.36	.96	3.66	1.79

**PROPERTIES OF
STANDARD ANGLES.
UNEQUAL LEGS.**

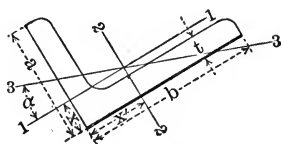

9	10	11	12	13	14	15	1
Radius of Gyration Axis 1-1.	Distance of Center of Gravity from back of Shorter Leg.	Moment of Inertia Axis 2-2.	Section Modulus Axis 2-2.	Radius of Gyration Axis 2-2.	Tangent of Angle.	Least Radius of Gyration Axis 3-3.	Section Number.
r	x'	I'	S'	r'	α	r''	
Inch.	Inch.	Inches. ⁴	Inches. ³	Inches.		Inch.	
.60	.76	.51	.29	.79	.632	.43	A91
.59	.79	.65	.38	.78	.626	.42	"
.58	.81	.79	.47	.78	.620	.42	"
.58	.83	.91	.55	.77	.614	.42	"
.57	.85	1.03	.62	.76	.607	.42	"
.56	.88	1.14	.70	.75	.600	.42	"
.75	.91	1.17	.56	.95	.684	.53	A93
.74	.93	1.42	.69	.94	.680	.53	"
.74	.96	1.66	.81	.93	.676	.52	"
.73	.98	1.88	.93	.92	.672	.52	"
.72	1.00	2.08	1.04	.91	.666	.52	"
.72	1.02	2.28	1.15	.91	.661	.52	"
.74	1.11	1.80	.75	1.12	.506	.54	A95
.73	1.14	2.19	.93	1.11	.501	.54	"
.72	1.16	2.56	1.09	1.10	.496	.54	"
.71	1.18	2.91	1.26	1.09	.491	.54	"
.70	1.20	3.24	1.41	1.09	.486	.53	"
.70	1.23	3.55	1.56	1.08	.480	.53	"
.91	1.04	1.91	.78	1.11	.727	.63	A97
.90	1.06	2.33	.95	1.10	.724	.63	"
.90	1.08	2.72	1.13	1.09	.721	.62	"
.89	1.10	3.10	1.29	1.08	.718	.62	"
.88	1.13	3.45	1.45	1.07	.714	.62	"
.87	1.15	3.79	1.61	1.07	.711	.62	"
.87	1.17	4.11	1.76	1.06	.707	.62	"
.86	1.19	4.41	1.91	1.05	.703	.62	"
.85	1.21	4.70	2.05	1.04	.698	.62	"
.85	1.23	4.98	2.20	1.04	.694	.62	"
.84	1.25	5.24	2.33	1.03	.689	.63	"
.89	1.26	3.38	1.23	1.27	.554	.65	A99
.88	1.28	3.96	1.46	1.26	.551	.64	"
.87	1.30	4.52	1.68	1.25	.547	.64	"
.86	1.33	5.05	1.89	1.25	.543	.64	"
.86	1.35	5.55	2.09	1.24	.538	.64	"
.85	1.37	6.03	2.30	1.23	.534	.64	"
.84	1.39	6.49	2.49	1.22	.529	.64	"
.84	1.42	6.93	2.68	1.22	.524	.64	"
.83	1.44	7.35	2.87	1.21	.518	.64	"
.83	1.46	7.75	3.05	1.20	.512	.64	"

PROPERTIES OF
STANDARD ANGLES.
UNEQUAL LEGS.

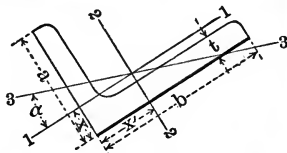

1	2	3	4	5	6	7	8
Section Number.	Dimensions.	Thickness.	Weight per Foot.	Area of Section.	Distance of Center of Gravity from Back of Longer Leg.	Moment of Inertia Axis 1-1.	Section Modulus Axis 1-1.
	Inches.	Inch.	Pounds.	Sq. Ins.	Inch.	Inches. ⁴	Inches. ³
A101	5 x 3	$\frac{1}{8}$	8.2	2.40	.68	1.75	.75
"	"	$\frac{3}{8}$	9.8	2.86	.70	2.04	.89
"	"	$\frac{1}{2}$	11.3	3.31	.73	2.32	1.02
"	"	$\frac{3}{4}$	12.8	3.75	.75	2.58	1.15
"	"	$\frac{7}{8}$	14.3	4.18	.77	2.83	1.27
"	"	$\frac{1}{4}$	15.7	4.61	.80	3.06	1.39
"	"	$\frac{3}{8}$	17.1	5.03	.82	3.29	1.51
"	"	$\frac{1}{2}$	18.5	5.44	.84	3.51	1.62
"	"	$\frac{3}{4}$	19.9	5.84	.86	3.71	1.74
"	"	$\frac{7}{8}$	21.2	6.23	.88	3.91	1.85
A103	5 x 3½	$\frac{1}{8}$	8.7	2.56	.84	2.72	1.02
"	"	$\frac{3}{8}$	10.4	3.05	.86	3.18	1.21
"	"	$\frac{1}{2}$	12.0	3.53	.88	3.63	1.39
"	"	$\frac{3}{4}$	13.6	4.00	.91	4.05	1.56
"	"	$\frac{7}{8}$	15.2	4.47	.93	4.45	1.73
"	"	$\frac{1}{4}$	16.8	4.92	.95	4.83	1.90
"	"	$\frac{3}{8}$	18.3	5.37	.97	5.20	2.06
"	"	$\frac{1}{2}$	19.8	5.81	1.00	5.55	2.22
"	"	$\frac{3}{4}$	21.3	6.25	1.02	5.89	2.37
"	"	$\frac{7}{8}$	22.7	6.67	1.04	6.21	2.52
"	"	$\frac{1}{8}$	24.2	7.09	1.06	6.52	2.67
A105	6 x 3½	$\frac{3}{8}$	11.7	3.42	.79	3.34	1.23
"	"	$\frac{1}{2}$	13.5	3.97	.81	3.81	1.41
"	"	$\frac{3}{4}$	15.3	4.50	.83	4.25	1.59
"	"	$\frac{7}{8}$	17.1	5.03	.86	4.67	1.77
"	"	$\frac{1}{4}$	18.9	5.55	.88	5.08	1.94
"	"	$\frac{3}{8}$	20.6	6.06	.90	5.47	2.11
"	"	$\frac{1}{2}$	22.4	6.56	.93	5.84	2.27
"	"	$\frac{3}{4}$	24.0	7.06	.95	6.20	2.43
"	"	$\frac{7}{8}$	25.7	7.55	.97	6.55	2.59
"	"	$\frac{1}{8}$	27.3	8.03	.99	6.88	2.74
"	"	1	28.9	8.50	1.01	7.21	2.90
A107	6 x 4	$\frac{3}{8}$	12.3	3.61	.94	4.90	1.60
"	"	$\frac{1}{2}$	14.3	4.18	.96	5.60	1.85
"	"	$\frac{3}{4}$	16.2	4.75	.99	6.27	2.08
"	"	$\frac{7}{8}$	18.1	5.31	1.01	6.91	2.31
"	"	$\frac{1}{4}$	20.0	5.86	1.03	7.52	2.54
"	"	$\frac{3}{8}$	21.8	6.40	1.06	8.11	2.76
"	"	$\frac{1}{2}$	23.6	6.94	1.08	8.68	2.97
"	"	$\frac{3}{4}$	25.4	7.47	1.10	9.23	3.18
"	"	$\frac{7}{8}$	27.2	7.98	1.12	9.75	3.39
"	"	$\frac{1}{8}$	28.9	8.50	1.14	10.26	3.59
"	"	1	30.6	9.00	1.17	10.76	3.79

**PROPERTIES OF
STANDARD ANGLES.
UNEQUAL LEGS.**

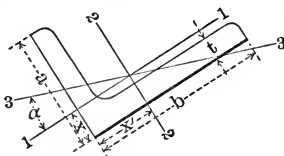

9	10	11	12	13	14	15	1
Radius of Gyration Axis 1-1.	Distance of Center of Gravity from Back of Shorter Leg.	Moment of Inertia Axis 2-2.	Section Modulus Axis 2-2.	Radius of Gyration Axis 2-2.	Tangent of Angle.	Least Radius of Gyration Axis 3-3.	Section Number.
r	x'	I'	S'	r'	α	r''	
Inch.	Inches.	Inches. ⁴	Inches. ³	Inch.		Inch.	
.85	1.68	6.26	1.89	1.61	.368	.66	A101
.84	1.70	7.37	2.24	1.61	.364	.65	"
.84	1.73	8.43	2.58	1.60	.361	.65	"
.83	1.75	9.45	2.91	1.59	.357	.65	"
.82	1.77	10.43	3.23	1.58	.353	.65	"
.82	1.80	11.37	3.55	1.57	.349	.64	"
.81	1.82	12.28	3.86	1.56	.345	.64	"
.80	1.84	13.15	4.16	1.55	.340	.64	"
.80	1.86	13.98	4.46	1.55	.336	.64	"
.79	1.88	14.78	4.75	1.54	.331	.64	"
1.03	1.59	6.60	1.94	1.61	.489	.77	A103
1.02	1.61	7.78	2.29	1.60	.485	.76	"
1.01	1.63	8.90	2.64	1.59	.482	.76	"
1.01	1.66	9.99	2.99	1.58	.479	.75	"
1.00	1.68	11.03	3.32	1.57	.476	.75	"
.99	1.70	12.03	3.65	1.56	.472	.75	"
.98	1.72	12.99	3.97	1.56	.468	.75	"
.98	1.75	13.92	4.28	1.55	.464	.75	"
.97	1.77	14.81	4.58	1.54	.460	.75	"
.96	1.79	15.67	4.88	1.53	.455	.75	"
.96	1.81	16.49	5.17	1.53	.451	.75	"
.99	2.04	12.86	3.24	1.94	.350	.77	A105
.98	2.06	14.76	3.75	1.93	.347	.76	"
.97	2.08	16.59	4.24	1.92	.344	.76	"
.96	2.11	18.37	4.72	1.91	.341	.75	"
.96	2.13	20.08	5.19	1.90	.338	.75	"
.95	2.15	21.74	5.65	1.89	.334	.75	"
.94	2.18	23.34	6.10	1.89	.331	.75	"
.94	2.20	24.89	6.55	1.88	.327	.75	"
.93	2.22	26.39	6.98	1.87	.323	.75	"
.93	2.24	27.84	7.41	1.86	.320	.75	"
.92	2.26	29.15	7.80	1.85	.317	.75	"
1.17	1.94	13.47	3.32	1.93	.446	.88	A107
1.16	1.96	15.46	3.83	1.92	.443	.87	"
1.15	1.99	17.40	4.33	1.91	.440	.87	"
1.14	2.01	19.26	4.83	1.90	.438	.87	"
1.13	2.03	21.07	5.31	1.90	.434	.86	"
1.13	2.06	22.82	5.78	1.89	.431	.86	"
1.12	2.08	24.51	6.25	1.88	.428	.86	"
1.11	2.10	26.15	6.70	1.87	.425	.86	"
1.11	2.12	27.73	7.15	1.86	.421	.86	"
1.10	2.14	29.26	7.59	1.86	.418	.86	"
1.09	2.17	30.75	8.02	1.85	.414	.86	"

**PROPERTIES OF SPECIAL ANGLES.
UNEQUAL LEGS.**

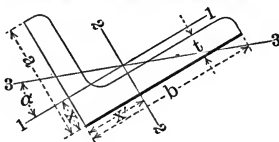

1	2	3	4	5	6	7	8
Section Number.	Dimensions.	Thickness.	Weight per Foot.	Area of Section.	Distance of Center of Gravity from Back of Longer Leg.	Moment of Inertia Axis 1-1.	Section Modulus Axis 1-1.
	b x a	t		A	x	I	S
	Inches.	Inch.	Pounds.	Sq. Ins.	Inch.	Inches. ⁴	Inches. ³
A129	3 x 2	$\frac{3}{8}$	3.07	.90	.47	.31	.20
"	"	$\frac{1}{4}$	4.1	1.19	.49	.39	.26
"	"	$\frac{5}{16}$	5.0	1.47	.51	.47	.32
"	"	$\frac{3}{8}$	5.9	1.73	.54	.54	.37
"	"	$\frac{7}{16}$	6.8	2.00	.56	.61	.42
"	"	$\frac{1}{2}$	7.7	2.25	.58	.67	.47
A131	4 x 3½	$\frac{3}{8}$	7.7	2.25	.93	2.55	.99
"	"	$\frac{1}{2}$	9.1	2.67	.96	2.99	1.17
"	"	$\frac{5}{16}$	10.6	3.09	.98	3.40	1.35
"	"	$\frac{1}{2}$	11.9	3.50	1.00	3.79	1.52
"	"	$\frac{5}{8}$	13.3	3.90	1.02	4.17	1.68
"	"	$\frac{3}{4}$	14.7	4.30	1.04	4.49	1.83
"	"	$\frac{7}{8}$	16.0	4.68	1.07	4.86	2.00
A135	5 x 4	$\frac{3}{8}$	11.0	3.23	1.03	4.66	1.57
"	"	$\frac{1}{2}$	12.8	3.75	1.05	5.32	1.81
"	"	$\frac{5}{16}$	14.5	4.25	1.07	5.96	2.04
"	"	$\frac{3}{8}$	16.2	4.75	1.10	6.56	2.26
"	"	$\frac{1}{2}$	17.8	5.23	1.12	7.14	2.48
"	"	$\frac{5}{8}$	19.5	5.72	1.14	7.70	2.69
A109	7 x 3½	$\frac{7}{16}$	15.0	4.40	.75	3.95	1.44
"	"	$\frac{1}{2}$	17.0	5.00	.78	4.41	1.62
"	"	$\frac{9}{16}$	19.1	5.59	.80	4.86	1.80
"	"	$\frac{5}{8}$	21.0	6.17	.82	5.28	1.97
"	"	$\frac{3}{4}$	23.0	6.75	.85	5.69	2.14
"	"	$\frac{7}{8}$	24.9	7.31	.87	6.08	2.31
"	"	$\frac{15}{16}$	26.8	7.87	.89	6.46	2.48
"	"	1	28.7	8.42	.91	6.83	2.64
"	"	$\frac{15}{16}$	30.5	8.97	.94	7.18	2.80
"	"	1	32.3	9.50	.96	7.53	2.96
A112	8 x 6	$\frac{1}{2}$	23.0	6.75	1.47	21.68	4.79
"	"	$\frac{5}{8}$	25.7	7.56	1.50	24.04	5.34
"	"	$\frac{3}{4}$	28.5	8.36	1.52	26.33	5.88
"	"	$\frac{7}{8}$	31.2	9.15	1.54	28.56	6.40
"	"	1	33.8	9.94	1.56	30.72	6.92
"	"	$\frac{15}{16}$	36.5	10.72	1.59	32.82	7.44
"	"	1	39.1	11.48	1.61	34.86	7.94
"	"	$\frac{15}{16}$	41.7	12.25	1.63	36.85	8.43
"	"	1	44.2	13.00	1.65	38.78	8.92

PROPERTIES OF SPECIAL ANGLES.
UNEQUAL LEGS.

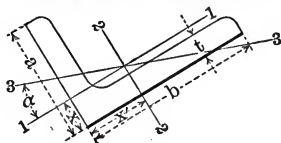

9	10	11	12	13	14	15	1
Radius of Gyration Axis 1-1.	Distance of Center of Gravity from Back of Shorter Leg.	Moment of Inertia Axis 2-2.	Section Modulus Axis 2-2.	Radius of Gyration Axis 2-2.	Tangent of Angle.	Radius of Gyration Axis 3-3.	Section Number.
r	x'	I'	S'	r'	α	r''	
Inch.	Inches.	Inches. ⁴	Inches. ³	Inches.		Inch.	
.58	.97	.84	.41	.97	.446	.44	A129
.57	.99	1.09	.54	.96	.440	.43	"
.57	1.02	1.32	.66	.95	.434	.43	"
.56	1.04	1.53	.78	.94	.428	.43	"
.55	1.06	1.73	.89	.93	.421	.43	"
.55	1.08	1.92	1.00	.92	.414	.43	"
1.07	1.18	3.56	1.26	1.26	.757	.73	A131
1.06	1.21	4.18	1.49	1.25	.755	.73	"
1.05	1.23	4.76	1.72	1.24	.753	.72	"
1.04	1.25	5.32	1.94	1.23	.750	.72	"
1.03	1.27	5.86	2.15	1.23	.747	.72	"
1.02	1.29	6.37	2.35	1.22	.742	.72	"
1.02	1.32	6.86	2.56	1.21	.742	.72	"
1.20	1.53	8.14	2.34	1.59	.631	.85	A135
1.19	1.55	9.32	2.70	1.58	.629	.85	"
1.18	1.57	10.46	3.05	1.57	.626	.85	"
1.18	1.60	11.55	3.39	1.56	.623	.85	"
1.17	1.62	12.61	3.73	1.55	.620	.84	"
1.16	1.64	13.62	4.05	1.54	.617	.84	"
.95	2.50	22.56	5.01	2.26	.267	.76	A109
.94	2.53	25.41	5.68	2.25	.264	.75	"
.93	2.55	28.18	6.34	2.25	.262	.75	"
.93	2.57	30.86	6.96	2.24	.259	.75	"
.92	2.60	33.47	7.60	2.23	.257	.74	"
.91	2.62	35.99	8.22	2.22	.253	.74	"
.91	2.64	38.45	8.83	2.21	.250	.74	"
.90	2.66	40.82	9.42	2.20	.247	.74	"
.89	2.69	43.13	10.00	2.19	.244	.74	"
.89	2.71	45.37	10.58	2.19	.241	.74	"
1.79	2.47	44.31	8.02	2.56	.558	1.30	A112
1.78	2.50	49.26	8.95	2.55	.556	1.30	"
1.77	2.52	54.10	9.87	2.54	.554	1.29	"
1.77	2.54	58.82	10.77	2.54	.554	1.29	"
1.76	2.56	63.42	11.67	2.53	.553	1.28	"
1.75	2.59	67.92	12.55	2.52	.549	1.28	"
1.74	2.61	72.32	13.41	2.51	.546	1.28	"
1.73	2.63	76.59	14.27	2.50	.545	1.28	"
1.73	2.65	80.78	15.11	2.49	.543	1.28	"

MOMENTS OF INERTIA OF RECTANGLES. I

Neutral  Axis

Depths 2 to 60 inches; widths $\frac{1}{4}$ to 1 inch, varying by $\frac{1}{8}$ inch.

Depth in Inches.	Width of Rectangle in Inches.						
	$\frac{1}{4}$	$\frac{5}{16}$	$\frac{3}{8}$	$\frac{7}{16}$	$\frac{1}{2}$	$\frac{9}{16}$	$\frac{5}{8}$
2	.17	.21	.25	.29	.33	.38	.42
3	.56	.70	.84	.98	1.13	1.27	1.41
4	1.33	1.67	2.00	2.33	2.67	3.00	3.33
5	2.60	3.26	3.91	4.56	5.21	5.86	6.51
6	4.50	5.63	6.75	7.88	9.00	10.13	11.25
7	7.15	8.93	10.72	12.51	14.29	16.08	17.86
8	10.67	13.33	16.00	18.67	21.33	24.00	26.67
9	15.19	18.98	22.78	26.58	30.38	34.17	37.97
10	20.83	26.04	31.25	36.46	41.67	46.87	52.08
11	27.73	34.66	41.59	48.53	55.46	62.39	69.32
12	36.00	45.00	54.00	63.00	72.00	81.00	90.00
13	45.77	57.21	68.66	80.10	91.54	102.98	114.43
14	57.17	71.46	85.75	100.04	114.33	128.63	142.92
15	70.31	87.89	105.47	123.05	140.63	158.20	175.78
16	85.33	106.67	128.00	149.33	170.67	192.00	213.33
17	102.35	127.94	153.53	179.12	204.71	230.30	255.89
18	121.50	151.88	182.25	212.63	243.00	273.38	303.75
19	142.90	178.62	214.34	250.07	285.79	321.52	357.24
20	166.67	208.33	250.00	291.67	333.33	375.00	416.67
21	192.94	241.17	289.41	337.64	385.88	434.11	482.34
22	221.83	277.29	332.75	388.21	443.67	499.13	554.58
23	253.48	316.85	380.22	443.59	506.96	570.33	633.70
24	288.00	360.00	432.00	504.00	576.00	648.00	720.00
25	325.52	406.90	488.28	569.66	651.04	732.42	813.80
26	366.17	457.71	549.25	640.79	732.33	823.88	915.42
27	410.06	512.58	615.09	717.61	820.13	922.64	1025.16
28	457.33	571.67	686.00	800.33	914.67	1029.00	1143.33
29	508.10	635.13	762.16	889.18	1016.21	1143.23	1270.26
30	562.50	703.13	843.75	984.38	1125.00	1265.63	1406.25
32	682.67	853.33	1024.00	1194.67	1365.33	1536.00	1706.67
34	818.83	1023.54	1228.25	1432.96	1637.67	1842.38	2047.08
36	972.00	1215.00	1458.00	1701.00	1944.00	2187.00	2430.00
38	1143.17	1428.96	1714.75	2000.54	2286.33	2572.13	2857.92
40	1333.33	1666.67	2000.00	2333.33	2666.67	3000.00	3333.33
42	1543.50	1929.38	2315.25	2701.13	3087.00	3472.88	3858.75
44	1774.67	2218.33	2662.00	3105.67	3549.33	3993.00	4436.67
46	2027.83	2534.79	3041.75	3548.71	4055.67	4562.63	5069.58
48	2304.00	2880.00	3456.00	4032.00	4608.00	5184.00	5760.00
50	2604.17	3255.21	3906.25	4557.29	5208.33	5859.38	6510.42
52	2929.33	3661.67	4394.00	5126.33	5858.67	6591.00	7323.33
54	3280.50	4100.63	4920.75	5740.88	6561.00	7381.13	8201.25
56	3658.67	4573.33	5488.00	6402.67	7317.33	8232.00	9146.67
58	4064.83	5081.04	6097.25	7113.46	8129.67	9145.87	10162.08
60	4500.00	5625.00	6750.00	7875.00	9000.00	10125.00	11250.00

MOMENTS OF INERTIA OF RECTANGLES. I

.....Neutral  Axis.....

Depths 2 to 60 inches; widths $\frac{1}{4}$ to 1 inch, varying by $\frac{1}{16}$ inch.

Width of Rectangle in Inches.						Depth in Inches.
$\frac{1}{16}$	$\frac{3}{4}$	$\frac{1}{16}$	$\frac{7}{8}$	$\frac{1}{16}$	1	
.46	.50	.54	.58	.63	.67	2
1.55	1.69	1.83	1.97	2.11	2.25	3
3.67	4.00	4.33	4.67	5.00	5.33	4
7.16	7.81	8.46	9.11	9.77	10.42	5
12.38	13.50	14.63	15.75	16.88	18.00	6
19.65	21.44	23.22	25.01	26.80	28.58	7
29.33	32.00	34.67	37.33	40.00	42.67	8
41.77	45.56	49.36	53.16	56.95	60.75	9
57.29	62.50	67.71	72.92	78.13	83.33	10
76.26	83.19	90.12	97.05	103.98	110.92	11
99.00	108.00	117.00	126.00	135.00	144.00	12
125.87	137.31	148.75	160.20	171.64	183.08	13
157.21	171.50	185.79	200.08	214.38	228.67	14
193.36	210.94	228.52	246.09	263.67	281.25	15
234.67	256.00	277.33	298.67	320.00	341.33	16
281.47	307.06	332.65	358.24	383.83	409.42	17
334.13	364.50	394.88	425.25	455.63	486.00	18
392.96	428.69	464.41	500.14	535.86	571.58	19
458.33	500.00	541.67	583.33	625.00	666.67	20
530.58	578.81	627.05	675.28	723.52	771.75	21
610.04	665.50	720.96	776.42	831.87	887.33	22
697.07	760.44	823.81	887.18	950.55	1013.92	23
792.00	864.00	936.00	1008.00	1080.00	1152.00	24
895.18	976.56	1057.94	1139.32	1220.70	1302.08	25
1006.96	1098.50	1190.04	1281.58	1373.13	1464.67	26
1127.67	1230.19	1332.70	1435.22	1537.73	1640.25	27
1257.67	1372.00	1486.33	1600.67	1715.00	1829.33	28
1397.29	1524.31	1651.34	1778.36	1905.39	2032.42	29
1546.88	1687.50	1828.13	1968.75	2109.38	2250.00	30
1877.33	2048.00	2218.67	2389.33	2560.00	2730.67	32
2251.79	2456.50	2661.21	2865.92	3070.63	3275.33	34
2673.00	2916.00	3159.00	3402.00	3645.00	3888.00	36
3143.71	3429.50	3715.29	4001.08	4286.88	4572.67	38
3666.67	4000.00	4333.33	4666.67	5000.00	5333.33	40
4244.63	4630.50	5016.38	5402.25	5788.13	6174.00	42
4880.33	5324.00	5767.67	6211.33	6655.00	7098.67	44
5576.54	6083.50	6590.46	7097.42	7694.38	8111.33	46
6336.00	6912.00	7488.00	8064.00	8640.00	9216.00	48
7161.46	7812.50	8463.54	9114.58	9765.63	10416.67	50
8055.67	8788.00	9520.33	10252.67	10985.00	11717.33	52
9021.38	9841.50	10661.63	11481.75	12301.88	13122.00	54
10061.33	10976.00	11890.67	12805.33	13720.00	14634.67	56
11178.29	12194.50	13210.71	14226.92	15243.12	16259.33	58
12375.00	13500.00	14625.00	15750.00	16875.00	18000.00	60

MOMENTS OF INERTIA OF RECTANGLES. II

ONE INCH WIDE.

NEUTRAL AXIS



Value for any width may be obtained from tabular value by direct multiplication.

Depth in Inches.	Additional Depth in Fractions of an Inch.							
	0	$\frac{1}{16}$	$\frac{1}{8}$	$\frac{3}{16}$	$\frac{1}{4}$	$\frac{5}{16}$	$\frac{3}{8}$	$\frac{7}{16}$
000002	.00016	.00055	.00130	.00254	.00439	.00698
1	.08333	.09995	.11865	.13955	.16276	.18842	.21663	.24754
2	.66667	.73114	.79964	.87229	.94922	1.0305	1.1164	1.2068
3	2.2500	2.3936	2.5431	2.6988	2.8607	3.0289	3.2036	3.3849
4	5.3333	5.5873	5.8491	6.1190	6.3971	6.6802	6.9783	7.2817
5	10.417	10.812	11.218	11.633	12.059	12.494	12.941	13.397
6	18.000	18.568	19.149	19.741	20.345	20.961	21.590	22.232
7	28.583	29.356	30.142	30.942	31.757	32.585	33.428	34.285
8	42.667	43.674	44.698	45.737	46.793	47.864	48.952	50.056
9	60.750	62.024	63.317	64.626	65.954	67.300	68.665	70.047
10	83.333	84.906	86.498	88.109	89.741	91.392	93.064	94.756
11	110.92	112.82	114.74	116.69	118.65	120.64	122.65	124.68
12	144.00	146.26	148.55	150.86	153.19	155.55	157.93	160.33
13	183.08	185.74	188.42	191.12	193.85	196.61	199.39	202.20
14	228.67	231.74	234.85	237.98	241.14	244.32	247.54	250.78
15	281.25	284.78	288.34	291.93	295.55	299.20	302.87	306.58
16	341.33	345.35	349.40	353.47	357.58	361.73	365.90	370.11
17	409.42	413.95	418.52	423.11	427.75	432.41	437.11	441.85
18	486.00	491.41	496.20	501.35	506.53	511.75	517.01	522.31
19	571.58	577.24	582.94	588.67	594.44	600.25	606.10	611.98
20	666.67	672.94	679.24	685.59	691.84	698.41	704.87	711.38
21	771.75	778.66	785.61	792.61	799.65	806.72	813.84	821.00
22	887.33	894.92	902.54	910.21	917.93	925.68	933.49	941.33
23	1013.9	1022.2	1030.5	1038.9	1047.3	1055.8	1064.3	1072.9
24	1152.0	1161.0	1170.1	1178.4	1188.4	1197.6	1206.8	1216.2
25	1302.1	1311.9	1321.7	1331.6	1341.5	1351.5	1361.6	1371.6
26	1464.7	1475.3	1485.9	1496.6	1507.3	1518.1	1529.0	1539.9
27	1640.2	1651.7	1663.1	1674.7	1686.2	1697.9	1709.5	1721.3
28	1829.3	1841.6	1853.9	1866.3	1878.8	1891.3	1903.8	1916.4
29	2032.4	2045.6	2058.8	2072.1	2085.4	2098.8	2112.3	2125.8
30	2250.0	2264.1	2278.2	2292.4	2306.7	2321.0	2335.4	2349.9
31	2482.6	2497.6	2512.7	2527.9	2543.1	2558.4	2573.8	2589.2
32	2730.7	2746.7	2762.8	2778.9	2795.2	2811.4	2827.8	2844.2
33	2994.7	3011.8	3028.9	3046.1	3063.3	3080.4	3098.0	3115.4
34	3275.3	3293.4	3311.6	3329.8	3348.1	3366.5	3384.9	3403.4
35	3572.9	3592.0	3611.3	3630.6	3650.0	3669.5	3689.0	3708.6
36	3888.0	3908.3	3928.6	3949.1	3969.6	3990.1	4010.8	4031.5
37	4221.1	4242.5	4264.0	4285.6	4307.3	4328.9	4350.7	4372.6
38	4572.7	4595.3	4617.9	4640.7	4663.5	4686.4	4719.4	4732.4
39	4943.3	4967.0	4990.9	5014.9	5038.9	5063.0	5087.2	5111.5
40	5333.3	5358.4	5383.5	5408.7	5433.9	5459.3	5484.7	5510.2
41	5743.4	5769.7	5796.1	5822.6	5849.1	5875.7	5902.5	5929.2
42	6174.0	6201.6	6229.3	6257.1	6284.9	6312.8	6340.9	6368.9
43	6625.6	6654.5	6683.5	6703.5	6741.8	6771.1	6800.4	6829.9
44	7098.7	7129.0	7159.3	7189.0	7220.3	7251.0	7281.7	7312.5
45	7593.8	7625.4	7657.2	7689.1	7721.0	7753.0	7785.2	7817.4
46	8111.3	8144.7	8177.6	8210.9	8244.3	8277.8	8311.3	8345.0
47	8651.9	8686.5	8721.1	8755.9	8790.7	8825.6	8860.7	8895.8
48	9216.0	9252.0	9288.2	9324.4	9360.7	9397.2	9433.7	9470.3
49	9804.1	9841.6	9879.3	9833.7	9954.9	9992.9	10031	10071
50	10417	10456	10495	10534	10574	10613	10653	10692

MOMENTS OF INERTIA OF RECTANGLES. II

ONE INCH WIDE.

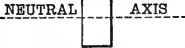

Value for any width may be obtained from tabular value by direct multiplication.

Additional Depth in Fractions of an Inch.								Depth in Inches.
$\frac{1}{2}$	$\frac{9}{16}$	$\frac{5}{8}$	$\frac{11}{16}$	$\frac{3}{4}$	$\frac{13}{16}$	$\frac{7}{8}$	$\frac{15}{16}$	
.01041	.01483	.02034	.02708	.03516	.04469	.05583	.06866	0
.28125	.31789	.35758	.40045	.44661	.49620	.54932	.60610	1
1.3021	1.4022	1.5073	1.6176	1.7331	1.8539	1.9803	2.1123	2
3.5729	3.7678	3.9696	4.1784	4.3945	4.6179	4.8488	5.0872	3
7.5937	7.9146	8.2443	8.5831	8.9310	9.2882	9.6548	10.031	4
13.865	14.343	14.832	15.331	15.843	16.365	16.898	17.443	5
22.885	23.552	24.231	24.924	25.629	26.347	27.079	27.825	6
35.156	36.043	36.944	37.859	38.790	39.736	40.698	41.674	7
51.177	52.314	53.468	54.639	55.827	57.032	58.254	59.493	8
71.448	72.867	74.305	75.762	77.238	78.733	80.247	81.780	9
96.469	98.203	99.955	101.73	103.52	105.34	107.18	109.04	10
126.74	128.82	130.92	133.04	135.19	137.35	139.55	141.76	11
162.76	165.21	167.69	170.19	172.72	175.28	177.85	180.46	12
205.03	207.89	210.78	213.69	216.63	219.60	222.60	225.62	13
254.05	257.35	260.68	264.04	267.42	270.83	274.28	277.75	14
310.32	314.09	317.89	321.72	325.58	329.47	333.40	337.35	15
374.34	378.61	382.92	387.25	391.62	396.02	400.45	404.92	16
446.61	451.42	456.25	461.12	466.03	470.97	475.94	480.95	17
527.63	533.00	538.40	543.84	549.32	554.83	560.38	565.96	18
617.91	623.87	629.87	635.90	641.98	648.09	654.24	660.44	19
717.93	724.51	731.14	737.81	744.51	751.26	758.05	764.88	20
828.20	835.44	842.73	850.05	857.43	864.84	872.29	879.79	21
949.22	957.15	965.13	973.15	981.21	989.32	997.47	1005.7	22
1081.5	1090.1	1098.8	1107.6	1116.4	1125.2	1134.1	1143.0	23
1225.5	1234.9	1244.4	1253.9	1263.4	1273.0	1282.6	1292.3	24
1381.8	1392.0	1402.2	1412.5	1422.8	1433.2	1443.6	1454.1	25
1550.8	1561.8	1572.8	1584.0	1595.1	1606.3	1617.6	1628.9	26
1733.1	1744.9	1756.8	1768.8	1780.8	1792.8	1804.9	1817.1	27
1929.1	1941.8	1954.6	1967.4	1980.3	1993.2	2006.2	2019.3	28
2139.4	2153.0	2166.7	2180.4	2194.2	2208.1	2222.0	2236.0	29
2364.4	2378.9	2393.6	2408.3	2423.0	2437.8	2452.7	2467.6	30
2604.7	2620.2	2635.8	2651.4	2667.2	2682.9	2698.8	2714.7	31
2860.7	2877.2	2893.8	2910.5	2927.2	2944.0	2960.8	2977.8	32
3132.9	3150.5	3168.1	3185.8	3203.6	3221.4	3239.3	3257.3	33
3422.0	3440.6	3459.3	3478.1	3496.9	3515.8	3534.8	3553.8	34
3728.2	3748.0	3767.8	3787.6	3807.6	3827.6	3847.6	3867.8	35
4052.3	4073.1	4094.0	4115.0	4136.1	4157.2	4178.4	4199.7	36
4394.5	4416.5	4438.6	4460.8	4483.0	4505.3	4527.7	4550.1	37
4755.5	4778.7	4802.0	4825.4	4848.8	4872.3	4895.9	4919.5	38
5135.8	5160.2	5184.7	5209.3	5239.6	5285.3	5285.3	5308.4	39
5535.8	5561.5	5587.3	5613.1	5639.0	5665.0	5691.0	5717.2	40
5956.1	5983.1	6010.1	6037.0	6064.4	6091.7	6119.0	6146.5	41
6397.1	6425.4	6453.7	6482.2	6510.7	6539.3	6568.0	6597.2	42
6867.7	6889.0	6918.7	6948.5	6978.3	7008.3	7038.3	7068.5	43
7343.4	7374.4	7405.5	7436.6	7467.9	7499.2	7530.6	7562.1	44
7849.7	7882.1	7914.6	7947.1	7979.8	8012.5	8045.4	8078.3	45
8378.7	8412.5	8446.5	8480.5	8514.6	8548.8	8583.1	8617.4	46
8931.0	8966.3	9001.7	9037.2	9072.7	9108.4	9144.2	9180.0	47
9507.0	9544.1	9580.7	9617.7	9654.8	9692.0	9729.2	9766.6	48
10107	10146	10184	10223	10261	10300	10339	10378	49
10732	10772	10812	10852	10892	10933	10973	11014	50

PROPERTIES AND PRINCIPAL DIMENSIONS OF STANDARD T-RAILS.

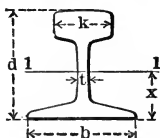

Stand- ard. (See Foot Note.)	Section Number.	Weight per Yard. Pounds.	Area. Sq. Ins.	b Inches.	d Inches.	k Inches.	t Inch.	Neutral Axis 1-1.		
								x Inches.	Moment of Inertia. I	Section Modulus. S
.....	580	12	1.17	2	2	1	$\frac{3}{16}$.96	.67	.64
.....	579	16	1.56	$2\frac{3}{8}$	$2\frac{3}{8}$	$1\frac{1}{4}$	$\frac{1}{2}$	1.14	1.23	.99
.....	578	20	1.98	$2\frac{3}{8}$	$2\frac{3}{8}$	$1\frac{1}{2}$	$\frac{1}{4}$	1.25	1.93	1.41
.....	577	25	2.40	$2\frac{3}{4}$	$2\frac{3}{4}$	$1\frac{1}{2}$	$\frac{3}{8}$	1.33	2.50	1.76
.....	576	30	3.02	$3\frac{1}{8}$	$3\frac{1}{8}$	$1\frac{1}{2}$	$\frac{3}{4}$	1.52	4.10	2.55
.....	575	35	3.42	$3\frac{5}{16}$	$3\frac{5}{16}$	$1\frac{3}{4}$	$\frac{2}{3}$	1.54	5.14	2.90
C	545	40	3.94	$3\frac{1}{2}$	$3\frac{1}{2}$	$1\frac{7}{8}$	$\frac{2}{3}$	1.69	6.52	3.60
C	549	45	4.40	$3\frac{1}{2}$	$3\frac{1}{2}$	2	$\frac{2}{3}$	1.76	8.09	4.19
C	542	50	4.87	$3\frac{7}{8}$	$3\frac{7}{8}$	$2\frac{1}{8}$	$\frac{1}{16}$	1.86	9.82	4.86
C	537	55	5.38	$4\frac{1}{16}$	$4\frac{1}{16}$	$2\frac{1}{4}$	$\frac{1}{16}$	1.98	12.03	5.78
A	568	60	5.86	4	$4\frac{1}{2}$	$2\frac{1}{4}$	$\frac{1}{16}$	2.13	15.41	6.50
C	533	60	5.93	$4\frac{1}{4}$	$4\frac{1}{4}$	$2\frac{3}{8}$	$\frac{3}{16}$	2.06	14.56	6.65
B	571	60	5.87	$3\frac{1}{16}$	$4\frac{3}{16}$	$2\frac{1}{8}$	$\frac{3}{16}$	1.95	13.30	5.94
C	534	65	6.33	$4\frac{1}{16}$	$4\frac{1}{16}$	$2\frac{1}{2}$	$\frac{1}{2}$	2.15	16.72	7.30
A	567	70	6.82	$4\frac{1}{4}$	$4\frac{3}{4}$	$2\frac{3}{8}$	$\frac{1}{2}$	2.20	21.05	8.26
C	532	70	6.81	$4\frac{5}{8}$	$4\frac{5}{8}$	$2\frac{7}{16}$	$\frac{3}{16}$	2.22	20.06	8.32
B	570	70	6.89	$4\frac{3}{16}$	$4\frac{3}{4}$	$2\frac{3}{8}$	$\frac{3}{16}$	2.16	18.60	7.78
C	529	75	7.33	$4\frac{1}{16}$	$4\frac{1}{16}$	$2\frac{1}{2}$	$\frac{1}{2}$	2.29	23.11	9.17
A	566	80	7.86	$4\frac{5}{8}$	$5\frac{1}{8}$	$2\frac{1}{2}$	$\frac{3}{16}$	2.31	28.80	10.21
C	530	80	7.86	5	5	$2\frac{1}{2}$	$\frac{3}{8}$	2.41	26.35	10.17
B	569	80	7.91	$4\frac{7}{16}$	$4\frac{1}{2}$	$2\frac{7}{16}$	$\frac{3}{16}$	2.27	25.10	9.40
C	531	85	8.33	$5\frac{1}{16}$	$5\frac{3}{8}$	$2\frac{9}{16}$	$\frac{1}{16}$	2.47	30.34	11.15
A	563	90	8.82	$5\frac{1}{8}$	$5\frac{3}{8}$	$2\frac{9}{16}$	$\frac{1}{16}$	2.54	38.70	12.52
C	535	90	8.83	$5\frac{3}{8}$	$5\frac{3}{8}$	$2\frac{3}{8}$	$\frac{1}{16}$	2.57	34.43	12.25
B	561	90	8.87	$4\frac{3}{4}$	$5\frac{1}{4}$	$2\frac{9}{16}$	$\frac{1}{16}$	2.45	32.30	11.45
C	550	95	9.28	$5\frac{9}{16}$	$5\frac{9}{16}$	$2\frac{1}{2}$	$\frac{1}{16}$	2.67	38.58	13.35
A	565	100	9.84	$5\frac{1}{2}$	6	$2\frac{3}{4}$	$\frac{1}{16}$	2.75	48.94	15.07
C	536	100	9.84	$5\frac{3}{4}$	$5\frac{3}{4}$	$2\frac{3}{4}$	$\frac{1}{16}$	2.73	43.42	14.38
B	564	100	9.85	$5\frac{3}{8}$	$5\frac{3}{4}$	$2\frac{3}{4}$	$\frac{1}{16}$	2.63	41.30	13.72
M	572	110	10.75	$5\frac{1}{2}$	6	$2\frac{1}{2}$	$\frac{1}{16}$	2.80	56.00	17.50
M	573	120	11.76	$5\frac{3}{4}$	$6\frac{1}{4}$	$2\frac{7}{8}$	$\frac{5}{8}$	2.89	60.04	17.87
M	574	130	12.76	6	$6\frac{1}{2}$	$2\frac{1}{2}$	$\frac{3}{16}$	3.00	71.02	20.29
.....	539	150	14.71	6	6	$4\frac{1}{4}$	1	3.00	69.30	23.10

For detail dimensions of Section No. 539, see page 26.

A; B;—Type A; Type B; American Railway Association Standard.
 C;—American Society of Civil Engineers Standard.
 M;—Manufacturers Standard.

**RADII OF GYRATION FOR TWO ANGLES
PLACED BACK TO BACK.
ANGLES WITH EQUAL LEGS.**

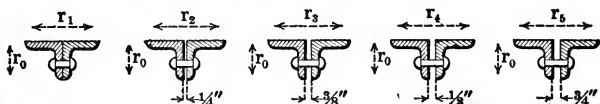

Radii of gyration correspond to directions indicated by arrowheads.

Section Number.	Dimensions. Inches.	Thickness. Inch.	Area of Two Angles. Sq. Ins.	Radii of Gyration.					
				r ₀	r ₁	r ₂	r ₃	r ₄	r ₅
A11	1½ x 1½	⅜	1.06	0.64	0.64	0.73	0.78	0.83	0.94
"	"	⅜	1.68	0.44	0.66	0.76	0.81	0.86	0.97
"	"	*⅝	1.97	0.44	0.67	0.77	0.82	0.88	0.99
*A40	1¾ x 1¾	⅜	.84	0.55	0.73	0.82	0.86	0.91	1.02
"	"	⅜	1.24	0.54	0.74	0.83	0.88	0.93	1.03
"	"	⅝	2.34	0.51	0.76	0.86	0.91	0.97	1.07
A15	2 x 2	*⅜	.97	0.63	0.84	0.92	0.97	1.02	1.12
"	"	⅜	1.44	0.62	0.84	0.93	0.98	1.03	1.13
"	"	⅝	2.30	0.60	0.86	0.95	1.00	1.05	1.16
"	"	⅜	3.12	0.59	0.88	0.98	1.03	1.08	1.19
*A41	2¼ x 2¼	⅜	1.62	0.70	0.94	1.03	1.08	1.12	1.22
"	"	⅜	2.62	0.68	0.96	1.05	1.10	1.15	1.25
A17	2½ x 2½	*⅜	1.22	0.79	1.04	1.12	1.17	1.21	1.31
"	"	⅜	2.38	0.77	1.05	1.14	1.19	1.24	1.34
"	"	⅝	3.46	0.75	1.07	1.16	1.21	1.26	1.36
"	"	⅜	4.50	0.74	1.09	1.19	1.24	1.29	1.39
*A48	2¾ x 2¾	¼	2.62	0.85	1.15	1.24	1.29	1.34	1.43
"	"	⅜	3.24	0.84	1.16	1.25	1.30	1.35	1.45
"	"	⅝	3.84	0.83	1.17	1.26	1.31	1.35	1.45
A19	3 x 3	¼	2.88	0.93	1.26	1.34	1.39	1.43	1.53
"	"	⅜	4.86	0.91	1.28	1.37	1.42	1.47	1.57
"	"	⅝	6.12	0.89	1.30	1.39	1.44	1.49	1.59
A21	3½ x 3½	¼	3.38	1.09	1.46	1.54	1.59	1.64	1.73
"	"	⅜	7.96	1.04	1.52	1.61	1.66	1.71	1.81
"	"	⅝	10.06	1.02	1.55	1.65	1.70	1.75	1.85
A23	4 x 4	⅝	4.80	1.24	1.67	1.76	1.80	1.85	1.94
"	"	⅜	8.36	1.21	1.71	1.80	1.85	1.89	1.99
"	"	⅝	11.68	1.18	1.75	1.85	1.89	1.94	2.04
*A47	5 x 5	⅜	7.22	1.56	2.09	2.17	2.22	2.26	2.35
"	"	⅝	9.50	1.54	2.10	2.19	2.24	2.28	2.38
"	"	⅜	13.88	1.50	2.14	2.25	2.27	2.32	2.42
A27	6 x 6	⅜	10.12	1.87	2.50	2.58	2.63	2.67	2.76
"	"	⅝	14.22	1.84	2.53	2.62	2.66	2.71	2.80
"	"	⅜	19.46	1.81	2.57	2.66	2.70	2.75	2.85
A35	8 x 8	½	15.50	2.51	3.32	3.41	3.45	3.49	3.58
"	"	⅝	19.22	2.49	3.34	3.43	3.47	3.51	3.60
"	"	⅜	22.88	2.47	3.36	3.44	3.49	3.53	3.62
"	"	⅝	26.46	2.45	3.38	3.46	3.51	3.55	3.64
"	"	⅜	30.00	2.44	3.40	3.48	3.53	3.57	3.67
"	"	1	33.46	2.42	3.42	3.51	3.55	3.60	3.69

Angles marked * are special sections.

**RADII OF GYRATION FOR TWO ANGLES
PLACED BACK TO BACK.
ANGLES WITH UNEQUAL LEGS.**

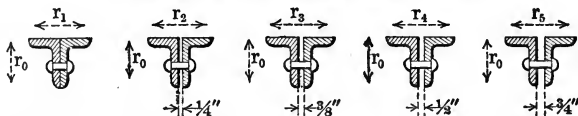

Radii of gyration correspond to directions indicated by arrowheads.

Section Number.	Dimensions. Inches.	Thickness Inch.	Area of Two Angles. Sq. Ins.	Radii of Gyration.					
				r ₀	r ₁	r ₂	r ₃	r ₄	r ₅
A91	2½ x 2	⅜	1.62	0.79	0.79	0.88	0.92	0.97	1.07
"	"	⅜	3.10	0.77	0.82	0.91	0.96	1.01	1.12
"	"	½	4.00	0.75	0.84	0.94	0.99	1.04	1.15
*A129	3 x 2	⅜	1.80	0.97	0.75	0.83	0.88	0.93	1.03
"	"	⅜	2.94	0.95	0.76	0.85	0.90	0.95	1.05
"	"	⅜	4.00	0.93	0.79	0.88	0.93	0.98	1.09
A93	3 x 2½	¼	2.62	0.95	1.00	1.09	1.13	1.18	1.23
"	"	⅜	3.84	0.93	1.02	1.11	1.16	1.21	1.31
"	"	⅜	5.56	0.91	1.05	1.15	1.20	1.25	1.35
A95	3½ x 2½	¼	2.88	1.12	0.96	1.04	1.09	1.13	1.23
"	"	½	5.50	1.09	1.00	1.09	1.14	1.19	1.29
"	"	⅜	6.12	1.08	1.01	1.10	1.15	1.20	1.31
A97	3½ x 3	¼	3.12	1.11	1.20	1.29	1.34	1.38	1.48
"	"	⅜	6.68	1.07	1.25	1.34	1.39	1.44	1.54
"	"	⅜	9.24	1.04	1.30	1.40	1.45	1.50	1.60
A99	4 x 3	⅜	4.18	1.27	1.17	1.25	1.30	1.34	1.44
"	"	⅜	7.24	1.24	1.21	1.30	1.34	1.39	1.49
"	"	⅜	10.06	1.21	1.25	1.35	1.40	1.45	1.55
*A131	4 x 3½	⅜	4.50	1.26	1.42	1.50	1.55	1.59	1.69
"	"	⅜	7.00	1.23	1.44	1.53	1.58	1.63	1.72
"	"	⅜	8.60	1.22	1.46	1.55	1.60	1.65	1.75
A101	5 x 3	⅜	4.80	1.61	1.09	1.17	1.22	1.26	1.36
"	"	⅜	8.36	1.58	1.13	1.22	1.26	1.31	1.41
"	"	⅜	11.68	1.55	1.17	1.27	1.32	1.37	1.47
A103	5 x 3½	⅜	6.10	1.60	1.34	1.42	1.46	1.51	1.60
"	"	⅜	9.84	1.56	1.37	1.46	1.51	1.56	1.66
"	"	⅜	13.34	1.53	1.42	1.51	1.56	1.61	1.71
*A135	5 x 4	⅜	6.46	1.59	1.58	1.66	1.71	1.75	1.85
"	"	⅜	8.50	1.57	1.60	1.68	1.73	1.78	1.87
"	"	⅜	10.46	1.55	1.62	1.71	1.75	1.80	1.90
A105	6 x 3½	⅜	6.84	1.94	1.26	1.34	1.39	1.43	1.53
"	"	⅜	11.10	1.90	1.30	1.39	1.43	1.48	1.58
"	"	⅜	15.10	1.87	1.34	1.44	1.49	1.53	1.64
A107	6 x 4	⅜	7.22	1.93	1.50	1.58	1.62	1.67	1.76
"	"	⅜	11.72	1.90	1.53	1.62	1.67	1.71	1.81
"	"	⅜	15.96	1.86	1.58	1.67	1.71	1.76	1.86
*A109	7 x 3½	⅜	8.80	2.26	1.16	1.29	1.33	1.38	1.47
"	"	⅜	10.00	2.25	1.22	1.30	1.35	1.39	1.48
"	"	⅜	12.34	2.24	1.24	1.32	1.37	1.42	1.51
"	"	⅜	15.74	2.21	1.27	1.36	1.41	1.46	1.56
"	"	1	19.00	2.19	1.31	1.40	1.45	1.50	1.60

Angles marked * are special sections.

**RADII OF GYRATION FOR TWO ANGLES
PLACED BACK TO BACK.
ANGLES WITH UNEQUAL LEGS.**

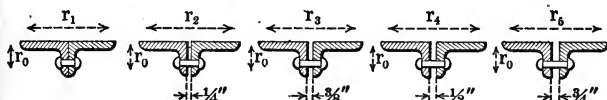

Radii of gyration correspond to directions indicated by arrowheads.

Section Number.	Dimensions. Inches.	Thickness. Inch.	Area of Two Angles. Sq. Ins.	Radii of Gyration.					
				r ₀	r ₁	r ₂	r ₃	r ₄	r ₅
A91	2½ x 2	⅜	1.62	0.60	1.10	1.19	1.24	1.29	1.39
"	"	⅝	3.10	0.58	1.13	1.23	1.28	1.33	1.43
"	"	¾	4.00	0.56	1.15	1.25	1.30	1.35	1.46
*A129	3 x 2	⅜	1.80	0.58	1.37	1.46	1.51	1.56	1.66
"	"	⅝	2.94	0.57	1.39	1.48	1.53	1.58	1.68
"	"	¾	4.00	0.55	1.41	1.51	1.56	1.61	1.71
A93	3 x 2½	¼	2.62	0.75	1.31	1.40	1.45	1.50	1.60
"	"	⅝	3.84	0.74	1.33	1.42	1.47	1.52	1.63
"	"	¾	5.56	0.72	1.37	1.46	1.51	1.56	1.66
A95	3½ x 2½	¼	2.88	0.74	1.58	1.67	1.72	1.76	1.86
"	"	⅝	5.50	0.70	1.62	1.72	1.77	1.81	1.92
"	"	¾	6.12	0.70	1.64	1.73	1.78	1.83	1.93
A97	3½ x 3	¼	3.12	0.91	1.52	1.61	1.66	1.70	1.80
"	"	⅝	6.68	0.87	1.57	1.66	1.71	1.76	1.86
"	"	¾	9.24	0.85	1.61	1.71	1.76	1.81	1.91
A99	4 x 3	⅜	4.18	0.89	1.79	1.88	1.93	1.97	2.07
"	"	⅝	7.24	0.86	1.83	1.93	1.97	2.02	2.12
"	"	¾	10.06	0.83	1.88	1.97	2.02	2.08	2.18
*A131	4 x 3½	⅜	4.50	1.07	1.73	1.81	1.86	1.91	2.00
"	"	⅝	7.00	1.04	1.76	1.85	1.89	1.94	2.04
"	"	¾	8.60	1.02	1.78	1.87	1.92	1.97	2.07
A101	5 x 3	⅜	4.80	0.85	2.33	2.42	2.47	2.52	2.61
"	"	⅝	8.86	0.82	2.37	2.47	2.52	2.57	2.67
"	"	¾	11.68	0.80	2.42	2.52	2.57	2.62	2.72
A103	5 x 3½	⅜	6.10	1.02	2.27	2.36	2.41	2.45	2.55
"	"	⅝	9.84	0.99	2.31	2.40	2.45	2.50	2.60
"	"	¾	13.34	0.96	2.36	2.45	2.50	2.55	2.65
*A135	5 x 4	⅜	6.46	1.20	2.20	2.29	2.34	2.38	2.48
"	"	⅝	8.50	1.18	2.22	2.31	2.36	2.41	2.50
"	"	¾	10.46	1.17	2.24	2.33	2.38	2.43	2.53
A105	6 x 3½	⅜	6.84	0.99	2.81	2.90	2.95	3.00	3.09
"	"	⅝	11.10	0.96	2.86	2.95	3.00	3.05	3.15
"	"	¾	15.10	0.93	2.90	3.00	3.05	3.10	3.20
A107	6 x 4	⅜	7.22	1.17	2.74	2.83	2.87	2.92	3.02
"	"	⅝	11.72	1.13	2.78	2.87	2.92	2.97	3.06
"	"	¾	15.96	1.11	2.82	2.92	2.97	3.02	3.12
*A109	7 x 3½	⅜	8.80	0.95	3.37	3.47	3.52	3.56	3.66
"	"	⅝	10.00	0.94	3.39	3.48	3.53	3.58	3.67
"	"	¾	12.34	0.93	3.40	3.50	3.55	3.60	3.70
"	"	¾	15.74	0.91	3.45	3.54	3.59	3.64	3.74
"	"	1	19.00	0.89	3.48	3.58	3.63	3.68	3.78

Angles marked * are special sections.

STRENGTH OF STEEL COLUMNS OR STRUTS.

For various values of $\frac{L}{r}$ in which L = length in feet and r = radius-of gyration in inches.

P = ultimate strength in lbs. per square inch.

FOR SOFT STEEL.

$$P = \frac{45\,000}{1 + \frac{(12L)^2}{36\,000r^2}} \quad \text{Pin and square bearing} \quad P = \frac{45\,000}{1 + \frac{(12L)^2}{24\,000r^2}} \quad \text{Pin bearing} \quad P = \frac{45\,000}{1 + \frac{(12L)^2}{18\,000r^2}}$$

To obtain safe unit stress:

For quiescent loads, as in buildings, divide by 4.

For moving loads, as in bridges, divide by 5.

$\frac{L}{r}$	Ultimate Strength in lbs. per Square Inch.			$\frac{L}{r}$	Ultimate Strength in lbs. per Square Inch.		
	Square.	Pin and Square.	Pin.		Square.	Pin and Square.	Pin.
3.0	43437	42694	41978	7.6	36554	33419	30779
3.2	43230	42395	41593	7.8	36193	32966	30268
3.4	43011	42081	41190				
3.6	42782	41754	40773	8.0	35828	32514	29762
3.8	42543	41412	40340	8.2	35462	32064	29260
				8.4	35095	31615	28763
4.0	42294	41058	39893	8.6	34727	31169	28272
4.2	42035	40693	39435	8.8	34358	30724	27787
4.4	41765	40317	38966				
4.6	41488	39930	38485	9.0	33988	30282	27306
4.8	41203	39534	37998	9.2	33611	29844	26832
				9.4	33249	29408	26364
5.0	40910	39130	37500	9.6	32880	28977	25903
5.2	40608	38807	36997	9.8	32511	28549	25448
5.4	40299	38300	36488				
5.6	39984	37874	35975	10.0	32143	28125	25000
5.8	39663	37443	35457	10.2	31776	27706	24559
				10.4	31411	27290	24125
6.0	39335	37006	34938	10.6	31054	26879	23698
6.2	39003	36566	34416	10.8	30684	26474	23279
6.4	38665	36122	33894				
6.6	38323	35676	33371	11.0	30324	26072	22866
6.8	37976	35219	32849	11.2	29965	25675	22460
				11.4	29608	25285	22063
7.0	37616	34776	32328	11.6	29247	24899	21671
7.2	37272	34324	31809	11.8	28903	24517	21288
7.4	36914	33872	31292				

STRENGTH OF STEEL COLUMNS OR STRUTS.

For various values of $\frac{L}{r}$ in which L = length in feet and r = radius of gyration in inches.

P = ultimate strength in lbs. per square inch.

FOR SOFT STEEL.

$$P = \frac{45\,000}{1 + \frac{(12L)^2}{36\,000r^2}} \quad \text{Pin and square bearing} \quad P = \frac{45\,000}{1 + \frac{(12L)^2}{24\,000r^2}} \quad \text{Pin bearing} \quad P = \frac{45\,000}{1 + \frac{(12L)^2}{18\,000r^2}}$$

To obtain safe unit stress:

For quiescent loads, as in buildings, divide by 4.

For moving loads, as in bridges, divide by 5.

$\frac{L}{r}$	Ultimate Strength in lbs. per Square Inch.			$\frac{L}{r}$	Ultimate Strength in lbs. per Square Inch.		
	Square.	Pin and Square.	Pin.		Square.	Pin and Square.	Pin.
12.0	28553	24142	20911	16.6	21406	16960	14043
12.2	28207	23771	20542	16.8	21137	16708	13812
12.4	27863	23406	20179				
12.6	27522	23046	19823	17.0	20872	16459	13584
12.8	27185	22693	19474	17.2	20611	16216	13366
				17.4	20353	15977	13150
13.0	26850	22343	19133	17.6	20098	15742	12938
13.2	26524	22005	18797	17.8	19847	15512	12731
13.4	26189	21662	18469				
13.6	25864	21329	18148	18.0	19599	15286	12528
13.8	25543	21002	17833	18.2	19351	15063	12329
				18.4	19114	14845	12135
14.0	25224	20680	17523	18.6	18878	14630	11944
14.2	24909	20363	17221	18.8	18644	14420	11757
14.4	24598	20052	16925				
14.6	24290	19746	16634	19.0	18418	14218	11579
14.8	23985	19445	16350	19.2	18185	14010	11394
				19.4	17961	13811	11219
15.0	23684	19148	16071	19.6	17740	13616	11048
15.2	23387	18858	15799	19.8	17519	13422	10877
15.4	23093	18572	15532				
15.6	22803	18288	15270	20.0	17308	13235	10715
15.8	22516	18015	15105	20.2	17096	13050	10553
				20.4	16888	12868	10434
16.0	22234	17744	14764	20.6	16682	12690	10249
16.2	21954	17478	14518	20.8	16480	12515	10087
16.4	21678	17216	14279				

STRENGTH OF STEEL COLUMNS OR STRUTS.

For various values of $\frac{L}{r}$ in which L = length in feet and r = radius of gyration in inches.

P = ultimate strength in lbs. per square inch.

FOR MEDIUM STEEL.

$$P = \frac{50\,000}{1 + \frac{(12L)^2}{36\,000r^2}} \quad \text{Pin and square bearing} \quad P = \frac{50\,000}{1 + \frac{(12L)^2}{24\,000r^2}} \quad \text{Pin bearing} \quad P = \frac{50\,000}{1 + \frac{(12L)^2}{18\,000r^2}}$$

To obtain safe unit stress:

For quiescent loads, as in buildings, divide by 4.

For moving loads, as in bridges, divide by 5.

$\frac{L}{r}$	Ultimate Strength in lbs. per Square Inch.			$\frac{L}{r}$	Ultimate Strength in lbs. per Square Inch.		
	Square.	Pin and Square.	Pin.		Square.	Pin and Square.	Pin.
3.0	48263	47438	46642	7.6	40616	37132	34199
3.2	48033	47106	46214	7.8	40214	36629	33631
3.4	47790	46757	45767				
3.6	47536	46393	45303	8.0	39809	36127	33069
3.8	47270	46013	44822	8.2	39402	35627	32511
				8.4	38994	35128	31959
4.0	46993	45620	44325	8.6	38585	34632	31413
4.2	46705	45214	43817	8.8	38175	34138	30874
4.4	46406	44797	43295				
4.6	46098	44367	42761	9.0	37764	33647	30340
4.8	45781	43927	42220	9.2	37354	33160	29813
				9.4	36943	32676	29293
5.0	45455	43478	41667	9.6	36533	32197	28781
5.2	45120	43020	41108	9.8	36123	31721	28275
5.4	44777	42555	40542				
5.6	44427	42082	39972	10.0	35714	31250	27778
5.8	44070	41603	39397	10.2	35307	30784	27288
				10.4	34901	30322	26806
6.0	43706	41118	38820	10.6	34496	29866	26331
6.2	43337	40629	38240	10.8	34093	29415	25865
6.4	42961	40136	37660				
6.6	42581	39640	37079	11.0	33693	28969	25407
6.8	42196	39141	36499	11.2	33294	28528	24956
				11.4	32898	28094	24514
7.0	41806	38640	35920	11.6	32505	27665	24079
7.2	41413	38138	35343	11.8	32114	27241	23653
7.4	41016	37635	34769				

STRENGTH OF STEEL COLUMNS OR STRUTS.

For various values of $\frac{L}{r}$ in which L = length in feet and r = radius of gyration in inches.

P = ultimate strength in lbs. per square inch.

FOR MEDIUM STEEL.

$$P = \frac{50\,000}{1 + \frac{(12L)^2}{36\,000r^2}} \quad \text{Pin and square bearing} \quad P = \frac{50\,000}{1 + \frac{(12L)^2}{24\,000r^2}} \quad \text{Pin bearing} \quad P = \frac{50\,000}{1 + \frac{(12L)^2}{18\,000r^2}}$$

To obtain safe unit stress:

For quiescent loads, as in buildings, divide by 4.

For moving loads, as in bridges, divide by 5.

$\frac{L}{r}$	Ultimate Strength in lbs. per Square Inch.			$\frac{L}{r}$	Ultimate Strength in lbs. per Square Inch.		
	Square.	Pin and Square.	Pin.		Square.	Pin and Square.	Pin.
12.0	31726	26824	23234	16.6	23784	18844	15603
12.2	31341	26412	22824	16.8	23486	18564	15347
12.4	30959	26007	22421				
12.6	30580	25607	22026	17.0	23191	18288	15097
12.8	30205	25214	21638	17.2	22901	18018	14851
				17.4	22614	17752	14611
13.0	29833	24826	21259	17.6	22331	17491	14376
13.2	29464	24445	20886	17.8	22052	17235	14145
13.4	29099	24069	20521				
13.6	28738	23699	20164	18.0	21777	16984	13920
13.8	28381	23336	19814	18.2	21506	16737	13699
				18.4	21238	16494	13483
14.0	28027	22978	19470	18.6	20975	16256	13271
14.2	27677	22626	19134	18.8	20715	16022	13063
14.4	27331	22280	18805				
14.6	26989	21940	18482	19.0	20458	15793	12860
14.8	26650	21605	18167	19.2	20206	15567	12661
				19.4	19957	15346	12466
15.0	26316	21276	17857	19.6	19711	15129	12275
15.2	25985	20953	17554	19.8	19466	14913	12086
15.4	25659	20636	17258				
15.6	25337	20320	16967	20.0	19231	14706	11905
15.8	25018	20017	16683	20.2	18996	14500	11725
				20.4	18764	14298	11549
16.0	24704	19716	16404	20.6	18536	14100	11377
16.2	24393	19420	16131	20.8	18311	13905	11208
16.4	24087	19129	15865				

EXAMPLE OF THE USE OF THE TABLES OF RADII OF GYRATION FOR TWO ANGLES PLACED BACK TO BACK AND THE TABLES OF STRENGTH OF STEEL COLUMNS OR STRUTS.

PAGES 215 TO 221 INCLUSIVE

What is the size of truss member required to safely sustain 50 000 pounds in compression, the safety factor being 4, the unsupported length 8 feet, the gusset plates at each end being $\frac{3}{8}$ " thick?

Assume for trial two 4" x 3" x $\frac{3}{8}$ " angles with the long legs together. Referring to page 216, the least Radius of Gyration, comparing values in columns r_0 and r_3 is found to be 1.27. The ratio of the length of the column in feet to the Least Radius of Gyration in inches, $\frac{L}{r}$ is, there-

fore, $\frac{8}{1.27} = 6.3$.

Referring to the table of Strength of Steel Columns or Struts for medium steel, page 220, the ultimate strength of a column in which $\frac{L}{r} = 6.3$ is found by interpolation between the values for 6.2 and 6.4 to be 43 149 pounds per square inch, which, divided by the safety factor 4, gives 10 787 pounds as the safe unit stress per square inch. Multiplying the safe unit stress per square inch, 10 787 pounds, by 4.18, the area of the two angles in square inches, gives 45 090 pounds as the total safe load. This is slightly less than the specified load of 50 000 pounds, and, therefore, it will be necessary to increase the assumed section. Assume the angles to be 4" x 3" x $\frac{3}{8}$ ", for which the Least Radius of Gyration is found by interpolation to be 1.26, and, by the same process used above, $\frac{L}{r}$ is found to be 6.35, which corresponds to an ultimate strength of 43 055 pounds per square inch, or a safe unit stress of 10 764 pounds per square inch, which, if multiplied by the area of the two angles, 4.96 square inches, gives a safe total load of 53 389 pounds, which is ample to meet the conditions stated.

EXPLANATION OF TABLES RELATING TO DIMENSIONS AND SAFE LOADS OF STEEL COLUMNS OF VARIOUS SECTIONS.

PAGES 224 TO 301 INCLUSIVE

Tables of Dimensions for Plate and Angle Columns are given on pages 224 and 225, the Moments of Inertia and Section Moduli about two rectangular axes are given on pages 226 to 228 and the Safe Loads for various lengths, calculated for the Radius of Gyration about each of the two rectangular axes, are given on pages 248 to 267 inclusive.

Tables of Dimensions for Latticed Channel Columns are given on pages 230, the Moments of Inertia and Section Moduli about two rectangular axes are given on page 231, the Safe Loads for various lengths

based upon the Least Radius of Gyration, are given on pages 268 to 271, and data relating to the proper sizes of lattice bars and stay-plates to be used with these columns are given on pages 272 and 273.

On pages 232 and 233 are given the Principal Dimensions of Plate and Channel Columns with comparatively narrow plates called, for convenience of reference, Series A, and on pages 234 and 235 for Series B, which differs from Series A, in having wider plates. Moments of Inertia and Section Moduli about two rectangular axes are given for Series A and B on pages 236 to 242 inclusive, and the Safe Loads for different lengths, based upon the Least Radius of Gyration, are given on pages 274 to 301 inclusive.

Safe Loads for I-Beams used as Columns or Struts are given on pages 244 to 247, and the dimensions of these sections can be obtained from the tables on pages 186 to 189 inclusive.

The Plate and Channel Columns given in Series A are particularly useful in buildings or locations in which it is desired to keep the extreme dimensions of the cross section as small as possible for this style of column, although in this series the Radius of Gyration about the central axis parallel to the channel webs is somewhat smaller than the Radius of Gyration about the axis perpendicular to the channel webs. This makes the narrower columns of Series A somewhat less economical of material than the wider columns of Series B, which, however, is small in amount for columns of ordinary story length of 10 feet to 14 feet, such as are used in skeleton buildings.

In Series B of Plate and Channel Columns with wider plates, the Radii of Gyration about the two axes are practically equal for the intermediate thicknesses and these columns are slightly more economical of material than those of Series A, although they require somewhat more space on account of their wider sections.

The Safe Loads for columns of various kinds, as given on pages 244 to 301 inclusive, are expressed in thousands of pounds, and have been figured by the use of Gordon's formula, as stated at the heads of the various tables, using the safety factor 4, which relates to static or quiescent loads such as occur in ordinary buildings.

On page 229 is given a table showing the Distances Back to Back for Spacing Two Channels of the same size in order to produce equal Moments of Inertia about the two rectangular axes. This table will be found to be useful in designing compression members of trusses, etc.

The Safe Loads of the tables are assumed to be centrally applied, and for convenience in computing the proper sizes required to support eccentric loads the tables of Moments of Inertia and Section Moduli for the different sections of columns are given.

The Safe Loads in the various tables are figured for extreme ratios from 30 to 150 for $\frac{l}{r}$, in which l is the length of the column and r the Least Radius of Gyration, both expressed in inches.

The weights of columns stated in the tables are per lineal foot of shaft, and do not include any allowances for bases, brackets or other connections, as these depend upon the particular details and requirements of each case.

Loads for other safety factors can be figured from the tables by inverse proportion, thus:

New safety factor : 4 :: load from tables : new loads.

Drawings of typical details of steel columns are given on page 243.

DIMENSIONS FOR PLATE AND ANGLE COLUMNS.

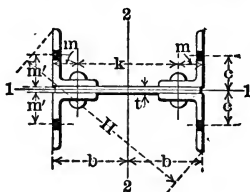

Size of Angles.	Size of Plates.	Weight of Column.	Area of Column Section.	b.	c.	m.	m'.	k.	H.
Inches.	Inches.	Lbs. per Ft.	Sq. Ins.	Inches.	Inches.	Inches.	Inches.	Inches.	Inches.
3" x 2½" x ¼"	6" x ¼"	23.1 44.2	6.74 13.00	3⅞"	1⅞"	1⅞"	1¼"	3½"	8½" 9"
3" x 2½" x ¼"	8" x ¼"	24.8 47.6	7.24 14.00	4⅞"	1⅞"	1⅞"	1¼"	5½"	10⅞" 10½"
3" x 2½" x ¼"	10" x ¼"	26.5 51.0	7.74 15.00	5⅞"	1⅞"	1⅞"	1¼"	7½"	12" 12½"
3" x 2½" x ¼"	12" x ¼"	28.2 54.4	8.24 16.00	6⅞"	1⅞"	1⅞"	1¼"	9½"	13¼" 13½"
3½" x 2½" x ¼"	7" x ¼"	25.6 59.5	7.51 17.49	3⅝"	2⅜"	1⅞"	2¼"	4½"	10¼" 10⅞"
3½" x 2½" x ¼"	8" x ¼"	26.4 62.0	7.76 18.24	4⅞"	2⅜"	1⅞"	2¼"	5½"	11" 11⅞"
3½" x 2½" x ¼"	10" x ¼"	28.1 67.1	8.26 19.74	5⅞"	2⅜"	1⅞"	2¼"	7½"	12¼" 12⅞"
3½" x 2½" x ¼"	12" x ¼"	29.8 72.2	8.76 21.24	6⅞"	2⅜"	1⅞"	2¼"	9½"	14¼" 14½"
4" x 3" x ⅝"	8" x ⅝"	37.3 97.0	10.86 28.44	4⅞"	2⅞"	1⅞"	2¼"	4¾"	11½" 12⅞"
4" x 3" x ⅝"	10" x ⅝"	39.4 103.0	11.49 30.19	5⅞"	2⅞"	1⅞"	2¼"	6¾"	13¼" 13⅞"
4" x 3" x ⅝"	12" x ⅝"	41.6 108.9	12.11 31.94	6⅞"	2⅞"	1⅞"	2¼"	8¾"	14½" 15⅞"
4" x 3" x ⅝"	14" x ⅝"	43.7 114.9	12.74 33.69	7⅞"	2⅞"	1⅞"	2¼"	10¾"	16½" 16⅞"

Dimensions m' and c may be varied to suit requirements.

DIMENSIONS FOR PLATE AND ANGLE COLUMNS.

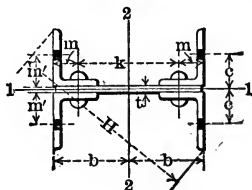

Size of Angles.	Size of Plates.	Weight of Column.	Area of Column Section.	b	c	m	m'	k	H
Inches.	Inches.	Lbs. per Ft.	Sq. Ins.	Inches.	Inches.	Inches.	Inches.	Inches.	Inches.
5 x 3½ x ⅜	10 x ⅜	45.4 128.7	13.37 37.74	5½	2½ 2½	2¼	2¼	5¼	14½ 15
5 x 3½ x ⅜	12 x ⅜	47.6 135.1	13.99 39.61	6½	2½ 2½	2¼	2¼	7¼	16 16½
5 x 3½ x ⅜	14 x ⅜	49.7 141.5	14.62 41.49	7½	2½ 2½	2¼	2¼	9¼	17½ 17½
5 x 3½ x ⅜	16 x ⅜	51.8 147.8	15.24 43.36	8½	2½ 2½	2¼	2¼	11¼	19¼ 19½
6 x 3½ x ½	12 x ½	62.1 156.4	18.18 46.00	6½	2½ 2½	2¼	2¼	7¼	17½ 17½
6 x 3½ x ½	14 x ½	64.7 163.2	18.93 48.00	7½	2½ 2½	2¼	2¼	9¼	18½ 19½
6 x 3½ x ½	16 x ½	67.2 170.0	19.68 50.00	8½	2½ 2½	2¼	2¼	11¼	20½ 20½
6 x 3½ x ½	18 x ½	69.8 176.8	20.43 52.00	9½	2½ 2½	2¼	2¼	13¼	22½ 22½
7 x 3½ x ⅞	14 x ⅞	80.8 176.8	23.73 52.00	7½	2½ 2½	2¼	2¼	9¼	20½ 20½
7 x 3½ x ⅞	16 x ⅞	83.8 183.6	24.60 54.00	8½	2½ 2½	2¼	2¼	11¼	21½ 22½
7 x 3½ x ⅞	18 x ⅞	86.8 190.4	25.48 56.00	9½	2½ 2½	2¼	2¼	13¼	23½ 23½
7 x 3½ x ⅞	20 x ⅞	89.8 197.2	26.35 58.00	10½	2½ 2½	2¼	2¼	15¼	24½ 25½

Dimensions m' and c may be varied to suit requirements.

MOMENTS OF INERTIA AND SECTION MODULI FOR PLATE AND ANGLE COLUMNS.

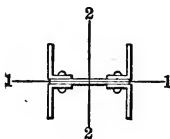

Size of Angles.	Size of Plate.	Axis 1-1.		Axis 2-2.		Size of Plate.	Axis 1-1.		Axis 2-2.		
		Moment of Inertia.	Section Modulus.	Moment of Inertia.	Section Modulus.		Moment of Inertia.	Section Modulus.	Moment of Inertia.	Section Modulus.	
Inches.	Inches.	Ins. ⁴	Ins. ³	Ins. ⁴	Ins. ³	Inches.	Ins. ⁴	Ins. ³	Ins. ⁴	Ins. ³	
3 x 2½ x ¼	6 x ¼	10.3	3.3	39.4	12.6	8 x ¼	10.3	3.3	76.7	18.6	
	¾	13.4	4.3	47.9	15.3		¾	13.4	4.3	93.7	22.7
	⅝	16.7	5.2	55.9	17.9		⅝	16.7	5.3	110.1	26.7
	⅜	20.2	6.3	63.5	20.3		⅜	20.3	6.3	125.6	30.5
	½	24.0	7.4	70.6	22.6		½	24.0	7.4	140.5	34.1
⅞	28.1	8.6	77.3	24.8	⅞	28.1	8.6	154.6	37.5		
3 x 2½ x ¼	10 x ¼	10.3	3.3	128.4	25.1	12 x ¼	10.3	3.3	195.7	32.0	
	¾	13.4	4.3	157.5	30.7		¾	13.4	4.3	240.5	39.3
	⅝	16.7	5.3	185.6	36.2		⅝	16.7	5.3	284.0	46.4
	⅜	20.3	6.3	212.5	41.5		⅜	20.3	6.3	325.8	53.2
	½	24.1	7.4	238.3	46.5		½	24.1	7.4	366.1	59.8
⅞	28.1	8.6	263.1	51.3	⅞	28.2	8.6	405.1	66.1		
3½ x 2½ x ¼	7 x ¼	16.0	4.4	62.4	17.2	8 x ¼	16.0	4.4	84.7	20.5	
	¾	20.7	5.7	76.2	21.0		¾	20.7	5.7	103.6	25.1
	⅝	25.6	6.9	89.3	24.6		⅝	25.6	6.9	121.7	29.5
	⅜	30.8	8.3	101.7	28.1		⅜	30.8	8.3	138.9	33.7
	½	36.3	9.7	113.6	31.3		½	36.3	9.7	155.5	37.7
⅞	42.1	11.1	124.8	34.4	⅞	42.1	11.1	171.2	41.5		
3½ x 2½ x ¼	10 x ¼	16.0	4.4	140.9	27.5	12 x ¼	16.0	4.4	213.7	34.9	
	¾	20.7	5.7	173.0	33.8		¾	20.7	5.7	262.9	42.9
	⅝	25.6	6.9	203.9	39.8		⅝	25.6	7.0	310.5	50.7
	⅜	30.8	8.3	233.5	45.6		⅜	30.8	8.3	356.2	58.2
	½	36.3	9.7	262.1	51.1		½	36.4	9.7	400.7	65.4
⅞	42.2	11.2	289.4	56.5	⅞	42.2	11.2	443.4	72.4		

MOMENTS OF INERTIA AND SECTION MODULI FOR PLATE AND ANGLE COLUMNS.

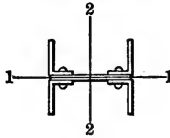

Size of Angles.	Size of Plate.	Axis 1-1.		Axis 2-2.		Size of Plate.	Axis 1-1.		Axis 2-2.		
		Moment of Inertia.	Section Modulus.	Moment of Inertia.	Section Modulus.		Moment of Inertia.	Section Modulus.	Moment of Inertia.	Section Modulus.	
Inches.	Inches.	Ins. ⁴	Ins. ³	Ins. ⁴	Ins. ³	Inches.	Ins. ⁴	Ins. ³	Ins. ⁴	Ins. ³	
4 x 3	x 1/8	8x 1/8	30.3	7.3	114.6	27.8	10x 1/8	30.3	7.3	192.0	37.5
"	" 3/8	" 3/8	37.4	8.9	134.8	32.7	" 3/8	37.4	8.9	226.4	44.2
"	" 1/2	" 1/2	44.8	10.6	154.0	37.3	" 1/2	44.8	10.6	259.5	50.6
"	" 5/8	" 5/8	52.6	12.4	172.4	41.8	" 5/8	52.6	12.4	291.5	56.9
"	" 7/8	" 7/8	60.8	14.2	190.0	46.1	" 7/8	60.9	14.2	322.2	62.9
"	" 1 1/8	" 1 1/8	69.5	16.1	206.9	50.2	" 1 1/8	69.5	16.1	352.0	68.7
"	" 1 1/4	" 1 1/4	78.6	18.1	223.0	54.1	" 1 1/4	78.6	18.1	380.5	74.2
"	" 1 3/8	" 1 3/8	88.1	20.1	238.3	57.8	" 1 3/8	88.2	20.2	408.0	79.6
"	" 1 1/2	" 1 1/2	98.1	22.3	253.0	61.3	" 1 1/2	98.2	22.3	434.4	84.7
"	" 1 5/8	" 1 5/8	108.5	24.4	267.0	64.7	" 1 5/8	108.6	24.5	459.8	89.7
4 x 3	x 1/8	12x 1/8	30.3	7.3	292.3	47.7	14x 1/8	30.3	7.3	416.8	58.5
"	" 3/8	" 3/8	37.4	8.9	345.5	56.4	" 3/8	37.4	8.9	493.4	69.3
"	" 1/2	" 1/2	44.8	10.6	396.7	64.8	" 1/2	44.8	10.6	567.4	79.6
"	" 5/8	" 5/8	52.6	12.4	446.6	72.9	" 5/8	52.7	12.4	639.7	89.8
"	" 7/8	" 7/8	60.9	14.2	494.7	80.8	" 7/8	60.9	14.2	709.6	99.6
"	" 1 1/8	" 1 1/8	69.6	16.1	541.5	88.4	" 1 1/8	69.6	16.1	777.8	109.2
"	" 1 1/4	" 1 1/4	78.7	18.1	586.5	95.8	" 1 1/4	78.7	18.1	843.7	118.4
"	" 1 3/8	" 1 3/8	88.2	20.2	630.1	102.9	" 1 3/8	88.3	20.2	907.7	127.4
"	" 1 1/2	" 1 1/2	98.2	22.3	672.2	109.8	" 1 1/2	98.3	22.3	969.8	136.1
"	" 1 5/8	" 1 5/8	108.7	24.5	713.1	116.4	" 1 5/8	108.8	24.5	1030.1	144.6
5 x 3 1/2	x 1/8	10x 1/8	57.6	11.2	225.0	43.9	12x 1/8	57.6	11.2	341.9	55.8
"	" 3/8	" 3/8	70.6	13.6	265.7	51.8	" 3/8	70.6	13.6	404.6	66.1
"	" 1/2	" 1/2	84.1	16.1	304.8	59.5	" 1/2	84.1	16.1	465.2	75.9
"	" 5/8	" 5/8	98.2	18.7	342.6	66.9	" 5/8	98.2	18.7	524.0	85.5
"	" 7/8	" 7/8	112.9	21.4	379.1	74.0	" 7/8	112.9	21.4	581.0	94.9
"	" 1 1/8	" 1 1/8	128.2	24.1	414.4	80.9	" 1 1/8	128.2	24.1	636.4	103.9
"	" 1 1/4	" 1 1/4	144.1	27.0	448.2	87.5	" 1 1/4	144.1	27.0	689.8	112.6
"	" 1 3/8	" 1 3/8	160.6	29.9	481.1	93.9	" 1 3/8	160.7	29.9	741.8	121.1
"	" 1 1/2	" 1 1/2	177.8	32.9	512.6	100.0	" 1 1/2	177.9	32.9	792.1	129.3
"	" 1 5/8	" 1 5/8	195.7	36.0	543.1	106.0	" 1 5/8	195.8	36.0	841.0	137.3
"	" 1 3/4	" 1 3/4	214.2	39.2	572.5	111.7	" 1 3/4	214.3	39.2	888.2	145.0
5 x 3 1/2	x 1/8	14x 1/8	57.6	11.2	486.8	68.3	16x 1/8	57.6	11.2	660.8	81.3
"	" 3/8	" 3/8	70.6	13.6	576.9	81.0	" 3/8	70.6	13.6	784.0	96.5
"	" 1/2	" 1/2	84.1	16.1	664.2	93.2	" 1/2	84.1	16.1	903.8	111.2
"	" 5/8	" 5/8	98.2	18.7	749.3	105.2	" 5/8	98.3	18.7	1020.6	125.6
"	" 7/8	" 7/8	112.9	21.4	832.1	116.8	" 7/8	113.0	21.4	1134.7	139.7
"	" 1 1/8	" 1 1/8	128.3	24.1	912.7	128.1	" 1 1/8	128.3	24.2	1245.9	153.3
"	" 1 1/4	" 1 1/4	144.2	27.0	990.8	139.1	" 1 1/4	144.2	27.0	1354.0	166.6
"	" 1 3/8	" 1 3/8	160.8	29.9	1067.1	149.8	" 1 3/8	160.8	29.9	1459.8	179.7
"	" 1 1/2	" 1 1/2	178.0	32.9	1141.0	160.1	" 1 1/2	178.1	32.9	1562.6	192.3
"	" 1 5/8	" 1 5/8	195.9	36.0	1213.2	170.3	" 1 5/8	196.0	36.0	1663.3	204.7
"	" 1 3/4	" 1 3/4	214.4	39.2	1283.1	180.1	" 1 3/4	214.6	39.2	1761.0	216.7

MOMENTS OF INERTIA AND SECTION MODULI FOR PLATE AND ANGLE COLUMNS.

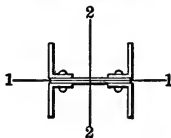

Size of Angles.	Size of Plate.	Axis 1-1.		Axis 2-2.		Size of Plate.	Axis 1-1.		Axis 2-2.	
		Moment of Inertia.	Section Modulus.	Moment of Inertia.	Section Modulus.		Moment of Inertia.	Section Modulus.	Moment of Inertia.	Section Modulus.
		Inch. ⁴	Inch. ³	Inch. ⁴	Inch. ³		Inch. ⁴	Inch. ³	Inch. ⁴	Inch. ³
6 x 3½ x ¾	12 x ¾	119.2	19.3	457.5	74.7	14 x ¾	119.2	19.3	649.1	91.1
"	" 1/8	141.5	22.8	526.2	85.9	" 1/8	141.5	22.8	747.7	104.9
"	" 1/2	164.5	26.3	593.0	96.8	" 1/2	164.5	26.3	843.9	118.4
"	" 5/8	188.3	30.0	657.9	107.4	" 5/8	188.3	30.0	937.6	131.6
"	" 3/4	212.9	33.7	720.9	117.7	" 3/4	212.9	33.7	1028.8	144.4
"	" 7/8	238.3	37.6	781.8	127.6	" 7/8	238.3	37.6	1117.3	156.8
"	" 1	264.5	41.5	841.2	137.3	" 1	264.5	41.5	1203.9	169.0
"	" 1 1/8	291.5	45.5	898.5	146.7	" 1 1/8	291.5	45.5	1287.9	180.8
"	" 1 1/4	319.5	49.6	954.4	155.8	" 1 1/4	319.5	49.6	1370.0	192.3
"	" 1 1/2	348.2	53.8	1008.4	164.6	" 1 1/2	348.2	53.9	1449.5	203.4
"	" 1 3/4	377.5	58.1	1060.8	173.2	" 1 3/4	377.7	58.1	1526.9	214.3
6 x 3½ x ¾	16 x ¾	119.2	19.3	878.6	108.1	18 x ¾	119.3	19.3	1147.4	125.7
"	" 1/8	141.5	22.8	1013.2	124.7	" 1/8	141.5	22.8	1324.4	145.1
"	" 1/2	164.5	26.3	1144.7	140.9	" 1/2	164.6	26.3	1497.5	164.1
"	" 5/8	188.4	30.0	1273.2	156.7	" 5/8	188.4	30.0	1667.1	182.7
"	" 3/4	213.0	33.7	1398.6	172.1	" 3/4	213.0	33.7	1832.8	200.9
"	" 7/8	238.4	37.6	1520.6	187.2	" 7/8	238.4	37.6	1994.3	218.6
"	" 1	264.6	41.5	1640.2	201.9	" 1	264.7	41.5	2152.9	235.9
"	" 1 1/8	291.7	45.5	1756.4	216.2	" 1 1/8	291.8	45.5	2307.4	252.9
"	" 1 1/4	319.7	49.7	1870.4	230.2	" 1 1/4	319.8	49.7	2459.2	269.5
"	" 1 1/2	348.5	53.9	1981.1	243.8	" 1 1/2	348.6	53.9	2606.8	285.7
"	" 1 3/4	377.8	58.1	2089.1	257.1	" 1 3/4	378.0	58.2	2751.3	301.5
7 x 3½ x 1	14 x 1	220.8	30.6	831.2	116.7	16 x 1	220.8	30.6	1122.6	138.2
"	" 1/2	255.8	35.3	938.4	131.7	" 1/2	255.8	35.3	1268.8	156.2
"	" 5/8	292.7	40.2	1043.0	146.4	" 5/8	292.7	40.2	1411.6	173.7
"	" 3/4	328.5	44.9	1144.6	160.7	" 3/4	328.5	44.9	1550.9	190.9
"	" 7/8	367.3	50.0	1243.9	174.6	" 7/8	367.4	50.0	1687.2	207.7
"	" 1	406.6	55.1	1340.7	188.2	" 1	406.7	55.1	1820.5	224.0
"	" 1 1/8	447.2	60.4	1434.8	201.4	" 1 1/8	447.3	60.4	1950.3	240.0
"	" 1 1/4	488.3	65.7	1526.7	214.3	" 1 1/4	488.4	65.7	2077.4	255.7
"	" 1 1/2	530.8	71.1	1615.9	226.8	" 1 1/2	530.9	71.1	2201.1	270.9
"	" 1 3/4	574.3	76.6	1702.8	239.0	" 1 3/4	574.5	76.6	2322.0	285.8
7 x 3½ x 1	18 x 1	220.8	30.6	1463.2	160.4	20 x 1	220.8	30.6	1854.8	183.2
"	" 1/2	255.9	35.3	1655.1	181.4	" 1/2	255.9	35.3	2099.4	207.4
"	" 5/8	292.8	40.2	1843.0	202.0	" 5/8	292.8	40.2	2339.4	231.1
"	" 3/4	328.6	44.9	2026.6	222.1	" 3/4	328.6	44.9	2574.2	254.2
"	" 7/8	367.4	50.0	2206.4	241.8	" 7/8	367.5	50.0	2804.4	277.0
"	" 1	406.7	55.2	2382.7	261.1	" 1	406.8	55.2	3030.5	299.3
"	" 1 1/8	447.4	60.4	2554.7	280.0	" 1 1/8	447.5	60.4	3251.4	321.1
"	" 1 1/4	488.5	65.7	2723.5	298.5	" 1 1/4	488.6	65.7	3468.5	342.6
"	" 1 1/2	531.0	71.1	2888.1	316.5	" 1 1/2	531.2	71.1	3680.5	363.5
"	" 1 3/4	574.7	76.6	3049.1	334.2	" 1 3/4	574.8	76.6	3888.3	384.0

SPACING OF CHANNELS FOR EQUAL MOMENTS OF INERTIA ABOUT THE TWO RECTANGULAR AXES 1-1 AND 2-2.

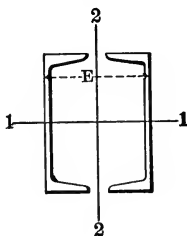
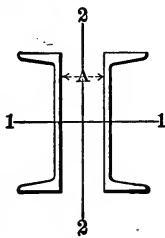

Section Number.	Depth of Channel.	Weight per foot of one Channel.	Area of Section of one Channel.			Section Number.	Depth of Channel.	Weight per foot of one Channel.	Area of Section of one Channel.			
	Inches.	Pounds.	Sq. Ins.	A	E		Inches.	Pounds.	Sq. Ins.	A	E	
C5	3	4.00	1.19	1.29	3.05	C33	10	15.00	4.46	6.33	8.89	
	"	5.00	1.47	1.17	2.93		"	"	20.00	5.88	5.96	8.40
	"	6.00	1.76	1.10	2.94		"	"	25.00	7.35	5.66	8.14
C9	4	5.25	1.55	2.08	3.92	" "	"	30.00	8.82	5.41	8.01	
	"	6.25	1.84	1.96	3.80		"	35.00	10.29	5.18	7.94	
	"	7.25	2.13	1.88	3.72		C41	12	20.50	6.03	7.68	10.48
C13	5	6.50	1.95	2.79	4.75	"		25.00	7.35	7.35	10.07	
	"	9.00	2.65	2.57	4.49	"		30.00	8.82	7.06	9.78	
	"	11.50	3.38	2.35	4.39	"	35.00	10.29	6.83	9.59		
C17	6	8.00	2.38	3.51	5.59	" "	"	40.00	11.76	6.60	9.48	
	"	10.50	3.09	3.29	5.29		C95	13	32.00	9.30	7.84	11.88
	"	13.00	3.82	3.08	5.16			"	35.00	10.29	7.66	11.62
	"	15.50	4.56	2.90	5.10			"	37.00	10.88	7.56	11.48
C21	7	9.75	2.85	4.21	6.41	"		40.00	11.76	7.44	11.32	
	"	12.25	3.60	4.00	6.12	"	45.00	13.24	7.22	11.10		
	"	14.75	4.34	3.82	5.94	"	50.00	14.71	7.02	10.94		
	"	17.25	5.07	3.65	5.85	"	55.00	16.18	6.84	10.84		
C25	"	19.75	5.81	3.49	5.81	C53	15	33.00	9.90	9.51	12.67	
	8	11.25	3.35	4.92	7.24		"	35.00	10.29	9.42	12.58	
	"	13.75	4.04	4.72	6.96		"	40.00	11.76	9.16	12.28	
	"	16.25	4.78	4.53	6.77		"	45.00	13.24	8.92	12.08	
	"	18.75	5.51	4.37	6.65		"	50.00	14.71	8.72	11.92	
C29	"	21.25	6.25	4.22	6.58	"	55.00	16.18	8.53	11.81		
	9	13.25	3.89	5.62	8.06	C65	18	45.00	13.25	11.48	14.84	
	"	15.00	4.41	5.48	7.84		"	50.00	14.71	11.20	14.52	
	"	20.00	5.88	5.14	7.46		"	55.00	16.18	10.98	14.30	
"	25.00	7.35	4.83	7.31	"		60.00	17.65	10.78	14.18		

DIMENSIONS FOR LATTICED CHANNEL COLUMNS.

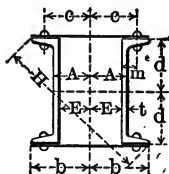

Depth of Channel and Section Number.	Weight per Foot.	t	b	d	H	c	E	A	m
	Pounds.	Inch.	Inches.	Inches.	Inches.	Inches.	Inches.	Inches.	Inches.
6" C17	8.00	.20	3 $\frac{1}{4}$	3	9 $\frac{5}{8}$	2 $\frac{1}{2}$	1 $\frac{1}{2}$	2	1 $\frac{1}{2}$
	10.50	.32	"	"	"	"	1 $\frac{1}{2}$	"	1 $\frac{1}{2}$
	13.00	.44	"	"	"	"	1 $\frac{1}{2}$	"	1 $\frac{1}{2}$
	15.50	.56	"	"	"	"	1 $\frac{1}{2}$	"	1 $\frac{1}{2}$
7" C21	9.75	.21	4 $\frac{1}{4}$	3 $\frac{1}{2}$	11	3 $\frac{3}{8}$	2 $\frac{1}{2}$	2 $\frac{1}{2}$	1 $\frac{1}{2}$
	12.25	.32	"	"	"	"	2 $\frac{1}{2}$	"	1 $\frac{1}{2}$
	14.75	.42	"	"	"	"	1 $\frac{1}{2}$	"	1 $\frac{1}{2}$
	17.25	.53	"	"	"	"	1 $\frac{1}{8}$	"	1 $\frac{1}{2}$
	19.75	.63	"	"	"	"	1 $\frac{1}{4}$	"	1 $\frac{1}{2}$
8" C25	11.25	.22	4 $\frac{1}{2}$	4	12 $\frac{1}{2}$	3 $\frac{1}{4}$	2 $\frac{1}{2}$	2 $\frac{1}{4}$	1 $\frac{1}{4}$
	13.75	.31	"	"	"	"	2 $\frac{1}{2}$	"	1 $\frac{1}{8}$
	16.25	.40	"	"	"	"	2 $\frac{1}{2}$	"	1 $\frac{1}{8}$
	18.75	.49	"	"	"	"	2 $\frac{1}{4}$	"	1 $\frac{1}{2}$
	21.25	.58	"	"	"	"	2 $\frac{1}{2}$	"	1 $\frac{1}{2}$
9" C29	13.25	.23	5 $\frac{1}{4}$	4 $\frac{1}{2}$	13 $\frac{3}{4}$	4 $\frac{1}{8}$	2 $\frac{3}{4}$	3	1 $\frac{3}{8}$
	15.00	.29	"	"	"	"	2 $\frac{1}{2}$	"	1 $\frac{1}{2}$
	20.00	.45	"	"	"	"	2 $\frac{1}{2}$	"	1 $\frac{1}{2}$
	25.00	.61	"	"	"	"	2 $\frac{3}{8}$	"	1 $\frac{1}{4}$
10" C33	15.00	.24	5 $\frac{3}{4}$	5	15 $\frac{1}{4}$	4 $\frac{3}{8}$	3 $\frac{1}{2}$	3 $\frac{1}{2}$	1 $\frac{1}{2}$
	20.00	.38	"	"	"	"	3	"	1 $\frac{5}{8}$
	25.00	.53	"	"	"	"	2 $\frac{1}{2}$	"	1 $\frac{1}{4}$
	30.00	.68	"	"	"	"	2 $\frac{1}{2}$	"	1 $\frac{1}{2}$
	35.00	.82	"	"	"	"	2 $\frac{1}{2}$	"	2 $\frac{1}{2}$
12" C41	20.50	.28	6 $\frac{1}{2}$	6	18 $\frac{3}{8}$	5 $\frac{1}{8}$	3 $\frac{3}{8}$	4 $\frac{1}{8}$	1 $\frac{3}{4}$
	25.00	.39	"	"	"	"	3 $\frac{3}{4}$	"	1 $\frac{7}{8}$
	30.00	.51	"	"	"	"	3 $\frac{1}{2}$	"	2
	35.00	.64	"	"	"	"	3 $\frac{1}{2}$	"	2 $\frac{1}{8}$
	40.00	.76	"	"	"	"	3 $\frac{1}{2}$	"	2 $\frac{1}{4}$
15" C53	33.00	.40	8 $\frac{3}{8}$	7 $\frac{1}{2}$	22 $\frac{3}{8}$	6 $\frac{1}{8}$	4 $\frac{1}{4}$	5 $\frac{1}{8}$	1 $\frac{7}{8}$
	35.00	.43	"	"	"	"	4 $\frac{1}{2}$	"	1 $\frac{1}{2}$
	40.00	.52	"	"	"	"	4 $\frac{1}{2}$	"	2
	45.00	.62	"	"	"	"	4 $\frac{1}{2}$	"	2 $\frac{1}{8}$
	50.00	.72	"	"	"	"	4 $\frac{1}{2}$	"	2 $\frac{1}{4}$
	55.00	.82	"	"	"	"	4 $\frac{1}{2}$	"	2 $\frac{1}{2}$

PROPERTIES OF LATTICED CHANNEL COLUMNS.

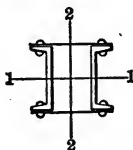

Depth of Channel and Section Number.	Weight per Foot.	Axis 1-1.		Axis 2-2.	
		Moment of Inertia.	Section Modulus.	Moment of Inertia.	Section Modulus.
		Pounds.	Inches. ⁴	Inches. ³	Inches. ⁴
6" C17	8.00	26.0	8.7	27.0	7.3
	10.50	30.2	10.1	31.1	8.4
	13.00	34.6	11.5	35.2	9.5
	15.50	39.0	13.0	38.7	10.4
7" C21	9.75	42.2	12.1	44.0	10.8
	12.25	48.4	13.8	50.5	11.9
	14.75	54.4	15.5	56.4	13.3
	17.25	60.4	17.3	61.4	14.4
8" C25	11.25	64.6	16.2	67.5	14.0
	13.75	72.0	18.0	75.8	15.8
	16.25	79.8	20.0	84.5	17.6
	18.75	87.7	21.9	92.3	19.3
9" C29	21.25	95.6	23.9	99.7	20.8
	13.25	94.6	21.0	92.4	17.8
	15.00	101.8	22.6	100.0	19.2
	20.00	121.6	27.0	120.1	28.1
10" C33	25.00	141.4	31.4	139.1	26.8
	15.00	133.8	26.8	131.7	23.0
	20.00	157.4	31.5	158.5	27.6
	25.00	182.0	36.4	183.3	32.0
12" C41	30.00	206.4	41.3	205.4	35.8
	35.00	231.0	46.2	226.0	39.4
	20.50	256.2	42.7	256.9	37.9
	25.00	288.0	48.0	295.6	43.6
15" C53	30.00	323.2	53.9	335.8	49.5
	35.00	358.6	59.8	370.5	54.6
	40.00	393.8	65.6	405.7	59.8
	33.00	625.2	83.4	618.7	76.1
15" C53	35.00	639.8	85.3	636.1	78.3
	40.00	695.0	92.7	700.8	86.8
	45.00	750.2	100.0	763.0	93.9
	50.00	805.4	107.4	819.5	100.9
	55.00	860.4	114.7	874.3	107.6

DIMENSIONS FOR PLATE AND CHANNEL COLUMNS.

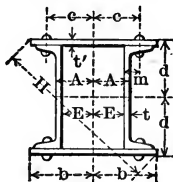

SERIES A.

Depth of Channel and Section No.	Weight per Foot	Size of Plates.		t	b	d	H	c	E	A	m
		Width.	Thick-ness t'								
	Pounds.	Inches.	Inch.	Inch.	Inches.	Inches.	Inches.	Inches.	Inches.	Inches.	Inches.
6" C17	8.0	8	1/4	.20	4	3 1/4	10 1/8	2 7/8	1 1/2	2	1 1/8
	10.5	"	5/8	.32	"	3 3/8	10 1/8	"	1 1/2	"	1 1/8
	13.0	"	1 1/4	.44	"	3 3/8	10 1/8	"	1 1/2	"	1 1/8
	15.5	"	5/8	.56	"	3 3/8	10 1/8	"	1 1/2	"	1 1/8
		"	1 1/4	.68	"	3 3/8	10 1/8	"	1 1/2	"	1 1/8
7" C21	9.75	9	1/4	.21	4 1/2	3 3/4	11 1/4	3 3/4	2 1/2	2 1/4	1 1/8
	12.25	"	5/8	.32	"	4 1/8	12 1/8	"	1 1/2	"	1 1/8
	14.75	"	1 1/4	.42	"	4 1/8	12 1/8	"	1 1/2	"	1 1/8
	17.25	"	5/8	.53	"	3 3/4	11 1/4	"	1 1/4	"	1 1/2
	19.75	"	1 1/4	.63	"	3 3/4	11 1/4	"	1 1/4	"	1 1/2
8" C25	11.25	10	1/4	.22	5	4 1/4	13 1/8	3 3/8	2 3/8	2 3/8	1 1/4
	13.75	"	5/8	.31	"	4 1/4	13 1/8	"	2 3/8	"	1 1/8
	16.25	"	1 1/4	.40	"	4 1/4	13 1/8	"	2 3/8	"	1 1/8
	18.75	"	5/8	.49	"	4 1/4	13 1/8	"	2 3/8	"	1 1/2
	21.25	"	1 1/4	.58	"	4 1/4	13 1/8	"	2 3/8	"	1 1/8
9" C29	13.25	11	1/4	.23	5 1/2	4 3/4	14 1/2	4 1/8	2 3/4	3	1 3/8
	15.00	"	5/8	.29	"	5 1/8	15 1/8	"	2 1/2	"	1 1/8
	20.00	"	1 1/4	.45	"	5 1/8	15 1/8	"	2 1/2	"	1 1/8
	25.00	"	5/8	.61	"	4 3/4	14 1/2	"	2 3/8	"	1 1/4
		"	1 1/4	.71	"	4 3/4	14 1/2	"	2 3/8	"	1 1/4

DIMENSIONS FOR PLATE AND CHANNEL COLUMNS.

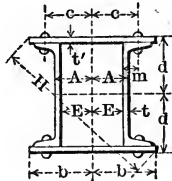

SERIES A.

Depth of Channel and Section No.	Weight per Foot.	Size of Plates.		t	b	d	H	c	E	A	m
		Width.	Thick-ness t'								
	Pounds.	Inches.	Inch.	Inch.	Inches.	Inches.	Inches.	Inches.	Inches.	Inches.	Inches.
10' C33	15.0	12	1/8	.24	6	5 1/4	15 11/16	4 1/2	3	3 3/4	1 1/2
	20.0	"	1/4	.38	"	5 5/8	15 11/16	"	2 3/8	"	1 5/8
	25.0	"	1/4	.53	"	5 1/4	15 11/16	"	2 3/4	"	1 3/4
	30.0	"	1/4	.68	"	5 5/8	15 11/16	"	2 1/2	"	1 11/16
	35.0	"	3/8	.82	"	5 1/4	15 11/16	"	2 1/2	"	2 1/16
12' C41	20.5	14	1/8	.28	7	6 1/4	18 3/4	5 5/8	3 3/8	4 1/8	1 3/4
	25.0	"	1/4	.39	"	6 5/8	18 3/4	"	3 3/4	"	1 7/8
	30.0	"	1/4	.51	"	6 1/4	18 3/4	"	3 3/8	"	2
	35.0	"	1/4	.64	"	6 5/8	18 3/4	"	3 1/2	"	2 1/8
	40.0	"	3/8	.76	"	6 1/4	18 3/4	"	3 3/8	"	2 1/4
15' C53	33.0	17	3/8	.40	8 1/2	7 7/8	23 1/16	6 3/4	4 1/8	5 1/4	1 7/8
	35.0	"	3/8	.43	"	8 1/4	23 1/16	"	4 1/16	"	1 11/16
	40.0	"	3/4	.52	"	8 1/4	23 1/16	"	4 3/8	"	2
	45.0	"	3/4	.62	"	8 1/4	23 1/16	"	4 1/8	"	2 1/8
	50.0	"	3/4	.72	"	8 1/4	23 1/16	"	4 1/4	"	2 1/4
	55.0	"	3/4	.82	"	8 1/4	23 1/16	"	4 1/4	"	2 1/8

DIMENSIONS FOR PLATE AND CHANNEL COLUMNS.

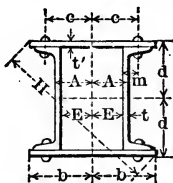

SERIES B.

Depth of Channel and Section No.	Weight per Foot.	Size of Plates.		t	b	d	H	c	E	A	m
		Width.	Thick-ness t'								
Pounds.	Inches.	Inch.	Inch.	Inches.	Inches.	Inches.	Inches.	Inches.	Inches.	Inches.	
6" C17	8.0	9	1/4	.20	4 1/2	3 1/4	11 1/8	3 3/8	2 1/4	2 1/2	1 1/4
	10.5	"	5/8	.32	"	3 5/8	11 1/8	"	2 1/4	"	1 1/4
	13.0	"	1 1/4	.44	"	3 5/8	11 1/8	"	2 1/4	"	1 1/4
	15.5	"	1 1/4	.56	"	3 5/8	11 1/8	"	1 1/2	"	1 1/4
7" C21	9.75	11	1/4	.21	5 1/2	3 3/4	13 1/8	4 1/4	3 1/4	3 3/4	1 1/4
	12.25	"	5/8	.32	"	4 1/8	13 3/4	"	2 1/2	"	1 1/4
	14.75	"	1 1/4	.42	"	4 1/8	13 3/4	"	2 1/2	"	1 1/4
	17.25	"	5/8	.53	"	4 1/8	13 3/4	"	2 1/4	"	1 1/2
	19.75	"	1 1/4	.63	"	4 1/8	13 3/4	"	2 3/8	"	1 1/2
	"	"	5/8	"	"	4 1/8	13 3/4	"	"	"	1 1/2
8" C25	11.25	12	1/4	.22	6	4 1/4	14 1/2	4 5/8	3 1/4	3 5/8	1 1/4
	13.75	"	5/8	.31	"	4 5/8	15 1/2	"	3 1/4	"	1 1/4
	16.25	"	1 1/4	.40	"	4 5/8	15 1/2	"	3 1/4	"	1 1/2
	18.75	"	5/8	.49	"	4 5/8	15 1/2	"	3 3/8	"	1 1/2
	21.25	"	1 1/4	.58	"	4 5/8	15 1/2	"	3 1/4	"	1 1/4
9" C29	13.25	13	1/4	.23	6 1/2	4 3/4	16 1/8	5 1/8	3 3/4	4	1 1/2
	15.00	"	5/8	.29	"	5 1/8	16 1/8	"	3 1/2	"	1 1/4
	20.00	"	1 1/4	.45	"	4 3/4	16 1/8	"	3 1/4	"	1 1/4
	25.00	"	5/8	.61	"	5 1/8	16 1/8	"	3 1/2	"	1 1/4
	"	"	1 1/4	"	"	4 3/4	16 1/8	"	3 1/2	"	1 1/4

DIMENSIONS FOR PLATE AND CHANNEL COLUMNS.

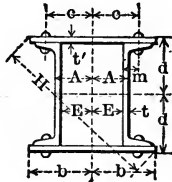

SERIES B.

Depth of Channel and Section No.	Weight per Foot.	Size of Plates.		t	b	d	H	c	E	A	m
		Width.	Thick-ness. t'								
	Pounds.	Inches.	Inch.	Inch.	Inches.	Inches.	Inches.	Inches.	Inches.	Inches.	Inches.
10" C33	15.0	15	1/4	.24	7 1/2	5 1/4	18 1/8	6	4 1/2	4 3/4	1 1/2
	20.0	"	1/4	.38	"	5 1/4	18 1/8	"	4 3/8	"	1 3/8
	25.0	"	1/4	.53	"	5 1/4	18 1/8	"	4 1/4	"	1 1/4
	30.0	"	1/4	.68	"	5 1/4	18 1/8	"	4 1/8	"	1 1/8
	35.0	"	1/4	.82	"	5 1/4	18 1/8	"	3 11/8	"	2 1/8
12" C41	20.5	16	1/4	.28	8	6 1/4	20 1/8	6 3/8	4 7/8	5 1/8	1 3/4
	25.0	"	1/4	.39	"	6 1/4	20 1/8	"	4 3/4	"	1 1/2
	30.0	"	1/4	.51	"	6 1/4	20 1/8	"	4 5/8	"	2
	35.0	"	1/4	.64	"	6 1/4	20 1/8	"	4 1/2	"	2 1/8
	40.0	"	1/4	.76	"	6 1/4	20 1/8	"	4 3/8	"	2 1/4
15" C53	33.0	20	3/8	.40	10	7 7/8	25 1/8	8 1/4	6 3/8	6 3/4	1 3/8
	35.0	"	3/8	.43	"	8 1/4	25 1/8	"	6 1/4	"	1 1/8
	40.0	"	3/8	.52	"	8 1/4	25 1/8	"	6 1/4	"	2
	45.0	"	3/8	.62	"	8 1/4	25 1/8	"	6 1/8	"	2 1/8
	50.0	"	3/8	.72	"	8 1/4	25 1/8	"	6 1/8	"	2 1/4
	55.0	"	3/8	.82	"	8 1/4	25 1/8	"	5 11/8	"	2 1/8

**MOMENTS OF INERTIA AND
SECTION MODULI FOR
PLATE AND CHAN-
NEL COLUMNS.**

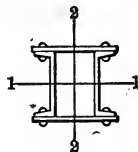

Depth of Channel and Section Number.	Weight per Foot.	SERIES A.						SERIES B.					
		Width of Plate.		Axis 1-1.		Axis 2-2.		Width of Plate.		Axis 1-1.		Axis 2-2.	
				Thickness of Plate.	Moment of Inertia.	Section Modulus.	Moment of Inertia.			Section Modulus.	Thickness of Plate.	Moment of Inertia.	Section Modulus.
		In.	In.					Ins. ⁴	Ins. ³				
6" C 17	8.00	8	1/4	65.1	20.0	48.4	12.1	9	1/4	70.0	21.5	69.6	15.5
	"	"	5/16	75.9	22.9	53.7	13.4	"	5/16	82.1	24.8	77.2	17.2
	"	"	3/8	87.0	25.8	59.0	14.8	"	3/8	94.7	28.1	84.8	18.9
	"	"	1/2	98.6	28.7	64.4	16.1	"	1/2	107.8	31.4	92.4	20.5
	"	"	5/8	110.7	31.6	69.7	17.4	"	5/8	121.3	34.6	100.0	22.2
	"	"	3/4	123.1	34.6	75.0	18.8	"	3/4	135.3	38.0	107.6	23.9
6" C 17	10.50	8	1/4	69.3	21.3	52.5	13.1	9	1/4	74.2	22.8	76.5	17.0
	"	"	5/16	80.1	24.2	57.8	14.5	"	5/16	86.3	26.1	84.1	18.7
	"	"	3/8	91.2	27.0	63.1	15.8	"	3/8	98.9	29.3	91.7	20.4
	"	"	1/2	102.8	29.9	68.5	17.1	"	1/2	112.0	32.6	99.3	22.1
	"	"	5/8	114.9	32.8	73.8	18.5	"	5/8	125.5	35.8	106.9	23.8
	"	"	3/4	127.3	35.7	79.1	19.8	"	3/4	139.5	39.2	114.5	25.4
6" C 17	13.00	8	1/4	73.7	22.7	56.5	14.1	9	1/4	78.6	24.2	83.4	18.5
	"	"	5/16	84.5	25.5	61.9	15.5	"	5/16	90.7	27.4	91.0	20.2
	"	"	3/8	95.6	28.3	67.2	16.8	"	3/8	103.3	30.6	98.6	21.9
	"	"	1/2	107.2	31.2	72.5	18.1	"	1/2	116.4	33.9	106.2	23.6
	"	"	5/8	119.3	34.1	77.9	19.5	"	5/8	129.9	37.1	113.7	25.3
	"	"	3/4	131.7	37.0	83.2	20.8	"	3/4	143.9	40.4	121.3	27.0
6" C 17	15.50	8	1/4	78.1	24.0	60.0	15.0	9	1/4	83.0	25.5	89.5	19.9
	"	"	5/16	88.9	26.8	65.4	16.3	"	5/16	95.1	28.7	97.1	21.6
	"	"	3/8	100.0	29.6	70.7	17.7	"	3/8	107.7	31.9	104.7	23.3
	"	"	1/2	111.5	32.5	76.0	19.0	"	1/2	120.8	35.1	112.3	25.0
	"	"	5/8	123.7	35.3	81.4	20.3	"	5/8	134.3	38.4	119.9	26.6
	"	"	3/4	136.1	38.2	86.7	21.7	"	3/4	148.3	41.6	127.4	28.3
			3/8	149.1	41.1	92.0	23.0		3/8	162.8	44.9	135.0	30.0

MOMENTS OF INERTIA AND SECTION MODULI FOR PLATE AND CHANNEL COLUMNS.

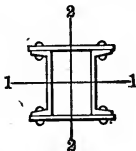

Depth of Channel and Section Number.	Weight per Foot.	SERIES A.						SERIES B.					
		Width of Plate.		Axis 1-1.		Axis 2-2.		Width of Plate.		Axis 1-1.		Axis 2-2.	
		In.	Thickness Plate.	Moment of Inertia.	Section Modulus.	Moment of Inertia.	Section Modulus.	In.	Thickness Plate.	Moment of Inertia.	Section Modulus.	Moment of Inertia.	Section Modulus.
7" C21	9.75	9	1/4	101.4	27.0	70.6	15.7	11	1/4	114.5	30.5	130.9	23.8
	"	"	5/8	117.4	30.8	78.1	17.4	"	5/8	134.2	35.2	144.7	26.3
	"	"	3/8	134.1	34.6	85.8	19.1	"	3/8	154.5	39.9	158.6	28.8
	"	"	1/2	151.3	38.4	93.4	20.8	"	1/2	175.5	44.6	172.5	31.4
	"	"	5/8	169.0	42.2	101.0	22.4	"	5/8	197.1	49.3	186.3	33.9
	"	"	3/4	187.2	46.1	108.5	24.1	"	3/4	219.5	54.0	200.2	36.4
7" C21	12.25	9	1/4	206.2	50.0	116.1	25.8	11	1/4	242.5	58.8	214.1	38.9
	"	"	5/8	225.6	53.9	123.8	27.5	"	5/8	266.3	63.6	227.9	41.4
	"	"	3/8	245.5	57.8	131.3	29.2	"	3/8	290.7	68.4	241.8	44.0
	"	"	1/2	107.6	28.7	76.3	17.0	11	1/4	120.7	32.2	144.0	26.2
	"	"	5/8	123.6	32.4	83.9	18.6	"	5/8	140.4	36.8	157.9	28.7
	"	"	3/8	140.3	36.2	91.5	20.3	"	3/8	160.7	41.5	171.8	31.2
7" C21	14.75	9	1/4	157.5	40.0	99.1	22.0	11	1/4	181.7	46.1	185.6	33.8
	"	"	5/8	175.2	43.8	106.7	23.7	"	5/8	203.3	50.8	199.5	36.3
	"	"	3/8	193.4	47.6	114.3	25.4	"	3/8	225.7	55.6	213.4	38.8
	"	"	1/2	212.4	51.5	121.9	27.1	"	1/2	248.7	60.3	227.2	41.3
	"	"	5/8	231.8	55.4	129.5	28.8	"	5/8	272.5	65.1	241.1	43.8
	"	"	3/4	251.7	59.2	137.1	30.5	"	3/4	296.9	69.9	255.0	46.4
7" C21	14.75	9	1/4	113.6	30.3	81.5	18.1	11	1/4	126.7	33.8	156.3	28.4
	"	"	5/8	129.6	34.0	89.1	19.8	"	5/8	146.4	38.4	170.1	30.9
	"	"	3/8	146.3	37.7	96.7	21.5	"	3/8	166.7	43.0	184.0	33.5
	"	"	1/2	163.5	41.5	104.3	23.2	"	1/2	187.7	47.7	197.8	36.0
	"	"	5/8	181.2	45.3	111.9	24.9	"	5/8	209.3	52.3	211.7	38.5
	"	"	3/4	199.4	49.1	119.5	26.5	"	3/4	231.7	57.0	225.6	41.0
7" C21	17.25	9	1/4	218.4	53.0	127.1	28.2	11	1/4	254.7	61.8	239.4	43.5
	"	"	5/8	237.8	56.8	134.7	29.9	"	5/8	278.5	66.5	253.3	46.1
	"	"	3/8	257.7	60.6	142.3	31.6	"	3/8	302.9	71.3	267.2	48.6
	"	"	1/2	119.6	31.9	85.9	19.1	11	1/4	132.7	35.4	167.1	30.4
	"	"	5/8	135.6	35.6	93.4	20.8	"	5/8	152.4	40.0	181.0	32.9
	"	"	3/8	152.3	39.3	101.1	22.5	"	3/8	172.7	44.6	194.9	35.4
7" C21	17.25	9	1/4	169.5	43.1	108.7	24.2	11	1/4	193.7	49.2	208.7	38.0
	"	"	5/8	187.2	46.8	116.2	25.8	"	5/8	215.3	53.8	222.6	40.5
	"	"	3/8	205.4	50.6	123.8	27.5	"	3/8	237.7	58.5	236.5	43.0
	"	"	1/2	224.4	54.4	131.4	29.2	"	1/2	260.7	63.2	250.3	45.5
	"	"	5/8	243.8	58.2	139.1	30.9	"	5/8	284.5	67.9	264.2	48.0
	"	"	3/4	263.7	62.1	146.6	32.6	"	3/4	308.9	72.7	278.1	50.6
7" C21	19.75	9	1/4	125.6	33.5	90.3	20.1	11	1/4	138.7	37.0	178.2	32.4
	"	"	5/8	141.6	37.1	97.9	21.8	"	5/8	158.4	41.5	192.0	34.9
	"	"	3/8	158.3	40.8	105.5	23.4	"	3/8	178.7	46.1	205.9	37.4
	"	"	1/2	175.5	44.6	113.1	25.1	"	1/2	199.7	50.7	219.7	40.0
	"	"	5/8	193.2	48.3	120.7	26.8	"	5/8	221.3	55.3	233.6	42.5
	"	"	3/4	211.4	52.0	128.3	28.5	"	3/4	243.7	60.0	247.5	45.0
7" C21	19.75	9	1/4	230.4	55.9	135.9	30.2	11	1/4	266.7	64.7	261.3	47.5
	"	"	5/8	249.8	59.7	143.5	31.9	"	5/8	290.5	69.4	275.2	50.0
	"	"	3/8	269.7	63.5	151.1	33.6	"	3/8	314.9	74.1	289.1	52.6

MOMENTS OF INERTIA AND SECTION MODULI FOR PLATE AND CHANNEL COLUMNS.

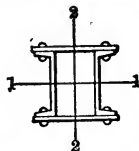

Depth of Channel and Section Number.	Weight per Foot.	SERIES A.								SERIES B.																																																																					
		Width of Plate.		Axis 1-1.				Axis 2-2.				Width of Plate.		Axis 1-1.				Axis 2-2.																																																													
				Thickness Plate.		Moment of Inertia.	Section Modulus.	Moment of Inertia.	Section Modulus.	Thickness Plate.				Moment of Inertia.	Section Modulus.	Moment of Inertia.	Section Modulus.	Moment of Inertia.	Section Modulus.																																																												
		In.	In.	Ins. ⁴	Ins. ³					Ins. ⁴	Ins. ³	In.	In.							Ins. ⁴	Ins. ³	Ins. ⁴	Ins. ³																																																								
8" C 25	11.25	10	1/4	149.7	35.2	104.0	20.8	12	1/4	166.7	39.2	181.1	30.2	1/4	172.6	40.0	114.4	22.9	1/4	194.2	45.0	199.1	33.2	1/4	222.5	50.9	217.1	36.2	1/4	251.7	56.7	235.1	39.2	1/4	281.6	62.6	253.1	42.2	1/4	312.4	68.5	271.1	45.2	1/4	344.1	74.4	289.1	48.2	1/4	376.6	80.3	307.1	51.2	1/4	410.0	86.3	325.1	54.2																					
	8" C 25	13.75	10	1/4	157.1	37.0	111.6	22.3	12	1/4	174.1	41.0	196.4	32.7	1/4	180.0	41.7	122.0	24.4	1/4	201.6	46.8	214.4	35.7	1/4	203.6	44.9	124.9	25.0	1/4	227.9	51.4	142.8	28.6	1/4	259.1	58.4	250.4	41.7	1/4	289.0	64.2	268.4	44.7	1/4	319.8	70.1	286.4	47.7	1/4	304.9	65.9	174.1	34.8	1/4	351.5	76.0	304.4	50.7	1/4	332.0	70.8	184.5	36.9	1/4	384.0	81.9	322.4	53.7	1/4	359.8	75.8	194.9	39.0	1/4	417.4	87.9	340.4	56.7
		8" C 25	16.25	10	1/4	164.9	38.8	119.4	23.9	12	1/4	181.9	42.8	212.5	35.4	1/4	187.8	43.6	129.8	26.0	1/4	209.4	48.6	230.5	38.4	1/4	211.4	48.3	140.2	28.0	1/4	237.7	54.3	248.5	41.4	1/4	266.9	60.1	266.5	44.4	1/4	296.8	66.0	284.5	47.4	1/4	327.6	71.8	302.5	50.4	1/4	359.3	77.7	320.5	53.4	1/4	391.8	83.6	338.5	56.4	1/4	425.2	89.5	356.5	59.4														
			8" C 25	18.75	10	1/4	172.7	40.6	126.3	25.3	12	1/4	189.7	44.6	227.3	37.9	1/4	195.6	45.4	136.7	27.4	1/4	217.2	50.4	245.3	40.9	1/4	219.2	50.1	147.2	29.4	1/4	245.5	56.1	263.3	43.9	1/4	274.7	61.9	281.3	46.9	1/4	304.6	67.7	299.3	49.9	1/4	335.4	73.5	317.3	52.9	1/4	367.1	79.4	335.3	55.9	1/4	399.6	85.2	353.3	58.9	1/4	433.0	91.2	371.3	61.9													
				8" C 25	21.25	10	1/4	180.7	42.5	133.0	26.6	12	1/4	197.7	46.5	241.7	40.3	1/4	203.6	47.2	143.4	28.7	1/4	225.2	52.2	259.7	43.3	1/4	227.2	51.9	153.8	30.8	1/4	253.5	58.0	277.7	46.3	1/4	282.7	63.7	295.7	49.3	1/4	312.6	69.5	313.7	52.3	1/4	343.4	75.3	331.7	55.3	1/4	375.1	81.1	349.7	58.3	1/4	407.6	87.0	367.7	61.3	1/4	441.0	92.8	385.7	64.3												

MOMENTS OF INERTIA AND SECTION MODULI FOR PLATE AND CHANNEL COLUMNS.

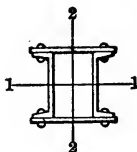

Depth of Channel and Section Number.	Weight per Foot.	SERIES A.						SERIES B.						
		Width of Plate.		Axis 1-1.		Axis 2-2.		Width of Plate.		Axis 1-1.		Axis 2-2.		
		In.	In.	Moment of Inertia.	Section Modulus.	Moment of Inertia.	Section Modulus.	In.	In.	Moment of Inertia.	Section Modulus.	Moment of Inertia.	Section Modulus.	
														Thickness of Plate.
Lbs.	In.	In.	Ins. ⁴	Ins. ³	Ins. ⁴	Ins. ³	In.	In.	Ins. ⁴	Ins. ³	Ins. ⁴	Ins. ³		
9" C29	13.25	11	1/4	212.3	44.7	147.9	26.9	13	1/4	233.7	49.2	244.3	37.6	
	"	"	1/8	243.8	50.7	161.8	29.4	"	1/8	270.8	56.3	267.2	41.1	
	"	"	3/8	276.0	56.6	175.6	31.9	"	3/8	308.9	63.4	290.1	44.6	
	"	"	1/2	309.0	62.6	189.4	34.4	"	1/2	348.1	70.5	313.0	48.2	
	"	"	5/8	343.0	68.6	203.3	37.0	"	5/8	388.2	77.6	335.9	51.7	
	"	"	7/8	377.9	74.7	217.3	39.5	"	7/8	429.3	84.8	358.8	55.2	
	"	"	1	413.5	80.7	231.1	42.0	"	1	471.5	92.0	381.6	58.7	
9" C29	"	"	1 1/8	449.9	86.7	244.9	44.5	"	1 1/8	514.7	99.2	404.5	62.2	
	"	"	3/4	487.5	92.9	258.8	47.1	"	3/4	558.9	106.5	427.4	65.8	
	"	15.00	11	1/4	219.5	46.2	155.4	28.3	13	1/4	240.9	50.7	258.5	39.8
	"	"	1/8	251.0	52.2	169.3	30.8	"	1/8	278.0	57.8	281.4	43.3	
	"	"	3/8	283.2	58.1	183.1	33.3	"	3/8	316.1	64.9	304.3	46.8	
	"	"	1/2	316.2	64.0	197.0	35.8	"	1/2	355.3	72.0	327.2	50.3	
	"	"	5/8	350.2	70.0	210.9	38.3	"	5/8	395.4	79.1	350.1	53.9	
9" C29	"	"	3/4	385.1	76.1	224.8	40.9	"	3/4	436.5	86.2	373.0	57.4	
	"	"	7/8	420.7	82.1	238.6	43.4	"	7/8	478.7	93.4	395.8	60.9	
	"	"	1	457.1	88.1	252.4	45.9	"	1	521.9	100.6	418.7	64.4	
	"	"	1 1/8	494.7	94.2	266.3	48.4	"	1 1/8	566.1	107.8	441.6	67.9	
	"	20.00	11	1/4	239.3	50.4	175.6	31.9	13	1/4	260.7	54.9	297.0	45.7
	"	"	1/8	270.8	56.3	189.5	34.5	"	1/8	297.8	61.9	319.9	49.2	
	"	"	3/8	303.0	62.2	203.3	37.0	"	3/8	335.9	68.9	342.8	52.7	
9" C29	"	"	1/2	336.0	68.0	217.1	39.5	"	1/2	375.1	76.0	365.7	56.3	
	"	"	5/8	370.0	74.0	231.0	42.0	"	5/8	415.2	83.0	388.6	59.8	
	"	"	3/4	404.9	80.0	244.9	44.5	"	3/4	456.3	90.1	411.5	63.3	
	"	"	7/8	440.5	86.0	258.8	47.1	"	7/8	498.5	97.3	434.3	66.8	
	"	"	1	476.9	91.9	272.6	49.6	"	1	541.7	104.4	457.2	70.3	
	"	"	1 1/8	514.5	98.0	286.5	52.1	"	1 1/8	585.9	111.6	480.1	73.9	
	9" C29	"	25.00	11	1/4	259.1	54.5	194.6	35.4	13	1/4	290.5	59.1	333.9
"		"	1/8	290.6	60.4	208.5	37.9	"	1/8	317.6	66.0	356.8	54.9	
"		"	3/8	322.8	66.2	222.3	40.4	"	3/8	355.7	73.0	379.7	58.4	
"		"	1/2	355.8	72.1	236.1	42.9	"	1/2	394.9	80.0	402.5	61.9	
"		"	5/8	389.8	78.0	250.1	45.5	"	5/8	435.0	87.0	425.4	65.5	
"		"	3/4	424.7	83.9	264.0	48.0	"	3/4	476.1	94.1	448.3	69.0	
"		"	7/8	460.3	89.8	277.8	50.5	"	7/8	518.3	101.1	471.2	72.5	
"	"	1	496.7	95.8	291.6	53.0	"	1	561.5	108.2	494.1	76.0		
"	"	1 1/8	534.3	101.8	305.5	55.6	"	1 1/8	605.7	115.4	517.0	79.5		

MOMENTS OF INERTIA AND SECTION MODULI FOR PLATE AND CHANNEL COLUMNS.

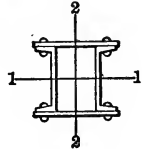

Depth of Channel and Section Number.	Weight per Foot.	SERIES A.						SERIES B.					
		Width of Plate.		Axis 1-1.		Axis 2-2.		Width of Plate.		Axis 1-1.		Axis 2-2.	
		In.	Thickness Plate.	Moment of Inertia.	Section Modulus.	Moment of Inertia.	Section Modulus.	In.	Thickness Plate.	Moment of Inertia.	Section Modulus.	Moment of Inertia.	Section Modulus.
12" C41	20.5	14	1/4	518.9	83.0	371.3	53.0	16	1/4	556.4	89.0	549.3	68.7
	"	"	"	587.9	93.1	399.9	57.1	"	"	635.3	100.6	592.0	74.0
	"	"	"	658.3	103.3	428.4	61.2	"	"	715.8	112.3	634.6	79.3
	"	"	"	730.1	113.4	457.0	65.3	"	"	797.3	123.9	677.3	84.7
	"	"	"	803.4	123.6	485.6	69.4	"	"	881.5	135.6	720.0	90.0
	"	"	"	878.0	133.8	514.2	73.5	"	"	966.9	147.3	762.6	95.3
	"	"	"	954.1	144.0	542.8	77.5	"	"	1053.8	159.1	805.3	100.7
	"	"	"	1031.6	154.3	571.4	81.6	"	"	1142.4	170.8	848.0	106.0
12" C41	25.0	14	1/4	1110.6	164.5	599.9	85.7	"	"	1232.7	182.6	890.6	111.3
	"	"	"	550.7	88.1	409.9	58.6	16	1/4	588.2	94.1	610.8	76.4
	"	"	"	619.7	98.2	438.5	62.7	"	"	667.1	105.7	653.4	81.7
	"	"	"	690.1	108.3	467.1	66.7	"	"	747.6	117.3	696.1	87.0
	"	"	"	761.9	118.4	495.7	70.8	"	"	829.6	128.9	738.8	92.4
	"	"	"	835.2	128.5	524.3	74.9	"	"	913.3	140.5	781.4	97.7
	"	"	"	909.8	138.6	552.9	79.0	"	"	998.7	152.2	824.1	103.0
	"	"	"	985.9	148.8	581.4	83.1	"	"	1085.6	163.9	866.8	108.4
12" C41	30.0	14	1/4	1063.4	159.0	610.0	87.2	"	"	1174.2	175.6	909.4	113.7
	"	"	"	1142.4	169.3	638.6	91.2	"	"	1264.5	187.3	952.1	119.0
	"	"	"	585.9	93.7	450.2	64.3	16	1/4	623.4	99.7	675.7	84.5
	"	"	"	654.9	103.7	478.8	68.4	"	"	702.3	111.3	718.3	89.8
	"	"	"	725.3	113.8	507.3	72.5	"	"	782.8	122.8	761.0	95.1
	"	"	"	797.1	123.8	535.9	76.6	"	"	864.8	134.3	803.7	100.5
	"	"	"	870.4	133.9	564.5	80.6	"	"	948.5	145.9	846.3	105.8
	"	"	"	945.0	144.0	593.1	84.7	"	"	1033.9	157.5	889.9	111.1
12" C41	35.0	14	1/4	1021.1	154.1	621.7	88.8	"	"	1120.8	169.2	931.6	116.5
	"	"	"	1093.6	164.3	650.3	92.9	"	"	1209.4	180.9	974.3	121.8
	"	"	"	1177.6	174.5	678.8	97.0	"	"	1299.7	192.6	1017.0	127.1
	"	"	"	621.3	99.4	484.9	69.3	16	1/4	658.8	105.4	733.6	91.7
	"	"	"	690.3	109.4	513.4	73.4	"	"	737.7	116.9	776.3	97.0
	"	"	"	760.7	119.3	542.0	77.4	"	"	818.2	128.3	818.9	102.4
	"	"	"	832.5	129.3	570.6	81.5	"	"	900.2	139.8	861.6	107.7
	"	"	"	905.8	139.4	599.2	85.6	"	"	983.9	151.4	904.3	113.0
12" C41	40.0	14	1/4	980.4	149.4	627.8	89.7	"	"	1069.3	162.9	946.9	118.4
	"	"	"	1056.5	159.5	656.4	93.8	"	"	1156.2	174.5	989.6	123.7
	"	"	"	1134.0	169.6	684.9	97.9	"	"	1244.8	186.1	1032.3	129.0
	"	"	"	1213.0	179.7	713.5	101.9	"	"	1335.1	197.8	1074.9	134.4
	"	"	"	658.5	105.0	520.1	74.3	16	1/4	694.0	111.0	792.1	99.0
	"	"	"	725.5	114.9	548.7	78.4	"	"	772.9	122.4	834.8	104.3
	"	"	"	795.9	124.9	577.2	82.5	"	"	853.4	133.9	877.4	109.7
	"	"	"	867.7	134.8	605.8	86.6	"	"	935.4	145.3	920.1	115.0
12" C41	45.0	14	1/4	941.0	144.8	634.4	90.6	"	"	1019.1	156.8	962.8	120.3
	"	"	"	1015.6	154.8	663.0	94.7	"	"	1104.5	168.3	1005.4	125.7
	"	"	"	1091.7	164.8	691.6	98.8	"	"	1191.4	179.8	1048.1	131.0
	"	"	"	1169.2	174.8	720.2	102.9	"	"	1280.0	191.4	1090.8	136.3
	"	"	"	1248.2	184.9	748.7	107.0	"	"	1370.3	203.0	1133.4	141.7

MOMENTS OF INERTIA AND SECTION MODULI FOR PLATE AND CHANNEL COLUMNS.

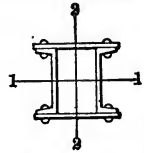

Depth of Channel and Section Number.	Weight per Foot.	SERIES A.						SERIES B.						
		Width of Plate.		Axis 1-1.		Axis 2-2.		Width of Plate.		Axis 1-1.		Axis 2-2.		
		Thickness of Plate.	Moment of Inertia.	Section Modulus.	Moment of Inertia.	Section Modulus.	Thickness of Plate.	Moment of Inertia.	Section Modulus.	Moment of Inertia.	Section Modulus.	Thickness of Plate.	Moment of Inertia.	Section Modulus.
15" C53	33.0	17	3/8	1378.9	175.1	953.4	112.2	20	3/8	1511.8	192.0	1525.9	152.6	
	"	"	1/2	1512.0	190.5	1004.7	118.2	"	1/2	1668.1	210.2	1609.2	160.9	
	"	"	5/8	1646.6	205.8	1055.7	124.2	"	5/8	1826.9	228.4	1692.5	169.3	
	"	"	1	1783.4	221.2	1106.8	130.2	"	1	1988.1	246.6	1775.9	177.6	
	"	"	1 1/4	1922.9	236.7	1158.1	136.2	"	1 1/4	2151.9	264.9	1859.2	185.9	
15" C53	35.0	17	3/8	2064.6	252.2	1209.4	142.3	20	3/8	2318.2	283.1	1942.5	194.3	
	"	"	1/2	2207.8	267.6	1260.4	148.3	"	1/2	2487.1	301.5	2025.9	202.6	
	"	"	5/8	1393.5	177.0	971.7	114.3	20	5/8	1526.4	193.8	1557.3	155.7	
	"	"	1	1526.6	192.3	1023.0	120.4	"	1	1682.7	212.0	1640.7	164.1	
	"	"	1 1/4	1661.2	207.7	1074.1	126.4	"	1 1/4	1841.5	230.2	1724.0	172.4	
15" C53	40.0	17	3/8	1798.0	223.0	1125.1	132.4	20	3/8	2002.7	248.4	1807.3	180.7	
	"	"	1/2	1937.5	238.5	1176.4	138.4	"	1/2	2166.5	266.6	1890.7	189.1	
	"	"	5/8	2079.2	254.0	1227.7	144.4	"	5/8	2332.8	284.9	1974.0	197.4	
	"	"	1	2222.4	269.4	1278.8	150.4	"	1	2501.7	303.2	2057.3	205.7	
	"	"	1 1/4	1448.7	184.0	1039.9	122.3	20	1 1/4	1581.6	200.8	1674.6	167.5	
15" C53	45.0	17	3/8	1581.8	199.3	1091.2	128.4	20	3/8	1737.9	219.0	1757.9	175.8	
	"	"	1/2	1716.4	214.6	1142.3	134.4	"	1/2	1896.7	237.1	1841.2	184.1	
	"	"	5/8	1853.2	229.9	1193.3	140.4	"	5/8	2057.9	255.3	1924.6	192.5	
	"	"	1	1992.7	245.3	1244.6	146.4	"	1	2221.7	273.4	2007.9	200.8	
	"	"	1 1/4	2134.4	260.7	1295.9	152.5	"	1 1/4	2388.0	291.7	2091.2	209.1	
15" C53	50.0	17	3/8	2277.6	276.1	1347.0	158.5	20	3/8	2556.9	309.9	2174.6	217.5	
	"	"	1/2	1503.9	191.0	1105.4	130.1	20	1/2	1636.8	207.9	1788.6	178.9	
	"	"	5/8	1637.0	206.2	1156.8	136.1	"	5/8	1793.1	225.9	1871.9	187.2	
	"	"	1	1771.6	221.5	1207.9	142.1	"	1	1951.9	244.0	1955.3	195.5	
	"	"	1 1/4	1908.4	236.7	1258.9	148.1	"	1 1/4	2113.1	262.1	2038.6	203.9	
15" C53	55.0	17	3/8	2047.9	252.0	1310.2	154.2	20	3/8	2276.9	290.2	2121.9	212.2	
	"	"	1/2	2189.6	267.4	1361.5	160.2	"	1/2	2443.2	298.4	2205.3	220.5	
	"	"	5/8	2332.8	282.8	1412.6	166.2	"	5/8	2612.1	316.6	2288.6	228.9	
	"	"	1	1559.1	198.0	1165.3	137.1	20	1	1692.0	214.9	1894.9	189.5	
	"	"	1 1/4	1692.2	213.2	1216.6	143.1	"	1 1/4	1848.3	232.9	1978.2	197.8	
15" C53	55.0	17	3/8	1826.8	228.4	1267.7	149.1	20	3/8	2007.1	250.9	2061.5	206.2	
	"	"	1/2	1963.6	243.5	1318.7	155.1	"	1/2	2168.3	268.9	2144.9	214.5	
	"	"	5/8	2103.1	258.8	1370.0	161.2	"	5/8	2332.1	287.0	2228.2	222.8	
	"	"	1	2244.8	274.2	1421.3	167.2	"	1	2498.4	305.2	2311.5	231.2	
	"	"	1 1/4	2388.0	289.5	1472.4	173.2	"	1 1/4	2667.3	323.3	2394.9	239.5	
15" C53	55.0	17	3/8	1614.1	205.0	1223.4	143.9	20	3/8	1747.0	221.9	1998.8	199.9	
	"	"	1/2	1747.2	220.1	1274.7	150.0	"	1/2	1903.3	239.8	2082.1	208.2	
	"	"	5/8	1881.8	235.2	1325.7	156.0	"	5/8	2062.1	257.8	2165.5	216.6	
	"	"	1	2018.6	250.4	1376.8	162.0	"	1	2223.3	275.8	2248.8	224.9	
	"	"	1 1/4	2158.1	265.6	1428.1	168.0	"	1 1/4	2387.1	293.8	2332.1	233.2	
			1 1/4	2299.8	280.9	1479.4	174.0		1 1/4	2553.4	311.9	2415.5	241.6	
			3/4	2443.0	296.1	1530.4	180.1		3/4	2722.3	330.0	2498.8	249.9	

**TYPICAL DETAILS OF PLATE GIRDERS, COLUMN
BASES AND STEEL COLUMNS.**

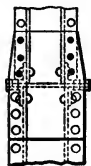
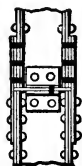
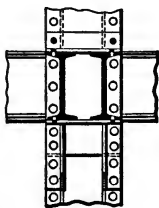
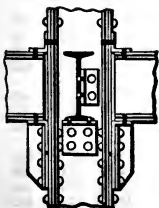
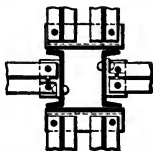
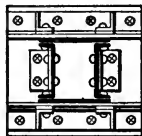
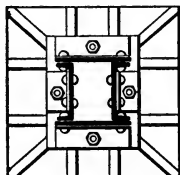
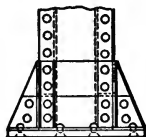
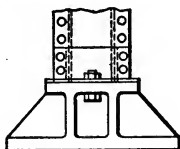
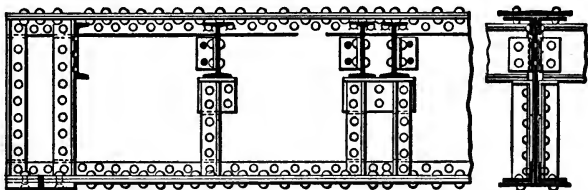

**SAFE LOADS IN THOUSANDS OF POUNDS
FOR I-BEAMS USED AS COLUMNS
WITH SQUARE ENDS.**

Based on Gordon's Formula, $P = \frac{50\,000}{1 + \frac{(12L)^2}{36\,000r^2}}$ Safety factor 4.

Depth of Beam and Section Number.	Weight per Foot. Pounds.	Area of Section. Sq. Ins.	Least Radius of Gyration. Inch.	Length in Feet.						
				2	3	4	5	6	7	8
3" B 5	5.5	1.63	.53	19	18	17	15	13	12	11
	6.5	1.91	.52	23	21	19	17	16	14	12
	7.5	2.21	.52	26	24	22	20	18	16	14
4" B 9	7.5	2.21	.59	26	25	23	21	20	18	16
	8.5	2.50	.58	30	28	26	24	22	20	18
	9.5	2.79	.58	33	31	29	27	24	22	20
	10.5	3.09	.57	37	35	32	29	27	24	22
5" B 13	9.75	2.87	.65	35	33	31	29	27	24	22
	12.25	3.60	.63	43	41	39	36	33	30	27
	14.75	4.34	.63	52	50	47	43	40	36	33
6" B 17	12.25	3.61	.72	44	42	40	38	35	33	30
	14.75	4.34	.69	52	51	48	45	42	39	35
	17.25	5.07	.68	61	59	56	52	48	44	41
7" B 21	15.0	4.42	.78	54	52	50	47	45	42	39
	17.5	5.15	.76	63	61	58	55	52	48	45
	20.0	5.88	.74	71	69	66	62	58	54	50
8" B 25	18.00	5.33	.84	65	63	61	58	55	52	49
	20.25	5.96	.82	73	71	68	65	61	58	54
	22.75	6.69	.81	82	79	76	72	69	65	60
	25.25	7.43	.80	91	88	84	80	76	71	66
9" B 29	21.0	6.31	.90	77	76	73	70	67	63	60
	25.0	7.35	.88	90	88	85	81	78	73	69
	30.0	8.82	.85	108	105	101	97	92	87	81
	35.0	10.29	.84	126	122	118	112	107	101	95
10" B 33	25.0	7.37	.97	91	89	86	83	80	76	73
	30.0	8.82	.93	108	106	103	99	94	90	85
	35.0	10.29	.91	126	123	119	115	110	104	98
	40.0	11.76	.90	144	141	136	131	125	118	112
12" B 41	31.5	9.26	1.01	114	112	109	105	102	97	93
	35.0	10.29	.99	127	124	121	117	112	107	102
	40.0	11.76	.96	144	142	137	133	127	121	115
12" B 105	40.0	11.84	1.08	146	144	140	136	132	127	121
	45.0	13.24	1.06	163	160	156	152	146	141	135
	50.0	14.71	1.05	181	178	174	168	163	156	149
	55.0	16.18	1.04	199	196	191	185	178	171	163

**SAFE LOADS IN THOUSANDS OF POUNDS
FOR I-BEAMS USED AS COLUMNS
WITH SQUARE ENDS.**

Based on Gordon's Formula, $P = \frac{50\,000}{1 + \frac{(12L)^2}{36\,000r^2}}$ Safety factor 4.

Length in Feet.									Weight per Foot.	Depth of Beam and Section Number.
9	10	11	12	13	14	15	16	17	Pounds.	
9									5.5	3" B 5
11									6.5	
13									7.5	
14	13								7.5	4" B 9
16	14								8.5	
18	16								9.5	
19	17								10.5	
20	18	17							9.75	5" B 13
25	22	20							12.25	
30	27	24							14.75	
28	25	23	21						12.25	6" B 17
32	29	27	25						14.75	
37	34	31	28						17.25	
36	33	31	28	26					15.0	7" B 21
41	38	35	32	30					17.5	
46	43	39	36	33					20.0	
46	43	40	37	34	31				18.00	8" B 25
50	47	43	40	37	34				20.25	
56	52	48	45	41	38				22.75	
61	57	53	49	45	42				25.25	
56	53	49	46	43	40	37			21.0	9" B 29
65	60	57	53	49	46	43			25.0	
76	71	66	61	57	53	49			30.0	
88	82	76	71	66	61	56			35.0	
68	65	61	57	54	50	47	44		25.0	10" B 33
80	75	71	66	62	58	54	50		30.0	
92	87	81	76	71	66	62	57		35.0	
105	98	92	86	80	74	69	65		40.0	
88	83	78	74	69	65	61	58	54	31.5	12" B 41
97	91	86	81	76	72	67	63	59	35.0	
109	103	96	90	85	79	74	69	65	40.0	
116	110	105	99	94	88	83	79	75	40.0	12" B 105
128	122	116	110	103	98	92	87	82	45.0	
142	135	128	121	114	108	101	96	90	50.0	
155	148	140	132	124	117	111	104	98	55.0	

**SAFE LOADS IN THOUSANDS OF POUNDS
FOR I-BEAMS USED AS COLUMNS
WITH SQUARE ENDS.**

Based on Gordon's Formula, $P = \frac{50\,000}{1 + \frac{(12L)^2}{36\,000r^2}}$ Safety factor 4.

Depth of Beam and Section	Weight per Foot.	Area of Section.	Least Radius of Gyration.	Length in Feet.							
				Number.	Pounds.	Sq. Ins.	Inches.	2	3	4	5
15" B 53	42.0	12.48	1.08	154	151	148	144	139	133	128	122
	45.0	13.24	1.07	163	160	157	152	147	142	135	129
	50.0	14.71	1.04	181	178	174	168	162	156	149	141
	55.0	16.18	1.03	199	196	191	185	178	171	163	155
	60.0	17.65	1.01	217	213	207	201	194	185	177	167
15" B 109	60.0	17.67	1.21	218	215	212	207	201	195	188	181
	65.0	19.12	1.20	236	233	229	223	217	211	203	195
	70.0	20.59	1.19	254	251	246	240	234	226	218	209
	75.0	22.06	1.18	273	269	264	258	250	242	233	224
	80.0	23.53	1.17	291	286	281	274	266	257	248	238
15" B 113	80.0	23.57	1.32	292	289	284	279	273	265	256	249
	85.0	25.00	1.32	309	306	302	295	289	281	272	264
	90.0	26.47	1.32	328	324	319	313	306	297	288	279
	95.0	27.94	1.31	346	342	336	330	322	314	304	293
	100.0	29.41	1.31	364	360	354	348	339	330	320	309
18" B 65	55.0	15.93	1.15	197	194	190	185	180	173	166	160
	60.0	17.65	1.13	218	214	210	205	198	191	184	176
	65.0	19.12	1.11	236	232	227	221	214	206	198	189
	70.0	20.59	1.09	254	250	244	237	230	221	212	202
20" B 73	65.0	19.08	1.21	236	233	229	223	217	210	203	196
	70.0	20.59	1.19	254	251	246	240	234	226	218	209
	75.0	22.06	1.17	273	268	264	257	250	241	233	223
20" B 121	80.0	23.73	1.39	294	291	287	282	276	270	261	254
	85.0	25.00	1.37	309	307	302	297	290	283	275	266
	90.0	26.47	1.36	328	325	320	314	307	300	290	282
	95.0	27.94	1.35	346	343	337	331	324	315	307	296
	100.0	29.41	1.34	364	361	355	349	340	332	321	312
24" B 89	80.0	23.32	1.36	289	286	282	276	271	264	256	248
	85.0	25.00	1.33	309	306	302	295	289	281	273	264
	90.0	26.47	1.31	328	324	319	313	305	297	288	278
	95.0	27.94	1.30	346	342	336	330	322	313	303	293
	100.0	29.41	1.28	364	360	354	347	338	328	317	307
24" B 127	105.0	30.98	1.60	385	382	378	373	367	360	352	344
	110.0	32.48	1.58	403	400	396	390	384	376	368	359
	115.0	33.98	1.57	422	419	414	408	401	393	385	375

**SAFE LOADS IN THOUSANDS OF POUNDS
FOR I-BEAMS USED AS COLUMNS
WITH SQUARE ENDS.**

Based on Gordon's Formula, $P = \frac{50\,000}{1 + \frac{(12 L)^2}{36\,000 r^2}}$ Safety factor 4.

Length in Feet.										Weight per Foot.	Depth of Beam and Section.
10	11	12	13	14	15	16	17	18	19	Pounds.	Number.
116	110	105	99	93	88	83	79	74	42.0	15" B 53
123	116	110	104	98	93	87	82	78	45.0	
134	127	120	113	106	101	94	89	84	50.0	
147	139	131	124	116	109	103	97	91	55.0	
158	150	141	132	124	117	110	104	97	60.0	
173	166	159	152	144	137	130	124	117	111	60.0	15" B 109
187	179	171	163	154	147	140	132	126	120	65.0	
201	192	183	174	165	157	150	142	135	127	70.0	
214	205	195	186	176	168	158	151	142	135	75.0	
228	217	206	197	187	178	168	160	151	143	80.0	
239	231	221	213	203	194	186	177	169	161	80.0	15" B 113
254	245	235	226	216	206	197	188	180	171	85.0	
269	259	249	239	228	218	209	199	190	181	90.0	
284	272	261	251	240	228	219	208	199	190	95.0	
299	287	275	264	252	240	230	219	210	200	100.0	
153	145	139	132	125	119	112	106	100	95	55.0	18" B 65
168	160	152	144	137	129	122	116	110	104	60.0	
181	172	163	154	146	138	131	123	117	110	65.0	
192	183	173	164	155	146	138	130	123	116	70.0	
187	179	171	164	155	148	141	134	126	120	65.0	20" B 73
201	192	183	174	165	157	150	142	135	127	70.0	
214	204	194	185	175	167	158	150	142	135	75.0	
246	237	229	219	211	202	194	186	177	169	80.0	20" B 121
258	249	239	230	221	212	202	194	185	176	85.0	
271	262	253	241	232	223	213	204	195	185	90.0	
286	277	265	255	244	234	223	214	205	195	95.0	
300	290	278	267	257	245	235	223	214	203	100.0	
239	231	223	213	205	196	187	179	172	163	80.0	24" B 89
255	245	236	226	217	207	198	189	181	172	85.0	
269	258	247	238	227	216	207	197	189	180	90.0	
282	271	261	249	239	228	218	207	198	188	95.0	
296	284	272	260	249	238	226	215	205	196	100.0	
335	326	316	306	296	286	277	266	257	247	105.0	24" B 127
350	340	330	319	309	298	288	278	267	257	110.0	
365	355	344	333	322	311	300	289	278	268	115.0	

**SAFE LOADS IN THOUSANDS OF POUNDS FOR
PLATE AND ANGLE COLUMNS, SQUARE ENDS.
CALCULATED FOR LEAST RADIUS OF GYRATION,
AXIS 1-1.**

Based on Gordon's Formula, $P = \frac{50\,000}{1 + \frac{(12L)^2}{36\,000r^2}}$
Safety factor 4.

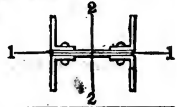

Size of Angles.	Size of Plate.	Weight of Column.	Area of Column Section.	Least Radius of Gyration Axis 1-1.	Radius of Gyration Axis 2-2.	Length in Feet.		
						2	4	6
Inches.	Inches.	Lbs. per Ft.	Sq. Ins.	Inches.	Inches.			
3 x 2 1/2 x 1/4	6 x 1/4	23.1	6.74	1.24	2.41	84	81	77
	" " 3/8	28.8	8.36	1.27	2.39	103	100	96
	" " 1/2	34.1	9.93	1.30	2.37	123	120	114
	" " 5/8	39.3	11.51	1.33	2.35	142	139	133
	" " 3/4	44.2	13.00	1.36	2.33	161	157	151
3 1/2 x 2 1/2 x 1/4	7 x 1/4	49.5	14.50	1.39	2.31	180	175	169
	" " 3/8	25.6	7.51	1.46	2.88	93	91	88
	" " 1/2	31.8	9.31	1.49	2.86	115	113	109
	" " 5/8	37.7	11.07	1.52	2.84	137	135	130
	" " 3/4	43.6	12.78	1.55	2.82	159	156	151
4 x 3 x 1/4	8 x 1/4	49.5	14.50	1.58	2.80	180	177	171
	" " 3/8	55.0	16.18	1.61	2.78	201	197	192
	" " 1/2	37.3	10.86	1.67	3.25	133	129
	" " 5/8	44.2	12.92	1.70	3.23	158	154
	" " 3/4	51.1	14.98	1.73	3.21	183	179
4 x 3 x 5/8	8 x 1/2	58.0	17.00	1.76	3.18	208	203
	" " 3/4	64.9	18.98	1.79	3.16	233	227
	" " 7/8	71.4	20.92	1.82	3.14	257	251
	" " 1 1/8	77.9	22.86	1.85	3.12	281	274
	" " 1 1/4	84.4	24.76	1.89	3.10	304	297
5 x 3 1/2 x 1/4	10 x 1/4	90.5	26.62	1.92	3.08	327	320
	" " 3/8	97.0	28.44	1.95	3.06	350	343
	" " 1/2	45.4	13.37	2.08	4.10	165	162
	" " 5/8	54.4	15.95	2.10	4.08	196	193
	" " 3/4	62.9	18.50	2.13	4.06	228	224
5 x 3 1/2 x 5/8	10 x 1/2	71.4	21.00	2.16	4.04	259	255
	" " 3/4	79.9	23.51	2.19	4.02	290	285
	" " 7/8	88.5	25.93	2.22	4.00	320	315
	" " 1 1/8	96.6	28.36	2.25	3.98	350	345
	" " 1 1/4	104.7	30.74	2.29	3.96	380	374
6 x 3 1/2 x 3/8	12 x 1/4	112.8	33.13	2.32	3.93	409	403
	" " 3/8	120.6	35.43	2.35	3.91	438	432
	" " 1/2	128.7	37.74	2.38	3.89	466	460
	" " 5/8	62.1	18.18	2.56	5.01	225	222
	" " 3/4	71.9	21.13	2.59	4.99	261	258
6 x 3 1/2 x 7/8	12 x 1/2	81.6	24.00	2.62	4.97	297	294
	" " 5/8	91.4	26.87	2.65	4.95	333	329
	" " 3/4	101.1	29.70	2.68	4.93	368	364
	" " 7/8	110.5	32.49	2.71	4.91	402	398
	" " 1 1/8	120.2	35.24	2.74	4.88	437	432
6 x 3 1/2 x 1 1/8	12 x 3/4	129.2	37.99	2.77	4.86	471	466
	" " 7/8	138.5	40.70	2.80	4.84	505	499
	" " 1 1/8	147.5	43.37	2.83	4.82	538	532
	" " 1 1/4	156.4	46.00	2.86	4.80	571	565

SAFE LOADS IN THOUSANDS OF POUNDS FOR PLATE AND ANGLE COLUMNS. SQUARE ENDS.

CALCULATED FOR LEAST RADIUS OF GYRATION, AXIS 1-1.

Based on Gordon's Formula,
$$P = \frac{50\,000}{1 + \frac{(12L)^2}{36\,000r^2}}$$

Safety factor 4.

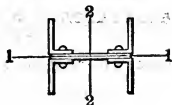

Length in Feet.

8	10	12	14	16	18	20	22	24	26	28	30	32	34
72	67	61	56	51
90	84	77	70	64
108	100	93	85	77
125	117	108	99	91
143	134	124	114	105
160	150	140	129	119
84	79	74	69	63	58	54
104	99	92	86	80	73	68
125	118	111	103	96	89	82
145	137	129	121	112	104	96
164	156	147	138	129	119	111
184	175	166	155	145	135	125
124	119	113	106	99	93	86	80	74
149	142	135	127	119	112	104	97	90
172	165	157	148	139	131	122	114	106
196	188	179	170	160	150	140	131	122
220	211	201	191	180	169	158	148	138
243	234	223	212	200	188	177	165	155
266	256	245	233	220	208	195	183	171
289	278	266	254	240	227	213	200	188
311	300	288	274	260	246	232	218	205
333	322	309	295	280	265	250	236	222
158	153	147	141	135	128	122	115	109	103	97
188	183	176	169	162	154	146	139	131	124	117
219	212	205	197	189	180	171	162	153	145	137
249	242	234	225	215	206	196	186	176	166	157
279	271	262	252	242	231	220	209	198	188	178
308	300	290	280	269	257	245	233	221	210	198
337	329	318	307	295	282	270	257	244	231	219
366	357	346	334	321	308	294	280	267	253	240
395	385	374	361	348	333	319	304	290	275	261
423	413	401	388	374	359	343	328	313	297	283
451	441	428	414	400	384	368	352	336	320	304
219	214	209	203	197	190	183	176	168	161	154	147	140	133
254	249	243	236	229	221	213	205	196	188	180	172	164	156
289	283	277	269	261	252	243	234	225	215	206	197	188	179
324	318	310	302	293	283	273	263	253	242	232	222	212	202
358	352	344	335	325	314	303	292	281	269	258	247	236	226
392	385	376	367	356	345	333	321	309	297	284	272	261	249
426	418	409	399	388	376	363	350	337	324	311	298	285	273
459	451	442	431	419	406	393	379	365	351	337	323	310	296
493	484	474	462	450	437	423	408	393	378	363	349	334	320
525	516	506	494	481	467	452	437	421	405	390	374	359	344
558	548	537	525	511	497	481	465	449	432	416	400	384	368

SAFE LOADS IN THOUSANDS OF POUNDS FOR PLATE AND ANGLE COLUMNS. SQUARE ENDS.

CALCULATED FOR LEAST RADIUS OF GYRATION,
AXIS 1-1.

Based on Gordon's Formula, $P = \frac{50\,000}{1 + \frac{(12L)^2}{36\,000r^2}}$
Safety factor 4.

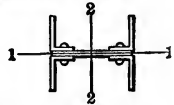

Size of Angles.	Size of Plate.	Weight of Column.	Area of Column Section.	Least Radius of Gyration Axis 1-1.	Radius of Gyration Axis 2-2.	Length in Feet.		
						2	4	6
Inches.	Inches.	Lbs. per Ft.	Sq. Ins.	Inches.	Inches.			
3	$2\frac{1}{2} \times \frac{1}{4}$	24.8	7.24	1.19	3.25	90	87	82
	$\frac{1}{8}$	30.9	8.98	1.22	3.23	111	108	102
	$\frac{3}{8}$	36.6	10.68	1.25	3.21	132	128	122
	$\frac{1}{2}$	42.3	12.38	1.28	3.19	153	149	142
	$\frac{5}{8}$	47.6	14.00	1.31	3.17	173	169	161
	$\frac{1}{8}$	53.3	15.62	1.34	3.15	193	188	181
3½	$2\frac{1}{2} \times \frac{1}{4}$	26.4	7.76	1.44	3.31	96	94	91
	$\frac{1}{8}$	32.9	9.62	1.47	3.28	119	117	113
	$\frac{3}{8}$	39.0	11.44	1.50	3.26	142	139	134
	$\frac{1}{2}$	45.1	13.22	1.53	3.24	164	161	156
	$\frac{5}{8}$	51.2	15.00	1.56	3.22	186	183	177
	$\frac{1}{8}$	56.9	16.74	1.59	3.20	208	204	198
4	$3 \times \frac{1}{8}$	39.4	11.49	1.62	4.09	140	136
	$\frac{3}{8}$	46.8	13.67	1.65	4.07	167	163
	$\frac{1}{2}$	54.1	15.86	1.68	4.04	194	189
	$\frac{5}{8}$	61.4	18.00	1.71	4.02	220	214
	$\frac{1}{8}$	68.7	20.11	1.74	4.00	246	240
	$\frac{3}{8}$	75.7	22.17	1.77	3.98	272	265
	$\frac{1}{2}$	82.6	24.24	1.80	3.96	297	290
	$\frac{5}{8}$	89.5	26.26	1.83	3.94	322	315
	$\frac{1}{8}$	96.0	28.25	1.86	3.92	347	339
	$\frac{3}{8}$	103.0	30.19	1.90	3.90	371	363
5	$3\frac{1}{2} \times \frac{1}{8}$	47.6	13.99	2.03	4.95	172	169
	$\frac{3}{8}$	56.9	16.70	2.06	4.92	206	202
	$\frac{1}{2}$	65.9	19.37	2.08	4.90	238	234
	$\frac{5}{8}$	74.8	22.00	2.11	4.88	271	266
	$\frac{1}{8}$	83.8	24.63	2.14	4.86	303	298
	$\frac{3}{8}$	92.7	27.18	2.17	4.84	335	330
	$\frac{1}{2}$	101.3	29.73	2.20	4.82	367	361
	$\frac{5}{8}$	109.8	32.24	2.23	4.80	398	392
	$\frac{1}{8}$	118.4	34.75	2.26	4.78	429	422
	$\frac{3}{8}$	126.5	37.18	2.29	4.76	459	452
	$\frac{1}{8}$	135.1	39.61	2.33	4.74	489	482
6	$3\frac{1}{2} \times \frac{3}{8}$	64.7	18.93	2.51	5.85	234	231
	$\frac{1}{2}$	74.8	22.01	2.54	5.83	272	269
	$\frac{5}{8}$	85.0	25.00	2.57	5.81	309	306
	$\frac{1}{8}$	95.2	28.00	2.59	5.79	347	343
	$\frac{3}{8}$	105.3	30.95	2.62	5.77	383	379
	$\frac{1}{2}$	115.1	33.87	2.65	5.74	419	415
	$\frac{5}{8}$	125.3	36.74	2.68	5.72	455	450
	$\frac{1}{8}$	134.7	39.62	2.71	5.70	491	486
	$\frac{3}{8}$	144.5	42.45	2.74	5.68	526	521
	$\frac{1}{2}$	153.8	45.25	2.77	5.66	561	555
	1	163.2	48.00	2.81	5.64	595	589

**SAFE LOADS IN THOUSANDS OF POUNDS FOR
PLATE AND ANGLE COLUMNS. SQUARE ENDS.**

CALCULATED FOR LEAST RADIUS OF GYRATION, AXIS 1-1.

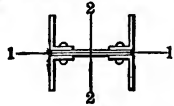

Based on Gordon's Formula,
$$P = \frac{50\,000}{1 + \frac{(12L)^2}{36\,000r^2}}$$

Safety factor 4.

Length in Feet.

8	10	12	14	16	18	20	22	24	26	28	30	32	34
77	71	65	58	53
96	89	81	74	67
115	106	98	89	81
134	124	114	105	95
152	142	131	120	110
171	160	148	136	124
86	81	76	70	65	60	55
107	101	95	88	81	75	69
128	121	114	106	98	91	83
149	141	133	124	115	106	98
170	161	151	142	132	122	113
190	180	170	159	149	138	128
131	125	118	111	103	96	89	83	77
156	149	141	133	124	116	108	100	93
182	174	165	155	145	136	127	118	109
207	198	188	177	167	156	145	135	126
232	222	211	200	188	176	164	153	143
256	246	234	222	209	196	184	171	160
281	270	257	244	230	216	203	190	177
305	293	280	266	251	237	222	208	195
329	317	303	288	273	257	242	227	212
352	340	325	310	294	277	261	245	230
165	159	153	147	140	133	126	119	112	105	99
197	191	184	176	168	160	151	143	135	127	120
229	222	214	205	196	186	177	167	158	149	141
260	252	244	234	224	213	202	192	181	171	162
291	283	273	263	251	240	228	216	205	194	183
322	313	303	291	279	267	254	241	228	216	204
353	343	332	320	307	293	279	266	252	239	226
383	373	361	348	334	320	305	290	276	261	247
413	403	390	376	362	346	331	315	299	284	269
443	432	419	405	389	373	357	340	323	307	291
473	461	447	432	416	399	382	365	347	330	313
228	223	217	211	204	196	189	181	173	166	158	151	143	136
264	259	252	245	237	229	220	211	202	194	185	176	168	160
301	295	287	279	270	261	251	241	231	221	212	202	193	184
337	330	322	313	304	293	283	272	261	250	239	228	217	207
373	366	357	347	337	325	314	302	290	278	266	254	242	231
408	400	391	381	369	357	345	332	319	306	293	280	268	255
444	435	425	414	402	389	376	362	348	334	320	306	293	280
478	470	459	447	435	421	407	392	377	362	347	333	318	304
513	504	493	480	467	453	438	422	406	390	375	359	344	329
547	538	526	513	499	484	468	452	435	419	402	385	369	353
581	571	559	546	531	515	499	482	464	447	429	412	395	378

**SAFE LOADS IN THOUSANDS OF POUNDS FOR
PLATE AND ANGLE COLUMNS. SQUARE ENDS.**

**CALCULATED FOR LEAST RADIUS OF GYRATION,
AXIS 1-1.**

Based on Gordon's Formula, $P = \frac{50\,000}{1 + \frac{(12L)^2}{36\,000r^2}}$

Safety factor 4.

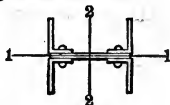

Size of Angles.	Size of Plate.	Weight of Column.	Area of Column Section.	Least Radius of Gyration Axis 1-1.	Radius of Gyration Axis 2-2.	Length in Feet.			
						2	4	6	
Inches.	Inches.	Lbs. per Ft.	Sq. Ins.	Inches.	Inches.				
3	x 2½ x ¼	10 x ¼	26.5	7.74	1.16	4.07	96	92	87
		10 x ⅜	33.0	9.61	1.18	4.05	119	115	109
		10 x ⅝	39.2	11.43	1.21	4.03	141	137	130
		10 x ¾	45.3	13.26	1.24	4.01	164	159	151
		10 x ⅞	51.0	15.00	1.27	3.99	186	180	172
3½	x 2½ x ¼	10 x ¼	28.1	8.26	1.39	4.13	102	100	96
		10 x ⅜	35.0	10.25	1.42	4.11	127	124	119
		10 x ⅝	41.6	12.19	1.45	4.09	151	148	143
		10 x ¾	48.1	14.10	1.48	4.07	175	171	165
		10 x ⅞	54.6	16.00	1.51	4.05	199	195	188
4	x 3 x ⅜	12 x ⅜	41.6	12.11	1.58	4.91	148	143
		12 x ½	49.3	14.42	1.61	4.89	176	171
		12 x ⅝	57.1	16.73	1.64	4.87	204	198
		12 x ¾	64.8	19.00	1.66	4.85	232	226
		12 x ⅞	72.6	21.23	1.69	4.83	260	253
		12 x 1	79.9	23.42	1.72	4.81	287	279
		12 x 1¼	87.3	25.61	1.75	4.79	314	306
		12 x 1½	94.6	27.76	1.78	4.77	340	332
		12 x 1¾	101.6	29.87	1.81	4.74	366	358
		12 x 1⅞	108.9	31.94	1.84	4.72	392	383
5	x 3½ x ⅝	14 x ⅝	49.7	14.62	1.98	5.77	180	176
		14 x ¾	59.5	17.45	2.01	5.75	215	211
		14 x ⅞	68.8	20.25	2.04	5.73	249	245
		14 x 1	78.2	23.00	2.07	5.71	283	278
		14 x 1¼	87.6	25.76	2.09	5.69	317	312
		14 x 1½	96.9	28.43	2.12	5.67	351	345
		14 x 1¾	105.9	31.11	2.15	5.64	381	377
		14 x 1⅞	114.9	33.74	2.18	5.62	416	410
		14 x 2	123.9	36.38	2.21	5.60	449	442
		14 x 2¼	132.5	38.93	2.24	5.58	481	473
6	x 3½ x ¾	16 x ¾	67.2	19.68	2.46	6.68	244	240
		16 x 1	77.8	22.88	2.49	6.66	283	279
		16 x 1¼	88.4	26.00	2.52	6.64	322	318
		16 x 1½	99.0	29.12	2.54	6.61	360	356
		16 x 1¾	109.6	32.20	2.57	6.59	399	394
		16 x 1⅞	119.8	35.24	2.60	6.57	436	431
		16 x 2	130.4	38.24	2.63	6.55	474	468
		16 x 2¼	140.2	41.24	2.66	6.53	511	505
		16 x 2½	150.4	44.20	2.69	6.51	548	542
		16 x 2¾	160.2	47.12	2.72	6.48	584	578
1	1	170.0	50.00	2.75	6.46	620	613	

**SAFE LOADS IN THOUSANDS OF POUNDS FOR
PLATE AND ANGLE COLUMNS. SQUARE ENDS.**

CALCULATED FOR LEAST RADIUS OF GYRATION, AXIS 1-1.

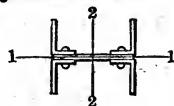

Based on Gordon's Formula, $P = \frac{50\,000}{1 + \frac{(12L)^2}{36\,000r^2}}$

Safety factor 4.

Length in Feet.

8	10	12	14	16	18	20	22	24	26	28	30	32	34
81	75	68	61	55
102	93	85	77	69
122	112	103	93	84
142	131	120	109	99
162	150	138	126	114
182	169	156	143	130
91	86	80	73	68	62	57
114	107	100	92	85	78	71
136	128	120	111	102	94	86
158	149	140	130	120	111	102
180	170	160	149	138	127	117
201	191	179	168	156	144	133
137	131	123	115	107	100	92	85	79
164	156	148	139	129	120	112	103	95
191	182	172	162	151	141	131	121	112
217	208	197	185	173	162	151	140	130
244	233	221	208	196	183	170	158	147
270	258	245	232	218	204	190	177	165
296	283	270	255	240	225	210	196	183
321	308	294	278	262	246	231	216	201
346	333	318	301	285	268	251	235	220
371	357	341	324	307	289	272	254	238
171	166	159	152	145	137	130	122	115	108	102
205	198	191	183	174	165	156	147	139	131	123
238	231	222	213	203	193	183	173	163	153	144
271	263	253	243	232	221	209	198	187	176	166
304	295	284	273	261	248	236	223	211	199	188
336	327	315	303	290	276	262	249	235	222	210
369	358	346	333	319	304	289	274	260	246	232
400	389	376	362	347	332	316	300	284	269	254
432	420	407	392	376	359	343	326	309	293	277
463	451	437	421	404	387	369	351	334	317	300
494	481	467	450	433	415	396	377	359	340	323
236	231	225	218	211	203	195	187	178	170	162	154	147	140
274	268	261	254	245	236	227	218	208	199	190	181	172	164
312	306	298	289	280	270	259	249	238	228	217	207	197	188
350	343	334	325	314	303	292	280	268	257	245	234	223	212
387	370	370	360	348	336	324	311	298	286	273	261	249	237
424	416	406	395	382	370	356	342	329	315	301	287	274	262
461	452	441	429	416	403	388	374	359	344	329	314	300	287
497	488	477	464	450	436	420	405	389	373	357	342	326	312
533	523	512	498	484	468	452	436	419	402	385	369	353	337
569	559	546	532	517	501	484	467	449	431	414	396	379	362
605	594	581	566	550	534	516	498	479	460	442	423	405	388

**SAFE LOADS IN THOUSANDS OF POUNDS FOR
PLATE AND ANGLE COLUMNS. SQUARE ENDS.
CALCULATED FOR LEAST RADIUS OF GYRATION,
AXIS 1-1.**

Based on Gordon's Formula, $P = \frac{50\,000}{1 + \frac{(12L)^2}{36\,000r^2}}$

Safety factor 4.

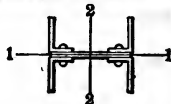

Size of Angles.	Size of Plate.	Weight of Column.	Area of Column Section.	Least Radius of Gyration Axis 1-1.	Radius of Gyration Axis 2-2.	Length in Feet.		
						2	4	6
Inches.	Inches.	Lbs. per Ft.	Sq. Ins.	Inches.	Inches.			
3	x 2½ x ¼	12 x ¼	8.24	1.12	4.87	102	98	92
		12 x ⅜	10.23	1.15	4.85	126	122	115
		12 x ½	12.18	1.17	4.83	151	146	138
		12 x ⅝	14.13	1.20	4.81	174	169	160
		12 x ¾	16.00	1.23	4.78	198	192	183
		61.0	17.87	1.26	4.76	221	215	205
3½	x 2½ x ¼	12 x ¼	8.76	1.35	4.94	108	106	101
		12 x ⅜	10.87	1.38	4.92	135	131	126
		12 x ½	12.94	1.41	4.90	160	157	151
		12 x ⅝	14.97	1.43	4.88	186	182	175
		12 x ¾	17.00	1.46	4.85	211	206	199
		64.6	18.99	1.49	4.83	236	231	223
4	x 3 x ⅜	14 x ⅜	12.74	1.54	5.72	155	150
		14 x ½	15.17	1.57	5.70	185	179
		14 x ⅝	17.61	1.60	5.68	215	208
		14 x ¾	20.00	1.62	5.66	244	237
		14 x ⅞	22.36	1.65	5.63	273	265
		14 x 1	24.67	1.68	5.61	302	294
		14 x 1¼	26.99	1.71	5.59	330	322
		14 x 1½	29.28	1.74	5.57	358	349
		14 x 1¾	31.50	1.77	5.55	386	376
		114.9	33.69	1.80	5.53	413	403
5	x 3½ x ⅜	16 x ⅜	15.24	1.94	6.59	187	183
		16 x ½	18.20	1.97	6.57	224	219
		16 x ⅝	21.12	2.00	6.54	260	255
		16 x ¾	24.00	2.02	6.52	295	290
		16 x ⅞	26.88	2.05	6.50	331	325
		16 x 1	29.68	2.08	6.48	366	359
		16 x 1¼	32.48	2.11	6.46	400	393
		16 x 1½	35.24	2.14	6.44	435	427
		16 x 1¾	38.00	2.17	6.41	468	461
		16 x 1⅞	40.68	2.19	6.39	502	494
				147.8	43.36	2.22	6.37
6	x 3½ x ⅝	18 x ⅝	20.43	2.42	7.49	253	249
		18 x ¾	23.76	2.44	7.47	294	290
		18 x ⅞	27.00	2.47	7.45	334	330
		18 x 1	30.25	2.50	7.42	374	369
		18 x 1¼	33.45	2.52	7.40	414	409
		18 x 1½	36.62	2.55	7.38	453	448
		18 x 1¾	39.74	2.58	7.36	492	486
		18 x 1⅞	42.87	2.61	7.34	531	525
		18 x 2	45.95	2.64	7.32	569	563
		18 x 2¼	49.00	2.67	7.29	607	600
		18 x 2½	52.00	2.70	7.27	644	637

**SAFE LOADS IN THOUSANDS OF POUNDS FOR
PLATE AND ANGLE COLUMNS. SQUARE ENDS.
CALCULATED FOR LEAST RADIUS OF GYRATION,
AXIS 1-1.**

Based on Gordon's Formula, $P = \frac{50\,000}{1 + \frac{(12\,L)^2}{36\,000\,r^2}}$

Safety factor 4.

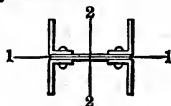

Length in Feet.

8	10	12	14	16	18	20	22	24	26	28	30	32	34
86	78	71	63	57
107	98	89	80	72
128	118	107	97	87
150	138	126	114	103
171	158	146	131	119
192	178	164	149	135
96	90	83	77	70	64	58
120	112	104	96	88	81	74
143	135	125	116	107	98	89
167	157	146	136	125	115	105
190	179	167	156	144	132	122
213	201	188	175	162	150	138
144	136	128	120	111	103	95	88	81
172	163	154	144	134	124	115	106	98
200	190	180	168	157	146	135	125	116
228	217	205	193	180	168	156	144	133
255	244	231	217	203	189	176	163	151
283	270	256	241	226	211	197	183	170
310	297	282	266	250	234	218	203	188
337	323	307	290	273	256	239	223	207
364	349	332	315	296	278	260	243	226
390	375	357	339	320	301	282	263	246
178	172	165	158	150	142	134	126	118	111	104
213	206	198	189	180	170	161	152	143	134	126
248	240	231	220	210	199	188	178	167	157	148
282	273	263	252	240	228	216	204	192	181	170
316	307	295	283	270	257	243	230	217	204	192
350	340	327	314	300	286	271	256	242	228	215
384	372	359	345	330	314	298	283	267	252	238
417	405	391	376	360	343	326	309	293	277	261
450	437	423	407	390	372	354	336	318	301	284
483	470	454	437	419	401	382	363	344	326	308
515	501	485	468	449	430	410	390	370	350	332
245	239	233	225	217	209	201	192	183	175	166	158	150	143
285	278	271	262	253	244	234	224	214	204	194	185	176	167
324	317	308	299	289	278	267	256	245	234	223	212	202	192
363	355	346	336	325	313	301	288	276	264	251	240	228	217
402	393	383	372	360	347	334	321	307	293	280	267	254	242
440	431	420	408	395	382	367	353	338	323	309	295	281	268
478	469	457	445	431	416	401	385	369	353	338	323	308	293
516	506	494	480	466	450	434	417	400	383	367	350	334	319
554	543	530	516	501	484	467	449	431	414	396	378	362	345
591	580	567	552	535	518	500	481	463	444	425	407	389	371
628	616	602	587	570	552	533	513	494	474	454	435	416	397

SAFE LOADS IN THOUSANDS OF POUNDS FOR PLATE AND ANGLE COLUMNS. SQUARE ENDS.

CALCULATED FOR LEAST RADIUS OF GYRATION,
AXIS 1-1.

Based on Gordon's Formula, $P = \frac{50\,000}{1 + \frac{(12L)^2}{36\,000r^2}}$
Safety factor 4.

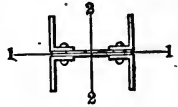

Size of Angles.	Size of Plate.	Weight of Column.	Area of Column Section.	Least Radius of Gyration Axis 1-1.	Radius of Gyration Axis 2-2.	Length in Feet.		
						6	8	10
Inches.	Inches.	Lbs. per Ft.	Sq. Ins.	Inches.	Inches.			
7 x 8½ x ⅞	14 x ⅞	80.8	23.73	3.05	5.92	292	289	285
" " ⅞	" " ⅞	91.8	27.00	3.08	5.90	332	329	324
" " ⅞	" " ⅞	103.2	30.24	3.11	5.87	372	368	363
" " ⅞	" " ⅞	113.7	33.43	3.13	5.85	412	407	402
" " ⅞	" " ⅞	124.7	36.63	3.17	5.83	451	446	440
" " ⅞	" " ⅞	135.3	39.74	3.20	5.81	490	485	478
" " ⅞	" " ⅞	145.9	42.86	3.23	5.79	528	523	516
" " ⅞	" " ⅞	156.5	45.93	3.26	5.76	567	561	553
" " ⅞	" " ⅞	166.6	49.01	3.29	5.74	604	598	591
" " 1	" " 1	176.8	52.00	3.32	5.72	642	636	627
7 x 8½ x ⅞	16 x ⅞	83.8	24.60	3.00	6.75	303	299	294
" " ⅞	" " ⅞	95.2	28.00	3.02	6.73	345	340	335
" " ⅞	" " ⅞	107.0	31.36	3.06	6.71	386	382	376
" " ⅞	" " ⅞	118.0	34.68	3.08	6.69	427	422	416
" " ⅞	" " ⅞	129.4	38.00	3.11	6.67	468	463	456
" " ⅞	" " ⅞	140.4	41.24	3.14	6.64	508	503	496
" " ⅞	" " ⅞	151.4	44.48	3.17	6.62	548	542	535
" " ⅞	" " ⅞	162.4	47.68	3.20	6.60	588	582	574
" " ⅞	" " ⅞	173.0	50.88	3.23	6.58	627	621	612
" " 1	" " 1	183.6	54.00	3.26	6.56	666	659	651
7 x 8½ x ⅞	18 x ⅞	86.8	25.48	2.94	7.58	313	309	305
" " ⅞	" " ⅞	98.6	29.00	2.97	7.55	357	352	347
" " ⅞	" " ⅞	110.8	32.49	3.00	7.53	400	395	389
" " ⅞	" " ⅞	122.3	35.93	3.02	7.51	442	437	430
" " ⅞	" " ⅞	134.1	39.38	3.06	7.49	485	479	472
" " ⅞	" " ⅞	145.5	42.74	3.08	7.47	526	520	513
" " ⅞	" " ⅞	156.9	46.11	3.11	7.44	568	562	554
" " ⅞	" " ⅞	168.4	49.43	3.14	7.42	609	602	594
" " ⅞	" " ⅞	179.4	52.76	3.17	7.40	650	643	634
" " 1	" " 1	190.4	56.00	3.20	7.38	690	683	674
7 x 8½ x ⅞	20 x ⅞	89.8	26.35	2.89	8.39	324	320	314
" " ⅞	" " ⅞	102.0	30.00	2.92	8.37	369	364	358
" " ⅞	" " ⅞	114.7	33.61	2.95	8.34	413	408	402
" " ⅞	" " ⅞	126.5	37.18	2.97	8.32	457	452	445
" " ⅞	" " ⅞	138.7	40.75	3.00	8.30	501	495	488
" " ⅞	" " ⅞	150.6	44.24	3.03	8.28	545	538	530
" " ⅞	" " ⅞	162.5	47.73	3.06	8.25	588	581	572
" " ⅞	" " ⅞	174.3	51.18	3.09	8.23	630	623	614
" " ⅞	" " ⅞	185.8	54.63	3.12	8.21	673	665	656
" " 1	" " 1	197.2	58.00	3.15	8.19	715	707	697

**SAFE LOADS IN THOUSANDS OF POUNDS FOR
PLATE AND ANGLE COLUMNS.
SQUARE ENDS.**

CALCULATED FOR LEAST RADIUS OF GYRATION, AXIS 1-1.

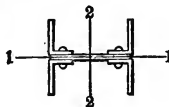

Based on Gordon's Formula, $P = \frac{50\,000}{1 + \frac{(12L)^2}{36\,000r^2}}$
Safety factor 4.

Length in Feet.

12	14	16	18	20	22	24	26	28	30	32	34	36	38	40
279	274	267	260	253	246	238	230	222	214	206	198	191	183	176
318	312	305	297	289	280	271	263	254	245	236	227	218	210	201
357	350	342	333	324	315	305	295	286	276	266	256	246	237	228
395	387	379	369	359	349	339	328	317	306	295	284	274	263	253
433	424	415	405	395	384	372	360	349	337	325	313	302	290	279
470	462	452	441	430	418	406	393	380	368	355	342	330	318	306
508	498	488	477	465	452	439	425	412	398	385	371	358	345	332
545	535	524	512	499	486	472	458	443	429	415	400	386	372	358
581	571	559	547	534	520	505	490	475	460	444	429	414	399	385
618	607	595	582	568	553	538	522	506	490	474	458	442	427	412
289	283	276	269	261	253	245	236	228	220	211	203	195	187	180
329	322	315	307	298	289	280	270	261	251	242	232	223	214	206
369	362	353	344	335	325	314	304	293	283	272	262	252	242	233
409	400	391	381	371	360	349	337	326	314	303	291	280	269	259
448	439	429	419	407	396	383	371	359	346	334	321	309	297	286
487	478	467	456	444	431	418	405	391	378	364	351	338	325	313
526	516	505	493	480	466	452	438	424	409	395	381	367	353	340
564	554	542	529	516	501	487	472	456	441	426	411	396	381	367
603	591	579	566	551	536	521	505	489	473	457	441	425	409	394
640	629	616	602	587	571	555	538	521	504	487	471	454	437	421
299	292	285	277	269	260	252	243	234	225	216	208	199	191
340	333	325	316	307	297	287	277	267	257	248	238	228	219
382	374	365	355	345	334	323	312	301	290	279	268	258	247
423	414	404	393	382	371	359	347	335	322	310	298	287	275
463	454	443	432	420	407	395	382	368	355	342	329	316	304
504	494	483	470	457	444	430	416	402	388	374	360	346	333
544	533	521	508	495	481	466	451	436	420	405	390	376	361
584	573	560	546	532	517	501	485	469	453	437	421	405	390
624	612	598	584	569	553	536	520	503	486	469	452	435	419
663	650	636	622	606	589	572	554	536	518	500	483	465	448
308	301	294	285	277	268	258	249	240	230	221	212	204	195
351	343	335	326	316	306	295	285	274	264	253	243	233	224
394	385	376	366	355	344	332	321	309	297	286	274	263	253
436	427	417	405	394	381	369	356	343	330	318	305	293	281
479	468	457	445	432	419	406	392	378	364	350	337	323	310
521	510	498	485	471	457	442	427	412	397	383	368	354	340
562	551	538	524	510	495	479	463	447	431	415	400	384	369
603	591	578	563	548	532	515	499	482	465	448	431	415	399
644	632	618	602	586	569	552	534	516	498	480	463	445	428
685	672	657	641	624	607	588	570	551	532	513	494	476	458

**SAFE LOADS IN THOUSANDS OF POUNDS FOR
PLATE AND ANGLE COLUMNS. SQUARE ENDS.**
CALCULATED FOR RADIUS OF GYRATION,
AXIS 2-2.

Based on Gordon's Formula, $P = \frac{50,000}{1 + \frac{(12L)^2}{36,000r^2}}$
Safety factor 4.

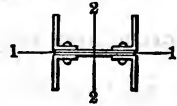

Size of Angles.	Size of Plate.	Weight of Column.	Area of Column Section.	Least Radius of Gyration Axis 1-1.	Radii of Gyration Axis 2-2.	Length in Feet.		
						4	6	8
Inches.	Inches.	Lbs. per Ft.	Sq. Ins.	Inches	Inches.			
3 x 2½ x ¼	6 x ¼	23.1	6.74	1.24	2.41	83	82	81
" " ⅜	" ⅜	28.8	8.36	1.27	2.39	103	102	100
" " ⅝	" ⅝	34.1	9.93	1.30	2.37	123	121	119
" " ¾	" ¾	39.3	11.51	1.33	2.35	142	140	137
" " ⅞	" ⅞	44.2	13.00	1.36	2.33	161	158	155
" " 1	" 1	49.5	14.50	1.39	2.31	179	176	173
3½ x 2½ x ¼	7 x ¼	25.6	7.51	1.46	2.88	93	92	91
" " ⅜	" ⅜	31.8	9.31	1.49	2.86	115	114	113
" " ⅝	" ⅝	37.7	11.07	1.52	2.84	137	136	134
" " ¾	" ¾	43.6	12.78	1.55	2.82	159	157	155
" " ⅞	" ⅞	49.5	14.50	1.58	2.80	180	178	176
" " 1	" 1	55.0	16.18	1.61	2.78	200	198	196
4 x 3 x ⅝	8 x ⅝	37.3	10.86	1.67	3.25	134	133
" " ¾	" ¾	44.2	12.92	1.70	3.23	160	158
" " ⅝	" ⅝	51.1	14.98	1.73	3.21	185	183
" " ¾	" ¾	58.0	17.00	1.76	3.18	210	207
" " ⅞	" ⅞	64.9	18.98	1.79	3.16	234	231
" " 1	" 1	71.4	20.92	1.82	3.14	258	255
" " 1 ⅛	" 1 ⅛	77.9	22.86	1.85	3.12	282	278
" " 1 ¼	" 1 ¼	84.4	24.76	1.89	3.10	305	301
" " 1 ⅝	" 1 ⅝	90.5	26.62	1.92	3.08	328	324
" " 1 ¾	" 1 ¾	97.0	28.44	1.95	3.06	350	346
5 x 3½ x ⅝	10 x ⅝	45.4	13.37	2.08	4.10	166	165
" " ¾	" ¾	54.4	15.95	2.10	4.08	198	196
" " ⅝	" ⅝	62.9	18.50	2.13	4.06	229	228
" " ¾	" ¾	71.4	21.00	2.16	4.04	260	258
" " ⅞	" ⅞	79.9	23.51	2.19	4.02	291	289
" " 1	" 1	88.5	25.93	2.22	4.00	321	319
" " 1 ⅛	" 1 ⅛	96.6	28.36	2.25	3.98	351	349
" " 1 ¼	" 1 ¼	104.7	30.74	2.29	3.96	381	378
" " 1 ⅝	" 1 ⅝	112.8	33.13	2.32	3.93	410	407
" " 1 ¾	" 1 ¾	120.6	35.43	2.35	3.91	439	436
" " 1 ⅞	" 1 ⅞	128.7	37.74	2.38	3.89	467	464
6 x 3½ x ⅝	12 x ⅝	62.1	18.18	2.56	5.01	225
" " ¾	" ¾	71.9	21.13	2.59	4.99	261
" " ⅝	" ⅝	81.6	24.00	2.62	4.97	297
" " ¾	" ¾	91.4	26.87	2.65	4.95	332
" " ⅞	" ⅞	101.1	29.70	2.68	4.93	367
" " 1	" 1	110.5	32.49	2.71	4.91	402
" " 1 ⅛	" 1 ⅛	120.2	35.24	2.74	4.88	436
" " 1 ¼	" 1 ¼	129.2	37.99	2.77	4.86	470
" " 1 ⅝	" 1 ⅝	138.5	40.70	2.80	4.84	503
" " 1 ¾	" 1 ¾	147.5	43.37	2.83	4.82	536
" " 1 ⅞	" 1 ⅞	156.4	46.00	2.86	4.80	569

**SAFE LOADS IN THOUSANDS OF POUNDS FOR
PLATE AND ANGLE COLUMNS. SQUARE ENDS.**

**CALCULATED FOR RADIUS OF GYRATION,
AXIS 2-2.**

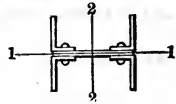

Based on Gordon's Formula, $P = \frac{50\,000}{1 + \frac{(12L)^2}{36\,000r^2}}$

Safety factor 4.

Length in Feet.

10	12	14	16	18	20	22	24	26	28	30	32	34	36	38	40
79	77	74	72	69	66	63	60	58	55	52
98	95	92	89	85	82	78	75	71	68	64
116	113	109	105	101	97	92	88	84	80	76
134	130	126	121	116	111	106	101	96	92	87
151	147	142	137	131	126	120	114	108	103	98
169	163	158	152	146	139	133	127	120	114	108
89	88	86	83	81	79	76	73	71	68	65	63	60	58
111	109	106	103	100	97	94	91	87	84	81	77	74	71
132	129	126	123	119	115	112	108	104	100	96	92	88	84
152	149	146	142	137	133	129	124	119	115	110	106	101	97
172	169	165	160	156	151	145	140	135	129	124	119	114	109
192	188	183	178	173	167	162	156	150	144	138	132	126	121
131	129	126	124	121	118	115	111	108	105	101	98	94	91	88	85
156	153	150	147	144	140	136	132	128	124	120	116	112	108	104	100
180	177	174	170	166	162	158	153	148	143	139	134	129	124	120	115
204	201	197	193	188	184	178	173	168	162	157	151	146	141	135	130
228	224	220	215	210	205	199	193	187	181	175	168	162	156	150	145
252	247	243	237	231	225	219	212	206	199	192	185	178	172	165	159
274	270	264	259	252	245	238	231	224	216	209	201	194	187	179	173
297	292	286	280	273	265	258	250	242	233	225	217	209	201	193	186
319	314	307	300	293	285	276	268	259	250	241	232	224	215	207	199
341	335	328	321	312	304	295	285	276	266	257	248	238	229	220	211
163	161	160	157	155	153	150	147	144	141	138	134	131	128	124	121
195	193	190	188	185	182	179	175	171	168	164	160	156	152	148	144
226	223	221	218	214	211	207	203	199	194	190	185	181	176	171	166
256	254	250	247	243	239	235	230	225	220	215	210	205	199	194	189
287	284	280	276	272	267	262	257	251	246	240	234	228	222	216	210
316	313	309	305	300	295	289	283	277	271	265	258	251	245	238	232
346	342	338	333	328	322	316	309	303	296	289	282	274	267	260	252
375	371	366	361	355	349	342	335	328	320	312	305	297	289	281	273
403	399	394	388	382	375	368	360	352	344	336	327	319	310	301	293
432	427	421	415	408	401	393	385	377	368	359	350	340	331	322	313
460	454	449	442	435	427	418	410	400	391	381	371	362	352	342	332
224	222	221	218	216	214	211	208	205	202	199	196	192	189	185	181
260	258	256	253	251	248	245	242	238	234	231	227	223	218	214	210
295	293	291	288	285	282	278	274	270	266	262	257	253	248	243	238
330	328	325	322	319	315	311	307	302	298	293	288	282	277	272	266
365	363	360	356	352	348	344	339	334	329	323	318	312	306	300	294
399	397	393	389	385	381	376	371	365	359	353	347	341	334	327	321
433	430	427	422	418	413	408	402	396	389	383	376	369	362	355	347
467	463	460	455	450	445	439	433	426	419	412	405	397	389	382	374
500	496	492	487	482	476	470	463	456	449	441	433	425	417	408	400
533	529	524	519	513	507	500	493	486	478	469	461	452	443	434	425
565	561	556	551	544	538	530	523	515	506	497	488	479	469	460	450

**SAFE LOADS IN THOUSANDS OF POUNDS FOR
PLATE AND ANGLE COLUMNS. SQUARE ENDS.
CALCULATED FOR RADIUS OF GYRATION,
AXIS 2-2.**

Based on Gordon's Formula, $P = \frac{50\,000}{1 + \frac{(12L)^2}{36\,000r^2}}$
Safety factor 4.

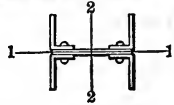

Size of Angles	Size of Plate.	Weight of Column.	Area of Column Section.	Least Radius of Gyration Axis 1-1.	Radius of Gyration Axis 2-2.	Length in Feet.		
						4	6	8
Inches.	Inches.	Lbs. per Ft.	Sq. Ins.	Inches.	Inches.			
3 x 2½ x ¼	8 x ¼	24.8	7.24	1.19	3.25	90	89	88
" " ⅜	" ⅜	30.9	8.98	1.22	3.23	112	111	110
" " ½	" ½	36.6	10.68	1.25	3.21	133	132	130
" " ⅝	" ⅝	42.3	12.38	1.28	3.19	154	152	151
" " ¾	" ¾	47.6	14.00	1.31	3.17	174	173	171
" " ⅞	" ⅞	53.3	15.62	1.34	3.15	194	192	190
3½ x 2½ x ¼	8 x ¼	26.4	7.76	1.44	3.31	96	95
" " ⅜	" ⅜	32.9	9.62	1.47	3.28	119	117
" " ½	" ½	39.0	11.44	1.50	3.26	141	140
" " ⅝	" ⅝	45.1	13.22	1.53	3.24	163	161
" " ¾	" ¾	51.2	15.00	1.56	3.22	185	183
" " ⅞	" ⅞	56.9	16.74	1.59	3.20	206	204
4 x 3 x ⅜	10 x ⅜	39.4	11.49	1.62	4.09	142	141
" " ½	" ½	46.8	13.67	1.65	4.07	170	169
" " ¾	" ¾	54.1	15.86	1.68	4.04	197	195
" " ⅝	" ⅝	61.4	18.00	1.71	4.02	223	222
" " ¾	" ¾	68.7	20.11	1.74	4.00	249	247
" " ⅞	" ⅞	75.7	22.17	1.77	3.98	275	273
" " 1	" 1	82.6	24.24	1.80	3.96	300	298
" " 1¼	" 1¼	89.5	26.26	1.83	3.94	325	323
" " 1½	" 1½	96.0	28.25	1.86	3.92	350	347
" " 1¾	" 1¾	103.0	30.19	1.90	3.90	374	371
5 x 3½ x ⅜	12 x ⅜	47.6	13.99	2.03	4.95	173
" " ½	" ½	56.9	16.70	2.06	4.92	206
" " ¾	" ¾	65.9	19.37	2.08	4.90	239
" " ⅝	" ⅝	74.8	22.00	2.11	4.88	272
" " ¾	" ¾	83.8	24.63	2.14	4.86	304
" " ⅞	" ⅞	92.7	27.18	2.17	4.84	336
" " 1	" 1	101.3	29.73	2.20	4.82	368
" " 1¼	" 1¼	109.8	32.24	2.23	4.80	399
" " 1½	" 1½	118.4	34.75	2.26	4.78	429
" " 1¾	" 1¾	126.5	37.18	2.29	4.76	460
" " 2	" 2	135.1	39.61	2.33	4.74	490
6 x 3½ x ⅜	14 x ⅜	64.7	18.93	2.51	5.85
" " ½	" ½	74.8	22.01	2.54	5.83
" " ¾	" ¾	85.0	25.00	2.57	5.81
" " ⅝	" ⅝	95.2	28.00	2.59	5.79
" " ¾	" ¾	105.3	30.95	2.62	5.77
" " ⅞	" ⅞	115.1	33.87	2.65	5.74
" " 1	" 1	125.3	36.74	2.68	5.72
" " 1¼	" 1¼	134.7	39.62	2.71	5.70
" " 1½	" 1½	144.5	42.45	2.74	5.68
" " 1¾	" 1¾	153.8	45.25	2.77	5.66
" " 2	" 2	163.2	48.00	2.81	5.64

**SAFE LOADS IN THOUSANDS OF POUNDS FOR
PLATE AND ANGLE COLUMNS. SQUARE ENDS.
CALCULATED FOR RADIUS OF GYRATION,
AXIS 2-2.**

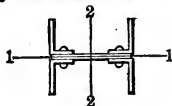

Based on Gordon's Formula, $P = \frac{50\,000}{1 + \frac{(12L)^2}{36\,000r^2}}$

Safety factor 4.

Length in Feet.

10	12	14	16	18	20	22	24	26	28	30	32	34	36	38	40
87	86	84	83	81	79	77	74	72	70	68	65	63	61	59	56
108	106	104	102	100	97	95	92	89	86	83	81	78	75	72	70
129	127	124	122	119	116	112	109	106	102	99	96	92	89	86	82
149	146	143	140	137	133	130	126	122	118	114	110	106	102	99	95
168	166	162	159	155	151	147	142	138	133	129	124	120	115	111	107
188	184	181	177	173	168	163	158	153	148	143	138	133	128	123	119
93	92	90	89	87	85	82	80	78	75	73	70	68	66	63	61
116	114	112	110	108	105	102	99	96	93	90	87	84	81	78	75
138	136	133	130	127	124	121	118	114	110	107	103	100	96	93	89
159	157	154	151	147	144	140	136	132	127	123	119	115	111	107	103
181	178	174	171	167	162	158	153	149	144	139	134	130	125	120	116
201	198	194	190	186	181	176	171	165	160	155	149	144	139	134	129
140	139	137	135	133	131	129	126	124	121	118	115	112	110	107	104
167	165	163	161	159	156	153	150	147	144	141	137	134	130	127	123
194	192	189	187	184	181	177	174	170	166	162	159	155	151	147	143
220	217	215	212	208	205	201	197	193	189	184	180	175	170	166	161
245	243	240	236	233	229	224	220	215	210	205	200	195	190	185	180
271	268	264	261	256	252	247	242	237	232	226	220	215	209	203	198
295	292	289	284	280	275	270	264	258	253	246	240	234	228	222	215
320	316	312	308	303	298	292	286	280	273	266	260	253	246	239	232
344	340	336	331	326	320	314	307	300	293	286	279	271	264	257	249
368	364	359	354	348	342	335	328	320	313	305	297	289	282	274	266
172	171	169	168	166	164	162	160	157	155	152	150	147	144	141	139
205	204	202	200	198	196	193	191	188	185	182	178	175	172	168	165
238	236	234	232	230	227	224	221	218	214	210	207	203	199	195	191
270	269	266	264	261	258	254	251	247	243	239	235	230	226	221	217
303	300	298	295	292	288	284	280	276	272	267	262	257	252	247	242
334	332	329	326	322	318	314	309	305	300	295	289	284	278	273	267
365	363	359	356	352	348	343	338	333	327	322	316	310	304	298	291
396	393	390	386	382	377	372	366	361	355	349	342	336	329	322	315
427	423	420	415	411	406	400	394	388	382	375	368	361	354	346	339
457	453	449	445	440	434	428	422	415	408	401	394	386	378	370	362
486	483	478	474	468	462	456	449	442	434	427	419	410	402	394	385
234	233	231	230	228	226	224	222	219	217	214	211	209	206	203	199
272	270	269	267	265	263	260	257	255	252	249	245	242	239	235	231
309	307	305	303	301	298	296	293	289	286	282	279	275	271	267	263
346	344	342	340	337	334	331	327	324	320	316	312	307	303	298	294
382	380	378	375	372	369	365	362	358	353	349	344	340	335	330	324
418	416	413	411	407	404	400	396	391	387	382	377	371	366	360	355
454	451	449	445	442	438	434	429	424	419	414	408	403	397	391	384
489	487	483	480	476	472	467	462	457	452	446	440	433	427	420	414
524	521	518	514	510	505	500	495	490	484	477	471	464	457	450	443
559	556	552	548	544	539	533	528	521	515	508	501	494	487	479	471
593	589	586	581	577	571	566	559	553	546	539	532	524	516	508	500

**SAFE LOADS IN THOUSANDS OF POUNDS FOR
PLATE AND ANGLE COLUMNS. SQUARE ENDS.
CALCULATED FOR RADIUS OF GYRATION,
AXIS 2-2.**

Based on Gordon's Formula, $P = \frac{50,000}{1 + \frac{(12L)^2}{36,000r^2}}$

Safety factor 4.

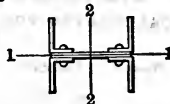

Size of Angles.	Size of Plate.	Weight of Column.	Area of Column Section.	Least Radius of Gyration Axis 1-1.	Radius of Gyration Axis 2-2.	Length in Feet.		
						6	8	10
Inches.	Inches.	Lbs. per Ft.	Sq. Ins.	Inches.	Inches.			
3 x 2½ x ¼	10 x ¼	26.5	7.74	1.16	4.07	96	95	95
	10 x ⅜	33.0	9.61	1.18	4.05	119	118	117
	10 x ½	39.2	11.43	1.21	4.03	142	141	140
	10 x ⅝	45.3	13.26	1.24	4.01	164	163	161
	10 x ¾	51.0	15.00	1.27	3.99	186	185	183
3½ x 2½ x ¼	10 x ¼	28.1	8.26	1.39	4.13	102	102	101
	10 x ⅜	35.0	10.25	1.42	4.11	127	126	125
	10 x ½	41.6	12.19	1.45	4.09	151	150	149
	10 x ⅝	48.1	14.10	1.48	4.07	175	174	172
	10 x ¾	54.6	16.00	1.51	4.05	198	197	195
4 x 3 x ¼	12 x ¼	41.6	12.11	1.58	4.91	150	149
	12 x ⅜	49.3	14.42	1.61	4.89	179	178
	12 x ½	57.1	16.73	1.64	4.87	207	206
	12 x ⅝	64.8	19.00	1.66	4.85	235	234
	12 x ¾	72.6	21.23	1.69	4.83	262	261
4 x 3 x ⅜	12 x ⅜	79.9	23.42	1.72	4.81	290	288
	12 x ½	87.3	25.61	1.75	4.79	317	315
	12 x ⅝	94.6	27.76	1.78	4.77	343	341
	12 x ¾	101.6	29.87	1.81	4.74	369	367
	12 x ⅞	108.9	31.94	1.84	4.72	395	392
5 x 3½ x ¼	14 x ¼	49.7	14.62	1.98	5.77	180
	14 x ⅜	59.5	17.45	2.01	5.75	215
	14 x ½	68.8	20.25	2.04	5.73	250
	14 x ⅝	78.2	23.00	2.07	5.71	284
	14 x ¾	87.6	25.76	2.09	5.69	318
5 x 3½ x ⅜	14 x ⅜	96.9	28.43	2.12	5.67	351
	14 x ½	105.9	31.11	2.15	5.64	384
	14 x ⅝	114.9	33.74	2.18	5.62	417
	14 x ¾	123.9	36.38	2.21	5.60	449
	14 x ⅞	132.5	38.93	2.24	5.58	481
6 x 3½ x ¼	16 x ¼	141.4	41.49	2.27	5.56	512
	16 x ⅜	67.2	19.68	2.46	6.68
	16 x ½	77.8	22.88	2.49	6.66
	16 x ⅝	88.4	26.00	2.52	6.64
	16 x ¾	99.0	29.12	2.54	6.61
6 x 3½ x ⅜	16 x ⅜	109.6	32.20	2.57	6.59
	16 x ½	119.8	35.24	2.60	6.57
	16 x ⅝	130.4	38.24	2.63	6.55
	16 x ¾	140.2	41.24	2.66	6.53
	16 x ⅞	150.4	44.20	2.69	6.51
6 x 3½ x ½	16 x ⅞	160.2	47.12	2.72	6.48
	16 x 1	170.0	50.00	2.75	6.46

**SAFE LOADS IN THOUSANDS OF POUNDS FOR
PLATE AND ANGLE COLUMNS. SQUARE ENDS.**

**CALCULATED FOR RADIUS OF GYRATION,
AXIS 2-2.**

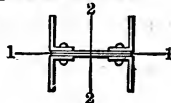

Based on Gordon's Formula, $P = \frac{50\,000}{1 + \frac{(12L)^2}{36\,000r^2}}$

Safety factor 4.

Length in Feet.

12	14	16	18	20	22	24	26	28	30	32	34	36	38	40
94	92	91	90	88	87	85	83	81	80	78	76	74	72	70
116	115	113	111	109	107	105	103	101	98	96	94	91	89	86
138	136	135	132	130	128	125	123	120	117	114	111	108	105	103
160	158	156	153	150	148	145	142	138	135	132	128	125	122	118
181	179	176	173	170	167	164	160	157	153	149	145	141	138	134
202	199	196	193	190	186	183	179	174	170	166	162	157	153	149
100	99	97	96	94	93	91	89	87	85	83	81	79	77	75
124	122	121	119	117	115	113	110	108	106	103	101	98	95	93
147	146	144	141	139	137	134	131	128	125	122	119	116	113	110
170	168	166	164	161	158	155	152	148	145	141	138	134	131	127
193	191	188	185	182	179	175	172	168	164	160	156	152	148	144
216	213	210	207	203	199	195	191	187	183	178	174	169	165	160
148	147	145	144	142	140	138	136	134	132	129	127	125	122	120
176	175	173	171	169	167	165	162	160	157	154	151	148	145	142
204	202	200	198	196	193	191	188	185	182	178	175	172	168	165
232	230	228	225	222	219	216	213	210	206	202	198	195	191	187
259	257	254	251	248	245	242	238	234	230	226	221	217	213	208
286	283	281	277	274	270	266	262	258	254	249	244	239	234	229
312	310	306	303	299	295	291	286	282	277	272	266	261	256	250
338	335	332	328	324	320	315	310	305	299	294	288	282	277	271
364	361	357	353	348	344	339	333	328	322	316	310	303	297	291
389	386	382	377	373	367	362	356	350	344	337	331	324	317	310
180	178	177	176	174	173	171	169	167	165	163	160	158	156	153
214	213	211	210	208	206	204	202	199	197	194	191	188	186	183
249	247	245	243	241	239	236	234	231	228	225	222	218	215	212
283	281	279	277	274	271	269	265	262	259	255	252	248	244	240
316	314	312	309	307	304	300	297	293	290	286	281	277	273	269
349	347	345	342	339	335	332	328	324	320	315	311	306	301	296
382	380	377	374	370	367	363	358	354	349	345	340	334	329	324
414	412	409	405	402	398	393	389	384	379	373	368	362	357	351
446	443	440	436	432	428	423	418	413	408	402	396	390	384	378
478	475	471	467	463	458	453	448	442	436	430	424	417	411	404
509	506	502	498	493	488	483	477	471	465	458	451	444	437	430
243	242	241	239	238	236	234	232	230	228	225	223	221	218	215
282	281	279	278	276	274	272	269	267	264	262	259	256	253	250
321	319	318	316	314	311	309	306	303	300	297	294	291	287	284
359	357	356	353	351	348	346	343	340	336	333	329	325	321	317
397	395	393	391	388	385	382	379	375	372	368	364	359	355	351
435	433	430	428	425	421	418	414	411	406	402	398	393	388	384
472	470	467	464	461	457	454	450	446	441	436	432	427	421	416
509	506	503	500	497	493	489	485	480	475	470	465	459	454	448
545	542	539	536	532	528	524	519	514	509	504	498	492	486	480
581	578	575	571	567	563	558	553	548	542	537	531	524	518	511
617	613	610	606	602	597	592	587	581	575	569	563	556	549	542

**SAFE LOADS IN THOUSANDS OF POUNDS FOR
PLATE AND ANGLE COLUMNS. SQUARE ENDS.**

**CALCULATED FOR RADIUS OF GYRATION,
AXIS 2-2.**

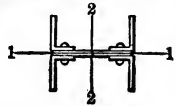

Based on Gordon's Formula, $P = \frac{50\,000}{1 + \frac{(12\,L)^2}{36\,000\,r^2}}$

Safety factor 4.

Size of Angles.	Size of Plate.	Weight of Column.	Area of Column Section.	Least Radius of Gyration Axis 1-1.	Radius of Gyration Axis 2-2.	Length in Feet.			
						6	8	10	
Inches.	Inches.	Lbs. per Ft.	Sq. Ins.	Inches.	Inches.				
3	x 2½ x ¼	12 x ¼	28.2	8.24	1.12	4.87	103	102	101
		12 x ⅜	35.2	10.23	1.15	4.85	127	126	126
		12 x ½	41.7	12.18	1.17	4.83	151	151	150
		12 x ⅝	48.3	14.13	1.20	4.81	175	174	173
		12 x ¾	54.4	16.00	1.23	4.78	199	198	197
12 x ⅞	61.0	17.87	1.26	4.76	222	221	219		
3½	x 2½ x ¼	12 x ¼	29.8	8.76	1.35	4.94	108	108
		12 x ⅜	37.2	10.87	1.38	4.92	134	134
		12 x ½	44.1	12.94	1.41	4.90	160	159
		12 x ⅝	51.1	14.97	1.43	4.88	185	184
		12 x ¾	58.0	17.00	1.46	4.85	210	209
12 x ⅞	64.6	18.99	1.49	4.83	235	233		
4	x 3 x ¼	14 x ¼	43.7	12.74	1.54	5.72	158	157
		14 x ⅜	51.9	15.17	1.57	5.70	188	188
		14 x ½	60.0	17.61	1.60	5.68	218	217
		14 x ⅝	68.2	20.00	1.62	5.66	248	247
		14 x ¾	76.4	22.36	1.65	5.63	277	276
		14 x ⅞	84.1	24.67	1.68	5.61	306	305
		14 x 1	91.9	26.99	1.71	5.59	335	333
		14 x 1¼	99.7	29.26	1.74	5.57	363	361
		14 x 1½	107.1	31.50	1.77	5.55	390	389
14 x 1¾	114.9	33.69	1.80	5.53	418	416		
5	x 3½ x ⅝	16 x ¼	51.8	15.24	1.94	6.59	189
		16 x ⅜	62.0	18.20	1.97	6.57	225
		16 x ½	71.8	21.12	2.00	6.54	261
		16 x ⅝	81.6	24.00	2.02	6.52	297
		16 x ¾	91.4	26.88	2.05	6.50	333
		16 x ⅞	101.2	29.68	2.08	6.48	368
		16 x 1	110.6	32.48	2.11	6.46	402
		16 x 1¼	120.0	35.24	2.14	6.44	436
		16 x 1½	129.4	38.00	2.17	6.41	470
		16 x 1¾	138.4	40.63	2.19	6.39	504
		16 x 1½	147.8	43.36	2.22	6.37	537
6	x 3½ x ⅝	18 x ⅝	69.8	20.43	2.42	7.49
		18 x ¾	80.8	23.76	2.44	7.47
		18 x ⅞	91.8	27.00	2.47	7.45
		18 x 1	102.8	30.25	2.50	7.42
		18 x 1¼	113.9	33.45	2.52	7.40
		18 x 1½	124.5	36.62	2.55	7.38
		18 x 1¾	135.5	39.74	2.58	7.36
		18 x 1½	145.7	42.87	2.61	7.34
		18 x 1½	156.4	45.95	2.64	7.32
		18 x 1½	166.6	49.00	2.67	7.29
		18 x 1	176.8	52.00	2.70	7.27

**SAFE LOADS IN THOUSANDS OF POUNDS FOR
PLATE AND ANGLE COLUMNS. SQUARE ENDS.**

CALCULATED FOR RADIUS OF GYRATION,
AXIS 2-2.

Based on Gordon's Formula, $P = \frac{50\,000}{1 + \frac{(12L)^2}{36\,000r^2}}$

Safety factor 4.

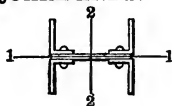

Length in Feet.

12	14	16	18	20	22	24	26	28	30	32	34	36	38	40
101	100	99	98	97	95	94	93	91	90	88	86	85	83	81
125	124	123	121	120	118	116	115	113	111	109	107	105	103	101
149	147	146	144	143	141	139	137	134	132	130	127	125	122	120
172	171	169	167	165	163	160	158	155	153	150	147	144	141	138
195	193	191	189	187	184	182	179	176	173	170	166	163	160	156
218	216	214	211	209	206	203	199	196	193	189	185	182	178	174
107	106	105	104	103	101	100	98	97	95	94	92	90	88	87
133	131	130	129	127	126	124	122	120	118	116	114	112	110	107
158	157	155	153	152	150	148	145	143	141	138	136	133	130	128
183	181	180	178	175	173	171	168	165	163	160	157	154	151	148
207	206	204	201	199	196	194	191	188	184	181	178	174	171	167
232	230	227	225	222	219	216	213	209	206	202	198	194	190	186
156	156	154	153	152	150	149	147	145	143	142	140	137	135	133
187	185	184	183	181	179	177	175	173	171	169	166	164	161	159
216	215	213	212	210	208	205	203	201	198	195	193	190	187	184
246	244	242	240	238	236	233	231	228	225	222	218	215	212	208
275	273	271	269	266	263	261	258	254	251	248	244	240	236	233
303	301	299	296	294	291	288	284	281	277	273	269	265	261	257
331	329	327	324	321	318	314	311	307	303	298	294	289	285	280
359	357	354	351	348	344	340	336	332	328	323	318	313	308	303
386	384	381	378	374	370	366	362	357	352	347	342	337	331	326
413	411	407	404	400	396	392	387	382	377	371	366	360	354	348
188	187	186	185	184	182	181	179	178	176	174	172	170	168	166
224	223	222	221	219	218	216	214	212	210	208	205	203	201	198
260	259	258	256	254	252	250	248	246	243	241	238	235	233	230
296	295	293	291	289	287	285	282	279	277	274	271	267	264	261
331	330	328	326	324	321	318	316	313	309	306	303	299	295	292
366	364	362	360	357	355	352	349	345	342	338	334	330	326	322
400	399	396	394	391	388	385	381	378	374	370	365	361	357	352
435	432	430	427	424	421	417	414	410	405	401	396	392	387	382
468	466	463	460	457	453	450	445	441	437	432	427	422	416	411
502	499	496	493	489	486	481	477	472	467	462	457	451	446	440
534	532	529	525	521	517	513	508	503	498	492	487	481	475	468
253	252	251	250	248	247	245	244	242	240	238	236	234	232	229
294	293	291	290	288	287	285	283	281	279	276	274	272	269	266
334	333	331	330	328	326	324	322	319	317	314	312	309	306	303
374	373	371	369	367	365	363	360	358	355	352	349	346	342	339
414	412	410	408	406	404	401	398	395	392	389	385	382	378	374
453	451	449	447	445	442	439	436	433	429	426	422	418	414	410
492	490	488	485	483	480	477	473	470	466	462	458	453	449	444
530	528	526	523	520	517	514	510	506	502	498	493	489	484	479
568	566	563	561	558	554	551	547	542	538	533	529	524	518	513
606	603	601	598	595	591	587	583	578	574	569	563	558	552	547
643	641	638	634	631	627	623	618	614	609	603	598	592	586	580

**SAFE LOADS IN THOUSANDS OF POUNDS FOR
PLATE AND ANGLE COLUMNS. SQUARE ENDS.**

**CALCULATED FOR RADIUS OF GYRATION,
AXIS 2-2.**

Based on Gordon's Formula, $P = \frac{50\,000}{1 + \frac{(12 L)^2}{36\,000 r^2}}$
Safety factor 4.

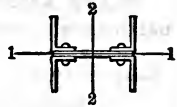

Size of Angles. Inches.	Size of Plate. Inches.	Weight of Column. Lbs. per Ft.	Area of Column Section. Sq. Ins.	Least Radius of Gyration Axis 1-1. Inches.	Radius of Gyration Axis 2-2. Inches.	Length in Feet.	
						10	12
7 x 3½ x ⅞	14 x ⅞	80.8	23.73	3.05	5.92	293	292
" " ⅞	" ½	91.8	27.00	3.08	5.90	334	332
" " ⅞	" ⅞	103.2	30.24	3.11	5.87	374	372
" " ⅞	" ⅞	113.7	33.43	3.13	5.85	413	411
" " ⅞	" ⅞	124.7	36.63	3.17	5.83	452	450
" " ⅞	" ⅞	135.3	39.74	3.20	5.81	491	489
" " ⅞	" ⅞	145.9	42.86	3.23	5.79	529	527
" " ⅞	" ⅞	156.5	45.93	3.26	5.76	567	564
" " ⅞	" ⅞	166.6	49.01	3.29	5.74	605	602
" " 1	" 1	176.8	52.00	3.32	5.72	642	639
7 x 3½ x ⅞	16 x ⅞	83.8	24.60	3.00	6.75	304
" " ⅞	" ½	95.2	28.00	3.02	6.73	346
" " ⅞	" ⅞	107.0	31.36	3.06	6.71	387
" " ⅞	" ⅞	118.0	34.68	3.08	6.69	428
" " ⅞	" ⅞	129.4	38.00	3.11	6.67	469
" " ⅞	" ⅞	140.4	41.24	3.14	6.64	509
" " ⅞	" ⅞	151.4	44.48	3.17	6.62	549
" " ⅞	" ⅞	162.4	47.68	3.20	6.60	588
" " ⅞	" ⅞	173.0	50.88	3.23	6.58	627
" " 1	" 1	183.6	54.00	3.26	6.56	666
7 x 3½ x ⅞	18 x ⅞	86.8	25.48	2.94	7.58	315
" " ⅞	" ½	98.6	29.00	2.97	7.55	359
" " ⅞	" ⅞	110.8	32.49	3.00	7.53	402
" " ⅞	" ⅞	122.3	35.93	3.02	7.51	445
" " ⅞	" ⅞	134.1	39.38	3.06	7.49	487
" " ⅞	" ⅞	145.5	42.74	3.08	7.47	529
" " ⅞	" ⅞	156.9	46.11	3.11	7.44	570
" " ⅞	" ⅞	168.4	49.43	3.14	7.42	612
" " ⅞	" ⅞	179.4	52.76	3.17	7.40	652
" " 1	" 1	190.4	56.00	3.20	7.38	693
7 x 3½ x ⅞	20 x ⅞	89.8	26.35	2.89	8.39
" " ⅞	" ½	102.0	30.00	2.92	8.37
" " ⅞	" ⅞	114.7	33.61	2.95	8.34
" " ⅞	" ⅞	126.5	37.18	2.97	8.32
" " ⅞	" ⅞	138.7	40.75	3.00	8.30
" " ⅞	" ⅞	150.6	44.24	3.03	8.28
" " ⅞	" ⅞	162.5	47.73	3.06	8.25
" " ⅞	" ⅞	174.3	51.18	3.09	8.23
" " ⅞	" ⅞	185.8	54.63	3.12	8.21
" " 1	" 1	197.2	58.00	3.15	8.19

**SAFE LOADS IN THOUSANDS OF POUNDS FOR
PLATE AND ANGLE COLUMNS. SQUARE ENDS.**

**CALCULATED FOR RADIUS OF GYRATION,
AXIS 2-2.**

Based on Gordon's Formula, $P = \frac{50\,000}{1 + \frac{(12L)^2}{36\,000r^2}}$
Safety factor 4.

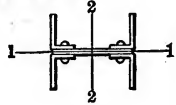

Length in Feet.

14	16	18	20	22	24	26	28	30	32	34	36	38	40
290	288	286	284	281	278	275	272	269	266	262	258	255	251
330	328	325	323	320	317	313	310	306	302	298	294	289	285
370	367	364	361	358	354	351	347	342	338	333	329	324	319
409	406	403	399	396	392	387	383	378	373	368	363	358	352
447	444	441	437	433	429	424	419	414	408	403	397	391	385
486	482	478	474	470	465	460	455	449	443	437	431	424	418
523	520	516	511	506	501	496	490	484	477	471	464	457	450
561	557	553	548	543	537	531	525	518	511	504	497	489	482
598	594	589	584	578	572	566	559	552	545	537	529	521	513
635	630	625	620	614	607	600	593	586	578	570	561	553	544
302	301	299	297	295	293	290	288	285	282	279	276	273	270
344	342	340	338	336	333	330	327	324	321	318	314	310	307
385	383	381	379	376	373	370	366	363	359	355	352	347	343
426	424	421	419	416	412	409	405	401	397	393	389	384	379
467	464	461	458	455	451	448	443	439	435	430	425	420	415
507	504	501	498	494	490	486	481	477	472	467	461	456	450
546	543	540	536	532	528	524	519	514	509	503	497	491	485
586	582	579	575	571	566	561	556	551	545	539	533	526	520
624	621	617	613	609	604	598	593	587	581	574	568	561	554
663	659	655	651	646	641	635	629	623	616	609	602	595	588
314	313	312	310	308	306	304	302	300	297	295	292	290	287
358	356	354	353	351	348	346	344	341	338	335	332	329	326
401	399	397	395	393	390	388	385	382	379	376	372	369	365
443	441	439	437	434	432	429	426	422	419	415	411	408	403
485	483	481	478	476	473	469	466	462	459	455	450	446	442
527	525	522	519	516	513	510	506	502	498	493	489	484	479
568	566	563	560	557	553	550	546	541	537	532	527	522	517
609	607	604	601	597	593	589	585	580	575	570	565	559	554
650	647	644	641	637	633	628	624	619	613	608	602	596	590
690	687	684	680	676	672	667	662	657	651	645	639	633	626
326	325	324	322	321	319	317	315	313	311	309	307	305	302
371	370	368	367	365	363	361	359	357	354	352	349	346	344
415	414	412	411	409	407	404	402	399	397	394	391	388	385
460	458	456	454	452	450	447	445	442	439	436	432	429	426
503	502	500	498	495	493	490	487	484	481	477	473	470	466
547	545	543	541	538	535	532	529	526	522	518	514	510	506
590	588	585	583	580	577	574	570	567	563	559	554	550	545
633	630	628	625	622	619	615	612	608	603	599	594	590	585
675	672	670	667	664	660	656	652	648	644	639	634	629	623
717	714	711	708	705	701	697	693	688	683	678	673	667	662

SAFE LOADS IN THOUSANDS OF POUNDS FOR LATTICED CHANNEL COLUMNS. SQUARE ENDS.

Based on Gordon's Formula $P = \frac{50\,000}{1 + \frac{(12L)^2}{36\,000r^2}}$. Safety factor 4.



Depth of Channel.	Weight of each Channel.	Area of Column Section.	Least Radius of Gyration.	Length in Feet.					
				Inches.	4	6	8	10	12
Inches.	Lbs. per Foot.	Sq. Ins.	Inches.						
6	8.0	4.76	2.34	59	58	57	55	54	52
"	10.5	6.18	2.21	76	75	73	71	69	67
"	13.0	7.64	2.13	94	93	90	88	85	81
"	15.5	9.12	2.06	112	110	107	104	100	96
7	9.75	5.70	2.72	71	70	69	68	66	65
"	12.25	7.20	2.59	89	88	87	85	83	81
"	14.75	8.68	2.50	107	106	104	102	99	96
"	17.25	10.14	2.44	125	124	121	119	116	112
"	19.75	11.62	2.39	144	142	139	136	132	128
8	11.25	6.70	3.11	83	83	82	80	79	77
"	13.75	8.08	2.99	100	99	98	97	95	93
"	16.25	9.56	2.89	119	117	116	114	112	109
"	18.75	11.02	2.82	137	135	134	131	128	125
"	21.25	12.50	2.77	155	153	151	149	145	142
9	13.25	7.78	3.45	96	95	94	93	91
"	15.00	8.82	3.37	109	108	107	105	103
"	20.00	11.76	3.20	145	143	142	139	137
"	25.00	14.70	3.08	181	179	177	173	170
10	15.0	8.92	3.84	110	110	109	107	106
"	20.0	11.76	3.66	146	144	143	141	139
"	25.0	14.70	3.52	182	180	178	176	173
"	30.0	17.64	3.41	218	216	213	210	207
"	35.0	20.58	3.31	254	251	248	245	240
12	20.5	12.06	4.61	149	148	147	146
"	25.0	14.70	4.43	181	180	179	177
"	30.0	17.64	4.28	217	216	214	211
"	35.0	20.58	4.17	254	251	249	246
"	40.0	23.52	4.09	289	287	284	281
15	33.0	19.80	5.59	246	244	243	241
"	35.0	20.58	5.56	255	254	252	251
"	40.0	23.52	5.44	291	290	288	286
"	45.0	26.48	5.32	328	326	324	322
"	50.0	29.42	5.23	364	363	360	357
"	55.0	32.36	5.16	400	399	396	393

For detail dimensions see page 230

**SAFE LOADS IN THOUSANDS OF POUNDS FOR
LATTICED CHANNEL COLUMNS.
SQUARE ENDS.**

Based on Gordon's Formula $P = \frac{50\,000}{1 + \frac{(12 L)^2}{36\,000 r^2}}$ Safety factor 4.



Length in Feet.								Weight of each Channel.	Depth of Channels.
16	18	20	22	24	26	28	30	Lbs. per Foot.	Inches.
50	48	46	44	42	8.0	6
64	61	58	55	52	10.5	"
78	74	71	67	63	13.0	"
92	88	83	78	74	15.5	"
63	61	58	56	54	52	9.75	7
78	76	73	70	67	64	12.25	"
93	90	86	83	79	76	14.75	"
108	104	100	96	92	87	17.25	"
123	119	113	108	104	98	19.75	"
76	74	72	70	68	65	63	61	11.25	8
90	88	86	83	80	78	75	72	13.75	"
107	104	100	97	94	90	87	83	16.25	"
122	118	115	111	107	103	99	95	18.75	"
138	134	129	124	120	115	111	106	21.25	"
90	88	86	84	82	80	77	75	13.25	9
101	99	97	94	92	90	87	84	15.00	"
134	131	127	124	120	116	113	109	20.00	"
166	162	157	153	149	143	139	134	25.00	"
104	102	101	99	97	95	93	90	15.0	10
136	134	131	128	125	122	119	116	20.0	"
170	166	163	159	155	151	146	143	25.0	"
203	198	194	189	185	179	174	168	30.0	"
236	230	225	219	213	207	201	194	35.0	"
144	142	140	138	136	134	131	129	20.5	12
175	172	170	167	165	161	159	155	25.0	"
209	206	203	200	198	192	187	184	30.0	"
243	240	236	231	227	223	218	213	35.0	"
277	273	268	263	258	253	248	243	40.0	"
240	238	235	233	230	228	225	222	33.0	15
249	247	245	242	240	236	234	230	35.0	"
284	282	279	276	273	269	266	262	40.0	"
319	316	313	310	306	302	298	294	45.0	"
354	352	348	344	339	334	329	325	50.0	"
390	386	381	377	372	368	362	357	55.0	"

For detail dimensions see page 230

SAFE LOADS IN THOUSANDS OF POUNDS FOR LATTICED CHANNEL COLUMNS. SQUARE ENDS.

Based on Gordon's Formula $P = \frac{50\,000}{1 + \frac{(12L)^2}{36\,000r^2}}$ Safety factor 4.



Depth of Channels.	Weight of each Channel.	Area of Column Section.	Least Radius of Gyration.	Length in Feet.				
				Inches.	32	34	36	38
Inches.	Lbs. per Foot.	Sq. Ins.	Inches.					
9	13.25	7.78	3.45	73	71
"	15.00	8.82	3.37	81	79
"	20.00	11.76	3.20	106	101
"	25.00	14.70	3.08	129	124
10	15.0	8.92	3.84	87	85	83
"	20.0	11.76	3.66	113	109	106
"	25.0	14.70	3.52	138	134	130
"	30.0	17.64	3.41	163	158	153
"	35.0	20.58	3.31	188	183	176
12	20.5	12.06	4.61	127	124	121	119	116
"	25.0	14.70	4.43	152	149	146	142	139
"	30.0	17.64	4.28	180	176	172	167	164
"	35.0	20.58	4.17	208	203	199	193	188
"	40.0	23.52	4.09	236	231	224	218	212
15	33.0	19.80	5.59	219	215	213	209	206
"	35.0	20.58	5.56	228	224	220	217	213
"	40.0	23.52	5.44	258	254	250	246	241
"	45.0	26.48	5.32	289	284	279	275	270
"	50.0	29.42	5.23	320	315	309	303	299
"	55.0	32.36	5.16	351	344	338	332	325

For detail dimensions see page 230.

**SAFE LOADS IN THOUSANDS OF POUNDS FOR
LATTICED CHANNEL COLUMNS.
SQUARE ENDS.**

Based on Gordon's Formula $P = \frac{50\,000}{1 + \frac{(12L)^2}{36\,000r^2}}$ Safety factor 4.



Length in Feet.							Weight of each Channel.	Depth of Channels.
42	44	46	48	50	52	54	Lbs. per Foot.	Inches.
.....	13.25	9
.....	15.00	"
.....	20.00	"
.....	25.00	"
.....	15.0	10
.....	20.0	"
.....	25.0	"
.....	30.0	"
.....	35.0	"
113	111	108	20.5	12
135	132	128	25.0	"
159	155	151	30.0	"
183	178	173	35.0	"
206	200	196	40.0	"
202	199	195	192	188	184	181	33.0	15
210	206	203	199	194	191	187	35.0	"
238	233	228	224	220	215	211	40.0	"
265	260	255	250	245	239	234	45.0	"
293	287	281	275	269	264	258	50.0	"
319	314	307	301	294	287	281	55.0	"

For detail dimensions see page 230.

SIZE OF SINGLE LATTICE BARS TO BE USED WITH LATTICED CHANNEL COLUMNS.

Depth of Channels.	Dimensions of Lattice Bars.		Weight of Lattice Bars per Foot.	Center of Hole to End of Bar. (a)	Distance Center to Center of Rivets. (d)	
	w	Thickness.			Maximum.	Minimum.
Inches.	Inches.	Inch.	Pounds.	Inch.	Inches.	Inches.
6	1¾	¼	1.49	1⅝	10	6⅝
7	2	¼	1.70	1¾	10	7⅝
8	2	⅝	2.12	1¾	12½	8¼
9	2¼	⅝	2.39	1¾	12½	9½
10	2¼	⅝	2.87	1¾	15	10¼
12	2¼	⅝	2.87	1¾	15	13
15	2½	⅝	3.72	1½	17½	15⅝

MAXIMUM LENGTHS OF LATTICE BARS BETWEEN FLANGE RIVET CENTERS FOR DIFFERENT BAR THICKNESSES.

Thickness of Lattice Bar.	Maximum Length (C)	
	Single Lattice.	Double Lattice.
Inch.	Inches.	Inches.
¼	10	15
⅝	12½	18¾
⅝	15	22½
⅞	17½	26¼
½	20	30
⅞	22½	33¾
⅝	25	37½

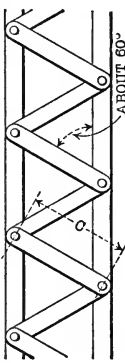
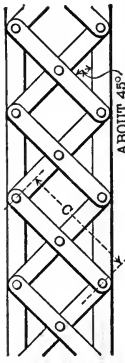



Latticing should be so proportioned to resist a shearing stress, 2% of direct stress.

Inclination of lattice bars to axis of member should not be less than 45 degrees Where distance between lines of flange rivets exceeds 15 inches, if single rivet bars be used, lattice should be double.

Pitch of lattice rivets along flange divided by least radius of gyration of the member between connections should be less than corresponding ratio of the member as a whole.

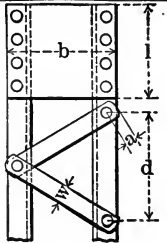
SIZE OF STAY PLATES TO BE USED WITH LATTICE CHANNEL COLUMNS.

Minimum size of Stay Plates at Ends of Columns.			Weight of Minimum Stay Plate.	Diameter of Rivets.	
b	Thickness.	l			
Inches.	Inch.	Inches.	Pounds.	Inch.	
7½	¼	5¾	3.06	5⁄8	
8½	¼	6¾	4.07	5⁄8, ¾	
9⁵⁄₈	¼	7½	5.12	5⁄8, ¾	
10³⁄₈	¼	8½	6.07	5⁄8, ¾	
11½	¼	9¼	7.54	5⁄8, ¾	
13⁵⁄₈	¼	11¼	10.86	5⁄8, ¾	
16¼	5⁄₁₆	13¼	19.07	¾, 7⁄₈	

DISTANCES TO BE ADDED TO LENGTHS OF LATTICE BARS BETWEEN FLANGE RIVET CENTERS TO GIVE FULL LENGTHS.

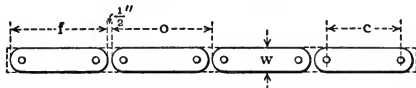

Width of Bar. w	Add to Length c							
	For Finished Length f.				For Ordered Length o.			
	Rivet Diameter.				Rivet Diameter.			
	1⁄2	5⁄8	¾	7⁄8	1⁄2	5⁄8	¾	7⁄8
Ins.	Ins.	Ins.	Ins.	Ins.	Ins.	Ins.	Ins.	
1½	2	2½
1¾	2¼	2¾
2	2½	2½	3	3
2¼	2½	2½	3	3
2½	3	3	3½	3½
2¾	3	3	3½	3½
3	3½	3½	4	4

Length of end stay plates should be not less than distance between lines of flange rivets.

Length of intermediate stay plates should be not less than one-half same distance.

Thickness of stay plates should be not less than 1⁄50 same distance.

**SAFE LOADS IN THOUSANDS OF POUNDS FOR
6" CHANNEL AND PLATE COLUMNS.
SQUARE ENDS.**

Based on Gordon's Formula $P = \frac{50\,000}{1 + \frac{(12L)^2}{36\,000r^2}}$. Safety factor 4.

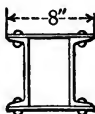

SERIES A.

Weight of each Channel.	Thickness of Plates.	Weight of Column.	Area of Column Section.	Least Radius of Gyration.	Length in Feet.			
					4	6	8	10
Lbs. per Foot.	Inch.	Lbs. per Ft.	Sq. Ins.	Inches.				
8	$\frac{1}{4}$	29.6	8.76	2.35	108	107	105	102
"	$\frac{3}{8}$	33.0	9.76	2.35	121	119	117	114
"	$\frac{1}{2}$	36.4	10.76	2.34	133	131	129	125
"	$\frac{3}{4}$	39.8	11.76	2.34	145	143	141	137
"	$\frac{1}{2}$	43.2	12.76	2.34	158	155	152	149
"	$\frac{3}{4}$	46.6	13.76	2.34	170	167	164	160
"	$\frac{1}{2}$	50.0	14.76	2.33	182	180	176	172
10.5	$\frac{1}{4}$	34.6	10.18	2.27	126	124	121	118
"	$\frac{3}{8}$	38.0	11.18	2.27	138	136	133	130
"	$\frac{1}{2}$	41.4	12.18	2.28	150	148	145	141
"	$\frac{3}{4}$	44.8	13.18	2.28	163	160	157	153
"	$\frac{1}{2}$	48.2	14.18	2.28	175	173	169	165
"	$\frac{3}{4}$	51.6	15.18	2.28	187	185	181	176
"	$\frac{1}{2}$	55.0	16.18	2.28	200	197	193	188
13	$\frac{1}{4}$	39.6	11.64	2.20	144	141	138	135
"	$\frac{3}{8}$	43.0	12.64	2.21	156	154	150	146
"	$\frac{1}{2}$	46.4	13.64	2.22	168	166	162	158
"	$\frac{3}{4}$	49.8	14.64	2.23	181	178	174	169
"	$\frac{1}{2}$	53.2	15.64	2.23	193	190	186	181
"	$\frac{3}{4}$	56.6	16.64	2.24	205	202	198	192
"	$\frac{1}{2}$	60.0	17.64	2.24	218	214	210	204
15.5	$\frac{1}{4}$	44.6	13.12	2.14	162	159	155	151
"	$\frac{3}{8}$	48.0	14.12	2.15	174	171	167	162
"	$\frac{1}{2}$	51.4	15.12	2.16	186	183	179	174
"	$\frac{3}{4}$	54.8	16.12	2.17	199	195	191	186
"	$\frac{1}{2}$	58.2	17.12	2.18	211	207	203	197
"	$\frac{3}{4}$	61.6	18.12	2.19	224	220	215	209
"	$\frac{1}{2}$	65.0	19.12	2.19	236	232	227	220

For detail dimensions see page 232

**SAFE LOADS IN THOUSANDS OF POUNDS FOR
6" CHANNEL AND PLATE COLUMNS.
SQUARE ENDS.**

Based on Gordon's Formula $P = \frac{50\,000}{1 + \frac{(12L)^2}{36\,000r^2}}$ Safety factor 4.

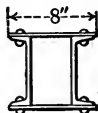

SERIES A.

Length in Feet.							Thickness of Plates.	Weight of each Channel.
12	14	16	18	20	22	24	Inch.	Lbs. per Foot.
99	96	92	89	85	81	77	1/4	8
111	107	103	99	95	90	86	1/8	"
122	118	114	109	104	99	94	3/8	"
133	128	124	119	114	109	103	1/2	"
144	139	135	129	124	118	112	1/2	"
156	150	145	139	133	127	121	1/8	"
166	161	155	149	142	136	130	5/8	"
114	110	106	102	97	92	88	1/4	10.5
126	121	117	112	107	102	96	1/8	"
137	133	127	122	116	111	106	3/8	"
148	143	138	132	126	120	114	1/2	"
159	154	148	142	135	130	123	1/2	"
171	165	159	152	144	139	132	1/8	"
182	176	169	162	154	148	140	3/8	"
130	125	120	115	109	104	99	1/4	13
141	136	131	125	119	113	107	1/8	"
153	147	141	135	129	122	116	3/8	"
164	158	152	145	138	131	125	1/2	"
175	169	162	155	148	140	133	1/2	"
186	179	173	166	158	150	143	1/8	"
197	190	183	176	167	159	151	3/8	"
146	140	134	128	122	115	109	1/4	15.5
157	151	145	138	131	125	118	1/8	"
170	162	155	148	140	133	127	3/8	"
180	172	165	158	150	143	135	1/2	"
191	184	176	168	160	152	144	1/2	"
202	195	187	178	170	162	153	1/8	"
213	205	197	188	180	171	161	3/8	"

SAFE LOADS IN THOUSANDS OF POUNDS FOR 7" CHANNEL AND PLATE COLUMNS. SQUARE ENDS.

Based on Gordon's Formula $P = \frac{50\,000}{1 + \frac{(12L)^2}{36\,000r^2}}$ · Safety factor 4.

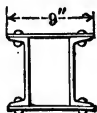

SERIES A.

Weight of each Channel. Lbs. per Foot.	Thickness of Plates. Inch.	Weight of Column. Lbs. per Ft.	Area of Column Section. Sq. Ins.	Least Radius of Gyration. Inches.	Length in Feet.			
					4	6	8	10
9.75	$\frac{1}{4}$	34.8	10.20	2.63	126	125	123	121
"	$\frac{5}{16}$	38.6	11.32	2.63	140	139	137	134
"	$\frac{3}{8}$	42.5	12.45	2.62	154	152	150	147
"	$\frac{7}{16}$	46.3	13.58	2.62	168	166	163	160
"	$\frac{1}{2}$	50.1	14.70	2.62	182	180	177	174
"	$\frac{9}{16}$	53.9	15.82	2.62	196	194	190	187
"	$\frac{5}{8}$	57.8	16.95	2.62	210	207	204	200
12.25	$\frac{1}{4}$	39.8	11.70	2.55	145	143	141	138
"	$\frac{5}{16}$	43.6	12.82	2.56	159	157	154	151
"	$\frac{3}{8}$	47.5	13.95	2.56	173	171	168	164
"	$\frac{7}{16}$	51.3	15.08	2.56	187	185	182	178
"	$\frac{1}{2}$	55.1	16.20	2.57	200	198	195	191
"	$\frac{9}{16}$	58.9	17.32	2.57	214	212	208	204
"	$\frac{5}{8}$	62.8	18.45	2.57	228	226	222	217
14.75	$\frac{1}{4}$	44.8	13.18	2.49	163	161	158	155
"	$\frac{5}{16}$	48.6	14.30	2.50	177	175	172	168
"	$\frac{3}{8}$	52.5	15.43	2.50	191	189	185	181
"	$\frac{7}{16}$	56.3	16.56	2.51	205	202	199	195
"	$\frac{1}{2}$	60.1	17.68	2.52	219	216	212	208
"	$\frac{9}{16}$	63.9	18.80	2.52	233	230	226	221
"	$\frac{5}{8}$	67.8	19.93	2.53	247	244	239	234
17.25	$\frac{1}{4}$	49.8	14.64	2.42	181	178	175	171
"	$\frac{5}{16}$	53.6	15.76	2.43	195	192	189	185
"	$\frac{3}{8}$	57.5	16.89	2.45	209	206	202	198
"	$\frac{7}{16}$	61.3	18.02	2.46	223	220	216	211
"	$\frac{1}{2}$	65.1	19.14	2.46	237	234	229	224
"	$\frac{9}{16}$	68.9	20.26	2.47	251	248	243	238
"	$\frac{5}{8}$	72.8	21.39	2.48	265	261	257	251
19.75	$\frac{1}{4}$	54.8	16.12	2.37	199	197	193	188
"	$\frac{5}{16}$	58.6	17.24	2.38	213	210	206	201
"	$\frac{3}{8}$	62.5	18.37	2.40	227	224	220	214
"	$\frac{7}{16}$	66.3	19.50	2.41	241	238	234	228
"	$\frac{1}{2}$	70.1	20.62	2.42	255	251	247	242
"	$\frac{9}{16}$	73.9	21.74	2.43	269	265	260	255
"	$\frac{5}{8}$	77.8	22.87	2.44	283	279	274	268

For detail dimensions see page 232

**SAFE LOADS IN THOUSANDS OF POUNDS FOR
7" CHANNEL AND PLATE COLUMNS.
SQUARE ENDS.**

Based on Gordon's Formula $P = \frac{50\,000}{1 + \frac{(12L)^2}{36\,000r^2}}$ Safety factor 4.

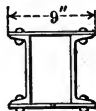

SERIES A.

Length in Feet.								Thickness of Plates.	Weight of each Channel.
12	14	16	18	20	22	24	26	Inch.	Lbs. per Ft.
118	115	111	108	104	99	96	92	1/4	9.75
130	127	123	119	115	110	106	102	5/16	"
143	140	135	131	126	121	116	112	3/8	"
156	153	148	143	138	132	127	122	1/2	"
169	165	160	154	149	143	137	132	5/8	"
182	178	172	166	161	154	148	142	3/4	"
195	190	184	178	172	165	158	152	7/8	"
134	130	126	122	118	113	108	103	1/4	12.25
147	143	139	134	129	124	118	113	5/16	"
160	156	151	146	140	135	129	123	3/8	"
173	168	163	158	152	145	139	133	1/2	"
186	181	176	169	163	156	150	144	5/8	"
199	194	188	181	174	167	161	154	3/4	"
212	207	200	193	185	178	171	164	7/8	"
151	146	142	136	131	126	120	115	1/4	14.75
164	159	154	148	142	136	131	125	5/16	"
177	171	166	160	154	147	141	135	3/8	"
190	184	178	171	165	158	151	144	1/2	"
202	196	191	184	177	170	162	155	5/8	"
215	209	203	196	188	180	173	165	3/4	"
229	222	215	207	199	191	183	175	7/8	"
166	161	156	150	143	137	131	126	1/4	17.25
180	174	168	162	155	148	142	135	5/16	"
193	187	181	174	166	159	153	146	3/8	"
206	199	193	186	178	171	163	155	1/2	"
218	212	205	197	190	182	173	165	5/8	"
231	224	217	209	201	192	184	176	3/4	"
245	238	229	220	212	203	194	186	7/8	"
183	177	170	164	157	150	143	136	1/4	19.75
196	189	183	175	168	161	153	146	5/16	"
209	202	195	187	180	172	164	157	3/8	"
222	215	208	199	191	183	174	166	1/2	"
234	227	220	211	202	194	185	177	5/8	"
248	240	231	223	214	204	195	186	3/4	"
261	253	243	235	225	216	207	196	7/8	"

For detail dimensions see page 232

SAFE LOADS IN THOUSANDS OF POUNDS FOR 8" CHANNEL AND PLATE COLUMNS. SQUARE ENDS.

Based on Gordon's Formula $P = \frac{50\,000}{1 + \frac{(12L)^2}{36\,000r^2}}$ Safety factor 4.

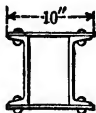

SERIES A.

Weight of each Channel.	Thickness of Plates.	Weight of Column.	Area of Column Section.	Least Radius of Gyration.	Length in Feet.				
					Lbs. per Foot.	Inch.	Sq. Ins.	Inches.	4
11.25	1/4	39.5	11.70	2.98	145	144	142	140	137
"	1/8	43.7	12.95	2.97	161	159	157	155	152
"	3/8	48.0	14.20	2.97	176	175	172	170	167
"	1/2	52.3	15.45	2.96	192	190	188	185	181
"	5/8	56.5	16.70	2.95	207	205	203	200	196
"	3/4	60.8	17.95	2.95	223	221	219	214	210
"	7/8	65.0	19.20	2.95	238	236	233	229	225
13.75	1/4	44.5	13.08	2.92	162	161	159	156	153
"	1/8	48.7	14.33	2.92	178	176	174	171	168
"	3/8	53.0	15.58	2.92	193	191	189	186	182
"	1/2	57.3	16.83	2.91	209	207	204	201	197
"	5/8	61.5	18.08	2.91	224	222	220	216	212
"	3/4	65.8	19.33	2.91	240	237	235	231	226
"	7/8	70.0	20.58	2.91	255	253	250	246	241
16.25	1/4	49.5	14.56	2.86	181	179	176	173	170
"	1/8	53.7	15.81	2.87	196	194	192	188	185
"	3/8	58.0	17.06	2.87	212	210	207	203	199
"	1/2	62.3	18.31	2.87	227	225	222	218	214
"	5/8	66.5	19.56	2.87	243	240	237	233	228
"	3/4	70.8	20.81	2.87	258	256	252	248	243
"	7/8	75.0	22.06	2.87	274	271	267	263	258
18.75	1/4	54.5	16.02	2.81	199	197	194	190	186
"	1/8	58.7	17.27	2.81	214	212	209	205	201
"	3/8	63.0	18.52	2.82	230	227	224	221	216
"	1/2	67.3	19.77	2.82	245	243	240	236	230
"	5/8	71.5	21.02	2.83	261	258	255	250	245
"	3/4	75.8	22.27	2.83	276	274	270	265	260
"	7/8	80.0	23.52	2.83	292	289	285	280	275
21.25	1/4	59.5	17.50	2.76	217	215	212	208	204
"	1/8	63.7	18.75	2.77	233	230	227	223	218
"	3/8	68.0	20.00	2.77	248	245	242	238	233
"	1/2	72.3	21.25	2.78	264	261	257	253	247
"	5/8	76.5	22.50	2.79	279	276	272	267	262
"	3/4	80.8	23.75	2.79	295	291	287	282	276
"	7/8	85.0	25.00	2.80	310	307	302	297	291

For detail dimensions see page 232

**SAFE LOADS IN THOUSANDS OF POUNDS FOR
8" CHANNEL AND PLATE COLUMNS.
SQUARE ENDS.**

Based on Gordon's Formula $P = \frac{50\,000}{1 + \frac{(12L)^2}{36\,000r^2}}$ Safety factor 4.

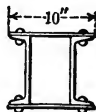

SERIES A.

Length in Feet.									Thickness of Plates.	Weight of each Channel.
14	16	18	20	22	24	26	28	30	Inch.	Lbs. per Foot.
134	131	128	124	120	116	112	108	104	1/4	11.25
149	145	141	137	133	128	124	120	115	1/8	"
163	159	154	150	146	141	136	131	126	3/8	"
177	173	168	163	158	153	147	142	137	1/2	"
192	187	182	176	170	165	159	153	147	1/2	"
206	201	195	189	183	178	171	165	158	1/2	"
221	215	209	203	196	190	183	177	169	5/8	"
150	146	142	138	133	129	124	119	115	1/4	13.75
164	160	155	151	146	141	136	131	126	1/8	"
178	174	169	164	159	153	148	142	137	3/8	"
193	188	182	177	171	166	160	153	148	1/2	"
207	202	196	190	184	178	172	164	159	1/2	"
221	216	209	203	196	190	183	176	170	1/2	"
236	229	223	216	209	203	195	187	181	5/8	"
166	162	157	152	147	142	137	131	126	1/4	16.25
180	176	171	165	160	154	148	143	137	1/8	"
195	189	184	178	172	166	160	154	148	3/8	"
209	203	198	191	185	178	172	165	159	1/2	"
223	217	211	204	198	191	184	177	170	1/2	"
237	231	224	217	210	203	195	188	181	1/2	"
252	245	238	231	223	215	207	199	191	5/8	"
182	177	172	167	161	155	149	143	137	1/4	18.75
196	191	185	180	174	167	160	154	148	1/8	"
210	205	199	193	186	180	173	166	160	3/8	"
225	219	212	206	199	192	185	178	171	1/2	"
240	233	226	219	211	204	196	189	181	1/2	"
254	246	239	232	224	216	208	200	192	1/2	"
268	260	253	245	236	228	220	211	203	5/8	"
198	193	187	181	174	168	162	155	148	1/4	21.25
212	207	200	194	187	180	173	166	159	1/8	"
226	220	214	207	200	192	185	178	170	3/8	"
241	234	227	220	213	205	196	189	181	1/2	"
256	249	241	233	225	217	209	201	192	1/2	"
270	263	254	246	238	229	221	212	202	1/2	"
284	277	268	260	250	241	232	223	214	5/8	"

For detail dimensions see page 232

**SAFE LOADS IN THOUSANDS OF POUNDS FOR
9" CHANNEL AND PLATE COLUMNS.
SQUARE ENDS.**

Based on Gordon's Formula $P = \frac{50\,000}{1 + \frac{(12L)^2}{36\,000r^2}}$. Safety factor 4.

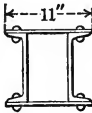

SERIES A.

Weight of each Channel.	Thick- ness of Plates.	Weight of Column.	Area of Columa Section.	Least Radius of Gyration.	Length in Feet.					
					6	8	10	12	14	16
Lbs. per Ft.	Inch.	Lbs. per Ft.	Sq. Ins.	Inches.						
13.25	1/4	45.2	13.28	3.34	164	162	160	158	155	152
"	5/16	49.9	14.66	3.32	181	179	177	174	171	168
"	3/8	54.6	16.03	3.31	198	196	193	191	187	183
"	7/16	59.2	17.40	3.30	215	213	210	207	203	199
"	1/2	63.9	18.78	3.29	232	229	227	223	219	214
"	5/8	68.5	20.16	3.28	249	246	243	239	235	230
"	3/4	73.3	21.53	3.28	266	263	260	255	251	246
15	1/4	48.7	14.32	3.29	177	175	173	170	167	163
"	5/16	53.4	15.70	3.28	194	192	189	186	183	179
"	3/8	58.1	17.07	3.28	211	209	206	202	199	195
"	7/16	62.7	18.44	3.27	228	225	222	219	215	210
"	1/2	67.4	19.82	3.26	245	242	239	235	231	226
"	5/8	72.0	21.20	3.26	262	259	255	251	247	242
"	3/4	76.8	22.57	3.25	279	275	272	267	263	257
20	1/4	58.7	17.26	3.19	213	210	208	204	200	196
"	5/16	63.4	18.64	3.19	230	227	224	220	216	212
"	3/8	68.1	20.01	3.19	247	244	241	236	232	227
"	7/16	72.7	21.38	3.19	263	261	257	253	248	243
"	1/2	77.4	22.76	3.19	280	278	274	269	264	259
"	5/8	82.0	24.14	3.19	297	294	291	285	280	274
"	3/4	86.8	25.51	3.18	314	311	307	301	296	290
25	1/4	68.7	20.20	3.10	249	246	243	238	234	228
"	5/16	73.4	21.58	3.11	266	263	259	254	250	244
"	3/8	78.1	22.95	3.11	283	279	276	270	265	260
"	7/16	82.7	24.32	3.12	300	296	292	287	281	275
"	1/2	87.4	25.70	3.12	317	313	309	304	297	291
"	5/8	92.0	27.08	3.12	334	330	325	320	313	307
"	3/4	96.8	28.45	3.12	351	346	342	336	329	322

For detail dimensions see page 232

**SAFE LOADS IN THOUSANDS OF POUNDS FOR
9" CHANNEL AND PLATE COLUMNS.
SQUARE ENDS.**

Based on Gordon's Formula $P = \frac{50\,000}{1 + \frac{(12 L)^2}{36\,000 r^2}}$ Safety factor 4.

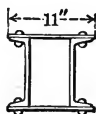

SERIES A.

Length in Feet.									Thickness of Plates.	Weight of each Channel.
18	20	22	24	26	28	30	32	34	Inch.	Lbs. per Foot.
149	145	141	137	134	129	125	121	117	1/4	13.25
164	160	156	152	147	143	138	134	129	5/16	"
179	175	171	165	160	155	150	146	141	3/8	"
194	189	184	179	174	169	163	158	153	1/2	"
209	204	199	194	188	182	176	171	165	5/8	"
225	219	214	208	202	195	189	182	176	1/2	"
240	234	228	222	215	209	202	194	188	5/8	"
160	156	152	148	143	139	134	130	126	1/4	15
175	171	166	162	157	152	147	142	137	5/16	"
190	186	181	176	171	166	160	154	149	3/8	"
206	201	195	190	184	178	172	167	161	1/2	"
221	216	210	203	197	191	185	179	173	5/8	"
236	231	225	217	211	204	198	191	185	1/2	"
252	245	238	231	225	218	211	204	196	5/8	"
192	186	181	176	170	165	159	154	148	1/4	20
207	201	196	190	184	178	172	166	160	5/16	"
222	216	210	204	197	191	185	179	172	3/8	"
237	231	224	218	211	204	197	191	183	1/2	"
253	246	239	232	224	217	210	203	195	5/8	"
268	260	253	246	238	230	223	216	207	1/2	"
282	275	268	260	251	243	236	226	219	5/8	"
223	216	210	204	197	191	183	177	170	1/4	25
238	232	224	218	210	204	197	189	183	5/16	"
253	246	239	232	224	217	210	201	194	3/8	"
268	261	253	246	238	230	222	213	206	1/2	"
283	276	267	260	252	243	235	226	218	5/8	"
298	291	282	274	265	256	247	238	229	1/2	"
313	306	296	287	279	269	260	250	241	5/8	"

For detail dimensions see page 232

SAFE LOADS IN THOUSANDS OF POUNDS FOR 10" CHANNEL AND PLATE COLUMNS. SQUARE ENDS.

Based on Gordon's Formula $P = \frac{50\,000}{1 + \frac{(12L)^2}{36\,000r^2}}$ Safety factor 4.

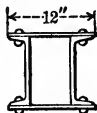

SERIES A.

Weight of each Channel.	Thick-ness of Plates.	Weight of Column.	Area of Column Section.	Least Radius of Gyration.	Length in Feet.					
					Lbs. per Ft.	Inch.	Lbs. per Ft.	Sq. Ins.	Inches.	6
15	1/4	50.4	14.92	3.62	184	183	181	179	176	173
	5/16	55.5	16.42	3.61	203	201	199	197	193	191
	3/8	60.6	17.92	3.59	221	220	217	215	211	207
	7/16	65.7	19.42	3.58	240	238	235	232	229	225
	1/2	70.8	20.92	3.58	259	257	254	250	247	242
	5/8	75.9	22.42	3.57	277	275	272	268	264	259
20	1/4	60.4	17.76	3.52	219	217	215	212	209	205
	5/16	65.5	19.26	3.52	238	236	233	230	226	223
	3/8	70.6	20.76	3.51	257	254	252	248	244	239
	7/16	75.7	22.26	3.51	275	272	270	266	262	257
	1/2	80.8	23.76	3.51	294	291	288	284	279	274
	5/8	85.9	25.26	3.50	312	309	305	302	297	291
25	1/4	70.4	20.70	3.42	255	253	250	247	242	238
	5/16	75.5	22.20	3.43	274	272	268	265	260	255
	3/8	80.6	23.70	3.43	293	290	287	282	278	272
	7/16	85.7	25.20	3.43	311	308	305	300	295	289
	1/2	90.8	26.70	3.43	330	327	323	318	313	307
	5/8	95.9	28.20	3.44	348	345	341	336	330	324
30	1/4	80.4	23.64	3.33	292	289	285	281	276	271
	5/16	85.5	25.14	3.34	310	307	303	299	294	288
	3/8	90.6	26.64	3.35	329	325	321	317	311	305
	7/16	95.7	28.14	3.36	347	344	340	334	329	322
	1/2	100.8	29.64	3.36	366	362	358	352	346	339
	5/8	105.9	31.14	3.37	384	380	376	370	364	358
35	1/4	90.4	26.58	3.26	328	324	320	315	309	303
	5/16	95.5	28.08	3.27	347	343	338	333	327	320
	3/8	100.6	29.58	3.28	365	361	357	351	344	337
	7/16	105.7	31.08	3.29	384	380	375	369	362	354
	1/2	110.8	32.58	3.29	402	398	393	387	379	372
	5/8	115.9	34.08	3.30	421	416	411	405	398	390
		121.0	35.58	3.31	439	435	429	423	415	407

For detail dimensions see page 233

**SAFE LOADS IN THOUSANDS OF POUNDS FOR
10" CHANNEL AND PLATE COLUMNS.
SQUARE ENDS.**

Based on Gordon's Formula $P = \frac{50\,000}{1 + \frac{(12L)^2}{36\,000r^2}}$ Safety factor 4.

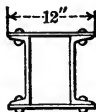

SERIES A.

Length in Feet.										Thick- ness of Plates.	Weight of each Channel.
18	20	22	24	26	28	30	32	34	36	Inch.	Lbs. per Ft.
170	166	162	159	154	151	146	142	138	134	1/4	15
187	183	179	175	170	165	161	156	152	147	1/4	"
204	199	195	190	186	180	175	170	165	160	1/4	"
221	216	211	206	200	195	189	184	178	172	1/4	"
238	232	228	222	216	210	204	199	192	186	1/4	"
255	249	243	238	231	225	219	212	206	199	1/4	"
271	266	259	253	246	239	233	226	218	212	1/4	"
201	196	192	187	182	177	172	167	161	157	1/4	20
218	213	208	203	197	192	187	181	175	170	1/4	"
235	230	224	219	213	207	201	195	189	182	1/4	"
252	246	240	235	228	222	216	209	202	195	1/4	"
269	263	256	251	244	236	230	223	216	209	1/4	"
286	279	272	265	259	251	244	237	229	222	1/4	"
303	296	289	281	274	266	258	251	243	235	1/4	"
233	228	222	216	210	204	198	191	186	180	1/4	25
250	245	238	232	225	219	213	206	199	193	1/4	"
267	261	255	248	241	233	227	220	213	206	1/4	"
284	278	271	263	256	248	242	234	226	219	1/4	"
301	294	287	279	271	263	256	248	240	232	1/4	"
318	311	303	295	286	279	271	262	253	245	1/4	"
335	327	319	310	302	294	285	276	267	258	1/4	"
265	258	252	245	238	230	223	216	209	201	1/4	30
281	275	268	260	253	245	237	230	222	214	1/4	"
298	291	284	276	268	260	252	243	237	228	1/4	"
315	307	301	293	284	276	267	258	250	241	1/4	"
332	324	317	308	299	290	281	272	263	254	1/4	"
350	342	333	324	315	305	296	286	276	267	1/4	"
357	358	349	339	330	320	310	300	290	280	1/4	"
296	289	282	273	265	256	248	240	232	224	1/4	35
313	306	298	289	279	271	262	254	245	237	1/4	"
330	322	313	305	296	287	278	267	258	249	1/4	"
347	338	329	320	311	301	292	282	273	263	1/4	"
363	354	345	336	326	316	306	296	286	276	1/4	"
380	371	361	351	341	330	320	310	299	289	1/4	"
398	389	379	367	356	345	334	323	312	301	1/4	"

For detail dimensions see page 233

SAFE LOADS IN THOUSANDS OF POUNDS FOR 12" CHANNEL AND PLATE COLUMNS. SQUARE ENDS.

Based on Gordon's Formula $P = \frac{50\,000}{1 + \frac{(12L)^2}{36\,000r^2}}$ Safety factor 4.

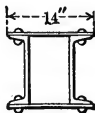

SERIES A.

Weight of each Channel.	Thick-ness of Plates.	Weight of Column.	Area of Column Section.	Least Radius of Gyration	Length in Feet.							
					Lbs. per Ft.	Inch.	Lbs. per Ft.	Sq. Ins.	Inches.	8	10	12
20.5	$\frac{1}{4}$	64.8	19.06	4.41	235	233	232	229	227	223	220	217
"	$\frac{5}{16}$	70.8	20.81	4.38	257	255	253	250	247	244	240	236
"	$\frac{3}{8}$	76.7	22.56	4.36	278	276	273	271	267	264	260	256
"	$\frac{1}{2}$	82.7	24.31	4.34	300	298	295	292	288	285	280	275
"	$\frac{5}{8}$	88.6	26.06	4.32	321	319	316	313	309	304	300	295
"	$\frac{3}{4}$	94.6	27.81	4.30	343	340	337	333	330	325	319	315
"	$\frac{7}{8}$	100.5	29.56	4.28	364	362	358	354	350	345	339	335
25	$\frac{1}{4}$	73.8	21.70	4.35	268	266	263	261	257	254	250	246
"	$\frac{5}{16}$	79.8	23.45	4.32	289	287	284	282	278	274	270	266
"	$\frac{3}{8}$	85.7	25.20	4.31	311	308	305	303	299	294	290	285
"	$\frac{1}{2}$	91.7	26.95	4.29	332	330	327	323	319	315	310	305
"	$\frac{5}{8}$	97.6	28.70	4.27	354	351	348	344	340	335	330	324
"	$\frac{3}{4}$	103.6	30.45	4.26	375	373	369	365	360	356	350	343
"	$\frac{7}{8}$	109.5	32.20	4.25	397	393	390	386	381	376	370	363
30	$\frac{1}{4}$	83.8	24.64	4.27	304	302	299	295	292	288	283	278
"	$\frac{5}{16}$	89.8	26.39	4.26	325	323	320	316	312	308	303	298
"	$\frac{3}{8}$	95.7	28.14	4.25	347	344	341	337	333	329	323	317
"	$\frac{1}{2}$	101.7	29.89	4.23	368	365	362	358	353	348	343	337
"	$\frac{5}{8}$	107.6	31.64	4.22	390	387	383	379	374	368	363	357
"	$\frac{3}{4}$	113.6	33.39	4.21	411	408	404	400	395	389	382	377
"	$\frac{7}{8}$	119.5	35.14	4.21	433	429	425	421	415	409	402	396
35	$\frac{1}{4}$	93.8	27.58	4.19	340	337	334	330	326	321	316	310
"	$\frac{5}{16}$	99.8	29.33	4.18	361	358	355	351	347	341	336	330
"	$\frac{3}{8}$	105.7	31.08	4.18	383	380	376	372	367	362	356	349
"	$\frac{1}{2}$	111.7	32.83	4.17	405	401	397	392	388	382	376	369
"	$\frac{5}{8}$	117.6	34.58	4.16	426	422	418	413	409	402	396	389
"	$\frac{3}{4}$	123.6	36.33	4.16	448	444	439	434	429	423	416	408
"	$\frac{7}{8}$	129.5	38.08	4.15	469	465	461	455	449	443	436	428
40	$\frac{1}{4}$	103.8	30.52	4.13	376	373	369	365	360	354	349	343
"	$\frac{5}{16}$	109.8	32.27	4.12	398	394	390	386	380	374	368	363
"	$\frac{3}{8}$	115.7	34.02	4.12	419	416	411	406	401	395	388	382
"	$\frac{1}{2}$	121.7	35.77	4.12	441	437	433	427	421	415	408	402
"	$\frac{5}{8}$	127.6	37.52	4.11	462	458	454	448	442	435	428	420
"	$\frac{3}{4}$	133.6	39.27	4.11	484	480	475	469	463	456	448	440
"	$\frac{7}{8}$	139.5	41.02	4.11	505	501	496	490	483	476	468	459

For detail dimensions see page 233

**SAFE LOADS IN THOUSANDS OF POUNDS FOR
12" CHANNEL AND PLATE COLUMNS.
SQUARE ENDS.**

Based on Gordon's Formula $P = \frac{50\,000}{1 + \frac{(12 L)^2}{36\,000 r^2}}$ Safety factor 4.

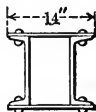

SERIES A.

Length in Feet.											Thick- ness of Plates.	Weight of each Channel.
24	26	28	30	32	34	36	38	40	42	44	Inch.	Lbs. per Ft.
213	209	206	201	196	193	188	184	179	175	170	1/4	20.5
232	228	223	220	214	209	205	200	195	190	186	5/16	"
252	246	242	237	232	227	221	216	211	206	200	3/8	"
271	266	260	255	249	244	238	232	227	223	216	1/2	"
289	285	279	274	267	261	255	249	242	237	230	5/16	"
309	304	297	291	285	278	271	265	258	251	245	1/2	"
328	322	316	309	302	296	288	281	274	267	259	5/8	"
242	237	233	228	223	218	213	208	203	197	193	1/4	25
260	256	251	246	240	235	230	224	218	213	207	5/16	"
280	275	269	263	258	252	246	241	234	229	222	3/8	"
299	293	288	282	275	270	263	256	250	243	237	1/2	"
319	312	306	300	293	286	280	272	265	259	252	5/16	"
338	331	324	318	311	303	295	289	281	273	267	1/2	"
358	350	343	335	329	320	312	306	297	289	281	5/8	"
274	268	262	257	251	245	240	234	228	223	216	1/4	30
293	287	281	276	269	263	256	250	244	237	232	5/16	"
313	306	300	293	287	280	273	267	260	253	246	3/8	"
331	325	318	311	304	297	290	282	275	268	261	1/2	"
350	343	337	329	321	313	307	299	291	282	276	5/16	"
369	362	354	347	339	331	322	315	307	298	290	1/2	"
389	381	372	365	357	348	339	332	323	314	305	5/8	"
305	299	292	286	280	273	266	259	253	246	239	1/4	35
324	318	311	304	296	290	283	275	268	262	254	5/16	"
344	337	329	322	314	308	300	292	284	277	270	3/8	"
362	356	348	340	332	323	317	308	300	291	283	1/2	"
381	375	366	358	349	341	332	325	316	307	298	5/16	"
400	394	385	376	367	358	349	341	332	323	313	1/2	"
420	411	404	394	385	375	365	356	348	338	328	5/8	"
336	329	322	314	308	301	293	285	277	269	262	1/4	40
356	348	340	333	324	316	310	301	293	285	277	5/16	"
375	367	359	351	342	333	326	318	309	300	292	3/8	"
394	386	377	369	360	351	343	334	325	316	307	1/2	"
413	405	396	387	377	368	358	350	341	331	322	5/16	"
433	424	412	405	395	385	375	367	357	347	337	1/2	"
452	442	433	423	412	402	391	383	373	362	352	5/8	"

For detail dimensions see page 233

SAFE LOADS IN THOUSANDS OF POUNDS FOR 15" CHANNEL AND PLATE COLUMNS. SQUARE ENDS.

Based on Gordon's Formula $P = \frac{50\,000}{1 + \frac{(12L)^2}{36\,000 r^2}}$ Safety factor 4.

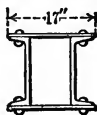

SERIES A.

Weight of each Channel.	Thick-ness of Plates.	Weight of Column.	Area of Column Section.	Least Radins of Gyration.	Length in Feet.										
					Lbs. per Ft.	Inch.	Sq. Ins.	Inches.	12	14	16	18	20	22	24
33	3/8	109.4	32.55	5.41	399	396	393	390	386	381	378	373	367		
"	1/2	116.6	34.68	5.38	425	422	418	415	411	406	401	397	391		
"	5/8	123.8	36.80	5.36	451	448	444	440	436	431	426	420	415		
"	3/4	131.0	38.92	5.33	476	474	470	465	460	456	450	444	437		
"	7/8	138.2	41.05	5.31	502	500	495	490	485	481	475	468	461		
"	1	145.4	43.18	5.29	529	526	521	516	510	504	499	492	485		
"	1 1/4	152.7	45.30	5.24	555	550	545	541	535	529	522	515	509		
35	3/8	113.4	33.33	5.40	409	406	402	399	395	390	387	381	376		
"	1/2	120.6	35.46	5.37	435	432	428	424	420	415	410	406	400		
"	5/8	127.8	37.58	5.35	461	457	453	449	445	440	435	429	424		
"	3/4	135.0	39.70	5.32	486	483	479	474	469	465	459	453	446		
"	7/8	142.2	41.83	5.30	512	509	505	500	494	488	484	477	470		
"	1	149.4	43.96	5.28	538	534	530	525	520	513	508	501	494		
"	1 1/4	156.7	46.08	5.27	564	560	556	551	545	538	531	525	518		
40	3/8	123.4	36.27	5.35	445	441	438	433	430	425	419	414	409		
"	1/2	130.6	38.40	5.33	470	467	463	459	454	450	444	438	432		
"	5/8	137.8	40.52	5.31	496	493	489	484	479	475	469	462	455		
"	3/4	145.0	42.64	5.29	522	519	514	509	504	498	493	486	479		
"	7/8	152.2	44.77	5.27	548	544	540	535	529	523	516	511	503		
"	1	159.4	46.90	5.26	574	570	566	560	554	548	540	535	527		
"	1 1/4	166.7	49.02	5.24	600	595	590	586	579	572	565	557	551		
45	3/8	133.4	39.23	5.31	480	477	473	469	464	459	454	447	441		
"	1/2	140.6	41.36	5.29	506	503	499	494	489	483	478	472	465		
"	5/8	147.8	43.48	5.27	532	528	525	519	514	508	501	496	489		
"	3/4	155.0	45.60	5.25	558	554	550	545	539	532	525	518	512		
"	7/8	162.2	47.73	5.24	584	580	575	570	564	557	550	542	536		
"	1	169.4	49.86	5.23	610	606	600	596	589	582	575	567	558		
"	1 1/4	176.7	51.98	5.21	636	631	626	619	614	607	599	591	582		
50	3/8	143.4	42.17	5.26	516	512	509	504	498	492	486	481	474		
"	1/2	150.6	44.30	5.24	542	538	533	529	524	517	511	503	498		
"	5/8	157.8	46.42	5.23	568	564	559	555	549	542	535	528	520		
"	3/4	165.0	48.54	5.21	594	590	584	578	574	567	559	552	543		
"	7/8	172.2	50.67	5.20	620	615	610	604	599	592	584	576	567		
"	1	179.4	52.80	5.19	646	641	636	629	622	616	608	600	591		
"	1 1/4	186.7	54.92	5.18	672	667	661	654	647	641	633	624	615		
55	3/8	153.4	45.11	5.21	552	548	543	538	533	527	520	513	505		
"	1/2	160.6	47.24	5.19	578	574	569	563	557	552	544	537	529		
"	5/8	167.8	49.36	5.18	604	600	594	588	582	576	569	561	553		
"	3/4	175.0	51.48	5.17	630	625	620	613	607	599	593	585	576		
"	7/8	182.2	53.61	5.16	656	651	645	639	632	624	616	609	600		
"	1	189.4	55.74	5.15	682	677	671	664	657	649	640	633	624		
"	1 1/4	196.7	57.86	5.14	708	703	696	689	682	673	665	655	648		

For detail dimensions see page 233

**SAFE LOADS IN THOUSANDS OF POUNDS FOR
15" CHANNEL AND PLATE COLUMNS.
SQUARE ENDS.**

Based on Gordon's Formula $P = \frac{50\,000}{1 + \frac{(12L)^2}{36\,000r^2}}$ Safety factor 4.

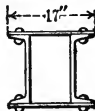

SERIES A.

Length in Feet.												Thick- ness of Plates.	Weight of each Channel.
30	32	34	36	38	40	42	44	46	48	50	52	Inch.	Lbs. per Ft.
363	357	351	345	340	334	327	322	316	309	304	297	3/8	33
385	381	374	368	361	356	349	342	335	329	322	315	1/2	"
409	402	397	390	383	376	370	362	355	347	342	334	5/8	"
432	425	418	411	405	397	389	381	375	367	359	351	7/8	"
456	449	441	433	425	419	411	402	394	388	379	371	1 1/8	"
478	472	464	456	447	438	432	423	414	405	397	390	1 1/4	"
501	493	484	476	467	460	451	442	432	423	416	407	3/4	"
370	366	360	353	348	342	335	330	323	316	310	304	3/8	35
394	387	383	376	369	364	357	349	342	337	329	322	1/2	"
417	411	404	398	391	383	376	370	362	355	349	341	5/8	"
441	434	426	419	413	405	397	389	383	375	367	359	7/8	"
463	457	449	441	433	427	418	410	401	393	386	378	1 1/8	"
486	478	472	464	455	446	437	431	422	413	404	397	1 1/4	"
510	501	493	486	477	468	459	452	442	433	423	414	3/4	"
403	396	390	384	377	370	363	357	350	342	337	329	3/8	40
427	420	412	405	399	392	384	376	370	363	355	347	1/2	"
450	443	435	427	420	413	405	397	389	383	374	366	5/8	"
472	466	458	450	441	433	427	418	409	400	392	385	7/8	"
495	487	479	472	464	455	446	439	430	420	411	402	1 1/8	"
519	510	502	495	486	476	467	457	450	440	431	421	1 1/4	"
542	533	524	515	505	498	488	478	468	458	450	440	3/4	"
436	429	421	414	406	400	392	384	376	370	362	354	3/8	45
458	452	444	436	428	420	414	405	397	388	380	374	1/2	"
481	473	465	459	450	441	433	426	417	408	399	390	5/8	"
504	496	488	479	472	463	454	445	435	428	419	409	7/8	"
528	519	510	501	492	485	475	465	456	446	438	429	1 1/8	"
552	542	533	523	514	506	496	486	476	465	455	448	1 1/4	"
573	566	556	546	536	525	515	507	496	485	475	464	3/4	"
466	459	451	445	437	428	420	411	405	396	387	379	3/8	50
490	482	474	465	456	450	441	432	423	414	407	398	1/2	"
513	505	496	487	478	471	462	453	443	433	424	417	5/8	"
535	528	519	510	500	490	481	473	463	453	443	433	7/8	"
558	549	542	532	522	512	502	491	484	473	463	452	1 1/8	"
582	572	562	554	544	533	523	512	501	493	482	471	1 1/4	"
605	595	585	574	566	555	544	533	521	510	499	490	3/4	"
497	491	482	474	465	456	447	440	431	421	412	403	3/8	55
520	512	503	496	487	477	468	458	448	441	431	422	1/2	"
544	535	525	516	509	499	489	479	469	458	448	441	5/8	"
567	558	548	538	528	520	510	499	489	478	468	457	7/8	"
591	581	571	560	550	539	531	520	509	498	487	476	1 1/8	"
614	604	593	582	572	560	549	541	529	518	506	495	1 1/4	"
638	627	616	605	593	582	570	558	549	537	525	514	3/4	"

For detail dimensions see page 233

SAFE LOADS IN THOUSANDS OF POUNDS FOR 6" CHANNEL AND PLATE COLUMNS. SQUARE ENDS.

Based on Gordon's Formula $P = \frac{50\,000}{1 + \frac{(12 L)^2}{36\,000 r^2}}$ Safety factor 4.

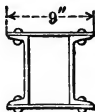

SERIES B.

Weight of each Channel.	Thickness of Plates.	Weight of Column.	Area of Column Section.	Least Radius of Gyration.	Length in Feet.				
					4	6	8	10	12
Lbs. per Foot.	Inch.	Lbs. per Ft.	Sq. Ins.	Inches.					
8	$\frac{1}{4}$	31.3	9.26	2.74	115	114	112	110	107
	$\frac{5}{16}$	35.1	10.39	2.73	129	127	126	123	121
	$\frac{3}{8}$	39.0	11.51	2.71	142	141	139	136	134
	$\frac{7}{16}$	42.8	12.64	2.70	156	155	153	150	147
	$\frac{1}{2}$	46.6	13.76	2.70	170	169	166	163	160
	$\frac{5}{8}$	50.4	14.89	2.69	184	183	180	176	172
$\frac{3}{4}$	54.3	16.01	2.68	198	196	193	190	185	
10.5	$\frac{1}{4}$	36.3	10.68	2.68	132	131	129	126	123
	$\frac{5}{16}$	40.1	11.81	2.67	146	145	142	140	137
	$\frac{3}{8}$	44.0	12.93	2.66	160	158	156	153	150
	$\frac{7}{16}$	47.8	14.06	2.66	174	172	170	166	163
	$\frac{1}{2}$	51.6	15.18	2.65	188	186	183	179	176
	$\frac{5}{8}$	55.4	16.31	2.65	202	200	197	193	189
$\frac{3}{4}$	59.3	17.43	2.65	216	213	210	206	202	
13	$\frac{1}{4}$	41.3	12.14	2.54	150	148	146	143	139
	$\frac{5}{16}$	45.1	13.27	2.62	164	162	160	157	153
	$\frac{3}{8}$	49.0	14.39	2.62	178	176	173	170	164
	$\frac{7}{16}$	52.8	15.52	2.62	192	190	187	183	179
	$\frac{1}{2}$	56.6	16.64	2.61	206	204	200	197	192
	$\frac{5}{8}$	60.4	17.77	2.61	220	218	214	210	205
$\frac{3}{4}$	64.3	18.89	2.61	234	231	227	223	218	
15.5	$\frac{1}{4}$	46.3	13.62	2.47	169	166	164	160	155
	$\frac{5}{16}$	50.1	14.75	2.54	183	180	178	174	169
	$\frac{3}{8}$	54.0	15.87	2.57	196	194	191	187	182
	$\frac{7}{16}$	57.8	17.00	2.57	210	208	205	200	195
	$\frac{1}{2}$	61.6	18.12	2.57	224	222	218	214	208
	$\frac{5}{8}$	65.4	19.25	2.57	238	236	232	227	221
$\frac{3}{4}$	69.3	20.37	2.57	252	249	245	240	234	

For detail dimensions see page 234

**SAFE LOADS IN THOUSANDS OF POUNDS FOR
6" CHANNEL AND PLATE COLUMNS.
SQUARE ENDS.**

Based on Gordon's Formula $P = \frac{50\,000}{1 + \frac{(12L)^2}{36\,000r^2}}$ Safety factor 4.

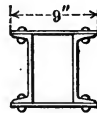

SERIES B.

Length in Feet.								Thickness of Plates.	Weight of each Channel.
14	16	18	20	22	24	26	28	Inch.	Lbs. per Ft.
105	102	99	95	92	88	85	82	1/4	8
118	114	111	107	103	99	95	91	1/8	"
130	126	123	118	114	109	105	101	3/8	"
143	139	134	130	125	120	115	110	1/2	"
155	151	146	141	136	131	126	120	5/8	"
168	163	158	153	147	141	135	130	1	"
181	175	170	163	158	151	145	140	5/8	"
120	116	113	108	105	100	96	92	1/4	10.5
133	129	125	121	116	111	107	102	1/8	"
145	141	136	132	127	122	117	112	3/8	"
158	154	148	143	138	133	127	122	1/2	"
171	166	160	155	149	143	137	131	5/8	"
183	178	172	166	160	153	147	141	1	"
196	190	184	178	171	164	157	151	5/8	"
135	131	126	121	116	112	107	102	1/4	13
149	144	139	135	129	124	119	114	1/8	"
162	157	151	146	134	134	129	123	3/8	"
174	169	163	158	151	145	139	133	1/2	"
186	181	175	168	162	155	149	143	5/8	"
199	193	187	180	173	166	159	152	1	"
211	206	198	191	184	176	169	162	5/8	"
151	146	140	135	129	124	118	113	1/4	15.5
164	159	153	148	142	136	130	124	1/8	"
178	172	166	160	153	147	141	134	3/8	"
190	184	178	171	164	158	151	144	1/2	"
203	196	189	182	175	168	161	154	5/8	"
215	209	201	194	186	179	171	163	1	"
228	221	213	205	196	189	181	173	5/8	"

For detail dimensions see page 234

SAFE LOADS IN THOUSANDS OF POUNDS FOR 7" CHANNEL AND PLATE COLUMNS. SQUARE ENDS.

Based on Gordon's Formula $P = \frac{50\,000}{1 + \frac{(12L)^2}{36\,000 r^2}}$ Safety factor 4.

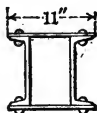

SERIES B.

Weight of each Channel.	Thick-ness of Plates.	Weight of Column.	Area of Column Section.	Least Radius of Gyration.	Length in Feet.					
					6	8	10	12	14	16
Lbs. per Ft.	Inch.	Lbs. per Ft.	Sq. Ina.	Inches.						
9.75	$\frac{1}{4}$	38.2	11.20	3.20	138	137	135	132	130	127
"	$\frac{3}{8}$	42.9	12.58	3.27	155	154	151	149	146	143
"	$\frac{1}{2}$	47.6	13.95	3.33	172	170	168	166	163	160
"	$\frac{5}{8}$	52.2	15.32	3.35	189	187	185	182	179	175
"	$\frac{3}{4}$	56.9	16.70	3.34	206	204	202	198	195	191
"	$\frac{7}{8}$	61.5	18.08	3.33	223	221	218	215	211	207
"	$\frac{1}{2}$	66.3	19.45	3.32	240	238	235	231	227	223
12.25	$\frac{1}{4}$	43.2	12.70	3.08	156	155	153	150	147	143
"	$\frac{3}{8}$	47.9	14.08	3.16	173	172	169	166	163	159
"	$\frac{1}{2}$	52.6	15.45	3.22	190	188	186	183	180	176
"	$\frac{5}{8}$	57.2	16.82	3.29	208	206	203	200	196	192
"	$\frac{3}{4}$	61.9	18.20	3.31	225	222	220	216	213	208
"	$\frac{7}{8}$	66.5	19.58	3.30	242	239	236	233	229	224
"	$\frac{1}{2}$	71.3	20.95	3.29	259	256	253	249	244	239
14.75	$\frac{1}{4}$	48.2	14.18	2.99	174	172	170	167	163	159
"	$\frac{3}{8}$	52.9	15.56	3.07	191	189	186	183	179	176
"	$\frac{1}{2}$	57.6	16.93	3.14	209	206	203	200	196	192
"	$\frac{5}{8}$	62.2	18.30	3.20	225	223	220	216	212	208
"	$\frac{3}{4}$	66.9	19.68	3.26	243	240	237	233	229	224
"	$\frac{7}{8}$	71.5	21.06	3.27	260	257	253	250	245	240
"	$\frac{1}{2}$	76.3	22.43	3.27	277	274	270	266	261	256
17.25	$\frac{1}{4}$	53.2	15.64	2.91	192	190	187	183	179	174
"	$\frac{3}{8}$	57.9	17.02	2.99	209	207	204	200	195	191
"	$\frac{1}{2}$	62.6	18.39	3.06	226	224	220	217	212	207
"	$\frac{5}{8}$	67.2	19.76	3.13	243	240	237	234	228	224
"	$\frac{3}{4}$	71.9	21.14	3.19	260	258	254	250	245	240
"	$\frac{7}{8}$	76.5	22.52	3.24	277	275	271	267	262	257
"	$\frac{1}{2}$	81.3	23.89	3.24	294	291	288	283	278	272
19.75	$\frac{1}{4}$	58.2	17.12	2.85	210	207	204	200	195	190
"	$\frac{3}{8}$	62.9	18.50	2.93	228	225	221	217	212	206
"	$\frac{1}{2}$	67.6	19.87	3.00	244	241	238	233	228	223
"	$\frac{5}{8}$	72.2	21.24	3.07	261	259	254	250	245	240
"	$\frac{3}{4}$	76.9	22.62	3.13	279	275	272	267	262	256
"	$\frac{7}{8}$	81.5	24.00	3.19	296	293	289	284	278	273
"	$\frac{1}{2}$	86.3	25.37	3.21	313	309	305	301	294	288

For detail dimensions see page 234

**SAFE LOADS IN THOUSANDS OF POUNDS FOR
7" CHANNEL AND PLATE COLUMNS.
SQUARE ENDS.**

Based on Gordon's Formula $P = \frac{50\,000}{1 + \frac{(12L)^2}{36\,000r^2}}$ Safety factor 4.

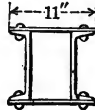

SERIES B.

Length in Feet.									Thickness of Plates.	Weight of each Channel.
18	20	22	24	26	28	30	32	34	Inch.	Lbs. per Ft.
124	121	118	114	111	107	103	100	97	1/4	9.75
140	137	133	130	125	121	117	114	110	1/8	"
156	152	148	144	140	136	132	127	123	3/8	"
171	167	163	159	154	149	145	140	136	1/2	"
187	182	178	173	168	163	158	153	147	5/8	"
202	198	192	187	182	173	171	165	160	1 1/8	"
218	213	207	201	196	190	184	178	172	1 3/8	"
140	136	132	128	124	119	115	111	107	1/4	12.25
156	152	147	143	139	134	129	125	120	1/8	"
172	167	163	158	153	148	143	139	133	3/8	"
188	183	178	173	168	163	158	153	148	1/2	"
204	199	194	188	182	176	171	165	160	5/8	"
218	213	207	202	196	190	184	178	172	1 1/8	"
234	228	222	216	210	203	197	190	184	1 3/8	"
155	150	145	141	136	131	127	122	117	1/4	14.75
171	166	161	156	151	146	141	136	130	1/8	"
187	182	177	172	166	161	155	149	144	3/8	"
203	198	192	187	181	175	169	163	158	1/2	"
219	214	209	202	196	190	184	178	172	5/8	"
235	229	223	217	210	203	197	190	184	1 1/8	"
250	244	238	231	223	216	209	203	196	1 3/8	"
169	164	159	154	148	143	137	132	128	1/4	17.25
186	180	175	169	163	157	152	146	140	1/8	"
202	197	190	185	178	172	166	160	154	3/8	"
218	212	206	200	194	188	180	174	167	1/2	"
235	228	222	216	208	202	195	189	181	5/8	"
250	244	238	231	224	217	209	202	195	1 1/8	"
265	259	252	245	238	230	222	215	207	1 3/8	"
185	179	173	167	161	155	149	143	137	1/4	19.75
201	195	189	182	176	169	163	157	150	1/8	"
217	211	205	198	191	185	177	170	164	3/8	"
233	227	220	214	206	199	192	185	178	1/2	"
249	243	236	229	222	215	207	200	192	5/8	"
267	259	252	245	236	229	222	214	206	1 1/8	"
282	275	266	259	251	243	236	227	219	1 3/8	"

For detail dimensions see page 234

SAFE LOADS IN THOUSANDS OF POUNDS FOR 8" CHANNEL AND PLATE COLUMNS. SQUARE ENDS.

Based on Gordon's Formula $P = \frac{50\,000}{1 + \frac{(12L)^2}{36\,000r^2}}$. Safety factor 4.

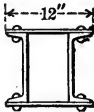

SERIES B.

Weight of each Channel. Lbs. per Ft.	Thick- ness of Plates. Inch.	Weight of Column. Lbs. per Ft.	Area of Column Section. Sq. Ins.	Least Radius of Gyration. Inches.	Length in Feet.						
					6	8	10	12	14	16	18
11.25	1/4	42.9	12.70	3.62	157	156	154	152	150	147	144
"	1/8	48.0	14.20	3.70	176	174	172	171	168	165	162
"	3/8	53.1	15.70	3.72	194	193	191	189	186	183	180
"	1/2	58.2	17.20	3.70	213	211	209	207	203	200	196
"	5/8	63.3	18.70	3.68	231	229	227	224	221	218	213
"	3/4	68.4	20.20	3.66	250	248	245	242	239	234	230
"	7/8	73.5	21.70	3.65	268	266	264	260	256	252	247
13.75	1/4	47.9	14.08	3.52	174	172	171	168	165	163	159
"	1/8	53.0	15.58	3.60	193	191	189	187	184	181	177
"	3/8	58.1	17.08	3.67	211	209	207	205	202	198	195
"	1/2	63.2	18.58	3.67	230	228	226	223	220	216	212
"	5/8	68.3	20.08	3.66	248	246	244	241	237	233	229
"	3/4	73.4	21.58	3.64	267	265	262	258	255	250	246
"	7/8	78.5	23.08	3.63	285	283	280	276	272	268	262
16.25	1/4	52.9	15.56	3.42	192	190	188	185	182	179	175
"	1/8	58.0	17.06	3.50	211	209	206	204	200	197	193
"	3/8	63.1	18.56	3.58	229	228	225	222	219	215	211
"	1/2	68.2	20.06	3.64	248	246	244	240	237	233	229
"	5/8	73.3	21.56	3.63	266	264	261	253	254	250	245
"	3/4	78.4	23.06	3.62	285	283	279	276	272	268	262
"	7/8	83.5	24.56	3.61	303	301	298	294	289	285	279
18.75	1/4	57.9	17.02	3.34	210	208	205	202	199	195	191
"	1/8	63.0	18.52	3.42	229	227	224	221	217	213	208
"	3/8	68.1	20.02	3.50	247	245	242	239	235	231	227
"	1/2	73.2	21.52	3.57	266	264	261	257	254	249	245
"	5/8	78.3	23.02	3.61	284	282	279	276	271	267	262
"	3/4	83.4	24.52	3.60	303	301	297	294	289	284	279
"	7/8	88.5	26.02	3.59	322	319	315	312	307	301	296
21.25	1/4	62.9	18.50	3.27	228	226	223	219	215	211	206
"	1/8	68.0	20.00	3.36	247	244	241	238	234	229	224
"	3/8	73.1	21.50	3.43	266	263	260	256	252	247	243
"	1/2	78.2	23.00	3.51	284	282	279	275	270	265	260
"	5/8	83.3	24.50	3.57	303	300	297	293	289	283	278
"	3/4	88.4	26.00	3.57	321	319	315	311	306	301	295
"	7/8	93.5	27.50	3.57	340	337	333	329	324	318	313

For detail dimensions see page 234

**SAFE LOADS IN THOUSANDS OF POUNDS FOR
8" CHANNEL AND PLATE COLUMNS.
SQUARE ENDS.**

Based on Gordon's Formula $P = \frac{50\,000}{1 + \frac{(12L)^2}{36\,000r^2}}$ Safety factor 4.

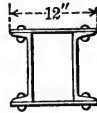

SERIES B.

Length in Feet.										Thick- ness of Plates.	Weight of each Channel.
20	22	24	26	28	30	32	34	36	38	Inch.	Lbs. per Ft.
142	138	135	131	128	124	121	117	114	110	1/4	11.25
159	156	152	148	144	141	137	133	129	125	5/16	"
176	172	168	164	160	155	151	147	143	139	3/8	"
193	189	184	180	175	170	166	161	156	151	1/2	"
209	204	200	194	190	184	179	175	169	164	5/8	"
225	221	215	210	204	199	194	188	182	176	1	"
242	237	231	226	219	214	207	202	195	189	5/8	"
156	152	149	144	140	137	132	128	124	120	1/4	13.75
173	170	165	161	157	153	148	144	139	134	5/16	"
191	187	183	178	173	168	164	159	154	149	3/8	"
208	203	199	193	187	183	178	173	168	162	1/2	"
224	219	214	209	203	198	193	186	181	175	5/8	"
241	236	230	224	218	213	206	200	194	188	1	"
257	251	246	239	233	226	220	213	207	200	5/8	"
171	167	163	158	153	149	144	140	135	130	1/4	16.25
189	184	179	175	170	165	160	155	150	145	5/16	"
206	202	197	191	187	181	176	170	165	160	3/8	"
224	219	214	209	203	198	191	186	180	175	1/2	"
240	235	230	223	218	211	206	199	194	187	5/8	"
257	251	245	239	233	226	220	213	207	200	1	"
274	267	261	254	247	241	233	227	219	213	5/8	"
186	181	176	171	166	161	155	150	145	140	1/4	18.75
204	199	194	188	182	177	171	166	161	155	5/16	"
221	216	210	205	199	193	188	182	176	170	3/8	"
239	233	228	222	216	210	203	198	191	186	1/2	"
257	250	245	238	231	226	219	213	206	200	5/8	"
272	267	260	254	247	240	233	226	219	212	1	"
289	283	276	269	262	254	247	239	232	224	5/8	"
201	196	191	184	178	173	167	161	156	150	1/4	21.25
219	214	208	202	196	190	184	178	172	165	5/16	"
237	231	225	218	212	206	200	193	187	180	3/8	"
254	248	243	236	229	223	216	209	202	196	1/2	"
272	265	260	252	246	239	231	225	218	211	5/8	"
289	282	276	268	261	253	245	239	231	224	1	"
305	298	291	283	276	268	260	253	244	237	5/8	"

For detail dimensions see page 234

SAFE LOADS IN THOUSANDS OF POUNDS FOR 9" CHANNEL AND PLATE COLUMNS. SQUARE ENDS.

Based on Gordon's Formula $P = \frac{50\,000}{1 + \frac{(12L)^2}{36\,000r^2}}$ Safety factor 4.

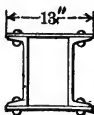

SERIES B.

Weight of each Channel.	Thick- ness of Plates.	Weight of Column.	Area of Column Section.	Least Radius of Gyration.	Length in Feet.								
					6	8	10	12	14	16	18	20	
Lbs. per Ft.	Inch.	Lbs. per Ft.	Sq. Ins.	Inches.									
13.25	1/4	48.6	14.28	4.05	177	176	174	172	170	168	166	163	
"	5/16	54.1	15.90	4.10	197	196	194	192	190	187	184	181	
"	3/8	59.7	17.53	4.07	217	216	214	212	209	207	203	200	
"	1/2	65.2	19.16	4.04	237	236	234	231	228	225	222	218	
"	5/8	70.7	20.78	4.02	257	256	253	251	248	244	240	236	
"	3/4	76.2	22.40	4.00	277	276	273	270	267	263	259	255	
"	7/8	81.7	24.03	3.99	297	296	293	290	286	282	278	273	
15.0	1/4	52.1	15.32	3.97	190	188	187	185	183	180	177	174	
"	5/16	57.6	16.94	4.05	210	208	207	204	202	199	197	193	
"	3/8	63.2	18.57	4.05	230	228	226	224	221	218	215	212	
"	1/2	68.7	20.20	4.03	250	249	246	244	241	237	234	230	
"	5/8	74.2	21.82	4.01	270	268	266	263	260	256	252	248	
"	3/4	79.7	23.44	3.99	290	288	286	283	279	275	271	266	
"	7/8	85.2	25.07	3.97	310	308	306	302	299	295	290	285	
20.0	1/4	62.1	18.26	3.78	226	224	222	219	216	213	209	205	
"	5/16	67.6	19.88	3.87	246	244	242	239	236	233	228	224	
"	3/8	73.2	21.51	3.95	266	264	262	260	256	252	248	244	
"	1/2	78.7	23.14	3.98	286	285	282	279	276	272	268	263	
"	5/8	84.2	24.76	3.96	306	305	302	299	295	291	286	280	
"	3/4	89.7	26.39	3.95	327	325	322	318	314	309	304	299	
"	7/8	95.2	28.01	3.94	347	345	342	338	333	328	323	317	
25.0	1/4	72.1	21.20	3.64	262	260	257	254	251	246	242	236	
"	5/16	77.6	22.82	3.73	282	280	277	274	270	266	261	255	
"	3/8	83.2	24.45	3.81	303	300	298	294	290	285	281	276	
"	1/2	88.7	26.08	3.89	323	320	317	314	310	305	301	295	
"	5/8	94.2	27.70	3.92	343	341	337	333	329	324	319	314	
"	3/4	99.7	29.32	3.91	363	361	357	353	348	343	338	332	
"	7/8	105.2	30.95	3.90	383	380	377	373	368	362	357	350	

For detail dimensions see page 234

**SAFE LOADS IN THOUSANDS OF POUNDS FOR
9" CHANNEL AND PLATE COLUMNS.
SQUARE ENDS.**

Based on Gordon's Formula $P = \frac{50\,000}{1 + \frac{(12 L)^2}{36\,000 r^2}}$ Safety factor 4.

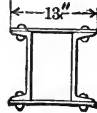

SERIES B.

Length in Feet.											Thickness of Plates.	Weight of each Channel.
22	24	26	28	30	32	34	36	38	40	42	Inch.	Lbs. per Ft.
160	157	153	150	146	143	139	136	132	128	125	1/4	13.25
178	174	172	168	164	160	156	152	148	144	140	5/16	"
196	192	188	184	180	175	171	167	163	158	154	3/8	"
214	210	206	201	196	192	187	182	177	172	167	7/16	"
232	227	222	217	212	207	202	196	191	186	181	1/2	"
250	245	240	234	229	223	217	211	206	200	194	5/8	"
268	263	257	251	245	239	233	227	221	215	208	5/8	"
171	167	164	159	156	152	148	144	140	136	132	1/4	15.0
190	186	182	178	174	169	165	161	156	152	148	5/16	"
208	204	199	195	190	186	181	176	172	167	162	3/8	"
225	221	216	212	207	202	197	192	187	181	176	7/16	"
243	238	233	228	223	217	212	206	200	195	189	1/2	"
261	256	251	245	239	233	227	221	215	209	203	5/8	"
280	274	268	261	255	248	242	235	229	223	216	5/8	"
201	197	192	187	183	177	172	168	162	158	153	1/4	20.0
220	215	211	206	200	195	190	185	180	174	168	5/16	"
239	234	229	224	218	213	207	202	196	191	186	3/8	"
258	253	247	242	236	230	224	218	213	205	200	7/16	"
275	269	264	258	251	245	239	232	226	220	214	1/2	"
293	287	281	274	268	261	255	248	241	234	228	5/8	"
311	305	298	291	284	277	270	263	256	247	240	5/8	"
232	226	221	214	209	202	197	190	185	179	173	1/4	25.0
250	245	238	233	227	220	214	207	201	196	189	5/16	"
269	264	258	252	245	238	232	226	218	212	206	3/8	"
288	283	276	270	264	257	250	242	236	229	222	7/16	"
308	301	295	288	280	273	266	259	252	245	238	1/2	"
326	319	312	304	296	289	281	274	266	260	251	5/8	"
344	335	328	320	313	309	297	289	281	273	264	5/8	"

**SAFE LOADS IN THOUSANDS OF POUNDS FOR
10" CHANNEL AND PLATE COLUMNS.
SQUARE ENDS.**

Based on Gordon's Formula $P = \frac{50\,000}{1 + \frac{(12 L)^2}{36\,000 r^2}}$ Safety factor 4.

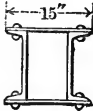

SERIES B.

Weight of each Channel. Lbs. per Ft.	Thick-ness of Plates. Inch.	Weight of Column. Lbs. per Ft.	Area of Column Section. Sq. Ins.	Least Radius of Gyration. Inches.	Length in Feet.											
					8	10	12	14	16	18	20	22	24			
15	1/4	55.5	16.42	4.49	203	201	199	198	195	193	190	187	185			
"	5/16	61.9	18.30	4.58	226	224	223	220	218	216	212	209	206			
"	3/8	68.3	20.17	4.65	249	247	245	243	241	238	235	232	228			
"	7/16	74.6	22.05	4.70	272	271	268	266	263	261	257	253	250			
"	1/2	81.0	23.92	4.67	296	294	291	289	286	282	278	275	271			
"	9/16	87.4	25.80	4.65	319	316	314	311	308	304	300	296	291			
"	5/8	93.8	27.67	4.63	342	339	337	334	330	326	322	317	312			
20	1/4	65.5	19.26	4.29	237	236	233	231	228	225	221	218	214			
"	5/16	71.9	21.14	4.39	261	259	257	254	251	248	244	240	236			
"	3/8	78.3	23.01	4.47	284	282	279	277	273	270	266	262	258			
"	7/16	84.6	24.80	4.55	307	305	303	300	297	292	289	285	280			
"	1/2	91.0	26.76	4.62	331	328	326	323	319	315	311	306	302			
"	9/16	97.4	28.64	4.63	354	351	349	346	341	337	333	328	323			
"	5/8	103.8	30.51	4.61	377	374	371	368	364	359	355	349	344			
25	1/4	75.5	22.20	4.13	274	271	268	265	262	258	254	249	245			
"	5/16	81.9	24.08	4.23	297	294	292	288	285	280	277	272	266			
"	3/8	88.3	25.95	4.32	320	318	315	312	308	303	299	294	288			
"	7/16	94.6	27.83	4.40	343	341	333	334	331	326	322	316	310			
"	1/2	101.0	29.70	4.48	367	364	361	357	353	349	343	339	332			
"	9/16	107.4	31.58	4.55	390	387	384	380	376	371	366	361	355			
"	5/8	113.8	33.45	4.58	413	410	407	403	399	394	388	383	377			
30	1/4	85.5	25.14	4.01	309	307	303	300	295	291	286	280	275			
"	5/16	91.9	27.02	4.11	333	330	327	323	318	313	308	302	298			
"	3/8	98.3	28.89	4.20	356	353	349	346	341	336	331	326	320			
"	7/16	104.6	30.77	4.28	379	377	373	369	365	359	353	348	342			
"	1/2	111.0	32.64	4.36	403	400	396	392	387	382	376	371	364			
"	9/16	117.4	34.52	4.43	426	423	419	415	410	404	399	392	386			
"	5/8	123.8	36.39	4.50	449	446	442	438	432	428	422	415	409			
35	1/4	95.5	28.08	3.90	345	342	338	334	329	324	318	312	304			
"	5/16	101.9	29.96	4.00	369	365	361	357	352	346	340	334	327			
"	3/8	108.3	31.83	4.10	392	389	385	380	375	369	363	356	349			
"	7/16	114.6	33.71	4.18	415	412	408	404	398	392	386	379	373			
"	1/2	121.0	35.58	4.26	438	436	431	426	420	415	409	401	395			
"	9/16	127.4	37.46	4.33	462	459	454	450	444	437	432	424	418			
"	5/8	133.8	39.33	4.40	485	481	478	472	467	461	455	447	439			

For detail dimensions see page 235

**SAFE LOADS IN THOUSANDS OF POUNDS FOR
10" CHANNEL AND PLATE COLUMNS.
SQUARE ENDS.**

Based on Gordon's Formula $P = \frac{50\,000}{1 + \frac{(12L)^2}{36\,000r^2}}$. Safety factor 4.

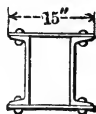

SERIES B.

Length in Feet.												Thick- ness of Plates.	Weight of each Channel.
26	28	30	32	34	36	38	40	42	44	46	48	Inch.	Lbs. per Ft.
181	178	174	171	167	163	159	156	152	148	145	141	1/4	15
202	199	195	191	188	183	179	176	171	167	163	159	5/16	"
224	220	216	212	208	204	199	195	190	185	181	177	3/8	"
246	241	237	233	228	223	218	214	209	204	199	195	1/2	"
266	261	257	251	246	242	237	231	226	221	215	210	5/8	"
287	282	276	271	266	261	254	249	244	237	232	226	1/2	"
307	302	296	291	285	278	273	267	260	254	248	241	5/8	"
210	206	201	197	193	188	183	179	174	169	165	160	1/4	20
232	227	223	218	214	208	203	198	193	189	183	179	5/16	"
254	248	244	238	234	228	223	218	213	208	202	197	3/8	"
275	270	265	260	254	249	243	238	232	226	221	216	1/2	"
297	291	286	281	274	269	264	257	251	246	239	233	5/8	"
318	313	306	301	295	288	282	276	269	263	257	250	1/2	"
339	332	326	320	313	307	301	293	286	280	272	266	5/8	"
239	234	229	224	219	213	207	202	196	190	186	180	1/4	25
262	256	250	245	240	234	227	221	216	210	204	199	5/16	"
284	277	272	266	260	254	248	241	236	229	223	217	3/8	"
305	299	294	287	281	274	268	261	256	248	241	236	1/2	"
327	322	315	309	302	296	288	282	274	268	261	255	5/8	"
349	342	336	330	322	316	308	301	295	287	280	274	1/2	"
370	364	356	350	343	335	328	321	312	305	299	290	5/8	"
269	263	257	250	244	237	231	224	218	212	205	199	1/4	30
291	285	278	272	265	258	252	245	239	232	225	218	5/16	"
313	306	300	293	286	279	273	265	258	251	243	238	3/8	"
335	329	322	314	308	300	292	286	278	270	264	256	1/2	"
357	351	342	336	328	320	313	305	298	290	282	275	5/8	"
379	372	364	357	349	342	333	326	317	310	301	294	1/2	"
401	394	386	378	370	362	355	345	338	329	321	312	5/8	"
298	291	284	277	269	262	255	248	239	232	225	219	1/4	35
320	313	306	298	291	283	275	267	260	252	245	238	5/16	"
343	336	328	320	312	304	296	287	281	273	265	257	3/8	"
365	357	349	340	334	325	317	309	301	292	284	276	1/2	"
387	379	372	363	354	345	338	329	320	312	303	294	5/8	"
409	401	393	384	375	367	358	350	340	331	323	314	1/2	"
432	422	415	405	397	387	379	369	361	351	341	333	5/8	"

For detail dimensions see page 235

SAFE LOADS IN THOUSANDS OF POUNDS FOR 12" CHANNEL AND PLATE COLUMNS. SQUARE ENDS.

Based on Gordon's Formula $P = \frac{50\,000}{1 + \frac{(12L)^2}{36\,000r^2}}$. Safety factor 4.

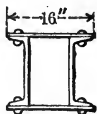

SERIES B.

Weight of each Channel.	Thick-ness of Plates.	Weight of Column.	Area of Column Section.	Least Radius of Gyration.	Length in Feet.												
					Lbs. per Ft.	Inch.	Lbs. per Ft.	Sq. Ins.	Inches.	8	10	12	14	16	18	20	22
20.5	1/4	68.2	20.06	5.23	248	247	246	244	241	240	237	234	231				
"	5/16	75.0	22.06	5.18	273	272	270	268	266	263	260	258	254				
"	3/8	81.8	24.06	5.14	298	296	295	292	290	287	283	280	276				
"	1/2	88.6	26.06	5.10	322	321	318	317	314	311	307	303	299				
"	5/8	95.4	28.06	5.07	347	345	343	340	337	333	331	327	322				
"	3/4	102.2	30.06	5.04	372	370	367	364	361	357	354	349	344				
"	7/8	109.0	32.06	5.01	397	394	392	389	385	381	377	372	367				
25	1/4	77.2	22.70	5.09	281	279	277	275	273	270	267	264	261				
"	5/16	84.0	24.70	5.14	306	304	302	300	297	294	291	287	284				
"	3/8	90.8	26.70	5.11	330	328	326	324	321	318	315	311	307				
"	1/2	97.6	28.70	5.07	355	353	351	348	345	341	338	334	330				
"	5/8	104.4	30.70	5.05	380	378	375	372	369	365	361	356	351				
"	3/4	111.2	32.70	5.02	405	402	400	396	393	389	384	379	374				
"	7/8	118.0	34.70	5.00	429	427	424	421	417	412	408	403	397				
30	1/4	87.2	25.64	4.93	317	315	313	311	308	304	300	296	292				
"	5/16	94.0	27.64	5.04	342	340	338	335	332	328	326	321	316				
"	3/8	100.8	29.64	5.07	367	365	362	359	356	352	349	345	340				
"	1/2	107.6	31.64	5.04	391	389	387	383	380	376	373	367	362				
"	5/8	114.4	33.64	5.02	416	414	411	408	404	400	395	390	385				
"	3/4	121.2	35.64	4.99	441	438	435	432	428	424	419	413	408				
"	7/8	128.0	37.64	4.98	466	463	460	456	452	447	442	437	431				
35	1/4	97.2	28.58	4.80	353	351	349	346	342	338	334	329	325				
"	5/16	104.0	30.58	4.91	378	376	374	370	366	362	358	354	349				
"	3/8	110.8	32.58	5.01	403	401	398	395	391	387	383	378	373				
"	1/2	117.6	34.58	4.99	428	425	422	419	415	411	406	401	396				
"	5/8	124.4	36.58	4.97	453	450	447	443	439	435	430	424	419				
"	3/4	131.2	38.58	4.95	477	475	471	468	463	458	453	448	442				
"	7/8	138.0	40.58	4.94	502	499	496	492	487	482	477	469	463				
40	1/4	107.2	31.52	4.69	389	387	384	380	377	373	367	362	357				
"	5/16	114.0	33.52	4.80	414	412	409	405	402	396	391	386	381				
"	3/8	120.8	35.52	4.90	439	437	434	430	425	421	416	411	405				
"	1/2	127.6	37.52	4.95	464	462	458	455	451	446	441	435	429				
"	5/8	134.4	39.52	4.94	489	486	483	479	474	470	464	457	451				
"	3/4	141.2	41.52	4.92	514	511	507	503	497	492	486	480	473				
"	7/8	148.0	43.52	4.91	538	535	532	526	521	516	510	503	496				

For detail dimensions see page 235

**SAFE LOADS IN THOUSANDS OF POUNDS FOR
12" CHANNEL AND PLATE COLUMNS.
SQUARE ENDS.**

Based on Gordon's Formula $P = \frac{50\,000}{1 + \frac{(12L)^2}{36\,000r^2}}$ Safety factor 4.

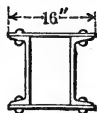

SERIES B.

Length in Feet.												Thick- ness of Plates.	Weight of each Channel.
26	28	30	32	34	36	38	40	42	44	46	48	Inch.	Lbs. per Ft.
228	225	222	218	215	211	207	204	200	196	191	187	1/4	20.5
251	247	243	239	235	231	227	223	218	214	209	205	5/16	"
272	269	265	261	256	251	247	242	237	232	228	223	3/8	"
295	291	286	281	276	271	266	262	257	251	246	241	1/2	"
318	313	308	303	297	292	286	281	275	269	263	258	5/8	"
339	334	328	324	319	313	307	301	295	288	282	276	1 1/8	"
362	356	350	344	338	332	326	319	313	306	299	293	1 3/8	"
257	253	249	245	241	236	232	227	222	219	214	210	1/4	25
280	276	272	268	263	258	253	248	243	238	234	229	5/16	"
302	298	293	288	283	279	274	268	263	258	252	247	3/8	"
325	320	315	310	304	299	293	287	281	275	269	264	1/2	"
348	342	337	331	325	319	313	307	301	295	288	282	5/8	"
369	363	357	351	345	339	332	325	319	312	305	299	1 1/8	"
391	385	379	373	366	359	352	345	338	331	324	317	1 3/8	"
288	284	279	274	269	264	259	254	249	243	238	233	1/4	30
312	307	302	298	293	287	282	276	271	265	260	254	5/16	"
336	330	325	320	314	308	302	296	290	284	278	272	3/8	"
357	351	346	341	335	329	323	316	310	304	297	291	1/2	"
379	374	368	361	355	348	342	335	328	321	314	307	5/8	"
402	396	389	383	376	369	362	355	347	340	333	326	1 1/8	"
425	418	411	404	397	390	382	375	367	359	351	344	1 3/8	"
320	315	310	308	297	292	286	280	273	267	261	255	1/4	35
344	338	333	327	321	315	309	303	295	289	282	276	5/16	"
368	362	356	350	344	337	331	324	318	311	304	298	3/8	"
390	384	378	371	365	358	351	344	337	330	323	316	1/2	"
413	406	400	393	386	379	371	364	355	347	340	332	5/8	"
434	427	420	413	405	398	390	382	374	366	358	350	1 1/8	"
456	449	442	434	426	418	410	402	394	385	377	369	1 3/8	"
351	344	339	333	326	318	312	306	298	291	285	278	1/4	40
375	369	363	355	349	342	335	328	320	313	306	299	5/16	"
399	393	386	380	373	366	357	350	343	335	328	321	3/8	"
422	415	408	401	394	387	379	372	364	356	348	341	1/2	"
444	437	430	423	415	407	399	391	383	375	367	359	5/8	"
466	459	452	444	436	428	420	411	403	394	386	375	1 1/8	"
489	481	473	465	457	448	440	431	420	411	402	393	1 3/8	"

For detail dimensions see page 235

**SAFE LOADS IN THOUSANDS OF POUNDS FOR
15" CHANNEL AND PLATE COLUMNS.
SQUARE ENDS.**

Based on Gordon's Formula $P = \frac{50\,000}{1 + \frac{(12L)^2}{36\,000r^2}}$ Safety factor 4.

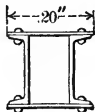

SERIES B.

Weight of each Channel.	Thick-ness of Plates.	Weight of Column.	Area of Column Section.	Least Radius of Gyration.	Length in Feet.														
					12	14	16	18	20	22	24	26	28						
Lbs. per Ft.	Inch.	Lbs. per Ft.	Sq. Ins.	Inches.															
33	3/8	117.0	34.80	6.59	429	427	425	423	420	417	414	410	406						
"	1/2	125.5	37.30	6.57	460	458	456	453	450	447	442	438	434						
"	5/8	134.0	39.80	6.52	491	489	485	482	479	476	472	468	463						
"	3/4	142.5	42.30	6.48	521	519	516	513	509	505	501	497	492						
"	7/8	151.0	44.80	6.44	552	549	546	543	539	535	531	526	521						
"	1 1/8	159.5	47.30	6.41	583	580	577	573	569	565	561	554	549						
"	1 1/4	168.0	49.80	6.38	614	611	607	604	599	595	591	583	578						
35	3/8	121.0	35.58	6.55	439	437	435	432	428	425	422	418	414						
"	1/2	129.5	38.08	6.56	470	468	465	463	459	455	451	447	443						
"	5/8	138.0	40.58	6.52	501	498	495	492	488	485	481	477	472						
"	3/4	146.5	43.08	6.48	531	528	525	522	519	515	511	506	501						
"	7/8	155.0	45.58	6.44	562	559	556	552	549	545	540	535	531						
"	1 1/8	163.5	48.08	6.41	592	590	586	583	579	574	570	563	558						
"	1 1/4	172.0	50.58	6.38	623	620	617	613	609	604	598	592	587						
40	3/8	131.0	38.52	6.41	475	472	470	467	464	460	457	451	447						
"	1/2	139.5	41.02	6.51	506	503	500	497	494	490	486	482	477						
"	5/8	148.0	43.52	6.50	537	534	531	527	524	520	516	511	507						
"	3/4	156.5	46.02	6.47	567	564	561	558	554	550	545	541	536						
"	7/8	165.0	48.52	6.43	598	595	592	588	584	580	575	570	563						
"	1 1/8	173.5	51.02	6.40	629	626	622	618	614	610	603	598	592						
"	1 1/4	182.0	53.52	6.37	659	656	653	649	644	638	633	627	621						
45	3/8	141.0	41.48	6.28	511	509	506	502	498	494	490	486	480						
"	1/2	149.5	43.98	6.39	542	539	536	533	529	525	520	515	510						
"	5/8	158.0	46.48	6.48	573	570	567	563	559	555	551	546	541						
"	3/4	166.5	48.98	6.45	604	601	597	594	590	585	580	575	570						
"	7/8	175.0	51.48	6.42	634	631	628	624	620	615	610	603	597						
"	1 1/8	183.5	53.98	6.39	665	662	658	654	650	645	638	632	626						
"	1 1/4	192.0	56.48	6.37	696	693	689	685	680	673	667	661	655						
50	3/8	151.0	44.42	6.17	547	544	541	537	533	528	523	519	514						
"	1/2	159.5	46.92	6.28	578	575	572	567	563	559	555	550	543						
"	5/8	168.0	49.42	6.37	609	606	603	599	595	589	584	579	573						
"	3/4	176.5	51.92	6.43	640	636	633	629	625	620	615	610	602						
"	7/8	185.0	54.42	6.40	671	667	664	660	655	650	643	637	631						
"	1 1/8	193.5	56.92	6.37	701	698	694	690	685	678	673	667	660						
"	1 1/4	202.0	59.42	6.35	732	729	725	720	715	708	702	696	689						
55	3/8	161.0	47.36	6.07	583	580	576	571	567	563	556	551	546						
"	1/2	169.5	49.86	6.18	614	610	607	603	599	593	588	582	577						
"	5/8	178.0	52.36	6.28	645	642	639	633	629	624	619	613	605						
"	3/4	186.5	54.86	6.37	676	673	669	665	660	654	648	643	636						
"	7/8	195.0	57.36	6.38	707	703	700	695	690	685	678	672	665						
"	1 1/8	203.5	59.86	6.35	738	734	730	726	721	713	707	701	694						
"	1 1/4	212.0	62.36	6.33	768	764	760	756	751	743	737	730	724						

For detail dimensions see page 235

**SAFE LOADS IN THOUSANDS OF POUNDS FOR
15" CHANNEL AND PLATE COLUMNS.
SQUARE ENDS.**

Based on Gordon's Formula $P = \frac{50\,000}{1 + \frac{(12L)^2}{36\,000r^2}}$ Safety factor 4.

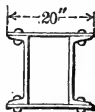

SERIES B.

Length in Feet.												Thick- ness of Plates.	Weight of each Channel.
30	32	34	36	38	40	42	44	46	48	50	52	Inch.	Lbs. per Ft.
401	397	393	388	383	379	374	369	364	359	353	348	3/8	33
430	425	421	416	411	406	401	395	390	384	379	373	1/4	"
459	454	449	444	439	433	427	422	414	408	402	396	1/2	"
487	482	477	470	464	458	452	446	440	434	427	421	3/8	"
515	509	503	498	492	485	479	473	466	457	450	444	5/8	"
543	538	532	525	519	512	504	497	490	483	476	468	1 1/8	"
572	566	560	553	544	537	530	523	516	508	501	491	3/4	"
410	406	401	397	392	387	382	377	372	367	361	356	3/8	35
439	434	430	425	420	414	409	404	398	392	387	381	1/4	"
468	463	358	452	447	442	436	430	422	416	410	404	1/2	"
496	491	486	478	473	467	461	454	448	442	435	429	3/8	"
523	518	512	506	500	494	487	481	474	465	458	451	5/8	"
552	546	540	534	528	521	512	505	498	491	483	476	1 1/8	"
581	575	568	562	553	546	538	531	524	516	509	498	3/4	"
442	438	433	428	423	417	410	404	399	393	387	381	3/8	40
473	468	463	457	452	446	439	433	427	421	414	408	1/4	"
502	496	491	485	480	471	465	459	453	446	440	433	1/2	"
530	525	517	511	505	499	492	485	479	472	465	458	3/8	"
557	551	545	539	532	526	519	512	502	495	488	480	5/8	"
586	580	573	567	560	553	543	536	528	521	513	505	1 1/8	"
615	608	601	592	585	577	570	562	554	546	538	527	3/4	"
475	470	464	459	451	445	440	433	427	421	413	407	3/8	45
505	500	494	488	483	474	468	462	455	449	442	435	1/4	"
536	530	524	518	510	504	497	490	483	477	470	463	1/2	"
563	557	550	544	537	531	524	517	509	502	492	485	3/8	"
591	585	578	572	565	558	550	540	533	525	518	510	5/8	"
620	613	607	600	592	582	575	567	559	551	543	535	1 1/8	"
649	642	635	625	617	609	601	593	585	576	568	556	3/4	"
507	501	495	489	481	475	469	462	453	447	440	433	3/8	50
537	531	525	519	510	504	497	493	483	476	467	460	1/4	"
568	562	555	547	540	533	526	519	512	504	497	487	1/2	"
596	590	583	577	570	563	555	548	538	530	522	514	3/8	"
625	618	612	604	597	590	579	571	563	555	547	539	5/8	"
654	647	640	630	622	614	606	598	589	581	572	561	1 1/8	"
682	675	665	657	649	641	632	623	615	603	594	585	3/4	"
540	532	526	520	511	504	497	490	481	474	466	457	3/8	55
569	562	556	549	542	533	526	519	511	501	494	486	1/4	"
599	593	586	579	570	562	555	547	540	532	521	513	1/2	"
630	623	616	607	599	592	584	576	568	560	552	540	3/8	"
659	652	645	637	627	619	611	602	594	585	577	565	5/8	"
687	680	670	662	654	646	637	628	620	608	599	590	1 1/8	"
716	706	698	690	681	673	664	652	643	633	624	614	3/4	"

For detail dimensions see page 235

SAFE LOADS IN THOUSANDS OF POUNDS FOR HOLLOW ROUND CAST IRON COLUMNS. SQUARE ENDS.

$$\text{Based on Gordon's Formula } P = \frac{10\,000}{1 + \frac{l^2}{800d^2}}$$

P = safe load in pounds per square inch.

l = length of column in inches.

d = outside diameter of column in inches.

Ultimate compressive strength = 80 000 pounds per square inch. Safety factor 8.

Safe loads for other safety factors than that of the tables may be obtained as

follows:—New safe load = Safe load from table $\times \frac{8}{\text{New factor}}$

Outside Diam- eter in Inches.	Thick- ness in Inches.	Length of Column in Feet.										Area of Metal in Sq. Ins.	Weight per Foot in Pounds.
		6	8	10	12	14	16	18	20	22	24		
6	3/4	105	94	82	72	62	54	47	41	36	32	12.4	38.7
	5/8	119	107	94	82	71	62	54	47	41	36	14.1	44.0
7	3/4	130	119	108	96	86	76	67	60	53	47	14.7	46.0
	5/8	149	136	123	110	98	87	77	68	61	54	16.8	52.6
8	3/4	155	145	133	122	110	99	89	80	72	65	17.1	53.4
	5/8	178	166	153	139	126	114	104	92	83	75	19.6	61.2
9	1	200	186	172	158	142	128	115	103	93	84	22.0	68.7
	7/8	207	196	183	169	156	142	130	118	108	98	22.3	69.8
10	1	233	220	206	190	175	160	146	133	121	110	25.1	78.5
	7/8	258	244	228	211	194	177	162	147	134	122	27.8	87.0
11	1	235	225	212	199	185	172	158	146	134	123	25.1	78.4
	7/8	265	254	240	224	209	194	178	164	151	139	28.3	88.4
12	1 1/8	294	281	266	249	232	215	198	182	168	154	31.4	98.0
	1 1/4	323	308	291	273	254	235	217	200	184	169	34.4	107.4
13	1 1/8	298	287	273	259	243	227	212	197	183	169	31.4	98.2
	1 1/4	330	319	304	287	270	253	235	219	203	188	34.9	109.1
14	1 1/4	363	350	333	315	296	277	258	240	223	206	38.3	119.7
	1 1/2	395	380	361	342	322	301	280	261	242	224	41.6	129.9
15	1 1/2	368	356	342	326	309	291	274	256	239	223	38.4	120.1
	1 3/4	404	391	375	358	339	320	300	281	263	245	42.2	131.9
16	1 3/4	439	425	408	389	369	348	327	306	287	267	45.9	143.4
	1 7/8	473	458	440	419	397	375	352	330	308	288	49.5	154.6
17	1 7/8	404	393	379	364	347	330	312	294	277	260	42.0	131.2
	1 3/4	444	432	417	400	382	363	343	323	304	286	46.1	144.2
18	1 3/4	484	470	454	435	415	395	373	352	331	311	50.2	156.9
	1 7/8	522	507	490	470	448	426	403	380	358	336	54.2	169.4
19	1 7/8	485	473	459	442	424	405	386	366	347	327	50.1	156.5
	1 3/4	528	515	499	482	462	441	420	399	378	357	54.5	170.4
20	1 3/4	570	556	540	520	499	477	454	431	408	385	58.9	184.1
	1 7/8	612	597	579	558	535	511	487	462	437	413	63.2	197.4
21	1 7/8	573	560	545	528	509	489	467	446	424	406	58.9	183.9
	1 3/4	618	605	589	570	550	528	505	482	459	439	63.6	198.8
22	1 3/4	664	650	632	612	590	567	542	517	492	471	68.3	213.4
	1 7/8	708	694	675	653	630	605	579	552	525	502	72.8	227.6
23	1 7/8	666	654	638	620	600	579	557	533	510	486	68.3	213.5
	1 3/4	716	702	686	666	645	622	598	573	548	522	73.4	229.3
24	1 3/4	764	750	732	711	689	664	638	611	584	558	78.3	244.8
	1 7/8	811	796	777	756	731	705	678	649	621	592	83.2	260.0

**SAFE LOADS IN THOUSANDS OF POUNDS FOR
HOLLOW ROUND CAST IRON COLUMNS.
SQUARE ENDS.**

Based on Gordon's Formula $P = \frac{10\ 000}{1 + \frac{l^2}{800\ d^2}}$.

P = safe load in pounds per square inch.

l = length of column in inches.

d = outside diameter of column in inches.

Ultimate compressive strength = 80 000 pounds per square inch. Safety factor 8.

Safe loads for other safety factors than that of the tables may be obtained as follows:—

New safe load = Safe load from table $\times \frac{8}{\text{New factor}}$.

Outside Diam-eter in Inches.	Thick-ness in Inches.	Length of Column in Feet.										Area of Metal in Sq. Ins.	Weight per Foot in Pounds.
		14	16	18	20	22	24	26	28	30	32		
18	1 5/8	754	732	708	684	659	633	608	596	557	533	83.6	261.2
	1 3/4	806	782	757	732	704	677	650	637	596	569	89.3	279.2
	1 7/8	857	832	805	777	749	720	691	677	633	605	95.0	296.8
	2	907	880	852	823	792	762	731	717	670	641	100.5	314.2
20	1 3/4	922	900	876	850	824	797	769	742	714	687	100.3	313.6
	1 7/8	981	957	932	905	877	848	819	789	760	731	106.8	333.6
	2	1039	1014	987	958	929	898	867	836	805	774	113.1	353.4
	2 1/8	1097	1070	1041	1011	980	948	915	882	849	817	119.3	372.9
22	1 7/8	1105	1082	1058	1032	1005	976	947	918	888	859	118.5	370.5
	2	1171	1147	1122	1094	1065	1035	1004	974	941	910	125.7	392.7
	2 1/8	1239	1213	1186	1157	1126	1094	1062	1029	996	962	132.9	415.3
	2 1/4	1301	1275	1246	1215	1183	1150	1116	1081	1046	1011	139.6	436.3
24	2	1303	1280	1241	1229	1201	1171	1141	1110	1079	1047	138.2	432.0
	2 1/8	1376	1352	1311	1298	1268	1238	1206	1173	1140	1106	146.0	456.4
	2 1/4	1449	1423	1380	1367	1335	1303	1269	1235	1200	1165	153.7	480.4
	2 3/8	1520	1494	1448	1434	1402	1367	1332	1296	1259	1222	161.4	504.2
26	2 1/8	1515	1492	1467	1440	1412	1382	1351	1319	1286	1252	159.4	498.1
	2 1/4	1596	1572	1546	1517	1487	1456	1423	1389	1354	1319	167.9	524.6
	2 3/8	1675	1650	1623	1593	1562	1528	1494	1458	1422	1385	176.3	550.9
	2 1/2	1754	1728	1699	1668	1635	1600	1564	1527	1489	1450	184.6	576.8
28	2 3/4	1742	1719	1694	1667	1638	1608	1576	1542	1508	1474	182.0	568.8
	2 7/8	1829	1806	1780	1751	1721	1689	1655	1620	1584	1548	191.2	597.5
	2 7/8	1917	1892	1864	1834	1802	1769	1734	1697	1660	1622	200.3	625.9
	2 9/8	2002	1967	1948	1917	1883	1848	1811	1773	1734	1694	209.3	653.9
30	2 3/8	1982	1961	1936	1909	1879	1848	1816	1782	1747	1711	206.1	644.1
	2 1/2	2078	2055	2028	2000	1969	1937	1903	1867	1830	1793	216.0	675.0
	2 5/8	2172	2148	2119	2090	2058	2024	1989	1952	1913	1874	225.8	705.5
	2 3/4	2265	2240	2210	2180	2147	2111	2074	2035	1995	1954	235.4	735.7
32	2 1/2	2239	2217	2192	2165	2135	2104	2071	2036	2000	1963	231.7	724.0
	2 5/8	2341	2318	2292	2264	2233	2200	2165	2129	2092	2053	242.2	757.0
	2 3/4	2442	2418	2391	2361	2329	2295	2259	2221	2182	2141	252.7	789.7
	2 7/8	2542	2517	2489	2458	2424	2389	2351	2312	2271	2229	263.1	822.1
34	2 5/8	2511	2488	2463	2436	2406	2374	2341	2306	2272	2232	258.7	808.6
	2 3/4	2620	2596	2570	2542	2511	2478	2441	2406	2370	2329	270.0	843.7
	2 7/8	2728	2703	2676	2646	2614	2580	2544	2505	2468	2425	281.1	878.5
	3	2835	2810	2781	2750	2717	2681	2643	2604	2565	2520	292.2	913.0
36	2 3/4	2796	2774	2749	2721	2692	2660	2626	2591	2553	2515	287.3	897.7
	2 7/8	2913	2889	2863	2834	2803	2770	2735	2698	2659	2619	299.2	935.0
	2 7/8	3028	3003	2976	2946	2904	2880	2849	2805	2765	2723	311.0	971.9

STRENGTH OF HOLLOW ROUND AND HOLLOW RECTANGULAR CAST IRON COLUMNS.

For various values of $\frac{L}{d}$ in which:—

L = length of column in feet.

d = least outside diameter in inches.

P = ultimate strength in pounds per square inch.

Based on Gordon's Formulæ for Columns with Square Ends.

Hollow Round.

Hollow Rectangular.

$$P = \frac{80000}{1 + \frac{(12L)^2}{800 d^2}}$$

$$P = \frac{80000}{1 + \frac{(12L)^2}{1067 d^2}}$$

$\frac{L}{d}$	Ultimate Strength in lbs. per sq. in.		$\frac{L}{d}$	Ultimate Strength in lbs. per sq. in.	
	Hollow Round.	Hollow Rectangular.		Hollow Round.	Hollow Rectangular.
1.0	67800	70487	2.5	37647	43396
1.1	65692	68770	2.6	36088	41834
1.2	63532	66983	2.7	34599	40326
1.3	61340	65142	2.8	33178	38871
1.4	59137	63265	2.9	31817	37471
1.5	56940	61366	3.0	30534	36123
1.6	54766	59458	3.1	29306	34829
1.7	52625	57553	3.2	28137	33586
1.8	50531	55660	3.3	27025	32393
1.9	48491	53792	3.4	25967	31249
2.0	46512	51954	3.5	24961	30152
2.1	44598	50151	3.6	24004	29101
2.2	42753	48391	3.7	23093	28094
2.3	40979	46676	3.8	22227	27130
2.4	39277	45011	3.9	21403	26206

Safe loads for any given hollow round or hollow rectangular columns, corresponding to any suitable factor of safety, can be found from the above table as follows:—

Find from the table the ultimate strength in pounds per square inch corresponding to the given value of $\frac{L}{d}$. Multiply this by the area of the column in square inches and divide the product by the safety factor which will give as a quotient the required safe load in pounds.

EXAMPLE:—Required the safe load for a hollow round cast iron column 16 feet long, 10 inches external diameter with metal 1 inch thick with safety factor of eight. The ratio of $\frac{L}{d}$ in this case is $\frac{16}{10} = 1.6$ and the corresponding ultimate strength from the tables is 54 766 pounds per square inch.

From the table of areas of circles it is found that the net area of the column is 28.3 square inches. The safe load is, therefore, $\frac{54\ 766 \times 28.3}{8} = 193\ 735$ pounds or approximately 97 net tons, which is the required result.

EXPLANATIONS OF TABLES OF SAFE LOADS FOR BEAM BOX-GIRDERS AND PLATE GIRDERS, PAGES 306 TO 326 INCLUSIVE.

For cases in which the loads to be carried exceed the capacities of single rolled beams or ordinary beam girders composed of two or more beams with the usual bolts and separators, it is necessary to use built-up sections.

BEAM BOX-GIRDERS.—A useful and economical section of this kind can be composed of two rolled beams with plates riveted to the top and bottom flanges, making a beam box-girder, for which tables of safe uniformly distributed loads are given on pages 306 to 316 inclusive.

The safe loads given in the tables include the weights of the beam box-girders, and are figured from the moment of inertia or the section modulus after making the necessary deductions for rivet holes, the fibre stress used in the calculations being 15 000 pounds per square inch of net section.

Beam box-girders are particularly useful for supporting wide walls and in other locations up to the limits of their capacity, but they should not be placed where exposed to moisture, as the section is such that access cannot be had to their interior for inspection and painting.

PLATE GIRDERS.—In cases where the widths of beam box-girders would prohibit their use, and for loads greater than their capacities, plate girders composed of plates and angles may be used.

Tables of safe loads uniformly distributed for plate girders from 24" to 48" deep are given on pages 317 to 326 inclusive.

The loads given in the tables include the weights of the girders and are calculated from the moment of inertia or the section modulus after making a proper deduction for rivet holes, the fibre stress used in the calculation being 15 000 pounds per square inch of net section.

Although the tables do not show the stiffener angles for plate girders, care should be taken that these are provided in all cases where necessary to prevent buckling of the web due to the shearing action therein. The stiffeners should be made of angles riveted to the web, fitted tightly between the top and bottom flange angles, and they should be provided, at the end of the girders, of such size and number as to be capable of carrying the total reaction at each end to the supports. Stiffeners should also be provided at intervals along the girder, spaced at suitable distances apart, as determined by the formula and explanations on pages 94 and 95.

Care should also be taken in arranging the rivet spacing for connecting the flange angles to the web, so that sufficient rivets are provided to properly transmit the stresses which act between these two portions of the construction. This will require the rivets to be spaced more closely at the ends than at the center, and the exact spacing at any point along the girder may be obtained by dividing the product of the distance between the center lines of the rivet holes in the two flanges and the resistance of one rivet by the total vertical shear at the given point, thus:

$$p = \frac{r h}{S} \text{ in which}$$

S = the total vertical shear, in pounds, at the point under consideration.

r = the resistance of one rivet, *i. e.*, the bearing value or shearing value, whichever is the smaller, expressed in pounds.

h = the depth of the girder between the upper and lower center lines of rivets, expressed in inches.

p = pitch of rivets in the flange angles, expressed in inches.

The formula above will give the theoretical rivet spacing at any point in the flanges due to the total shear, but in practice the pitch for various portions of the length should be stated for the least possible number of spacing panels containing an even number of spaces, the pitch in each of which should preferably be expressed in even inches or even inches and halves or quarters of an inch, and the usual limits of pitch will vary from 2½" to 6".

The rivet spacing should also conform to the rules given on page 358, and in cases where loads are applied directly to the flanges, sufficient rivets must be provided to carry these in addition to the rivets necessary for securing the web and flanges together as explained above.

It should also be noted that the safe loads given in the tables are based on the assumption that the girder is supported laterally, otherwise a proper reduction in the allowable safe load must be made, as explained in connection with beams on pages 82 and 83.

The weights of beam box-girders and plate girders in the tables are expressed in pounds per lineal foot, including the rivets necessary to secure the web and flanges together, but the weights do not include any allowance for brackets, stiffeners, connections or other details, as these will vary, subject to the conditions of each case.

SAFE LOADS IN THOUSANDS OF POUNDS UNIFORMLY DISTRIBUTED FOR BEAM BOX GIRDERS.

Safe loads below are figured for fibre stress of 15 000 pounds per square inch, with $\frac{11}{16}$ " rivet holes in both flanges deducted, and include weight of girder.

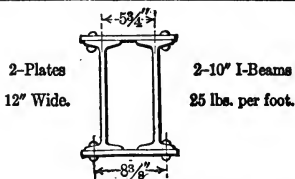

Distance Center to Center of Bearings in Feet.	Thickness of Plates in Inches. For Thicknesses Greater than $\frac{3}{4}$ " Use Two Plates.								
	$\frac{1}{2}$	$\frac{9}{16}$	$\frac{5}{8}$	$\frac{11}{16}$	$\frac{3}{4}$	$\frac{13}{16}$	$\frac{7}{8}$	$\frac{15}{16}$	1
10	90	96	102	109	115	121	127	134	140
11	82	87	93	99	104	110	116	121	127
12	75	80	85	90	96	101	106	111	117
13	69	74	79	84	88	93	98	103	108
14	64	69	73	78	82	86	91	95	100
15	60	64	68	72	77	81	85	89	93
16	56	60	64	68	72	76	80	83	87
17	53	57	60	64	68	71	75	79	82
18	50	53	57	60	64	67	71	74	78
19	47	51	54	57	60	64	67	70	74
20	45	48	51	54	57	60	64	67	70
21	43	46	49	52	55	58	61	64	67
22	41	44	47	49	52	55	58	61	64
23	39	42	45	47	50	53	55	58	61
24	38	40	43	45	48	50	53	56	58
25	36	38	41	43	46	48	51	53	56
26	35	37	39	42	44	47	49	51	54
27	33	36	38	40	43	45	47	49	52
28	32	34	37	39	41	43	45	48	50
29	31	33	35	37	40	42	44	46	48
30	30	32	34	36	38	40	42	45	47
31	29	31	33	35	37	39	41	43	45
32	28	30	32	34	36	38	40	42	44
33	27	29	31	33	35	37	39	40	42
34	26	28	30	32	34	36	37	39	41
Weight per Foot in Pounds.	94.6	99.8	104.8	110.0	115.0	120.1	125.2	130.3	135.4
Section Modulus.	90.1	96.3	102.4	108.6	114.8	121.0	127.2	133.5	139.8
Coefficient of Deflection.	0.00000145			0.00000118			0.00000098		

For safe loads below the heavy lines, the deflections will be greater than the allowable limit for plastered ceilings = $\frac{1}{250}$ span.

**SAFE LOADS IN THOUSANDS OF POUNDS
UNIFORMLY DISTRIBUTED FOR
BEAM BOX GIRDERS.**

Safe loads below are figured for fibre stress of 15 000 pounds per square inch, with $\frac{1}{4}$ " rivet holes in both flanges deducted, and include weight of girder.

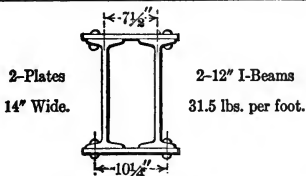

Distance Center to Center of Bearings in Feet.	Thickness of Plates in Inches. For Thicknesses Greater than $\frac{3}{4}$ " Use Two Plates.								
	$\frac{1}{2}$	$\frac{9}{16}$	$\frac{5}{8}$	$\frac{11}{16}$	$\frac{3}{4}$	$\frac{13}{16}$	$\frac{7}{8}$	$\frac{15}{16}$	1
10	132	141	150	159	167	176	185	194	203
11	120	128	136	144	152	160	168	177	185
12	110	117	125	132	140	147	154	162	169
13	102	108	115	122	129	136	143	149	156
14	94	101	107	113	120	126	132	139	145
15	88	94	100	106	112	118	123	129	135
16	83	88	94	99	105	110	116	121	127
17	78	83	88	93	98	104	109	114	120
18	73	78	83	88	93	98	103	108	113
19	70	74	79	83	88	93	98	102	107
20	66	70	75	79	84	88	93	97	102
21	63	67	71	76	80	84	88	92	97
22	60	64	68	72	76	80	84	88	92
23	57	61	65	69	73	77	81	84	88
24	55	59	62	66	70	73	77	81	85
25	53	56	60	63	67	71	74	78	81
26	51	54	58	61	64	68	71	75	78
27	49	52	55	59	62	65	69	72	75
28	47	50	53	57	60	63	66	69	73
29	46	49	52	55	58	61	64	67	70
30	44	47	50	53	56	59	62	65	68
31	43	45	48	51	54	57	60	63	66
32	41	44	47	50	52	55	58	61	64
33	40	43	45	48	51	53	56	59	62
34	39	41	44	47	49	52	54	57	60
Weight per Foot in Pounds.	114.4	120.4	126.3	132.3	138.3	144.2	150.1	156.1	162.0
Section Modulus.	132.1	140.9	149.7	158.5	167.4	176.3	185.3	194.2	203.2
Coefficient of Deflection.	0.00000842			0.00000688			0.00000577		

For safe loads below the heavy lines, the deflections will be greater than the allowable limit for plastered ceilings = $\frac{1}{300}$ span.

**SAFE LOADS IN THOUSANDS OF POUNDS
UNIFORMLY DISTRIBUTED FOR
BEAM BOX GIRDERS.**

Safe loads below are figured for fibre stress of 15 000 pounds per square inch, with $\frac{1}{4}$ " rivet holes in both flanges deducted, and include weight of girder.

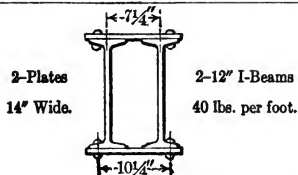

Distance Center to Center of Bearings in Feet.	Thickness of Plates in Inches.								
	For Thicknesses Greater than $\frac{3}{4}$ " Use Two Plates.								
	$\frac{1}{2}$	$\frac{9}{16}$	$\frac{5}{8}$	$\frac{11}{16}$	$\frac{3}{4}$	$\frac{13}{16}$	$\frac{7}{8}$	$\frac{15}{16}$	1
10	147	155	164	173	181	190	199	208	217
11	133	141	149	157	165	173	181	189	197
12	122	129	137	144	151	158	166	173	181
13	113	119	126	133	140	146	153	160	167
14	105	111	117	123	130	136	142	148	155
15	98	104	109	115	121	127	133	139	144
16	92	97	102	108	113	119	124	130	135
17	86	91	96	102	107	112	117	122	127
18	81	86	91	96	101	106	111	115	120
19	77	82	86	91	95	100	105	109	114
20	73	78	82	86	91	95	99	104	108
21	70	74	78	82	86	91	95	99	103
22	67	71	75	78	82	86	90	94	99
23	64	68	71	75	79	83	87	90	94
24	61	65	68	72	76	79	83	87	90
25	59	62	66	69	73	76	80	83	87
26	56	60	63	66	70	73	77	80	83
27	54	58	61	64	67	70	74	77	80
28	52	55	59	62	65	68	71	74	77
29	51	54	57	60	63	66	69	72	75
30	49	52	55	58	60	63	66	69	72
31	47	50	53	56	59	61	64	67	70
32	46	49	51	54	57	59	62	65	68
33	44	47	50	52	55	58	60	63	66
34	43	46	48	51	53	56	59	61	64
Weight per Foot in Pounds.	131.4	137.4	143.3	149.3	155.3	161.2	167.1	173.1	179.0
Section Modulus.	146.6	155.3	163.9	172.7	181.4	190.2	199.0	207.8	216.7
Coefficient of Deflection.	0.000000763			0.000000635			0.000000539		

For safe loads below the heavy lines, the deflections will be greater than the allowable limit for plastered ceilings = $\frac{1}{360}$ span.

SAFE LOADS IN THOUSANDS OF POUNDS UNIFORMLY DISTRIBUTED FOR BEAM BOX GIRDERS.

Safe loads below are figured for fibre stress of 15 000 pounds per square inch, with $\frac{1}{4}$ " rivet holes in both flanges deducted, and include weight of girder.

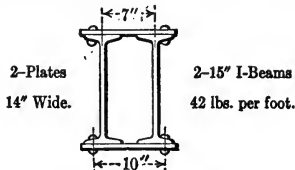

Distance Center to Center of Bearings in Feet.	Thickness of Plates in Inches. For Thicknesses Greater than $\frac{3}{4}$ " Use Two Plates.										
	$\frac{5}{8}$	$\frac{11}{16}$	$\frac{3}{4}$	$\frac{13}{16}$	$\frac{7}{8}$	$\frac{15}{16}$	1	$1\frac{1}{16}$	$1\frac{1}{8}$	$1\frac{3}{16}$	$1\frac{1}{2}$
10	212	223	234	245	256	267	278	289	300	312	323
11	193	203	213	223	233	243	253	263	273	283	293
12	177	186	195	204	213	223	232	241	250	260	269
13	163	172	180	188	197	205	214	223	231	240	248
14	151	159	167	175	183	191	199	207	215	223	231
15	141	149	156	163	171	178	185	193	200	208	215
16	133	139	146	153	160	167	174	181	188	195	202
17	125	131	138	144	151	157	164	170	177	183	190
18	118	124	130	136	142	148	155	161	167	173	179
19	112	117	123	129	135	141	146	152	158	164	170
20	106	112	117	122	128	134	139	145	150	156	161
21	101	106	111	117	122	127	132	138	143	148	154
22	96	101	106	111	116	121	126	131	137	142	147
23	92	97	102	107	111	116	121	126	131	135	140
24	88	93	98	102	107	111	116	121	125	130	135
25	85	89	94	98	102	107	111	116	120	125	129
26	82	86	90	94	98	103	107	111	116	120	124
27	79	83	87	91	95	99	103	107	111	115	120
28	76	80	84	88	91	95	99	103	107	111	115
29	73	77	81	84	88	92	96	100	104	107	111
30	71	74	78	82	85	89	93	96	100	104	108
31	68	72	75	79	83	86	90	93	97	101	104
32	66	70	73	77	80	83	87	90	94	97	101
33	64	68	71	74	78	81	84	88	91	94	98
34	62	66	69	72	75	79	82	85	88	92	95
Weight per Foot in Pounds.	147.3	153.3	159.3	165.2	171.1	177.1	183.0	189.0	194.9	200.9	206.8
Section Modulus.	212.1	223.0	234.0	245.0	256.0	267.1	278.2	289.3	300.5	311.6	322.8
Coefficient of Deflection.	0.00000426			0.00000362			0.00000314			0.00000281	

SAFE LOADS IN THOUSANDS OF POUNDS UNIFORMLY DISTRIBUTED FOR BEAM BOX GIRDERS.

Safe loads below are figured for fibre stress of 15 000 pounds per square inch, with $\frac{1}{8}$ " rivet holes in both flanges deducted, and include weight of girder.

2-Plates
15" Wide.



2-15" I-Beams
60 lbs. per foot.

Distance Center to Center of Bearings in Feet.	Thickness of Plates in Inches.										
	$\frac{5}{8}$	$\frac{11}{16}$	$\frac{3}{4}$	$\frac{13}{16}$	$\frac{7}{8}$	$\frac{15}{16}$	1	$1\frac{1}{16}$	$1\frac{1}{8}$	$1\frac{3}{16}$	$1\frac{1}{2}$
10	259	271	282	294	306	318	329	341	353	365	377
11	236	246	257	267	278	289	299	310	321	332	342
12	216	226	235	245	255	265	274	284	294	304	314
13	199	208	217	226	235	244	253	262	272	281	290
14	185	193	202	210	218	227	235	244	252	261	269
15	173	181	188	196	204	212	220	227	235	243	251
16	162	169	177	184	191	198	206	213	221	228	235
17	152	159	166	173	180	187	194	201	208	215	222
18	144	150	157	163	170	176	183	190	196	203	209
19	136	143	149	155	161	167	173	180	186	192	198
20	130	135	141	147	153	159	165	171	176	182	188
21	123	129	134	140	146	151	157	162	168	174	179
22	118	123	128	134	139	144	150	155	160	166	171
23	113	118	123	128	133	138	143	148	153	159	164
24	108	113	118	123	127	132	137	142	147	152	157
25	104	108	113	118	122	127	132	136	141	146	151
26	100	104	109	113	118	122	127	131	136	140	145
27	96	100	105	109	113	118	122	126	131	135	140
28	93	97	101	105	109	113	118	122	126	130	135
29	89	93	97	101	105	109	114	118	122	126	130
30	86	90	94	98	102	106	110	114	118	122	126
31	84	87	91	95	99	102	106	110	114	118	122
32	81	85	88	92	96	99	103	107	110	114	118
33	79	82	86	89	93	96	100	103	107	111	114
34	76	80	83	87	90	93	97	100	104	107	111
Weight per Foot in Pounds.	187.6	194.0	200.4	206.7	213.1	219.5	225.8	232.2	238.6	245.0	251.4
Section Modulus	259.2	270.8	282.4	294.1	305.8	317.5	329.3	341.1	353.0	364.9	376.8
Coefficient of Deflection.	0.00000350			0.00000303			0.00000266			0.00000240	

**SAFE LOADS IN THOUSANDS OF POUNDS
UNIFORMLY DISTRIBUTED FOR
BEAM BOX GIRDERS.**

Safe loads below are figured for fibre stress of 15 000 pounds per square inch; with $\frac{1}{8}$ " rivet holes in both flanges deducted, and include weight of girder.

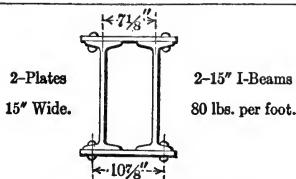

Distance Center to Center of Bearings in Feet.	Thickness of Plates in Inches. For Thicknesses Greater than $\frac{3}{4}$ " Use Two Plates.										
	$\frac{5}{8}$	$\frac{1}{16}$	$\frac{3}{4}$	$\frac{1}{16}$	$\frac{7}{8}$	$\frac{1}{16}$	1	$1\frac{1}{16}$	$1\frac{1}{8}$	$1\frac{3}{16}$	$1\frac{1}{4}$
10	300	311	322	334	345	357	368	380	391	403	414
11	272	283	293	303	314	324	335	345	356	366	377
12	250	259	269	278	288	297	307	316	326	336	345
13	231	239	248	257	265	274	283	292	301	310	319
14	214	222	230	238	247	255	263	271	279	288	296
15	200	207	215	222	230	238	245	253	261	269	276
16	187	194	201	209	216	223	230	237	244	252	259
17	176	183	190	196	203	210	217	223	230	237	244
18	167	173	179	185	192	198	204	211	217	224	230
19	158	164	170	176	182	188	194	200	206	212	218
20	150	156	161	167	173	178	184	190	196	201	207
21	143	148	154	159	164	170	175	181	186	192	197
22	136	141	147	152	157	162	167	173	178	183	188
23	130	135	140	145	150	155	160	165	170	173	180
24	125	130	134	139	144	149	153	158	163	168	173
25	120	124	129	133	138	143	147	152	156	161	166
26	115	120	124	128	133	137	142	146	150	155	159
27	111	115	119	124	128	132	136	141	145	149	153
28	107	111	115	119	123	127	131	136	140	144	148
29	103	107	111	115	119	123	127	131	135	139	143
30	100	104	107	111	115	119	123	127	130	134	138
31	97	100	104	108	111	115	119	122	126	130	134
32	94	97	101	104	108	111	115	119	122	126	130
33	91	94	98	101	105	108	112	115	119	122	126
34	88	91	95	98	102	105	108	112	115	118	122
Weight per Foot in Pounds.	227.6	234.0	240.4	246.7	253.1	259.5	265.8	272.2	278.6	285.0	291.4
Section Modulus.	299.7	311.0	322.4	333.7	345.1	356.6	368.1	379.6	391.2	402.8	414.4
Coefficient of Deflection.	0.000000305			0.000000269			0.000000239			0.000000218	

SAFE LOADS IN THOUSANDS OF POUNDS UNIFORMLY DISTRIBUTED FOR BEAM BOX GIRDERS.

Safe loads below are figured for fibre stress of 15 000 pounds per square inch, with $\frac{1}{8}$ " rivet holes in both flanges deducted, and include weight of girder.

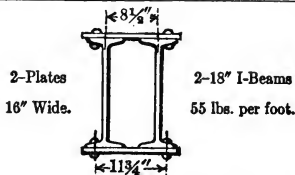

Distance Center to Center of Bearings in Feet.	Thickness of Plates in Inches. For Thicknesses Greater than $\frac{3}{4}$ " Use Two Plates.										
	$\frac{3}{4}$	$\frac{13}{16}$	$\frac{7}{8}$	$\frac{15}{16}$	1	$1\frac{1}{16}$	$1\frac{1}{8}$	$1\frac{3}{16}$	$1\frac{1}{4}$	$1\frac{5}{16}$	$1\frac{3}{8}$
15	227	237	247	258	268	278	289	299	309	320	330
16	213	222	232	242	251	261	271	280	290	300	310
17	200	209	218	227	237	246	255	264	273	282	291
18	189	198	206	215	223	232	241	249	258	267	275
19	179	187	195	203	212	220	228	236	244	253	261
20	170	178	186	193	201	209	217	224	232	240	248
21	162	169	177	184	191	199	206	214	221	228	236
22	155	162	169	176	183	190	197	204	211	218	225
23	148	155	161	168	175	182	188	195	202	209	215
24	142	148	155	161	168	174	180	187	193	200	206
25	136	142	148	155	161	167	173	179	186	192	198
26	131	137	143	149	155	161	167	173	179	185	191
27	126	132	137	143	149	155	160	166	172	178	183
28	122	127	133	138	144	149	155	160	166	171	177
29	117	123	128	133	139	144	149	155	160	165	171
30	113	119	124	129	134	139	144	150	155	160	165
31	110	115	120	125	130	135	140	145	150	155	160
32	106	111	116	121	126	130	135	140	145	150	155
33	103	108	112	117	122	127	131	136	141	145	150
34	100	105	109	114	118	123	127	132	137	141	146
35	97	102	106	110	115	119	124	128	133	137	142
36	95	99	103	107	112	116	120	125	129	133	138
37	92	96	100	104	109	113	117	121	125	130	134
38	90	94	98	102	106	110	114	118	122	126	130
39	87	91	95	99	103	107	111	115	119	123	127
Weight per Foot in Pounds.	195.5	202.2	209.0	215.8	222.6	229.4	236.2	243.1	249.8	256.7	263.4
Section Modulus.	340.5	355.8	371.2	386.6	402.1	417.5	433.0	448.6	464.2	479.8	495.4
Coefficient of Deflection.	0.00000223			0.00000193			0.00000170			0.00000154	

**SAFE LOADS IN THOUSANDS OF POUNDS
UNIFORMLY DISTRIBUTED FOR
BEAM BOX GIRDERS.**

Safe loads below are figured for fibre stress of 15 000 pounds per square inch, with $\frac{1}{4}$ " rivet holes in both flanges deducted, and include weight of girder.

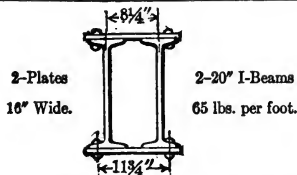

Distance Center to Center of Bearings in Feet.	Thickness of Plates in Inches. For Thicknesses Greater than $\frac{3}{4}$ " Use Two Plates.										
	$\frac{3}{4}$	$\frac{13}{16}$	$\frac{7}{8}$	$\frac{15}{16}$	1	$1\frac{1}{16}$	$1\frac{1}{8}$	$1\frac{3}{16}$	$1\frac{1}{4}$	$1\frac{5}{16}$	$1\frac{3}{8}$
15	275	286	297	308	320	331	343	354	365	377	388
16	257	268	279	289	300	310	321	332	343	350	364
17	242	252	262	272	282	292	302	312	322	333	343
18	229	238	248	257	266	276	285	295	305	314	324
19	217	226	235	244	252	261	270	280	288	298	307
20	206	214	223	231	240	248	257	266	274	283	291
21	196	204	212	220	228	237	245	253	261	269	277
22	187	195	203	210	218	226	234	241	249	257	265
23	179	186	194	201	209	216	223	231	238	246	253
24	172	179	186	193	200	207	214	221	228	236	243
25	165	171	178	185	192	199	206	212	219	226	233
26	158	165	171	178	184	191	198	204	211	217	224
27	153	159	165	171	178	184	190	197	203	209	216
28	147	153	159	165	171	177	184	190	196	202	208
29	142	148	154	160	165	171	177	183	189	195	201
30	137	143	149	154	160	166	171	177	183	188	194
31	133	138	144	149	155	160	166	171	177	182	188
32	129	134	139	145	150	155	161	166	171	177	182
33	125	130	135	140	145	151	156	161	166	171	177
34	121	126	131	136	141	146	151	156	161	166	171
35	118	122	127	132	137	142	147	152	157	162	166
36	114	119	124	129	133	138	143	148	152	157	162
37	111	116	120	125	130	134	139	144	148	153	157
38	108	113	117	122	126	131	135	140	144	149	153
39	106	110	114	119	123	127	132	136	141	145	149
Weight per Foot in Pounds.	215.5	222.2	229.0	235.8	242.6	249.4	256.2	263.1	269.8	276.7	283.4
Section Modulus.	411.8	428.7	445.7	462.7	479.7	496.7	513.8	531.2	548.1	565.3	582.5
Coefficient of Deflection.	0.000000168			0.000000147			0.000000131			0.000000119	

SAFE LOADS IN THOUSANDS OF POUNDS UNIFORMLY DISTRIBUTED FOR BEAM BOX GIRDERS.

Safe loads below are figured for fibre stress of 15 000 pounds per square inch, with $\frac{1}{8}$ " rivet holes in both flanges deducted, and include weight of girder.

2-Plates
16" Wide.



2-20" I-Beams
80 lbs. per foot.

Distance Center to Center of Bearings in Feet.	Thickness of Plates in Inches. For Thicknesses Greater than $\frac{3}{4}$ " Use Two Plates.										
	$\frac{3}{4}$	$\frac{13}{16}$	$\frac{7}{8}$	$\frac{15}{16}$	1	$1\frac{1}{16}$	$1\frac{1}{8}$	$1\frac{3}{16}$	$1\frac{1}{4}$	$1\frac{5}{16}$	$1\frac{3}{8}$
15	309	320	331	343	354	365	376	387	399	410	421
16	290	300	311	321	332	342	353	363	374	384	395
17	273	283	292	302	312	322	332	342	352	362	372
18	258	267	276	285	295	304	313	323	332	342	351
19	244	253	262	270	279	288	297	306	315	324	332
20	232	240	249	257	265	274	282	291	299	307	316
21	221	229	237	245	253	261	269	277	285	293	301
22	211	218	226	234	241	249	256	264	272	279	287
23	202	209	216	223	231	238	245	253	260	267	275
24	193	200	207	214	221	228	235	243	249	256	263
25	186	192	199	206	212	219	226	232	239	246	253
26	178	185	191	198	204	211	217	224	230	236	243
27	172	178	184	190	196	203	209	215	221	228	234
28	166	172	178	184	189	195	201	208	214	220	226
29	160	166	171	177	183	189	195	200	206	212	218
30	155	160	166	171	177	182	188	194	199	205	211
31	150	155	160	166	171	177	182	187	193	198	204
32	145	150	155	161	166	171	176	182	187	192	197
33	141	146	151	156	161	166	171	176	181	186	191
34	136	141	146	151	156	161	166	171	176	181	186
35	133	137	142	147	152	156	161	166	171	176	180
36	129	133	138	143	147	152	157	161	166	171	175
37	125	130	134	139	143	148	152	157	162	166	171
38	122	126	131	135	140	144	148	153	157	162	166
39	119	123	127	132	136	140	145	149	153	158	162
Weight per Foot in Pounds.	245.5	252.2	259.0	265.8	272.6	279.4	286.2	293.1	299.8	306.7	313.4
Section Modulus.	463.8	480.4	497.1	513.8	530.6	547.3	564.1	581.2	597.8	614.7	631.7
Coefficient of Deflection.	0.000000149			0.000000133			0.000000119			0.000000110	

SAFE LOADS IN THOUSANDS OF POUNDS UNIFORMLY DISTRIBUTED FOR BEAM BOX GIRDERS.

Safe loads below are figured for fibre stress of 15 000 pounds per square inch, with $\frac{11}{16}$ " rivet holes in both flanges deducted, and include weight of girder.

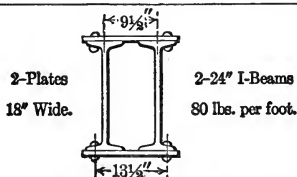

Distance Center to Center of Bearings in Feet.	Thickness of Plates in Inches. For Thicknesses Greater than $\frac{3}{4}$ " Use Two Plates.										
	$\frac{3}{4}$	$\frac{13}{16}$	$\frac{7}{8}$	$\frac{15}{16}$	1	$1\frac{1}{16}$	$1\frac{1}{8}$	$1\frac{3}{16}$	$1\frac{1}{4}$	$1\frac{5}{16}$	$1\frac{3}{8}$
15	396	411	427	442	458	473	489	505	520	536	551
16	371	386	400	415	429	444	458	473	488	502	517
17	349	363	377	390	404	418	431	445	459	473	487
18	330	343	356	369	381	394	407	421	433	446	460
19	312	325	337	349	361	374	386	398	411	423	435
20	297	308	320	332	343	355	367	379	390	402	414
21	283	294	305	316	327	338	349	361	372	383	394
22	270	280	291	302	312	323	333	344	355	365	376
23	258	268	278	288	299	309	319	329	339	349	360
24	247	257	267	276	286	296	306	315	325	335	345
25	237	247	256	265	275	284	293	303	312	321	331
26	228	237	246	255	264	273	282	291	300	309	318
27	220	228	237	246	254	263	272	280	289	298	306
28	212	220	229	237	245	254	262	270	279	287	295
29	205	213	221	229	237	245	253	261	269	277	285
30	198	206	213	221	229	237	244	252	260	268	276
31	192	199	206	214	222	229	237	244	252	259	267
32	186	193	200	207	215	222	229	237	244	251	258
33	180	187	194	201	208	215	222	229	236	244	251
34	175	181	188	195	202	209	216	223	229	236	243
35	170	176	183	190	196	203	210	216	223	230	236
36	165	171	178	184	191	197	204	210	217	223	230
37	160	167	173	179	186	192	198	205	211	217	224
38	156	162	168	175	181	187	193	199	205	211	218
39	152	158	164	170	176	182	188	194	200	206	212
Weight per Foot in Pounds.	255.7	263.3	271.0	278.6	286.2	293.9	301.5	309.2	316.8	324.5	332.1
Section Modulus.	593.7	616.9	640.1	663.4	686.7	710.0	733.3	757.1	780.2	803.6	827.1
Coefficient of Deflection.	0.000000983			0.000000870			0.000000778			0.000000713	

SAFE LOADS IN THOUSANDS OF POUNDS UNIFORMLY DISTRIBUTED FOR BEAM BOX GIRDERS.

Safe loads below are figured for fibre stress of 15 000 pounds per square inch, with $\frac{1}{8}$ " rivet holes in both flanges deducted, and include weight of girder.

2 Plates
18" Wide.

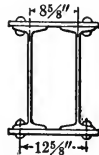



2-24" I-Beams
105 lbs. per foot.

Distance Center to Center of Bearings in Feet.	Thickness of Plates in Inches.										
	For Thicknesses Greater than $\frac{3}{4}$ ", Use Two Plates.										
	$\frac{3}{4}$	$\frac{13}{16}$	$\frac{7}{8}$	$\frac{15}{16}$	1	$1\frac{1}{16}$	$1\frac{1}{8}$	$1\frac{3}{16}$	$1\frac{1}{4}$	$1\frac{5}{16}$	$1\frac{3}{8}$
15	466	481	496	511	526	541	557	572	587	602	618
16	437	451	465	479	493	507	522	536	550	565	579
17	411	424	437	451	464	478	491	505	518	532	545
18	388	401	413	426	438	451	464	477	489	502	515
19	368	379	391	403	415	427	439	451	463	476	488
20	349	361	372	383	395	406	417	429	440	452	463
21	333	343	354	365	376	387	398	408	419	430	441
22	317	328	338	348	359	369	379	390	400	411	421
23	304	314	323	333	352	353	363	373	383	393	403
24	291	300	310	319	329	338	348	357	367	376	386
25	279	288	297	307	316	325	334	343	352	361	371
26	269	277	286	295	303	312	321	330	339	347	356
27	259	267	275	284	292	301	309	318	326	335	343
28	249	258	265	274	282	290	298	306	314	323	331
29	241	249	256	264	272	280	288	296	304	312	319
30	233	240	248	255	263	271	278	286	293	301	309
31	225	232	240	247	254	262	269	277	284	291	299
32	218	225	232	239	246	254	261	268	275	282	289
33	211	218	225	232	239	246	253	260	267	274	281
34	205	212	219	225	232	239	245	252	259	266	272
35	199	206	212	219	225	232	238	245	251	258	265
36	194	200	206	213	219	225	232	238	245	251	257
37	189	195	201	207	213	219	226	232	238	244	250
38	184	190	196	202	208	214	220	226	237	238	244
39	179	185	191	196	202	208	214	220	226	232	237
Weight per Foot in Pounds	305.6	313.3	320.9	328.6	336.2	343.9	351.5	359.2	366.8	374.5	382.1
Section Modulus.	698.6	721.3	744.0	766.8	789.6	812.4	835.3	858.2	881.1	904.1	927.1
Coefficient of Deflection = 0.00000001 X	87	84	81	78	76	73	71	69	66	64	63



SAFE UNIFORMLY DISTRIBUTED LOADS FOR PLATE GIRDERS IN THOUSANDS OF POUNDS.

The safe loads below include the weight of the girder and are calculated for a fibre stress of 15 000 pounds per square inch on the net section. The net section is obtained by deducting holes figured at $\frac{1}{8}$ of an inch in diameter (for $\frac{3}{4}$ " rivets) from both flanges.

<div style="display: flex; justify-content: space-around; align-items: center;"> <div style="text-align: center;"> <p>Web Plate</p> <p>$24" \times \frac{3}{8}"$</p>  </div> <div style="text-align: center;"> <p>Flange Angles</p> <p>$5" \times 3\frac{1}{2}"$</p> </div> </div>					<div style="display: flex; justify-content: space-around; align-items: center;"> <div style="text-align: center;"> <p>Web Plate</p> <p>$27" \times \frac{3}{8}"$</p>  </div> <div style="text-align: center;"> <p>Flange Angles</p> <p>$5" \times 3\frac{1}{2}"$</p> </div> </div>			
Distance Center to Center of Bearings in Feet.	Thickness of Flange Angles in Inches.				Thickness of Flange Angles in Inches.			
	$\frac{3}{8}$	$\frac{1}{2}$	$\frac{5}{8}$	$\frac{3}{4}$	$\frac{3}{8}$	$\frac{1}{2}$	$\frac{5}{8}$	$\frac{3}{4}$
25	59	74	87		69	85	101	
26	57	71	84		67	82	97	
27	55	68	81	92	64	79	93	
28	53	66	78	89	62	76	90	103
29	51	63	75	86	60	74	87	99
30	50	61	73	83	58	71	84	96
31	48	59	70	80	56	69	81	93
32	46	57	68	78	54	67	79	90
33	45	56	66	75	53	65	76	87
34	44	54	64	73	51	63	74	85
35	42	53	62	71	50	61	72	82
36	41	51	60	69	48	59	70	80
37	40	50	59	67	47	58	68	78
38	39	48	57	66	46	56	66	76
39	38	47	56	64	44	55	65	74
40	37	46	54	62	43	53	63	72
41	36	45	53	61	42	52	61	70
42	35	44	52	59	41	51	60	69
43	35	43	51	58	40	50	59	67
44	34	42	49	57	39	49	57	65
45	33	41	48	55	39	47	56	64
46	32	40	47	54	38	46	55	63
47	32	39	46	53	37	45	54	61
48	31	38	45	52	36	44	53	60
49	30	38	44	51	35	44	51	59
50	30	37	44	50	35	43	50	58
51	29	36	43	49	34	42	49	57
52	29	35	42	48	33	41	48	55
53	28	35	41	47	33	40	48	54
54	28	34	40	46	32	40	47	53
Weight per Foot in Pounds.	74.1	86.9	99.7	111.7	78	90.8	103.6	115.6

SAFE UNIFORMLY DISTRIBUTED LOADS FOR PLATE GIRDERS IN THOUSANDS OF POUNDS.

The safe loads below include the weight of the girder and are calculated for a fibre stress of 15 000 pounds per square inch on the net section. The net section is obtained by deducting holes figured at $\frac{1}{8}$ of an inch in diameter (for $\frac{3}{4}$ " rivets) from both flanges.

<div style="display: flex; justify-content: space-around; align-items: center;"> <div style="text-align: center;"> <p>Web Plate $30" \times \frac{3}{8}"$</p>  </div> <div style="text-align: center;"> <p>Flange Angles $6" \times 3\frac{1}{2}"$</p> </div> </div>					<div style="display: flex; justify-content: space-around; align-items: center;"> <div style="text-align: center;"> <p>Web Plate $33" \times \frac{3}{8}"$</p>  </div> <div style="text-align: center;"> <p>Flange Angles $6" \times 3\frac{1}{2}"$</p> </div> </div>			
Distance Center to Center of Bearings in Feet.	Thickness of Flange Angles in Inches.				Thickness of Flange Angles in Inches.			
	$\frac{3}{8}$	$\frac{1}{2}$	$\frac{5}{8}$	$\frac{3}{4}$	$\frac{3}{8}$	$\frac{1}{2}$	$\frac{5}{8}$	$\frac{3}{4}$
30	74	91	108		83	103	122	
31	71	88	105		81	100	118	
32	69	86	101	116	78	97	114	131
33	67	83	98	113	76	94	111	127
34	65	81	95	109	74	91	107	123
35	63	78	93	106	72	88	104	119
36	61	76	90	103	70	86	101	116
37	60	74	88	101	68	84	99	113
38	58	72	85	98	66	81	96	110
39	57	70	83	95	64	79	94	107
40	55	69	81	93	63	77	91	104
41	54	67	79	91	61	75	89	102
42	53	65	77	89	60	74	87	99
43	51	64	75	86	58	72	85	97
44	50	62	74	85	57	70	83	95
45	49	61	72	83	56	69	81	93
46	48	60	71	81	54	67	79	91
47	47	58	69	79	53	66	78	89
48	46	57	68	77	52	64	76	87
49	45	56	66	76	51	63	75	85
50	44	55	65	74	50	62	73	84
51	43	54	64	73	49	61	72	82
52	43	53	62	72	48	59	70	80
53	42	52	61	70	47	58	69	79
54	41	51	60	69	46	57	68	77
55	40	50	59	68	46	56	66	76
56	39	49	58	66	45	55	65	75
57	39	48	57	65	44	54	64	73
58	38	47	56	64	43	53	63	72
59	37	46	55	63	42	52	62	71
Weight per Foot in Pounds.	87.0	101.4	115.8	129.8	90.8	105.2	119.6	133.6

**SAFE UNIFORMLY DISTRIBUTED LOADS FOR
PLATE GIRDERS IN THOUSANDS OF
POUNDS.**

The safe loads below include the weight of the girder and are calculated for a fibre stress of 15 000 pounds per square inch on the net section. The net section is obtained by deducting holes figured at one inch in diameter (for $\frac{3}{8}$ " rivets) from both flanges.

Web Plate $36" \times \frac{3}{8}"$
Flange Angles $6" \times 4"$

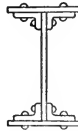

Web Plate $36" \times \frac{3}{8}"$
Flange Angles $6" \times 4" \times \frac{3}{4}"$
Flange Plate $14"$

Distance Center to Center of Bearings in Feet.	Thickness of Flange Angles in Inches.					Thickness of Flange Plate in Inches.					
	$\frac{3}{8}$	$\frac{1}{2}$	$\frac{5}{8}$	$\frac{3}{4}$	$\frac{7}{8}$	$\frac{3}{8}$	$\frac{1}{2}$	$\frac{5}{8}$	$\frac{3}{4}$	$\frac{7}{8}$	1
30	95	117	138	158	177	191	209	226	243	260	277
31	92	113	133	152	171	185	202	218	235	252	268
32	89	109	129	148	166	179	196	212	227	244	260
33	86	106	125	143	161	174	190	205	221	236	252
34	84	103	121	139	156	169	184	199	214	229	244
35	81	100	118	135	151	164	179	193	208	223	237
36	79	97	115	131	147	159	174	188	202	217	231
37	77	94	112	128	143	155	169	183	197	211	225
38	75	92	109	124	140	151	165	178	192	205	219
39	73	90	106	121	136	147	160	174	187	200	213
40	71	87	103	118	132	143	156	169	182	195	208
41	69	85	101	115	129	140	153	165	178	190	203
42	68	83	98	113	126	137	149	161	173	186	198
43	66	81	96	110	123	133	146	157	169	181	193
44	65	79	94	107	120	130	142	154	165	177	189
45	63	78	92	105	118	127	139	150	162	173	185
46	62	76	90	103	115	125	136	147	158	169	181
47	61	74	88	101	113	122	133	144	155	166	177
48	59	73	86	98	110	120	130	141	152	162	173
49	58	71	84	96	108	117	128	138	149	158	170
50	57	70	83	95	106	115	125	135	146	156	166
51	56	69	81	93	104	112	123	133	143	153	163
52	55	67	79	91	102	110	120	130	140	150	160
53	54	66	78	89	100	108	118	128	137	147	157
54	53	65	76	88	98	106	116	125	135	144	154
55	52	64	75	86	96	104	114	123	132	142	151
56	51	62	74	84	95	102	112	121	130	139	148
57	50	61	72	83	93	101	110	119	128	137	146
58	49	60	71	82	91	99	108	117	125	134	143
59	48	59	70	80	90	97	106	115	123	132	141
Weight per Foot in Pounds.	98.0	113.6	128.8	143.2	157.6	184.8	196.7	208.6	220.5	232.4	244.3

SAFE UNIFORMLY DISTRIBUTED LOADS FOR PLATE GIRDERS IN THOUSANDS OF POUNDS.

The safe loads below include the weight of the girder and are calculated for a fibre stress of 15,000 pounds per square inch on the net section. The net section is obtained by deducting holes figured at $\frac{3}{8}$ of an inch in diameter (for $\frac{3}{4}$ " rivets) from both flanges.

Web Plate 36" \times $\frac{3}{8}$ "
Flange Angles 6" \times 6"

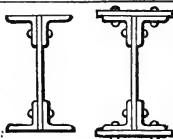

Web Plate 36" \times $\frac{3}{8}$ "
Flange Angles 6" \times 6" \times $\frac{3}{4}$ "
Flange Plates 14"

Distance Center to Center of Bearings in Feet.	Thickness of Flange Angles in Inches.				Thickness of Flange Plate in Inches.				
	$\frac{3}{8}$	$\frac{1}{2}$	$\frac{5}{8}$	$\frac{3}{4}$	$\frac{1}{2}$	$\frac{5}{8}$	$\frac{3}{4}$	$\frac{7}{8}$	1
30	108	134	159	183	238	255			
31	104	130	154	177	230	247	264		
32	101	125	149	171	223	239	256		
33	98	122	144	166	216	232	248	264	
34	95	118	140	161	210	225	241	256	
35	92	115	136	157	204	219	234	249	264
36	90	112	132	152	198	213	227	242	257
37	87	109	129	148	193	207	221	235	250
38	85	106	125	144	188	201	215	229	243
39	83	103	122	141	183	196	210	223	237
40	81	100	119	137	178	191	205	218	231
41	79	98	116	134	174	187	200	213	225
42	77	96	113	131	170	182	195	207	220
43	75	93	111	128	166	178	190	203	215
44	74	91	108	125	162	174	186	198	210
45	72	89	106	122	158	170	182	194	205
46	70	87	104	119	155	166	178	189	201
47	69	85	101	117	152	163	174	185	197
48	67	84	99	114	149	160	171	182	193
49	66	82	97	112	146	156	167	178	189
50	65	80	95	110	143	153	164	174	185
51	63	79	93	108	140	150	160	171	181
52	62	77	92	106	137	147	157	168	178
53	61	76	90	104	135	144	154	164	174
54	60	74	88	102	132	142	152	161	171
55	59	73	87	100	130	139	149	158	168
56	58	72	85	98	127	137	146	156	165
57	57	70	84	96	125	134	144	153	162
58	56	69	82	95	123	132	141	150	159
59	55	68	81	93	121	130	139	148	157
Weight per Foot in Pounds.	107.5	126.3	144.7	162.7	214.1	226	237.9	249.8	261.7

NOTE.—When Flange plates are thicker than $\frac{3}{4}$ ", use two plates.

**SAFE UNIFORMLY DISTRIBUTED LOADS FOR
PLATE GIRDERS IN THOUSANDS OF
POUNDS.**

The safe loads below include the weight of the girder and are calculated for a fibre stress of 15 000 pounds per square inch on the net section. The net section is obtained by deducting holes figured at one inch in diameter (for 3/8" rivets) from both flanges.

Web Plate 42" x 3/8"
Flange Angles 6" x 4"

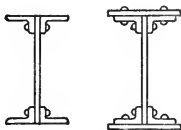

Web Plate 42" x 3/8"
Flange Angles 6" x 4" x 3/4"
Flange Plates 14"

Distance Center to Center of Bearings in Feet.	Thickness of Flange Angles in Inches.					Thickness of Flange Plate in Inches.					
	3/8	1/2	5/8	3/4	7/8	3/8	1/2	5/8	3/4	7/8	1
35	100	122	143	164	183	198	215	232	249	267	284
36	97	119	139	159	178	192	209	226	242	259	276
37	95	116	136	155	173	187	203	220	236	252	269
38	92	113	132	151	169	182	198	214	230	246	261
39	90	110	129	147	165	178	193	208	224	239	255
40	87	107	125	143	160	173	188	203	218	233	248
41	86	104	122	140	157	169	184	198	213	228	242
42	83	102	119	137	153	165	179	193	208	222	237
43	81	99	117	133	149	161	175	189	203	217	231
44	79	97	114	130	146	157	171	185	198	212	226
45	78	95	111	127	143	154	167	181	194	207	221
46	76	93	109	125	140	151	164	177	190	203	216
47	74	91	107	122	137	147	160	173	186	199	211
48	73	89	105	120	134	144	157	169	182	194	207
49	71	87	102	117	131	141	154	166	178	191	203
50	70	86	100	115	128	139	151	163	175	187	199
51	69	84	98	112	126	136	148	159	171	183	195
52	67	82	96	110	123	133	145	156	168	180	191
53	66	81	95	108	121	131	142	153	165	176	187
54	65	79	93	106	119	128	139	150	162	173	184
55	64	78	91	104	117	126	137	148	159	170	181
56	62	76	90	102	115	124	134	145	156	167	177
57	61	75	88	101	113	121	132	143	153	164	174
58	60	74	86	99	111	119	130	140	150	161	171
59	59	73	85	97	109	117	128	138	148	158	168
60	58	71	84	96	107	115	125	135	145	156	166
61	57	70	82	94	105	114	123	133	143	153	163
62	56	69	81	92	103	112	121	131	141	151	160
63	55	68	80	91	102	110	119	129	138	148	158
64	55	67	78	90	100	108	118	127	136	146	155
Weight per Foot in Pounds.	105.7	121.3	136.5	150.9	165.3	192.5	204.4	216.3	228.2	240.1	252.0

SAFE UNIFORMLY DISTRIBUTED LOADS FOR PLATE GIRDERS IN THOUSANDS OF POUNDS.

The safe loads below include the weight of the girder and are calculated for a fibre stress of 15 000 pounds per square inch on the net section. The net section is obtained by deducting holes figured at one inch in diameter (for $\frac{3}{8}$ " rivets) from both flanges.

Web Plate 42" \times $\frac{3}{8}$ "

Flange Angles 6" \times 6"

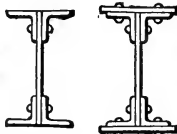

Web Plate 42" \times $\frac{3}{8}$ "

Flange Angles 6" \times 6" \times $\frac{3}{4}$ "

Flange Plates 14"

Distance Center to Center of Bearings in Feet.	Thickness of Flange Angles in Inches.			Thickness of Flange Plate in Inches.					
	$\frac{1}{2}$	$\frac{5}{8}$	$\frac{3}{4}$	$\frac{1}{2}$	$\frac{5}{8}$	$\frac{3}{4}$	$\frac{7}{8}$	1	1 $\frac{1}{4}$
35	139	164	189	240	257	275	292	309	
36	135	160	184	234	250	267	284	301	
37	131	155	179	227	244	260	276	293	
38	128	151	174	221	237	253	269	285	
39	125	148	169	216	231	247	260	278	309
40	122	144	165	210	225	240	256	271	301
41	119	140	161	205	220	235	249	264	294
42	116	137	157	200	215	229	243	258	287
43	113	134	154	195	210	224	238	252	280
44	111	131	150	191	205	219	232	246	274
45	108	128	147	187	200	214	227	241	268
46	106	125	144	183	196	209	222	235	262
47	103	122	141	179	192	205	217	230	256
48	101	120	138	175	188	200	213	226	251
49	99	117	135	172	184	196	209	221	246
50	97	115	132	168	180	192	204	217	241
51	95	113	130	165	177	189	200	212	236
52	94	111	127	162	173	185	197	208	232
53	92	109	125	159	170	181	193	204	227
54	90	107	122	156	167	178	189	201	223
55	88	105	120	153	164	175	186	197	219
56	87	103	118	150	161	172	183	193	215
57	85	101	116	147	158	169	179	190	211
58	84	99	114	145	155	166	176	187	208
59	82	98	112	142	153	163	173	184	204
60	81	96	110	140	150	160	170	180	201
61	80	94	108	138	148	158	168	178	197
62	78	93	107	136	145	155	165	175	194
63	77	91	105	133	143	153	162	172	191
64	76	90	103	131	141	150	160	169	188
Weight per Foot in Pounds.	134.9	153.3	171.3	224.7	236.6	248.5	260.4	272.3	296.1

NOTE.—When Flange plates are thicker than $\frac{3}{4}$ ", use two plates.

SAFE UNIFORMLY DISTRIBUTED LOADS FOR PLATE GIRDERS IN THOUSANDS OF POUNDS.

The safe loads below include the weight of the girder and are calculated for a fibre stress of 15000 pounds per square inch on the net section. The net section is obtained by deducting holes figured at one inch in diameter (for $\frac{3}{8}$ " rivets) from both flanges.

Web Plate 48" \times $\frac{3}{8}$ "

Flange Angles 6" \times 4"



Web Plate 48" \times $\frac{3}{8}$ "

Flange Angles 6" \times 4" \times $\frac{3}{4}$ "

Flange Plates 14"

Distance Center to Center of Bearings in Feet.	Thickness of Flange Angles in Inches.					Thickness of Flange Plate in Inches.					
	$\frac{3}{8}$	$\frac{1}{2}$	$\frac{5}{8}$	$\frac{3}{4}$	$\frac{7}{8}$	$\frac{3}{8}$	$\frac{1}{2}$	$\frac{5}{8}$	$\frac{3}{4}$	$\frac{7}{8}$	1
35	120	146	170	194	217	233	253	273	293	312	332
36	117	142	165	189	211	227	246	265	284	303	322
37	113	138	161	183	205	220	239	258	276	295	314
38	110	134	157	179	199	215	233	251	269	287	305
39	108	131	153	174	194	209	227	245	262	280	298
40	105	127	149	170	189	204	221	238	256	273	290
41	102	124	145	166	185	199	216	233	249	266	283
42	100	121	142	162	180	194	211	227	243	260	276
43	98	119	139	158	176	190	206	222	238	254	270
44	95	116	135	154	172	185	201	217	232	248	264
45	93	113	132	151	168	181	197	212	227	243	258
46	91	111	130	148	165	177	192	207	222	237	252
47	89	108	127	144	161	174	188	203	218	232	247
48	87	106	124	141	158	170	184	199	213	227	242
49	86	104	122	138	156	166	181	195	209	223	237
50	84	102	119	136	152	163	177	191	205	218	232
51	82	100	117	133	149	160	174	187	201	214	228
52	81	98	115	131	146	157	170	183	197	210	223
53	79	96	112	128	143	154	167	180	193	206	219
54	78	94	110	126	140	151	164	177	189	202	215
55	76	93	108	123	138	148	161	173	186	198	211
56	75	91	106	121	135	146	158	170	182	195	207
57	74	89	104	119	133	143	155	167	179	192	204
58	72	88	103	117	131	141	153	164	176	188	200
59	71	86	101	115	128	138	150	162	173	185	197
60	70	85	99	113	126	136	147	159	170	182	193
61	69	84	98	111	124	134	145	156	168	179	190
62	68	82	96	109	122	132	143	154	165	176	187
63	67	81	95	108	120	129	140	151	162	173	184
64	66	80	93	106	118	127	138	149	160	171	181
Weight per Foot in Pounds.	113.3	128.9	144.1	158.5	172.9	200.1	212.0	223.9	235.8	247.7	259.6

SAFE UNIFORMLY DISTRIBUTED LOADS FOR PLATE GIRDERS IN THOUSANDS OF POUNDS.

The safe loads below include the weight of the girder and are calculated for a fibre stress of 15 000 pounds per square inch on the net section. The net section is obtained by deducting holes figured at one inch in diameter (for $\frac{1}{8}$ " rivets) from both flanges.

Web Plate 48" \times $\frac{3}{8}$ "
Flange Angles 6" \times 6"

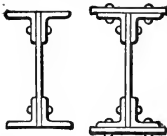

Web Plate 48" \times $\frac{3}{8}$ "
Flange Angles 6" \times 6" \times $\frac{3}{4}$ "
Flange Plates 14"

Distance Center to Center of Bearings in Feet.	Thickness of Flange Angles in Inches.			Thickness of Flange Plate in Inches.					
	$\frac{1}{2}$	$\frac{5}{8}$	$\frac{3}{4}$	$\frac{1}{2}$	$\frac{5}{8}$	$\frac{3}{4}$	$\frac{7}{8}$	1	1 $\frac{1}{4}$
35	166	195	224	283	303	322	342	362	
36	161	190	218	275	294	313	333	352	
37	157	185	212	267	286	305	324	342	
38	153	180	206	260	279	297	315	333	
39	149	175	201	254	272	289	307	325	361
40	145	171	196	247	265	282	299	317	352
41	141	167	191	241	258	275	292	309	343
42	138	163	187	236	252	269	285	302	335
43	135	159	182	230	246	263	279	295	327
44	132	155	178	225	241	256	272	288	320
45	129	152	174	220	235	251	266	282	312
46	126	149	170	215	230	245	260	275	306
47	123	145	167	211	225	240	255	270	299
48	121	142	163	206	221	235	249	264	293
49	118	140	160	202	216	230	244	259	287
50	116	137	157	198	212	226	240	253	281
51	114	134	154	194	208	221	235	248	276
52	112	131	151	190	204	217	230	244	270
53	109	129	148	187	200	213	226	239	265
54	107	127	145	183	196	209	222	235	260
55	105	124	142	180	193	205	218	230	256
56	104	122	140	177	189	201	214	226	251
57	102	120	137	174	186	198	210	222	247
58	100	118	135	171	183	195	206	218	242
59	98	116	133	168	179	191	203	215	238
60	97	114	131	165	176	188	200	211	234
61	95	112	128	162	174	185	196	208	231
62	94	110	126	160	171	182	193	204	227
63	92	109	124	157	168	179	190	201	223
64	91	107	122	155	165	176	187	198	220
Weight per Foot in Pounds.	142.5	160.9	178.9	232.3	244.2	256.2	268	279.9	303.7

SAFE UNIFORMLY DISTRIBUTED LOADS FOR PLATE GIRDERS IN THOUSANDS OF POUNDS.

The safe loads below include the weight of the girder and are calculated for a fibre stress of 15000 pounds per square inch on the net section. The net section is obtained by deducting holes figured at one inch in diameter (for $\frac{1}{8}$ " rivets) from both flanges.

Web Plate $60'' \times \frac{3}{8}''$

Flange Angles $6'' \times 4''$

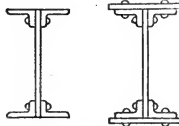

Web Plate $60'' \times \frac{3}{8}''$

Flange Angles $6'' \times 4'' \times \frac{3}{4}''$

Flange Plates $14''$

Distance Center to Center of Bearings in Feet.	Thickness of Flange Angles in Inches.					Thickness of Flange Plate in Inches.					
	$\frac{3}{8}$	$\frac{1}{2}$	$\frac{5}{8}$	$\frac{3}{4}$	$\frac{7}{8}$	$\frac{3}{8}$	$\frac{1}{2}$	$\frac{5}{8}$	$\frac{3}{4}$	$\frac{7}{8}$	1
40	143	172	199	226	251	269	291	312	334	356	377
41	140	168	195	220	245	262	284	305	326	347	368
42	137	164	190	215	239	256	277	297	318	339	359
43	133	161	186	210	234	250	270	290	311	331	351
44	130	156	181	205	228	244	264	284	304	323	343
45	127	153	177	201	223	239	258	277	297	316	335
46	125	149	173	196	218	234	253	271	290	309	328
47	122	146	170	192	214	229	247	266	284	303	321
48	120	143	166	188	209	224	242	260	278	296	314
49	117	140	163	184	205	220	237	255	273	290	308
50	115	138	160	181	201	215	233	250	267	285	302
51	112	135	156	177	197	211	228	245	262	279	296
52	110	132	153	174	193	207	224	240	257	274	290
53	108	130	150	171	190	203	219	236	252	268	285
54	106	127	148	167	186	200	215	231	247	263	280
55	104	125	145	164	183	196	211	227	243	259	274
56	102	123	142	161	179	192	208	223	238	254	270
57	101	121	140	159	176	189	204	219	234	250	265
58	99	119	138	156	173	185	200	215	230	245	260
59	97	117	135	153	170	182	197	212	226	241	256
60	96	115	133	151	167	179	194	208	223	237	252
61	94	113	131	148	165	176	191	205	219	233	247
62	92	111	129	146	162	173	187	201	215	229	243
63	91	109	127	143	159	171	185	198	212	226	240
64	90	107	125	141	157	168	182	195	209	222	236
65	88	106	123	139	155	165	179	191	205	220	232
66	87	104	121	137	152	163	176	189	202	216	229
67	86	103	119	135	150	160	173	186	199	213	225
68	84	101	117	133	148	158	171	184	196	210	222
69	83	100	116	131	146	156	168	181	194	207	219
70	82	98	114	129	143	154	166	178	191	204	216
Weight per Foot in Pounds.	128.6	144.2	159.4	173.8	188.2	215.4	227.3	239.2	251.1	263.0	274.9

SAFE UNIFORMLY DISTRIBUTED LOADS FOR PLATE GIRDERS IN THOUSANDS OF POUNDS.

The safe loads below include the weight of the girder and are calculated for a fibre stress of 15000 pounds per square inch on the net section. The net section is obtained by deducting holes figured at one inch in diameter (for $\frac{7}{8}$ " rivets) from both flanges.

Web Plate $60'' \times \frac{3}{8}''$
Flange Angles $6'' \times 6''$

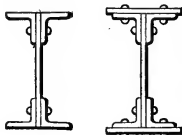

Web Plate $60'' \times \frac{3}{8}''$
Flange Angles $6'' \times 6'' \times \frac{3}{4}''$
Flange Plates $14''$

Distance Center to Center of Bearings in Feet.	Thickness of Flange Angles in Inches.					Thickness of Flange Plate in Inches.					
	$\frac{3}{8}$	$\frac{1}{2}$	$\frac{5}{8}$	$\frac{3}{4}$	$\frac{7}{8}$	$\frac{1}{2}$	$\frac{5}{8}$	$\frac{3}{4}$	$\frac{7}{8}$	1	$1\frac{1}{4}$
40	160	194	227	259	290	323	345	366	388	410	453
41	157	190	222	253	283	316	336	357	379	400	442
42	153	185	217	247	276	308	328	349	370	390	431
43	149	181	212	241	270	301	321	341	361	381	421
44	146	177	207	236	264	294	314	333	353	372	412
45	143	173	202	230	258	287	307	326	345	364	403
46	140	169	198	225	252	281	300	319	338	356	394
47	137	165	194	221	247	275	294	312	330	349	385
48	134	162	190	216	242	269	287	305	323	341	377
49	131	159	186	212	237	264	282	299	317	334	370
50	128	156	182	207	232	259	276	293	311	328	362
51	126	152	178	203	227	254	270	287	304	321	355
52	123	150	175	199	223	249	265	282	298	315	348
53	121	147	172	196	219	244	260	277	293	309	342
54	119	144	168	192	215	240	255	271	287	303	335
55	117	141	165	188	211	235	251	266	282	298	329
56	115	139	162	185	207	231	246	262	277	293	323
57	113	136	160	182	203	227	242	257	272	287	318
58	111	134	157	179	200	223	238	253	268	282	312
59	109	132	154	176	197	219	234	248	263	278	307
60	107	130	152	173	193	216	230	244	259	273	302
61	105	127	149	170	190	212	226	240	254	269	297
62	103	125	147	167	187	209	222	236	250	264	292
63	102	123	144	165	184	205	219	232	246	260	288
64	100	121	142	162	181	202	216	229	243	256	283
65	99	120	140	159	178	199	212	225	239	252	279
66	97	118	138	157	176	196	209	222	235	248	274
67	96	116	136	155	173	193	206	219	232	245	270
68	94	114	134	152	171	190	203	215	228	241	267
69	93	113	132	150	168	187	200	212	225	237	263
70	92	111	130	148	166	185	197	209	222	234	259
Weight per Foot in Pounds.	139.0	157.8	176.2	194.2	211.8	247.7	259.6	271.5	283.4	295.3	319.1

GRILLAGE BEAMS FOR FOUNDATIONS.

In designing foundations for walls or columns carrying heavy loads resting upon the soil, it is necessary to distribute the weight over a suitable area, and this is readily accomplished, in a small depth, by using a grillage composed of steel beams imbedded in concrete, thus obviating the necessity of large masses of masonry and deep excavations. For heavy loads on soil of small bearing power three tiers of beams may be necessary, while for lighter loads and soil of greater bearing power two tiers of beams will ordinarily suffice.

The grillage beams which are to be surrounded by concrete should be spaced not less than 3" apart in the clear between the flanges, so that the concrete may be thoroughly rammed between them, and gas-pipe, or standard cast-iron separators should be used to maintain the beams in proper position.

Knowing the total weight to be carried and the allowable intensity of loading per square foot of the supporting soil, the area of the footing required can be readily found, which, taken into consideration with any other conditions limiting the form or proportions of the footing, will determine the external dimensions of the foundation. The beams may be considered as subjected to a uniform load extending over a portion of their upper surfaces, the center of which is at the center of length of the beams, and as being uniformly supported from below throughout their length.

Under these circumstances, the maximum bending moment will occur at the center of the beam and, using the notation given for the upper tier in the sketch below, this bending moment for one beam will be as follows:

$$\text{Bending moment in inch pounds} = \frac{W}{8} (c - b)$$

in which c and b are expressed in inches and W is the total weight in pounds on one beam, obtained by dividing the total load by the number of beams composing the tier in question.

This formula for the bending moment is the same as that for a beam of the length $(c - b)$ supported at the ends and uniformly loaded with the total weight W , so that the proper sizes of beams, bending considered, may be obtained directly from the tables of safe loads uniformly distributed for Cambria I-Beams, on pages 106 to 117 inclusive, or for cases in which the lengths are shorter than those given in these tables, the sizes may be calculated from the coefficients of strength or the section moduli given in the tables of properties of I-Beams, pages 182 to 185 inclusive, taking care, however, to use as the length, the distance $(c - b)$, for the upper tier, and the corresponding figures for the other tiers.

After determining the size of beam required based upon bending, as stated above, an examination should also be made of the capacity of the beam web to resist buckling. This may be done by considering the web as a column of height equal to the clear distance between the fillets and calculating the safe load therefor by the use of the tables of strength for steel columns or struts, on pages 218 to 221, using the proper safety factor.

If the beam web is found insufficient as a column when calculated in this manner, a beam with a web of greater thickness should be tried until one is found that will meet this requirement and the conditions for bending; or it might be more economical, in some cases, to use the beam with the thinner web and provide it with sufficient separators, fitting between the beam flanges, or stiffeners secured to the web to assist it in resisting as a column.

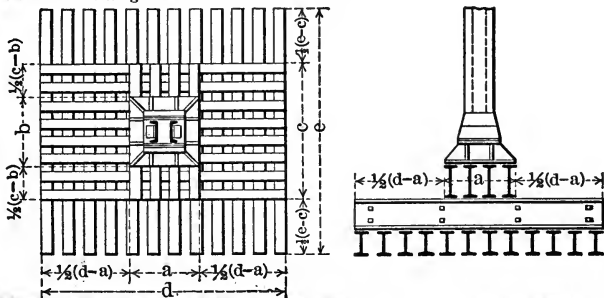

EXTRACTS FROM THE BUILDING LAWS OF VARIOUS CITIES.**Live Loads for Floors in Different Classes of Buildings, Exclusive of the Weight of the Materials of Construction.****(Revised to 1917.)****Pounds per Square Foot.**

No.	City.	Dwell's, Apart- ments, Hotels, Tenements or Lodginga.	Office Buildings.		Schools or Places of Instruction.	Buildings for Public Assembly.
			First Floor.	Upper Floors.		
1	Atlanta.....	60	150	75	75	90
2	Baltimore.....	60	150	75	75	75(a), 125
3	Boston.....	{100(b) 50	100	100	{125(c) 60	125
4	Buffalo.....	{40(d) 70	70	70	100	100
5	Chicago.....	{50(e) 40	50	50	75	100
6	Cincinnati.....	40	100	50	60	100
7	Cleveland.....	{60(u) 80	125	80	{80(a) 125	{125(c) 100
8	Denver.....	{40 50(h)	70	70	50(a)	{80(a) 120(f)
9	Detroit.....	{80(f) 50	125	75	{100(c) 75	{80(a) 100
10	Hartford.....	50	100	100	120
11	Jersey City.....	60	150	75	75	90
12	Los Angeles.....	{125(t) 60	75	75	125
13	Louisville.....	60	150	75	75	100
14	Milwaukee.....	30	80	40	{40 60	{80 50(a)
15	Minneapolis.....	50	100	75	100	125
16	Newark, N. J.....	60	150	75	75	90
17	New Haven.....	{100(g) 60	75	110
18	New Orleans.....	{70(b) 40	70	70	{125(c) 60	125
19	New York.....	40	60	60	75	100
20	Philadelphia.....	70	100	100	120
21	Pittsburgh.....	{50 70(h)	70	70	70	125
22	Portland, Ore....	{80(f) 50	100	60	{80(c) 60	{80(a) 100
23	Providence.....	{100(b) 50	150	75	{125(c) 60	25
24	Rochester.....	{60(h) 50	70	70	70	70
25	St. Louis.....	60	150	70	100	100
26	St. Paul.....	50	125	60	{125(c) 60	125
27	San Francisco....	60	60	60	{125(c) 75(a)	{75(a) 125(c)
28	Seattle.....	{75(b) 40	125	50	{100(c) 75	{75(a) 100
29	Syracuse.....	60	{100(g) 75	{100(g) 75	{90(c) 75	{80(a) 100
30	Washington.....	{75(g) 50	{110(g) 75	{110(g) 75	75	110
31	Worcester, Mass..	60	125	75	75	125

(a) Where seats are fixed; (b) Public rooms exceeding 500 sq. ft. area; (c) Assembly rooms; (d) Occupied by less than 25 persons; (e) Sleeping accommodations for 20 or more persons; (f) First floor—Hotels, Tenements and Lodging Houses; (g) Rooms and spaces for public use or common use of tenants; (h) Tenement Houses and Hotels.

EXTRACTS FROM THE BUILDING LAWS OF VARIOUS CITIES.

Live Loads for Floors in Different Classes of Buildings, Exclusive of the Weight of the Materials of Construction.

(Revised to 1917.)

Pounds per Square Foot.

Stables or Carriage Houses.	Garages.	Ord. Stores, Light Manufacturing, Light Storage.	Stores (Heavy Materials, Warehouses, Factories.	Roofs.		Side-walks.	No.
				Slope <20°.	Slope >20°.		
75	120	150	40(i)	30(j)	200	1
100	125	250(k), 175	40(i)	20(j)(l)	200	2
.....	125	250	40(m)	3
40 (n)	120	150	40(j)	40(j)	4
{ 40 (o)	{ 40(o)	100	100	25(j)	25(j)	5
{ 100	{ 100	100	150	25(j)	25(j)	300	6
75	100	150	25(j)	25(j)	300	6
80	{ 100	{ 125(q)	200	35(m)	30(i)	200	7
.....	{ 150(q)	{ 100
.....	150	150	40	20	8
{ 60(p)	{ 60(p)	{ 125(q)	{ 200(s)	40	40	250	9
{ 80	{ 80	{ 130(r), 100	{ 175	40	40	250	9
.....	125	125	50(i)	50(i)	10
75	120	150	50(i)	30(j)	300	11
.....	150	150	{ 20(v)(u)	{ 20(v)(u)	12
100	100	150	30	30
80	80	100	40	30(j)	300	13
85	100	100	30	30	150	14
75	120	150	30(i)	30(i)	300(j)	15
.....	120	150	50(i)	30(j)	300	16
.....	120	150	40(i)	40(i)	17
.....	125	200	30(m)	300	18
120	120	120	120	40	30(j)	300	19
.....	120	150	30	30	20
.....	125	200	{ 50(j)	50(j)	21
.....	{ 40(m)
80	{ 125(q)	200	40	40	300	22
.....	{ 100
.....	125	250	40(m)	23
{ 50(n)	{ 50(n)	100	200	40(j)	40(j)	24
{ 100	{ 100	150	150	40(m)	25
.....	100	200	30(j)	30(j)	300	26
85	100	200	30(j)	30(j)	300	26
75	125	250	30(i)	20(j)	150	27
75	125	125	40(j)	40(j)	28
80	125	125	200	40	40	250	29
.....	110	150	25(i)	25(i)	30
125	125-175	125	200	50(i)	30(j)	300	31

(i) Per square foot of surface; (j) Per square foot, measured horizontally; (k) Heavy storage; (l) Where used for public assembly or special purpose use same load as floors; (m) Flat; (n) Private; (o) Ground area less than 500 sq. ft.; (p) Small; (q) 1st floor; (r) Light storage and manufacturing; (s) Heavy Merchandise storage; (t) Hotel corridors; (u) Dwellings; (v) Sheds and outbuildings.

EXTRACTS FROM THE BUILDING LAWS OF VARIOUS CITIES.

ALLOWABLE UNIT STRESSES FOR STEEL AND IRON.

(Revised to 1917.)

Pounds per Square Inch.

No.	City.	Tension.			
		Rolled Steel.	Cast Steel.	Wrought Iron.	Cast Iron.
1	Atlanta.....	16 000	16 000	12 000	3 000
2	Baltimore.....	16 000	16 000	12 000	5 000
3	Boston.....	16 000	16 000	12 000
4	Buffalo.....	16 000	16 000	12 000	3 000
5	Chicago.....	16 000	16 000	12 000
6	Cincinnati.....	16 000	16 000	12 000	3 000
7	Cleveland.....	16 000	12 000
8	Denver.....	16 000	16 000	12 000	3 000
9	Detroit.....	16 000(d)	16 000(d)	12 000	3 000
10	Hartford(f).....
11	Jersey City.....	16 000	16 000	12 000	3 000
12	Los Angeles(e).....
13	Louisville.....	16 000	16 000	12 000
14	Milwaukee.....	16 000	16 000	12 000
15	Minneapolis.....	16 000	16 000	12 000	3 000
16	Newark, N. J.....	16 000	16 000	12 000	3 000
17	New Haven.....	16 000	12 000
18	New Orleans.....	16 000	16 000	12 000	3 000
19	New York.....	16 000	16 000	3 000
20	Philadelphia.....	{ 14 500(c) 16 250(d)	12 500
21	Pittsburgh.....	16 000	12 000
22	Portland, Ore.....	16 000	16 000	12 000	3 000
23	Providence(e).....	3 000
24	Rochester.....	16 000	16 000	12 000	3 000
25	St. Louis(f).....	3 000
26	St. Paul.....	16 000	16 000	12 000
27	San Francisco.....	16 000	16 000	12 000
28	Seattle.....
29	Syracuse.....	16 000	{ 10 000(b) 16 000(a)	3 000
30	Washington.....	16 000	16 000	12 000	3 000
31	Worcester, Mass.....	16 000	16 000	12 000	3 000

(a) Annealed; (b) Not annealed; (c) Mild Steel; (d) Medium Steel; (e)

**EXTRACTS FROM THE BUILDING LAWS OF
VARIOUS CITIES.**

ALLOWABLE UNIT STRESSES FOR STEEL AND IRON.

(Revised to 1917.)

Pounds per Square Inch.

Extreme Fibre Stress (Bending).								No.
Steel.			Wrought Iron.			Cast Iron.		
Rolled Beams.	Rolled Pins, Rivets and Bolts.	Riveted Beams Net Flange Section.	Rolled Beams.	Rolled Pins, Rivets and Bolts.	Riveted Beams Net Flange Section.	Compression Side.	Tension Side.	
16 000	20 000	14 000	12 000	15 000	12 000	16 000	3 000	1
16 000	20 000	15 000	15 000	16 000	5 000	2
16 000	22 500	12 000	18 000	16 000	3 000	3
16 000	16 000	12 000	12 000	13 000	3 000	4
16 000	25 000	12 000	10 000	3 000	5
16 000	24 000	16 000	12 000	12 000	16 000	3 000	6
16 000	24 000	16 000	7
16 000	16 000	12 000	12 000	8
16 000	16 000	12 000	12 000	9
16 000	20 000	14 000	12 000	15 000	12 000	16 000	3 000	11
.....	12
16 000	20 000	15 000	15 000	16 000	3 000	13
16 000	25 000	12 000	10 000	3 000	14
16 000	16 000	12 000	12 000	15
16 000	20 000	14 000	12 000	15 000	12 000	16 000	3 000	16
16 000	20 000	16 000	12 000	15 000	12 000	17
16 000	22 000	12 000	18 000	16 000	3 000	18
16 000	20 000	16 000	16 000	3 000	19
.....	3 750	20
16 000	24 000	16 000	21
16 000	20 000	15 000	12 000	15 000	12 000	16 000	3 000	22
.....	23
16 000	20 000	14 000	12 000	15 000	12 000	16 000	3 000	24
.....	25
16 000	20 000	14 000	12 000	15 000	12 000	16 000	3 000	26
16 000	15 000	3 000	27
16 000	24 000	16 000	12 000	12 000	10 000	3 000	28
16 000	20 000	16 000	16 000	2 500	29
16 000	20 000	14 000	12 000	15 000	12 000	16 000	3 000	30
16 000	20 000	16 000	12 000	15 000	12 000	16 000	3 000	31

Determined by the best modern practice; (f) Building Laws being revised, 1917.

EXTRACTS FROM THE BUILDING LAWS OF VARIOUS CITIES.

ALLOWABLE UNIT STRESSES FOR STEEL AND IRON.

(Revised to 1917.)

Pounds per Square Inch.

No.	City.	Compression.					
		Rolled Steel.	Cast Steel.	Wrought Iron.	Cast Iron (in short blocks).	Steel Pins and Rivets Bearing.	Wrought Iron Pins and Rivets Bearing.
1	Atlanta.....	16 000	16 000	12 000	16 000	20 000	15 000
2	Baltimore....	16 000	16 000	12 000	16 000	20 000	15 000
3	Boston.....	16 000	16 000	12 000	16 000	18 000	15 000
4	Buffalo.....	15 000	15 000	15 000
5	Chicago.....	14 000(a)	14 000(a)	10 000(a)	10 000(a)	{20 000(f) 25 000(s)}
6	Cincinnati....	16 000	16 000	12 000	16 000	20 000
7	Cleveland.....	16 000	12 000	20 000	12 000(t)
8	Denver.....	15 000	18 000	15 000
9	Detroit.....	(b)	(b)	75% Steel	(b)	{15 000(f) 20 000(s)}	12 000(t)
10	Hartford(l)...
11	Jersey City...	16 000	16 000	12 000	16 000	20 000	15 000
12	Los Angeles(j)
13	Louisville....	16 000	16 000	12 000	16 000	20 000	15 000
14	Milwaukee....	12 000(a)	12 000(a)	10 000(a)	8 000(a)	20 000(k)
15	Minneapolis..	16 000	16 000	12 000	16 000	18 000	15 000
16	Newark, N. J.	16 000	16 000	12 000	16 000	20 000	15 000
17	New Haven....	16 000	12 000	20 000	15 000
18	New Orleans..	16 000	12 000	18 000	15 000
19	New York....	16 000	16 000	16 000	24 000	15 000
20	Philadelphia..	{14 500(c) 16 250(d)}	12 500	11 670	{17 600(f) 22 000(s)}	{14 400(f) 18 000(s)}
21	Pittsburgh....	16 000	16 000	12 000	12 000	{20 000(f) 24 000(s)}	20 000(t)
22	Portland, Ore.	16 000	16 000	12 000	16 000	20 000	15 000
23	Providence(j)
24	Rochester....	16 000	16 000	12 000	16 000	20 000	15 000
25	St. Louis(l)...
26	St. Paul.....	16 000	16 000	12 000	16 000	20 000	15 000
27	San Francisco	16 000	16 000	12 000	16 000	20 000
28	Seattle.....	16 000	16 000	12 000	10 000(a)	{20 000(f) 24 000(s)}
29	Syracuse.....	16 000	{10 000(g) 16 000(e)}	{10 000(g) 16 000}	16 000(h)
30	Washington..	16 000	16 000	12 000	16 000	20 000	15 000
31	Worcester...	16 000	16 000	12 000	16 000	20 000	15 000

(a) Based on gross section; (b) Based on values given by standard steel manufacturer's handbook; (c) Mild steel; (d) Medium steel; (e) Annealed; (f) Field rivets; (g) Not annealed; (h) Field rivets driven by hand;

**EXTRACTS FROM THE BUILDING LAWS OF
VARIOUS CITIES.**

ALLOWABLE UNIT STRESSES FOR STEEL AND IRON.

(Revised to 1917.)

Pounds per Square Inch.

Shear.								Cast Iron.	No.
Steel.				Wrought Iron.					
Web Plates.	Shop Rivets and Pins.	Field Rivets.	Field Bolts.	Web Plates.	Shop Rivets and Pins.	Field Rivets.	Field Bolts.		
9 000	10 000	8 000	7 000	6 000	7 500	6 000	5 500	3 000	1
9 000	10 000	8 000	7 000	6 000	7 500	6 000	5 500	3 000	2
10 000	10 000	10 000	8 000	9 000	9 000	9 000	7 200	3
7 000	9 000	8 000	6 000	7 500	6 000	4
10 000(a)	12 000	10 000	2 000(i)	5
10 000	10 000	9 000	7 500	6 000	6 000	6 000	6 000	3 000	6
10 000	10 000	6 000	7
9 000	10 000	7 000	6 000	7 500	5 000	8
10 000	10 000	7 500	6 000	3 000	9
9 000	10 000	10 000	7 000	6 000	7 500	6 000	5 500	3 000	10
.....	11
.....	12
9 000	10 000	8 000	8 000	7 500	6 000	5 000	2 500	13
10 000	10 000	8 000	7 000	2 000(i)	14
10 000	9 000	6 750	6 000	7 500	6 000	15
9 000	10 000	8 000	7 000	6 000	7 500	6 000	5 500	3 000	16
10 000	10 000	8 000	6 000	7 500	6 000	17
10 000	10 000	10 000	8 000	9 000	9 000	9 000	7 200	18
10 000	12 000	8 000	7 000	3 000	19
{ 8 750(c)	11 000	8 800	7 500	9 000	7 200	20
{ 10 000(d)
10 000	12 000	10 000	10 000	21
9 000	10 000	8 000	7 000	6 000	7 500	6 000	5 500	3 000	22
.....	23
9 000	10 000	8 000	7 000	6 000	7 500	6 000	5 500	3 000	24
.....	25
9 000	10 000	8 000	7 000	6 000	7 500	6 000	5 500	3 000	26
9 000	10 000	8 000	7 000	6 000	27
10 000(a)	12 000	10 000	2 000(i)	28
10 000	10 000	{ 8 000(h)	7 000	2 000	29
.....	{ 10 000(k)
9 000	10 000	8 000	7 000	6 000	7 500	6 000	5 500	3 000	30
10 000	10 000	8 000	7 000	6 000	7 500	6 000	5 500	3 000	31

(i) Brackets; (j) Based on best modern practice; (k) Power driven; (l) Building Laws being revised, 1917; (s) Shop rivets; (t) Bearing on steel bolts.

EXTRACTS FROM THE BUILDING LAWS OF VARIOUS CITIES.

ALLOWABLE UNIT STRESSES FOR STEEL AND IRON.

(Revised to 1917.)

Pounds per Square Inch.

No.	City.	Columns.					
		Steel.		Cast Iron.		Wrought Iron.	
		Formula.	Max. Length L= =	Formula.	Max. Length L= =	Formula.	Max. Length L= =
1	Atlanta.....	(A)	120 R	(B)	70 R	(C)	120 R
2	Baltimore...	{Soft Steel (E) Medium " (F)	120 R	{<50 R—10 000 > " (G)	60 R		
3	Boston.....	(H)	120 R	(B)	70 R	(I)	
4	Buffalo.....	{<90 R-12 000 > " (J)	40 D	{Round (M) Rectangular (N)	30 D	{<90 R-8 000 > " (K)	40 D
5	Chicago.....	{(O) 14 000 max.	120 R	(Q)	70 R	{(P) 10 000 max.	
6	Cincinnati...	{<70 R-13 000 > " (J)	180 R	{Round (T) Rectangular (S) Others (U)	180 R		
7	Cleveland(f).	(f)	120 R	(f)	30 D	(f)
8	Denver.....	(J)	(EE)	30 D	(K)
9	Detroit.....	{<60 R-12 000 > " (O)(b)	44 D	Round (T)	30 D	75% Steel
10	Hartford(e).						
11	Jersey City..	(A)	120 R	(B)	70 R	(C)	120 R
12	Los Angeles(d)						
13	Louisville....	{<70 R-13 000 > " (CC)	120 R	{Round (T) Rectangular(S) Others (U)	120 R		
14	Milwaukee...	(J)	120 R	(Q)	25 D	(P)	120 R
15	Minneapolis..	(J)	40 D	{Round (V) Rectangular(W)	30 D	(K)	40 D
16	Newark, N.J.	(A)	120 R	(B)	70 R	(C)	120 R

L = Length in inches; R = Radius of Gyration in inches; D = Diameter or Least Dimension in inches.

FORMULÆ:—

(A) $15\,200 - 58 \frac{L}{R}$

(B) $11\,300 - 30 \frac{L}{R}$

(C) $14\,000 - 80 \frac{L}{R}$

(E) $\frac{14\,000}{1 + \frac{L^2}{13\,500 R^2}}$

(F) $\frac{15\,000}{1 + \frac{L^2}{13\,500 R^2}}$

(G) $\frac{11\,000}{1 + \frac{L^2}{1\,000 R^2}}$

(H) $\frac{16\,000}{1 + \frac{L^2}{20\,000 R^2}}$

(I) $\frac{12\,000}{1 + \frac{L^2}{20\,000 R^2}}$

(J) $17\,100 - 57 \frac{L}{R}$

(K) $10\,600 - 30 \frac{L}{R}$

(M) $\frac{14\,000}{1 + \frac{L^2}{600 D^2}}$

(N) $\frac{14\,000}{1 + \frac{L^2}{850 D^2}}$

(O) $16\,000 - 70 \frac{L}{R}$

(P) $12\,000 - 60 \frac{L}{R}$

(Q) $10\,000 - 60 \frac{L}{R}$

(b) 85% for soft steel.

EXTRACTS FROM THE BUILDING LAWS OF VARIOUS CITIES.

ALLOWABLE UNIT STRESSES FOR STEEL AND IRON.

(Revised to 1917.)

Pounds per Square Inch.

No.	City	Columns					
		Steel		Cast Iron		Wrought Iron	
		Formula	Max. Length L=	Formula	Max. Length L=	Formula	Max. Length L=
17	New Haven...	12 500(c)	{ 40 D 120 R	13 330(c)	20 D	10 000(c)	{ 40 D 120 R 120 R
18	New Orleans..	(H)		(B)	70 R	(I)	
19	New York....	(O)	120 R	(BB)	70 R
20	Philadelphia..	{Mild Steel (X) Med'm " (Y)	140 R	(Z)	20 D	(AA)	140 R
21	Pittsburgh....	(GG)Max.13000	120 R	(HH) Max. 9000	70 R	120 R
22	Portland, Ore.	(A)	120 R	(B)	70 R	(C)	120 R
23	Providence.....
24	Rochester.....	(A)	120 R	(B)	70 R	(C)	120 R
25	St. Louis	(f).....	(II)	25 D
26	St. Paul.....	(T)	(T)
27	San Francisco.	{ <30 R-12 000 > " (DD)	120 R	{ Round (EE) Rectangular(FF)	20 D
28	Seattle.....	(O) 14 000 max.	120 R	(Q)	70 R	(P)
29	Syracuse.....	(A)	120 R	(BB)	70 R
30	Washington...	(A)	120 R	(B)	70 R	(C)	120 R
31	Worcester.....	(A)	(BB)

L = Length in inches; R = Least Radius of Gyration in inches; D = Diameter or Least Dimension in inches.

FORMULÆ (continued):—

(S) $\frac{10\ 000}{1 + \frac{L^2}{1\ 067\ D^2}}$	(X) $\frac{14\ 500}{1 + \frac{L^2}{13\ 500\ R^2}}$	(CC) $17\ 000 - 57 \frac{L}{R}$
(T) $\frac{10\ 000}{1 + \frac{L^2}{800\ D^2}}$	(Y) $\frac{16\ 250}{1 + \frac{L^2}{11\ 000\ R^2}}$	(DD) $15\ 000 - 50 \frac{L}{R}$
(U) $\frac{10\ 000}{1 + \frac{L^2}{6\ 400\ R^2}}$	(Z) $\frac{11\ 670}{1 + \frac{L^2}{400\ D^2}}$	(EE) $\frac{8\ 000}{1 + \frac{L^2}{800\ D^2}}$
(V) $\frac{13\ 330}{1 + \frac{L^2}{400\ D^2}}$	(AA) $\frac{12\ 500}{1 + \frac{L^2}{15\ 000\ R^2}}$	(FF) $\frac{8\ 000}{1 + \frac{L^2}{1\ 067\ D^2}}$
(W) $\frac{13\ 330}{1 + \frac{L^2}{500\ D^2}}$	(BB) $9\ 000 - 40 \frac{L}{R}$	(GG) $19\ 000 - 100 \frac{L}{R}$
		(HH) $10\ 500 - 50 \frac{L}{R}$
		(II) $11\ 100 - 220 \frac{L}{R}$

(c) Coefficients for use with Gordon's Formula. (d) Based on best modern practice. (e) Building Laws being revised, 1917. (f) See Building Laws.

EXTRACTS FROM THE BUILDING LAWS OF VARIOUS CITIES.

Allowable Unit Stresses for Masonry and Building Materials.

(Revised to 1917.)

Pounds per Square Inch.

No.	City.	Compression.							
		Concrete.				Rubble Stonework.			
		Portland Cement 1:2:4	Portland Cement 1:2:5	Rosedale Cement 1:2:4	Rosedale Cement 1:2:5	Portland Cement Mortar	Rosedale Cement Mortar.	Lime and Cement Mortar.	Lime Mortar.
1	Atlanta.....	230	208	125	111	140	111	97	70
2	Baltimore...	400	350	125	111	125	100	70	50
3	Boston.....	417
4	Buffalo.....	56 (a)	56 (a)	70
5	Chicago.....	{ 400 (d) 350 (e)	{ 350 (d,f) 300 (e,f)	150	{ 200 (b) 100 (c)	{ 120 (b) 60 (c)
6	Cincinnati...	208	208	167	125	83
7	Cleveland....	400	350(h)
8	Denver.....	56	139	167	56-111
9	Detroit.....	417	417	111	111	139	111	{ 83 97(g)	70
10	Hartford....	153	153
11	Jersey City..	230	208	125	111	140	111	97	70
12	Los Angeles..	278(a)	278(a)
13	Louisville....	167
14	Milwaukee..	400	{ 250(k) 300(f)	111	83	175	125	97	90
15	Minneapolis..	{ 500(i) 300	208(h)	167	125	111	83
16	Newark, N. J.	230	208	125	111	140	111	97	70
17	New Haven..	208(a)	208(a)
18	New Orleans..
19	New York....	500	400(f)	210	150(f)	140	110	100
20	Philadelphia.	208	208	139	111	70
21	Pittsburgh(j).
22	Portland, Ore.	347	278(k)	{ 208(b) 167(c)	{ 167(b) 139(c)	{ 139(b) 83(c)
23	Providence..	222	195	111	83	{ 139(c) 153(b)	{ 125(b) 97(c)	{ 97(b) 70(c)	{ 83(b) 56(c)
24	Rochester...	230	208	125	111	140	111	97	70
25	St. Louis....	250(h)
26	St. Paul....	500	400	125	111	200	100	125(g)	80
27	San Francisco	277	277
28	Seattle.....	400	350(f)	{ 200(b) 100(c)	{ 120(b) 60(c)
29	Syracuse....	400	300	100	80	110
30	Washington..	400	320	125	111	140	111	97	70
31	Worcester....	278	208(k)	111	111	139	111	97	70

(a) Foundations; (b) Coursed; (c) Ordinary; (d) Machine-mixed; (e) Hand-mixed; (f) 1:2½:5; (g) Portland Cement Mortar; (h) 1:3:5; (i) 300 where height is 12 diameters; 500 for 5 diameters or under; intermediate heights, intermediate values; (j) Based on best modern practice; (k) 1:3:6.

EXTRACTS FROM THE BUILDING LAWS OF VARIOUS CITIES.
Allowable Unit Stresses on Masonry and Building Materials.
 (Revised to 1917.) Pounds per Square Inch.

Brickwork				Compression										No.
Portland Cem. Mortar 1:3	Rosendale Cem. Mortar 1:3	Lime and Cem. Mortar 1:1:6	Lime Mortar 1:4	Granites (per Test)	Greenwich Stone	Gneiss	Limestone (per Test)	Marble (per Test)	Sandstone (per Test)	Blinestone	Hard-burned Brick, flatwise	Slate		
250	208	160	111	{1000-2400	1200	{700-2300	{600-1200	{400-1600	2000	300	1000	1	
250	208	160	111 (l)	{1000-2400	1000	{1000-2000	400 n	1500 m	2	
{278 q 250 r 167 q	{250 q 208 r 125 t 70 u	{167 q 139 r	{111 q p 97 r p 83 t 42 u	833	556	556	417	3	
{350 v 175 u	150	125	100	600	400	4	
250	167	111	{1000-2400	{400-1600	5	
200	175	150	100	1000	600	400	6	
125	125	40	560	167	7	
208	{153 g 125	97	8	
208 t	208 t	160	111 t	9	
250	208	160	111	{1000-2400	1200	{700-2300	{600-1200	{400-1600	2000	300	1000	10	
208	208	111	11	
250	167	111	12	
{180 250 t	{139 160 t	111	{83 120 t	13	
208	160	111	14	
250	208	160	111	{1000-2400	1200	{700-2300	{600-1200	{400-1600	2000	300	1000	15	
208	160	111	16	
{250 q 167 u	{125 83	830	550	550	415	17	
250	210	160	110	1000	1200	1000	700	600	400	2000	1000	18	
208	167	111	19	
{167 u 222 v 181 u 222 v	{139 u 167 v 139 v	{111 u 139 v 83 v 111 v	20	
250	208	160	111	{1000-2400	1200	{1300 w, x	{600-1200	{400-1600	300	1000	21	
300	210	120	22	
250	208	225 g	111	{1000-2000	{700-2300	{600-1200	{400-1600	{150-300	23	
208	208	139	97	389y	24	
175 v	125 v	100	800y	400	{235-350	25	
250	175	160 g	110	{1000-2400	1200	1300	{700-2300	{600-1200	{400-1600	2000	300	1000	26	
250	160	111	"	1200	1300	"	"	"	2000	1000	27	
208	167	139	111	"	1200	"	"	"	2000	300	1000	28	

(l) Mortar 1:3; (m) Falls Road Stone; (n) Cement Stone; (o) Mortar 1:2; (p) Mortar 1:6; (q) Hard-burned Brick—first-class work; (r) Same—Ordinary work; (t) Hard-burned Brick; (u) Common Brick; (v) Higher values for special Brick; (w) Local; (x) Medina—2000; (y) Granite Masonry.

EXTRACTS FROM THE BUILDING LAWS OF VARIOUS CITIES.
Allowable Unit Stresses for Masonry, Etc.
(Revised to 1917.) **Pounds per Square Inch**

No.	City.	Extreme Fibre Stress (Bending).					
		Granite.	Greenwich Stone.	Gneiss.	Limestone.	Slate.	Marble.
1, 16	Atlanta, Newark	180	150	150	400	120
11	Jersey City.....						
31	Worcester.....						
2	Baltimore.....	180	150	150	400	120
6	Cincinnati.....	50
14	Milwaukee.....
24	Rochester.....	180	150(b)	400	120
26	St. Paul.....	180	150	400	120
29	Syracuse.....	180	150	150	150	400	120

Safe Bearing Capacity of Soils, Etc.
Tons per Square Foot.

No.	City.	Soft Clay.	Ordinary Clay and Sand, in Layers, Wet and Springy.	Loam, Clay or Fine Sand, Firm and Dry.	Very Firm Coarse Sand, Stiff Gravel or Hard Clay	Piers of Stone, Brick and Concrete in Caissons.		
						Carried down to Rock.	Carried down to Firm Gravel or Hard Clay.	Open Caissons or Sheet Pile Trenches, to Rock.
1	Atlanta.....	1	2	2-3	3-4	15	8-10	8
2	Baltimore.....	1	2	3	6(a), 4	20-24	12-18(d)
3	Boston.....
4	Buffalo.....	3½
5	Chicago.....	1½	1¾-2½	1¾-2½
6	Cincinnati.....	1	1-2	4	8(c), 5
7	Cleveland.....	1	1½	2-4	3-8	10(h)
8	Denver.....	½(g), 1	1-2	3	4, 8(d)
9	Detroit.....	2	3	4
11	Jersey City.....	1	2	3	4	15	10	8
12	Los Angeles.....	1-3	1 e	2-4	4
13	Louisville.....	2½	4
14	Milwaukee.....	{ ½(g) 1	2	3	{ 4-5(c) 6(d) 20(h)
15	Minneapolis.....	1	2	3	4
16	Newark, N. J... ..	1	2	3	4	15	10	8
17	New Haven.....	4(f)
18	New Orleans.....	0.7
19	New York.....	1	2	3-4	4-6	8-40
20	Philadelphia.....	6(c), 3½
21	Pittsburgh.....
22	Portland, Ore... ..	{ ½(g) 1½ ½(g)	3	4	8(c)
23	Providence.....	1	2-3	2-5	4-10(c)	25-50(h)	10-15(d)
24	Rochester.....	1	2	3	10(c), 6	15	10	8
26	St. Paul.....	1	2	3	6(a), 4
27	San Francisco... ..	1	2	3	6(a), 4	20(h)	10(d)
28	Seattle.....	1	2	2½	{ 8(c) 3½-5
29	Syracuse.....	1	2	3	4
30	Washington.....	1	2	3	4

(a) Coarse Gravel; (b) Local; (c) Well cemented; (d) Bearing—Hardpan or Hard Shale rock unexposed to air, frost and water; (e) Sandy loam; (f) Good, solid, natural earth; (g) Quicksand or alluvial soil; (h) Bearing—Very hard, native bed rock.

EXTRACTS FROM THE BUILDING LAWS OF VARIOUS CITIES.
Allowable Unit Stresses for Masonry, Etc.
 (Revised to 1917.) Pounds per Square Inch.

Extreme Fibre Stress (Bending).								No.
Sand-stone.	Blue-stone.	Portland Concrete.		Rosendale Concrete.		Brick— Hardburned	Brickwork in Cement.	
		1 : 2 : 4.	1 : 2 : 5.	1 : 2 : 4.	1 : 2 : 5.			
100	300	30	20	16	10	50	30	1,16
100	300	30	20	16	10	50	30	11
50	300	30	20	16	10	50	30	31
.....	2
.....	6
.....	35	25(k)30(l)	14
100(j)	300	30	20	16	10	50(i)	30	24
100	300	30	20	16	10	50(i)	30	26
100	300	29

Allowable Safe Loads and Sizes for Wooden Piles.

Spacing		Minimum Diameter.			Safe Load—Tons.		Concrete Capping.		No.	
Maximum C. to C. in inches.	Minimum C. to C. in inches.	Of Small End. Inches.	Of Butt. Lengths = <20ft. Inches.	Of Butt. Lengths >20 ft. Inches.	Formula for Single Pile.	Not to exceed per Pile	Thickness Rammed Between Heads. Inches.	Width Outside of Piles. Inches.		
										36
.....	24	8(m), 6	10	10	12(n), 6	2
36	16(n)	3
36	24	6	12	12	25	12	12	4
.....	6	(D)&(S)	25	5
.....	6
.....	6	12	12	7
36	24	6	12	25	12	12	8
.....	5	10	12	(D)	25	10	12	9
.....	(D)	7-20	12	12	11
.....	12
36	20	5	10	12	(D)	20	13
.....	6	(D)&(S)	500(p)	14
36	20	5	10	12	(D)	20	12	12	15
35	20	5	10	12	(D)	7-20	12	12	16
36	6	20	12	12	17
.....	5	10	12	6(n), 12	6	18
36	20	6	10(q)	12(q)	(D)&(S)	20	19
30	5	20	12	12	20
.....	6	(D)&(S)	20	21
.....	6	12	12	(D)	25	6	12	22
36	24	12	12	12	23
36	20	5	10	12	(D)	20	12	12	24
.....	5	10	12	(D)	25	9(n), 9	12	26
.....	12(o)	7	25	12(n)	27
.....	24	6	12	12	(D)&(S)	25	{ 6(n)	12	28
.....	6	10	10	(D)	10-15	{ 6 9	12	29
.....	30

(i) Common; (j) Medina; (k) 1:3:6 mixture; (l) 1:2½:5 mixture; (m) Length =>20 ft.; (n) Capping, on top of heads; (o) In clear between piles; (D) For Drop Hammer, $\frac{2WH}{P+1}$; (S) For Steam Hammer, $\frac{2WH}{P+1\frac{1}{10}}$ where W=Weight of hammer in Tons; H=Height of drop in Feet; P=Penetration of last blow (or average of last several blows) in Ins.; (p) Pounds per sq. in.; (q) Lengths <or>25 ft.

EXTRACTS FROM THE BUILDING LAWS OF VARIOUS CITIES.

ALLOWABLE UNIT STRESSES FOR TIMBER.

(Revised to 1917.)

Pounds per Square Inch.

No.	City.	Compression.					
		Oak.		Yellow Pine.		White Pine.	
		With Grain.	Across Grain.	With Grain.	Across Grain.	With Grain.	Across Grain.
1	Atlanta.....	900	800	1000	600	800	400
2	Baltimore.....	1000	600	1000	600	800	400
3	Boston.....	810(e)	600(e)	900	500	630	250
4	Buffalo.....	800(c)		1000(g)		700	
5	Chicago.....	900	500	{ 1100(g,d) 800(f)	250(d)	700(c)	200(c)
6	Cincinnati.....	900	800	1000	600	800	400
7	Cleveland.....		300		350		300
8	Denver.....	800(c)		1000		700	
9	Detroit.....	1000		1250		875	
10	Hartford(q).....						
11	Jersey City.....	900	800	1000	600	800	400
12	Los Angeles(a).....						
13	Louisville.....	1000	600	1000	600	800	400
14	Milwaukee.....	1500(e)	500(e)	{ 1500(g) 1200(f)	{ 350(g) 300(f)	1100(d)	200(d)
15	Minneapolis.....	800(e)		1000(h)		700	
16	Newark, N. J.....	1100	800	1500	600	800	400
17	New Haven(a).....						
18	New Orleans.....				{ 400(f) 500(g)		
19	New York.....	1400	1000	1600(g)	1000(g)	1000(b,f)	800(b,f)
20	Philadelphia.....			750	550		
21	Pittsburgh(a).....						
22	Portland, Ore.....					900(l)	200(l)
23	Providence(a).....						
24	Rochester.....	900	800	1000	600	800	400
25	St. Louis(q).....						
26	St. Paul.....	1000	700	1100(h)	600(h)	900	400
27	San Francisco.....					800(l)	200(l)
28	Seattle.....						
29	Syracuse.....	900	800	{ 800(f,b) 1000(g)	{ 400(f,b) 600(g)	800	400
30	Washington.....	900	800	1000	600	800	400
31	Worcester(a).....						

(a) Based on best modern practice; (b) Applies also to North Carolina Pine; (c) Also for Norway Pine; (d) Also for Douglas Fir; (e) White Oak; (f) Shortleaf; (g) Longleaf; (h) Also for Washington or Oregon Fir; (i) Douglas or Yellow Fir only.

**EXTRACTS FROM THE BUILDING LAWS OF
VARIOUS CITIES.**

ALLOWABLE UNIT STRESSES FOR TIMBER.

(Revised to 1917.)

Pounds per Square Inch.

Compression.								No.
Spruce		Locust.		Hemlock.		Chestnut.		
With Grain	Across Grain	With Grain.	Across Grain.	With Grain.	Across Grain.	With Grain.	Across Grain.	
800	400	1200	1000	500	500	1
800(b,k)	400(b,k)	1200	1000	600	500	2
630	250	3
.....	700	4
.....	500	150	5
800	400	1200	1000	500	500	500	1000	6
.....	200	7
700	700	600(r)	8
950(n)	850(m)	750	9
.....	10
800	400	1800	1000	500	500	500	1000	11
.....	12
.....	600	500	600	1000	13
1100(o)	300(o)	1000(n)	250(n)	900	200	1100(m)	240(m)	14
1000	200	600	15
800	760(n)	16
800	400	1200	1000	600	500	500	1000	17
.....	18
.....	200(m)	19
1200(d)	800(d)	1200	1000	800	800	20
500	300	350	250	21
.....	22
1500(i)	400(i)	1200(j)	250(j)	23
.....	24
800	400	1200	1000	500	500	500	1000	25
.....	26
800	400	1200	1000	500	300	800	400	27
800	200	1600(i)	300(i)	900(j)	250(j)	28
800	300	1600(i)	400(i)	1400(p)	350(p)	29
800	400	600	300	30
800(k)	400(k)	1200	1000	500	1000	31
.....	31

(j) Red Fir only; (k) Also for Virginia Pine; (l) Also for Redwood; (m) Cypress only; (n) Norway Pine only; (o) Cedar; (p) Western Hemlock; (q) Building Laws being revised, 1917; (r) Colorado, Texas or Mexican Hemlock.

EXTRACTS FROM THE BUILDING LAWS OF VARIOUS CITIES.

ALLOWABLE UNIT STRESSES FOR TIMBER.

(Revised to 1917.)

Pounds per Square Inch.

No.	City.	Extreme Fibre Stress (Bending).						
		Yellow Pine.	White Pine.	Spruce.	Oak.	Locust.	Hemlock.	Chestnut.
1	Atlanta.....	1200	800	800	1000	1200	600	800
2	Baltimore.....	1800(l)	1000	1350(f)	1500	1000
3	Boston.....	1500(l)	1000	1000	1000(d)
4	Buffalo.....	1800(l)	1080(b)	1350	1080
5	Chicago.....	{ 1000(s) 1300(l,r)	800(b)	1200	600
6	Cincinnati.....	1200	800	800	1000	1200	600	800
7	Cleveland.....	1600	1250	1250	1000
8	Denver.....	1260(a)	1170(w)	720(v)
9	Detroit.....	1250	750	750	1000(d)	950(e)
10	Hartford(u).....
11	Jersey City....	1200	800	800	1000	1200	600	800
12	Los Angeles....	1620(c)	1260	1260	2160
13	Louisville.....	1200	1000	800
14	Milwaukee.....	{ 1500(s) 1800(l)	{ 1200(e) 1000	1000	1500(d)	1300(h)	700	1100(p)
15	Minneapolis....	1620(a)	1080(b)	1350	1080
16	Newark, N. J..	1500	800	800	1100	1200	600	800
17	New Haven.....	1800	1080	1260	1350	954
18	New Orleans....	{ 1200(s) 1500(l)	900(o)
19	New York.....	1600(l)	1200	1200(m)	1200	800	1000(s,g)
20	Philadelphia...	1600(l)	1100	900
21	Pittsburgh(k)..
22	Portland, Ore..	1600(h)	900	1000(i)	800(j)
23	Providence(k)..
24	Rochester.....	1200	800	800	1000	1200	600	800
25	St. Louis(u)....
26	St. Paul.....	1200(a)	800	800	1000	1200	600	800
27	San Francisco..	1200(h)	700	700	800(i)	750(j)
28	Seattle.....	1600(h)	1000	1400(t)
29	Syracuse.....	{ 800(s)(g) 1200(l)	700	800	1200	600
30	Washington....	1200	800(f)	800	1000	1200	800
31	Worcester(k)..

(a) Also for Washington and Oregon Fir; (b) Also for Norway Pine; (c) Oregon Pine only; (d) White Oak; (e) Norway Pine only; (f) Also for Virginia Pine; (g) Also for North Carolina Pine; (h) Douglas Oregon Yellow Fir only; (i) Washington or Red Fir only; (j) Redwood only; (k) Based on best modern practice;

**EXTRACTS FROM THE BUILDING LAWS OF
VARIOUS CITIES.**

ALLOWABLE UNIT STRESSES FOR TIMBER.

(Revised to 1917.)

Pounds per Square Inch.

Tension.					No.
Yellow Pine.	White Pine.	Spruce.	Oak.	Hemlock.	
1200	800	800	1000	600	1
1800(l)	1000	1200(f)	1500	800	2
.....					3
.....					4
{ 1000(s) 1300(l)(m)	800(b)	1200	600	5
1200	800	800	1000	600 (n)	6
.....					7
.....					8
.....					9
.....					10
1200	800	800	1000	600	11
.....					12
1200	1000	13
{ 1000(s) 1200(l) 1200(a)	700(q)	800(m)(b)	1200(d)	600(r)	14
.....	800	800	1000	15
1200	800	800	1000	600	16
.....					17
.....					18
{ 900(s) 1200(l) 1800(l)	700	800(m)	1200	600	19
.....	1250	1000	20
1300(h)	800	1000(i)	700(j)	21
.....					22
1200	800	800	1000	600	23
.....					24
.....					25
1200(a)	800	800	1000	600	26
1200(h)	700	700	1000(i)	700(j)	27
1600(h)	1000	1400(t)	28
{ 800(s) 1200(l)	800	800	1000	600	29
1200	800	800(f)	1000	30
.....					31

(l) Longleaf; (m) Also for Douglas Fir; (n) Also for Chestnut; (o) Cypress only; (p) Cypress and Cedar only; (q) Also for Cedar; (r) Also Cypress; (s) Shortleaf; (t) Western Hemlock; (u) Building Laws being revised, 1917; (v) Colorado or Mexican; (w) Also for Texas Pine, Spruce or Hemlock.

EXTRACTS FROM THE BUILDING LAWS OF VARIOUS CITIES.

ALLOWABLE UNIT STRESSES FOR TIMBER.

(Revised to 1917.)

Pounds per Square Inch.

No.	City.	Shear.					
		Yellow Pine.		White Pine.		Spruce.	
		With Fibre.	Across Fibre.	With Fibre.	Across Fibre.	With Fibre.	Across Fibre.
1	Atlanta.....	70	500	40	250	50	320
2	Baltimore.....	100(l)	500(l)	85	350	90	350
3	Boston.....	100(l)		80		80	
4	Buffalo(r).....						
5	Chicago.....	{ 120(s) 130(l)(c)		80(d)			
6	Cincinnati.....	70	500	40	250	40	250
7	Cleveland.....	150	500	100	400		
8	Denver(q).....						
9	Detroit.....	100(l)		80		80	
10	Hartford(q).....						
11	Jersey City.....	70	500	40	250	50	320
12	Los Angeles(e).....						
13	Louisville.....	80	400				
14	Milwaukee.....	{ 150(s)(c) 175(l)	{ 1000(s) 1250(l)	{ 120(n) 100	500	125	750
15	Minneapolis(r).....						
16	Newark, N. J.....	70	500	40	250	50	320
17	New Haven(e).....						
18	New Orleans.....	{ 65(s) 70(l)		50(f)			
19	New York.....	150(l)	1000(l)	100	500	100	500
20	Philadelphia.....	100(l)	1125			75	750
21	Pittsburgh(e).....						
22	Portland, Ore.....	150(g)	500(g)	100	500	100(h)	600(h)
23	Providence(e).....						
24	Rochester.....	70	500	40	250	50	320
25	St. Louis(q).....						
26	St. Paul.....	70(j)	500(j)	50	250	50	320
27	San Francisco.....	150(g)	750(g)	100	500	100	500
28	Seattle.....	200(g)				130	
29	Syracuse.....	{ 50(s) 70(l)	{ 300(s) 500(l)	50	300	50	300
30	Washington.....	70	500	40	250	50(k)	320(k)
31	Worcester(e).....						

(a) Virginia Pine only; (b) White Oak; (c) Also for Douglas Fir; (d) Also for Norway Pine; (e) Based upon best modern practice; (f) Cypress only; (g) Douglas or Yellow Fir only; (h) Red Fir only;

**EXTRACTS FROM THE BUILDING LAWS OF
VARIOUS CITIES.**

ALLOWABLE UNIT STRESSES FOR TIMBER.

(Revised to 1917.)

Pounds per Square Inch.

Shear.							No.
Oak.		Locust		Hemlock.		Chestnut.	
With Fibre.	Across Fibre.	With Fibre.	Across Fibre.	With Fibre.	Across Fibre.	Across Fibre.	
100	600	100	720	40	275	150	1
100	720	90(a)	400(a)	75	350	150	2
150(b)							3
							4
200				60			5
100	600	100	720	40	270	150	6
100	400			80	300		7
							8
150(b)		90(n)					9
							10
100	600	100	720	40	275	150	11
80	400						12
240(b)	1000(b)	100(m)	400(m)	100(o)	600		13
							14
							15
100	600	100	720	40	275	150	16
							17
							18
200	1000(c) (s)			100	600		19
				63	625		20
							21
80(i)	400(i)						22
							23
100	600	100	720	40	275	150	24
							25
100	600	100	720	40	275	150	26
125(h)	600(h)	100(i)	400(i)				27
				180(p)			28
100	600			35	250		29
100	600	100	720				30
							31

(i) Redwood only; (j) Also for Washington Fir; (k) Also for Virginia Pine; (l) Longleaf; (s) Shortleaf; (m) Cedar only; (n) Norway Pine only; (o) Also for Cypress; (p) Western Hemlock; (q) Building Laws being revised, 1917. (r) Do not specify.

EXTRACTS FROM THE BUILDING LAWS OF VARIOUS CITIES.

ALLOWABLE UNIT STRESSES FOR TIMBER.

(Revised to 1917.)

Pounds per Square Inch.

No.	City.	Columns.					
		Longleaf Yellow Pine.	White Pine, Norway Pine and Spruce.	Oak.	Chestnut and Hemlock.	Locust.	Maximum Length L =
1	Atlanta.....	(A)	(B)	(I)	$\frac{5}{8}$ (B)	$1\frac{1}{2}$ (B)	30 D
2	Baltimore....	$\left\{ \begin{array}{l} <12D \text{ (C)} \\ >" \text{ (E)} \end{array} \right.$	$\left\{ \begin{array}{l} <12D \text{ (C)} \\ >" \text{ (E)} \end{array} \right.$	$\left\{ \begin{array}{l} <12D \text{ (C)} \\ >" \text{ (E)} \end{array} \right.$	$\left\{ \begin{array}{l} <12D \text{ (C)} \\ >" \text{ (E)} \end{array} \right.$	$\left\{ \begin{array}{l} <12D \text{ (C)} \\ >" \text{ (E)} \end{array} \right.$
3	Boston.....	(F)	(G)	(H)			30 D
4	Buffalo.....	$\left\{ \begin{array}{l} <12D-1000 \\ >" \text{ (F)} \end{array} \right.$	$\left\{ \begin{array}{l} <12D-700 \\ >" \text{ (J)(b)} \end{array} \right.$	$\left\{ \begin{array}{l} <12D-800 \\ >" \text{ (K)(a)} \end{array} \right.$	$\left\{ \begin{array}{l} <12D-700 \\ >" \text{ (J)(c)} \end{array} \right.$	
5	Chicago.....	(M)	(M)	(M)	(M) (c)		30 D
6	Cincinnati....	$\left\{ \begin{array}{l} <12D-1000 \\ >" \text{ (F)} \end{array} \right.$	$\left\{ \begin{array}{l} <12D-700 \\ >" \text{ (J)} \end{array} \right.$	$\left\{ \begin{array}{l} <12D-800 \\ >" \text{ (K)} \end{array} \right.$			180 R
7	Cleveland(m)	(u)	(u)	(u)	(u)		150 R
8	Denver....	$\left\{ \begin{array}{l} <12D-1000 \\ \text{ (O)} \end{array} \right.$	$\left\{ \begin{array}{l} <12D-700 \\ \text{ (O)} \end{array} \right.$	$\left\{ \begin{array}{l} <12D-800 \\ \text{ (O)} \end{array} \right.$	$\left\{ \begin{array}{l} <12D-700 \text{ (e)} \\ \text{ (O)} \end{array} \right.$	$\left\{ \begin{array}{l} <12D-600 \text{ (v)} \\ \text{ (O)} \end{array} \right.$
9	Detroit.....	$\left\{ \begin{array}{l} <12D-1250 \\ >" \text{ (F)} \end{array} \right.$	$\left\{ \begin{array}{l} <10D-875 \\ >" \text{ (J)(d)} \end{array} \right.$	$\left\{ \begin{array}{l} <10D-1000 \\ >" \text{ (K)(a)} \end{array} \right.$			24 D
10	Hartford(m)..					
11	Jersey City...	(A)	(B)	(I)	$\frac{5}{8}$ (B)	$1\frac{1}{2}$ (B)	30 D
12	Los Angeles (l)					
13	Louisville....	$\left\{ \begin{array}{l} <12D-1000 \\ >" \text{ (F)} \end{array} \right.$		$\left\{ \begin{array}{l} <12D-1000 \\ >" \text{ (F)} \end{array} \right.$			120 R
14	Milwaukee....	$\left\{ \begin{array}{l} <15D-1125 \\ >" \text{ (T)(k)} \end{array} \right.$	$\left\{ \begin{array}{l} <15D-825 \text{ i} \\ >" \text{ (T)(b)} \end{array} \right.$	$\left\{ \begin{array}{l} <15D-1125 \\ >" \text{ (T)} \end{array} \right.$	$\left\{ \begin{array}{l} <15D-675 \\ >" \text{ (T)(c)} \end{array} \right.$	$\left\{ \begin{array}{l} <15D-750 \text{ j} \\ >" \text{ (T)} \end{array} \right.$	30 D
15	Minneapolis..	$\left\{ \begin{array}{l} <12D-1000 \\ >" \text{ (F)(e)} \end{array} \right.$	$\left\{ \begin{array}{l} <12D-700 \\ >" \text{ (J)(b)} \end{array} \right.$	$\left\{ \begin{array}{l} <12D-800 \\ >" \text{ (K)(a)} \end{array} \right.$	$\left\{ \begin{array}{l} <12D-600 \\ >" \text{ (J)(c)} \end{array} \right.$	
16	Newark, N. J.	(A)	(B)	(I)	$\frac{5}{8}$ (B)	$1\frac{1}{2}$ (B)	30 D

L = Length of column in inches; D = Diameter or least dimension of column in inches; R = Least radius of gyration in inches; C = Allowable compressive unit stress (with grain) for that wood.

(a) Also for Norway Pine; (b) White Pine only; (c) Hemlock only; (d) White Pine and Spruce only; (e) Also for Washington and Oregon Fir; (f) Spruce only; (g) Oregon Pine only; (h) White Pine and Virginia Pine only; (i) Also Douglas

FORMULÆ:—

$(A) 1000 - 18 \frac{L}{D}$	$(E) C - 125 \frac{L}{12D}$	$(H) 900 - 9 \frac{L}{D}$
$(B) 800 - 15 \frac{L}{D}$	$(G) 700 - 7 \frac{L}{D}$	$(I) 900 - 17 \frac{L}{D}$
		$(J) 625 - 6 \frac{L}{D}$

**EXTRACTS FROM THE BUILDING LAWS OF
VARIOUS CITIES.**

ALLOWABLE UNIT STRESSES FOR TIMBER.

(Revised to 1917.)

Pounds per Square Inch.

No.	City.	Columns.					Maximum Length L =
		Longleaf Yellow Pine.	White Pine, Norway Pine and Spruce.	Oak.	Chestnut and Hemlock.	Locust.	
17	New Haven.....	1000 (N)	{ 700(b) 800(f) (N)	900(N)
18	New Orleans.....	(F)	(V) (k)	(U) (t)	30 D
19	New York.....	(W)	(l)	(W)	30 D
20	Philadelphia....	(O)	(O)	(O)	(O)	(O)
21	Pittsburgh(l)....
22	Portland, Ore....	(P)	(P)	(P)	(P)	(P)	20 D
23	Providence(l)....	20 D
24	Rochester.....	(A)	(B)	(I)	5/8 (B)	1 1/2 (B)	30 D
25	St. Louis.....
26	St. Paul.....	(M)	(M)	(M)	(M)	(M)
27	San Francisco... >15D(Q)(g)
28	Seattle.....	(P)	(P)	(P)	(P)	(P)	24 D
29	Syracuse.....	{ 3/4(A)(s) (A)	(B)	(I)	(S) (c)	30 D
30	Washington.....	(A)	(B) (h)	(I)	(A)	30 D
31	Worcester(l)....

L = Length of column in inches; D = Diameter or least dimension of column in inches; R = Least radius of gyration in inches; C = Allowable compressive unit stress (with grain) for that wood.

Fir, Cypress and Cedar; (j) For Norway Pine, Spruce and Eastern Fir only; (k) Shortleaf; (< 15D = 900); (l) Based on best modern practice; (s) Shortleaf; (t) Cypress only; (u) See Building Laws; (v) Colorado, Texas or Mexican Hemlock.

(K) $750 - 7.5 \frac{L}{D}$ (P) $C \left(1 - \frac{L}{70D}\right)$ (U) $450 - 5 \frac{L}{D}$

(M) $C \left(1 - \frac{L}{80D}\right)$ (Q) $1300 - 20 \frac{L}{D}$ (V) $815 - 8 \frac{L}{D}$

(N) Coefficients to apply to Gordon's Formula. (S) $500 - 9 \frac{L}{D}$ (W) $1200 - 20 \frac{L}{D}$

(O) $C \left(1 - \frac{L}{100D}\right)$ (T) $C \left(1 - \frac{L}{60D}\right)$

EXTRACTS FROM THE BUILDING LAWS OF VARIOUS CITIES.

Allowable Unit Stresses for Reinforced Concrete.

(Revised to 1917.)

Pounds per Square Inch.

No.	City.	Concrete Mixture.	Ratio Moduli or Elasticity Steel to Concrete.	Concrete—Allowable Unit Stresses.					
				Compression.			Shear.	Tension.	Bond.
				Direct.	Extreme Fibre Bending	In Hooped Columns			
2	Baltimore.....	1 : 2 : 4	15	{500(b) 500	500	1200(ff)	50	60
3	Boston.....	1 : 5 (h)	15	500	60	60
4	Buffalo.....	1 : 2 : 5	12	350	500	50	50
5	Chicago.....	1 : 2 : 4	15	400	700	{500 (l) 500(d)	40	40(w)	{50(x) 70(y)
6	Cincinnati.....	1 : 2 : 4	15	600	700	(z)	65
7	Cleveland.....	1 : 2 : 4	15	500	700	650 (j)	40	40(w)	{70 50 m
8	Denver.....	1 : 2 : 3	15	450	500	50	75
9	Detroit.....	{1 : 1½ : 3t 1 : 2 : 4	{12 15	450	650	{(z) 800 (l)	40	{80 100(q)
11	Jersey City....	1 : 2 : 4	18	350	500	(z)	50	50
12	Los Angeles....	1:2½:3½	15	650	800	{40 120(n)	{80(y) 120(q)
13	Louisville.....	1 : 2 : 4	15	{450(b) 650	650	{650 d,l 540	50
14	Milwaukee....	1 : 2 : 4	15	500(b)	700	{800(d) 600 600 (l)	{120(n) 60 cc 40 bb	{40aa 80
15	Minneapolis....	1 : 2 : 4	{10 15	600 dd	650	{800ee 1830 ff	50	{100(q) 75(u)
16	Newark, N. J..	1 : 2 : 4	15	450(b)	650	{650(d) 540	40	40
18	New Orleans....	15	500 (r)	650 (r)	50 (r)	50
19	New York.....	1 : 6 (h)	15	500	650	725	{40 150(n)	{100(q) 80
20	Philadelphia....	1 : 2 : 4	15	500	650	750	{120(n) 40	{100(q) 80
21	Pittsburgh....	1 : 6 (h)	{8gg 15	500	650	{540(ff) 450	120	90(w)	80
24	Rochester.....	1 : 6 (h)	15	{450(b) 650	650	{540 (l) 650	60	{150(p) 80
25	St. Louis.....	1 : 6 (h)	{20(ii) 15	{300(ii) 500	{400(ii) 800	500	{100(ii) 175	65
26	St. Paul.....	1 : 2 : 4	15	500(b)	650	750(d)	50	{80(q) 50
27	San Francisco..	1 : 6 (h)	15	500	500	700	75	60
28	Seattle.....	1 : 2 : 4	15	450	667	500 (j)	{120(n) 60cc	{50(x) 70(y)
30	Washington....	1 : 2 : 4	15	{120(c) 450	{150(c) 650	60	50

(b) Columns not hooped; (c) Cinder-Concrete; (d) Vertical bars with hoops; (e) Actual compression in concrete surrounding steel; (f) Floor slabs; (g) Girders and beams; (h) Cement; aggregate; (i) Pure shear; (j) Spiral reinforcement; (k) Minimum area, gross section; (l) Structural steel units encasing concrete; (m) High carbon steel; (n) Where thoroughly reinforced for shear; (o) Without sign or crack; (p) Where adequate mechanical bond is provided; (q) Deformed bars; (r) Rock or gravel concrete; (s) Slag concrete;

EXTRACTS FROM THE BUILDING LAWS OF VARIOUS CITIES.

Allowable Unit Stresses for Reinforced Concrete.

(Revised to 1917.)

Pounds per Square Inch.

Steel—Allowable Unit Stresses.				Columns.			Tests.		No.
Tension.	Compression.	Compression Vertical Reinforcement in Columns	Shear.	Maximum Length $\frac{L}{D}$	Minimum Allow- able Dimen- sion Inches.	Actual less Effective Diam. — Inches.	Ratio Test to Calcu- lated Load.	Ratio Span to Maximum Deflection.	
{ 12000 (v) 15000 16000	{ 8000v 7500	{ 8000v 10000	16	3	2
16000	3	3
16000	10000	16	3	4
18000	10500	7500	12000	12	64(k)	3	2	800	5
16000	16000	10000	32(z)	2	4	6
{ 18000(m) 16000	{ 16000(l)	{ 9750(j) 7500	{ 10000w	15	4	7
$\frac{1}{2}$ (hh)	10000	15	2	2	700	8
{ 18000m,q 16000	{ 15×(e) 16000	{ (z) 12000 (l)	15	10	4	2	400	9
16000	16000	6000	12	2	11
16000	15×(e)	(ff)	30	7	3	2	12
16000	16000	15	3	4	13
16000	10500	{ 12000(d) 7500(b)	15	64(k)	3	2(o)	14
{ 20000(m) 16000	{ 8000- 12000	{ 8000 dd 10000 ee	10000	15	12	3	2	{ 1000 g 300(f)	15
{ 20000(m) 16000	{ 8100(d) 6750(b)	15	4	16
16000	10000	4	18
{ 20000(aa) 16000	16000	7500	15	12	4	1 $\frac{3}{4}$	19
16000	16000	{ 6000 9000(d) 16000 (l)	15	12	4	2(o)	20
16000	7500	{ 6750 8100(ff)	4500	15	9	3	2	21
{ 20000(m) 16000	9750	{ 9750(d) 6750(b)	15	3	24
{ 20000(m) 14000	{ 20000m 14000	15	2	25
{ 20000(m) 16000	{ 8000- 12000	{ 7500(b) 10000(d)	10000	15	12	4	2	{ 100 gg 300(f)	26
20000	7500	(ff)	10000	15	10	4	2	700	27
18000	{ 7500 (j) 6750	12000	15	8	3	2	700	28
16000	14000	10000	15	50(k)	4	30

(t) For columns; (u) Bars $\frac{3}{4}$ inch or less; larger bars, proportionately less; (v) Soft steel; (w) Diagonal tension; (x) Flat bars with size ratio less than 2, and high carbon rounds and squares; (y) Structural steel rounds and squares; (z) For hooped columns, see Building Laws; (aa) Cold drawn material as wire; (bb) Horizontal bars; (cc) Bent up bars; (dd) Square columns; (ee) Round core columns; (ff) Special cases, see Building Laws; (gg) For calculating deflections; (hh) Elastic limit; (ii) Burnt clay concrete.

EXPLANATION OF TABLES OF RIVETS AND PINS.**RIVETS.**

In the design of riveted joints the total stress transmitted is assumed to be taken up by the rivets, no allowance being made for the friction between the plates riveted together, and the manner of failure of the joint will be by shearing of the rivet or crushing of the plate. This assumes that the rules given on page 358 are followed and failure by tearing off the plate caused by the rivets being too near the edge is thus prevented.

In the table of "Shearing Value of Rivets and Bearing Value of Riveted Plates," pages 352 and 353, these values are given for all customary sizes and thicknesses corresponding to various usual allowable unit stresses.

For any given size of rivet or thickness of plate to be used, an inspection of the table will show at once if the bearing value of the plate or the shearing value of the rivet is to govern the design and the amount of stress that can be transmitted by each rivet.

PINS.

In designing pin-connected joints the points which govern the design are the bending moments produced in the pin by the bars or plates connected, and the bearing value of the plates themselves. The bearing value in the case of eye-bars of proper proportions is sufficiently ample and need not be computed. Shear in pins need not ordinarily be considered, as the bending and bearing stresses usually determine the size.

In the table of "Maximum Bending Moments on Pins," pages 360 and 361, is given the allowable bending moments on pins of various diameters for the usual allowable fibre stresses.

In the table of "Bearing Values of Pin Plates for One-Inch Thickness of Plate," on page 359, is given the allowable bearing values of plates against pins of various usual diameters, corresponding to the customary unit stresses of this character.

If the bearing value exceeds the allowable limit in any given case pin-plates must be added, thus increasing the bearing value until it is reduced to a safe limit as shown by the tables.

CONVENTIONAL SIGNS FOR RIVETING.

	SHOP	FIELD	
Two Full Heads.			
Countersunk Inside (Farside) and Chipped.			
Countersunk Outside (Nearside) and Chipped.			
Countersunk both Sides and Chipped.			
	INSIDE. (FARSIDE.)	OUTSIDE. (NEARSIDE.)	BOTH SIDES.
Flattened to $\frac{1}{8}$" high or Countersunk and not Chipped.			
Flattened to $\frac{1}{4}$" high.			
Flattened to $\frac{3}{8}$" high.			

This system, designed by F. C. Osborn, C. E., has for foundation the diagonal cross to represent a countersink, the blackened circle for a field rivet and the diagonal stroke to indicate a flattened head. The position of the cross, with respect to the circle (inside, outside or both sides), indicates the location of the countersink and, similarly, the number and position of the diagonal strokes indicate the height and position of the flattened heads.

Any combination of field, countersunk and flattened head rivets liable to occur may be readily indicated by the proper combination of above signs.

SHEARING VALUE OF RIVETS AND BEARING VALUE OF RIVETED PLATES.

All Dimensions in Inches.

Shearing Value = Area of Rivet × Allowable Shearing Stress per Square Inch.

Diameter of Rivet.	Area in Square Inches.	Unit Stress = 6 000 lbs.		Bearing Value for Different			
		Single Shear.	Double Shear.	$\frac{1}{4}$	$\frac{5}{16}$	$\frac{3}{8}$	$\frac{7}{16}$
$\frac{3}{8}$.1105	663	1325	1125	1406	1688	
$\frac{1}{2}$.1964	1178	2356	1500	1875	2250	2625
$\frac{5}{8}$.3068	1841	3682	1875	2344	2813	3281
$\frac{3}{4}$.4418	2651	5301	2250	2813	3375	3938
$\frac{7}{8}$.6013	3608	7216	2625	3281	3938	4594
1	.7854	4712	9425	3000	3750	4500	5250

Diameter of Rivet.	Area in Square Inches.	Unit Stress = 8 000 lbs.		Bearing Value for Different			
		Single Shear.	Double Shear.	$\frac{1}{4}$	$\frac{5}{16}$	$\frac{3}{8}$	$\frac{7}{16}$
$\frac{3}{8}$.1105	884	1767	1500	1875	2250	
$\frac{1}{2}$.1964	1571	3142	2000	2500	3000	3500
$\frac{5}{8}$.3068	2454	4909	2500	3125	3750	4375
$\frac{3}{4}$.4418	3534	7069	3000	3750	4500	5250
$\frac{7}{8}$.6013	4811	9621	3500	4375	5250	6125
1	.7854	6283	12566	4000	5000	6000	7000

Diameter of Rivet.	Area in Square Inches.	Unit Stress = 10 000 lbs.		Bearing Value for Different			
		Single Shear.	Double Shear.	$\frac{1}{4}$	$\frac{5}{16}$	$\frac{3}{8}$	$\frac{7}{16}$
$\frac{3}{8}$.1105	1105	2209	1875	2344	2813	
$\frac{1}{2}$.1964	1964	3927	2500	3125	3750	4375
$\frac{5}{8}$.3068	3068	6136	3125	3906	4688	5469
$\frac{3}{4}$.4418	4418	8836	3750	4688	5625	6563
$\frac{7}{8}$.6013	6013	12026	4375	5469	6563	7656
1	.7854	7854	15708	5000	6250	7500	8750

Diameter of Rivet.	Area in Square Inches.	Unit Stress = 12 000 lbs.		Bearing Value for Different			
		Single Shear.	Double Shear.	$\frac{1}{4}$	$\frac{5}{16}$	$\frac{3}{8}$	$\frac{7}{16}$
$\frac{3}{8}$.1105	1325	2651	2250	2813	3375	
$\frac{1}{2}$.1964	2356	4712	3000	3750	4500	5220
$\frac{5}{8}$.3068	3682	7363	3750	4688	5625	6562
$\frac{3}{4}$.4418	5301	10603	4500	5625	6750	7875
$\frac{7}{8}$.6013	7216	14432	5250	6563	7875	9187
1	.7854	9425	18850	6000	7500	9000	10500

In the above tables the bearing values between the lower and upper zigzag black lines are greater than single and less than double shear for the corresponding dimensions, so that in case of single shear, the single shearing value governs, and in case of double shear, the bearing value governs the design.

SHEARING VALUE OF RIVETS AND BEARING VALUE OF RIVETED PLATES.

All Dimensions in Inches.

Bearing Value = Diameter of Rivet × Thickness of Plate × Allowable Bearing
Stress per Square Inch.

Thicknesses of Plate in Inches at 12 000 Pounds per Square Inch.

$\frac{1}{2}$	$\frac{9}{16}$	$\frac{5}{8}$	$\frac{11}{16}$	$\frac{3}{4}$	$\frac{13}{16}$	$\frac{7}{8}$	$\frac{15}{16}$	1
3000								
3750	4219	4688						
4500	5063	5625	6188	6750				
5250	5906	6563	7219	7875	8531	9188	9844	
6000	6750	7500	8250	9000	9750	10500	11250	12000

Thicknesses of Plate in Inches at 16 000 Pounds per Square Inch.

$\frac{1}{2}$	$\frac{9}{16}$	$\frac{5}{8}$	$\frac{11}{16}$	$\frac{3}{4}$	$\frac{13}{16}$	$\frac{7}{8}$	$\frac{15}{16}$	1
4000								
5000	5625	6250						
6000	6750	7500	8250	9000				
7000	7875	8750	9625	10500	11375	12250	13125	
8000	9000	10000	11000	12000	13000	14000	15000	16000

Thicknesses of Plate in Inches at 20 000 Pounds per Square Inch.

$\frac{1}{2}$	$\frac{9}{16}$	$\frac{5}{8}$	$\frac{11}{16}$	$\frac{3}{4}$	$\frac{13}{16}$	$\frac{7}{8}$	$\frac{15}{16}$	1
5000								
6250	7031	7813						
7500	8438	9375	10313	11250				
8750	9844	10938	12031	13125	14219	15313	16406	
10000	11250	12500	13750	15000	16250	17500	18750	20000

Thicknesses of Plate in Inches at 24 000 Pounds per Square Inch.

$\frac{1}{2}$	$\frac{9}{16}$	$\frac{5}{8}$	$\frac{11}{16}$	$\frac{3}{4}$	$\frac{13}{16}$	$\frac{7}{8}$	$\frac{15}{16}$	1
6000								
7500	8437	9375						
9000	10125	11250	12375	13500				
10500	11812	13125	14437	15750	17062	18375	19687	
12000	13500	15000	16500	18000	19500	21000	22500	24000

The bearing values above and to the right of the upper zigzag black lines are greater than double shear for the corresponding dimensions, so that in these cases the shearing values govern the design.

The bearing values below and to the left of the lower zigzag black lines are less than single shear, so that in these cases the bearing values govern the design.

LENGTH OF RIVETS REQUIRED FOR VARIOUS GRIPS INCLUDING AMOUNT NECESSARY TO FORM ONE HEAD.

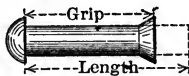

Grip of Rivet in Inches.	Diameter of Rivet in Inches.							
	$\frac{1}{4}$ "	$\frac{3}{8}$ "	$\frac{1}{2}$ "	$\frac{5}{8}$ "	$\frac{3}{4}$ "	$\frac{7}{8}$ "	1"	$1\frac{1}{8}$ "
$\frac{1}{2}$	1	$1\frac{1}{4}$	$1\frac{1}{2}$	$1\frac{3}{4}$	$1\frac{7}{8}$	2	$2\frac{1}{8}$	$2\frac{1}{4}$
$\frac{5}{8}$	$1\frac{1}{8}$	$1\frac{3}{8}$	$1\frac{5}{8}$	$1\frac{7}{8}$	2	$2\frac{1}{8}$	$2\frac{1}{4}$	$2\frac{3}{8}$
$\frac{3}{4}$	$1\frac{1}{4}$	$1\frac{1}{2}$	$1\frac{3}{4}$	2	$2\frac{1}{8}$	$2\frac{1}{4}$	$2\frac{3}{8}$	$2\frac{1}{2}$
$\frac{7}{8}$	$1\frac{3}{8}$	$1\frac{5}{8}$	$1\frac{7}{8}$	$2\frac{1}{8}$	$2\frac{1}{4}$	$2\frac{3}{8}$	$2\frac{1}{2}$	$2\frac{5}{8}$
1	$1\frac{1}{2}$	$1\frac{3}{4}$	2	$2\frac{1}{4}$	$2\frac{3}{8}$	$2\frac{1}{2}$	$2\frac{5}{8}$	$2\frac{3}{4}$
$1\frac{1}{8}$	$1\frac{5}{8}$	$1\frac{7}{8}$	$2\frac{1}{8}$	$2\frac{3}{8}$	$2\frac{1}{2}$	$2\frac{5}{8}$	$2\frac{3}{4}$	$2\frac{7}{8}$
$1\frac{1}{4}$	$1\frac{3}{4}$	2	$2\frac{1}{4}$	$2\frac{1}{2}$	$2\frac{3}{8}$	$2\frac{1}{2}$	$2\frac{3}{4}$	3
$1\frac{1}{2}$	$1\frac{7}{8}$	$2\frac{1}{8}$	$2\frac{1}{4}$	$2\frac{3}{8}$	$2\frac{1}{2}$	3	$3\frac{1}{8}$	$3\frac{1}{8}$
$1\frac{5}{8}$	$1\frac{7}{8}$	$2\frac{1}{8}$	$2\frac{1}{4}$	$2\frac{3}{8}$	$2\frac{1}{2}$	3	3	$3\frac{1}{8}$
$1\frac{1}{2}$	2	$2\frac{1}{4}$	$2\frac{1}{4}$	$2\frac{3}{4}$	3	$3\frac{1}{8}$	$3\frac{1}{8}$	$3\frac{1}{4}$
$1\frac{5}{8}$	$2\frac{1}{8}$	$2\frac{3}{8}$	$2\frac{1}{2}$	$2\frac{3}{8}$	$3\frac{1}{8}$	$3\frac{1}{4}$	$3\frac{1}{4}$	$3\frac{1}{2}$
$1\frac{3}{4}$	$2\frac{1}{4}$	$2\frac{1}{2}$	$2\frac{3}{4}$	3	$3\frac{1}{4}$	$3\frac{3}{8}$	$3\frac{1}{2}$	$3\frac{3}{8}$
$1\frac{7}{8}$	$2\frac{3}{8}$	$2\frac{5}{8}$	$2\frac{1}{2}$	$3\frac{1}{4}$	$3\frac{3}{8}$	$3\frac{1}{2}$	$3\frac{3}{8}$	$3\frac{3}{4}$
2	$2\frac{1}{2}$	$2\frac{3}{4}$	$3\frac{1}{8}$	$3\frac{3}{8}$	$3\frac{1}{2}$	$3\frac{3}{8}$	$3\frac{3}{4}$	$3\frac{3}{8}$
$2\frac{1}{8}$	$2\frac{5}{8}$	$2\frac{7}{8}$	$3\frac{1}{4}$	$3\frac{1}{2}$	$3\frac{3}{8}$	$3\frac{3}{4}$	$3\frac{3}{4}$	4
$2\frac{1}{4}$	$2\frac{3}{4}$	3	$3\frac{3}{8}$	$3\frac{3}{8}$	$3\frac{3}{4}$	$3\frac{7}{8}$	4	$4\frac{1}{8}$
$2\frac{3}{8}$	$2\frac{7}{8}$	$3\frac{1}{8}$	$3\frac{1}{2}$	$3\frac{3}{4}$	$3\frac{7}{8}$	4	$4\frac{1}{8}$	$4\frac{1}{4}$
$2\frac{1}{2}$	3	$3\frac{1}{4}$	$3\frac{3}{8}$	$3\frac{3}{4}$	4	$4\frac{1}{8}$	$4\frac{1}{4}$	$4\frac{3}{8}$
$2\frac{5}{8}$	$3\frac{1}{8}$	$3\frac{1}{2}$	$3\frac{3}{4}$	4	$4\frac{1}{8}$	$4\frac{1}{4}$	$4\frac{3}{8}$	$4\frac{1}{2}$
$2\frac{3}{4}$	$3\frac{1}{4}$	$3\frac{3}{8}$	$3\frac{3}{8}$	$4\frac{1}{8}$	$4\frac{1}{4}$	$4\frac{3}{8}$	$4\frac{1}{2}$	$4\frac{3}{8}$
$2\frac{7}{8}$	$3\frac{3}{8}$	$3\frac{3}{4}$	4	$4\frac{1}{4}$	$4\frac{3}{8}$	$4\frac{1}{2}$	$4\frac{3}{4}$	$4\frac{3}{4}$
3	$3\frac{1}{2}$	$3\frac{7}{8}$	$4\frac{1}{8}$	$4\frac{3}{8}$	$4\frac{1}{2}$	$4\frac{5}{8}$	$4\frac{3}{4}$	$4\frac{7}{8}$
$3\frac{1}{8}$	$3\frac{5}{8}$	4	$4\frac{1}{4}$	$4\frac{1}{2}$	$4\frac{3}{4}$	$4\frac{3}{4}$	5	5
$3\frac{1}{4}$	$3\frac{3}{4}$	$4\frac{1}{8}$	$4\frac{3}{8}$	$4\frac{3}{4}$	$4\frac{7}{8}$	5	$5\frac{1}{8}$	$5\frac{1}{4}$
$3\frac{3}{8}$	$3\frac{7}{8}$	$4\frac{1}{4}$	$4\frac{1}{2}$	$4\frac{3}{4}$	5	$5\frac{1}{8}$	$5\frac{1}{4}$	$5\frac{3}{8}$
$3\frac{1}{2}$	4	$4\frac{3}{8}$	$4\frac{5}{8}$	5	$5\frac{1}{8}$	$5\frac{1}{4}$	$5\frac{3}{8}$	$5\frac{1}{2}$
$3\frac{5}{8}$	$4\frac{1}{8}$	$4\frac{1}{2}$	$4\frac{3}{4}$	$5\frac{1}{8}$	$5\frac{1}{4}$	$5\frac{3}{8}$	$5\frac{1}{2}$	$5\frac{5}{8}$
$3\frac{3}{4}$	$4\frac{1}{4}$	$4\frac{3}{8}$	$4\frac{1}{8}$	$5\frac{1}{4}$	$5\frac{3}{8}$	$5\frac{1}{2}$	$5\frac{5}{8}$	$5\frac{3}{4}$
$3\frac{7}{8}$	$4\frac{3}{8}$	$4\frac{3}{4}$	5	$5\frac{3}{8}$	$5\frac{1}{2}$	$5\frac{5}{8}$	$5\frac{3}{4}$	$5\frac{7}{8}$
4	$4\frac{1}{2}$	$4\frac{7}{8}$	$5\frac{1}{8}$	$5\frac{1}{2}$	$5\frac{5}{8}$	$5\frac{3}{4}$	$5\frac{7}{8}$	6
$4\frac{1}{8}$	$4\frac{3}{8}$	5	$5\frac{1}{4}$	$5\frac{5}{8}$	$5\frac{3}{4}$	$5\frac{7}{8}$	6	$6\frac{1}{8}$
$4\frac{1}{4}$	$4\frac{3}{4}$	$5\frac{1}{8}$	$5\frac{1}{2}$	$5\frac{3}{4}$	$5\frac{7}{8}$	6	$6\frac{1}{8}$	$6\frac{1}{4}$
$4\frac{3}{8}$	$4\frac{7}{8}$	$5\frac{1}{4}$	$5\frac{5}{8}$	$5\frac{7}{8}$	6	$6\frac{1}{8}$	$6\frac{1}{4}$	$6\frac{3}{8}$
$4\frac{1}{2}$	5	$5\frac{3}{8}$	$5\frac{3}{4}$	6	$6\frac{1}{8}$	$6\frac{1}{4}$	$6\frac{3}{8}$	$6\frac{1}{2}$
$4\frac{5}{8}$	$5\frac{1}{8}$	$5\frac{1}{2}$	$5\frac{7}{8}$	$6\frac{1}{8}$	$6\frac{1}{4}$	$6\frac{3}{8}$	$6\frac{1}{2}$	$6\frac{5}{8}$
$4\frac{3}{4}$	$5\frac{1}{4}$	$5\frac{5}{8}$	6	$6\frac{1}{4}$	$6\frac{1}{2}$	$6\frac{5}{8}$	$6\frac{3}{4}$	$6\frac{3}{4}$
$4\frac{7}{8}$	$5\frac{3}{8}$	$5\frac{3}{4}$	$6\frac{1}{8}$	$6\frac{1}{2}$	$6\frac{3}{8}$	$6\frac{3}{4}$	$6\frac{7}{8}$	$6\frac{7}{8}$
5	$5\frac{1}{2}$	$5\frac{7}{8}$	$6\frac{1}{4}$	$6\frac{5}{8}$	$6\frac{3}{4}$	$6\frac{7}{8}$	7	7
$5\frac{1}{8}$	$5\frac{5}{8}$	6	$6\frac{3}{8}$	$6\frac{3}{4}$	$6\frac{7}{8}$	7	$7\frac{1}{8}$	$7\frac{1}{8}$
$5\frac{1}{4}$	$5\frac{3}{4}$	$6\frac{1}{8}$	$6\frac{1}{2}$	$6\frac{7}{8}$	7	$7\frac{1}{8}$	$7\frac{1}{4}$	$7\frac{1}{4}$
$5\frac{3}{8}$	$5\frac{7}{8}$	$6\frac{1}{4}$	$6\frac{5}{8}$	7	$7\frac{1}{8}$	$7\frac{1}{4}$	$7\frac{3}{8}$	$7\frac{3}{8}$
$5\frac{1}{2}$	6	$6\frac{3}{8}$	$6\frac{3}{4}$	$7\frac{1}{8}$	$7\frac{1}{4}$	$7\frac{3}{8}$	$7\frac{1}{2}$	$7\frac{1}{2}$
$5\frac{5}{8}$	$6\frac{1}{8}$	$6\frac{1}{2}$	$6\frac{7}{8}$	$7\frac{1}{4}$	$7\frac{1}{2}$	$7\frac{3}{4}$	$7\frac{5}{8}$	$7\frac{5}{8}$
$5\frac{3}{4}$	$6\frac{1}{4}$	$6\frac{3}{4}$	7	$7\frac{3}{8}$	$7\frac{3}{8}$	$7\frac{5}{8}$	$7\frac{3}{4}$	$7\frac{3}{4}$
$5\frac{7}{8}$	$6\frac{3}{8}$	$6\frac{7}{8}$	$7\frac{1}{8}$	$7\frac{1}{2}$	$7\frac{3}{4}$	$7\frac{3}{4}$	$7\frac{7}{8}$	$7\frac{7}{8}$
6	$6\frac{1}{2}$	7	$7\frac{1}{4}$	$7\frac{5}{8}$	$7\frac{7}{8}$	$7\frac{7}{8}$	8	$8\frac{1}{8}$

Amount in Inches to be subtracted from above lengths for
Countersunk Heads.

$\frac{1}{8}$	$\frac{1}{4}$	$\frac{1}{2}$	$\frac{1}{2}$	$\frac{5}{8}$	$\frac{3}{4}$	$\frac{7}{8}$	$\frac{7}{8}$
---------------	---------------	---------------	---------------	---------------	---------------	---------------	---------------

WEIGHT OF 100 STEEL RIVETS.
INCLUDING 100 HEADS.

Length Under Head.	Diameter of Rivet in Inches.				
	$\frac{1}{2}$	$\frac{5}{8}$	$\frac{3}{4}$	$\frac{7}{8}$	1
Inches.	Average Weight in Pounds.				
$1\frac{1}{4}$	9.2				
1	10.5	17.0			
$1\frac{1}{8}$	11.15	18.0			
$1\frac{1}{2}$	11.80	19.0	28.0	41.3	
$1\frac{3}{8}$	12.45	20.0	29.5	43.4	
$1\frac{1}{4}$	13.10	21.0	31.0	45.5	63.5
$1\frac{3}{8}$	13.75	22.0	32.5	47.6	66.2
$1\frac{1}{2}$	14.40	23.0	34.0	49.7	68.9
$1\frac{3}{8}$	15.00	24.0	35.5	51.8	71.7
2	15.70	25.0	37.0	53.9	74.4
$2\frac{1}{8}$	16.35	26.0	38.5	56.0	77.1
$2\frac{1}{4}$	17.00	27.0	40.0	58.0	79.8
$2\frac{3}{8}$	17.65	28.0	41.5	60.1	82.6
$2\frac{1}{2}$	18.30	29.0	43.0	62.2	85.3
$2\frac{3}{8}$	18.95	30.0	44.5	64.3	88.0
$2\frac{1}{2}$	19.60	31.0	46.0	66.4	90.7
$2\frac{3}{4}$	20.25	32.0	47.5	68.5	93.5
3	20.90	33.0	49.0	70.6	96.2
$3\frac{1}{8}$		34.0	50.5	72.7	99.0
$3\frac{1}{4}$		35.0	52.0	74.7	101.6
$3\frac{3}{8}$		36.0	53.5	76.8	103.8
$3\frac{1}{2}$		37.0	55.0	78.9	107.1
$3\frac{3}{8}$		38.0	56.5	81.0	109.8
$3\frac{1}{4}$		39.0	58.0	83.1	112.6
$3\frac{3}{4}$		40.0	59.5	85.2	115.2
4		41.0	61.0	87.3	118.0
$4\frac{1}{4}$			64.0	91.4	123.5
$4\frac{1}{2}$			67.0	95.6	128.9
$4\frac{3}{4}$			70.0	99.8	134.4
5			73.0	104.0	139.8
$5\frac{1}{4}$			76.0	108.2	145.3
$5\frac{1}{2}$			79.0	112.3	150.7
$5\frac{3}{4}$			82.0	116.5	156.2
6			85.0	120.7	161.6
Weight of 100 Heads.	5.3	9.0	13.0	20.5	30.8

AREAS TO BE DEDUCTED TO OBTAIN NET AREA OF RIVETED PLATE.

Square Inches.

Thick- ness Plates in Inches.	SIZE OF HOLE. Inches.														
	¼	⅕	⅜	⅙	½	⅔	¾	⅚	¾	⅞	1	1 ⅕	1 ¼	1 ⅓	1 ⅔
¼	.06	.08	.09	.11	.13	.14	.16	.17	.19	.20	.22	.23	.25	.27	.27
⅕	.08	.10	.12	.14	.16	.18	.20	.21	.23	.25	.27	.29	.31	.33	.33
⅜	.09	.12	.14	.16	.19	.21	.23	.26	.28	.30	.33	.35	.38	.40	.40
⅙	.11	.14	.16	.19	.22	.25	.27	.30	.33	.36	.38	.41	.44	.46	.46
½	.13	.16	.19	.22	.25	.28	.31	.34	.38	.41	.44	.47	.50	.53	.53
⅔	.14	.18	.21	.25	.28	.32	.35	.39	.42	.46	.49	.53	.56	.60	.60
¾	.16	.20	.23	.27	.31	.35	.39	.43	.47	.51	.55	.59	.63	.66	.66
⅚	.17	.21	.26	.30	.34	.39	.43	.47	.52	.56	.60	.64	.69	.73	.73
¾	.19	.23	.28	.33	.38	.42	.47	.52	.56	.61	.66	.70	.75	.80	.80
⅞	.20	.25	.30	.36	.41	.46	.51	.56	.61	.66	.71	.76	.81	.86	.86
1	.22	.27	.33	.38	.44	.49	.55	.60	.66	.71	.77	.82	.88	.93	.93
1 ⅕	.23	.29	.35	.41	.47	.53	.59	.64	.70	.76	.82	.88	.94	1.00	1.00
1 ⅔	.25	.31	.38	.44	.50	.56	.63	.69	.75	.81	.88	.94	1.00	1.06	1.06
1 ¾	.27	.33	.40	.46	.53	.60	.66	.73	.80	.86	.93	1.00	1.06	1.13	1.13
1 ⅞	.28	.35	.42	.49	.56	.63	.70	.77	.84	.91	.98	1.05	1.13	1.20	1.20
1 1 ⅕	.30	.37	.45	.52	.59	.67	.74	.82	.89	.96	1.04	1.11	1.19	1.26	1.26
1 1 ⅔	.31	.39	.47	.55	.63	.70	.78	.86	.94	1.02	1.09	1.17	1.25	1.33	1.33
1 1 ¾	.33	.41	.49	.57	.66	.74	.82	.90	.98	1.07	1.15	1.23	1.31	1.39	1.39
1 1 ⅞	.34	.43	.52	.60	.69	.77	.86	.95	1.03	1.12	1.20	1.29	1.38	1.46	1.46
1 1 1 ⅕	.36	.45	.54	.63	.72	.81	.90	.99	1.08	1.17	1.26	1.35	1.44	1.53	1.53
1 1 1 ⅔	.38	.47	.56	.66	.75	.84	.94	1.03	1.13	1.22	1.31	1.41	1.50	1.59	1.59
1 1 1 ¾	.39	.49	.59	.68	.78	.88	.98	1.07	1.17	1.27	1.37	1.46	1.56	1.66	1.66
1 1 1 ⅞	.41	.51	.61	.71	.81	.91	1.02	1.12	1.22	1.32	1.42	1.52	1.63	1.73	1.73
1 1 1 1 ⅕	.42	.53	.63	.74	.84	.95	1.05	1.16	1.27	1.37	1.47	1.58	1.69	1.79	1.79
1 1 1 1 ⅔	.44	.55	.66	.77	.88	.98	1.09	1.20	1.31	1.42	1.53	1.64	1.75	1.86	1.86
1 1 1 1 ¾	.45	.57	.68	.79	.91	1.02	1.13	1.25	1.36	1.47	1.59	1.70	1.81	1.93	1.93
1 1 1 1 ⅞	.47	.59	.70	.82	.94	1.05	1.17	1.29	1.41	1.52	1.64	1.76	1.88	1.99	1.99
1 1 1 1 1 ⅕	.48	.61	.73	.85	.97	1.09	1.21	1.33	1.45	1.57	1.70	1.82	1.94	2.06	2.06
2	.50	.63	.75	.88	1.00	1.13	1.25	1.38	1.50	1.63	1.75	1.88	2.00	2.13	2.13

MAXIMUM SIZE OF RIVETS IN ANGLES AND IN FLANGES OF BEAMS AND CHANNELS.

I-BEAMS.						CHANNELS.			ANGLES.			
Depth of Beam. Ins.	Weight per Foot. Pounds.	Size of Rivet. Inch.	Depth of Beam. Ins.	Weight per Foot. Pounds.	Size of Rivet. Inch.	Depth of Channel. Inches.	Weight per Foot. Pounds.	Size of Rivet. Inch.	Length of Leg. Inches.	Size of Rivet. Inch.	Length of Leg. Inches.	Size of Rivet. Inch.
3	5.5	⅜	15	42.0	¾	3	4.0	⅜	¾	¼	3	⅞
4	7.5	½	15	60.0	¾	4	5.25	½	1	¼	3 ½	⅞
5	9.75	½	15	80.0	¾	5	6.50	½	1 ¼	⅜	4	⅞
6	12.25	⅝	18	55.0	⅞	6	8.0	⅝	1 ⅜	⅝	4 ½	⅞
7	15.0	⅝	20	65.0	1	7	9.75	⅝	1 ½	⅝	5	⅞
8	18.00	¾	20	80.0	1	8	11.25	¾	1 ¾	⅝	6	⅞
9	21.0	¾	24	80.0	1	9	13.25	¾	2	⅝	7	1 ⅞
10	25.0	¾	24	105.0	1	10	15.0	¾	2 ¼	¾	8	1 ⅞
12	31.5	¾				12	20.50	¾	2 ½	¾		
12	40.0	¾				15	33.0	¾	2 ¾	¾		

AREAS TO BE DEDUCTED TO OBTAIN NET AREA OF RIVETED PLATE.

Square Inches.

SIZE OF HOLE.																Thick- ness Plates in Inches.
Inches.																
1/8	1/16	1/4	1/16	1/8	1/16	1/2	1/16	1/8	1 1/8	1/4	1 1/8	1/8	1 1/8	2		
.28	.30	.31	.33	.34	.36	.38	.39	.41	.42	.44	.45	.47	.48	.50	1/4	
.35	.37	.39	.41	.43	.45	.47	.49	.51	.53	.55	.57	.59	.61	.63	5/8	
.42	.45	.47	.49	.52	.54	.56	.59	.61	.63	.66	.68	.70	.73	.75	3/8	
.49	.52	.55	.57	.60	.63	.66	.68	.71	.74	.77	.79	.82	.85	.88	1/2	
.56	.59	.63	.66	.69	.72	.75	.78	.81	.84	.88	.91	.94	.97	1.00	1 1/2	
.63	.67	.70	.74	.77	.81	.84	.88	.91	.95	.98	1.02	1.05	1.09	1.13	1.13	
.70	.74	.78	.82	.86	.90	.94	.98	1.02	1.05	1.09	1.13	1.17	1.21	1.25	1 1/2	
.77	.82	.86	.90	.95	.99	1.03	1.07	1.12	1.16	1.20	1.25	1.29	1.33	1.38	1 1/2	
.84	.89	.94	.98	1.03	1.08	1.13	1.17	1.22	1.27	1.31	1.36	1.41	1.45	1.50	3/4	
.91	.96	1.02	1.07	1.12	1.17	1.22	1.27	1.32	1.37	1.42	1.47	1.52	1.57	1.63	1 1/8	
.98	1.04	1.09	1.15	1.20	1.26	1.31	1.37	1.42	1.48	1.53	1.59	1.64	1.70	1.75	1 1/8	
1.05	1.11	1.17	1.23	1.29	1.35	1.41	1.46	1.52	1.58	1.64	1.70	1.76	1.82	1.88	1 1/8	
1.13	1.19	1.25	1.31	1.38	1.44	1.50	1.56	1.63	1.69	1.75	1.81	1.88	1.94	2.00	1	
1.20	1.26	1.33	1.39	1.46	1.53	1.59	1.66	1.73	1.79	1.86	1.93	1.99	2.06	2.13	1 1/8	
1.27	1.34	1.41	1.48	1.55	1.62	1.69	1.76	1.83	1.90	1.97	2.04	2.11	2.18	2.25	1 1/8	
1.34	1.41	1.48	1.56	1.63	1.71	1.78	1.86	1.93	2.00	2.08	2.15	2.23	2.30	2.38	1 1/8	
1.41	1.48	1.56	1.64	1.72	1.80	1.88	1.95	2.03	2.11	2.19	2.27	2.34	2.42	2.50	1 1/4	
1.48	1.56	1.64	1.72	1.80	1.89	1.97	2.05	2.13	2.21	2.30	2.38	2.46	2.54	2.63	1 1/4	
1.55	1.63	1.72	1.80	1.89	1.98	2.06	2.15	2.23	2.32	2.41	2.49	2.58	2.66	2.75	1 3/8	
1.62	1.71	1.80	1.89	1.98	2.07	2.16	2.25	2.34	2.43	2.52	2.61	2.70	2.79	2.88	1 1/4	
1.69	1.78	1.88	1.97	2.06	2.16	2.25	2.34	2.44	2.53	2.63	2.72	2.81	2.91	3.00	1 1/2	
1.76	1.86	1.95	2.05	2.15	2.25	2.34	2.44	2.54	2.64	2.73	2.83	2.93	3.03	3.13	1 1/2	
1.83	1.93	2.03	2.13	2.23	2.34	2.44	2.54	2.64	2.74	2.84	2.95	3.05	3.15	3.25	1 1/2	
1.90	2.00	2.11	2.21	2.32	2.43	2.53	2.64	2.74	2.85	2.95	3.06	3.16	3.27	3.38	1 1/2	
1.97	2.08	2.19	2.30	2.41	2.52	2.63	2.73	2.84	2.95	3.06	3.17	3.28	3.39	3.50	1 3/4	
2.04	2.15	2.27	2.38	2.49	2.61	2.72	2.83	2.95	3.06	3.17	3.29	3.40	3.51	3.63	1 1/2	
2.11	2.23	2.34	2.46	2.58	2.70	2.81	2.93	3.05	3.16	3.28	3.40	3.52	3.63	3.75	1 1/2	
2.18	2.30	2.42	2.54	2.66	2.79	2.91	3.03	3.15	3.27	3.39	3.51	3.63	3.75	3.88	1 1/2	
2.25	2.38	2.50	2.63	2.75	2.88	3.00	3.13	3.25	3.38	3.50	3.63	3.75	3.88	4.00	2	

RIVET SPACING.

All Dimensions in Inches.

Size of Rivet.	Minimum Pitch.		Maximum Pitch at Ends of Compression Members.	Minimum Distance from Edge of Piece to Center of Rivet Hole.		Maximum Pitch in Line of Stress for Plate and Shape Members.
	Allowable.	Preferable.		Sheared Edge.	Rolled Edge.	
1/4	3/4
5/8	1 1/2
1/2	1 1/2
5/8	1 7/8
3/4	2 1/4
7/8	2 5/8
1	3
1 1/8	3 3/8

For General Rules for Rivet Spacing see next page.

GENERAL RULES FOR RIVET SPACING FOR BRIDGE AND STRUCTURAL WORK.

The pitch or distance from center to center of rivets should not be less than 3 diameters of the rivet, preferably not less than 3 inches for $\frac{7}{8}$ inch rivets, $2\frac{1}{2}$ inches for $\frac{3}{4}$ inch rivets, 2 inches for $\frac{5}{8}$ inch rivets and $1\frac{3}{4}$ inches for $\frac{1}{2}$ inch rivets.

At the ends of compression members the pitch should not exceed 4 diameters of the rivet for a length equal to $1\frac{1}{2}$ times the maximum width of the member.

Where two or more plates are in contact, rivets spaced not more than 12 inches in either direction shall be used to hold them together.

For members composed of plates and shapes the pitch in the direction of the line of stress should not exceed 6 inches for $\frac{7}{8}$ and $\frac{3}{4}$ inch rivets, $4\frac{1}{2}$ inches for $\frac{5}{8}$ inch rivets and 4 inches for $\frac{1}{2}$ inch rivets. For angles with two gauge lines in built-up members, rivets staggered, the maximum pitch in each line may be twice these distances.

The distance between the sheared edge of any piece and the center of the rivet hole should not be less than $1\frac{1}{2}$ inches for $\frac{7}{8}$ inch rivets, $1\frac{1}{4}$ inches for $\frac{3}{4}$ inch rivets, $1\frac{1}{8}$ inches for $\frac{5}{8}$ inch rivets and 1 inch for $\frac{1}{2}$ inch rivets; for a rolled edge, these distances may be $1\frac{1}{4}$, $1\frac{1}{8}$, 1 and $\frac{7}{8}$ inches, respectively; when practicable it should, for all sizes, be at least 2 diameters of the rivet and should not exceed 8 times the thickness of the plate.

Minimum spacing is generally used in pin plates, at ends of columns, girders, etc., etc.

In figuring clearance of rivets for special cases, allow $\frac{5}{8}$ inch in addition to diameter of head.

BEARING VALUES OF PIN PLATES.

For One Inch Thickness of Plate.

Bearing value = Diameter of Pin × 1" × Stress per Square Inch.

Diameter of Pin.	Area of Pin.	Bearing Value at 12 000 Pounds per Square Inch.	Bearing Value at 13 500 Pounds per Square Inch.	Bearing Value at 15 000 Pounds per Square Inch.	Diameter of Pin.	Area of Pin.	Bearing Value at 12 000 Pounds per Square Inch.	Bearing Value at 13 500 Pounds per Square Inch.	Bearing Value at 15 000 Pounds per Square Inch.
Inches.	Sq. Ins.	Pounds.	Pounds.	Pounds.	Inches.	Sq. Ins.	Pounds.	Pounds.	Pounds.
1	.785	12000	13500	15000	4 1/2	15.90	54000	60750	67500
1 1/8	.994	13500	15190	16880	4 3/8	16.80	55500	62440	69380
1 1/4	1.227	15000	16880	18750	4 3/4	17.72	57000	64130	71250
1 3/8	1.485	16500	18560	20630	4 7/8	18.67	58500	65810	73130
1 1/2	1.767	18000	20250	22500	5	19.64	60000	67500	75000
1 5/8	2.074	19500	21940	24380	5 1/8	20.63	61500	69190	76880
1 3/4	2.405	21000	23630	26250	5 1/4	21.65	63000	70880	78750
1 7/8	2.761	22500	25310	28130	5 3/8	22.69	64500	72560	80630
2	3.142	24000	27000	30000	5 1/2	23.76	66000	74250	82500
2 1/8	3.547	25500	28690	31880	5 5/8	24.85	67500	75940	84380
2 1/4	3.976	27000	30380	33750	5 3/4	25.97	69000	77630	86250
2 3/8	4.430	28500	32060	35630	5 7/8	27.11	70500	79310	88130
2 1/2	4.909	30000	33750	37500	6	28.27	72000	81000	90000
2 5/8	5.412	31500	35440	39380	6 1/8	29.46	73500	82690	91880
2 3/4	5.940	33000	37130	41250	6 1/4	30.68	75000	84380	93750
2 7/8	6.492	34500	38810	43130	6 3/8	31.92	76500	86060	95630
3	7.069	36000	40500	45000	6 1/2	33.18	78000	87750	97500
3 1/8	7.670	37500	42190	46880	6 5/8	34.47	79500	89440	99380
3 1/4	8.296	39000	43880	48750	6 3/4	35.79	81000	91130	101250
3 3/8	8.946	40500	45560	50630	6 7/8	37.12	82500	92810	103130
3 1/2	9.621	42000	47250	52500	7	38.48	84000	94500	105000
3 5/8	10.32	43500	48940	54380	7 1/2	44.18	90000	101250	112500
3 3/4	11.05	45000	50630	56250	8	50.27	96000	108000	120000
3 7/8	11.79	46500	52310	58130	8 1/2	56.75	102000	114750	127500
4	12.57	48000	54000	60000	9	63.62	108000	121500	135000
4 1/8	13.36	49500	55690	61880	10	78.54	120000	135000	150000
4 1/4	14.19	51000	57380	63750	11	95.03	132000	148500	165000
4 3/8	15.03	52500	59060	65630	12	113.10	144000	162000	180000

EXAMPLE.—The stress in the end post of a bridge is 250 000 pounds and the diameter of the pin is 5 5/8". Required the total thickness of steel pin plates for a bearing value of 15 000 pounds per square inch.

From the table the bearing value of a 5 5/8" pin in a 1" plate for 15 000 pounds unit stress is 84 380 pounds. Therefore the total thickness of metal required is 250 000

$$\frac{250\ 000}{84\ 380} = 2.96".$$

The nearest commercial size would therefore be 1 1/2" on each side, including web and necessary reinforcing plates.

MAXIMUM BENDING MOMENTS ON PINS.

With Extreme Fibre Stresses Varying from 15 000 to 25 000
Pounds per Square Inch.

Diameter of Pin in Inches.	Area of Pin in Square Inches.	Moments in Inch-Pounds for Fibre Stresses of				
		15 000 Lbs. per Square Inch.	18 000 Lbs. per Square Inch	20 000 Lbs. per Square Inch.	22 500 Lbs. per Square Inch.	25 000 Lbs. per Square Inch.
1	.785	1470	1770	1960	2210	2450
1 $\frac{1}{8}$.994	2100	2520	2800	3150	3490
1 $\frac{1}{4}$	1.227	2900	3450	3830	4310	4790
1 $\frac{3}{8}$	1.485	3830	4590	5100	5740	6380
1 $\frac{1}{2}$	1.767	4970	5960	6630	7460	8280
1 $\frac{5}{8}$	2.074	6320	7580	8430	9480	10530
1 $\frac{3}{4}$	2.405	7890	9470	10520	11840	13150
1 $\frac{7}{8}$	2.761	9710	11650	12940	14560	16180
2	3.142	11780	14140	15710	17670	19630
2 $\frac{1}{8}$	3.547	14130	16960	18840	21200	23550
2 $\frac{1}{4}$	3.976	16770	20130	22370	25160	27960
2 $\frac{3}{8}$	4.430	19730	23670	26300	29590	32880
2 $\frac{1}{2}$	4.909	23010	27610	30680	34510	38350
2 $\frac{5}{8}$	5.412	26640	31960	35520	39960	44400
2 $\frac{3}{4}$	5.940	30630	36750	40830	45940	51040
2 $\frac{7}{8}$	6.492	34990	41990	46660	52490	58320
3	7.069	39730	47680	52970	59600	66220
3 $\frac{1}{8}$	7.670	44940	53930	59920	67410	74900
3 $\frac{1}{4}$	8.296	50550	60660	67400	75830	84250
3 $\frac{3}{8}$	8.946	56610	67940	75480	84920	94350
3 $\frac{1}{2}$	9.621	63140	75770	84180	94710	105230
3 $\frac{5}{8}$	10.321	70150	84180	93530	105220	116910
3 $\frac{3}{4}$	11.045	77660	93190	103540	116490	129430
3 $\frac{7}{8}$	11.793	85690	102820	114250	128530	142810
4	12.566	94250	113100	125660	141370	157080
4 $\frac{1}{8}$	13.364	103360	124040	137820	155040	172270
4 $\frac{1}{4}$	14.186	113050	135660	150730	169570	188410
4 $\frac{3}{8}$	15.033	123320	147980	164420	184980	205530
4 $\frac{1}{2}$	15.904	134190	161030	178920	201290	223650
4 $\frac{5}{8}$	16.800	145690	174830	194250	218510	242810
4 $\frac{3}{4}$	17.721	157820	189390	210430	236740	263040
4 $\frac{7}{8}$	18.665	170580	204740	227490	255920	284360
5	19.635	184080	220890	245440	276120	306800
5 $\frac{1}{8}$	20.629	198230	237880	264310	297350	330390
5 $\frac{1}{4}$	21.648	213090	255710	284120	319640	355160
5 $\frac{3}{8}$	22.691	228680	274420	304910	343020	381130
5 $\frac{1}{2}$	23.758	245010	294010	326680	367510	408350
5 $\frac{5}{8}$	24.850	262100	314510	349460	393140	436830
5 $\frac{3}{4}$	25.967	279960	335950	373280	419940	466600
5 $\frac{7}{8}$	27.109	298620	358340	398160	447930	497700

MAXIMUM BENDING MOMENTS ON PINS.

With Extreme Fibre Stresses Varying from 15 000 to 25 000
Pounds per Square Inch.

Diameter of Pin in Inches.	Area of Pin in Square Inches.	Moments in Inch-Pounds for Fibre Stresses of				
		15 000 Lbs. per Square Inch.	18 000 Lbs. per Square Inch.	20 000 Lbs. per Square Inch.	22 500 Lbs. per Square Inch.	25 000 Lbs. per Square Inch.
6	28.274	318090	381700	424120	477130	530140
6 $\frac{1}{8}$	29.465	338380	406060	451180	507580	563970
6 $\frac{1}{4}$	30.680	359530	431430	479370	539290	599210
6 $\frac{3}{8}$	31.919	381530	457840	508710	572300	635890
6 $\frac{1}{2}$	33.183	404420	485400	539230	606630	674030
6 $\frac{5}{8}$	34.472	428200	513840	570940	642300	713670
6 $\frac{3}{4}$	35.785	452900	543480	603870	679350	754830
6 $\frac{7}{8}$	37.122	478530	574240	638040	717800	797550
7	38.485	505110	606130	673480	757660	841850
7 $\frac{1}{8}$	39.871	532650	639190	710210	798980	887760
7 $\frac{1}{4}$	41.282	561180	673420	748250	841780	935310
7 $\frac{3}{8}$	42.718	590710	708860	787620	886070	984520
7 $\frac{1}{2}$	44.179	621260	745510	828350	931890	1035440
7 $\frac{5}{8}$	45.664	652850	783410	870460	979270	1088080
7 $\frac{3}{4}$	47.173	685480	822580	913980	1028220	1142470
7 $\frac{7}{8}$	48.707	719190	863030	958920	1078780	1198650
8	50.265	753980	904780	1005310	1130970	1256640
8 $\frac{1}{8}$	51.849	789880	947860	1053170	1184820	1316470
8 $\frac{1}{4}$	53.456	826900	992280	1102530	1240350	1378170
8 $\frac{3}{8}$	55.088	865060	1038070	1153410	1297590	1441760
8 $\frac{1}{2}$	56.745	904370	1085250	1205830	1356560	1507290
8 $\frac{5}{8}$	58.426	944860	1133830	1259820	1417290	1574770
8 $\frac{3}{4}$	60.132	986540	1183850	1315390	1479810	1644220
8 $\frac{7}{8}$	61.862	1029430	1235310	1372570	1544140	1715710
9	63.617	1073540	1288250	1431390	1610310	1789240
9 $\frac{1}{8}$	65.397	1118900	1342680	1491860	1678340	1864830
9 $\frac{1}{4}$	67.201	1165510	1398610	1554010	1748270	1942520
9 $\frac{3}{8}$	69.029	1213400	1456080	1617870	1820100	2022340
9 $\frac{1}{2}$	70.882	1262590	1515110	1683450	1893880	2104310
9 $\frac{5}{8}$	72.760	1313090	1575700	1750780	1969630	2188480
9 $\frac{3}{4}$	74.662	1364910	1637900	1819880	2047370	2274850
9 $\frac{7}{8}$	76.590	1418090	1701700	1890780	2127130	2363480
10	78.540	1472620	1767150	1963500	2208930	2454370
10 $\frac{1}{4}$	82.516	1585850	1903020	2114470	2378780	2643090
10 $\frac{1}{2}$	86.590	1704740	2045690	2272990	2557120	2841240
10 $\frac{3}{4}$	90.763	1829430	2195320	2439250	2744150	3049060
11	95.033	1960060	2352070	2613410	2940090	3266770
11 $\frac{1}{4}$	99.402	2096760	2516110	2795680	3145140	3494600
11 $\frac{1}{2}$	103.869	2239670	2687610	2986230	3359510	3732790
12	113.098	2544690	3053630	3392920	3817040	4241150

DIMENSIONS OF BOLTS AND NUTS.

Franklin Institute Standard.

Bolts and Threads.						Rough Nuts and Heads.				
Diameter of Bolt.	Threads per Inch.	Diameter at Root of Thread.	Width of Flat.	Area of Bolt Body.	Area of Bolt at Root of Thread.	Short Diameter of Square and Hexagon.	Long Diameter of Square.	Long Diameter of Hexagon.	Thickness of Nuts.	Thickness of Heads.
Ins.	No.	Ins.	Ins.	Sq. Ins.	Sq. Ins.	Ins.	Ins.	Ins.	Ins.	Ins.
$\frac{1}{4}$	20	.185	.0062	.049	.027	$\frac{1}{4}$.707	.577	$\frac{1}{4}$	$\frac{1}{4}$
$\frac{5}{16}$	18	.240	.0070	.077	.045	$\frac{5}{16}$.840	.686	$\frac{5}{16}$	$\frac{5}{16}$
$\frac{3}{8}$	16	.294	.0078	.110	.068	$\frac{3}{8}$.972	.794	$\frac{3}{8}$	$\frac{3}{8}$
$\frac{7}{16}$	14	.344	.0089	.150	.093	$\frac{7}{16}$	1.105	.902	$\frac{7}{16}$	$\frac{7}{16}$
$\frac{1}{2}$	13	.400	.0096	.196	.126	$\frac{1}{2}$	1.238	1.010	$\frac{1}{2}$	$\frac{1}{2}$
$\frac{9}{16}$	12	.454	.0104	.249	.162	$\frac{9}{16}$	1.370	1.119	$\frac{9}{16}$	$\frac{9}{16}$
$\frac{5}{8}$	11	.507	.0113	.307	.202	$\frac{5}{8}$	1.503	1.227	$\frac{5}{8}$	$\frac{5}{8}$
$\frac{3}{4}$	10	.620	.0125	.442	.302	$\frac{3}{4}$	1.768	1.443	$\frac{3}{4}$	$\frac{3}{4}$
$\frac{7}{8}$	9	.731	.0140	.601	.420	$\frac{7}{8}$	2.033	1.660	$\frac{7}{8}$	$\frac{7}{8}$
1	8	.837	.0156	.785	.550	1	2.298	1.876	1	1
$1\frac{1}{8}$	7	.940	.0180	.994	.694	$1\frac{1}{8}$	2.563	2.093	$1\frac{1}{8}$	$1\frac{1}{8}$
$1\frac{1}{4}$	7	1.065	.0180	1.227	.893	2	2.829	2.309	$1\frac{1}{4}$	1
$1\frac{3}{8}$	6	1.160	.0210	1.485	1.057	$2\frac{3}{8}$	3.094	2.526	$1\frac{3}{8}$	$1\frac{3}{8}$
$1\frac{1}{2}$	6	1.284	.0210	1.767	1.295	$2\frac{1}{2}$	3.359	2.742	$1\frac{1}{2}$	$1\frac{1}{2}$
$1\frac{3}{4}$	$5\frac{1}{2}$	1.389	.0227	2.074	1.515	$2\frac{1}{2}$	3.624	2.959	$1\frac{3}{4}$	$1\frac{3}{4}$
$1\frac{7}{8}$	5	1.490	.0250	2.405	1.744	$2\frac{3}{4}$	3.889	3.175	$1\frac{7}{8}$	$1\frac{7}{8}$
2	5	1.615	.0250	2.761	2.048	$2\frac{5}{8}$	4.154	3.392	$1\frac{7}{8}$	$1\frac{7}{8}$
$2\frac{1}{8}$	$4\frac{1}{2}$	1.712	.0280	3.142	2.302	$3\frac{1}{8}$	4.420	3.608	2	$1\frac{9}{16}$
$2\frac{1}{4}$	$4\frac{1}{2}$	1.962	.0280	3.976	3.023	$3\frac{1}{2}$	4.950	4.042	$2\frac{1}{4}$	$1\frac{1}{2}$
$2\frac{1}{2}$	4	2.175	.0310	4.909	3.715	$3\frac{3}{8}$	5.480	4.475	$2\frac{1}{2}$	$1\frac{5}{8}$
$2\frac{3}{4}$	4	2.425	.0310	5.940	4.619	$4\frac{1}{4}$	6.011	4.908	$2\frac{3}{4}$	$2\frac{1}{8}$
3	$3\frac{1}{2}$	2.629	.0357	7.069	5.428	$4\frac{3}{8}$	6.541	5.341	3	$2\frac{5}{8}$
$3\frac{1}{4}$	$3\frac{1}{2}$	2.879	.0357	8.296	6.510	5	7.071	5.774	$3\frac{1}{4}$	$2\frac{3}{4}$
$3\frac{3}{8}$	$3\frac{1}{4}$	3.100	.0384	9.621	7.548	$5\frac{3}{8}$	7.602	6.207	$3\frac{3}{8}$	$2\frac{1}{2}$
$3\frac{1}{2}$	3	3.317	.0410	11.045	8.641	$5\frac{1}{2}$	8.132	6.640	$3\frac{1}{2}$	$2\frac{1}{8}$
4	3	3.567	.0410	12.566	9.993	$6\frac{1}{4}$	8.662	7.073	4	$3\frac{1}{8}$
$4\frac{1}{4}$	2	3.798	.0435	14.186	11.329	$6\frac{1}{2}$	9.193	7.506	$4\frac{1}{4}$	$3\frac{1}{4}$
$4\frac{1}{2}$	$2\frac{3}{4}$	4.028	.0460	15.904	12.743	$6\frac{3}{8}$	9.723	7.939	$4\frac{1}{2}$	$3\frac{7}{8}$
$4\frac{3}{4}$	$2\frac{3}{4}$	4.255	.0480	17.721	14.220	$7\frac{1}{4}$	10.253	8.372	$4\frac{3}{4}$	$3\frac{3}{8}$
5	$2\frac{1}{2}$	4.480	.0500	19.635	15.763	$7\frac{3}{8}$	10.784	8.805	5	$3\frac{1}{2}$
$5\frac{1}{4}$	$2\frac{1}{2}$	4.730	.0500	21.648	17.572	8	11.314	9.238	$5\frac{1}{4}$	4
$5\frac{1}{2}$	$2\frac{1}{2}$	4.953	.0526	23.758	19.267	$8\frac{3}{8}$	11.844	9.671	$5\frac{1}{2}$	$4\frac{3}{8}$
$5\frac{3}{4}$	$2\frac{1}{2}$	5.203	.0526	25.967	21.262	$8\frac{3}{4}$	12.375	10.104	$5\frac{3}{4}$	$4\frac{1}{2}$
6	$2\frac{1}{4}$	5.423	.0555	28.274	23.098	$9\frac{1}{8}$	12.905	10.537	6	$4\frac{7}{8}$

RULES FOR PROPORTIONS OF BOLTS AND NUTS.

Franklin Institute Standard.

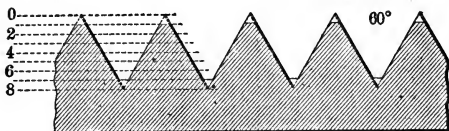

The dimensions of nuts and bolts are determined by the following rules, which apply to both square and hexagon.

Short diameter of rough nut = $1\frac{1}{2} \times$ diameter of bolt + $\frac{1}{8}$ in.

Short diameter of finished nut = $1\frac{1}{2} \times$ diameter of bolt + $\frac{1}{16}$ in.

Thickness of rough nut = diameter of bolt.

Thickness of finished nut = diameter of bolt - $\frac{1}{16}$ in.

Short diameter of rough head = $1\frac{1}{2} \times$ diameter of bolt + $\frac{1}{8}$ in.

Short diameter of finished head = $1\frac{1}{2} \times$ diameter of bolt + $\frac{1}{16}$ in.

Thickness of rough head = $\frac{1}{2}$ of short diameter of head.

Thickness of finished head = diameter of bolt - $\frac{1}{16}$ in.

In 1864, a committee of the Franklin Institute recommended the above system of screw threads and bolts which was devised by Mr. William Sellers, of Philadelphia. This system as far as it relates to screw threads is generally used in the United States, but the proportions of bolt heads and nuts are not adhered to because the sizes of bar required to make the nuts are special and extra work is necessary to make the bolt heads. Sizes of nuts and bolt heads in accordance with the *Manufacturers' Standard* are given on pages 369, 370 and 371.

WEIGHTS OF 100 MACHINE BOLTS WITH SQUARE HEADS AND HEXAGON NUTS.

Franklin Institute Standard Sizes.
Basis—1 cubic foot Iron = 480 pounds.

Length under Head to Point. Inches.	Diameter of Bolts in Inches.						
	$\frac{1}{4}$	$\frac{5}{16}$	$\frac{3}{8}$	$\frac{7}{16}$	$\frac{1}{2}$	$\frac{9}{16}$	$\frac{5}{8}$
1½	4.9	8.2	12.2	17.5	24.0	31.8	41.1
1¾	5.3	8.7	13.0	18.5	25.3	33.5	43.2
2	5.6	9.2	13.8	19.6	26.7	35.2	45.3
2¼	6.0	9.8	14.5	20.6	28.1	37.0	47.5
2½	6.3	10.3	15.3	21.6	29.4	38.7	49.6
2¾	6.6	10.8	16.1	22.7	30.8	40.4	51.7
3	7.0	11.4	16.8	23.7	32.1	42.1	53.9
3¼	7.3	11.9	17.6	24.8	33.5	43.9	56.0
3½	7.7	12.4	18.4	25.8	34.9	45.6	58.1
3¾	8.0	13.0	19.1	26.9	36.2	47.3	60.3
4	8.3	13.5	19.9	27.9	37.6	49.0	62.4
4½	9.0	14.6	21.4	30.0	40.3	52.5	66.6
5	9.7	15.6	23.0	32.1	43.0	55.9	70.9
5½	10.4	16.7	24.5	34.2	45.8	59.4	75.2
6	11.1	17.8	26.0	36.2	48.5	62.8	79.4
6½	11.7	18.8	27.6	38.3	51.2	66.3	83.7
7	12.4	19.9	29.1	40.4	53.9	69.7	87.9
7½	13.1	21.0	30.6	42.5	56.7	73.2	92.2
8	13.8	22.0	32.2	44.6	59.4	76.6	96.5
8½	14.5	23.1	33.7	46.7	62.1	80.1	100.7
9	15.1	24.2	35.3	48.8	64.8	83.5	105.0
9½	15.8	25.2	36.8	50.8	67.6	87.0	109.2
10	16.5	26.3	38.3	52.9	70.3	90.4	113.5
10½	17.2	27.4	39.9	55.0	73.0	93.9	117.8
11	17.9	28.4	41.4	57.1	75.7	97.3	122.0
11½	18.5	29.5	42.9	59.2	78.5	100.8	126.3
12	30.5	44.5	61.3	81.2	104.2	130.5
12½	31.6	46.0	63.3	83.9	107.7	134.8
13	32.7	47.5	65.4	86.6	111.1	139.1
13½	33.7	49.1	67.5	89.4	114.6	143.3
14	50.6	69.6	92.1	118.0	147.6
14½	52.1	71.7	94.8	121.5	151.8
15	53.7	73.8	97.5	124.9	156.1
15½	55.2	75.9	100.3	128.4	160.4
16	77.9	103.0	131.8	164.6
16½	80.0	105.7	135.3	168.9
17	82.1	108.4	138.7	173.1
17½	84.2	111.2	142.2	177.4
18	113.9	145.6	181.7
18½	116.6	149.1	185.9
19	119.3	152.5	190.2
19½	122.1	156.0	194.4
20	124.8	159.4	198.7
One inch in length of 100 Bolts.	1.36	2.13	3.07	4.18	5.45	6.90	8.52
To obtain Weights with Square Nuts per 100: Add23	.41	.66	.99	1.42	1.96	2.62
Weight of one Hexagon Nut.....	.0116	.020	.031	.046	.065	.088	.117
Weight of one Hexagon Head.....	.0150	.025	.039	.057	.081	.109	.144
Weight of one Square Nut.....	.0139	.024	.038	.056	.079	.108	.143
Weight of one Square Head.....	.0173	.029	.045	.066	.093	.126	.167

All weights are approximate.

WEIGHTS OF 100 MACHINE BOLTS WITH SQUARE HEADS AND HEXAGON NUTS.

Franklin Institute Standard Sizes.

Basis—1 cubic foot Iron = 480 pounds.

Length under Head to Point. Inches.	Diameter of Bolt in Inches.						
	$\frac{3}{4}$	$\frac{7}{8}$	1	$1\frac{1}{8}$	$1\frac{1}{4}$	$1\frac{3}{8}$	$1\frac{1}{2}$
$1\frac{1}{2}$	64.5	95.2	134	182	240	309	390
$1\frac{3}{4}$	67.6	99.4	140	189	248	319	402
2	70.6	103.5	145	196	257	329	414
$2\frac{1}{4}$	73.7	107.7	150	203	265	340	426
$2\frac{1}{2}$	76.8	111.9	156	210	274	350	439
$2\frac{3}{4}$	79.8	116.1	161	216	282	360	451
3	82.9	120.2	167	223	291	371	463
$3\frac{1}{4}$	86.0	124.4	172	230	300	381	475
$3\frac{1}{2}$	89.1	128.6	178	237	308	391	488
$3\frac{3}{4}$	92.1	132.8	183	244	317	402	500
4	95.2	136.9	189	251	325	412	512
$4\frac{1}{2}$	101.3	145.3	199	265	342	432	537
5	107.4	153.6	210	279	359	453	561
$5\frac{1}{2}$	113.6	162.0	221	292	376	474	586
6	119.7	170.3	232	306	393	494	610
$6\frac{1}{2}$	125.9	178.7	243	320	410	515	635
7	132.0	187.0	254	334	427	536	659
$7\frac{1}{2}$	138.1	195.4	265	348	444	556	684
8	144.3	203.7	276	361	461	577	709
$8\frac{1}{2}$	150.4	212.1	287	375	478	597	733
9	156.5	220.4	298	389	495	618	758
$9\frac{1}{2}$	162.7	228.8	308	402	513	639	782
10	168.8	237.1	319	417	530	659	807
$10\frac{1}{2}$	174.9	245.5	330	430	547	680	831
11	181.1	253.8	341	444	564	701	856
$11\frac{1}{2}$	187.2	262.2	352	458	581	721	880
12	193.3	270.5	363	472	598	742	905
$12\frac{1}{2}$	199.5	278.9	374	486	615	762	929
13	205.6	287.2	385	499	632	783	954
$13\frac{1}{2}$	211.7	295.6	396	513	649	804	978
14	217.9	303.9	407	527	666	824	1003
$14\frac{1}{2}$	224.0	312.3	417	541	683	845	1027
15	230.1	320.6	428	555	700	866	1052
$15\frac{1}{2}$	236.3	329.0	439	568	717	886	1077
16	242.4	337.3	450	582	734	907	1101
$16\frac{1}{2}$	248.5	345.7	461	596	751	927	1126
17	254.7	354.0	472	610	768	948	1150
$17\frac{1}{2}$	260.8	362.4	483	624	785	969	1175
18	266.9	370.7	494	637	802	989	1199
$18\frac{1}{2}$	273.1	379.1	505	651	819	1010	1224
19	279.2	387.4	516	665	836	1031	1248
$19\frac{1}{2}$	285.3	395.8	526	679	853	1051	1273
20	291.5	404.1	537	693	870	1072	1297
One inch in length of 100 Bolts...	12.27	16.70	21.82	27.61	34.09	41.25	49.09
To obtain Weights with Square Nuts per 100: Add	4.35	6.72	9.81	13.73	18.57	24.42	31.42
Weight of one Hexagon Nut.....	.190	.289	.417	.579	.777	1.016	1.299
Weight of one Hexagon Head.....	.235	.357	.516	.716	.962	1.259	1.611
Weight of one Square Nut.....	.234	.356	.515	.716	.963	1.260	1.614
Weight of one Square Head.....	.271	.412	.596	.827	1.111	1.453	1.860

All weights are approximate.

WEIGHTS OF 100 MACHINE BOLTS WITH SQUARE HEADS AND NUTS.

WROUGHT IRON.

Manufacturers' Standard Sizes.

Basis—Hoopes & Townsend's List.

Length under Head to Point. Inches.	Diameter of Bolt in Inches.							
	$\frac{1}{4}$	$\frac{5}{16}$	$\frac{3}{8}$	$\frac{7}{16}$	$\frac{1}{2}$	$\frac{9}{16}$	$\frac{5}{8}$	$\frac{3}{4}$
1½	3.4	6.0	9.2	13.6	19.1	26.0	33.8	55.3
2	4.1	7.1	10.8	15.7	21.8	29.5	38.1	61.5
2½	4.8	8.2	12.3	17.8	24.6	33.0	42.4	67.7
3	5.5	9.2	13.8	19.9	27.4	36.5	46.7	73.9
3½	6.2	10.3	15.3	21.8	29.8	40.0	51.0	80.1
4	6.9	11.4	16.9	24.0	32.6	43.5	55.4	86.3
4½	7.5	12.4	18.4	26.1	35.4	46.7	59.3	92.1
5	8.2	13.5	19.9	28.2	38.1	50.2	63.6	98.3
5½	8.9	14.6	21.5	30.3	40.9	53.7	67.9	104.5
6	9.6	15.6	23.0	32.4	43.7	57.2	72.3	110.7
6½	10.3	16.7	24.6	34.5	46.4	60.7	76.6	116.9
7	11.0	17.8	26.1	36.6	49.2	64.2	80.9	123.1
7½	11.7	18.9	27.7	38.8	51.9	67.6	85.2	129.4
8	12.4	20.0	29.2	40.9	54.7	71.1	89.5	135.6
9	13.7	22.1	32.4	44.9	60.0	77.8	97.8	147.5
10	15.1	24.3	35.5	49.1	65.5	84.8	106.4	160.0
11	16.5	26.4	38.6	53.4	71.0	91.8	115.1	172.4
12	17.9	28.6	41.7	57.6	76.5	98.8	123.7	184.8
13	19.3	30.7	44.8	61.8	82.0	105.5	132.0	197.2
14	20.6	32.9	47.9	66.0	87.6	112.5	140.6	209.7
15	22.0	35.1	51.0	70.3	93.1	119.5	149.2	222.1
16	23.4	37.2	54.1	74.5	98.6	126.4	157.9	234.5
17	24.8	39.4	57.2	78.7	104.1	133.4	166.5	246.9
18	26.2	41.5	60.3	82.9	109.7	140.4	175.1	259.4
19	27.5	43.7	63.4	87.2	115.2	147.4	183.7	271.8
20	28.9	45.8	66.5	91.4	120.7	154.4	192.4	284.2
21	30.3	48.0	69.6	95.6	126.2	161.4	201.0	296.6
22	31.7	50.2	72.7	99.9	131.7	168.4	209.6	309.1
23	33.1	52.3	75.8	104.1	137.3	175.4	218.3	321.5
24	34.4	54.5	78.9	108.3	142.8	182.4	226.9	333.9
25	35.8	56.6	82.1	112.5	148.3	189.3	235.5	346.3

WEIGHTS OF 100 MACHINE BOLTS WITH SQUARE HEADS AND NUTS.

WROUGHT IRON.

Manufacturers' Standard Sizes.

Basis—Hoopes & Townsend's List.

Length under Head to Point. Inches.	Diameter of Bolt in Inches.							
	$\frac{7}{8}$	1	$1\frac{1}{8}$	$1\frac{1}{4}$	$1\frac{3}{8}$	$1\frac{1}{2}$	$1\frac{3}{4}$	2
$1\frac{1}{2}$	83.4
2	91.8	129.0	184.5
$2\frac{1}{2}$	99.7	140.1	198.4	264.8
3	108.1	151.1	212.4	282.0	350	470
$3\frac{1}{2}$	116.6	162.2	226.4	299.3	370	495
4	125.0	173.2	240.4	316.6	390	520	720
$4\frac{1}{2}$	132.9	182.7	253.3	332.6	410	525	753
5	141.3	193.7	267.3	349.9	430	570	786	1180
$5\frac{1}{2}$	149.8	204.8	281.2	367.1	450	595	820	1225
6	158.2	215.8	295.2	384.4	470	620	854	1270
$6\frac{1}{2}$	166.7	226.9	309.2	401.6	490	645	888	1315
7	175.1	237.9	323.2	418.9	510	670	922	1316
$7\frac{1}{2}$	183.6	248.9	337.2	436.2	530	695	956	1405
8	192.0	260.0	351.1	453.4	550	725	990	1450
9	208.3	281.3	377.0	486.7	590	775	1058	1540
10	225.2	303.3	404.9	521.2	630	825	1126	1630
11	242.2	325.5	432.9	555.8	670	875	1194	1720
12	259.1	347.6	460.8	590.3	710	925	1262	1810
13	276.0	369.6	488.8	624.8	751	975	1330	1900
14	292.9	391.7	516.7	659.3	793	1025	1398	1990
15	309.8	413.8	544.7	693.8	835	1075	1468	2080
16	326.7	435.9	572.7	728.3	877	1125	1536	2170
17	343.6	458.0	600.6	762.8	919	1175	1604	2260
18	360.5	480.1	628.6	797.4	961	1225	1672	2350
19	377.5	502.2	656.5	831.9	1003	1275	1740	2440
20	394.4	524.3	684.5	866.4	1045	1325	1808	2530
21	411.3	546.4	712.4	900.9	1087	1375	1876	2620
22	428.2	568.4	740.4	935.4	1129	1425	1944	2710
23	445.1	590.5	768.3	969.9	1171	1475	2012	2800
24	462.0	612.6	796.3	1004.5	1213	1525	2080	2890
25	478.9	634.7	824.3	1039.0	1255	1575	2148	2980

Bolts from $1\frac{1}{8}$ inch to 2 inches, inclusive, are fitted with nuts made to U. S. Standard.

WEIGHTS OF 100 ROUND-HEADED RIVETS OR ROUND-HEADED BOLTS WITHOUT NUTS.

WROUGHT IRON.

Basis—1 cubic foot Iron = 480 pounds.

Length under Head to Point. Inches.	Diameter of Rivet in Inches.						
	$\frac{3}{8}$	$\frac{1}{2}$	$\frac{5}{8}$	$\frac{3}{4}$	$\frac{7}{8}$	1	$1\frac{1}{8}$
1	4.7	9.3	16.0	25.2	37.2	52.6	71.3
$1\frac{1}{4}$	5.5	10.7	18.1	28.3	41.3	58.0	78.2
$1\frac{1}{2}$	6.2	12.1	20.2	31.3	45.5	63.5	85.1
$1\frac{3}{4}$	7.0	13.4	22.4	34.4	49.7	68.9	92.0
2	7.8	14.8	24.5	37.5	53.9	74.4	98.9
$2\frac{1}{4}$	8.5	16.2	26.6	40.5	58.0	79.8	105.8
$2\frac{1}{2}$	9.3	17.5	28.8	43.6	62.2	85.3	112.7
$2\frac{3}{4}$	10.1	18.9	30.9	46.7	66.4	90.7	119.6
3	10.8	20.3	33.0	49.8	70.6	96.2	126.5
$3\frac{1}{4}$	11.6	21.6	35.1	52.8	74.7	101.6	133.4
$3\frac{1}{2}$	12.4	23.0	37.3	55.9	78.9	107.1	140.3
$3\frac{3}{4}$	13.1	24.3	39.4	59.0	83.1	112.6	147.2
4	13.9	25.7	41.5	62.0	87.3	118.0	154.1
$4\frac{1}{4}$	14.7	27.1	43.7	65.1	91.4	123.5	161.0
$4\frac{1}{2}$	15.4	28.4	45.8	68.2	95.6	128.9	167.9
$4\frac{3}{4}$	16.2	29.8	47.9	71.2	99.8	134.4	174.8
5	17.0	31.2	50.1	74.3	104.0	139.8	181.7
$5\frac{1}{4}$	17.7	32.5	52.2	77.4	108.2	145.3	188.6
$5\frac{1}{2}$	18.5	33.9	54.3	80.4	112.3	150.7	195.6
$5\frac{3}{4}$	19.3	35.3	56.4	83.5	116.5	156.2	202.5
6	20.0	36.6	58.6	86.6	120.7	161.6	209.4
$6\frac{1}{4}$	20.8	38.0	60.7	89.6	124.8	167.1	216.3
$6\frac{1}{2}$	21.6	39.3	62.8	92.7	129.0	172.5	223.2
$6\frac{3}{4}$	22.3	40.7	65.0	95.8	133.2	178.0	230.1
7	23.1	42.1	67.1	98.8	137.4	183.5	237.0
$7\frac{1}{4}$	23.9	43.4	69.2	101.9	141.6	188.9	243.9
$7\frac{1}{2}$	24.6	44.8	71.4	105.0	145.7	194.4	250.8
$7\frac{3}{4}$	25.4	46.2	73.5	108.0	149.9	199.8	257.7
8	26.2	47.5	75.6	111.1	154.1	205.3	264.6
$8\frac{1}{2}$	27.7	50.2	79.9	117.2	162.4	216.2	278.4
9	29.2	53.0	84.1	123.4	170.8	227.1	292.2
$9\frac{1}{2}$	30.8	55.7	88.4	129.5	179.1	238.0	306.0
10	32.3	58.4	92.7	135.6	187.5	248.8	319.8
$10\frac{1}{2}$	33.8	61.2	96.9	141.8	195.8	259.8	333.6
11	35.4	63.9	101.2	147.9	204.2	270.7	347.4
$11\frac{1}{2}$	36.9	66.6	105.4	154.1	212.5	281.6	361.2
12	38.4	69.3	109.7	160.2	220.9	292.5	375.0
One inch in length of 100 Rivets	3.07	5.45	8.52	12.27	16.70	21.82	27.61
Weight of 100 Rivet Heads. . . .	1.78	4.82	9.95	16.12	24.29	34.77	47.67

WEIGHTS AND DIMENSIONS OF BOLT HEADS.

MANUFACTURERS' STANDARD SIZES.

Basis—Hoopes & Townsend's List.

Diameter of Bolt.	Square.				Hexagon.			
	Short Diameter.	Long Diameter.	Thickness.	Weight per 100.	Short Diameter.	Long Diameter.	Thickness.	Weight per 100.
Inches.	Inches	Inches.	Inch.	Pounds.	Inches.	Inches.	Inches.	Pounds.
$\frac{1}{4}$	$\frac{3}{8}$.530	$\frac{3}{16}$.7	$\frac{3}{8}$.433	$\frac{3}{16}$.6
$\frac{5}{16}$	$\frac{15}{32}$.664	$\frac{15}{64}$	1.4	$\frac{15}{32}$.541	$\frac{15}{64}$	1.2
$\frac{3}{8}$	$\frac{9}{16}$.795	$\frac{9}{32}$	2.5	$\frac{9}{16}$.670	$\frac{9}{32}$	2.2
$\frac{7}{16}$	$\frac{21}{32}$.928	$\frac{21}{64}$	4.0	$\frac{21}{32}$.758	$\frac{21}{64}$	3.4
$\frac{1}{2}$	$\frac{3}{4}$	1.061	$\frac{3}{8}$	5.9	$\frac{3}{4}$.866	$\frac{3}{8}$	5.1
$\frac{9}{16}$	$\frac{27}{32}$	1.193	$\frac{27}{64}$	8.4	$\frac{27}{32}$.974	$\frac{27}{64}$	7.3
$\frac{5}{8}$	$\frac{15}{8}$	1.326	$\frac{15}{32}$	11.5	$\frac{15}{8}$	1.083	$\frac{15}{32}$	10.0
$\frac{3}{4}$	$1\frac{1}{8}$	1.591	$\frac{9}{16}$	19.9	$1\frac{1}{8}$	1.299	$\frac{9}{16}$	17.3
$\frac{7}{8}$	$1\frac{5}{16}$	1.856	$\frac{23}{32}$	31.1	$1\frac{5}{16}$	1.516	$\frac{23}{32}$	27.4
1	$1\frac{1}{2}$	2.122	$\frac{3}{4}$	47.3	$1\frac{1}{2}$	1.733	$\frac{3}{4}$	42.0
$1\frac{1}{8}$	$1\frac{11}{16}$	2.386	$\frac{27}{32}$	67.3	$1\frac{11}{16}$	1.944	$\frac{27}{32}$	58.3
$1\frac{1}{4}$	$1\frac{7}{8}$	2.652	$\frac{15}{8}$	92.3	$1\frac{7}{8}$	2.166	$\frac{15}{8}$	80.0
$1\frac{3}{8}$	$2\frac{1}{16}$	2.917	$1\frac{1}{32}$	122.8	$2\frac{1}{16}$	2.383	$1\frac{1}{32}$	106.5
$1\frac{1}{2}$	$2\frac{1}{4}$	3.182	$1\frac{1}{8}$	159.5	$2\frac{1}{4}$	2.599	$1\frac{1}{8}$	138.2
$1\frac{5}{8}$	$2\frac{7}{16}$	3.447	$1\frac{7}{32}$	202.7	$2\frac{7}{16}$	2.818	$1\frac{7}{32}$	175.7
$1\frac{3}{4}$	$2\frac{5}{8}$	3.712	$1\frac{5}{16}$	253.2	$2\frac{5}{8}$	3.032	$1\frac{5}{16}$	219.5
$1\frac{7}{8}$	$2\frac{13}{16}$	3.977	$1\frac{13}{32}$	311.5	$2\frac{13}{16}$	3.349	$1\frac{13}{32}$	269.8
2	3	4.243	$1\frac{1}{2}$	378.0	3	3.464	$1\frac{1}{2}$	327.6

WEIGHTS AND DIMENSIONS OF HEXAGON NUTS.

MANUFACTURERS' STANDARD SIZES.

Basis—Hoopes & Townsend's List.

Diameter of Bolt.	Short Diameter.	Long Diameter.	Thickness.	Diameter of Rough Hole.	Plain.		Cupped.	
					Weight per 100.	Number in 100	Weight per 100.	Number in 100
					Pounds.	Pounds.	Pounds.	Pounds.
$\frac{1}{4}$	$\frac{1}{2}$.578	$\frac{7}{16}$	$\frac{7}{32}$	1.3	7800	1.2	8500
$\frac{5}{16}$	$\frac{3}{8}$.722	$\frac{5}{16}$	$\frac{9}{32}$	2.3	4440	2.1	4790
$\frac{3}{8}$	$\frac{3}{8}$.866	$\frac{3}{8}$	$\frac{11}{32}$	4.3	2330	4.0	2510
$\frac{7}{16}$	$\frac{7}{8}$	1.011	$\frac{7}{16}$	$\frac{13}{32}$	7.0	1430	6.3	1580
$\frac{1}{2}$	$\frac{7}{8}$	1.011	$\frac{1}{2}$	$\frac{7}{16}$	7.5	1330	6.9	1440
$\frac{1}{2}$	1	1.155	$\frac{1}{2}$	$\frac{9}{16}$	9.9	1010	9.2	1090
$\frac{1}{2}$	1	1.155	$\frac{9}{16}$	$\frac{7}{16}$	10.8	930	10.2	980
$\frac{1}{2}$	$1\frac{1}{8}$	1.299	$\frac{9}{16}$	$\frac{1}{2}$	13.7	730	12.5	800
$\frac{1}{2}$	$1\frac{1}{8}$	1.299	$\frac{5}{8}$	$\frac{9}{16}$	15.9	630	15.2	660
$\frac{1}{2}$	$1\frac{1}{8}$	1.299	$\frac{3}{4}$	$\frac{9}{16}$	17.9	560	17.0	588
$\frac{1}{2}$	$1\frac{1}{4}$	1.444	$\frac{3}{4}$	$\frac{9}{16}$	19.5	514	18.5	541
$\frac{1}{2}$	$1\frac{1}{4}$	1.444	$\frac{3}{4}$	$\frac{9}{16}$	23.0	435	21.7	460
$\frac{1}{2}$	$1\frac{1}{4}$	1.444	$\frac{3}{4}$	$\frac{21}{32}$	22.2	450	20.6	485
$\frac{1}{2}$	$1\frac{3}{8}$	1.588	$\frac{3}{4}$	$\frac{21}{32}$	26.6	376	25.4	394
$\frac{1}{2}$	$1\frac{3}{8}$	1.588	$\frac{7}{8}$	$\frac{21}{32}$	30.3	330	28.8	347
$\frac{1}{2}$	$1\frac{3}{8}$	1.733	$\frac{3}{4}$	$\frac{21}{32}$	34.5	290	32.3	310
$\frac{1}{2}$	$1\frac{3}{8}$	1.733	$\frac{7}{8}$	$\frac{21}{32}$	40.0	250	37.6	266
$\frac{1}{2}$	$1\frac{3}{8}$	1.733	$\frac{7}{8}$	$\frac{21}{32}$	37.7	265	35.3	283
$\frac{1}{2}$	$1\frac{3}{8}$	1.733	1	$\frac{25}{32}$	45.9	218	43.5	230
$\frac{1}{2}$	$1\frac{5}{8}$	1.877	$\frac{7}{8}$	$\frac{25}{32}$	45.3	221	42.6	235
$\frac{1}{2}$	$1\frac{5}{8}$	1.877	1	$\frac{25}{32}$	50.8	197	47.6	210
$\frac{1}{2}$	$1\frac{5}{8}$	2.021	1	$\frac{7}{8}$	57.5	174	53.8	186
$\frac{1}{2}$	$1\frac{5}{8}$	2.021	$1\frac{1}{8}$	$\frac{7}{8}$	63.7	157	59.5	168
$\frac{1}{2}$	2	2.309	$1\frac{1}{4}$	$\frac{15}{16}$	100.0	100	90.9	110
$\frac{1}{2}$	$2\frac{1}{4}$	2.599	$1\frac{3}{8}$	$1\frac{1}{16}$	138.9	72	126.6	79
$\frac{1}{2}$	$2\frac{1}{4}$	2.888	$1\frac{1}{2}$	$1\frac{3}{16}$	185.2	54	169.5	59
$\frac{1}{2}$	$2\frac{3}{4}$	3.176	$1\frac{5}{8}$	$1\frac{5}{16}$	243.9	41	222.2	45
$\frac{1}{2}$	3	3.464	$1\frac{3}{4}$	$1\frac{7}{16}$	333.3	30	303.0	33
$\frac{1}{2}$	$3\frac{1}{4}$	3.754	$1\frac{7}{8}$	$1\frac{9}{16}$	408.2	24	370.4	27
$\frac{1}{2}$	$3\frac{1}{2}$	4.043	2	$1\frac{11}{16}$	493.8	20	459.8	21
2	$3\frac{1}{2}$	4.043	2	$1\frac{13}{16}$	487.8	20	454.5	22
2	$3\frac{3}{4}$	4.043	$2\frac{1}{8}$	$1\frac{13}{16}$	512.8	19	487.8	20

WEIGHTS AND DIMENSIONS OF SQUARE NUTS.

MANUFACTURERS' STANDARD SIZES.

Basis—Hoopes & Townsend's List.

Diameter of Bolt.	Short Diameter.	Long Diameter.	Thickness.	Diameter of Rough Hole.	Plain.		Cupped.	
					Weight per 100.	Number in 100	Weight per 100.	Number in 100
Inches.	Inches.	Inches.	Inches.	Inch.	Pounds.	Pounds.	Pounds.	Pounds.
$\frac{1}{4}$	$\frac{1}{2}$.707	$\frac{1}{4}$	$\frac{7}{32}$	1.5	6750	1.4	7200
$\frac{5}{16}$	$\frac{5}{8}$.884	$\frac{5}{16}$	$\frac{9}{32}$	2.8	3540	2.5	4000
$\frac{3}{8}$	$\frac{3}{4}$	1.061	$\frac{3}{8}$	$\frac{11}{32}$	4.8	2100	4.2	2380
$\frac{7}{16}$	$\frac{7}{8}$	1.237	$\frac{7}{16}$	$\frac{13}{32}$	7.5	1330	6.8	1460
$\frac{1}{2}$	$\frac{7}{8}$	1.237	$\frac{1}{2}$	$\frac{7}{16}$	8.9	1120	8.1	1230
$\frac{1}{2}$	1	1.414	$\frac{1}{2}$	$\frac{7}{16}$	11.9	840	10.8	930
$\frac{9}{16}$	$1\frac{1}{8}$	1.591	$\frac{9}{16}$	$\frac{1}{2}$	15.4	650	14.3	700
$\frac{5}{8}$	$1\frac{1}{8}$	1.591	$\frac{5}{8}$	$\frac{9}{16}$	17.3	575	16.1	620
$\frac{5}{8}$	$1\frac{1}{4}$	1.768	$\frac{5}{8}$	$\frac{9}{16}$	23.0	435	21.1	475
$\frac{3}{4}$	$1\frac{1}{4}$	1.768	$\frac{3}{4}$	$\frac{21}{32}$	27.8	360	25.0	400
$\frac{3}{4}$	$1\frac{3}{8}$	1.945	$\frac{3}{4}$	$\frac{21}{32}$	31.7	315	29.0	345
$\frac{3}{4}$	$1\frac{1}{2}$	2.122	$\frac{3}{4}$	$\frac{21}{32}$	41.0	244	37.0	270
$\frac{7}{8}$	$1\frac{1}{2}$	2.122	$\frac{7}{8}$	$\frac{23}{32}$	46.5	215	41.7	240
$\frac{7}{8}$	$1\frac{5}{8}$	2.298	$\frac{7}{8}$	$\frac{23}{32}$	55.6	180	48.8	205
$\frac{7}{8}$	$1\frac{3}{4}$	2.475	$\frac{7}{8}$	$\frac{25}{32}$	61.3	163	54.6	183
1	$1\frac{3}{4}$	2.475	1	$\frac{7}{8}$	70.9	141	64.1	156
1	2	2.828	1	$\frac{7}{8}$	95.2	105	87.0	115
$1\frac{1}{8}$	2	2.828	$1\frac{1}{8}$	$\frac{15}{16}$	102.0	98	94.3	106
$1\frac{1}{8}$	$2\frac{1}{4}$	3.182	$1\frac{1}{8}$	$\frac{15}{16}$	135.1	74	123.5	81
$1\frac{1}{4}$	$2\frac{1}{4}$	3.182	$1\frac{1}{4}$	$1\frac{1}{16}$	156.3	64	142.9	70
$1\frac{1}{4}$	$2\frac{1}{2}$	3.536	$1\frac{1}{4}$	$1\frac{1}{16}$	192.3	52	175.4	57
$1\frac{3}{8}$	$2\frac{3}{4}$	3.889	$1\frac{3}{8}$	$1\frac{3}{16}$	250.0	40	227.3	44
$1\frac{1}{2}$	3	4.243	$1\frac{1}{2}$	$1\frac{5}{16}$	307.7	32 $\frac{1}{2}$	285.7	35
$1\frac{5}{8}$	$3\frac{1}{4}$	4.597	$1\frac{5}{8}$	$1\frac{7}{16}$	454.5	22	400.0	25
$1\frac{3}{4}$	$3\frac{1}{2}$	4.950	$1\frac{3}{4}$	$1\frac{9}{16}$	555.6	18	500.0	20
$1\frac{7}{8}$	$3\frac{3}{4}$	5.303	$1\frac{7}{8}$	$1\frac{11}{16}$	666.7	15	625.0	16
2	4	5.657	2	$1\frac{13}{16}$	816.3	12 $\frac{1}{4}$	784.3	12 $\frac{3}{4}$

UPSET SCREW ENDS FOR ROUND BARS.

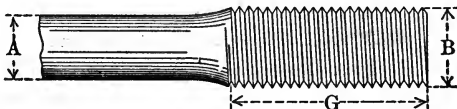

Diameter of Bar.	Area of Body of Bar.	Diameter of Screw.	Length of Upset.	Area at Root of Thread.	Number of Threads per Inch.	Weight per Foot of Bar.	Add for Upset.	Excess of Area at Root of Thread Over that of Body of Bar.
A		B	G					
Inch.	Sq. Ins.	Inches.	Inches.	Sq. Ins.		Pounds.	Inches.	Per Cent.
$\frac{1}{2}$.196	$\frac{3}{4}$	$4\frac{1}{4}$.302	10	.668	$6\frac{1}{2}$	54
$\frac{5}{16}$.249	$\frac{3}{4}$	$4\frac{1}{4}$.302	10	.845	$4\frac{1}{4}$	21
$\frac{3}{8}$.307	$\frac{3}{4}$	$4\frac{1}{2}$.420	9	1.043	$5\frac{1}{2}$	37
$\frac{1}{2}$.371	1	$4\frac{1}{2}$.550	8	1.262	$6\frac{1}{2}$	48
$\frac{3}{4}$.442	1	$4\frac{1}{2}$.550	8	1.502	$4\frac{1}{2}$	25
$\frac{7}{8}$.519	$1\frac{1}{8}$	$4\frac{3}{4}$.694	7	1.763	$5\frac{1}{2}$	34
$1\frac{1}{8}$.601	$1\frac{1}{4}$	$4\frac{3}{4}$.893	7	2.044	$6\frac{1}{2}$	49
$1\frac{1}{4}$.690	$1\frac{1}{2}$	$4\frac{3}{4}$.893	7	2.347	$4\frac{3}{4}$	29
1	.785	$1\frac{3}{8}$	5	1.057	6	2.670	$5\frac{1}{2}$	35
$1\frac{1}{8}$.887	$1\frac{3}{8}$	5	1.057	6	3.014	$4\frac{1}{2}$	19
$1\frac{1}{4}$.994	$1\frac{1}{2}$	5	1.295	6	3.379	$4\frac{3}{4}$	30
$1\frac{3}{8}$	1.108	$1\frac{1}{2}$	5	1.295	6	3.766	$3\frac{3}{4}$	17
$1\frac{1}{2}$	1.227	$1\frac{5}{8}$	$5\frac{1}{4}$	1.515	$5\frac{1}{2}$	4.173	$4\frac{1}{2}$	23
$1\frac{5}{8}$	1.353	$1\frac{3}{4}$	$5\frac{1}{4}$	1.744	5	4.600	5	29
$1\frac{3}{4}$	1.485	$1\frac{3}{4}$	$5\frac{1}{4}$	1.744	5	5.049	4	18
$1\frac{7}{8}$	1.623	$1\frac{7}{8}$	$5\frac{1}{2}$	2.048	5	5.518	$4\frac{3}{4}$	26
$1\frac{1}{2}$	1.767	2	$5\frac{1}{2}$	2.302	$4\frac{1}{2}$	6.008	$5\frac{1}{4}$	30
$1\frac{9}{16}$	1.918	2	$5\frac{1}{2}$	2.302	$4\frac{1}{2}$	6.520	$4\frac{1}{2}$	20
$1\frac{5}{8}$	2.074	$2\frac{1}{8}$	$5\frac{3}{4}$	2.650	$4\frac{1}{2}$	7.051	5	28
$1\frac{11}{16}$	2.237	$2\frac{1}{8}$	$5\frac{3}{4}$	2.650	$4\frac{1}{2}$	7.604	$4\frac{1}{2}$	18
$1\frac{3}{4}$	2.405	$2\frac{1}{4}$	$5\frac{3}{4}$	3.023	$4\frac{1}{2}$	8.178	$4\frac{3}{4}$	26
$1\frac{7}{8}$	2.580	$2\frac{1}{4}$	$5\frac{3}{4}$	3.023	$4\frac{1}{2}$	8.773	4	17
$1\frac{1}{2}$	2.761	$2\frac{3}{8}$	6	3.419	$4\frac{1}{2}$	9.388	$4\frac{1}{2}$	24
$1\frac{1}{2}$	2.948	$2\frac{3}{8}$	6	3.715	4	10.020	5	26

Lengths of Upset Ends above are best adapted for use with Turnbuckles of standard length, six inches between heads, as shown on page 378, and with Clevises shown on page 380. Lengths of Upset Ends for use with ordinary Right and Left Nuts, shown on page 379 may be one inch shorter than above.

UPSET SCREW ENDS FOR ROUND BARS.

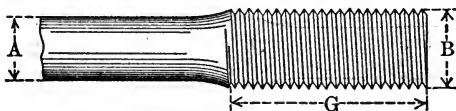

Diameter of Bar.	Area of Body of Bar.	Diameter of Screw.	Length of Upset.	Area at Root of Thread.	Number of Threads per Inch.	Weight per foot of Bar.	Add for Upset.	Excess of Area at Root of Thread Over that of Body of Bar.
A	B	G						
Inches.	Sq. Ins.	Inches.	Inches.	Sq. Ins.		Pounds.	Inches.	Per Cent.
2	3.142	2½	6	3.715	4	10.68	4¼	18
2⅛	3.341	2⅝	6¼	4.155	4	11.36	4¾	24
2⅓	3.547	2⅝	6¼	4.155	4	12.06	4	17
2⅜	3.758	2¾	6¼	4.619	4	12.78	4½	23
2½	3.976	2⅞	6½	5.108	4	13.52	5¼	28
2⅝	4.200	2⅞	6½	5.108	4	14.28	4½	22
2⅞	4.430	3	6½	5.428	3½	15.07	4¾	23
2⅞	4.666	3⅛	6¾	5.957	3½	15.86	5½	28
2¾	4.909	3⅛	6¾	5.957	3½	16.69	4¾	21
2⅞	5.157	3¼	6¾	6.510	3½	17.53	5¼	26
2⅞	5.412	3¼	6¾	6.510	3½	18.40	4½	20
2⅞	5.673	3⅝	7	7.087	3½	19.29	5	25
2¾	5.940	3⅝	7	7.087	3½	20.20	4½	19
2⅞	6.213	3½	7	7.548	3¼	21.12	4¾	22
2⅞	6.492	3⅝	7¼	8.171	3¼	22.07	5½	26
2⅞	6.777	3⅝	7¼	8.171	3¼	23.04	4¾	21
3	7.069	3¾	7¼	8.641	3	24.03	5	22
3⅛	7.670	3⅞	7½	9.305	3	26.08	5¼	21
3¼	8.296	4	7½	9.993	3	28.20	4¾	20
3⅝	8.946	4⅛	7¾	10.706	3	30.42	4¾	20
3¾	9.621	4¼	8	11.329	2⅞	32.71	4½	18
3⅞	10.321	4½	8	12.743	2¾	35.09	5¼	23
3⅞	11.045	4⅝	8½	13.544	2⅝	37.56	5¼	23
3⅞	11.793	4¾	8½	14.220	2⅝	40.10	5	21
4	12.566	5	8½	15.763	2½	42.73	5¼	25

Lengths of Upset Ends above are best adapted for use with Turnbuckles of standard length, six inches between heads, as shown on page 378, and with Clevises shown on page 380. Lengths of Upset Ends for use with ordinary Right and Left Nuts, shown on page 379, may be one inch shorter than above.

UPSET SCREW ENDS FOR SQUARE BARS.

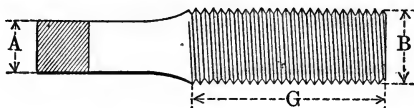

Side of Square Bar.	Area of Body of Bar.	Diameter of Screw.	Length of Upset.	Area at Root of Thread.	Number of Threads per Inch.	Weight per Foot of Bar.	Add for Upset.	Excess of Area at Root of Thread Over that of Body of Bar.
A	B	B	G					
Inch.	Sq. Ins.	Inches.	Inches.	Sq. Ins.		Pounds.	Inches.	Per Cent.
$\frac{1}{2}$.250	$\frac{3}{4}$	$4\frac{1}{2}$.302	10	.850	4	21
$\frac{9}{16}$.316	$\frac{7}{8}$	$4\frac{1}{2}$.420	9	1.076	5	33
$\frac{5}{8}$.391	1	$4\frac{1}{2}$.550	8	1.328	$5\frac{3}{4}$	41
$\frac{11}{16}$.473	1	$4\frac{1}{2}$.550	8	1.607	$3\frac{3}{4}$	17
$\frac{3}{4}$.563	$1\frac{1}{8}$	$4\frac{3}{4}$.694	7	1.913	$4\frac{1}{2}$	23
$\frac{13}{16}$.660	$1\frac{1}{4}$	$4\frac{3}{4}$.893	7	2.245	5	35
$\frac{7}{8}$.766	$1\frac{3}{8}$	5	1.057	6	2.603	$5\frac{3}{4}$	38
$\frac{15}{16}$.879	$1\frac{3}{8}$	5	1.057	6	2.989	$4\frac{1}{2}$	20
1	1.000	$1\frac{1}{2}$	5	1.295	6	3.400	$4\frac{3}{4}$	29
$1\frac{1}{16}$	1.129	$1\frac{5}{8}$	$5\frac{1}{4}$	1.515	$5\frac{1}{2}$	3.838	$5\frac{1}{2}$	34
$1\frac{1}{8}$	1.266	$1\frac{5}{8}$	$5\frac{1}{4}$	1.515	$5\frac{1}{2}$	4.303	$4\frac{1}{2}$	20
$1\frac{3}{16}$	1.410	$1\frac{3}{4}$	$5\frac{1}{4}$	1.744	5	4.795	$4\frac{3}{4}$	24
$1\frac{1}{4}$	1.563	$1\frac{7}{8}$	$5\frac{1}{2}$	2.048	5	5.312	$5\frac{1}{4}$	31
$1\frac{5}{16}$	1.723	$1\frac{7}{8}$	$5\frac{1}{2}$	2.048	5	5.851	$4\frac{1}{2}$	19
$1\frac{3}{8}$	1.891	2	$5\frac{1}{2}$	2.302	$4\frac{1}{2}$	6.428	$4\frac{1}{2}$	22
$1\frac{7}{16}$	2.066	$2\frac{1}{8}$	$5\frac{3}{4}$	2.650	$4\frac{1}{2}$	7.026	$5\frac{1}{4}$	28
$1\frac{1}{2}$	2.250	$2\frac{1}{8}$	$5\frac{3}{4}$	2.650	$4\frac{1}{2}$	7.650	$4\frac{1}{2}$	18
$1\frac{9}{16}$	2.441	$2\frac{1}{4}$	$5\frac{3}{4}$	3.023	$4\frac{1}{2}$	8.300	$4\frac{1}{2}$	24
$1\frac{5}{8}$	2.641	$2\frac{3}{8}$	6	3.419	$4\frac{1}{2}$	8.978	5	30
$1\frac{11}{16}$	2.848	$2\frac{3}{8}$	6	3.419	$4\frac{1}{2}$	9.682	$4\frac{1}{4}$	20
$1\frac{3}{4}$	3.063	$2\frac{1}{2}$	6	3.715	4	10.410	$4\frac{1}{2}$	21
$1\frac{13}{16}$	3.285	$2\frac{5}{8}$	$6\frac{1}{4}$	4.155	4	11.170	5	26
$1\frac{7}{8}$	3.516	$2\frac{5}{8}$	$6\frac{1}{4}$	4.155	4	11.950	$4\frac{1}{4}$	18
$1\frac{15}{16}$	3.754	$2\frac{3}{4}$	$6\frac{1}{4}$	4.619	4	12.760	$4\frac{1}{2}$	23

Lengths of Upset Ends above are best adapted for use with Turnbuckles of standard length, six inches between heads, as shown on page 378, and with Clevises shown on page 380. Lengths of Upset Ends for use with ordinary Right and Left Nuts, shown on page 379, may be one inch shorter than above.

UPSET SCREW ENDS FOR SQUARE BARS.

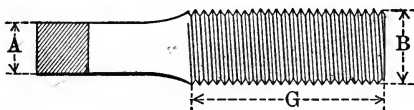

Side of Square Bar.	Area of Body of Bar.	Diameter of Screw.	Length of Upset.	Area at Root of Thread.	Number of Threads per Inch.	Weight per Foot of Bar.	Add for Upset.	Excess of Area at Root of Thread Over that of Body of Bar.
A	B	G						
Inches.	Sq. Ins.	Inches.	Inches.	Sq. Ins.		Pounds.	Inches.	Per Cent.
2	4.000	2 ⁷ / ₈	6 ¹ / ₂	5.108	4	13.60	5	28
2 ¹ / ₁₆	4.254	2 ⁷ / ₈	6 ¹ / ₂	5.108	4	14.46	4 ¹ / ₂	20
2 ¹ / ₈	4.516	3	6 ¹ / ₂	5.428	3 ¹ / ₂	15.35	4 ¹ / ₂	20
2 ³ / ₁₆	4.785	3 ¹ / ₈	6 ³ / ₄	5.957	3 ¹ / ₂	16.27	5	24
2 ¹ / ₄	5.063	3 ¹ / ₈	6 ³ / ₄	5.957	3 ¹ / ₂	17.22	4 ¹ / ₄	18
2 ⁵ / ₁₆	5.348	3 ¹ / ₄	6 ³ / ₄	6.510	3 ¹ / ₂	18.19	4 ³ / ₄	22
2 ³ / ₈	5.641	3 ³ / ₈	7	7.087	3 ¹ / ₂	19.18	5 ¹ / ₄	26
2 ⁷ / ₁₆	5.941	3 ³ / ₈	7	7.087	3 ¹ / ₂	20.20	4 ¹ / ₂	19
2 ¹ / ₂	6.250	3 ¹ / ₂	7	7.548	3 ¹ / ₄	21.25	4 ³ / ₄	21
2 ⁹ / ₁₆	6.566	3 ⁵ / ₈	7 ¹ / ₄	8.171	3 ¹ / ₄	22.33	5 ¹ / ₄	24
2 ⁵ / ₈	6.891	3 ⁵ / ₈	7 ¹ / ₄	8.171	3 ¹ / ₄	23.43	4 ¹ / ₂	19
2 ¹¹ / ₁₆	7.223	3 ³ / ₄	7 ¹ / ₄	8.641	3	24.56	4 ³ / ₄	20
2 ³ / ₄	7.563	3 ⁷ / ₈	7 ¹ / ₂	9.305	3	25.71	5 ¹ / ₄	23
2 ¹³ / ₁₆	7.910	3 ⁷ / ₈	7 ¹ / ₂	9.305	3	26.90	4 ¹ / ₂	18
2 ⁷ / ₈	8.266	4	7 ¹ / ₂	9.993	3	28.10	4 ³ / ₄	21
2 ¹⁵ / ₁₆	8.629	4 ¹ / ₈	7 ¹ / ₂	10.706	3	29.34	5	24
3	9.000	4 ¹ / ₈	7 ³ / ₄	10.706	3	30.60	4 ¹ / ₂	19
3 ¹ / ₈	9.766	4 ³ / ₈	8	12.087	2 ⁷ / ₈	33.20	5 ¹ / ₄	24
3 ¹ / ₄	10.563	4 ¹ / ₂	8	12.743	2 ³ / ₄	35.92	5	21
3 ³ / ₈	11.391	4 ⁵ / ₈	8 ¹ / ₄	13.544	2 ³ / ₄	38.73	5	19
3 ¹ / ₂	12.250	4 ⁷ / ₈	8 ¹ / ₂	15.068	2 ⁵ / ₈	41.65	5 ¹ / ₂	23
3 ⁵ / ₈	13.141	5	8 ¹ / ₂	15.763	2 ¹ / ₂	44.68	5 ¹ / ₄	20
3 ³ / ₄	14.063	5 ¹ / ₈	8 ³ / ₄	16.658	2 ¹ / ₂	47.82	5	18
3 ⁷ / ₈	15.016	5 ¹ / ₄	8 ³ / ₄	17.572	2 ¹ / ₂	51.05	4 ³ / ₄	17
4	16.000	5 ¹ / ₂	9	19.267	2 ³ / ₈	54.40	5 ¹ / ₄	20

Lengths of Upset Ends above are best adapted for use with Turnbuckles of standard length, six inches between heads, as shown on page 378, and with Clevises shown on page 380. Lengths of Upset Ends for use with ordinary Right and Left Nuts, shown on page 379, may be one inch shorter than above.

UPSET SCREW ENDS FOR FLAT BARS.

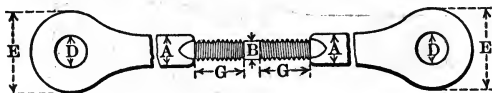

Width of Bar.	Thickness of Bar.	Diameter of Upset.	Area of Bar.	Area at Root of Thread.	Length of Upset.	Add for Upset.
A	T	B			G	
Inches.	Inch.	Inches.	Sq. Inches.	Sq. Inches.	Inches.	Inches.
2	1	2	2.00	2.30	5½	6
3	¾	2½	2.63	3.023	6½	11½
3	1	2½	3.00	3.719	6½	11½
3	1¼	2⅝	3.38	4.159	7	11¼
3	1½	2¾	3.75	4.62	7	11
3	1⅝	2⅞	4.13	4.92	7	10
3	1¾	3	4.50	5.43	7	10
4	¾	2½	3.00	3.719	6½	12¾
4	1	2⅝	3.50	4.159	7	12
4	1¼	2¾	4.00	4.62	7	11
4	1½	3	4.50	5.43	7	11
4	1¾	3¼	5.00	6.51	7½	11
4	1⅝	3½	5.50	6.51	7½	11
4	1⅞	3¾	6.00	7.54	7½	10
4	1⅝	3¾	6.50	7.54	7½	10
4	1¾	3¾	7.00	8.64	7½	9½
5	¾	2½	3.75	4.62	7	11
5	1	3	4.38	5.43	7	11
5	1¼	3¼	5.00	6.51	7½	10½
5	1½	3¼	5.63	6.51	7½	10½
5	1¾	3½	6.25	7.55	7½	9½
5	1⅝	3½	6.88	8.64	7½	9½
5	1⅞	3¾	7.50	8.64	7½	9½
5	1⅝	3¾	8.13	9.99
5	1¾	..	8.75	9.99
6	1⅝	3¾	6.75	8.64	7½	10
6	1¾	3¾	7.50	8.64	7½	9
6	1⅞	..	8.25	9.99
6	1¾	..	9.00	9.99

For dimensions of heads corresponding to different-sized pins, see table of Eye Bars on page 377.

Shortest length of bar permissible on account of method of manufacture is 6' 0" center to end.

The above length is used only for bars having heads 12½" diameter or less.

When possible lengths of 7' 0" are preferred.

STEEL EYE BARS.

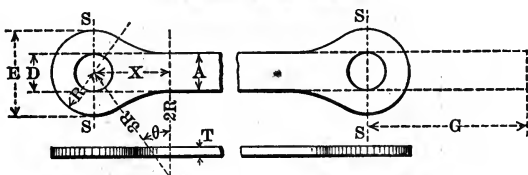

A_x = Area of Excess to form one Head = Plane Area of Head - AX .

$$A_x = \frac{(180 + 2\theta)}{360} \pi R^2 + \left(4R^2 - \frac{A^2}{4} \right) \tan. \theta - .0698 R^2 \theta.$$

$$\cos \theta = \frac{2R + \frac{A}{2}}{3R} \quad G = \frac{5A_x}{4A} \quad \text{Log. } \frac{\pi}{360} = 7.940848 - 10.$$

“.0698 = 8.843855 - 10.

Width of Body of Bar.	Minimum Thickness.	Diameter of Head.	Diameter of Largest Pin Hole.	Sectional Area of the Head on Line S-S in Excess of that in Body of Bar.	Additional Length of Bar Beyond Center of Eye Required to Form One Head.
A	T	E	D		G
Inches.	Inch.	Inches.	Inches.		Inches.
2	..	4½	1⅞	33%	7½
2	..	5½	2⅞	"	12½
2½	..	5½	2⅞	"	9½
2½	..	6½	3⅞	"	13½
3	..	6½	2½	"	10½
3	..	8	4	"	17½
3	..	9	5	"	22½
4	..	9½	4½	"	17½
4	..	10½	5½	"	21
4	..	11½	6½	"	27½
5	..	11½	4⅞	37%	20
5	..	12½	5⅞	"	24
5	1	13	6½	"	27½
5	1	14	7½	"	32
6	1⅞	13½	5½	"	21½
6	1⅞	14½	6½	"	27
6	1	15½	7½	"	31½
7	1⅞	15½	5⅞	40%	26
7	1⅞	17	7⅞	"	32
8	1	17	5½	"	25½
8	1	18	6½	"	30½
8	1	19	8	"	35
9	1½	19½	7	"	32½
9	1½	21½	9	"	36½
9	1½	22½	10
10	1½	24½	10½

The size of head given is the size of die. The size of finished head will overrun this about ¼". Eye Bars are Hydraulic Forged without the addition of extraneous metal and without buckles or welds. The heads on Eye Bars are finished of the same thickness "T" as body of bar.

TURNBUCKLES.

PRESSED WROUGHT IRON.

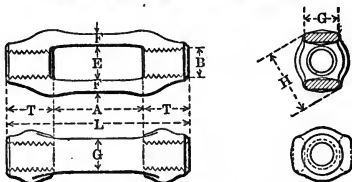

The Cleveland City Forge and Iron Co.

Dimensions of Bar.

Diameter of Screw. B	Diameter of Bar.	Side of Square Bar.	L	T	A	E	F	H	G
Inches.	Inches.	Inches.	Inches.	Inches.	Inches.	Inches.	Inches.	Inches.	Inches.
$\frac{3}{8}$			$7\frac{1}{8}$	$\frac{5}{8}$	6	$\frac{5}{8}$	$\frac{3}{4}$	$1\frac{1}{8}$	$\frac{1}{2}$
$\frac{1}{2}$			$7\frac{1}{4}$	$\frac{3}{4}$	6	$\frac{5}{8}$	$1\frac{1}{4}$	$1\frac{1}{2}$	$\frac{5}{8}$
$\frac{3}{4}$			$7\frac{1}{2}$	$\frac{3}{4}$	6	$\frac{5}{8}$	$1\frac{1}{4}$	$1\frac{1}{2}$	$\frac{5}{8}$
$\frac{7}{8}$			$7\frac{3}{4}$	$\frac{3}{4}$	6	$\frac{5}{8}$	$1\frac{1}{2}$	$1\frac{1}{2}$	$\frac{3}{4}$
$\frac{1}{2}$			$7\frac{1}{8}$	$\frac{1}{2}$	6	$\frac{1}{2}$	$1\frac{1}{2}$	$1\frac{1}{2}$	$\frac{3}{4}$
$\frac{3}{4}$			$8\frac{1}{4}$	$1\frac{1}{8}$	6	$1\frac{1}{8}$	$1\frac{1}{2}$	2	$\frac{1}{2}$
$\frac{7}{8}$			$8\frac{3}{8}$	$1\frac{1}{8}$	6	$1\frac{1}{8}$	$1\frac{1}{2}$	$2\frac{1}{4}$	$1\frac{1}{8}$
1	$\frac{1}{2}$ and $\frac{3}{8}$	$\frac{1}{2}$	9	$1\frac{1}{2}$	6	$1\frac{1}{8}$	$1\frac{1}{2}$	$2\frac{1}{2}$	$1\frac{1}{4}$
$1\frac{1}{8}$	$\frac{1}{2}$ and $\frac{3}{8}$	$\frac{3}{4}$ and $1\frac{1}{8}$	$9\frac{3}{8}$	$1\frac{1}{2}$	6	$1\frac{1}{8}$	$1\frac{1}{2}$	$2\frac{1}{2}$	$1\frac{1}{4}$
$1\frac{1}{4}$	$\frac{1}{2}$ and $\frac{3}{8}$	$\frac{1}{2}$ and $1\frac{1}{8}$	$9\frac{3}{4}$	$1\frac{1}{2}$	6	$1\frac{1}{8}$	$1\frac{1}{2}$	$2\frac{1}{2}$	$1\frac{1}{4}$
$1\frac{3}{8}$	1	$1\frac{1}{8}$ and $1\frac{1}{4}$	$10\frac{1}{8}$	$2\frac{1}{8}$	6	$1\frac{1}{8}$	$1\frac{1}{2}$	$3\frac{1}{8}$	$1\frac{5}{8}$
$1\frac{1}{2}$	$1\frac{1}{8}$	$1\frac{1}{8}$ and $1\frac{1}{4}$	$10\frac{1}{2}$	$2\frac{1}{4}$	6	2	$1\frac{1}{2}$	$3\frac{1}{8}$	$1\frac{5}{8}$
$1\frac{5}{8}$	$1\frac{1}{4}$	$1\frac{1}{8}$ and $1\frac{1}{2}$	$10\frac{3}{8}$	$2\frac{1}{8}$	6	2	$1\frac{1}{2}$	$3\frac{1}{2}$	$1\frac{5}{8}$
$1\frac{3}{4}$	$1\frac{1}{8}$	$1\frac{1}{8}$ and $1\frac{1}{4}$	$11\frac{1}{4}$	$2\frac{3}{8}$	6	$2\frac{1}{8}$	$1\frac{1}{2}$	$3\frac{3}{8}$	2
$1\frac{7}{8}$	$1\frac{1}{8}$	$1\frac{1}{8}$ and $1\frac{1}{4}$	$11\frac{1}{2}$	$2\frac{1}{2}$	6	$2\frac{1}{8}$	$1\frac{1}{2}$	$3\frac{3}{8}$	$2\frac{1}{8}$
2	$1\frac{1}{2}$	$1\frac{1}{8}$ and $1\frac{1}{4}$	12	3	6	$2\frac{3}{8}$	$1\frac{1}{2}$	$4\frac{1}{4}$	$2\frac{1}{4}$
$2\frac{1}{8}$	$1\frac{5}{8}$	$1\frac{1}{8}$ and $1\frac{1}{4}$	$12\frac{3}{8}$	$3\frac{1}{8}$	6	$2\frac{1}{2}$	$1\frac{1}{2}$	$4\frac{1}{2}$	$2\frac{1}{8}$
$2\frac{1}{4}$	$1\frac{3}{4}$	$1\frac{1}{8}$ and $1\frac{1}{4}$	$12\frac{3}{4}$	$3\frac{3}{8}$	6	$2\frac{1}{2}$	$1\frac{1}{2}$	$4\frac{3}{4}$	$2\frac{1}{8}$
$2\frac{3}{8}$	$1\frac{7}{8}$	$1\frac{1}{8}$ and $1\frac{1}{4}$	$13\frac{1}{8}$	$3\frac{1}{4}$	6	$2\frac{3}{4}$	$1\frac{1}{2}$	$4\frac{3}{4}$	$2\frac{3}{4}$
$2\frac{1}{2}$	$1\frac{1}{2}$	$1\frac{1}{8}$ and $1\frac{1}{4}$	$13\frac{1}{2}$	$3\frac{3}{4}$	6	$3\frac{1}{8}$	$1\frac{1}{2}$	$5\frac{1}{8}$	3
$2\frac{5}{8}$	$1\frac{5}{8}$	$1\frac{1}{8}$ and $1\frac{1}{4}$	$13\frac{3}{4}$	$3\frac{1}{2}$	6	$3\frac{1}{8}$	$1\frac{1}{2}$	$5\frac{1}{8}$	3
$2\frac{3}{4}$	$1\frac{3}{4}$	$1\frac{1}{8}$ and $1\frac{1}{4}$	$14\frac{1}{4}$	$4\frac{1}{8}$	6	$3\frac{1}{4}$	$1\frac{1}{2}$	$5\frac{1}{4}$	$3\frac{1}{4}$
$2\frac{7}{8}$	$2\frac{1}{4}$	2	$14\frac{3}{8}$	$4\frac{1}{4}$	6	$3\frac{3}{8}$	$1\frac{1}{2}$	$6\frac{1}{8}$	$3\frac{1}{4}$
3	$2\frac{3}{8}$	$2\frac{1}{8}$ and $2\frac{1}{4}$	15	$4\frac{1}{2}$	6	$3\frac{7}{8}$	$1\frac{1}{2}$	$6\frac{3}{8}$	$3\frac{1}{2}$
$3\frac{1}{4}$	$2\frac{1}{2}$	$2\frac{1}{8}$ and $2\frac{1}{4}$	$15\frac{1}{4}$	$4\frac{7}{8}$	6	$3\frac{3}{4}$	$1\frac{1}{2}$	7	4
$3\frac{1}{2}$	$2\frac{3}{8}$	$2\frac{1}{8}$ and $2\frac{1}{4}$	$16\frac{1}{2}$	$5\frac{1}{4}$	6	$3\frac{7}{8}$	$1\frac{1}{2}$	$7\frac{1}{2}$	$4\frac{1}{2}$
$3\frac{3}{4}$	3	$2\frac{1}{8}$ and $2\frac{1}{4}$	$17\frac{1}{4}$	$5\frac{5}{8}$	6	$4\frac{1}{8}$	$1\frac{1}{2}$	$8\frac{3}{8}$	5
4	$3\frac{1}{4}$	$2\frac{1}{8}$ and $2\frac{1}{4}$	18	6	6	$4\frac{3}{8}$	$1\frac{5}{8}$	$9\frac{3}{8}$	$5\frac{1}{8}$
$4\frac{1}{4}$	$3\frac{1}{2}$	$3\frac{1}{8}$ and $3\frac{1}{4}$	$21\frac{1}{2}$	$6\frac{1}{4}$	9	5	$1\frac{3}{4}$	$10\frac{1}{8}$	6
$4\frac{1}{2}$	$3\frac{3}{8}$	$3\frac{1}{4}$ and $3\frac{1}{2}$	$22\frac{1}{2}$	$6\frac{3}{4}$	9	$5\frac{1}{8}$	$1\frac{3}{4}$	$10\frac{3}{8}$	$6\frac{1}{4}$
$4\frac{3}{4}$	$3\frac{7}{8}$	$3\frac{3}{8}$ and $3\frac{1}{2}$	$23\frac{1}{2}$	$7\frac{1}{4}$	9	$5\frac{1}{2}$	2	$11\frac{3}{8}$	$6\frac{1}{2}$
5	$4\frac{1}{8}$	$3\frac{7}{8}$ and $4\frac{1}{4}$	24	$7\frac{1}{2}$	9	$5\frac{3}{8}$	$2\frac{1}{4}$	12	$6\frac{1}{2}$

Standard Lengths, 6, 9, 12, 15, 18, 24, 36, 48 and 72 inches between heads (A) for all sizes.

Lengths of Upset Ends shown on pages 372 to 375 inclusive are those best adapted for use with Turnbuckles of Standard Lengths, as above.

Dimensions E, F, G and H depend upon the specifications of the Bars with which the Turnbuckles are to be used.

RIGHT AND LEFT NUTS.

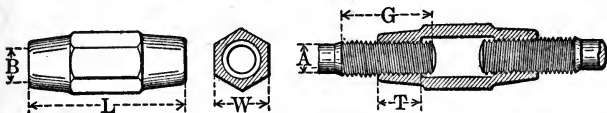

Diameter of Screw.	Length of Upset.	Diameter of Bar.	Side of Square Bar.	Length of Nut.	Length of Thread.	Diameter of Hex.	Weight of	
							One Nut.	One Nut and Two Screw Ends.
B	G	A	A	L	T	W	Pounds.	Pounds.
Inches.	Inches.	Inches.	Inches.	Inches.	Inches.	Inches.		
				Ordinary Lengths.				
$\frac{7}{8}$	$4\frac{1}{2}$	$\frac{5}{8}$	$\frac{9}{16}$	6	$1\frac{7}{8}$	$1\frac{5}{8}$	$1\frac{3}{4}$	$4\frac{1}{4}$
1	$4\frac{1}{2}$	$\frac{11}{16}$ and $\frac{3}{4}$	$\frac{3}{8}$ and $\frac{1}{2}$	6	$1\frac{7}{8}$	$1\frac{5}{8}$	$1\frac{3}{4}$	$4\frac{1}{4}$
$1\frac{1}{8}$	$4\frac{3}{4}$	$\frac{13}{16}$	$\frac{3}{4}$	$6\frac{1}{2}$	$1\frac{7}{8}$	2	3	$7\frac{1}{2}$
$1\frac{1}{4}$	$4\frac{3}{4}$	"	$\frac{7}{8}$	$6\frac{1}{2}$	$1\frac{7}{8}$	2	3	$7\frac{1}{2}$
$1\frac{3}{8}$	5	"	$\frac{15}{16}$	7	$1\frac{7}{8}$	$2\frac{3}{8}$	$4\frac{3}{4}$	$11\frac{3}{4}$
$1\frac{1}{2}$	5	$1\frac{1}{8}$ " $1\frac{1}{16}$	1 " $\frac{15}{16}$	7	$1\frac{7}{8}$	$2\frac{3}{8}$	$4\frac{3}{4}$	$11\frac{3}{4}$
$1\frac{5}{8}$	$5\frac{1}{4}$	$1\frac{1}{4}$ " $1\frac{3}{16}$	$1\frac{1}{16}$ " $1\frac{1}{8}$	$7\frac{1}{2}$	$2\frac{1}{16}$	$2\frac{3}{4}$	$6\frac{3}{4}$	$16\frac{3}{4}$
$1\frac{3}{4}$	$5\frac{1}{4}$	$1\frac{5}{16}$ " $1\frac{3}{8}$	$1\frac{3}{16}$ " $1\frac{1}{8}$	$7\frac{1}{2}$	$2\frac{1}{16}$	$2\frac{3}{4}$	$6\frac{3}{4}$	$16\frac{3}{4}$
$1\frac{7}{8}$	$5\frac{1}{2}$	$1\frac{7}{16}$ " $1\frac{1}{2}$	$1\frac{1}{4}$ " $1\frac{5}{16}$	8	$2\frac{1}{16}$	$3\frac{1}{8}$	$9\frac{1}{4}$	$23\frac{1}{4}$
2	$5\frac{1}{2}$	$1\frac{1}{2}$ " $1\frac{9}{16}$	$1\frac{3}{8}$ " $1\frac{1}{2}$	8	$2\frac{1}{16}$	$3\frac{1}{8}$	$9\frac{1}{4}$	$23\frac{1}{4}$
$2\frac{1}{4}$	$5\frac{3}{4}$	$1\frac{3}{4}$ " $1\frac{11}{16}$	$1\frac{7}{16}$ " $1\frac{1}{2}$	$8\frac{1}{2}$	$2\frac{1}{2}$	$3\frac{1}{2}$	$12\frac{1}{2}$	$31\frac{1}{2}$
$2\frac{1}{2}$	$5\frac{3}{4}$	$1\frac{7}{8}$ " $1\frac{13}{16}$	$1\frac{9}{16}$ " $1\frac{1}{2}$	$8\frac{1}{2}$	$2\frac{1}{2}$	$3\frac{1}{2}$	$12\frac{1}{2}$	$31\frac{1}{2}$
$2\frac{3}{8}$	6	$1\frac{7}{8}$ " $1\frac{15}{16}$	$1\frac{5}{8}$ " $1\frac{11}{16}$	9	$2\frac{3}{4}$	$3\frac{7}{8}$	$16\frac{3}{4}$	$41\frac{3}{4}$
$2\frac{1}{2}$	6	$1\frac{15}{16}$ " 2	$1\frac{3}{4}$ " $1\frac{7}{8}$	9	$2\frac{3}{4}$	$3\frac{7}{8}$	$16\frac{3}{4}$	$41\frac{3}{4}$
$2\frac{5}{8}$	$6\frac{1}{4}$	$2\frac{1}{16}$ " $2\frac{1}{8}$	$1\frac{3}{8}$ " $1\frac{7}{8}$	$9\frac{1}{2}$	$2\frac{5}{16}$	$4\frac{1}{4}$	$21\frac{1}{2}$	$53\frac{1}{2}$
$2\frac{3}{4}$	$6\frac{1}{4}$	$2\frac{3}{16}$ " $2\frac{1}{4}$	$1\frac{1}{2}$ " $1\frac{7}{8}$	$9\frac{1}{2}$	$2\frac{5}{16}$	$4\frac{1}{4}$	$21\frac{1}{2}$	$53\frac{1}{2}$
$2\frac{7}{8}$	$6\frac{1}{2}$	$2\frac{1}{4}$ " $2\frac{5}{16}$	2 " $2\frac{1}{16}$	10	$3\frac{3}{16}$	$4\frac{5}{8}$	$26\frac{1}{2}$	$66\frac{1}{2}$
3	$6\frac{1}{2}$	$2\frac{3}{8}$ " $2\frac{5}{8}$	$2\frac{1}{8}$ " $2\frac{1}{16}$	10	$3\frac{3}{16}$	$4\frac{5}{8}$	$26\frac{1}{2}$	$66\frac{1}{2}$
$3\frac{1}{4}$	$6\frac{3}{4}$	$2\frac{9}{16}$ " $2\frac{5}{8}$	$2\frac{5}{16}$ " $2\frac{1}{16}$	$10\frac{1}{2}$	$3\frac{5}{8}$	5	32	81
$3\frac{1}{2}$	7	$2\frac{11}{16}$ " $2\frac{5}{8}$	$2\frac{3}{4}$ " $2\frac{1}{16}$	11	$3\frac{5}{8}$	$5\frac{3}{8}$	$38\frac{1}{4}$	$97\frac{3}{4}$
$3\frac{3}{4}$	$7\frac{1}{4}$	3 " $2\frac{11}{16}$	$2\frac{11}{16}$ " $2\frac{1}{16}$	$11\frac{1}{2}$	$3\frac{11}{16}$	$5\frac{3}{4}$	45	116
4	$7\frac{1}{2}$	$3\frac{1}{4}$ " $2\frac{7}{8}$	$2\frac{7}{8}$ " $2\frac{1}{16}$	12	$4\frac{1}{16}$	$6\frac{1}{8}$	$53\frac{1}{2}$	138
				Extra Lengths.				
$1\frac{1}{4}$	$4\frac{3}{4}$	$\frac{7}{8}$ " $\frac{15}{16}$	$\frac{13}{16}$	12	$2\frac{1}{8}$	2		$9\frac{3}{4}$
$1\frac{1}{2}$	$4\frac{3}{4}$	$\frac{13}{16}$ " $\frac{15}{16}$	$\frac{3}{4}$	$8\frac{1}{2}$	$1\frac{5}{8}$	2	4	$9\frac{3}{4}$
$1\frac{3}{4}$	$4\frac{3}{4}$	" $\frac{15}{16}$	$\frac{13}{16}$	$8\frac{1}{2}$	$1\frac{5}{8}$	2	4	$9\frac{3}{4}$
$1\frac{5}{8}$	5	1 " $1\frac{1}{16}$	$\frac{7}{8}$ " $\frac{15}{16}$	9	$1\frac{7}{8}$	$2\frac{3}{8}$	$6\frac{1}{4}$	$15\frac{1}{4}$
$1\frac{1}{2}$	5	$1\frac{1}{8}$ " $1\frac{3}{16}$	1 " $\frac{15}{16}$	9	$1\frac{7}{8}$	$2\frac{3}{8}$	$6\frac{1}{4}$	$15\frac{1}{4}$
$1\frac{5}{8}$	$5\frac{1}{4}$	$1\frac{1}{4}$ " $1\frac{1}{16}$	$1\frac{1}{16}$ " $1\frac{1}{8}$	$9\frac{1}{2}$	$2\frac{1}{16}$	$2\frac{3}{4}$	$8\frac{3}{4}$	$21\frac{1}{2}$
$1\frac{3}{4}$	$5\frac{1}{4}$	$1\frac{5}{16}$ " $1\frac{3}{8}$	$1\frac{3}{16}$ " $1\frac{1}{8}$	$9\frac{1}{2}$	$2\frac{1}{16}$	$2\frac{3}{4}$	$8\frac{3}{4}$	$21\frac{1}{2}$
$1\frac{7}{8}$	$5\frac{1}{2}$	$1\frac{7}{16}$ " $1\frac{1}{2}$	$1\frac{1}{4}$ " $1\frac{5}{16}$	10	$2\frac{1}{16}$	$3\frac{1}{8}$	$12\frac{1}{4}$	$29\frac{3}{4}$
2	$5\frac{1}{2}$	$1\frac{1}{2}$ " $1\frac{9}{16}$	$1\frac{3}{8}$ " $1\frac{1}{16}$	10	$2\frac{5}{16}$	$3\frac{1}{8}$	$12\frac{1}{4}$	$29\frac{3}{4}$

For Details of Upset Ends, see pages 372 to 375 inclusive.
 Length of Upset Ends for use with Right and Left Nuts may be made one inch shorter than the dimensions given in column "G" above.

CLEVISES.

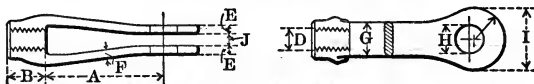

The Cleveland City Forge and Iron Co.

Diameter of Screw.	Length of Fork.	Length of Thread.	Diameter of Pin in Inches.												Dimensions to be used with Specified Diameters I.					
			1	1 1/4	1 1/2	1 3/4	2	2 1/4	2 1/2	2 3/4	3	3 1/4	3 1/2	3 3/4	4	I	G	F	E	
D	A	B	Diameter I in Inches.												I	G	F	E		
Ins.	Ins.	Ins.													Ins.	Ins.	Ins.	Ins.		
3/4	5 1/2	1 1/8	2 3/4	2 3/4	2 3/4	3	3	3 1/2	3 1/2	3 1/2	3 1/2	3 1/2	3 1/2	3 1/2	3 1/2	3 1/2	1 1/2	1 1/2	1 1/2	1 1/2
7/8	5 1/2	1 3/8	2 3/4	2 3/4	2 3/4	3	3	3 1/2	3 1/2	3 1/2	3 1/2	3 1/2	3 1/2	3 1/2	3 1/2	3 1/2	1 1/2	1 1/2	1 1/2	1 1/2
1	6	1 1/2	2 3/4	2 3/4	2 3/4	3	3	3 1/2	3 1/2	3 1/2	3 1/2	3 1/2	3 1/2	3 1/2	3 1/2	3 1/2	1 1/2	1 1/2	1 1/2	1 1/2
1 1/8	6	1 3/4	3	3	3	3 1/4	3 1/4	3 1/2	3 1/2	3 3/4	3 3/4	3 3/4	3 3/4	3 3/4	3 3/4	3 3/4	1 3/4	1 3/4	1 3/4	1 3/4
1 1/4	6 1/2	1 7/8	3	3	3	3 1/2	3 1/2	3 1/2	3 1/2	3 3/4	3 3/4	3 3/4	3 3/4	3 3/4	3 3/4	3 3/4	1 3/4	1 3/4	1 3/4	1 3/4
1 3/8	6 1/2	2 1/8	3 1/4	3 1/4	3 1/4	3 3/4	3 3/4	4	4	4 1/8	4 1/8	4 1/8	4 1/8	4 1/8	4 1/8	4 1/8	2	2	2	2
1 1/2	7	2 1/4	3 3/4	3 3/4	3 3/4	4	4	4 1/2	4 1/2	4 3/4	4 3/4	4 3/4	4 3/4	4 3/4	4 3/4	4 3/4	2 1/8	2 1/8	2 1/8	2 1/8
1 5/8	7	2 3/8	4	4	4	4 1/2	4 1/2	4 3/4	4 3/4	5	5	5	5	5	5	5	2 1/8	2 1/8	2 1/8	2 1/8
1 3/4	8	2 5/8	4 1/2	4 1/2	4 1/2	4 3/4	4 3/4	5 1/4	5 1/4	5 1/2	5 1/2	5 1/2	5 1/2	5 1/2	5 1/2	5 1/2	2 3/8	2 3/8	2 3/8	2 3/8
1 7/8	8	2 7/8	5 1/4	5 1/4	5 1/4	5 1/2	5 1/2	5 3/4	5 3/4	5 3/4	5 3/4	5 3/4	5 3/4	5 3/4	5 3/4	5 3/4	2 3/8	2 3/8	2 3/8	2 3/8
2	9	3	5 1/4	5 1/4	5 1/4	5 1/2	5 1/2	5 3/4	5 3/4	5 3/4	5 3/4	5 3/4	5 3/4	5 3/4	5 3/4	5 3/4	2 3/8	2 3/8	2 3/8	2 3/8
2 1/8	9	3 1/4	5 1/4	5 1/4	5 1/4	5 1/2	5 1/2	5 3/4	5 3/4	5 3/4	5 3/4	5 3/4	5 3/4	5 3/4	5 3/4	5 3/4	2 3/8	2 3/8	2 3/8	2 3/8
2 1/4	10	3 1/2	5 1/4	5 1/4	5 1/4	5 1/2	5 1/2	5 3/4	5 3/4	5 3/4	5 3/4	5 3/4	5 3/4	5 3/4	5 3/4	5 3/4	2 3/8	2 3/8	2 3/8	2 3/8
2 3/8	10	3 3/4	5 1/4	5 1/4	5 1/4	5 1/2	5 1/2	5 3/4	5 3/4	5 3/4	5 3/4	5 3/4	5 3/4	5 3/4	5 3/4	5 3/4	2 3/8	2 3/8	2 3/8	2 3/8
2 1/2	10	3 3/4	5 1/4	5 1/4	5 1/4	5 1/2	5 1/2	5 3/4	5 3/4	5 3/4	5 3/4	5 3/4	5 3/4	5 3/4	5 3/4	5 3/4	2 3/8	2 3/8	2 3/8	2 3/8
2 5/8	10	4	5 1/4	5 1/4	5 1/4	5 1/2	5 1/2	5 3/4	5 3/4	5 3/4	5 3/4	5 3/4	5 3/4	5 3/4	5 3/4	5 3/4	2 3/8	2 3/8	2 3/8	2 3/8
2 3/4	12	4 1/4	5 1/4	5 1/4	5 1/4	5 1/2	5 1/2	5 3/4	5 3/4	5 3/4	5 3/4	5 3/4	5 3/4	5 3/4	5 3/4	5 3/4	2 3/8	2 3/8	2 3/8	2 3/8
2 7/8	12	4 1/4	5 1/4	5 1/4	5 1/4	5 1/2	5 1/2	5 3/4	5 3/4	5 3/4	5 3/4	5 3/4	5 3/4	5 3/4	5 3/4	5 3/4	2 3/8	2 3/8	2 3/8	2 3/8
3	12	4 1/2	5 1/4	5 1/4	5 1/4	5 1/2	5 1/2	5 3/4	5 3/4	5 3/4	5 3/4	5 3/4	5 3/4	5 3/4	5 3/4	5 3/4	2 3/8	2 3/8	2 3/8	2 3/8

Dimension "H" is usually 1/4" larger than diameter of pin and "J" is made to suit the thickness of the pin plate. The above Clevises are designed for use with medium steel rods of 60000 to 68000 pounds tensile strength per square inch. All clevis nuts with diameter "I" 8 inches or larger dimension "A" will be 12 inches.

DIMENSIONS OF RIVET HEADS AFTER DRIVING.

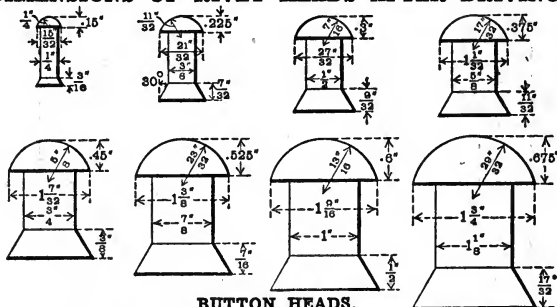

BUTTON HEADS.

Height of Head = $\frac{1}{16} \times$ Diameter of Rivet. Radius of Head = $\frac{3}{4}$ Diameter of Rivet + $\frac{1}{16}$ ".

COUNTERSUNK HEADS.

Diameter of Countersunk Head same as Button Head. Angle of Countersink = 30°. In figuring Clearances for Rivet Heads allow for Heights as follows: 5/8" for 3/4" rivets, 3/4" for 7/8" rivets. All dimensions in inches.

WEIGHTS, DIMENSIONS AND SAFE LOADS OF CHAINS.

As given by Standard Manufacturers.

Size.	Common Coil.				Crane.				Stud Link.				
	Thickness of Link Bar.	Length of Link.	Width of Link.	Approximate Weight per Foot.	Safe Load in Thousand Lbs.	Length of Link.	Width of Link.	Approximate Weight per Foot.	Safe Load in Thousand Lbs.	Length of Link.	Width of Link.	Approximate Weight per Foot.	Safe Load in Thousand Lbs.
Ins.	Ins.	Ins.	Lbs.		Ins.	Ins.	Lbs.		Ins.	Ins.	Lbs.		
$\frac{1}{16}$	$1\frac{3}{8}$	$\frac{7}{8}$.46	.5
$\frac{1}{8}$	$1\frac{1}{2}$	$1\frac{1}{4}$.75	.8
$\frac{3}{16}$	$1\frac{3}{4}$	$1\frac{1}{4}$	1.10	1.3
$\frac{1}{4}$	$2\frac{1}{8}$	$1\frac{1}{2}$	1.55	1.8
$\frac{5}{16}$	$2\frac{1}{4}$	$1\frac{1}{2}$	2.00	2.3
$\frac{3}{8}$	$2\frac{1}{2}$	$1\frac{7}{8}$	2.60	3.3	3	$1\frac{3}{4}$	2.3	4.8
$\frac{7}{16}$	$2\frac{7}{8}$	$2\frac{1}{8}$	3.25	4.0	$3\frac{3}{8}$	2	3.0	5.9
$\frac{1}{2}$	$3\frac{3}{8}$	$2\frac{1}{4}$	4.00	4.8	$3\frac{1}{2}$	$2\frac{1}{8}$	4.0	6.9	$3\frac{3}{4}$	$2\frac{1}{4}$	4.0	6.3
$\frac{5}{8}$	4	$2\frac{1}{2}$	4.8	8.5
$\frac{3}{4}$	$3\frac{7}{8}$	$2\frac{1}{2}$	5.90	6.8	$3\frac{3}{8}$	$2\frac{1}{2}$	6.3	9.6	$4\frac{3}{8}$	$2\frac{3}{4}$	5.7	10.1
$\frac{7}{8}$	$4\frac{3}{4}$	3	6.7	11.9
$1\frac{1}{8}$	$4\frac{3}{8}$	$3\frac{1}{8}$	8.0	9.3	$4\frac{1}{8}$	$2\frac{1}{8}$	8.0	13.5	5	$3\frac{1}{4}$	7.3	14.0
$1\frac{1}{4}$	$5\frac{3}{8}$	$3\frac{1}{2}$	8.5	15.8
$1\frac{1}{2}$
1	5	$3\frac{5}{8}$	10.0	12.0	$4\frac{3}{4}$	$3\frac{1}{4}$	10.0	17.0	$5\frac{1}{8}$	$3\frac{3}{4}$	9.8	18.0
$1\frac{1}{8}$	$5\frac{1}{2}$	4	13.0	14.5	$5\frac{1}{4}$	$3\frac{3}{4}$	13.0	21.5	$6\frac{1}{2}$	$4\frac{3}{8}$	12.5	22.8
$1\frac{1}{4}$	$6\frac{1}{8}$	$4\frac{3}{8}$	15.0	19.5	$5\frac{7}{8}$	$4\frac{1}{8}$	16.0	27.0	$7\frac{1}{8}$	$4\frac{1}{2}$	15.2	28.1
$1\frac{3}{8}$	$6\frac{1}{8}$	$4\frac{1}{8}$	19.0	31.0	$7\frac{3}{4}$	$4\frac{7}{8}$	18.8	34.0
$1\frac{1}{2}$	$7\frac{1}{8}$	5	23.0	36.0	$8\frac{1}{2}$	$5\frac{3}{8}$	22.0	40.5
$1\frac{5}{8}$	$7\frac{7}{8}$	$5\frac{1}{2}$	28.0	41.5	$9\frac{1}{4}$	$5\frac{7}{8}$	26.0	47.5
$1\frac{3}{4}$	$8\frac{3}{8}$	$5\frac{7}{8}$	31.0	44.8	10	$6\frac{1}{4}$	29.2	55.1
$1\frac{7}{8}$	$9\frac{3}{8}$	$6\frac{3}{8}$	35.0	51.3	$10\frac{1}{2}$	$6\frac{3}{4}$	34.2	63.3
2	$10\frac{1}{8}$	$6\frac{3}{4}$	40.0	58.3	$11\frac{1}{8}$	$7\frac{1}{4}$	40.0	72.0
$2\frac{1}{8}$	$10\frac{7}{8}$	$7\frac{1}{8}$	47.0	65.8	12	$7\frac{3}{4}$	44.2	81.3
$2\frac{1}{4}$	$11\frac{3}{8}$	$7\frac{5}{8}$	53.0	73.7	13	$8\frac{1}{4}$	50.0	91.1
$2\frac{3}{8}$	12	8	58.5	82.0	$13\frac{1}{2}$	$8\frac{3}{4}$	54.2	101.5
$2\frac{1}{2}$	$12\frac{5}{8}$	$8\frac{3}{8}$	65.0	90.9	14	9	60.0	112.5

Safe Loads based on one-half Proof Test, or one-fourth of the approximate breaking load of chain.

BRIDGE PINS, NUTS AND PILOT NUTS.



All Threads 8 per inch.

Nominal Diameter of Pin.	Turned Diameter of Pin.	Diameter of Thread.	Short Diameter of Nut.	Long Diameter of Nut.	Diameter of Holes in Eye Bars.
	D	F	A	G	
Inches.	Inches.	Inches.	Inches.	Inches.	
1 1/2	1 7/8	1 1/4	2	2 5/8	D + 1/8
1 3/4	1 7/8	1 1/2	2 1/2	2 7/8	" + 1/8
2	1 7/8	1 1/2	2 1/2	2 7/8	" + 1/8
2 1/4	2 1/8	1 1/2	3	3 1/2	" + 1/8
2 1/2	2 1/8	2	3	3 1/2	" + 1/8
2 3/4	2 1/8	2	3 1/2	4 1/8	" + 1/8
3	2 1/8	2	3 1/2	4 1/8	" + 1/8
3 1/4	3 1/8	2 1/2	4	4 1/4	" + 1/8
3 1/2	3 1/8	2 1/2	4	4 1/4	" + 1/8
3 3/4	3 1/8	2 3/4	4 1/2	5 1/8	" + 1/8
4	3 1/8	3	4 1/2	5 1/8	" + 1/8
4 1/4	4 1/8	3 1/2	5	5 1/4	" + 1/8
4 1/2	4 1/8	3 1/2	5	5 1/4	" + 1/8
4 3/4	4 1/8	4	5 1/2	6 3/8	" + 1/8
5	4 1/8	4	5 1/2	6 3/8	" + 1/8
5 1/4	5 1/8	4	6	6 1/4	" + 1/8
5 1/2	5 1/8	4	6	6 1/4	" + 1/8
5 3/4	5 1/8	4	6 1/2	7 1/2	" + 1/8
6	5 1/8	4	6 1/2	7 1/2	" + 1/8
6 1/4	6 1/8	4	7	8 1/8	" + 1/8
6 1/2	6 1/8	4	7	8 1/8	" + 1/8
6 3/4	6 1/8	4	7 1/2	8 1/4	" + 1/8
7	6 1/8	4	7 1/2	8 1/4	" + 1/8

Allow 1/8" excess for each eye bar packed on the pin.

COLD ROLLED STEEL COTTER PINS.

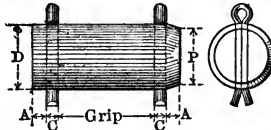

Dimensions of Pin in Inches.

Diameter of Pin.	D	1	1 1/4	1 1/2	1 3/4	2	2 1/4	2 1/2	2 3/4	3	3 1/4	3 1/2	3 3/4	4
Diameter of Reduced Point.	P	7/8	1 1/8	1 1/4	1 1/2	1 3/4	2	2 1/4	2 1/2	2 3/4	3	3 1/4	3 1/2	3 3/4
Lengths of Ends.	A	1/8	1/8	1/2	1/2	1/2	1/2	1/2	1/2	7/8	7/8	7/8	7/8	7/8
Diameter of Cotter.	C	1/8	1/8	1/8	1/8	3/8	3/8	3/8	3/8	1/2	1/2	1/2	1/2	1/2
Diameter of Pin Hole.		1 1/8	1 1/8	1 1/8	1 1/8	2 1/8	2 1/8	2 1/8	2 1/8	2 1/8	3 1/8	3 1/8	3 1/8	4 1/8

LATERAL PINS.

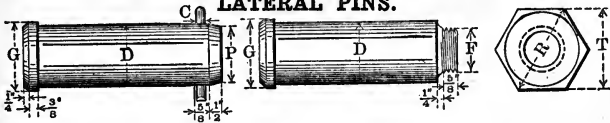

Rough Diameter of Pin.	Nominal Diameter of Pin.	Finished Diameter of Pin.	Reduced Point.	Short Diameter of Nut.	Long Diameter of Nut.	Diameter of Thread.	Diameter of Cotter Pin.
G	N	D	P	T	R	F	C
Inches.	Inches.	Inches.	Inches.	Inches.	Inches.	Inches.	Inch.
1 1/2	1 1/4	1 1/8	1	1 3/8	1 7/8	1	1/4
1 3/4	1 1/2	1 1/8	1 1/4	2	2 1/8	1 1/4	"
2	1 3/4	1 1/4	1 1/2	2 1/2	2 1/8	1 1/2	"
2 1/4	2	1 1/2	1 3/4	2 3/4	2 3/8	1 1/2	"
2 1/2	2 1/4	2 1/8	2	2 1/2	2 3/8	1 1/2	3/8
2 3/4	2 1/2	2 1/8	2 1/4	3 1/2	4 1/8	2	"
3	2 3/4	2 1/2	2 1/2	3 1/2	4 1/8	2	"
3 1/4	3	2 1/2	2 3/4	3 1/2	4 1/8	2	"
3 1/2	3 1/4	3 1/8	3	4 1/2	5 1/8	2 1/2	"
3 3/4	3 1/2	3 1/8	3 1/4	4 1/2	5 1/8	2 1/2	"
4	3 3/4	3 1/2	3 1/2	4 1/2	5 1/8	2 1/2	"

$D = G - \frac{1}{16}''$.

$P = N - \frac{1}{4}''$.

COUNTER AND LATERAL RODS.
SOLID OR UPSET EYES.

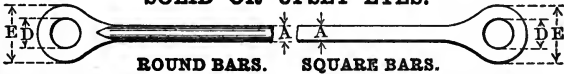

ROUND BARS.

SQUARE BARS.

Diameter of Bar.	Diameter of Largest Head.	Diameter of Largest Pin.	Add for One Head.	Side of Square Bar.	Diameter of Largest Head.	Diameter of Largest Pin.	Add for One Head.
A	E	D		A	E	D	
Inches.	Inches.	Inches.	Inches.	Inches.	Inches.	Inches.	Inches.
3/8	2 1/4	1 1/4	9	1	4 1/4	2 1/2	16
1	4 1/4	2 1/2	18	1 1/8	4 1/4	2 1/2	14
1 1/8	4 1/4	2 1/2	16	1 1/4	5	2 3/4	18 1/2
1 1/4	5	2 3/4	20 1/2	1 3/8	5	2 3/4	16 1/2
1 3/8	5	2 3/4	18 1/2	1 1/2	5 1/2	3	18
1 1/2	5 1/2	3	20	1 5/8	5 1/2	3	16 1/2
1 5/8	5 1/2	3	18 1/2	1 3/4	6	3 1/4	18
1 3/4	6	3 1/4	21	1 7/8	6	3 1/4	16 1/2
1 7/8	6	3 1/4	19 1/2	2	6 1/2	3 1/2	18 1/2
2	6 1/2	3 1/2	21 1/2	2 1/8	6 1/2	3 1/2	17
2 1/8	6 1/2	3 1/2	20	2 1/4	7 1/2	4	21 1/2
2 1/4	7 1/2	4	24 1/2	2 5/8	7 1/2	4	19 3/4
2 3/8	7 1/2	4	22 3/4	2 1/2	8	4	22 1/2
2 1/2	8	4	25 1/2	2 5/8	8	4	21
2 5/8	8	4	24	2 3/4	8	4	19 1/2
2 3/4	8	4	22 1/2	1 3/8	5 1/4	3 1/8	23
.....	1 1/4	5 1/2	3 1/8	23
.....	1 3/8	5 3/4	3 1/8	20
.....	1 1/2	6	3 1/8	20
.....	7/8	3 1/2	2 1/4
.....	1 1/8	4 1/2	2 1/2	18

For details of upset screw ends for round and square bars see pages 372 to 375.

COUNTER AND LATERAL RODS. LOOP WELDED EYES.

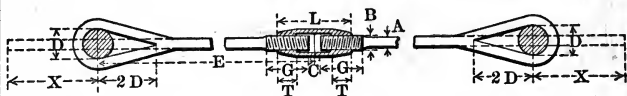

Additional length of bar beyond center of pin required to make eye for square or round bars.

Diameter or Side of Bar. Inches.	Diameter of Pin in Inches.										
	$\frac{3}{4}$	1	$1\frac{1}{4}$	$1\frac{1}{2}$	$1\frac{3}{4}$	2	$2\frac{1}{4}$	$2\frac{1}{2}$	$2\frac{3}{4}$	3	$3\frac{1}{4}$
$\frac{1}{2}$	$5\frac{3}{4}$	$6\frac{3}{4}$	$7\frac{1}{2}$	$8\frac{1}{2}$	$9\frac{1}{2}$	$10\frac{1}{4}$	$11\frac{1}{4}$	$12\frac{1}{4}$	$13\frac{1}{4}$	14	15
$\frac{2}{8}$	$6\frac{1}{4}$	$7\frac{1}{4}$	8	9	10	$10\frac{3}{4}$	$11\frac{3}{4}$	$12\frac{3}{4}$	$13\frac{1}{2}$	$14\frac{1}{2}$	$15\frac{1}{2}$
$\frac{3}{8}$	$6\frac{3}{4}$	$7\frac{1}{2}$	$8\frac{1}{2}$	$9\frac{1}{2}$	$10\frac{1}{4}$	$11\frac{1}{4}$	$12\frac{1}{4}$	$13\frac{1}{4}$	14	15	16
$\frac{4}{8}$	8	9	10	$10\frac{3}{4}$	$11\frac{3}{4}$	$12\frac{3}{4}$	$13\frac{1}{2}$	$14\frac{1}{2}$	$15\frac{1}{2}$	$16\frac{1}{2}$
1	$8\frac{1}{2}$	$9\frac{1}{2}$	$10\frac{1}{4}$	$11\frac{1}{4}$	$12\frac{1}{4}$	$13\frac{1}{4}$	14	15	16	$16\frac{3}{4}$
$1\frac{1}{8}$	10	$10\frac{3}{4}$	$11\frac{3}{4}$	$12\frac{3}{4}$	$13\frac{1}{2}$	$14\frac{1}{2}$	$15\frac{1}{2}$	$16\frac{1}{2}$	$17\frac{1}{4}$
$1\frac{1}{4}$	$10\frac{1}{4}$	$11\frac{1}{4}$	$12\frac{1}{4}$	$13\frac{1}{4}$	14	15	16	$16\frac{3}{4}$	$17\frac{3}{4}$
$1\frac{3}{8}$	$11\frac{3}{4}$	$12\frac{3}{4}$	$13\frac{1}{2}$	$14\frac{1}{2}$	$15\frac{1}{2}$	$16\frac{1}{2}$	$17\frac{1}{4}$	$18\frac{1}{4}$
$1\frac{1}{2}$	$12\frac{1}{4}$	$13\frac{1}{4}$	14	15	16	$16\frac{3}{4}$	$17\frac{3}{4}$	$18\frac{3}{4}$
$1\frac{5}{8}$	$13\frac{1}{2}$	$14\frac{1}{2}$	$15\frac{1}{2}$	$16\frac{1}{2}$	$17\frac{1}{4}$	$18\frac{1}{4}$	$19\frac{1}{4}$
$1\frac{3}{4}$	14	15	16	$16\frac{3}{4}$	$17\frac{3}{4}$	$18\frac{3}{4}$	$19\frac{1}{2}$
$1\frac{7}{8}$	$15\frac{1}{2}$	$16\frac{1}{2}$	$17\frac{1}{4}$	$18\frac{1}{4}$	$19\frac{1}{4}$	20
2	16	$16\frac{3}{4}$	$17\frac{3}{4}$	$18\frac{3}{4}$	$19\frac{1}{2}$	$20\frac{1}{2}$
$2\frac{1}{8}$	$17\frac{1}{4}$	$18\frac{1}{4}$	$19\frac{1}{4}$	$20\frac{1}{4}$	21
$2\frac{1}{4}$	18	$18\frac{3}{4}$	$19\frac{3}{4}$	$20\frac{3}{4}$	$21\frac{1}{2}$
$2\frac{3}{8}$	$19\frac{1}{4}$	$20\frac{1}{4}$	$21\frac{1}{4}$	22
$2\frac{1}{2}$	$19\frac{3}{4}$	$20\frac{3}{4}$	$21\frac{3}{4}$	$22\frac{3}{4}$
$2\frac{5}{8}$	$21\frac{1}{4}$	$22\frac{1}{4}$	$23\frac{1}{4}$
$2\frac{3}{4}$	$21\frac{3}{4}$	$22\frac{3}{4}$	$23\frac{3}{4}$
$2\frac{7}{8}$	$23\frac{1}{4}$	$24\frac{1}{4}$
3	$23\frac{3}{4}$	$24\frac{3}{4}$
$3\frac{1}{8}$	$25\frac{1}{4}$
$3\frac{1}{4}$	25

Length in inches beyond center of pin required to form one eye = X.

FORMULÆ: When $\frac{A}{2} =$ or < 1

$$X = 3.7 [D + A] + 1$$

When $\frac{A}{2} > 1$

$$X = 3.7 [D + A] + \frac{A}{2}$$

A = Side or Diameter of Bar.

D = Diameter of Pin.

Length of bar including amount required to form one eye = E - $\frac{1}{2}$ C + X.

COUNTER AND LATERAL RODS.

LOOP WELDED EYES.

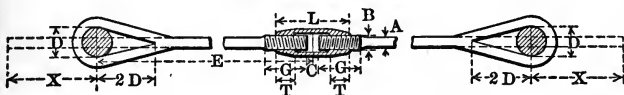

Additional length of bar beyond center of pin required to make eye for square or round bars.

Diameter or Side of Bar. Inches.	Diameter of Pin in Inches.										
	3½	3¾	4	4¼	4½	4¾	5	5¼	5½	5¾	6
½	16	16¾	17¾	18¾	19½	20½	21½	22½	23¼	24¼	25¼
5/8	16½	17¼	18¼	19¼	20	21	22	22¾	23¾	24¾	25¾
¾	16¾	17¾	18¾	19½	20½	21½	22½	23¼	24¼	25¼	26
7/8	17¼	18¼	19¼	20	21	22	22¾	23¾	24¾	25¾	26½
1	17¾	18¾	19½	20½	21½	22½	23¼	24¼	25¼	26	27
1¼	18¼	19¼	20	21	22	22¾	23¾	24¾	25¾	26½	27½
1½	18¾	19½	20½	21½	22½	23¼	24¼	25¼	26	27	28
1¾	19¼	20	21	22	22¾	23¾	24¾	25¾	26½	27½	28½
2	19½	20½	21½	22½	23¼	24¼	25¼	26	27	28	28¾
2¼	20	21	22	22¾	23¾	24¾	25¾	26½	27½	28½	29½
2½	20½	21½	22½	23¼	24¼	25¼	26	27	28	28¾	29¾
2¾	21	22	22¾	23¾	24¾	25¾	26½	27½	28½	29½	30¼
3	21½	22½	23¼	24¼	25¼	26	27	28	28¾	29¾	30¾
3¼	22	23	23¾	24¾	25¾	26½	27½	28½	29½	30¼	31¼
3½	22½	23½	24¼	25¼	26¼	27¼	28	29	30	30¾	31¾
3¾	23	24	25	25¾	26¾	27¾	28½	29½	30½	31¼	32¼
4	23½	24½	25½	26¼	27¼	28¼	29	30	31	32	32¾
4¼	24	25	26	26¾	27¾	28¾	29¾	30½	31½	32½	33¼
4½	24½	25½	26½	27½	28¼	29¼	30¼	31	32	33	33¾
4¾	25¼	26	27	28	28¾	29¾	30¾	31½	32½	33½	34½
5	25¾	26½	27½	28½	29¼	30¼	31¼	32¼	33	34	35
5¼	26¼	27	28	29	30	30¾	31¾	32¾	33½	34½	35½
5½	26¾	27¾	28½	29½	30½	31½	32½	33½	34	35	36
5¾	27¼	28¼	29	30	31	31¾	32¾	33¾	34¾	35½	36½
6	27¾	28¾	29½	30½	31½	32½	33¼	34¼	35¼	36	37

For additional length required to form upset end and details of same see tables of Upset Ends, pages 372 to 375 inclusive.

For details of Turnbuckles, see page 378.

For details of Right and Left Nuts, see page 379.

MISCELLANEOUS STEEL WIRE NAILS.

Approximate Number per Pound.

Washburn & Moen Gauge.	Diameter in Inches.	Length in Inches.												
		$\frac{3}{16}$	$\frac{1}{4}$	$\frac{5}{8}$	$\frac{1}{2}$	$\frac{5}{8}$	$\frac{3}{4}$	$\frac{7}{8}$	1	$1\frac{1}{8}$	$1\frac{1}{4}$	$1\frac{1}{2}$		
000	.362											28	23	
00	.331											33	27	
0	.307											38	32	
1	.283										57	50	45	38
2	.263										65	58	52	44
3	.244							100	87		76	67	60	50
4	.225							120	104		90	80	72	60
5	.207				211	169		141	121		106	94	85	71
6	.192				247	197		164	141		123	111	99	82
7	.177				299	239		200	171		149	133	120	100
8	.162				345	275		229	197		172	153	137	115
9	.148				414	331		276	236		207	184	165	138
10	.135			663	496	397		333	283		248	220	198	165
11	.120			837	628	502		418	359		314	279	251	209
12	.105			1096	822	658		548	469		411	365	329	274
13	.092			1429	1072	857		714	613		536	476	429	357
14	.080		2840	1893	1420	1136		947	811		710	631	568	473
15	.072		3504	2336	1752	1402	1168	1001	876		778	701	631	584
16	.063		4571	3048	2280	1828	1523	1305	1143		1015	913	831	761
17	.054		6233	4156	3116	2495	2077	1781	1558	1385	1246	1136	1038	1038
18	.047		8276	5517	4138	3310	2758	2364	2069	1839	1655	1539	1439	1379
19	.041		10668	7112	5334	4267	3556	2933	2667	2370	2133	1978	1839	1778
20	.035	20000	15000	10000	7500	6000	5000	4400	3750	3333	3000			
21	.032	23702	17777	11850	8888	7111	5926	5079	4444					
22	.028	30476	22856	15237	11428	9143	7618							

Washburn & Moen Gauge.	Diameter in Inches.	Length in Inches.															
		$1\frac{1}{4}$	2	$2\frac{1}{4}$	$2\frac{1}{2}$	$2\frac{3}{4}$	3	$3\frac{1}{2}$	4	$4\frac{1}{2}$	5	6	7	8	9	10	
000	.362	20	17	16	14	13	12	10	9	8	7	6	5	$4\frac{1}{2}$	4	$3\frac{1}{2}$	
00	.331	23	20	18	16	15	14	12	10	9	8	7	6	5	$4\frac{1}{2}$	4	
0	.307	27	24	21	19	17	16	14	12	10	9	8	7	6	5	$4\frac{1}{2}$	
1	.283	32	28	25	23	21	19	16	14	13	11	10	8	7	6	$5\frac{1}{2}$	
2	.263	37	32	29	26	24	22	19	16	14	13	11	9	8	7	$6\frac{1}{2}$	
3	.244	43	38	34	30	28	25	22	19	17	15	13	11	10	8	$7\frac{1}{2}$	
4	.225	51	45	40	36	33	30	26	23	20	18	15	13	11	10	9	
5	.207	60	53	47	42	39	35	30	26	24	21	18	15				
6	.192	71	62	55	50	45	41	35	31	28	25	21	18				
7	.177	85	75	67	60	54	50	43	37	33	30	25	21				
8	.162	98	86	76	69	62	57	49	43	39	35	29					
9	.148	118	103	92	82	75	69	59	52	46	41						
10	.135	142	124	110	99	90	83	71	62	55	50						
11	.120	179	157	139	125	114	105	90	79	70							
12	.105	235	204	182	164	149	137	117	103								
13	.092	306	268	238	214	195	178	153									
14	.080	406	350	315	284	258	236										
15	.072	500	438	389	350												
16	.063	653	571	508													
17	.054	890	779														
18	.047	1182															
												W. & M. Gauge.					
													11		12		
													000	$3\frac{1}{4}$	3		
													00	$3\frac{3}{4}$	$3\frac{1}{4}$		
													0	$4\frac{1}{4}$	4		
													1	5	$4\frac{1}{2}$		
													2	6	$5\frac{1}{2}$		

These approximate numbers are an average only, and the figures given may be varied either way, by changes in the dimensions of heads or points. Brads and no-head nails will have more to the pound than table shows, and large or thick-headed nails will have less.

CUT STEEL NAILS AND SPIKES.

Sizes, Lengths, and Approximate Number per Pound.

Sizes.	Length. Inches.	Common.	Clinch.	Finishing.	Casing and Box.	Fencing.	Spiques.
2d	1	740	400	1100			
3d	1¼	460	260	880			
4d	1½	280	180	530	420		
5d	1¾	210	125	350	300	100	
6d	2	160	100	300	210	80	
7d	2¼	120	80	210	180	60	
8d	2½	88	68	168	130	52	
9d	2¾	73	52	130	107	38	
10d	3	60	48	104	88	26	
12d	3¼	46	40	96	70	20	
16d	3½	33	34	86	52	18	17
20d	4	23	24	76	38	16	14
25d	4¼	20
30d	4½	16½	30	11
40d	5	12	26	9
50d	5½	10	20	7½
60d	6	8	16	6
	6½	5½
	7	5

Sizes.	Length. Inches.	Barrel.	Light Barrel.	Slating.	Sizes.	Length. Inches.	Flat Grip. Fine.	Edge Grip. Fine.
	⅝	750	¾	1462	
	¾	600	⅞	1300	
	⅞	500	2d	1	1100	960
2d	1	450	340	3d	1⅛	800	750
	1⅛	310	400	4d	1⅜	650	600
3d	1¼	280	304	280	Tobacco.		Brads.	Shingle.
	1½	210				
4d	1½	190	224	220				
5d	1¾	180				
6d	2			130	
				97	120
7d	2¼			85	94
8d	2½			68	74
9d	2¾			58	62
10d	3			48	50
12d	3¼	40
16d	3½	27

SQUARE BOAT SPIKES.
Approximate Number in a Keg of 200 Pounds.

Size. Inch.	Length of Spike—Inches.												
	3	4	5	6	7	8	9	10	11	12	14	16	
1/4	3000	2375	2050	1825									
5/16	1660	1360	1230	1175	990	880							
3/8	1320	1140	940	800	650	600	525	475					
7/16	600	590	510	400	360	320	280			
1/2	450	375	335	300	275	260	240			
5/8	260	240	220	205	190	175	160	

WROUGHT SPIKES.
Approximate Number in a Keg of 150 Pounds.

Size. Inch.	Length of Spike—Inches.												
	3	3 1/2	4	4 1/2	5	6	7	8	9	10	11	12	
1/4	2250	1890	1650	1464	1380	1292	1161						
5/16		1208	1135	1064	930	868	662	635	573				
3/8					742	570	482	455	424	391			
7/16							445	384	300	270	249	236	
1/2							306	256	240	222	203	180	

WOOD SCREWS.

Size Number.	Diameter. Inch.	Size Number.	Diameter. Inch.	Size Number.	Diameter. Inch.	Size Number.	Diameter. Inch.	Size Number.	Diameter. Inch.	Size Number.	Diameter. Inch.
0	.056	5	.122	10	.188	15	.255	20	.321	25	.387
1	.069	6	.135	11	.201	16	.268	21	.334	26	.401
2	.082	7	.149	12	.215	17	.281	22	.347	27	.414
3	.096	8	.162	13	.228	18	.293	23	.361	28	.427
4	.109	9	.175	14	.241	19	.308	24	.374	29	.440
										30	.453

RAILROAD SPIKES.

Size Measured Under Head. Inches.	Average Number per Keg of 200 Pounds	Quantity of Spikes per Mile of Single Track. Ties 2 feet c. to c. 4 Spikes per Tie.		Rail Used. Weight per Yard. Pounds.
		Pounds.	Kgs.	
5 1/2 x 5/8	300	7040	35 1/8	75 to 100
5 1/2 x 9/16	375	5870	29 1/3	45 " 75
5 x 9/16	400	5170	26	40 " 56
5 x 1/2	450	4660	23 1/3	35 " 40
4 1/2 x 1/2	530	3960	20	30 " 35
4 x 1/2	600	3520	17 2/3	25 " 35
4 1/2 x 7/16	680	3110	15 1/2	20 " 30
4 x 7/16	720	2910	14 3/4	20 " 30
3 1/2 x 7/16	900	2350	11	16 " 25
4 x 3/8	1000	2090	10 1/2	16 " 25
3 1/2 x 3/8	1190	1780	9	16 " 20
3 x 3/8	1240	1710	8 1/2	16 " 20
2 1/2 x 3/8	1342	1575	7 1/8	12 " 16

DIMENSIONS, WEIGHTS AND PROPERTIES OF STANDARD PIPE.

Diameter in Inches.			Weight per Foot. Pounds.	Moment of Inertia. Inches. ⁴	Section Modulus. Inches. ³	Radius of Gyration. Inches.
Nominal.	External.	Internal.				

BLACK OR GALVANIZED STANDARD WEIGHT PIPE.

1/8	.405	.269	.244	.001	.005	.12
1/8	.540	.364	.424	.003	.012	.16
1/4	.675	.493	.567	.007	.022	.21
1/4	.840	.622	.850	.017	.041	.26
3/8	1.050	.824	1.130	.037	.071	.33
1	1.315	1.049	1.678	.09	.13	.42
1 1/4	1.660	1.380	2.272	.19	.23	.54
1 1/2	1.900	1.610	2.717	.31	.36	.62
2	2.375	2.067	3.652	.67	.56	.79
2 1/2	2.875	2.469	5.793	1.53	1.06	.95
3	3.500	3.068	7.575	3.02	1.72	1.16
3 1/2	4.000	3.548	9.109	4.79	2.39	1.34
4	4.500	4.026	10.790	7.23	3.21	1.51
4 1/2	5.000	4.506	12.538	10.4	4.2	1.68
5	5.563	5.047	14.617	15.2	5.5	1.88
6	6.625	6.065	18.974	28.1	8.5	2.25
7	7.625	7.023	23.544	46.5	12.2	2.59
8	8.625	8.071	24.696	63.4	14.7	3.31
8	8.625	7.981	28.554	72.5	16.8	2.94
9	9.625	8.941	33.907	107.6	22.4	3.28
10	10.750	10.192	31.201	125.9	23.4	3.70
10	10.750	10.020	40.483	160.9	29.9	3.67
10	10.750	10.136	34.240	137.1	25.5	3.69
11	11.750	11.000	45.557	217.0	36.9	4.02
12	12.750	12.090	43.773	248.5	40.0	3.91
12	12.750	12.000	49.562	285.4	44.7	4.38
13	14.00	13.25	54.568	372.8	53.3	4.82
14	15.00	14.25	58.573	461.0	61.5	5.23
15	16.00	15.25	62.579	562.0	70.3	5.53

STANDARD EXTRA STRONG PIPE.

1/8	.405	.215	.314	.001	.006	.11
1/8	.540	.302	.535	.004	.014	.15
1/4	.675	.423	.738	.009	.026	.20
1/4	.840	.546	1.087	.020	.048	.25
3/8	1.050	.742	1.473	.045	.085	.32

**DIMENSIONS, WEIGHTS AND PROPERTIES
OF STANDARD PIPE (CONTINUED).**

Diameter in Inches.			Weight per Foot. Pounds.	Moment of Inertia. Inches. ⁴	Section Modulus. Inches. ³	Radius of Gyration. Inches.
Nominal.	External.	Internal.				

STANDARD EXTRA STRONG PIPE (CONTINUED).

1	1.315	.957	2.171	.11	.16	.41
1 $\frac{1}{4}$	1.660	1.278	2.996	.24	.29	.52
1 $\frac{1}{2}$	1.900	1.500	3.631	.39	.46	.61
2	2.375	1.939	5.022	.87	.73	.77
2 $\frac{1}{2}$	2.875	2.323	7.661	1.92	1.34	.92
3	3.500	2.900	10.252	3.89	2.23	1.14
3 $\frac{1}{2}$	4.000	3.364	12.505	6.28	3.14	1.29
4	4.500	3.826	14.983	9.6	4.3	1.48
4 $\frac{1}{2}$	5.000	4.290	17.611	14.1	5.6	1.65
5	5.563	4.813	20.778	20.7	7.4	1.84
6	6.625	5.761	28.573	40.5	12.2	2.19
7	7.625	6.625	38.048	71.4	18.7	2.53
8	8.625	7.625	43.388	105.7	24.5	2.88
9	9.625	8.625	48.728	149.4	31.0	3.23
10	10.750	9.75	54.735	212.0	39.3	3.63
11	11.750	10.75	60.075	280.1	47.7	3.98
12	12.750	11.75	65.415	360.7	56.6	4.33

STANDARD DOUBLE EXTRA STRONG PIPE.

1 $\frac{1}{4}$.840	.252	1.714	.024	.058	.22
1 $\frac{1}{2}$	1.050	.434	2.440	.058	.110	.28
1	1.315	.599	3.659	.14	.21	.36
1 $\frac{1}{4}$	1.660	.896	5.214	.34	.41	.47
1 $\frac{1}{2}$	1.900	1.100	6.408	.57	.67	.55
2	2.375	1.503	9.029	1.31	1.10	.70
2 $\frac{1}{2}$	2.875	1.771	13.695	2.87	2.00	.84
3	3.500	2.300	18.583	6.0	3.4	1.05
3 $\frac{1}{2}$	4.000	2.728	22.850	9.8	4.9	1.21
4	4.500	3.152	27.541	15.3	6.8	1.37
4 $\frac{1}{2}$	5.000	3.580	32.530	22.6	9.0	1.54
5	5.563	4.063	38.552	33.7	12.3	1.72
6	6.625	4.897	53.160	66.3	20.0	2.08
7	7.625	5.875	62.079	107.5	28.2	2.41
8	8.625	6.875	72.424	162.0	37.6	2.76

WROUGHT IRON WELDED STEAM, GAS AND WATER PIPE.

DIAMETER.			Thickness.	Weight per Foot.	CIRCUMFERENCE.		Lineal Feet to 1 Sq.	
Nominal.	Inside.	Outside.			Internal.	External.	Ft. Surface.	
Inches.	Inches.	Inches.	Inches.	Pounds.	Inches.	Inches.	Inside.	Outside.
1/8	.269	.405	.068	.244	.85	1.27	14.13	9.45
1/4	.364	.540	.088	.424	1.14	1.70	10.52	7.06
3/8	.493	.675	.091	.567	1.55	2.12	7.74	5.66
1/2	.622	.840	.109	.850	1.95	2.64	6.15	4.55
3/4	.824	1.050	.113	1.130	2.59	3.30	4.63	3.64
1	1.049	1.315	.133	1.678	3.30	4.13	3.64	2.91
1 1/4	1.380	1.660	.140	2.272	4.34	5.22	2.77	2.30
1 1/2	1.610	1.900	.145	2.717	5.06	5.97	2.37	2.01
2	2.067	2.375	.154	3.652	6.49	7.46	1.85	1.61
2 1/2	2.469	2.875	.203	5.793	7.76	9.03	1.55	1.33
3	3.068	3.500	.216	7.575	9.64	11.00	1.24	1.09
3 1/2	3.548	4.000	.226	9.109	11.15	12.57	1.08	.95
4	4.026	4.500	.237	10.790	12.65	14.14	.95	.85
4 1/2	4.506	5.000	.247	12.538	14.16	15.71	.85	.76
5	5.047	5.563	.258	14.617	15.86	17.48	.76	.69
6	6.065	6.625	.280	18.974	19.05	20.81	.63	.58
7	7.023	7.625	.301	23.544	22.06	23.95	.54	.50
8	8.071	8.625	.277	24.696	25.36	27.10	.47	.44
8	7.981	8.625	.322	28.554	25.07	27.10	.48	.44
9	8.941	9.625	.342	33.907	28.09	30.24	.43	.40
10	10.192	10.750	.279	31.201	32.02	33.77	.37	.36
10	10.136	10.750	.307	34.240	31.84	33.77	.38	.36
10	10.020	10.750	.365	40.483	31.48	33.77	.38	.36
11	11.000	11.750	.375	45.557	34.56	36.91	.35	.33
12	12.090	12.750	.330	43.773	37.98	40.06	.32	.30
12	12.000	12.750	.375	49.562	37.70	40.06	.32	.30
13	13.250	14.000	.375	54.568	41.63	43.98	.29	.27
14	14.250	15.000	.375	58.573	44.77	47.12	.27	.25
15	15.250	16.000	.375	62.579	47.91	50.27	.25	.24

Nominal Diameter.	AREA.		Lineal Feet containing 1 Cubic Foot.	No. of Threads per Inch.	Contents to 1 Lineal Foot.	COUPLINGS FOR PIPE.	
	Internal.	External.				Lineal Foot.	Length.
Inches.	Sq. Inches.	Sq. Inches.			Gallons.	Inches.	Inches.
1/8	.06	.13	2540.00	27	.003	.59	.81
1/4	.10	.23	1384.00	18	.005	.72	.94
3/8	.19	.36	754.40	18	.010	.84	1.06
1/2	.30	.55	473.90	14	.016	1.00	1.31
3/4	.53	.87	270.00	14	.028	1.33	1.56
1	.87	1.35	166.60	11 1/2	.045	1.56	1.81
1 1/4	1.50	2.16	96.28	11 1/2	.078	1.95	2.13
1 1/2	2.04	2.84	70.73	11 1/2	.106	2.22	2.38
2	3.35	4.43	42.91	11 1/2	.174	2.75	2.63
2 1/2	4.78	6.49	30.08	8	.249	3.28	2.88
3	7.38	9.62	19.48	8	.380	3.94	3.13
3 1/2	9.88	12.57	14.57	8	.514	4.44	3.63
4	12.72	15.90	11.31	8	.661	5.00	3.63
4 1/2	15.93	19.63	9.03	8	.828	5.50	3.63
5	19.99	24.30	7.20	8	1.040	6.22	4.13
6	28.87	34.47	4.98	8	1.500	7.31	4.13
7	38.71	45.66	3.72	8	2.010	8.31	4.13
8	51.16	58.43	2.82	8	2.660	9.31	4.63
8	50.03	58.43	2.88	8	2.610	9.31	4.63
9	62.79	72.76	2.29	8	3.260	10.38	5.13
10	81.47	90.76	1.77	8	4.230	11.66	6.13
10	80.33	90.76	1.78	8	4.190	11.66	6.13
10	78.86	90.76	1.83	8	4.100	11.66	6.13
11	95.03	108.43	1.52	8	4.940	12.66	6.13
12	114.63	127.68	1.25	8	5.960	13.88	6.13
12	113.10	127.68	1.27	8	5.880	13.88	6.13
13	137.89	153.94	1.04	8	7.160	15.06	6.13
14	159.48	176.71	.90	8	8.280	16.38	6.13
15	182.65	201.06	.79	8	9.490	17.38	6.13

MANUFACTURERS' STANDARD SPECIFICATIONS.

REVISED APRIL 22, 1919

STRUCTURAL STEEL.**Grades.**

1. These specifications cover three classes of structural steel, namely:

Class A steel, to be used for railway bridges and ships.

Class B steel, to be used for buildings, highway bridges, train sheds and similar structures.

Class C steel, to be used for structural rivets.

I. MANUFACTURE.**Process.**

2. Steel for Classes A and C shall be made by the open-hearth process. Steel for Class B may be made either by the open-hearth or by the Bessemer process.

II. CHEMICAL PROPERTIES AND TESTS.**Chemical Composition.**

3. The steel shall conform to the following requirements as to chemical composition:

Elements Considered.	Class A Steel.	Class B Steel.	Class C Steel.
Phosphorus, max., per cent.:			
Basic open hearth.....	0.04	0.06	0.04
Acid open hearth.....	0.06	0.08	0.04
Bessemer.....	0.10
Sulphur, max., per cent.....	0.06	0.05

Ladle Analyses.

4. To determine whether the material conforms to the requirements specified in section 3, an analysis shall be made by the manufacturer from a test ingot taken during the pouring of each melt. A copy of this analysis shall be given to the purchaser or his representative, if requested.

Check Analyses.

5. A check analysis of Class A and Class C steel may be made by the purchaser from finished material representing each melt, in which case an excess of 25 per cent. above the requirements specified in section 3 shall be allowed.

III. PHYSICAL PROPERTIES AND TESTS.

Tension Tests.

6. The steel shall conform to the following requirements as to tensile properties:

Properties Considered.	Class A Steel.	Class B Steel.	Class C Steel.
Tensile strength, lb. per sq. in.	55,000-65,000	55,000-65,000*	46,000-56,000
Yield point, minimum, lb. per sq. in.	0.5 tens. str.	0.5 tens. str.	0.5 tens. str.
Elongation in 8 in., min., per cent.	<u>1,400,000</u> † tens. str.	<u>1,400,000</u> † tens. str.	<u>1,400,000</u> tens. str.
Elongation in 2 in., min., per cent. (Fig. 2).....	22	22

* See section 8. † See section 9.

Yield Point.

7. The yield point shall be determined by the drop of the beam of the testing machine.

Modification in Tensile Strength.

8. Class B steel may have tensile strength up to 70,000 lb. maximum, provided the elongation is not less than the percentage required for 65,000 lb. tensile strength.

Modifications in Elongation.

9. (a) For material over $\frac{3}{4}$ in. in thickness, a deduction of 1 from the percentage of elongation in 8 in. specified for Classes A and B in section 6 shall be made for each increase of $\frac{1}{8}$ in. in thickness above $\frac{3}{4}$ in., to a minimum of 18 per cent.

(b) For material under $\frac{5}{16}$ in. in thickness, a deduction of 2.5 from the percentage of elongation in 8 in. specified for Classes A and B in section 6 shall be made for each decrease of $\frac{1}{16}$ in. in thickness below $\frac{5}{16}$ in.

Character of Fracture.

10. All broken tension test specimens shall show a silky fracture.

Bend Tests.

11. (a) The test specimen for plates, shapes and bars shall bend cold through 180 deg. without fracture on the outside of the bent portion, as follows: For material $\frac{3}{4}$ in. and under in thickness, flat on itself; for material over $\frac{3}{4}$ in. up to $1\frac{1}{4}$ in. in thickness, around a pin the diameter of which is equal to $1\frac{1}{2}$ times the thickness of the specimen; and for material over $1\frac{1}{4}$ in. in thickness, around a pin the diameter of which is equal to twice the thickness of the specimen.

- (b) The test specimen for pins and rollers shall bend cold through 180 deg. around a 1-in. pin without fracture on the outside of the bent portion.
- (c) A rivet rod shall bend cold through 180 deg. flat on itself without fracture on the outside of the bent portion.
- (d) Bend tests may be made by pressure or by blows.

Test Specimens.

12. (a) Tension and bend test specimens shall be taken from the finished rolled or forged product, and shall not be annealed or otherwise treated, except as specified in section 13.

(b) Tension and bend test specimens for plates, shapes and bars, except as specified in paragraph (c), shall be of the full thickness of material as rolled, and with both edges milled to the form and dimensions shown in Fig. 1, or may have both edges parallel.

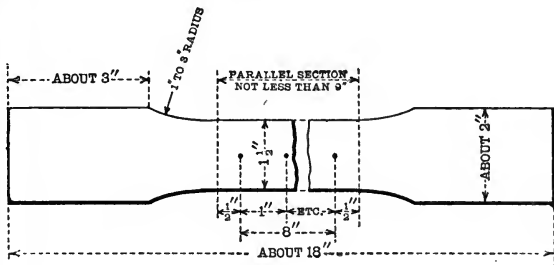

FIG. 1.

(c) Tension and bend test specimens for plates and bars (except eye-bar flats) over $1\frac{1}{2}$ in. in thickness or diameter may be turned or planed to a diameter or thickness of at least $\frac{3}{4}$ in. for a length of at least 9 in.

(d) Tension and bend test specimens for pins and rollers shall be taken parallel to the axis, 1 in. from the surface of the bar. Tension test specimens shall be of the form and dimensions shown in Fig. 2. Bend test specimens shall be 1 in. by $\frac{1}{2}$ in. in section.

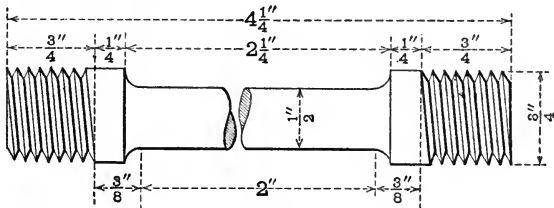

FIG. 2.

(e) Rivet bars shall be tested in full-size section as rolled.

Annealed Specimens.

13. Test specimens for material which is to be annealed or otherwise treated before use shall be cut from properly annealed or similarly treated short lengths of the full section of the piece.

Number of Tests.

14. (a) At least one tension test and one bend test shall be made from each melt. If material from one melt differs $\frac{3}{8}$ in. or more in thickness, tests shall be made from both the thickest and the thinnest material rolled.

(b) If any test specimen develops flaws, or if an 8-in. tension test specimen breaks outside the middle third of the gage length, or if a 2-in. tension test specimen breaks outside the gage length, it may be discarded and another specimen substituted therefor.

(c) Material intended for fillers or ornamental purposes will not be subject to test.

IV. PERMISSIBLE VARIATIONS IN WEIGHT AND GAGE.**Permissible Variations.**

15. (a) The sectional area or weight of each structural shape and of each rolled-edge plate up to and including 36 inches in width shall not vary more than 2.5 per cent. from theoretical or specified amounts.

(b) The thickness or weight of each universal plate over 36 in. in width, and of each sheared plate, shall conform to the schedules of permissible variations for sheared plates, Manufacturers' Standard Practice, appended to these specifications.

(c) The weights of angles, tees, zees and channels of bar sizes, and the dimensions of rounds, squares, hexagons and flats, shall conform to the Manufacturers' Standard Practice governing the allowable variations in size and weight of hot-rolled bars.

V. FINISH.**Finish.**

16. The finished material shall be free from injurious defects and shall have a workmanlike finish.

VI. MARKING.**Marking.**

17. The name of the manufacturer and the melt number shall be legibly marked, stamped or rolled upon all finished material, except that each pin and roller shall be stamped on the end. Rivet and lattice steel and other small pieces may be shipped in securely fastened bundles, with the above marks legibly stamped on attached metal tags. Test specimens shall have their melt numbers plainly marked or stamped.

VII. INSPECTION AND REJECTION.**Inspection.**

18. The inspector representing the purchaser shall have free entry, at all times while work on the contract of the purchaser is being performed, to all parts of the manufacturer's works which concern the manufacture of the

material ordered. The manufacturer shall afford the inspector, free of cost, all reasonable facilities to satisfy him that the material is being furnished in accordance with these specifications. All tests and inspection shall be made at the place of manufacture prior to shipment, and shall be so conducted as not to interfere unnecessarily with the operation of the works.

Rejection.

19. Material which, subsequent to the above tests at the mills and its acceptance there, develops weak spots, brittleness, cracks or other imperfections, or is found to have injurious defects, may be rejected at the shop, and shall then be replaced by the manufacturer at his own cost.

BOILER STEEL.

Grades.

1. There shall be three grades of steel for boilers, namely: flange, firebox, and boiler rivet.

I. MANUFACTURE.

Process.

2. The steel shall be made by the open-hearth process.

II. CHEMICAL PROPERTIES AND TESTS.

Chemical Composition.

3. The steel shall conform to the following requirements as to chemical composition:

Elements Considered.	Flange Steel.	Firebox Steel.	Boiler Rivet Steel.
Manganese, per cent.	0.30 to 0.60	0.30 to 0.50	0.30 to 0.50
Phosphorus, max., per cent.:			
Basic.....	0.04	0.035	0.04
Acid.....	0.05	0.04	0.04
Sulphur, max., per cent.....	0.05	0.04	0.045

Ladle Analyses.

4. To determine whether the material conforms to the requirements specified in section 3, an analysis shall be made by the manufacturer from a test ingot taken during the pouring of each melt. A copy of this analysis shall be given to the purchaser or his representative.

Check Analyses.

5. A check analysis may be made by the purchaser from a broken tension test specimen representing each plate as rolled, and this analysis shall conform to the requirements specified in section 3.

III. PHYSICAL PROPERTIES AND TESTS.

Tension Tests.

6. The steel shall conform to the following requirements as to tensile properties:

Properties Considered.	Flange Steel.	Firebox Steel.	Boiler Rivet Steel.
Tensile strength, lb. per sq. in.....	55,000-65,000	52,000-60,000	45,000-55,000
Yield point, min., lb. per sq. in.....	0.5 tens. str.	0.5 tens. str.	0.5 tens. str.
Elongation in 8 in., min., per cent.....	<u>1,450,000*</u> tens. str.	<u>1,450,000*</u> tens. str.	<u>1,450,000</u> tens. str.

* See section 8.

Yield Point.

7. The yield point shall be determined by the drop of the beam of the testing machine.

Modifications in Elongation.

8. (a) For plates over $\frac{3}{4}$ in. in thickness, a deduction of 0.5 from the specified percentage of elongation will be allowed for each increase of $\frac{1}{8}$ in. in thickness above $\frac{3}{4}$ in., to a minimum of 20 per cent.

(b) For plates under $\frac{1}{8}$ in. in thickness, a deduction of 2.5 from the percentage of elongation specified in section 6 shall be made for each decrease of $\frac{1}{8}$ in. in thickness below $\frac{1}{8}$ in.

Bend Tests.

9. (a) Cold-bend tests shall be made on the material as rolled.

(b) Quench-bend test specimens, before bending, shall be heated to a light cherry red as seen in the dark (about 1200 deg. F.), and quenched in water the temperature of which is about 80 deg. F.

(c) Specimens for cold-bend and quench-bend tests of flange and firebox steel shall bend through 180 deg. without fracture on the outside of the bent portion, as follows: For material $\frac{3}{4}$ in. and under in thickness, flat on themselves; for material over $\frac{3}{4}$ in. up to $1\frac{1}{4}$ in. in thickness, around a pin the diameter of which is equal to the thickness of the specimen; and for material over $1\frac{1}{4}$ in. in thickness, around a pin the diameter of which is equal to $1\frac{1}{2}$ times the thickness of the specimen.

(d) Specimens for cold-bend and quench-bend tests of boiler rivet steel shall bend cold through 180 deg. flat on themselves without fracture on the outside of the bent portion.

(e) Bend tests may be made by pressure or by blows.

Test Specimens.

10. (a) Tension and bend test specimens for plates shall be taken from the finished product, and shall be of the full thickness of material as rolled. Tension test specimens shall be of the form and dimensions shown in Fig. 1. Bend test specimens shall be $1\frac{1}{2}$ in. to $2\frac{1}{2}$ in. wide, and shall have the sheared edges milled or planed.

(b) The tension and bend test specimens for rivet bars shall be of the full-size section of material as rolled.

Number of Tests.

11. (a) One tension, one cold-bend, and one quench-bend test shall be made from each plate as rolled.

(b) Two tension, two cold-bend, and two quench-bend tests shall be made for each melt of rivet steel.

(c) If any test specimen develops flaws, or if a tension test specimen breaks outside the middle third of the gage length, it may be discarded and another specimen substituted therefor.

IV. PERMISSIBLE VARIATIONS IN WEIGHT AND GAGE.**Permissible Variations.**

12. (a) The thickness or weight of each sheared plate shall conform to the schedule of permissible variations, Manufacturers' Standard Practice, appended to these specifications.

(b) The dimensions of rivet bars shall conform to the Manufacturers' Standard Practice governing allowable variations in the size of hot-rolled bars.

V. FINISH.**Finish.**

13. The finished material shall be free from injurious defects and shall have a workmanlike finish.

VI. MARKING.**Marking.**

14. The melt or slab number, name of the manufacturer, grade, and the minimum tensile strength for its grade as specified in section 6 shall be legibly stamped on each plate. The melt or slab number shall be legibly stamped on each test specimen representing that melt or slab.

VII. INSPECTION AND REJECTION.**Inspection.**

15. The inspector representing the purchaser shall have free entry, at all times while work on the contract of the purchaser is being performed, to all parts of the manufacturer's works which concern the manufacture of the material ordered. The manufacturer shall afford the inspector, free of cost, all reasonable facilities to satisfy him that the material is being furnished in accordance with these specifications. All tests and inspection shall be made at the place of manufacture prior to shipment, and shall be so conducted as not to interfere unnecessarily with the operation of the works.

Rejection.

16. Material which, subsequent to the above tests at the mills and its acceptance there, develops weak spots, brittleness, cracks or other imperfections, or is found to have injurious defects, may be rejected at the shop, and shall then be replaced by the manufacturer at his own cost.

MANUFACTURERS' STANDARD PRACTICE.

PERMISSIBLE VARIATIONS IN WEIGHT AND THICKNESS OF SHEARED PLATES.

WHEN ORDERED TO WEIGHT.

One cubic inch of rolled steel is assumed to weigh 0.2833 pound.

When ordered to weight per square foot, the weight of each lot* in each shipment shall not vary from the weight ordered more than the amount given in the following table:

Ordered Weight Lbs. per Sq. Ft.	Permissible Variations in Average Weights per Square Foot of Plates for Widths Given, Expressed in Percentages of Ordered Weights.									
	Under 48 In.		48 in. incl. to 60 in. excl.		60 in. incl. to 72 in. excl.		72 in. incl. to 84 in. excl.		84 in. incl. to 96 in. excl.	
	Over.	Under.	Over.	Under.	Over.	Under.	Over.	Under.	Over.	Under.
Under 5	5	3	5.5	3	6	3	7	3
5 incl. to 7.5 excl.	4.5	3	5	3	5.5	3	6	3
7.5 " " 10 "	4	3	4.5	3	5	3	5.5	3	6	3
10 " " 12.5 "	3.5	2.5	4	3	4.5	3	5	3	5.5	3
12.5 " " 15 "	3	2.5	3.5	2.5	4	3	4.5	3	5	3
15 " " 17.5 "	2.5	2.5	3	2.5	3.5	2.5	4	3	4.5	3
17.5 " " 20 "	2.5	2	2.5	2.5	3	2.5	3.5	2.5	4	3
20 " " 25 "	2	2	2.5	2	2.5	2.5	3	2.5	3.5	2.5
25 " " 30 "	2	2	2	2	2.5	2	2.5	2.5	3	2.5
30 " " 40 "	2	2	2	2	2	2	2.5	2	2.5	2.5
40 or over	2	2	2	2	2	2	2	2	2.5	2

NOTE:—The weight per square foot of individual plates shall not vary from the ordered weight by more than $1\frac{1}{2}$ times the amount given in this table.

* The term "lot" applied to this table means all of the plates of each group width and group weight.

MANUFACTURERS' STANDARD PRACTICE.

**PERMISSIBLE VARIATIONS IN WEIGHT AND THICKNESS
OF SHEARED PLATES.**

WHEN ORDERED TO WEIGHT.

One cubic inch of rolled steel is assumed to weigh 0.2833 pound.

When ordered to weight per square foot, the weight of each lot* in each shipment shall not vary from the weight ordered more than the amount given in the following table:

Permissible Variations in Average Weights per Square Foot of Plates for Widths Given, Expressed in Percentages of Ordered Weights.								Ordered Weight Lbs. per Sq. Ft.
96 in. incl. to 108 in. excl.		108 in. incl. to 120 in. excl.		120 in. incl. to 132 in. excl.		132 in. or over.		
Over.	Under.	Over.	Under.	Over.	Under.	Over.	Under.	
.....	Under 5
.....	5 incl. to 7.5 excl.
7	3	8	3	7.5 " " 10 "
6	3	7	3	8	3	9	3	10 " " 12.5 "
5.5	3	6	3	7	3	8	3	12.5 " " 15 "
5	3	5.5	3	6	3	7	3	15 " " 17.5 "
4.5	3	5	3	5.5	3	6	3	17.5 " " 20 "
4	3	4.5	3	5	3	5.5	3	20 " " 25 "
3.5	3	4	3	4.5	3	5	3	25 " " 30 "
3	2.5	3.5	3	4	3	4.5	3	30 " " 40 "
2.5	2.5	3	2.5	3.5	3	4	3	40 or over

NOTE:—The weight per square foot of individual plates shall not vary from the ordered weight by more than 1½ times the amount given in this table.

* The term "lot" applied to this table means all of the plates of each group width and group weight.

MANUFACTURERS' STANDARD PRACTICE.

PERMISSIBLE VARIATIONS IN WEIGHT AND THICKNESS OF SHEARED PLATES (CONTINUED).

WHEN ORDERED TO THICKNESS.

One cubic inch of rolled steel is assumed to weigh 0.2833 pound.

When ordered to thickness, the thickness of each plate shall not vary more than 0.01 inch under that ordered. The overweight of each lot* in each shipment shall not exceed the amount given in the following table:

Ordered Thickness Inch.	Permissible Excess in Average Weights Per Square Foot of Plates for Widths Given, Expressed in Percentages of Nominal Weights.								
	Under 48 in.	48 in. incl. to 60 in. excl.	60 in. incl. to 72 in. excl.	72 in. incl. to 84 in. excl.	84 in. incl. to 96 in. excl.	96 in. incl. to 108 in. excl.	108 in. incl. to 120 in. excl.	120 in. incl. to 132 in. excl.	132 in. or over
Under $\frac{1}{8}$	9	10	12	14					
$\frac{1}{8}$ incl. to $\frac{3}{8}$ excl.	8	9	10	12					
$\frac{3}{8}$ " " $\frac{1}{4}$ "	7	8	9	10	12				
$\frac{1}{4}$ " " $\frac{5}{8}$ "	6	7	8	9	10	12	14	16	19
$\frac{5}{8}$ " " $\frac{3}{8}$ "	5	6	7	8	9	10	12	14	17
$\frac{3}{8}$ " " $\frac{7}{8}$ "	4.5	5	6	7	8	9	10	12	15
$\frac{7}{8}$ " " $\frac{1}{2}$ "	4	4.5	5	6	7	8	9	10	13
$\frac{1}{2}$ " " $\frac{5}{8}$ "	3.5	4	4.5	5	6	7	8	9	11
$\frac{5}{8}$ " " $\frac{3}{4}$ "	3	3.5	4	4.5	5	6	7	8	9
$\frac{3}{4}$ " " 1 "	2.5	3	3.5	4	4.5	5	6	7	8
1 or over	2.5	2.5	3	3.5	4	4.5	5	6	7

* The term "lot" applied to this table means all of the plates of each group width and group thickness.

WOODEN BEAMS AND COLUMNS.

The results of a series of studies of wooden beams and columns of various kinds of American timber are contained in the Proceedings of the Fifth Annual Convention of the Association of Railway Superintendents of Bridges and Buildings, October, 1895, at which the Committee on Strength of Bridge and Trestle Timbers presented a report, portions of which have been used in preparing certain of the tables on the following pages, but as noted thereon the arrangement and values in many cases have been modified by later information from various sources.

The publications of the Forestry Division of the United States Department of Agriculture, Bulletins Nos. 8 and 12, and Circular No. 15, contain reports of tests of American woods, and deductions drawn therefrom. Extracts and tables from these reports are given on the following pages.

The tables of safe loads for wooden beams and tables of strength of wooden columns given on the following pages have been specially calculated for this book, using the information regarding the properties of the various species contained in the reports above referred to, as modified in some cases by later data.

In order that information on this subject will be more complete, tables are given herein showing structural timber stress values, as published in the United States Forestry Service Bulletin, No. 108, and also those recommended by the American Railway Engineering and Maintenance of Way Association, Bulletin No. 107.

Explanation of the Tables of Safe Loads in Pounds, Uniformly Distributed, for Rectangular Wooden Beams One Inch Thick, Pages 416 to 421 Inclusive.

General.

For convenience in use, three of these tables have been prepared from which the safe loads of the various species can be obtained, either directly or by proportion as stated in the footnotes.

The values given in the tables are the safe loads in pounds uniformly distributed, including the weight of the beam itself, for rectangular beams one inch thick for spans from four to forty feet and for depths from four to twenty-four inches. The safe load for a beam of any thickness may be found by multiplying the values given in the tables by the thickness of the beam in inches.

The last column of each of the three Tables of Safe Loads for

Rectangular Wooden Beams gives a coefficient of deflection, by means of which the deflection for any beam may be obtained, corresponding to the given span and safe load, by dividing the coefficient by the depth of the beam in inches, which will give approximately the deflection in inches under the given conditions.

In each table the deflection coefficient is given for only one species of wood, as shown, but the deflections for other species may be obtained from these by proportion as explained hereafter.

For the reason that wood has no well-defined limit or modulus of elasticity the deflections obtained by the use of the coefficients are only approximate and will vary, according to the moisture content of the wood and the character of the loading. The deflections thus obtained are, therefore, useful only as a general indication of the amount of bending to be expected under the given conditions and are not exact as in the case of materials like steel, which has a well-defined limit and modulus of elasticity.*

The safe loads for other species of woods than those stated in the headings of the tables may be obtained from those given, by direct proportion, dependent upon the ratio of their allowable unit stress as compared with that for which the table is figured, as stated in the foot-notes at the bottom of the tables.

* NOTE.—“A series of tests, undertaken at the College of Forestry at Cornell University, seems to demonstrate that, at least in coniferous wood, a definite elastic limit for any particular piece can be easily shown, and, that it coincides with the theoretically calculated elastic limit upon the bases of compression tests and their application, according to Neely's formula.”

Explanation of the Table of Safe Loads for Rectangular Beams of White Pine, Cedar, Spruce or Eastern Fir.

The values for the various species of woods, which are included in this table are calculated for an allowable fibre stress, for flexure, of 700 pounds per square inch.

The deflection coefficients are given for white pine and are based upon a modulus of elasticity of 1 000 000 pounds per square inch.

The lower dotted line crossing the table indicates the limits of spans for which the deflection will exceed $\frac{1}{80}$ of the span for the kind of wood for which the deflection coefficient is given. For spans below the line the safe loads given in the tables will produce a deflection greater than $\frac{1}{80}$ of the span, while those above the line will produce less than this, which is the usual limit of deflection in order to prevent cracking of plastered ceilings. Similarly,

the upper dotted line indicates the limit of deflection for the kind of wood for which the deflection coefficient is given, corresponding to a modulus of elasticity of 500 000 pounds per square inch, which should be considered in cases where the deflection should be more closely limited.

The coefficients of deflection for Cedar corresponding to moduli of 700 000 and 350 000 may be obtained by multiplying those of the table by $\frac{1}{7}$ and $\frac{2}{7}$ respectively, and for Spruce and Eastern Fir corresponding to moduli of 1 200 000 and 600 000 by multiplying those of the table by $\frac{5}{8}$ and $\frac{5}{3}$ respectively.

The full zig-zag line in the table gives the limits of the safe loads corresponding to the allowable shearing stress along the neutral axis of the beam. The safe loads above the line, which are based upon the extreme fibre strains, will produce shearing stresses along the axis or with the grain in excess of that allowable, which, in the case of White Pine and the other woods of this table, is 100 pounds per square inch.

The position of this line, which indicates the limit of safe loads for shearing along the neutral axis, was determined by the aid of the following formula:

$$W = \frac{4bds}{3}$$

in which

W = safe load in pounds uniformly distributed.

d = depth of beam in inches.

b = breadth of beam in inches.

s = allowable shear in the direction of the grain in pounds per square inch.

Explanation of the Table of Safe Loads for Rectangular Beams of Short-leaf Yellow Pine.

The table is calculated for an allowable fibre stress, for flexure, of 1 000 pounds per square inch.

The deflection coefficients are figured for a modulus of elasticity of 1 200 000 pounds per square inch, but may be used for other moduli, after obtaining the corresponding coefficients by proportion as heretofore explained.

The lower dotted line across the table indicates the limits of spans for which the safe load will produce deflections greater than

$\frac{1}{360}$ of the length of the beam. Values above the line will give less deflection than this, and those below will give greater, based on a modulus of 1 200 000 pounds per square inch. Similarly, the upper dotted line indicates the limit of deflection corresponding to a modulus of elasticity of 600 000 pounds per square inch.

The full zig-zag line across the table indicates the limiting spans and loads based on the allowable intensity of shearing stress along the neutral axis of the beam. The values above the full zig-zag line correspond to shearing stresses greater than the allowable stress in the direction of the grain for Short-leaf Yellow Pine, while those below the line correspond to shearing stresses less than that allowable, which, in this case, is assumed to be 100 pounds per square inch.

Explanation of Tables of Safe Loads for Rectangular Beams of White Oak and Long-leaf Yellow Pine.

This table is computed for an allowable fibre stress of 1 200 pounds per square inch, for flexure, and the deflection coefficients are calculated for a modulus of elasticity of 1 500 000 pounds per square inch.

The limit for a deflection of $\frac{1}{360}$ of the span is indicated by the lower dotted zig-zag line on the tables, the values below which correspond to deflections greater than, and those above to deflections less than, the limiting deflections. The upper dotted zig-zag line similarly indicates the limits of deflection for a modulus of elasticity of 750 000 pounds per square inch.

The lower full zig-zag line indicates the limit of allowable shearing stress along the axis corresponding to the allowable intensity, for Yellow Pine, of 150 pounds per square inch.

Similarly, the upper full zig-zag line indicates the limits for shearing along the axis for White Oak based on an allowable intensity of 200 pounds per square inch.

BEARING AT POINTS OF SUPPORT.

Care should be taken in designing to provide sufficient bearing at the points of support so that the allowable intensity of compression across the grain, as given in the tables on pages 409 to 415, is not exceeded.

This may be obtained, where necessary, by the use of corbels or bearing plates of harder wood arranged so as to give a large bearing area against the softer beam.

The following statements are made in Bulletin No. 12, U. S. Department of Agriculture, Division of Forestry:

RECOMMENDED PRACTICE.

"Since the strength of timber varies very greatly with the moisture contents (see Bulletin 8 of the Forestry Division), the economical designing of such structures will necessitate their being separated into groups according to the maximum moisture contents in use.

MOISTURE CLASSIFICATION.

"Class A (moisture contents, 18 per cent.)—Structures freely exposed to the weather, such as railway trestles, uncovered bridges, etc.

"Class B (moisture contents, 15 per cent.)—Structures under roof but without side shelter, freely exposed to outside air, but protected from rain, such as roof trusses of open shops and sheds, covered bridges over streams, etc.

"Class C (moisture contents, 12 per cent.)—Structures in buildings unheated, but more or less protected from outside air, such as roof trusses of barns, enclosed shops and sheds, etc.

"Class D (moisture contents, 10 per cent.)—Structures in buildings at all times protected from the outside air, heated in the winter, such as roof trusses in houses, halls, churches, etc.

"For long-leaf pine add to all the values given in the tables, except those for moduli of elasticity, tension and shearing, for Class B, 15 per cent.; for Class C, 40 per cent.; and for Class D, 55 per cent. For the other species add to these values, for Class B, 8 per cent.; for Class C, 18 per cent., and for Class D, 25 per cent."

Based upon the above classification of structures, the two following tables have been figured to facilitate calculations of allowable loads for wooden beams and columns.

Proportion of the Values given in the "Tables of Safe Loads for Wooden Beams," Pages 416 to 421 inclusive, to be used in order to obtain the Safe Loads for the various classes of structures referred to above.

Classes.	Yellow Pine.	All Others.
Class A.....	1.00	1.00
Class B.....	1.15	1.08
Class C.....	1.40	1.18
Class D.....	1.55	1.25

Safety Factors to be applied to the Values given in the Table of "Strength of Solid Wooden Columns," Pages 422 and 423, in order to obtain the Safe Loads for the various classes of structures referred to above.

Classes.	Yellow Pine.	All Others.
Class A.....	0.20	0.20
Class B.....	0.23	0.22
Class C.....	0.28	0.24
Class D.....	0.31	0.25

**SPECIFIC GRAVITY AND WEIGHT PER FOOT
FOR VARIOUS KINDS OF TIMBER.**

Name of Wood.	Specific Gravity.	Weight per Cubic Foot.	Weight per Foot, Board Measure.
White Oak.....	0.80	49.94	4.16
White Pine.....	0.38	23.72	1.98
Southern Long-leaf or Georgia Yellow Pine.....	0.61	38.08	3.17
Douglas Fir.....	0.51	31.84	2.65
Short-leaf Yellow Pine.....	0.51	31.84	2.65
Red Pine (Norway Pine).....	0.50	31.21	2.60
Spruce and Eastern Fir.....	0.40	24.97	2.08
Hemlock.....	0.40	24.97	2.08
Cypress.....	0.46	28.72	2.39
Cedar.....	0.37	23.10	1.93
Chestnut.....	0.66	41.20	3.43
California Redwood.....	0.39	24.16	2.01
California Spruce.....	0.40	24.97	2.08

The specific gravities and weights given above are the averages of a large number of determinations by various authorities, for woods containing less than 15 per cent. of moisture or such as are commercially known as dry timber. The weights of green or unseasoned woods will be from 20 to 40 per cent. greater than those given in the above table.

SAFE UNIT STRESSES FOR TIMBER.

RECOMMENDED IN BULLETIN NO. 12, U. S. DEPARTMENT OF AGRICULTURE, DIVISION OF FORESTRY.

Safe Unit Stresses at 13% Moisture.

Species.	Modulus of Strength at Rupture per Square Inch.	Modulus of Elasticity per Square Inch.	Elastic Resilience per Cubic Inch.	Crushing Strength Endwise per Square Inch.	Crushing Strength Across the Grain per Square Inch.	Tensile Strength per Square Inch.	Shearing Strength per Square Inch.
	Lbs.	Lbs.	Lbs.	Lbs.	Lbs.	Lbs.	Lbs.
Long-leaf Pine (<i>Pinus palustris</i>) D	1550	720000	1.30	1000	215	12000	125
Short-leaf Pine (<i>Pinus echinata</i>) D.....	1300	600000	1.30	840	215	9000	100
White Pine (<i>Pinus strobus</i>).....	880	435000	1.00	700	147	7000	75
Norway Pine (<i>Pinus resinosa</i>).....	1090	566000	760	143
Colorado Pine (<i>Pinus ponderosa</i>).....	980	444000	630	180
Douglas Fir (<i>Pseudotsuga douglasii</i>).....	1320	690000	880	167
Redwood (<i>Sequoia sempervirens</i>).....	*1440	†226000	650	115
Red Cedar (<i>Juniperus virginiana</i>).....	1000	335000	700	250
Bald Cypress (<i>Taxodium distichum</i>) D...	1000	450000	1.10	675	120	6000	60
White Oak (<i>Quercus alba</i>) D.....	1200	550000	1.25	800	400	10000	200
Factor of Safety.....	5	2	1	5	3	1	4

The values marked "D" were obtained from experiments made by the Forestry Division. The other values were obtained from various sources, chiefly the 10th Census Report, but so modified as to give results comparable with Forestry Division values. To arrive at true average values of strength multiply safe loads by factor of safety given in each column. The value for resilience and tensile strength are the ultimate values. The former is practically never used in designing. The latter is a factor impossible to develop in practice, since the piece will always fail in some other way, usually by shearing.

The crushing strength across the grain in above is based upon a crushing of 3 per cent. of the cross sectional height of the piece.

* This value is certainly too large.

† " " " " small.—Ed.

AVERAGE TESTED STRENGTH VALUES OF STRUCTURAL TIMBERS WITH ORDINARY DEFECTS.

Kind of Timber.	Condition.	Average Moisture Content.	Bending.	
			Fibre Stress at Elastic Limit.	Modulus of Rupture.
			Per Cent.	Lbs. per Sq. In.
Long-leaf Pine (Pinus Palustris).	Green.....	27.6	3734	6140
	Air Seasoned	19.2	3691	5749
Douglas Fir (Pseudo- tsuga Taxifolia).	Green.....	33.2	3968	5983
	Air Seasoned	17.3	4563	6372
Short-leaf Pine (Pinus Echinata).	Green.....	46.4	3237	5548
	Air Seasoned	15.9	4675	6573
Western Larch (Larix Occidentalis).	Green.....	51.3	3324	4948
	Air Seasoned	17.9	3503	5856
Loblolly Pine (Pinus Tæda).	Green.....	34.4	3040	5084
	Air Seasoned	17.9	3517	6118
Tamarack (Larix Lari- cina).	Green.....	42.0	2813	4556
	Air Seasoned	21.5	3730	5498
Western Hemlock (Tsuga Heterophylla).	Green.....	47.6	3516	5296
	Air Seasoned	17.7	4398	6420
Redwood (Sequoia Sem- pervirens).	Green.....	87.5	3760	4472
	Air Seasoned	20.9	3442	3891
Norway Pine (Pinus Resinosa).	Green.....	49.0	2492	3864
	Air Seasoned	15.7	4069	6054

The above table presents the average results of an extensive series of tests on structural timbers as conducted by the United States Forestry Service and published in Bulletin No. 108, issued September 23, 1912. Many engineering handbooks and other publications dealing with timber quote results of tests made only on small thoroughly seasoned specimens, free from defects. Such values may be from one and one-half to two times as high as stresses developed in large timbers and joists.

The above tabulations, with the exception of those in final column headed "Shear," are based upon tests of structural size timbers having such defects as are ordinarily to be found. The "Shear" column values, owing to the method of testing, were obtained from small specimens and it will be seen that the shearing stresses developed are much higher than the calculated shearing stresses in beams that failed by horizontal shear. The difference is doubtless due to the fact that on account of checks and shakes, the actual area resisting shear is likely to be much less than the calculated area used in the formula for horizontal shear. Since large timbers almost invariably form checks during seasoning, it is not safe, in designing timber beams, to use shearing stresses higher than those determined for beams that failed in horizontal shear.

AVERAGE TESTED STRENGTH VALUES OF STRUCTURAL TIMBERS WITH ORDINARY DEFECTS.

Bending.		Compression.				Shear.
Modulus of Elasticity.	*Horizontal Shear.	Parallel to Grain.			Perpendicular to Grain.	Shearing Strength (Small Specimens).
		Crushing Strength at Elastic Limit.	Crushing Strength at Maximum Load.	Modulus of Elasticity.	Crushing Strength at Elastic Limit.	
1000 Lbs. per Sq. In.	Lbs. per Sq. In.	Lbs. per Sq. In.	Lbs. per Sq. In.	1000 Lbs. per Sq. In.	Lbs. per Sq. In.	Lbs. per Sq. In.
1463	353	3480	4800	568	973
1705	272	3480	4800	572	984
1517	166	2770	3495	1414	570	765
1549	221	3271	4258	1038	639	822
1473	332	2460	3435	1548	351	704
1726	364	4070	6030	1951	796	1135
1301	288	2675	3510	1575	456	700
1487	340	5746	597	905
1387	335	2050	2940	548	500	630
1487	434	3011	4292	1206	655	1115
1220	261	2400	3230	1373	668
1341	299	3349	4320	1351	879
1445	288	2905	3355	1617	434	630
1737	307	4840	5814	2140	473	924
1042	302	3194	3882	1240	434	742
890	4276	525	671
1133	232	2065	2555	1002	589
1418	278	3047	4228	1367	1145

* Only those pieces which failed first by horizontal shear are included in this column.

The averages for the bending tests are the results of tests on timbers ranging in cross section from 4 by 10 inches to 8 by 16 inches, over a 15-ft. span.

A comparison of the results of tests on air seasoned material with those on green material shows that, in general, all of the mechanical properties are increased by seasoning. Increase in strength of wood fibre, due to drying, is, in the case of large timbers, largely offset by a weakening of the timber due to the formation of checks. If the moisture content of a seasoned timber is increased, it loses strength rapidly, and if thoroughly soaked with water will become slightly weaker than when green. On this account, it is not safe in practice to depend upon any increase of strength in timbers, due to seasoning. When, however, large beams are seasoned with ordinary care, it is safe to assume that they are not weaker than when green.

UNIT STRESSES FOR STRUCTURAL TIMBER.

(Expressed in Pounds per Square Inch.)

Kind of Timber.	Bending.			Shearing.			
	Extreme Fibre Stress.		Modulus of Elasticity in Thousands.	Parallel to Grain.		Longitudinal Shear in Beams.	
	Average Ultimate.	Safe Stress.		Average Ultimate.	Safe Stress.	Average Ultimate.	Safe Stress.
Douglas Fir	6100	1200	1510	690	170	270	110
Long-leaf Pine	6500	1300	1610	720	180	300	120
Short-leaf Pine	5600	1100	1480	710	170	330	130
White Pine	4400	900	1130	400	100	180	70
Spruce	4800	1000	1310	600	150	170	70
Norway Pine	4200	800	1190	*590	130	250	100
Tamarack	4600	900	1220	670	170	260	100
Western Hemlock	5800	1100	1480	630	160	*270	100
Redwood	5000	900	800	300	80
Bald Cypress	4800	900	1150	500	120
Red Cedar	4200	800	800
White Oak	5700	1100	1150	840	210	270	110

NOTE.—These unit stresses are for a green condition of timber and are to * Partially air-dry.

The above table gives the ultimate and safe unit stress values for structural timber as adopted by the American Railway Engineering and Maintenance of Way Association, upon recommendation of their Committee on Wooden Bridges and Trestles, Convention of 1909; and published in the Association's "Bulletin No. 107," 1909, and "Manual," 1911.

They state that the working unit stresses given in this table are intended for railroad bridges and trestles. For highway bridges and trestles, the unit stresses may be increased twenty-five (25) per cent. For buildings and similar structures, in which the timber is protected from the weather and practically free from impact, the unit stresses may be increased fifty (50) per cent. To compute the deflection of a beam under long continued loading instead of that when the load is first applied, only fifty (50) per cent. of the corresponding modulus of elasticity given in the tables is to be employed.†

The safe unit stresses were determined by carefully considering both the average ultimate stresses, which represent the best results now available, as well as the unit stresses which have been in use in designing wooden bridges and trestles, and have been demonstrated by extensive practice to be safe.

† Timber has no well-defined modulus of elasticity.—Ed.

UNIT STRESSES FOR STRUCTURAL TIMBER.

(Expressed in Pounds per Square Inch.)

Compression.						Ratio of Length to Stringer Depth.
Perpendicular to Grain.		Parallel to Grain.		Columns under 15 Diams.	Long Columns over 15 Diameters.	
Elastic Limit.	Safe Stress.	Average Ultimate.	Safe Stress.	Safe Stress.	Safe Stress.	
630	310	3600	1200	900	1200 ($1 - \frac{L}{60D}$)	10
520	260	3800	1300	980	1300 (")	10
340	170	3400	1100	830	1100 (")	10
290	150	3000	1000	750	1000 (")	10
370	180	3200	1100	830	1100 (")
.....	150	*2600	800	600	800 (")
.....	220	*3200	1000	750	1000 (")
440	220	3500	1200	900	1200 (")
400	150	3300	900	680	900 (")
340	170	3900	1100	830	1100 (")
470	230	2800	900	680	900 (")
920	450	3500	1300	980	1300 (")	12

be used without increasing the live load stresses for impact.
 L = length in inches. D = least side or diameter in inches.

The relation between the strength of the lowest 10 per cent. group of tests and the average strength for each series, the relation between the elastic limit and the ultimate strength, as well as the fact that the live load stresses are not to be increased for impact, are all to be taken into account in determining the general relation between the safe stress and the average ultimate stress; it being always remembered that it is more rational to relate the safe unit stress to the elastic limit of the material than to its ultimate strength.

As large columns not over 15 diameters in length may not develop more than 70 per cent. of the strength of short blocks, the column formulas are arranged to give approximately these relative values at the given limit of length when L, the length of the column in inches, equals 15 times its least diameter D, also expressed in inches.

It is expected that these unit stresses will be revised at intervals of a few years, whenever new results of timber tests are published, or when the experience of bridge engineers who have adapted them shall indicate that revision is desirable.

AVERAGE ULTIMATE BREAKING UNIT

Kind of Timber.	Tension.	
	With Grain.	Across Grain.
White Oak.....	12000	2000
White Pine.....	7000	500
Southern Long-leaf or Georgia Yellow Pine.....	12000	600
Douglas Fir.....	8000
Short-leaf Yellow Pine.....	9000	500
Red Pine (Norway Pine).....	8000	500
Spruce and Eastern Fir.....	8000	500
Hemlock.....	6000
Cypress.....	6000
Cedar.....	7000
Chestnut.....	8500
California Redwood.....	7000
California Spruce.....

AVERAGE SAFE ALLOWABLE WORKING UNIT

Kind of Timber.	Tension.	
	With Grain.	Across Grain.
Factor of Safety.	Ten.	Ten.
White Oak.....	1200	200
White Pine.....	700	50
Southern Long-leaf or Georgia Yellow Pine.....	1200	60
Douglas Fir.....	800
Short-leaf Yellow Pine.....	900	50
Red Pine (Norway Pine).....	800	50
Spruce and Eastern Fir.....	800	50
Hemlock.....	600
Cypress.....	600
Cedar.....	700
Chestnut.....	850
California Redwood.....	700
California Spruce.....

The above tables are based on those recommended by the committee on intendents of Bridges and Buildings at their Fifth Annual Convention in by later data from various sources.

STRESSES, IN POUNDS PER SQUARE INCH.

Compression.			Transverse.		Shearing.	
With Grain.		Across Grain.	Extreme Fibre Stress.	Modulus of Elasticity.	With Grain.	Across Grain.
End Bearing.	Columns Under 15 Diams.					
7000	5000	2000	7000	1500000	800	4000
5500	3500	700	4000	1000000	400	2000
7000	5000	1400	7000	1500000	600	5000
5700	4500	800	5000	1400000	500
6000	4500	1000	6000	1200000	400	4000
5000	4000	800	5000	1130000
6000	4000	700	4000	1200000	400	3000
.....	4000	600	3500	900000	350	2500
5000	4000	700	5000	900000
5500	3500	700	4000	700000	400	1500
.....	4000	900	5000	1000000	600	2000
.....	4000	600	4500	700000	400
.....	4000	5000	1200000

STRESSES, IN POUNDS PER SQUARE INCH.

Compression.			Transverse.		Shearing.	
With Grain.		Across Grain.	Extreme Fibre Stress.	Modulus of Elasticity.	With Grain.	Across Grain.
End Bearing.	Columns Under 15 Diams.					
Five.	Five.	Four.	Six.	Two.	Four.	Four.
1400	1000	500	1200	750000	200	1000
1100	700	200	700	500000	100	500
1400	1000	350	1200	750000	150	1250
1100	900	200	800	750000	130
1200	900	250	1000	600000	100	1000
1000	800	200	800	565000
1200	800	200	700	600000	100	750
.....	800	150	600	450000	100	600
1000	800	200	800	450000
1100	700	200	700	350000	100	400
.....	800	250	800	500000	150	500
.....	800	150	750	350000	100
.....	800	800	600000

“Strength of Bridge and Trestle Timbers” of the Association of Railway Super-October, 1895, but the arrangement and values in many cases are now modified

**SAFE LOAD IN POUNDS
FOR RECTANGULAR
OF WHITE PINE, CEDAR**

Allowable fibre stress 700 pounds per square inch. Safety factor 6.

Safe loads for other safety factors may be obtained as follows:

Span in Feet.	Depth of Beam in Inches.											Deflection Coefficient for White Pine V
	4	5	6	7	8	9	10	11	12	13	14	
4	311	486	700	953	1244	1575	1944	2352	2800	3286	3811	.34
5	249	389	560	762	996	1260	1556	1882	2240	2629	3049	.53
6	207	324	467	635	830	1050	1296	1569	1867	2191	2541	.76
7	178	278	400	544	711	900	1111	1344	1600	1878	2178	1.03
8	156	243	350	476	622	788	972	1176	1400	1643	1906	1.34
9	138	216	311	423	553	700	864	1046	1244	1460	1694	1.70
10	124	194	280	381	498	630	778	941	1120	1314	1524	2.10
11	113	177	255	346	453	573	707	856	1018	1195	1386	2.54
12	103	162	233	318	415	525	648	784	933	1095	1270	3.02
13	96	150	215	293	383	485	598	724	862	1011	1173	3.55
14	89	139	200	272	356	450	556	672	800	939	1089	4.12
15	83	130	187	254	332	420	519	627	747	876	1016	4.73
16	78	122	175	238	311	394	486	588	700	821	953	5.38
17	73	114	165	224	293	371	458	554	659	773	897	6.07
18	69	108	156	212	277	350	432	523	622	730	847	6.80
19	65	102	147	201	262	332	409	495	589	692	802	7.58
20		97	140	191	249	315	389	471	560	657	762	8.40
21		93	133	182	237	300	370	448	533	626	726	9.26
22		88	127	173	226	286	354	428	509	597	693	10.16
23		85	122	166	216	274	338	409	487	572	663	11.11
24			117	159	207	263	324	392	467	548	635	12.10
25			112	152	199	252	311	376	448	526	610	13.13
26			108	147	191	242	299	362	431	506	586	14.20
27			104	141	184	233	288	349	415	487	565	15.31
28			100	136	178	225	278	336	400	469	544	16.46
29			97	131	172	217	268	325	386	453	526	17.66
30			93	127	166	210	259	314	373	438	508	18.90
31			90	123	161	203	251	304	361	424	492	20.18
32			88	119	156	197	243	294	350	411	476	21.50
33			85	115	151	191	236	285	339	398	462	22.87
34				112	146	185	229	277	329	387	448	24.28
35				109	142	180	222	269	320	376	436	25.73

**UNIFORMLY DISTRIBUTED
BEAMS ONE INCH THICK
AND SPRUCE OR EASTERN FIR.**

Modulus of rupture 4 200 pounds per square inch.

$$\text{New safe load} = \text{Safe load from table} \times \frac{6}{\text{New factor}}$$

Span in Feet.	Depth of Beam in Inches.										Deflection Coefficient for White Pine V
	15	16	17	18	19	20	21	22	23	24	
9	1944	2212	2498	2800	3120	3457	3811	4183	4571	4978	1.70
10	1750	1991	2248	2520	2808	3111	3430	3764	4114	4480	2.10
11	1601	1810	2044	2291	2552	2828	3118	3422	3740	4073	2.54
12	1458	1659	1873	2100	2340	2593	2858	3137	3428	3733	3.02
13	1346	1531	1729	1938	2160	2393	2638	2896	3165	3446	3.55
14	1250	1422	1606	1800	2056	2222	2450	2689	2939	3200	4.12
15	1167	1328	1499	1680	1872	2074	2287	2510	2743	2987	4.73
16	1094	1244	1405	1575	1755	1944	2144	2353	2571	2800	5.38
17	1029	1171	1322	1482	1652	1830	2018	2214	2420	2635	6.07
18	972	1106	1249	1400	1560	1728	1906	2091	2286	2489	6.80
19	921	1048	1183	1326	1478	1637	1805	1981	2165	2358	7.58
20	875	996	1124	1260	1404	1556	1715	1882	2057	2240	8.40
21	833	948	1070	1200	1337	1481	1633	1793	1959	2133	9.26
22	795	905	1022	1145	1276	1414	1559	1711	1870	2036	10.16
23	761	866	977	1096	1221	1353	1491	1637	1789	1948	11.11
24	729	830	937	1050	1170	1296	1429	1569	1714	1867	12.10
25	700	796	899	1008	1123	1244	1372	1506	1645	1792	13.13
26	673	766	865	969	1080	1197	1319	1448	1582	1723	14.20
27	648	737	833	933	1040	1152	1270	1394	1524	1659	15.31
28	625	711	803	900	1003	1111	1225	1344	1469	1600	16.46
29	603	687	775	869	968	1073	1183	1298	1419	1545	17.66
30	583	664	749	840	936	1037	1143	1255	1371	1493	18.90
31	565	642	725	813	906	1004	1106	1214	1327	1445	20.18
32	547	622	703	787	877	972	1072	1176	1286	1400	21.50
33	534	603	681	764	850	943	1039	1141	1247	1358	22.87
34	515	586	661	741	826	915	1009	1107	1210	1318	24.28
35	500	569	642	720	802	889	980	1076	1176	1280	25.73
36	486	553	624	700	780	864	953	1046	1143	1244	27.22
37	473	538	608	681	759	841	927	1017	1112	1211	28.75
38	460	524	592	663	739	819	903	991	1083	1179	30.32
39	449	511	576	646	720	798	880	965	1055	1149	31.94
40	438	498	562	630	702	778	858	941	1029	1120	33.60

SAFE LOADS IN POUNDS FOR RECTANGULAR OF SHORT-LEAF

Allowable fibre stress 1 000 pounds per square inch. Safety factor 6.

Safe loads for other safety factors may be obtained as follows:

Span in Feet.	Depth of Beam in Inches.											Deflection Coefficient V
	4	5	6	7	8	9	10	11	12	13	14	
4	444	694	1000	1361	1778	2250	2778	3361	4000	4694	5444	.40
5	356	556	800	1089	1422	1800	2222	2689	3200	3756	4356	.63
6	296	463	667	907	1185	1500	1852	2241	2667	3130	3630	.90
7	254	397	571	778	1016	1286	1587	1921	2286	2683	3111	1.23
8	222	347	500	681	889	1125	1389	1681	2000	2347	2722	1.60
9	198	309	444	605	790	1000	1235	1494	1778	2086	2420	2.03
10	178	278	400	544	711	900	1111	1344	1600	1878	2178	2.50
11	162	253	364	495	646	818	1010	1222	1455	1707	1980	3.03
12	148	231	333	454	593	750	926	1120	1333	1565	1815	3.60
13	137	214	308	419	547	692	855	1034	1231	1444	1675	4.23
14	127	198	286	389	508	643	794	960	1143	1341	1556	4.90
15	119	185	267	363	474	600	741	896	1067	1252	1452	5.63
16	111	174	250	340	444	563	694	840	1000	1174	1361	6.40
17	105	163	235	320	418	529	654	791	941	1105	1281	7.23
18	99	154	222	302	395	500	617	747	889	1043	1210	8.10
19	94	146	211	287	374	474	585	708	842	988	1146	9.03
20	89	139	200	272	356	450	556	672	800	939	1089	10.00
21	85	132	190	259	339	429	529	640	762	894	1037	11.03
22	81	126	182	247	323	409	505	611	727	854	990	12.10
23	77	121	174	237	309	391	483	585	696	816	947	13.23
24		116	162	227	296	375	463	560	667	782	907	14.40
25		111	160	218	284	360	444	538	640	751	871	15.63
26		107	154	209	274	346	427	517	615	722	838	16.90
27		103	148	202	263	333	412	498	593	695	807	18.23
28		99	143	194	254	321	397	480	571	671	778	19.60
29			138	188	245	310	383	464	552	648	751	21.03
30			133	181	237	300	370	448	533	626	726	22.50
31			129	176	229	290	358	434	516	606	703	24.03
32			125	170	222	281	347	420	500	587	681	25.60
33			121	165	215	273	337	407	485	569	660	27.23
34			118	160	209	265	327	395	471	552	641	28.90
35			114	156	203	257	317	384	457	537	602	30.63

Safe loads for any fibre stress may be readily obtained from this table by proportion.

**UNIFORMLY DISTRIBUTED,
BEAMS ONE INCH THICK,
YELLOW PINE.**

Modulus of rupture 6 000 pounds per square inch.

$$\text{New safe load} = \text{Safe load from table} \times \frac{6}{\text{New factor}}$$

Span in Feet.	Depth of Beam in Inches.										Deflection Coefficient V
	15	16	17	18	19	20	21	22	23	24	
9	2778	3160	3568	4000	4457	4938	5444	5975	6531	7111	2.03
10	2500	2844	3211	3600	4011	4444	4900	5378	5878	6400	2.50
11	2273	2586	2919	3273	3646	4040	4455	4889	5343	5818	3.03
12	2083	2370	2676	3000	3343	3704	4083	4481	4898	5333	3.60
13	1923	2188	2470	2769	3085	3419	3769	4137	4521	4923	4.23
14	1786	2032	2294	2571	2865	3175	3500	3841	4198	4571	4.90
15	1667	1896	2141	2400	2674	2963	3267	3585	3919	4267	5.63
16	1563	1778	2007	2250	2507	2778	3062	3361	3674	4000	6.40
17	1471	1673	1889	2118	2359	2614	2882	3163	3458	3765	7.23
18	1389	1580	1789	2000	2228	2469	2722	2988	3265	3556	8.10
19	1316	1497	1690	1895	2111	2339	2579	2830	3094	3368	9.03
20	1250	1422	1606	1800	2006	2222	2450	2689	2939	3200	10.00
21	1190	1354	1529	1714	1910	2116	2333	2561	2799	3048	11.03
22	1136	1293	1460	1636	1823	2020	2227	2444	2672	2909	12.10
23	1087	1237	1396	1565	1744	1932	2130	2338	2556	2783	13.23
24	1042	1185	1338	1500	1671	1852	2042	2241	2449	2667	14.40
25	1000	1138	1284	1440	1604	1778	1960	2131	2351	2560	15.63
26	962	1094	1235	1385	1543	1709	1885	2068	2261	2462	16.90
27	926	1053	1189	1333	1486	1646	1815	1992	2177	2370	18.23
28	893	1016	1147	1286	1433	1587	1750	1921	2099	2286	19.60
29	862	981	1107	1241	1383	1533	1690	1854	2027	2207	21.03
30	833	948	1070	1200	1337	1481	1633	1793	1959	2133	22.50
31	806	918	1036	1161	1294	1434	1581	1735	1896	2065	24.03
32	781	889	1003	1125	1253	1389	1531	1681	1837	2000	25.60
33	758	862	973	1091	1215	1347	1485	1630	1781	1939	27.23
34	735	837	944	1059	1180	1307	1441	1582	1728	1882	28.90
35	714	813	917	1029	1146	1270	1400	1537	1677	1829	30.63
36	694	780	894	1000	1114	1235	1361	1494	1633	1778	32.40
37	676	769	868	973	1084	1201	1324	1453	1589	1730	34.23
38	658	749	845	947	1056	1169	1289	1415	1547	1684	36.10
39	641	729	823	923	1028	1140	1256	1379	1507	1641	38.03
40	625	711	803	900	1003	1111	1225	1344	1469	1600	40.00

Safe loads for beams of California Redwood, $\frac{3}{4}$ of above.

SAFE LOADS IN POUNDS FOR RECTANGULAR OF WHITE OAK AND

Allowable fibre stress 1 200 pounds per square inch. Safety factor 6.

Safe loads for other safety factors may be obtained as follows:

Span in Feet.	Depth of Beam in Inches.											Deflection Coefficient V
	4	5	6	7	8	9	10	11	12	13	14	
4	533	833	1200	1633	2133	2700	3333	4033	4800	5633	6533	.38
5	427	667	960	1307	1707	2160	2667	3227	3840	4507	5227	.60
6	356	556	800	1089	1422	1800	2222	2689	3200	3756	4356	.86
7	305	476	686	933	1219	1543	1905	2305	2743	3219	3733	1.18
8	267	417	600	817	1067	1350	1667	2017	2400	2817	3267	1.54
9	237	370	533	726	948	1200	1481	1793	2133	2504	2904	1.94
10	213	333	480	653	853	1080	1333	1613	1920	2253	2613	2.40
11	194	303	436	594	776	982	1212	1467	1745	2048	2376	2.90
12	178	278	400	544	711	900	1111	1344	1600	1878	2178	3.46
13	164	256	369	503	656	831	1026	1241	1477	1733	2010	4.06
14	152	238	343	467	610	771	952	1152	1371	1610	1867	4.70
15	142	222	320	436	569	720	889	1076	1280	1502	1742	5.40
16	133	208	300	408	533	675	833	1008	1200	1408	1633	6.14
17	125	196	282	384	502	635	784	949	1129	1325	1537	6.94
18	119	185	267	363	474	600	741	896	1067	1252	1452	7.78
19	112	175	253	344	449	568	702	849	1011	1186	1375	8.66
20	107	167	240	327	427	540	667	807	960	1127	1307	9.60
21	102	159	229	311	406	514	635	768	914	1073	1244	10.58
22	97	152	218	297	388	491	606	733	873	1024	1188	11.62
23	93	145	209	284	371	470	580	701	835	980	1136	12.70
24	89	139	200	272	356	450	556	672	800	939	1089	13.82
25	85	133	192	261	341	432	533	645	768	901	1045	15.00
26		128	185	251	328	415	513	621	738	867	1005	16.22
27		123	178	242	316	400	494	598	711	835	968	17.50
28		119	171	233	305	386	476	576	686	805	933	18.82
29		115	166	225	294	372	460	556	662	777	901	20.18
30		111	160	218	284	360	444	538	640	751	871	21.60
31		108	155	211	275	348	430	520	619	727	843	23.06
32			150	204	267	338	417	504	600	704	817	24.58
33			145	198	259	327	404	489	582	683	792	26.14
34			141	192	251	318	392	475	565	663	769	27.74
35			137	187	244	309	381	461	549	644	747	29.40

Safe loads for beams of Douglas Fir, Red Pine (Norway Pine), Cypress, Chestnut and California Spruce, $\frac{2}{3}$ of above.

**UNIFORMLY DISTRIBUTED,
BEAMS ONE INCH THICK,
LONG-LEAF YELLOW PINE.**

Modulus of rupture 7 200 pounds per square inch.

New safe load = Safe load from table $\times \frac{6}{\text{New factor}}$.

Span in Feet.	Depth of Beam in Inches.										Deflection Coefficient V
	15	16	17	18	19	20	21	22	23	24	
9	3333	3793	4281	4800	5348	5926	6533	7170	7837	8533	1.94
10	3000	3413	3853	4320	4813	5333	5880	6453	7053	7680	2.40
11	2727	3103	3503	3927	4376	4848	5358	5867	6412	6982	2.90
12	2500	2844	3211	3600	4011	4444	4900	5378	5878	6400	3.46
13	2308	2626	2964	3323	3703	4103	4523	4964	5426	5908	4.06
14	2143	2438	2752	3086	3438	3810	4200	4610	5038	5486	4.70
15	2000	2276	2569	2880	3209	3556	3920	4302	4702	5120	5.40
16	1875	2133	2408	2700	3008	3333	3675	4033	4433	4800	6.14
17	1765	2008	2267	2541	2831	3137	3459	3796	4149	4518	6.94
18	1667	1896	2141	2400	2674	2963	3267	3585	3819	4267	7.78
19	1579	1796	2027	2274	2533	2807	3095	3396	3712	4042	8.66
20	1500	1707	1927	2160	2407	2667	2940	3227	3527	3840	9.60
21	1429	1625	1835	2057	2292	2540	2800	3073	3359	3657	10.58
22	1364	1552	1752	1964	2188	2424	2678	2933	3206	3491	11.62
23	1304	1484	1675	1878	2093	2319	2557	2806	3067	3339	12.70
24	1250	1422	1606	1800	2006	2222	2450	2689	2939	3200	13.82
25	1200	1365	1541	1728	1925	2133	2352	2581	2821	3072	15.00
26	1154	1313	1482	1662	1851	2051	2262	2482	2713	2954	16.22
27	1111	1264	1427	1600	1783	1975	2178	2390	2612	2844	17.50
28	1071	1219	1376	1543	1719	1905	2100	2305	2519	2743	18.82
29	1034	1177	1329	1490	1660	1839	2028	2225	2432	2648	20.18
30	1000	1138	1284	1440	1604	1778	1960	2151	2351	2560	21.60
31	968	1101	1243	1394	1553	1720	1897	2082	2275	2477	23.06
32	938	1067	1204	1350	1504	1667	1838	2017	2217	2400	24.58
33	909	1034	1168	1309	1459	1616	1785	1956	2137	2327	26.14
34	882	1004	1133	1271	1416	1569	1729	1898	2075	2259	27.74
35	857	975	1101	1234	1375	1524	1680	1844	2013	2194	29.40
36	833	948	1070	1200	1337	1481	1633	1793	1959	2133	31.10
37	811	923	1041	1168	1301	1441	1589	1744	1906	2076	32.86
38	789	893	1014	1137	1267	1404	1547	1698	1856	2021	34.66
39	769	875	988	1108	1234	1368	1508	1655	1809	1969	36.50
40	750	853	963	1080	1203	1333	1470	1613	1763	1920	38.40

Safe loads for beams of Hemlock, $\frac{1}{2}$ of above.

STRENGTH OF SOLID WOODEN COLUMNS OF DIFFERENT KINDS OF TIMBER.

For various values of $\frac{l}{d}$.

l = length of column in inches. d = least diameter in inches.

BASED ON THE FORMULA OF THE U. S. DEPARTMENT OF AGRICULTURE, DIVISION OF FORESTRY.

$$P = F \times \frac{700 + 15c}{700 + 15c + c^2}$$

P = ultimate strength in pounds per square inch.

F = ultimate crushing strength of timber. $c = \frac{l}{d}$.

Values of F are those given in table on pages 414 and 415 herein.

Ultimate Strength in Pounds per Square Inch:				
	White Oak and Southern Long-leaf or Georgia Yellow Pine.	Douglas Fir and Short-leaf Yellow Pine.	Red Pine (Norway Pine), Spruce or Eastern Fir, Hemlock, Cypress, Chestnut, California Redwood and Cali- fornia Spruce.	White Pine and Cedar.
F	5000	4500	4000	3500
$\frac{l}{d}$				
2	4973	4475	3978	3481
3	4940	4446	3952	3458
4	4897	4407	3918	3428
5	4844	4359	3875	3391
6	4782	4304	3826	3347
7	4713	4242	3770	3299
8	4638	4174	3710	3247
9	4558	4102	3646	3190
10	4474	4026	3579	3132
11	4386	3948	3509	3070
12	4297	3867	3438	3008
13	4206	3785	3365	2944
14	4114	3703	3291	2880
15	4022	3620	3217	2815
16	3930	3537	3144	2751
17	3838	3455	3071	2687
18	3748	3373	2998	2624
19	3659	3293	2927	2561

For safety factors for various classes of structures to be used in connection with the above table, see p. 408.

STRENGTH OF SOLID WOODEN COLUMNS OF DIFFERENT KINDS OF TIMBER.

For various values of $\frac{l}{d}$.

l = length of column in inches. d = least diameter in inches.

BASED ON THE FORMULA OF THE U. S. DEPARTMENT OF AGRICULTURE, DIVISION OF FORESTRY.

$$P = F \times \frac{700 + 15c}{700 + 15c + c^2}$$

P = ultimate strength in pounds per square inch.

F = ultimate crushing strength of timber. $c = \frac{l}{d}$.

Values of F are those given in table on pages 414 and 415 herein.

	Ultimate Strength in Pounds per Square Inch.			
	White Oak and Southern Long-leaf or Georgia Yellow Pine.	Douglas Fir and Short-leaf Yellow Pine.	Red Pine (Norway Pine), Spruce or Eastern Fir, Hemlock, Cypress, Chestnut, California Redwood and California Spruce.	White Pine and Cedar.
F	5000	4500	4000	3500
$\frac{l}{d}$				
20	3571	3214	2857	2500
21	3486	3137	2788	2440
22	3402	3061	2721	2381
23	3320	2988	2656	2324
24	3240	2916	2592	2268
25	3162	2846	2529	2213
26	3086	2777	2469	2160
27	3013	2711	2410	2109
28	2941	2647	2353	2059
29	2872	2585	2298	2010
30	2805	2524	2244	1963
32	2677	2409	2142	1874
34	2557	2301	2046	1790
36	2445	2200	1956	1711
38	2340	2106	1872	1638
40	2241	2017	1793	1569
42	2149	1934	1719	1505
44	2063	1857	1650	1444
46	1982	1784	1586	1388
48	1907	1716	1525	1335
50	1835	1652	1468	1285

For safety factors for various classes of structures to be used in connection with the above table, see p. 408.

SPECIFIC GRAVITIES AND WEIGHTS OF VARIOUS SUBSTANCES.

The Basis for Specific Gravities is Pure Water at 62 Degrees Fah., Barometer 30 Inches. Weight of One Cubic Foot, 62.355 Pounds.	Average Specific Gravity. Water=1.	Average Weight of One Cubic Foot. Pounds.
Acid, acetic, 90%	1.062	66.3
“ fluoric, 58%	1.20	75
“ muriatic (hydrochloric), 40%	1.20	75
“ nitric, 35%	1.217	76
“ phosphoric, 72%	1.558	97.2
“ sulphuric, 97%	1.841	115
Air, atmospheric at 60 degrees F., under pressure of one atmosphere, or 14.7 pounds per square inch, weighs $\frac{1}{815}$ as much as water00123	.0765
Alabaster		160
Alcohol, commercial833	52
Alder wood68	42
Alum53	33
Aluminum bronze, 10%	7.70	480
“ “ 5%	8.26	516
“ nickel alloy, annealed	2.74	170.9
“ “ cast	2.85	178.1
“ “ rolled	2.76	172.1
“ pure, annealed	2.66	165.9
“ cast	2.56	159.6
“ rolled	2.68	167.1
“ wire	2.70	168
“ wrought	2.67	167
Ammonia, liquid, 29%897	56
Anthracite, 1.3 to 1.84; of Penna., 1.3 to 1.7	1.5	93.5
“ broken, of any size, loose		52 to 57
“ “ moderately shaken		56 to 60
“ “ heaped bushel, loose, 77 to 83 pounds		
“ “ a ton loose occupies 40 to 43 cubic feet		
Antimony, cast	6.70	418
“ native	6.67	416
Apple wood76	47
Arsenic	5.67	354
Asbestos	2.40	149
Ash, American white, dry (see note p. 433)61	38
“ perfectly dry (see note p. 423)752	47
Ashes of soft coal, solidly packed		40 to 45
Asphaltum, 1 to 1.8	1.4	87.3
Bamboo wood35	22
Barley		40
Basalt	2.86	178
Beech wood73	46
Beer, lager	1.034	64.5

SPECIFIC GRAVITIES AND WEIGHTS OF VARIOUS SUBSTANCES.

The Basis for Specific Gravities is Pure Water at 62 Degrees Fah., Barometer 30 Inches. Weight of One Cubic Foot, 62.355 Pounds.	Average Specific Gravity. Water=1.	Average Weight of One Cubic Foot. Pounds.
Beeswax.....	.965	60.2
Benzine.....		50
Birch wood.....	.65	41
Bismuth.....	9.78	611
Bleaching powder.....		31
Bluestone.....		150
Borax.....		110
Boxwood.....	.97	60
Brass, cu. 67, zn. 33, cast.....	8.32	519
“ high yellow plates.....	8.59	535
“ Muntz metal.....	8.22	512
“ Naval rolled.....	8.51	530
“ sheet.....	8.46	527
“ wire.....	8.56	533
Brick, best pressed.....		150
“ common and hard.....		125
“ soft inferior.....		100
Brickwork, at 125 pounds per cubic foot, 1 cubic yard equals 1.507 tons, and 17.92 cubic feet equal 1 ton.....		100
“ coarse, inferior, soft.....		125
“ medium quality.....		140
“ pressed brick, fine joints.....		170
Bronze, cu. 90, tin 10.....	8.67	541
“ gun.....	8.75	546
“ Tobin.....	8.38	523
Butter.....	.94	59
Butternut wood.....	.45	28
Calcite.....		170
Calcium.....	1.57	98
Camphor.....	.99	61.7
Caoutchouc.....	.96	60
Carbon.....	2.15	134
Carpet.....		12
Caustic soda.....		88
Cedar, American.....	.56	35
Cement barrel, 15-30 pounds, average 20 pounds.....		135
“ mortar, Portland, 1 : 2½.....		88 to 92
“ natural, per barrel, net, 282 pounds.....		108 to 115
“ “ “ bag, net, 94 pounds.....		
“ Portland, loose.....		88 to 92
“ “ packed, as in barrels.....		108 to 115
“ “ per bag, net, 94 pounds.....		

SPECIFIC GRAVITIES AND WEIGHTS OF VARIOUS SUBSTANCES.

The Basis for Specific Gravities is Pure Water at 62 Degrees Fah., Barometer 30 Inches. Weight of One Cubic Foot, 62.355 Pounds.	Average Specific Gravity. Water=1.	Average Weight of One Cubic Foot. Pounds.
Cement, Portland, per barrel, net, 376 pounds		
" " standard proportioning		100
" set	2.85	178
Chalk	2.5	156
Charcoal of pines and oaks		15 to 30
Cheese		30
Cherry wood, perfectly dry (see note p. 433)672	42
Chestnut66	41
Chromium	6.8	425
Cider	1.02	63.4
Cinders (coal ashes and clinkers)		40
Cinnabar	8.81	550
Citron73	45
Clay, dry in lump, loose		63
" hard, ordinary	2.1	150
" potters', dry, 1.8 to 2.1	1.9	119
Coal, anthracite (see Anthracite).		
" bituminous, a heaped bushel, loose, 70 to 78		
" " broken, of any size, loose		47 to 52
" " moderately shaken		51 to 56
" " solid, Cambria Co., Pa., 1.27-1.34		79 to 84
" " " 1.2 to 1.5	1.35	84
" " 1 ton occupies 43 to 48 cubic feet		
" lignite83	52
Cobalt	8.77	546
Coke	1.34	85
" loose, a heaped bushel, 35 to 42		
" " good quality		23 to 32
" 1 ton occupies 80 to 97 cubic feet		
Concrete, cinder, with Portland cement		112
" conglomerate " " 		150
" gravel " " 		150
" limestone " " 		148
" sandstone " " 		143
" trap " " 		155
" loose, unrammed, weighs 5 to 25% lighter, varying with consistency		
Copper, cast, 8.6 to 8.8	8.7	542
" hammered	8.93	557
" plates and sheets	8.93	557
" pure	8.82	549
" rolled, 8.8 to 9	8.9	555
" wire	8.89	554
" wrought	8.9	555
Cork, dry (see note p. 433)24	15

SPECIFIC GRAVITIES AND WEIGHTS OF VARIOUS SUBSTANCES.

The Basis for Specific Gravities is Pure Water at 62 Degrees Fah., Barometer 30 Inches. Weight of One Cubic Foot, 62.355 Pounds.	Average Specific Gravity. Water=1.	Average Weight of One Cubic Foot. Pounds.
Corn.....		31
Cornmeal.....		37
Corundum, pure, 3.8 to 4.....	3.9
Cotton goods.....		11-33
Crockery.....		40
Cypress wood.....	.46	29
Dogwood.....	.76	47
Dolomite.....		180
Earth, common loam, perfectly dry, loose.....		72 to 80
“ “ “ “ “ shaken.....		82 to 92
“ “ “ “ “ rammed.....		90 to 100
“ “ “ slightly moist, loose.....		70 to 76
“ “ “ more moist, loose.....		66 to 68
“ “ “ “ “ shaken.....		75 to 90
“ “ “ “ “ packed.....		90 to 100
“ “ “ as soft flowing mud.....		104 to 112
“ “ “ “ “ “ “ well pressed.....		110 to 120
Ebonite.....	1.15	72
Ebony wood, American.....	1.33	83
“ “ Indian.....	1.21	75
Eggs.....	1.09
Elder wood.....	.70	44
Elm wood, perfectly dry (see note p. 433).....	.56	35
Fat—beef, hog and mutton.....	.92	57
Feldspar.....		160
Fir wood.....	.55	34
Flax.....		90
Flint.....	2.6	162
Flour, compact.....		40
“ loose.....		30
Gamboge.....	1.22	76
Gasoline (motor).....	.71-.75	44 to 47
Glass, common window.....	2.52	157
“ crown or plate.....		160
“ crystal.....		188
“ flint.....	3.70	230
Glassware in boxes.....		60
Gneiss, common, 2.62 to 2.76.....	2.69	168

SPECIFIC GRAVITIES AND WEIGHTS OF VARIOUS SUBSTANCES.

The Basis for Specific Gravities is Pure Water at 62 Degrees Fah., Barometer 30 Inches. Weight of One Cubic Foot, 62.355 Pounds.	Average Specific Gravity. Water = 1.	Average Weight of One Cubic Foot. Pounds.
Gneiss, in loose piles.....		96
Gold, cast, pure or 24-karat.....	19.258	1204
“ pure, hammered.....	19.5	1217
“ standard 22-k. (gold 11, copper 1).....	17.5	1090
Granite, solid.....	2.72	170
“ broken.....		96
“ dressed.....		165
“ rubble.....		154
“ dry.....		138
Graphite.....		130
Gravel.....		120
“ and sand.....		90-130
Greenstone, trap, 2.8 to 3.2.....	3.00	187
Gum arabic.....	1.45	90
Gum wood.....	.92	57
Gunpowder, loose.....	.90	56
“ shaken.....	1.00	62.4
“ solid.....	1.55-1.80	97-113
Gutta-percha.....	.98	61
Gypsum, plaster of Paris or stucco mixed with water into a stiff mass, such as mortar, set and dried out.....		77
“ rock, natural, free from surface water, not calcined in block form.....		140-145
“ crushed, not calcined, all to pass through 1-inch ring.....		90-100
“ ground, 90% to pass through 100-mesh screen dried of all free moisture, not calcined, known as “land plaster”.....		75-80
“ same, but calcined, known as “stucco” or “plaster of Paris”—loose.....		55-65
“ well shaken down or in bins.....		65-75
Hackmatack wood (American larch) (tamarack).....	.59	37
Hay, baled.....		24
Hazel wood.....	.60	38
Hemlock wood.....	.40	25
Hemp.....		90
Hickory wood, perfectly dry (see note p. 433).....	.85	53
Holly wood.....	.76	47
Honey.....	1.45	91
Hornbeam wood.....	.76	47
Hornblende.....		190
Human blood.....	1.054	65.7

SPECIFIC GRAVITIES AND WEIGHTS OF VARIOUS SUBSTANCES.

The Basis for Specific Gravities is Pure Water at 62 Degrees Fah., Barometer 30 Inches. Weight of One Cubic Foot, 62.355 Pounds.	Average Specific Gravity. Water=1.	Average Weight of One Cubic Foot. Pounds.
Hydrogen.....	.00008	.0052
Ice, .917 to .922.....	.92	57.4
India rubber93	58
Indigo.....	1.01	63
Iron, cast, 6.9 to 7.4.....	7.15	446
" grey cast.....	7.08	442
" " foundry, cold.....	7.21	450
" " " molten.....	6.94	433
" pure.....	7.86	491
" white cast.....	7.65	477
" wire.....	7.77	485
" wrought.....	7.69	480
Jasmine wood, Spanish.....	.77	48
Juniper wood.....	.56	35
Larch wood.....	.56	35
Lard.....	.95	59
Lead, cast.....	11.37	708
" commercial.....	11.38	709.6
" sheet.....	11.43	712
Leather, dry.....	.86	54
" greased.....	1.02	64
" in bales.....		16-23
Lignite.....		80
Lignum-vitæ wood (dry).....	.65-1.33	41 to 83
Lime.....	1.03	64
" quick.....	1.5	95
" " ground, thoroughly shaken, per struck bushel 93¾ pounds.....		75
" " " well shaken, per struck bushel 80 pounds.....		64
Limestone and marble.....	2.6	164.4
" broken.....	1.61	100
" solid.....	2.70	168
Linden wood60	38
Loam.....	1.23	77
Locust wood, dry (see note p. 433).....	.71	44
Logwood.....	.91	57
Lye.....		110
Magnesite.....		190

SPECIFIC GRAVITIES AND WEIGHTS OF VARIOUS SUBSTANCES.

The Basis for Specific Gravities is Pure Water at 62 Degrees Fah., Barometer 30 Inches. ↓ Weight of One Cubic Foot, 62.355 Pounds.	Average Specific Gravity. Water=1.	Average Weight of One Cubic Foot. Pounds.
Magnesium.....	1.74	109
Mahogany wood, Spanish, dry (see note p. 433)85	53
“ “ Honduras, dry (see note. p. 433).....	.56	35
Manganese.....	8.00	500
Maple wood, dry (see note p. 433).....	.79	49
Marble (see Limestone).		
Marl.....		140
Masonry debris		90
“ of brickwork (see Brickwork).		
“ “ granite or limestone, well dressed.....		165
“ “ well-scabbled mortar rubble, about 1/5 of mass will be mortar		154
“ “ “ well-scabbled dry rubble.....		138
“ “ “ roughly scabbled mortar rubble, about 1/4 to 1/3 of mass will be mortar		150
“ “ “ scabbled dry rubble.....		125
“ “ sandstone, 1/2 less than granite.....	
Mastic wood.....	.85	53
Mercury, at 32° F.....	13.62	849
“ at 68° F.....	13.5	846
Mica, 2.75 to 3.1.....	2.93	183
Milk.....	1.03	64.5
Molybdenum.....	8.50	532
Mortar, hardened, 1.4 to 1.9.....	1.65	103
Muck (decayed vegetable matter, manure, etc.).....	.92	57
Mud, dry, close.....		80 to 110
“ wet, moderately pressed		110 to 130
“ “ fluid		104 to 120
Mulberry wood.....	.73	46
Nickel, cast.....	8.29	516
“ rolled.....	8.69	541
“ silver (52 cu. +26 zn. +22 ni.)	8.44	527
Nitrogen.....	.00125	.0782
Oak wood, heart of old.....	1.17	73
“ “ live, perfectly dry, .88-1.02 (see note p. 433)	.95	59.3
“ “ red, black, perfectly dry		32 to 45
“ “ white84	52
Oats.....		27
Oil—bone, colza, cylinder, engine, 500° fire test, mustard seed, neatsfoot, paraffin, rape seed, tallow90	56.2
“ burning (kerosene), 150° and 300°.....	.83	51.7

**SPECIFIC GRAVITIES AND WEIGHTS OF
VARIOUS SUBSTANCES.**

The Basis for Specific Gravities is Pure Water at 62 Degrees Fah., Barometer 30 Inches. Weight of One Cubic Foot, 62.355 Pounds.	Average Specific Gravity. Water=1.	Average Weight of One Cubic Foot. Pounds.
Oil, cotton seed96	60.2
“ gasoline (motor)71-.75	44 to 49
“ lard92	57.4
“ linseed94	58.8
“ mineral lubricating91	57
“ Navy sperm87	54
“ olive91	57
“ petroleum88	55
“ signal85	53
“ turpentine87	54
“ whale93	58
Oxygen00143	.0895
Paper, calendered		50-70
“ strawboard newspaper		33-44
“ writing or wrapping		70-90
Paraffine89	55.5
Pear wood66	41
Peat		50
Petroleum878	54.8
Phosphate rock		200
Pine wood, white40	25
“ “ yellow, Northern55	34
“ “ “ Southern72	45
Pitch	1.15	71.7
Plaster		53
“ of Paris (see Gypsum).		
Platinum	21.5	1342
Plum wood78	49
Poplar wood, dry (see note p. 433)47	29
“ “ white Spanish53	33
Porcelain	2.40	149
Potassium87	54
Potatoes, in pile		45
Proof spirit93	58
Pumice stone63	39
Quartz	2.65	165
Rags in bales		15-36
Redwood48	30
Rope		42
Rosin	1.10	68.6

SPECIFIC GRAVITIES AND WEIGHTS OF VARIOUS SUBSTANCES.

The Basis for Specific Gravities is Pure Water at 62 Degrees Fah., Barometer 30 Inches. Weight of One Cubic Foot, 62.355 Pounds.	Average Specific Gravity. Water=1.	Average Weight of One Cubic Foot. Pounds.
Rubber.....		60
Rubber goods.....		95
Rye.....		50
Salt, coarse (per struck bushel, Syracuse, N. Y., 56 lbs.).....		45
Saltpetre.....		68
Sand, of pure quartz, perfectly dry and loose.....		90 to 106
" " " voids full of water.....		118 to 129
" " " very large and small grains, dry.....		117
Sandstone, dressed.....		144
" 2.1 to 2.73, 131 to 171.....	2.41	151
" quarried and piled, 1 measure solid makes 1¾ (about) piled.....		86
Sassafras wood.....	.48	30
Shales, red or black, 2.4 to 2.8.....	2.6	162
Silk.....		8-32
Silver.....	10.5	655
Slag.....		160 to 180
" furnace, granulated.....		53
Slate, 2.7 to 2.9.....	2.8	175
Snow, fresh-fallen.....		5 to 12
" moistened, compacted by rain.....		15 to 50
Soapstone, 2.65 to 2.8.....	2.73	170
Soda ash.....		62
Sodium.....	.97	61
Spelter, 6.8 to 7.2.....	7.00	437.5
Spermaceti.....	.94	59
Spruce wood.....	.50	31.2
" " old.....	.46	28.7
Starch.....		95
Starch (in barrels).....		23
Steam at 212° F.....	.0006	.0368
Steel.....	7.85	489.6
Straw, baled.....		24
Sugar.....	1.60	100
" stored.....		42
Sulphur.....	2.00	125
Sumac wood.....		39
Sycamore wood, perfectly dry (see note p. 433).....	.59	37
Talc.....		170
Tallow.....	.94	58.6
Tar.....	1.15	71.7

SPECIFIC GRAVITIES AND WEIGHTS OF VARIOUS SUBSTANCES.

The Basis for Specific Gravities is Pure Water at 62 Degrees Fah., Barometer 30 Inches. Weight of One Cubic Foot, 62.355 Pounds.	Average Specific Gravity. Water=1.	Average Weight of One Cubic Foot. Pounds.
Teak wood82	51
Tile (see page 69).		
Tin, cast, 7.2 to 7.5	7.35	459
" pure	7.29	455
Tobacco		28
Trap rock, compact	3.02	188
" " in pile		190
Tungsten	19.1	1192
Turf40	25
Vanadium	5.5	343
Vapor, alcohol00198	.122
" turpentine spirits00615	.378
" water00077	.047
Vine wood	1.33	83
Vinegar	1.08	67.4
Walnut wood, black, perfectly dry (see note below)61	38
Water, pure rain, distilled, at 32° F., Bar. 30 inches.		62.417
" " " " " 62° F., " 30 "	1	62.355
" " " " " 212° F., " 30 "		59.7
" sea, 1.026 to 1.030	1.028	64.08
Wax, bees-97	61
Wheat		39-44
White metal (Babbitts)	7.32	456
Willow wood54	34
Wine99	62
Wool, in bales		15-22
Woolen goods		13-22
Yew wood79	49
Zinc, cast	6.86	428
" pure	7.15	446
" rolled	7.19	449

NOTE.—Green timbers usually weigh from one-fifth to nearly one-half more than dry; ordinary building timbers, tolerably seasoned, one-sixth more.

For specific gravities of woods not given in this table, see page 408.

STANDARD DECIMAL GAUGE.

Standard Decimal Gauge in Inches.	Thickness in Fractions of an Inch.	Approximate Thickness in Millimetres.	Weight per Square Foot in Pounds, Avoirdupois.	
			IRON. Basis—480 Pounds per Cubic Foot.	STEEL. Basis—489.6 Pounds per Cubic Foot.
.002	1-500	.05080010	.08	.0816
.004	1-250	.10160020	.16	.1632
.006	3-500	.15240030	.24	.2448
.008	1-125	.20320041	.32	.3264
.010	1-100	.25400051	.40	.4080
.012	3-250	.30480061	.48	.4896
.014	7-500	.35560071	.56	.5712
.016	2-125 ($\frac{1}{4}+$)	.40640081	.64	.6528
.018	9-500	.45720091	.72	.7344
.020	1-50	.50800102	.80	.8160
.022	11-500	.55880112	.88	.8976
.025	1-40	.63500127	1.00	1.0200
.028	7-250	.71120142	1.12	1.1424
.032	4-125 ($\frac{1}{2}+$)	.81280163	1.28	1.3056
.036	9-250	.91440183	1.44	1.4688
.040	1-25	1.01600203	1.60	1.6320
.045	9-200	1.14300229	1.80	1.8360
.050	1-20	1.27000254	2.00	2.0400
.055	11-200	1.39700280	2.20	2.2440
.060	3-50 ($\frac{1}{3}-$)	1.52400305	2.40	2.4480
.065	13-200	1.65100330	2.60	2.6520
.070	7-100	1.77800356	2.80	2.8560
.075	3-40	1.90500381	3.00	3.0600
.080	2-25	2.03200406	3.20	3.2640
.085	17-200	2.15900432	3.40	3.4680
.090	9-100	2.28600457	3.60	3.6720
.095	19-200	2.41300483	3.80	3.8760
.100	1-10	2.54000508	4.00	4.0800
.110	11-100	2.79400559	4.40	4.4880
.125	1-8	3.17500630	5.00	5.1000
.135	27-200	3.42900686	5.40	5.5080
.150	3-20	3.81000762	6.00	6.1200
.165	33-200	4.19100838	6.60	6.7320
.180	9-50	4.57200914	7.20	7.3440
.200	1-5	5.08001016	8.00	8.1600
.220	11-50	5.58801118	8.80	8.9760
.240	6-25	6.09601219	9.60	9.7920
.250	1-4	6.35001270	10.00	10.2000

WIRE AND SHEET METAL GAUGES.

In Decimals of an Inch.

Number of Gauge.	Birmingham or Stubbs Iron Wire Gauge (B. W. G.)	American or Brown & Sharpe Wire Gauge.	United States Standard Gauge for Sheet and Plate Iron and Steel.	Washburn & Moen Manufacturing Co. and John A. Roebling's Sons Co. Wire Gauge.	Trenton Iron Co. Wire Gauge.	American Screw Co. Screw Wire Gauge.	British Imperial or English Legal Standard Wire Gauge.	New Birmingham Standard Sheet and Hoop Gauge (B. G.)
7/05500	.6666
6/046875	.4600464	.625
5/04375	.4300	.450432	.5883
4/0	.454	.460000	.40625	.3938	.400400	.5416
3/0	.425	.409642	.375	.3625	.360	.0315	.372	.500
00	.380	.364796	.34375	.3310	.330	.0447	.348	.4452
0	.340	.324861	.3125	.3065	.305	.0578	.324	.3964
1	.300	.289297	.28125	.2830	.285	.0710	.300	.3532
2	.284	.257627	.265625	.2625	.265	.0842	.276	.3147
3	.259	.229423	.25	.2437	.245	.0973	.252	.2804
4	.238	.204307	.234375	.2263	.225	.1105	.232	.250
5	.220	.181940	.21875	.2070	.205	.1236	.212	.2225
6	.203	.162023	.203125	.1920	.190	.1368	.192	.1981
7	.180	.144285	.1875	.1770	.175	.1500	.176	.1764
8	.165	.128490	.171875	.1620	.160	.1631	.160	.1570
9	.148	.114423	.15625	.1483	.145	.1763	.144	.1398
10	.134	.101897	.140625	.1350	.130	.1894	.128	.1250
11	.120	.090742	.125	.1205	.1175	.2026	.116	.1113
12	.109	.080808	.109375	.1055	.105	.2158	.104	.0991
13	.095	.071962	.09375	.0915	.0925	.2289	.092	.0882
14	.083	.064084	.078125	.0800	.0806	.2421	.080	.0785
15	.072	.057068	.0703125	.0720	.070	.2552	.072	.0699
16	.065	.050821	.0625	.0625	.061	.2684	.064	.0625
17	.058	.045257	.05625	.0540	.0525	.2816	.056	.0556
18	.049	.040303	.05	.0475	.045	.2947	.048	.0495
19	.042	.035890	.04375	.0410	.040	.3079	.040	.0440
20	.035	.031961	.0375	.0348	.035	.3210	.036	.0392
21	.032	.028462	.034375	.03175	.031	.3342	.032	.0349
22	.028	.025346	.03125	.0286	.028	.3474	.028	.03125
23	.025	.022572	.028125	.0258	.025	.3605	.024	.02782
24	.022	.020101	.025	.0230	.0225	.3737	.022	.02476
25	.020	.017900	.021875	.0204	.020	.3868	.020	.02204
26	.018	.015941	.01875	.0181	.018	.4000	.018	.01961
27	.016	.014195	.0171875	.0173	.017	.4132	.0164	.01745
28	.014	.012641	.015625	.0162	.016	.4263	.0148	.015625
29	.013	.011257	.0140625	.0150	.015	.4395	.0136	.0139
30	.012	.010025	.0125	.0140	.014	.4526	.0124	.0123
31	.010	.008928	.0109375	.0132	.013	.4658	.0116	.0110
32	.009	.007950	.01015625	.0128	.012	.4790	.0108	.0098
33	.008	.007080	.009375	.0118	.011	.4921	.0100	.0087
34	.007	.006305	.00859375	.0104	.010	.5053	.0092	.0077
35	.005	.005615	.0078125	.0095	.0095	.5184	.0084	.0069
36	.004	.005000	.00703125	.0090	.009	.5316	.0076	.0061
37004453	.006640625	.0085	.0085	.5448	.0068	.0054
38003965	.00625	.0080	.008	.5579	.0060	.0048
390035310075	.0075	.5711	.0052	.0043
400031440070	.007	.5842	.0048	.00386

WEIGHTS OF SHEETS AND PLATES OF STEEL, WROUGHT IRON, COPPER AND BRASS.

American or Browne & Sharpe Gauge.

Number of Gauge.	Thickness in Inches.	Weight per Square Foot.			
		Steel.	Iron.	Copper.	Brass.
0000	.460000	18.7680	18.4000	20.8380	19.6880
000	.409642	16.7134	16.3857	18.5568	17.5327
00	.364796	14.8837	14.5918	16.5253	15.6133
0	.324861	13.2543	12.9944	14.7162	13.9041
1	.289297	11.8033	11.5719	13.1052	12.3819
2	.257627	10.5112	10.3051	11.6705	11.0264
3	.229423	9.3605	9.1769	10.3929	9.8193
4	.204307	8.3357	8.1723	9.2551	8.7443
5	.181940	7.4232	7.2776	8.2419	7.7870
6	.162023	6.6105	6.4809	7.3396	6.9346
7	.144285	5.8868	5.7714	6.5361	6.1754
8	.128490	5.2424	5.1396	5.8206	5.4994
9	.114423	4.6685	4.5769	5.1834	4.8973
10	.101897	4.1574	4.0759	4.6159	4.3612
11	.090742	3.7023	3.6297	4.1106	3.8838
12	.080808	3.2970	3.2323	3.6606	3.4586
13	.071962	2.9360	2.8785	3.2599	3.0800
14	.064084	2.6146	2.5634	2.9030	2.7428
15	.057068	2.3284	2.2827	2.5852	2.4425
16	.050821	2.0735	2.0328	2.3022	2.1751
17	.045257	1.8465	1.8103	2.0501	1.9370
18	.040303	1.6444	1.6121	1.8257	1.7250
19	.035890	1.4643	1.4356	1.6258	1.5361
20	.031961	1.3040	1.2784	1.4478	1.3679
21	.028462	1.1612	1.1385	1.2893	1.2182
22	.025346	1.0341	1.0138	1.1482	1.0848
23	.022572	.92094	.90288	1.0225	.96608
24	.020101	.82012	.80404	.91058	.86032
25	.017900	.73032	.71600	.81087	.76612
26	.015941	.65039	.63764	.72213	.68227
27	.014195	.57916	.56780	.64303	.60755
28	.012641	.51575	.50564	.57264	.54103
29	.011257	.45929	.45028	.50994	.48180
30	.010025	.40902	.40100	.45413	.42907
31	.008928	.36426	.35712	.40444	.38212
32	.007950	.32436	.31800	.36014	.34026
33	.007080	.28886	.28320	.32072	.30302
34	.006305	.25724	.25220	.28562	.26985
35	.005615	.22909	.22460	.25436	.24032
36	.005000	.20400	.20000	.22650	.21400
37	.004453	.18168	.17812	.20172	.19059
38	.003965	.16177	.15860	.17961	.16970
39	.003531	.14406	.14124	.15995	.15113
40	.003144	.12828	.12576	.14242	.13456

For weights of steel plates $\frac{1}{16}$ " and over in thickness, see "Table of Weights of Flat Rolled Bars," pages 475 to 483 inclusive.

WEIGHTS OF SHEETS AND PLATES OF STEEL, WROUGHT IRON, COPPER AND BRASS.

Birmingham Wire Gauge (B. W. G.)

Number of Gauge.	Thickness in Inches.	Weight per Square Foot.			
		Steel.	Iron.	Copper.	Brass.
0000	.454	18.5232	18.16	20.5662	19.4312
000	.425	17.3400	17.00	19.2525	18.1900
00	.380	15.5040	15.20	17.2140	16.2640
0	.340	13.8720	13.60	15.4020	14.5520
1	.300	12.2400	12.00	13.5900	12.8400
2	.284	11.5872	11.36	12.8652	12.1552
3	.259	10.5672	10.36	11.7327	11.0852
4	.238	9.7104	9.52	10.7814	10.1864
5	.220	8.9760	8.80	9.966	9.4160
6	.203	8.2824	8.12	9.1959	8.6884
7	.180	7.3440	7.20	8.1540	7.7040
8	.165	6.7320	6.60	7.4745	7.0620
9	.148	6.0384	5.92	6.7044	6.3344
10	.134	5.4672	5.36	6.0702	5.7352
11	.120	4.8960	4.80	5.4360	5.1360
12	.109	4.4472	4.36	4.9377	4.6652
13	.095	3.8760	3.80	4.3035	4.0660
14	.083	3.3864	3.32	3.7599	3.5524
15	.072	2.9376	2.88	3.2616	3.0816
16	.065	2.6520	2.60	2.9445	2.7820
17	.058	2.3664	2.32	2.6274	2.4824
18	.049	1.9992	1.96	2.2197	2.0972
19	.042	1.7136	1.68	1.9026	1.7976
20	.035	1.4280	1.40	1.5855	1.4980
21	.032	1.3056	1.28	1.4496	1.3696
22	.028	1.1424	1.12	1.2684	1.1984
23	.025	1.0200	1.00	1.1325	1.0700
24	.022	.8976	.88	.9966	.9416
25	.020	.8160	.80	.9060	.8560
26	.018	.7344	.72	.8154	.7704
27	.016	.6528	.64	.7248	.6848
28	.014	.5712	.56	.6342	.5992
29	.013	.5304	.52	.5889	.5564
30	.012	.4896	.48	.5436	.5136
31	.010	.4080	.40	.4530	.4280
32	.009	.3672	.36	.4077	.3852
33	.008	.3264	.32	.3624	.3424
34	.007	.2856	.28	.3171	.2996
35	.005	.2040	.20	.2265	.2140
36	.004	.1632	.16	.1812	.1712
Specific Gravities		7.85	7.70	8.72	8.24
Weight of a Cubic Foot ...		489.6	480.0	543.6	513.6
" " " Inch ..		.2833	.2778	.3146	.2972

COMBINED TABLE OF SIZES IN THE PRINCIPAL WIRE GAUGES.

Values printed in bold-faced type are exact; values not exact are rounded off to four significant figures, except diameters of the American (B. & S.) Wire Gauge and of the Metric Wire Gauge in the column headed "Diameter, inches," are given to 0.001 inch for the larger sizes and to 0.0001 inch for the smaller. This represents the usual degree of accuracy in the measurement of wires.

Diameter			Wire Gauge Numbers					Cross Section			
Mils	Mm.	Ins.	American (B. & S.)	Washburn & Moen	Birmingham (Stubs')	British Standard	Metric	Sq. Ins.	Sq. Mils	Circular Mils	Sq. Mm.
500	12.70	.500	7-01963	196 300	250 000	126.7
490	12.45	.490	7-01886	188 600	240 100	121.7
464	11.79	.464	6-01691	169 100	215 300	109.1
461.5	11.70	.4615	6-01673	167 300	213 000	107.9
460	11.68	.460	4-01662	166 200	211 600	107.2
454	11.53	.454	4-01619	161 900	206 100	104.4
432	10.97	.432	5-01466	146 600	186 600	94.56
430.5	10.93	.4305	5-01456	145 600	185 300	93.91
425	10.80	.425	3-01419	141 900	180 600	91.52
409.6	10.40	.410	3-01318	131 800	167 800	85.03
400	10.16	.400	4-01257	125 700	160 000	81.07
393.8	10.00	.3938	4-01218	121 800	155 100	78.58
393.7	10.0	.3937	100	.1217	121 700	155 000	78.54
380	9.652	.380	2-01134	113 400	144 400	73.17
372	9.449	.372	3-01087	108 700	138 400	70.12
364.8	9.266	.365	2-01045	104 500	133 100	67.43
362.5	9.208	.3625	3-01032	103 200	131 400	66.58
354.3	9.0	.354	90	.098 61	98 610	125 500	63.62
348	8.839	.348	2-0095 11	95 110	121 100	61.36
340	8.636	.340	0090 79	90 790	115 600	58.58
331	8.407	.331	2-0086 05	86 050	109 600	55.52
324.9	8.251	.325	0082 89	82 890	105 500	53.48
324	8.230	.324	0082 45	82 450	105 000	53.19
315	8.0	.315	80	.077 91	77 910	99 200	50.27
306.5	7.785	.3065	0073 78	73 780	93 940	47.60
300	7.620	.300	1	1070 69	70 690	90 000	45.60
289.3	7.348	.289	1065 73	65 730	83 690	42.41

COMBINED TABLE OF SIZES IN THE PRINCIPAL WIRE GAUGES—(Continued).

Diameter			Wire Gauge Numbers					Cross Section			
Mils	Mm.	Ins.	American (B. & S.)	Washburn & Moen	Birmingham (Stubs)	British Standard	Metric	Sq. Ins.	Sq. Mils	Circular Mils	Sq. Mm.
284	7.214	.284			2			.063 35	63 350	80 660	40.87
283	7.188	.283		1				.062 90	62 900	80 090	40.58
276	7.010	.276				2		.059 83	59 830	76 180	38.60
275.6	7.0	.276					70	.059 65	59 650	75 950	38.48
262.5	6.668	.2625		2				.054 12	54 120	68 910	34.92
259	6.579	.259			3			.052 69	52 690	67 080	33.99
257.6	6.544	.258	2					.052 13	52 130	66 370	33.63
252	6.401	.252				3		.049 88	49 880	63 500	32.18
243.7	6.190	.2437		3				.046 64	46 640	59 390	30.09
238	6.045	.238			4			.044 49	44 490	56 640	28.70
236.2	6.0	.236					60	.043 83	43 830	55 800	28.27
232	5.893	.232				4		.042 27	42 270	53 820	27.27
229.4	5.827	.229	3					.041 34	41 340	52 630	26.67
225.3	5.723	.2253		4				.039 87	39 870	50 760	25.72
220	5.588	.220			5			.038 01	38 010	48 400	24.52
212	5.385	.212				5		.035 30	35 300	44 940	22.77
207	5.258	.207		5				.033 65	33 650	42 850	21.71
204.3	5.189	.204	4					.032 78	32 780	41 740	21.15
203	5.156	.203			6			.032 37	32 370	41 210	20.88
196.8	5.0	.197					50	.030 43	30 430	38 750	19.63
192	4.877	.192		6		6		.028 95	28 950	36 860	18.68
181.9	4.621	.182	5					.026 00	26 000	33 100	16.77
180	4.572	.180			7			.025 45	25 450	32 400	16.42
177.2	4.5	.177					45	.024 65	24 650	31 390	15.90
177	4.496	.177		7				.024 61	24 610	31 330	15.87
176	4.470	.176				7		.024 33	24 330	30 980	15.70
165	4.191	.165			8			.021 38	21 380	27 220	13.80
162	4.115	.162	6	8				.020 62	20 620	26 250	13.30
160	4.064	.160				8		.020 11	20 110	25 600	12.97
157.5	4.0	.157					40	.019 48	19 480	24 810	12.57
148.3	3.767	.1483		9				.017 27	17 270	21 990	11.14
148	3.759	.148			9			.017 20	17 200	21 900	11.10
144.3	3.665	.144	7					.016 35	16 350	20 820	10.55
144	3.658	.144				9		.016 29	16 290	20 740	10.51
137.8	3.5	.138					35	.014 91	14 910	18 990	9.621
135	3.429	.135		10				.014 31	14 310	18 220	9.235
134	3.404	.134			10			.014 10	14 100	17 960	9.098
128.5	3.264	.128	8					.012 97	12 970	16 510	8.366
128	3.251	.128				10		.012 87	12 870	16 380	8.302

COMBINED TABLE OF SIZES IN THE PRINCIPAL WIRE GAUGES—(Continued).

Diameter			Wire Gauge Numbers					Cross Section			
Mils	Mm.	Ins.	American (B. & S.)	Washburn & Moen	Birmingham (Stubs)	British Standard	Metric	Sq. Ins.	Sq. Mils	Circular Mils	Sq. Mm.
120.5	3.061	.1205	11011 40	11 400	14 520	7.358
120	3.048	.120	11011 31	11 310	14 400	7.297
118.1	3.0	.118	30	.010 96	10 960	13 950	7.069
116	2.946	.116	11010 57	10 570	13 460	6.818
114.4	2.906	.114	9010 28	10 280	13 090	6.634
109	2.769	.109	12009 331	9331	11 880	6.020
105.5	2.680	.1055	12008 742	8742	11 130	5.640
104	2.642	.104	12008 495	8495	10 820	5.481
101.9	2.588	.102	10008 155	8155	10 380	5.261
98.42	2.5	.098	25	.007 609	7609	9687	4.909
95	2.413	.095	13007 088	7088	9025	4.573
92	2.337	.092	13006 648	6648	8464	4.289
91.5	2.324	.0915	13006 576	6576	8372	4.242
90.74	2.305	.091	11006 467	6467	8234	4.172
83	2.108	.083	14005 411	5411	6889	3.491
80.81	2.053	.081	12005 129	5129	6530	3.309
80	2.032	.080	14	14005 027	5027	6400	3.243
78.74	2.0	.079	20	.004 869	4869	6200	3.142
72	1.829	.072	15	15	15004 072	4072	5184	2.627
71.96	1.828	.072	13004 067	4067	5178	2.624
70.87	1.8	.071	18	.003 944	3944	5022	2.545
65	1.651	.065	16003 318	3318	4225	2.141
64.08	1.628	.064	14003 225	3225	4107	2.081
64	1.626	.064	16003 217	3217	4096	2.075
62.99	1.6	.063	16	.003 116	3116	3968	2.011
62.5	1.588	.0625	16003 068	3068	3906	1.979
58	1.473	.058	17002 642	2642	3364	1.705
57.07	1.450	.057	15002 558	2558	3257	1.650
56	1.422	.056	17002 463	2463	3136	1.589
55.12	1.4	.055	14	.002 386	2386	3038	1.539
54	1.372	.054	17002 290	2290	2916	1.478
50.82	1.291	.051	16002 028	2028	2583	1.309
49	1.245	.049	18001 836	1836	2401	1.217
48	1.219	.048	18001 810	1810	2304	1.167
47.5	1.207	.0475	18001 772	1772	2256	1.143
47.24	1.2	.047	12	.001 753	1753	2232	1.131
45.26	1.150	.045	17001 609	1609	2048	1.038
42	1.067	.042	19001 385	1385	1764	0.8938
41	1.041	.041	19001 320	1320	1681	0.8518

COMBINED TABLE OF SIZES IN THE PRINCIPAL WIRE GAUGES—(Continued).

Diameter			Wire Gauge Numbers					Cross Section			
Mils	Mm.	Ins.	American (B. & S.)	Washburn & Moen	Birmingham (Stubs')	British Standard	Metric	Sq. Ins.	Sq. Mils	Circular Mils	Sq. Mm.
40.3	1.024	.040	18001 276	1276	1624	.8231
40	1.016	.040	19001 257	1257	1600	.8107
39.37	1.0	.039	10	.001 217	1217	1550	.7854
36	.9144	.036	20001 018	1018	1296	.6567
35.80	.9116	.036	19001 012	1012	1288	.6527
35.43	.90	.035	9	.0009861	986.1	1255	.6362
35	.8900	.035	200009621	962.1	1225	.6207
34.8	.8839	.0343	200009511	951.1	1211	.6136
32	.8128	.032	21	210009042	904.2	1024	.5189
31.96	.8118	.032	200008023	802.3	1022	.5176
31.7	.8052	.0317	210007892	789.2	1005	.5092
31.5	.80	.031	8	.0007791	779.1	992	.5027
28.6	.7264	.0286	220006424	642.4	818	.4145
28.46	.7229	.0285	210006363	636.3	810.1	.4105
28	.7112	.028	22	220006158	615.8	784	.3973
27.56	.70	.0276	7	.0005965	596.5	759.5	.3848
25.8	.6553	.0253	230005228	522.8	665.6	.3373
25.35	.6438	.0253	220005046	504.6	642.4	.3255
25	.6350	.025	230004909	490.9	625	.3167
24	.6096	.024	230004524	452.4	576	.2919
23.62	.60	.0236	6	.0004383	438.3	558	.2827
23	.5842	.023	240004155	415.5	529	.2675
22.57	.5733	.0226	230004001	400.1	509.5	.2582
22	.5588	.022	24	240003801	380.1	484	.2452
20.4	.5182	.0204	250003269	326.9	416.2	.2109
20.1	.5106	.0201	240003173	317.3	404	.2047
20	.5080	.020	25	250003142	314.2	400	.2027
19.68	.50	.0197	5	.0003043	304.3	387.5	.1963
18.1	.4597	.0181	260002573	257.3	327.6	.1660
18	.4572	.018	26	260002545	254.5	324	.1642
17.9	.4547	.0179	250002517	251.7	320.4	.1624
17.72	.45	.0177	4-5	.0002465	246.5	313.9	.1590
17.3	.4394	.0173	270002351	235.1	299.3	.1517
16.4	.4166	.0164	270002112	211.2	269	.1363
16.2	.4115	.0162	280002061	206.1	262.4	.1330
16	.4064	.016	270002011	201.1	256	.1297
15.94	.4049	.0159	260001996	199.6	254.1	.1288
15.75	.40	.0157	4	.0001948	194.8	248	.1257
15	.3810	.015	290001767	176.7	225	.1140

COMBINED TABLE OF SIZES IN THE PRINCIPAL WIRE GAUGES—(Continued).

Diameter			Wire Gauge Numbers					Cross Section			
Mils	Mm.	Ins.	American (B. & S.)	Washburn & Moen	Birmingham (Stubbs')	British Standard	Metric	Sq. Ins.	Sq. Mils	Circular Mils	Sq. Mm.
14.8	.3759	.0148	28031720	172.0	219	.1110
14.2	.3606	.0142	27031583	158.3	201.5	.1021
14	.3556	.0140	30	28031539	153.9	196	.09932
13.78	.35	.0138	3-5	.031491	149.1	189.9	.09621
13.5	.3454	.0136	29031453	145.3	185	.09372
13.2	.3353	.0132	31031368	136.8	174.2	.08829
13	.3302	.0130	29031327	132.7	169	.08563
12.8	.3251	.0128	32031287	128.7	163.8	.08302
12.64	.3211	.0126	28031255	125.5	159.8	.08098
12.4	.3150	.0124	30031208	120.8	153.8	.07791
12	.3048	.0120	30031131	113.1	144	.07297
11.81	.30	.0118	3	.031096	109.6	139.5	.07069
11.8	.2997	.0118	33031094	109.4	139.2	.07055
11.6	.2946	.0116	31031057	105.7	134.6	.06818
11.26	.2859	.0113	29030954	99.54	126.7	.06422
10.8	.2743	.0108	32030916	91.61	116.6	.05910
10.4	.2642	.0104	34030895	84.95	108.2	.05481
10.03	.2546	.0100	300307894	78.94	100.5	.05093
10	.2540	.0100	31	330307854	78.54	100	.05067
9.842	.25	.0098	2-5	.0307609	76.09	96.87	.04909
9.5	.2413	.0095	350307088	70.88	90.25	.04573
9.2	.2337	.0092	340306648	66.48	84.64	.04289
9	.2286	.0090	36	320306362	63.62	81	.04104
8.928	.2268	.0089	310306260	62.60	79.7	.04039
8.5	.2159	.0085	370305675	56.75	72.25	.03661
8.4	.2134	.0084	350305542	55.42	70.56	.03575
8	.2032	.0080	38	330305027	50.27	64	.03243
7.95	.2019	.0080	320304964	49.64	63.21	.03203
7.874	.20	.0079	2	.0304869	48.69	62.00	.03142
7.6	.1930	.0076	360304536	45.36	57.76	.02927
7.5	.1905	.0075	390304418	44.18	56.25	.02850
7.087	.18	.0071	1-8	.0303944	39.44	50.22	.02545
7.08	.1798	.0071	330303937	39.37	50.13	.02540
7	.1778	.0070	40	340303848	38.48	49	.02483
6.8	.1727	.0068	370303632	36.32	46.24	.02343
6.6	.1676	.0066	410303421	34.21	43.56	.02207
6.305	.1601	.0063	340303122	31.22	39.75	.02014
6.299	.16	.0063	1-6	.0303116	31.16	39.68	.02011
6.2	.1575	.0062	420303019	30.19	38.44	.01948

COMBINED TABLE OF SIZES IN THE PRINCIPAL WIRE GAUGES—(Continued).

Diameter			Wire Gauge Numbers					Cross Section			
Mils	Mm.	Ins.	American (B. & S.)	Washburn & Moen	Birmingham (Stubs)	British Standard	Metric	Sq. Ins.	Sq. Mils	Circular Mils	Sq. Mm.
6	.1524	.0060	43	38042827	28.27	36	.018 24
5.906	.15	.0059	1-5	.042739	27.39	34.87	.017 67
5.8	.1473	.0053	44042642	26.42	33.64	.017 05
5.615	.1426	.0056	35042476	24.76	31.52	.015 97
5.512	.14	.0055	1-4	.042386	23.86	30.38	.015 39
5.5	.1397	.0055	45042376	23.76	30.25	.015 33
5.2	.1321	.0052	46	39042124	21.24	27.04	.013 70
5	.1270	.0050	36	47	35041963	19.63	25	.012 67
4.8	.1219	.0048	48	40041810	18.10	23.04	.011 67
4.724	.12	.0047	1-2	.041753	17.53	22.32	.011 31
4.6	.1168	.0046	49041662	16.62	21.16	.010 72
4.453	.1131	.0045	37041557	15.57	19.83	.010 05
4.4	.1118	.0044	50	41041521	15.21	19.36	.009 810
4	.1016	.0040	36	42041257	12.57	16	.008 107
3.965	.1007	.0040	38041235	12.35	15.72	.007 967
3.937	.10	.0039	1	.041217	12.17	15.50	.007 854
3.6	.09144	.0036	43041018	10.18	12.96	.006 567
3.531	.08969	.0035	39039793	9.793	12.47	.006 318
3.2	.08128	.0032	44038042	8.042	10.24	.005 189
3.145	.07987	.0031	40037766	7.766	9.888	.005 010
2.800	.07113	.0028	41036159	6.159	7.842	.003 973
2.8	.07112	.0028	45036158	6.158	7.84	.003 973
2.494	.06334	.0025	42034884	4.884	6.219	.003 151
2.4	.06096	.0024	46034524	4.524	5.76	.002 919
2.221	.05641	.0022	43033873	3.873	4.932	.002 499
2	.05080	.0020	47033142	3.142	4	.002 027
1.978	.05023	.0020	44033072	3.072	3.911	.001 982
1.969	.05	.0020	0-5	.033044	3.044	3.875	.001 963
1.761	.04473	.0018	45032436	2.436	3.102	.001 572
1.6	.04064	.0016	48032011	2.011	2.560	.001 297
1.568	.03984	.0016	46031932	1.932	2.460	.001 246
1.397	.03547	.0014	47031532	1.532	1.951	.039884
1.243	.03159	.0012	48031215	1.215	1.547	.037838
1.2	.03048	.0012	49031131	1.131	1.44	.037297
1.107	.02813	.0011	49030635	.9635	1.227	.036216
1	.02540	.0010	500307854	.7854	1	.035067
.9863	.02505	.0010	500307641	.7641	.9728	.034929

DECIMAL EQUIVALENTS OF NON-BINARY FRACTIONS

(Denominators 7 to 19.)

Nu- mer- ator	DENOMINATOR									
	7	9	11	12	13	14	15	17	18	19
1	.1429	.1111	.0909	.0833	.0769	.0714	.0667	.0588	.0556	.0526
2	.2857	.2222	.1818	.1667	.1538	.1429	.1333	.1176	.1111	.1053
3	.4286	.3333	.2727	.2500	.2308	.2143	.2000	.1765	.1667	.1579
4	.5714	.4444	.3636	.3333	.3077	.2857	.2667	.2353	.2222	.2105
5	.7143	.5556	.4545	.4167	.3846	.3571	.3333	.2941	.2778	.2632
6	.8571	.6667	.5455	.5000	.4615	.4286	.4000	.3529	.3333	.3158
77778	.6364	.5833	.5385	.5000	.4667	.4118	.3889	.3684
88889	.7273	.6667	.6154	.5714	.5333	.4706	.4444	.4211
98182	.7500	.6923	.6429	.6000	.5294	.5000	.4737
109091	.8333	.7692	.7143	.6667	.5882	.5556	.5263
119167	.8462	.7857	.7333	.6471	.6111	.5789
129231	.8571	.8000	.7059	.6667	.6316
139286	.8667	.7647	.7222	.6842
149333	.8235	.7778	.7368
158824	.8333	.7895
169412	.8889	.8421
179444	.8947
189474

SQUARE ROOTS AND CUBE ROOTS OF FRACTIONS

Frac- tion	Square Root	Cube Root	Frac- tion	Square Root	Cube Root	Frac- tion	Square Root	Cube Root
$\frac{1}{2}$.70711	.79370	$\frac{6}{7}$.92582	.94991	$\frac{1}{12}$.28868	.43679
$\frac{1}{3}$.57735	.69336	$\frac{1}{8}$.35355	.50000	$\frac{1}{15}$.64550	.74690
$\frac{2}{3}$.81650	.87358	$\frac{3}{8}$.61237	.72112	$\frac{7}{12}$.76376	.83555
$\frac{1}{4}$.50000	.62996	$\frac{5}{8}$.79057	.85499	$\frac{11}{12}$.95743	.97141
$\frac{3}{4}$.86603	.90856	$\frac{7}{8}$.93541	.95647	$\frac{1}{16}$.25000	.39685
$\frac{1}{6}$.40825	.55032	$\frac{1}{9}$.33333	.48075	$\frac{3}{16}$.43301	.57236
$\frac{5}{6}$.91287	.94104	$\frac{2}{9}$.47140	.60571	$\frac{5}{16}$.55902	.67860
$\frac{1}{7}$.37796	.52275	$\frac{4}{9}$.66667	.76314	$\frac{7}{16}$.66144	.75915
$\frac{2}{7}$.53452	.65863	$\frac{5}{9}$.74536	.82207	$\frac{9}{16}$.75000	.82548
$\frac{3}{7}$.65465	.75395	$\frac{7}{9}$.88192	.91963	$\frac{11}{16}$.82916	.88259
$\frac{4}{7}$.75593	.82983	$\frac{8}{9}$.94281	.96150	$\frac{13}{16}$.90138	.93313
$\frac{5}{7}$.84515	.89390	$\frac{15}{16}$.96825	.97872

**DECIMALS OF A FOOT FOR EACH $\frac{1}{64}$ OF
AN INCH.**

Inch.	0"	1"	2"	3"	4"	5"
0	0	.0833	.1667	.2500	.3333	.4167
$\frac{1}{64}$.0013	.0846	.1680	.2513	.3346	.4180
$\frac{2}{64}$.0026	.0859	.1693	.2526	.3359	.4193
$\frac{3}{64}$.0039	.0872	.1706	.2539	.3372	.4206
$\frac{4}{64}$.0052	.0885	.1719	.2552	.3385	.4219
$\frac{5}{64}$.0065	.0898	.1732	.2565	.3398	.4232
$\frac{6}{64}$.0078	.0911	.1745	.2578	.3411	.4245
$\frac{7}{64}$.0091	.0924	.1758	.2591	.3424	.4258
$\frac{8}{64}$.0104	.0937	.1771	.2604	.3437	.4271
$\frac{9}{64}$.0117	.0951	.1784	.2617	.3451	.4284
$\frac{10}{64}$.0130	.0964	.1797	.2630	.3464	.4297
$\frac{11}{64}$.0143	.0977	.1810	.2643	.3477	.4310
$\frac{12}{64}$.0156	.0990	.1823	.2656	.3490	.4323
$\frac{13}{64}$.0169	.1003	.1836	.2669	.3503	.4336
$\frac{14}{64}$.0182	.1016	.1849	.2682	.3516	.4349
$\frac{15}{64}$.0195	.1029	.1862	.2695	.3529	.4362
$\frac{16}{64}$.0208	.1042	.1875	.2708	.3542	.4375
$\frac{17}{64}$.0221	.1055	.1888	.2721	.3555	.4388
$\frac{18}{64}$.0234	.1068	.1901	.2734	.3568	.4401
$\frac{19}{64}$.0247	.1081	.1914	.2747	.3581	.4414
$\frac{20}{64}$.0260	.1094	.1927	.2760	.3594	.4427
$\frac{21}{64}$.0273	.1107	.1940	.2773	.3607	.4440
$\frac{22}{64}$.0286	.1120	.1953	.2786	.3620	.4453
$\frac{23}{64}$.0299	.1133	.1966	.2799	.3633	.4466
$\frac{24}{64}$.0312	.1146	.1979	.2812	.3646	.4479
$\frac{25}{64}$.0326	.1159	.1992	.2826	.3659	.4492
$\frac{26}{64}$.0339	.1172	.2005	.2839	.3672	.4505
$\frac{27}{64}$.0352	.1185	.2018	.2852	.3685	.4518
$\frac{28}{64}$.0365	.1198	.2031	.2865	.3698	.4531
$\frac{29}{64}$.0378	.1211	.2044	.2878	.3711	.4544
$\frac{30}{64}$.0391	.1224	.2057	.2891	.3724	.4557
$\frac{31}{64}$.0404	.1237	.2070	.2904	.3737	.4570
$\frac{32}{64}$.0417	.1250	.2083	.2917	.3750	.4583

DECIMALS OF A FOOT FOR EACH $\frac{1}{64}$ OF AN INCH.

Inch.	6"	7"	8"	9"	10"	11"
0	.5000	.5833	.6667	.7500	.8333	.9167
$\frac{1}{64}$.5013	.5846	.6680	.7513	.8346	.9180
$\frac{2}{64}$.5026	.5859	.6693	.7526	.8359	.9193
$\frac{3}{64}$.5039	.5872	.6706	.7539	.8372	.9206
$\frac{4}{64}$.5052	.5885	.6719	.7552	.8385	.9219
$\frac{5}{64}$.5065	.5898	.6732	.7565	.8398	.9232
$\frac{6}{64}$.5078	.5911	.6745	.7578	.8411	.9245
$\frac{7}{64}$.5091	.5924	.6758	.7591	.8424	.9258
$\frac{8}{64}$.5104	.5937	.6771	.7604	.8437	.9271
$\frac{9}{64}$.5117	.5951	.6784	.7617	.8451	.9284
$\frac{10}{64}$.5130	.5964	.6797	.7630	.8464	.9297
$\frac{11}{64}$.5143	.5977	.6810	.7643	.8477	.9310
$\frac{12}{64}$.5156	.5990	.6823	.7656	.8490	.9323
$\frac{13}{64}$.5169	.6003	.6836	.7669	.8503	.9336
$\frac{14}{64}$.5182	.6016	.6849	.7682	.8516	.9349
$\frac{15}{64}$.5195	.6029	.6862	.7695	.8529	.9362
$\frac{16}{64}$.5208	.6042	.6875	.7708	.8542	.9375
$\frac{17}{64}$.5221	.6055	.6888	.7721	.8555	.9388
$\frac{18}{64}$.5234	.6068	.6901	.7734	.8568	.9401
$\frac{19}{64}$.5247	.6081	.6914	.7747	.8581	.9414
$\frac{20}{64}$.5260	.6094	.6927	.7760	.8594	.9427
$\frac{21}{64}$.5273	.6107	.6940	.7773	.8607	.9440
$\frac{22}{64}$.5286	.6120	.6953	.7786	.8620	.9453
$\frac{23}{64}$.5299	.6133	.6966	.7799	.8633	.9466
$\frac{24}{64}$.5312	.6146	.6979	.7812	.8646	.9479
$\frac{25}{64}$.5326	.6159	.6992	.7826	.8659	.9492
$\frac{26}{64}$.5339	.6172	.7005	.7839	.8672	.9505
$\frac{27}{64}$.5352	.6185	.7018	.7852	.8685	.9518
$\frac{28}{64}$.5365	.6198	.7031	.7865	.8698	.9531
$\frac{29}{64}$.5378	.6211	.7044	.7878	.8711	.9544
$\frac{30}{64}$.5391	.6224	.7057	.7891	.8724	.9557
$\frac{31}{64}$.5404	.6237	.7070	.7904	.8737	.9570
$\frac{32}{64}$.5417	.6250	.7083	.7917	.8750	.9583

**DECIMALS OF A FOOT FOR EACH $\frac{1}{16}$ OF
AN INCH.**

Inch.	0"	1"	2"	3"	4"	5"
$\frac{33}{64}$.0430	.1263	.2096	.2930	.3763	.4596
$\frac{34}{64}$.0443	.1276	.2109	.2943	.3776	.4609
$\frac{35}{64}$.0456	.1289	.2122	.2956	.3789	.4622
$\frac{36}{64}$.0469	.1302	.2135	.2969	.3802	.4635
$\frac{37}{64}$.0482	.1315	.2148	.2982	.3815	.4648
$\frac{38}{64}$.0495	.1328	.2161	.2995	.3828	.4661
$\frac{39}{64}$.0508	.1341	.2174	.3008	.3841	.4674
$\frac{40}{64}$.0521	.1354	.2188	.3021	.3854	.4688
$\frac{41}{64}$.0534	.1367	.2201	.3034	.3867	.4701
$\frac{42}{64}$.0547	.1380	.2214	.3047	.3880	.4714
$\frac{43}{64}$.0560	.1393	.2227	.3060	.3893	.4727
$\frac{44}{64}$.0573	.1406	.2240	.3073	.3906	.4740
$\frac{45}{64}$.0586	.1419	.2253	.3086	.3919	.4753
$\frac{46}{64}$.0599	.1432	.2266	.3099	.3932	.4766
$\frac{47}{64}$.0612	.1445	.2279	.3112	.3945	.4779
$\frac{48}{64}$.0625	.1458	.2292	.3125	.3958	.4792
$\frac{49}{64}$.0638	.1471	.2305	.3138	.3971	.4805
$\frac{50}{64}$.0651	.1484	.2318	.3151	.3984	.4818
$\frac{51}{64}$.0664	.1497	.2331	.3164	.3997	.4831
$\frac{52}{64}$.0677	.1510	.2344	.3177	.4010	.4844
$\frac{53}{64}$.0690	.1523	.2357	.3190	.4023	.4857
$\frac{54}{64}$.0703	.1536	.2370	.3203	.4036	.4870
$\frac{55}{64}$.0716	.1549	.2383	.3216	.4049	.4883
$\frac{56}{64}$.0729	.1562	.2396	.3229	.4062	.4896
$\frac{57}{64}$.0742	.1576	.2409	.3242	.4076	.4909
$\frac{58}{64}$.0755	.1589	.2422	.3255	.4089	.4922
$\frac{59}{64}$.0768	.1602	.2435	.3268	.4102	.4935
$\frac{60}{64}$.0781	.1615	.2448	.3281	.4115	.4948
$\frac{61}{64}$.0794	.1628	.2461	.3294	.4128	.4961
$\frac{62}{64}$.0807	.1641	.2474	.3307	.4141	.4974
$\frac{63}{64}$.0820	.1654	.2487	.3320	.4154	.4987
1						

DECIMALS OF A FOOT FOR EACH $\frac{1}{16}$ OF AN INCH.

Inch.	6"	7"	8"	9"	10"	11"
$\frac{3}{16}$.5430	.6263	.7096	.7930	.8763	.9596
$\frac{4}{16}$.5443	.6276	.7109	.7943	.8776	.9609
$\frac{5}{16}$.5456	.6289	.7122	.7956	.8789	.9622
$\frac{6}{16}$.5469	.6302	.7135	.7969	.8802	.9635
$\frac{7}{16}$.5482	.6315	.7148	.7982	.8815	.9648
$\frac{8}{16}$.5495	.6328	.7161	.7995	.8828	.9661
$\frac{9}{16}$.5508	.6341	.7174	.8008	.8841	.9674
$\frac{10}{16}$.5521	.6354	.7188	.8021	.8854	.9688
$\frac{11}{16}$.5534	.6367	.7201	.8034	.8867	.9701
$\frac{12}{16}$.5547	.6380	.7214	.8047	.8880	.9714
$\frac{13}{16}$.5560	.6393	.7227	.8060	.8893	.9727
$\frac{14}{16}$.5573	.6406	.7240	.8073	.8906	.9740
$\frac{15}{16}$.5586	.6419	.7253	.8086	.8919	.9753
$\frac{16}{16}$.5599	.6432	.7266	.8099	.8932	.9766
$\frac{17}{16}$.5612	.6445	.7279	.8112	.8945	.9779
$\frac{18}{16}$.5625	.6458	.7292	.8125	.8958	.9792
$\frac{19}{16}$.5638	.6471	.7305	.8138	.8971	.9805
$\frac{20}{16}$.5651	.6484	.7318	.8151	.8984	.9818
$\frac{21}{16}$.5664	.6497	.7331	.8164	.8997	.9831
$\frac{22}{16}$.5677	.6510	.7344	.8177	.9010	.9844
$\frac{23}{16}$.5690	.6523	.7357	.8190	.9023	.9857
$\frac{24}{16}$.5703	.6536	.7370	.8203	.9036	.9870
$\frac{25}{16}$.5716	.6549	.7383	.8216	.9049	.9883
$\frac{26}{16}$.5729	.6562	.7396	.8229	.9062	.9896
$\frac{27}{16}$.5742	.6576	.7409	.8242	.9076	.9909
$\frac{28}{16}$.5755	.6589	.7422	.8255	.9089	.9922
$\frac{29}{16}$.5768	.6602	.7435	.8268	.9102	.9935
$\frac{30}{16}$.5781	.6615	.7448	.8281	.9115	.9948
$\frac{31}{16}$.5794	.6628	.7461	.8294	.9128	.9961
$\frac{32}{16}$.5807	.6641	.7474	.8307	.9141	.9974
$\frac{33}{16}$.5820	.6654	.7487	.8320	.9154	.9987
1						1.0000





**DECIMALS OF AN INCH FOR EACH $\frac{1}{64}$ TH.
WITH MILLIMETRE EQUIVALENTS.**

Fraction	$\frac{1}{64}$ ths	Decimal	Millimetres	Fraction	$\frac{1}{64}$ ths	Decimal	Millimetres
..	1	.015625	0.397	...	33	.515625	13.097
$\frac{1}{32}$	2	.03125	0.794	$\frac{17}{32}$	34	.53125	13.494
..	3	.046875	1.191	...	35	.546875	13.891
$\frac{1}{16}$	4	.0625	1.588	$\frac{9}{16}$	36	.5625	14.288
..	5	.078125	1.984	...	37	.578125	14.684
$\frac{3}{32}$	6	.09375	2.381	$\frac{19}{32}$	38	.59375	15.081
..	7	.109375	2.778	...	39	.609375	15.478
$\frac{1}{8}$	8	.125	3.175	$\frac{5}{8}$	40	.625	15.875
..	9	.140625	3.572	...	41	.640625	16.272
$\frac{5}{32}$	10	.15625	3.969	$\frac{21}{32}$	42	.65625	16.669
..	11	.171875	4.366	...	43	.671875	17.066
$\frac{3}{16}$	12	.1875	4.763	$\frac{11}{16}$	44	.6875	17.463
..	13	.203125	5.159	...	45	.703125	17.859
$\frac{7}{32}$	14	.21875	5.556	$\frac{23}{32}$	46	.71875	18.256
..	15	.234375	5.953	...	47	.734375	18.653
$\frac{1}{4}$	16	.25	6.350	$\frac{3}{4}$	48	.75	19.050
..	17	.265625	6.747	...	49	.765625	19.447
$\frac{9}{32}$	18	.28125	7.144	$\frac{25}{32}$	50	.78125	19.844
..	19	.296875	7.541	...	51	.796875	20.241
$\frac{5}{16}$	20	.3125	7.938	$\frac{13}{16}$	52	.8125	20.638
..	21	.328125	8.334	...	53	.828125	21.034
$\frac{11}{32}$	22	.34375	8.731	$\frac{27}{32}$	54	.84375	21.431
..	23	.359375	9.128	...	55	.859375	21.828
$\frac{3}{8}$	24	.375	9.525	$\frac{7}{8}$	56	.875	22.225
..	25	.390625	9.922	...	57	.890625	22.622
$\frac{13}{32}$	26	.40625	10.319	$\frac{29}{32}$	58	.90625	23.019
..	27	.421875	10.716	...	59	.921875	23.416
$\frac{7}{16}$	28	.4375	11.113	$\frac{15}{16}$	60	.9375	23.813
..	29	.453125	11.509	...	61	.953125	24.209
$\frac{15}{32}$	30	.46875	11.906	$\frac{31}{32}$	62	.96875	24.606
..	31	.484375	12.303	...	63	.984375	25.003
$\frac{1}{2}$	32	.5	12.700	1	64	1.	25.400

WEIGHTS AND AREAS OF SQUARE AND ROUND BARS AND CIRCUMFERENCES OF ROUND BARS.





One cubic foot of steel weighs 489.6 lbs.

The following tables of weights of rounds, squares, flats, etc., are theoretical only. The various sizes made by us are listed elsewhere herein under appropriate headings, and the weights of rolled steel are subject to variation in accordance with mill practice for the different classes of products.

Thickness or Diameter in Inches.	Weight of  Bar One Foot Long.	Weight of  Bar One Foot Long.	Area of  Bar in Sq. Inches.	Area of  Bar in Sq. Inches.	Circumference of  Bar in Inches.
$\frac{1}{16}$.013	.010	.0039	.0031	.1964
$\frac{3}{64}$.021	.016	.0061	.0048	.2454
$\frac{1}{32}$.030	.023	.0088	.0069	.2945
$\frac{7}{64}$.041	.032	.0120	.0094	.3436
$\frac{1}{8}$.053	.042	.0156	.0123	.3927
$\frac{9}{64}$.067	.053	.0198	.0155	.4418
$\frac{5}{32}$.083	.065	.0244	.0192	.4909
$\frac{11}{64}$.100	.079	.0295	.0232	.5400
$\frac{3}{16}$.120	.094	.0352	.0276	.5891
$\frac{13}{64}$.140	.110	.0413	.0324	.6381
$\frac{7}{32}$.163	.128	.0479	.0376	.6872
$\frac{15}{64}$.187	.147	.0549	.0431	.7363
$\frac{1}{4}$.212	.167	.0625	.0491	.7854
$\frac{17}{64}$.240	.188	.0706	.0554	.8345
$\frac{9}{32}$.269	.211	.0791	.0621	.8836
$\frac{19}{64}$.300	.235	.0881	.0692	.9327
$\frac{5}{16}$.332	.261	.0977	.0767	.9818
$\frac{21}{64}$.366	.288	.1077	.0846	1.0308
$\frac{11}{32}$.402	.316	.1182	.0928	1.0799
$\frac{23}{64}$.439	.345	.1292	.1014	1.1290
$\frac{3}{8}$.478	.376	.1406	.1104	1.1781
$\frac{25}{64}$.519	.407	.1526	.1198	1.2272
$\frac{13}{32}$.561	.441	.1650	.1296	1.2763
$\frac{27}{64}$.605	.475	.1780	.1398	1.3254
$\frac{7}{16}$.651	.511	.1914	.1503	1.3745
$\frac{29}{64}$.698	.548	.2053	.1613	1.4235
$\frac{15}{32}$.747	.587	.2197	.1726	1.4726
$\frac{31}{64}$.798	.627	.2346	.1843	1.5217
$\frac{1}{2}$.850	.668	.2500	.1963	1.5708
$\frac{33}{64}$.904	.710	.2659	.2088	1.6199
$\frac{17}{32}$.960	.754	.2822	.2217	1.6690
$\frac{35}{64}$	1.017	.799	.2991	.2349	1.7181





SQUARE AND ROUND BARS.

(CONTINUED.)

Thickness or Diameter in Inches.	Weight of  Bar One Foot Long.	Weight of  Bar One Foot Long.	Area of  Bar in Sq. Inches.	Area of  Bar in Sq. Inches.	Circumference of  Bar in Inches.
$\frac{9}{16}$	1.076	.845	.3164	.2485	1.7672
$\frac{3}{4}$	1.136	.893	.3342	.2625	1.8162
$\frac{13}{16}$	1.199	.941	.3525	.2769	1.8653
$\frac{7}{8}$	1.263	.992	.3713	.2916	1.9144
$\frac{5}{8}$	1.328	1.043	.3906	.3068	1.9635
$\frac{11}{16}$	1.395	1.096	.4104	.3223	2.0126
$\frac{3}{4}$	1.464	1.150	.4307	.3382	2.0617
$\frac{13}{16}$	1.535	1.205	.4514	.3545	2.1108
$\frac{11}{16}$	1.607	1.262	.4727	.3712	2.1599
$\frac{45}{64}$	1.681	1.320	.4944	.3883	2.2089
$\frac{23}{32}$	1.756	1.380	.5166	.4057	2.2580
$\frac{27}{32}$	1.834	1.440	.5393	.4236	2.3071
$\frac{3}{4}$	1.913	1.502	.5625	.4418	2.3562
$\frac{13}{16}$	2.245	1.763	.6602	.5185	2.5526
$\frac{7}{8}$	2.603	2.044	.7656	.6013	2.7489
$\frac{15}{16}$	2.988	2.347	.8789	.6903	2.9453
1	3.400	2.670	1.0000	.7854	3.1416
$\frac{1}{16}$	3.838	3.015	1.1289	.8866	3.3380
$\frac{1}{8}$	4.303	3.380	1.2656	.9940	3.5343
$\frac{3}{16}$	4.795	3.766	1.4102	1.1075	3.7306
$\frac{1}{4}$	5.313	4.172	1.5625	1.2272	3.9270
$\frac{5}{16}$	5.857	4.600	1.7227	1.3530	4.1234
$\frac{3}{8}$	6.428	5.049	1.8906	1.4849	4.3197
$\frac{7}{16}$	7.026	5.518	2.0664	1.6230	4.5161
$\frac{1}{2}$	7.650	6.008	2.2500	1.7671	4.7124
$\frac{9}{16}$	8.301	6.519	2.4414	1.9175	4.9088
$\frac{5}{8}$	8.978	7.051	2.6406	2.0739	5.1051
$\frac{11}{16}$	9.682	7.604	2.8477	2.2365	5.3015
$\frac{3}{4}$	10.41	8.178	3.0625	2.4053	5.4978
$\frac{13}{16}$	11.17	8.773	3.2852	2.5802	5.6942
$\frac{7}{8}$	11.95	9.388	3.5156	2.7612	5.8905
$\frac{15}{16}$	12.76	10.02	3.7539	2.9483	6.0869





SQUARE AND ROUND BARS.

(CONTINUED.)

Thickness or Diameter in Inches.	Weight of  Bar One Foot Long.	Weight of  Bar One Foot Long.	Area of  Bar in Sq. Inches.	Area of  Bar in Sq. Inches.	Circumference of  Bar in Inches.
2	13.60	10.68	4.0000	3.1416	6.2832
$\frac{1}{16}$	14.46	11.36	4.2539	3.3410	6.4796
$\frac{1}{8}$	15.35	12.06	4.5156	3.5466	6.6759
$\frac{3}{16}$	16.27	12.78	4.7852	3.7583	6.8723
$\frac{1}{4}$	17.21	13.52	5.0625	3.9761	7.0686
$\frac{5}{16}$	18.18	14.28	5.3477	4.2000	7.2650
$\frac{3}{8}$	19.18	15.06	5.6406	4.4301	7.4613
$\frac{7}{16}$	20.20	15.87	5.9414	4.6664	7.6577
$\frac{1}{2}$	21.25	16.69	6.2500	4.9087	7.8540
$\frac{9}{16}$	22.33	17.53	6.5664	5.1573	8.0504
$\frac{5}{8}$	23.43	18.40	6.8906	5.4119	8.2467
$\frac{11}{16}$	24.56	19.29	7.2227	5.6727	8.4431
$\frac{3}{4}$	25.71	20.19	7.5625	5.9396	8.6394
$\frac{13}{16}$	26.90	21.12	7.9102	6.2126	8.8358
$\frac{7}{8}$	28.10	22.07	8.2656	6.4918	9.0321
$\frac{15}{16}$	29.34	23.04	8.6289	6.7771	9.2285
3	30.60	24.03	9.0000	7.0686	9.4248
$\frac{1}{16}$	31.89	25.05	9.3789	7.3662	9.6212
$\frac{1}{8}$	33.20	26.08	9.7656	7.6699	9.8175
$\frac{3}{16}$	34.55	27.13	10.160	7.9798	10.014
$\frac{1}{4}$	35.92	28.21	10.563	8.2958	10.210
$\frac{5}{16}$	37.31	29.30	10.973	8.6179	10.407
$\frac{3}{8}$	38.73	30.42	11.391	8.9462	10.603
$\frac{7}{16}$	40.18	31.55	11.816	9.2806	10.799
$\frac{1}{2}$	41.65	32.71	12.250	9.6211	10.996
$\frac{9}{16}$	43.15	33.89	12.691	9.9678	11.192
$\frac{5}{8}$	44.68	35.09	13.141	10.321	11.388
$\frac{11}{16}$	46.23	36.31	13.598	10.680	11.585
$\frac{3}{4}$	47.82	37.55	14.063	11.045	11.781
$\frac{13}{16}$	49.42	38.81	14.535	11.416	11.977
$\frac{7}{8}$	51.05	40.10	15.016	11.793	12.174
$\frac{15}{16}$	52.71	41.40	15.504	12.177	12.370





SQUARE AND ROUND BARS.

(CONTINUED.)

Thickness or Diameter in Inches.	Weight of  Bar One Foot Long.	Weight of  Bar One Foot Long.	Area of  Bar in Sq. Inches.	Area of  Bar in Sq. Inches.	Circumference of  Bar in Inches.
4	54.40	42.73	16.000	12.566	12.566
$\frac{1}{16}$	56.11	44.07	16.504	12.962	12.763
$\frac{1}{8}$	57.85	45.44	17.016	13.364	12.959
$\frac{3}{16}$	59.62	46.33	17.535	13.772	13.155
$\frac{1}{4}$	61.41	48.24	18.063	14.186	13.352
$\frac{5}{16}$	63.23	49.66	18.598	14.607	13.548
$\frac{3}{8}$	65.08	51.11	19.141	15.033	13.745
$\frac{7}{16}$	66.95	52.58	19.691	15.466	13.941
$\frac{1}{2}$	68.85	54.07	20.250	15.904	14.137
$\frac{9}{16}$	70.78	55.59	20.816	16.349	14.334
$\frac{5}{8}$	72.73	57.12	21.391	16.800	14.530
$\frac{11}{16}$	74.71	58.67	21.973	17.257	14.726
$\frac{3}{4}$	76.71	60.25	22.563	17.721	14.923
$\frac{13}{16}$	78.74	61.85	23.160	18.190	15.119
$\frac{7}{8}$	80.80	63.46	23.766	18.665	15.315
$\frac{15}{16}$	82.89	65.10	24.379	19.147	15.512
5	85.00	66.76	25.000	19.635	15.708
$\frac{1}{16}$	87.14	68.44	25.629	20.129	15.904
$\frac{1}{8}$	89.30	70.14	26.266	20.629	16.101
$\frac{3}{16}$	91.49	71.86	26.910	21.135	16.297
$\frac{1}{4}$	93.71	73.60	27.563	21.648	16.493
$\frac{5}{16}$	95.96	75.37	28.223	22.166	16.690
$\frac{3}{8}$	98.23	77.15	28.891	22.691	16.886
$\frac{7}{16}$	100.5	78.95	29.566	23.221	17.082
$\frac{1}{2}$	102.9	80.78	30.250	23.758	17.279
$\frac{9}{16}$	105.2	82.62	30.941	24.301	17.475
$\frac{5}{8}$	107.6	84.49	31.641	24.851	17.672
$\frac{11}{16}$	110.0	86.38	32.348	25.406	17.868
$\frac{3}{4}$	112.4	88.29	33.063	25.967	18.064
$\frac{13}{16}$	114.9	90.22	33.785	26.535	18.261
$\frac{7}{8}$	117.4	92.17	34.516	27.109	18.457
$\frac{15}{16}$	119.9	94.14	35.254	27.688	18.653





SQUARE AND ROUND BARS.

(CONTINUED.)

Thickness or Diameter in Inches.	Weight of  Bar One Foot Long.	Weight of  Bar One Foot Long.	Area of  Bar in Sq. Inches.	Area of  Bar in Sq. Inches.	Circumference of  Bar in Inches.
6	122.4	96.13	36.000	28.274	18.850
$\frac{1}{16}$	125.0	98.15	36.754	28.867	19.046
$\frac{1}{8}$	127.6	100.2	37.516	29.465	19.242
$\frac{3}{16}$	130.2	102.2	38.285	30.069	19.439
$\frac{1}{4}$	132.8	104.3	39.063	30.680	19.635
$\frac{5}{16}$	135.5	106.4	39.848	31.296	19.831
$\frac{3}{8}$	138.2	108.5	40.641	31.919	20.028
$\frac{7}{16}$	140.9	110.7	41.441	32.548	20.224
$\frac{1}{2}$	143.7	112.8	42.250	33.183	20.420
$\frac{9}{16}$	146.5	115.0	43.066	33.824	20.617
$\frac{5}{8}$	149.2	117.2	43.891	34.472	20.813
$\frac{11}{16}$	152.1	119.4	44.723	35.125	21.009
$\frac{3}{4}$	154.9	121.7	45.563	35.785	21.206
$\frac{13}{16}$	157.8	123.9	46.410	36.451	21.402
$\frac{7}{8}$	160.7	126.2	47.266	37.122	21.599
$\frac{15}{16}$	163.6	128.5	48.129	37.800	21.795
7	166.6	130.8	49.000	38.485	21.991
$\frac{1}{16}$	169.6	133.2	49.879	39.175	22.188
$\frac{1}{8}$	172.6	135.6	50.766	39.871	22.384
$\frac{3}{16}$	175.6	138.0	51.660	40.574	22.580
$\frac{1}{4}$	178.7	140.4	52.563	41.283	22.777
$\frac{5}{16}$	181.8	142.8	53.473	41.997	22.973
$\frac{3}{8}$	184.9	145.2	54.391	42.718	23.169
$\frac{7}{16}$	188.1	147.7	55.316	43.446	23.366
$\frac{1}{2}$	191.3	150.2	56.250	44.179	23.562
$\frac{9}{16}$	194.5	152.7	57.191	44.918	23.758
$\frac{5}{8}$	197.7	155.3	58.141	45.664	23.955
$\frac{11}{16}$	200.9	157.8	59.098	46.415	24.151
$\frac{3}{4}$	204.2	160.4	60.063	47.173	24.347
$\frac{13}{16}$	207.5	163.0	61.035	47.937	24.544
$\frac{7}{8}$	210.9	165.6	62.016	48.707	24.740
$\frac{15}{16}$	214.2	168.2	63.004	49.483	24.936





SQUARE AND ROUND BARS.

(CONTINUED.)

Thickness or Diameter in Inches.	Weight of  Bar One Foot Long.	Weight of  Bar One Foot Long.	Area of  Bar in Sq. Inches.	Area of  Bar in Sq. Inches.	Circumference of  Bar in Inches.
8	217.6	170.9	64.000	50.266	25.133
$\frac{1}{16}$	221.0	173.6	65.004	51.054	25.329
$\frac{1}{8}$	224.5	176.3	66.016	51.849	25.526
$\frac{3}{16}$	227.9	179.0	67.035	52.649	25.722
$\frac{1}{4}$	231.4	181.8	68.063	53.456	25.918
$\frac{5}{16}$	234.9	184.5	69.098	54.269	26.115
$\frac{3}{8}$	238.5	187.3	70.141	55.088	26.311
$\frac{7}{16}$	242.1	190.1	71.191	55.914	26.507
$\frac{1}{2}$	245.7	192.9	72.250	56.745	26.704
$\frac{9}{16}$	249.3	195.8	73.316	57.583	26.900
$\frac{5}{8}$	252.9	198.6	74.391	58.426	27.096
$\frac{11}{16}$	256.6	201.5	75.473	59.276	27.293
$\frac{3}{4}$	260.3	204.4	76.563	60.132	27.489
$\frac{13}{16}$	264.0	207.4	77.660	60.994	27.685
$\frac{7}{8}$	267.8	210.3	78.766	61.863	27.882
$\frac{15}{16}$	271.6	213.3	79.879	62.737	28.078
9	275.4	216.3	81.000	63.617	28.274
$\frac{1}{16}$	279.2	219.3	82.129	64.504	28.471
$\frac{1}{8}$	283.1	222.3	83.266	65.397	28.667
$\frac{3}{16}$	287.0	225.4	84.410	66.296	28.863
$\frac{1}{4}$	290.9	228.5	85.563	67.201	29.060
$\frac{5}{16}$	294.9	231.6	86.723	68.112	29.256
$\frac{3}{8}$	298.8	234.7	87.891	69.029	29.453
$\frac{7}{16}$	302.8	237.8	89.066	69.953	29.649
$\frac{1}{2}$	306.9	241.0	90.250	70.882	29.845
$\frac{9}{16}$	310.9	244.2	91.441	71.818	30.042
$\frac{5}{8}$	315.0	247.4	92.641	72.760	30.238
$\frac{11}{16}$	319.1	250.6	93.848	73.708	30.434
$\frac{3}{4}$	323.2	253.8	95.063	74.662	30.631
$\frac{13}{16}$	327.4	257.1	96.285	75.622	30.827
$\frac{7}{8}$	331.6	260.4	97.516	76.589	31.023
$\frac{15}{16}$	335.8	263.7	98.754	77.561	31.220





SQUARE AND ROUND BARS.

(CONCLUDED.)

Thickness or Diameter in Inches.	Weight of  Bar One Foot Long.	Weight of  Bar One Foot Long.	Area of  Bar in Sq. Inches.	Area of  Bar in Sq. Inches.	Circumference of  Bar in Inches.
10	340.0	267.0	100.00	78.540	31.416
$\frac{1}{16}$	344.3	270.4	101.25	79.525	31.612
$\frac{1}{8}$	348.6	273.8	102.52	80.516	31.809
$\frac{3}{16}$	352.9	277.1	103.79	81.513	32.005
$\frac{1}{4}$	357.2	280.6	105.06	82.516	32.201
$\frac{5}{16}$	361.6	284.0	106.35	83.525	32.398
$\frac{3}{8}$	366.0	287.4	107.64	84.541	32.594
$\frac{7}{16}$	370.4	290.9	108.94	85.563	32.790
$\frac{1}{2}$	374.9	294.4	110.25	86.590	32.987
$\frac{9}{16}$	379.3	297.9	111.57	87.624	33.183
$\frac{5}{8}$	383.8	301.5	112.89	88.664	33.380
$\frac{11}{16}$	388.4	305.0	114.22	89.710	33.576
$\frac{3}{4}$	392.9	308.6	115.56	90.763	33.772
$\frac{13}{16}$	397.5	312.2	116.91	91.821	33.969
$\frac{7}{8}$	402.1	315.8	118.27	92.886	34.165
$\frac{15}{16}$	406.7	319.5	119.63	93.957	34.361
11	411.4	323.1	121.00	95.033	34.558
$\frac{1}{16}$	416.1	326.8	122.38	96.116	34.754
$\frac{1}{8}$	420.8	330.5	123.77	97.206	34.950
$\frac{3}{16}$	425.5	334.3	125.16	98.301	35.147
$\frac{1}{4}$	430.3	338.0	126.56	99.402	35.343
$\frac{5}{16}$	435.1	341.7	127.97	100.51	35.539
$\frac{3}{8}$	439.9	345.5	129.39	101.62	35.736
$\frac{7}{16}$	444.8	349.3	130.82	102.74	35.932
$\frac{1}{2}$	449.7	353.2	132.25	103.87	36.128
$\frac{9}{16}$	454.6	357.0	133.69	105.00	36.325
$\frac{5}{8}$	459.5	360.9	135.14	106.14	36.521
$\frac{11}{16}$	464.4	364.8	136.60	107.28	36.717
$\frac{3}{4}$	469.4	368.7	138.06	108.43	36.914
$\frac{13}{16}$	474.4	372.6	139.54	109.59	37.110
$\frac{7}{8}$	479.5	376.6	141.02	110.75	37.307
$\frac{15}{16}$	484.5	380.5	142.50	111.92	37.503

WEIGHTS OF SQUARE AND ROUND BARS PER RUNNING INCH.

One cubic inch of steel weighs 0.2833 lb.

Thickness or Diameter in Inches.	Weight of  Bar One Inch Long.	Weight of  Bar One Inch Long.	Thickness or Diameter in Inches.	Weight of  Bar One Inch Long.	Weight of  Bar One Inch Long.
			2	1.13	.89
$\frac{1}{16}$	$\frac{1}{16}$	1.21	.95
$\frac{1}{8}$	$\frac{1}{8}$	1.28	1.01
$\frac{3}{16}$.01	$\frac{3}{16}$	1.36	1.07
$\frac{1}{4}$.02	.01	$\frac{1}{4}$	1.43	1.13
$\frac{5}{16}$.03	.02	$\frac{5}{16}$	1.52	1.19
$\frac{3}{8}$.04	.03	$\frac{3}{8}$	1.60	1.26
$\frac{7}{16}$.05	.04	$\frac{7}{16}$	1.68	1.32
$\frac{1}{2}$.07	.06	$\frac{1}{2}$	1.77	1.39
$\frac{9}{16}$.09	.07	$\frac{9}{16}$	1.86	1.46
$\frac{5}{8}$.11	.09	$\frac{5}{8}$	1.95	1.54
$\frac{11}{16}$.13	.11	$\frac{11}{16}$	2.05	1.61
$\frac{3}{4}$.16	.13	$\frac{3}{4}$	2.14	1.69
$\frac{13}{16}$.19	.15	$\frac{13}{16}$	2.24	1.76
$\frac{7}{8}$.22	.17	$\frac{7}{8}$	2.34	1.84
$\frac{15}{16}$.25	.20	$\frac{15}{16}$	2.44	1.92
1	.28	.22	3	2.55	2.01
$\frac{1}{16}$.32	.25	$\frac{1}{16}$	2.66	2.09
$\frac{1}{8}$.36	.28	$\frac{1}{8}$	2.77	2.18
$\frac{3}{16}$.40	.31	$\frac{3}{16}$	2.88	2.26
$\frac{1}{4}$.44	.35	$\frac{1}{4}$	2.99	2.35
$\frac{5}{16}$.49	.38	$\frac{5}{16}$	3.11	2.44
$\frac{3}{8}$.54	.42	$\frac{3}{8}$	3.23	2.53
$\frac{7}{16}$.58	.46	$\frac{7}{16}$	3.35	2.63
$\frac{1}{2}$.64	.50	$\frac{1}{2}$	3.47	2.73
$\frac{9}{16}$.69	.54	$\frac{9}{16}$	3.60	2.82
$\frac{5}{8}$.75	.59	$\frac{5}{8}$	3.72	2.92
$\frac{11}{16}$.81	.63	$\frac{11}{16}$	3.85	3.03
$\frac{3}{4}$.87	.68	$\frac{3}{4}$	3.98	3.13
$\frac{13}{16}$.94	.73	$\frac{13}{16}$	4.12	3.23
$\frac{7}{8}$	1.00	.78	$\frac{7}{8}$	4.25	3.34
$\frac{15}{16}$	1.06	.84	$\frac{15}{16}$	4.39	3.45

SQUARE AND ROUND BARS.

(CONTINUED.)

Thickness or Diameter in Inches.	Weight of \square Bar One Inch Long.	Weight of \circ Bar One Inch Long.	Thickness or Diameter in Inches.	Weight of \square Bar One Inch Long.	Weight of \circ Bar One Inch Long.
4	4.53	3.57	6	10.20	8.01
$\frac{1}{16}$	4.68	3.67	$\frac{1}{16}$	10.41	8.18
$\frac{1}{8}$	4.82	3.79	$\frac{1}{8}$	10.63	8.35
$\frac{3}{16}$	4.97	3.90	$\frac{3}{16}$	10.85	8.52
$\frac{1}{4}$	5.12	4.02	$\frac{1}{4}$	11.07	8.69
$\frac{5}{16}$	5.27	4.14	$\frac{5}{16}$	11.29	8.87
$\frac{3}{8}$	5.42	4.26	$\frac{3}{8}$	11.51	9.04
$\frac{7}{16}$	5.58	4.38	$\frac{7}{16}$	11.74	9.22
$\frac{1}{2}$	5.74	4.51	$\frac{1}{2}$	11.97	9.40
$\frac{9}{16}$	5.90	4.63	$\frac{9}{16}$	12.20	9.58
$\frac{5}{8}$	6.06	4.76	$\frac{5}{8}$	12.43	9.77
$\frac{11}{16}$	6.23	4.89	$\frac{11}{16}$	12.67	9.95
$\frac{3}{4}$	6.39	5.02	$\frac{3}{4}$	12.91	10.14
$\frac{13}{16}$	6.56	5.15	$\frac{13}{16}$	13.15	10.33
$\frac{7}{8}$	6.73	5.29	$\frac{7}{8}$	13.39	10.52
$\frac{15}{16}$	6.91	5.42	$\frac{15}{16}$	13.64	10.71
5	7.08	5.56	7	13.88	10.90
$\frac{1}{16}$	7.26	5.70	$\frac{1}{16}$	14.13	11.10
$\frac{1}{8}$	7.44	5.84	$\frac{1}{8}$	14.38	11.30
$\frac{3}{16}$	7.62	5.99	$\frac{3}{16}$	14.64	11.50
$\frac{1}{4}$	7.81	6.13	$\frac{1}{4}$	14.89	11.70
$\frac{5}{16}$	8.00	6.28	$\frac{5}{16}$	15.15	11.90
$\frac{3}{8}$	8.19	6.43	$\frac{3}{8}$	15.41	12.10
$\frac{7}{16}$	8.38	6.58	$\frac{7}{16}$	15.67	12.31
$\frac{1}{2}$	8.57	6.73	$\frac{1}{2}$	15.94	12.52
$\frac{9}{16}$	8.77	6.88	$\frac{9}{16}$	16.20	12.73
$\frac{5}{8}$	8.96	7.04	$\frac{5}{8}$	16.47	12.94
$\frac{11}{16}$	9.16	7.20	$\frac{11}{16}$	16.74	13.15
$\frac{3}{4}$	9.37	7.36	$\frac{3}{4}$	17.02	13.36
$\frac{13}{16}$	9.57	7.52	$\frac{13}{16}$	17.29	13.58
$\frac{7}{8}$	9.78	7.68	$\frac{7}{8}$	17.57	13.80
$\frac{15}{16}$	9.99	7.84	$\frac{15}{16}$	17.85	14.02

SQUARE AND ROUND BARS.

(CONTINUED.)

Thickness or Diameter in Inches.	Weight of □ Bar One Inch Long.	Weight of ○ Bar One Inch Long.	Thickness or Diameter in Inches.	Weight of □ Bar One Inch Long.	Weight of ○ Bar One Inch Long.
8	18.11	14.24	10	28.33	22.25
$\frac{1}{16}$	18.42	14.46	$\frac{1}{16}$	28.69	22.53
$\frac{1}{8}$	18.70	14.69	$\frac{1}{8}$	29.04	22.81
$\frac{3}{16}$	18.99	14.92	$\frac{3}{16}$	29.41	23.09
$\frac{1}{4}$	19.28	15.14	$\frac{1}{4}$	29.77	23.38
$\frac{5}{16}$	19.58	15.38	$\frac{5}{16}$	30.13	23.66
$\frac{3}{8}$	19.87	15.61	$\frac{3}{8}$	30.50	23.95
$\frac{7}{16}$	20.17	15.84	$\frac{7}{16}$	30.87	24.24
$\frac{1}{2}$	20.47	16.08	$\frac{1}{2}$	31.24	24.53
$\frac{9}{16}$	20.77	16.31	$\frac{9}{16}$	31.61	24.82
$\frac{5}{8}$	21.08	16.55	$\frac{5}{8}$	31.98	25.12
$\frac{11}{16}$	21.38	16.79	$\frac{11}{16}$	32.36	25.42
$\frac{3}{4}$	21.69	17.04	$\frac{3}{4}$	32.74	25.71
$\frac{13}{16}$	22.00	17.28	$\frac{13}{16}$	33.12	26.01
$\frac{7}{8}$	22.31	17.53	$\frac{7}{8}$	33.51	26.32
$\frac{15}{16}$	22.63	17.77	$\frac{15}{16}$	33.89	26.62
9	22.95	18.02	11	34.28	26.92
$\frac{1}{16}$	23.27	18.27	$\frac{1}{16}$	34.67	27.23
$\frac{1}{8}$	23.59	18.53	$\frac{1}{8}$	35.06	27.54
$\frac{3}{16}$	23.91	18.78	$\frac{3}{16}$	35.46	27.85
$\frac{1}{4}$	24.24	19.04	$\frac{1}{4}$	35.86	28.16
$\frac{5}{16}$	24.57	19.30	$\frac{5}{16}$	36.26	28.48
$\frac{3}{8}$	24.90	19.56	$\frac{3}{8}$	36.66	28.79
$\frac{7}{16}$	25.23	19.82	$\frac{7}{16}$	37.06	29.11
$\frac{1}{2}$	25.57	20.08	$\frac{1}{2}$	37.47	29.43
$\frac{9}{16}$	25.91	20.35	$\frac{9}{16}$	37.88	29.75
$\frac{5}{8}$	26.25	20.61	$\frac{5}{8}$	38.29	30.07
$\frac{11}{16}$	26.59	20.88	$\frac{11}{16}$	38.70	30.39
$\frac{3}{4}$	26.93	21.15	$\frac{3}{4}$	39.12	30.72
$\frac{13}{16}$	27.28	21.42	$\frac{13}{16}$	39.53	31.04
$\frac{7}{8}$	27.63	21.70	$\frac{7}{8}$	39.95	31.38
$\frac{15}{16}$	27.98	21.97	$\frac{15}{16}$	40.37	31.71

SQUARE AND ROUND BARS.

(CONTINUED.)

Thickness or Diameter in Inches.	Weight of □ Bar One Inch Long.	Weight of ○ Bar One Inch Long.	Thickness or Diameter in Inches.	Weight of □ Bar One Inch Long.	Weight of ○ Bar One Inch Long.
12 1/8 1/4 3/8 1/2 5/8 3/4 7/8	40.80	32.04	16 1/8 1/4 3/8 1/2 5/8 3/4 7/8	72.53	56.96
	41.65	32.71		73.67	57.86
	42.52	33.39		74.81	58.76
	43.39	34.08		75.97	59.66
	44.27	34.77		77.13	60.58
	45.16	35.47		78.31	61.50
	46.06	36.17		79.49	62.43
	46.96	36.88		80.68	63.36
13 1/8 1/4 3/8 1/2 5/8 3/4 7/8	47.88	37.60	17 1/8 1/4 3/8 1/2 5/8 3/4 7/8	81.88	64.30
	48.81	38.33		83.09	65.25
	49.74	39.06		84.30	66.21
	50.68	39.80		85.53	67.17
	51.63	40.55		86.77	68.14
	52.59	41.31		88.01	69.12
	53.56	42.07		89.26	70.10
	54.54	42.84		90.52	71.09
14 1/8 1/4 3/8 1/2 5/8 3/4 7/8	55.53	43.62	18 1/8 1/4 3/8 1/2 5/8 3/4 7/8	91.79	72.09
	56.53	44.39		93.07	73.10
	57.53	45.18		94.36	74.11
	58.54	45.98		95.66	75.13
	59.57	46.78		96.96	76.15
	60.60	47.59		98.28	77.19
	61.64	48.41		99.60	78.22
	62.69	49.23		100.94	79.27
15 1/8 1/4 3/8 1/2 5/8 3/4 7/8	63.75	50.06	19 1/8 1/4 3/8 1/2 5/8 3/4 7/8	102.28	80.32
	64.81	50.90		103.63	81.39
	65.89	51.75		104.99	82.45
	66.97	52.60		106.35	83.53
	68.07	53.46		107.73	84.61
	69.17	54.32		109.12	85.70
	70.28	55.20		110.51	86.79
	71.40	56.08		111.91	87.89

SQUARE AND ROUND BARS.

(CONTINUED.)

Thickness or Diameter in Inches.	Weight of □ Bar One Inch Long.	Weight of ○ Bar One Inch Long.	Thickness or Diameter in Inches.	Weight of □ Bar One Inch Long.	Weight of ○ Bar One Inch Long.
20	113.33	89.00	24	163.19	128.16
$\frac{1}{8}$	114.75	90.12	$\frac{1}{8}$	164.89	129.50
$\frac{1}{4}$	116.18	91.24	$\frac{1}{4}$	166.61	130.85
$\frac{3}{8}$	117.62	92.37	$\frac{3}{8}$	168.33	132.20
$\frac{1}{2}$	119.06	93.51	$\frac{1}{2}$	170.06	133.57
$\frac{5}{8}$	120.52	94.65	$\frac{5}{8}$	171.80	134.93
$\frac{3}{4}$	121.98	95.80	$\frac{3}{4}$	173.55	136.30
$\frac{7}{8}$	123.46	96.96	$\frac{7}{8}$	175.31	137.68
21	124.94	98.13	25	177.07	139.07
$\frac{1}{8}$	126.43	99.30	$\frac{1}{8}$	178.85	140.46
$\frac{1}{4}$	127.93	100.48	$\frac{1}{4}$	180.63	141.86
$\frac{3}{8}$	129.44	101.66	$\frac{3}{8}$	182.42	143.27
$\frac{1}{2}$	130.96	102.85	$\frac{1}{2}$	184.23	144.68
$\frac{5}{8}$	132.49	104.05	$\frac{5}{8}$	186.04	146.11
$\frac{3}{4}$	134.03	105.26	$\frac{3}{4}$	187.86	147.54
$\frac{7}{8}$	135.57	106.47	$\frac{7}{8}$	189.68	148.97
22	137.12	107.69	26	191.52	150.41
$\frac{1}{8}$	138.69	108.92	$\frac{1}{8}$	193.37	151.86
$\frac{1}{4}$	140.26	110.15	$\frac{1}{4}$	195.22	153.32
$\frac{3}{8}$	141.84	111.40	$\frac{3}{8}$	197.09	154.78
$\frac{1}{2}$	143.43	112.64	$\frac{1}{2}$	198.96	156.25
$\frac{5}{8}$	145.03	113.90	$\frac{5}{8}$	200.84	157.73
$\frac{3}{4}$	146.63	115.16	$\frac{3}{4}$	202.73	159.22
$\frac{7}{8}$	148.25	116.43	$\frac{7}{8}$	204.63	160.71
23	149.88	117.71	27	206.54	162.21
$\frac{1}{8}$	151.51	118.99	$\frac{1}{8}$	208.45	163.71
$\frac{1}{4}$	153.15	120.28	$\frac{1}{4}$	210.38	165.22
$\frac{3}{8}$	154.81	121.58	$\frac{3}{8}$	212.31	166.74
$\frac{1}{2}$	156.46	122.88	$\frac{1}{2}$	214.26	168.27
$\frac{5}{8}$	158.13	124.19	$\frac{5}{8}$	216.21	169.80
$\frac{3}{4}$	159.81	125.51	$\frac{3}{4}$	218.17	171.34
$\frac{7}{8}$	161.49	126.83	$\frac{7}{8}$	220.14	172.89

SQUARE AND ROUND BARS.

(CONTINUED.)

Thickness or Diameter in Inches.	Weight of □ Bar One Inch Long.	Weight of ○ Bar One Inch Long.	Thickness or Diameter in Inches.	Weight of □ Bar One Inch Long.	Weight of ○ Bar One Inch Long.
28 1/8 1/4 3/8 1/2 5/8 3/4 7/8	222.12	174.44	32 1/8 1/4 3/8 1/2 5/8 3/4 7/8	290.11	227.85
	224.11	176.01		292.39	229.63
	226.10	177.57		294.67	231.42
	228.11	179.15		296.95	233.22
	230.12	180.73		299.25	235.02
	232.15	182.32		301.56	236.83
	234.18	183.91		303.87	238.65
	236.22	185.52		306.20	240.48
29 1/8 1/4 3/8 1/2 5/8 3/4 7/8	238.27	187.13	33 1/8 1/4 3/8 1/2 5/8 3/4 7/8	308.53	242.31
	240.33	188.74		310.87	244.15
	242.39	190.37		313.22	245.99
	244.47	192.00		315.58	247.85
	246.56	193.64		317.95	249.71
	248.65	195.28		320.33	251.57
	250.75	196.93		322.71	253.45
	252.86	198.59		325.11	255.33
30 1/8 1/4 3/8 1/2 5/8 3/4 7/8	254.98	200.25	34 1/8 1/4 3/8 1/2 5/8 3/4 7/8	327.51	257.22
	257.11	201.93		329.93	259.11
	259.25	203.61		332.35	261.01
	261.40	205.29		334.78	262.92
	263.55	206.99		337.22	264.84
	265.72	208.69		339.66	266.76
	267.89	210.39		342.12	268.69
	270.07	212.11		344.59	270.63
31 1/8 1/4 3/8 1/2 5/8 3/4 7/8	272.27	213.83	35 1/8 1/4 3/8 1/2 5/8 3/4 7/8	347.06	272.57
	274.47	215.56		349.54	274.52
	276.68	217.29		352.04	276.48
	278.89	219.03		354.54	278.44
	281.12	220.78		357.05	280.41
	283.36	222.54		359.57	282.39
	285.60	224.30		362.09	284.38
	287.85	226.07		364.63	286.37

WEIGHTS OF CIRCULAR STEEL PLATES. POUNDS.

Diameters 35 to 134 ins.; Thicknesses $\frac{3}{16}$ to 1 inch.

Diameter in Inches	Thickness, Inches						
	$\frac{3}{16}$	$\frac{1}{4}$	$\frac{5}{16}$	$\frac{3}{8}$	$\frac{7}{16}$	$\frac{1}{2}$	$\frac{9}{16}$
35	51.1	68.1	85.2	102.2	119.3	136.3	153.3
36	54.1	72.1	90.1	108.1	126.2	144.2	162.2
37	57.1	76.2	95.2	114.2	133.3	152.3	171.4
38	60.2	80.3	100.4	120.5	140.6	160.7	180.7
39	63.5	84.6	105.8	126.9	148.1	169.2	190.4
40	66.8	89.0	111.3	133.5	155.8	178.0	200.3
41	70.1	93.5	116.9	140.3	163.7	187.0	210.4
42	73.6	98.1	122.7	147.2	171.7	196.3	220.8
43	77.1	102.9	128.6	154.3	180.0	205.7	231.4
44	80.8	107.7	134.6	161.6	188.5	215.4	242.3
45	84.5	112.6	140.8	169.0	197.1	225.3	253.5
46	88.3	117.7	147.1	176.6	206.0	235.4	264.9
47	92.2	122.9	153.6	184.3	215.1	245.8	276.5
48	96.1	128.2	160.2	192.3	224.3	256.4	288.4
49	100.2	133.6	167.0	200.4	233.8	267.1	300.5
50	104.3	139.1	173.9	208.6	243.4	278.2	312.9
51	108.5	144.7	180.9	217.0	253.2	289.4	325.6
52	112.8	150.4	188.0	225.6	263.3	300.9	338.5
53	117.2	156.3	195.3	234.4	273.5	312.5	351.6
54	121.7	162.2	202.8	243.3	283.9	324.4	365.0
55	126.2	168.3	210.4	252.4	294.5	336.6	378.6
56	130.8	174.5	218.1	261.7	305.3	348.9	392.5
57	135.6	180.7	225.9	271.1	316.3	361.5	406.7
58	140.4	187.1	233.9	280.7	327.5	374.3	421.1
59	145.2	193.7	242.1	290.5	338.9	387.3	435.7
60	150.2	200.3	250.3	300.4	350.5	400.6	450.6
61	155.3	207.0	258.8	310.5	362.3	414.0	465.8
62	160.4	213.9	267.3	320.8	374.2	427.7	481.2
63	165.6	220.8	276.0	331.2	386.4	441.6	496.8
64	170.9	227.9	284.8	341.8	398.8	455.7	512.7
65	176.3	235.0	293.8	352.6	411.3	470.1	528.9
66	181.8	242.3	302.9	363.5	424.1	484.7	545.3
67	187.3	249.7	312.2	374.6	437.0	499.5	561.9
68	192.9	257.2	321.6	385.9	450.2	514.5	578.8
69	198.6	264.9	331.1	397.3	463.5	529.7	595.9
70	204.4	272.6	340.7	408.9	477.0	545.2	613.3
71	210.3	280.4	350.6	420.7	490.8	560.9	631.0
72	216.3	288.4	360.5	432.6	504.7	576.8	648.9
73	222.3	296.5	370.6	444.7	518.8	592.9	667.0
74	228.5	304.6	380.8	457.0	533.1	609.3	685.4
75	234.7	312.9	391.2	469.4	547.6	625.9	704.1
76	241.0	321.3	401.7	482.0	562.3	642.7	723.0
77	247.4	329.8	412.3	494.8	577.2	659.7	742.1
78	253.9	338.5	423.1	507.7	592.3	676.9	761.6
79	260.4	347.2	434.0	520.8	607.6	694.4	781.2
80	267.0	356.0	445.1	534.1	623.1	712.1	801.1
81	273.8	365.0	456.3	547.5	638.8	730.0	821.3
82	280.6	374.1	467.6	561.1	654.6	748.1	841.7
83	287.4	383.3	479.1	574.9	670.7	766.5	862.3
84	294.4	392.5	490.7	588.8	686.9	785.1	883.2

WEIGHTS OF CIRCULAR STEEL PLATES. POUNDS.

Diameters 35 to 134 ins.; Thicknesses $\frac{3}{16}$ to 1 inch.

Thickness, Inches							Diameter in Inches
$\frac{5}{8}$	$\frac{11}{16}$	$\frac{3}{4}$	$\frac{13}{16}$	$\frac{7}{8}$	$\frac{15}{16}$	1	
170.4	187.4	204.4	221.5	238.6	255.6	272.6	35
180.2	198.3	216.3	234.3	252.4	270.3	288.3	36
190.4	209.4	228.3	247.5	266.6	285.6	304.6	37
200.8	220.9	241.0	261.0	281.2	301.2	321.3	38
211.5	232.7	253.9	275.0	296.2	317.3	338.4	39
222.5	244.8	267.0	289.3	311.6	333.8	356.0	40
233.8	257.2	280.6	303.9	327.5	350.7	374.1	41
245.3	269.9	294.4	318.9	343.4	368.0	392.5	42
257.2	282.9	308.6	334.3	360.0	385.8	411.5	43
269.3	296.2	323.1	350.1	377.0	403.9	430.9	44
281.6	309.8	338.0	366.1	394.3	422.4	450.6	45
294.3	323.7	353.2	382.6	412.1	441.4	470.9	46
307.2	338.0	368.7	399.4	430.2	460.8	491.5	47
320.4	352.5	384.5	416.5	448.6	480.6	512.7	48
333.9	367.3	400.7	434.1	467.6	500.9	534.3	49
347.7	382.5	417.2	452.0	486.8	521.6	556.3	50
361.7	397.9	434.1	470.2	506.4	542.6	578.7	51
376.1	413.7	451.3	488.9	526.6	564.1	601.7	52
390.7	429.7	468.8	507.9	547.0	586.0	625.1	53
405.6	446.1	486.7	527.3	567.8	608.4	648.9	54
420.7	462.8	504.9	546.9	589.0	631.1	673.2	55
436.2	479.8	523.4	567.0	610.7	654.3	697.9	56
451.9	497.1	542.2	587.4	632.6	677.8	723.0	57
467.9	514.7	561.4	608.2	655.0	701.8	748.6	58
484.1	532.6	581.0	629.4	677.8	726.2	774.7	59
500.7	550.8	600.8	650.9	701.0	751.0	801.1	60
517.5	569.3	621.0	672.8	724.5	776.3	828.1	61
534.6	588.1	641.6	695.1	758.5	800.9	855.4	62
552.0	607.2	662.4	717.6	772.8	828.0	883.2	63
569.7	626.6	683.6	740.6	797.6	854.5	911.4	64
587.6	646.4	705.1	763.9	822.6	881.4	940.2	65
605.8	666.4	727.0	787.6	848.1	908.7	969.3	66
624.3	686.8	749.2	811.6	874.0	936.5	999.0	67
643.1	707.4	771.7	836.0	900.3	964.7	1029	68
662.2	728.4	794.6	860.8	927.1	993.3	1060	69
681.5	749.6	817.8	885.9	954.1	1023	1091	70
701.1	771.2	841.3	919.4	985.5	1052	1122	71
721.0	793.1	865.2	937.3	1010	1082	1154	72
741.2	815.3	889.4	963.5	1038	1112	1186	73
761.6	837.8	913.9	990.0	1066	1143	1219	74
782.3	860.6	938.8	1017	1096	1174	1252	75
803.3	883.7	964.0	1045	1125	1205	1286	76
824.6	907.1	989.5	1072	1155	1237	1320	77
846.2	930.8	1015	1100	1185	1270	1354	78
868.0	954.8	1042	1129	1216	1302	1389	79
890.1	979.1	1068	1158	1247	1336	1425	80
912.5	1004	1095	1187	1278	1369	1460	81
935.2	1029	1122	1216	1310	1403	1497	82
958.1	1054	1150	1246	1342	1438	1533	83
981.4	1080	1178	1276	1374	1472	1571	84

WEIGHTS OF CIRCULAR STEEL PLATES.

POUNDS.

Diameters 35 to 134 ins.; Thicknesses $\frac{3}{16}$ to 1 inch.

Diameter in Inches	Thickness, Inches						
	$\frac{3}{16}$	$\frac{1}{4}$	$\frac{5}{16}$	$\frac{3}{8}$	$\frac{7}{16}$	$\frac{1}{2}$	$\frac{9}{16}$
85	301.5	401.9	502.4	602.9	703.4	803.9	904.4
86	308.6	411.5	514.3	617.2	720.0	822.9	925.8
87	315.8	421.1	526.4	631.6	736.9	842.2	947.4
88	323.1	430.8	538.5	646.2	753.9	861.6	969.3
89	330.5	440.7	550.8	661.0	771.2	881.3	991.5
90	338.0	450.6	563.3	675.9	788.6	901.2	1014
91	345.5	460.7	575.9	691.0	806.2	921.4	1037
92	353.2	470.9	588.6	706.3	824.0	941.7	1060
93	360.9	481.2	601.5	721.7	842.0	962.3	1083
94	368.7	491.6	614.5	737.4	860.2	983.1	1106
95	376.6	502.1	627.6	753.1	878.6	1004	1130
96	384.5	512.7	640.9	769.1	897.2	1025	1154
97	392.6	523.4	654.3	785.2	916.0	1047	1178
98	400.7	534.3	667.9	801.4	935.0	1069	1202
99	408.9	545.3	681.6	817.9	954.2	1091	1227
100	417.2	556.3	695.4	834.5	973.6	1113	1252
101	425.6	567.5	709.4	851.3	993.1	1135	1277
102	434.1	578.8	723.5	868.2	1013	1158	1302
103	442.7	590.2	737.8	885.3	1033	1180	1328
104	451.3	601.7	752.1	902.6	1053	1203	1354
105	460.0	613.3	766.7	920.0	1073	1227	1380
106	468.8	625.1	781.4	937.6	1094	1250	1406
107	477.7	636.9	796.2	955.4	1115	1274	1433
108	486.7	648.9	811.1	973.3	1136	1298	1460
109	495.7	661.0	826.2	991.5	1157	1322	1487
110	504.9	673.2	841.4	1010	1178	1346	1515
111	514.1	685.4	856.8	1028	1200	1371	1542
112	523.4	697.9	872.3	1047	1221	1396	1570
113	532.8	710.4	888.0	1066	1243	1421	1598
114	542.2	723.0	903.7	1085	1265	1446	1627
115	551.8	735.7	919.7	1104	1288	1472	1655
116	561.4	748.6	935.7	1123	1310	1497	1684
117	571.2	761.6	951.9	1142	1333	1523	1714
118	581.0	774.6	968.3	1162	1356	1549	1743
119	590.9	787.8	984.8	1182	1379	1576	1773
120	600.8	801.1	1001	1202	1402	1602	1803
121	610.9	814.5	1018	1222	1425	1629	1833
122	621.0	828.0	1035	1242	1449	1656	1863
123	631.2	841.7	1052	1263	1473	1683	1894
124	641.6	855.4	1069	1283	1497	1711	1925
125	651.9	869.3	1087	1304	1521	1739	1956
126	662.4	883.2	1104	1325	1546	1766	1987
127	673.0	897.3	1122	1346	1570	1795	2019
128	683.6	911.5	1139	1367	1595	1823	2051
129	694.3	925.8	1157	1389	1620	1852	2083
130	705.1	940.2	1175	1410	1645	1880	2115
131	716.0	954.7	1193	1432	1671	1909	2148
132	727.0	969.3	1212	1454	1696	1939	2181
133	738.1	984.1	1230	1476	1722	1968	2214
134	749.2	998.9	1249	1498	1748	1998	2248

WEIGHTS OF CIRCULAR STEEL PLATES.

POUNDS.

Diameters 35 to 134 ins.; Thicknesses $\frac{3}{16}$ to 1 inch.

Thickness, Inches							Diameter in Inches
$\frac{5}{8}$	$\frac{11}{16}$	$\frac{3}{4}$	$\frac{13}{16}$	$\frac{7}{8}$	$\frac{15}{16}$	1	
1005	1105	1206	1307	1407	1509	1608	85
1029	1132	1234	1338	1441	1543	1646	86
1053	1158	1263	1369	1474	1580	1685	87
1077	1185	1293	1400	1508	1616	1724	88
1102	1212	1322	1433	1543	1653	1763	89
1127	1239	1352	1465	1577	1690	1803	90
1152	1267	1382	1498	1613	1728	1843	91
1177	1295	1413	1531	1648	1766	1884	92
1203	1323	1444	1564	1684	1804	1925	93
1229	1352	1475	1598	1721	1843	1967	94
1255	1381	1506	1632	1757	1883	2008	95
1282	1410	1538	1666	1795	1923	2051	96
1309	1440	1570	1701	1832	1963	2094	97
1336	1469	1603	1737	1870	2004	2137	98
1363	1499	1636	1772	1908	2045	2181	99
1391	1530	1669	1808	1947	2086	2225	100
1419	1561	1703	1844	1986	2128	2270	101
1447	1592	1736	1881	2026	2171	2315	102
1476	1623	1771	1918	2066	2213	2361	103
1504	1655	1805	1956	2106	2256	2407	104
1533	1687	1840	1993	2147	2300	2453	105
1563	1719	1875	2032	2188	2344	2500	106
1592	1752	1911	2070	2229	2389	2548	107
1622	1785	1947	2109	2271	2433	2596	108
1652	1818	1983	2148	2313	2479	2644	109
1683	1851	2020	2188	2356	2524	2693	110
1714	1885	2056	2228	2399	2570	2742	111
1745	1919	2094	2268	2443	2617	2791	112
1776	1954	2131	2309	2486	2664	2842	113
1808	1988	2169	2350	2531	2711	2892	114
1839	2023	2207	2391	2575	2759	2943	115
1872	2059	2246	2433	2620	2807	2994	116
1904	2094	2285	2475	2665	2856	3046	117
1937	2130	2324	2518	2711	2905	3099	118
1970	2167	2363	2560	2757	2954	3151	119
2003	2203	2403	2604	2804	3004	3204	120
2036	2240	2444	2647	2851	3054	3258	121
2070	2277	2484	2691	2898	3105	3312	122
2104	2315	2525	2735	2946	3156	3367	123
2139	2352	2566	2780	2994	3208	3422	124
2173	2391	2608	2825	3042	3260	3477	125
2208	2429	2650	2871	3091	3312	3533	126
2243	2468	2692	2916	3141	3365	3589	127
2279	2507	2734	2962	3190	3418	3646	128
2314	2546	2777	3009	3240	3472	3703	129
2351	2586	2821	3056	3291	3526	3761	130
2387	2625	2864	3103	3342	3580	3819	131
2423	2666	2908	3150	3393	3635	3877	132
2460	2706	2952	3198	3444	3690	3936	133
2497	2747	2997	3247	3496	3746	3996	134

AREAS OF FLAT ROLLED STEEL BARS.

For Thicknesses from $\frac{1}{16}$ in. to 2 in. and Widths from 1 in. to $12\frac{1}{2}$ in.

Thickness in Inches.	1"	1 $\frac{1}{4}$ "	1 $\frac{1}{2}$ "	1 $\frac{3}{4}$ "	2"	2 $\frac{1}{4}$ "	2 $\frac{1}{2}$ "	2 $\frac{3}{4}$ "	12"
$\frac{1}{16}$.063	.078	.094	.109	.125	.141	.156	.172	.750
$\frac{1}{8}$.125	.156	.188	.219	.250	.281	.313	.344	1.50
$\frac{3}{16}$.188	.234	.281	.328	.375	.422	.469	.516	2.25
$\frac{1}{4}$.250	.313	.375	.438	.500	.563	.625	.688	3.00
$\frac{5}{16}$.313	.391	.469	.547	.625	.703	.781	.859	3.75
$\frac{3}{8}$.375	.469	.563	.656	.750	.844	.938	1.03	4.50
$\frac{7}{16}$.438	.547	.656	.766	.875	.984	1.09	1.20	5.25
$\frac{1}{2}$.500	.625	.750	.875	1.00	1.13	1.25	1.38	6.00
$\frac{9}{16}$.563	.703	.844	.984	1.13	1.27	1.41	1.55	6.75
$\frac{5}{8}$.625	.781	.938	1.09	1.25	1.41	1.56	1.72	7.50
$\frac{11}{16}$.688	.859	1.03	1.20	1.38	1.55	1.72	1.89	8.25
$\frac{3}{4}$.750	.938	1.13	1.31	1.50	1.69	1.88	2.06	9.00
$\frac{13}{16}$.813	1.02	1.22	1.42	1.63	1.83	2.03	2.23	9.75
$\frac{7}{8}$.875	1.09	1.31	1.53	1.75	1.97	2.19	2.41	10.50
$\frac{15}{16}$.938	1.17	1.41	1.64	1.88	2.11	2.34	2.58	11.25
1	1.00	1.25	1.50	1.75	2.00	2.25	2.50	2.75	12.00
$1\frac{1}{16}$	1.06	1.33	1.59	1.86	2.13	2.39	2.66	2.92	12.75
$1\frac{1}{8}$	1.13	1.41	1.69	1.97	2.25	2.53	2.81	3.09	13.50
$1\frac{3}{16}$	1.19	1.48	1.78	2.08	2.38	2.67	2.97	3.27	14.25
$1\frac{1}{4}$	1.25	1.56	1.88	2.19	2.50	2.81	3.13	3.44	15.00
$1\frac{5}{16}$	1.31	1.64	1.97	2.30	2.63	2.95	3.28	3.61	15.75
$1\frac{3}{8}$	1.38	1.72	2.06	2.41	2.75	3.09	3.44	3.78	16.50
$1\frac{7}{16}$	1.44	1.80	2.16	2.52	2.88	3.23	3.59	3.95	17.25
$1\frac{1}{2}$	1.50	1.88	2.25	2.63	3.00	3.38	3.75	4.13	18.00
$1\frac{9}{16}$	1.56	1.95	2.34	2.73	3.13	3.52	3.91	4.30	18.75
$1\frac{5}{8}$	1.63	2.03	2.44	2.84	3.25	3.66	4.06	4.47	19.50
$1\frac{11}{16}$	1.69	2.11	2.53	2.95	3.38	3.80	4.22	4.64	20.25
$1\frac{3}{4}$	1.75	2.19	2.63	3.06	3.50	3.94	4.38	4.81	21.00
$1\frac{13}{16}$	1.81	2.27	2.72	3.17	3.63	4.08	4.53	4.98	21.75
$1\frac{7}{8}$	1.88	2.34	2.81	3.28	3.75	4.22	4.69	5.16	22.50
$1\frac{15}{16}$	1.94	2.42	2.91	3.39	3.88	4.36	4.84	5.33	23.25
2	2.00	2.50	3.00	3.50	4.00	4.50	5.00	5.50	24.00

AREAS OF FLAT ROLLED STEEL BARS.

(CONTINUED.)

Thickness in Inches.	3"	3 $\frac{1}{4}$ "	3 $\frac{1}{2}$ "	3 $\frac{3}{4}$ "	4"	4 $\frac{1}{4}$ "	4 $\frac{1}{2}$ "	4 $\frac{3}{4}$ "	12"
$\frac{1}{16}$.188	.203	.219	.234	.250	.266	.281	.297	.750
$\frac{1}{8}$.375	.406	.438	.469	.500	.531	.563	.594	1.50
$\frac{3}{16}$.563	.609	.656	.703	.750	.797	.844	.891	2.25
$\frac{1}{4}$.750	.813	.875	.938	1.00	1.06	1.13	1.19	3.00
$\frac{5}{16}$.938	1.02	1.09	1.17	1.25	1.33	1.41	1.48	3.75
$\frac{3}{8}$	1.13	1.22	1.31	1.41	1.50	1.59	1.69	1.78	4.50
$\frac{7}{16}$	1.31	1.42	1.53	1.64	1.75	1.86	1.97	2.08	5.25
$\frac{1}{2}$	1.50	1.63	1.75	1.88	2.00	2.13	2.25	2.38	6.00
$\frac{9}{16}$	1.69	1.83	1.97	2.11	2.25	2.39	2.53	2.67	6.75
$\frac{5}{8}$	1.88	2.03	2.19	2.34	2.50	2.66	2.81	2.97	7.50
$\frac{11}{16}$	2.06	2.23	2.41	2.58	2.75	2.92	3.09	3.27	8.25
$\frac{3}{4}$	2.25	2.44	2.63	2.81	3.00	3.19	3.38	3.56	9.00
$\frac{13}{16}$	2.44	2.64	2.84	3.05	3.25	3.45	3.66	3.86	9.75
$\frac{7}{8}$	2.63	2.84	3.06	3.28	3.50	3.72	3.94	4.16	10.50
$\frac{15}{16}$	2.81	3.05	3.28	3.52	3.75	3.98	4.22	4.45	11.25
1	3.00	3.25	3.50	3.75	4.00	4.25	4.50	4.75	12.00
$1\frac{1}{16}$	3.19	3.45	3.72	3.98	4.25	4.52	4.78	5.05	12.75
$1\frac{1}{8}$	3.38	3.66	3.94	4.22	4.50	4.78	5.06	5.34	13.50
$1\frac{3}{16}$	3.56	3.86	4.16	4.45	4.75	5.05	5.34	5.64	14.25
$1\frac{1}{4}$	3.75	4.06	4.38	4.69	5.00	5.31	5.63	5.94	15.00
$1\frac{5}{16}$	3.94	4.27	4.59	4.92	5.25	5.58	5.91	6.23	15.75
$1\frac{3}{8}$	4.13	4.47	4.81	5.16	5.50	5.84	6.19	6.53	16.50
$1\frac{7}{16}$	4.31	4.67	5.03	5.39	5.75	6.11	6.47	6.83	17.25
$1\frac{1}{2}$	4.50	4.88	5.25	5.63	6.00	6.38	6.75	7.13	18.00
$1\frac{9}{16}$	4.69	5.08	5.47	5.86	6.25	6.64	7.03	7.42	18.75
$1\frac{5}{8}$	4.88	5.28	5.69	6.09	6.50	6.91	7.31	7.72	19.50
$1\frac{11}{16}$	5.06	5.48	5.91	6.33	6.75	7.17	7.59	8.02	20.25
$1\frac{3}{4}$	5.25	5.69	6.13	6.56	7.00	7.44	7.88	8.31	21.00
$1\frac{13}{16}$	5.44	5.89	6.34	6.80	7.25	7.70	8.16	8.61	21.75
$1\frac{7}{8}$	5.63	6.09	6.56	7.03	7.50	7.97	8.44	8.91	22.50
$1\frac{15}{16}$	5.81	6.30	6.78	7.27	7.75	8.23	8.72	9.20	23.25
2	6.00	6.50	7.00	7.50	8.00	8.50	9.00	9.50	24.00

AREAS OF FLAT ROLLED STEEL BARS.

(CONTINUED.)

Thickness in Inches.	5"	5¼"	5½"	5¾"	6"	6¼"	6½"	6¾"	12"
$\frac{1}{16}$.313	.328	.344	.359	.375	.391	.406	.422	.750
$\frac{1}{8}$.625	.656	.688	.719	.750	.781	.813	.844	1.50
$\frac{3}{16}$.938	.984	1.03	1.08	1.13	1.17	1.22	1.27	2.25
$\frac{1}{4}$	1.25	1.31	1.38	1.44	1.50	1.56	1.63	1.69	3.00
$\frac{5}{16}$	1.56	1.64	1.72	1.80	1.88	1.95	2.03	2.11	3.75
$\frac{3}{8}$	1.88	1.97	2.06	2.16	2.25	2.34	2.44	2.53	4.50
$\frac{7}{16}$	2.19	2.30	2.41	2.52	2.63	2.73	2.84	2.95	5.25
$\frac{1}{2}$	2.50	2.63	2.75	2.88	3.00	3.13	3.25	3.38	6.00
$\frac{9}{16}$	2.81	2.95	3.09	3.23	3.38	3.52	3.66	3.80	6.75
$\frac{5}{8}$	3.13	3.28	3.44	3.59	3.75	3.91	4.06	4.22	7.50
$\frac{11}{16}$	3.44	3.61	3.78	3.95	4.13	4.30	4.47	4.64	8.25
$\frac{3}{4}$	3.75	3.94	4.13	4.31	4.50	4.69	4.88	5.06	9.00
$\frac{13}{16}$	4.06	4.27	4.47	4.67	4.88	5.08	5.28	5.48	9.75
$\frac{7}{8}$	4.38	4.59	4.81	5.03	5.25	5.47	5.69	5.91	10.50
$\frac{15}{16}$	4.69	4.92	5.16	5.39	5.63	5.86	6.09	6.33	11.25
1	5.00	5.25	5.50	5.75	6.00	6.25	6.50	6.75	12.00
$1\frac{1}{16}$	5.31	5.58	5.84	6.11	6.38	6.64	6.91	7.17	12.75
$1\frac{1}{8}$	5.63	5.91	6.19	6.47	6.75	7.03	7.31	7.59	13.50
$1\frac{3}{16}$	5.94	6.23	6.53	6.83	7.13	7.42	7.72	8.02	14.25
$1\frac{1}{4}$	6.25	6.56	6.88	7.19	7.50	7.81	8.13	8.44	15.00
$1\frac{5}{16}$	6.56	6.89	7.22	7.55	7.88	8.20	8.53	8.86	15.75
$1\frac{3}{8}$	6.88	7.22	7.56	7.91	8.25	8.59	8.94	9.28	16.50
$1\frac{7}{16}$	7.19	7.55	7.91	8.27	8.63	8.98	9.34	9.70	17.25
$1\frac{1}{2}$	7.50	7.88	8.25	8.63	9.00	9.38	9.75	10.13	18.00
$1\frac{9}{16}$	7.81	8.20	8.59	8.98	9.38	9.77	10.16	10.55	18.75
$1\frac{5}{8}$	8.13	8.53	8.94	9.34	9.75	10.16	10.56	10.97	19.50
$1\frac{11}{16}$	8.44	8.86	9.28	9.70	10.13	10.55	10.97	11.39	20.25
$1\frac{3}{4}$	8.75	9.19	9.63	10.06	10.50	10.94	11.38	11.81	21.00
$1\frac{13}{16}$	9.06	9.52	9.97	10.42	10.88	11.33	11.78	12.23	21.75
$1\frac{7}{8}$	9.38	9.84	10.31	10.78	11.25	11.72	12.19	12.66	22.50
$1\frac{15}{16}$	9.69	10.17	10.66	11.14	11.63	12.11	12.59	13.08	23.25
2	10.00	10.50	11.00	11.50	12.00	12.50	13.00	13.50	24.00

AREAS OF FLAT ROLLED STEEL BARS.

(CONTINUED.)

Thickness in Inches.	7"	7 $\frac{1}{4}$ "	7 $\frac{1}{2}$ "	7 $\frac{3}{4}$ "	8"	8 $\frac{1}{4}$ "	8 $\frac{1}{2}$ "	8 $\frac{3}{4}$ "	12"
$\frac{1}{16}$.438	.453	.469	.484	.500	.516	.531	.547	.750
$\frac{1}{8}$.875	.906	.938	.969	1.00	1.03	1.06	1.09	1.50
$\frac{3}{16}$	1.31	1.36	1.41	1.45	1.50	1.55	1.59	1.64	2.25
$\frac{1}{4}$	1.75	1.81	1.88	1.94	2.00	2.06	2.13	2.19	3.00
$\frac{5}{16}$	2.19	2.27	2.34	2.42	2.50	2.58	2.66	2.73	3.75
$\frac{3}{8}$	2.63	2.72	2.81	2.91	3.00	3.09	3.19	3.28	4.50
$\frac{7}{16}$	3.06	3.17	3.28	3.39	3.50	3.61	3.72	3.83	5.25
$\frac{1}{2}$	3.50	3.63	3.75	3.88	4.00	4.13	4.25	4.38	6.00
$\frac{9}{16}$	3.94	4.08	4.22	4.36	4.50	4.64	4.78	4.92	6.75
$\frac{5}{8}$	4.38	4.53	4.69	4.84	5.00	5.16	5.31	5.47	7.50
$1\frac{1}{8}$	4.81	4.98	5.16	5.33	5.50	5.67	5.84	6.02	8.25
$\frac{3}{4}$	5.25	5.44	5.63	5.81	6.00	6.19	6.38	6.56	9.00
$1\frac{1}{8}$	5.69	5.89	6.09	6.30	6.50	6.70	6.91	7.11	9.75
$\frac{7}{8}$	6.13	6.34	6.56	6.78	7.00	7.22	7.44	7.66	10.50
$1\frac{1}{8}$	6.56	6.80	7.03	7.27	7.50	7.73	7.97	8.20	11.25
1	7.00	7.25	7.50	7.75	8.00	8.25	8.50	8.75	12.00
$1\frac{1}{8}$	7.44	7.70	7.97	8.23	8.50	8.77	9.03	9.30	12.75
$1\frac{1}{4}$	7.88	8.16	8.44	8.72	9.00	9.28	9.56	9.84	13.50
$1\frac{3}{8}$	8.31	8.61	8.91	9.20	9.50	9.80	10.09	10.39	14.25
$1\frac{1}{2}$	8.75	9.06	9.38	9.69	10.00	10.31	10.63	10.94	15.00
$1\frac{5}{8}$	9.19	9.52	9.84	10.17	10.50	10.83	11.16	11.48	15.75
$1\frac{3}{4}$	9.63	9.97	10.31	10.66	11.00	11.34	11.69	12.03	16.50
$1\frac{7}{8}$	10.06	10.42	10.78	11.14	11.50	11.86	12.22	12.58	17.25
$1\frac{1}{2}$	10.50	10.88	11.25	11.63	12.00	12.38	12.75	13.13	18.00
$1\frac{9}{8}$	10.94	11.33	11.72	12.11	12.50	12.89	13.28	13.67	18.75
$1\frac{5}{4}$	11.38	11.78	12.19	12.59	13.00	13.41	13.81	14.22	19.50
$1\frac{11}{8}$	11.81	12.23	12.66	13.08	13.50	13.92	14.34	14.77	20.25
$1\frac{3}{4}$	12.25	12.69	13.13	13.56	14.00	14.44	14.88	15.31	21.00
$1\frac{13}{8}$	12.69	13.14	13.59	14.05	14.50	14.95	15.41	15.86	21.75
$1\frac{7}{4}$	13.13	13.59	14.06	14.53	15.00	15.47	15.94	16.41	22.50
$1\frac{15}{8}$	13.56	14.05	14.53	15.02	15.50	15.98	16.47	16.95	23.25
2	14.00	14.50	15.00	15.50	16.00	16.50	17.00	17.50	24.00

AREAS OF FLAT ROLLED STEEL BARS.

(CONTINUED.)

Thickness in Inches.	9"	9 $\frac{1}{4}$ "	9 $\frac{1}{2}$ "	9 $\frac{3}{4}$ "	10"	10 $\frac{1}{4}$ "	10 $\frac{1}{2}$ "	10 $\frac{3}{4}$ "	12"
$\frac{1}{16}$.563	.578	.594	.609	.625	.641	.656	.672	.750
$\frac{1}{8}$	1.13	1.16	1.19	1.22	1.25	1.28	1.31	1.34	1.50
$\frac{3}{16}$	1.69	1.73	1.78	1.83	1.88	1.92	1.97	2.02	2.25
$\frac{1}{4}$	2.25	2.31	2.38	2.44	2.50	2.56	2.63	2.69	3.00
$\frac{5}{16}$	2.81	2.89	2.97	3.05	3.13	3.20	3.28	3.36	3.75
$\frac{3}{8}$	3.38	3.47	3.56	3.66	3.75	3.84	3.94	4.03	4.50
$\frac{7}{16}$	3.94	4.05	4.16	4.27	4.38	4.48	4.59	4.70	5.25
$\frac{1}{2}$	4.50	4.63	4.75	4.88	5.00	5.13	5.25	5.38	6.00
$\frac{9}{16}$	5.06	5.20	5.34	5.48	5.63	5.77	5.91	6.05	6.75
$\frac{5}{8}$	5.63	5.78	5.94	6.09	6.25	6.41	6.56	6.72	7.50
$1\frac{1}{16}$	6.19	6.36	6.53	6.70	6.88	7.05	7.22	7.39	8.25
$\frac{3}{4}$	6.75	6.94	7.13	7.31	7.50	7.69	7.88	8.06	9.00
$1\frac{1}{8}$	7.31	7.52	7.72	7.92	8.13	8.33	8.53	8.73	9.75
$\frac{7}{8}$	7.88	8.09	8.31	8.53	8.75	8.97	9.19	9.41	10.50
$1\frac{1}{16}$	8.44	8.67	8.91	9.14	9.38	9.61	9.84	10.08	11.25
1	9.00	9.25	9.50	9.75	10.00	10.25	10.50	10.75	12.00
$1\frac{1}{16}$	9.56	9.83	10.09	10.36	10.63	10.89	11.16	11.42	12.75
$1\frac{1}{8}$	10.13	10.41	10.69	10.97	11.25	11.53	11.81	12.09	13.50
$1\frac{3}{16}$	10.69	10.98	11.28	11.58	11.88	12.17	12.47	12.77	14.25
$1\frac{1}{4}$	11.25	11.56	11.88	12.19	12.50	12.81	13.13	13.44	15.00
$1\frac{5}{16}$	11.81	12.14	12.47	12.80	13.13	13.45	13.78	14.11	15.75
$1\frac{3}{8}$	12.38	12.72	13.06	13.41	13.75	14.09	14.44	14.78	16.50
$1\frac{7}{16}$	12.94	13.30	13.66	14.02	14.38	14.73	15.09	15.45	17.25
$1\frac{1}{2}$	13.50	13.88	14.25	14.63	15.00	15.38	15.75	16.13	18.00
$1\frac{9}{16}$	14.06	14.45	14.84	15.23	15.63	16.02	16.41	16.80	18.75
$1\frac{5}{8}$	14.63	15.03	15.44	15.84	16.25	16.66	17.06	17.47	19.50
$1\frac{11}{16}$	15.19	15.61	16.03	16.45	16.88	17.30	17.72	18.14	20.25
$1\frac{3}{4}$	15.75	16.19	16.63	17.06	17.50	17.94	18.38	18.81	21.00
$1\frac{13}{16}$	16.31	16.77	17.22	17.67	18.13	18.58	19.03	19.48	21.75
$1\frac{7}{8}$	16.88	17.34	17.81	18.28	18.75	19.22	19.69	20.16	22.50
$1\frac{15}{16}$	17.44	17.92	18.41	18.89	19.38	19.86	20.34	20.83	23.25
2	18.00	18.50	19.00	19.50	20.00	20.50	21.00	21.50	24.00

AREAS OF FLAT ROLLED STEEL BARS.

(CONCLUDED.)

Thickness in Inches.	11"	11 $\frac{1}{4}$ "	11 $\frac{1}{2}$ "	11 $\frac{3}{4}$ "	12"	12 $\frac{1}{4}$ "	12 $\frac{1}{2}$ "	12 $\frac{3}{4}$ "
$\frac{1}{16}$.688	.703	.719	.734	.750	.766	.781	.797
$\frac{1}{8}$	1.38	1.41	1.44	1.47	1.50	1.53	1.56	1.59
$\frac{3}{16}$	2.06	2.11	2.16	2.20	2.25	2.30	2.34	2.39
$\frac{1}{4}$	2.75	2.81	2.88	2.94	3.00	3.06	3.13	3.19
$\frac{5}{16}$	3.44	3.52	3.59	3.67	3.75	3.83	3.91	3.98
$\frac{3}{8}$	4.13	4.22	4.31	4.41	4.50	4.59	4.69	4.78
$\frac{7}{16}$	4.81	4.92	5.03	5.14	5.25	5.36	5.47	5.58
$\frac{1}{2}$	5.50	5.63	5.75	5.88	6.00	6.13	6.25	6.38
$\frac{9}{16}$	6.19	6.33	6.47	6.61	6.75	6.89	7.03	7.17
$\frac{5}{8}$	6.88	7.03	7.19	7.34	7.50	7.66	7.81	7.97
$\frac{11}{16}$	7.56	7.73	7.91	8.08	8.25	8.42	8.59	8.77
$\frac{3}{4}$	8.25	8.44	8.63	8.81	9.00	9.19	9.38	9.56
$\frac{13}{16}$	8.94	9.14	9.34	9.55	9.75	9.95	10.16	10.36
$\frac{7}{8}$	9.63	9.84	10.06	10.28	10.50	10.72	10.94	11.16
$\frac{15}{16}$	10.31	10.55	10.78	11.02	11.25	11.48	11.72	11.95
1	11.00	11.25	11.50	11.75	12.00	12.25	12.50	12.75
$1\frac{1}{16}$	11.69	11.95	12.22	12.48	12.75	13.02	13.28	13.55
$1\frac{1}{8}$	12.38	12.66	12.94	13.22	13.50	13.78	14.06	14.34
$1\frac{3}{16}$	13.06	13.36	13.66	13.95	14.25	14.55	14.84	15.14
$1\frac{1}{4}$	13.75	14.06	14.38	14.69	15.00	15.31	15.63	15.94
$1\frac{5}{16}$	14.44	14.77	15.09	15.42	15.75	16.08	16.41	16.73
$1\frac{3}{8}$	15.13	15.47	15.81	16.16	16.50	16.84	17.19	17.53
$1\frac{7}{16}$	15.81	16.17	16.53	16.89	17.25	17.61	17.97	18.33
$1\frac{1}{2}$	16.50	16.88	17.25	17.63	18.00	18.38	18.75	19.13
$1\frac{9}{16}$	17.19	17.58	17.97	18.36	18.75	19.14	19.53	19.92
$1\frac{5}{8}$	17.88	18.28	18.69	19.09	19.50	19.91	20.31	20.72
$1\frac{11}{16}$	18.56	18.98	19.41	19.83	20.25	20.67	21.09	21.52
$1\frac{3}{4}$	19.25	19.69	20.13	20.56	21.00	21.44	21.88	22.31
$1\frac{13}{16}$	19.94	20.39	20.84	21.30	21.75	22.20	22.66	23.11
$1\frac{7}{8}$	20.63	21.09	21.56	22.03	22.50	22.97	23.44	23.91
$1\frac{15}{16}$	21.31	21.80	22.28	22.77	23.25	23.73	24.22	24.70
2	22.00	22.50	23.00	23.50	24.00	24.50	25.00	25.50

The areas for 12" width are repeated on each page to facilitate making the additions necessary to obtain the areas of plates of any width greater than 12". Thus, to find the area of 15 $\frac{1}{4}$ " \times $\frac{7}{8}$ ", add the areas to be found in the same line for 3 $\frac{1}{4}$ " \times $\frac{7}{8}$ " and 12" \times $\frac{7}{8}$ " = 2.84 + 10.50 = 13.34 square inches. Area of plate 4' 6 $\frac{1}{2}$ " \times $\frac{5}{8}$ " = 4 \times 7.50 + 4.06 = 34.06 square inches.

WEIGHTS OF FLAT ROLLED STRIPS, HOOP OR BAND STEEL.

Pounds per Lineal Foot.

Thicknesses by Birmingham Wire Gauge.

One cubic foot of steel weighs 489.6 pounds.

For widths from $\frac{1}{4}$ inch to $\frac{3}{4}$ inch and thicknesses from No. 19 to No. 11 B.W.G.

Width in Inches.	No. 19. .042 In.	No. 18. .049 In.	No. 17. .058 In.	No. 16. .065 In.	No. 15. .072 In.	No. 14. .083 In.	No. 13. .095 In.	No. 12. .109 In.	No. 11. .120 In.
$\frac{1}{4}$.036	.042	.049	.055	.061	.071	.081	.093	.102
$\frac{1}{8}$ $\frac{1}{4}$.038	.044	.052	.059	.065	.075	.086	.098	.108
$\frac{9}{32}$.040	.047	.055	.062	.069	.079	.091	.104	.115
$\frac{10}{64}$.042	.049	.059	.066	.073	.084	.096	.110	.121
$\frac{5}{16}$.045	.052	.062	.069	.077	.088	.101	.116	.128
$\frac{5}{16}$ $\frac{1}{4}$.047	.055	.065	.073	.080	.093	.106	.122	.134
$\frac{11}{32}$.049	.057	.068	.076	.084	.097	.111	.127	.140
$\frac{12}{64}$.051	.060	.071	.079	.088	.101	.116	.133	.147
$\frac{3}{8}$.054	.062	.074	.083	.092	.106	.121	.139	.153
$\frac{25}{64}$ $\frac{5}{16}$.056	.065	.077	.086	.096	.110	.126	.145	.159
$\frac{13}{32}$.058	.068	.080	.090	.099	.115	.131	.151	.166
$\frac{14}{64}$.060	.070	.083	.093	.103	.119	.136	.156	.172
$\frac{7}{16}$.062	.073	.086	.097	.107	.123	.141	.162	.179
$\frac{29}{64}$ $\frac{3}{8}$.065	.075	.089	.100	.111	.128	.146	.168	.185
$\frac{15}{32}$.067	.078	.092	.104	.115	.132	.151	.174	.191
$\frac{16}{64}$.069	.081	.096	.107	.119	.137	.156	.180	.198
$\frac{1}{2}$.071	.083	.099	.111	.122	.141	.162	.185	.204
$\frac{33}{64}$ $\frac{3}{8}$.074	.086	.102	.114	.126	.146	.167	.191	.210
$\frac{17}{32}$.076	.089	.105	.117	.130	.150	.172	.197	.217
$\frac{35}{64}$.078	.091	.108	.121	.134	.154	.177	.203	.223
$\frac{9}{16}$.080	.094	.111	.124	.138	.159	.182	.208	.230
$\frac{17}{32}$ $\frac{3}{8}$.083	.096	.114	.128	.142	.163	.187	.214	.236
$\frac{19}{64}$.085	.099	.117	.131	.145	.168	.192	.220	.242
$\frac{20}{32}$.087	.102	.120	.135	.149	.172	.197	.226	.249
$\frac{5}{8}$.089	.104	.123	.138	.153	.176	.202	.232	.255
$\frac{41}{64}$ $\frac{1}{2}$.091	.107	.126	.142	.157	.181	.207	.237	.261
$\frac{21}{32}$.094	.109	.129	.145	.161	.185	.212	.243	.268
$\frac{43}{64}$.096	.112	.132	.148	.164	.190	.217	.249	.274
$\frac{11}{16}$.098	.115	.136	.152	.168	.194	.222	.255	.281
$\frac{23}{32}$ $\frac{5}{8}$.100	.117	.139	.155	.172	.198	.227	.261	.287
$\frac{24}{64}$.103	.120	.142	.159	.176	.203	.232	.266	.293
$\frac{25}{32}$.105	.122	.145	.162	.180	.207	.237	.272	.300
$\frac{26}{64}$.107	.125	.148	.166	.184	.212	.242	.278	.306

WEIGHTS OF FLAT ROLLED STEEL BARS.

Pounds per Lineal Foot.

One cubic foot of steel weighs 489.6 pounds.

For thicknesses from $\frac{1}{16}$ inch to $\frac{1}{2}$ inch and widths from $\frac{1}{4}$ inch to 1 inch.

Thickness in Inches.	$\frac{1}{4}$ "	$\frac{1}{2}$ "	$\frac{3}{4}$ "	$1\frac{1}{4}$ "	$1\frac{1}{2}$ "	$2\frac{1}{4}$ "	$3\frac{1}{2}$ "	$4\frac{1}{2}$ "	6 "
$\frac{1}{16}$.053	.056	.060	.063	.066	.070	.073	.076	.080
$\frac{3}{32}$.066	.071	.075	.079	.083	.087	.091	.095	.100
$\frac{1}{8}$.080	.085	.090	.095	.100	.105	.110	.115	.120
$\frac{5}{32}$.093	.099	.105	.110	.116	.122	.128	.134	.139
$\frac{3}{16}$.106	.113	.120	.126	.133	.139	.146	.153	.159
$\frac{7}{32}$.120	.127	.134	.142	.149	.157	.164	.172	.179
$\frac{1}{2}$.133	.141	.149	.158	.166	.174	.183	.191	.199
$\frac{5}{8}$.146	.155	.164	.173	.183	.192	.201	.210	.219
$\frac{3}{8}$.159	.169	.179	.189	.199	.209	.219	.229	.239
$\frac{7}{16}$.173	.183	.194	.205	.216	.227	.237	.248	.259
$\frac{1}{2}$.186	.198	.209	.221	.232	.244	.256	.267	.279
$\frac{5}{8}$.199	.212	.224	.237	.249	.261	.274	.286	.299
$\frac{3}{4}$.213	.226	.239	.252	.266	.279	.292	.305	.319
$\frac{7}{8}$.226	.240	.254	.268	.282	.296	.310	.325	.339
$1\frac{1}{8}$.239	.254	.269	.284	.299	.314	.329	.344	.359
$1\frac{1}{4}$.252	.268	.284	.300	.315	.331	.347	.363	.379
$1\frac{5}{8}$.266	.282	.299	.315	.332	.349	.365	.382	.398
$1\frac{7}{8}$.279	.296	.314	.331	.349	.366	.383	.401	.418
$2\frac{1}{8}$.292	.310	.329	.347	.365	.383	.402	.420	.438
$2\frac{1}{4}$.305	.325	.344	.363	.382	.401	.420	.439	.458
$2\frac{3}{8}$.319	.339	.359	.379	.398	.418	.438	.458	.478
$2\frac{1}{2}$.332	.353	.374	.394	.415	.436	.457	.477	.498
$2\frac{7}{8}$.345	.367	.388	.410	.432	.453	.475	.496	.518
$3\frac{1}{8}$.359	.381	.403	.426	.448	.471	.493	.515	.538
$3\frac{1}{4}$.372	.395	.418	.442	.465	.488	.511	.535	.558
$3\frac{3}{8}$.385	.409	.433	.457	.481	.506	.530	.554	.578
$3\frac{1}{2}$.398	.423	.448	.473	.498	.523	.548	.573	.598
$3\frac{3}{4}$.412	.437	.463	.489	.515	.540	.566	.592	.618
$4\frac{1}{8}$.425	.452	.478	.505	.531	.558	.584	.611	.638
$4\frac{1}{4}$.438	.466	.493	.520	.548	.575	.603	.630	.657
$4\frac{3}{8}$.452	.480	.508	.536	.564	.593	.621	.649	.677
$4\frac{1}{2}$.465	.494	.523	.552	.581	.610	.639	.668	.697
$4\frac{3}{4}$.478	.508	.538	.567	.598	.628	.657	.687	.717

WEIGHTS OF FLAT ROLLED STEEL BARS.

Pounds per Lineal Foot.

(CONTINUED.)

Thickness in Inches.	$\frac{25}{64}$ "	$\frac{13}{32}$ "	$\frac{27}{64}$ "	$\frac{7}{16}$ "	$\frac{29}{64}$ "	$\frac{15}{32}$ "	$\frac{31}{64}$ "	$\frac{1}{2}$ "	12"
$\frac{1}{16}$.083	.086	.090	.093	.096	.100	.103	.106	2.55
$\frac{5}{64}$.104	.108	.112	.116	.120	.125	.129	.133	3.19
$\frac{3}{32}$.125	.129	.134	.139	.144	.149	.154	.159	3.83
$\frac{7}{64}$.145	.151	.157	.163	.169	.174	.180	.186	4.46
$\frac{1}{8}$.166	.173	.179	.186	.193	.199	.206	.212	5.10
$\frac{9}{64}$.187	.194	.202	.209	.217	.224	.232	.239	5.74
$\frac{5}{32}$.208	.216	.224	.232	.241	.249	.257	.266	6.38
$\frac{11}{64}$.228	.237	.247	.256	.265	.274	.283	.292	7.01
$\frac{3}{16}$.249	.259	.269	.279	.289	.299	.309	.319	7.65
$\frac{13}{64}$.270	.281	.291	.302	.313	.324	.335	.345	8.29
$\frac{7}{32}$.291	.302	.314	.325	.337	.349	.360	.372	8.93
$\frac{15}{64}$.311	.324	.336	.349	.361	.374	.386	.398	9.56
$\frac{1}{4}$.332	.345	.359	.372	.385	.398	.412	.425	10.20
$\frac{17}{64}$.353	.367	.381	.395	.409	.423	.437	.452	10.84
$\frac{9}{32}$.374	.388	.403	.418	.433	.448	.463	.478	11.48
$\frac{19}{64}$.394	.410	.426	.442	.457	.473	.489	.505	12.11
$\frac{5}{16}$.415	.432	.448	.465	.481	.498	.515	.531	12.75
$\frac{21}{64}$.436	.453	.471	.488	.506	.523	.540	.558	13.39
$\frac{11}{32}$.457	.475	.493	.511	.530	.548	.566	.584	14.03
$\frac{23}{64}$.477	.496	.515	.535	.554	.573	.592	.611	14.66
$\frac{3}{8}$.498	.518	.538	.558	.578	.598	.618	.638	15.30
$\frac{25}{64}$.519	.540	.560	.581	.602	.623	.643	.664	15.94
$\frac{13}{32}$.540	.561	.583	.604	.626	.647	.669	.691	16.58
$\frac{27}{64}$.560	.583	.605	.628	.650	.672	.695	.717	17.21
$\frac{7}{16}$.581	.604	.628	.651	.674	.697	.721	.744	17.85
$\frac{29}{64}$.602	.626	.650	.674	.698	.722	.746	.770	18.49
$\frac{15}{32}$.623	.647	.672	.697	.722	.747	.772	.797	19.13
$\frac{31}{64}$.643	.669	.695	.721	.746	.772	.798	.823	19.76
$\frac{1}{2}$.664	.691	.717	.744	.770	.797	.823	.850	20.40
$\frac{33}{64}$.685	.712	.740	.767	.794	.822	.849	.877	21.04
$\frac{17}{32}$.706	.734	.762	.790	.818	.847	.875	.903	21.68
$\frac{35}{64}$.726	.755	.784	.813	.843	.872	.901	.930	22.31
$\frac{9}{16}$.747	.777	.807	.837	.867	.896	.926	.956	22.95

WEIGHTS OF FLAT ROLLED STEEL BARS.

Pounds per Lineal Foot.

(CONTINUED.)

Thickness in Inches.	$\frac{3}{8}$ "	$\frac{7}{16}$ "	$\frac{1}{2}$ "	$\frac{9}{16}$ "	$\frac{5}{8}$ "	$\frac{3}{4}$ "	$\frac{7}{8}$ "	$\frac{1}{2}$ "	12"
$\frac{1}{16}$.110	.113	.116	.120	.123	.126	.129	.133	2.55
$\frac{5}{64}$.137	.141	.145	.149	.154	.158	.162	.166	3.19
$\frac{3}{32}$.164	.169	.174	.179	.184	.189	.194	.199	3.83
$\frac{7}{64}$.192	.198	.203	.209	.215	.221	.227	.232	4.46
$\frac{1}{8}$.219	.226	.232	.239	.246	.252	.259	.266	5.10
$\frac{9}{64}$.247	.254	.261	.269	.276	.284	.291	.299	5.74
$\frac{5}{32}$.274	.282	.291	.299	.307	.315	.324	.332	6.38
$\frac{11}{64}$.301	.310	.320	.329	.338	.347	.356	.365	7.01
$\frac{3}{16}$.329	.339	.349	.359	.369	.379	.388	.398	7.65
$\frac{13}{64}$.356	.367	.378	.388	.399	.410	.421	.432	8.29
$\frac{7}{32}$.383	.395	.407	.418	.430	.442	.453	.465	8.93
$\frac{15}{64}$.411	.423	.436	.448	.461	.473	.486	.498	9.56
$\frac{1}{4}$.438	.452	.465	.478	.491	.505	.518	.531	10.20
$\frac{17}{64}$.466	.480	.494	.508	.522	.536	.550	.564	10.84
$\frac{9}{32}$.493	.508	.523	.538	.553	.568	.583	.598	11.48
$\frac{19}{64}$.520	.536	.552	.568	.584	.599	.615	.631	12.11
$\frac{5}{16}$.548	.564	.581	.598	.614	.631	.647	.664	12.75
$\frac{21}{64}$.575	.593	.610	.628	.645	.662	.680	.697	13.39
$\frac{11}{32}$.603	.621	.639	.657	.676	.694	.712	.730	14.03
$\frac{23}{64}$.630	.649	.668	.687	.706	.725	.745	.764	14.66
$\frac{3}{8}$.657	.677	.697	.717	.737	.757	.777	.797	15.30
$\frac{25}{64}$.685	.706	.726	.747	.768	.789	.809	.830	15.94
$\frac{13}{32}$.712	.734	.755	.777	.799	.820	.842	.863	16.58
$\frac{27}{64}$.740	.762	.784	.807	.829	.852	.874	.896	17.21
$\frac{7}{16}$.767	.790	.813	.837	.860	.883	.906	.930	17.85
$\frac{29}{64}$.794	.818	.843	.867	.891	.915	.939	.963	18.49
$\frac{15}{32}$.822	.847	.872	.896	.921	.946	.971	.996	19.13
$\frac{31}{64}$.849	.875	.901	.926	.952	.978	1.00	1.03	19.76
$\frac{1}{2}$.877	.903	.930	.956	.983	1.01	1.04	1.06	20.40
$\frac{33}{64}$.904	.931	.959	.986	1.01	1.04	1.07	1.10	21.04
$\frac{17}{32}$.931	.960	.988	1.02	1.04	1.07	1.10	1.13	21.68
$\frac{35}{64}$.959	.988	1.02	1.05	1.07	1.10	1.13	1.16	22.31
$\frac{37}{64}$.986	1.02	1.05	1.08	1.11	1.14	1.17	1.20	22.95

WEIGHTS OF FLAT ROLLED STEEL BARS.

Pounds per Lineal Foot.

(CONTINUED.)

Thickness in Inches.	$\frac{1}{4}$ "	$\frac{3}{8}$ "	$\frac{1}{2}$ "	$\frac{5}{8}$ "	$\frac{3}{4}$ "	$\frac{7}{8}$ "	1 "	$1\frac{1}{4}$ "	$1\frac{1}{2}$ "
$\frac{1}{16}$.136	.139	.143	.146	.149	.153	.156	.159	2.55
$\frac{5}{64}$.170	.174	.178	.183	.187	.191	.195	.199	3.19
$\frac{3}{32}$.204	.209	.214	.219	.224	.229	.234	.239	3.83
$\frac{7}{64}$.238	.244	.250	.256	.261	.267	.273	.279	4.46
$\frac{1}{8}$.272	.279	.286	.292	.299	.305	.312	.319	5.10
$\frac{9}{64}$.306	.314	.321	.329	.336	.344	.351	.359	5.74
$\frac{5}{32}$.340	.349	.357	.365	.374	.382	.390	.398	6.38
$\frac{11}{64}$.374	.383	.393	.402	.411	.420	.429	.438	7.01
$\frac{3}{16}$.408	.418	.428	.438	.448	.458	.468	.478	7.65
$\frac{13}{64}$.442	.453	.464	.475	.486	.496	.507	.518	8.29
$\frac{7}{32}$.476	.488	.500	.511	.523	.535	.546	.558	8.93
$\frac{15}{64}$.510	.523	.535	.548	.560	.573	.585	.598	9.56
$\frac{1}{4}$.545	.558	.571	.584	.598	.611	.624	.638	10.20
$\frac{17}{64}$.579	.593	.607	.621	.635	.649	.663	.677	10.84
$\frac{9}{32}$.613	.628	.642	.657	.672	.687	.702	.717	11.48
$\frac{19}{64}$.647	.662	.678	.694	.710	.725	.741	.757	12.11
$\frac{5}{16}$.681	.697	.714	.730	.747	.764	.780	.797	12.75
$\frac{21}{64}$.715	.732	.750	.767	.784	.802	.819	.827	13.39
$\frac{11}{32}$.749	.767	.785	.804	.822	.840	.858	.877	14.03
$\frac{23}{64}$.783	.802	.821	.840	.859	.878	.897	.916	14.66
$\frac{3}{8}$.817	.837	.857	.877	.896	.916	.936	.956	15.30
$\frac{25}{64}$.851	.872	.892	.913	.934	.955	.975	.996	15.94
$\frac{13}{32}$.885	.906	.928	.950	.971	.993	1.01	1.04	16.58
$\frac{27}{64}$.919	.941	.964	.986	1.01	1.03	1.05	1.08	17.21
$\frac{7}{16}$.953	.976	.999	1.02	1.05	1.07	1.09	1.12	17.85
$\frac{29}{64}$.987	1.01	1.04	1.06	1.08	1.11	1.13	1.16	18.49
$\frac{15}{32}$	1.02	1.05	1.07	1.10	1.12	1.15	1.17	1.20	19.13
$\frac{31}{64}$	1.06	1.08	1.11	1.13	1.16	1.18	1.21	1.24	19.76
$\frac{1}{2}$	1.09	1.12	1.14	1.17	1.20	1.22	1.25	1.28	20.40
$\frac{33}{64}$	1.12	1.15	1.18	1.21	1.23	1.26	1.29	1.31	21.04
$\frac{17}{32}$	1.16	1.19	1.21	1.24	1.27	1.30	1.33	1.35	21.68
$\frac{35}{64}$	1.19	1.22	1.25	1.28	1.31	1.34	1.37	1.39	22.31
$\frac{19}{32}$	1.23	1.26	1.28	1.31	1.34	1.37	1.40	1.43	22.95

WEIGHTS OF FLAT ROLLED STEEL BARS.

Pounds per Lineal Foot.

(CONTINUED.)

Thickness in Inches.	$\frac{49}{64}$ "	$\frac{25}{32}$ "	$\frac{51}{64}$ "	$\frac{13}{16}$ "	$\frac{53}{64}$ "	$\frac{27}{32}$ "	$\frac{55}{64}$ "	$\frac{7}{8}$ "	12"
$\frac{1}{16}$.163	.166	.169	.173	.176	.179	.183	.186	2.55
$\frac{5}{64}$.203	.208	.212	.216	.220	.224	.228	.232	3.19
$\frac{3}{32}$.244	.249	.254	.259	.264	.269	.274	.279	3.83
$\frac{7}{64}$.285	.291	.296	.302	.308	.314	.320	.325	4.46
$\frac{1}{8}$.325	.332	.339	.345	.352	.359	.365	.372	5.10
$\frac{9}{64}$.365	.374	.381	.388	.396	.403	.411	.418	5.74
$\frac{5}{32}$.407	.415	.423	.432	.440	.448	.457	.465	6.38
$\frac{11}{64}$.447	.457	.466	.475	.484	.493	.502	.511	7.01
$\frac{3}{16}$.488	.498	.508	.518	.528	.538	.548	.558	7.65
$\frac{13}{64}$.529	.540	.550	.561	.572	.583	.594	.604	8.29
$\frac{7}{32}$.569	.581	.593	.604	.616	.628	.639	.651	8.93
$\frac{15}{64}$.610	.623	.635	.647	.660	.672	.685	.697	9.56
$\frac{1}{4}$.651	.664	.677	.691	.704	.717	.730	.744	10.20
$\frac{17}{64}$.691	.706	.720	.734	.748	.762	.776	.790	10.84
$\frac{9}{32}$.732	.747	.762	.777	.792	.807	.822	.837	11.48
$\frac{19}{64}$.773	.789	.804	.820	.836	.852	.867	.883	12.11
$\frac{5}{16}$.813	.830	.847	.863	.880	.897	.913	.930	12.75
$\frac{21}{64}$.854	.872	.889	.906	.924	.941	.959	.976	13.39
$\frac{11}{32}$.895	.913	.931	.950	.968	.986	1.00	1.02	14.03
$\frac{23}{64}$.936	.955	.974	.993	1.01	1.03	1.05	1.07	14.66
$\frac{3}{8}$.976	.996	1.02	1.04	1.06	1.08	1.10	1.12	15.30
$\frac{25}{64}$	1.02	1.04	1.06	1.08	1.10	1.12	1.14	1.16	15.94
$\frac{13}{32}$	1.06	1.08	1.10	1.12	1.14	1.17	1.19	1.21	16.58
$\frac{27}{64}$	1.10	1.12	1.14	1.17	1.19	1.21	1.23	1.26	17.21
$\frac{7}{16}$	1.14	1.16	1.19	1.21	1.23	1.26	1.28	1.30	17.85
$\frac{29}{64}$	1.18	1.20	1.23	1.25	1.28	1.30	1.32	1.35	18.49
$\frac{15}{32}$	1.22	1.25	1.27	1.30	1.32	1.35	1.37	1.40	19.13
$\frac{31}{64}$	1.26	1.29	1.31	1.34	1.36	1.39	1.42	1.44	19.76
$\frac{1}{2}$	1.30	1.33	1.35	1.38	1.41	1.43	1.46	1.49	20.40
$\frac{33}{64}$	1.34	1.37	1.40	1.42	1.45	1.48	1.51	1.53	21.04
$\frac{17}{32}$	1.38	1.41	1.44	1.47	1.50	1.52	1.55	1.58	21.68
$\frac{35}{64}$	1.42	1.45	1.48	1.51	1.54	1.57	1.60	1.63	22.31
$\frac{9}{16}$	1.46	1.49	1.52	1.55	1.58	1.61	1.64	1.67	22.95

WEIGHTS OF FLAT ROLLED STEEL BARS.

Pounds per Lineal Foot.

(CONTINUED.)

Thickness in Inches.	$\frac{5}{64}$ "	$\frac{29}{32}$ "	$\frac{59}{64}$ "	$\frac{15}{16}$ "	$\frac{61}{64}$ "	$\frac{31}{32}$ "	$\frac{63}{64}$ "	1"	12"
$\frac{1}{16}$.189	.193	.196	.199	.203	.206	.209	.213	2.55
$\frac{5}{64}$.237	.241	.245	.249	.253	.257	.262	.266	3.19
$\frac{3}{32}$.284	.289	.294	.299	.304	.309	.314	.319	3.83
$\frac{7}{64}$.331	.337	.343	.349	.354	.360	.366	.372	4.46
$\frac{1}{8}$.379	.385	.392	.398	.405	.412	.418	.425	5.10
$\frac{9}{64}$.426	.433	.441	.448	.456	.463	.471	.478	5.74
$\frac{5}{32}$.473	.481	.490	.498	.506	.515	.523	.531	6.38
$\frac{11}{64}$.520	.529	.538	.548	.557	.566	.575	.584	7.01
$\frac{3}{16}$.568	.578	.588	.598	.608	.618	.628	.638	7.65
$\frac{13}{64}$.615	.626	.637	.648	.658	.669	.680	.691	8.29
$\frac{7}{32}$.662	.674	.686	.697	.709	.721	.732	.744	8.93
$\frac{15}{64}$.710	.722	.735	.747	.760	.772	.784	.797	9.56
$\frac{1}{4}$.757	.770	.784	.797	.810	.823	.837	.850	10.20
$\frac{17}{64}$.804	.818	.833	.847	.861	.875	.889	.903	10.84
$\frac{9}{32}$.852	.867	.882	.896	.911	.926	.941	.956	11.48
$\frac{19}{64}$.899	.915	.931	.946	.962	.978	.994	1.01	12.11
$\frac{5}{16}$.946	.963	.980	.996	1.01	1.03	1.05	1.06	12.75
$\frac{21}{64}$.994	1.01	1.03	1.05	1.06	1.08	1.10	1.12	13.39
$\frac{11}{32}$	1.04	1.06	1.08	1.10	1.11	1.13	1.15	1.17	14.03
$\frac{23}{64}$	1.09	1.11	1.13	1.15	1.17	1.18	1.20	1.22	14.66
$\frac{3}{8}$	1.14	1.16	1.18	1.20	1.22	1.24	1.26	1.28	15.30
$\frac{25}{64}$	1.18	1.20	1.22	1.25	1.27	1.29	1.31	1.33	15.94
$\frac{13}{32}$	1.23	1.25	1.27	1.30	1.32	1.34	1.36	1.38	16.58
$\frac{27}{64}$	1.28	1.30	1.32	1.35	1.37	1.39	1.41	1.43	17.21
$\frac{7}{16}$	1.33	1.35	1.37	1.40	1.42	1.44	1.46	1.49	17.85
$\frac{29}{64}$	1.37	1.40	1.42	1.44	1.47	1.49	1.52	1.54	18.49
$\frac{15}{32}$	1.42	1.44	1.47	1.49	1.52	1.54	1.57	1.59	19.13
$\frac{31}{64}$	1.47	1.49	1.52	1.54	1.57	1.60	1.62	1.65	19.76
$\frac{1}{2}$	1.51	1.54	1.57	1.59	1.62	1.65	1.67	1.70	20.40
$\frac{33}{64}$	1.56	1.59	1.62	1.64	1.67	1.70	1.73	1.75	21.04
$\frac{17}{32}$	1.61	1.64	1.67	1.69	1.72	1.75	1.78	1.81	21.68
$\frac{35}{64}$	1.66	1.69	1.71	1.74	1.77	1.80	1.83	1.86	22.31
$\frac{9}{16}$	1.70	1.73	1.76	1.79	1.82	1.85	1.88	1.91	22.95

WEIGHTS OF FLAT ROLLED STEEL BARS.

Pounds per Lineal Foot.

One cubic foot of steel weighs 489.6 pounds.

For Thicknesses from $\frac{1}{16}$ in. to 2 ins. and Widths from 1 in. to $12\frac{3}{4}$ ins.

Thickness in Inches.	1"	1 $\frac{1}{4}$ "	1 $\frac{1}{2}$ "	1 $\frac{3}{4}$ "	2"	2 $\frac{1}{4}$ "	2 $\frac{1}{2}$ "	2 $\frac{3}{4}$ "	12"
$\frac{1}{16}$.213	.266	.319	.372	.425	.478	.531	.584	2.55
$\frac{1}{8}$.425	.531	.638	.744	.850	.956	1.06	1.17	5.10
$\frac{3}{16}$.638	.797	.956	1.12	1.28	1.43	1.59	1.75	7.65
$\frac{1}{4}$.850	1.06	1.28	1.49	1.70	1.91	2.13	2.34	10.20
$\frac{5}{16}$	1.06	1.33	1.59	1.86	2.13	2.39	2.66	2.92	12.75
$\frac{3}{8}$	1.28	1.59	1.91	2.23	2.55	2.87	3.19	3.51	15.30
$\frac{7}{16}$	1.49	1.86	2.23	2.60	2.98	3.35	3.72	4.09	17.85
$\frac{1}{2}$	1.70	2.13	2.55	2.98	3.40	3.83	4.25	4.68	20.40
$\frac{9}{16}$	1.91	2.39	2.87	3.35	3.83	4.30	4.78	5.26	22.95
$\frac{5}{8}$	2.13	2.66	3.19	3.72	4.25	4.78	5.31	5.84	25.50
$\frac{11}{16}$	2.34	2.92	3.51	4.09	4.68	5.26	5.84	6.43	28.05
$\frac{3}{4}$	2.55	3.19	3.83	4.46	5.10	5.74	6.38	7.01	30.60
$\frac{13}{16}$	2.76	3.45	4.14	4.83	5.53	6.22	6.91	7.60	33.15
$\frac{7}{8}$	2.98	3.72	4.46	5.21	5.95	6.69	7.44	8.18	35.70
$\frac{15}{16}$	3.19	3.98	4.78	5.58	6.38	7.17	7.97	8.77	38.25
1	3.40	4.25	5.10	5.95	6.80	7.65	8.50	9.35	40.80
1 $\frac{1}{16}$	3.61	4.52	5.42	6.32	7.23	8.13	9.03	9.93	43.35
1 $\frac{1}{8}$	3.83	4.78	5.74	6.69	7.65	8.61	9.56	10.52	45.90
1 $\frac{1}{4}$	4.04	5.05	6.06	7.07	8.08	9.08	10.09	11.10	48.45
1 $\frac{1}{2}$	4.25	5.31	6.38	7.44	8.50	9.56	10.63	11.69	51.00
1 $\frac{5}{16}$	4.46	5.58	6.69	7.81	8.93	10.04	11.16	12.27	53.55
1 $\frac{3}{8}$	4.68	5.84	7.01	8.18	9.35	10.52	11.69	12.86	56.10
1 $\frac{7}{16}$	4.89	6.11	7.33	8.55	9.78	11.00	12.22	13.44	58.65
1 $\frac{1}{2}$	5.10	6.38	7.65	8.93	10.20	11.48	12.75	14.03	61.20
1 $\frac{9}{16}$	5.31	6.64	7.97	9.30	10.63	11.95	13.28	14.61	63.75
1 $\frac{5}{8}$	5.53	6.91	8.29	9.67	11.05	12.43	13.81	15.19	66.30
1 $\frac{11}{16}$	5.74	7.17	8.61	10.04	11.48	12.91	14.34	15.78	68.85
1 $\frac{3}{4}$	5.95	7.44	8.93	10.41	11.90	13.39	14.88	16.36	71.40
1 $\frac{13}{16}$	6.16	7.70	9.24	10.78	12.33	13.87	15.41	16.95	73.95
1 $\frac{7}{8}$	6.38	7.97	9.56	11.16	12.75	14.34	15.94	17.53	76.50
1 $\frac{15}{16}$	6.59	8.23	9.88	11.53	13.18	14.82	16.47	18.12	79.05
2	6.80	8.50	10.20	11.90	13.60	15.30	17.00	18.70	81.60

WEIGHTS OF FLAT ROLLED STEEL BARS.

Pounds per Lineal Foot.

(CONTINUED.)

Thickness in Inches.	3"	3 $\frac{1}{4}$ "	3 $\frac{1}{2}$ "	3 $\frac{3}{4}$ "	4"	4 $\frac{1}{4}$ "	4 $\frac{1}{2}$ "	4 $\frac{3}{4}$ "	12"
$\frac{1}{16}$.638	.691	.744	.797	.850	.903	.956	1.01	2.55
$\frac{1}{8}$	1.28	1.38	1.49	1.59	1.70	1.81	1.91	2.20	5.10
$\frac{3}{16}$	1.91	2.07	2.23	2.39	2.55	2.71	2.87	3.03	7.65
$\frac{1}{4}$	2.55	2.76	2.98	3.19	3.40	3.61	3.83	4.04	10.20
$\frac{5}{16}$	3.19	3.45	3.72	3.98	4.25	4.52	4.78	5.05	12.75
$\frac{3}{8}$	3.83	4.14	4.46	4.78	5.10	5.42	5.74	6.06	15.30
$\frac{7}{16}$	4.46	4.83	5.21	5.58	5.95	6.32	6.69	7.07	17.85
$\frac{1}{2}$	5.10	5.53	5.95	6.38	6.80	7.22	7.65	8.08	20.40
$\frac{9}{16}$	5.74	6.22	6.69	7.17	7.65	8.13	8.61	9.08	22.95
$\frac{5}{8}$	6.38	6.91	7.44	7.97	8.50	9.03	9.56	10.09	25.50
$\frac{11}{16}$	7.01	7.60	8.18	8.77	9.35	9.93	10.52	11.10	28.05
$\frac{3}{4}$	7.65	8.29	8.93	9.56	10.20	10.84	11.48	12.11	30.60
$\frac{13}{16}$	8.29	8.98	9.67	10.36	11.05	11.74	12.43	13.12	33.15
$\frac{7}{8}$	8.93	9.67	10.41	11.16	11.90	12.64	13.39	14.13	35.70
$\frac{15}{16}$	9.56	10.36	11.16	11.95	12.75	13.55	14.34	15.14	38.25
1	10.20	11.05	11.90	12.75	13.60	14.45	15.30	16.15	40.80
$1\frac{1}{16}$	10.84	11.74	12.64	13.55	14.45	15.35	16.26	17.16	43.35
$1\frac{1}{8}$	11.48	12.43	13.39	14.34	15.30	16.26	17.21	18.17	45.90
$1\frac{1}{4}$	12.11	13.12	14.13	15.14	16.15	17.16	18.17	19.18	48.45
$1\frac{3}{8}$	12.75	13.81	14.88	15.94	17.00	18.06	19.13	20.19	51.00
$1\frac{5}{16}$	13.39	14.50	15.62	16.73	17.85	18.97	20.08	21.20	53.55
$1\frac{3}{8}$	14.03	15.19	16.36	17.53	18.70	19.87	21.04	22.21	56.10
$1\frac{7}{16}$	14.66	15.88	17.11	18.33	19.55	20.77	21.99	23.22	58.65
$1\frac{1}{2}$	15.30	16.58	17.85	19.13	20.40	21.68	22.95	24.23	61.20
$1\frac{9}{16}$	15.92	17.27	18.59	19.92	21.25	22.58	23.91	25.23	63.75
$1\frac{5}{8}$	16.58	17.96	19.34	20.72	22.10	23.48	24.86	26.24	66.30
$1\frac{11}{16}$	17.21	18.65	20.08	21.52	22.95	24.38	25.82	27.25	68.85
$1\frac{3}{4}$	17.85	19.34	20.83	22.31	23.80	25.29	26.78	28.26	71.40
$1\frac{13}{16}$	18.49	20.03	21.57	23.11	24.65	26.19	27.73	29.27	73.95
$1\frac{7}{8}$	19.13	20.72	22.31	23.91	25.50	27.09	28.69	30.28	76.50
$1\frac{15}{16}$	19.76	21.41	23.06	24.70	26.35	28.00	29.64	31.29	79.05
2	20.40	22.10	23.80	25.50	27.20	28.90	30.60	32.30	81.60

WEIGHTS OF FLAT ROLLED STEEL BARS.

Pounds per Lineal Foot.

(CONTINUED.)

Thickness in Inches.	5"	5½"	5¾"	5¾"	6"	6¼"	6½"	6¾"	12"
1/16	1.06	1.12	1.17	1.22	1.28	1.33	1.38	1.43	2.55
1/8	2.13	2.23	2.34	2.44	2.55	2.66	2.76	2.87	5.10
3/16	3.19	3.35	3.51	3.67	3.83	3.98	4.14	4.30	7.65
1/4	4.25	4.46	4.68	4.89	5.10	5.31	5.53	5.74	10.20
5/16	5.31	5.58	5.84	6.11	6.38	6.64	6.91	7.17	12.75
3/8	6.38	6.69	7.01	7.33	7.65	7.97	8.29	8.61	15.30
7/16	7.44	7.81	8.18	8.55	8.93	9.30	9.67	10.04	17.85
1/2	8.50	8.93	9.35	9.78	10.20	10.63	11.05	11.48	20.40
9/16	9.56	10.04	10.52	11.00	11.48	11.95	12.43	12.91	22.95
5/8	10.63	11.16	11.69	12.22	12.75	13.28	13.81	14.34	25.50
11/16	11.69	12.27	12.86	13.44	14.03	14.61	15.19	15.78	28.05
3/4	12.75	13.39	14.03	14.67	15.30	15.94	16.58	17.21	30.60
13/16	13.81	14.50	15.19	15.88	16.58	17.27	17.96	18.65	33.15
7/8	14.88	15.62	16.36	17.11	17.85	18.59	19.34	20.08	35.70
15/16	15.94	16.73	17.53	18.33	19.13	19.92	20.72	21.52	38.25
1	17.00	17.85	18.70	19.55	20.40	21.25	22.10	22.95	40.80
1 1/16	18.06	18.97	19.87	20.77	21.68	22.58	23.48	24.38	43.35
1 1/8	19.13	20.08	21.04	21.99	22.95	23.91	24.86	25.82	45.90
1 3/16	20.19	21.20	22.21	23.22	24.23	25.23	26.24	27.25	48.45
1 1/4	21.25	22.31	23.38	24.44	25.50	26.56	27.63	28.69	51.00
1 5/16	22.31	23.43	24.54	25.66	26.78	27.89	29.01	30.12	53.55
1 3/8	23.38	24.54	25.71	26.88	28.05	29.22	30.39	31.56	56.10
1 7/16	24.44	25.66	26.88	28.10	29.33	30.55	31.77	32.99	58.65
1 1/2	25.50	26.78	28.05	29.33	30.60	31.88	33.15	34.43	61.20
1 9/16	26.56	27.89	29.22	30.55	31.88	33.20	34.53	35.86	63.75
1 5/8	27.63	29.01	30.39	31.77	33.15	34.53	35.91	37.29	66.30
1 11/16	28.69	30.12	31.56	32.99	34.43	35.86	37.29	38.73	68.85
1 3/4	29.75	31.24	32.73	34.21	35.70	37.19	38.68	40.16	71.40
1 13/16	30.81	32.35	33.89	35.43	36.98	38.52	40.06	41.60	73.95
1 7/8	31.88	33.47	35.06	36.66	38.25	39.84	41.44	43.03	76.50
1 15/16	32.94	34.58	36.23	37.88	39.53	41.17	42.82	44.47	79.05
2	34.00	35.70	37.40	39.10	40.80	42.50	44.20	45.90	81.60

WEIGHTS OF FLAT ROLLED STEEL BARS.

Pounds per Lineal Foot.

(CONTINUED.)

Thickness in Inches.	7"	7 $\frac{1}{4}$ "	7 $\frac{1}{2}$ "	7 $\frac{3}{4}$ "	8"	8 $\frac{1}{4}$ "	8 $\frac{1}{2}$ "	8 $\frac{3}{4}$ "	12"
$\frac{1}{16}$	1.49	1.54	1.59	1.65	1.70	1.75	1.81	1.86	2.55
$\frac{1}{8}$	2.98	3.08	3.19	3.29	3.40	3.51	3.61	3.72	5.10
$\frac{3}{16}$	4.46	4.62	4.78	4.94	5.10	5.26	5.42	5.58	7.65
$\frac{1}{4}$	5.95	6.16	6.38	6.59	6.80	7.01	7.23	7.44	10.20
$\frac{5}{16}$	7.44	7.70	7.97	8.23	8.50	8.77	9.03	9.30	12.75
$\frac{3}{8}$	8.93	9.24	9.56	9.88	10.20	10.52	10.84	11.16	15.30
$\frac{7}{16}$	10.41	10.78	11.16	11.53	11.90	12.27	12.64	13.02	17.85
$\frac{1}{2}$	11.90	12.33	12.75	13.18	13.60	14.03	14.45	14.88	20.40
$\frac{9}{16}$	13.39	13.87	14.34	14.82	15.30	15.78	16.26	16.73	22.95
$\frac{5}{8}$	14.88	15.41	15.94	16.47	17.00	17.53	18.06	18.59	25.50
$\frac{11}{16}$	16.36	16.95	17.53	18.12	18.70	19.28	19.87	20.45	28.05
$\frac{3}{4}$	17.85	18.49	19.13	19.76	20.40	21.04	21.68	22.31	30.60
$\frac{13}{16}$	19.34	20.03	20.72	21.41	22.10	22.79	23.48	24.17	33.15
$\frac{7}{8}$	20.83	21.57	22.31	23.06	23.80	24.54	25.29	26.03	35.70
$\frac{15}{16}$	22.31	23.11	23.91	24.70	25.50	26.30	27.09	27.89	38.25
1	23.80	24.65	25.50	26.35	27.20	28.05	28.90	29.75	40.80
$1\frac{1}{16}$	25.29	26.19	27.09	28.00	28.90	29.80	30.71	31.61	43.35
$1\frac{1}{8}$	26.78	27.73	28.69	29.64	30.60	31.56	32.51	33.47	45.90
$1\frac{3}{16}$	28.26	29.27	30.28	31.29	32.30	33.31	34.32	35.33	48.45
$1\frac{1}{4}$	29.75	30.81	31.88	32.94	34.00	35.06	36.13	37.19	51.00
$1\frac{5}{16}$	31.24	32.35	33.47	34.58	35.70	36.82	37.93	39.05	53.55
$1\frac{3}{8}$	32.73	33.89	35.05	36.23	37.40	38.57	39.74	40.91	56.10
$1\frac{7}{16}$	34.21	35.43	36.66	37.88	39.10	40.32	41.54	42.77	58.65
$1\frac{1}{2}$	35.70	36.98	38.25	39.53	40.80	42.08	43.35	44.63	61.20
$1\frac{9}{16}$	37.19	38.52	39.84	41.17	42.50	43.83	45.16	46.48	63.75
$1\frac{5}{8}$	38.68	40.06	41.44	42.82	44.20	45.58	46.96	48.34	66.30
$1\frac{11}{16}$	40.16	41.60	43.03	44.47	45.90	47.33	48.77	50.20	68.85
$1\frac{3}{4}$	41.65	43.14	44.63	46.11	47.60	49.09	50.58	52.06	71.40
$1\frac{13}{16}$	43.14	44.68	46.22	47.76	49.30	50.84	52.38	53.92	73.95
$1\frac{7}{8}$	44.63	46.22	47.81	49.41	51.00	52.59	54.19	55.78	76.50
$1\frac{15}{16}$	46.11	47.76	49.41	51.05	52.70	54.35	55.99	57.64	79.05
2	47.60	49.30	51.00	52.70	54.40	56.10	57.80	59.50	81.60

WEIGHTS OF FLAT ROLLED STEEL BARS.

Pounds per Lineal Foot.

(CONTINUED.)

Thickness in Inches.	9"	9 $\frac{1}{4}$ "	9 $\frac{1}{2}$ "	9 $\frac{3}{4}$ "	10"	10 $\frac{1}{4}$ "	10 $\frac{1}{2}$ "	10 $\frac{3}{4}$ "	12"
$\frac{1}{16}$	1.91	1.97	2.02	2.07	2.13	2.18	2.23	2.28	2.55
$\frac{1}{8}$	3.83	3.93	4.04	4.15	4.25	4.36	4.46	4.57	5.10
$\frac{3}{16}$	5.74	5.90	6.06	6.22	6.38	6.53	6.69	6.85	7.65
$\frac{1}{4}$	7.65	7.86	8.08	8.29	8.50	8.71	8.93	9.14	10.20
$\frac{5}{16}$	9.56	9.83	10.09	10.36	10.63	10.89	11.16	11.42	12.75
$\frac{3}{8}$	11.48	11.79	12.11	12.43	12.75	13.07	13.39	13.71	15.30
$\frac{7}{16}$	13.39	13.76	14.13	14.50	14.88	15.25	15.62	15.99	17.85
$\frac{1}{2}$	15.30	15.73	16.15	16.58	17.00	17.43	17.85	18.28	20.40
$\frac{9}{16}$	17.21	17.69	18.17	18.65	19.13	19.60	20.08	20.56	22.95
$\frac{5}{8}$	19.13	19.66	20.19	20.72	21.25	21.78	22.31	22.84	25.50
$\frac{11}{16}$	21.04	21.62	22.21	22.79	23.38	23.96	24.54	25.13	28.05
$\frac{3}{4}$	22.95	23.59	24.23	24.86	25.50	26.14	26.78	27.41	30.60
$\frac{13}{16}$	24.86	25.55	26.24	26.93	27.63	28.32	29.01	29.70	33.15
$\frac{7}{8}$	26.78	27.52	28.26	29.01	29.75	30.49	31.24	31.98	35.70
$\frac{15}{16}$	28.69	29.48	30.28	31.08	31.88	32.67	33.47	34.27	38.25
1	30.60	31.45	32.30	33.15	34.00	34.85	35.70	36.55	40.80
$1\frac{1}{16}$	32.51	33.42	34.32	35.22	36.13	37.03	37.93	38.83	43.35
$1\frac{1}{8}$	34.43	35.38	36.34	37.29	38.25	39.21	40.16	41.12	45.90
$1\frac{3}{16}$	36.34	37.35	38.36	39.37	40.38	41.38	42.39	43.40	48.45
$1\frac{1}{4}$	38.25	39.31	40.38	41.44	42.50	43.56	44.63	45.69	51.00
$1\frac{5}{16}$	40.16	41.28	42.39	43.51	44.63	45.74	46.86	47.97	53.55
$1\frac{3}{8}$	42.08	43.24	44.41	45.58	46.75	47.92	49.09	50.26	56.10
$1\frac{7}{16}$	43.99	45.21	46.43	47.65	48.88	50.10	51.32	52.54	58.65
$1\frac{1}{2}$	45.90	47.18	48.45	49.73	51.00	52.28	53.55	54.83	61.20
$1\frac{9}{16}$	47.81	49.14	50.47	51.80	53.13	54.45	55.78	57.11	63.75
$1\frac{5}{8}$	49.73	51.11	52.49	53.87	55.25	56.63	58.01	59.39	66.30
$1\frac{11}{16}$	51.64	53.07	54.51	55.94	57.38	58.81	60.24	61.68	68.85
$1\frac{3}{4}$	53.55	55.04	56.53	58.01	59.50	60.99	62.48	63.96	71.40
$1\frac{13}{16}$	55.46	57.00	58.54	60.08	61.63	63.17	64.71	66.25	73.95
$1\frac{7}{8}$	57.38	58.97	60.56	62.16	63.75	65.34	66.94	68.53	76.50
$1\frac{15}{16}$	59.29	60.93	62.58	64.23	65.88	67.52	69.17	70.82	79.05
2	61.20	62.90	64.60	66.30	68.00	69.70	71.40	73.10	81.60

WEIGHTS OF FLAT ROLLED STEEL BARS.

Pounds per Lineal Foot.

(CONCLUDED.)

Thick- ness in Inches.	11"	11 $\frac{1}{4}$ "	11 $\frac{1}{2}$ "	11 $\frac{3}{4}$ "	12"	12 $\frac{1}{4}$ "	12 $\frac{1}{2}$ "	12 $\frac{3}{4}$ "
$\frac{1}{16}$	2.34	2.39	2.44	2.50	2.55	2.60	2.66	2.71
$\frac{1}{8}$	4.68	4.78	4.89	4.99	5.10	5.21	5.31	5.42
$\frac{3}{16}$	7.01	7.17	7.33	7.49	7.65	7.81	7.97	8.13
$\frac{1}{4}$	9.35	9.56	9.78	9.99	10.20	10.41	10.63	10.84
$\frac{5}{16}$	11.69	11.95	12.22	12.48	12.75	13.02	13.28	13.55
$\frac{3}{8}$	14.03	14.34	14.66	14.98	15.30	15.62	15.94	16.26
$\frac{7}{16}$	16.36	16.73	17.11	17.48	17.85	18.22	18.59	18.97
$\frac{1}{2}$	18.70	19.13	19.55	19.98	20.40	20.83	21.25	21.68
$\frac{9}{16}$	21.04	21.52	21.99	22.47	22.95	23.43	23.91	24.38
$\frac{5}{8}$	23.38	23.91	24.44	24.97	25.50	26.03	26.56	27.09
$\frac{11}{16}$	25.71	26.30	26.88	27.47	28.05	28.63	29.22	29.80
$\frac{3}{4}$	28.05	28.69	29.33	29.96	30.60	31.24	31.88	32.51
$\frac{13}{16}$	30.39	31.08	31.77	32.46	33.15	33.84	34.53	35.22
$\frac{7}{8}$	32.73	33.47	34.21	34.96	35.70	36.44	37.19	37.93
$\frac{15}{16}$	35.06	35.86	36.66	37.45	38.25	39.05	39.84	40.64
1	37.40	38.25	39.10	39.95	40.80	41.65	42.50	43.35
1 $\frac{1}{16}$	39.74	40.64	41.54	42.45	43.35	44.25	45.16	46.06
1 $\frac{1}{8}$	42.08	43.03	43.99	44.94	45.90	46.86	47.81	48.77
1 $\frac{3}{16}$	44.41	45.42	46.43	47.44	48.45	49.46	50.47	51.48
1 $\frac{1}{4}$	46.75	47.81	48.88	49.94	51.00	52.06	53.13	54.19
1 $\frac{5}{16}$	49.09	50.20	51.32	52.43	53.55	54.67	55.78	56.90
1 $\frac{3}{8}$	51.43	52.59	53.76	54.93	56.10	57.27	58.44	59.61
1 $\frac{7}{16}$	53.76	54.98	56.21	57.43	58.65	59.87	61.09	62.32
1 $\frac{1}{2}$	56.10	57.38	58.65	59.93	61.20	62.48	63.75	65.03
1 $\frac{9}{16}$	58.44	59.77	61.09	62.42	63.75	65.08	66.41	67.73
1 $\frac{5}{8}$	60.78	62.16	63.54	64.92	66.30	67.68	69.06	70.44
1 $\frac{11}{16}$	63.11	64.55	65.98	67.42	68.85	70.28	71.72	73.15
1 $\frac{3}{4}$	65.45	66.94	68.43	69.91	71.40	72.89	74.38	75.86
1 $\frac{13}{16}$	67.79	69.33	70.87	72.41	73.95	75.49	77.03	78.57
1 $\frac{7}{8}$	70.13	71.72	73.31	74.91	76.50	78.09	79.69	81.28
1 $\frac{15}{16}$	72.46	74.11	75.76	77.40	79.05	80.70	82.34	83.99
2	74.80	76.50	78.20	79.90	81.60	83.30	85.00	86.70

The weights for 12" width are repeated on each page to facilitate making the additions necessary to obtain the weights of plates of any width greater than 12". Thus, to find the weight of 15 $\frac{1}{2}$ " \times $\frac{7}{8}$ ", add the weights to be found in the same line for 3 $\frac{1}{2}$ " \times $\frac{7}{8}$ " and 12" \times $\frac{7}{8}$ " = 10.41 + 35.70 = 46.11 pounds. Weight of plate 4" \times 6 $\frac{1}{2}$ " \times $\frac{5}{8}$ " = 4 \times 25.50 + 13.81 = 115.81.

AREAS AND CIRCUMFERENCES OF CIRCLES.

For Diameters from $\frac{1}{10}$ to 100, advancing by Tenths.

Diameter.	Area.	Circumference.	Diameter.	Area.	Circumference.
0.0			4.0	12.5664	12.5664
.1	.007854	.31416	.1	13.2025	12.8805
.2	.031416	.62832	.2	13.8544	13.1947
.3	.070686	.94248	.3	14.5220	13.5088
.4	.12566	1.2566	.4	15.2053	13.8230
.5	.19635	1.5708	.5	15.9043	14.1372
.6	.28274	1.8850	.6	16.6190	14.4513
.7	.38485	2.1991	.7	17.3494	14.7655
.8	.50265	2.5133	.8	18.0956	15.0796
.9	.63617	2.8274	.9	18.8574	15.3938
1.0	.7854	3.1416	5.0	19.6350	15.7080
.1	.9503	3.4558	.1	20.4282	16.0221
.2	1.1310	3.7699	.2	21.2372	16.3363
.3	1.3273	4.0841	.3	22.0618	16.6504
.4	1.5394	4.3982	.4	22.9022	16.9646
.5	1.7671	4.7124	.5	23.7583	17.2788
.6	2.0106	5.0265	.6	24.6301	17.5929
.7	2.2698	5.3407	.7	25.5176	17.9071
.8	2.5447	5.6549	.8	26.4208	18.2212
.9	2.8353	5.9690	.9	27.3397	18.5354
2.0	3.1416	6.2832	6.0	28.2743	18.8496
.1	3.4636	6.5973	.1	29.2247	19.1637
.2	3.8013	6.9115	.2	30.1907	19.4779
.3	4.1548	7.2257	.3	31.1725	19.7920
.4	4.5239	7.5398	.4	32.1699	20.1062
.5	4.9087	7.8540	.5	33.1831	20.4204
.6	5.3093	8.1681	.6	34.2119	20.7345
.7	5.7256	8.4823	.7	35.2565	21.0487
.8	6.1575	8.7965	.8	36.3168	21.3628
.9	6.6052	9.1106	.9	37.3928	21.6770
3.0	7.0686	9.4248	7.0	38.4845	21.9911
.1	7.5477	9.7389	.1	39.5919	22.3053
.2	8.0425	10.0531	.2	40.7150	22.6195
.3	8.5530	10.3673	.3	41.8539	22.9336
.4	9.0792	10.6814	.4	43.0084	23.2478
.5	9.6211	10.9956	.5	44.1786	23.5619
.6	10.1788	11.3097	.6	45.3646	23.8761
.7	10.7521	11.6239	.7	46.5663	24.1903
.8	11.3411	11.9381	.8	47.7836	24.5044
.9	11.9459	12.2522	.9	49.0167	24.8186

AREAS AND CIRCUMFERENCES OF CIRCLES.

(CONTINUED.)

Diameter.	Area.	Circumference.	Diameter.	Area.	Circumference.
8.0	50.2655	25.1327	12.0	113.0973	37.6991
.1	51.5300	25.4469	.1	114.9901	38.0133
.2	52.8102	25.7611	.2	116.8987	38.3274
.3	54.1061	26.0752	.3	118.8229	38.6416
.4	55.4177	26.3894	.4	120.7628	38.9557
.5	56.7450	26.7035	.5	122.7185	39.2699
.6	58.0880	27.0177	.6	124.6898	39.5841
.7	59.4468	27.3319	.7	126.6769	39.8982
.8	60.8212	27.6460	.8	128.6796	40.2124
.9	62.2114	27.9602	.9	130.6981	40.5265
9.0	63.6173	28.2743	13.0	132.7323	40.8407
.1	65.0388	28.5885	.1	134.7822	41.1549
.2	66.4761	28.9027	.2	136.8478	41.4690
.3	67.9291	29.2168	.3	138.9291	41.7832
.4	69.3978	29.5310	.4	141.0261	42.0973
.5	70.8822	29.8451	.5	143.1388	42.4115
.6	72.3823	30.1593	.6	145.2672	42.7257
.7	73.8981	30.4734	.7	147.4114	43.0398
.8	75.4296	30.7876	.8	149.5712	43.3540
.9	76.9769	31.1018	.9	151.7468	43.6681
10.0	78.5398	31.4159	14.0	153.9380	43.9823
.1	80.1185	31.7301	.1	156.1450	44.2965
.2	81.7128	32.0442	.2	158.3677	44.6106
.3	83.3229	32.3584	.3	160.6061	44.9248
.4	84.9487	32.6726	.4	162.8602	45.2389
.5	86.5901	32.9867	.5	165.1300	45.5531
.6	88.2473	33.3009	.6	167.4155	45.8673
.7	89.9202	33.6150	.7	169.7167	46.1814
.8	91.6088	33.9292	.8	172.0336	46.4956
.9	93.3132	34.2434	.9	174.3662	46.8097
11.0	95.0332	34.5575	15.0	176.7146	47.1239
.1	96.7689	34.8717	.1	179.0786	47.4380
.2	98.5203	35.1858	.2	181.4584	47.7522
.3	100.2875	35.5000	.3	183.8539	48.0664
.4	102.0703	35.8142	.4	186.2650	48.3805
.5	103.8689	36.1283	.5	188.6919	48.6947
.6	105.6832	36.4425	.6	191.1345	49.0088
.7	107.5132	36.7566	.7	193.5928	49.3230
.8	109.3588	37.0708	.8	196.0668	49.6372
.9	111.2202	37.3850	.9	198.5565	49.9513

AREAS AND CIRCUMFERENCES OF CIRCLES.

(CONTINUED.)

Diameter.	Area.	Circumference.	Diameter.	Area.	Circumference.
16.0	201.0619	50.2655	20.0	314.1593	62.8319
.1	203.5831	50.5796	.1	317.3087	63.1460
.2	206.1199	50.8938	.2	320.4739	63.4602
.3	208.6724	51.2080	.3	323.6547	63.7743
.4	211.2407	51.5221	.4	326.8513	64.0885
.5	213.8246	51.8363	.5	330.0636	64.4026
.6	216.4243	52.1504	.6	333.2916	64.7168
.7	219.0397	52.4646	.7	336.5353	65.0310
.8	221.6708	52.7788	.8	339.7947	65.3451
.9	224.3176	53.0929	.9	343.0698	65.6593
17.0	226.9801	53.4071	21.0	346.3606	65.9734
.1	229.6583	53.7212	.1	349.6671	66.2876
.2	232.3522	54.0354	.2	352.9893	66.6018
.3	235.0618	54.3496	.3	356.3273	66.9159
.4	237.7871	54.6637	.4	359.6809	67.2301
.5	240.5282	54.9779	.5	363.0503	67.5442
.6	243.2849	55.2920	.6	366.4354	67.8584
.7	246.0574	55.6062	.7	369.8361	68.1726
.8	248.8456	55.9203	.8	373.2526	68.4867
.9	251.6494	56.2345	.9	376.6848	68.8009
18.0	254.4690	56.5487	22.0	380.1327	69.1150
.1	257.3043	56.8628	.1	383.5963	69.4292
.2	260.1553	57.1770	.2	387.0756	69.7434
.3	263.0220	57.4911	.3	390.5707	70.0575
.4	265.9044	57.8053	.4	394.0814	70.3717
.5	268.8025	58.1195	.5	397.6078	70.6858
.6	271.7163	58.4336	.6	401.1500	71.0000
.7	274.6459	58.7478	.7	404.7078	71.3142
.8	277.5911	59.0619	.8	408.2814	71.6283
.9	280.5521	59.3761	.9	411.8706	71.9425
19.0	283.5287	59.6903	23.0	415.4756	72.2566
.1	286.5211	60.0044	.1	419.0963	72.5708
.2	289.5292	60.3186	.2	422.7327	72.8849
.3	292.5530	60.6327	.3	426.3848	73.1991
.4	295.5925	60.9469	.4	430.0526	73.5133
.5	298.6477	61.2611	.5	433.7361	73.8274
.6	301.7186	61.5752	.6	437.4354	74.1416
.7	304.8052	61.8894	.7	441.1503	74.4557
.8	307.9075	62.2035	.8	444.8809	74.7699
.9	311.0255	62.5177	.9	448.6273	75.0841

AREAS AND CIRCUMFERENCES OF CIRCLES.

(CONTINUED.)

Diameter.	Area.	Circumference.	Diameter.	Area.	Circumference.
24.0	452.3893	75.3982	28.0	615.7522	87.9646
.1	456.1671	75.7124	.1	620.1582	88.2788
.2	459.9606	76.0265	.2	624.5800	88.5929
.3	463.7698	76.3407	.3	629.0175	88.9071
.4	467.5946	76.6549	.4	633.4707	89.2212
.5	471.4352	76.9690	.5	637.9397	89.5354
.6	475.2916	77.2832	.6	642.4243	89.8495
.7	479.1636	77.5973	.7	646.9246	90.1637
.8	483.0513	77.9115	.8	651.4406	90.4779
.9	486.9547	78.2257	.9	655.9724	90.7920
25.0	490.8739	78.5398	29.0	660.5199	91.1062
.1	494.8087	78.8540	.1	665.0830	91.4203
.2	498.7592	79.1681	.2	669.6619	91.7345
.3	502.7255	79.4823	.3	674.2565	92.0487
.4	506.7075	79.7965	.4	678.8668	92.3628
.5	510.7052	80.1106	.5	683.4927	92.6770
.6	514.7185	80.4248	.6	688.1345	92.9911
.7	518.7476	80.7389	.7	692.7919	93.3053
.8	522.7924	81.0531	.8	697.4650	93.6195
.9	526.8529	81.3672	.9	702.1538	93.9336
26.0	530.9292	81.6814	30.0	706.8583	94.2478
.1	535.0211	81.9956	.1	711.5786	94.5619
.2	539.1287	82.3097	.2	716.3145	94.8761
.3	543.2521	82.6239	.3	721.0662	95.1903
.4	547.3911	82.9380	.4	725.8336	95.5044
.5	551.5459	83.2522	.5	730.6167	95.8186
.6	555.7163	83.5664	.6	735.4154	96.1327
.7	559.9025	83.8805	.7	740.2299	96.4469
.8	564.1044	84.1947	.8	745.0601	96.7611
.9	568.3220	84.5088	.9	749.9060	97.0752
27.0	572.5553	84.8230	31.0	754.7676	97.3894
.1	576.8043	85.1372	.1	759.6450	97.7035
.2	581.0690	85.4513	.2	764.5380	98.0177
.3	585.3494	85.7655	.3	769.4467	98.3319
.4	589.6455	86.0796	.4	774.3712	98.6460
.5	593.9574	86.3938	.5	779.3113	98.9602
.6	598.2849	86.7080	.6	784.2672	99.2743
.7	602.6282	87.0221	.7	789.2388	99.5885
.8	606.9871	87.3363	.8	794.2260	99.9026
.9	611.3618	87.6504	.9	799.2290	100.2168

AREAS AND CIRCUMFERENCES OF CIRCLES.

(CONTINUED.)

Diameter.	Area.	Circumference.	Diameter.	Area.	Circumference.
32.0	804.2477	100.5310	36.0	1017.8760	113.0973
.1	809.2821	100.8451	.1	1023.5387	113.4115
.2	814.3322	101.1593	.2	1029.2172	113.7257
.3	819.3980	101.4734	.3	1034.9113	114.0398
.4	824.4796	101.7876	.4	1040.6211	114.3540
.5	829.5768	102.1018	.5	1046.3467	114.6681
.6	834.6897	102.4159	.6	1052.0880	114.9823
.7	839.8184	102.7301	.7	1057.8449	115.2965
.8	844.9628	103.0442	.8	1063.6176	115.6106
.9	850.1229	103.3584	.9	1069.4060	115.9248
33.0	855.2986	103.6726	37.0	1075.2101	116.2389
.1	860.4902	103.9867	.1	1081.0299	116.5531
.2	865.6973	104.3009	.2	1086.8654	116.8672
.3	870.9202	104.6150	.3	1092.7166	117.1814
.4	876.1588	104.9292	.4	1098.5835	117.4956
.5	881.4131	105.2434	.5	1104.4662	117.8097
.6	886.6831	105.5575	.6	1110.3645	118.1239
.7	891.9688	105.8717	.7	1116.2786	118.4380
.8	897.2703	106.1858	.8	1122.2083	118.7522
.9	902.5874	106.5000	.9	1128.1538	119.0664
34.0	907.9203	106.8142	38.0	1134.1149	119.3805
.1	913.2688	107.1283	.1	1140.0918	119.6947
.2	918.6331	107.4425	.2	1146.0844	120.0088
.3	924.0131	107.7566	.3	1152.0927	120.3230
.4	929.4088	108.0708	.4	1158.1167	120.6372
.5	934.8202	108.3849	.5	1164.1564	120.9513
.6	940.2473	108.6991	.6	1170.2118	121.2655
.7	945.6901	109.0133	.7	1176.2830	121.5796
.8	951.1486	109.3274	.8	1182.3698	121.8938
.9	956.6228	109.6416	.9	1188.4723	122.2080
35.0	962.1127	109.9557	39.0	1194.5906	122.5221
.1	967.6184	110.2699	.1	1200.7246	122.8363
.2	973.1397	110.5841	.2	1206.8742	123.1504
.3	978.6768	110.8982	.3	1213.0396	123.4646
.4	984.2296	111.2124	.4	1219.2207	123.7788
.5	989.7980	111.5265	.5	1225.4175	124.0929
.6	995.3822	111.8407	.6	1231.6300	124.4071
.7	1000.9821	112.1549	.7	1237.8582	124.7212
.8	1006.5977	112.4690	.8	1244.1021	125.0354
.9	1012.2290	112.7832	.9	1250.3617	125.3495

AREAS AND CIRCUMFERENCES OF CIRCLES.

(CONTINUED.)

Diameter.	Area.	Circumference.	Diameter.	Area.	Circumference.
40.0	1256.6371	125.6637	44.0	1520.5308	138.2301
.1	1262.9281	125.9779	.1	1527.4502	138.5442
.2	1269.2348	126.2920	.2	1534.3853	138.8584
.3	1275.5573	126.6062	.3	1541.3360	139.1726
.4	1281.8955	126.9203	.4	1548.3025	139.4867
.5	1288.2493	127.2345	.5	1555.2847	139.8009
.6	1294.6189	127.5487	.6	1562.2826	140.1150
.7	1301.0042	127.8628	.7	1569.2962	140.4292
.8	1307.4052	128.1770	.8	1576.3255	140.7434
.9	1313.8219	128.4911	.9	1583.3705	141.0575
41.0	1320.2543	128.8053	45.0	1590.4313	141.3717
.1	1326.7024	129.1195	.1	1597.5077	141.6858
.2	1333.1663	129.4336	.2	1604.5999	142.0000
.3	1339.6458	129.7478	.3	1611.7077	142.3141
.4	1346.1410	130.0619	.4	1618.8313	142.6283
.5	1352.6520	130.3761	.5	1625.9705	142.9425
.6	1359.1786	130.6903	.6	1633.1255	143.2566
.7	1365.7210	131.0044	.7	1640.2962	143.5708
.8	1372.2791	131.3186	.8	1647.4826	143.8849
.9	1378.8529	131.6327	.9	1654.6847	144.1991
42.0	1385.4424	131.9469	46.0	1661.9025	144.5133
.1	1392.0476	132.2611	.1	1669.1360	144.8274
.2	1398.6685	132.5752	.2	1676.3852	145.1416
.3	1405.3051	132.8894	.3	1683.6502	145.4557
.4	1411.9574	133.2035	.4	1690.9308	145.7699
.5	1418.6254	133.5177	.5	1698.2272	146.0841
.6	1425.3092	133.8318	.6	1705.5392	146.3982
.7	1432.0086	134.1460	.7	1712.8670	146.7124
.8	1438.7238	134.4602	.8	1720.2105	147.0265
.9	1445.4546	134.7743	.9	1727.5696	147.3407
43.0	1452.2012	135.0885	47.0	1734.9445	147.6549
.1	1458.9635	135.4026	.1	1742.3351	147.9690
.2	1465.7415	135.7168	.2	1749.7414	148.2832
.3	1472.5352	136.0310	.3	1757.1634	148.5973
.4	1479.3446	136.3451	.4	1764.6012	148.9115
.5	1486.1697	136.6593	.5	1772.0546	149.2257
.6	1493.0105	136.9734	.6	1779.5237	149.5398
.7	1499.8670	137.2876	.7	1787.0086	149.8540
.8	1506.7392	137.6018	.8	1794.5091	150.1681
.9	1513.6272	137.9159	.9	1802.0254	150.4823

AREAS AND CIRCUMFERENCES OF CIRCLES.

(CONTINUED.)

Diameter.	Area.	Circumference.	Diameter.	Area.	Circumference.
48.0	1809.5574	150.7964	52.0	2123.7166	163.3628
.1	1817.1050	151.1106	.1	2131.8926	163.6770
.2	1824.6684	151.4248	.2	2140.0843	163.9911
.3	1832.2475	151.7389	.3	2148.2917	164.3053
.4	1839.8423	152.0531	.4	2156.5149	164.6195
.5	1847.4528	152.3672	.5	2164.7537	164.9336
.6	1855.0790	152.6814	.6	2173.0082	165.2478
.7	1862.7210	152.9956	.7	2181.2785	165.5619
.8	1870.3786	153.3097	.8	2189.5644	165.8761
.9	1878.0519	153.6239	.9	2197.8661	166.1903
49.0	1885.7410	153.9380	53.0	2206.1834	166.5044
.1	1893.4457	154.2522	.1	2214.5165	166.8186
.2	1901.1662	154.5664	.2	2222.8653	167.1327
.3	1908.9024	154.8805	.3	2231.2298	167.4469
.4	1916.6543	155.1947	.4	2239.6100	167.7610
.5	1924.4218	155.5088	.5	2248.0059	168.0752
.6	1932.2051	155.8230	.6	2256.4175	168.3894
.7	1940.0041	156.1372	.7	2264.8448	168.7035
.8	1947.8189	156.4513	.8	2273.2879	169.0177
.9	1955.6493	156.7655	.9	2281.7466	169.3318
50.0	1963.4954	157.0796	54.0	2290.2210	169.6460
.1	1971.3572	157.3938	.1	2298.7112	169.9602
.2	1979.2348	157.7080	.2	2307.2171	170.2743
.3	1987.1280	158.0221	.3	2315.7386	170.5885
.4	1995.0370	158.3363	.4	2324.2759	170.9026
.5	2002.9617	158.6504	.5	2332.8289	171.2168
.6	2010.9020	158.9646	.6	2341.3976	171.5310
.7	2018.8581	159.2787	.7	2349.9820	171.8451
.8	2026.8299	159.5929	.8	2358.5821	172.1593
.9	2034.8174	159.9071	.9	2367.1979	172.4734
51.0	2042.8206	160.2212	55.0	2375.8294	172.7876
.1	2050.8395	160.5354	.1	2384.4767	173.1018
.2	2058.8742	160.8495	.2	2393.1396	173.4159
.3	2066.9245	161.1637	.3	2401.8183	173.7301
.4	2074.9905	161.4779	.4	2410.5126	174.0442
.5	2083.0723	161.7920	.5	2419.2227	174.3584
.6	2091.1697	162.1062	.6	2427.9485	174.6726
.7	2099.2829	162.4203	.7	2436.6899	174.9867
.8	2107.4118	162.7345	.8	2445.4471	175.3009
.9	2115.5563	163.0487	.9	2454.2200	175.6150

AREAS AND CIRCUMFERENCES OF CIRCLES.

(CONTINUED.)

Diameter.	Area.	Circumference.	Diameter.	Area.	Circumference.
56.0	2463.0086	175.9292	60.0	2827.4334	188.4956
.1	2471.8129	176.2433	.1	2836.8660	188.8097
.2	2480.6330	176.5575	.2	2846.3143	189.1239
.3	2489.4687	176.8717	.3	2855.7784	189.4380
.4	2498.3201	177.1858	.4	2865.2582	189.7522
.5	2507.1873	177.5000	.5	2874.7536	190.0664
.6	2516.0701	177.8141	.6	2884.2648	190.3805
.7	2524.9687	178.1283	.7	2893.7917	190.6947
.8	2533.8830	178.4425	.8	2903.3343	191.0088
.9	2542.8129	178.7566	.9	2912.8925	191.3230
57.0	2551.7586	179.0708	61.0	2922.4666	191.6372
.1	2560.7200	179.3849	.1	2932.0563	191.9513
.2	2569.6971	179.6991	.2	2941.6617	192.2655
.3	2578.6899	180.0133	.3	2951.2828	192.5796
.4	2587.6984	180.3274	.4	2960.9196	192.8938
.5	2596.7227	180.6416	.5	2970.5722	193.2079
.6	2605.7626	180.9557	.6	2980.2404	193.5221
.7	2614.8182	181.2699	.7	2989.9244	193.8363
.8	2623.8896	181.5841	.8	2999.6241	194.1504
.9	2632.9766	181.8982	.9	3009.3394	194.4646
58.0	2642.0794	182.2124	62.0	3019.0705	194.7787
.1	2651.1979	182.5265	.1	3028.8173	195.0929
.2	2660.3321	182.8407	.2	3038.5798	195.4071
.3	2669.4820	183.1549	.3	3048.3580	195.7212
.4	2678.6475	183.4690	.4	3058.1519	196.0354
.5	2687.8289	183.7832	.5	3067.9616	196.3495
.6	2697.0259	184.0973	.6	3077.7869	196.6637
.7	2706.2386	184.4115	.7	3087.6279	196.9779
.8	2715.4670	184.7256	.8	3097.4847	197.2920
.9	2724.7112	185.0398	.9	3107.3571	197.6062
59.0	2733.9710	185.3540	63.0	3117.2453	197.9203
.1	2743.2465	185.6681	.1	3127.1492	198.2345
.2	2752.5378	185.9823	.2	3137.0687	198.5487
.3	2761.8448	186.2964	.3	3147.0040	198.8628
.4	2771.1675	186.6106	.4	3156.9550	199.1770
.5	2780.5058	186.9248	.5	3166.9217	199.4911
.6	2789.8599	187.2389	.6	3176.9041	199.8053
.7	2799.2297	187.5531	.7	3186.9023	200.1195
.8	2808.6152	187.8672	.8	3196.9161	200.4336
.9	2818.0165	188.1814	.9	3206.9456	200.7478

AREAS AND CIRCUMFERENCES OF CIRCLES.

(CONTINUED.)

Diameter.	Area.	Circumference.	Diameter.	Area.	Circumference.
64.0	3216.9909	201.0620	68.0	3631.6811	213.6283
.1	3227.0518	201.3761	.1	3642.3704	213.9425
.2	3237.1285	201.6902	.2	3653.0753	214.2566
.3	3247.2208	202.0044	.3	3663.7960	214.5708
.4	3257.3289	202.3186	.4	3674.5324	214.8849
.5	3267.4527	202.6327	.5	3685.2845	215.1991
.6	3277.5922	202.9469	.6	3696.0523	215.5133
.7	3287.7474	203.2610	.7	3706.8358	215.8274
.8	3297.9183	203.5752	.8	3717.6351	216.1416
.9	3308.1049	203.8894	.9	3728.4500	216.4556
65.0	3318.3072	204.2035	69.0	3739.2807	216.7699
.1	3328.5253	204.5177	.1	3750.1270	217.0841
.2	3338.7590	204.8318	.2	3760.9890	217.3982
.3	3349.0084	205.1460	.3	3771.8668	217.7124
.4	3359.2736	205.4602	.4	3782.7603	218.0265
.5	3369.5545	205.7743	.5	3793.6695	218.3407
.6	3379.8510	206.0885	.6	3804.5944	218.6548
.7	3390.1633	206.4026	.7	3815.5349	218.9690
.8	3400.4913	206.7168	.8	3826.4913	219.2832
.9	3410.8350	207.0310	.9	3837.4633	219.5973
66.0	3421.1944	207.3451	70.0	3848.4510	219.9115
.1	3431.5695	207.6593	.1	3859.4544	220.2256
.2	3441.9603	207.9734	.2	3870.4735	220.5398
.3	3452.3668	208.2876	.3	3881.5084	220.8540
.4	3462.7891	208.6017	.4	3892.5589	221.1681
.5	3473.2270	208.9159	.5	3903.6252	221.4823
.6	3483.6807	209.2301	.6	3914.7072	221.7964
.7	3494.1500	209.5442	.7	3925.8048	222.1106
.8	3504.6351	209.8584	.8	3936.9182	222.4248
.9	3515.1359	210.1725	.9	3948.0473	222.7389
67.0	3525.6523	210.4867	71.0	3959.1921	223.0531
.1	3536.1845	210.8009	.1	3970.3526	223.3672
.2	3546.7324	211.1150	.2	3981.5288	223.6814
.3	3557.2960	211.4292	.3	3992.7208	223.9956
.4	3567.8753	211.7433	.4	4003.9284	224.3097
.5	3578.4704	212.0575	.5	4015.1517	224.6239
.6	3589.0811	212.3717	.6	4026.3908	224.9380
.7	3599.7075	212.6858	.7	4037.6455	225.2522
.8	3610.3497	213.0000	.8	4048.9160	225.5664
.9	3621.0075	213.3141	.9	4060.2022	225.8805

AREAS AND CIRCUMFERENCES OF CIRCLES.

(CONTINUED.)

Diameter.	Area.	Circumference.	Diameter.	Area.	Circumference.
72.0	4071.5041	226.1947	76.0	4536.4598	238.7610
.1	4082.8216	226.5088	.1	4548.4057	239.0752
.2	4094.1549	226.8230	.2	4560.3673	239.3894
.3	4105.5039	227.1371	.3	4572.3446	239.7035
.4	4116.8687	227.4513	.4	4584.3376	240.0177
.5	4128.2491	227.7655	.5	4596.3464	240.3318
.6	4139.6452	228.0796	.6	4608.3708	240.6460
.7	4151.0570	228.3938	.7	4620.4110	240.9602
.8	4162.4846	228.7079	.8	4632.4668	241.2743
.9	4173.9278	229.0221	.9	4644.5384	241.5885
73.0	4185.3868	229.3363	77.0	4656.6257	241.9026
.1	4196.8615	229.6504	.1	4668.7287	242.2168
.2	4208.3518	229.9646	.2	4680.8474	242.5310
.3	4219.8579	230.2787	.3	4692.9818	242.8451
.4	4231.3797	230.5929	.4	4705.1319	243.1592
.5	4242.9172	230.9071	.5	4717.2977	243.4734
.6	4254.4704	231.2212	.6	4729.4792	243.7876
.7	4266.0393	231.5354	.7	4741.6765	244.1017
.8	4277.6240	231.8495	.8	4753.8894	244.4159
.9	4289.2243	232.1637	.9	4766.1180	244.7301
74.0	4300.8403	232.4779	78.0	4778.3624	245.0442
.1	4312.4721	232.7920	.1	4790.6225	245.3584
.2	4324.1195	233.1062	.2	4802.8982	245.6725
.3	4335.7827	233.4203	.3	4815.1897	245.9867
.4	4347.4616	233.7345	.4	4827.4969	246.3009
.5	4359.1562	234.0487	.5	4839.8198	246.6150
.6	4370.8664	234.3628	.6	4852.1584	246.9292
.7	4382.5924	234.6770	.7	4864.5127	247.2433
.8	4394.3341	234.9911	.8	4876.8828	247.5575
.9	4406.0915	235.3053	.9	4889.2685	247.8717
75.0	4417.8647	235.6194	79.0	4901.6699	248.1858
.1	4429.6535	235.9336	.1	4914.0871	248.5000
.2	4441.4580	236.2478	.2	4926.5199	248.8141
.3	4453.2783	236.5619	.3	4938.9685	249.1283
.4	4465.1142	236.8761	.4	4951.4328	249.4425
.5	4476.9659	237.1902	.5	4963.9127	249.7566
.6	4488.8332	237.5044	.6	4976.4084	250.0708
.7	4500.7163	237.8186	.7	4988.9198	250.3849
.8	4512.6151	238.1327	.8	5001.4469	250.6991
.9	4524.5296	238.4469	.9	5013.9897	251.0133

AREAS AND CIRCUMFERENCES OF CIRCLES.

(CONTINUED.)

Diameter.	Area.	Circumference.	Diameter.	Area.	Circumference.
80.0	5026.5482	251.3274	84.0	5541.7694	263.8938
.1	5039.1224	251.6416	.1	5554.9720	264.2079
.2	5051.7124	251.9557	.2	5568.1902	264.5221
.3	5064.3180	252.2699	.3	5581.4242	264.8363
.4	5076.9394	252.5840	.4	5594.6738	265.1504
.5	5089.5764	252.8982	.5	5607.9392	265.4646
.6	5102.2292	253.2124	.6	5621.2203	265.7787
.7	5114.8977	253.5265	.7	5634.5171	266.0929
.8	5127.5818	253.8407	.8	5647.8296	266.4071
.9	5140.2817	254.1548	.9	5661.1578	266.7212
81.0	5152.9973	254.4690	85.0	5674.5017	267.0354
.1	5165.7286	254.7832	.1	5687.8613	267.3495
.2	5178.4756	255.0973	.2	5701.2367	267.6637
.3	5191.2384	255.4115	.3	5714.6277	267.9779
.4	5204.0168	255.7256	.4	5728.0344	268.2920
.5	5216.8109	256.0398	.5	5741.4569	268.6062
.6	5229.6208	256.3540	.6	5754.8951	268.9203
.7	5242.4463	256.6681	.7	5768.3489	269.2345
.8	5255.2876	256.9823	.8	5781.8185	269.5486
.9	5268.1446	257.2964	.9	5795.3038	269.8628
82.0	5281.0172	257.6106	86.0	5808.8048	270.1770
.1	5293.9056	257.9248	.1	5822.3215	270.4911
.2	5306.8097	258.2389	.2	5835.8539	270.8053
.3	5319.7295	258.5531	.3	5849.4020	271.1194
.4	5332.6650	258.8672	.4	5862.9659	271.4336
.5	5345.6162	259.1814	.5	5876.5454	271.7478
.6	5358.5832	259.4956	.6	5890.1406	272.0619
.7	5371.5658	259.8097	.7	5903.7516	272.3761
.8	5384.5641	260.1239	.8	5917.3782	272.6902
.9	5397.5782	260.4380	.9	5931.0206	273.0044
83.0	5410.6079	260.7522	87.0	5944.6787	273.3186
.1	5423.6534	261.0663	.1	5958.3525	273.6327
.2	5436.7146	261.3805	.2	5972.0419	273.9469
.3	5449.7914	261.6947	.3	5985.7471	274.2610
.4	5462.8840	262.0088	.4	5999.4680	274.5752
.5	5475.9923	262.3230	.5	6013.2047	274.8894
.6	5489.1163	262.6371	.6	6026.9570	275.2035
.7	5502.2560	262.9513	.7	6040.7250	275.5177
.8	5515.4115	263.2655	.8	6054.5088	275.8318
.9	5528.5826	263.5796	.9	6068.3082	276.1460

AREAS AND CIRCUMFERENCES OF CIRCLES.

(CONTINUED.)

Diameter.	Area.	Circumference.	Diameter.	Area.	Circumference.
88.0	6082.1234	276.4602	92.0	6647.6100	289.0265
.1	6095.9542	276.7743	.1	6662.0692	289.3407
.2	6109.8008	277.0885	.2	6676.5441	289.6548
.3	6123.6631	277.4026	.3	6691.0347	289.9690
.4	6137.5410	277.7168	.4	6705.5410	290.2832
.5	6151.4347	278.0309	.5	6720.0630	290.5973
.6	6165.3441	278.3451	.6	6734.6007	290.9115
.7	6179.2692	278.6593	.7	6749.1542	291.2256
.8	6193.2101	278.9734	.8	6763.7233	291.5398
.9	6207.1666	279.2876	.9	6778.3081	291.8540
89.0	6221.1388	279.6017	93.0	6792.9087	292.1681
.1	6235.1268	279.9159	.1	6807.5249	292.4823
.2	6249.1304	280.2301	.2	6822.1569	292.7964
.3	6263.1498	280.5442	.3	6836.8046	293.1106
.4	6277.1848	280.8584	.4	6851.4680	293.4248
.5	6291.2356	281.1725	.5	6866.1471	293.7389
.6	6305.3021	281.4867	.6	6880.8419	294.0531
.7	6319.3843	281.8009	.7	6895.5524	294.3672
.8	6333.4822	282.1150	.8	6910.2786	294.6814
.9	6347.5958	282.4292	.9	6925.0205	294.9956
90.0	6361.7251	282.7433	94.0	6939.7781	295.3097
.1	6375.8701	283.0575	.1	6954.5515	295.6239
.2	6390.0308	283.3717	.2	6969.3405	295.9380
.3	6404.2073	283.6858	.3	6984.1453	296.2522
.4	6418.3994	284.0000	.4	6998.9657	296.5663
.5	6432.6073	284.3141	.5	7013.8019	296.8805
.6	6446.8308	284.6283	.6	7028.6538	297.1947
.7	6461.0701	284.9425	.7	7043.5214	297.5088
.8	6475.3251	285.2566	.8	7058.4047	297.8230
.9	6489.5958	285.5708	.9	7073.3037	298.1371
91.0	6503.8822	285.8849	95.0	7088.2184	298.4513
.1	6518.1843	286.1991	.1	7103.1488	298.7655
.2	6532.5021	286.5132	.2	7118.0949	299.0796
.3	6546.8356	286.8274	.3	7133.0568	299.3938
.4	6561.1848	287.1416	.4	7148.0343	299.7079
.5	6575.5497	287.4557	.5	7163.0276	300.0221
.6	6589.9304	287.7699	.6	7178.0365	300.3363
.7	6604.3267	288.0840	.7	7193.0612	300.6504
.8	6618.7388	288.3982	.8	7208.1016	300.9646
.9	6633.1666	288.7124	.9	7223.1577	301.2787

AREAS AND CIRCUMFERENCES OF CIRCLES.

(CONCLUDED.)

Diameter.	Area.	Circumference.	Diameter.	Area.	Circumference.
96.0	7238.2294	301.5929	98.0	7542.9639	307.8761
.1	7253.3169	301.9071	.1	7558.3656	308.1902
.2	7268.4201	302.2212	.2	7573.7830	308.5044
.3	7283.5391	302.5354	.3	7589.2161	308.8186
.4	7298.6737	302.8495	.4	7604.6648	309.1327
.5	7313.8240	303.1637	.5	7620.1293	309.4469
.6	7328.9901	303.4779	.6	7635.6095	309.7610
.7	7344.1718	303.7920	.7	7651.1054	310.0752
.8	7359.3693	304.1062	.8	7666.6170	310.3894
.9	7374.5824	304.4203	.9	7682.1443	310.7035
97.0	7389.8113	304.7345	99.0	7697.6874	311.0177
.1	7405.0559	305.0486	.1	7713.2461	311.3318
.2	7420.3162	305.3628	.2	7728.8205	311.6460
.3	7435.5921	305.6770	.3	7744.4107	311.9602
.4	7450.8838	305.9911	.4	7760.0166	312.2743
.5	7466.1913	306.3053	.5	7775.6381	312.5885
.6	7481.5144	306.6194	.6	7791.2754	312.9026
.7	7496.8532	306.9336	.7	7806.9284	313.2168
.8	7512.2077	307.2478	.8	7822.5971	313.5309
.9	7527.5780	307.5619	.9	7838.2815	313.8451
			100.0	7853.9816	314.1593

To find from the table areas or circumferences for larger diameters than those given.

CASE I.

For diameters greater than 100 and less than 1001:

Take from the table the area or circumference for a circle the diameter of which is one-tenth of the given diameter.

To obtain the required area or circumference, multiply the area so found by 100 and the circumference so found by 10.

For Example.—What is the area and circumference corresponding to a diameter of 459?

From the tables the area and circumference for diameter 45.9 are 1 654.6847 and 144.1991. Therefore 165 468.47 and 1 441.991 are the area and circumference required.

CASE II.

For diameters greater than 1000:

Divide the given diameter by any convenient factor which will give as a quotient a diameter found in the table, and take from the table the area or circumference for this diameter.

To obtain the required area or circumference multiply the area so found by the square of the factor and the circumference so found by the factor.

For Example.—What is the area and circumference corresponding to a diameter of 1 983?

$1\ 983 \div 3 = 661$. From the tables and Case I the area and circumference for diameter 661 are 343 156.95 and 2 076.593. Therefore $343\ 156.95 \times 9 = 3\ 088\ 412.55 =$ area required, and $2\ 076.593 \times 3 = 6\ 229.779 =$ circumference required.

AREAS AND CIRCUMFERENCES OF CIRCLES.

Diameters $\frac{1}{16}$ to 100.

Diameter.	Area.	Circumference.	Diameter.	Area.	Circumference.
$\frac{1}{16}$.0031	.1963	5	19.6350	15.7080
$\frac{1}{8}$.0123	.3927	$\frac{1}{8}$	20.6290	16.1007
$\frac{1}{4}$.0491	.7854	$\frac{1}{4}$	21.6476	16.4934
$\frac{3}{8}$.1104	1.1781	$\frac{3}{8}$	22.6907	16.8861
$\frac{1}{2}$.1963	1.5708	$\frac{1}{2}$	23.7583	17.2788
$\frac{5}{8}$.3068	1.9635	$\frac{5}{8}$	24.8505	17.6715
$\frac{3}{4}$.4418	2.3562	$\frac{3}{4}$	25.9673	18.0642
$\frac{7}{8}$.6013	2.7489	$\frac{7}{8}$	27.1086	18.4569
1	.7854	3.1416	6	28.2744	18.8496
$\frac{1}{8}$.9940	3.5343	$\frac{1}{8}$	29.4648	19.2423
$\frac{1}{4}$	1.2272	3.9270	$\frac{1}{4}$	30.6797	19.6350
$\frac{3}{8}$	1.4849	4.3197	$\frac{3}{8}$	31.9191	20.0277
$\frac{1}{2}$	1.7671	4.7124	$\frac{1}{2}$	33.1831	20.4204
$\frac{5}{8}$	2.0739	5.1051	$\frac{5}{8}$	34.4717	20.8131
$\frac{3}{4}$	2.4053	5.4978	$\frac{3}{4}$	35.7848	21.2058
$\frac{7}{8}$	2.7612	5.8905	$\frac{7}{8}$	37.1224	21.5985
2	3.1416	6.2832	7	38.4846	21.9912
$\frac{1}{8}$	3.5466	6.6759	$\frac{1}{8}$	39.8713	22.3839
$\frac{1}{4}$	3.9761	7.0686	$\frac{1}{4}$	41.2826	22.7766
$\frac{3}{8}$	4.4301	7.4613	$\frac{3}{8}$	42.7184	23.1693
$\frac{1}{2}$	4.9087	7.8540	$\frac{1}{2}$	44.1787	23.5620
$\frac{5}{8}$	5.4119	8.2467	$\frac{5}{8}$	45.6636	23.9547
$\frac{3}{4}$	5.9396	8.6394	$\frac{3}{4}$	47.1731	24.3474
$\frac{7}{8}$	6.4918	9.0321	$\frac{7}{8}$	48.7071	24.7401
3	7.0686	9.4248	8	50.2656	25.1328
$\frac{1}{8}$	7.6699	9.8175	$\frac{1}{8}$	51.8487	25.5255
$\frac{1}{4}$	8.2958	10.2102	$\frac{1}{4}$	53.4563	25.9182
$\frac{3}{8}$	8.9462	10.6029	$\frac{3}{8}$	55.0884	26.3109
$\frac{1}{2}$	9.6211	10.9956	$\frac{1}{2}$	56.7451	26.7036
$\frac{5}{8}$	10.3206	11.3883	$\frac{5}{8}$	58.4264	27.0963
$\frac{3}{4}$	11.0447	11.7810	$\frac{3}{4}$	60.1322	27.4890
$\frac{7}{8}$	11.7933	12.1737	$\frac{7}{8}$	61.8625	27.8817
4	12.5664	12.5664	9	63.6174	28.2744
$\frac{1}{8}$	13.3641	12.9591	$\frac{1}{8}$	65.3968	28.6671
$\frac{1}{4}$	14.1863	13.3518	$\frac{1}{4}$	67.2008	29.0598
$\frac{3}{8}$	15.0330	13.7445	$\frac{3}{8}$	69.0293	29.4525
$\frac{1}{2}$	15.9043	14.1372	$\frac{1}{2}$	70.8823	29.8452
$\frac{5}{8}$	16.8002	14.5299	$\frac{5}{8}$	72.7599	30.2379
$\frac{3}{4}$	17.7206	14.9226	$\frac{3}{4}$	74.6621	30.6306
$\frac{7}{8}$	18.6655	15.3153	$\frac{7}{8}$	76.5889	31.0233

AREAS AND CIRCUMFERENCES OF CIRCLES.

Diameters $\frac{1}{8}$ to 100.

Diameter.	Area.	Circumference.	Diameter.	Area.	Circumference.
10	78.540	31.4160	15	176.715	47.1240
$\frac{1}{8}$	80.516	31.8087	$\frac{1}{8}$	179.673	47.5167
$\frac{1}{4}$	82.516	32.2014	$\frac{1}{4}$	182.655	47.9094
$\frac{3}{8}$	84.541	32.5941	$\frac{3}{8}$	185.661	48.3021
$\frac{1}{2}$	86.590	32.9868	$\frac{1}{2}$	188.692	48.6948
$\frac{5}{8}$	88.664	33.3795	$\frac{5}{8}$	191.748	49.0875
$\frac{3}{4}$	90.763	33.7722	$\frac{3}{4}$	194.828	49.4802
$\frac{7}{8}$	92.886	34.1649	$\frac{7}{8}$	197.933	49.8729
11	95.033	34.5576	16	201.062	50.2656
$\frac{1}{8}$	97.205	34.9503	$\frac{1}{8}$	204.216	50.6583
$\frac{1}{4}$	99.402	35.3430	$\frac{1}{4}$	207.395	51.0510
$\frac{3}{8}$	101.623	35.7357	$\frac{3}{8}$	210.598	51.4437
$\frac{1}{2}$	103.869	36.1284	$\frac{1}{2}$	213.825	51.8364
$\frac{5}{8}$	106.139	36.5211	$\frac{5}{8}$	217.077	52.2291
$\frac{3}{4}$	108.434	36.9138	$\frac{3}{4}$	220.354	52.6218
$\frac{7}{8}$	110.754	37.3065	$\frac{7}{8}$	223.655	53.0145
12	113.098	37.6992	17	226.981	53.4072
$\frac{1}{8}$	115.466	38.0919	$\frac{1}{8}$	230.331	53.7999
$\frac{1}{4}$	117.859	38.4846	$\frac{1}{4}$	233.706	54.1926
$\frac{3}{8}$	120.277	38.8773	$\frac{3}{8}$	237.105	54.5853
$\frac{1}{2}$	122.719	39.2700	$\frac{1}{2}$	240.529	54.9780
$\frac{5}{8}$	125.185	39.6627	$\frac{5}{8}$	243.977	55.3707
$\frac{3}{4}$	127.677	40.0554	$\frac{3}{4}$	247.450	55.7634
$\frac{7}{8}$	130.192	40.4481	$\frac{7}{8}$	250.948	56.1561
13	132.733	40.8408	18	254.470	56.5488
$\frac{1}{8}$	135.297	41.2335	$\frac{1}{8}$	258.016	56.9415
$\frac{1}{4}$	137.887	41.6262	$\frac{1}{4}$	261.587	57.3342
$\frac{3}{8}$	140.501	42.0189	$\frac{3}{8}$	265.183	57.7269
$\frac{1}{2}$	143.139	42.4116	$\frac{1}{2}$	268.803	58.1196
$\frac{5}{8}$	145.802	42.8043	$\frac{5}{8}$	272.448	58.5123
$\frac{3}{4}$	148.490	43.1970	$\frac{3}{4}$	276.117	58.9050
$\frac{7}{8}$	151.202	43.5897	$\frac{7}{8}$	279.811	59.2977
14	153.938	43.9824	19	283.529	59.6904
$\frac{1}{8}$	156.700	44.3751	$\frac{1}{8}$	287.272	60.0831
$\frac{1}{4}$	159.485	44.7678	$\frac{1}{4}$	291.040	60.4758
$\frac{3}{8}$	162.296	45.1605	$\frac{3}{8}$	294.832	60.8685
$\frac{1}{2}$	165.130	45.5532	$\frac{1}{2}$	298.648	61.2612
$\frac{5}{8}$	167.990	45.9459	$\frac{5}{8}$	302.489	61.6539
$\frac{3}{4}$	170.874	46.3386	$\frac{3}{4}$	306.355	62.0466
$\frac{7}{8}$	173.782	46.7313	$\frac{7}{8}$	310.245	62.4393

AREAS AND CIRCUMFERENCES OF CIRCLES.

Diameters $\frac{1}{8}$ to 100.

Diameter.	Area.	Circumference.	Diameter.	Area.	Circumference.
20	314.160	62.8320	25	490.875	78.5400
$\frac{1}{8}$	318.099	63.2247	$\frac{1}{8}$	495.796	78.9327
$\frac{1}{4}$	322.063	63.6174	$\frac{1}{4}$	500.742	79.3254
$\frac{3}{8}$	326.051	64.0101	$\frac{3}{8}$	505.712	79.7181
$\frac{1}{2}$	330.064	64.4028	$\frac{1}{2}$	510.706	80.1108
$\frac{5}{8}$	334.102	64.7955	$\frac{5}{8}$	515.726	80.5035
$\frac{3}{4}$	338.164	65.1882	$\frac{3}{4}$	520.769	80.8962
$\frac{7}{8}$	342.250	65.5809	$\frac{7}{8}$	525.838	81.2889
21	346.361	65.9736	26	530.930	81.6816
$\frac{1}{8}$	350.497	66.3663	$\frac{1}{8}$	536.048	82.0743
$\frac{1}{4}$	354.657	66.7590	$\frac{1}{4}$	541.190	82.4670
$\frac{3}{8}$	358.842	67.1517	$\frac{3}{8}$	546.356	82.8597
$\frac{1}{2}$	363.051	67.5444	$\frac{1}{2}$	551.547	83.2524
$\frac{5}{8}$	367.285	67.9371	$\frac{5}{8}$	556.763	83.6451
$\frac{3}{4}$	371.543	68.3298	$\frac{3}{4}$	562.003	84.0378
$\frac{7}{8}$	375.826	68.7225	$\frac{7}{8}$	567.267	84.4305
22	380.134	69.1152	27	572.557	84.8232
$\frac{1}{8}$	384.466	69.5079	$\frac{1}{8}$	577.870	85.2159
$\frac{1}{4}$	388.822	69.9006	$\frac{1}{4}$	583.209	85.6086
$\frac{3}{8}$	393.203	70.2933	$\frac{3}{8}$	588.571	86.0013
$\frac{1}{2}$	397.609	70.6860	$\frac{1}{2}$	593.959	86.3940
$\frac{5}{8}$	402.038	71.0787	$\frac{5}{8}$	599.371	86.7867
$\frac{3}{4}$	406.494	71.4714	$\frac{3}{4}$	604.807	87.1794
$\frac{7}{8}$	410.973	71.8641	$\frac{7}{8}$	610.268	87.5721
23	415.477	72.2568	28	615.754	87.9648
$\frac{1}{8}$	420.004	72.6495	$\frac{1}{8}$	621.264	88.3575
$\frac{1}{4}$	424.558	73.0422	$\frac{1}{4}$	626.798	88.7502
$\frac{3}{8}$	429.135	73.4349	$\frac{3}{8}$	632.357	89.1429
$\frac{1}{2}$	433.737	73.8276	$\frac{1}{2}$	637.941	89.5356
$\frac{5}{8}$	438.364	74.2203	$\frac{5}{8}$	643.549	89.9283
$\frac{3}{4}$	443.015	74.6130	$\frac{3}{4}$	649.182	90.3210
$\frac{7}{8}$	447.690	75.0057	$\frac{7}{8}$	654.840	90.7137
24	452.390	75.3984	29	660.521	91.1064
$\frac{1}{8}$	457.115	75.7911	$\frac{1}{8}$	666.228	91.4991
$\frac{1}{4}$	461.864	76.1838	$\frac{1}{4}$	671.959	91.8918
$\frac{3}{8}$	466.638	76.5765	$\frac{3}{8}$	677.714	92.2845
$\frac{1}{2}$	471.436	76.9692	$\frac{1}{2}$	683.494	92.6772
$\frac{5}{8}$	476.259	77.3619	$\frac{5}{8}$	689.299	93.0699
$\frac{3}{4}$	481.107	77.7546	$\frac{3}{4}$	695.128	93.4626
$\frac{7}{8}$	485.979	78.1473	$\frac{7}{8}$	700.982	93.8553

AREAS AND CIRCUMFERENCES OF CIRCLES.

Diameters $\frac{1}{16}$ to 100.

Diameter.	Area.	Circumference.	Diameter.	Area.	Circumference.
30	706.860	94.248	35	962.115	109.956
$\frac{1}{16}$	712.763	94.641	$\frac{1}{16}$	969.000	110.349
$\frac{1}{8}$	718.690	95.033	$\frac{1}{8}$	975.909	110.741
$\frac{3}{16}$	724.642	95.426	$\frac{3}{16}$	982.842	111.134
$\frac{1}{4}$	730.618	95.819	$\frac{1}{4}$	989.800	111.527
$\frac{5}{16}$	736.619	96.212	$\frac{5}{16}$	996.783	111.919
$\frac{3}{8}$	742.645	96.604	$\frac{3}{8}$	1003.790	112.312
$\frac{7}{16}$	748.695	96.997	$\frac{7}{16}$	1010.822	112.705
31	754.769	97.390	36	1017.878	113.098
$\frac{1}{8}$	760.869	97.782	$\frac{1}{8}$	1024.960	113.490
$\frac{1}{4}$	766.992	98.175	$\frac{1}{4}$	1032.065	113.883
$\frac{3}{8}$	773.140	98.568	$\frac{3}{8}$	1039.195	114.276
$\frac{1}{2}$	779.313	98.960	$\frac{1}{2}$	1046.349	114.668
$\frac{5}{8}$	785.510	99.353	$\frac{5}{8}$	1053.528	115.061
$\frac{3}{4}$	791.732	99.746	$\frac{3}{4}$	1060.732	115.454
$\frac{7}{8}$	797.979	100.138	$\frac{7}{8}$	1067.960	115.846
32	804.250	100.531	37	1075.213	116.239
$\frac{1}{8}$	810.545	100.924	$\frac{1}{8}$	1082.490	116.632
$\frac{1}{4}$	816.865	101.317	$\frac{1}{4}$	1089.792	117.025
$\frac{3}{8}$	823.210	101.709	$\frac{3}{8}$	1097.118	117.417
$\frac{1}{2}$	829.579	102.102	$\frac{1}{2}$	1104.469	117.810
$\frac{5}{8}$	835.972	102.495	$\frac{5}{8}$	1111.844	118.203
$\frac{3}{4}$	842.391	102.887	$\frac{3}{4}$	1119.244	118.595
$\frac{7}{8}$	848.833	103.280	$\frac{7}{8}$	1126.669	118.988
33	855.301	103.673	38	1134.118	119.381
$\frac{1}{8}$	861.792	104.065	$\frac{1}{8}$	1141.591	119.773
$\frac{1}{4}$	868.309	104.458	$\frac{1}{4}$	1149.089	120.166
$\frac{3}{8}$	874.850	104.851	$\frac{3}{8}$	1156.612	120.559
$\frac{1}{2}$	881.415	105.244	$\frac{1}{2}$	1164.159	120.952
$\frac{5}{8}$	888.005	105.636	$\frac{5}{8}$	1171.731	121.344
$\frac{3}{4}$	894.620	106.029	$\frac{3}{4}$	1179.327	121.737
$\frac{7}{8}$	901.259	106.422	$\frac{7}{8}$	1186.948	122.130
34	907.922	106.814	39	1194.593	122.522
$\frac{1}{8}$	914.611	107.207	$\frac{1}{8}$	1202.263	122.915
$\frac{1}{4}$	921.323	107.600	$\frac{1}{4}$	1209.958	123.308
$\frac{3}{8}$	928.061	107.992	$\frac{3}{8}$	1217.677	123.700
$\frac{1}{2}$	934.822	108.385	$\frac{1}{2}$	1225.420	124.093
$\frac{5}{8}$	941.609	108.778	$\frac{5}{8}$	1233.188	124.486
$\frac{3}{4}$	948.420	109.171	$\frac{3}{4}$	1240.981	124.879
$\frac{7}{8}$	955.255	109.563	$\frac{7}{8}$	1248.798	125.271

AREAS AND CIRCUMFERENCES OF CIRCLES.

Diameters $\frac{1}{16}$ to 100.

Diameter.	Area.	Circumference.	Diameter.	Area.	Circumference.
40	1256.64	125.664	45	1590.43	141.372
$\frac{1}{16}$	1264.51	126.057	$\frac{1}{8}$	1599.28	141.765
$\frac{1}{8}$	1272.40	126.449	$\frac{3}{16}$	1608.16	142.157
$\frac{3}{16}$	1280.31	126.842	$\frac{1}{4}$	1617.05	142.550
$\frac{1}{2}$	1288.25	127.235	$\frac{5}{16}$	1625.97	142.943
$\frac{5}{8}$	1296.22	127.627	$\frac{3}{8}$	1634.92	143.335
$\frac{7}{8}$	1304.21	128.020	$\frac{7}{8}$	1643.89	143.728
	1312.22	128.413		1652.89	144.121
41	1320.26	128.806	46	1661.91	144.514
$\frac{1}{8}$	1328.32	129.198	$\frac{1}{8}$	1670.95	144.906
$\frac{1}{4}$	1336.41	129.591	$\frac{1}{4}$	1680.02	145.299
$\frac{3}{8}$	1344.52	129.984	$\frac{3}{8}$	1689.11	145.692
$\frac{1}{2}$	1352.66	130.376	$\frac{1}{2}$	1698.23	146.084
$\frac{5}{8}$	1360.82	130.769	$\frac{5}{8}$	1707.37	146.477
$\frac{7}{8}$	1369.00	131.162	$\frac{7}{8}$	1716.54	146.870
	1377.21	131.554		1725.73	147.262
42	1385.45	131.947	47	1734.95	147.655
$\frac{1}{8}$	1393.70	132.340	$\frac{1}{8}$	1744.19	148.048
$\frac{1}{4}$	1401.99	132.733	$\frac{1}{4}$	1753.45	148.441
$\frac{3}{8}$	1410.30	133.125	$\frac{3}{8}$	1762.74	148.833
$\frac{1}{2}$	1418.63	133.518	$\frac{1}{2}$	1772.06	149.226
$\frac{5}{8}$	1426.99	133.911	$\frac{5}{8}$	1781.40	149.619
$\frac{7}{8}$	1435.37	134.303	$\frac{7}{8}$	1790.76	150.011
	1443.77	134.696		1800.15	150.404
43	1452.20	135.089	48	1809.56	150.797
$\frac{1}{8}$	1460.66	135.481	$\frac{1}{8}$	1819.00	151.189
$\frac{1}{4}$	1469.14	135.874	$\frac{1}{4}$	1828.46	151.582
$\frac{3}{8}$	1477.64	136.267	$\frac{3}{8}$	1837.95	151.975
$\frac{1}{2}$	1486.17	136.660	$\frac{1}{2}$	1847.46	152.368
$\frac{5}{8}$	1494.73	137.052	$\frac{5}{8}$	1856.99	152.760
$\frac{7}{8}$	1503.30	137.445	$\frac{7}{8}$	1866.55	153.153
	1511.91	137.838		1876.14	153.546
44	1520.53	138.230	49	1885.75	153.938
$\frac{1}{8}$	1529.19	138.623	$\frac{1}{8}$	1895.38	154.331
$\frac{1}{4}$	1537.86	139.016	$\frac{1}{4}$	1905.04	154.724
$\frac{3}{8}$	1546.56	139.408	$\frac{3}{8}$	1914.72	155.116
$\frac{1}{2}$	1555.29	139.801	$\frac{1}{2}$	1924.43	155.509
$\frac{5}{8}$	1564.04	140.194	$\frac{5}{8}$	1934.16	155.902
$\frac{7}{8}$	1572.81	140.587	$\frac{7}{8}$	1943.91	156.295
	1581.61	140.979		1953.69	156.687

AREAS AND CIRCUMFERENCES OF CIRCLES.

Diameters $\frac{1}{16}$ to 100.

Diameter.	Area.	Circumference.	Diameter.	Area.	Circumference.
50	1963.50	157.080	55	2375.83	172.788
$\frac{1}{8}$	1973.33	157.473	$\frac{1}{8}$	2386.65	173.181
$\frac{1}{4}$	1983.18	157.865	$\frac{1}{4}$	2397.48	173.573
$\frac{3}{8}$	1993.06	158.258	$\frac{3}{8}$	2408.34	173.966
$\frac{1}{2}$	2002.97	158.651	$\frac{1}{2}$	2419.23	174.359
$\frac{5}{8}$	2012.89	159.043	$\frac{5}{8}$	2430.14	174.751
$\frac{3}{4}$	2022.85	159.436	$\frac{3}{4}$	2441.07	175.144
$\frac{7}{8}$	2032.82	159.829	$\frac{7}{8}$	2452.03	175.537
51	2042.83	160.222	56	2463.01	175.930
$\frac{1}{8}$	2052.85	160.614	$\frac{1}{8}$	2474.02	176.322
$\frac{1}{4}$	2062.90	161.007	$\frac{1}{4}$	2485.05	176.715
$\frac{3}{8}$	2072.98	161.400	$\frac{3}{8}$	2496.11	177.108
$\frac{1}{2}$	2083.08	161.792	$\frac{1}{2}$	2507.19	177.500
$\frac{5}{8}$	2093.20	162.185	$\frac{5}{8}$	2518.30	177.893
$\frac{3}{4}$	2103.35	162.578	$\frac{3}{4}$	2529.43	178.286
$\frac{7}{8}$	2113.52	162.970	$\frac{7}{8}$	2540.58	178.678
52	2123.72	163.363	57	2551.76	179.071
$\frac{1}{8}$	2133.94	163.756	$\frac{1}{8}$	2562.97	179.464
$\frac{1}{4}$	2144.19	164.149	$\frac{1}{4}$	2574.20	179.857
$\frac{3}{8}$	2154.46	164.541	$\frac{3}{8}$	2585.45	180.249
$\frac{1}{2}$	2164.76	164.934	$\frac{1}{2}$	2596.73	180.642
$\frac{5}{8}$	2175.08	165.327	$\frac{5}{8}$	2608.03	181.035
$\frac{3}{4}$	2185.42	165.719	$\frac{3}{4}$	2619.36	181.427
$\frac{7}{8}$	2195.79	166.112	$\frac{7}{8}$	2630.71	181.820
53	2206.19	166.505	58	2642.09	182.213
$\frac{1}{8}$	2216.61	166.897	$\frac{1}{8}$	2653.49	182.605
$\frac{1}{4}$	2227.05	167.290	$\frac{1}{4}$	2664.91	182.998
$\frac{3}{8}$	2237.52	167.683	$\frac{3}{8}$	2676.36	183.391
$\frac{1}{2}$	2248.01	168.076	$\frac{1}{2}$	2687.84	183.784
$\frac{5}{8}$	2258.53	168.468	$\frac{5}{8}$	2699.33	184.176
$\frac{3}{4}$	2269.07	168.861	$\frac{3}{4}$	2710.86	184.569
$\frac{7}{8}$	2279.64	169.254	$\frac{7}{8}$	2722.41	184.962
54	2290.23	169.646	59	2733.98	185.354
$\frac{1}{8}$	2300.84	170.039	$\frac{1}{8}$	2745.57	185.747
$\frac{1}{4}$	2311.48	170.432	$\frac{1}{4}$	2757.20	186.140
$\frac{3}{8}$	2322.15	170.824	$\frac{3}{8}$	2768.84	186.532
$\frac{1}{2}$	2332.83	171.217	$\frac{1}{2}$	2780.51	186.925
$\frac{5}{8}$	2343.55	171.610	$\frac{5}{8}$	2792.21	187.318
$\frac{3}{4}$	2354.29	172.003	$\frac{3}{4}$	2803.93	187.711
$\frac{7}{8}$	2365.05	172.395	$\frac{7}{8}$	2815.67	188.103

AREAS AND CIRCUMFERENCES OF CIRCLES.

Diameters $\frac{1}{8}$ to 100.

Diameter.	Area.	Circumference.	Diameter.	Area.	Circumference.
60	2827.44	188.496	65	3318.31	204.204
$\frac{1}{8}$	2839.23	188.889	$\frac{1}{8}$	3331.09	204.597
$\frac{1}{4}$	2851.05	189.281	$\frac{1}{4}$	3343.89	204.989
$\frac{3}{8}$	2862.89	189.674	$\frac{3}{8}$	3356.71	205.382
$\frac{1}{2}$	2874.76	190.067	$\frac{1}{2}$	3369.56	205.775
$\frac{5}{8}$	2886.65	190.459	$\frac{5}{8}$	3382.44	206.167
$\frac{3}{4}$	2898.57	190.852	$\frac{3}{4}$	3395.33	206.560
$\frac{7}{8}$	2910.51	191.245	$\frac{7}{8}$	3408.26	206.953
61	2922.47	191.638	66	3421.20	207.346
$\frac{1}{8}$	2934.46	192.030	$\frac{1}{8}$	3434.17	207.738
$\frac{1}{4}$	2946.48	192.423	$\frac{1}{4}$	3447.17	208.131
$\frac{3}{8}$	2958.52	192.816	$\frac{3}{8}$	3460.19	208.524
$\frac{1}{2}$	2970.58	193.208	$\frac{1}{2}$	3473.24	208.916
$\frac{5}{8}$	2982.67	193.601	$\frac{5}{8}$	3486.30	209.309
$\frac{3}{4}$	2994.78	193.994	$\frac{3}{4}$	3499.40	209.702
$\frac{7}{8}$	3006.92	194.386	$\frac{7}{8}$	3512.52	210.094
62	3019.08	194.779	67	3525.66	210.487
$\frac{1}{8}$	3031.26	195.172	$\frac{1}{8}$	3538.83	210.880
$\frac{1}{4}$	3043.47	195.565	$\frac{1}{4}$	3552.02	211.273
$\frac{3}{8}$	3055.71	195.957	$\frac{3}{8}$	3565.24	211.665
$\frac{1}{2}$	3067.97	196.350	$\frac{1}{2}$	3578.48	212.058
$\frac{5}{8}$	3080.25	196.743	$\frac{5}{8}$	3591.74	212.451
$\frac{3}{4}$	3092.56	197.135	$\frac{3}{4}$	3605.04	212.843
$\frac{7}{8}$	3104.89	197.528	$\frac{7}{8}$	3618.35	213.236
63	3117.25	197.921	68	3631.69	213.629
$\frac{1}{8}$	3129.64	198.313	$\frac{1}{8}$	3645.05	214.021
$\frac{1}{4}$	3142.04	198.706	$\frac{1}{4}$	3658.44	214.414
$\frac{3}{8}$	3154.47	199.099	$\frac{3}{8}$	3671.86	214.807
$\frac{1}{2}$	3166.93	199.492	$\frac{1}{2}$	3685.29	215.200
$\frac{5}{8}$	3179.41	199.884	$\frac{5}{8}$	3698.76	215.592
$\frac{3}{4}$	3191.91	200.277	$\frac{3}{4}$	3712.24	215.985
$\frac{7}{8}$	3204.44	200.670	$\frac{7}{8}$	3725.75	216.378
64	3217.00	201.062	69	3739.29	216.770
$\frac{1}{8}$	3229.58	201.455	$\frac{1}{8}$	3752.85	217.163
$\frac{1}{4}$	3242.18	201.848	$\frac{1}{4}$	3766.43	217.556
$\frac{3}{8}$	3254.81	202.240	$\frac{3}{8}$	3780.04	217.948
$\frac{1}{2}$	3267.46	202.633	$\frac{1}{2}$	3793.68	218.341
$\frac{5}{8}$	3280.14	203.026	$\frac{5}{8}$	3807.34	218.734
$\frac{3}{4}$	3292.84	203.419	$\frac{3}{4}$	3821.02	219.127
$\frac{7}{8}$	3305.56	203.811	$\frac{7}{8}$	3834.73	219.519

AREAS AND CIRCUMFERENCES OF CIRCLES.

Diameters $\frac{1}{16}$ to 100.

Diameter.	Area.	Circumference.	Diameter.	Area.	Circumference.
70	3848.46	219.912	75	4417.87	235.620
$\frac{1}{16}$	3862.22	220.305	$\frac{1}{8}$	4432.61	236.013
$\frac{1}{8}$	3876.00	220.697	$\frac{3}{16}$	4447.38	236.405
$\frac{1}{4}$	3889.80	221.090	$\frac{1}{2}$	4462.16	236.798
$\frac{3}{8}$	3903.63	221.483	$\frac{5}{8}$	4476.98	237.191
$\frac{1}{2}$	3917.49	221.875	$\frac{3}{4}$	4491.81	237.583
$\frac{5}{8}$	3931.37	222.268	$\frac{7}{8}$	4506.67	237.976
$\frac{3}{4}$	3945.27	222.661	$\frac{15}{16}$	4521.56	238.369
71	3959.20	223.054	76	4536.47	238.762
$\frac{1}{16}$	3973.15	223.446	$\frac{1}{8}$	4551.41	239.154
$\frac{1}{8}$	3987.13	223.839	$\frac{3}{16}$	4566.36	239.547
$\frac{1}{4}$	4001.13	224.232	$\frac{1}{2}$	4581.35	239.940
$\frac{3}{8}$	4015.16	224.624	$\frac{5}{8}$	4596.36	240.332
$\frac{1}{2}$	4029.21	225.017	$\frac{3}{4}$	4611.39	240.725
$\frac{5}{8}$	4043.29	225.410	$\frac{7}{8}$	4626.45	241.118
$\frac{3}{4}$	4057.39	225.802	$\frac{15}{16}$	4641.53	241.510
72	4071.51	226.195	77	4656.64	241.903
$\frac{1}{16}$	4085.66	226.588	$\frac{1}{8}$	4671.77	242.296
$\frac{1}{8}$	4099.84	226.981	$\frac{3}{16}$	4686.92	242.689
$\frac{1}{4}$	4114.04	227.373	$\frac{1}{2}$	4702.10	243.081
$\frac{3}{8}$	4128.26	227.766	$\frac{5}{8}$	4717.31	243.474
$\frac{1}{2}$	4142.51	228.159	$\frac{3}{4}$	4732.54	243.867
$\frac{5}{8}$	4156.78	228.551	$\frac{7}{8}$	4747.79	244.259
$\frac{3}{4}$	4171.08	228.944	$\frac{15}{16}$	4763.07	244.652
73	4185.40	229.337	78	4778.37	245.045
$\frac{1}{16}$	4199.74	229.729	$\frac{1}{8}$	4793.70	245.437
$\frac{1}{8}$	4214.11	230.122	$\frac{3}{16}$	4809.05	245.830
$\frac{1}{4}$	4228.51	230.515	$\frac{1}{2}$	4824.43	246.223
$\frac{3}{8}$	4242.93	230.908	$\frac{5}{8}$	4839.83	246.616
$\frac{1}{2}$	4257.37	231.300	$\frac{3}{4}$	4855.26	247.008
$\frac{5}{8}$	4271.84	231.693	$\frac{7}{8}$	4870.71	247.401
$\frac{3}{4}$	4286.33	232.086	$\frac{15}{16}$	4886.18	247.794
74	4300.85	232.478	79	4901.68	248.186
$\frac{1}{16}$	4315.39	232.871	$\frac{1}{8}$	4917.21	248.579
$\frac{1}{8}$	4329.96	233.264	$\frac{3}{16}$	4932.75	248.972
$\frac{1}{4}$	4344.55	233.656	$\frac{1}{2}$	4948.33	249.364
$\frac{3}{8}$	4359.17	234.049	$\frac{5}{8}$	4963.92	249.757
$\frac{1}{2}$	4373.81	234.442	$\frac{3}{4}$	4979.55	250.150
$\frac{5}{8}$	4388.47	234.835	$\frac{7}{8}$	4995.19	250.543
$\frac{3}{4}$	4403.16	235.227	$\frac{15}{16}$	5010.86	250.935

AREAS AND CIRCUMFERENCES OF CIRCLES.

Diameters $\frac{1}{8}$ to 100.

Diameter.	Area.	Circumference.	Diameter.	Area.	Circumference.
80	5026.56	251.328	85	5674.51	267.036
$\frac{1}{8}$	5042.28	251.721	$\frac{1}{8}$	5691.22	267.429
$\frac{1}{4}$	5058.03	252.113	$\frac{1}{4}$	5707.94	267.821
$\frac{3}{8}$	5073.79	252.506	$\frac{3}{8}$	5724.69	268.214
$\frac{1}{2}$	5089.59	252.899	$\frac{1}{2}$	5741.47	268.607
$\frac{5}{8}$	5105.41	253.291	$\frac{5}{8}$	5758.27	268.999
$\frac{3}{4}$	5121.25	253.684	$\frac{3}{4}$	5775.10	269.392
$\frac{7}{8}$	5137.12	254.077	$\frac{7}{8}$	5791.94	269.785
81	5153.01	254.470	86	5808.82	270.178
$\frac{1}{8}$	5168.93	254.862	$\frac{1}{8}$	5825.72	270.570
$\frac{1}{4}$	5184.87	255.255	$\frac{1}{4}$	5842.64	270.963
$\frac{3}{8}$	5200.83	255.648	$\frac{3}{8}$	5859.59	271.356
$\frac{1}{2}$	5216.82	256.040	$\frac{1}{2}$	5876.56	271.748
$\frac{5}{8}$	5232.84	256.433	$\frac{5}{8}$	5893.55	272.141
$\frac{3}{4}$	5248.88	256.826	$\frac{3}{4}$	5910.58	272.534
$\frac{7}{8}$	5264.94	257.218	$\frac{7}{8}$	5927.62	272.926
82	5281.03	257.611	87	5944.69	273.319
$\frac{1}{8}$	5297.14	258.004	$\frac{1}{8}$	5961.79	273.712
$\frac{1}{4}$	5313.28	258.397	$\frac{1}{4}$	5978.91	274.105
$\frac{3}{8}$	5329.44	258.789	$\frac{3}{8}$	5996.05	274.497
$\frac{1}{2}$	5345.63	259.182	$\frac{1}{2}$	6013.22	274.890
$\frac{5}{8}$	5361.84	259.575	$\frac{5}{8}$	6030.41	275.283
$\frac{3}{4}$	5378.08	259.967	$\frac{3}{4}$	6047.63	275.675
$\frac{7}{8}$	5394.34	260.360	$\frac{7}{8}$	6064.87	276.068
83	5410.62	260.753	88	6082.14	276.461
$\frac{1}{8}$	5426.93	261.145	$\frac{1}{8}$	6099.43	276.853
$\frac{1}{4}$	5443.26	261.538	$\frac{1}{4}$	6116.74	277.246
$\frac{3}{8}$	5459.62	261.931	$\frac{3}{8}$	6134.08	277.638
$\frac{1}{2}$	5476.01	262.324	$\frac{1}{2}$	6151.45	278.032
$\frac{5}{8}$	5492.41	262.716	$\frac{5}{8}$	6168.84	278.424
$\frac{3}{4}$	5508.84	263.109	$\frac{3}{4}$	6186.25	278.817
$\frac{7}{8}$	5525.30	263.502	$\frac{7}{8}$	6203.69	279.210
84	5541.78	263.894	89	6221.15	279.602
$\frac{1}{8}$	5558.29	264.287	$\frac{1}{8}$	6238.64	279.995
$\frac{1}{4}$	5574.82	264.680	$\frac{1}{4}$	6256.15	280.388
$\frac{3}{8}$	5591.37	265.072	$\frac{3}{8}$	6273.69	280.780
$\frac{1}{2}$	5607.95	265.465	$\frac{1}{2}$	6291.25	281.173
$\frac{5}{8}$	5624.56	265.858	$\frac{5}{8}$	6308.84	281.566
$\frac{3}{4}$	5641.18	266.251	$\frac{3}{4}$	6326.45	281.959
$\frac{7}{8}$	5657.84	266.643	$\frac{7}{8}$	6344.08	282.351

AREAS AND CIRCUMFERENCES OF CIRCLES.

Diameters $\frac{1}{8}$ to 100.

Diameter.	Area.	Circumference.	Diameter.	Area.	Circumference.
90	6361.74	282.744	95	7088.24	298.452
$\frac{1}{8}$	6379.42	283.137	$\frac{1}{8}$	7106.90	298.845
$\frac{1}{4}$	6397.13	283.529	$\frac{1}{4}$	7125.59	299.237
$\frac{3}{8}$	6414.86	283.922	$\frac{3}{8}$	7144.31	299.630
$\frac{1}{2}$	6432.62	284.315	$\frac{1}{2}$	7163.04	300.023
$\frac{5}{8}$	6450.40	284.707	$\frac{5}{8}$	7181.81	300.415
$\frac{3}{4}$	6468.21	285.100	$\frac{3}{4}$	7200.60	300.808
$\frac{7}{8}$	6486.04	285.493	$\frac{7}{8}$	7219.41	301.201
91	6503.90	285.886	96	7238.25	301.594
$\frac{1}{8}$	6521.78	286.278	$\frac{1}{8}$	7257.11	301.986
$\frac{1}{4}$	6539.68	286.671	$\frac{1}{4}$	7275.99	302.379
$\frac{3}{8}$	6557.61	287.064	$\frac{3}{8}$	7294.91	302.772
$\frac{1}{2}$	6575.56	287.456	$\frac{1}{2}$	7313.84	303.164
$\frac{5}{8}$	6593.54	287.849	$\frac{5}{8}$	7332.80	303.557
$\frac{3}{4}$	6611.55	288.242	$\frac{3}{4}$	7351.79	303.950
$\frac{7}{8}$	6629.57	288.634	$\frac{7}{8}$	7370.79	304.342
92	6647.63	289.027	97	7389.83	304.735
$\frac{1}{8}$	6665.70	289.420	$\frac{1}{8}$	7408.89	305.128
$\frac{1}{4}$	6683.80	289.813	$\frac{1}{4}$	7427.97	305.521
$\frac{3}{8}$	6701.93	290.205	$\frac{3}{8}$	7447.08	305.913
$\frac{1}{2}$	6720.08	290.598	$\frac{1}{2}$	7466.21	306.306
$\frac{5}{8}$	6738.25	290.991	$\frac{5}{8}$	7485.37	306.699
$\frac{3}{4}$	6756.45	291.383	$\frac{3}{4}$	7504.55	307.091
$\frac{7}{8}$	6774.68	291.776	$\frac{7}{8}$	7523.75	307.484
93	6792.92	292.169	98	7542.98	307.877
$\frac{1}{8}$	6811.20	292.562	$\frac{1}{8}$	7562.24	308.270
$\frac{1}{4}$	6829.49	292.954	$\frac{1}{4}$	7581.52	308.662
$\frac{3}{8}$	6847.82	293.347	$\frac{3}{8}$	7600.82	309.055
$\frac{1}{2}$	6866.16	293.740	$\frac{1}{2}$	7620.15	309.448
$\frac{5}{8}$	6884.53	294.132	$\frac{5}{8}$	7639.50	309.840
$\frac{3}{4}$	6902.93	294.525	$\frac{3}{4}$	7658.88	310.233
$\frac{7}{8}$	6921.35	294.918	$\frac{7}{8}$	7678.28	310.626
94	6939.79	295.310	99	7697.71	311.018
$\frac{1}{8}$	6958.26	295.703	$\frac{1}{8}$	7717.16	311.411
$\frac{1}{4}$	6976.76	296.096	$\frac{1}{4}$	7736.63	311.804
$\frac{3}{8}$	6995.28	296.488	$\frac{3}{8}$	7756.13	312.196
$\frac{1}{2}$	7013.82	296.881	$\frac{1}{2}$	7775.66	312.589
$\frac{5}{8}$	7032.39	297.274	$\frac{5}{8}$	7795.21	312.982
$\frac{3}{4}$	7050.98	297.667	$\frac{3}{4}$	7814.78	313.375
$\frac{7}{8}$	7069.59	298.059	$\frac{7}{8}$	7834.38	313.767
			100	7854.00	314.160

LOGARITHMS OF NUMBERS, FROM 0 TO 1000.

No.	0	1	2	3	4	5	6	7	8	9
0	0	00000	30103	47712	60206	69897	77815	84510	90309	95424
10	00000	00432	00860	01284	01703	02119	02531	02938	03342	03743
11	04139	04532	04922	05308	05690	06070	06446	06819	07188	07555
12	07918	08279	08636	08991	09342	09691	10037	10380	10721	11059
13	11394	11727	12057	12385	12710	13033	13354	13672	13988	14301
14	14613	14922	15229	15534	15836	16137	16435	16732	17026	17319
15	17609	17898	18184	18469	18752	19033	19312	19590	19866	20140
16	20412	20683	20952	21219	21484	21748	22011	22272	22531	22789
17	23045	23300	23553	23805	24055	24304	24551	24797	25042	25285
18	25527	25768	26007	26245	26482	26717	26951	27184	27416	27646
19	27875	28103	28330	28556	28780	29003	29226	29447	29667	29885
20	30103	30320	30535	30750	30963	31175	31387	31597	31806	32015
21	32222	32428	32634	32838	33041	33244	33445	33646	33846	34044
22	34242	34439	34635	34830	35025	35218	35411	35603	35793	35984
23	36173	36361	36549	36736	36922	37107	37291	37475	37658	37840
24	38021	38202	38382	38561	38739	38917	39094	39270	39445	39620
25	39794	39967	40140	40312	40483	40654	40824	40993	41162	41330
26	41497	41664	41830	41996	42160	42325	42488	42651	42813	42975
27	43136	43297	43457	43616	43775	43933	44091	44248	44404	44560
28	44716	44871	45025	45179	45332	45484	45637	45788	45939	46090
29	46240	46389	46538	46687	46835	46982	47129	47276	47422	47567
30	47712	47857	48001	48144	48287	48430	48572	48714	48855	48996
31	49136	49276	49415	49554	49693	49831	49969	50106	50243	50379
32	50515	50651	50786	50920	51055	51188	51322	51455	51587	51720
33	51851	51983	52114	52244	52375	52504	52634	52763	52892	53020
34	53148	53275	53403	53529	53656	53782	53908	54033	54158	54283
35	54407	54531	54654	54777	54900	55023	55145	55267	55388	55509
36	55630	55751	55871	55991	56110	56229	56348	56467	56585	56703
37	56820	56937	57054	57171	57287	57403	57519	57634	57749	57864
38	57978	58093	58206	58320	58433	58546	58659	58771	58883	58995
39	59106	59218	59329	59439	59550	59660	59770	59879	59988	60097
40	60206	60314	60423	60531	60638	60746	60853	60959	61066	61172
41	61278	61384	61490	61595	61700	61805	61909	62014	62118	62221
42	62325	62428	62531	62634	62737	62839	62941	63043	63144	63246
43	63347	63448	63548	63649	63749	63849	63949	64048	64147	64246
44	64345	64444	64542	64640	64738	64836	64933	65031	65128	65225
45	65321	65418	65514	65610	65706	65801	65896	65992	66087	66181
46	66276	66370	66464	66558	66652	66745	66839	66932	67025	67117
47	67210	67302	67394	67486	67578	67669	67761	67852	67943	68034
48	68124	68215	68305	68395	68485	68574	68664	68753	68842	68931
49	69020	69108	69197	69285	69373	69461	69548	69636	69723	69810
50	69897	69984	70070	70157	70243	70329	70415	70501	70586	70672
51	70757	70842	70927	71012	71096	71181	71265	71349	71433	71517
52	71600	71684	71767	71850	71933	72016	72099	72181	72263	72346
53	72428	72509	72591	72673	72754	72835	72916	72997	73078	73159
54	73239	73320	73400	73480	73560	73640	73719	73799	73878	73957

LOGARITHMS OF NUMBERS, FROM 0 TO 1000

(CONTINUED.)

No.	0	1	2	3	4	5	6	7	8	9
55	74036	74115	74194	74273	74351	74429	74507	74586	74663	74741
56	74819	74896	74974	75051	75128	75205	75282	75358	75435	75511
57	75587	75664	75740	75815	75891	75967	76042	76118	76193	76268
58	76343	76418	76492	76567	76641	76716	76790	76864	76938	77012
59	77085	77159	77232	77305	77379	77452	77525	77597	77670	77743
60	77815	77887	77960	78032	78104	78176	78247	78319	78390	78462
61	78533	78604	78675	78746	78817	78888	78958	79029	79099	79169
62	79239	79309	79379	79449	79518	79588	79657	79727	79796	79865
63	79934	80003	80072	80140	80209	80277	80346	80414	80482	80550
64	80618	80686	80754	80821	80889	80956	81023	81090	81158	81224
65	81291	81358	81425	81491	81558	81624	81690	81757	81823	81889
66	81954	82020	82086	82151	82217	82282	82347	82413	82478	82543
67	82607	82672	82737	82802	82866	82930	82995	83059	83123	83187
68	83251	83315	83378	83442	83506	83569	83632	83696	83759	83822
69	83885	83948	84011	84073	84136	84198	84261	84323	84386	84448
70	84510	84572	84634	84696	84757	84819	84880	84942	85003	85065
71	85126	85187	85248	85309	85370	85431	85491	85552	85612	85673
72	85733	85794	85854	85914	85974	86034	86094	86153	86213	86273
73	86332	86392	86451	86510	86570	86629	86688	86747	86806	86864
74	86923	86982	87040	87099	87157	87216	87274	87332	87390	87448
75	87506	87564	87622	87680	87737	87795	87852	87910	87967	88024
76	88081	88138	88196	88252	88309	88366	88423	88480	88536	88593
77	88649	88705	88762	88818	88874	88930	88986	89042	89098	89154
78	89209	89265	89321	89376	89432	89487	89542	89597	89653	89708
79	89763	89818	89873	89927	89982	90037	90091	90146	90200	90255
80	90309	90363	90417	90472	90526	90580	90634	90687	90741	90795
81	90849	90902	90956	91009	91062	91116	91169	91222	91275	91328
82	91381	91434	91487	91540	91593	91645	91698	91751	91803	91855
83	91908	91960	92012	92065	92117	92169	92221	92273	92324	92376
84	92428	92480	92531	92583	92634	92686	92737	92788	92840	92891
85	92942	92993	93044	93095	93146	93197	93247	93298	93349	93399
86	93450	93500	93551	93601	93651	93702	93752	93802	93852	93902
87	93952	94002	94052	94101	94151	94201	94250	94300	94349	94399
88	94448	94498	94547	94596	94645	94694	94743	94792	94841	94890
89	94939	94988	95036	95085	95134	95182	95231	95279	95328	95376
90	95424	95472	95521	95569	95617	95665	95713	95761	95809	95856
91	95904	95952	95999	96047	96095	96142	96190	96237	96284	96332
92	96379	96426	96473	96520	96567	96614	96661	96708	96755	96802
93	96848	96895	96942	96988	97035	97081	97128	97174	97220	97267
94	97313	97359	97405	97451	97497	97543	97589	97635	97681	97727
95	97772	97818	97864	97909	97955	98000	98046	98091	98137	98182
96	98227	98272	98318	98363	98408	98453	98498	98543	98588	98632
97	98677	98722	98767	98811	98856	98900	98945	98989	99034	99078
98	99123	99167	99211	99255	99300	99344	99388	99432	99476	99520
99	99564	99607	99651	99695	99739	99782	99826	99870	99913	99957

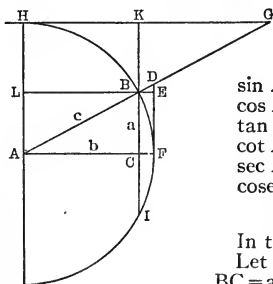
TRIGONOMETRIC FORMULAE.**TRIGONOMETRIC FUNCTIONS.**

Let $A = \text{angle } BAC = \text{arc } BF$.
Let radius $AF = AB = AH = 1$.

Then

$\sin A = BC$	$\text{versin } A = CF = BE$
$\cos A = AC$	$\text{covers } A = BK = HL$
$\tan A = DF$	$\text{exsec } A = BD$
$\cot A = HG$	$\text{coexsec } A = BG$
$\sec A = AD$	$\text{chord } A = BF$
$\text{cosec } A = AG$	$\text{chord } 2A = BI = 2BC$

RIGHT-ANGLED TRIANGLES.

In the right-angled triangle ABC ,

Let side $AB = c$, side $AC = b$, and side $BC = a$; let angle $ABC = B$.

Then

$$\sin A = \frac{a}{c} = \cos B \qquad a = c \sin A = b \tan A$$

$$\cos A = \frac{b}{c} = \sin B \qquad b = c \cos A = a \cot A$$

$$\tan A = \frac{a}{b} = \cot B \qquad c = \frac{a}{\sin A} = \frac{b}{\cos A}$$

$$\cot A = \frac{b}{a} = \tan B \qquad a = c \cos B = b \cot B$$

$$\sec A = \frac{c}{b} = \text{cosec } B \qquad b = c \sin B = a \tan B$$

$$\text{cosec } A = \frac{c}{a} = \sec B \qquad c = \frac{a}{\cos B} = \frac{b}{\sin B}$$

$$\text{vers } A = \frac{c-b}{c} = \text{covers } B \qquad a = \sqrt{(c+b)(c-b)}$$

$$\text{exsec } A = \frac{c-b}{b} = \text{coexsec } B \qquad b = \sqrt{(c+a)(c-a)}$$

$$\text{covers } A = \frac{c-a}{c} = \text{versin } B \qquad c = \sqrt{a^2 + b^2}$$

$$\text{coexsec } A = \frac{c-a}{a} = \text{exsec } B \qquad C = 90^\circ = A + B$$

$$\text{Area} = \frac{ab}{2} = \frac{a}{2} \sqrt{c^2 - a^2} = \frac{a^2 \cot A}{2} = \frac{b^2 \tan A}{2} = \frac{c^2 \sin 2A}{4}$$

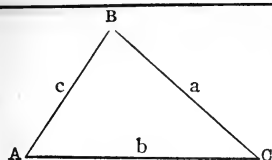

TRIGONOMETRIC FORMULÆ

(Continued).

OBLIQUE TRIANGLES.

$$s = \frac{1}{2} (a + b + c)$$

KNOWN	REQUIRED	FORMULÆ
A, B, a	C, b c	$C = 180^\circ - (A + B), \quad b = \frac{a}{\sin A} \cdot \sin B,$ $c = \frac{a}{\sin A} \sin (A + B)$
A, a, b	B, C c	$\sin B = \frac{\sin A}{a} \cdot b, \quad C = 180^\circ - (A + B),$ $c = \frac{a}{\sin A} \cdot \sin C$
C, a, b	$\frac{1}{2} (A + B)$ $\frac{1}{2} (A - B)$ A, B c	$\frac{1}{2} (A + B) = 90^\circ - \frac{1}{2} C$ $\tan \frac{1}{2} (A - B) = \frac{a - b}{a + b} \tan \frac{1}{2} (A + B)$ $A = \frac{1}{2} (A + B) + \frac{1}{2} (A - B),$ $B = \frac{1}{2} (A + B) - \frac{1}{2} (A - B)$ $c = (a + b) \frac{\cos \frac{1}{2} (A + B)}{\cos \frac{1}{2} (A - B)}$ $= (a - b) \frac{\sin \frac{1}{2} (A + B)}{\sin \frac{1}{2} (A - B)}$ $= \sqrt{a^2 + b^2 - 2ab \cdot \cos C}$
a, b, c	area A	$\text{area} = \frac{1}{2} a b \sin C.$ $\sin \frac{1}{2} A = \sqrt{\frac{(s - b)(s - c)}{bc}}$ $\cos \frac{1}{2} A = \sqrt{\frac{s(s - a)}{bc}}$ $\tan \frac{1}{2} A = \sqrt{\frac{(s - b)(s - c)}{s(s - a)}}$ $\sin A = \frac{2 \sqrt{s(s - a)(s - b)(s - c)}}{bc}$ $\text{vers } A = \frac{2(s - b)(s - c)}{bc}$
A, B, C, a	area	$\text{area} = \sqrt{s(s - a)(s - b)(s - c)}$ $\text{area} = \frac{a^2 \sin B \cdot \sin C}{2 \sin A}$

TRIGONOMETRIC FORMULÆ—(Continued).
GENERAL.

$$\begin{aligned}\sin A &= \frac{1}{\operatorname{cosec} A} = \sqrt{1 - \cos^2 A} = \tan A \cos A \\ &= 2 \sin \frac{1}{2} A \cos \frac{1}{2} A = \operatorname{vers} A \cot \frac{1}{2} A \\ &= \sqrt{\frac{1}{2} \operatorname{vers} 2 A} = \sqrt{\frac{1}{2} (1 - \cos 2 A)}\end{aligned}$$

$$\begin{aligned}\cos A &= \frac{1}{\sec A} = \sqrt{1 - \sin^2 A} = \cot A \sin A \\ &= 1 - \operatorname{vers} A = 2 \cos^2 \frac{1}{2} A - 1 = 1 - 2 \sin^2 \frac{1}{2} A \\ &= \cos^2 \frac{1}{2} A - \sin^2 \frac{1}{2} A = \sqrt{\frac{1}{2} + \frac{1}{2} \cos 2 A}\end{aligned}$$

$$\begin{aligned}\tan A &= \frac{1}{\cot A} = \frac{\sin A}{\cos A} = \sqrt{\sec^2 A - 1} \\ &= \sqrt{\frac{1}{\cos^2 A} - 1} = \frac{\sqrt{1 - \cos^2 A}}{\cos A} = \frac{\sin 2 A}{1 + \cos 2 A} \\ &= \frac{1 - \cos 2 A}{\sin 2 A} = \frac{\operatorname{vers} 2 A}{\sin 2 A} = \operatorname{exsec} A \cot \frac{1}{2} A\end{aligned}$$

$$\begin{aligned}\cot A &= \frac{1}{\tan A} = \frac{\cos A}{\sin A} = \sqrt{\operatorname{cosec}^2 A - 1} \\ &= \frac{\sin 2 A}{1 - \cos 2 A} = \frac{\sin 2 A}{\operatorname{vers} 2 A} = \frac{1 + \cos 2 A}{\sin 2 A} = \frac{\tan \frac{1}{2} A}{\operatorname{exsec} A}\end{aligned}$$

$$\begin{aligned}\operatorname{vers} A &= 1 - \cos A = \sin A \tan \frac{1}{2} A = 2 \sin^2 \frac{1}{2} A \\ &= \operatorname{exsec} A \cos A\end{aligned}$$

$$\operatorname{exsec} A = \sec A - 1 = \tan A \tan \frac{1}{2} A = \frac{\operatorname{vers} A}{\cos A}$$

$$\sin \frac{1}{2} A = \sqrt{\frac{1 - \cos A}{2}} = \sqrt{\frac{\operatorname{vers} A}{2}}$$

$$\cos \frac{1}{2} A = \sqrt{\frac{1 + \cos A}{2}}$$

$$\tan \frac{1}{2} A = \frac{\tan A}{1 + \sec A} = \operatorname{cosec} A - \cot A = \frac{1 - \cos A}{\sin A} = \sqrt{\frac{1 - \cos A}{1 + \cos A}}$$

$$\cot \frac{1}{2} A = \frac{\sin A}{\operatorname{vers} A} = \frac{1 + \cos A}{\sin A} = \frac{1}{\operatorname{cosec} A - \cot A}$$

$$\operatorname{vers} \frac{1}{2} A = \frac{\frac{1}{2} \operatorname{vers} A}{1 + \sqrt{1 - \frac{1}{2} \operatorname{vers} A}} = \frac{1 - \cos A}{2 + \sqrt{2(1 + \cos A)}}$$

TRIGONOMETRIC FORMULÆ—(Continued).
GENERAL.

$$\operatorname{exsec} \frac{1}{2} A = \frac{1 - \cos A}{(1 + \cos A) + \sqrt{2(1 + \cos A)}}$$

$$\sin 2 A = 2 \sin A \cos A$$

$$\cos 2 A = 2 \cos^2 A - 1 = \cos^2 A - \sin^2 A = 1 - 2 \sin^2 A$$

$$\tan 2 A = \frac{2 \tan A}{1 - \tan^2 A}$$

$$\cot 2 A = \frac{\cot^2 A - 1}{2 \cot A}$$

$$\operatorname{vers} 2 A = 2 \sin^2 A = 2 \sin A \cos A \tan A$$

$$\operatorname{exsec} 2 A = \frac{2 \tan^2 A}{1 - \tan^2 A}$$

$$\sin 3 A = 3 \sin A - 4 \sin^3 A$$

$$\cos 3 A = 4 \cos^3 A - 3 \cos A$$

$$\tan 3 A = \frac{3 \tan A - \tan^3 A}{1 - 3 \tan^2 A}$$

$$\sin 4 A = 4 \sin A \cos A - 8 \sin^3 A \cos A$$

$$\cos 4 A = 1 - 8 \cos^2 A + 8 \cos^4 A$$

$$\tan 4 A = \frac{4 \tan A - 4 \tan^3 A}{1 - 6 \tan^2 A + \tan^4 A}$$

$$\sin (A+B) = \sin A \cdot \cos B + \sin B \cdot \cos A$$

$$\sin (A-B) = \sin A \cdot \cos B - \sin B \cdot \cos A$$

$$\cos (A+B) = \cos A \cdot \cos B - \sin A \cdot \sin B$$

$$\cos (A-B) = \cos A \cdot \cos B + \sin A \cdot \sin B$$

$$\sin A + \sin B = 2 \sin \frac{1}{2} (A+B) \cos \frac{1}{2} (A-B)$$

$$\sin A - \sin B = 2 \cos \frac{1}{2} (A+B) \sin \frac{1}{2} (A-B)$$

$$\cos A + \cos B = 2 \cos \frac{1}{2} (A+B) \cos \frac{1}{2} (A-B)$$

$$\cos B - \cos A = 2 \sin \frac{1}{2} (A+B) \sin \frac{1}{2} (A-B)$$

$$\sin^2 A - \sin^2 B = \cos^2 B - \cos^2 A = \sin (A+B) \sin (A-B)$$

$$\cos^2 A - \sin^2 B = \cos (A+B) \cos (A-B)$$

$$\tan A + \tan B = \frac{\sin (A+B)}{\cos A \cdot \cos B}$$

$$\tan A - \tan B = \frac{\sin (A-B)}{\cos A \cdot \cos B}$$

FUNCTION.	QUADRANT SIGN.			
	1st	2nd	3rd	4th
sine, cosecant, coexsecant	+	+	-	-
cosine, secant, exsecant	+	-	-	+
tangent, cotangent	+	-	+	-
versed sine, covered sine	+	+	+	+

NATURAL SINES, COSECANTS, TANGENTS, ETC.

°	'	Sine.	Cosecant.	Tangent.	Cotangent.	Secant.	Cosine.	'	°
0	0	.000000	Infinite.	.000000	Infinite.	1.00000	1.000000	0	90
	10	.002909	343.77516	.002909	343.77371	1.00000	.999996	50	
	20	.005818	171.88831	.005818	171.88540	1.00002	.999983	40	
	30	.008727	114.59301	.008727	114.58865	1.00004	.999962	30	
	40	.011635	85.945609	.011636	85.939791	1.00007	.999932	20	
	50	.014544	68.757360	.014545	68.750087	1.00011	.999894	10	
1	0	.017452	57.298688	.017455	57.289962	1.00015	.999848	0	89
	10	.020361	49.114062	.020365	49.103881	1.00021	.999793	50	
	20	.023269	42.975713	.023275	42.964077	1.00027	.999729	40	
	30	.026177	38.201550	.026186	38.188459	1.00034	.999657	30	
	40	.029085	34.382316	.029097	34.367771	1.00042	.999577	20	
	50	.031992	31.257577	.032009	31.241577	1.00051	.999488	10	
2	0	.034899	28.653708	.034921	28.636253	1.00061	.999391	0	88
	10	.037806	26.450510	.037834	26.431600	1.00072	.999285	50	
	20	.040713	24.562123	.040747	24.541758	1.00083	.999171	40	
	30	.043619	22.925586	.043661	22.903766	1.00095	.999048	30	
	40	.046525	21.493676	.046576	21.470401	1.00108	.998917	20	
	50	.049431	20.230284	.049491	20.205553	1.00122	.998778	10	
3	0	.052336	19.107323	.052408	19.081137	1.00137	.998630	0	87
	10	.055241	18.102619	.055325	18.074977	1.00153	.998473	50	
	20	.058145	17.198434	.058243	17.169337	1.00169	.998308	40	
	30	.061049	16.380408	.061163	16.349855	1.00187	.998135	30	
	40	.063952	15.636793	.064083	15.604784	1.00205	.997953	20	
	50	.066854	14.957882	.067004	14.924417	1.00224	.997763	10	
4	0	.069756	14.335587	.069927	14.300666	1.00244	.997564	0	86
	10	.072658	13.763115	.072851	13.726738	1.00265	.997357	50	
	20	.075559	13.234717	.075776	13.196888	1.00287	.997141	40	
	30	.078459	12.745495	.078702	12.706205	1.00309	.996917	30	
	40	.081359	12.291252	.081629	12.250505	1.00333	.996685	20	
	50	.084258	11.868370	.084558	11.826167	1.00357	.996444	10	
5	0	.087156	11.473713	.087489	11.430052	1.00382	.996195	0	85
	10	.090053	11.104549	.090421	11.059431	1.00408	.995937	50	
	20	.092950	10.758488	.093354	10.711913	1.00435	.995671	40	
	30	.095846	10.433431	.096289	10.385397	1.00463	.995396	30	
	40	.098741	10.127522	.099226	10.078031	1.00491	.995113	20	
	50	.101635	9.8391227	.102164	9.7881732	1.00521	.994822	10	
6	0	.104528	9.5667722	.105104	9.5143645	1.00551	.994522	0	84
	10	.107421	9.3091699	.108046	9.2553035	1.00582	.994214	50	
	20	.110313	9.0651512	.110990	9.0098261	1.00614	.993897	40	
°	'	Cosine.	Secant.	Cotangent.	Tangent.	Cosecant.	Sine.	'	°

For functions from 83°-40' to 90° read from bottom of table upward.

**NATURAL SINES, COSECANTS,
TANGENTS, ETC.**

°	'	Sine.	Cosecant.	Tangent.	Cotangent.	Secant.	Cosine.	'	°
6	30	.113203	8.8336715	.113936	8.7768874	1.00647	.993572	30	
	40	.116093	8.6137901	.116883	8.5555468	1.00681	.993238	20	
	50	.118982	8.4045586	.119833	8.3449558	1.00715	.992896	10	
7	0	.121869	8.2055090	.122785	8.1443464	1.00751	.992546	0	83
	10	.124756	8.0156450	.125738	7.9530224	1.00787	.992187	50	
	20	.127642	7.8344335	.128694	7.7703506	1.00825	.991820	40	
	30	.130526	7.6612976	.131653	7.5957541	1.00863	.991445	30	
	40	.133410	7.4957100	.134613	7.4287064	1.00902	.991061	20	
	50	.136292	7.3371909	.137576	7.2687255	1.00942	.990669	10	
8	0	.139173	7.1852965	.140541	7.1153697	1.00983	.990268	0	82
	10	.142053	7.0396220	.143508	6.9682335	1.01024	.989859	50	
	20	.144932	6.8997942	.146478	6.8269437	1.01067	.989442	40	
	30	.147809	6.7654691	.149451	6.6911562	1.01111	.989016	30	
	40	.150686	6.6363293	.152426	6.5605538	1.01155	.988582	20	
	50	.153561	6.5120812	.155404	6.4348428	1.01200	.988139	10	
9	0	.156434	6.3924532	.158384	6.3137515	1.01247	.987688	0	81
	10	.159307	6.2771933	.161368	6.1970279	1.01294	.987229	50	
	20	.162178	6.1660674	.164354	6.0844381	1.01342	.986762	40	
	30	.165048	6.0588583	.167343	5.9757644	1.01391	.986286	30	
	40	.167916	5.9553625	.170334	5.8708042	1.01440	.985801	20	
	50	.170783	5.8553921	.173329	5.7693688	1.01491	.985309	10	
10	0	.173648	5.7587705	.176327	5.6712818	1.01543	.984808	0	80
	10	.176512	5.6653331	.179328	5.5763786	1.01595	.984298	50	
	20	.179375	5.5749258	.182332	5.4845052	1.01649	.983781	40	
	30	.182236	5.4874043	.185339	5.3955172	1.01703	.983255	30	
	40	.185095	5.4026333	.188359	5.3092793	1.01758	.982721	20	
	50	.187953	5.3204860	.191363	5.2256647	1.01815	.982178	10	
11	0	.190809	5.2408431	.194380	5.1445540	1.01872	.981627	0	79
	10	.193664	5.1635924	.197401	5.0658352	1.01930	.981068	50	
	20	.196517	5.0886284	.200425	4.9894027	1.01989	.980500	40	
	30	.199368	5.0158517	.203452	4.9151570	1.02049	.979925	30	
	40	.202218	4.9451687	.206483	4.8430045	1.02110	.979341	20	
	50	.205065	4.8764907	.209518	4.7728568	1.02171	.978748	10	
12	0	.207912	4.8097343	.212557	4.7046301	1.02234	.978148	0	78
	10	.210756	4.7448206	.215599	4.6382457	1.02298	.977539	50	
	20	.213599	4.6816748	.218645	4.5736287	1.02362	.976921	40	
	30	.216440	4.6202263	.221695	4.5107085	1.02428	.976296	30	
	40	.219279	4.5604080	.224748	4.4494181	1.02494	.975662	20	
	50	.222116	4.5021565	.227806	4.3896940	1.02562	.975020	10	
°	'	Cosine.	Secant.	Cotangent.	Tangent.	Cosecant.	Sine.	'	°

For functions from 77°-10' to 83°-30' read from bottom of table upward.

**NATURAL SINES, COSECANTS,
TANGENTS, ETC.**

°	'	Sine.	Cosecant.	Tangent.	Cotangent.	Secant.	Cosine.	'	°
13	0	.224951	4.4454115	.230868	4.3314759	1.02630	.974370	0	77
	10	.227784	4.3901158	.233934	4.2747066	1.02700	.973712	50	
	20	.230616	4.3362150	.237004	4.2193318	1.02770	.973045	40	
	30	.233445	4.2836576	.240079	4.1652998	1.02842	.972370	30	
	40	.236273	4.2323943	.243158	4.1125614	1.02914	.971687	20	
	50	.239098	4.1823785	.246241	4.0610700	1.02987	.970995	10	
14	0	.241922	4.1335655	.249328	4.0107809	1.03061	.970296	0	76
	10	.244743	4.0859130	.252420	3.9616518	1.03137	.969588	50	
	20	.247563	4.0393804	.255517	3.9136420	1.03213	.968872	40	
	30	.250380	3.9939292	.258618	3.8667131	1.03290	.968148	30	
	40	.253195	3.9495224	.261723	3.8208231	1.03368	.967415	20	
	50	.256008	3.9061250	.264834	3.7759519	1.03447	.966675	10	
15	0	.258819	3.8637033	.267949	3.7320508	1.03528	.965926	0	75
	10	.261628	3.8222251	.271069	3.6890927	1.03609	.965169	50	
	20	.264434	3.7816596	.274195	3.6470467	1.03691	.964404	40	
	30	.267238	3.7419775	.277325	3.6058835	1.03774	.963630	30	
	40	.270040	3.7031506	.280460	3.5655749	1.03858	.962849	20	
	50	.272840	3.6651518	.283600	3.5260938	1.03944	.962059	10	
16	0	.275637	3.6279553	.286745	3.4874144	1.04030	.961262	0	74
	10	.278432	3.5915363	.289896	3.4495120	1.04117	.960456	50	
	20	.281225	3.5558710	.293052	3.4123626	1.04206	.959642	40	
	30	.284015	3.5209365	.296214	3.3759434	1.04295	.958820	30	
	40	.286803	3.4867110	.299380	3.3402326	1.04385	.957990	20	
	50	.289589	3.4531735	.302553	3.3052091	1.04477	.957151	10	
17	0	.292372	3.4203036	.305731	3.2708526	1.04569	.956305	0	73
	10	.295152	3.3880820	.308914	3.2371438	1.04663	.955450	50	
	20	.297930	3.3564900	.312104	3.2040638	1.04757	.954588	40	
	30	.300706	3.3255095	.315299	3.1715948	1.04853	.953717	30	
	40	.303479	3.2951234	.318500	3.1397194	1.04950	.952838	20	
	50	.306249	3.2653149	.321707	3.1084210	1.05047	.951951	10	
18	0	.309017	3.2360680	.324920	3.0776835	1.05146	.951057	0	72
	10	.311782	3.2073673	.328139	3.0474915	1.05246	.950154	50	
	20	.314545	3.1791978	.331364	3.0178301	1.05347	.949243	40	
	30	.317305	3.1515453	.334595	2.9886850	1.05449	.948324	30	
	40	.320062	3.1243959	.337833	2.9600422	1.05552	.947397	20	
	50	.322816	3.0977363	.341077	2.9318885	1.05657	.946462	10	
19	0	.325568	3.0715535	.344328	2.9042109	1.05762	.945519	0	71
	10	.328317	3.0458352	.347585	2.8769970	1.05869	.944568	50	
	20	.331063	3.0205693	.350848	2.8502349	1.05976	.943609	40	
°	'	Cosine.	Secant.	Cotangent.	Tangent.	Cosecant.	Sine.	'	°

For functions from 70°-40' to 77°-0' read from bottom of table upward.

NATURAL SINES, COSECANTS, TANGENTS, ETC.

°	'	Sine.	Cosecant.	Tangent.	Cotangent.	Secant.	Cosine.	'	°
19	30	.333807	2.9957443	.354119	2.8239129	1.06085	.942641	30	70
	40	.336547	2.9713490	.357396	2.7980198	1.06195	.941666	20	
	50	.339285	2.9473724	.360680	2.7725448	1.06306	.940684	10	
20	0	.342020	2.9238044	.363970	2.7474774	1.06418	.939693	0	70
	10	.344752	2.9006346	.367268	2.7228076	1.06531	.938694	50	
	20	.347481	2.8778532	.370573	2.6985254	1.06645	.937687	40	
	30	.350207	2.8554510	.373885	2.6746215	1.06761	.936672	30	
	40	.352931	2.8334185	.377204	2.6510867	1.06878	.935650	20	
	50	.355651	2.8117471	.380530	2.6279121	1.06995	.934619	10	
21	0	.358368	2.7904281	.383864	2.6050891	1.07115	.933580	0	69
	10	.361082	2.7694532	.387205	2.5826094	1.07235	.932534	50	
	20	.363793	2.7488144	.390554	2.5604649	1.07356	.931480	40	
	30	.366501	2.7285038	.393911	2.5386479	1.07479	.930418	30	
	40	.369206	2.7085139	.397275	2.5171507	1.07602	.929348	20	
	50	.371908	2.6888374	.400647	2.4959661	1.07727	.928270	10	
22	0	.374607	2.6694672	.404026	2.4750869	1.07853	.927184	0	68
	10	.377302	2.6503962	.407414	2.4545061	1.07981	.926090	50	
	20	.379994	2.6316180	.410810	2.4342172	1.08109	.924989	40	
	30	.382683	2.6131259	.414214	2.4142136	1.08239	.923880	30	
	40	.385369	2.5949137	.417626	2.3944889	1.08370	.922762	20	
	50	.388052	2.5769753	.421046	2.3750372	1.08503	.921638	10	
23	0	.390731	2.5593047	.424475	2.3558524	1.08636	.920505	0	67
	10	.393407	2.5418961	.427912	2.3369287	1.08771	.919364	50	
	20	.396080	2.5247440	.431358	2.3182606	1.08907	.918216	40	
	30	.398749	2.5078428	.434812	2.2998425	1.09044	.917060	30	
	40	.401415	2.4911874	.438276	2.2816693	1.09183	.915896	20	
	50	.404078	2.4747726	.441748	2.2637357	1.09323	.914725	10	
24	0	.406737	2.4585933	.445229	2.2460368	1.09464	.913545	0	66
	10	.409392	2.4426448	.448719	2.2285676	1.09606	.912358	50	
	20	.412045	2.4269222	.452218	2.2113234	1.09750	.911164	40	
	30	.414693	2.4114210	.455726	2.1942997	1.09895	.909961	30	
	40	.417338	2.3961367	.459244	2.1774920	1.10041	.908751	20	
	50	.419980	2.3810650	.462771	2.1608958	1.10189	.907533	10	
25	0	.422618	2.3662016	.466308	2.1445069	1.10338	.906308	0	65
	10	.425253	2.3515424	.469854	2.1283213	1.10488	.905075	50	
	20	.427884	2.3370833	.473410	2.1123348	1.10640	.903834	40	
	30	.430511	2.3228205	.476976	2.0965436	1.10793	.902585	30	
	40	.433135	2.3087501	.480551	2.0809438	1.10947	.901329	20	
	50	.435755	2.2948685	.484137	2.0655318	1.11103	.900065	10	
°	'	Cosine.	Secant.	Cotangent.	Tangent.	Cosecant.	Sine.	'	°

For functions from 64°-10' to 70°-30' read from bottom of table upward.

NATURAL SINES, COSECANTS, TANGENTS, ETC.

°	'	Sine.	Cosecant.	Tangent.	Cotangent.	Secant.	Cosine.	'	°
64	0	.438371	2.2811720	.487733	2.0503038	1.11260	.898794	0	64
	10	.440984	2.2676571	.491339	2.0352565	1.11419	.897515	50	
	20	.443593	2.2543204	.494955	2.0203862	1.11579	.896229	40	
	30	.446198	2.2411585	.498582	2.0056897	1.11740	.894934	30	
	40	.448799	2.2281681	.502219	1.9911637	1.11903	.893633	20	
	50	.451397	2.2153460	.505867	1.9768050	1.12067	.892323	10	
63	0	.453990	2.2026893	.509525	1.9626105	1.12233	.891007	0	63
	10	.456580	2.1901947	.513195	1.9485772	1.12400	.889682	50	
	20	.459166	2.1778595	.516876	1.9347020	1.12568	.888350	40	
	30	.461749	2.1656806	.520567	1.9209821	1.12738	.887011	30	
	40	.464327	2.1536553	.524270	1.9074147	1.12910	.885664	20	
	50	.466901	2.1417808	.527984	1.8939971	1.13083	.884309	10	
62	0	.469472	2.1300545	.531709	1.8807265	1.13257	.882948	0	62
	10	.472038	2.1184737	.535447	1.8676003	1.13433	.881578	50	
	20	.474600	2.1070359	.539195	1.8546159	1.13610	.880201	40	
	30	.477159	2.0957385	.542956	1.8417708	1.13789	.878817	30	
	40	.479713	2.0845792	.546728	1.8290628	1.13970	.877425	20	
	50	.482263	2.0735556	.550515	1.8164892	1.14152	.876026	10	
61	0	.484810	2.0626653	.554309	1.8040478	1.14335	.874620	0	61
	10	.487352	2.0519061	.558118	1.7917362	1.14521	.873206	50	
	20	.489890	2.0412757	.561939	1.7795524	1.14707	.871784	40	
	30	.492424	2.0307720	.565773	1.7674940	1.14896	.870356	30	
	40	.494953	2.0203929	.569619	1.7555590	1.15085	.868920	20	
	50	.497479	2.0101362	.573478	1.7437453	1.15277	.867476	10	
60	0	.500000	2.0000000	.577350	1.7320508	1.15470	.866025	0	60
	10	.502517	1.9899822	.581235	1.7204736	1.15665	.864567	50	
	20	.505030	1.9800810	.585134	1.7090116	1.15861	.863102	40	
	30	.507538	1.9702944	.589045	1.6976631	1.16059	.861629	30	
	40	.510043	1.9606206	.592970	1.6864261	1.16259	.860149	20	
	50	.512543	1.9510577	.596908	1.6752988	1.16460	.858662	10	
59	0	.515038	1.9416040	.600861	1.6642795	1.16663	.857167	0	59
	10	.517529	1.9322578	.604827	1.6533663	1.16868	.855665	50	
	20	.520016	1.9230173	.608807	1.6425576	1.17075	.854156	40	
	30	.522499	1.9138809	.612801	1.6318517	1.17283	.852640	30	
	40	.524977	1.9048469	.616809	1.6212469	1.17493	.851117	20	
	50	.527450	1.8959138	.620832	1.6107417	1.17704	.849586	10	
58	0	.529919	1.8870799	.624869	1.6003345	1.17918	.848048	0	58
	10	.532384	1.8783438	.628921	1.5900238	1.18133	.846503	50	
	20	.534844	1.8697040	.632988	1.5798079	1.18350	.844951	40	
°	'	Cosine.	Secant.	Cotangent.	Tangent.	Cosecant.	Sine.	'	°

For functions from 57°-40' to 64°-0' read from bottom of table upward.

NATURAL SINES, COSECANTS,
TANGENTS, ETC.

°	'	Sine.	Cosecant.	Tangent.	Cotangent.	Secant.	Cosine.	'	°
32	30	.537300	1.8611590	.637070	1.5696856	1.18569	.843391	30	57
	40	.539751	1.8527073	.641167	1.5596552	1.18790	.841825	20	
	50	.542197	1.8443476	.645280	1.5497155	1.19012	.840251	10	
33	0	.544639	1.8360785	.649408	1.5398650	1.19236	.838671	0	56
	10	.547076	1.8278985	.653551	1.5301025	1.19463	.837083	50	
	20	.549509	1.8198065	.657710	1.5204261	1.19691	.835488	40	
	30	.551937	1.8118010	.661886	1.5108352	1.19920	.833886	30	
	40	.554360	1.8038809	.666077	1.5013282	1.20152	.832277	20	
	50	.556779	1.7960449	.670285	1.4919039	1.20386	.830661	10	
34	0	.559193	1.7882916	.674509	1.4825610	1.20622	.829038	0	55
	10	.561602	1.7806201	.678749	1.4732983	1.20859	.827407	50	
	20	.564007	1.7730290	.683007	1.4641147	1.21099	.825770	40	
	30	.566406	1.7655173	.687281	1.4550090	1.21341	.824126	30	
	40	.568801	1.7580837	.691573	1.4459801	1.21584	.822475	20	
	50	.571191	1.7507273	.695881	1.4370268	1.21830	.820817	10	
35	0	.573576	1.7434468	.700208	1.4281480	1.22077	.819152	0	54
	10	.575957	1.7362413	.704552	1.4193427	1.22327	.817480	50	
	20	.578332	1.7291096	.708913	1.4106098	1.22579	.815801	40	
	30	.580703	1.7220508	.713293	1.4019483	1.22833	.814116	30	
	40	.583069	1.7150639	.717691	1.3933571	1.23089	.812423	20	
	50	.585429	1.7081478	.722108	1.3848355	1.23347	.810723	10	
36	0	.587785	1.7013016	.726543	1.3763810	1.23607	.809017	0	53
	10	.590136	1.6945244	.730996	1.3679959	1.23869	.807304	50	
	20	.592482	1.6878151	.735469	1.3596764	1.24134	.805584	40	
	30	.594823	1.6811730	.739961	1.3514224	1.24400	.803857	30	
	40	.597159	1.6745970	.744472	1.3432331	1.24669	.802123	20	
	50	.599489	1.6680864	.749003	1.3351075	1.24940	.800383	10	
37	0	.601815	1.6616401	.753554	1.3270448	1.25214	.798636	0	52
	10	.604136	1.6552575	.758125	1.3190441	1.25489	.796882	50	
	20	.606451	1.6489376	.762716	1.3111046	1.25767	.795121	40	
	30	.608761	1.6426796	.767327	1.3032254	1.26047	.793353	30	
	40	.611067	1.6364828	.771959	1.2954057	1.26330	.791579	20	
	50	.613367	1.6303462	.776612	1.2876447	1.26615	.789798	10	
38	0	.615661	1.6242692	.781286	1.2799416	1.26902	.788011	0	51
	10	.617951	1.6182510	.785981	1.2722957	1.27191	.786217	50	
	20	.620235	1.6122908	.790698	1.2647062	1.27483	.784416	40	
	30	.622515	1.6063879	.795436	1.2571723	1.27773	.782608	30	
	40	.624789	1.6005416	.800196	1.2496933	1.28075	.780794	20	
	50	.627057	1.5947511	.804979	1.2422685	1.28374	.778973	10	
°	'	Cosine.	Secant.	Cotangent.	Tangent.	Cosecant.	Sine.	'	°

For functions from 51°-10' to 57°-30' read from bottom of table upward.

NATURAL SINES, COSECANTS, TANGENTS, ETC.

°	'	Sine.	Cosecant.	Tangent.	Cotangent.	Secant.	Cosine.	'	°
39	0	.629320	1.5890157	.809784	1.2348972	1.28676	.777146	0	51
	10	.631578	1.5833318	.814612	1.2275786	1.28980	.775312	50	
	20	.633831	1.5777077	.819463	1.2203121	1.29287	.773472	40	
	30	.636078	1.5721337	.824336	1.2130970	1.29597	.771625	30	
	40	.638320	1.5666121	.829234	1.2059327	1.29909	.769771	20	
	50	.640557	1.5611424	.834155	1.1988184	1.30223	.767911	10	
40	0	.642788	1.5557238	.839100	1.1917536	1.30541	.766044	0	50
	10	.645013	1.5503558	.844069	1.1847376	1.30861	.764171	50	
	20	.647233	1.5450378	.849062	1.1777698	1.31183	.762292	40	
	30	.649448	1.5397690	.854081	1.1708496	1.31509	.760406	30	
	40	.651657	1.5345491	.859124	1.1639763	1.31837	.758514	20	
	50	.653861	1.5293773	.864193	1.1571495	1.32168	.756615	10	
41	0	.656059	1.5242531	.869287	1.1503684	1.32501	.754710	0	49
	10	.658252	1.5191759	.874407	1.1436326	1.32838	.752798	50	
	20	.660439	1.5141452	.879553	1.1369414	1.33177	.750880	40	
	30	.662620	1.5091605	.884725	1.1302944	1.33519	.748956	30	
	40	.664796	1.5042211	.889924	1.1236909	1.33864	.747025	20	
	50	.666966	1.4993267	.895151	1.1171305	1.34212	.745088	10	
42	0	.669131	1.4944765	.900404	1.1106125	1.34563	.743145	0	48
	10	.671289	1.4896703	.905685	1.1041365	1.34917	.741195	50	
	20	.673443	1.4849073	.910994	1.0977020	1.35274	.739239	40	
	30	.675590	1.4801872	.916331	1.0913085	1.35634	.737277	30	
	40	.677732	1.4755095	.921697	1.0849554	1.35997	.735309	20	
	50	.679868	1.4708736	.927091	1.0786423	1.36363	.733335	10	
43	0	.681998	1.4662792	.932515	1.0723687	1.36733	.731354	0	47
	10	.684123	1.4617257	.937968	1.0661341	1.37105	.729367	50	
	20	.686242	1.4572127	.943451	1.0599381	1.37481	.727374	40	
	30	.688355	1.4527397	.948965	1.0537801	1.37860	.725374	30	
	40	.690462	1.4483063	.954508	1.0476598	1.38242	.723369	20	
	50	.692563	1.4439120	.960083	1.0415767	1.38628	.721357	10	
44	0	.694658	1.4395565	.965689	1.0355303	1.39016	.719340	0	46
	10	.696748	1.4352393	.971326	1.0295203	1.39409	.717316	50	
	20	.698832	1.4309602	.976996	1.0235461	1.39804	.715286	40	
	30	.700909	1.4267182	.982697	1.0176074	1.40203	.713251	30	
	40	.702981	1.4225134	.988432	1.0117088	1.40606	.711209	20	
	50	.705047	1.4183454	.994199	1.0058348	1.41012	.709161	10	
45	0	.707107	1.4142136	1.000000	1.0000000	1.41421	.707107	0	45
°	'	Cosine.	Secant.	Cotangent.	Tangent.	Cosecant.	Sine.	'	°

For functions from 45°-0' to 51°-0' read from bottom of table upward.

**SQUARES, CUBES, SQUARE ROOTS,
CUBE ROOTS AND RECIPROCAL.**

No.	Squares.	Cubes.	Square Roots.	Cube Roots.	Reciprocals.
1	1	1	1.0000000	1.0000000	1.000000000
2	4	8	1.4142136	1.2599210	.500000000
3	9	27	1.7320508	1.4422496	.333333333
4	16	64	2.0000000	1.5874011	.250000000
5	25	125	2.2360680	1.7099759	.200000000
6	36	216	2.4494897	1.8171206	.166666667
7	49	343	2.6457513	1.9129312	.142857143
8	64	512	2.8284271	2.0000000	.125000000
9	81	729	3.0000000	2.0800837	.111111111
10	100	1000	3.1622777	2.1544347	.100000000
11	121	1331	3.3166248	2.2239801	.090909091
12	144	1728	3.4641016	2.2894286	.083333333
13	169	2197	3.6055513	2.3513347	.076923077
14	196	2744	3.7416574	2.4101422	.071428571
15	225	3375	3.8729833	2.4662121	.066666667
16	256	4096	4.0000000	2.5198421	.062500000
17	289	4913	4.1231056	2.5712816	.058823529
18	324	5832	4.2426407	2.6207414	.055555556
19	361	6859	4.3583989	2.6684016	.052631579
20	400	8000	4.4721360	2.7144177	.050000000
21	441	9261	4.5825757	2.7589243	.047619048
22	484	10648	4.6904158	2.8020393	.045454545
23	529	12167	4.7958315	2.8438670	.043478261
24	576	13824	4.8989795	2.8844991	.041666667
25	625	15625	5.0000000	2.9240177	.040000000
26	676	17576	5.0990195	2.9624960	.038461538
27	729	19683	5.1961524	3.0000000	.037037037
28	784	21952	5.2915026	3.0365889	.035714286
29	841	24389	5.3851648	3.0723168	.034482759
30	900	27000	5.4772256	3.1072325	.033333333
31	961	29791	5.5677644	3.1413806	.032258065
32	1024	32768	5.6568542	3.1748021	.031250000
33	1089	35937	5.7445826	3.2075343	.030303030
34	1156	39304	5.8309519	3.2396118	.029411765
35	1225	42875	5.9160798	3.2710663	.028571429
36	1296	46656	6.0000000	3.3019272	.027777778
37	1369	50653	6.0827625	3.3322218	.027027027
38	1444	54872	6.1644140	3.3619754	.026315789
39	1521	59319	6.2449980	3.3912114	.025641026
40	1600	64000	6.3245553	3.4199519	.025000000
41	1681	68921	6.4031242	3.4482172	.024390244
42	1764	74088	6.4807407	3.4760266	.023809524
43	1849	79507	6.5574385	3.5033981	.023255814
44	1936	85184	6.6332496	3.5303483	.022727273
45	2025	91125	6.7082039	3.5568933	.022222222
46	2116	97336	6.7823300	3.5830479	.021739130
47	2209	103823	6.8556546	3.6088261	.021276596
48	2304	110592	6.9282032	3.6342411	.020833333
49	2401	117649	7.0000000	3.6593057	.020408163
50	2500	125000	7.0710678	3.6840314	.020000000
51	2601	132651	7.1414284	3.7084298	.019607843
52	2704	140608	7.2111026	3.7325111	.019230769
53	2809	148877	7.2801099	3.7562858	.018867925
54	2916	157464	7.3484692	3.7797631	.018518519
55	3025	166375	7.4161985	3.8029525	.018181818
56	3136	175616	7.4833148	3.8258624	.017857143
57	3249	185193	7.5498344	3.8485011	.017543860
58	3364	195112	7.6157731	3.8708766	.017241379
59	3481	205379	7.6811457	3.8929965	.016949153

SQUARES, CUBES, SQUARE ROOTS, CUBE ROOTS AND RECIPROCAL.

No.	Squares.	Cubes.	Square Roots.	Cube Roots.	Reciprocals.
60	3600	216000	7.7459667	3.9148676	.016666667
61	3721	226981	7.8102497	3.9364972	.016393443
62	3844	238328	7.8740079	3.9578915	.016129032
63	3969	250047	7.9372539	3.9790571	.015873018
64	4096	262144	8.0000000	4.0000000	.015625000
65	4225	274625	8.0622577	4.0207256	.015384615
66	4356	287496	8.1240384	4.0412401	.015151515
67	4489	300763	8.1853528	4.0615480	.014925373
68	4624	314432	8.2462113	4.0816551	.014705882
69	4761	328509	8.3066239	4.1015661	.014492754
70	4900	343000	8.3666003	4.1212853	.014285714
71	5041	357911	8.4261498	4.1408178	.014084507
72	5184	373248	8.4852814	4.1601676	.013888889
73	5329	389017	8.5440037	4.1793390	.013698630
74	5476	405224	8.6023253	4.1983364	.013513514
75	5625	421875	8.6602540	4.2171633	.013333333
76	5776	438976	8.7177979	4.2358236	.013157895
77	5929	456533	8.7749644	4.2543210	.012987013
78	6084	474552	8.8317609	4.2726586	.012820513
79	6241	493039	8.8881944	4.2908404	.012658228
80	6400	512000	8.9442719	4.3088695	.012500000
81	6561	531441	9.0000000	4.3267487	.012345679
82	6724	551368	9.0553851	4.3444815	.012195122
83	6889	571787	9.1104336	4.3620707	.012048193
84	7056	592704	9.1651514	4.3795191	.011904762
85	7225	614125	9.2195445	4.3968206	.011764702
86	7396	636056	9.2736185	4.4140049	.011627907
87	7569	658503	9.3273791	4.4310476	.011494253
88	7744	681472	9.3808315	4.4479602	.011363636
89	7921	704969	9.4339811	4.4647451	.011235955
90	8100	729000	9.4868330	4.4814047	.011111111
91	8281	753571	9.5393920	4.4979414	.010989011
92	8464	778688	9.5916630	4.5143574	.010869565
93	8649	804357	9.6436508	4.5306549	.010752688
94	8836	830584	9.6953597	4.5468359	.010638298
95	9025	857375	9.7467943	4.5629026	.010526316
96	9216	884736	9.7979590	4.5788570	.010416667
97	9409	912673	9.8488578	4.5947009	.010309278
98	9604	941192	9.8994949	4.6104363	.010204082
99	9801	970299	9.9498744	4.6260650	.010101010
100	10000	1000000	10.0000000	4.6415888	.010000000
101	10201	1030301	10.0498756	4.6570095	.009900990
102	10404	1061208	10.0995049	4.6723287	.009803922
103	10609	1092727	10.1488916	4.6875482	.009708733
104	10816	1124864	10.1980390	4.7026694	.009615385
105	11025	1157625	10.2469508	4.7176940	.009523810
106	11236	1191016	10.2956301	4.7326235	.009433962
107	11449	1225043	10.3440804	4.7474594	.009345794
108	11664	1259712	10.3923048	4.7622032	.009259259
109	11881	1295029	10.4403065	4.7768562	.009174312
110	12100	1331000	10.4880885	4.7914199	.009090909
111	12321	1367631	10.5356538	4.8058955	.009009009
112	12544	1404928	10.5830052	4.8202845	.008928571
113	12769	1442897	10.6301458	4.8345881	.008849558
114	12996	1481544	10.6770783	4.8488076	.008771930
115	13225	1520875	10.7238053	4.8629442	.008695652
116	13456	1560896	10.7703296	4.8769990	.008620690
117	13689	1601613	10.8166538	4.8909732	.008547009
118	13924	1643032	10.8627805	4.9048681	.008474576
119	14161	1685159	10.9087121	4.9186847	.008403361

**SQUARES, CUBES, SQUARE ROOTS,
CUBE ROOTS AND RECIPROCAL.**

No.	Squares.	Cubes.	Square Roots.	Cube Roots.	Reciprocals.
120	14400	1728000	10.9544512	4.9324242	.008333333
121	14641	1771561	11.0000000	4.9460874	.008264463
122	14884	1815848	11.0453610	4.9596757	.008196721
123	15129	1860867	11.0905365	4.9731898	.008130081
124	15376	1906624	11.1355287	4.9866310	.008064516
125	15625	1953125	11.1803399	5.0000000	.008000000
126	15876	2000376	11.2249722	5.0132979	.007936508
127	16129	2048383	11.2694277	5.0265257	.007874016
128	16384	2097152	11.3137085	5.0396842	.007812500
129	16641	2146689	11.3578167	5.0527743	.007751938
130	16900	2197000	11.4017543	5.0657970	.007692308
131	17161	2248091	11.4455231	5.0787531	.007633588
132	17424	2299968	11.4891253	5.0916434	.007575758
133	17689	2352637	11.5325626	5.1044687	.007518797
134	17956	2406104	11.5758369	5.1172299	.007462687
135	18225	2460375	11.6189500	5.1299278	.007407407
136	18496	2515456	11.6619038	5.1425632	.007352941
137	18769	2571353	11.7046999	5.1551367	.007299270
138	19044	2628072	11.7473401	5.1676493	.007246377
139	19321	2685619	11.7898261	5.1801015	.007194245
140	19600	2744000	11.8321596	5.1924941	.007142857
141	19881	2803221	11.8743421	5.2048279	.007092199
142	20164	2863288	11.9163753	5.2171034	.007042254
143	20449	2924207	11.9582607	5.2293215	.006993007
144	20736	2985984	12.0000000	5.2414828	.006944444
145	21025	3048625	12.0415946	5.2535879	.006896552
146	21316	3112136	12.0830460	5.2656374	.006849315
147	21609	3176523	12.1243557	5.2776321	.006802721
148	21904	3241792	12.1655251	5.2895725	.006756757
149	22201	3307949	12.2065556	5.3014592	.006711409
150	22500	3375000	12.2474487	5.3132928	.006666667
151	22801	3442951	12.2882057	5.3250740	.006622517
152	23104	3511808	12.3288280	5.3368033	.006578947
153	23409	3581577	12.3693169	5.3484812	.006535948
154	23716	3652264	12.4096736	5.3601084	.006493506
155	24025	3723875	12.4498996	5.3716854	.006451613
156	24336	3796416	12.4899960	5.3832126	.006410256
157	24649	3869893	12.5299641	5.3946907	.006369427
158	24964	3944312	12.5698051	5.4061202	.006329114
159	25281	4019679	12.6095202	5.4175015	.006289308
160	25600	4096000	12.6491106	5.4288352	.006250000
161	25921	4173281	12.6885775	5.4401218	.006211180
162	26244	4251528	12.7279221	5.4513618	.006172840
163	26569	4330747	12.7671453	5.4625556	.006134969
164	26896	4410944	12.8062485	5.4737037	.006097561
165	27225	4492125	12.8452326	5.4848066	.006060606
166	27556	4574296	12.8840987	5.4958647	.006024096
167	27889	4657463	12.9228480	5.5068784	.005988024
168	28224	4741632	12.9614814	5.5178484	.005952381
169	28561	4826809	13.0000000	5.5287748	.005917160
170	28900	4913000	13.0384048	5.5396583	.005882353
171	29241	5000211	13.0766968	5.5504991	.005847953
172	29584	5088448	13.1148770	5.5612978	.005813953
173	29929	5177717	13.1529464	5.5720546	.005780347
174	30276	5268024	13.1909060	5.5827702	.005747126
175	30625	5359375	13.2287566	5.5934447	.005714286
176	30976	5451776	13.2664992	5.6040787	.005681818
177	31329	5545233	13.3041347	5.6146724	.005649718
178	31684	5639752	13.3416641	5.6252263	.005617978
179	32041	5735339	13.3790882	5.6357408	.005586592

SQUARES, CUBES, SQUARE ROOTS, CUBE ROOTS AND RECIPROCAL.

No.	Squares.	Cubes.	Square Roots.	Cube Roots.	Reciprocals.
180	32400	5832000	13.4164079	5.6462162	.005555556
181	32761	5929741	13.4536240	5.6566528	.005524862
182	33124	6028568	13.4907376	5.6670511	.005494505
183	33489	6128487	13.5277493	5.6774114	.005464481
184	33856	6229504	13.5646600	5.6877340	.005434783
185	34225	6331625	13.6014705	5.6980192	.005405405
186	34596	6434856	13.6381817	5.7082675	.005376344
187	34969	6539203	13.6747943	5.7184791	.005347594
188	35344	6644672	13.7113092	5.7286543	.005319149
189	35721	6751269	13.7477271	5.7387936	.005291005
190	36100	6859000	13.7840488	5.7488971	.005263158
191	36481	6967871	13.8202750	5.7589652	.005235602
192	36864	7077888	13.8564065	5.7689982	.005208333
193	37249	7189057	13.8924440	5.7789966	.005181347
194	37636	7301384	13.9283883	5.7889604	.005154639
195	38025	7414875	13.9642400	5.7988900	.005128205
196	38416	7529536	14.0000000	5.8087857	.005102041
197	38809	7645373	14.0356688	5.8186479	.005076142
198	39204	7762392	14.0712473	5.8284767	.005050505
199	39601	7880599	14.1067360	5.8382725	.005025126
200	40000	8000000	14.1421356	5.8480355	.005000000
201	40401	8120601	14.1774469	5.8577660	.004975124
202	40804	8242408	14.2126704	5.8674643	.004950495
203	41209	8365427	14.2478068	5.8771307	.004926108
204	41616	8489664	14.2828569	5.8867653	.004901961
205	42025	8615125	14.3178211	5.8963685	.004878049
206	42436	8741816	14.3527001	5.9059406	.004854369
207	42849	8869743	14.3874946	5.9154817	.004830918
208	43264	8998912	14.4222051	5.9249921	.004807692
209	43681	9129329	14.4568323	5.9344721	.004784689
210	44100	9261000	14.4913767	5.9439220	.004761905
211	44521	9393931	14.5258390	5.9533418	.004739336
212	44944	9528128	14.5602198	5.9627320	.004716981
213	45369	9663597	14.5945195	5.9720926	.004694836
214	45796	9800344	14.6287388	5.9814240	.004672897
215	46225	9938375	14.6628783	5.9907264	.004651163
216	46656	10077696	14.6969385	6.0000000	.004629630
217	47089	10218313	14.7309199	6.0092450	.004608295
218	47524	10360232	14.7648231	6.0184617	.004587156
219	47961	10503459	14.7986486	6.0276502	.004566210
220	48400	10648000	14.8323970	6.0368107	.004545455
221	48841	10793861	14.8660687	6.0459435	.004524887
222	49284	10941048	14.8996644	6.0550489	.004504505
223	49729	11089567	14.9331845	6.0641270	.004484305
224	50176	11239424	14.9666295	6.0731779	.004464286
225	50625	11390625	15.0000000	6.0822020	.004444444
226	51076	11543176	15.0332964	6.0911994	.004424779
227	51529	11697083	15.0665192	6.1001702	.004405286
228	51984	11852352	15.0996689	6.1091147	.004385965
229	52441	12008989	15.1327460	6.1180332	.004366812
230	52900	12167000	15.1657509	6.1269257	.004347826
231	53361	12326391	15.1986842	6.1357924	.004329004
232	53824	12487168	15.2315462	6.1446337	.004310345
233	54289	12649337	15.2643375	6.1534495	.004291845
234	54756	12812904	15.2970585	6.1622401	.004273504
235	55225	12977875	15.3297097	6.1710058	.004255319
236	55696	13144256	15.3622915	6.1797466	.004237288
237	56169	13312053	15.3948043	6.1884628	.004219409
238	56644	13481272	15.4272486	6.1971544	.004201681
239	57121	13651919	15.4596248	6.2058218	.004184100

SQUARES, CUBES, SQUARE ROOTS, CUBE ROOTS AND RECIPROCAL.

No.	Squares.	Cubes.	Square Roots.	Cube Roots.	Reciprocals.
240	57600	13824000	15.4919334	6.2144650	.004166667
241	58081	13997521	15.5241747	6.2230843	.004149378
242	58564	14172488	15.5563492	6.2316797	.004132231
243	59049	14348907	15.5884573	6.2402515	.004115226
244	59536	14526784	15.6204994	6.2487998	.004098361
245	60025	14706125	15.6524758	6.2573248	.004081633
246	60516	14886936	15.6843871	6.2658266	.004065041
247	61009	15069223	15.7162336	6.2743054	.004048583
248	61504	15252992	15.7480157	6.2827613	.004032258
249	62001	15438249	15.7797338	6.2911946	.004016064
250	62500	15625000	15.8113883	6.2996053	.004000000
251	63001	15813251	15.8429795	6.3079935	.003984064
252	63504	16003008	15.8745079	6.3163596	.003968254
253	64009	16194277	15.9059737	6.3247035	.003952569
254	64516	16387064	15.9373775	6.3330256	.003937008
255	65025	16581375	15.9687194	6.3413257	.003921569
256	65536	16777216	16.0000000	6.3496042	.003906250
257	66049	16974593	16.0312195	6.3578611	.003891051
258	66564	17173512	16.0623784	6.3660968	.003875969
259	67081	17373979	16.0934769	6.3743111	.003861004
260	67600	17576000	16.1245155	6.3825043	.003846154
261	68121	17779581	16.1554944	6.3906765	.003831418
262	68644	17984728	16.1864141	6.3988279	.003816794
263	69169	18191447	16.2172747	6.4069585	.003802281
264	69696	18399744	16.2480708	6.4150687	.003787879
265	70225	18609625	16.2788206	6.4231583	.003773585
266	70756	18821096	16.3095064	6.4312276	.003759398
267	71289	19034163	16.3401346	6.4392767	.003745318
268	71824	19248832	16.3707055	6.4473057	.003731343
269	72361	19465109	16.4012195	6.4553148	.003717472
270	72900	19683000	16.4316767	6.4633041	.003703704
271	73441	19902511	16.4620776	6.4712736	.003690037
272	73984	20123648	16.4924225	6.4792236	.003676471
273	74529	20346417	16.5227116	6.4871541	.003663004
274	75076	20570824	16.5529454	6.4950653	.003649635
275	75625	20796875	16.5831240	6.5029572	.003636364
276	76176	21024576	16.6132477	6.5108300	.003623188
277	76729	21253933	16.6433170	6.5186839	.003610108
278	77284	21484952	16.6733320	6.5265189	.003597122
279	77841	21717639	16.7032931	6.5343351	.003584229
280	78400	21952000	16.7332005	6.5421326	.003571429
281	78961	22188041	16.7630546	6.5499116	.003558719
282	79524	22425768	16.7928556	6.5576722	.003546099
283	80089	22665187	16.8226038	6.5654144	.003533569
284	80656	22906304	16.8522995	6.5731385	.003521127
285	81225	23149125	16.8819430	6.5808443	.003508772
286	81796	23393656	16.9115345	6.5885323	.003496503
287	82369	23639903	16.9410743	6.5962023	.003484321
288	82944	23887872	16.9705627	6.6038545	.003472222
289	83521	24137569	17.0000000	6.6114890	.003460208
290	84100	24389000	17.0293864	6.6191060	.003448276
291	84681	24642171	17.0587221	6.6267054	.003436426
292	85264	24897088	17.0880075	6.6342874	.003424658
293	85849	25153757	17.1172428	6.6418522	.003412969
294	86436	25412184	17.1464282	6.6493998	.003401361
295	87025	25672375	17.1755640	6.6569302	.003389831
296	87616	25934336	17.2046505	6.6644437	.003378378
297	88209	26198073	17.2336879	6.6719403	.003367003
298	88804	26463592	17.2626765	6.6794200	.003355705
299	89401	26730899	17.2916165	6.6868831	.003344482

SQUARES, CUBES, SQUARE ROOTS, CUBE ROOTS AND RECIPROCAL.

No.	Squares.	Cubes.	Square Roots.	Cube Roots.	Reciprocals.
300	90000	27000000	17.3205081	6.6943295	.003333333
301	90601	27270901	17.3493516	6.7017593	.003322259
302	91204	27543608	17.3781472	6.7091729	.003311258
303	91809	27818127	17.4068952	6.7165700	.003300330
304	92416	28094464	17.4355958	6.7239508	.003289474
305	93025	28372625	17.4642492	6.7313155	.003278689
306	93636	28652616	17.4928557	6.7386641	.003267974
307	94249	28934443	17.5214155	6.7459967	.003257329
308	94864	29218112	17.5499288	6.7533134	.003246753
309	95481	29503629	17.5783958	6.7606143	.003236246
310	96100	29791000	17.6068169	6.7678995	.003225806
311	96721	30080231	17.6351921	6.7751690	.003215434
312	97344	30371328	17.6635217	6.7824229	.003205128
313	97969	30664297	17.6918060	6.7896613	.003194889
314	98596	30959144	17.7200451	6.7968844	.003184713
315	99225	31255875	17.7482393	6.8040921	.003174603
316	99856	31554496	17.7763888	6.8112847	.003164557
317	100489	31855013	17.8044938	6.8184620	.003154574
318	101124	32157432	17.8325545	6.8256242	.003144654
319	101761	32461759	17.8605711	6.8327714	.003134796
320	102400	32768000	17.8885438	6.8399037	.003125000
321	103041	33076161	17.9164729	6.8470213	.003115265
322	103684	33386248	17.9443584	6.8541240	.003105590
323	104329	33698267	17.9722008	6.8612120	.003095975
324	104976	34012224	18.0000000	6.8682855	.003086420
325	105625	34328125	18.0277564	6.8753443	.003076923
326	106276	34645976	18.0554701	6.8823888	.003067485
327	106929	34965783	18.0831413	6.8894188	.003058104
328	107584	35287552	18.1107703	6.8964345	.003048780
329	108241	35611289	18.1383571	6.9034359	.003039514
330	108900	35937000	18.1659021	6.9104232	.003030303
331	109561	36264691	18.1934054	6.9173964	.003021148
332	110224	36594368	18.2208672	6.9243556	.003012048
333	110889	36926037	18.2482876	6.9313008	.003003003
334	111556	37259704	18.2756669	6.9382321	.002994012
335	112225	37595375	18.3030052	6.9451496	.002985075
336	112896	37933056	18.3303028	6.9520533	.002976190
337	113569	38272753	18.3575598	6.9589434	.002967359
338	114244	38614472	18.3847763	6.9658198	.002958580
339	114921	38958219	18.4119526	6.9726826	.002949853
340	115600	39304000	18.4390889	6.9795321	.002941176
341	116281	39651821	18.4661853	6.9863681	.002932551
342	116964	40001688	18.4932420	6.9931906	.002923977
343	117649	40353607	18.5202592	7.0000000	.002915452
344	118336	40707584	18.5472370	7.0067962	.002906977
345	119025	41063625	18.5741756	7.0135791	.002898551
346	119716	41421736	18.6010752	7.0203490	.002890173
347	120409	41781923	18.6279360	7.0271058	.002881844
348	121104	42144192	18.6547581	7.0338497	.002873563
349	121801	42508549	18.6815417	7.0405806	.002865330
350	122500	42875000	18.7082869	7.0472987	.002857143
351	123201	43243551	18.7349940	7.0540041	.002849003
352	123904	43614208	18.7616630	7.0606967	.002840909
353	124609	43986977	18.7882942	7.0673767	.002832861
354	125316	44361864	18.8148877	7.0740440	.002824859
355	126025	44738875	18.8414437	7.0806988	.002816901
356	126736	45118016	18.8679623	7.0873411	.002808989
357	127449	45499293	18.8944436	7.0939709	.002801120
358	128164	45882712	18.9208879	7.1005885	.002793296
359	128881	46268279	18.9472953	7.1071937	.002785515

**SQUARES, CUBES, SQUARE ROOTS,
CUBE ROOTS AND RECIPROCAL.**

No.	Squares.	Cubes.	Square Roots.	Cube Roots.	Reciprocals.
360	129600	46656000	18.9736660	7.1137866	.002777778
361	130321	47045881	19.0000000	7.1203674	.002770083
362	131044	47437928	19.0262976	7.1269360	.002762431
363	131769	47832147	19.0525589	7.1334925	.002754821
364	132496	48225444	19.0787840	7.1400370	.002747253
365	133225	48627125	19.1049732	7.1465695	.002739726
366	133956	49027896	19.1311265	7.1530901	.002732240
367	134689	49430863	19.1572441	7.1595988	.002724796
368	135424	49836032	19.1833261	7.1660957	.002717391
369	136161	50243409	19.2093727	7.1725809	.002710027
370	136900	50653000	19.2353841	7.1790544	.002702703
371	137641	51064811	19.2613603	7.1855162	.002695418
372	138384	51478848	19.2873015	7.1919663	.002688172
373	139129	51895117	19.3132079	7.1984050	.002680965
374	139876	52313624	19.3390796	7.2048322	.002673797
375	140625	52734375	19.3649167	7.2112479	.002666667
376	141376	53157376	19.3907194	7.2176522	.002659574
377	142129	53582633	19.4164878	7.2240450	.002652520
378	142884	54010152	19.4422221	7.2304268	.002645503
379	143641	54439939	19.4679223	7.2367972	.002638522
380	144400	54872000	19.4935887	7.2431565	.002631579
381	145161	55306341	19.5192213	7.2495045	.002624672
382	145924	55742968	19.5448203	7.2558415	.002617801
383	146689	56181887	19.5703858	7.2621675	.002610966
384	147456	56623104	19.5959179	7.2684824	.002604167
385	148225	57066625	19.6214169	7.2747864	.002597403
386	148996	57512456	19.6468827	7.2810794	.002590674
387	149769	57960603	19.6723156	7.2873617	.002583979
388	150544	58411072	19.6977156	7.2936330	.002577320
389	151321	58863869	19.7230829	7.2998936	.002570694
390	152100	59319000	19.7484177	7.3061436	.002564103
391	152881	59776471	19.7737199	7.3123828	.002557545
392	153664	60236288	19.7989899	7.3186114	.002551020
393	154449	60698457	19.8242276	7.3248295	.002544529
394	155236	61162984	19.8494332	7.3310369	.002538071
395	156025	61629875	19.8746069	7.3372339	.002531646
396	156816	62099136	19.8997487	7.3434205	.002525253
397	157609	62570773	19.9248588	7.3495966	.002518892
398	158404	63044792	19.9499373	7.3557624	.002512563
399	159201	63521199	19.9749844	7.3619178	.002506266
400	160000	64000000	20.0000000	7.3680630	.002500000
401	160801	64481201	20.0249844	7.3741979	.002493766
402	161604	64964808	20.0499377	7.3803227	.002487562
403	162409	65450827	20.0748599	7.3864373	.002481390
404	163216	65939264	20.0997512	7.3925418	.002475248
405	164025	66430125	20.1246118	7.3986363	.002469136
406	164836	66923416	20.1494417	7.4047206	.002463054
407	165649	67419143	20.1742410	7.4107950	.002457002
408	166464	67917312	20.1990099	7.4168595	.002450980
409	167281	68417929	20.2237484	7.4229142	.002444988
410	168100	68921000	20.2484567	7.4289589	.002439024
411	168921	69426531	20.2731349	7.4349938	.002433090
412	169744	69934528	20.2977831	7.4410189	.002427184
413	170569	70444997	20.3224014	7.4470342	.002421308
414	171396	70957944	20.3469899	7.4530399	.002415459
415	172225	71473375	20.3715488	7.4590359	.002409639
416	173056	71991296	20.3960781	7.4650223	.002403846
417	173889	72511713	20.4205779	7.4709991	.002398082
418	174724	73034632	20.4450483	7.4769664	.002392344
419	175561	73560059	20.4694895	7.4829242	.002386635

SQUARES, CUBES, SQUARE ROOTS, CUBE ROOTS AND RECIPROCAL.

No.	Squares.	Cubes.	Square Roots.	Cube Roots.	Reciprocals.
420	176400	74088000	20.4939015	7.4888724	.002380952
421	177241	74618461	20.5182845	7.4948113	.002375297
422	178084	75151448	20.5426386	7.5007406	.002369668
423	178929	75686967	20.5669638	7.5066607	.002364066
424	179776	76225024	20.5912603	7.5125715	.002358491
425	180625	76765625	20.6155281	7.5184730	.002352941
426	181476	77308776	20.6397674	7.5243652	.002347418
427	182329	77854483	20.6639783	7.5302482	.002341920
428	183184	78402752	20.6881609	7.5361221	.002336449
429	184041	78953589	20.7123152	7.5419867	.002331002
430	184900	79507000	20.7364414	7.5478423	.002325581
431	185761	80062991	20.7605395	7.5536888	.002320186
432	186624	80621568	20.7846097	7.5595263	.002314815
433	187489	81182737	20.8086520	7.5653548	.002309469
434	188356	81746504	20.8326667	7.5711743	.002304147
435	189225	82312875	20.8566536	7.5769849	.002298851
436	190096	82881856	20.8806130	7.5827865	.002293578
437	190969	83453453	20.9045450	7.5885793	.002288330
438	191844	84027672	20.9284495	7.5943633	.002283105
439	192721	84604519	20.9523268	7.6001385	.002277904
440	193600	85184000	20.9761770	7.6059049	.002272727
441	194481	85766121	21.0000000	7.6116626	.002267574
442	195364	86350888	21.0237960	7.6174116	.002262443
443	196249	86938307	21.0475652	7.6231519	.002257336
444	197136	87528384	21.0713075	7.6288837	.002252252
445	198025	88121125	21.0950231	7.6346067	.002247191
446	198916	88716536	21.1187121	7.6403213	.002242152
447	199809	89314623	21.1423745	7.6460272	.002237136
448	200704	89915392	21.1660105	7.6517247	.002232143
449	201601	90518849	21.1896201	7.6574138	.002227171
450	202500	91125000	21.2132034	7.6630943	.002222222
451	203401	91733851	21.2367606	7.6687665	.002217295
452	204304	92345408	21.2602916	7.6744303	.002212389
453	205209	92959677	21.2837967	7.6800857	.002207506
454	206116	93576664	21.3072758	7.6857328	.002202643
455	207025	94196375	21.3307290	7.6913717	.002197802
456	207936	94818816	21.3541565	7.6970023	.002192982
457	208849	95443993	21.3775583	7.7026246	.002188184
458	209764	96071912	21.4009346	7.7082388	.002183406
459	210681	96702579	21.4242853	7.7138448	.002178649
460	211600	97336000	21.4476106	7.7194426	.002173913
461	212521	97972181	21.4709106	7.7250325	.002169197
462	213444	98611128	21.4941853	7.7306141	.002164502
463	214369	99252847	21.5174348	7.7361877	.002159827
464	215296	99897344	21.5406592	7.7417532	.002155172
465	216225	100544625	21.5638587	7.7473109	.002150538
466	217156	101194696	21.5870331	7.7528606	.002145923
467	218089	101847563	21.6101828	7.7584023	.002141328
468	219024	102503232	21.6333077	7.7639361	.002136752
469	219961	103161709	21.6564078	7.7694620	.002132196
470	220900	103823000	21.6794834	7.7749801	.002127660
471	221841	104487111	21.7025344	7.7804904	.002123142
472	222784	105154048	21.7255610	7.7859928	.002118644
473	223729	105823817	21.7485632	7.7914875	.002114165
474	224676	106496424	21.7715411	7.7969745	.002109705
475	225625	107171875	21.7944947	7.8024538	.002105263
476	226576	107850176	21.8174242	7.8079254	.002100840
477	227529	108531333	21.8403297	7.8133892	.002096436
478	228484	109215352	21.8632111	7.8188456	.002092050
479	229441	109902239	21.8860686	7.8242942	.002087683

**SQUARES, CUBES, SQUARE ROOTS,
CUBE ROOTS AND RECIPROCAL.**

No.	Squares.	Cubes.	Square Roots.	Cube Roots.	Reciprocals.
480	230400	110592000	21.9089023	7.8297353	.002083333
481	231361	111284641	21.9317122	7.8351688	.002079002
482	232324	111980168	21.9544984	7.8405949	.002074689
483	233289	112678587	21.9772610	7.8460134	.002070393
484	234256	113379904	22.0000000	7.8514244	.002066116
485	235225	114084125	22.0227155	7.8568281	.002061856
486	236196	114791256	22.0454077	7.8622242	.002057613
487	237169	115501303	22.0680765	7.8676130	.002053388
488	238144	116214272	22.0907220	7.8729944	.002049180
489	239121	116930169	22.1133444	7.8783684	.002044990
490	240100	117649000	22.1359436	7.8837352	.002040816
491	241081	118370771	22.1585198	7.8890946	.002036660
492	242064	119095488	22.1810730	7.8944468	.002032520
493	243049	119823157	22.2036033	7.8997917	.002028398
494	244036	120553784	22.2261108	7.9051294	.002024291
495	245025	121287375	22.2485955	7.9104599	.002020202
496	246016	122023936	22.2710575	7.9157832	.002016129
497	247009	122763473	22.2934968	7.9210994	.002012072
498	248004	123505992	22.3159136	7.9264085	.002008032
499	249001	124251499	22.3383079	7.9317104	.002004008
500	250000	125000000	22.3606798	7.9370053	.002000000
501	251001	125751501	22.3830293	7.9422931	.001996008
502	252004	126506008	22.4053565	7.9475739	.001992032
503	253009	127263527	22.4276615	7.9528477	.001988072
504	254016	128024064	22.4499443	7.9581144	.001984127
505	255025	128787625	22.4722051	7.9633743	.001980198
506	256036	129554216	22.4944438	7.9686271	.001976285
507	257049	130323843	22.5166605	7.9738731	.001972387
508	258064	131096512	22.5388553	7.9791122	.001968504
509	259081	131872229	22.5610283	7.9843444	.001964637
510	260100	132651000	22.5831796	7.9895697	.001960784
511	261121	133432831	22.6053091	7.9947883	.001956947
512	262144	134217728	22.6274170	8.0000000	.001953125
513	263169	135005697	22.6495033	8.0052049	.001949318
514	264196	135796744	22.6715681	8.0104032	.001945525
515	265225	136590875	22.6936114	8.0155946	.001941748
516	266256	137388096	22.7156334	8.0207794	.001937984
517	267289	138188413	22.7376340	8.0259574	.001934236
518	268324	138991832	22.7596134	8.0311287	.001930502
519	269361	139798359	22.7815715	8.0362935	.001926782
520	270400	140608000	22.8035085	8.0414515	.001923077
521	271441	141420761	22.8254244	8.0466030	.001919386
522	272484	142236648	22.8473193	8.0517479	.001915709
523	273529	143055667	22.8691933	8.0568862	.001912046
524	274576	143877824	22.8910463	8.0620180	.001908397
525	275625	144703125	22.9128785	8.0671432	.001904762
526	276676	145531576	22.9346899	8.0722620	.001901141
527	277729	146363183	22.9564806	8.0773743	.001897533
528	278784	147197952	22.9782506	8.0824800	.001893939
529	279841	148035889	23.0000000	8.0875794	.001890359
530	280900	148877000	23.0217289	8.0926723	.001886792
531	281961	149721291	23.0434372	8.0977589	.001883239
532	283024	150568768	23.0651252	8.1028390	.001879699
533	284089	151419437	23.0867928	8.1079128	.001876173
534	285156	152273304	23.1084400	8.1129803	.001872659
535	286225	153130375	23.1300670	8.1180414	.001869159
536	287296	153990656	23.1516738	8.1230962	.001865672
537	288369	154854153	23.1732605	8.1281447	.001862197
538	289444	155720872	23.1948270	8.1331870	.001858736
539	290521	156590819	23.2163735	8.1382230	.001855288

SQUARES, CUBES, SQUARE ROOTS, CUBE ROOTS AND RECIPROCAL.

No.	Squares.	Cubes.	Square Roots.	Cube Roots.	Reciprocals.
540	291600	157464000	23.2379001	8.1432529	.001851852
541	292681	158340421	23.2594067	8.1482765	.001848429
542	293764	159220088	23.2808935	8.1532939	.001845018
543	294849	160103007	23.3023604	8.1583051	.001841621
544	295936	160989184	23.3238076	8.1633102	.001838235
545	297025	161878625	23.3452351	8.1683092	.001834862
546	298116	162771336	23.3666429	8.1733020	.001831502
547	299209	163667323	23.3880311	8.1782888	.001828154
548	300304	164566592	23.4093993	8.1832695	.001824818
549	301401	165469149	23.4307490	8.1882441	.001821494
550	302500	166375000	23.4520788	8.1932127	.001818182
551	303601	167284151	23.4733892	8.1981753	.001814882
552	304704	168196608	23.4946802	8.2031319	.001811594
553	305809	169112377	23.5159520	8.2080825	.001808317
554	306916	170031464	23.5372046	8.2130271	.001805054
555	308025	170953875	23.5584380	8.2179657	.001801802
556	309136	171879616	23.5796522	8.2228985	.001798561
557	310249	172808693	23.6008474	8.2278254	.001795332
558	311364	173741112	23.6220236	8.2327463	.001792115
559	312481	174676879	23.6431808	8.2376614	.001788909
560	313600	175616000	23.6643191	8.2425706	.001785714
561	314721	176558481	23.6854386	8.2474740	.001782531
562	315844	177504328	23.7065392	8.2523715	.001779359
563	316969	178453547	23.7276210	8.2572633	.001776199
564	318096	179406144	23.7486842	8.2621492	.001773050
565	319225	180362125	23.7697286	8.2670294	.001769912
566	320356	181321496	23.7907545	8.2719039	.001766784
567	321489	182284263	23.8117618	8.2767726	.001763668
568	322624	183250432	23.8327506	8.2816355	.001760563
569	323761	184220009	23.8537209	8.2864928	.001757469
570	324900	185193000	23.8746728	8.2913444	.001754386
571	326041	186169411	23.8956063	8.2961903	.001751313
572	327184	187149248	23.9165215	8.3010304	.001748252
573	328329	188132517	23.9374184	8.3058651	.001745201
574	329476	189119224	23.9582971	8.3106994	.001742160
575	330625	190109375	23.9791576	8.3155175	.001739130
576	331776	191102976	24.0000000	8.3203353	.001736111
577	332929	192100033	24.0208243	8.3251475	.001733102
578	334084	193100552	24.0416306	8.3299542	.001730104
579	335241	194104539	24.0624188	8.3347553	.001727116
580	336400	195112000	24.0831891	8.3395509	.001724138
581	337561	196122941	24.1039416	8.3443410	.001721170
582	338724	197137368	24.1246762	8.3491256	.001718213
583	339889	198155287	24.1453929	8.3539047	.001715266
584	341056	199176704	24.1660919	8.3586784	.001712329
585	342225	200201625	24.1867732	8.3634466	.001709402
586	343396	201230056	24.2074369	8.3682095	.001706485
587	344569	202262003	24.2280829	8.3729668	.001703578
588	345744	203297472	24.2487113	8.3777188	.001700680
589	346921	204336469	24.2693222	8.3824653	.001697793
590	348100	205379000	24.2899156	8.3872065	.001694915
591	349281	206425071	24.3104916	8.3919423	.001692047
592	350464	207474688	24.3310501	8.3966729	.001689189
593	351649	208527857	24.3515913	8.4013981	.001686341
594	352836	209584584	24.3721152	8.4061180	.001683502
595	354025	210644875	24.3926218	8.4108326	.001680672
596	355216	211708736	24.4131112	8.4155419	.001677852
597	356409	212776173	24.4335834	8.4202460	.001675042
598	357604	213847192	24.4540385	8.4249448	.001672241
599	358801	214921799	24.4744765	8.4296383	.001669449

SQUARES, CUBES, SQUARE ROOTS, CUBE ROOTS AND RECIPROCAL.

No.	Squares.	Cubes.	Square Roots.	Cube Roots.	Reciprocals.
600	360000	216000000	24.4948974	8.4343267	.001666667
601	361201	217081801	24.5153013	8.4390098	.001663894
602	362404	218167208	24.5356883	8.4436877	.001661130
603	363609	219256227	24.5560583	8.4483605	.001658375
604	364816	220348864	24.5764115	8.4530281	.001655629
605	366025	221445125	24.5967478	8.4576906	.001652893
606	367236	222545016	24.6170673	8.4623479	.001650165
607	368449	223648543	24.6373700	8.4670001	.001647446
608	369664	224755712	24.6576560	8.4716471	.001644732
609	370881	225866529	24.6779254	8.4762892	.001642036
610	372100	226981000	24.6981781	8.4809261	.001639344
611	373321	228099131	24.7184142	8.4855579	.001636661
612	374544	229220928	24.7386338	8.4901848	.001633987
613	375769	230346397	24.7588368	8.4948065	.001631321
614	376996	231475544	24.7790234	8.4994233	.001628664
615	378225	232608375	24.7991935	8.5040350	.001626016
616	379456	233744896	24.8193473	8.5086417	.001623377
617	380689	234885113	24.8394847	8.5132435	.001620746
618	381924	236029032	24.8596058	8.5178403	.001618123
619	383161	237176659	24.8797106	8.5224321	.001615509
620	384400	238328000	24.8997992	8.5270189	.001612903
621	385641	239483061	24.9198716	8.5316009	.001610306
622	386884	240641848	24.9399278	8.5361780	.001607717
623	388129	241804367	24.9599679	8.5407501	.001605136
624	389376	242970624	24.9799920	8.5453173	.001602564
625	390625	244140625	25.0000000	8.5498797	.001600000
626	391876	245314376	25.0199920	8.5544372	.001597444
627	393129	246491883	25.0399681	8.5589899	.001594896
628	394384	247673152	25.0599282	8.5635377	.001592357
629	395641	248858189	25.0798724	8.5680807	.001589825
630	396900	250047000	25.0998008	8.5726189	.001587302
631	398161	251239591	25.1197134	8.5771523	.001584786
632	399424	252435968	25.1396102	8.5816809	.001582278
633	400689	253636137	25.1594913	8.5862047	.001579779
634	401956	254840104	25.1793566	8.5907238	.001577287
635	403225	256047875	25.1992063	8.5952380	.001574803
636	404496	257259456	25.2190404	8.5997476	.001572327
637	405769	258474853	25.2388589	8.6042525	.001569859
638	407044	259694072	25.2586619	8.6087526	.001567398
639	408321	260917119	25.2784493	8.6132480	.001564945
640	409600	262144000	25.2982213	8.6177388	.001562500
641	410881	263374721	25.3179778	8.6222248	.001560062
642	412164	264609288	25.3377189	8.6267063	.001557632
643	413449	265847707	25.3574447	8.6311830	.001555210
644	414736	267089984	25.3771551	8.6356551	.001552795
645	416025	268336125	25.3968502	8.6401226	.001550388
646	417316	269586136	25.4165301	8.6445855	.001547988
647	418609	270840023	25.4361947	8.6490437	.001545595
648	419904	272097792	25.4558441	8.6534974	.001543210
649	421201	273359449	25.4754784	8.6579465	.001540832
650	422500	274625000	25.4950976	8.6623911	.001538462
651	423801	275894451	25.5147016	8.6668310	.001536098
652	425104	277167808	25.5342907	8.6712665	.001533742
653	426409	278445077	25.5538647	8.6756974	.001531394
654	427716	279726264	25.5734237	8.6801237	.001529052
655	429025	281011375	25.5929678	8.6845456	.001526718
656	430336	282300416	25.6124969	8.6889630	.001524390
657	431649	283593933	25.6320112	8.6933759	.001522070
658	432964	284890312	25.6515107	8.6977843	.001519757
659	434281	286191179	25.6709953	8.7021882	.001517451

SQUARES, CUBES, SQUARE ROOTS, CUBE ROOTS AND RECIPROCAL.

No.	Squares.	Cubes.	Square Roots.	Cube Roots.	Reciprocals.
660	435600	287496000	25.6904652	8.7065877	.001515152
661	436921	288804781	25.7099203	8.7109827	.001512859
662	438244	290117528	25.7293607	8.7153734	.001510574
663	439569	291432427	25.7487864	8.7197596	.001508296
664	440896	292754944	25.7681975	8.7241414	.001506024
665	442225	294079625	25.7875939	8.7285187	.001503759
666	443556	295408296	25.8069758	8.7328918	.001501502
667	444889	296740963	25.8263431	8.7372604	.001499250
668	446224	298077632	25.8456960	8.7416246	.001497006
669	447561	299418309	25.8650343	8.7459846	.001494768
670	448900	300763000	25.8843582	8.7503401	.001492537
671	450241	302111711	25.9036677	8.7546913	.001490313
672	451584	303464448	25.9229628	8.7590383	.001488095
673	452929	304821217	25.9422435	8.7633809	.001485884
674	454276	306182024	25.9615100	8.7677192	.001483680
675	455625	307546875	25.9807621	8.7720532	.001481481
676	456976	308915776	26.0000000	8.7763830	.001479290
677	458329	310288733	26.0192237	8.7807084	.001477105
678	459684	311665752	26.0384331	8.7850293	.001474926
679	461041	313046839	26.0576284	8.7893463	.001472754
680	462400	314432000	26.0768096	8.7936593	.001470588
681	463761	315821241	26.0959767	8.7979679	.001468429
682	465124	317214568	26.1151297	8.8022721	.001466276
683	466489	318611987	26.1342687	8.8065722	.001464129
684	467856	320013504	26.1533937	8.8108681	.001461988
685	469225	321419125	26.1725047	8.8151598	.001459854
686	470596	322828856	26.1916017	8.8194474	.001457726
687	471969	324242703	26.2106848	8.8237307	.001455604
688	473344	325660672	26.2297541	8.8280099	.001453488
689	474721	327082769	26.2488095	8.8322850	.001451379
690	476100	328509000	26.2678511	8.8365559	.001449275
691	477481	329939371	26.2868789	8.8408227	.001447178
692	478864	331373888	26.3058929	8.8450854	.001445087
693	480249	332812557	26.3248932	8.8493440	.001443001
694	481636	334255384	26.3438797	8.8535985	.001440922
695	483025	335702375	26.3628527	8.8578489	.001438849
696	484416	337153536	26.3818119	8.8620952	.001436782
697	485809	338608873	26.4007576	8.8663375	.001434720
698	487204	340068392	26.4196896	8.8705757	.001432665
699	488601	341532099	26.4386081	8.8748099	.001430615
700	490000	343000000	26.4575131	8.8790400	.001428571
701	491401	344472101	26.4764046	8.8832661	.001426534
702	492804	345948408	26.4952826	8.8874882	.001424501
703	494209	347428927	26.5141472	8.8917063	.001422475
704	495616	348913664	26.5329983	8.8959204	.001420455
705	497025	350402625	26.5518361	8.9001304	.001418440
706	498436	351895816	26.5706605	8.9043366	.001416431
707	499849	353393243	26.5894716	8.9085387	.001414427
708	501264	354894912	26.6082694	8.9127369	.001412429
709	502681	356400829	26.6270539	8.9169311	.001410437
710	504100	357911000	26.6458252	8.9211214	.001408451
711	505521	359425431	26.6645833	8.9253078	.001406470
712	506944	360944128	26.6833281	8.9294902	.001404494
713	508369	362467097	26.7020598	8.9336687	.001402525
714	509796	363994344	26.7207784	8.9378433	.001400560
715	511225	365525875	26.7394839	8.9420140	.001398601
716	512656	367061696	26.7581763	8.9461809	.001396648
717	514089	368601813	26.7768557	8.9503438	.001394700
718	515524	370146232	26.7955220	8.9545029	.001392758
719	516961	371694959	26.8141754	8.9586651	.001390821

SQUARES, CUBES, SQUARE ROOTS, CUBE ROOTS AND RECIPROCAL.

No.	Squares.	Cubes.	Square Roots.	Cube Roots.	Reciprocals.
720	518400	373248000	26.8328157	8.9628095	.001388889
721	519841	374805361	26.8514432	8.9669570	.001386963
722	521284	376362704	26.8700577	8.9711007	.001385042
723	522729	377930067	26.8886593	8.9752406	.001383126
724	524176	379503424	26.9072481	8.9793766	.001381215
725	525625	381078125	26.9258240	8.9835089	.001379310
726	527076	382657176	26.9443872	8.9876373	.001377410
727	528529	384240583	26.9629375	8.9917620	.001375516
728	529984	385828352	26.9814751	8.9958829	.001373626
729	531441	387420489	27.0000000	9.0000000	.001371742
730	532900	389017000	27.0185122	9.0041134	.001369863
731	534361	390617891	27.0370117	9.0082229	.001367989
732	535824	392223168	27.0554985	9.0123288	.001366120
733	537289	393832837	27.0739727	9.0164309	.001364256
734	538756	395446904	27.0924344	9.0205293	.001362398
735	540225	397065375	27.1108834	9.0246239	.001360544
736	541696	398688256	27.1293199	9.0287149	.001358696
737	543169	400315553	27.1477439	9.0328021	.001356852
738	544644	401947272	27.1661554	9.0368857	.001355014
739	546121	403583419	27.1845544	9.0409655	.001353180
740	547600	405224000	27.2029410	9.0450417	.001351351
741	549081	406869021	27.2213152	9.0491142	.001349528
742	550564	408518488	27.2396769	9.0531831	.001347709
743	552049	410172407	27.2580263	9.0572482	.001345895
744	553536	411830784	27.2763634	9.0613098	.001344086
745	555025	413493625	27.2946881	9.0653677	.001342282
746	556516	415160936	27.3130006	9.0694220	.001340483
747	558009	416832723	27.3313007	9.0734726	.001338688
748	559504	418508992	27.3495887	9.0775197	.001336898
749	561001	420189749	27.3678644	9.0815631	.001335113
750	562500	421875000	27.3861279	9.0856030	.001333333
751	564001	423564751	27.4043792	9.0896392	.001331558
752	565504	425259008	27.4226184	9.0936719	.001329787
753	567009	426957777	27.4408455	9.0977010	.001328021
754	568516	428661064	27.4590604	9.1017265	.001326260
755	570025	430368875	27.4772633	9.1057485	.001324503
756	571536	432081216	27.4954542	9.1097669	.001322751
757	573049	433798093	27.5136330	9.1137818	.001321004
758	574564	435519512	27.5317998	9.1177931	.001319261
759	576081	437245479	27.5499546	9.1218010	.001317523
760	577600	438976000	27.5680975	9.1258053	.001315789
761	579121	440711081	27.5862284	9.1298061	.001314060
762	580644	442450728	27.6043475	9.1338034	.001312336
763	582169	444194947	27.6224546	9.1377971	.001310616
764	583696	445943744	27.6405499	9.1417874	.001308901
765	585225	447697125	27.6586334	9.1457742	.001307190
766	586756	449455096	27.6767050	9.1497576	.001305483
767	588289	451217663	27.6947648	9.1537375	.001303781
768	589824	452984832	27.7128129	9.1577139	.001302083
769	591361	454756609	27.7308492	9.1616869	.001300390
770	592900	456533000	27.7488739	9.1656565	.001298701
771	594441	458314011	27.7668868	9.1696225	.001297017
772	595984	460099648	27.7848880	9.1735852	.001295337
773	597529	461889917	27.8028775	9.1775445	.001293661
774	599076	463684824	27.8208555	9.1815003	.001291990
775	600625	465484375	27.8388218	9.1854527	.001290323
776	602176	467288576	27.8567766	9.1894018	.001288660
777	603729	469097433	27.8747197	9.1933474	.001287001
778	605284	470910952	27.8926514	9.1972897	.001285347
779	606841	472729139	27.9105715	9.2012286	.001283697

SQUARES, CUBES, SQUARE ROOTS, CUBE ROOTS AND RECIPROCAL.

No.	Squares.	Cubes.	Square Roots.	Cube Roots.	Reciprocals.
780	608400	474552000	27.9284801	9.2051641	.001282051
781	609961	476379541	27.9463772	9.2090962	.001280410
782	611524	478211768	27.9642629	9.2130250	.001278772
783	613089	480048687	27.9821372	9.2169505	.001277139
784	614656	481890304	28.0000000	9.2208726	.001275510
785	616225	483736625	28.0178515	9.2247914	.001273885
786	617796	485587656	28.0356915	9.2287068	.001272265
787	619369	487443403	28.0535203	9.2326189	.001270648
788	620944	489303872	28.0713377	9.2365277	.001269036
789	622521	491169069	28.0891438	9.2404333	.001267427
790	624100	493039000	28.1069386	9.2443355	.001265823
791	625681	494913671	28.1247222	9.2482344	.001264223
792	627264	496793088	28.1424946	9.2521300	.001262626
793	628849	498677257	28.1602557	9.2560224	.001261034
794	630436	500566184	28.1780056	9.2599114	.001259446
795	632025	502459875	28.1957444	9.2637973	.001257862
796	633616	504358336	28.2134720	9.2676798	.001256281
797	635209	506261573	28.2311884	9.2715592	.001254705
798	636804	508169592	28.2488938	9.2754352	.001253133
799	638401	510082399	28.2665881	9.2793081	.001251564
800	640000	512000000	28.2842712	9.2831777	.001250000
801	641601	513922401	28.3019434	9.2870440	.001248439
802	643204	515849608	28.3196045	9.2909072	.001246883
803	644809	517781627	28.3372546	9.2947671	.001245330
804	646416	519718464	28.3548938	9.2986239	.001243781
805	648025	521660125	28.3725219	9.3024775	.001242236
806	649636	523606616	28.3901391	9.3063278	.001240695
807	651249	525557943	28.4077454	9.3101750	.001239157
808	652864	527514112	28.4253408	9.3140190	.001237624
809	654481	529475129	28.4429253	9.3178599	.001236094
810	656100	531441000	28.4604989	9.3216975	.001234568
811	657721	533411731	28.4780617	9.3255320	.001233046
812	659344	535387328	28.4956137	9.3293634	.001231527
813	660969	537367797	28.5131549	9.3331916	.001230012
814	662596	539353144	28.5306852	9.3370167	.001228501
815	664225	541343375	28.5482048	9.3408386	.001226994
816	665856	543338496	28.5657137	9.3446575	.001225490
817	667489	545338513	28.5832119	9.3484731	.001223989
818	669124	547343432	28.6006993	9.3522857	.001222494
819	670761	549353259	28.6181760	9.3560952	.001221001
820	672400	551368000	28.6356421	9.3599016	.001219512
821	674041	553387661	28.6530976	9.3637049	.001218027
822	675684	555412248	28.6705424	9.3675051	.001216545
823	677329	557441767	28.6879766	9.3713022	.001215067
824	678976	559476224	28.7054002	9.3750963	.001213592
825	680625	561515625	28.7228132	9.3788873	.001212121
826	682276	563559976	28.7402157	9.3826752	.001210654
827	683929	565609283	28.7576077	9.3864600	.001209190
828	685584	567663552	28.7749891	9.3902419	.001207729
829	687241	569722789	28.7923601	9.3940206	.001206273
830	688900	571787000	28.8097206	9.3977964	.001204819
831	690561	573856191	28.8270706	9.4015691	.001203369
832	692224	575930368	28.8444102	9.4053387	.001201923
833	693889	578009537	28.8617394	9.4091054	.001200480
834	695556	580093704	28.8790582	9.4128690	.001199041
835	697225	582182875	28.8963666	9.4166297	.001197605
836	698896	584277056	28.9136646	9.4203873	.001196172
837	700569	586376253	28.9309523	9.4241420	.001194743
838	702244	588480472	28.9482297	9.4278936	.001193317
839	703921	590589719	28.9654967	9.4316423	.001191895

SQUARES, CUBES, SQUARE ROOTS, CUBE ROOTS AND RECIPROCAL.

No.	Squares.	Cubes.	Square Roots.	Cube Roots.	Reciprocals.
840	705600	592704000	28.9827535	9.4353880	.001190476
841	707281	594823321	29.0000000	9.4391307	.001189061
842	708964	596947688	29.0172363	9.4428704	.001187648
843	710649	599077107	29.0344823	9.4466072	.001186240
844	712336	601211584	29.0516781	9.4503410	.001184834
845	714025	603351125	29.0688837	9.4540719	.001183432
846	715716	605495736	29.0860791	9.4577999	.001182033
847	717409	607645423	29.1032644	9.4615249	.001180638
848	719104	609800192	29.1204396	9.4652470	.001179245
849	720801	611960049	29.1376046	9.4689661	.001177856
850	722500	614125000	29.1547595	9.4726824	.001176471
851	724201	616295051	29.1719043	9.4763957	.001175088
852	725904	618470208	29.1890390	9.4801061	.001173709
853	727609	620650477	29.2061637	9.4838136	.001172333
854	729316	622835864	29.2232784	9.4875182	.001170960
855	731025	625026375	29.2403830	9.4912200	.001169591
856	732736	627222016	29.2574777	9.4949188	.001168224
857	734449	629422793	29.2745623	9.4986147	.001166861
858	736164	631628712	29.2916370	9.5023078	.001165501
859	737881	633839779	29.3087018	9.5059980	.001164144
860	739600	636056000	29.3257566	9.5096854	.001162791
861	741321	638277381	29.3428015	9.5133699	.001161440
862	743044	640503928	29.3598365	9.5170515	.001160093
863	744769	642735647	29.3768616	9.5207303	.001158749
864	746496	644972544	29.3938769	9.5244063	.001157407
865	748225	647214625	29.4108823	9.5280794	.001156069
866	749956	649461896	29.4278779	9.5317497	.001154734
867	751689	651714363	29.4448637	9.5354172	.001153403
868	753424	653972032	29.4618397	9.5390818	.001152074
869	755161	656234909	29.4788059	9.5427437	.001150748
870	756900	658503000	29.4957624	9.5464027	.001149425
871	758641	660776311	29.5127091	9.5500589	.001148106
872	760384	663054848	29.5296461	9.5537123	.001146789
873	762129	665338617	29.5465734	9.5573630	.001145475
874	763876	667627624	29.5634910	9.5610108	.001144165
875	765625	669921875	29.5803989	9.5646559	.001142857
876	767376	672221376	29.5972972	9.5682982	.001141553
877	769129	674526133	29.6141858	9.5719377	.001140251
878	770884	676836152	29.6310648	9.5755745	.001138952
879	772641	679151439	29.6479342	9.5792085	.001137656
880	774400	681472000	29.6647939	9.5828397	.001136364
881	776161	683797841	29.6816442	9.5864682	.001135074
882	777924	686128968	29.6984848	9.5900939	.001133787
883	779689	688465387	29.7153159	9.5937169	.001132503
884	781456	690807104	29.7321375	9.5973373	.001131222
885	783225	693154125	29.7489496	9.6009548	.001129944
886	784996	695506456	29.7657521	9.6045696	.001128668
887	786769	697864103	29.7825452	9.6081817	.001127396
888	788544	700227072	29.7993289	9.6117911	.001126126
889	790321	702595369	29.8161030	9.6153977	.001124859
890	792100	704969000	29.8328678	9.6190017	.001123596
891	793881	707347971	29.8496231	9.6226030	.001122334
892	795664	709732288	29.8663690	9.6262016	.001121076
893	797449	712121957	29.8831056	9.6297975	.001119821
894	799236	714516984	29.8998328	9.6333907	.001118568
895	801025	716917375	29.9165506	9.6369812	.001117318
896	802816	719323136	29.9332591	9.6405690	.001116071
897	804609	721734273	29.9499583	9.6441542	.001114827
898	806404	724150792	29.9666481	9.6477367	.001113586
899	808201	726572699	29.9833287	9.6513166	.001112347

SQUARES, CUBES, SQUARE ROOTS, CUBE ROOTS AND RECIPROCAL.

No.	Squares.	Cubes.	Square Roots.	Cube Roots.	Reciprocals.
900	810000	729000000	30.0000000	9.6548938	.001111111
901	811801	731432701	30.0166620	9.6584684	.001109878
902	813604	733870808	30.0333148	9.6620403	.001108647
903	815409	736314327	30.0499584	9.6656096	.001107420
904	817216	738763264	30.0665928	9.6691762	.001106195
905	819025	741217625	30.0832179	9.6727403	.001104972
906	820836	743677416	30.0998339	9.6763017	.001103753
907	822649	746142643	30.1164407	9.6798604	.001102536
908	824464	748613312	30.1330383	9.6834166	.001101322
909	826281	751089429	30.1496269	9.6869701	.001100110
910	828100	753571000	30.1662063	9.6905211	.001098901
911	829921	756058031	30.1827765	9.6940694	.001097695
912	831744	758550528	30.1993377	9.6976151	.001096491
913	833569	761048497	30.2158899	9.7011583	.001095290
914	835396	763551944	30.2324329	9.7046989	.001094092
915	837225	766060875	30.2489669	9.7082369	.001092896
916	839056	768575296	30.2654919	9.7117723	.001091703
917	840889	771095213	30.2820079	9.7153051	.001090513
918	842724	773620632	30.2985148	9.7188354	.001089325
919	844561	776151559	30.3150128	9.7223631	.001088139
920	846400	778688000	30.3315018	9.7258883	.001086957
921	848241	781229961	30.3479818	9.7294109	.001085776
922	850084	783777448	30.3644529	9.7329309	.001084599
923	851929	786330467	30.3809151	9.7364484	.001083424
924	853776	788889024	30.3973683	9.7399634	.001082251
925	855625	791453125	30.4138127	9.7434758	.001081081
926	857476	794022776	30.4302481	9.7469857	.001079914
927	859329	796597983	30.4466747	9.7504930	.001078749
928	861184	799178752	30.4630924	9.7539979	.001077588
929	863041	801765089	30.4795013	9.7575002	.001076426
930	864900	804357000	30.4959014	9.7610001	.001075269
931	866761	806954491	30.5122926	9.7644974	.001074114
932	868624	809557568	30.5286750	9.7679922	.001072961
933	870489	812166237	30.5450487	9.7714845	.001071811
934	872356	814780504	30.5614136	9.7749743	.001070664
935	874225	817400375	30.5777697	9.7784616	.001069519
936	876096	820025856	30.5941171	9.7819466	.001068376
937	877969	822656953	30.6104557	9.7854288	.001067236
938	879844	825293672	30.6267857	9.7889087	.001066098
939	881721	827936019	30.6431069	9.7923861	.001064963
940	883600	830584000	30.6594194	9.7958611	.001063830
941	885481	833237621	30.6757233	9.7993336	.001062699
942	887364	835896888	30.6920185	9.8028036	.001061571
943	889249	838561807	30.7083051	9.8062711	.001060445
944	891136	841232384	30.7245830	9.8097362	.001059322
945	893025	843908525	30.7408523	9.8131989	.001058201
946	894916	846590536	30.7571130	9.8166591	.001057082
947	896809	849278123	30.7733651	9.8201169	.001055966
948	898704	851971392	30.7896086	9.8235723	.001054852
949	900601	854670349	30.8058436	9.8270252	.001053741
950	902500	857375000	30.8220700	9.8304757	.001052632
951	904401	860085351	30.8382879	9.8339238	.001051525
952	906304	862801408	30.8544972	9.8373695	.001050420
953	908209	865523177	30.8706981	9.8408127	.001049318
954	910116	868250664	30.8868904	9.8442536	.001048218
955	912025	870983875	30.9030743	9.8476920	.001047120
956	913936	873722816	30.9192497	9.8511280	.001046025
957	915849	876467493	30.9354166	9.8545617	.001044932
958	917764	879217912	30.9515751	9.8579929	.001043841
959	919681	881974079	30.9677251	9.8614218	.001042753

**SQUARES, CUBES, SQUARE ROOTS,
CUBE ROOTS AND RECIPROCAL.**

No.	Squares.	Cubes.	Square Roots.	Cube Roots.	Reciprocals.
960	921600	884736000	30.9838668	9.8648483	.001041667
961	923521	887503681	31.0000000	9.8682724	.001040583
962	925444	890277128	31.0161248	9.8716941	.001039501
963	927369	893056347	31.0322413	9.8751135	.001038422
964	929296	895841344	31.0483494	9.8785305	.001037344
965	931225	898632125	31.0644491	9.8819451	.001036269
966	933156	901428696	31.0805405	9.8853574	.001035197
967	935089	904231063	31.0966236	9.8887673	.001034126
968	937024	907039232	31.1126984	9.8921749	.001033058
969	938961	909853209	31.1287648	9.8955801	.001031992
970	940900	912673000	31.1448230	9.8989830	.001030928
971	942841	915498611	31.1608729	9.9023835	.001029866
972	944784	918330048	31.1769145	9.9057817	.001028807
973	946729	921167317	31.1929479	9.9091776	.001027749
974	948676	924010424	31.2089731	9.9125712	.001026694
975	950625	926859375	31.2249900	9.9159624	.001025641
976	952576	929714176	31.2409987	9.9193513	.001024590
977	954529	932574833	31.2569992	9.9227379	.001023541
978	956484	935441352	31.2729915	9.9261222	.001022495
979	958441	938313739	31.2889757	9.9295042	.001021450
980	960400	941192000	31.3049517	9.9328839	.001020408
981	962361	944076141	31.3209195	9.9362613	.001019363
982	964324	946966168	31.3368792	9.9396363	.001018330
983	966289	949862087	31.3528308	9.9430092	.001017294
984	968256	952763904	31.3687743	9.9463797	.001016260
985	970225	955671625	31.3847097	9.9497479	.001015228
986	972196	958585256	31.4006369	9.9531138	.001014199
987	974169	961504803	31.4165561	9.9564775	.001013171
988	976144	964430272	31.4324673	9.9598389	.001012146
989	978121	967361669	31.4483704	9.9631981	.001011122
990	980100	970299000	31.4642654	9.9665549	.001010101
991	982081	973242271	31.4801525	9.9699095	.001009082
992	984064	976191488	31.4960315	9.9732619	.001008065
993	986049	979146657	31.5119025	9.9766120	.001007049
994	988036	982107784	31.5277655	9.9799599	.001006036
995	990025	985074875	31.5436206	9.9833055	.001005025
996	992016	988047936	31.5594677	9.9866488	.001004016
997	994009	991026973	31.5753068	9.9899900	.001003009
998	996004	994011992	31.5911380	9.9933289	.001002004
999	998001	997002999	31.6069613	9.9966656	.001001001
1000	1000000	1000000000	31.6227766	10.0000000	.001000000
1001	1002001	1003003001	31.6385840	10.0033322	.0009990010
1002	1004004	1006012008	31.6543836	10.0066622	.0009980040
1003	1006009	1009027027	31.6701752	10.0099899	.0009970090
1004	1008016	1012048064	31.6859590	10.0133155	.0009960159
1005	1010025	1015075125	31.7017349	10.0166389	.0009950249
1006	1012036	1018108216	31.7175030	10.0199601	.0009940358
1007	1014049	1021147343	31.7332633	10.0232791	.0009930487
1008	1016064	1024192512	31.7490157	10.0265958	.0009920635
1009	1018081	1027243729	31.7647603	10.0299104	.0009910803
1010	1020100	1030301000	31.7804972	10.0332228	.0009900990
1011	1022121	1033364331	31.7962262	10.0365330	.0009891197
1012	1024144	1036433728	31.8119474	10.0398410	.0009881423
1013	1026169	1039509197	31.8276609	10.0431469	.0009871668
1014	1028196	1042590744	31.8433666	10.0464506	.0009861933
1015	1030225	1045678375	31.8590646	10.0497521	.0009852217
1016	1032256	1048772096	31.8747549	10.0530514	.0009842520
1017	1034289	1051871913	31.8904374	10.0563485	.0009832842
1018	1036324	1054977832	31.9061123	10.0596435	.0009823183
1019	1038361	1058089859	31.9217794	10.0629364	.0009813543

SQUARES OF NUMBERS AND FRACTIONAL INTERVALS.

Fraction	0	1	2	3	4	5
0	.000000	1.00000	4.00000	9.00000	16.00000	25.00000
$\frac{1}{64}$.000244	1.03149	4.06274	9.09399	16.12524	25.15649
$\frac{2}{64}$.000977	1.06348	4.12598	9.18849	16.25098	25.31348
$\frac{3}{64}$.002197	1.09595	4.18970	9.28345	16.37720	25.47095
$\frac{1}{16}$.003906	1.12891	4.25391	9.37891	16.50391	25.62891
$\frac{5}{64}$.006104	1.16235	4.31860	9.47485	16.63110	25.78735
$\frac{6}{64}$.008789	1.19629	4.38379	9.57129	16.75879	25.94629
$\frac{7}{64}$.011963	1.23071	4.44946	9.66821	16.88596	26.10571
$\frac{1}{8}$.015625	1.26563	4.51563	9.76563	17.01563	26.26563
$\frac{9}{64}$.019775	1.30103	4.58223	9.86353	17.14473	26.42603
$\frac{10}{64}$.024414	1.33691	4.64941	9.96191	17.27441	26.58691
$\frac{11}{64}$.029541	1.37329	4.71704	10.06079	17.40454	26.74829
$\frac{3}{16}$.035156	1.41016	4.78516	10.16016	17.53516	26.91016
$\frac{13}{64}$.041260	1.44751	4.85376	10.26000	17.66626	27.07251
$\frac{14}{64}$.047852	1.48535	4.92285	10.36035	17.79785	27.23535
$\frac{15}{64}$.054932	1.52368	4.99243	10.46118	17.92993	27.39868
$\frac{1}{4}$.062500	1.56250	5.06250	10.56250	18.06250	27.56250
$\frac{17}{64}$.070557	1.60131	5.13306	10.66431	18.19556	27.72681
$\frac{18}{64}$.079102	1.64160	5.20410	10.76660	18.32910	27.89160
$\frac{19}{64}$.088135	1.68188	5.27563	10.86938	18.46313	28.05688
$\frac{5}{16}$.097656	1.72266	5.34766	10.97266	18.59765	28.22266
$\frac{21}{64}$.107666	1.76392	5.42017	11.07642	18.73267	28.38892
$\frac{22}{64}$.118164	1.80566	5.49316	11.18066	18.86816	28.55566
$\frac{23}{64}$.129150	1.84790	5.56665	11.28540	19.00415	28.72290
$\frac{3}{8}$.140625	1.89063	5.64063	11.39063	19.14063	28.89063
$\frac{25}{64}$.152583	1.93384	5.71509	11.49634	19.27759	29.05884
$\frac{26}{64}$.165039	1.97754	5.79004	11.60254	19.41504	29.22754
$\frac{27}{64}$.177979	2.02173	5.86548	11.70923	19.55298	29.39673
$\frac{7}{16}$.191406	2.06641	5.94141	11.81641	19.69141	29.56641
$\frac{29}{64}$.205322	2.11157	6.01782	11.92407	19.83032	29.73657
$\frac{30}{64}$.219727	2.15723	6.09473	12.03223	19.96973	29.90723
$\frac{31}{64}$.234619	2.20337	6.17212	12.14087	20.10962	30.07837
$\frac{1}{2}$.250000	2.25000	6.25000	12.25000	20.25000	30.25000
$\frac{33}{64}$.265869	2.29712	6.32837	12.35962	20.39037	30.42212
$\frac{34}{64}$.282227	2.34473	6.40723	12.46973	20.53223	30.59473
$\frac{35}{64}$.299072	2.39282	6.48657	12.58032	20.67407	30.76782
$\frac{9}{16}$.316406	2.44141	6.56641	12.69141	20.81641	30.94141
$\frac{37}{64}$.334229	2.49048	6.64673	12.80298	20.95923	31.11548
$\frac{38}{64}$.352539	2.54004	6.72754	12.91504	21.10254	31.29004
$\frac{39}{64}$.371338	2.59009	6.80884	13.02759	21.24634	31.46509
$\frac{5}{8}$.390625	2.64063	6.89063	13.14063	21.39063	31.64063
$\frac{41}{64}$.410400	2.69165	6.97290	13.25415	21.53540	31.81665
$\frac{42}{64}$.430664	2.74316	7.05666	13.36816	21.68066	31.99316
$\frac{43}{64}$.451416	2.79517	7.13892	13.48267	21.82642	32.17017
$\frac{11}{16}$.472656	2.84766	7.22266	13.59765	21.97266	32.34766
$\frac{45}{64}$.494385	2.90063	7.30688	13.71313	22.11938	32.52563
$\frac{46}{64}$.516602	2.95410	7.39160	13.82910	22.26660	32.70410
$\frac{47}{64}$.539307	3.00806	7.47681	13.94556	22.41431	32.88306

SQUARES OF NUMBERS
AND FRACTIONAL INTERVALS.

Fraction	6	7	8	9	10	11
0	36.00000	49.00000	64.00000	81.00000	100.00000	121.00000
$\frac{1}{64}$	36.18774	49.21899	64.25024	81.28149	100.31274	121.34399
$\frac{2}{64}$	36.37598	49.43848	64.50098	81.56348	100.62598	121.68848
$\frac{3}{64}$	36.56470	49.65845	64.75220	81.84595	100.93970	122.03345
$\frac{1}{16}$	36.75391	49.87891	65.00391	82.12391	101.25391	122.37891
$\frac{2}{16}$	36.94360	50.09985	65.25610	82.41235	101.56860	122.72485
$\frac{3}{16}$	37.13379	50.32129	65.50879	82.69629	101.88379	123.07129
$\frac{4}{16}$	37.32446	50.54221	65.76196	82.98071	102.19946	123.41821
$\frac{1}{8}$	37.51563	50.76563	66.01563	83.26563	102.51563	123.76563
$\frac{2}{8}$	37.70728	50.98853	66.26978	83.55103	102.83228	124.11353
$\frac{3}{8}$	37.89941	51.21191	66.52441	83.83691	103.14941	124.46191
$\frac{4}{8}$	38.08204	51.43579	66.77954	84.12329	103.46704	124.81079
$\frac{3}{16}$	38.28516	51.66016	67.03516	84.41016	103.78516	125.16016
$\frac{4}{16}$	38.47876	51.88501	67.29126	84.69751	104.10376	125.51001
$\frac{5}{16}$	38.67285	52.11035	67.54785	84.98535	104.42285	125.86035
$\frac{6}{16}$	38.86743	52.33618	67.80493	85.27368	104.74243	126.21118
$\frac{1}{4}$	39.06250	52.56250	68.06250	85.56250	105.06250	126.56250
$\frac{2}{4}$	39.25806	52.78931	68.32056	85.85181	105.38306	126.91431
$\frac{3}{4}$	39.45410	53.01660	68.57910	86.14160	105.70410	127.26660
$\frac{4}{4}$	39.65063	53.24438	68.83813	86.43188	106.02563	127.61938
$\frac{5}{16}$	39.84766	53.47266	69.09766	86.72266	106.34766	127.97266
$\frac{6}{16}$	40.04517	53.70142	69.35767	87.01392	106.67017	128.32642
$\frac{7}{16}$	40.24316	53.93066	69.61816	87.30568	106.99316	128.68066
$\frac{8}{16}$	40.44165	54.16040	69.87915	87.59790	107.31665	129.03540
$\frac{3}{8}$	40.64063	54.39063	70.14063	87.89063	107.64063	129.39063
$\frac{4}{8}$	40.84009	54.62134	70.40269	88.18384	107.96509	129.74634
$\frac{5}{8}$	41.04004	54.85254	70.66504	88.47754	108.29004	130.10254
$\frac{6}{8}$	41.24048	55.08423	70.92798	88.77173	108.61548	130.45923
$\frac{7}{16}$	41.44141	55.31641	71.19141	89.06641	108.94141	130.81641
$\frac{8}{16}$	41.64282	55.54907	71.45532	89.36157	109.26782	131.17407
$\frac{9}{16}$	41.84473	55.78223	71.71973	89.65723	109.59473	131.53223
$\frac{10}{16}$	42.04712	56.01587	71.98462	89.95337	109.92212	131.89087
$\frac{1}{2}$	42.25000	56.25000	72.25000	90.25000	110.25000	132.25000
$\frac{2}{2}$	42.45337	56.48462	72.51587	90.54712	110.57837	132.60962
$\frac{3}{2}$	42.65723	56.71973	72.78223	90.84473	110.90723	132.96973
$\frac{4}{2}$	42.86157	56.95532	73.04907	91.14282	111.23657	133.33032
$\frac{5}{16}$	43.06641	57.19141	73.31641	91.44141	111.56641	133.69141
$\frac{6}{16}$	43.27173	57.42798	73.58423	91.74048	111.89673	134.05298
$\frac{7}{16}$	43.47754	57.66504	73.85254	92.04004	112.22754	134.41504
$\frac{8}{16}$	43.68384	57.90259	74.12134	92.34009	112.55884	134.77759
$\frac{5}{8}$	43.89063	58.14063	74.39063	92.64063	112.89063	135.14063
$\frac{6}{8}$	44.09790	58.37915	74.66040	92.94165	113.22290	135.50415
$\frac{7}{8}$	44.30566	58.61816	74.93066	93.24316	113.55566	135.86816
$\frac{8}{8}$	44.51392	58.85767	75.20142	93.54517	113.88892	136.23267
$\frac{11}{16}$	44.72266	59.09766	75.47266	93.84766	114.22266	136.59766
$\frac{12}{16}$	44.93188	59.33813	75.74438	94.15063	114.55688	136.96313
$\frac{13}{16}$	45.14160	59.57910	76.01660	94.45410	114.89160	137.32910
$\frac{14}{16}$	45.35181	59.82056	76.28931	94.75806	115.22681	137.69566

SQUARES OF NUMBERS AND FRACTIONAL INTERVALS.

Fraction	0	1	2	3	4	5
$\frac{49}{64}$.562500	3.06250	7.56250	14.06250	22.56250	33.06250
$\frac{51}{64}$.586182	3.11743	7.64868	14.17993	22.71118	33.24243
$\frac{53}{64}$.610352	3.17285	7.73535	14.29785	22.86035	33.42285
$\frac{55}{64}$.635010	3.22876	7.82251	14.41626	23.01001	33.60376
$\frac{57}{64}$.660156	3.28516	7.91016	14.53516	23.16016	33.78516
$\frac{59}{64}$.685791	3.34204	7.99829	14.65454	23.31079	33.96704
$\frac{61}{64}$.711914	3.39941	8.08691	14.77441	23.46191	34.14941
$\frac{63}{64}$.738525	3.45728	8.17603	14.89478	23.61353	34.33228
$\frac{65}{64}$.765625	3.51563	8.26563	15.01563	23.76563	34.51563
$\frac{67}{64}$.793213	3.57446	8.35571	15.13693	23.91821	34.69946
$\frac{69}{64}$.821289	3.63379	8.44629	15.25879	24.07129	34.88379
$\frac{71}{64}$.849854	3.69360	8.53735	15.38110	24.22485	35.06860
$\frac{73}{64}$.878906	3.75391	8.62891	15.50391	24.37891	35.25391
$\frac{75}{64}$.908447	3.81470	8.72095	15.62720	24.53345	35.43970
$\frac{77}{64}$.938477	3.87598	8.81348	15.75098	24.68848	35.62598
$\frac{79}{64}$.968994	3.93774	8.90649	15.87524	24.84399	35.81274
Fraction	12	13	14	15	16	17
0	144.0000	169.0000	196.0000	225.0000	256.0000	289.0000
$\frac{1}{32}$	144.7510	169.8135	196.8760	225.9385	257.0010	290.0635
$\frac{3}{32}$	145.5039	170.6289	197.7539	226.8789	258.0039	291.1289
$\frac{5}{32}$	146.2588	171.4463	198.6338	227.8213	259.0088	292.1963
$\frac{7}{32}$	147.0156	172.2656	199.5156	228.7656	260.0156	293.2656
$\frac{9}{32}$	147.7744	173.0869	200.3994	229.7119	261.0244	294.3369
$\frac{11}{32}$	148.5352	173.9102	201.2852	230.6602	262.0352	295.4102
$\frac{13}{32}$	149.2979	174.7354	202.1725	231.6104	263.0479	296.4854
$\frac{15}{32}$	150.0625	175.5625	203.0625	232.5625	264.0625	297.5625
$\frac{17}{32}$	150.8291	176.3916	203.9541	233.5166	265.0791	298.6416
$\frac{19}{32}$	151.5977	177.2227	204.8477	234.4727	266.0977	299.7227
$\frac{21}{32}$	152.3682	178.0557	205.7432	235.4307	267.1182	300.8057
$\frac{23}{32}$	153.1406	178.8906	206.6406	236.3906	268.1406	301.8906
$\frac{25}{32}$	153.9150	179.7275	207.5400	237.3525	269.1650	302.9775
$\frac{27}{32}$	154.6914	180.5664	208.4414	238.3164	270.1914	304.0664
$\frac{29}{32}$	155.4697	181.4072	209.3447	239.2822	271.2197	305.1572
$\frac{31}{32}$	156.2500	182.2500	210.2500	240.2500	272.2500	306.2500
$\frac{33}{32}$	157.0322	183.0947	211.1572	241.2197	273.2822	307.3447
$\frac{35}{32}$	157.8164	183.9414	212.0664	242.1914	274.3164	308.4414
$\frac{37}{32}$	158.6025	184.7900	212.9775	243.1650	275.3525	309.5400
$\frac{39}{32}$	159.3906	185.6406	213.8906	244.1406	276.3906	310.6406
$\frac{41}{32}$	160.1807	186.4932	214.8057	245.1182	277.4307	311.7432
$\frac{43}{32}$	160.9727	187.3477	215.7227	246.0977	278.4727	312.8477
$\frac{45}{32}$	161.7666	188.2041	216.6416	247.0791	279.5166	313.9541
$\frac{47}{32}$	162.5625	189.0625	217.5625	248.0625	280.5625	315.0625
$\frac{49}{32}$	163.3604	189.9229	218.4854	249.0479	281.6104	316.1729
$\frac{51}{32}$	164.1602	190.7852	219.4102	250.0352	282.6602	317.2852
$\frac{53}{32}$	164.9619	191.6494	220.3369	251.0244	283.7119	318.3994
$\frac{55}{32}$	165.7656	192.5156	221.2656	252.0156	284.7656	319.5156
$\frac{57}{32}$	166.5713	193.3838	222.1963	253.0088	285.8213	320.6338
$\frac{59}{32}$	167.3789	194.2539	223.1289	254.0039	286.8789	321.7539
$\frac{61}{32}$	168.1885	195.1260	224.0630	255.0010	287.9385	322.8760

SQUARES OF NUMBERS
AND FRACTIONAL INTERVALS.

Fraction	6	7	8	9	10	11
$\frac{49}{64}$	45.56250	60.06250	76.56250	95.06250	115.56250	138.06250
$\frac{53}{64}$	45.77368	60.30493	76.83618	95.35743	115.89868	138.42993
$\frac{57}{64}$	45.98535	60.54785	77.11035	95.67285	116.23535	138.79785
$\frac{61}{64}$	46.19751	60.79126	77.38501	95.97876	116.57251	139.16626
$\frac{13}{16}$	46.41016	61.03516	77.66016	96.28516	116.91016	139.53516
$\frac{17}{16}$	46.62329	61.27954	77.93579	96.59204	117.24829	139.90454
$\frac{21}{16}$	46.83691	61.52441	78.21191	96.89941	117.58691	140.27441
$\frac{25}{16}$	47.05103	61.76978	78.48853	97.20728	117.92603	140.64478
$\frac{7}{8}$	47.26563	62.01563	78.76563	97.51563	118.26563	141.01563
$\frac{9}{8}$	47.48071	62.26196	79.04321	97.82446	118.60571	141.38696
$\frac{11}{8}$	47.69629	62.50879	79.32129	98.13379	118.94629	141.75879
$\frac{13}{8}$	47.91235	62.75610	79.59985	98.44360	119.28735	142.13110
$\frac{15}{16}$	48.12891	63.00391	79.87891	98.75391	119.62891	142.50391
$\frac{17}{16}$	48.34595	63.25220	80.15845	99.06470	119.97095	142.87720
$\frac{19}{16}$	48.56348	63.50098	80.43848	99.37598	120.31348	143.25098
$\frac{21}{16}$	48.78149	63.75024	80.71899	99.68774	120.65649	143.62524
Fraction	18	19	20	21	22	23
0	324.0000	361.0000	400.0000	441.0000	484.0000	529.0000
$\frac{1}{32}$	325.1260	362.1885	401.2510	442.3135	485.3760	530.4385
$\frac{1}{16}$	326.2539	363.3789	402.5039	443.6289	486.7539	531.8789
$\frac{3}{32}$	327.3838	364.5713	403.7588	444.9463	488.1338	533.3213
$\frac{1}{8}$	328.5156	365.7656	405.0156	446.2656	489.5156	534.7656
$\frac{5}{32}$	329.6494	366.9619	406.2744	447.5869	490.8994	536.2119
$\frac{3}{16}$	330.7852	368.1602	407.5352	448.9102	492.2852	537.6602
$\frac{7}{32}$	331.9229	369.3604	408.7979	450.2354	493.6729	539.1104
$\frac{1}{4}$	333.0625	370.5625	410.0625	451.5625	495.0625	540.5625
$\frac{5}{16}$	334.2041	371.7666	411.3291	452.8916	496.4541	542.0166
$\frac{3}{8}$	335.3477	372.9727	412.5977	454.2227	497.8477	543.4727
$\frac{11}{32}$	336.4932	374.1807	413.8682	455.5557	499.2432	544.9307
$\frac{3}{8}$	337.6406	375.3906	415.1406	456.8906	500.6406	546.3906
$\frac{13}{32}$	338.7900	376.6025	416.4150	458.2275	502.0400	547.8525
$\frac{7}{16}$	339.9414	377.8164	417.6914	459.5664	503.4414	549.3164
$\frac{15}{32}$	341.0947	379.0322	418.9697	460.9072	504.8447	550.7822
$\frac{1}{2}$	342.2500	380.2500	420.2500	462.2500	506.2500	552.2500
$\frac{17}{32}$	343.4072	381.4697	421.5322	463.5947	507.6572	553.7197
$\frac{9}{16}$	344.5664	382.6914	422.8164	464.9414	509.0664	555.1914
$\frac{19}{32}$	345.7275	383.9150	424.1025	466.2900	510.4775	556.6650
$\frac{5}{8}$	346.8906	385.1406	425.3906	467.6406	511.8906	558.1406
$\frac{21}{32}$	348.0557	386.3682	426.6807	468.9932	513.3057	559.6182
$\frac{11}{16}$	349.2227	387.5977	427.9727	470.3477	514.7227	561.0977
$\frac{23}{32}$	350.3916	388.8291	429.2666	471.7041	516.1416	562.5791
$\frac{3}{4}$	351.5625	390.0625	430.5625	473.0625	517.5625	564.0625
$\frac{13}{16}$	352.7354	391.2979	431.8604	474.4229	518.9854	565.5479
$\frac{7}{8}$	353.9102	392.5352	433.1602	475.7852	520.4102	567.0352
$\frac{27}{32}$	355.0869	393.7744	434.4619	477.1494	521.8369	568.5244
$\frac{5}{8}$	356.2656	395.0156	435.7656	478.5156	523.2656	570.0156
$\frac{29}{32}$	357.4463	396.2588	437.0713	479.8838	524.6963	571.5088
$\frac{15}{16}$	358.6289	397.5039	438.3789	481.2539	526.1289	573.0039
$\frac{31}{32}$	359.8135	398.7510	439.6885	482.6260	527.5635	574.5010

SQUARES OF NUMBERS AND FRACTIONAL INTERVALS.

No.	0	$\frac{1}{8}$	$\frac{1}{4}$	$\frac{3}{8}$	$\frac{1}{2}$	$\frac{5}{8}$	$\frac{3}{4}$	$\frac{7}{8}$
24	576	582.0156	588.0625	594.1406	600.25	606.3906	612.5625	618.7656
25	625	631.2656	637.5625	643.8906	650.25	656.6406	663.0625	669.5156
26	676	682.5156	689.0625	695.6406	702.25	708.8906	715.5625	722.2656
27	729	735.7656	742.5625	749.3906	756.25	763.1406	770.0625	777.0156
28	784	791.0156	798.0625	805.1406	812.25	819.3906	826.5625	833.7656
29	841	848.2656	855.5625	862.8906	870.25	877.6406	885.0625	892.5156
30	900	907.5156	915.0625	922.6406	930.25	937.8906	945.5625	953.2656
31	961	968.7656	976.5625	984.3906	992.25	1000.1406	1008.0625	1016.0156
32	1024	1032.0156	1040.0625	1048.1406	1056.25	1064.3906	1072.5625	1080.7656
33	1089	1097.2656	1105.5625	1113.8906	1122.25	1130.6406	1139.0625	1147.5156
34	1156	1164.5156	1173.0625	1181.6406	1190.25	1198.8906	1207.5625	1216.2656
35	1225	1233.7656	1242.5625	1251.3906	1260.25	1269.1406	1278.0625	1287.0156
36	1296	1305.0156	1314.0625	1323.1406	1332.25	1341.3906	1350.5625	1359.7656
37	1369	1378.2656	1387.5625	1396.8906	1406.25	1415.6406	1425.0625	1434.5156
38	1444	1453.5156	1463.0625	1472.6406	1482.25	1491.8906	1501.5625	1511.2656
39	1521	1530.7656	1540.5625	1550.3906	1560.25	1570.1406	1580.0625	1590.0156
40	1600	1610.0156	1620.0625	1630.1406	1640.25	1650.3906	1660.5625	1670.7656
41	1681	1691.2656	1701.5625	1711.8906	1722.25	1732.6406	1743.0625	1753.5156
42	1764	1774.5156	1785.0625	1795.6406	1806.25	1816.8906	1827.5625	1838.2656
43	1849	1859.7656	1870.5625	1881.3906	1892.25	1903.1406	1914.0625	1925.0156
44	1936	1947.0156	1958.0625	1969.1406	1980.25	1991.3906	2002.5625	2013.7656
45	2025	2036.2656	2047.5625	2058.8906	2070.25	2081.6406	2093.0625	2104.5156
46	2116	2127.5156	2139.0625	2150.6406	2162.25	2173.8906	2185.5625	2197.2656
47	2209	2220.7656	2232.5625	2244.3906	2256.25	2268.1406	2280.0625	2292.0156
48	2304	2316.0156	2328.0625	2340.1406	2352.25	2364.3906	2376.5625	2388.7656
49	2401	2413.2656	2425.5625	2437.8906	2450.25	2462.6406	2475.0625	2487.5156
50	2500	2512.5156	2525.0625	2537.6406	2550.25	2562.8906	2575.5625	2588.2656
51	2601	2613.7656	2626.5625	2639.3906	2652.25	2665.1406	2678.0625	2691.0156
52	2704	2717.0156	2730.0625	2743.1406	2756.25	2769.3906	2782.5625	2795.7656
53	2809	2822.2656	2835.5625	2848.8906	2862.25	2875.6406	2889.0625	2902.5156
54	2916	2929.5156	2943.0625	2956.6406	2970.25	2983.8906	2997.5625	3011.2656
55	3025	3038.7656	3052.5625	3066.3906	3080.25	3094.1406	3108.0625	3122.0156
56	3136	3150.0156	3164.0625	3178.1406	3192.25	3206.3906	3220.5625	3234.7656
57	3249	3263.2656	3277.5625	3291.8906	3306.25	3320.6406	3335.0625	3349.5156
58	3364	3378.5156	3393.0625	3407.6406	3422.25	3436.8906	3451.5625	3466.2656
59	3481	3495.7656	3510.5625	3525.3906	3540.25	3555.1406	3570.0625	3585.0156
60	3600	3615.0156	3630.0625	3645.1406	3660.25	3675.3906	3690.5625	3705.7656
61	3721	3736.2656	3751.5625	3766.8906	3782.25	3797.6406	3813.0625	3828.5156
62	3844	3859.5156	3875.0625	3890.6406	3906.25	3921.8906	3937.5625	3953.2656
63	3969	3984.7656	4000.5625	4016.3906	4032.25	4048.1406	4064.0625	4080.0156
64	4096	4112.0156	4128.0625	4144.1406	4160.25	4176.3906	4192.5625	4208.7656
65	4225	4241.2656	4257.5625	4273.8906	4290.25	4306.6406	4323.0625	4339.5156
66	4356	4372.5156	4389.0625	4405.6406	4422.25	4438.8906	4455.5625	4472.2656
67	4489	4505.7656	4522.5625	4539.3906	4556.25	4573.1406	4590.0625	4607.0156
68	4624	4641.0156	4658.0625	4675.1406	4692.25	4709.3906	4726.5625	4743.7656
69	4761	4778.2656	4795.5625	4812.8906	4830.25	4847.6406	4865.0625	4882.5156
70	4900	4917.5156	4935.0625	4952.6406	4970.25	4987.8906	5005.5625	5023.2656

CUBES OF NUMBERS AND FRACTIONAL INTERVALS.

Fraction	0	1	2	3	4	5
0	0	1.000009	8.000000	27.00000	64.00000	125.00000
$\frac{1}{32}$.030518	1.096710	8.380890	27.85257	65.51175	127.35843
$\frac{2}{32}$.062036	1.194463	8.773682	28.72290	67.04712	129.74634
$\frac{3}{32}$.093554	1.308441	9.178558	29.61118	68.60629	132.16391
$\frac{4}{32}$.125072	1.423828	9.595703	30.51758	70.18945	134.61133
$\frac{5}{32}$.156590	1.545807	10.025299	31.44229	71.79678	137.08878
$\frac{6}{32}$.188108	1.674561	10.467529	32.38550	73.42847	139.59644
$\frac{7}{32}$.219626	1.810272	10.922577	33.34738	75.08469	142.13449
$\frac{8}{32}$.251144	1.953125	11.390625	34.32813	76.76563	144.70313
$\frac{9}{32}$.282662	2.103302	11.871857	35.32791	78.47147	147.30252
$\frac{10}{32}$.314180	2.260986	12.366455	36.34692	80.20239	149.93286
$\frac{11}{32}$.345698	2.426361	12.874693	37.38653	81.95859	152.59433
$\frac{12}{32}$.377216	2.599609	13.396484	38.44336	83.74023	155.28711
$\frac{13}{32}$.408734	2.780914	13.932281	39.52115	85.54752	158.01138
$\frac{14}{32}$.440252	2.970459	14.482178	40.61890	87.38062	160.76733
$\frac{15}{32}$.471770	3.168427	15.045356	41.73679	89.23972	163.55515
$\frac{16}{32}$.503288	3.375000	15.625000	42.87500	91.12500	166.37500
$\frac{17}{32}$.534806	3.590363	16.218292	44.03372	93.03665	169.22708
$\frac{18}{32}$.566324	3.814697	16.826416	45.21313	94.97485	172.11157
$\frac{19}{32}$.597842	4.048187	17.449554	46.41342	96.93979	175.02866
$\frac{20}{32}$.629360	4.291016	18.087891	47.63477	98.93164	177.97852
$\frac{21}{32}$.660878	4.543365	18.741608	48.87735	100.95059	180.96133
$\frac{22}{32}$.692396	4.805420	19.410889	50.14136	102.99683	183.97729
$\frac{23}{32}$.723914	5.077362	20.095917	51.42697	105.07063	187.02558
$\frac{24}{32}$.755432	5.359375	20.796875	52.73438	107.17188	190.10938
$\frac{25}{32}$.786950	5.651642	21.513947	54.06375	109.30106	193.22536
$\frac{26}{32}$.818468	5.954346	22.247314	55.41528	111.45925	196.37622
$\frac{27}{32}$.849986	6.267670	22.997152	56.78915	113.64365	199.56064
$\frac{28}{32}$.881504	6.591797	23.763672	58.18555	115.85742	202.77930
$\frac{29}{32}$.913022	6.926910	24.547028	59.60464	118.09976	206.03238
$\frac{30}{32}$.944540	7.273193	25.347412	61.04663	120.37085	209.32007
$\frac{31}{32}$.976058	7.630829	26.165009	62.51169	122.67087	212.64255
Fraction	6	7	8	9	10	11
0	216.00000	343.00000	512.00000	729.0000	1000.0000	1331.0000
$\frac{1}{32}$	219.39261	347.61429	518.02347	736.6201	1009.4043	1342.3760
$\frac{2}{32}$	222.82056	352.26978	524.09399	744.2932	1018.8674	1353.8167
$\frac{3}{32}$	226.28403	356.96664	530.21176	752.0194	1028.3895	1365.3221
$\frac{4}{32}$	229.78320	361.70508	536.37695	759.7988	1037.9707	1376.8926
$\frac{5}{32}$	233.31827	366.48526	542.58975	767.6317	1047.6112	1388.5282
$\frac{6}{32}$	236.88940	371.30737	548.85034	775.5183	1057.3113	1400.2292
$\frac{7}{32}$	240.49680	376.17160	555.15891	783.4587	1067.0710	1411.9958
$\frac{8}{32}$	244.14063	381.07813	561.51563	791.4531	1076.8906	1423.8281
$\frac{9}{32}$	247.82108	386.02713	567.92068	799.5017	1086.7703	1435.7263
$\frac{10}{32}$	251.53833	391.01890	574.37427	807.6047	1096.7102	1447.6907
$\frac{11}{32}$	255.29257	396.05331	580.87656	815.7623	1106.7105	1459.7213
$\frac{12}{32}$	259.08398	401.13086	587.42773	823.9746	1116.7715	1471.8184
$\frac{13}{32}$	262.91275	406.25162	594.02798	832.2418	1126.8932	1483.9821
$\frac{14}{32}$	266.77905	411.41577	600.67749	840.5642	1137.0759	1496.2126
$\frac{15}{32}$	270.68307	416.62350	607.37643	848.9419	1147.3198	1508.5102

CUBES OF NUMBERS AND FRACTIONAL INTERVALS.

Fraction	6	7	8	9	10	11
$\frac{1}{2}$	274.62500	421.87500	614.12500	857.37500	1157.62500	1520.87500
$\frac{1}{3}$	278.60501	427.17044	620.92337	865.86338	1167.9917	1533.3072
$\frac{1}{4}$	282.62329	432.51001	627.77173	874.4084	1178.4202	1545.8069
$\frac{1}{5}$	286.68002	437.89389	634.67026	883.0091	1188.9105	1558.3774
$\frac{1}{6}$	290.77539	443.32227	641.61914	891.6660	1199.4629	1571.0098
$\frac{1}{7}$	294.90958	448.79532	648.61856	900.3793	1210.0775	1583.7133
$\frac{1}{8}$	299.08276	454.31323	655.66870	909.1491	1220.7546	1596.4851
$\frac{1}{9}$	303.29514	459.87619	662.76974	917.9758	1231.4943	1609.3254
$\frac{1}{10}$	307.54688	465.48438	669.92188	926.8594	1242.2969	1622.2344
$\frac{1}{11}$	311.83817	471.13797	677.12527	935.8001	1253.1624	1635.2122
$\frac{1}{12}$	316.16919	476.83716	684.38013	944.7981	1264.0911	1648.2590
$\frac{1}{13}$	320.54013	482.58212	691.68661	953.8536	1275.0831	1661.3751
$\frac{1}{14}$	324.95117	488.37305	699.04492	962.9668	1286.1387	1674.5505
$\frac{1}{15}$	329.40250	494.21011	706.45523	972.1378	1297.2580	1687.8156
$\frac{1}{16}$	333.89429	500.09351	713.91772	981.3669	1308.4412	1701.1404
$\frac{1}{17}$	338.42673	506.02341	721.43259	990.6543	1319.6384	1714.5351
Fraction	12	13	14	15	16	17
0	1728.0000	2197.0000	2744.0000	3375.0000	4096.0000	4913.0000
$\frac{1}{16}$	1755.1409	2228.8401	2780.9143	3417.3635	4144.1877	4967.3870
$\frac{1}{8}$	1782.5645	2260.9863	2818.1582	3460.0801	4192.7520	5022.1738
$\frac{3}{16}$	1810.2722	2293.4402	2855.7332	3503.1511	4241.6941	5077.3621
$\frac{1}{4}$	1838.2656	2326.2031	2893.6406	3546.5781	4291.0156	5132.9531
$\frac{5}{16}$	1866.5461	2359.2766	2931.8821	3590.3625	4340.7180	5188.9485
$\frac{3}{8}$	1895.1152	2392.6621	2970.4590	3634.5059	4390.8027	5245.3496
$\frac{7}{16}$	1923.9744	2426.3611	3009.3728	3679.0095	4441.2712	5302.1580
$\frac{1}{2}$	1953.1250	2460.3750	3048.6250	3723.8750	4492.1250	5359.3750
$\frac{9}{16}$	1982.5686	2494.7053	3088.2170	3769.1038	4543.3555	5417.0022
$\frac{5}{8}$	2012.3066	2529.3535	3128.1504	3814.6973	4594.9941	5475.0410
$\frac{11}{16}$	2042.3406	2564.3210	3168.4265	3860.6570	4647.0125	5533.4929
$\frac{3}{4}$	2072.6719	2599.6094	3209.0469	3906.9844	4699.4219	5592.3594
$\frac{13}{16}$	2103.3020	2635.2200	3250.0129	3953.6809	4752.2239	5651.6418
$\frac{7}{8}$	2134.2324	2671.1543	3291.3262	4000.7480	4805.4199	5711.3418
$\frac{15}{16}$	2165.4546	2707.4138	3332.9880	4048.1873	4859.0115	5771.4607
Fraction	18	19	20	21	22	23
0	5832.0000	6859.0000	8000.0000	9261.0000	10648.0000	12167.0000
$\frac{1}{16}$	5892.9612	6926.9104	8075.2346	9343.934	10739.008	12266.457
$\frac{1}{8}$	5954.3457	6995.2676	8150.9395	9427.361	10830.533	12366.455
$\frac{3}{16}$	6016.1550	7064.0730	8227.1160	9511.284	10922.577	12466.995
$\frac{1}{4}$	6078.3906	7133.3281	8303.7656	9595.703	11015.141	12568.078
$\frac{5}{16}$	6141.0540	7203.0344	8380.8899	9680.620	11108.226	12669.706
$\frac{3}{8}$	6204.1465	7273.1934	8458.4902	9766.037	11201.834	12771.881
$\frac{7}{16}$	6267.6697	7343.8064	8536.5681	9851.955	11295.967	12874.603
$\frac{1}{2}$	6331.6250	7414.8750	8615.1250	9938.375	11390.625	12977.875
$\frac{9}{16}$	6396.0139	7486.4006	8694.1624	10025.299	11485.811	13081.698
$\frac{5}{8}$	6460.8379	7558.3848	8773.6816	10112.729	11581.525	13186.072
$\frac{11}{16}$	6526.0984	7630.8289	8853.6843	10200.665	11677.770	13291.001
$\frac{3}{4}$	6591.7969	7703.7344	8934.1719	10289.109	11774.547	13396.484
$\frac{13}{16}$	6657.9348	7777.1028	9015.1458	10378.064	11871.857	13502.525
$\frac{7}{8}$	6724.5137	7850.9355	9096.6074	10467.529	11969.701	13609.123
$\frac{15}{16}$	6791.5349	7925.2341	9178.5583	10557.508	12068.082	13716.281

CUBES OF NUMBERS AND FRACTIONAL INTERVALS.

No	0	$\frac{1}{8}$	$\frac{1}{4}$	$\frac{3}{8}$	$\frac{1}{2}$	$\frac{5}{8}$	$\frac{3}{4}$	$\frac{7}{8}$
24	13824	14041.127	14260.516	14482.178	14706.125	14932.369	15160.922	15391.796
25	15625	15860.549	16098.453	16338.725	16581.375	16826.416	17073.859	17323.717
26	17576	17830.721	18087.891	18347.521	18609.625	18874.213	19141.297	19410.889
27	19683	19957.643	20234.828	20514.568	20796.875	21081.760	21369.234	21659.311
28	21952	22247.315	22545.266	22845.865	23149.125	23455.057	23763.672	24074.982
29	24389	24705.736	25025.203	25347.412	25672.375	26000.104	26330.609	26663.904
30	27000	27338.908	27680.641	28025.209	28372.625	28722.900	29076.047	29432.076
31	29791	30152.830	30517.578	30885.256	31255.875	31629.447	32005.984	32385.498
32	32768	33153.502	33542.016	33933.553	34328.125	34725.744	35126.422	35530.170
33	35937	36346.924	36759.953	37176.100	37595.375	38017.791	38443.359	38872.092
34	39304	39739.096	40177.391	40618.896	41063.625	41511.588	41962.797	42417.264
35	42875	43336.018	43800.328	44267.943	44738.875	45213.135	45690.734	46171.686
36	46656	47143.689	47634.766	48129.240	48627.125	49128.432	49633.172	50141.357
37	50653	51168.111	51686.703	52208.787	52734.375	53263.479	53796.109	54332.279
38	54872	55415.283	55962.141	56512.584	57066.625	57624.275	58185.547	58750.451
39	59319	59891.205	60467.078	61046.631	61629.875	62216.822	62807.484	63401.873
40	64000	64601.877	65207.516	65816.928	66430.125	67047.119	67667.922	68292.545
41	68921	69553.299	70189.453	70829.475	71473.375	72121.166	72772.859	73428.467
42	74088	74751.471	75418.891	76090.272	76765.625	77444.963	78128.297	78815.639
43	79507	80202.393	80901.828	81605.318	82312.875	83024.510	83740.234	84460.061
44	85184	85912.065	86644.266	87380.615	88121.125	88865.807	89614.672	90367.732
45	91125	91886.486	92652.203	93422.162	94196.375	94974.854	95757.609	96544.654
46	97336	98131.658	98931.641	99735.959	100544.63	101357.65	102175.05	102996.83
47	103823	104653.58	105488.58	106328.01	107171.87	108020.20	108872.98	109730.25
48	110592	111458.25	112329.02	113204.30	114084.12	114968.49	115857.42	116750.92
49	117649	118551.67	119458.95	120370.85	121287.37	122208.54	123134.36	124064.84
50	125000	125939.85	126884.39	127833.65	128787.62	129746.34	130709.80	131678.01
51	132651	133628.77	134611.33	135598.69	136590.87	137587.88	138589.73	139596.44
52	140608	141624.44	142645.77	143671.99	144703.12	145739.18	146780.17	147826.11
53	148877	149932.86	150993.70	152059.54	153130.37	154206.23	155287.11	156373.03
54	157464	158560.03	159661.14	160767.33	161878.62	162995.03	164116.55	165243.20
55	166375	167511.96	168654.08	169801.38	170953.87	172111.57	173274.48	174442.62
56	175616	176794.63	177978.52	179167.68	180362.12	181561.87	182766.92	183977.29
57	185193	186414.05	187640.45	188872.22	190109.37	191351.92	192599.86	193853.22
58	196112	196376.22	197645.89	198921.02	200201.62	201487.71	202779.30	204076.39
59	205379	206687.14	208000.83	209320.07	210644.87	211975.26	213311.23	214652.81
60	216000	217352.81	218711.27	220075.37	221445.12	222820.56	224201.67	225588.48
61	226981	228379.24	229783.20	231192.91	232608.38	234029.60	235456.61	236889.40
62	238328	239772.41	241222.64	242678.71	244140.63	245608.40	247082.05	248561.58
63	250047	251538.33	253035.58	254538.76	256047.88	257562.95	259083.98	260611.00
64	262144	263683.00	265228.02	266779.05	268336.13	269899.24	271468.42	273043.67
65	274625	276212.42	277805.95	279405.60	281011.38	282623.29	284241.36	285865.59
66	287496	289132.60	290775.39	292424.40	294079.63	295741.09	297408.80	299082.76
67	300763	302449.52	304142.33	305841.44	307546.88	309258.63	310976.73	312701.19
68	314432	316169.19	317912.77	319662.74	321419.13	323181.93	324951.17	326726.86
69	328509	330297.61	332092.70	333894.29	335702.37	337516.98	339338.11	341165.78
70	343000	344840.78	346688.14	348542.08	350402.61	352269.77	354143.55	356023.95

VALUES FOR COMBINATIONS OF π ($\pi = 3.14159265359$).

Combination.	Values for n .				
	1	2	3	4	5
$n\pi$	3.141593	6.283185	9.424778	12.566371	15.707963
$\frac{n\pi}{4}$785398	1.570796	2.356194	3.141593	3.926991
$\frac{n\pi}{6}$523599	1.047196	1.570796	2.094395	2.617994
$\frac{n\pi}{8}$392699	.785398	1.178097	1.570796	1.963495
$\frac{n\pi}{16}$196350	.392699	.589049	.785398	.981748
$\frac{n\pi}{32}$098175	.196350	.294524	.392699	.490874
$\frac{n\pi}{64}$049087	.098175	.147262	.196350	.245437
$\frac{\pi}{n}$	3.141593	1.570796	1.047198	.785398	.628319
$\frac{n}{\pi}$318310	.636620	.954930	1.273240	1.591549
$\frac{\pi}{n 90^\circ}$034907	.017453	.011636	.008727	.006981
$\frac{n 90^\circ}{\pi}$	28.647890	57.295780	85.943670	114.59156	143.239450
π^n	3.141593	9.869604	31.006277	97.409091	306.01979
$\frac{1}{\pi^n}$318310	.101321	.032252	.010266	.003268
$\frac{1}{\sqrt{n\pi}}$	3.141593	1.772454	1.464592	1.331335	1.257274
$\frac{1}{\sqrt{n\pi}}$318310	.564190	.682784	.751126	.795371
$n\pi^2$	9.869604	19.739209	29.008813	39.478418	49.348022
$\frac{n}{\pi^2}$101321	.202642	.303963	.405284	.506605
$\sqrt{n\pi}$	1.772454	2.506628	3.069980	3.544908	3.963328
$\sqrt{\frac{n}{\pi}}$564190	.797885	.977205	1.128379	1.261566
$n\sqrt{\pi}$	1.772454	3.544908	5.317362	7.089815	8.862269
$\frac{n}{\sqrt{\pi}}$564190	1.128379	1.692569	2.256785	2.820948
$n\pi^3$	31.006277	62.012553	93.018830	124.02511	155.03138
$\frac{n}{\pi^3}$032252	.064503	.096755	.129006	.161258
$\sqrt[3]{n\pi}$	1.464592	1.845270	2.112469	2.324895	2.504417
$\sqrt[3]{\frac{n}{\pi}}$682784	.860254	.984745	1.086351	1.167544
$n\sqrt[3]{\pi}$	1.464592	2.929184	4.393776	5.858368	7.322959
$\frac{n}{\sqrt[3]{\pi}}$682784	1.365568	2.048352	2.731136	3.413920
$n\pi^4$	97.409091	194.81818	292.22727	389.63636	487.04545
$\frac{n}{\pi^4}$010266	.020532	.030797	.041063	.051329
$\sqrt[4]{n\pi}$	1.331335	1.583233	1.752136	1.882793	1.990811
$\sqrt[4]{\frac{n}{\pi}}$751126	.893244	.988537	1.062252	1.123195

VALUES FOR COMBINATIONS OF π ($\pi = 3.14159265359$).

Values for n.				Combination.
6	7	8	9	
18.849556	21.991149	25.132741	28.274334 $n\pi$
4.712389	5.497787	6.283185	7.038533 $\frac{n\pi}{4}$
3.141593	3.665191	4.188790	4.712389 $\frac{n\pi}{6}$
2.356194	2.743894	3.141593	3.534292 $\frac{n\pi}{8}$
1.178097	1.374447	1.570796	1.767146 $\frac{n\pi}{16}$
.583049	.687223	.785398	.883573 $\frac{n\pi}{32}$
.294524	.343512	.392699	.441786 $\frac{n\pi}{64}$
.523599	.448790	.392699	.349066 $\frac{\pi}{n}$
1.903859	2.228169	2.546479	2.864789 $\frac{n}{\pi}$
.005818	.004987	.004363	.003879 $\frac{\pi}{n90^\circ}$
171.88738	200.53523	223.18312	237.84101 $\frac{n90^\circ}{\pi}$
961.38937	3020.1938	9438.5331	23803.103 π^n
.001040	.000231	.000105	.000034 $\frac{1}{\pi^n}$
1.210203	1.177664	1.153835	1.136635 $\sqrt[n]{\frac{1}{\pi}}$
.826307	.849139	.866675	.880564 $\frac{1}{\sqrt[n]{\pi}}$
59.217626	69.087231	79.956835	88.326440 $n\pi^2$
.607026	.709247	.810563	.911880 $\frac{n}{\pi^2}$
4.341608	4.689471	5.013257	5.317362 $\sqrt[n]{n\pi}$
1.381977	1.432705	1.595769	1.692569 $\sqrt{\frac{n}{\pi}}$
10.634723	12.407177	14.179631	15.952085 $n\sqrt{\frac{n}{\pi}}$
3.385133	3.949327	4.513517	5.077705 $\frac{n}{\sqrt{\pi}}$
186.03766	217.04394	248.05021	279.05649 $n\pi^3$
.193509	.225761	.258013	.290264 $\frac{n}{\pi^3}$
2.661340	2.801663	2.929184	3.046474 $\sqrt[3]{n\pi}$
1.240701	1.306189	1.365563	1.420248 $\sqrt[3]{\frac{n}{\pi}}$
8.787551	10.252143	11.716735	13.181327 $n\sqrt[3]{\frac{n}{\pi}}$
4.096704	4.779489	5.462273	6.145057 $\frac{n}{\sqrt[3]{\pi}}$
584.45455	681.86364	779.27273	876.68182 $n\pi^4$
.061596	.071862	.082123	.092394 $\frac{n}{\pi^4}$
2.083653	2.165519	2.239030	2.305940 $\sqrt[4]{n\pi}$
1.175575	1.221763	1.263237	1.300988 $\sqrt[4]{\frac{n}{\pi}}$

MENSURATION.

LENGTH.

Circumference of circle = diameter \times 3.1416.

Diameter of circle = circumference \times 0.3183.

Side of square of equal periphery as circle = diameter \times 0.7854.

Diameter of circle of equal periphery as square = side \times 1.2732.

Side of an inscribed square = diameter of circle \times 0.7071.

Diameter of circle circumscribed about square = side \times 1.4142.

Circumference of circle whose diameter is 1 =

$$\pi = 3.14159265$$

$$\log. \pi = 0.4971499$$

$$\sqrt{\pi} = 1.772454$$

$$\pi^2 = 9.869604$$

$$r = \frac{c^2}{8v} + \frac{v}{2}$$

$$x = \sqrt{r^2 - (r + o - v)^2}$$

$$v = r - \sqrt{r^2 - \frac{c^2}{4}} = \frac{c}{2} \tan \frac{A}{4} = 2r \sin^2 \frac{A}{4} = r + o - \sqrt{r^2 - x^2}$$

$$c = 2 \sqrt{2vr - v^2} = 2r \sin \frac{A}{2}$$

$$\text{Length of arc} = \frac{\pi r A^\circ}{180} = .0174533 r A^\circ$$

$$\text{Angle } A^\circ = \frac{180 \times \text{arc}}{\pi r} = \frac{57.29578 \times \text{arc}}{r}$$

$$\cos \frac{A}{2} = \frac{c^2 - 4v^2}{c^2 + 4v^2}$$

For division of circle into n parts, $c = 2r \sin \frac{180^\circ}{n}$

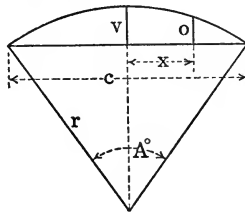

$$\frac{1}{\pi} = 0.318310$$

$$\frac{1}{\pi^2} = 0.101321$$

$$\sqrt{\frac{1}{\pi}} = 0.564190$$

$$o = \sqrt{r^2 - x^2} - (r - v)$$

MENSURATION—(Continued).**AREA.**

Triangle = base \times half perpendicular height.

Parallelogram = base \times perpendicular height.

Trapezoid = half the sum of the parallel sides \times perpendicular height.

Trapezium, found by dividing into two triangles.

Circle = diameter squared $\times 0.7854$; or, = circumference squared $\times 0.07958$.

Sector of circle = length of arc \times half radius.

Segment of circle = area of sector of equal radius - triangle when segment is less, and + triangle when segment is greater than the semicircle; also for flat segments very nearly =

$$\frac{4v}{3} \sqrt{0.388 v^2 + \frac{c^2}{4}}$$

Side of square of equal area as circle = diameter $\times 0.8862$; also, = circumference $\times 0.2821$.

Diameter of circle of equal area as square = side $\times 1.1284$.

Parabola = base $\times \frac{2}{3}$ height.

Ellipse = long diameter \times short diameter $\times 0.7854$.

Regular polygon = sum of sides \times half perpendicular distance from center to sides.

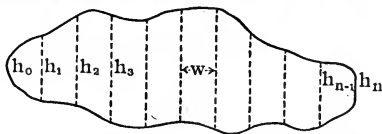
APPROXIMATE AREA OF IRREGULAR FIGURE.

Divide figure into n strips by equidistant parallel ordinates, h_0, h_1, h_2 , etc.

Then by

Simpson's Rule, (n must be even)

$$\text{Area} = \frac{w}{3} [(h_0 + h_n) + 4(h_1 + h_3 + \dots + h_{n-1}) + 2(h_2 + h_4 + \dots + h_{n-2})]$$

Durand's Rule

$$\text{Area} = w [0.4(h_0 + h_n) + 1.1(h_1 + h_{n-1}) + (h_2 + h_3 + \dots + h_{n-2})]$$

Trapezoidal Rule

$$\text{Area} = w [\frac{1}{2}(h_0 + h_n) + (h_1 + h_2 + h_3 + \dots + h_{n-1})]$$

RELATIONS IN CIRCULAR SEGMENTS

Central Angle Degrees	Area Radius ²	Chord Radius	Height Radius	Arc Radius	Central Angle Degrees	Area Radius ²	Chord Radius	Height Radius	Arc Radius
1	.0640	.017	.040	.017	46	.04176	.781	.0795	.803
2	.0535	.035	.0315	.035	47	.04448	.797	.0829	.820
3	.0412	.052	.0334	.052	48	.04731	.813	.0865	.838
4	.028	.070	.0361	.070	49	.05025	.829	.0900	.855
5	.0455	.087	.0395	.087	50	.05331	.845	.0937	.873
6	.096	.105	.0014	.105	51	.05649	.861	.0974	.890
7	.00015	.122	.0019	.122	52	.05978	.877	.1012	.908
8	.00023	.140	.0024	.140	53	.06319	.892	.1051	.925
9	.00032	.157	.0031	.157	54	.06673	.908	.1090	.942
10	.00044	.174	.0038	.175	55	.07039	.923	.1130	.960
11	.00059	.192	.0046	.192	56	.07417	.939	.1171	.977
12	.00076	.209	.0055	.209	57	.07808	.954	.1212	.995
13	.00097	.226	.0064	.227	58	.08212	.970	.1254	1.012
14	.00121	.244	.0075	.244	59	.08629	.985	.1296	1.030
15	.00149	.261	.0086	.262	60	.09059	1.000	.1340	1.047
16	.00181	.278	.0097	.279	61	.09502	1.015	.1384	1.065
17	.00217	.296	.0110	.297	62	.09958	1.030	.1428	1.082
18	.00257	.313	.0123	.314	63	.10428	1.045	.1474	1.100
19	.00302	.330	.0137	.332	64	.10911	1.060	.1520	1.117
20	.00352	.347	.0152	.349	65	.11408	1.075	.1566	1.134
21	.00408	.364	.0167	.367	66	.11919	1.089	.1613	1.152
22	.00468	.382	.0184	.384	67	.12443	1.104	.1661	1.169
23	.00535	.399	.0201	.401	68	.12982	1.118	.1710	1.187
24	.00607	.416	.0219	.419	69	.13535	1.133	.1759	1.204
25	.00686	.433	.0237	.436	70	.14102	1.147	.1808	1.222
26	.00771	.450	.0256	.454	71	.14683	1.161	.1859	1.239
27	.00862	.467	.0276	.471	72	.15279	1.176	.1910	1.257
28	.00961	.484	.0297	.489	73	.15889	1.190	.1961	1.274
29	.01067	.501	.0319	.506	74	.16514	1.204	.2014	1.292
30	.01180	.518	.0341	.524	75	.17154	1.218	.2066	1.309
31	.01301	.534	.0364	.541	76	.17808	1.231	.2120	1.326
32	.01429	.551	.0387	.559	77	.18477	1.245	.2174	1.344
33	.01566	.568	.0412	.576	78	.19160	1.259	.2229	1.361
34	.01711	.585	.0437	.593	79	.19859	1.272	.2284	1.379
35	.01864	.601	.0463	.611	80	.20573	1.286	.2340	1.396
36	.02027	.618	.0489	.628	81	.21301	1.299	.2396	1.414
37	.02198	.635	.0517	.646	82	.22045	1.312	.2453	1.431
38	.02378	.651	.0545	.663	83	.22804	1.325	.2510	1.449
39	.02568	.668	.0574	.681	84	.23578	1.338	.2569	1.466
40	.02767	.684	.0603	.698	85	.24367	1.351	.2627	1.484
41	.02976	.700	.0633	.716	86	.25171	1.364	.2686	1.501
42	.03195	.717	.0664	.733	87	.25990	1.377	.2746	1.518
43	.03425	.733	.0696	.750	88	.26825	1.389	.2807	1.536
44	.03664	.749	.0728	.768	89	.27677	1.402	.2867	1.553
45	.03915	.765	.0761	.785	90	.28540	1.414	.2929	1.571

RELATIONS IN CIRCULAR SEGMENTS

Central Angle Degrees	Area Radius ²	Chord Radius	Height Radius	Arc Radius	Central Angle Degrees	Area Radius ²	Chord Radius	Height Radius	Arc Radius
91	.2942	1.427	.2991	1.588	136	.8395	1.854	.6254	2.374
92	.3032	1.439	.3053	1.606	137	.8545	1.861	.6335	2.391
93	.3123	1.451	.3116	1.623	138	.8697	1.867	.6416	2.409
94	.3215	1.463	.3180	1.641	139	.8850	1.873	.6498	2.426
95	.3309	1.475	.3244	1.658	140	.9003	1.879	.6580	2.443
96	.3405	1.486	.3309	1.676	141	.9158	1.885	.6662	2.461
97	.3502	1.498	.3374	1.693	142	.9313	1.891	.6744	2.478
98	.3601	1.509	.3439	1.710	143	.9470	1.897	.6827	2.496
99	.3701	1.521	.3506	1.728	144	.9627	1.902	.6910	2.513
100	.3803	1.532	.3572	1.745	145	.9786	1.907	.6993	2.531
101	.3906	1.543	.3639	1.763	146	.9945	1.913	.7076	2.548
102	.4010	1.554	.3707	1.780	147	1.0105	1.918	.7160	2.566
103	.4117	1.565	.3775	1.798	148	1.0265	1.923	.7244	2.583
104	.4224	1.576	.3843	1.815	149	1.0427	1.927	.7328	2.601
105	.4333	1.587	.3912	1.833	150	1.0590	1.932	.7412	2.618
106	.4444	1.597	.3982	1.850	151	1.0753	1.936	.7496	2.635
107	.4556	1.608	.4052	1.868	152	1.0917	1.941	.7581	2.653
108	.4669	1.618	.4122	1.885	153	1.1082	1.945	.7666	2.670
109	.4784	1.628	.4193	1.902	154	1.1247	1.949	.7750	2.688
110	.4901	1.638	.4264	1.920	155	1.1413	1.953	.7836	2.705
111	.5019	1.648	.4336	1.937	156	1.1580	1.956	.7921	2.723
112	.5138	1.658	.4408	1.955	157	1.1747	1.960	.8006	2.740
113	.5259	1.668	.4481	1.972	158	1.1915	1.963	.8092	2.758
114	.5381	1.677	.4554	1.990	159	1.2083	1.967	.8178	2.775
115	.5504	1.687	.4627	2.007	160	1.2252	1.970	.8264	2.793
116	.5629	1.696	.4701	2.025	161	1.2422	1.973	.8350	2.810
117	.5755	1.705	.4775	2.042	162	1.2592	1.975	.8436	2.827
118	.5883	1.714	.4850	2.059	163	1.2763	1.978	.8522	2.845
119	.6012	1.723	.4925	2.077	164	1.2933	1.981	.8608	2.862
120	.6142	1.732	.5000	2.094	165	1.3105	1.983	.8695	2.880
121	.6273	1.741	.5076	2.112	166	1.3277	1.985	.8781	2.897
122	.6406	1.749	.5152	2.129	167	1.3449	1.987	.8868	2.915
123	.6540	1.758	.5228	2.147	168	1.3621	1.989	.8955	2.932
124	.6676	1.766	.5305	2.164	169	1.3794	1.991	.9042	2.950
125	.6812	1.774	.5383	2.182	170	1.3967	1.992	.9128	2.967
126	.6950	1.782	.5460	2.199	171	1.4140	1.994	.9215	2.985
127	.7090	1.790	.5538	2.217	172	1.4314	1.995	.9302	3.002
128	.7230	1.798	.5616	2.234	173	1.4488	1.996	.9390	3.019
129	.7372	1.805	.5695	2.251	174	1.4662	1.997	.9477	3.037
130	.7514	1.813	.5774	2.269	175	1.4836	1.998	.9564	3.054
131	.7658	1.820	.5853	2.286	176	1.5010	1.999	.9651	3.072
132	.7803	1.827	.5933	2.304	177	1.5185	1.999	.9738	3.089
133	.7950	1.834	.6013	2.321	178	1.5359	2.000	.9825	3.107
134	.8097	1.841	.6093	2.339	179	1.5533	2.000	.9913	3.124
135	.8245	1.848	.6173	2.356	180	1.5708	2.000	1.0000	3.142

SURFACES AND VOLUMES OF SOLIDS.

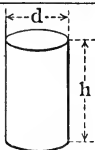
**CYLINDER**

$$\text{Convex Surface} = \pi dh$$

$$\text{Total Surface} = \pi dh + \frac{\pi d^2}{2}$$

$$\text{Volume} = \frac{\pi}{4} d^2 h$$

Volume Cylinder, right or oblique = area of section at right angles to sides \times length of side.

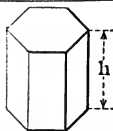
**PRISM**

$$\text{Lateral Surface} = h \times \text{Base Perimeter}$$

$$\text{Total Surface} = \text{Lateral Surface} + (2 \times \text{Base Area})$$

$$\text{Volume} = h \times \text{Base Area}$$

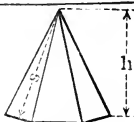
**PYRAMID**

$$\text{Lateral Surface} = \frac{s}{2} \times \text{Base Perimeter}$$

$$\text{Total Surface} = \text{Lateral Surface} + \text{Base Area}$$

$$\text{Volume} = \frac{h}{3} \times \text{Base Area}$$

$$\text{Center of Gravity} = \frac{h}{4}, \text{ above base}$$

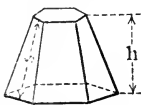
**FRUSTUM OF PYRAMID**

$$\text{Lateral Surface} = s(\text{Top} + \text{Base Perimeters}) + 2$$

If a = top area and A = base area,

$$\text{Total Surface} = \text{Lateral Surface} + (a + A)$$

$$\text{Volume} = \frac{h}{3}(a + A + \sqrt{aA}) + 3$$

$$\text{Center of Gravity} = \frac{h}{4} \left(\frac{3a + A + 2\sqrt{aA}}{a + A + \sqrt{aA}} \right)$$

above base

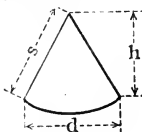
**CONE**

$$\text{Convex Surface} = \frac{\pi}{2} ds = \frac{\pi d}{4} \sqrt{d^2 + 4h^2}$$

$$\text{Total Surface} = \text{Convex Surface} + \frac{\pi d^2}{4}$$

$$\text{Volume} = \frac{\pi}{12} d^2 h = \frac{\pi}{24} d^2 \sqrt{4s^2 - d^2}$$

$$\text{Center of Gravity above base} = \frac{h}{4}$$

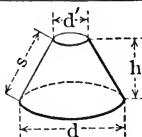
**FRUSTUM OF CONE**

$$\text{Convex Surface} = \frac{\pi s}{2}(d + d') = \frac{\pi}{4}(d + d') \sqrt{4h^2 + (d - d')^2}$$

$$\text{Total Surface} = \frac{\pi s}{2}(d + d') + \frac{\pi}{4}(d^2 + d'^2)$$

$$\text{Volume} = \frac{\pi h}{12}(d^2 + dd' + d'^2)$$

$$\text{Center of Gravity above base} = \frac{h(d^2 + 2dd' + 3d'^2)}{4(d^2 + dd' + d'^2)}$$

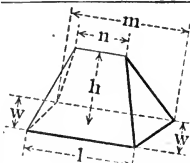
**WEDGE**

$$\text{Surface} = \text{Sum of surfaces of bounding planes}$$

$$\text{Volume} = \frac{wh}{6}(l + m + n)$$

SURFACES AND VOLUMES OF SOLIDS.

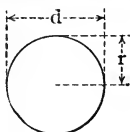
**SPHERE**

Surface = $\pi d^2 = 4\pi r^2$

Volume = $\frac{\pi d^3}{6} = \frac{4}{3}\pi r^3$

Side of an equal cube = diameter of sphere $\times 0.806$
 Length of an equal cylinder = diameter of sphere
 $\times 0.6667$

Center of Gravity of Half Sphere
 = $\frac{3}{8}r$ above spherical center

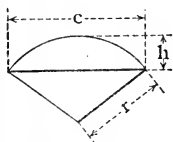
**SPHERICAL SECTOR**

Total Surface = $\frac{\pi r}{2}(4h + c)$

Volume = $\frac{2}{3}\pi r^2 h = \frac{2}{3}\pi r^2 \left(r - \sqrt{r^2 - \frac{c^2}{4}} \right)$

Center of Gravity = $\frac{3}{4} \left(r - \frac{h}{2} \right)$
 above center of sphere

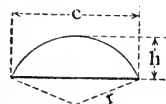
**SPHERICAL SEGMENT**

Spherical Surface = $2\pi r h = \pi(c^2 + 4h^2) + 4$

Total Surface = Spherical Surface + $(\pi c^2 + 4)$

Volume = $\pi h^2(3r - h) + 3 = \pi h(3c^2 + 4h^2) + 24$

Center of gravity above base of segment
 = $\frac{h(4r - h) + 4}{4(3r - h)}$

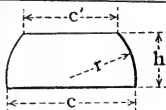
**SPHERICAL ZONE**

Convex Surface = $2\pi r h$

Total Surface = $2\pi r h + \frac{\pi}{4}(c^2 + c'^2)$

Volume = $\frac{\pi h}{24}(3c^2 + 3c'^2 + 4h^2)$

ELLIPSOID (I. Revolution about transverse axis)

Surface = $2\pi r \left[r + R \left(\frac{\sin^{-1} e}{e} \right) \right]$

Volume = $\frac{4}{3}\pi R r^2$

ELLIPSOID (II. Revolution about conjugate axis)

Surface = $\pi \left[2R^2 + \frac{2.302r^2}{e} \log \left(\frac{1+e}{1-e} \right) \right]$

Volume = $\frac{4}{3}\pi R^2 r$ Where $e = \frac{\sqrt{R^2 - r^2}}{R}$

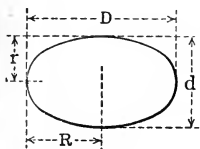
**PARABOLOID**

Convex Surface = $\frac{\pi r}{6h^2} \left[(r^2 + 4h^2)^{3/2} - r^3 \right]$

Total Surface = Convex Surface + πr^2

Volume = $\frac{\pi r^2 h}{2}$ Center of Gravity = $\frac{h}{3}$ above base

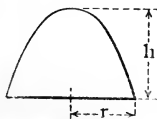

SURFACES AND VOLUMES OF SOLIDS

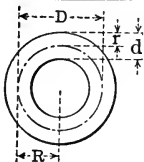
**CIRCULAR RING (TORUS)**

D & R = Mean Diameter and Mean Radius, respectively, of Ring

d & r = Mean Diameter and Mean Radius, respectively, of Section

$$\text{Surface} = \pi^2 Dd = 4\pi^2 Rr$$

$$\text{Volume} = 2\pi^2 Rr^2 = \frac{\pi^2}{4} Dd^2$$

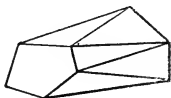
**PRISMOID**

End faces are in parallel planes.

$$\text{Volume} = \frac{1}{6}(A + A' + 4M), \text{ where}$$

1 = perpendicular distance between ends

A, A' = areas of ends

M = area of mid section, parallel to ends

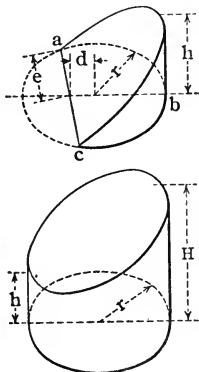
**UNGULAS FROM RIGHT CIRCULAR CYLINDER**

(As formed by cutting plane oblique to base)

I. Base, abc, less than semicircle;

Convex Surface

$$= h(2re - (d \times \text{length arc abc})) + (r - d)$$

$$\text{Volume} = h(\frac{2}{3}e^2 - (d \times \text{area base abc})) + (r - d)$$

II. Base, abc, = semicircle;

Convex Surface = 2rh

$$\text{Volume} = \frac{2}{3}r^2h$$

III. Base, abc, greater than semicircle (figure);

Convex Surface

$$= h(2re + (d \times \text{length arc abc})) + (r + d)$$

$$\text{Volume} = h(\frac{2}{3}e^2 + (d \times \text{area base abc})) + (r + d)$$

IV. Base, abc, = circle, oblique plane touching circumference.

Convex Surface = πrh

$$\text{Volume} = \frac{1}{2}\pi r^2h$$

V. Base, abc, = circle, oblique plane entirely above (figure).

Convex Surface = 2 πr

$$\times \frac{1}{2}(h, \text{minimum} + H, \text{maximum})$$

$$\text{Volume} = \pi r^2 \times \frac{1}{2}(h, \text{minimum} + H, \text{maximum})$$

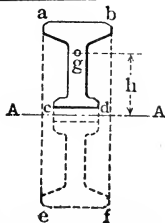
**ANY SOLID OF REVOLUTION**

Let abcd represent the generating section about axis A-A of solid abef.

Let g at distance h from A-A be the center of gravity of abcd.

Let α° be the angular amount of generating revolution.

Then

Total Surface of solid abef

$$= (2\pi h\alpha + 360) \times \text{perimeter abcd}$$

$$\text{Volume of solid abef} = (\frac{2}{3}\pi h\alpha + 360) \times \text{area abcd}$$

$$\text{For complete revolution } (2\pi h\alpha + 360) = 2\pi h$$

MINUTES AND SECONDS EXPRESSED AS DECIMALS OF A DEGREE

Minutes	0	10	20	30	40	50
016667	.33333	.50000	.66667	.83333
1	.01667	.18333	.35000	.51667	.68333	.85000
2	.03333	.20000	.36667	.53333	.70000	.86667
3	.05000	.21667	.38333	.55000	.71667	.88333
4	.06667	.23333	.40000	.56667	.73333	.90000
5	.08333	.25000	.41667	.58333	.75000	.91667
6	.10000	.26667	.43333	.60000	.76667	.93333
7	.11667	.28333	.45000	.61667	.78333	.95000
8	.13333	.30000	.46667	.63333	.80000	.96667
9	.15000	.31667	.48333	.65000	.81667	.98333
Seconds	0	10	20	30	40	50
000278	.00556	.00833	.01111	.01389
1	.00028	.00306	.00583	.00861	.01139	.01417
2	.00056	.00333	.00611	.00889	.01167	.01444
3	.00083	.00361	.00639	.00917	.01194	.01472
4	.00111	.00389	.00667	.00944	.01222	.01500
5	.00139	.00417	.00694	.00972	.01250	.01528
6	.00167	.00444	.00722	.01000	.01278	.01556
7	.00194	.00472	.00750	.01028	.01306	.01583
8	.00222	.00500	.00778	.01056	.01333	.01611
9	.00250	.00528	.00806	.01083	.01361	.01639

DECIMALS OF A DEGREE EXPRESSED AS MINUTES OR SECONDS

Degree	.00		.10		.20		.30		.40	
	Min.	(Sec.)	Min.	(Sec.)	Min.	(Sec.)	Min.	(Sec.)	Min.	(Sec.)
.00		6.0 (360)		12.0 (720)		18.0 (1080)		24.0 (1440)	
.01	.6 (36)		6.6 (396)		12.6 (756)		18.6 (1116)		24.6 (1476)	
.02	1.2 (72)		7.2 (432)		13.2 (792)		19.2 (1152)		25.2 (1512)	
.03	1.8 (108)		7.8 (468)		13.8 (828)		19.8 (1188)		25.8 (1548)	
.04	2.4 (144)		8.4 (504)		14.4 (864)		20.4 (1224)		26.4 (1584)	
.05	3.0 (180)		9.0 (540)		15.0 (900)		21.0 (1260)		27.0 (1620)	
.06	3.6 (216)		9.6 (576)		15.6 (936)		21.6 (1296)		27.6 (1656)	
.07	4.2 (252)		10.2 (612)		16.2 (972)		22.2 (1332)		28.2 (1692)	
.08	4.8 (288)		10.8 (648)		16.8 (1008)		22.8 (1368)		28.8 (1728)	
.09	5.4 (324)		11.4 (684)		17.4 (1044)		23.4 (1404)		29.4 (1764)	
Degree	.50		.60		.70		.80		.90	
	Min.	(Sec.)	Min.	(Sec.)	Min.	(Sec.)	Min.	(Sec.)	Min.	(Sec.)
.00	30.0 (1800)		36.0 (2160)		42.0 (2520)		48.0 (2880)		54.0 (3240)	
.01	30.6 (1836)		36.6 (2196)		42.6 (2556)		48.6 (2916)		54.6 (3276)	
.02	31.2 (1872)		37.2 (2232)		43.2 (2592)		49.2 (2952)		55.2 (3312)	
.03	31.8 (1908)		37.8 (2268)		43.8 (2628)		49.8 (2988)		55.8 (3348)	
.04	32.4 (1944)		38.4 (2304)		44.4 (2664)		50.4 (3024)		56.4 (3384)	
.05	33.0 (1980)		39.0 (2340)		45.0 (2700)		51.0 (3060)		57.0 (3420)	
.06	33.6 (2016)		39.6 (2376)		45.6 (2736)		51.6 (3096)		57.6 (3456)	
.07	34.2 (2052)		40.2 (2412)		46.2 (2772)		52.2 (3132)		58.2 (3492)	
.08	34.8 (2088)		40.8 (2448)		46.8 (2808)		52.8 (3168)		58.8 (3528)	
.09	35.4 (2124)		41.4 (2484)		47.4 (2844)		53.4 (3204)		59.4 (3564)	

WEIGHTS AND MEASURES.**AVOIRDUPOIS WEIGHT.**

United States and British.

Grains.	Drams.	Ounces.	Pounds.	Hundred-weight.	Gross Tons.
1.	.03657	.002286	.000143	.00000128	.000000064
27.34375	1.	.0625	.003906	.00003488	.000001744
437.5	16.	1.	.0625	.00055804	.00002790
7000.	256.	16.	1.	.0089286	.0004464
784000.	28672.	1792.	112.	1.	.05
15680000.	573440.	35840.	2240.	20.	1.

1 pound avoirdupois = 1.215278 pounds troy.

1 net ton = 2000 pounds = .892857 gross ton.

TROY WEIGHT.

United States and British.

Grains.	Pennyweight.	Ounces.	Pounds.
1	.041667	.0020833	.0001736
24	1.	.05	.0041667
480	20.	1.	.0833333
5760	240.	12.	1.

1 pound troy = .822857 pound avoirdupois.

175 ounces troy = 192 ounces avoirdupois.

APOTHECARIES' WEIGHT.

United States and British.

Grains.	Scruples.	Drama.	Ounces.	Pounds.
1	.05	.016667	.0020833	.000173611
20	1.	.333333	.0416667	.0034722
60	3.	1.	.125	.0104167
480	24.	8.	1.	.0833333
5760	288.	96.	12.	1.

The pound, ounce and grain are the same as in troy weight.

The avoirdupois grain = troy grain = apothecaries' grain.

WEIGHTS AND MEASURES—Continued.

LINEAR MEASURE.

United States and British.

Inches.	Feet.	Yards.	Rods.	Furlongs.	Miles.
1	.08333	.02778	.0050505	.00012626	.00001578
12	1.	.33333	.0606061	.00151515	.00018939
36	3.	1.	.1818182	.00454545	.00056818
198	16.5	5.5	1.	.025	.003125
7920	660.	220.	40.	1.	.125
63360	5280.	1760.	320.	8.	1.

ROPE AND CABLE MEASURE.

- 1 inch = .111111 span = .013889 fathom = .0001157 cable's length.
- 1 span = 9 inches = .125 fathom = .00104167 cable's length.
- 1 fathom = 6 feet = 8 spans = 72 inches = .008333 cable's length.
- 1 cable's length = 120 fathoms = 720 feet = 960 spans = 8640 inches.

NAUTICAL MEASURE.

- 1 nautical mile, as adopted by the United States Coast and Geodetic Survey, equals the length of one minute of arc of a great circle of a sphere whose surface equals that of the earth = 6080.204 feet = 1.1516 statute miles.
- 1 league = 3 nautical miles = 18240.613 feet.

GUNTER'S CHAIN.

- 1 link = 7.92 inches = .01 chain = .000125 mile.
- 1 chain = 100 links = 66 feet = 4 rods = .0125 mile.
- 1 mile = 80 chains = 8000 links.

SQUARE OR LAND MEASURE.

United States and British.

Square Inches.	Square Feet.	Square Yards.	Square Rods.	Acres.	Square Miles.
1	.006944	.0007716
144	1.	.111111
1296	9.0	1.	.03306	.0002066
39204	272.25	30.25	1.	.00625	.00000977
6272640	43560.	4840.	160.	1.	.0015625
	27878400.	3097600.	102400.	640.	1.

- 1 square rod = 40 square rods.
- 1 acre = 4 square rods.
- 1 square acre = 208.71 feet square.

WEIGHTS AND MEASURES—Continued.**CUBIC OR SOLID MEASURE.****United States and British.**

1 cubic inch = .0005787 cubic foot = .000021433 cubic yard.

1 cubic foot = 1728 cubic inches = .03703704 cubic yard.

1 cubic yard = 27 cubic feet = 46656 cubic inches.

1 cord of wood = 128 cubic feet = 4 feet by 4 feet by 8 feet.

1 perch of masonry = 24.75 cubic feet = 16.5 feet by 1.5 feet by 1 foot. It is usually taken as 25 cubic feet.

DRY MEASURE.**United States only.**

Pints.	Quarts.	Gallons.	Pecks.	Bushels	Cubic Inches.
1	.50	.125	.0625	.015625	33.6003125
2	1.	.25	.125	.03125	67.200625
8	4.	1.	.05	.125	268.8025
16	8.	2.	1.	.25	537.605
64	32.	8.	4.	1.	2150.42

1 heaped bushel = 1.25 struck bushel, and the cone must be not less than 6 inches high.

LIQUID MEASURE.**United States only.**

Gills.	Pints.	Quarts.	Gallons.	Barrels.	Cubic Inches.
1	.25	.125	.03125	.000992	7.21875
4	1.	.5	.125	.003968	28.875
8	2.	1.	.25	.007937	57.75
32	8.	4.	1.	.031746	231.
1008	252.	126.	31.5	1.	7276.5

The British imperial gallon = 277.410 cubic inches or 10 pounds avoirdupois of pure water at 62° F. and barometer at 30 inches.

The British imperial gallon = 1.20091 United States gallons.

1 fluid drachm = 60 minims = .125 fluid ounce = .0078125 pint.

1 fluid ounce = 480 minims = 8 drachms = .0625 pint.

WEIGHTS AND MEASURES—Concluded.

METRIC SYSTEM.

Measures of Length, Capacity and Weight.

LENGTH.	Kilometre.	Hecto- metre.	Decametre.	Metre.	Decimetre.	Centimetre.	Millimetre.
CAPACITY.	Kilolitre or Stere.	Hectolitre or Decistere.	Decalitre or Centistere.	Litre or Millistere.	Decilitre.	Centilitre.	Millilitre.
WEIGHT.	Kilo- gramme.	Hecto- gramme.	Deca- gramme.	Gramme.	Deci- gramme.	Centi- gramme.	Milli- gramme.
	1	10 1	100 10 1	1000 100 10 1 .1 .01 .001	10000 1000 100 10 1 .1 .01	100000 10000 1000 100 10 1 .1	1000000 100000 10000 1000 100 10 1

1 myriametre = 10 kilometres = 10000 metres.

1 tonne = 1000 kilogrammes = 100 quintals = 10 myriagrammes.

1 gramme = weight of 1 cubic centimetre of distilled water at its maximum density at sea level in latitude of Paris and barometer at 760 millimetres.

1 litre = 1 cubic decimetre.

METRIC SYSTEM.

Square or Surface Measure.

Square Kilometre.	Square Hectometre or Hectare.	Square Decametre or Are.	Square Metre or Centiare.	Square Decimetre.	Square Centimetre.	Square Millimetre.
1	100 1 .01 .0001 .000001	10000 100 1 .01 .0001 .000001	1000000 10000 100 1 .01 .0001 .000001	1000000 10000 100 1 .01 .0001	1000000 10000 100 1 .01	1000000 10000 100 1

1 square myriametre = 100 square kilometres = 100 000 000 square metres.

METRIC SYSTEM.

Cubic Measure.

Cubic Decametre.	Cubic Metre.	Cubic Decimetre.	Cubic Centimetre.	Cubic Millimetre.
1	1000 1 .001 .000001 .000000001	1000000 1000 1 .001 .000001	1000000000 1000000 1000 1 .001	1000000000 1000000 1000000 1000 1

1 cubic metre = 1 kilolitre = 1 stere.

TABLES FOR CONVERTING UNITED STATES WEIGHTS AND MEASURES.

CUSTOMARY TO METRIC.

Weights.

See Page 590

No.	Grains to Milligrammes.	Troy Ounces to Grammes.	Avoirdupois Ounces to Grammes.	Avoirdupois Pounds to Kilogrammes. Page 582	Net Tons of 2000 Pounds to Tonnes.	Gross Tons of 2240 Pounds to Tonnes.
1	64.79892	31.10348	28.34953	.45359	.90718	1.01605
2	129.59784	62.20696	56.69905	.90718	1.81437	2.03209
3	194.39675	93.31044	85.04858	1.36078	2.72155	3.04814
4	259.19567	124.41392	113.39811	1.81437	3.62874	4.06419
5	323.99459	155.51740	141.74763	2.26796	4.53592	5.08024
6	388.79351	186.62088	170.09716	2.72155	5.44311	6.09628
7	453.59243	217.72437	198.44669	3.17515	6.35029	7.11233
8	518.39135	248.82785	226.79621	3.62874	7.25748	8.12838
9	583.19026	279.93133	255.14574	4.08233	8.16466	9.14442

1 Avoirdupois Pound = 453.5924277 Grammes.

Linear Measure.

No.	64ths of an Inch to Millimetres. Page 450	Inches to Centimetres. Page 568	Feet to Metres. Page 574	Yards to Metres.	Statute Miles to Kilometres.	Nautical Miles to Kilometres.
1	.39688	2.54001	.304801	.914402	1.60935	1.85325
2	.79375	5.08001	.609601	1.828804	3.21869	3.70650
3	1.19063	7.62002	.914402	2.743205	4.82804	5.55975
4	1.58750	10.16002	1.219202	3.657607	6.43739	7.41300
5	1.98438	12.70003	1.524003	4.572009	8.04674	9.26625
6	2.38125	15.24003	1.828804	5.486411	9.65608	11.11950
7	2.77813	17.78004	2.133604	6.400813	11.26543	12.97275
8	3.17501	20.32004	2.438405	7.315215	12.87478	14.82600
9	3.57188	22.86005	2.743205	8.229616	14.48412	16.67925

1 Nautical Mile = 1853.25 Metres.

1 Gunter's Chain = 20.1168 Metres.

1 Fathom = 1.829 Metres.

TABLES FOR CONVERTING UNITED STATES WEIGHTS AND MEASURES.

METRIC TO CUSTOMARY.

Weights.

See Page 590

No.	Milligrammes to Grains.	Grammes to Troy Ounces.	Grammes to Avoirdupois Ounces.	Kilogrammes to Avoirdupois Pounds. Page 586	Tonnes to Net Tons of 2000 Pounds.	Tonnes to Gross Tons of 2240 Pounds.
1	.01543	.03215	.03527	2.20462	1.10231	.98421
2	.03086	.06430	.07055	4.40924	2.20462	1.96841
3	.04630	.09645	.10582	6.61387	3.30693	2.95262
4	.06173	.12860	.14110	8.81849	4.40924	3.93682
5	.07716	.16075	.17637	11.02311	5.51156	4.92103
6	.09259	.19290	.21164	13.22773	6.61387	5.90524
7	.10803	.22506	.24692	15.43236	7.71618	6.88944
8	.12346	.25721	.28219	17.63698	8.81849	7.87365
9	.13889	.28936	.31747	19.84160	9.92080	8.85785

1 Kilogramme = 15432.35639 Grains.

Linear Measure.

No.	Millimetres to 64ths of an Inch.	Centimetres to Inches. Page 570	Metres to Feet. Page 578	Metres to Yards.	Kilometres to Statute Miles.	Kilometres to Nautical Miles.
1	2.51968	.39370	3.280833	1.093611	.62137	.53959
2	5.03936	.78740	6.561667	2.187222	1.24274	1.07919
3	7.55904	1.18110	9.842500	3.280833	1.86411	1.61878
4	10.07872	1.57480	13.123333	4.374444	2.48548	2.15837
5	12.59840	1.96850	16.404167	5.468056	3.10685	2.69796
6	15.11808	2.36220	19.685000	6.561667	3.72822	3.23756
7	17.63776	2.75590	22.965833	7.655278	4.34959	3.77715
8	20.15744	3.14960	26.246667	8.748889	4.97096	4.31674
9	22.67712	3.54330	29.527500	9.842500	5.59233	4.85633

TABLES FOR CONVERTING UNITED STATES WEIGHTS AND MEASURES.

CUSTOMARY TO METRIC.

Square Measure.

No.	Square Inches to Square Centimetres.	Square Feet to Square Metres.	Square Yards to Square Metres.	Acres to Hectares.	Square Miles to Square Kilometres.
1	6.45163	.09290	.83613	.40470	2.59000
2	12.90325	.18581	1.67226	.80939	5.18000
3	19.35488	.27871	2.50839	1.21409	7.77000
4	25.80650	.37161	3.34452	1.61879	10.35999
5	32.25813	.46452	4.18065	2.02349	12.94999
6	38.70975	.55742	5.01679	2.42818	15.53999
7	45.16138	.65032	5.85292	2.83288	18.12999
8	51.61300	.74323	6.68905	3.23758	20.71999
9	58.06463	.83613	7.52518	3.64228	23.30999

1 Square Statute Mile = 259.00 Hectares.

Cubic Measure

No.	Cubic Inches to Cubic Centimetres.	Cubic Inches to Cubic Decimetres.	Cubic Feet to Cubic Metres.	Cubic Yards to Cubic Metres.
1	16.38716	.01639	.02832	.76456
2	32.77432	.03277	.05663	1.52912
3	49.16148	.04916	.08495	2.29368
4	65.54864	.06555	.11327	3.05824
5	81.93580	.08194	.14159	3.82280
6	98.32296	.09832	.16990	4.58736
7	114.71013	.11471	.19822	5.35192
8	131.09729	.13110	.22654	6.11648
9	147.48445	.14748	.25485	6.88104

**TABLES FOR CONVERTING UNITED STATES
WEIGHTS AND MEASURES.**

METRIC TO CUSTOMARY.

Square Measure.

No.	Square Centimetres to Square Inches.	Square Metres to Square Feet.	Square Metres to Square Yards.	Hectares to Acres.	Square Kilometres to Square Miles.
1	.15500	10.76387	1.19599	2.47104	.38610
2	.31000	21.52773	2.39197	4.94209	.77220
3	.46500	32.29160	3.58796	7.41313	1.15830
4	.62000	43.05547	4.78394	9.88418	1.54440
5	.77500	53.81934	5.97993	12.35522	1.93050
6	.93000	64.58320	7.17591	14.82626	2.31660
7	1.08500	75.34707	8.37190	17.29731	2.70270
8	1.24000	86.11094	9.56788	19.76835	3.08880
9	1.39500	96.87481	10.76387	22.23940	3.47490

1 Hectare = .003861 Square Statute Mile.

Cubic Measure

No.	Cubic Centimetres to Cubic Inches.	Cubic Decimetres to Cubic Inches.	Cubic Metres to Cubic Feet.	Cubic Metres to Cubic Yards.
1	.06102	61.02338	35.31445	1.30794
2	.12205	122.04676	70.62891	2.61589
3	.18307	183.07013	105.94336	3.92383
4	.24409	244.09351	141.25782	5.23177
5	.30512	305.11689	176.57227	6.53971
6	.36614	366.14027	211.88673	7.84766
7	.42716	427.16365	247.20118	9.15560
8	.48819	488.18702	282.51564	10.46354
9	.54921	549.21040	317.83009	11.77149

TABLES FOR CONVERTING UNITED STATES WEIGHTS AND MEASURES.

CUSTOMARY TO METRIC.

Capacity Measures.

No.	Liquid Quarts to Litres.	Gallons to Litres.	Gallons to Cubic Metres.	Bushels to Hectolitres.	Fluid Drachms to Millilitres or Cubic Centimetres.	Fluid Ounces to Millilitres or Cubic Centimetres.
1	.94636	3.78543	.00379	.35239	3.69671	29.57370
2	1.89272	7.57087	.00757	.70479	7.39343	59.14741
3	2.83908	11.35630	.01136	1.05718	11.09014	88.72111
4	3.78543	15.14174	.01514	1.40957	14.78685	118.29482
5	4.73179	18.92717	.01893	1.76196	18.48357	147.86352
6	5.67815	22.71260	.02271	2.11436	22.18028	177.44222
7	6.62451	26.49804	.02650	2.46675	25.87699	207.01593
8	7.57087	30.28347	.03028	2.81914	29.57370	236.58963
9	8.51723	34.06891	.03407	3.17154	33.27042	266.16334

Miscellaneous.

No.	Pounds per Lineal Foot to Kilogrammes per Lineal Metre.	Pounds per Square Inch to Kilogrammes per Square Centimetre.	Pounds per Square Foot to Kilogrammes per Square Metre.	Pounds per Cubic Foot to Kilogrammes per Cubic Metre.	Foot-Pounds to Kilogramme- Metres	United States Horsepower to Metric Horsepower.
1	1.48816	.07031	4.88241	16.01837	.13826	1.01387
2	2.97632	.14061	9.76482	32.03674	.27651	2.02775
3	4.46448	.21092	14.64723	48.05510	.41477	3.04162
4	5.95264	.28123	19.52963	64.07348	.55302	4.05549
5	7.44081	.35153	24.41204	80.09185	.69128	5.06937
6	8.92897	.42184	29.29445	96.11021	.82953	6.08324
7	10.41713	.49215	34.17686	112.12858	.96779	7.09711
8	11.90529	.56245	39.05927	128.14695	1.10604	8.11098
9	13.39345	.63276	43.94168	144.16532	1.24430	9.12486

TABLES FOR CONVERTING UNITED STATES WEIGHTS AND MEASURES.

METRIC TO CUSTOMARY.

Capacity Measures.

No.	Litres to Fluid Quarts.	Litres to Gallons.	Cubic Metres to Gallons.	Hectolitres to Bushels.	Millilitres or Cubic Centi- metres to Fluid Drachms.	Millilitres or Cubic Centi- metres to Fluid Ounces.
1	1.05668	.26417	264.17047	2.83774	.27051	.03381
2	2.11336	.52834	528.34093	5.67548	.54102	.06763
3	3.17005	.79251	792.51140	8.51323	.81153	.10144
4	4.22673	1.05668	1056.68187	11.35097	1.08204	.13526
5	5.28341	1.32085	1320.85234	14.18871	1.35255	.16907
6	6.34009	1.58502	1585.02280	17.02645	1.62306	.20288
7	7.39677	1.84919	1849.19327	19.86420	1.89357	.23670
8	8.45345	2.11336	2113.36374	22.70194	2.16408	.27051
9	9.51014	2.37753	2377.53420	25.53968	2.43460	.30432

Miscellaneous.

No.	Kilogrammes per Lineal Metre to Pounds per Lineal Foot.	Kilogrammes per Square Centimetre to Pounds per Square Inch.	Kilogrammes per Square Metre to Pounds per Square Foot.	Kilogrammes per Cubic Metre to Pounds per Cubic Foot.	Kilogramme- Metres to Foot-Pounds.	Metric Horsepower to United States Horsepower.
1	.67197	14.22340	.20482	.06243	7.23300	.98632
2	1.34393	28.44680	.40963	.12486	14.46600	1.97264
3	2.01590	42.67020	.61445	.18728	21.69899	2.95895
4	2.68787	56.89359	.81927	.24971	28.93199	3.94527
5	3.35984	71.11699	1.02408	.31214	36.16499	4.93159
6	4.03180	85.34039	1.22890	.37457	43.39799	5.91791
7	4.70377	99.56379	1.43372	.43700	50.63098	6.90423
8	5.37574	113.78719	1.63854	.49943	57.86398	7.89054
9	6.04770	128.01059	1.84335	.56185	65.09698	8.87686

EQUIVALENTS OF INCHES IN MILLIMETRES.

FRACTIONS OF AN INCH ADVANCING BY 32nds.

Page 450 shows values for each $\frac{1}{16}$ to 1 inch.

Conversion Factor: 1 inch = 25.40005 millimetres.

Inches	0"	1"	2"	3"	4"	5"
.. .. 0	25.400	50.800	76.200	101.600	127.000
$\frac{1}{32}$794	26.194	51.594	76.994	102.394	127.794
.. $\frac{1}{16}$..	1.588	26.988	52.388	77.788	103.188	128.588
$\frac{3}{32}$	2.381	27.781	53.181	78.581	103.981	129.382
.. .. $\frac{1}{8}$	3.175	28.575	53.975	79.375	104.775	130.175
$\frac{5}{32}$	3.969	29.369	54.769	80.169	105.569	130.969
.. $\frac{3}{16}$..	4.763	30.163	55.563	80.963	106.363	131.763
$\frac{7}{32}$	5.556	30.956	56.356	81.756	107.156	132.557
.. .. $\frac{1}{4}$	6.350	31.750	57.150	82.550	107.950	133.350
$\frac{9}{32}$	7.144	32.544	57.944	83.344	108.744	134.144
.. $\frac{5}{16}$..	7.938	33.338	58.738	84.138	109.538	134.938
$\frac{11}{32}$	8.731	34.131	59.531	84.931	110.331	135.732
.. .. $\frac{3}{8}$	9.525	34.925	60.325	85.725	111.125	136.525
$\frac{13}{32}$	10.319	35.719	61.119	86.519	111.919	137.319
.. $\frac{7}{16}$..	11.113	36.513	61.913	87.313	112.713	138.113
$\frac{15}{32}$	11.906	37.306	62.706	88.106	113.506	138.907
.. .. $\frac{1}{2}$	12.700	38.100	63.500	88.900	114.300	139.700
$\frac{17}{32}$	13.494	38.894	64.294	89.694	115.094	140.494
.. $\frac{9}{16}$..	14.288	39.688	65.088	90.488	115.888	141.288
$\frac{19}{32}$	15.081	40.481	65.881	91.281	116.681	142.082
.. .. $\frac{5}{8}$	15.875	41.275	66.675	92.075	117.475	142.875
$\frac{21}{32}$	16.669	42.069	67.469	92.869	118.269	143.669
.. $\frac{11}{16}$..	17.463	42.863	68.263	93.663	119.063	144.463
$\frac{23}{32}$	18.256	43.656	69.056	94.456	119.856	145.257
.. .. $\frac{3}{4}$	19.050	44.450	69.850	95.250	120.650	146.050
$\frac{25}{32}$	19.844	45.244	70.644	96.044	121.444	146.844
.. $\frac{13}{16}$..	20.638	46.038	71.438	96.838	122.238	147.638
$\frac{27}{32}$	21.431	46.831	72.231	97.631	123.031	148.432
.. .. $\frac{7}{8}$	22.225	47.625	73.025	98.425	123.825	149.225
$\frac{29}{32}$	23.019	48.419	73.819	99.219	124.619	150.019
.. $\frac{15}{16}$..	23.813	49.213	74.613	100.013	125.413	150.813
$\frac{31}{32}$	24.606	50.006	75.406	100.806	126.206	151.607

12 Inches = 304.8006 Millimetres.

EQUIVALENTS OF INCHES IN MILLIMETRES.

(Continued)

Inches	6"	7"	8"	9"	10"	11"
.. .. 0	152.400	177.800	203.200	228.601	254.001	279.401
$\frac{1}{32}$	153.194	178.594	203.994	229.394	254.794	280.194
.. .. $\frac{1}{16}$	153.988	179.388	204.788	230.188	255.588	280.988
$\frac{3}{32}$	154.782	180.182	205.582	230.982	256.382	281.782
.. .. $\frac{1}{8}$	155.575	180.975	206.375	231.775	257.176	282.576
$\frac{5}{32}$	156.369	181.769	207.169	232.569	257.969	283.369
.. .. $\frac{3}{16}$	157.163	182.563	207.963	233.363	258.763	284.163
$\frac{7}{32}$	157.957	183.357	208.757	234.157	259.557	284.957
.. .. $\frac{1}{4}$	158.750	184.150	209.550	234.950	260.351	285.751
$\frac{9}{32}$	159.544	184.944	210.344	235.744	261.144	286.544
.. .. $\frac{5}{16}$	160.338	185.738	211.138	236.538	261.938	287.338
$\frac{11}{32}$	161.132	186.532	211.932	237.332	262.732	288.132
.. .. $\frac{3}{8}$	161.925	187.325	212.725	238.125	263.526	288.926
$\frac{13}{32}$	162.719	188.119	213.519	238.919	264.319	289.719
.. .. $\frac{7}{16}$	163.513	188.913	214.313	239.713	265.113	290.513
$\frac{15}{32}$	164.307	189.707	215.107	240.507	265.907	291.307
.. .. $\frac{1}{2}$	165.100	190.500	215.900	241.300	266.701	292.101
$\frac{17}{32}$	165.894	191.294	216.694	242.094	267.494	292.894
.. .. $\frac{9}{16}$	166.688	192.088	217.488	242.888	268.288	293.688
$\frac{19}{32}$	167.482	192.882	218.282	243.682	269.082	294.482
.. .. $\frac{5}{8}$	168.275	193.675	219.075	244.475	269.876	295.276
$\frac{21}{32}$	169.069	194.469	219.869	245.269	270.669	296.069
.. .. $\frac{11}{16}$	169.863	195.263	220.663	246.063	271.463	296.863
$\frac{23}{32}$	170.657	196.057	221.457	246.857	272.257	297.657
.. .. $\frac{3}{4}$	171.450	196.850	222.250	247.650	273.051	298.451
$\frac{25}{32}$	172.244	197.644	223.044	248.444	273.844	299.244
.. .. $\frac{13}{16}$	173.038	198.438	223.838	249.238	274.638	300.038
$\frac{27}{32}$	173.832	199.232	224.632	250.032	275.432	300.832
.. .. $\frac{7}{8}$	174.625	200.025	225.425	250.825	276.226	301.626
$\frac{29}{32}$	175.419	200.819	226.219	251.619	277.019	302.419
.. .. $\frac{15}{16}$	176.213	201.613	227.013	252.413	277.813	303.213
$\frac{31}{32}$	177.007	202.407	227.807	253.207	278.607	304.007

12 Inches=304.8006 Millimetres.

EQUIVALENTS OF MILLIMETRES IN INCHES.

Conversion Factor: 1 millimetre=.03937 inch.

Millimetres	0	100	200	300	400
0	.000	3.937	7.874	11.811	15.748
1	.039	3.976	7.913	11.850	15.788
2	.079	4.016	7.953	11.890	15.827
3	.118	4.055	7.992	11.929	15.866
4	.157	4.095	8.032	11.969	15.906
5	.197	4.134	8.071	12.008	15.945
6	.236	4.173	8.110	12.047	15.984
7	.276	4.213	8.150	12.087	16.024
8	.315	4.252	8.189	12.126	16.063
9	.354	4.291	8.228	12.165	16.103
10	.394	4.331	8.268	12.205	16.142
11	.433	4.370	8.307	12.244	16.181
12	.472	4.409	8.347	12.284	16.221
13	.512	4.449	8.386	12.323	16.260
14	.551	4.488	8.425	12.362	16.299
15	.591	4.528	8.465	12.402	16.339
16	.630	4.567	8.504	12.441	16.378
17	.669	4.606	8.543	12.480	16.417
18	.709	4.646	8.583	12.520	16.457
19	.748	4.685	8.622	12.559	16.496
20	.787	4.724	8.661	12.599	16.536
21	.827	4.764	8.701	12.638	16.575
22	.866	4.803	8.740	12.677	16.614
23	.906	4.843	8.780	12.717	16.654
24	.945	4.882	8.819	12.756	16.693
25	.984	4.921	8.858	12.795	16.732
26	1.024	4.961	8.898	12.835	16.772
27	1.063	5.000	8.937	12.874	16.811
28	1.102	5.039	8.976	12.913	16.851
29	1.142	5.079	9.016	12.953	16.890
30	1.181	5.118	9.055	12.992	16.929
31	1.220	5.158	9.095	13.032	16.969
32	1.260	5.197	9.134	13.071	17.008
33	1.299	5.236	9.173	13.110	17.047
34	1.339	5.276	9.213	13.150	17.087
35	1.378	5.315	9.252	13.189	17.126
36	1.417	5.354	9.291	13.228	17.166
37	1.457	5.394	9.331	13.268	17.205
38	1.496	5.433	9.370	13.307	17.244
39	1.535	5.472	9.410	13.347	17.284
40	1.575	5.512	9.449	13.386	17.323
41	1.614	5.551	9.488	13.425	17.362
42	1.654	5.591	9.528	13.465	17.402
43	1.693	5.630	9.567	13.504	17.441
44	1.732	5.669	9.606	13.543	17.480
45	1.772	5.709	9.646	13.583	17.520
46	1.811	5.748	9.685	13.622	17.559
47	1.850	5.787	9.724	13.662	17.599
48	1.890	5.827	9.764	13.701	17.638
49	1.929	5.866	9.803	13.740	17.677

EQUIVALENTS OF MILLIMETRES IN INCHES.

(Continued)

Millimetres	0	100	200	300	400
50	1.969	5.906	9.843	13.780	17.717
51	2.008	5.945	9.882	13.819	17.756
52	2.047	5.984	9.921	13.858	17.795
53	2.087	6.024	9.961	13.898	17.835
54	2.126	6.063	10.000	13.937	17.874
55	2.165	6.102	10.039	13.977	17.914
56	2.205	6.142	10.079	14.016	17.953
57	2.244	6.181	10.118	14.055	17.992
58	2.283	6.221	10.158	14.095	18.032
59	2.323	6.260	10.197	14.134	18.071
60	2.362	6.299	10.236	14.173	18.110
61	2.402	6.339	10.276	14.213	18.150
62	2.441	6.378	10.315	14.252	18.189
63	2.480	6.417	10.354	14.291	18.229
64	2.520	6.457	10.394	14.331	18.268
65	2.559	6.496	10.433	14.370	18.307
66	2.598	6.535	10.473	14.410	18.347
67	2.638	6.575	10.512	14.449	18.386
68	2.677	6.614	10.551	14.488	18.425
69	2.717	6.654	10.591	14.528	18.465
70	2.756	6.693	10.630	14.567	18.504
71	2.795	6.732	10.669	14.606	18.543
72	2.835	6.772	10.709	14.646	18.583
73	2.874	6.811	10.748	14.685	18.622
74	2.913	6.850	10.787	14.725	18.662
75	2.953	6.890	10.827	14.764	18.701
76	2.992	6.929	10.866	14.803	18.740
77	3.032	6.969	10.906	14.843	18.780
78	3.071	7.008	10.945	14.882	18.819
79	3.110	7.047	10.984	14.921	18.858
80	3.150	7.087	11.024	14.961	18.898
81	3.189	7.126	11.063	15.000	18.937
82	3.228	7.165	11.102	15.040	18.977
83	3.268	7.205	11.142	15.079	19.016
84	3.307	7.244	11.181	15.118	19.055
85	3.346	7.284	11.221	15.158	19.095
86	3.386	7.323	11.260	15.197	19.134
87	3.425	7.362	11.299	15.236	19.173
88	3.465	7.402	11.339	15.276	19.213
89	3.504	7.441	11.378	15.315	19.252
90	3.543	7.480	11.417	15.354	19.292
91	3.583	7.520	11.457	15.394	19.331
92	3.622	7.559	11.496	15.433	19.370
93	3.661	7.598	11.536	15.473	19.410
94	3.701	7.638	11.575	15.512	19.449
95	3.740	7.677	11.614	15.551	19.488
96	3.780	7.717	11.654	15.591	19.528
97	3.819	7.756	11.693	15.630	19.567
98	3.858	7.795	11.732	15.669	19.606
99	3.898	7.835	11.772	15.709	19.646

EQUIVALENTS OF MILLIMETRES IN INCHES.

(Continued)

Millimetres	500	600	700	800	900
0	19.685	23.622	27.559	31.496	35.433
1	19.725	23.662	27.599	31.536	35.473
2	19.764	23.701	27.638	31.575	35.512
3	19.803	23.740	27.677	31.614	35.552
4	19.843	23.780	27.717	31.654	35.591
5	19.882	23.819	27.756	31.693	35.630
6	19.921	23.858	27.796	31.733	35.670
7	19.961	23.898	27.835	31.772	35.709
8	20.000	23.937	27.874	31.811	35.748
9	20.040	23.977	27.914	31.851	35.788
10	20.079	24.016	27.953	31.890	35.827
11	20.118	24.055	27.992	31.929	35.866
12	20.158	24.095	28.032	31.969	35.906
13	20.197	24.134	28.071	32.008	35.945
14	20.236	24.173	28.110	32.048	35.985
15	20.276	24.213	28.150	32.087	36.024
16	20.315	24.252	28.189	32.126	36.063
17	20.355	24.292	28.229	32.166	36.103
18	20.394	24.331	28.268	32.205	36.142
19	20.433	24.370	28.307	32.244	36.181
20	20.473	24.410	28.347	32.284	36.221
21	20.512	24.449	28.386	32.323	36.260
22	20.551	24.488	28.425	32.362	36.300
23	20.591	24.528	28.465	32.402	36.339
24	20.630	24.567	28.504	32.441	36.378
25	20.669	24.607	28.544	32.481	36.418
26	20.709	24.646	28.583	32.520	36.457
27	20.748	24.685	28.622	32.559	36.496
28	20.788	24.725	28.662	32.599	36.536
29	20.827	24.764	28.701	32.638	36.575
30	20.866	24.803	28.740	32.677	36.615
31	20.906	24.843	28.780	32.717	36.654
32	20.945	24.882	28.819	32.756	36.693
33	20.984	24.921	28.859	32.796	36.733
34	21.024	24.961	28.898	32.835	36.772
35	21.063	25.000	28.937	32.874	36.811
36	21.103	25.040	28.977	32.914	36.851
37	21.142	25.079	29.016	32.953	36.890
38	21.181	25.118	29.055	32.992	36.929
39	21.221	25.158	29.095	33.032	36.969
40	21.260	25.197	29.134	33.071	37.008
41	21.299	25.236	29.173	33.111	37.048
42	21.339	25.276	29.213	33.150	37.087
43	21.378	25.315	29.252	33.189	37.126
44	21.418	25.355	29.292	33.229	37.166
45	21.457	25.394	29.331	33.268	37.205
46	21.496	25.433	29.370	33.307	37.244
47	21.536	25.473	29.410	33.347	37.284
48	21.575	25.512	29.449	33.386	37.323
49	21.614	25.551	29.488	33.425	37.363

EQUIVALENTS OF MILLIMETRES IN INCHES.

(Continued)

Millimetres	500	600	700	800	900
50	21.654	25.591	29.528	33.465	37.402
51	21.693	25.630	29.567	33.504	37.441
52	21.732	25.670	29.607	33.544	37.481
53	21.772	25.709	29.646	33.583	37.520
54	21.811	25.748	29.685	33.622	37.559
55	21.851	25.788	29.725	33.662	37.599
56	21.890	25.827	29.764	33.701	37.638
57	21.929	25.866	29.803	33.740	37.677
58	21.969	25.906	29.843	33.780	37.717
59	22.008	25.945	29.882	33.819	37.756
60	22.047	25.984	29.922	33.859	37.796
61	22.087	26.024	29.961	33.898	37.835
62	22.126	26.063	30.000	33.937	37.874
63	22.166	26.103	30.040	33.977	37.914
64	22.205	26.142	30.079	34.016	37.953
65	22.244	26.181	30.118	34.055	37.992
66	22.284	26.221	30.158	34.095	38.032
67	22.323	26.260	30.197	34.134	38.071
68	22.362	26.299	30.236	34.174	38.111
69	22.402	26.339	30.276	34.213	38.150
70	22.441	26.378	30.315	34.252	38.189
71	22.481	26.418	30.355	34.292	38.229
72	22.520	26.457	30.394	34.331	38.268
73	22.559	26.496	30.433	34.370	38.307
74	22.599	26.536	30.473	34.410	38.347
75	22.638	26.575	30.512	34.449	38.386
76	22.677	26.614	30.551	34.488	38.426
77	22.717	26.654	30.591	34.528	38.465
78	22.756	26.693	30.630	34.567	38.504
79	22.795	26.733	30.670	34.607	38.544
80	22.835	26.772	30.709	34.646	38.583
81	22.874	26.811	30.748	34.685	38.622
82	22.914	26.851	30.788	34.725	38.662
83	22.953	26.890	30.827	34.764	38.701
84	22.992	26.929	30.866	34.803	38.741
85	23.032	26.969	30.906	34.843	38.780
86	23.071	27.008	30.945	34.882	38.819
87	23.110	27.047	30.985	34.922	38.859
88	23.150	27.087	31.024	34.961	38.898
89	23.189	27.126	31.063	35.000	38.937
90	23.229	27.166	31.103	35.040	38.977
91	23.268	27.205	31.142	35.079	39.016
92	23.307	27.244	31.181	35.118	39.055
93	23.347	27.284	31.221	35.158	39.095
94	23.385	27.323	31.260	35.197	39.134
95	23.424	27.362	31.299	35.237	39.174
96	23.464	27.402	31.339	35.276	39.213
97	23.503	27.441	31.378	35.315	39.252
98	23.543	27.481	31.418	35.355	39.292
99	23.582	27.520	31.457	35.394	39.331

EQUIVALENTS OF FEET IN METRES.

Conversion Factor: 1 foot = 0.3048006096 metre.

Feet	0	100	200	300	400
0		30.48006	60.96012	91.44018	121.92024
1	.30480	30.78486	61.26492	91.74498	122.22504
2	.60960	31.08966	61.56972	92.04978	122.52985
3	.91440	31.39446	61.87452	92.35458	122.83465
4	1.21920	31.69926	62.17932	92.65939	123.13945
5	1.52400	32.00406	62.48412	92.96419	123.44425
6	1.82880	32.30886	62.78893	93.26899	123.74905
7	2.13360	32.61366	63.09373	93.57379	124.05385
8	2.43840	32.91847	63.39853	93.87859	124.35865
9	2.74321	33.22327	63.70333	94.18339	124.66345
10	3.04801	33.52807	64.00813	94.48819	124.96825
11	3.35281	33.83287	64.31293	94.79299	125.27305
12	3.65761	34.13767	64.61773	95.09779	125.57785
13	3.96241	34.44247	64.92253	95.40259	125.88265
14	4.26721	34.74727	65.22733	95.70739	126.18745
15	4.57201	35.05207	65.53213	96.01219	126.49225
16	4.87681	35.35687	65.83693	96.31699	126.79705
17	5.18161	35.66167	66.14173	96.62179	127.10185
18	5.48641	35.96647	66.44653	96.92659	127.40665
19	5.79121	36.27127	66.75133	97.23139	127.71145
20	6.09601	36.57607	67.05613	97.53620	128.01626
21	6.40081	36.88087	67.36093	97.84100	128.32106
22	6.70561	37.18567	67.66574	98.14580	128.62586
23	7.01041	37.49047	67.97054	98.45060	128.93066
24	7.31521	37.79528	68.27534	98.75540	129.23546
25	7.62002	38.10008	68.58014	99.06020	129.54026
26	7.92482	38.40488	68.88494	99.36500	129.84506
27	8.22962	38.70968	69.18974	99.66980	130.14986
28	8.53442	39.01448	69.49454	99.97460	130.45466
29	8.83922	39.31928	69.79934	100.27940	130.75946
30	9.14402	39.62408	70.10414	100.58420	131.06426
31	9.44882	39.92888	70.40894	100.88900	131.36906
32	9.75362	40.23368	70.71374	101.19380	131.67386
33	10.05842	40.53848	71.01854	101.49860	131.97866
34	10.36322	40.84328	71.32334	101.80340	132.28346
35	10.66802	41.14808	71.62814	102.10820	132.58827
36	10.97282	41.45288	71.93294	102.41300	132.89307
37	11.27762	41.75768	72.23774	102.71781	133.19787
38	11.58242	42.06248	72.54255	103.02261	133.50267
39	11.88722	42.36728	72.84735	103.32741	133.80747
40	12.19202	42.67209	73.15215	103.63221	134.11227
41	12.49682	42.97689	73.45695	103.93701	134.41707
42	12.80163	43.28169	73.76175	104.24181	134.72187
43	13.10643	43.58649	74.06655	104.54661	135.02667
44	13.41123	43.89129	74.37135	104.85141	135.33147
45	13.71603	44.19609	74.67615	105.15621	135.63627
46	14.02083	44.50089	74.98095	105.46101	135.94107
47	14.32563	44.80569	75.28575	105.76581	136.24587
48	14.63043	45.11049	75.59055	106.07061	136.55067
49	14.93523	45.41529	75.89535	106.37541	136.85547

1 inch = .02540 metre. 2 inches = .05080 metre. 3 inches = .07620 metre.

EQUIVALENTS OF FEET IN METRES.

(Continued)

Feet	0	100	200	300	400
50	15.24003	45.72009	76.20015	106.68021	137.16027
51	15.54483	46.02489	76.50495	106.98501	137.46507
52	15.84963	46.32969	76.80975	107.28981	137.76988
53	16.15443	46.63449	77.11455	107.59462	138.07468
54	16.45923	46.93929	77.41935	107.89942	138.37948
55	16.76403	47.24409	77.72416	108.20422	138.68428
56	17.06883	47.54890	78.02896	108.50902	138.98908
57	17.37363	47.85370	78.33376	108.81382	139.29388
58	17.67844	48.15850	78.63856	109.11862	139.59868
59	17.98324	48.46330	78.94336	109.42342	139.90348
60	18.28804	48.76810	79.24816	109.72822	140.20828
61	18.59284	49.07290	79.55296	110.03302	140.51308
62	18.89764	49.37770	79.85776	110.33782	140.81788
63	19.20244	49.68250	80.16256	110.64262	141.12268
64	19.50724	49.98730	80.46736	110.94742	141.42748
65	19.81204	50.29210	80.77216	111.25222	141.73228
66	20.11684	50.59690	81.07696	111.55702	142.03708
67	20.42164	50.90170	81.38176	111.86182	142.34188
68	20.72644	51.20650	81.68656	112.16662	142.64669
69	21.03124	51.51130	81.99136	112.47142	142.95149
70	21.33604	51.81610	82.29616	112.77622	143.25629
71	21.64084	52.12090	82.60097	113.08103	143.56109
72	21.94564	52.42570	82.90577	113.38583	143.86589
73	22.25044	52.73051	83.21057	113.69063	144.17069
74	22.55525	53.03531	83.51537	113.99543	144.47549
75	22.86005	53.34011	83.82017	114.30023	144.78029
76	23.16485	53.64491	84.12497	114.60503	145.08509
77	23.46965	53.94971	84.42977	114.90983	145.38989
78	23.77445	54.25451	84.73457	115.21463	145.69469
79	24.07925	54.55931	85.03937	115.51943	145.99949
80	24.38405	54.86411	85.34417	115.82423	146.30429
81	24.68885	55.16891	85.64897	116.12903	146.60909
82	24.99365	55.47371	85.95377	116.43383	146.91389
83	25.29845	55.77851	86.25857	116.73863	147.21869
84	25.60325	56.08331	86.56337	117.04343	147.52350
85	25.90805	56.38811	86.86817	117.34823	147.82830
86	26.21285	56.69291	87.17297	117.65303	148.13310
87	26.51765	56.99771	87.47777	117.95783	148.43790
88	26.82245	57.30251	87.78258	118.26264	148.74270
89	27.12725	57.60732	88.08738	118.56744	149.04750
90	27.43205	57.91212	88.39218	118.87224	149.35230
91	27.73686	58.21692	88.69698	119.17704	149.65710
92	28.04166	58.52172	89.00178	119.48184	149.96190
93	28.34646	58.82652	89.30658	119.78664	150.26670
94	28.65126	59.13132	89.61138	120.09144	150.57150
95	28.95606	59.43612	89.91618	120.39624	150.87630
96	29.26086	59.74092	90.22098	120.70104	151.18110
97	29.56566	60.04572	90.52578	121.00584	151.48590
98	29.87046	60.35052	90.83058	121.31064	151.79070
99	30.17526	60.65532	91.13538	121.61544	152.09550

4 inches = .10160 metre. 5 inches = .12700 metre. 6 inches = .15240 metre.

EQUIVALENTS OF FEET IN METRES.

(Continued)

Feet	500	600	700	800	900
0	152.40030	182.88037	213.36043	243.84049	274.32055
1	152.70511	183.18517	213.66523	244.14523	274.62535
2	153.00991	183.48997	213.97003	244.45009	274.93015
3	153.31471	183.79477	214.27483	244.75489	275.23495
4	153.61951	184.09957	214.57963	245.05969	275.53975
5	153.92431	184.40437	214.88443	245.36449	275.84455
6	154.22911	184.70917	215.18923	245.66929	276.14935
7	154.53391	185.01397	215.49403	245.97409	276.45415
8	154.83871	185.31877	215.79883	246.27889	276.75895
9	155.14351	185.62357	216.10363	246.58369	277.06375
10	155.44831	185.92837	216.40843	246.88849	277.36855
11	155.75311	186.23317	216.71323	247.19329	277.67335
12	156.05791	186.53797	217.01803	247.49809	277.97815
13	156.36271	186.84277	217.32283	247.80290	278.28295
14	156.66751	187.14757	217.62764	248.10770	278.58775
15	156.97231	187.45237	217.93244	248.41250	278.89255
16	157.27711	187.75717	218.23724	248.71730	279.19735
17	157.58192	188.06198	218.54204	249.02210	279.50215
18	157.88672	188.36678	218.84684	249.32690	279.80695
19	158.19152	188.67158	219.15164	249.63170	280.11175
20	158.49632	188.97638	219.45644	249.93650	280.41655
21	158.80112	189.28118	219.76124	250.24130	280.72135
22	159.10592	189.58598	220.06604	250.54610	281.02615
23	159.41072	189.89078	220.37084	250.85090	281.33095
24	159.71552	190.19558	220.67564	251.15570	281.63575
25	160.02032	190.50038	220.98044	251.46050	281.94055
26	160.32512	190.80518	221.28524	251.76530	282.24535
27	160.62992	191.10998	221.59004	252.07010	282.55015
28	160.93472	191.41478	221.89484	252.37490	282.85495
29	161.23952	191.71958	222.19964	252.67971	283.15975
30	161.54432	192.02438	222.50444	252.98451	283.46455
31	161.84912	192.32918	222.80925	253.28931	283.76935
32	162.15392	192.63399	223.11405	253.59411	284.07415
33	162.45872	192.93879	223.41885	253.89891	284.37895
34	162.76353	193.24359	223.72365	254.20371	284.68375
35	163.06833	193.54839	224.02845	254.50851	284.98855
36	163.37313	193.85319	224.33325	254.81331	285.29335
37	163.67793	194.15799	224.63805	255.11811	285.59815
38	163.98273	194.46279	224.94285	255.42291	285.90295
39	164.28753	194.76759	225.24765	255.72771	286.20775
40	164.59233	195.07239	225.55245	256.03251	286.51255
41	164.89713	195.37719	225.85725	256.33731	286.81735
42	165.20193	195.68199	226.16205	256.64211	287.12215
43	165.50673	195.98679	226.46685	256.94691	287.42695
44	165.81153	196.29159	226.77165	257.25171	287.73175
45	166.11633	196.59639	227.07645	257.55652	288.03655
46	166.42113	196.90119	227.38125	257.86132	288.34135
47	166.72593	197.20599	227.68605	258.16612	288.64615
48	167.03073	197.51079	227.99085	258.47092	288.95095
49	167.33553	197.81559	228.29565	258.77572	289.25575

7 inches=.17780 metre. 8 inches=.20320 metre. 9 inches=.22860 metre.

EQUIVALENTS OF FEET IN METRES.

(Continued)

Feet	500	600	700	800	900
50	167.64034	198.12040	228.60046	259.08052	289.56058
51	167.94514	198.42520	228.90526	259.38532	289.86538
52	168.24994	198.73000	229.21006	259.69012	290.17018
53	168.55474	199.03480	229.51486	259.99492	290.47498
54	168.85954	199.33960	229.81966	260.29972	290.77978
55	169.16434	199.64440	230.12446	260.60452	291.08458
56	169.46914	199.94920	230.42926	260.90932	291.38938
57	169.77394	200.25400	230.73406	261.21412	291.69418
58	170.07874	200.55880	231.03886	261.51892	291.99898
59	170.38354	200.86360	231.34366	261.82372	292.30378
60	170.68834	201.16840	231.64846	262.12852	292.60859
61	170.99314	201.47320	231.95326	262.43332	292.91339
62	171.29794	201.77800	232.25806	262.73813	293.21819
63	171.60274	202.08280	232.56287	263.04293	293.52299
64	171.90754	202.38760	232.86767	263.34773	293.82779
65	172.21234	202.69241	233.17247	263.65253	294.13259
66	172.51715	202.99721	233.47727	263.95733	294.43739
67	172.82195	203.30201	233.78207	264.26213	294.74219
68	173.12675	203.60681	234.08687	264.56693	295.04699
69	173.43155	203.91161	234.39167	264.87173	295.35179
70	173.73635	204.21641	234.69647	265.17653	295.65659
71	174.04115	204.52121	235.00127	265.48133	295.96139
72	174.34595	204.82601	235.30607	265.78613	296.26619
73	174.65075	205.13081	235.61087	266.09093	296.57099
74	174.95555	205.43561	235.91567	266.39573	296.87579
75	175.26035	205.74041	236.22047	266.70053	297.18059
76	175.56515	206.04521	236.52527	267.00533	297.48539
77	175.86995	206.35001	236.83007	267.31013	297.79020
78	176.17475	206.65481	237.13487	267.61494	298.09500
79	176.47955	206.95961	237.43967	267.91974	298.39980
80	176.78435	207.26441	237.74448	268.22454	298.70460
81	177.08915	207.56921	238.04928	268.52934	299.00940
82	177.39395	207.87402	238.35408	268.83414	299.31420
83	177.69876	208.17882	238.65888	269.13894	299.61900
84	178.00356	208.48362	238.96368	269.44374	299.92380
85	178.30836	208.78842	239.26848	269.74854	300.22860
86	178.61316	209.09322	239.57328	270.05334	300.53340
87	178.91796	209.39802	239.87808	270.35814	300.83820
88	179.22276	209.70282	240.18288	270.66294	301.14300
89	179.52756	210.00762	240.48768	270.96774	301.44780
90	179.83236	210.31242	240.79248	271.27254	301.75260
91	180.13716	210.61722	241.09728	271.57734	302.05740
92	180.44196	210.92202	241.40208	271.88214	302.36220
93	180.74676	211.22682	241.70688	272.18694	302.66700
94	181.05156	211.53162	242.01168	272.49174	302.97180
95	181.35636	211.83642	242.31648	272.79654	303.27660
96	181.66116	212.14122	242.62128	273.10134	303.58140
97	181.96596	212.44602	242.92608	273.40614	303.88620
98	182.27076	212.75082	243.23088	273.71094	304.19100
99	182.57557	213.05563	243.53569	274.01575	304.49580

10 inches = .25400 metre. 11 inches = .27940 metre. 12 inches = .30480 metre.

EQUIVALENTS OF METRES IN FEET.

Conversion factor: 1 metre = 3.28083333 feet.

Metres	0	100	200	300	400
0		328.08333	656.16667	984.25000	1,312.33333
1	3.28083	331.36417	659.44750	987.53083	1,315.61417
2	6.56167	334.64500	662.72833	990.81167	1,318.89500
3	9.84250	337.92583	666.00917	994.09250	1,322.17583
4	13.12333	341.20667	669.29000	997.37333	1,325.45667
5	16.40417	344.48750	672.57083	1,000.65417	1,328.73750
6	19.68500	347.76833	675.85167	1,003.93500	1,332.01833
7	22.96583	351.04917	679.13250	1,007.21583	1,335.29917
8	26.24667	354.33000	682.41333	1,010.49667	1,338.58000
9	29.52750	357.61083	685.69417	1,013.77750	1,341.86083
10	32.80833	360.89167	688.97500	1,017.05833	1,345.14167
11	36.08917	364.17250	692.25583	1,020.33917	1,348.42250
12	39.37000	367.45333	695.53667	1,023.62000	1,351.70333
13	42.65083	370.73417	698.81750	1,026.90083	1,354.98417
14	45.93167	374.01500	702.09833	1,030.18167	1,358.26500
15	49.21250	377.29583	705.37917	1,033.46250	1,361.54583
16	52.49333	380.57667	708.66000	1,036.74333	1,364.82667
17	55.77417	383.85750	711.94083	1,040.02417	1,368.10750
18	59.05500	387.13833	715.22167	1,043.30500	1,371.38833
19	62.33583	390.41917	718.50250	1,046.58583	1,374.66917
20	65.61667	393.70000	721.78333	1,049.86667	1,377.95000
21	68.89750	396.98083	725.06417	1,053.14750	1,381.23083
22	72.17833	400.26167	728.34500	1,056.42833	1,384.51167
23	75.45917	403.54250	731.62583	1,059.70917	1,387.79250
24	78.74000	406.82333	734.90667	1,062.99000	1,391.07333
25	82.02083	410.10417	738.18750	1,066.27083	1,394.35417
26	85.30167	413.38500	741.46833	1,069.55167	1,397.63500
27	88.58250	416.66583	744.74917	1,072.83250	1,400.91583
28	91.86333	419.94667	748.03000	1,076.11333	1,404.19667
29	95.14417	423.22750	751.31083	1,079.39417	1,407.47750
30	98.42500	426.50833	754.59167	1,082.67500	1,410.75833
31	101.70583	429.78917	757.87250	1,085.95583	1,414.03917
32	104.98667	433.07000	761.15333	1,039.23667	1,417.32000
33	108.26750	436.35083	764.43417	1,092.51750	1,420.60083
34	111.54833	439.63167	767.71500	1,095.79833	1,423.88167
35	114.82917	442.91250	770.99583	1,099.07917	1,427.16250
36	118.11000	446.19333	774.27667	1,102.36000	1,430.44333
37	121.39083	449.47417	777.55750	1,105.64083	1,433.72417
38	124.67167	452.75500	780.83833	1,108.92167	1,437.00500
39	127.95250	456.03583	784.11917	1,112.20250	1,440.28583
40	131.23333	459.31667	787.40000	1,115.48333	1,443.56667
41	134.51417	462.59750	790.68083	1,118.76417	1,446.84750
42	137.79500	465.87833	793.96167	1,122.04500	1,450.12833
43	141.07583	469.15917	797.24250	1,125.32583	1,453.40917
44	144.35667	472.44000	800.52333	1,128.60667	1,456.69000
45	147.63750	475.72083	803.80417	1,131.88750	1,459.97083
46	150.91833	479.00167	807.08500	1,135.16833	1,463.25167
47	154.19917	482.28250	810.36583	1,138.44917	1,466.53250
48	157.48000	485.56333	813.64667	1,141.73000	1,469.81333
49	160.76083	488.84417	816.92750	1,145.01083	1,473.09417

EQUIVALENTS OF METRES IN FEET.

(Continued)

Metres	0	100	200	300	400
50	164.04167	492.12500	820.20833	1,148.29167	1,476.37500
51	167.32250	495.40583	823.45917	1,151.57250	1,479.65583
52	170.60333	498.68667	826.77000	1,154.85333	1,482.93667
53	173.88417	501.96750	830.05083	1,158.13417	1,486.21750
54	177.16500	505.24833	833.33167	1,161.41500	1,489.49833
55	180.44583	508.52917	836.61250	1,164.69583	1,492.77917
56	183.72667	511.81000	839.89333	1,167.97667	1,496.06000
57	187.00750	515.09083	843.17417	1,171.25750	1,499.34083
58	190.28833	518.37167	846.45500	1,174.53833	1,502.62167
59	193.56917	521.65250	849.73583	1,177.81917	1,505.90250
60	196.85000	524.93333	853.01667	1,181.10000	1,509.18333
61	200.13083	528.21417	856.29750	1,184.38083	1,512.46417
62	203.41167	531.49500	859.57833	1,187.66167	1,515.74500
63	206.69250	534.77583	862.85917	1,190.94250	1,519.02583
64	209.97333	538.05667	866.14000	1,194.22333	1,522.30667
65	213.25417	541.33750	869.42083	1,197.50417	1,525.58750
66	216.53500	544.61833	872.70167	1,200.78500	1,528.86833
67	219.81583	547.89917	875.98250	1,204.06583	1,532.14917
68	223.09667	551.18000	879.26333	1,207.34667	1,535.43000
69	226.37750	554.46083	882.54417	1,210.62750	1,538.71083
70	229.65833	557.74167	885.82500	1,213.90833	1,541.99167
71	232.93917	561.02250	889.10583	1,217.18917	1,545.27250
72	236.22000	564.30333	892.38667	1,220.47000	1,548.55333
73	239.50083	567.58417	895.66750	1,223.75083	1,551.83417
74	242.78167	570.86500	898.94833	1,227.03167	1,555.11500
75	246.06250	574.14583	902.22917	1,230.31250	1,558.39583
76	249.34333	577.42667	905.51000	1,233.59333	1,561.67667
77	252.62417	580.70750	908.79083	1,236.87417	1,564.95750
78	255.90500	583.98833	912.07167	1,240.15500	1,568.23833
79	259.18583	587.26917	915.35250	1,243.43583	1,571.51917
80	262.46667	590.55000	918.63333	1,246.71667	1,574.80000
81	265.74750	593.83083	921.91417	1,249.99750	1,578.08083
82	269.02833	597.11167	925.19500	1,253.27833	1,581.36167
83	272.30917	600.39250	928.47583	1,256.55917	1,584.64250
84	275.59000	603.67333	931.75667	1,259.84000	1,587.92333
85	278.87083	606.95417	935.03750	1,263.12083	1,591.20417
86	282.15167	610.23500	938.31833	1,266.40167	1,594.48500
87	285.43250	613.51583	941.59917	1,269.68250	1,597.76583
88	288.71333	616.79667	944.88000	1,272.96333	1,601.04667
89	291.99417	620.07750	948.16083	1,276.24417	1,604.32750
90	295.27500	623.35833	951.44167	1,279.52500	1,607.60833
91	298.55583	626.63917	954.72250	1,282.80583	1,610.88917
92	301.83667	629.92000	958.00333	1,286.08667	1,614.17000
93	305.11750	633.20083	961.28417	1,289.36750	1,617.45083
94	308.39833	636.48167	964.56500	1,292.64833	1,620.73167
95	311.67917	639.76250	967.84583	1,295.92917	1,624.01250
96	314.96000	643.04333	971.12667	1,299.21000	1,627.29333
97	318.24083	646.32417	974.40750	1,302.49083	1,630.57417
98	321.52167	649.60500	977.68833	1,305.77167	1,633.85500
99	324.80250	652.88583	980.96917	1,309.05250	1,637.13583

EQUIVALENTS OF METRES IN FEET.

(Continued)

Metres	500	600	700	800	900
0	1,640.41667	1,968.50000	2,296.58333	2,624.66667	2,952.75000
1	1,643.69750	1,971.78083	2,299.86417	2,627.94750	2,956.03083
2	1,646.97833	1,975.06167	2,303.14500	2,631.22833	2,959.31167
3	1,650.25917	1,978.34250	2,306.42583	2,634.50917	2,962.59250
4	1,653.54000	1,981.62333	2,309.70667	2,637.79000	2,965.87333
5	1,656.82083	1,984.90417	2,312.98750	2,641.07083	2,969.15417
6	1,660.10167	1,988.18500	2,316.26833	2,644.35167	2,972.43500
7	1,663.38250	1,991.46583	2,319.54917	2,647.63250	2,975.71583
8	1,666.66333	1,994.74667	2,322.83000	2,650.91333	2,978.99667
9	1,669.94417	1,998.02750	2,326.11083	2,654.19417	2,982.27750
10	1,673.22500	2,001.30833	2,329.39167	2,657.47500	2,985.55833
11	1,676.50583	2,004.58917	2,332.67250	2,660.75583	2,988.83917
12	1,679.78667	2,007.87000	2,335.95333	2,664.03667	2,992.12000
13	1,683.06750	2,011.15083	2,339.23417	2,667.31750	2,995.40083
14	1,686.34833	2,014.43167	2,342.51500	2,670.59833	2,998.68167
15	1,689.62917	2,017.71250	2,345.79583	2,673.87917	3,001.96250
16	1,692.91000	2,020.99333	2,349.07667	2,677.16000	3,005.24333
17	1,696.19083	2,024.27417	2,352.35750	2,680.44083	3,008.52417
18	1,699.47167	2,027.55500	2,355.63833	2,683.72167	3,011.80500
19	1,702.75250	2,030.83583	2,358.91917	2,687.00250	3,015.08583
20	1,706.03333	2,034.11667	2,362.20000	2,690.28333	3,018.36667
21	1,709.31417	2,037.39750	2,365.48083	2,693.56417	3,021.64750
22	1,712.59500	2,040.67833	2,368.76167	2,696.84500	3,024.92833
23	1,715.87583	2,043.95917	2,372.04250	2,700.12583	3,028.20917
24	1,719.15667	2,047.24000	2,375.32333	2,703.40667	3,031.49000
25	1,722.43750	2,050.52083	2,378.60417	2,706.68750	3,034.77083
26	1,725.71833	2,053.80167	2,381.88500	2,709.96833	3,038.05167
27	1,728.99917	2,057.08250	2,385.16583	2,713.24917	3,041.33250
28	1,732.28000	2,060.36333	2,388.44667	2,716.53000	3,044.61333
29	1,735.56083	2,063.64417	2,391.72750	2,719.81083	3,047.89417
30	1,738.84167	2,066.92500	2,395.00833	2,723.09167	3,051.17500
31	1,742.12250	2,070.20583	2,398.28917	2,726.37250	3,054.45583
32	1,745.40333	2,073.48667	2,401.57000	2,729.65333	3,057.73667
33	1,748.68417	2,076.76750	2,404.85083	2,732.93417	3,061.01750
34	1,751.96500	2,080.04833	2,408.13167	2,736.21500	3,064.29833
35	1,755.24583	2,083.32917	2,411.41250	2,739.49583	3,067.57917
36	1,758.52667	2,086.61000	2,414.69333	2,742.77667	3,070.86000
37	1,761.80750	2,089.89083	2,417.97417	2,746.05750	3,074.14083
38	1,765.08833	2,093.17167	2,421.25500	2,749.33833	3,077.42167
39	1,768.36917	2,096.45250	2,424.53583	2,752.61917	3,080.70250
40	1,771.65000	2,099.73333	2,427.81667	2,755.90000	3,083.98333
41	1,774.93083	2,103.01417	2,431.09750	2,759.18083	3,087.26417
42	1,778.21167	2,106.29500	2,434.37833	2,762.46167	3,090.54500
43	1,781.49250	2,109.57583	2,437.65917	2,765.74250	3,093.82583
44	1,784.77333	2,112.85667	2,440.94000	2,769.02333	3,097.10667
45	1,788.05417	2,116.13750	2,444.22083	2,772.30417	3,100.38750
46	1,791.33500	2,119.41833	2,447.50167	2,775.58500	3,103.66833
47	1,794.61583	2,122.69917	2,450.78250	2,778.86583	3,106.94917
48	1,797.89667	2,125.98000	2,454.06333	2,782.14667	3,110.23000
49	1,801.17750	2,129.26083	2,457.34417	2,785.42750	3,113.51083

EQUIVALENTS OF METRES IN FEET.

(Continued)

Metres	500	600	700	800	900
50	1,804.45833	2,132.54167	2,460.62500	2,788.70833	3,116.79167
51	1,807.73917	2,135.82250	2,463.90583	2,791.98917	3,120.07250
52	1,811.02000	2,139.10333	2,467.18667	2,795.27000	3,123.35333
53	1,814.30083	2,142.38417	2,470.46750	2,798.55083	3,126.63417
54	1,817.58167	2,145.66500	2,473.74833	2,801.83167	3,129.91500
55	1,820.86250	2,148.94583	2,477.02917	2,805.11250	3,133.19583
56	1,824.14333	2,152.22667	2,480.31000	2,808.39333	3,136.47667
57	1,827.42417	2,155.50750	2,483.59083	2,811.67417	3,139.75750
58	1,830.70500	2,158.78833	2,486.87167	2,814.95500	3,143.03833
59	1,833.98583	2,162.06917	2,490.15250	2,818.23583	3,146.31917
60	1,837.26667	2,165.35000	2,493.43333	2,821.51667	3,149.60000
61	1,840.54750	2,168.63083	2,496.71417	2,824.79750	3,152.88083
62	1,843.82833	2,171.91167	2,499.99500	2,828.07833	3,156.16167
63	1,847.10917	2,175.19250	2,503.27583	2,831.35917	3,159.44250
64	1,850.39000	2,178.47333	2,506.55667	2,834.64000	3,162.72333
65	1,853.67083	2,181.75417	2,509.83750	2,837.92083	3,166.00417
66	1,856.95167	2,185.03500	2,513.11833	2,841.20167	3,169.28500
67	1,860.23250	2,188.31583	2,516.39917	2,844.48250	3,172.56583
68	1,863.51333	2,191.59667	2,519.68000	2,847.76333	3,175.84667
69	1,866.79417	2,194.87750	2,522.96083	2,851.04417	3,179.12750
70	1,870.07500	2,198.15833	2,526.24167	2,854.32500	3,182.40833
71	1,873.35583	2,201.43917	2,529.52250	2,857.60583	3,185.68917
72	1,876.63667	2,204.72000	2,532.80333	2,860.88667	3,188.97000
73	1,879.91750	2,208.00083	2,536.08417	2,864.16750	3,192.25083
74	1,883.19833	2,211.28167	2,539.36500	2,867.44833	3,195.53167
75	1,886.47917	2,214.56250	2,542.64583	2,870.72917	3,198.81250
76	1,889.76000	2,217.84333	2,545.92667	2,874.01000	3,202.09333
77	1,893.04083	2,221.12417	2,549.20750	2,877.29083	3,205.37417
78	1,896.32167	2,224.40500	2,552.48833	2,880.57167	3,208.65500
79	1,899.60250	2,227.68583	2,555.76917	2,883.85250	3,211.93583
80	1,902.88333	2,230.96667	2,559.05000	2,887.13333	3,215.21667
81	1,906.16417	2,234.24750	2,562.33083	2,890.41417	3,218.49750
82	1,909.44500	2,237.52833	2,565.61167	2,893.69500	3,221.77833
83	1,912.72583	2,240.80917	2,568.89250	2,896.97583	3,225.05917
84	1,916.00667	2,244.09000	2,572.17333	2,900.25667	3,228.34000
85	1,919.28750	2,247.37083	2,575.45417	2,903.53750	3,231.62083
86	1,922.56833	2,250.65167	2,578.73500	2,906.81833	3,234.90167
87	1,925.84917	2,253.93250	2,582.01583	2,910.09917	3,238.18250
88	1,929.13000	2,257.21333	2,585.29667	2,913.38000	3,241.46333
89	1,932.41083	2,260.49417	2,588.57750	2,916.66083	3,244.74417
90	1,935.69167	2,263.77500	2,591.85833	2,919.94167	3,248.02500
91	1,938.97250	2,267.05583	2,595.13917	2,923.22250	3,251.30583
92	1,942.25333	2,270.33667	2,598.42000	2,926.50333	3,254.58667
93	1,945.53417	2,273.61750	2,601.70083	2,929.78417	3,257.86750
94	1,948.81500	2,276.89833	2,604.98167	2,933.06500	3,261.14833
95	1,952.09583	2,280.17917	2,608.26250	2,936.34583	3,264.42917
96	1,955.37667	2,283.46000	2,611.54333	2,939.62667	3,267.71000
97	1,958.65750	2,286.74083	2,614.82417	2,942.90750	3,270.99083
98	1,961.93833	2,290.02167	2,618.10500	2,946.18833	3,274.27167
99	1,965.21917	2,293.30250	2,621.38583	2,949.46917	3,277.55250

EQUIVALENTS OF AVOIRDUPOIS POUNDS IN KILOGRAMS.

Conversion Factor: 1 avoirdupois pound = 0.4535924277 kilogram.

Pounds	0	100	200	300	400
0		45.35924	90.71849	136.07773	181.43697
1	.45359	45.81284	91.17208	136.53132	181.89056
2	.90718	46.26643	91.62567	136.98491	182.34416
3	1.36078	46.72002	92.07926	137.43851	182.79775
4	1.81437	47.17361	92.53286	137.89210	183.25134
5	2.26796	47.62720	92.98645	138.34569	183.70493
6	2.72155	48.08080	93.44004	138.79928	184.15853
7	3.17515	48.53439	93.89363	139.25288	184.61212
8	3.62874	48.98798	94.34722	139.70647	185.06571
9	4.08233	49.44157	94.80082	140.16006	185.51930
10	4.53592	49.89517	95.25441	140.61365	185.97290
11	4.98952	50.34876	95.70800	141.06725	186.42649
12	5.44311	50.80235	96.16159	141.52084	186.88008
13	5.89670	51.25594	96.61519	141.97443	187.33367
14	6.35029	51.70954	97.06878	142.42802	187.78727
15	6.80389	52.16313	97.52237	142.88161	188.24086
16	7.25748	52.61672	97.97596	143.33521	188.69445
17	7.71107	53.07031	98.42956	143.78880	189.14804
18	8.16466	53.52391	98.88315	144.24239	189.60163
19	8.61826	53.97750	99.33674	144.69598	190.05523
20	9.07185	54.43109	99.79033	145.14958	190.50882
21	9.52544	54.88468	100.24393	145.60317	190.96241
22	9.97903	55.33828	100.69752	146.05676	191.41600
23	10.43263	55.79187	101.15111	146.51035	191.86960
24	10.88622	56.24546	101.60470	146.96395	192.32319
25	11.33981	56.69905	102.05830	147.41754	192.77678
26	11.79340	57.15265	102.51189	147.87113	193.23037
27	12.24700	57.60624	102.96548	148.32472	193.68397
28	12.70059	58.05983	103.41907	148.77832	194.13756
29	13.15418	58.51342	103.87267	149.23191	194.59115
30	13.60777	58.96702	104.32626	149.68550	195.04474
31	14.06137	59.42061	104.77985	150.13909	195.49834
32	14.51496	59.87420	105.23344	150.59269	195.95193
33	14.96855	60.32779	105.68704	151.04628	196.40552
34	15.42214	60.78139	106.14063	151.49987	196.85911
35	15.87573	61.23498	106.59422	151.95346	197.31271
36	16.32933	61.68857	107.04781	152.40706	197.76630
37	16.78292	62.14216	107.50141	152.86065	198.21989
38	17.23651	62.59576	107.95500	153.31424	198.67348
39	17.69010	63.04935	108.40859	153.76783	199.12708
40	18.14370	63.50294	108.86218	154.22143	199.58067
41	18.59729	63.95653	109.31578	154.67502	200.03426
42	19.05088	64.41012	109.76937	155.12861	200.48785
43	19.50447	64.86372	110.22296	155.58220	200.94145
44	19.95807	65.31731	110.67655	156.03580	201.39504
45	20.41166	65.77090	111.13014	156.48939	201.84863
46	20.86525	66.22449	111.58374	156.94298	202.30222
47	21.31884	66.67809	112.03733	157.39657	202.75582
48	21.77244	67.13168	112.49092	157.85016	203.20941
49	22.22603	67.58527	112.94451	158.30376	203.66300

1 oz. = .028350 kg. 2 oz. = .056699 kg. 3 oz. = .085049 kg. 4 oz. = .113398 kg.

EQUIVALENTS OF AVOIRDUPOIS POUNDS IN KILOGRAMS.

(Continued)

Pounds	0	100	200	300	400
50	22.67962	68.03886	113.39811	158.75735	204.11659
51	23.13321	68.49246	113.85170	159.21094	204.57018
52	23.58681	68.94605	114.30529	159.66453	205.02378
53	24.04040	69.39964	114.75888	160.11813	205.47737
54	24.49399	69.85323	115.21248	160.57172	205.93096
55	24.94758	70.30683	115.66607	161.02531	206.38455
56	25.40118	70.76042	116.11966	161.47890	206.83815
57	25.85477	71.21401	116.57325	161.93250	207.29174
58	26.30836	71.66760	117.02685	162.38609	207.74533
59	26.76195	72.12120	117.48044	162.83968	208.19892
60	27.21555	72.57479	117.93403	163.29327	208.65252
61	27.66914	73.02838	118.38762	163.74687	209.10611
62	28.12273	73.48197	118.84122	164.20046	209.55970
63	28.57632	73.93557	119.29481	164.65405	210.01329
64	29.02992	74.38916	119.74840	165.10764	210.46689
65	29.48351	74.84275	120.20199	165.56124	210.92048
66	29.93710	75.29634	120.65559	166.01483	211.37407
67	30.39069	75.74994	121.10918	166.46842	211.82766
68	30.84429	76.20353	121.56277	166.92201	212.28125
69	31.29788	76.65712	122.01636	167.37561	212.73485
70	31.75147	77.11071	122.46996	167.82920	213.18844
71	32.20506	77.56431	122.92355	168.28279	213.64203
72	32.65865	78.01790	123.37714	168.73638	214.09563
73	33.11225	78.47149	123.83073	169.18998	214.54922
74	33.56584	78.92509	124.28433	169.64357	215.00281
75	34.01943	79.37867	124.73792	170.09716	215.45640
76	34.47302	79.83227	125.19151	170.55075	215.91000
77	34.92662	80.28586	125.64510	171.00435	216.36359
78	35.38021	80.73945	126.09869	171.45794	216.81718
79	35.83380	81.19304	126.55229	171.91153	217.27077
80	36.28739	81.64664	127.00588	172.36512	217.72437
81	36.74099	82.10023	127.45947	172.81871	218.17796
82	37.19458	82.55382	127.91306	173.27231	218.63155
83	37.64817	83.00741	128.36666	173.72590	219.08514
84	38.10176	83.46101	128.82025	174.17949	219.53874
85	38.55536	83.91460	129.27384	174.63308	219.99233
86	39.00895	84.36819	129.72743	175.08668	220.44592
87	39.46254	84.82178	130.18103	175.54027	220.89951
88	39.91613	85.27538	130.63462	175.99386	221.35310
89	40.36973	85.72897	131.08821	176.44745	221.80670
90	40.82332	86.18256	131.54180	176.90105	222.26029
91	41.27691	86.63615	131.99540	177.35464	222.71388
92	41.73050	87.08975	132.44899	177.80823	223.16747
93	42.18410	87.54334	132.90258	178.26182	223.62107
94	42.63769	87.99693	133.35617	178.71542	224.07466
95	43.09128	88.45052	133.80977	179.16901	224.52825
96	43.54487	88.90412	134.26336	179.62260	224.98184
97	43.99847	89.35771	134.71695	180.07619	225.43544
98	44.45206	89.81130	135.17054	180.52979	225.88903
99	44.90565	90.26489	135.62414	180.98338	226.34262

5 oz. = .141748 kg. 6 oz. = .170997 kg. 7 oz. = .198447 kg. 8 oz. = .226796 kg.

EQUIVALENTS OF AVOIRDUPOIS POUNDS IN KILOGRAMS.

(Continued)

Pounds	500	600	700	800	900
0	226.79621	272.15546	317.51470	362.87394	408.23318
1	227.24981	272.60905	317.96829	363.32753	408.68678
2	227.70340	273.06264	318.42188	363.78113	409.14037
3	228.15699	273.51623	318.87548	364.23472	409.59396
4	228.61058	273.96983	319.32907	364.68831	410.04755
5	229.06418	274.42342	319.78266	365.14190	410.50115
6	229.51777	274.87701	320.23625	365.59550	410.95474
7	229.97136	275.33060	320.68985	366.04909	411.40833
8	230.42495	275.78420	321.14344	366.50268	411.86192
9	230.87855	276.23779	321.59703	366.95627	412.31552
10	231.33214	276.69138	322.05062	367.40987	412.76911
11	231.78573	277.14497	322.50422	367.86346	413.22270
12	232.23932	277.59857	322.95781	368.31705	413.67629
13	232.69292	278.05216	323.41140	368.77064	414.12988
14	233.14651	278.50575	323.86499	369.22424	414.58348
15	233.60010	278.95934	324.31859	369.67783	415.03707
16	234.05369	279.41294	324.77218	370.13142	415.49066
17	234.50729	279.86653	325.22577	370.58501	415.94426
18	234.96088	280.32012	325.67936	371.03861	416.39785
19	235.41447	280.77371	326.13296	371.49220	416.85144
20	235.86806	281.22731	326.58655	371.94579	417.30503
21	236.32165	281.68090	327.04014	372.39938	417.75863
22	236.77525	282.13449	327.49373	372.85298	418.21222
23	237.22884	282.58808	327.94733	373.30657	418.66581
24	237.68243	283.04167	328.40092	373.76016	419.11940
25	238.13602	283.49527	328.85451	374.21375	419.57300
26	238.58962	283.94886	329.30810	374.66735	420.02659
27	239.04321	284.40245	329.76169	375.12094	420.48018
28	239.49680	284.85604	330.21529	375.57453	420.93377
29	239.95039	285.30964	330.66888	376.02812	421.38737
30	240.40399	285.76323	331.12247	376.48171	421.84096
31	240.85758	286.21682	331.57606	376.93531	422.29455
32	241.31117	286.67041	332.02966	377.38890	422.74814
33	241.76476	287.12401	332.48325	377.84249	423.20174
34	242.21836	287.57760	332.93684	378.29608	423.65533
35	242.67195	288.03119	333.39043	378.74968	424.10892
36	243.12554	288.48478	333.84403	379.20327	424.56251
37	243.57913	288.93838	334.29762	379.65686	425.01610
38	244.03273	289.39197	334.75121	380.11045	425.46970
39	244.48632	289.84556	335.20480	380.56405	425.92329
40	244.93991	290.29915	335.65840	381.01764	426.37688
41	245.39350	290.75275	336.11199	381.47123	426.83047
42	245.84710	291.20634	336.56558	381.92482	427.28407
43	246.30069	291.65993	337.01917	382.37842	427.73766
44	246.75428	292.11352	337.47277	382.83201	428.19125
45	247.20787	292.56712	337.92636	383.28560	428.64484
46	247.66147	293.02071	338.37995	383.73919	429.09844
47	248.11506	293.47430	338.83354	384.19279	429.55203
48	248.56865	293.92789	339.28714	384.64638	430.00562
49	249.02224	294.38149	339.74073	385.09997	430.45921

9 oz. = .255146 kg. 10 oz. = .283495 kg. 11 oz. = .311845 kg. 12 oz. = .340194 kg.

EQUIVALENTS OF AVOIRDUPOIS POUNDS IN KILOGRAMS.

(Continued)

Pounds	500	600	700	800	900
50	249.47584	294.83508	340.19432	385.55356	430.91281
51	249.92943	295.28867	340.64791	386.00716	431.36640
52	250.38302	295.74226	341.10151	386.46075	431.81999
53	250.83661	296.19586	341.55510	386.91434	432.27358
54	251.29020	296.64945	342.00869	387.36793	432.72718
55	251.74380	297.10304	342.46228	387.82153	433.18077
56	252.19739	297.55663	342.91588	388.27512	433.63436
57	252.65098	298.01022	343.36947	388.72871	434.08795
58	253.10457	298.46382	343.82306	389.18230	434.54155
59	253.55817	298.91741	344.27665	389.63590	434.99514
60	254.01176	299.37100	344.73025	390.08949	435.44873
61	254.46535	299.82459	345.18384	390.54308	435.90232
62	254.91894	300.27819	345.63743	390.99667	436.35592
63	255.37254	300.73178	346.09102	391.45027	436.80951
64	255.82613	301.18537	346.54461	391.90386	437.26310
65	256.27972	301.63896	346.99821	392.35745	437.71669
66	256.73331	302.09256	347.45180	392.81104	438.17029
67	257.18691	302.54615	347.90539	393.26463	438.62388
68	257.64050	302.99974	348.35898	393.71823	439.07747
69	258.09409	303.45333	348.81258	394.17182	439.53106
70	258.54768	303.90693	349.26617	394.62541	439.98465
71	259.00128	304.36052	349.71976	395.07900	440.43825
72	259.45487	304.81411	350.17335	395.53260	440.89184
73	259.90846	305.26770	350.62695	395.98619	441.34543
74	260.36205	305.72130	351.08054	396.43978	441.79902
75	260.81565	306.17489	351.53413	396.89337	442.25262
76	261.26924	306.62848	351.98772	397.34697	442.70621
77	261.72283	307.08207	352.44132	397.80056	443.15980
78	262.17642	307.53567	352.89491	398.25415	443.61339
79	262.63002	307.98926	353.34850	398.70774	444.06699
80	263.08361	308.44285	353.80209	399.16134	444.52058
81	263.53720	308.89644	354.25569	399.61493	444.97417
82	263.99079	309.35004	354.70928	400.06852	445.42776
83	264.44439	309.80363	355.16287	400.52211	445.88136
84	264.89798	310.25722	355.61646	400.97571	446.33495
85	265.35157	310.71081	356.07006	401.42930	446.78854
86	265.80516	311.16441	356.52365	401.88289	447.24213
87	266.25876	311.61800	356.97724	402.33648	447.69573
88	266.71235	312.07159	357.43083	402.79008	448.14932
89	267.16594	312.52518	357.88443	403.24367	448.60291
90	267.61953	312.97878	358.33802	403.69726	449.05650
91	268.07312	313.43237	358.79161	404.15085	449.51010
92	268.52672	313.88596	359.24520	404.60445	449.96369
93	268.98031	314.33955	359.69880	405.05804	450.41728
94	269.43390	314.79314	360.15239	405.51163	450.87087
95	269.88749	315.24674	360.60598	405.96522	451.32447
96	270.34109	315.70033	361.05957	406.41882	451.77806
97	270.79468	316.15392	361.51316	406.87241	452.23165
98	271.24827	316.60751	361.96676	407.32600	452.68524
99	271.70186	317.06111	362.42035	407.77959	453.13884

13 oz. = .368544 kg. 14 oz. = .396893 kg. 15 oz. = .425243 kg. 16 oz. = .453593 kg.

EQUIVALENTS OF KILOGRAMS IN AVOIRDUPOIS POUNDS.

Conversion factor: 1 kilogram = 2.204622341 avoirdupois pounds.

Kilos	0	100	200	300	400
0		220.4622	440.9245	661.3867	881.8489
1	2.2046	222.6669	443.1291	663.5913	884.0536
2	4.4092	224.8715	445.3337	665.7959	886.2582
3	6.6139	227.0761	447.5383	668.0006	888.4628
4	8.8185	229.2807	449.7430	670.2052	890.6674
5	11.0231	231.4853	451.9476	672.4098	892.8720
6	13.2277	233.6900	454.1522	674.6144	895.0767
7	15.4324	235.8946	456.3568	676.8191	897.2813
8	17.6370	238.0992	458.5614	679.0237	899.4859
9	19.8416	240.3038	460.7661	681.2283	901.6905
10	22.0462	242.5085	462.9707	683.4329	903.8952
11	24.2508	244.7131	465.1753	685.6375	906.0998
12	26.4555	246.9177	467.3799	687.8422	908.3044
13	28.6601	249.1223	469.5846	690.0468	910.5090
14	30.8647	251.3269	471.7892	692.2514	912.7136
15	33.0693	253.5316	473.9938	694.4560	914.9183
16	35.2740	255.7362	476.1984	696.6607	917.1229
17	37.4786	257.9408	478.4030	698.8653	919.3275
18	39.6832	260.1454	480.6077	701.0699	921.5321
19	41.8878	262.3501	482.8123	703.2745	923.7368
20	44.0924	264.5547	485.0169	705.4791	925.9414
21	46.2971	266.7593	487.2215	707.6838	928.1460
22	48.5017	268.9639	489.4262	709.8884	930.3506
23	50.7063	271.1685	491.6308	712.0930	932.5553
24	52.9109	273.3732	493.8354	714.2976	934.7599
25	55.1156	275.5778	496.0400	716.5023	936.9645
26	57.3202	277.7824	498.2446	718.7069	939.1691
27	59.5248	279.9870	500.4493	720.9115	941.3737
28	61.7294	282.1917	502.6539	723.1161	943.5784
29	63.9340	284.3963	504.8585	725.3208	945.7830
30	66.1387	286.6009	507.0631	727.5254	947.9876
31	68.3433	288.8055	509.2678	729.7300	950.1922
32	70.5479	291.0101	511.4724	731.9346	952.3969
33	72.7525	293.2148	513.6770	734.1392	954.6015
34	74.9572	295.4194	515.8816	736.3439	956.8061
35	77.1618	297.6240	518.0863	738.5485	959.0107
36	79.3664	299.8286	520.2909	740.7531	961.2153
37	81.5710	302.0333	522.4955	742.9577	963.4200
38	83.7756	304.2379	524.7001	745.1624	965.6246
39	85.9803	306.4426	526.9047	747.3670	967.8292
40	88.1849	308.6471	529.1094	749.5716	970.0338
41	90.3895	310.8518	531.3140	751.7762	972.2385
42	92.5941	313.0564	533.5186	753.9808	974.4431
43	94.7988	315.2610	535.7232	756.1855	976.6477
44	97.0034	317.4656	537.9279	758.3901	978.8523
45	99.2080	319.6702	540.1325	760.5947	981.0569
46	101.4126	321.8749	542.3371	762.7993	983.2616
47	103.6173	324.0795	544.5417	765.0040	985.4662
48	105.8219	326.2841	546.7463	767.2086	987.6708
49	108.0265	328.4887	548.9510	769.4132	989.8754

EQUIVALENTS OF KILOGRAMS IN
AVOIRDUPOIS POUNDS.

(Continued)

Kilos	0	100	200	300	400
50	110.2311	330.6934	551.1556	771.6178	992.0801
51	112.4357	332.8980	553.3602	773.8224	994.2847
52	114.6404	335.1026	555.5648	776.0271	996.4893
53	116.8450	337.3072	557.7695	778.2317	998.6939
54	119.0496	339.5118	559.9741	780.4363	1,000.8985
55	121.2542	341.7165	562.1787	782.6409	1,003.1032
56	123.4589	343.9211	564.3833	784.8456	1,005.3078
57	125.6635	346.1257	566.5879	787.0502	1,007.5124
58	127.8681	348.3303	568.7926	789.2548	1,009.7170
59	130.0727	350.5350	570.9972	791.4594	1,011.9217
60	132.3773	352.7396	573.2018	793.6640	1,014.1263
61	134.4820	354.9442	575.4064	795.8687	1,016.3309
62	136.6866	357.1488	577.6111	798.0733	1,018.5355
63	138.8912	359.3534	579.8157	800.2779	1,020.7401
64	141.0958	361.5581	582.0203	802.4825	1,022.9448
65	143.3005	363.7627	584.2249	804.6872	1,025.1494
66	145.5051	365.9673	586.4295	806.8918	1,027.3540
67	147.7097	368.1719	588.6342	809.0964	1,029.5586
68	149.9143	370.3766	590.8388	811.3010	1,031.7633
69	152.1189	371.5812	593.0434	813.5056	1,033.9679
70	154.3236	374.7858	595.2480	815.7103	1,036.1725
71	156.5282	376.9904	597.4527	817.9149	1,038.3771
72	158.7328	379.1950	599.6573	820.1195	1,040.5817
73	160.9374	381.3997	601.8619	822.3241	1,042.7864
74	163.1421	383.6043	604.0665	824.5288	1,044.9910
75	165.3467	385.8089	606.2711	826.7334	1,047.1956
76	167.5513	388.0135	608.4758	828.9380	1,049.4002
77	169.7559	390.2182	610.6804	831.1426	1,051.6049
78	171.9605	392.4228	612.8850	833.3472	1,053.8095
79	174.1652	394.6274	615.0896	835.5519	1,056.0141
80	176.3698	396.8320	617.2943	837.7565	1,058.2187
81	178.5744	399.0366	619.4989	839.9611	1,060.4233
82	180.7790	401.2413	621.7035	842.1657	1,062.6280
83	182.9837	403.4459	623.9081	844.3704	1,064.8326
84	185.1883	405.6505	626.1127	846.5750	1,067.0372
85	187.3929	407.8551	628.3174	848.7796	1,069.2418
86	189.5975	410.0598	630.5220	850.9842	1,071.4465
87	191.8021	412.2644	632.7266	853.1888	1,073.6511
88	194.0068	414.4690	634.9312	855.3935	1,075.8557
89	196.2114	416.6736	637.1359	857.5981	1,078.0603
90	198.4160	418.8782	639.3405	859.8027	1,080.2649
91	200.6206	421.0829	641.5451	862.0073	1,082.4696
92	202.8253	423.2875	643.7497	864.2120	1,084.6742
93	205.0299	425.4921	645.9543	866.4166	1,086.8788
94	207.2345	427.6967	648.1590	868.6212	1,089.0834
95	209.4391	429.9014	650.3636	870.8258	1,091.2881
96	211.6437	432.1060	652.5682	873.0304	1,093.4927
97	213.8484	434.3106	654.7728	875.2351	1,095.6973
98	216.0530	436.5152	656.9775	877.4397	1,097.9019
99	218.2576	438.7198	659.1821	879.6443	1,100.1065

EQUIVALENTS OF KILOGRAMS IN AVOIRDUPOIS POUNDS.

(Continued)

Kilos	500	600	700	800	900
0	1,102.3112	1,322.7734	1,543.2356	1,763.6979	1,984.1601
1	1,104.5158	1,324.9780	1,545.4403	1,765.9025	1,986.3647
2	1,106.7204	1,327.1826	1,547.6449	1,768.1071	1,988.5694
3	1,108.9250	1,329.3873	1,549.8495	1,770.3117	1,990.7740
4	1,111.1297	1,331.5919	1,552.0541	1,172.5164	1,992.9786
5	1,113.3343	1,333.7965	1,554.2588	1,774.7210	1,995.1832
6	1,115.5389	1,336.0011	1,556.4634	1,776.9256	1,997.3878
7	1,117.7435	1,338.2058	1,558.6680	1,779.1302	1,999.5925
8	1,119.9481	1,340.4104	1,560.8726	1,781.3349	2,001.7971
9	1,122.1528	1,342.6150	1,563.0772	1,783.5395	2,004.0017
10	1,124.3574	1,344.8196	1,565.2819	1,785.7441	2,006.2063
11	1,126.5620	1,347.0243	1,567.4865	1,787.9487	2,008.4110
12	1,128.7666	1,349.2289	1,569.6911	1,790.1533	2,010.6156
13	1,130.9713	1,351.4335	1,571.8957	1,792.3580	2,012.8202
14	1,133.1759	1,353.6381	1,574.1004	1,794.5626	2,015.0248
15	1,135.3805	1,355.8427	1,576.3050	1,796.7672	2,017.2294
16	1,137.5851	1,358.0474	1,578.5096	1,798.9718	2,019.4341
17	1,139.7898	1,360.2520	1,580.7142	1,801.1765	2,021.6387
18	1,141.9944	1,362.4566	1,582.9188	1,803.3811	2,023.8433
19	1,144.1990	1,364.6612	1,585.1235	1,805.5857	2,026.0479
20	1,146.4036	1,366.8659	1,587.3281	1,807.7903	2,028.2526
21	1,148.6082	1,369.0705	1,589.5327	1,809.9949	2,030.4572
22	1,150.8129	1,371.2751	1,591.7373	1,812.1996	2,032.6618
23	1,153.0175	1,373.4797	1,593.9420	1,814.4042	2,034.8664
24	1,155.2221	1,375.6843	1,596.1466	1,816.6088	2,037.0710
25	1,157.4267	1,377.8890	1,598.3512	1,818.8134	2,039.2757
26	1,159.6314	1,380.0936	1,600.5558	1,821.0181	2,041.4803
27	1,161.8360	1,382.2982	1,602.7604	1,823.2227	2,043.6849
28	1,164.0406	1,384.5028	1,604.9651	1,825.4273	2,045.8895
29	1,166.2452	1,386.7075	1,607.1697	1,827.6319	2,048.0942
30	1,168.4498	1,388.9121	1,609.3743	1,829.8365	2,050.2988
31	1,170.6545	1,391.1167	1,611.5789	1,832.0412	2,052.5034
32	1,172.8591	1,393.3213	1,613.7836	1,834.2458	2,054.7080
33	1,175.0637	1,395.5259	1,615.9882	1,836.4504	2,056.9126
34	1,177.2683	1,397.7306	1,618.1928	1,838.6550	2,059.1173
35	1,179.4730	1,399.9352	1,620.3974	1,840.8597	2,061.3219
36	1,181.6776	1,402.1398	1,622.6020	1,843.0643	2,063.5265
37	1,183.8822	1,404.3444	1,624.8067	1,845.2689	2,065.7311
38	1,186.0868	1,406.5491	1,627.0113	1,847.4735	2,067.9358
39	1,188.2914	1,408.7537	1,629.2159	1,849.6781	2,070.1404
40	1,190.4961	1,410.9583	1,631.4205	1,851.8828	2,072.3450
41	1,192.7007	1,413.1629	1,633.6252	1,854.0874	2,074.5496
42	1,194.9053	1,415.3675	1,635.8298	1,856.2920	2,076.7542
43	1,197.1099	1,417.5722	1,638.0344	1,858.4966	2,078.9589
44	1,199.3146	1,419.7768	1,640.2390	1,860.7013	2,081.1635
45	1,201.5192	1,421.9814	1,642.4436	1,862.9059	2,083.3681
46	1,203.7238	1,424.1860	1,644.6483	1,865.1105	2,085.5727
47	1,205.9284	1,426.3907	1,646.8529	1,867.3151	2,087.7774
48	1,208.1330	1,428.5953	1,649.0575	1,869.5197	2,089.9820
49	1,210.3377	1,430.7999	1,651.2621	1,871.7244	2,092.1866

EQUIVALENTS OF KILOGRAMS IN
AVOIRDUPOIS POUNDS.

(Continued)

Kilos	500	600	700	800	900
50	1,212.5423	1,433.0045	1,653.4668	1,873.9290	2,094.3912
51	1,214.7469	1,435.2091	1,655.6714	1,876.1336	2,096.5958
52	1,216.9515	1,437.4138	1,657.8760	1,878.3382	2,098.8005
53	1,219.1562	1,439.6184	1,660.0806	1,880.5429	2,101.0051
54	1,221.3608	1,441.8230	1,662.2852	1,882.7475	2,103.2097
55	1,223.5654	1,444.0276	1,664.4899	1,884.9521	2,105.4143
56	1,225.7700	1,446.2323	1,666.6945	1,887.1567	2,107.6190
57	1,227.9746	1,448.4369	1,668.8991	1,889.3613	2,109.8236
58	1,230.1793	1,450.6415	1,671.1037	1,891.5660	2,112.0282
59	1,232.3839	1,452.8461	1,673.3084	1,893.7706	2,114.2328
60	1,234.5885	1,455.0507	1,675.5130	1,895.9752	2,116.4374
61	1,236.7931	1,457.2554	1,677.7176	1,898.1798	2,118.6421
62	1,238.9978	1,459.4600	1,679.9222	1,900.3845	2,120.8467
63	1,241.2024	1,461.6646	1,682.1268	1,902.5891	2,123.0513
64	1,243.4070	1,463.8692	1,684.3315	1,904.7937	2,125.2559
65	1,245.6116	1,466.0739	1,686.5361	1,906.9983	2,127.4606
66	1,247.8162	1,468.2785	1,688.7407	1,909.2029	2,129.6652
67	1,250.0209	1,470.4831	1,690.9453	1,911.4076	2,131.8698
68	1,252.2255	1,472.6877	1,693.1500	1,913.6122	2,134.0744
69	1,254.4301	1,474.8923	1,695.3546	1,915.8168	2,136.2790
70	1,256.6347	1,477.0970	1,697.5592	1,918.0214	2,138.4837
71	1,258.8394	1,479.3016	1,699.7638	1,920.2261	2,140.6883
72	1,261.0440	1,481.5062	1,701.9684	1,922.4307	2,142.8929
73	1,263.2486	1,483.7108	1,704.1731	1,924.6353	2,145.0975
74	1,265.4532	1,485.9155	1,706.3777	1,926.8399	2,147.3022
75	1,267.6578	1,488.1201	1,708.5823	1,929.0445	2,149.5068
76	1,269.8625	1,490.3247	1,710.7869	1,931.2492	2,151.7114
77	1,272.0671	1,492.5293	1,712.9916	1,933.4538	2,153.9160
78	1,274.2717	1,494.7339	1,715.1962	1,935.6584	2,156.1206
79	1,276.4763	1,496.9386	1,717.4008	1,937.8630	2,158.3253
80	1,278.6810	1,499.1432	1,719.6054	1,940.0677	2,160.5299
81	1,280.8856	1,501.3478	1,721.8100	1,942.2723	2,162.7345
82	1,283.0902	1,503.5524	1,724.0147	1,944.4769	2,164.9391
83	1,285.2948	1,505.7571	1,726.2193	1,946.6815	2,167.1438
84	1,287.4994	1,507.9617	1,728.4239	1,948.8861	2,169.3484
85	1,289.7041	1,510.1663	1,730.6285	1,951.0908	2,171.5530
86	1,291.9087	1,512.3709	1,732.8332	1,953.2954	2,173.7576
87	1,294.1133	1,514.5755	1,735.0378	1,955.5000	2,175.9623
88	1,296.3179	1,516.7802	1,737.2424	1,957.7046	2,178.1669
89	1,298.5226	1,518.9848	1,739.4470	1,959.9093	2,180.3715
90	1,300.7272	1,521.1894	1,741.6516	1,962.1139	2,182.5761
91	1,302.9318	1,523.3940	1,743.8563	1,964.3185	2,184.7807
92	1,305.1364	1,525.5987	1,746.0609	1,966.5231	2,186.9854
93	1,307.3410	1,527.8033	1,748.2655	1,968.7278	2,189.1900
94	1,309.5457	1,530.0079	1,750.4701	1,970.9324	2,191.3946
95	1,311.7503	1,532.2125	1,752.6748	1,973.1370	2,193.5992
96	1,313.9549	1,534.4171	1,754.8794	1,975.3416	2,195.8039
97	1,316.1595	1,536.6218	1,757.0840	1,977.5462	2,198.0085
98	1,318.3642	1,538.8264	1,759.2886	1,979.7509	2,200.2131
99	1,320.5688	1,541.0310	1,761.4933	1,981.9555	2,202.4177

COMPARISON OF THE VARIOUS TONS AND POUNDS IN USE IN THE UNITED STATES.

(See Pages 562, 563, 582, 586)

Troy Pounds	Avoirdupois Pounds	Kilograms	Short Tons	Long Tons	Metric Tons
1	.822 857	.373 24	.000 411 43	.000 367 35	.000 373 24
2	1.645 71	.746 48	.000 822 83	.000 734 69	.000 746 48
3	2.468 57	1.119 73	.001 234 29	.001 102 04	.001 119 73
4	3.291 43	1.492 97	.001 645 71	.001 469 39	.001 492 97
5	4.114 29	1.866 21	.002 057 14	.001 836 73	.001 866 21
6	4.937 14	2.239 45	.002 468 57	.002 204 08	.002 239 45
7	5.760 00	2.612 69	.002 880 00	.002 571 43	.002 612 69
8	6.582 86	2.985 93	.003 291 43	.002 938 78	.002 985 93
9	7.405 71	3.359 18	.003 702 86	.003 306 12	.003 359 18
1.215 28	1	.453 59	.0005	.000 446 43	.000 453 59
2.430 56	2	.907 18	.0010	.000 892 86	.000 907 18
3.645 83	3	1.360 78	.0015	.001 339 29	.001 360 78
4.861 11	4	1.814 37	.0020	.001 785 71	.001 814 37
6.076 39	5	2.267 96	.0025	.002 232 14	.002 267 96
7.291 67	6	2.721 55	.0030	.002 678 57	.002 721 55
8.506 94	7	3.175 15	.0035	.003 125 00	.003 175 15
9.722 22	8	3.628 74	.0040	.003 571 43	.003 628 74
10.937 50	9	4.082 33	.0045	.004 017 86	.004 082 33
2.679 23	2.204 62	1	.001 102 31	.000 984 21	.001
5.358 46	4.409 24	2	.002 204 62	.001 968 41	.002
8.037 69	6.613 87	3	.003 306 93	.002 952 62	.003
10.716 91	8.818 49	4	.004 409 24	.003 936 83	.004
13.937 50	11.023 11	5	.005 511 56	.004 921 03	.005
16.075 37	13.227 73	6	.006 613 87	.005 905 24	.006
18.754 60	15.432 36	7	.007 716 18	.006 889 44	.007
21.433 83	17.636 98	8	.008 818 49	.007 873 65	.008
24.113 06	19.841 60	9	.009 920 80	.008 857 86	.009
2430.56	2000	907.18	1	.892 87	.907 18
4861.11	4000	1814.37	2	1.785 71	1.814 37
7291.67	6000	2721.55	3	2.678 57	2.721 55
9722.22	8000	3628.74	4	3.571 43	3.628 74
12 152.78	10 000	4535.92	5	4.464 29	4.535 92
14 583.33	12 000	5443.11	6	5.357 14	5.443 11
17 013.89	14 000	6350.29	7	6.250 00	6.350 29
19 444.44	16 000	7257.48	8	7.142 86	7.257 48
21 875.00	18 000	8164.66	9	8.035 71	8.164 66
2722.22	2240	1016.05	1.12	1	1.016 05
5444.44	4480	2032.09	2.24	2	2.032 09
8166.67	6720	3048.14	3.36	3	3.048 14
10 888.89	8960	4064.19	4.48	4	4.064 19
13 611.11	11 200	5080.24	5.60	5	5.080 24
16 333.33	13 440	6096.28	6.72	6	6.096 28
19 055.55	15 680	7112.32	7.84	7	7.112 32
21 777.78	17 920	8128.33	8.96	8	8.128 33
24 500.00	20 160	9144.42	10.08	9	9.144 42
2679.23	2204.62	1000	1.102 31	.984 21	1
5358.46	4409.24	2000	2.204 62	1.968 41	2
8037.69	6613.87	3000	3.306 93	2.952 62	3
10 716.91	8818.49	4000	4.409 24	3.936 83	4
13 937.50	11 023.11	5000	5.511 56	4.921 03	5
16 075.37	13 227.73	6000	6.613 87	5.905 24	6
18 754.60	15 432.36	7000	7.716 18	6.889 44	7
21 433.83	17 636.98	8000	8.818 49	7.873 65	8
24 113.06	19 841.60	9000	9.920 80	8.857 86	9

INDEX.

	PAGE
ANGLES, bulb, cuts of sections of	20-23
" properties of	192-195
" weights and dimensions of	45, 46
connection, for I-beams and channels, cuts of	53
" " notes on	52, 56
" " tables of	54-61
" " location of	54, 55
cuts of sections of special, equal and unequal legs	19
" " standard, equal legs	17
" " unequal legs	18
" " bulb and top guard angles	20, 23
explanation of tables of properties of	178
maximum sizes of rivets, and spacing of rivet and bolt holes in	62, 356
properties of special, equal legs	202, 203
" " unequal legs	208, 209
" " standard, equal legs	198-201
" " unequal legs	204-207
radii of gyration for two, back to back	215-217
tables of safe loads for, used as beams	138-159
" " notes on	95-103
weights and dimensions of special, equal legs	50
" " unequal legs	51
" " standard, equal legs	48
" " unequal legs	49, 50
APOTHECARIES' weight	558
ARCHES, notes and tables for spacing tie rods for tile	76, 77
" " of floor, end construction	69
" " of material for fireproof floor	68, 69
" on thrust of	75, 78-81
" " tie rods to withstand thrust of	75
terra-cotta floor, explanation of tables of	70
" " flat and segmental, tables of	71-73
tests and breaking loads for hollow tile floor	74
weights of hollow brick and tile floor	69
" " segmental floor	69
AREAS in mensuration	551
method of increasing sectional	26
of circles	487-509
" " for diameters greater than one hundred	499
" " flat rolled steel bars	468-473
" " hollow cast iron columns	302, 303
" " rivet holes, to be deducted to obtain net areas of plates	356, 357
" " square and round bars	451, 457
" " various sections, formulæ for	168-175
" " for standard sections	166, 167
ATLANTA, extracts from building laws of	328-349
AVOIRDUPOIS pounds equivalents in kilograms	582
weight	558
BALTIMORE, extracts from building laws of	328-349
BAND or hoop steel, table of weights of	474
BANDS, light, dimensions of	33
BARS, eye	377
" flat, dimensions of upset screw ends for	376
" " rolled steel, areas of	468-473
" " notes on areas of	473
" " weights of	486
" " weights of	475-486
lattice, sizes of and rivet spacing in, for latticed channel columns	272, 273
round and square, dimensions of upset screw ends for	372-375
" " weights, areas and circumferences of	451-457
sheet and tin	36

	PAGE
BASES, typical details of column.....	243
BEAM box girders, explanations of tables of safe loads for.....	305
" " tables of safe loads for.....	306-316
BEAMS, notes on bearing plates for shapes used as.....	63
coefficients for deflection of.....	98, 99
general formulæ for flexure of.....	160, 161
girders, notes on.....	52
grillage, notes on, for foundations.....	327
I section, cast iron separators for.....	66, 67
" cuts of sections of special.....	4, 5, 7, 9
" " standard.....	2-4, 6-8
" " standard connection angles for.....	53
" explanation of tables of properties of.....	176, 177
" diagram of sections of minimum standard.....	28
" location of connection angles for.....	54, 55
" maximum bending moments in foot pounds for.....	136
" size of rivets in.....	54, 356
" minimum spans for, with standard connection angles.....	58
" notes on lateral strength of.....	78-83
" " without lateral support.....	82
" " safe loads for.....	100-105
" " spacing for.....	102-105
" proportions of sections of standard.....	27
" spacing of rivet and bolt holes in flanges and connection angles of.....	60
" spans limiting and maximum safe loads due to crippling of web.....	96
" tables of bearing plates for.....	66
" " properties of special.....	184, 185
" " " standard.....	182-185
" " safe loads for.....	106-117
" " " used as columns.....	244-247
" " spacing for.....	124-135
" tangent distances between fillets.....	60
" weights and dimensions of special.....	41
" " " standard.....	40, 41
reduction in safe loads and fibre stress, due to lateral flexure of.....	83
of uniform section, bending moments and deflections for.....	162-165
" " safe superimposed loads and shears for.....	162-165
wooden, notes on bearing at points of support.....	406
" notes on safe loads for.....	403-406
" tables of safe loads for.....	416-421
BEARING plates for I-beams and channels, tables of sizes of.....	64, 65
" for shapes used as beams, notes on.....	63
values of pin plates, tables of.....	359
" wall plates, safe unit.....	64
" rivets and plates.....	352, 353
of wooden beams at points of support, notes on.....	406
BEARINGS and bearing plates, standard, tables of sizes of.....	64
BENDING moments for beams of uniform section.....	162-165
" for I-beams and channels, tables of maximum.....	136, 137
" for pins, tables of maximum.....	360, 361
BILLETS, dimensions of square and round cornered steel.....	34-36
BIRMINGHAM wire gauge (B. W. G.).....	435
" new standard sheet and hoop gauge (B. G.).....	435
BLOOMS, dimensions of steel.....	34, 35
BOLSTERS for column bases, typical details of.....	243
BOLT and rivet holes, spacing of, through connection angles.....	60, 61
" heads, weights and dimensions of, Manufacturers' standard.....	369
BOLTS and nuts, Franklin Institute standard.....	362-365
for standard and special cast iron beam separators.....	66, 67
weights of round headed, without nuts.....	368
" with square heads and nuts, Manufacturers' standard.....	366, 367
BOSTON, extracts from building laws of.....	328-349
BOX girders, beam, tables of safe loads of.....	306-316

	PAGE
BOX girders, beam, tables of safe loads of, explanation of	305
BRACKETS for riveted columns, typical details of	243
BRASS, weights of sheets and plates of	436, 437
BREAKING unit stresses, tables of, for timber	410-415
BRICK, hollow, for partitions and arches, weights of	69
BRIDGE pins and nuts, dimensions of	382
BUCKLE plates, dimensions of	90
BUFFALO, extracts from building laws of	328-349
BUILDING laws of various cities, extracts from	328-349
BULB angles, cuts of sections of	20-23
" properties of	192-195
" weights and dimensions of	45, 46
CABLE and rope measure	559
CAR forgings and pressed steel parts	30, 31
CAR side stakes, cut of section of	23
" properties of	194, 195
" weights and dimensions of	46
CAST iron columns, tables of safe loads for hollow, round	302, 303
" " " strength of hollow, round and rectangular	304
" bases for columns, typical details of	243
" separators, standard and special, for I-beams	66, 67
CEILINGS, weights of porous terra-cotta for	69
CENTER of gravity, formulæ for location of, in Cambria sections	166, 167
" location of, in various sections	168-175
" of solids	554-556
CHAINS, dimensions and weights of, safe loads for	381
CHANNEL and plate columns, tables of dimensions of	232-235
" " " safe loads for, series A	274-287
" " " " series B	288-301
columns, latticed, diameter of rivets for	273
" " spacing of rivets for lacing bars	272
" " tables of dimensions of	230
" " safe loads for	268-271
CHANNELS, bearing plates for, tables of	65
" " (standard) for, tables of	64
cuts of sections of special	12-16
" " standard	10-12
" standard connection angles for	53
diagram of sections of minimum standard	29
explanation of properties of standard and special	177
limiting spans and maximum safe loads due to web crippling	97
maximum bending moments in foot pounds for	137
" size of rivets for	62, 356
minimum spans for, with standard connection angles	56
proportions of sections of standard	27
safe loads for, tables of	118-123
" " " notes on	100-105
spacing of rivet and bolt holes in flanges and connection angles of	61
tables of properties of special	188-191
" " standard	186, 187
tangent distances between fillets	61
weights and dimensions of special	43-45
" " standard	42, 43
CHICAGO, extracts from building laws of	328-349
CINCINNATI, extracts from building laws of	328-349
CIRCLES, areas and circumferences of, for diameters greater than 100	499
" " tables of	487-509
CIRCULAR plates, limiting sizes of	38, 39
" " weights of	464-467
segments, relations in	552, 553
CIRCUMFERENCES of circles	487-509
" " for diameters greater than 100	499
" " round bars	451-457

	PAGE
DEGREE, decimals of, expressed as minutes and seconds	557
DENVER, extracts from building laws of	328-349
DESIGN of reinforced concrete floor slabs	91-93
DETAILS of plate girders and column bases, steel columns, splices and brackets	243
DETROIT, extracts from building laws of	328-349
DIAGRAM for minimum standard beams	28
" " " channels	29
DIMENSIONS and safe loads of steel columns, explanation of tables of of angles, special, equal legs	222, 223 50
" " " unequal legs	51
" " " standard, equal legs	46
" " " unequal legs	49, 50
" bolt heads and nuts, Manufacturer's standard	369-371
" bolts and nuts, Franklin Institute standard	362
" bridge pins, nuts and pilot nuts	382
" buckle plates	40
" bulb angles	45, 46
" cast iron separators, standard and special, and bolts for beams	66, 67 381
" chains, weights of, safe loads for	43-45
" channels, special and ship	42, 43
" " standard	380
" clevises	222, 223
" columns, explanation of tables for	384, 385
" counter and lateral rods with loop welded eyes	37-39
" edged and sheared plates	377
" eye bars	33
" flats and thin flats or light bands	41
" l-beams, special	40, 41
" " standard	383
" lateral pins and rods	272
" lattice bars to be used with latticed channel columns	230
" latticed channel columns, tables of	273
" minimum stay plates with latticed channel columns	224, 225
" plate and angle columns, tables of	232-235
" " channel columns, tables of, series A and B	379
" right and left nuts	380
" rivet heads after driving	90
" safety floor plate, rolled	390-392
" standard pipe	214
" " T-rails and crane rail	34-36
" steel billets	34, 35
" " square cornered	34, 35
" " blooms and slabs	33
" " guide and hand rounds	32
" " ingots	85
" " sheeting, flat and corrugated	33
" " squares	47
" T-bars	45
" top guard angles	378
" turnbuckles	376
" upset screw ends for flat bars	372-375
" " " " round and square bars	166, 167
DISTANCE from neutral axis to extreme fibre of standard sections	26
DOOR spreader section, cut of	194, 195
" " properties of	560
DRY measure	37
EDGED plates, dimensions of	178
EXPLANATIONS of tables of properties of angles	177
" " " channels	176, 177
" " " I-beams	305
" " " safe loads for beam box girders and plate girders	70
" " " " " terra-cotta floor arches	

	PAGE
EYE bars, dimensions of.....	377
FACTORS of safety for various wooden structures.....	408
FASTENINGS for steel sheeting.....	85
FEET equivalents in metres.....	574
FIBRE stress, allowable, for direct flexure, in extreme fibre.....	83
FIREPROOF floors and materials, notes and tables for.....	68-93
FLAT bars, upset screw ends for.....	376
" " " rolled steel bars, areas of.....	468-473
" " " tables of weights of.....	475-486
FLATS, regular and thin, dimensions of.....	33
FLEXURE, lateral, reduction of allowable stress in beams due to.....	83
" strength of beams to resist thrust of arches.....	78-81
of beams, formulæ for.....	160-175
FLOOR arches, tables on end construction of.....	69
" terra-cotta, flat and segmental.....	70-73
" tests and breaking loads for hollow tile.....	74
plates, rolled safety.....	90
slabs, reinforced concrete, notes on, design of.....	91-93
FLOORS, notes and tables for fireproof, and material for.....	68-93
usual live loads for.....	52, 328
FOOT, decimals of, fractions of an inch, tables of.....	446-449
FORGINGS, car.....	31
FORMULÆ for bending moments, shears, safe loads and deflections... ..	162-175
" moments of inertia for Cambria sections.....	166, 167
" the properties of various sections.....	168-175
general, for flexure of beams.....	160, 161
FOUNDATIONS, notes on grillage beams for.....	327
FRACTIONS of an inch in decimals of a foot.....	446-449
" " " an inch.....	450
non-binary, values of.....	444, 445
square and cube roots of.....	444
FRANKLIN INSTITUTE STANDARD for bolts and nuts.....	362-365
FUNCTIONS, natural trigonometrical.....	516-522
FURRING, weights of porous terra-cotta for.....	69
GAS, steam and water pipe, sizes of wrought iron welded.....	390-392
GAUGE, table of American or Brown & Sharpe wire.....	435
" " Screw Co. screw wire.....	435
" Birmingham or Stubs iron wire (B. W. G.).....	435
" new Birmingham sheet and hoop (B. G.).....	435
" British Imperial standard wire.....	435
" standard decimal.....	435
" Trenton Iron Co. wire.....	435
" U. S. standard for iron and steel sheets and plates.....	435
" Washburn & Moen Co. and Roebbling's Sons Co. wire.....	435
GAUGES, wire, combined table of.....	438-443
GIRDERS, beam box and plate, explanations of tables of safe loads for.....	305
" tables of safe loads for.....	306-316
notes on beams used as.....	52
plate, stiffener angles and rivet spacing for, notes on.....	305
" tables of safe loads for.....	317-326
GRAVITY, specific, for various kinds of timber.....	408
" of various substances, tables of.....	424-433
GRILLAGE beams for foundations, notes on.....	327
GRIP of rivets and bolts through flanges of beams and channels.....	60, 61
" lengths required for.....	354
GUIDE rounds, dimensions of.....	33
GUNTER'S chain measure.....	559
GYRATION, radii of, see Radii of gyration.....	
HAND rounds, dimensions of.....	33
HARTFORD, extracts from building laws of.....	328-349
HATCH section, Z-Bar, cut of.....	23
" " properties of.....	190, 191

	PAGE
HEADS, bolt, weights and dimensions of, Manufacturers' standard . . .	369
or circular plates, limiting sizes of	38, 39
rivet, dimensions of, after driving	380
square and hexagon, weights of, Franklin Institute standard . .	364, 365
HOLLOW brick, weights of, for arches and partitions	69
round and rectangular cast iron columns, strength of	304
HOOP or band steel, tables of weights of	474
INCH, decimals of, for each $\frac{1}{16}$, tables of	450
" a foot for fractions of an	446-449
INCH, equivalents in millimetres	568
INERTIA, moments of, explanations of tables of, for rectangles	178
" formulae for various sections	169-175
" for standard sections	166, 167
" tables of, for rectangles	210-213
INGOTS, grades, sizes and weights of steel	32
JERSEY CITY, extracts from building laws of	328-349
KILOGRAM equivalents in avoirdupois pounds	586
LAND or square measure	559
LATERAL flexure, reduction of allowable fibre stress due to	83
pins and rods, dimensions of	383
rods, loop welded eyes, dimensions of	384, 385
strength of I-beams	78-83
" without lateral support, notes on	82
LATTICE bars to be used with latticed channel columns, rivet spacing for	272
" " " " " " weights and di-	
" " " " " " mensions of	272
LATTICED channel columns, spacing of rivets for lacing bars	272
" " rivets for, diameter of	273
" " tables of dimensions of	230
" " " moments of inertia and section	
" " " moduli of	231
" " " safe loads for	268-271
LAWS, building, of various cities, extracts from	328-349
LINEAR measure	559
LIQUID "	560
LIVE loads for floors	52, 328
LOADS and unit stresses, allowable, from building laws of various cities	328-349
safe (see Safe Loads).	
LOGARITHMS of numbers	510, 511
LOOP welded eyes for counter and lateral rods, dimensions of	384, 385
LOS ANGELES, extracts from building laws of	328-349
LOUISVILLE, extracts from building laws of	328-349
MACHINE bolts, Franklin Institute standard	364, 365
" Manufacturers' standard	366, 367
MANUFACTURERS' standard chains	381
" machine bolts and bolt heads	366-369
" square and hexagon nuts	370, 371
" specifications	393-402
" structural and boiler steel	393-402
MASONRY, allowable pressure on	65
MAXIMUM loads for I-beams and channels due to web crippling	94-97
shear at points of support for beams of uniform section	162-165
MEASURES, Metric System, length, capacity and weight	561
" " square or surface and cubic	561
U. S. and British, linear, rope, chain, nautical and land	559
" " cubic or solid, dry and liquid	560
MEASURES and weights	558-561
" " U. S., tables for converting	562-590
MENSURATION tables	550-556
METRE equivalents in feet	578
METRIC System, measures of length, capacity, weight, area and volume	561
weights and measures converted to U. S.	562-590
MILLIMETRE equivalents in inches	570
MILWAUKEE, extracts from building laws of	328-349

	PAGE
MINIMUM spans for beams and channels due to web crippling.....	94-97
" " with standard angle connections.....	58, 59
" channels with standard angle connections.....	56, 57
MINNEAPOLIS, extracts from building laws of.....	328-349
MINUTES and seconds expressed as decimals of a degree.....	557
MODULI, Section, for beams, explanation of.....	176
" " latticed channel columns.....	231
" " plate and angle columns.....	226-228
" " " channel columns.....	236-242
" " various sections, formulæ for.....	169-175
MOISTURE classification of wooden structures.....	407, 408
MOMENTS, bending, for beams of uniform section.....	162-165
of inertia, formula for standard sections.....	166, 167
" " various sections.....	169-175
" of latticed channel columns, tables of.....	231
" " plate and angle columns, tables of.....	226-228
" " plate and channel columns, tables of.....	236-242
" " rectangles, explanation of tables of.....	178
" " tables of.....	210-213
NAILS, standard cut wire and miscellaneous, tables of.....	386-389
NATURAL sines, cosecants, tangents, etc.....	516-522
NAUTICAL measure.....	559
NEWARK, extracts from building laws of.....	328-349
NEW HAVEN " " " " " ".....	328-349
NEW ORLEANS, " " " " " ".....	328-349
NEW YORK, " " " " " ".....	328-349
NUTS and bolts.....	362-367
dimensions of pin and pilot.....	382
" " right and left.....	379
square and hexagon, Franklin Institute standard.....	362-365
" " Manufacturers' standard.....	370, 371
PARTITIONS, weights and dimensions of porous terra-cotta and hollow brick for.....	69
PHILADELPHIA, extracts from building laws of.....	328-349
PI, π , numerical combinations of.....	548, 549
PILES, wooden, safe loads and sizes for.....	339
PILOT nuts, bridge pins and pin nuts, dimensions of.....	382
PIN plates, table of bearing values of.....	359
PINS and rivets, explanation of tables of.....	350
dimensions of bridge.....	382
" " lateral.....	383
table of maximum bending moments on.....	360, 361
PIPE, weights, dimensions and properties of standard.....	390-392
PITTSBURGH, extracts from building laws of.....	328-349
PLATE and angle columns, safe loads for, notes on.....	222
" " " tables of dimensions of.....	224, 225
" " " " " moments of inertia and section moduli of.....	226-228
" " " " " safe loads for.....	248-267
" channel " " " dimensions of.....	232-235
" " " " " moments of inertia and section moduli of.....	236-242
" " " " " safe loads for, series A.....	274-287
" " " " " " B.....	288-301
girders, explanations of tables of safe loads for.....	305
" safe loads for, tables of.....	317-326
" stiffener angles and rivet spacing for, notes on.....	305
PLATES and sheets of steel, iron, copper and brass, weights of.....	436, 437
bearing, for I-beams and channels, table of.....	65
" " shapes used as beams, notes on.....	63
buckle, dimensions of.....	90
circular, limiting sizes of.....	36, 37
" weights of.....	464-467
edged, dimensions of.....	37
pin, table of bearing values of.....	359

	PAGE
SYRACUSE, extracts from building laws of.....	328-349
TANGENT distances between fillets of I-beams and channels.....	60, 61
T-BARS, cuts of sections of.....	24, 25
properties of.....	196, 197
weights and dimensions of.....	47
TERRA-COTTA floor arches, notes on, tables for.....	70-73
porous, notes and tables for.....	69
THRUST of arches, notes on.....	75, 78-81
TIE rods for arches, notes on.....	75
" tile arches, notes and tables for spacing of.....	76, 77
TILE arches, breaking loads and tests for hollow floor.....	74
" notes and tables for spacing of tie rods for.....	76, 77
hollow, weights of, for floor arches.....	69
TIMBER, safe unit stresses for.....	409-415
table of breaking and working unit stresses for.....	409-415
" " safe loads for beams.....	416-421
TIMBER, table of specific gravities and weights per foot.....	408
" " strength of solid wooden columns.....	422, 423
TIN bars.....	36
TONS and pounds used in the U. S., comparison of.....	590
TOP-GUARD angles, cuts of sections of.....	20
" properties of.....	192, 193
" weights and dimensions of.....	45
T-RAILS, properties, weights and dimensions of standard.....	214
TRIGONOMETRICAL formulæ.....	512-515
functions, natural.....	516-522
TROY weight.....	558
TRUSSES, roof, coefficients and formulæ for.....	86-89
TURNBUCKLES, dimensions of.....	378
ULTIMATE breaking unit stresses, in lbs. per sq. in., for wood.....	409-415
strength of hollow, round and rectangular cast iron columns.....	304
" steel columns.....	218-221
UNIT stresses and loads from the building laws of various cities.....	328-349
UPSET eyes for counter and lateral rods.....	383
screw ends, dimensions of, for flat bars.....	376
" " " " round and square bars.....	372-375
VOLUMES and surfaces of solids.....	554-556
WASHINGTON, extracts from building laws of.....	328-349
WATER, steam and gas pipe, sizes of.....	390-392
WEB crippling in I-beams and channels.....	94-97
WEIGHTS and measures.....	558-561
" " tables for converting.....	562-590
avoirdupois, troy and apothecaries'.....	558
of angles, special, equal legs.....	50
" " " unequal legs.....	51
" " standard, equal legs.....	48
" " " unequal legs.....	49, 50
" bulb angles.....	45, 46
" cast iron separators and bolts for I-beams.....	66, 67
" " " standard and special.....	66, 67
" chains.....	381
" channels, special and ship.....	43, 45
" " standard.....	42, 43
" flat arches of hollow brick.....	69
" " rolled steel bars, tables of.....	475-486
" " " strips, hoop or band steel.....	474
" hollow brick and porous terra-cotta partitions.....	69
" " round cast iron columns.....	302, 303
" " tile floor arches and fireproof materials.....	69
" I-beams, special.....	41
" " standard.....	40, 41
" ingots, steel.....	32
" lattice bars to be used with latticed channel columns.....	272, 273
" machine bolts, bolt heads and nuts, Mfrs.' standard.....	366, 367
	369, 371

	PAGE
WEIGHTS of machine bolts, with square heads and hexagon nuts, Franklin Institute standard.....	364, 365
" minimum stay plates to be used with latticed channel columns.....	273
" porous terra-cotta, furring, roofing and ceiling.....	69
" roofing materials.....	84
" round headed rivets and bolts without nuts.....	368
" rivets and rivet heads.....	355
" sheets and plates of iron, steel, copper and brass.....	436, 437
" square and round bars.....	451-463
" standard pipe.....	390-392
" standard T-rails and crane rail.....	214
" various substances per cubic foot, tables of.....	424-433
per foot board measure and cubic foot for various kinds of timber.....	408
WIRE and sheet metal gauges.....	434-443
WIRE gauges, in combined table.....	438-443
nails and spikes, standard and miscellaneous sizes.....	386-389
WOODEN beams, bearing at points of support, notes on.....	406
" explanations of tables of safe loads for.....	403-406
" tables of safe loads for.....	416-421
columns, notes on.....	403, 422
" tables of strength of solid.....	422, 423
structures, moisture classification.....	407, 408
" proportions of safe loads for.....	407
" safety factors for.....	408
WOOD screws, diameters of.....	389
WORCESTER, extracts from building laws of.....	328-349
WROUGHT iron welded steam, gas and water pipe.....	392
" weights of sheets and plates of.....	436, 437
spikes, weights and sizes of.....	389
Z-BAR, hatch section, cut of.....	23
" properties of.....	190, 191

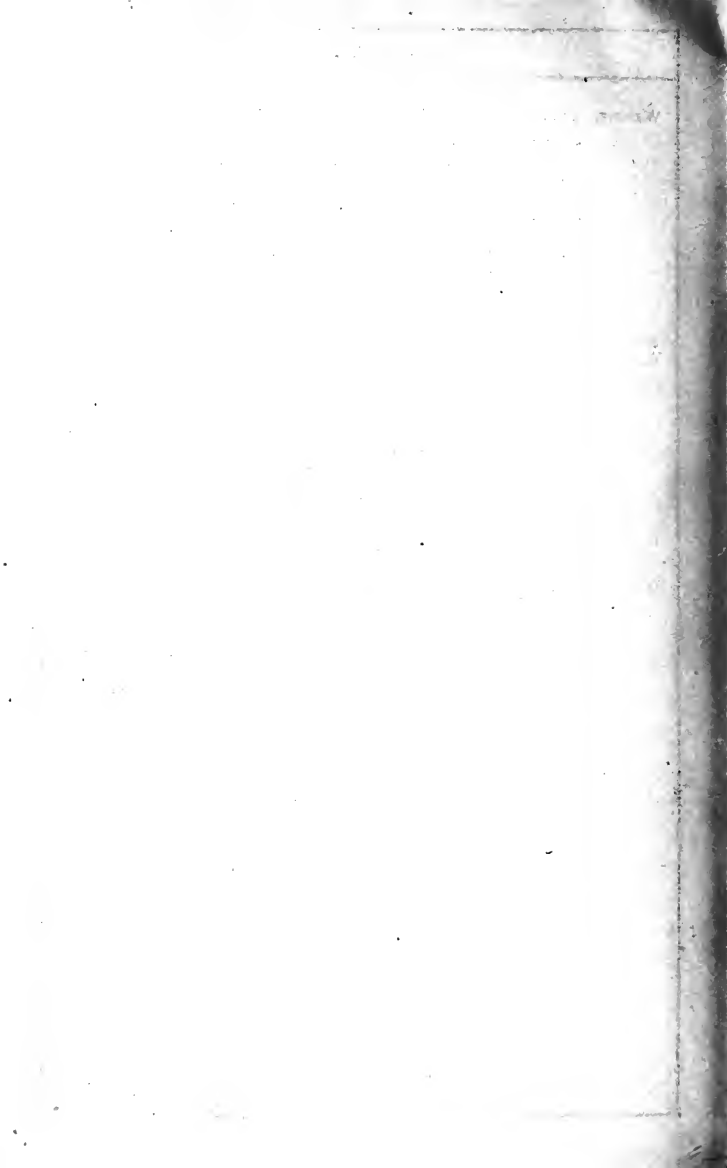

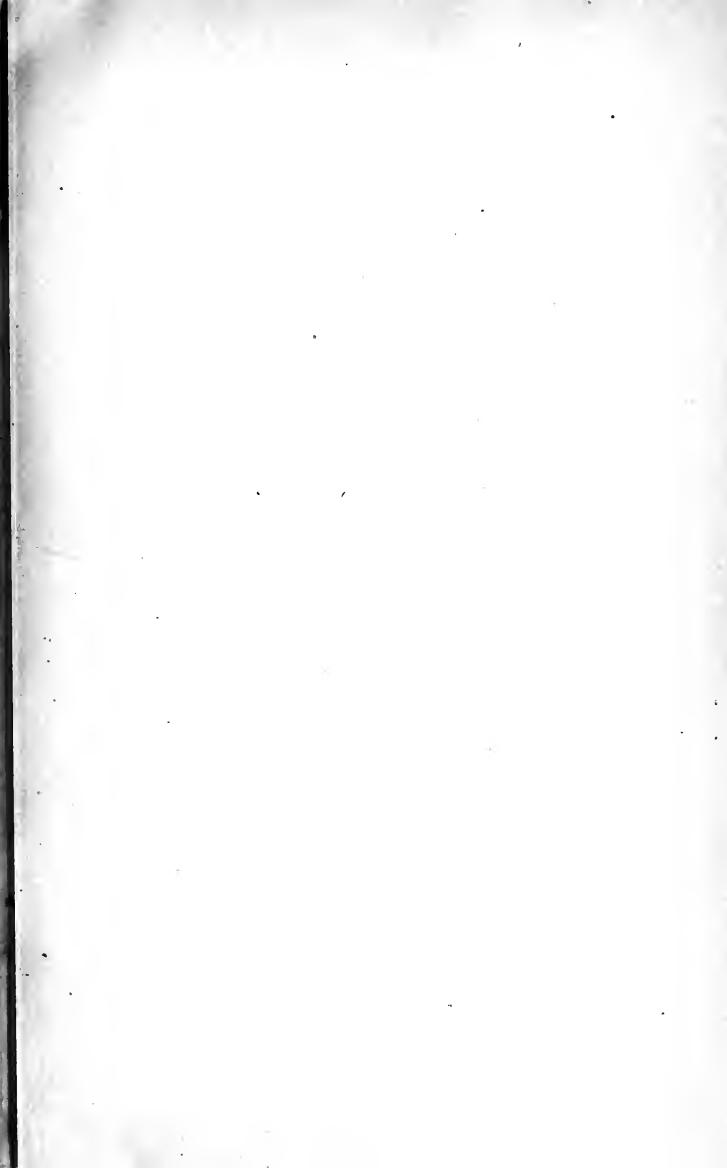

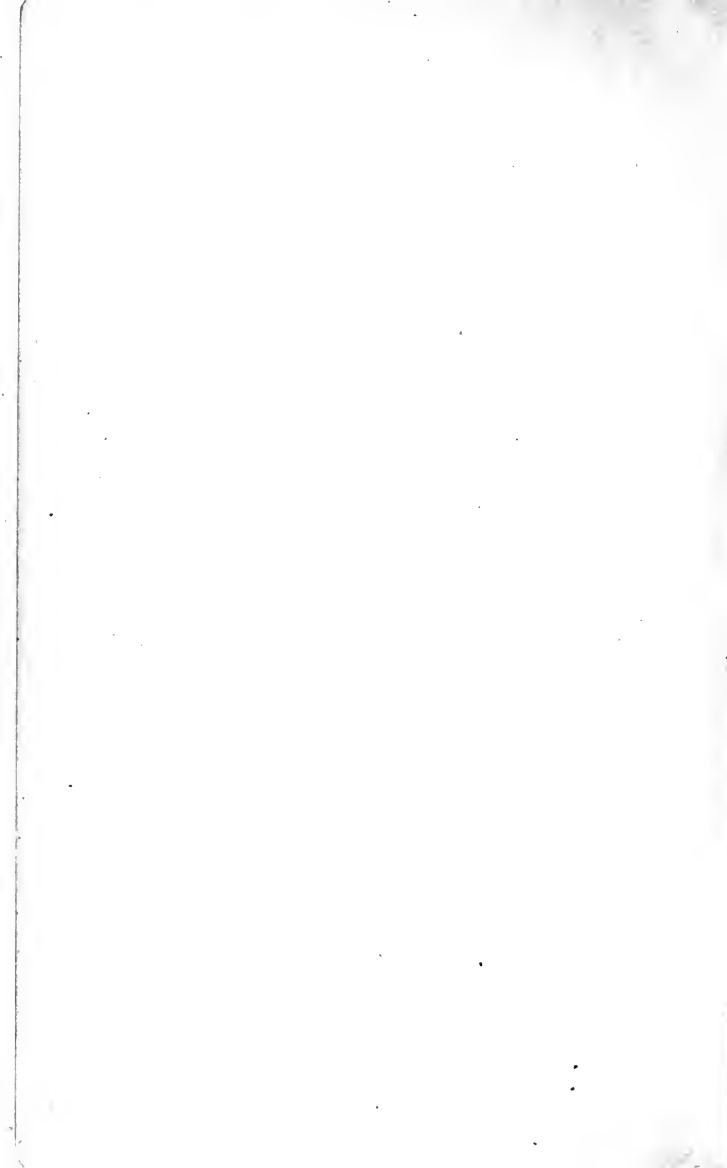

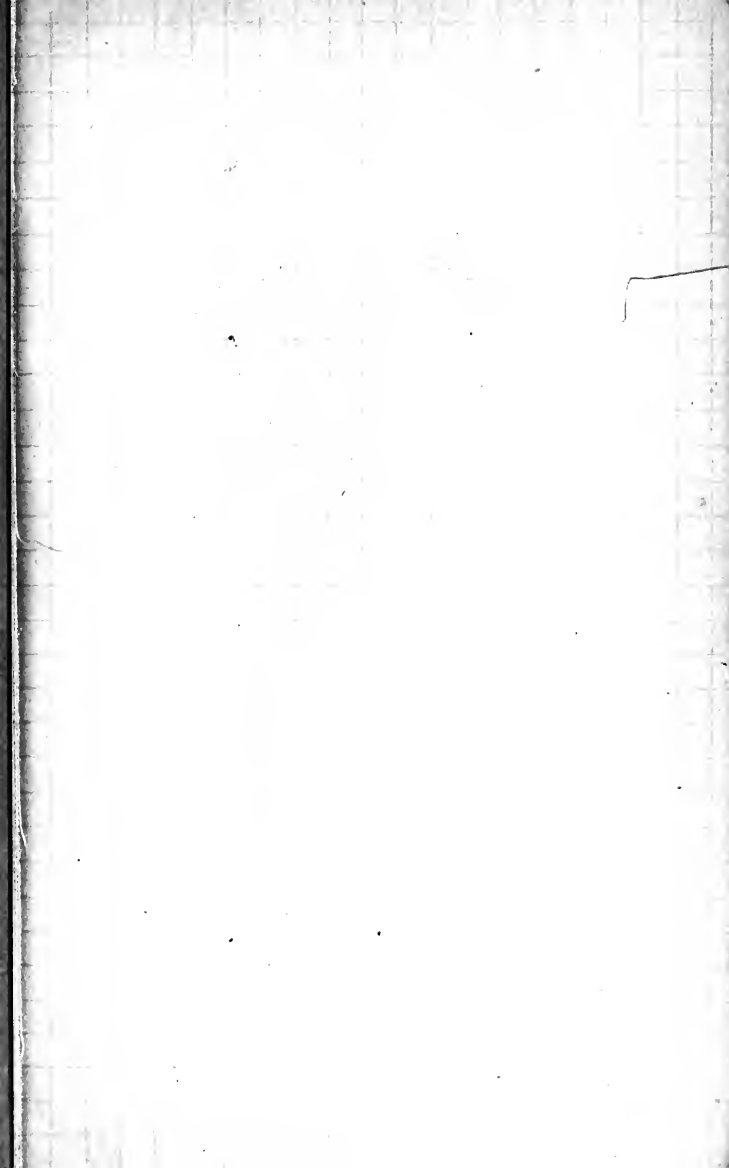

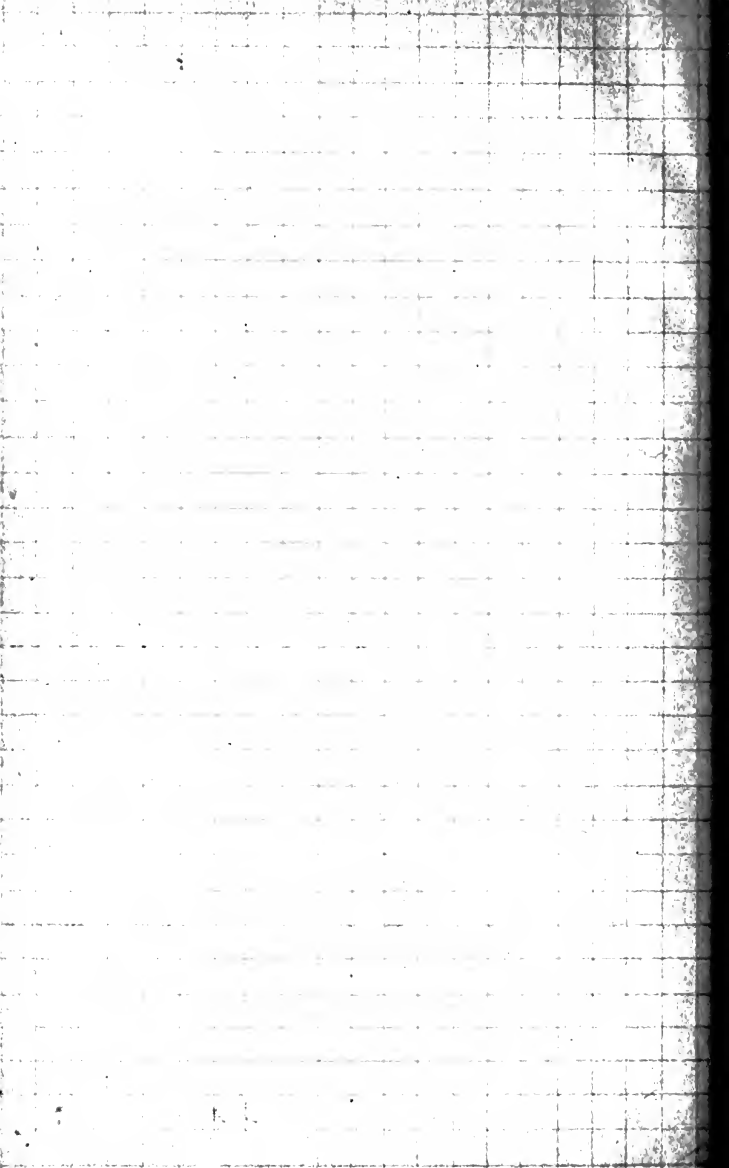

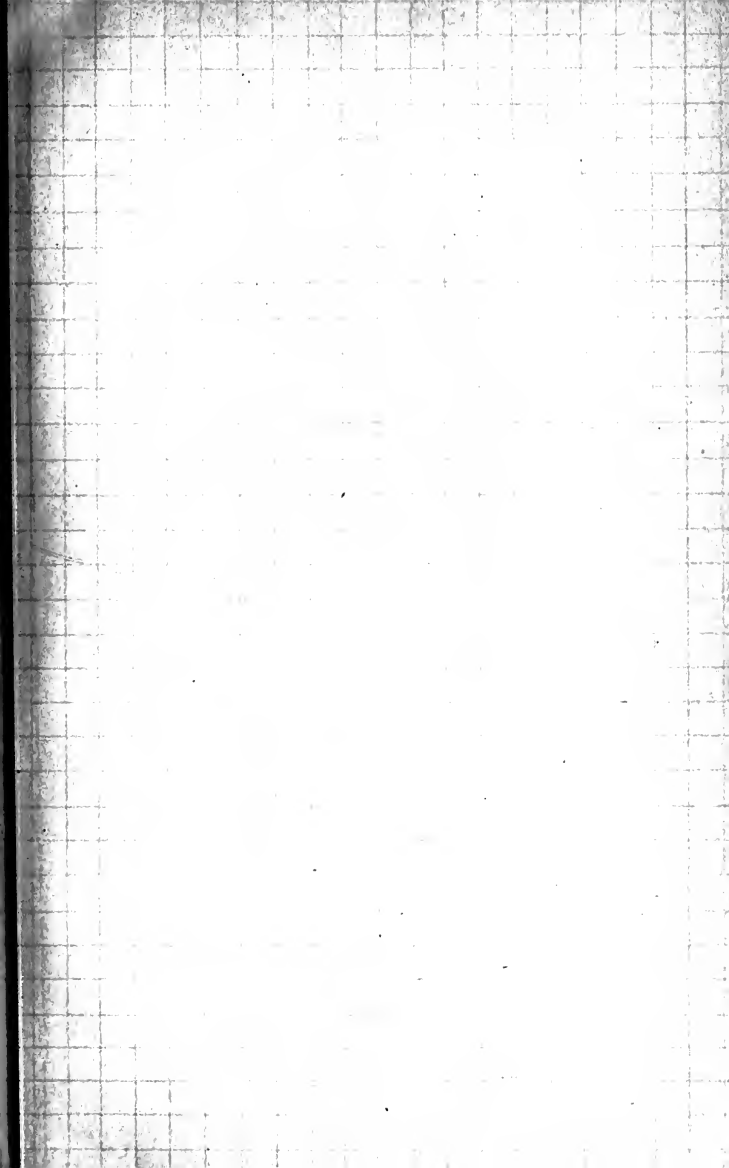

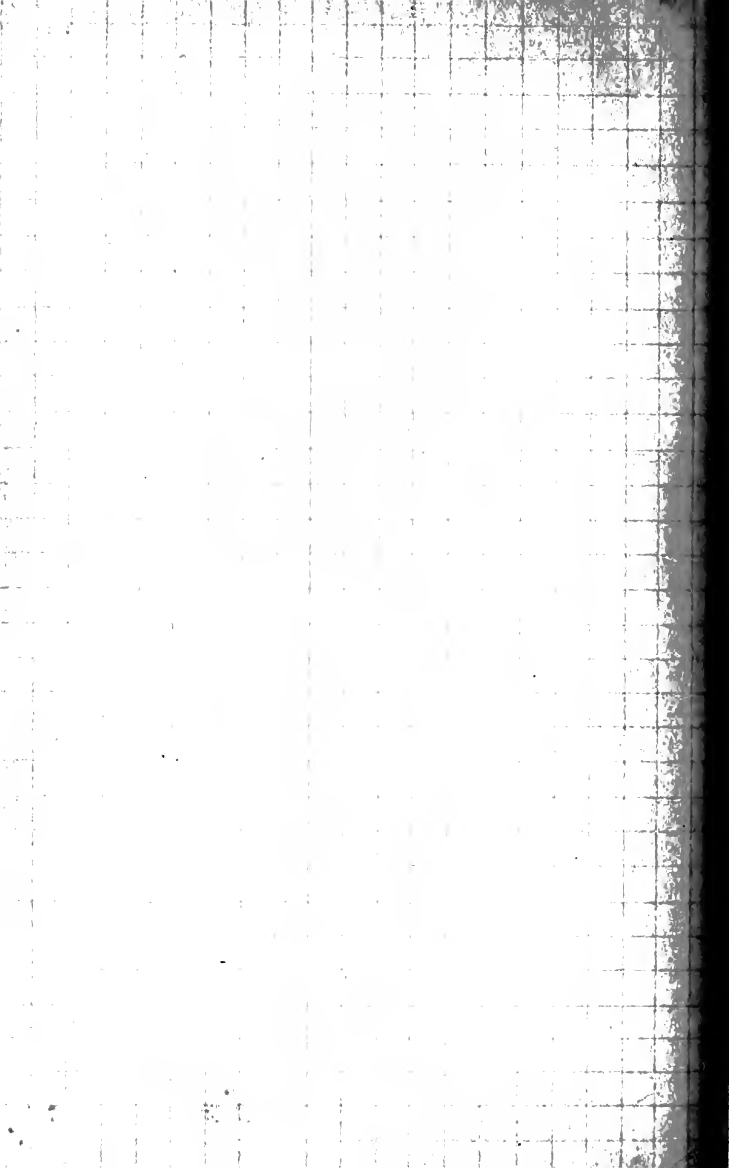

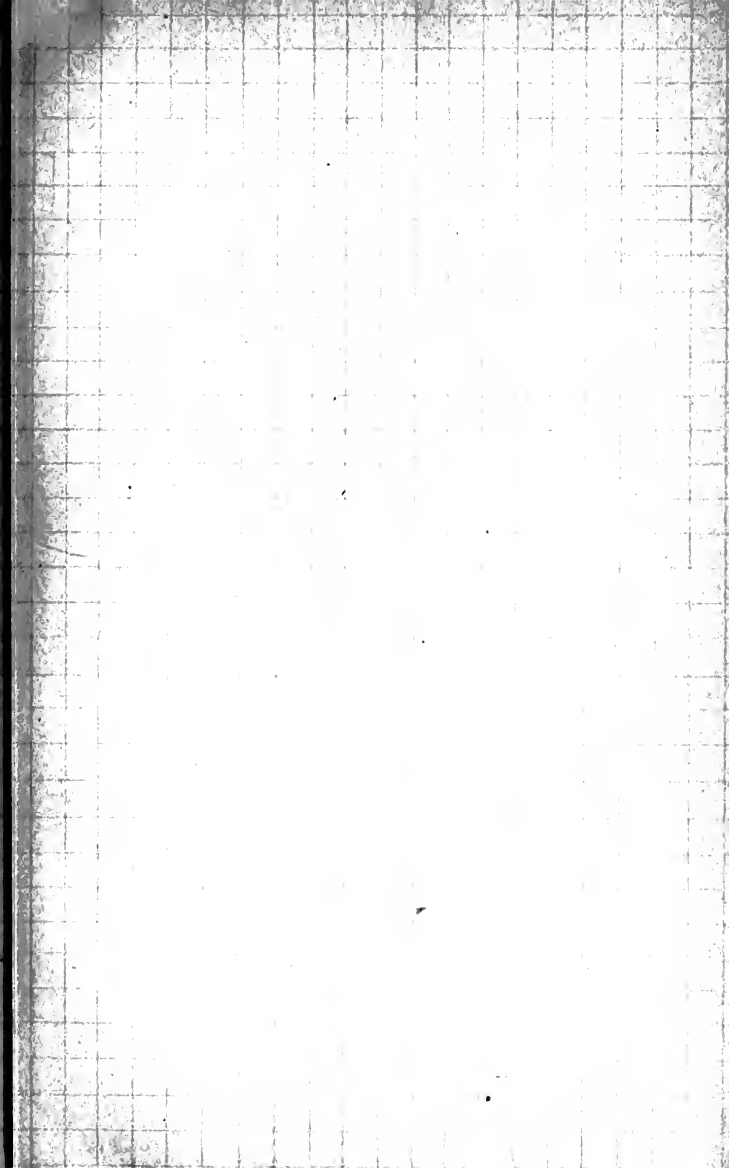

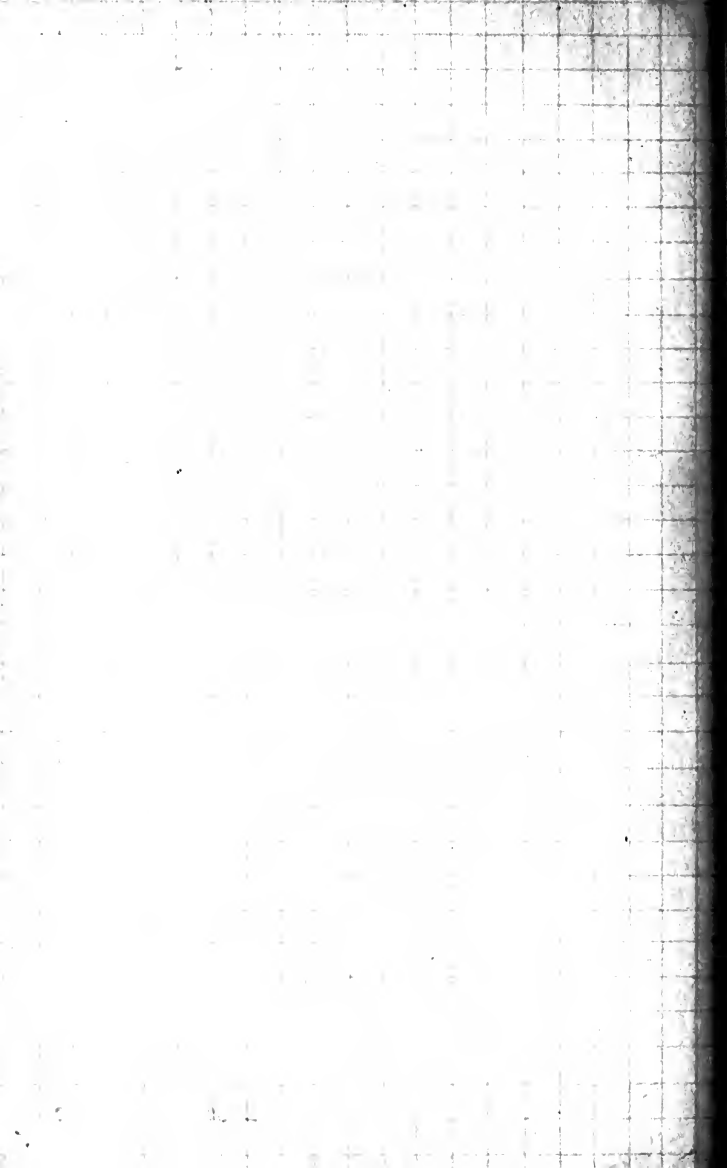

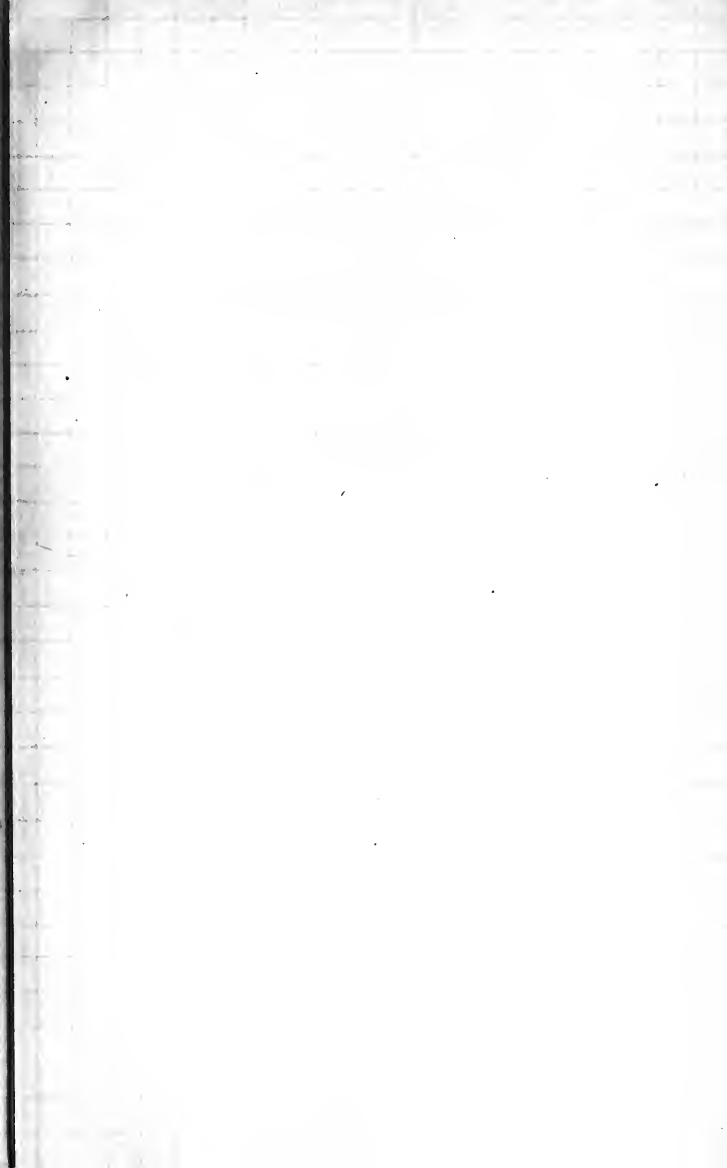

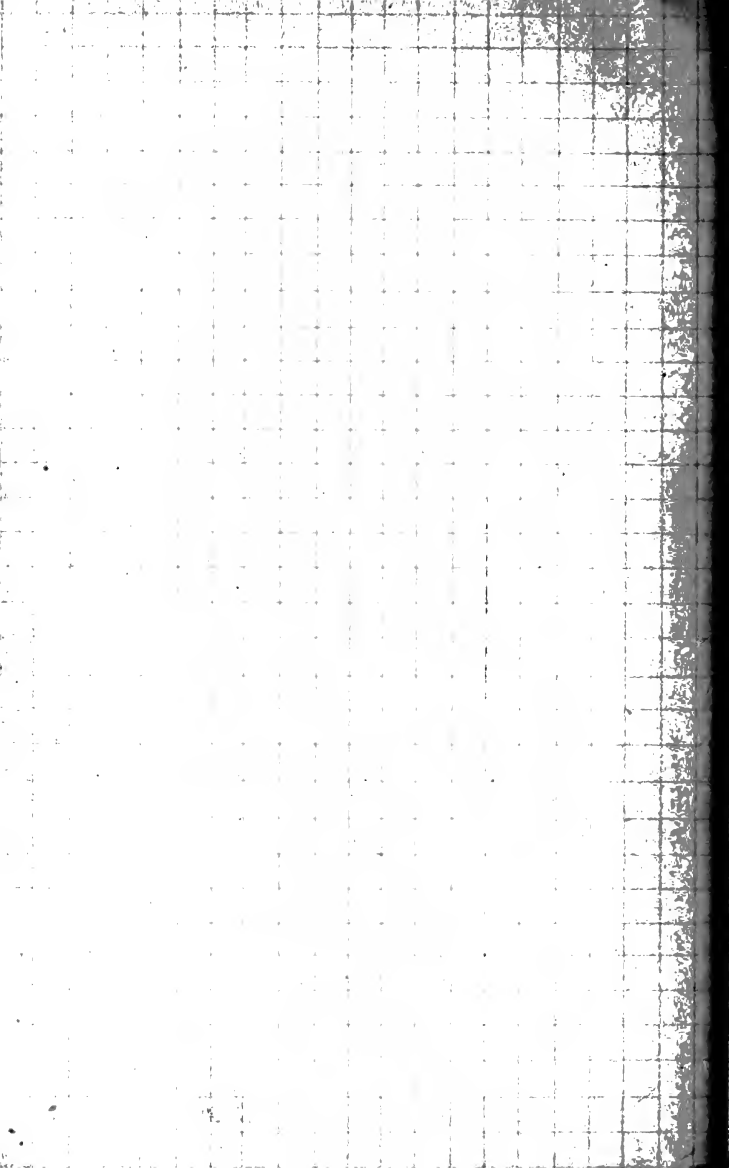

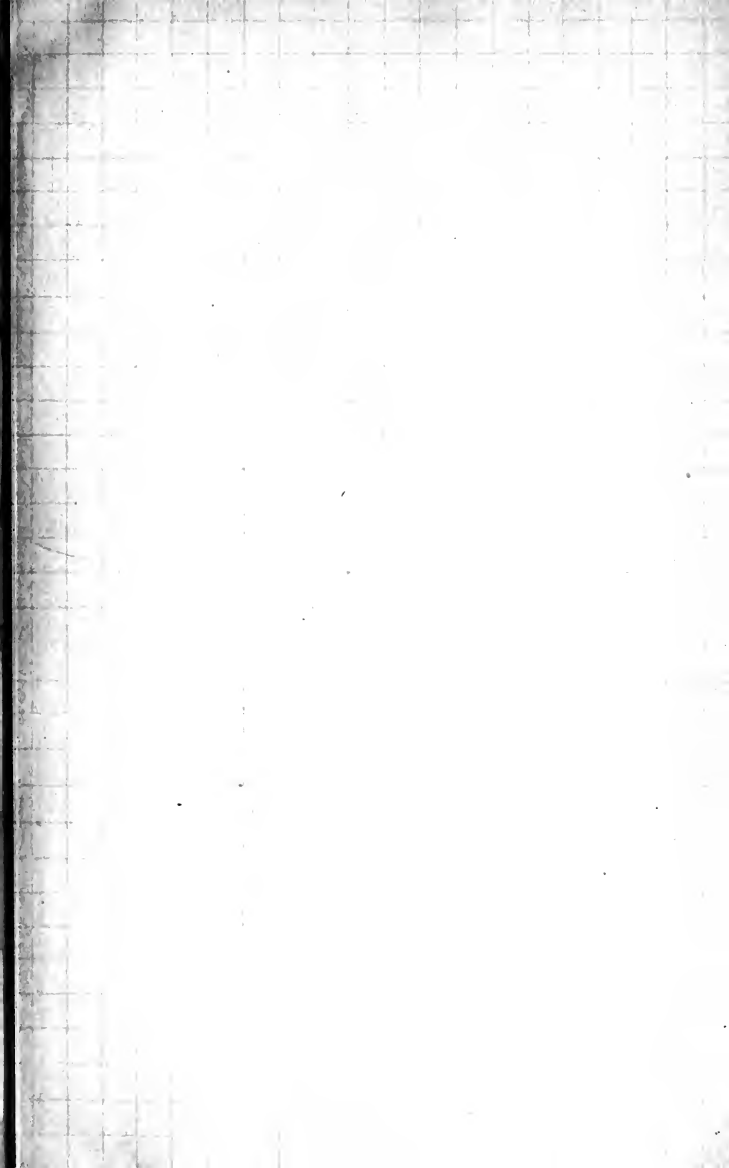

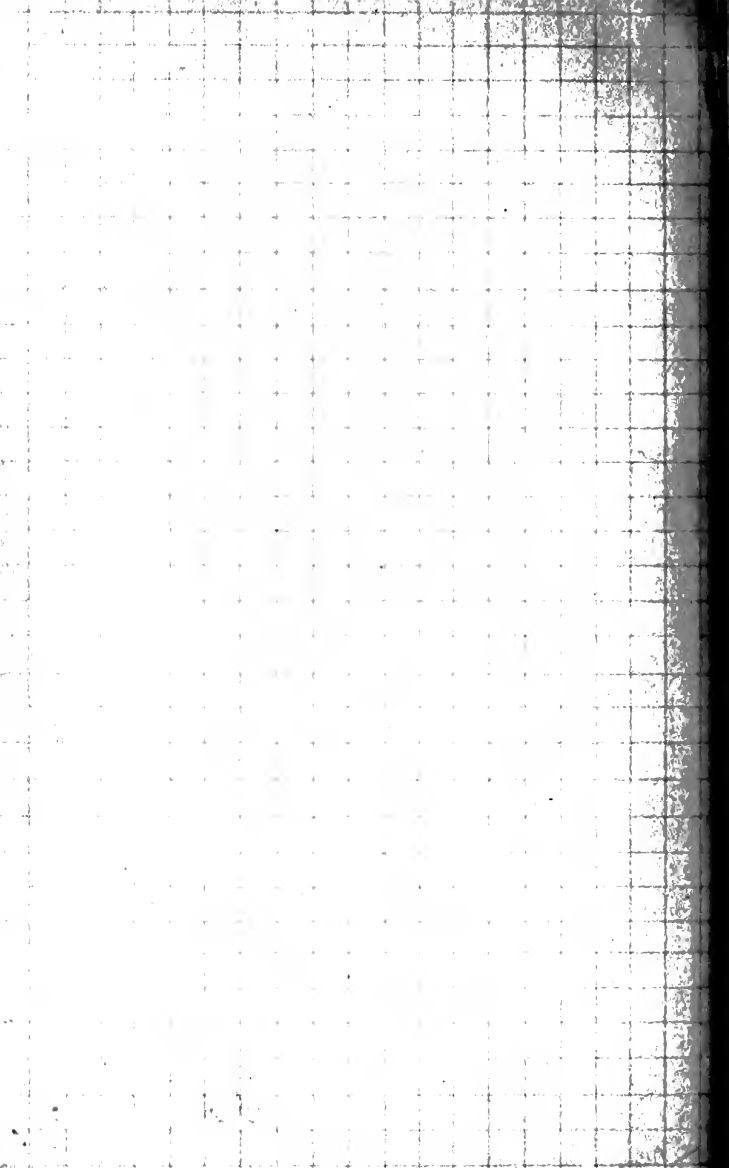

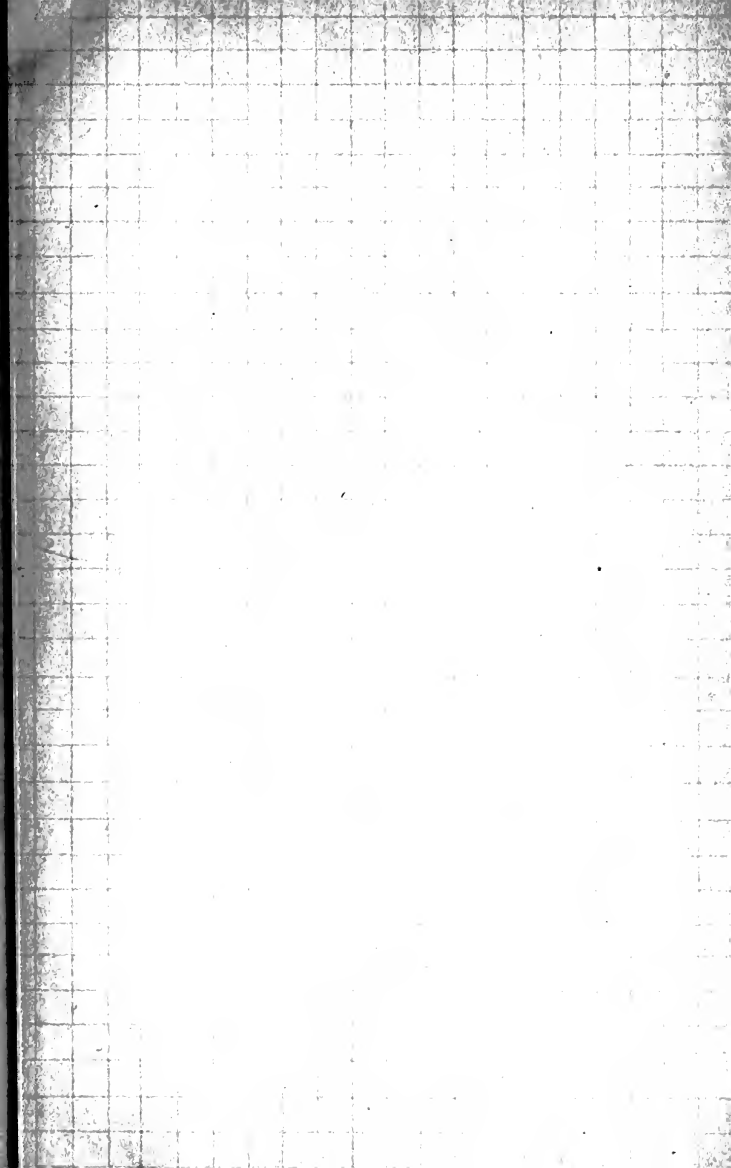

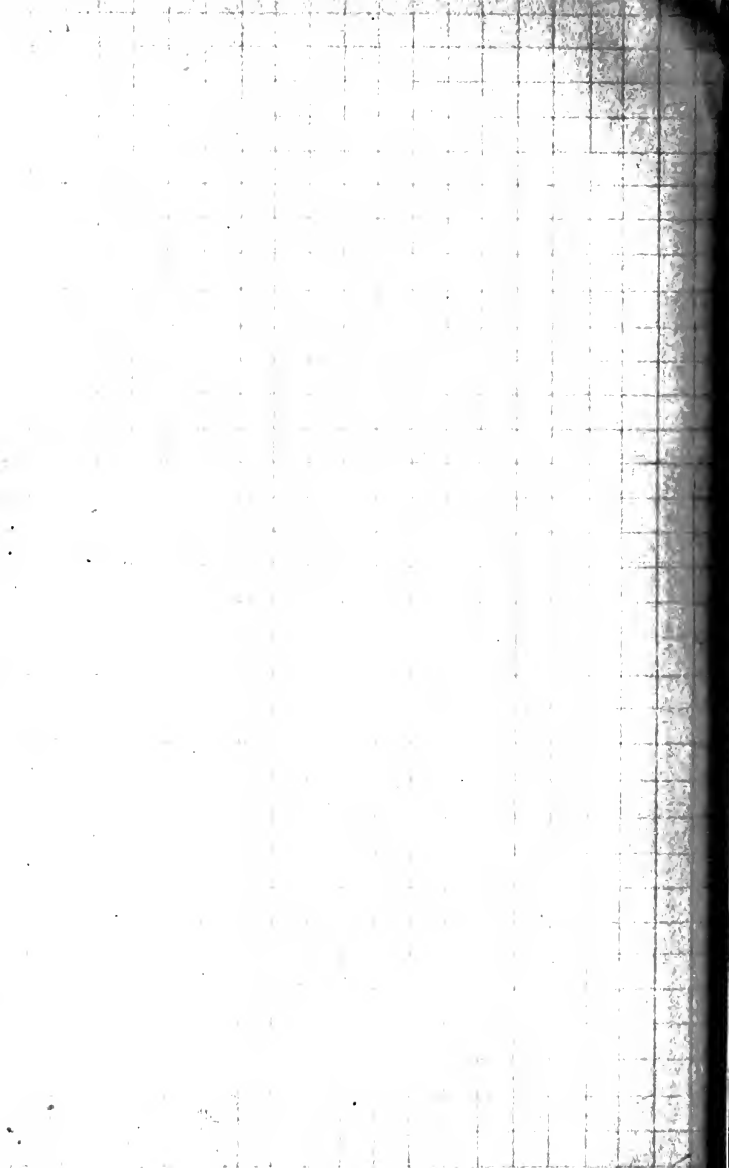

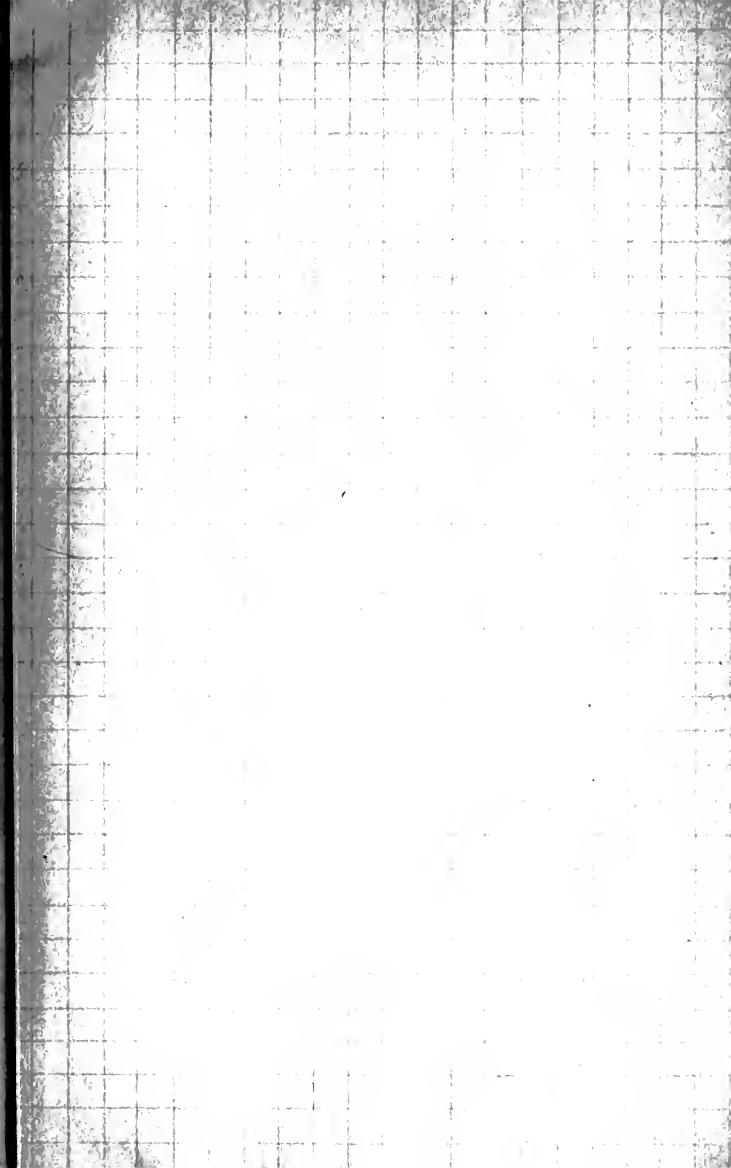

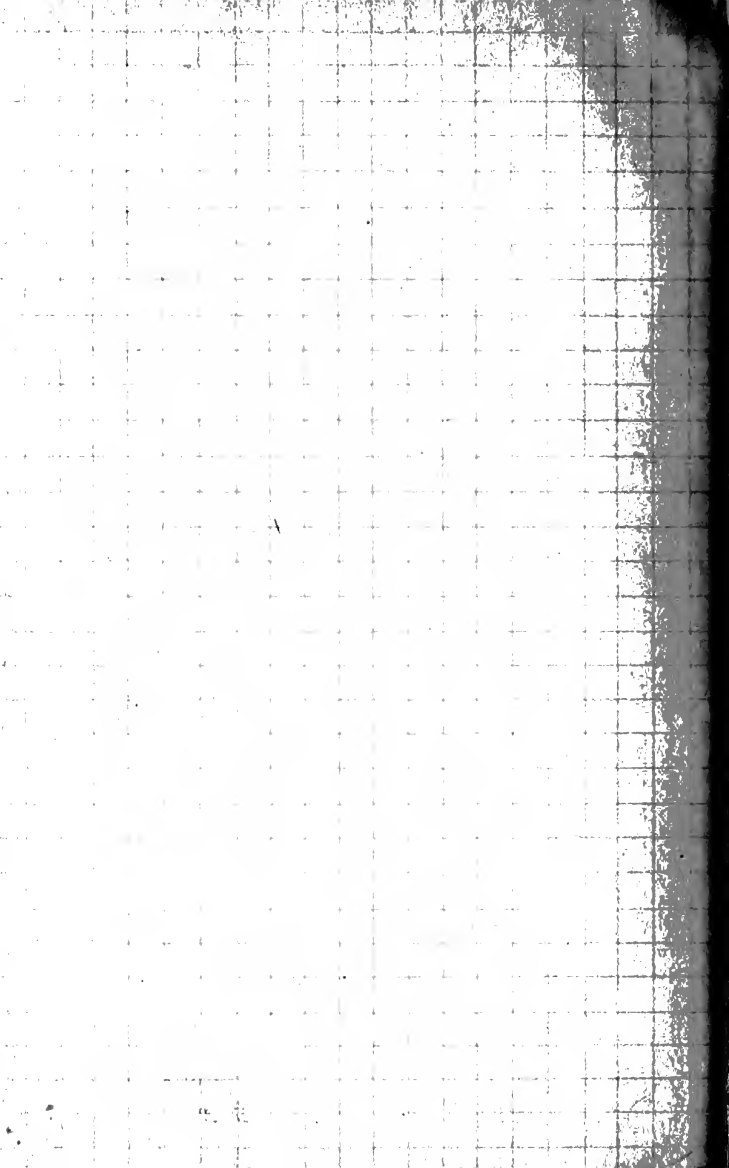



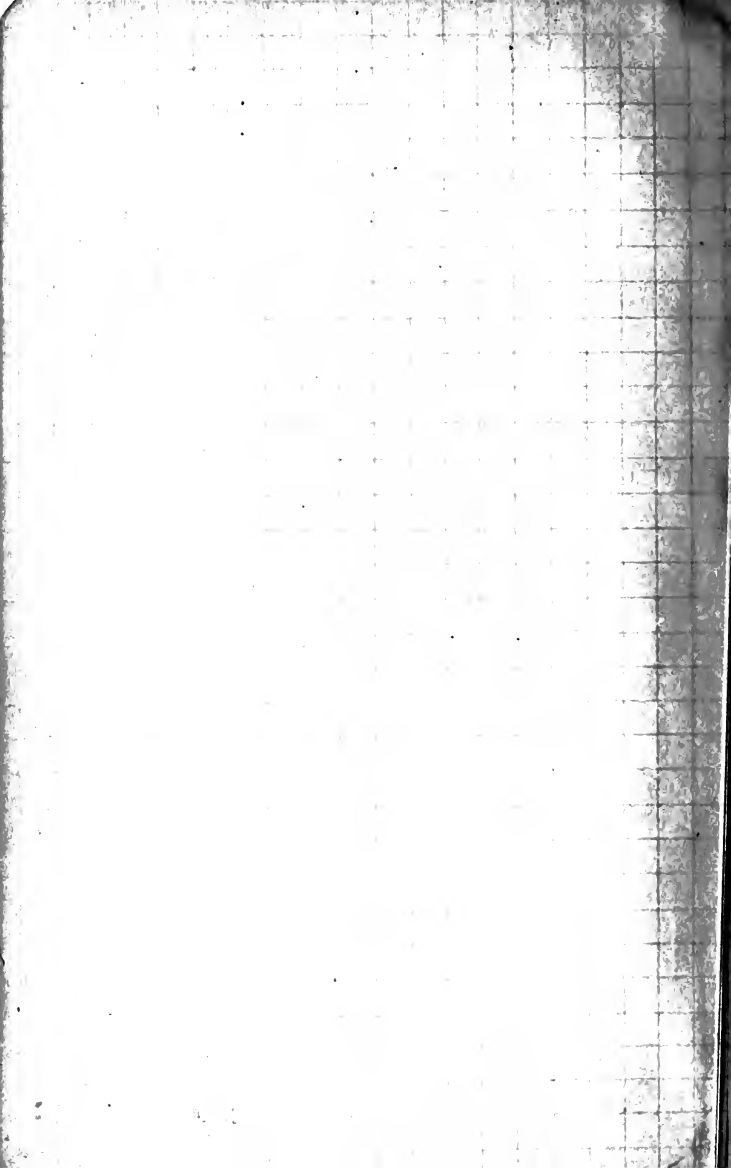

PLEASE DO NOT REMOVE
CARDS OR SLIPS FROM THIS POCKET

UNIVERSITY OF TORONTO LIBRARY

S&M
A
77

11

CONSOLIDATED STEEL CORPORATION
TORONTO, ONT.

CONSOLIDATED STEEL CORPORATION
TORONTO, ONT.

