

Historic, archived document

Do not assume content reflects current scientific knowledge, policies, or practices.

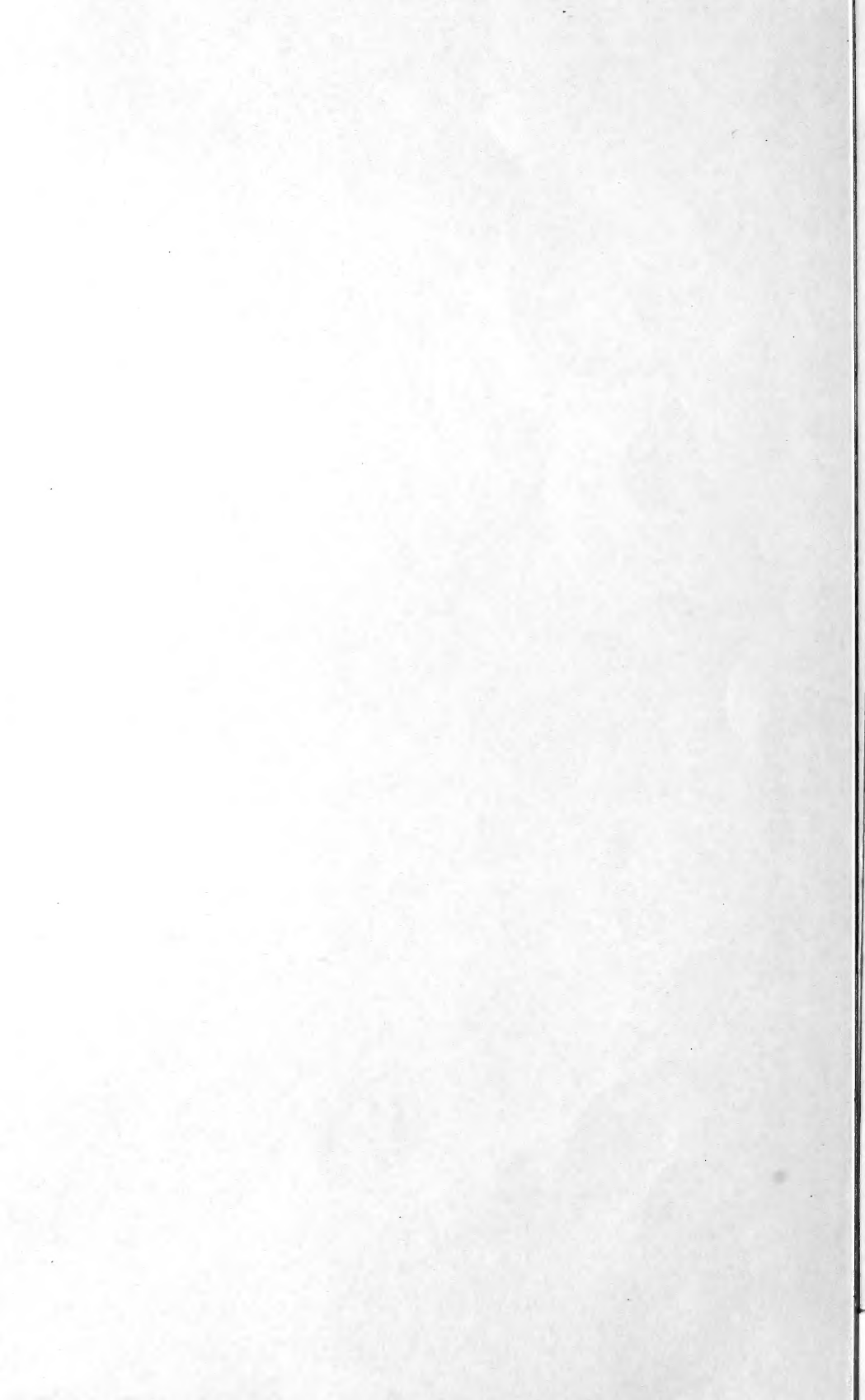

84711
Cop 5

Handbook on INSECT ENEMIES of FLOWERS and SHRUBS



Miscellaneous
Publication
No. 626

U. S. DEPARTMENT OF AGRICULTURE

HOW TO USE THIS BULLETIN

FAMILIARITY with the arrangement of this bulletin will aid in its use. The more common flowering and ornamental plants are arranged alphabetically in the section Insects Attacking Specific Plants (pp. 18 to 94), as indicated in the table of contents. Under each plant the pests most likely to attack it are mentioned, and either a discussion or a reference to a discussion elsewhere in this publication follows.

If the name of the insect or group of insects is known, consult the index at the end of the publication for the page reference. If the insect is not known, look under the name of the plant that is infested. From the descriptions of the insects and the nature of the injury which they cause, attempt to identify the pest responsible for the damage. The treatment and preventive measures suggested for control are given at the end of the discussion on each pest.

If the plant is not listed, or the discussion of the pest causing injury cannot be located, consult the section on insecticides (pp. 94 to 106) for general control measures. The materials used to combat insects, and methods for their preparation, are also discussed in this section.

Since this publication was prepared, DDT has become an outstanding insecticide. Therefore, a brief discussion of the preparation and possible uses of DDT for the control of certain insects has been included as an appendix.

This publication supersedes Farmers' Bulletin 1495, Insect Enemies of the Flower Garden.

UNITED STATES
DEPARTMENT OF AGRICULTURE
MISCELLANEOUS PUBLICATION NO. 626

Washington, D. C.

January 1948

HANDBOOK ON INSECT ENEMIES OF
FLOWERS AND SHRUBS

By
C. A. WEIGEL
and
L. G. BAUMHOFER



UNITED STATES
GOVERNMENT PRINTING OFFICE
WASHINGTON : 1948

PREFACE

THE garden program which the Government initiated during the war aimed to intensify farm and home vegetable gardening as a means of increasing the Nation's food production. This program has stimulated gardening of all types, and although the home gardener is still urged to continue producing vegetables, he is also interested in growing flowers and shrubs. With this widespread interest in home gardening has come greater consciousness of the damage caused by insects, and of the need for information on insect control if a satisfactory product is to be grown, whether it be vegetables or flowers. A greater popular demand on Government and State agencies has accordingly arisen for publications on garden insects and their control.

The information in this handbook should enable the gardener to recognize the common insect and related pests he may encounter in the flower garden and to apply the proper remedies, thus protecting not only his own plants but also those of his neighbors.

Flower-garden troubles are due to many causes, such as poor soil, unfavorable weather conditions, plant diseases, and attacks by insects. Plants in a healthy, vigorous condition are best able to withstand or outgrow light injury by insects. Consequently, it is important that the best horticultural practices be followed in regard to planting, watering, fertilizing, and cultivation.

CONTENTS

Page		Page	
How insects develop and feed.....	1	Insects attacking specific plants—	
General plant pests.....	2	Continued	
Cutworms.....	2	Hydrangea.....	52
Armyworms.....	3	Iris.....	52
Cabbage looper.....	3	Ivy.....	54
Yellow woolly bear.....	3	Juniper.....	55
Hornworms.....	4	Lilac.....	56
Greenhouse leaf tier.....	5	Marigold.....	58
Poisonous caterpillars.....	5	Morning-glory.....	59
Cucumber beetles.....	7	Mountain-laurel.....	60
Blister beetles.....	7	Narcissus.....	60
Flea beetles.....	8	Nasturtium.....	63
Grasshoppers and crickets.....	9	Palms.....	64
Aphids, or plant lice.....	9	Pansy.....	65
Leafhoppers.....	10	Peony.....	66
Red spiders, or spider mites.....	11	Petunia.....	67
Ants.....	12	Phlox.....	67
Termites.....	13	Pine.....	68
White grubs.....	14	Pittosporum.....	71
Wireworms.....	15	Privet.....	72
Slugs and snails.....	16	Rhododendron.....	73
Sowbugs, or pillbugs.....	17	Rose.....	74
Millipedes or "thousand- legged worms".....	17	Salvia.....	83
Earthworms.....	18	Snapdragon.....	83
Insects attacking specific plants.....	18	Spirea.....	83
Ageratum.....	18	Spruce.....	84
Arborvitae.....	19	Sweet pea.....	87
Aster.....	20	Tulip.....	87
Azalea.....	22	Verbena.....	88
Barberry.....	24	Viburnum.....	90
Boxwood.....	24	Violet.....	91
Calendula.....	25	Virginia creeper.....	91
Camellia.....	26	Waterlily.....	92
Canna.....	26	Yew, or Taxus.....	93
Chrysanthemum.....	27	Yucca.....	94
Clematis.....	30	Zinnia.....	94
Coleus.....	31	Insecticides.....	94
Columbine.....	32	Stomach poisons.....	95
Cosmos.....	34	Contact insecticides.....	97
Dahlia.....	34	Spreaders, wetters, and stickers.....	103
Delphinium.....	38	Fumigants.....	103
Dogwood.....	39	Table of measures.....	104
Euonymus.....	41	Where insecticides may be pur- chased.....	104
Ferns.....	42	When and how to apply insecti- cides.....	104
Gaillardia.....	43	Quantity of sprays or dusts to apply.....	105
Gardenia.....	43	Spraying and dusting equip- ment.....	106
Geranium.....	44	Sprayers.....	106
Gladiolus.....	45	Dusters.....	108
Goldenglow.....	46	Appendix (DDT-Insecticides)....	110
Hawthorn.....	46	Index.....	111
Hibiscus.....	48		
Holly.....	49		
Hollyhock.....	50		
Honeysuckle.....	51		

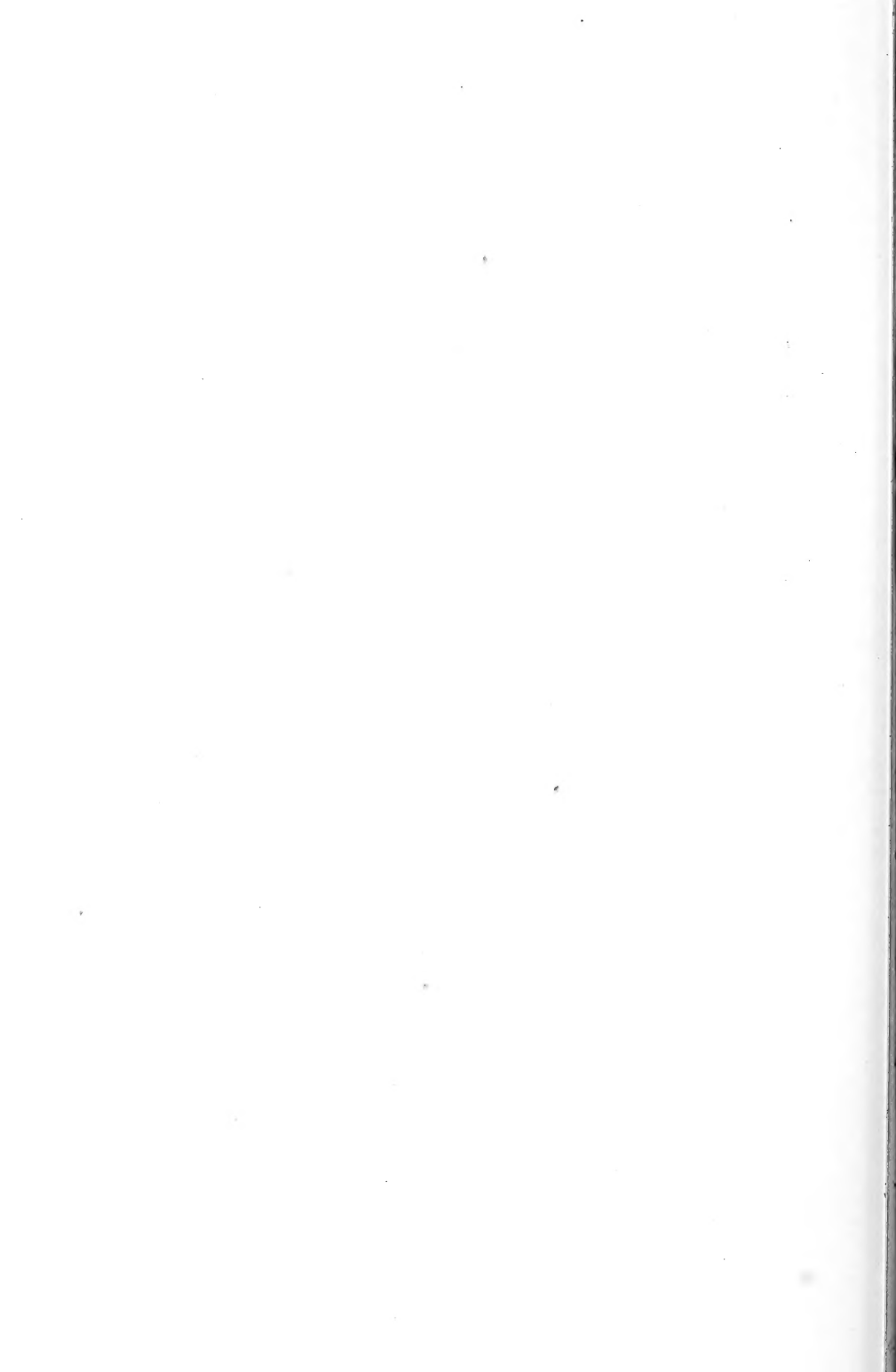

UNITED STATES
DEPARTMENT OF AGRICULTURE
MISCELLANEOUS PUBLICATION NO. 626

Washington, D. C.

Issued January 1948

HANDBOOK ON INSECT ENEMIES OF FLOWERS AND SHRUBS

By C. A. WEIGEL, *senior entomologist, Division of Truck Crop and Garden Insect Investigations*, and L. G. BAUMHOFER,¹ *associate entomologist, Division of Forest Insect Investigations, Bureau of Entomology and Plant Quarantine, Agricultural Research Administration.*

HOW INSECTS DEVELOP AND FEED

To combat insect pests successfully the gardener should know something about the manner in which they develop and feed. Insects normally hatch from eggs laid by the adult females. The adults are usually individuals with fully developed wings, although a few species of insects never have wings. Insects pass through several stages during their development. Plant lice, plant bugs, leafhoppers, thrips, and grasshoppers hatch from the egg in a form known as a nymph. The nymph resembles the full-grown insect, except that it lacks wings and is smaller. It sheds its skin periodically as it gradually increases in size. Moths, beetles, and flies, on the other hand, hatch from the egg as a wormlike form, or larva. The larva of a moth or butterfly is commonly called a caterpillar, the larva of a beetle is called a grub, and the larva of a fly is known as a maggot. After the larva has grown to full size, it changes to an inactive form, which is known as a pupa. From this pupa the adult insect emerges. The length of life varies greatly with different species of insects. Some develop from egg to adult in a few weeks, many require a full year, and a few take 2 or 3 years to reach maturity.

Insects are provided with either chewing or sucking mouth parts (fig. 1). The chewing insects bite off and swallow portions of the plant tissue. They may

devour the leaves or flowers, bore into the stems, or feed on the roots. Sucking insects have beaklike mouth parts, which are used for piercing the plant tissue and sucking the plant juices for food. This difference in the manner of feeding is important when control work is considered, since certain insecticides used to poison chewing insects will have no effect on sucking insects.



FIGURE 1.—A, Insect with chewing mouth parts; B, insect with sucking mouth parts.

Not all the insects encountered in the flower garden are injurious. A number of species help us by destroying injurious pests. These beneficial insects are generally divided into two groups—the predators and the true parasites. The predators prey upon and devour other insects. Examples of these are the praying mantis, ladybird beetles, certain ground beetles, assassin bugs, and the larvae of syrphid flies and lacewing flies. The larvae of parasitic insects live on, or within, the eggs or bodies of other insects, which they destroy. The

¹ Mr. Baumhofer died June 13, 1942; after his death R. A. St. George, Division of Forest Insect Investigations, assisted in revising the manuscript.

adults of most parasites are either tiny wasplike insects or small flies. These predatory and parasitic insects are among our best friends, since they aid materially in reducing the damage caused by injurious pests.

GENERAL PLANT PESTS

Although many insects attack only one crop or a group of related plants, some of them attack almost any kind of vegetation, including the various annuals, perennials, and shrubs. Some examples of these general feeders are discussed in this section. Also included here are the soil insects and other ground-inhabiting pests found around various kinds of plants.

CUTWORMS

Cutworms are caterpillars that are seldom seen because they usually remain hidden during the day under clods of earth or in the topsoil. In the evening they emerge and feed by cutting off small plants (fig. 2) at or near the ground



FIGURE 2.—Plant damaged by cutworm. Inset, spotted cutworm in curled position, about natural size.

line. They are specially destructive in the spring to growing plants in the seedbed and to small transplants that have just been set out. Cutworms attack a wide range of plants, including aster, carnation, dahlia, geranium, rose, zinnia, and many others. A few species climb such plants as chrysanthemums, dahlias, and sweet peas, and feed on the foliage or bore into the developing flower bud in much the same manner as the corn earworm (p. 29). Plants are usually ruined overnight or are fed upon to such an extent that they wither and die. A single cutworm can kill several plants in a night.

The cutworms are smooth, plump caterpillars, gray or brownish, and 1 to 2 inches in length when full grown. They hatch from eggs laid late in the summer by brownish moths. By late fall they are nearly full grown and bury themselves in the ground for protection during the winter.

Among the common species are the spotted cutworm (*Amathes c-nigrum* (L.)), the black cutworm (*Amathes ypsilon* (Rott.)), and the variegated cutworm (*Peridroma margaritosa* (Haw.)).

Treatment.—A poisoned bait, such as the one described below, scattered about the infested areas, is one of the best remedies.

	<i>Large quantities</i>	<i>Small quantities</i>
Sodium fluosilicate or paris green.....	4 ounces.	2 teaspoonfuls.
Dry wheat bran.....	1 peck or 5 pounds.	1 quart.
Water (to moisten) ..	3 to 4 quarts.	1 pint.

Mix the poison and dry bran thoroughly. Then moisten the mixture with water until each flake of bran has been wetted, using only enough liquid to make a crumbly mass. Prepare the bait in the morning to permit the bran to take up the arsenic, and apply it late in the day so that it will be moist and attractive when the cutworms begin to feed in the evening. Scatter the bait thinly over the ground or about the bases of the plants that have been set out. Repeat the treatment if necessary. One quart of the prepared bait is adequate for treating a garden 50 by 50 feet in size.

On soil which has been in sod, or which was weedy, the previous season, it is well to apply poison bait as insurance against cutworms, especially before setting out plants or before the plants appear above ground.

Caution.—As this bait is poisonous, children, livestock, and poultry should be kept away from it.

Where the bait is spread thinly over the ground, and not in the form of lumps, there is little danger of its being picked up by birds and pets in sufficient quantity to become poisoned. Any particles of the material which adhere to tender plants should be dislodged to avoid injury.

In small gardens hand picking is often effective. The cutworms usually may be found during the day in a curled position (fig. 2) just below the surface of the ground within 3 or 4 inches of the cut plants. Plants may be protected

by placing collars made of stiff cardboard, tar paper, or tin about them, inserting the base of the collar an inch or more into the soil, 2 inches above, and about $\frac{1}{2}$ inch from the plant stem.

ARMYWORMS

Armyworms are closely related to cutworms. These caterpillars derive their name from their habit of traveling in hordes, or "armies," in search of food. Infestations usually originate in the spring in fields of small grains, and when this food supply gives out the caterpillars move to adjacent areas. Gardens in their path are invaded, and all kinds of plants may be quickly stripped of their foliage and destroyed. The common armyworm (*Cirphis unipuncta* (Haw.)) is a widely distributed species, and at times other species may be encountered. The caterpillar (fig. 3) is dark green, marked with white stripes, and about $1\frac{1}{2}$ inches long. It hides under clods or litter during the day and feeds at night. The adult is a pale-brownish moth. This worm passes the winter as a partly grown larva.

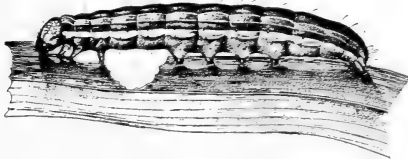

FIGURE 3.—Full-grown caterpillar, or larva, of the armyworm. About natural size.

Treatment.—Use the poisoned-bran mash recommended for cutworms (p. 2), or spray or dust the plants with lead arsenate.

Prevention.—For larger gardens or nurseries, the advancing worms may be stopped by digging a ditch with vertical sides for the worms to tumble into, where they can then be killed by dragging a log back and forth or by spraying them with kerosene.

CABBAGE LOOPER

The cabbage looper (*Trichoplusia ni* (Hbn.)) is an example of a caterpillar that feeds more or less exposed on the plant, in contrast to cutworms and borers, which are usually not seen. Although this species is chiefly a pest of cabbage, it is often found chewing irregular holes in the leaves and buds of carnation, chrysanthemum, mignon-

ette, geranium, German ivy, and many other flowering and ornamental plants. The cabbage looper derives its name from its preferred economic food plant and its curious looping or measuring movement (fig. 4) while crawling. The caterpillar is delicate pale green when first hatched. When full-grown it is about $1\frac{1}{2}$ inches in length and green with a white stripe along each side of its body. The adult is a medium-sized grayish-brown moth.



FIGURE 4.—Cabbage looper feeding on a leaf. About natural size.

Treatment.—The caterpillars can be poisoned by spraying or dusting the foliage with lead arsenate. Derris or cube dusts (p. 100) containing from 0.5 to 1 percent of rotenone give satisfactory control. Pure, fresh pyrethrum dusts (p. 98) containing 0.15 percent of total pyrethrins are also effective. Use the commercially prepared dusts of derris and pyrethrum according to the directions furnished by the manufacturer, because the dusts may vary in strength. Treatments with these dusts should begin when the worms first appear and be repeated as often as necessary to protect the plants. To reach the insects, dust thoroughly all infested parts of the plant.

Prevention.—Cleaning up and burning in the fall all crop remnants, and such weeds as mustard, shepherds-purse, and pepper grass that may be near the garden will aid in keeping down the number of worms.

YELLOW WOOLLY BEAR

The yellow woolly bear (*Diacrisia virginica* (F.)) is a hairy caterpillar that occurs throughout the United States.

It is a general feeder and may attack almost any kind of garden plant. It devours the leaves, tender stems, buds, and flowers, and imparts a ragged appearance to the plants. Among the many plants attacked are calendula, calla, canna, chrysanthemum, coleus, dahlia, fuchsia, hollyhock, moonflower, morning-glory, petunia, salvia, snapdragon, sunflower, verbena, and violet. The caterpillar (fig. 5) is about 2 inches long when full-grown and is covered with many long hairs, which are usually pale yellow, brownish yellow, or fox red and give the caterpillar its characteristic color and appearance. It is especially prevalent during July and August and overwinters in cocoons constructed from its wooly coat and silk, under loose shelters, such as trash, dead leaves, and clods of earth. Sometimes many cocoons, even 20 or 30, are made under the same shelter. The salt-marsh caterpillar (*Estigmene acrea* (Drury)) is also one of the wooly bears which may at times invade the flower garden and injure plants.

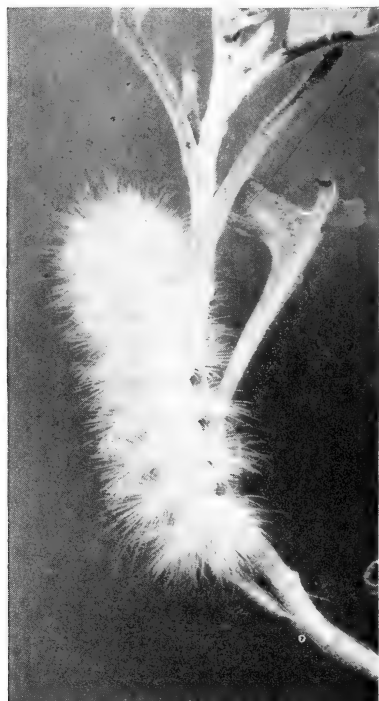

FIGURE 5.—A yellow woolly bear caterpillar feeding on chrysanthemum. Natural size.

Treatment.—Spray or dust with lead arsenate.

Prevention.—Destroy clusters of overwintering cocoons wherever they are found in sheltered places.

HORNWORMS

The hornworms commonly found feeding on the foliage of plants and shrubs are large caterpillars, 3 to 4 inches long when full-grown, with a short fleshy projection, or "horn," on top of the last body segment. The purpose of this horn is not known, but it is not poisonous. These caterpillars develop into sphinx or hawk moths, which in size and flight roughly resemble hummingbirds. The tobacco hornworm (*Protoparce sexta* (Johan.)) is usually pale green with oblique whitish stripes on each side of the body. The tomato hornworm (*Protoparce quinquemaculata* (Haw.)) is similar in appearance (fig. 6), but has a V-shaped marking on each body segment; it is most common in the Northern States. The white-lined sphinx (*Celerio lineata* (F.)) varies from green to blackish, with narrow broken lines on the back, and the head and horn are yellow or orange.



FIGURE 6.—Tomato hornworm. About one-half natural size.

Treatment.—Because of their large size the hornworms can easily be collected and killed. Their protective coloration often makes it difficult to see them when at rest, but they are more readily seen when feeding. The presence of small pellets of excrement on the ground or on leaves is good evidence of their presence.

Do not destroy any hornworm caterpillars that are covered with white objects on their backs, because these objects are the cocoons of parasitic insects that prey upon and kill the hornworms. Killing the parasitized caterpillar destroys the parasites also and thus prevents the continuation of their good work.

If a heavy infestation exists, dust or spray with lead arsenate. Derris or pyrethrum will usually be effective against the very young caterpillars.

GREENHOUSE LEAF TIER

The greenhouse leaf tier (*Phlyctaenia rubigalis* (Guen.)) is a good representative of a group of caterpillars that roll, fold, and tie together the leaves and terminal growths (fig. 7). It feeds on the inner surface of the folded leaves but may also eat into the buds and flowers. Although chiefly a greenhouse pest, it attacks also many flower-garden plants, including abutilon, ageratum, anemone, aster, canna, carnation, chrysanthemum, dahlia, forget-me-not, geranium, heliotrope, marigold, nasturtium, pansy, peony, rose, salvia, sweet pea, violet, and wallflower. When full-grown the yellowish-green caterpillars (fig. 7) are about $\frac{3}{4}$ inch long. The adult is a small tan-colored moth.



FIGURE 7.—Terminal leaves of aster folded and tied together by the greenhouse leaf tier. Inset, full-grown caterpillar, $1\frac{1}{4}$ times natural size.

Other species with similar habits, but discussed elsewhere, are listed in the index under "leaf tiers" and "leaf rollers." Similar remedies can be used for these related species.

Treatment.—Where only a few plants are infested the affected parts can be pinched off and destroyed. This often prevents an infestation from becoming serious. If a heavy infestation exists, dust the plants with a mixture consisting of equal parts of tobacco dust and pyrethrum powder (containing about 0.9 to 1.3 percent of pyrethrins). Make two successive applications, separated by an interval of

$\frac{1}{2}$ hour. The first one drives the caterpillars from their place of concealment, and the second one kills them. Another remedy is to spray with a combination of derris and pyrethrum prepared as given on page 99, or a commercial preparation of pyrethrum and rotenone. Make two applications 30 minutes apart. Spraying or dusting with lead arsenate when the infestation first starts is another means of control.

POISONOUS CATERpillARS

Although most caterpillars are not poisonous, those of several species have bodies provided with stiff hairs or spines that are somewhat poisonous. These spines may inflict a painful burning sensation when they come in contact with tender skin. Only certain hairs of the body are poisonous. These caterpillars occasionally feed on and injure certain garden plants, shrubs, and trees. The more common species are discussed in the paragraphs that follow.

Singing Rose Caterpillar

The stinging rose caterpillar (*Parasa indetermina* (Bvdl.)) is sluglike and feeds on rose leaves from the under side. It also attacks various low-growing bushes and trees, as dogwood, chestnut, oak, wild cherry, hickory, pawpaw, bayberry, plum, apple, and pear. It usually becomes full-grown in September, and overwinters in a dark-colored cocoon among leaves and other refuse on the ground. The mature caterpillar is about $\frac{3}{4}$ inch long. It is rather strikingly marked (fig. 8) with red, white, and violet stripes and seven pairs of large spine-bearing processes. The adult, a pale cinnamon-brown moth with wings branded with green and brown, appears and lays its eggs in July.

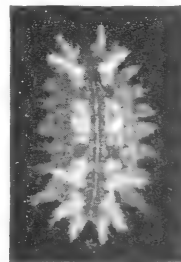

FIGURE 8.—Stinging rose caterpillar. About natural size.

Saddleback Caterpillar

The saddleback caterpillar (*Sibine stimulea* (Clem.)) attacks canna, dahlia, holly, lily, palm, rose, and other plants. When full-grown it is about an inch long. It is brown at each end, and the middle is green with a purple center, resembling a small saddle (fig. 9), whence the name. The moth is dark, velvety, reddish brown, with two white dots near the apex of the wings.

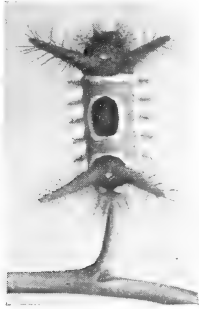

FIGURE 9.—Saddleback caterpillar. About natural size.

Hag Moth

The hag moth (*Phobetron pilhecium* (A. and S.)) has a brownish caterpillar about $\frac{3}{4}$ inch long. It is unusual in appearance, having plumelike processes extending from each side of the body (fig. 10). These are curved and twisted, suggesting the disheveled locks of a hag, and are clothed with stinging hairs. During the summer it is occasionally found feeding on the foliage of various shrubs and trees, but is seldom numerous enough to cause defoliation.

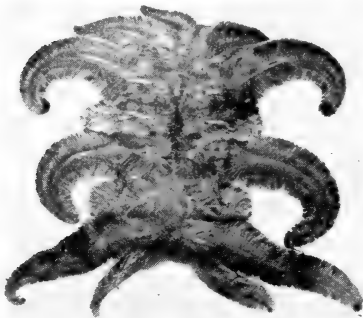

FIGURE 10.—Hag moth caterpillar. About $1\frac{1}{2}$ times natural size.

Crinkled Flannel Moth

The crinkled flannel moth (*Megalopyge crispata* (Pack.)) caterpillar (fig. 11) is thick and fleshy and from $\frac{3}{4}$ to 1 inch long when full-grown. It is covered with long, silky, brown hairs, which project upward to form a crest along the middle of the back. This species is commonly found in the Northern States, where it feeds on apple, bayberry, birch, cherry, locust, oak, raspberry, and sweetfern. The moth is cream-colored, with black and brownish markings on the wings.



FIGURE 11.—Flannel moth caterpillar. About natural size.

Puss Caterpillar

The puss caterpillar (*Megalopyge opercularis* (A. and S.)) is broad and flat and completely covered with long, silken, reddish-yellow hairs, and resembles the flannel moth caterpillar (fig. 11). It is about an inch long when full-grown. This caterpillar is found from Virginia to Texas. It is a general feeder, and occurs often on hackberry, maple, oak, and sycamore trees. It also has been found on roses and English ivy.

Treatment.—Spray the leaves with lead arsenate. Where only a few caterpillars are present, these may be picked by hand, but gloves should be worn as a protection against the stinging spines.

Prevention.—Clean up refuse around plants in the fall and burn it. Use clean straw or mulch if the plants must be protected.

CUCUMBER BEETLES

Spotted Cucumber Beetle

The spotted cucumber beetle (*Diabrotica undecimpunctata howardi* Barber) may be found destroying many plants grown in both flower and vegetable gardens. Among the flowering plants attacked are aster, calendula, canna, chrysanthemum, cosmos, dahlia, daisy, rose, sweet pea, zinnia, and several others. It feeds on the leaves, buds, and flowers, although its chief injury consists in eating holes in the blossom petals. If many beetles are present, their excrement may discolor the blossoms even when they do no other damage. This insect often causes serious damage in late summer or early fall, when many of its more favored host plants have matured or become unpalatable and the beetles have therefore migrated to asters, dahlias, and other late-season garden flowers. The beetles are about $\frac{1}{4}$ inch long, yellowish green, with 12 black spots on the wing covers (fig. 12). They pass the winter in the adult, or beetle, stage. The eggs are laid in the ground in the spring, and the larvae feed on the roots of various garden plants and weeds about a month before the adults emerge.



FIGURE 12.—The spotted cucumber beetle, and feeding injury and discolored areas on aster caused by it. About twice natural size.

Western Spotted Cucumber Beetle

The western spotted cucumber beetle (*Diabrotica undecimpunctata* Mann.), which is similar in appearance to the spotted cucumber beetle, attacks chrysanthemum, daisy, rose, and zinnia.

Striped Cucumber Beetle

Another species, the striped cucumber beetle (*Acalymma vittata* (F.)), eats holes in the leaves and flower petals of aster and rose. This beetle (fig. 13) is pale yellow, with three stripes on its wing covers.



FIGURE 13.—Striped cucumber beetle. About twice natural size.

Treatment.—Since these beetles are generally distributed and are likely to be a recurrent problem, they should be destroyed on the first evidence of injury to plants. Spraying with enough pyrethrum to wet the beetles is recommended. It is usually necessary to repeat the spray applications, since the beetles may continue to fly in from surrounding areas.

Dusting with eryolite (p. 97), rotenone (p. 99), or nicotine dust (p. 98), or with a mixture of 1 part of calcium arsenate and 15 parts of gypsum (land plaster) by weight once or twice a week, is also of value. Spraying with bordeaux mixture (p. 97) repels these beetles.

Prevention.—Choice plants and flowers, especially asters, dahlias, or roses, may be protected by covering them late in the summer with cheesecloth.

BLISTER BEETLES

Blister beetles are general feeders that chew and devour the foliage and flowers of many kinds of plants. At times the adult beetles occur in enormous numbers and often travel in swarms, devouring nearly all plants in their path. They usually appear about the middle of June and continue their feeding until early fall. They are about $\frac{3}{4}$ inch long, slender, rather soft-bodied, and of various colors. Some species are entirely black, some are brown or yellow with black stripes or spots, whereas

others are dark gray or gray spotted with black. The larvae, or grubs, live in the soil, but are not destructive to vegetation. They usually feed on egg masses of grasshoppers and crickets. The most common form is the black blister beetle (*Epicauta pennsylvanica* (Deg.)) (fig. 14, p. 8), sometimes called the aster bug because it is so destructive to asters. Other species are the striped blister beetle (*Epicauta vittata* (F.)) and the gray blister beetle (*Epicauta cinerea* (Forst.)).



FIGURE 14.—Adult of the black blister beetle. About $1\frac{1}{2}$ times natural size.

Treatment.—Blister beetles are difficult to control because they are so active that they are not easily covered with contact insecticides. Spraying with a combination of derris powder and pyrethrum extract (p. 99) kills such beetles as are actually hit by the spray. Arsenical sprays or dusts will repel the beetles and poison some of them. Dusting or spraying the plants with barium fluosilicate or cryolite (p. 97) is also useful. Where only a few plants are infested, hand picking often suffices, **but gloves should be worn because contact with the beetles may blister tender skin.** Knocking the beetles into a container holding a small quantity of water upon which kerosene or other oil has been poured is another means of killing them.

Prevention.—Valuable plants may be protected by covering them with cheesecloth or fine wire screen.

FLEA BEETLES

Flea beetles are general feeders and are frequently found on the foliage of flower-garden plants, where they gnaw small holes through the leaves from the

under side, giving the leaves a shot-hole appearance. At times, however, they eat only through the upper epidermis (fig. 15, *B*). The beetles are especially injurious to young seedlings. These insects derive their name from the fact that when disturbed they jump away in a manner resembling fleas, and they

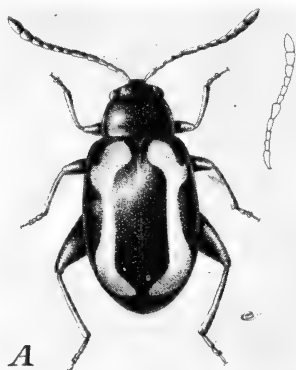

A



B

FIGURE 15.—A, Adult of the striped flea beetle, about 3 times natural size; B, holes eaten in the surface of a wallflower leaf by the striped flea beetle, natural size.

are provided with legs especially adapted for this purpose. Most of them are of a dark metallic color, but some are steel blue, and all are very small, usually not more than $\frac{1}{2}$ inch long. Several species are known to attack flowering plants. The potato flea beetle (*Epitrix cucumeris* Harr.) (p. 67) feeds on the leaves and flowers of petunia (fig. 111, p. 67). The striped flea beetle (*Phyllotreta vittata* (F.)) (fig. 15, A) and the western black flea beetle (*P. pusilla* Horn), although better known as pests of the truck garden, attack stock, wallflower, and alpine rock cress. The primrose flea beetle (*Altica marevagans* (Horn)) is metallic blue and is often abundant in both the larval and adult stages on evening primrose. The larvae, or grubs, of some species feed on the roots of the plant; whereas the larvae of other kinds feed along with the adults on the foliage and other parts of the plants above ground. Usually two or more generations of beetles are produced annually, and the adults pass the winter hidden in weeds, grass, and debris.

Treatment.—Dust thoroughly with a derris and tobacco-dust mixture containing 1 percent of rotenone (p. 97). Thorough applications of bordeaux mixture or a combination of lead arsenate and bordeaux mixture (p. 97), either as a spray or as a dust, are effective as repellents. Dusting with barium fluosilicate or cryolite (p. 97) is also useful. Begin treatment when the first evidence of injury appears in the spring and repeat the applications if necessary.

Prevention.—Protect seedlings and choice plants with cheesecloth or fine wire screen.

GRASSHOPPERS AND CRICKETS

Grasshoppers (fig. 16) and crickets frequently become a problem in iris beds or the flower garden generally, eating foliage, flowers, and tender growth. Attacks may occur at almost any time during the growing season. Grasshoppers often migrate into flower beds from adjoining vacant lots or grassy fields, where the eggs were laid in the ground the previous fall.

Treatment.—Apply the poisoned-bran bait recommended for cutworms (p. 2), scattering it thinly over the surface of infested areas in the form of flakes. For grasshoppers this bait should be applied on a sunny morning when the temperature is between 70° and 80° F., since this is when the grasshoppers are on the ground and starting



FIGURE 16.—Grasshopper feeding on leaves of a plant. About natural size.

to feed. After the bait has dried out it is no longer attractive. Baiting is most effective in the spring soon after the young grasshoppers appear, and two or more applications at this time may be necessary. Where fields surrounding gardens are infested, it may be necessary to bait them to protect the gardens. For best results against crickets the bait should be spread late in the day, since crickets remain hidden during sunshiny days and do most of their feeding late in the afternoon and at night.

Prevention.—Deep spading of the soil and turning it under or plowing and disking adjacent grass and weed land in the fall will bury or expose many of the eggs and prevent them from hatching the following spring.

APHIDS, OR PLANT LICE

Aphids, or plant lice, infest all sorts of plants, including annuals, perennials, and shrubs. They feed by sucking the plant juices. Although they do not usually kill plants they frequently reduce plant vigor, curl or distort the leaves, harden the buds, or cause malformation of the flowers. Aphids move about somewhat, but they are rather sluggish and are usually found in

colonies or clusters (fig. 17) on the new growth, at the base of buds, or on the under sides of the leaves. Infested plants are often visited by large numbers of ants and other insects that feed upon the honeydew excreted by the aphids. Honeydew is a sweet, sticky, liquid excretion which often coats the leaves or objects below the aphids, giving them a sticky or varnished appearance, or a sooty appearance as a result of a sooty mold developing on the honeydew.



FIGURE 17.—Colony of aphids clustered on an ivy stem. About $1\frac{1}{2}$ times natural size.

Aphids are soft-bodied, whitish or greenish to blackish insects with pear-shaped or nearly globular bodies, and they have three pairs of comparatively long legs (fig. 18). They are usually not over $\frac{1}{8}$ inch in length, and many species are smaller. Most of them are

without protective covering, although the bodies of some of the woolly aphids are covered with white waxy threads. The rate of development and multiplication is rapid, and many generations may be produced in a season. Both winged and wingless forms are produced; the winged forms migrate to start new colonies either on the same type of plant, or, with some species, on an entirely different, or secondary, host plant. Several successive generations may consist almost entirely of wingless females, but when they become crowded or the time for migration comes, winged forms are produced. The young are either hatched from eggs or born alive.



FIGURE 18.—Stages of the melon aphid (*Aphis gossypii* Glov.): a, Winged adult; b, wingless adult. About 10 times natural size.

Certain species of aphids attack the roots of asters (p. 21) and various other plants, whereas other species attack the bulbs of tulip, iris, crocus, and other flowering bulbs (p. 87).

Treatment.—On the first evidence of aphids or their injury, spray or dust the infested plants with nicotine sulfate, derris, or pyrethrum. Strong soapsuds, made of fish-oil soap or other soaps dissolved in water, is also an effective spray. Be sure that the insecticide covers the insects. Several applications about a week apart may be required. Do not delay treatment; otherwise the plants may be seriously damaged. Syringing infested plants with water under considerable pressure, and directing the stream to the under sides of the leaves from several angles to dislodge the insects that are congregated there, is useful in the case of shrubs and hardier plants, but is too severe a treatment for tender annuals or perennials.

LEAFHOPPERS

Leafhoppers are small sucking insects which may injure plants in various ways. The draining of the plant juices may cause a whitening and curling of the leaves and killing of the tender tips, as

in the case of the rose leafhopper (p. 80). The potato leafhopper (p. 35) causes a dying of the edges of dahlia and other leaves which is called hopperburn (fig. 19). Some species transmit certain plant diseases; for example, the aster leafhopper (p. 20) transmits the virus of aster yellows from diseased to healthy plants.



FIGURE 19.—Hopperburn injury on leaves caused by leafhoppers. Inset, adult and nymphs of the potato leafhopper, about 6 times natural size.

Leafhoppers are slender, delicate insects, usually $\frac{1}{8}$ inch or less in length. They vary in color from brown to pale green. They are very active and have the habit of hopping a considerable distance when disturbed. The eggs are laid in the leaf tissue or stalks, and two or more broods may occur annually. Aster, calendula, dahlia, gladiolus, hollyhock, marigold, rose, and zinnia are among the many plants that are commonly attacked.

Treatment.—Dusting once a week with a mixture of 9 parts of dusting sulfur and 1 part of pyrethrum powder (containing at least 0.9 percent of pyrethrins) by weight is one of the most effective measures, especially on aster leafhopper. Pyrethrum applied as a spray is also useful. Nicotine sulfate as a spray or dust may also be used. Bordeaux mixture applied at frequent intervals serves as a repellent.

Prevention.—Burn over all weed patches in early spring before the insects can reach the garden plants, wherever such measures are practical and the burning can be done without danger of the fire spreading.

RED SPIDERS, OR SPIDER MITES

Among the most persistent of the general plant-feeding pests are the spider mites, especially the two-spotted spider mite (*Tetranychus bimaculatus* Harvey) (fig. 20). These minute animals are not

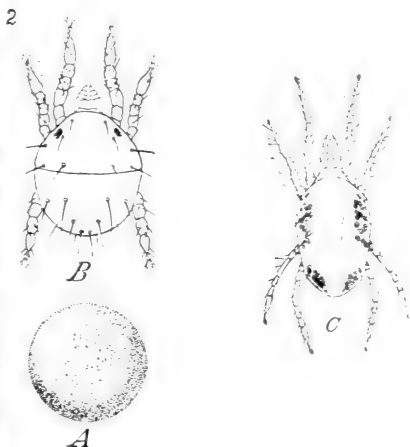

FIGURE 20.—Stages of the two-spotted spider mite: A, Egg; B, newly hatched nymph, having three pairs of legs; C, adult, having four pairs of legs. About 25 times natural size.

really insects, but are relatives of the spiders. Their injury to plants, however, is similar to that caused by sucking insects. Spider mites feed by sucking juices from the leaves and other tender plant tissue. Their attack causes paling or browning of the foliage, which on close examination resembles stippling. Sometimes the infested parts of the plant are covered with fine webbing (fig. 21), and in heavy infestations the mites can be found gathering in swarms on the under sides of leaves or running over the webbing which they spin. If the infestation is light there may be little or no webbing, and some species do not spin a web. The individual mites are so small that they can scarcely be seen with the naked eye. Although the living mites are not always found on injured plant specimens, their whitish shed skins and globular eggs or eggshells are usually present and visible under a lens. If these are numerous, this evidence is usually sufficient to identify the cause of the poor health of the plants.

The red spider spends the winter in protected places, as among the buds or

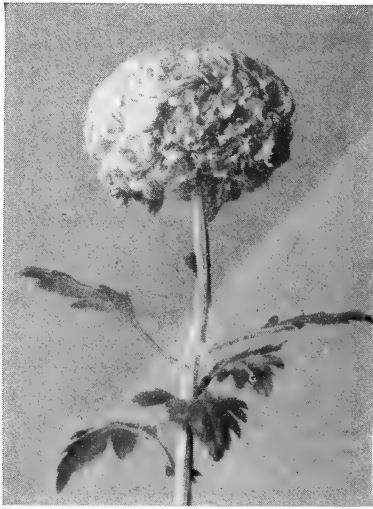

FIGURE 21.—Webbing spun by the two-spotted spider mite on a chrysanthemum plant.

crowns of various perennials and weeds, and attacks the new growth as soon as it starts in the spring. Certain other species hibernate in the egg stage on the bark and under the bud scales of various trees and shrubs which they infest.

Treatment.—Spraying with a combination of derris and sulfonated castor oil (p. 99) is very effective. The thiocyanate sprays are also satisfactory, but they should be followed by syringing with water an hour or two after application to avoid injury, especially on young and tender plants. White-oil emulsions used as directed by the manufacturer will give good control and may be used on the hardier plants. Dusting with dusting sulfur is effective during the summer, but in extremely hot weather it may burn the leaves of tender plants. Several applications of the insecticide selected are usually necessary and should be made with an interval of a week or 10 days between treatments. Frequent syringing or washing with a stream of water applied with force from several angles is of considerable value but should not be depended on for complete control.

Prevention.—Cleaning up the garden is the first step to be practiced, including the gathering of all litter, old leaves, weeds, and dead, dying, or heavily infested plants, and burning them. This is especially true for the common red spider, which overwinters

in the litter and in the crowns and buds of various host plants. Much damage can be prevented if such clean-up measures are carried out and if treatments are started early in the spring on the first evidence of red spider injury.

Glues are recommended by some authorities as a safe spray for use on most plants, particularly evergreens which are subject to injury where dormant oils or sulfur sprays are applied. A spray may be prepared by dissolving 1 pound of cabinetmaker's glue in 10 gallons of water.

ANTS

Ants are frequently annoying and occasionally injurious in flower gardens. Sometimes they damage plants by nesting among the roots and exposing them to drying. Some ants may also steal newly planted seeds. Sometimes they are injurious through colonizing and protecting aphids, mealybugs, and certain scale insects. Often, however, they are merely annoying, being attracted to plants by the presence of aphids or other sucking insects which are excreting quantities of honeydew, a liquid much sought after by ants and other insects as food. Ants are also attracted by souring sap from tree and plant wounds, and by sweet secretions of certain parts of plants, such as the flower buds of peonies.

Treatment and prevention.—When honeydew is responsible for the presence of ants, the insects supplying this material should be combated. Spraying the infested portions with a nicotine sulfate and soap solution or a strong pyrethrum spray is of considerable value. Where wounds or hollows are the attraction the infested plants should be destroyed, or in the case of woody shrubs the wounds should be cleaned and protected by a thin coating of shellac, white-lead paint, or grafting wax.

Ants are difficult to control, and no entirely satisfactory remedy is available that will serve under all conditions and for all species. Several methods of control are therefore suggested. Permanent control depends upon locating the nest and destroying the colony therein, especially the reproductive forms and the young. These forms are located deeply within the nest, and if they are not killed the trouble will occur again. When the nests are in the soil of the lawn or garden, the individual anthills or infested area should be treated with carbon disulfide, according

to the directions given on page 103. Undiluted derris or cube powder (containing 4 to 5 percent of rotenone) is often effective when placed or blown into the entrance holes or applied in an unbroken ring around the anthills. Several applications may be necessary, especially if rains occur within a day or two after treatment.

In small lawn areas ants that like sweet materials can sometimes be controlled by broadcasting a mixture consisting of 1 pound of brown sugar and 1 ounce of paris green. This mixture should be scattered thinly so that there will be no danger of animals picking up lumps of the bait. One pound of this mixture is sufficient for two treatments of 10,000 square feet of lawn. The second treatment, if necessary, should be applied after an interval of 10 days.

Poisoned-sirup baits are effective in combating certain species of ants, especially when choicer foods are scarce. The worker ants will feed on the sirup, carry it back to the nest, and feed it to the queens and the young and in this way poison the colony. No one bait can be depended on to destroy all kinds of ants. Some ants like only sweets, whereas others eat only meats and grease. Poisoned-sirup baits must be carefully prepared in clean utensils or the ants may not eat them. If a bait is too strong with poison the worker ants may detect the poison before the queens get a toxic dose, and discard the bait before it has had an appreciable effect upon the colony. It is therefore most satisfactory to purchase one of the ready-prepared ant baits sold by reliable dealers and to follow the directions given on the package. If the bait is to be prepared at home the active ingredients should be purchased from a druggist in the exact quantities to be used.

The following mixture is used against the cornfield ant (*Lasius niger alienus americanus* Emery): Dissolve 4 ounces of sugar in 1 quart of water and then add $\frac{1}{2}$ ounce (14 grams) of tartar emetic. Another bait is made by dissolving $\frac{1}{2}$ pound of sugar in a pint of hot water and adding 62.5 grains (4 grams) of disodium arsenate. This mixture should be brought to a slow boil and strained. Small pieces of sponge or blotting paper may be saturated with the poisoned sirup and distributed about the infested places, with an inverted flowerpot or other shelter placed over them. A small quantity of the sirup can also be put in a covered tin can or paraffined pill

box, the cover or sides of which should be perforated with large holes so that the ants may easily reach the bait. If pieces of sponge are placed in the containers so that they come in contact with the sides, the ants will find easier access to the poison.

For ants that will not eat sweets but prefer grease and meat, use a bait made up by working small quantities of tartar emetic with grease or pieces of bacon rind. Put small quantities in shallow tins and place them about the ant runways.

The Argentine ant (*Iridomyrmex humilis* Mayr), which occurs throughout the Southern States and in parts of California, is very destructive. It is best controlled, by a campaign conducted by the communities affected, by using the poisoned bait discussed below. The bait is placed in perforated tins or waxed containers, and a few cans are attached to the foundations of buildings or trunks of trees on the premises. The bait is prepared as follows: (1) Mix 9 pounds of granulated sugar, 93 grains (6 grams) of crystallized tartaric acid, and 130 grains (8.4 grams) of sodium benzoate in 9 pints of water; boil the mixture slowly for 30 minutes and allow it to cool. (2) Dissolve 231 grains (15 grams) of sodium arsenite (c. p.) in $\frac{1}{2}$ pint of hot water and allow it to cool. Add (2) to (1) and stir well, then add $1\frac{1}{4}$ pounds of strained honey and mix thoroughly.

Caution.—Since tartar emetic, sodium arsenite, and disodium arsenate are poisonous, children and domestic animals must not be allowed access to them.

TERMITES

Occasionally termites work in the roots of living plants, hollowing them out and extending their burrows up into the stems. These plants wither and die. Although the stems may be honey-combed, there is usually no external evidence of termite work above ground because the outer surface of the stem is left intact. These termites are subterranean in habit, living in colonies in the soil. They normally feed on dead or decaying wood, such as old roots, stumps, logs, dead trees, stakes, and other wood or dead vegetable matter in, or in contact with, the ground. When termites are numerous in the soil and this type of food becomes scarce, they may attack living roots of trees, shrubs, and flowering plants, especially those of a more woody type. They may also enter plants through dead or

dying roots or through wounds near the ground line.

The worker termites (fig. 22) are whitish, soft-bodied, wingless insects, about $\frac{1}{4}$ inch long. They are sometimes called white ants, although not related to the true ants. These whitish workers are never seen in the open, but can usually be found in the infested wood or plant stems and in their tunnels in the adjacent soil. In the spring the reproductive forms, which are black with whitish wings (fig. 23, A), swarm from the old nest and migrate to start new colonies. Flying ants are often mistaken for these winged termites. The ants, however, are distinguished by having the middle of the body thin or constricted, like a wasp, whereas the termite body is about the same width throughout. The wings of ants are usually not much longer than the body, the hind wings being much smaller than the front wings, whereas the wings of the termites are about twice as long as the body, and both pairs are of the same size (compare A and B in fig. 23).

Treatment.—No entirely satisfac-



FIGURE 22.—Lily stem cut open to show worker termites. About twice natural size.



FIGURE 23.—A, Winged adult termite; B, winged adult ant. About twice natural size.

tory method is known for the control of termites in living plants. The following treatments, however, will aid in reducing the termite population in the soil: Remove and dispose of all infested wood and infested and dying plants. Remove all old wood and accumulations of dead vegetable matter from the soil in and adjacent to the garden or near other infested shrubs or trees, since such material is often the main source of infestation. In addition, where termites are numerous, the soil may be fumigated with carbon disulfide (p. 103), as suggested for white grubs, to reduce the population. Several treatments may be necessary during the season if the termites continue to multiply. Avoid the use of manure or compost while termites are present in the soil, since such materials serve as additional food. Chemical fertilizers may be substituted. Deep spading or deep cultivation is of value in disturbing termite tunnels.

Prevention.—Keep the soil free of old wood, to discourage termites from multiplying. Scraps of lumber or wooden forms from building construction should not be left buried in the soil next to the house, since this wood makes a favorable place for termite development near the foundation plantings. The soil near the house should be well drained, since low, wet areas are suitable places for termites to start colonies. If wooden stakes or supports are being damaged by termites, substitute metal stakes. Creosoted stakes or those treated with a 5-percent solution of pentachlorophenol are resistant to attack, but to avoid root injury by these chemicals they should not be placed in contact with the plant roots.

WHITE GRUBS

White grubs (fig. 24), the immature forms of May beetles (*Phyllophaga* spp.) or "June bugs," live in the soil and sometimes injure plants by feeding upon the roots or underground parts. Other grubs similar in appearance and causing the same type of injury are the green June beetle (*Cotinis nitida* (L.)) and the Japanese beetle (*Popillia japonica* Newm.) (p. 48). Annual larkspur and phlox, aster, chrysanthemum, dahlia, geranium, gladiolus, hyacinth, iris, privet, rose, violet, and nursery stock are among the plants attacked. The grubs often feed also on the roots of grass on lawns and golf courses, causing the grass to die. The adult May beetles, during their spring flight, eat the leaves of certain trees and shrubs, and if numerous may cause defoliation.



FIGURE 24.—A white grub, the larva of a May beetle. Twice natural size.

Treatment.—White grubs are often a pest in ground which has been in sod for several years and which is being planted for the first time. Generally the practice of turning the soil in late summer or early fall or carefully working it during the spring, and killing such grubs as are found, is helpful in ridding the flower garden of grubs.

When the infestation is heavy enough to warrant treatment, undiluted carbon disulfide may be used as recommended on page 103. Another method, especially useful on small areas of lawn or garden, consists of treating them with a carbon disulfide emulsion prepared and applied according to the directions given on page 104.

Grubs in the lawn may also be killed by applying lead arsenate to the turf at the rate of 1 pound to 100 square feet of area. To obtain a more uniform distribution, it should be mixed with sand or dry soil at the rate of 1 pound of lead arsenate to 1 peck of sand or dry soil and then broadcast over the surface. Lead arsenate, however, is likely to injure young plants for several seasons following application; consequently, it is not advisable to apply it to soil in the flower garden.

WIREWORMS

Wireworms, as their name implies, are slender larvae (fig. 25) with cylindrical, wiry, smooth, shiny bodies. They grow to about an inch in length, usually requiring more than one season to develop, and are pale yellow to brown. Wireworms feed on the roots of pansies and asters and burrow into corms, bulbs, tubers, and the fleshy

underground parts of plants. They are often found partially buried in these feeding burrows. The adults are slender, brown to black beetles about $\frac{1}{2}$ inch long, and are known as click beetles.

Treatment.—Fertilizing to increase plant vigor will lessen the seriousness of injury due to wireworms. Deep plowing in midsummer is helpful. In small plantings the wireworms may be collected during spading operations and killed. In case of a heavy, persistent infestation a new piece of ground should be selected for planting. Whenever possible avoid planting susceptible crops in sod lands or other soils infested with wireworms.

The soil may be fumigated with carbon disulfide as described under "Fumigants" or with crude naphthalene. If naphthalene is used it should almost come in contact with the wireworms to be effective. The naphthalene should be thoroughly mixed with the soil to a depth of 7 to 12 inches late in the spring or early in the summer, when the wireworms are nearest the soil surface. Best results have been obtained by spreading 2 ounces to every 10 square feet of soil surface, 1 ounce before disking and plowing and the second ounce after plowing but before a second disking. In small areas the first ounce may be chopped into the soil with a hoe before spading. The second ounce may then be applied after spading and raked into the soil.



FIGURE 25.—Wireworms. About twice natural size.

SLUGS AND SNAILS

Garden slugs (fig. 26) and snails (fig. 27) are injurious to flower-garden plants, especially in damp and shady areas. They feed at night, eating large, ragged holes in the leaves (fig. 28), and devouring completely young seedlings grown in cold frames or hotbeds. Slugs are soft, slimy creatures, black, gray, or brown, and often spotted with black. They look like snails without shells, and leave a slimy trail wherever they have crawled. Some species are as much as 5 to 6 inches long. During the day they hide under stones, old boards, or other debris, although they venture forth on dark or damp days.

Treatment.—Distribute, after sundown, a poisoned bait prepared by mixing about $\frac{1}{2}$ ounce (4 gm.) of metaldehyde with 8 ounces of wheat bran (or 1 ounce of metaldehyde to $3\frac{1}{2}$ pounds of bran) and adding enough water to make a mash of such a consistency that it will scatter in fine particles but not in lumps. Make up the mash several hours before applying it, so that the bran will take up the poison.

After eating metaldehyde baits, the slugs become stupefied and finally die. Where vegetation is dense and humidity is high, the affected snails are killed more slowly or they may recover. The following bait containing calcium arsenate and metaldehyde is then more effective.

	For small quantities	For large quantities
Calcium arsenate.....	1 ounce.	1 pound.
Metaldehyde.....	$\frac{1}{2}$ ounce.	$\frac{1}{2}$ pound.
Bran.....	1 pound.	16 pounds.
Molasses.....	2 teaspoonfuls.	1 pint.
Water.....	1 pint.	2 gallons.

In situations where no domestic or farm animals have access to the bait, apply it in piles of about a tablespoonful each, spaced about 2 feet apart; otherwise scatter it in the infested area as recommended for applying poisoned-bran bait (p. 2). Unless washed away by watering or rains, it remains effective for some time, and baiting two or three times during the year gives adequate control. Ready-mixed baits containing calcium arsenate and metaldehyde are available on the market.

Caution.—Since metaldehyde may cause poisoning when taken internally, the containers should be plainly labeled "poison" and kept out of reach of children and others.

The poisoned-bran bait recommended for cutworms (p. 2) is also fairly



FIGURE 26.—Garden slugs. Natural size.

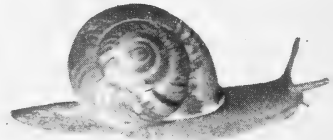

FIGURE 27.—White-lipped snail. About natural size.



FIGURE 28.—Snail injury to tender iris growth.

effective, and it may be used if the metaldehyde bait is not readily available.

Prevention.—Since slugs and snails conceal themselves during daytime under boards, stones, and other debris, all materials which may serve as hiding places should be removed and the infested area dusted liberally with air-slacked lime. The masses of translucent, yellowish eggs found in dark and damp places should be collected and destroyed.

SOWBUGS, OR PILLBUGS

Sowbugs, or pillbugs, are about $\frac{1}{2}$ inch long, dark gray, and oval. On being exposed to light most species are very active, although some forms roll themselves up into the shape of a round pill (fig. 29) upon the least disturbance, and from this action the name "pillbug" is derived. Sowbugs are not true insects. Their flattened bodies have about seven pairs of legs. Their usual abode is under some shelter, such as decayed boards or flowerpots, in decayed manure, or in any other dark place where decomposition is in progress. They may feed on the roots and tender portions of plants, especially carnation and sweet pea.

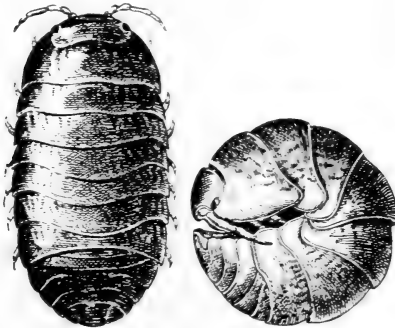

FIGURE 29.—The greenhouse pillbug: Left, extended; right, contracted. About 3 times natural size.

Treatment.—Sprinkle the surface of the soil lightly with a dry mixture consisting of 9 parts of sugar and 1 part of paris green, or with the poisoned-bran mash as directed for cutworms (p. 2). A similar remedy, which may be applied in the same manner, consists of 2 parts of wheat flour, 2 parts of sugar, and 1 part of paris green. To prevent leaf injury, avoid putting the bait on the foliage. Dry tobacco dust is very effective as a repellent. Spraying the infested soil with a nicotine sulfate and

soap solution or a strong pyrethrum spray will kill those actually hit by the spray.

Prevention.—Destroy the hiding places of sowbugs by cleaning up and disposing of all refuse.

MILLIPEDES, OR "THOUSAND-LEGGED WORMS"

Millipedes, or "thousand-legged worms," are not insects, which never have more than six true legs. Millipedes are brown or grayish, hard-shelled, wormlike creatures (fig. 30), which hide beneath stones, boards, and other debris during the day. When disturbed, they crawl away rapidly. They live principally in the soil in damp places that afford abundant decaying organic matter, such as manure. Millipedes sometimes bore into the roots, tubers, bulbs, and fleshy stems of plants. They also eat planted seeds and occasionally leaves or fruits that touch the ground.



FIGURE 30.—Millipedes. Twice natural size.

Treatment.—Poisoned baits are effective means of control. Sliced potatoes, apples, or turnips, rolled in dry paris green and placed about the infested beds, have proved efficient. **Precautions should be taken, however, to see that the poisoned baits will not be picked up by children or domestic animals.** Sprinkling the surface of the soil lightly with a dry mixture consisting of 9 parts of sugar and 1 part of dry paris green is also effective. Avoid

getting any of the mixture on the foliage of the plants, for it will cause burning. Drenching the infested areas with a strong pyrethrum solution is useful.

Prevention.—Rake up all dead leaves and other decaying vegetation, and remove stones, boards, or other materials under which millipedes may hide.

EARTHWORMS

The soil of pots and flower beds often becomes overstocked with earthworms, in some instances causing injury to the plants. The worms may be brought in with the soil or manure, and they breed rapidly under favorable conditions. Their habit of tunneling through the fine root systems is often damaging and destructive to the plants.

Treatment.—Bichloride of mercury (corrosive sublimate) is a good remedy. It is prepared for use by dissolving $\frac{1}{2}$ ounce in 4 gallons of water, and applied by saturating the infested soil. The worms usually come to the surface within a few minutes after the application and should be gathered and disposed of immediately to avoid any danger of poisoning birds that might feed on them. **Since this chemical is a deadly poison and may seriously burn the skin when undiluted, extreme care should be taken in preparing and handling it. It corrodes metals, and should preferably be prepared in a glass or glazed vessel, which should be thoroughly cleaned immediately after use.**

A saturated limewater applied to the soil freely is also of value. About 2 cupsful of unslaked lime placed in a 2-gallon bucket of water, thoroughly agitated and allowed to settle, will furnish the desired clear liquid. This should not be used around azaleas, rhododendrons, or other acid-loving plants. Tobacco dust thoroughly worked into the soil will prove effective also, and at the same time may have some value as a fertilizer.

INSECTS ATTACKING SPECIFIC PLANTS

In this section the discussion of the insects is presented under the specific plant, or host, on which they are likely to occur. The plants are arranged alphabetically. When a pest has been discussed elsewhere in the bulletin, reference is made to the page where the information is given.

Space limitations prevent including a discussion or even a list of the many kinds of plants that are used in home surroundings or the flower garden.

However, many of the annual and perennial plants are subject to injury by the same insects, that is, the general feeders which attack a wide range of plants. Some of the more common of these, as well as the soil pests, are discussed in the preceding section on General Plant Pests, pages 2 to 18. For plants not included in this bulletin, therefore, the discussions in that section and in the section on Insecticides, pages 94 to 104, will be useful for obtaining information on the control of various kinds of insects and related pests that may occur on such plants.

AGERATUM

Greenhouse Whitefly

The greenhouse whitefly (*Trialeurodes vaporariorum* (Westw.)) feeds in both the immature and adult stages by sucking the plant juices. Heavy feeding gives the infested leaves a mottled appearance or causes them to turn yellow and die. The sticky honeydew liquid excreted by the insect often glazes the lower leaves and permits the development of black sooty mold on the surface, thus detracting from the beauty of the plants. This insect is chiefly a pest in greenhouses, but at times it attacks outdoor plants. This is especially true of those growing near infested greenhouses or conservatories or in flower gardens where infested plants have unknowingly been set out. The species has been recorded on many kinds of plants, but is most frequently found on ageratum, aster, calendula, coleus, goldenglow, and lantana.

The adult (fig. 31) has four wings, is about $\frac{1}{16}$ inch long, and the wings and



FIGURE 31.—Adults of the greenhouse whitefly, male and female. About 8 times natural size.

top of the body are covered with a white, waxy powder. Superficially, it resembles a tiny white moth. The immature form, or nymph, attached to the leaves, is about the size of a small pinhead, oval, flattened, and light greenish. The nymph looks somewhat like a small, soft scale insect and remains attached to the leaf until it matures.

Treatment.—Spray thoroughly, especially the under sides of the leaves, with a combination of derris and pyrethrum, or with a nicotine sulfate and soap solution, making two or three applications at weekly intervals. A white-oil emulsion can often be used with success on the hardier shrubs, although frequent applications at such short intervals may not be advisable.

Prevention.—Do not set in the garden any cuttings or plants that are infested, and take special precautions with those originating in greenhouses or conservatories.

Other Pests of Ageratum

	Page
Red spider.....	11
Greenhouse leaf tier.....	5
Mealybugs.....	28, 31
Corn earworm.....	29
Asiatic garden beetle.....	21
Stalk borer.....	34

ARBORVITAE

Bagworm

The bagworm (*Thyridopteryx ephemeræformis* (Haw.)) is a caterpillar that lives in a silken, cocoonlike bag, to which are attached bits of leaves from the host plant. The bag is dragged about by the caterpillar as it feeds on the foliage. The caterpillar gradually increases the size of the bag as it grows. By late summer it reaches a length of 1½ to 2 inches and it is then attached by one end to a twig (fig. 32). In early fall the male emerges as a winged moth, whereas the female is wingless and remains in the bag, where she lays a mass of eggs. These eggs pass the winter in the bags attached to the twigs, and by removing these bags the eggs may be destroyed before they hatch. Hatching occurs in May in the South and late in May or early in June in the North. The bagworm is distributed over the eastern half of the country except in the more northern States. It prefers to feed on arborvitae and juniper but also infests pine, spruce, willow, black locust, maple, and many other evergreen and deciduous trees and shrubs.



FIGURE 32.—Bag or case of the bagworm attached to a twig. Natural size.

Treatment.—Spray with lead arsenate soon after the caterpillars hatch—in the first half of May in the South, late in May or early in June in the North—using 2 ounces of the poison to 3 gallons of water. If spraying is delayed until July, when the insects are more than half grown, increase the dosage to 3 ounces to 3 gallons. In the case of small shrubs, pick off and destroy the bags containing the feeding caterpillars.

Prevention.—Remove and burn all bags during the winter, thus destroying the enclosed eggs and preventing their hatching the following spring.

Arborvitae Aphid

The arborvitae aphid (*Cinara tujaefilina* (DelG.)) feeds in colonies, sucking the sap from twigs and small branches of arborvitae, Italian cypress, and retinospora (*Chamaecyparis*). It is widely distributed over the country and when numerous it weakens the branches or the entire tree. The aphid is a small, brownish insect, about ¼ inch long, with the body partially covered with a whitish, hairy pattern. Its presence can often be detected by the occurrence of numerous bees and flies attracted by the

sweet honeydew excreted by the aphids, or by the sooty mold that develops in the honeydew on the foliage, giving the plant a sooty appearance.

Treatment.—See treatment for aphids (p. 9).

Arborvitae Leaf Miner

The tips of arborvitae twigs in the Eastern States sometimes become discolored (fig. 33) and gradually turn brown as a result of having the interior of the needles eaten out or mined by the small caterpillars of the arborvitae leaf miner (*Argyresthia thuicella* (Pack.)). The reddish-green caterpillars, about $\frac{1}{8}$ inch long, pass the winter in the infested tips, and the small moths emerge late in May and during June to deposit their eggs on the foliage.

Treatment.—Cut off and burn the infested tips during the fall or winter.



FIGURE 33.—Discolored tips of arborvitae tunneled by leaf miners.

Spray with nicotine sulfate or pyrethrum a number of times during June to kill the moths and newly hatched larvae. Spraying with a combination of nicotine sulfate and lead arsenate late in June or early in July is also useful.

Other Pests of Arborvitae

	Page
Juniper scale.....	55
Spider mites.....	11

ASTER

Six-Spotted Leafhopper

The six-spotted leafhopper (*Macrostelus divinus* (Uhl.)), also known as the aster leafhopper, causes injury by extracting the plant juices from the leaves, which may turn brown and die. On asters it also transmits, as a result of its feeding, a virus disease known as aster yellows from diseased to healthy plants. Often an entire planting may become so badly infected that all the plants are worthless. Practically all horticultural varieties of asters of the genus *Callistephus* are susceptible. After feeding on infested wild plants in the spring the leafhoppers carry the disease with them to asters. Other flowering plants on which the leafhoppers feed include African marigold, calendula, chrysanthemum, cosmos, dahlia, and gaillardia. The adult leafhoppers are greenish gray and slightly less than $\frac{1}{8}$ inch in length. They are rather robust and not so slender as most other species (fig. 19, p. 11). The young, or nymphs, are grayish. The insects feed on the under sides of the leaves and mostly on the lower foliage. The leafhoppers usually spend the winter on weeds in nearby fields.

Treatment.—See treatment for leafhoppers (p. 11).

Prevention.—The only satisfactory way of preventing infection by the aster yellows disease is to grow the asters under a cloth shelter, wherever this is feasible. Better flowers are produced in this way. Another preventive measure is to burn over all nearby weed patches in early spring, where this is practical, before the insects can reach the garden plants.

Black Blister Beetles

Blister beetles are especially fond of the petals of flowers, on which they chew. They feed on the foliage also. The black blister beetle (*Epicauta pennsylvanica* (Deg.)) is commonly known as the black aster bug because

it so frequently attacks and destroys aster. It also attacks calendula, clematis, chrysanthemum, dahlia, dianthus, gladiolus, phlox, and zinnia. This beetle (fig. 14, p. 7) is about half an inch long and is uniformly black. It is a voracious feeder and usually occurs in large numbers.

Treatment and prevention.—See Blister Beetles, page 7.

Root Aphids

Certain species of aphids, especially the corn root aphid (*Anuraphis maidiradicis* (Forbes)), attack the roots of asters and a number of other plants, including browallia, calendula, primrose, and sweet pea, and frequently cause extensive damage to those infested. When asters are heavily attacked little or no growth is made, and the leaves turn yellow and wilt in the bright sun. Upon examining the roots, small, bluish-green aphids are usually found. These pests are fostered by several species of garden ants, which place the aphids upon stems of desirable plants and care for the eggs during the winter, later transferring the young plant lice to the roots along which the ants have made their burrows.

Treatment.—Root aphids are difficult to control on growing vegetation, and no entirely satisfactory remedy is known. Usually the elimination of ants (p. 12) will do much toward reducing an infestation.

Where growing plants are infested, one of the following measures will usually be of value. A nicotine sulfate solution, containing 2 teaspoonfuls to each gallon of water, without soap, can be applied by pulling back some of the soil at the base of the plant and pouring from 1 cupful to a pint or more, depending on the size of the plant, into this depression, after which the soil is pushed back into place. Fresh tobacco or nicotine dust mixed with equal parts of air-slaked lime can be worked in around the roots of infested plants.

Where it is necessary to plant in ground previously infested, the soil may in some cases be treated by applying a heavy coating of equal parts of tobacco dust and air-slaked lime over the entire area and then spading this in, permitting rains to leach the material through the soil before planting; or the carbon disulfide treatment (p. —) can be used, and may be applied only a few days prior to planting. These treatments are more effective when soil temperatures are fairly high.

Prevention.—Where a planting of aster or other susceptible plants has been infested, it is advisable to rotate these crops, using the ground the following year for plants not closely related. Thorough spading in the fall will disturb the ant nests, where the aphid eggs are found, and will destroy many of these eggs by exposure.

Asiatic Garden Beetle

The Asiatic garden beetle (*Autoserica castanea* (Arrow)), which is of oriental origin, has in recent years become a pest of flowering and ornamental plants in several localities in the Eastern States. It is often found along with the Japanese beetle. The beetle (fig. 34) is less than half an inch long, is dull chestnut brown, and looks somewhat like a coffee bean. It feeds on the leaves, buds, and flowers of aster, barberry, chrysanthemum, dahlia, rose, strawflower, sunflower, viburnum, and many other plants. In some cases 50 to 100 percent of the blossoms are ruined. The foliage on which the beetle feeds becomes ragged, and in a case of heavy feeding only the midribs are left. Unlike the Japanese beetle, which is active in the daytime, the adults hide in the soil during the day but appear at dusk and feed only at night. The beetles are attracted to electric lights, and often they become so numerous in brightly lighted places that they annoy persons by flying about and alighting on them. The larvae feed on the roots of plants and at times destroy many ornamental and vegetable garden plants.

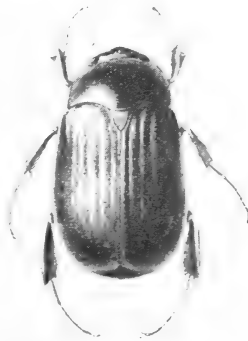

FIGURE 34.—The Asiatic garden beetle. About 3 times natural size.

Treatment and prevention.—Protect plants by applying a spray made up of 5 ounces of powdered lead arsenate and 3½ ounces of flour in 5 gallons of water. For more complete information on the life history and control of this insect, write to the United States Department of Agriculture, Washington, D. C.

Other Pests of Aster

	Page
Spotted cucumber beetle.....	7
Tarnished plant bug.....	25
Four-lined plant bug.....	94
Red spiders.....	11
Cutworms.....	2
Thrips.....	74
Greenhouse leaf tier.....	5
Stalk borer.....	34
Potato flea beetle.....	67
Wireworms.....	15
White grubs.....	14

AZALEA

Azalea Lacebug

Typical injury by the azalea lacebug (*Stephanitis pyrioides* Scott), shows as a spotted or mottled grayish discoloration and unhealthy appearance on the upper surface of azalea leaves, with numerous flattened specks of blackish shiny excrement on the lower surface. The injury is like that caused by the rhododendron lacebug, as shown in figure 119, page 73. The nymphs are small and spiny. The adults are about ½-inch long, with lacelike wings lying flat over the oval body, similar to those of the lacebug shown in figure 45, page 28. Nymphs and adults may be found during the summer sucking the juices from the under sides of the foliage. The winter is passed in the egg stage on the leaves, and hatching begins about midspring.

Treatment.—Spray the under sides of leaves when the insects are present, especially when the nymphs first appear in the spring, with either nicotine sulfate or pyrethrum. A combination of white-oil emulsion and derris powder (p. 10) or of white-oil emulsion and nicotine sulfate (p. 10) is effective and may be used for heavy infestations.

Mulberry Whitefly

Azalea foliage becomes discolored as a result of the sucking of the plant juices by the mulberry whitefly (*Tetraleurodes mori* (Quaint.)), especially when the insect occurs in abundance. This whitefly is found mostly on the lower leaf surface. The nymphs appear as oval, black, scalelike insects with a fringe of white waxy filaments around the edges, and are about the size of a pinhead.

The adults resemble tiny white moths and are similar in appearance to those of the greenhouse whitefly (fig. 31, p. 18). The insect is usually present from spring until fall and may become most numerous late in the summer. Additional plants attacked are dogwood, holly, maple, mountain-laurel, and mulberry, and occasionally others.

Treatment and prevention.—Same as for the greenhouse whitefly (p. 18).

Azalea Bark Scale

Small, white, cottony or woolly masses on the stems, especially in the axils of the branches, usually indicate the presence of the azalea bark scale (*Eriococcus azaleae* Comst.). When numerous these insects withdraw so much sap for food that the plant is weakened and appears sickly. Each insect is enclosed in a white, feltlike sac (fig. 35), and these sacs are the white masses found adhering to the bark.



FIGURE 35.—White, feltlike sacs covering females of the azalea scale on a stem. About 3 times natural size.

Treatment.—During the dormant season, spray with a white-oil emulsion diluted for dormant spraying. With early-blooming varieties this can be applied on a warm day in late fall, to avoid spray injury to the blossoms in early spring. After the blooming period in the spring many of the newly hatched, unprotected scale insects can be killed by making two or more applications, 2 or 3 weeks apart, of white-oil emulsion, or a combination of oil emulsion and nicotine sulfate (p. 101).

Peony Scale

In the South the stems of azalea may become infested with the peony scale (*Pseudaonidia paeoniae* (Ckll.)). When numerous these tiny sucking insects weaken the plants, or they may kill them if there is a continuous heavy infestation. On azalea the thin bark usually grows over the insects, leaving small "bumps," or swellings, on the bark surface. If these bark swellings are opened, the circular, convex, grayish-brown scale, about $\frac{1}{10}$ inch in diameter, may be found. When the insect is removed, a thin layer of whitish wax usually remains, giving the depression in the bark the appearance of a whitish scar (fig. 36). In the Southern States the young scale insects start hatching about the last of March and continue to hatch for over a month. The young attach themselves to the bark and remain exposed for about 4 weeks before

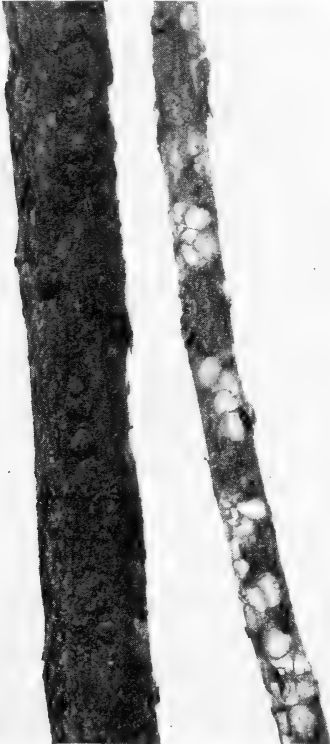

FIGURE 36.—Azalea stem infested with the peony scale and stem showing whitish scars where scales have been removed. Slightly enlarged.

the bark covers them. Spraying for the young stages must therefore be carried out during this period of exposure. Apparently only one generation of the insect occurs annually. Although this scale occasionally attacks camellia and a few other woody plants, it is not covered by bark swellings and is usually not so serious on such plants.

Treatment.—About 10 days or 2 weeks after the young have begun hatching, spray the stems and branches with a white-oil emulsion, diluted to contain 2 percent of oil (p. 100), and make a second application about 3 weeks later; or make three applications at intervals of 2 weeks, to cover the hatching period.

Azalea Leaf Miner

The azalea leaf miner (*Gracilaria azaleella* Brants) is a small yellowish caterpillar, about half an inch long when full-grown. Until nearly half-grown it mines inside the azalea leaves, but after this it comes out and folds over the tip or margin of the leaf (fig. 37) and feeds on the surface within this fold. The mined and skeletonized leaves turn yellow and drop. The small moths, yellow with purplish markings, deposit their eggs on the leaves. This insect is more common in greenhouses but occasionally injures outside plants.

Treatment.—Same as for the greenhouse leaf tier (p. 5).



FIGURE 37.—Azalea leaves folded at tip and margin by the azalea leaf miner. Young caterpillar on leaf at left. Slightly enlarged.

Azalea Stem Borer

The adult beetle of the azalea stem borer (*Oberrea myops* Hald.) girdles the tips of azalea, rhododendron, and mountain-laurel, usually after the spring blooming period. It deposits an egg in the bark below the girdle or between two adjacent girdles. During the first summer the grub bores downward, hollowing out the stem and expelling the boring dust through a series of small holes in the bark. The following season, in the Northeastern States, the grubs continue down to the roots, and toward fall may cut off some of the stems above the ground. The cylindrical, yellowish beetle is about half an inch long and has two small black spots on the thorax, which is just back of the head. The larva, or grub, is legless, yellowish, and about an inch long when full-grown. It is similar in appearance to the larva of the dogwood twig borer (fig. 65, p. 40).

Treatment.—Cut off the girdled and wilted tips as soon as they become evident in early summer, making the cut several inches below the girdled portion so as to remove the eggs or newly hatched grubs. If the removal of infested stems is delayed until later in the season, care should be taken to cut the stem below the point where the grub is located in the burrow and to destroy these infested parts.

Other Pests of Azalea

Rhododendron borer.....	Page
Spider mites.....	73
Black vine weevil.....	11
Fuller's rose beetle.....	93
	44

BARBERRY

Barberry Aphid

The barberry aphid (*Liosomaphis berberidis* (Kalt.)) is a small yellowish-green aphid that attacks barberry and Oregon grape. It is usually found in groups on the under sides of the leaves and tender shoots, where it sucks the sap and weakens the infested portions of the plant.

Treatment.—See treatment for aphids (p. 9).

Barberry Webworm

The barberry webworm (*Omphalocera dentosa* Grote) webs together the leaves and twigs of barberry. From within these web nests the caterpillars feed on the leaves. The feeding and webbing usually start after midsummer, and the unsightly nests often remain on the

bushes during the winter. The caterpillar is blackish with white spots, and when full-grown is nearly 1½ inches long. Apparently it spends the winter in the soil and transforms to a moth the following summer.

Treatment.—Spray the foliage with lead arsenate or paris green when the young caterpillars begin feeding. Spraying or dusting with a combination of derris and pyrethrum, as suggested for the greenhouse leaf tier (p. 5), would probably be effective if done thoroughly while the caterpillars are small.

Other Pests of Barberrry

Eight-spotted forester.....	Page
Greenhouse whitefly.....	91
Red spiders.....	18
Asiatic garden beetle.....	11
	21

BOXWOOD

Boxwood Leaf Miner

The boxwood leaf miner (*Monarthropalpus buxi* Lab.) is a very small fly, the larvae or maggots of which feed inside the leaves of boxwood. The mines produced by this feeding appear as blotches or blisters on the lower leaf surface (fig. 38), and when numerous they kill the heavily infested leaves and thus disfigure the plant. The tiny yellowish-orange maggots require a year for development, from the time of hatching in late spring until the following spring, when they transform to pupae within the mines. The orange-colored, gnatlike flies emerge from the leaves over a period of about 2 weeks, usually starting during the first or second week in May around Washington, D. C., depending on the lateness of the season, and deposit their eggs in the new leaf tissue. Emergence would start earlier farther south and later in States to the north.

Treatment.—Start spraying as soon as the flies begin to emerge in the spring, using a spray composed of 1 gallon of cheap molasses, 5 gallons of water, and 10 teaspoonfuls of nicotine sulfate. Repeat the spraying every 3 or 4 days, or as often as necessary to keep both surfaces of the foliage thoroughly sticky during the flight period of about 2 weeks, thus sticking the delicate flies to the leaves. Spraying at other seasons of the year has not been successful. Trimming back part of the new growth in late spring will eliminate some of the newly infested leaves and permit additional growth later which will not become infested.



FIGURE 38.—Blisters produced by the boxwood leaf miner on the lower leaf surface. About 4 times natural size.

Boxwood Psyllid

A characteristic cupping of terminal boxwood leaves results from the feeding of the boxwood psyllid (*Psylla buxi* (L.)). This is a small, grayish-green sucking insect related to the aphids. The nymphs are covered with a whitish waxy material and usually appear first in early spring. Plants are seldom injured seriously, although their appearance may become unattractive. Severe infestations may retard growth.

Treatment.—Spray with a nicotine sulfate and soap solution (p. 97) at the first evidence of leaf cupping or occurrence of the psyllid. A second or third spraying, at intervals of 10 days, may be necessary for a heavy infestation. A pyrethrum spray should also be effective.

Other Pests of Boxwood

	Page
Spider mites.....	11
Giant hornet.....	57
Mealy flata.....	90

CALENDULA

Painted-Lady

The caterpillar of the painted-lady butterfly (*Vanessa cardui* (L.)) feeds on the foliage of calendula, hollyhock, lupine, and sunflower, and occasionally on other plants. It also ties together the terminal leaves, giving the plant an unsightly appearance. This insect is also common on weeds, especially on thistle, and is sometimes called the thistle butterfly. The full-grown caterpillar (fig. 39) is about 1½ inches long, dull brown or black, shiny, with a pale-yellow stripe on each side. The adult is a large, beautifully marked butterfly. It is widely distributed and sometimes occurs in migratory flights.



FIGURE 39.—Caterpillar of the painted lady butterfly and its work on hollyhock. About natural size.

Treatment.—Spray or dust with lead arsenate. Where only a few insects are present, remove and destroy the infested tips.

Other Pests of Calendula

	Page
Black blister beetle.....	20
Tarnished plant bug.....	35
Spotted cucumber beetle.....	7
Yellow woolly bear.....	3
Stalk borer.....	34
Bean aphid.....	63
Green peach aphid.....	88
Root aphids.....	21
Leafhoppers.....	10
Flea beetles.....	8
Red spiders.....	11
Greenhouse whitefly.....	18

CAMELLIA

Camellia Scale

The leaves of camellia occasionally become infested with the camellia scale (*Lepidosaphes camelliae* Hoke). When numerous these tiny sucking insects, tightly attached to the leaf surface, cause the foliage to appear sickly and fall prematurely. The waxy scale covering the mature insect is about $\frac{1}{10}$ inch long, somewhat pear-shaped, flattened, and dark brown.

Treatment.—Spray in the spring with a 2-percent white-oil emulsion (p. 100), wetting both sides of the leaves. Best results will be obtained by making two or more applications about 3 weeks apart. To avoid injury to the blossoms, the spraying can be begun at the close of the blooming period. The same type of oil spray at twice the above strength may be applied when the plants are dormant, in severe or continued infestation. Where only a few leaves are infested on small plants, the scale insects may be wiped off with a soft cloth.

Tea Scale

The tea scale (*Florinia theae* Green) attacks the leaves of camellia and tea, causing injury similar to that of the camellia scale, discussed above. It is most prevalent on the under sides of the leaves. The female scales are about $\frac{1}{16}$ inch long, elongate oval, and dark brown to blackish. The male scales, however, are snow white, and when numerous they give the under sides of the leaves a whitish or frosted appearance (fig. 40).

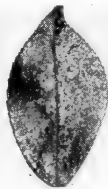

FIGURE 40.—Camellia leaf covered with the tea scale. About natural size.

Treatment.—Same as for the camellia scale, above.

Other Pests of Camellia

	Page
Citrus mealybug	31
Long-tailed mealybug	31
Citrus whitefly	43
Oleander scale	54
Soft scale	43
Peony scale	23
Fuller's rose beetle	44

CANNA

Canna Leaf Rollers

In the Southern States canna leaves are often attacked by two leaf rollers, the larger canna leaf roller (*Calpodex ethlius* (Stoll.)) and the lesser canna leaf roller (*Geshna cannalis* (Quaint.)). They should receive prompt attention. Occasionally these species appear in the Northern States, but the severe winters seem to prevent their survival.

The young caterpillar of the larger canna leaf roller cuts a small oblong strip from the leaf margin and neatly folds this over the leaf surface. From within this retreat it feeds on the leaf margin above and below. As the caterpillar grows it forms a tubular retreat and eats out larger irregular holes (fig. 41). The body of the caterpillar is semitransparent and greenish, and the dark-orange head is set off by a narrow "neck" (fig. 42). When full-grown it is about $1\frac{3}{4}$ inches long. The adult is a brownish butterfly, or "skipper," with white spots on the wings.

The lesser canna leaf roller also attacks canna leaves and in Florida it often causes serious injury. The caterpillar rolls the leaves and feeds on the inner surface of the roll. More often, however, it fastens the younger leaves before they have unrolled to any extent. Infested leaves may be so badly eaten



FIGURE 41.—Portion of leaf folded and irregular holes eaten by the larger canna leaf roller.



FIGURE 42.—Full-grown caterpillar of the larger canna leaf roller. About 1½ times natural size.

that they die, becoming brown and ragged. The full-grown caterpillars are about an inch long, rather transparent, and yellow-white, but they have a greenish appearance after feeding on green foliage. The moth is a uniform light brown. In Florida this species overwinters as larvae and as pupae, and the moths appear in February and March.

Treatment.—Spray or dust with lead arsenate early in the season when the injury is first observed. Later injury may be prevented or forestalled by hand-picking the injured and rolled areas and destroying the culprits contained therein as soon as they appear in the spring. Where only a light infestation exists, squeeze the leaf areas that are rolled, to kill the caterpillars.

Prevention.—Clean off and burn the dead plants and trash from the beds during the winter to kill any larvae or pupae contained therein.

Other Pests of Canna

	Page
Yellow woolly bear.....	3
Greenhouse leaf tier.....	5
Spotted cucumber beetle.....	7
Corn earworm.....	29
Asiatic garden beetle.....	21
Fuller's rose beetle.....	44
Saddleback caterpillar.....	6

CHRYSANTHEMUM

Aphids

Although several species of aphids attack chrysanthemum, the chrysanthemum aphid (*Macrosiphoniella sanborni* (Gill.)) is the one most frequently encountered. This species is distinguished from the others by its chocolate-brown color and by its habit of clustering on the tender terminal shoots (fig. 43) and on the under sides of the leaves. As a result of the continuous draining of the plant juices, the tender growth becomes stunted and the leaves curl up, causing serious disfigurement and eventually the death of the plants. The honeydew excreted by the aphids serves as a medium for the growth of sooty mold, an objectionable black deposit which ruins the beauty of the plant. The sweet honeydew also attracts such insects as ants, flies, and wasps. The chrysanthemum aphid is very prolific and develops rapidly. A single female may give birth to as many as 100 young at the rate of 4 to 9 individuals a day.

Treatment.—Same treatment as for aphids in general, discussed on page 9.

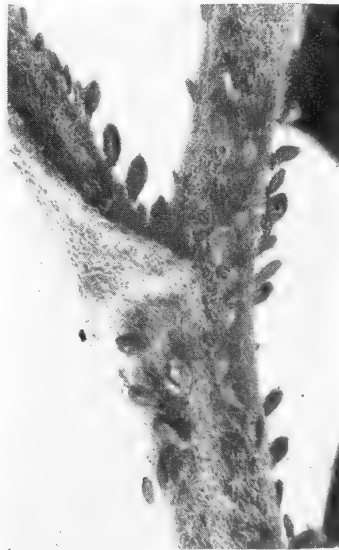

FIGURE 43.—Chrysanthemum stem heavily infested with aphids. About twice natural size.

Mexican Mealybug

Although other species of mealybugs occur on chrysanthemum, the Mexican mealybug (*Phenacoccus gossypii* Towns. and Ckll.) is the most serious pest. This species will also feed on and injure other garden plants, including coleus, gerbera, fuchsia, bouvardia, and calendula. It attacks the leaves, stems (fig. 44), and flowers in all stages of growth.



FIGURE 44.—Mexican mealybugs clustered on a chrysanthemum stem. Slightly enlarged.

On chrysanthemum especially it causes a stunting and distortion of the leaves; otherwise the injury, habits, and appearance are similar to those described under Coleus, on page 31. The adult female is light bluish gray and about $\frac{1}{8}$ inch long. A female may deposit an

average of about 400 eggs, and these are laid in cottony sacs. Plants obtained from infested nurseries or greenhouses are responsible for infestations. This insect does not survive the winter in the Northern States.

Treatment.—Apply a thiocyanate spray (p. 102) at intervals of a week or 10 days. It is advisable to syringe the plants with water within a few hours after spraying, to avoid spray injury. The treatments recommended for other mealybugs (p. 31) may be of some value, but are less effective against this species.

Prevention.—Carefully examine all new plants before they are set out in the garden. If found infested, treat them with the above-mentioned spray, or, if badly infested, destroy the plants.

Chrysanthemum Lacebug

The chrysanthemum lacebug (*Corythucha marmorata* (Uhl.)) may at times inflict considerable damage to the foliage and stems of chrysanthemums by sucking the sap. The adult, similar to the one shown in figure 45, is less than $\frac{1}{8}$ inch long and is easily recognized by its lacelike wings and lacy hood over the head. The nymphs, or young, are wingless and have spines on the body. They leave tiny, dark, resinous spots of excreta on the under sides of the areas fed upon (fig. 46). This lacebug breeds on many weeds and is often found on goldenrod, from which it migrates to chrysanthemum, aster, scabiosa, and other garden flowers. When present in large numbers it quickly ruins the plants. There are several generations annually.

Treatment.—Spray or dust the under sides of the leaves with nicotine or pyrethrum.



FIGURE 45.—Adult of the sycamore lacebug. Eight times natural size.



FIGURE 46.—Feeding injury and dark spots of excreta left by the chrysanthemum lacebug. Slightly reduced.

Corn Earworm

The corn earworm (*Heliothis armigera* (Hbn.)), also known as the tomato fruitworm and the cotton bollworm, is better known for its ravages in the vegetable than in the flower garden. Nevertheless, it is a pest of annual and perennial flowers and attacks abutilon, ageratum, amaranth, canna, carnation, chrysanthemum, dahlia, geranium, gladiolus, hibiscus, mignonette, morning-glory, nasturtium, phlox, poppy, rose, sunflower, and sweet pea. The caterpillars show a marked preference for the opening buds and flowers of chrysanthemum, calendula, dahlia, gladiolus (fig. 47, *A*), and rose, although they also feed on the leaves and may tunnel the stems of certain plants. Their injury to the buds is not unlike that by climbing cutworms, with which they are often confused. They gouge out the inner part so deeply that the flowers are a complete loss. The caterpillars (fig. 47, *B*) when full-grown are about 1½ inches long, and their color may change from reddish brown to green, with brown, black, or green stripes, as they mature. The parent is a fawn-colored moth with dark spots on the forewings.

Treatment.—Dusting or spraying two or three times with lead arsenate, or with calcium arsenate, paris green, or cryolite (pp. 95, 96, 97), will be of some value. If the flower buds have been bored into there is little that can be done



FIGURE 47.—*A*, Corn earworm boring in a gladiolus flower; *B*, caterpillar, natural size.

except to remove and destroy the worm-infested buds.

Prevention.—Screen choice and valuable plants with cheesecloth to prevent them from becoming infested.

Burdock Leaf Miner

The burdock leaf miner (*Agromyza maculosa* Malloch) is at times destructive to the leaves of chrysanthemums, although it is primarily a pest of burdock. The tiny white maggots feed between the upper and lower leaf surfaces and make a blotch mine (fig. 48). Several maggots work together in one mine. The part of the leaf that is mined turns brown and eventually dies. The adult is a tiny two-winged fly.



FIGURE 48.—Blotch or blisterlike mine on chrysanthemum caused by the burdock leaf miner. Slightly reduced.

Treatment.—Hand-pick and destroy the mine-infested leaves by burning them, to prevent the insects from completing their development. This is usually all that is necessary. If the infestation is heavy, however, spray with a nicotine sulfate and soap solution when the mines are just beginning to form.

Prevention.—Raking and burning all dead leaves below the plants late in the fall or very early in the spring will dispose of some of the overwintering stages.

Spittle Bugs

The spittle bugs or froghoppers, although not often sufficiently injurious or numerous to do much damage, sometimes cause losses to chrysanthemums, roses, and other plants. They are small sucking insects of the family Cercopidae, and there are a number of species that occur on weeds as well as certain flowering plants. Their name is derived from the peculiar frothy material (fig. 49) with which the nymphs cover themselves, and the squatty, froglike appear-



FIGURE 49.—Spittle bug covered with froth on a rose stem. Natural size.

ance of the adults. They have a number of local names, such as "frog-spit" and "snake-spit."

Treatment.—Spray with pyrethrum or a nicotine sulfate and soap solution, if there is evidence of injury.

Prevention.—Burning infested weedy areas near the garden in late winter or early spring is of some value.

Other Pests of Chrysanthemum

	Page
Cutworms.....	2
Yellow woolly bear.....	3
Spotted cucumber beetle.....	7
Asiatic garden beetle.....	21
Stalk borer.....	34
Rose chafer.....	66
Thrips.....	74
Termites.....	13
Grasshoppers.....	9
Tarnished plant bug.....	35
Red spiders.....	11
Slugs.....	16
Snowbugs.....	17

CLEMATIS**Clematis Root Borer**

The clematis root borer (*Alcathoe caudata* (Harr.)) attacks the fleshy roots and infests the crown of clematis, especially virgins-bower. It sometimes hollows out the bases of stems, causing the plants to show a lack of vigor and to

become stunted. The borers, which are full-grown by June or July, are then $\frac{3}{8}$ inch long, dull white, with a brown head. They change to brown pupae in a slight cocoon, and in midsummer the adult clear-winged moths emerge and soon thereafter lay their eggs. The caterpillars pass the winter in the hosts.

Treatment.—Cut out and burn the infested portions containing the borers, or dig out the boring insects.

Other Pests of Clematis

	Page
Fall webworm	51
Black blister beetle.....	7, 20
Tarnished plant bug.....	35

COLEUS

Mealybugs

Several species of mealybugs occur on coleus and many other garden plants, but the citrus mealybug (*Pseudococcus citri* (Risso)) and the long-tailed mealybug (*Pseudococcus adonidum* (L.)) are most commonly found (fig. 50). With their sucking mouth parts they remove the vital plant juices, causing a loss of color, wilting, and death of the affected parts, if they are not controlled. Moreover, mealybugs excrete copious quantities of sticky honeydew, which may coat the foliage. A black sooty mold that grows in the honeydew spoils the ornamental value of the plants. Mealybugs in general feed on so many plants and shrubs that it seems unnecessary to list them here. However, they prefer the more succulent plants like coleus, ferns, geranium, heliotrope, lantana, salvia, and ageratum that are used in flower boxes or in borders. These in-

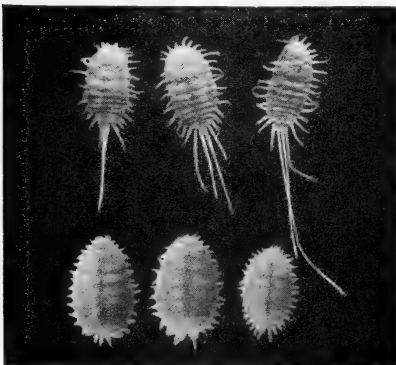

FIGURE 50.—Mealybug adults: Upper, long-tailed mealybug; lower, citrus mealybug. About $2\frac{1}{2}$ times natural size.



FIGURE 51.—Citrus mealybugs on under surface of leaf. About twice natural size.

sects are usually found in clusters along the veins on the under sides of leaves (fig. 51) and in crevices at the base of the leaf stems. Since they multiply rapidly, all stages may be present at the same time. Mealybugs are usually brought into gardens by accidentally setting out plants that are infested. Ants usually aid in transferring them from plant to plant, so that in a comparatively short time they become generally distributed throughout a garden. The ants are attracted by and feed on the honeydew excreted by the mealybugs.

Mealybugs are only about $\frac{1}{8}$ inch long when full-grown. They derive their name from the fact that their oval or elongate bodies are covered with a white, waxy, or mealy excretion. This covering is peculiarly protective against spray materials. The young, or nymphs, are much like the adults except that they are smaller and lack the mealy covering. The males develop into small, winged, midgelike adults, but are rarely seen.

The female of the citrus mealybug (fig. 50) is distinguished by its amber-colored body and the short waxy filaments along the margin. None of these filaments are nearly as long as the body. The eggs are laid in a cottony mass, resembling a small puff of cotton. The long-tailed mealybug (fig. 50) is a smaller species, and the body is gray or yellowish. In addition to the shorter body filament, it has four long ones at the hind end, forming a long tail. It produces no egg mass, because the young are born alive.

Treatment.—The first step in the control of all species of mealybugs is to eliminate ants in and about the garden

(p. 12). For very tender plants, spray at weekly intervals with nicotine sulfate and soap until the infestation is eliminated. This will kill many of the newly hatched young and eventually eliminate the insects. Less tender plants may be sprayed with a white-oil emulsion, with the oil and nicotine combined (p. 101), or with thiocyanate. The spray should be applied with as much force as the plants will stand. It is advisable, however, to rinse the plants with water an hour or two after spraying with thiocyanate to avoid any possible spray injury. Syringing the infested plants frequently, especially the hardier ones, with water under considerable pressure is usually effective in reducing an infestation. Before spraying is undertaken all dead, dying, and heavily infested portions should be removed and destroyed.

Prevention.—All plants should be carefully examined before they are set out to see that they are free of infestation.

Greenhouse Orthezia

Although primarily a pest of plants grown under glass, the greenhouse orthezia (*Orthezia insignis* Browne) is a scale insect which is related to the mealybugs and has habits similar to theirs. It feeds on many varieties of bedding plants out of doors, especially in the warmer parts of the country. The

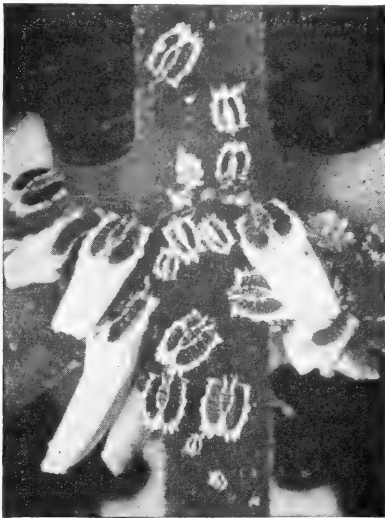

FIGURE 52.—Portion of coleus plant infested with the greenhouse orthezia. Three times natural size.

constant sucking of the vital juices weakens the hosts so that they become sickly and sometimes die. Lantana, chrysanthemum, coleus, heliotrope, periwinkle, petunia, salvia, and verbenas are particularly subject to injury. The mature female is pale brown or dark green and is conspicuous because of its waxy marginal fringe and long, white, fluted egg sac (fig. 52). The length of the insect together with its egg sac is about $\frac{1}{8}$ inch. All stages are active and settle in colonies on the leaves and stems of the plants.

Treatment and prevention.—Same as for mealybugs (p. 31).

Other Pests of Coleus

	Page
Red spider.....	11
Greenhouse whitefly.....	18
Yellow woolly bear.....	3

COLUMBINE

Columbine Borer

The columbine borer (*Papaipema purpurifascia* (G. and R.)) attacks the stems and especially the roots of columbine, both cultivated and wild. The caterpillar, or borer, burrows through the stems and fleshy roots, causing the infested plants to wilt or the stems to break easily. Small piles of frass or dark sawdustlike castings near the base of the plants are evidence that the borers are at work. The moth lays her eggs in scattered fashion over the ground late in the summer. The eggs hatch the following April or May, and the tiny larvae soon enter the stems. They first bore in the stems above the ground but later they work their way down to the roots. By July they reach full size, ranging from 1 to $1\frac{1}{2}$ inches in length, and have a pinkish cast, resembling somewhat the larvae of the iris borer (fig. 85, p. 52). They may usually be found tunneling the main roots at this time. Later the caterpillars transform to pupae, and finally to adult moths, which are reddish brown.

Treatment.—Cut out and burn the infested parts where the insects are at work, whenever practical. Probing the burrows with a fine flexible wire to kill the borers within gives some relief. Injecting a strong solution of pyrethrum into the burrow in the stem kills such borers as are reached. Carbon disulfide is sometimes used by injecting a teaspoonful into each of 5 or 6 holes a few inches deep in the soil several inches from the base of the plant. **Great care**

must be taken when using this chemical, because it is poisonous, highly inflammable, and explosive when mixed with air in certain proportions.

Prevention.—Thorough raking and working of the soil around the base of the plants early in the spring has been suggested to destroy the overwintering eggs.

Cambium Curculio

Another boring insect, the cambium curculio (*Conotrachelus anaglypticus* (Say)), has recently been found to injure columbine seriously. In nature this insect is rather common and feeds in a variety of situations. The beetles often occur in company with those of the plum curculio. The larvae, which are small, whitish, legless grubs, have been found attacking peaches, cotton bolls, and the cambium and inner bark (fig. 53, A) of

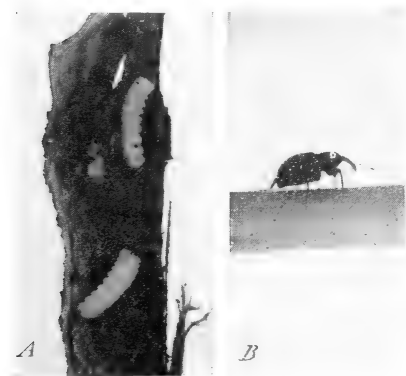

FIGURE 53.—Cambium curculio: A, Larvae, or grubs, exposed by removal of bark; B, adult. Both about $1\frac{1}{2}$ times natural size.

many fruit, shade, and forest trees. They work around the edges of wounds, retarding the healing processes and enlarging the injured areas. In columbine they seem to prefer the crown and roots. Their feeding results in a wilting and dying of the plants attacked, and the injury is usually not discovered until these symptoms appear. The adult is a small weevil, or snout beetle (fig. 53, B), less than $\frac{1}{4}$ inch long.

Treatment.—No satisfactory treatment is known except to remove and burn the infested parts. This operation destroys the insects contained therein and in this way reduces the chances for future reinfestation.

Prevention.—Clean culture late in

the fall is useful in that it destroys the overwintering quarters of the adults, which are among the debris and litter on the ground.

Columbine Leaf Miner

The columbine leaf miner (*Phytomyza minuscula* Gour.) is rather abundant throughout the United States. The tiny whitish maggots feed between the leaf surfaces of columbine (fig. 54) and aster and produce a whitish, tortuous or serpentine trail or mine, which is visible on the upper leaf surface. The mine frequently crosses itself and ends in a spot about $\frac{1}{8}$ inch wide. This miner attacks the lower leaves first and then continues upward on the plant. The small, shiny, black, two-winged flies emerge in May or June, feed, and deposit eggs in the under side of the leaf. The larvae hatch, feed for about 10 days to 2 weeks, and then form small football-shaped puparia on the leaf. Eight or ten larvae may develop in a single leaf. The last, or fourth, generation appears about the middle of September and passes the winter as pupae in the soil about the base of the plants.

A closely related species (*P. aquilegiae* Hardy) also occurs on columbine but differs from the one discussed above in that it forms a blotchlike mine.

Treatment.—Spray with a nicotine sulfate and soap solution. An infestation may often be checked if all infested leaves are promptly removed and burned.

Prevention.—Spade the ground thoroughly about the base of the plants early in the spring to destroy the pupae before the flies have a chance to emerge.



FIGURE 54.—Work of the columbine leaf miner.

Columbine Aphid

The columbine aphid (*Pergandeidia trirhoda* (Walk.)) is a small, cream-colored, rather flat plant louse which sometimes infests columbine in such numbers as to require treatment. Infestation usually occurs late in the summer. Like other aphids, the columbine aphids suck the plant juices from the under side of the leaves and cause a stunting of the plant growth. The bean aphid (p. 63) also attacks columbine at times.

Treatment.—Same as recommended for aphids (p. 9).

Columbine Skipper

The caterpillar of the columbine skipper (*Erynnis lucilius* (Scud. & Burg.)) chews holes in the leaves of columbine and apparently confines its feeding largely to this plant. When not feeding, it hides in a rolled-up leaf. The caterpillar is about 3/4 inch long when full-grown, is velvety green, rather stout, and has a small black head. The adult is one of the butterflies that are known as skippers. Several generations of caterpillars are produced each year.

Treatment.—Spray or dust with lead arsenate to poison the caterpillars. Spraying or dusting with pyrethrum or derris may be effective against the very small caterpillars. Where only a few are present they can be picked off easily.

Other Pests of Columbine

	Page
Rose budworm.....	83
Black stinkbug.....	83
Eastern tent caterpillar.....	47
Red spiders.....	11
Asiatic garden beetle.....	21

COSMOS

This popular flowering plant is subject to attack by a number of insects. For the most part, however, these are general feeders and have been discussed under other plants. The insects most frequently encountered are the following:

	Page
Bean aphid.....	63
Potato aphid.....	75
Spotted cucumber beetle.....	7
Asiatic garden beetle.....	21
European corn borer.....	36
Stalk borer.....	34
Six-spotted leafhopper.....	20
Four-lined plant bug.....	94
Tarnished plant bug.....	35
Red spiders.....	11

DAHLIA

Stalk Borer

Several species of caterpillars have the insidious habit of boring and tunneling through the stalks and stems of fleshy and thick-stemmed plants, such as aster, cosmos, dahlia, delphinium, goldenglow, hollyhock, lily, peony, phlox, and zinnia. The stalk borer (*Papaipema nebris* (Guen.)) is the chief offender in the flower garden. Before it is discovered its work usually has progressed to the point where wilting and breaking over of the plants occur. A close examination of plants so affected will disclose a small round hole in the stem. This hole is the entrance to the stalk borer's burrow and the opening from which the castings are expelled. By splitting the stalk lengthwise one may find the culprit, a slender caterpillar (fig. 55) which is a little over an inch long when full-grown. The caterpillar frequently moves from the stem of one plant to that of another and consequently may cause considerable damage. The young caterpillar is brownish and bears a dark-brown or purple band around the middle of the body, with several conspicuous brown or purple stripes running lengthwise. The grayish-brown moths occur late in the summer and deposit their eggs for the next season's brood on burdock and ragweed as well as on a variety of other plants.



FIGURE 55.—A, Stem of goldenglow split to show the stalk borer; B, entrance hole to the stalk borer's burrow in hollyhock stem. Slightly enlarged.

Treatment.—There is no effective way of poisoning the stalk borer, as it is an internal feeder. Individual plants can often be saved by splitting the stem lengthwise, removing the borers, and then binding the stem together again. Cutting and crushing or burning the infested stems having wilted tips is effective in reducing the borer population. A small amount of pyrethrum spray injected into the burrows may kill such borers as are actually reached by it.

Prevention.—The best remedy is clean cultivation and the burning of all stems and plant remains that are likely to harbor overwintering eggs. The growth of large weeds, especially the giant ragweed, should be prevented, or the weeds should be cut, raked together, and burned before the caterpillars contained within them can escape and migrate to garden plants.

Potato Leafhopper

The potato leafhopper (*Empoasca fabae* (Harr.)) sometimes seriously injures dahlias. Its sucking of the plant juices causes a whitening of the potato foliage and gives it a fine stippled appearance. A more serious effect is the so-called hopperburn which it causes, wherein the edges of infested leaves turn pale, curl, and finally become brown and die (fig. 19, p. 11). This insect also attacks African marigold (p. 58), aster, gladiolus, hollyhock, rose, and zinnia. The adult leafhopper (fig. 95, p. 59) is wedge-shaped, pale yellowish green, and about $\frac{1}{2}$ inch long.

Treatment and prevention.—Same as given for leafhoppers (p. 10).

Tarnished Plant Bug

The tarnished plant bug (*Lygus oblineatus* (Say)) is particularly injurious to dahlia, aster, calendula, cosmos, and marigold. It is a general feeder and has been recorded as attacking 50 or more economic plants, besides many weeds and grasses. This habit greatly complicates the effective use of insecticides and the protection of flowering plants. Both the nymphs and adults, when feeding, sting the young tips, and especially the buds of dahlia, and cause them to become "blasted" and die (fig. 56). They also puncture the leaves so that small spots appear in the areas fed upon. While feeding, the tarnished plant bugs seem to inject a poisonous substance into the plant, killing the surrounding tissue. The adult is a small, brownish, flattened bug, about $\frac{1}{4}$ inch long (fig. 57). It has a brassy



FIGURE 56.—Injury to terminal growth of dahlia by the tarnished plant bug.



FIGURE 57.—The tarnished plant bug. About 4 times natural size.

appearance and is marked with yellowish and black dashes. The adults hibernate under leaf mold, stones, or bark of trees, or among leaves of clover, alfalfa, and mullein and in other protected places. They appear in early spring, and the bugs are most numerous by late summer. Their eggs are laid in the stems, petioles, buds, and tender growths of many herbaceous weeds and garden plants.

Another species, the four-lined plant bug (p. 94), which is a little larger, also attacks the leaves of dahlia, giving them a spotted appearance (fig. 159, p. 94) similar to that caused by the tarnished plant bug.

Treatment.—Since most adult plant bugs are extremely active, it is difficult to reach them with sprays or dust un-

less treatments are applied very early in the day. The adults may be collected early in the morning, however, by beating them into a pan containing water covered with a film of kerosene or other oil. To control the insects, especially the nymphs, which do not have fully developed wings, dust with a mixture of 9 parts of dusting sulfur and 1 part of pyrethrum (containing 0.9 to 1.3 percent of pyrethrins by weight); or spray with pyrethrum, derris, or nicotine sulfate. Since these treatments kill only the insects present at the time, it is necessary to repeat the applications as the bugs appear.

Prevention.—For the tarnished plant bug, one of the most important practices is clean culture in and about the garden. All weeds and trash, which may serve as winter hibernating quarters for the adults, should be gathered and burned. The four-lined plant bug, however, winters in the egg stage. The small white eggs are inserted in slits in the tender shoots of current and other plants, with one end protruding. Wherever groups of these eggs can be detected, clip and burn the twigs.

European Corn Borer

The European corn borer (*Pyrausta nubilalis* (Hbn.)) is an important enemy of corn, but it also burrows in the stems of many kinds of plants and weeds. The stems of dahlia seem to be the most susceptible of the flower crops attacked, although aster, chrysanthemum, cosmos (fig. 58), geranium, gladiolus, hollyhock, zinnia, and other plants are also tunneled. Sometimes the borers are found feeding in flowers of dahlia, chrysanthemum, and gladiolus. If an infested dahlia stalk is cut open, a grayish-pink caterpillar (fig. 59) with a dark head will be found in the debris of its tunnel. When full-grown it is about an inch long. The corn borer is easily distinguished from the stalk borer (p. 34) by the absence of conspicuous bands or stripes characteristic of the latter, although the injury it causes is somewhat similar. Moreover, the burrows of the corn borer are smaller than those of the stalk borer. The corn borer larvae hibernate in stems during the winter, whereas the stalk borer lives over in the egg stage. The first indication of infestation in dahlia is when the new foliage and new blossom buds begin to wilt. In severe injury the blooms are greatly reduced in size and numbers, and sometimes the affected plants are destroyed before the propagating roots



FIGURE 58.—Cosmos stems cut to show the European corn borer and its injury.

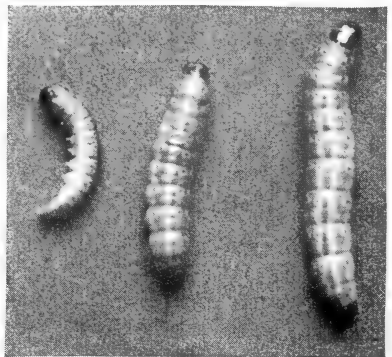

FIGURE 59.—Larvae of the European corn borer. Slightly enlarged.

have been formed. Eventually the borer tunnels downward in the branches and finally reaches the pith cavity of the main stem, causing the stem to break.

Treatment.—On dahlia the young caterpillar is susceptible to insecticides at the time it feeds on the surface of developing foliage and blossom buds and before it tunnels deeper into the pith of the main stem. The sprays found effective for this purpose contain either derris powder or phenothiazine. These sprays may be made up in small lots at the rate of 2 ounces, or 12 level tablespoonfuls, of either derris or phenothiazine to 3 gallons of water in which a small amount of spreader, such as sodium lauryl sulfate, has been previously added. It is best to make up a thin paste of each before adding it to the spray water. Time the spray applications to begin on the first sign of wilting and repeat five or six times at intervals of 5 days. Repeat the next day after a heavy rainfall if this occurs soon after spraying.

Prevention.—Grow choice or valuable plants under cloth shelter. Pruning and disbudding serve to remove some of the borer population but do not provide protection for the remaining blooms. Cut off the stalks close to the crown of the plant to prevent the larvae from hibernating over the winter in root clumps.

Cocklebur Billbug

The cocklebur billbug (*Rhodoabaenus tredecimpunctatus* (Ill.)), though of rare occurrence on dahlia, has become important in some regions during the last few years. It is a common pest of cocklebur, ironweed, sunflower, joe-pye-weed, leaf cup, thistle, ragweed, evening primrose, and the seed stalks of sugar beet, and has recently been reported on chrysanthemum. The adult (fig. 60) is a reddish weevil, or snout beetle, with 13 black spots on the back and a long curved snout on the head, and is about 1/3 inch long. The adults overwinter in trash, appear in May or June, and lay

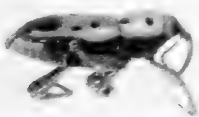

FIGURE 60.—Cocklebur billbug: Adult. About 3 times natural size.



FIGURE 61.—Portion of dahlia stem split to show tunneling by grubs of the cocklebur billbug.

eggs on the tender stalks. The eggs hatch into white, legless grubs, which bore into the pith and may hollow out the stalk (fig. 61) for a foot or more near the base of the plant. The weakened stems break over easily. The grubs pupate in August, and the beetles emerge from the stems late in August and early in September.

Treatment.—Once the stems have become infested, there is little that can be done except to stake the plants well to prevent their breaking, so that the plants will not be entirely lost. Slitting the stems and removing the grubs is suggested where the infestation is light. Hand-picking of the conspicuous beetles is also useful.

Prevention.—Since the adults deposit their eggs in May or early in June, and since dahlias may be planted rather late in the season for the production of good plants, delaying the planting of tubers, so that the young shoots will not be present until after the beetles have disappeared, will be helpful.

Other Pests of Dahlia

	Page
Yellow woolly bear	8
Flower thrips.....	74
Red spiders.....	11
Asiatic garden beetle.....	21
Green peach aphid.....	88

DELPHINIUM

Cyclamen Mite

The cyclamen mite (*Tarsonemus pallidus* Banks) is chiefly a pest of greenhouse plants, but at times it seriously injures perennial delphinium, although dahlia, gerbera, geum, and a few other garden plants are attacked. The mites (fig. 62) are too small to be seen without magnification, but their injury, consisting of distortion of foliage and flowers, with or without blackening, is usually recognized. On delphinium (fig. 63) the cyclamen mite enters through breaks in the surface layer on injured leaves, breeds within the leaf tissue, and causes gnarling of the tip growth and blackening of the areas fed upon. It also penetrates the crown of delphinium deeply to the base of the leaves. The adult mite is of a caramel color, whereas the younger stages are milky white. The mites travel only short distances but may go to nearby plants if the foliage touches. They may also be spread to other plants by hands, tools, wind, or rain, or carried by other insects. The mites pass the winter in the crowns of delphinium and survive between crops on many weeds or other living plant hosts, but not in the soil.

Treatment.—Since the mites are not exposed on delphinium, spraying or dusting is of little value. The best treatment is to immerse the infested plants in water held at a temperature

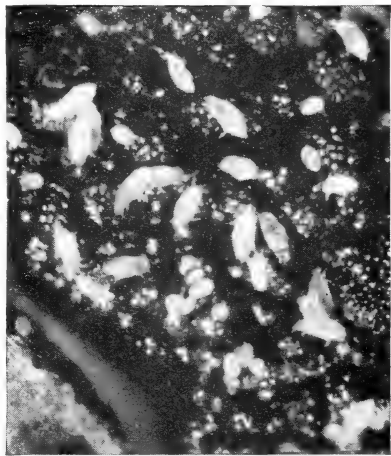

FIGURE 62.—Cyclamen mite, in its several stages, as it occurs in crevices of infested plant parts; 35 times natural size.



FIGURE 63.—Terminal growth of delphinium distorted and blackened by the feeding of cyclamen mites.

of 110° F. for 15 or 20 minutes, depending upon their size. The best time to do this is when the plants are lifted for division and transplanting. Where enough plants are to be treated they may be placed in a tray provided with suitable handles to facilitate handling during treatment. An even water temperature should be maintained by checking frequently with an accurate thermometer, adding more hot water as needed. Stir the water with a paddle to keep it well agitated during the treatment. Set the treated plants in a mite-free place.

Prevention.—Since the mites are easily spread from plant to plant because they cling to the hands or tools, care should be exercised when working with plants known to be infested. Cleanse the hands and tools thoroughly before touching other plants.

Larkspur Leaf Miner

Another pest of garden delphinium is the larkspur leaf miner (*Phytomyza delphiniae* Frost). Its injury is twofold. The small maggots feed between the leaf surfaces and make an ugly blotch or blisterlike mine similar to that produced by the burdock leaf miner (fig. 48, p. 30). The adult flies puncture the leaves from the under side, and the punctured tissue turns brown and dies. Both summer and early fall growth of larkspur is attacked. As many as six or

more maggots may be found feeding in one mine. When they are full-grown they come to the leaf surface, pupate, and transform to small two-winged flies. Several generations occur during the season: The seedlike pupae of the last generation are thought to overwinter in the soil.

Treatment.—Remove and destroy all infested leaves, thus killing the insects therein. Spray thoroughly with nicotine sulfate or pyrethrum if the infestation is severe.

Prevention.—Remove and burn all plant remains in the fall, and cultivate thoroughly the soil around the base of the plants to destroy any overwintering pupae that might be present.

Other Pests of Delphinium

	Page
Red spiders.....	11
Stalk borer.....	34
Japanese beetle.....	45
Asiatic garden beetle.....	21
Rose bud worm.....	83

DOGWOOD

Dogwood Borer

The caterpillar of the dogwood borer (*Thamnosphesia scitula* (Harris)) makes an irregular burrow under the bark on the trunk, around the base of limbs, or frequently at the edges of wounds or scars on dogwood trees. Small trees or the base of branches may be girdled, or old wounds enlarged. Healthy trees may be attacked by this borer. The whitish caterpillars pass the winter in the burrows under the bark, where they complete their feeding and transform to pupae in the spring or early summer. When full-grown they are about ½ inch long. The adult clear-winged moths emerge from late in the spring until after midsummer and lay their eggs on the bark, usually in places where it is roughened. This insect also infests pecan trees and is sometimes called the pecan borer.

Treatment.—Examine the trees late in the summer and in spring for evidence of injured bark or of fine boring dust being pushed from the burrows, and cut out the borers with a sharp knife. Small wet areas on the bark earlier in the summer may indicate the presence of the young borers just starting to work. It is advisable to clean the dead material from the larger wounds, trim the edges smoothly back to green bark, and then paint the wound with shellac or a tree-wound dressing.

Flathead Borers

Transplanted dogwood trees, or those seriously weakened from other causes such as drought, defoliation, or scale insects, are often attacked by one or more species of small wood borers, known as flatheaded borers. The flat-headed apple tree borer (*Chrysobothris femorata* (Oliv.)) is one of the more common species and attacks many kinds of deciduous shade trees, fruit trees, and shrubs. The adult beetles emerge in late spring and early summer and are attracted to weakened trees and shrubs, where they lay their eggs in bark crevices. The grubs make broad, irregular tunnels filled with boring dust under the bark. When nearly full-grown, in late fall or spring, they bore into the wood, where pupation occurs prior to the time of adult emergence. The yellowish-white legless grub (fig. 64) is about an inch long when mature. The body is somewhat flattened, and the first segment just back of the head is much broader than the remainder of the body. The adult is a brownish, metallic, flattened beetle about ½ inch long, blunt at the head end, and more pointed at the posterior end.

Another flatheaded borer, *Agrilus cephalicus* Lec., attacks weakened or dying dogwood trees in a similar manner. The whitish grubs are elongate and flattened, but the segment back of the head is not enlarged so much as that of the species discussed above.

Treatment.—Since these beetles attack seriously weakened trees, the best preventive is to keep the trees growing



FIGURE 64.—Larva, or grub, of the flat-headed apple tree borer in a tunnel under bark. Slightly enlarged.

vigorously. Wrapping the trunks of newly transplanted trees with either burlap or heavy paper will often prevent egg-laying on the bark. The wrapping should extend from the ground line to the branches or higher on the trunk if the branches are low. Apply the wrapping by the first of May and maintain it in good condition during the first season or two, or until the trees are making good growth. Where borers are present they may be cut out with a sharp knife. If they have entered the wood they can usually be killed by injecting a few drops of carbon disulfide (p. 103) into the tunnel and immediately closing the opening with putty, grafting wax, or moist clay to retain the fumes. The presence of young borers may be indicated by wet spots on the bark when they first penetrate the inner bark tissue, or later by deadened, sunken bark areas over the borer tunnels.

Another method is to treat the infested areas with a borer paint consisting of 1 pound of paradichlorobenzene dissolved in 2 quarts of hot cottonseed oil. The paint penetrates the galleries and kills the grubs. Applications should be confined to the wet spots so as to avoid injury that will result if excess paint is allowed to run down the bark.

Dogwood Twig Borer

Wilting leaves on individual twigs or the dropping of girdled tips usually indicates the work of the dogwood twig borer (*Oberca tripunctata* (Swed.)). Early in the summer the small, cylindrical beetle girdles the tip of a small branch and below this, or between two separate girdles, deposits an egg in the bark. The hatching grub tunnels down the center of the twig, expelling the boring dust through a row of small holes in the bark. A portion of the hollowed branch may occasionally be cut off from within. The winter is passed by the yellowish, legless, larva, or grub, about $\frac{3}{8}$ inch long, in the tunnel (fig. 65), and the adult beetles begin emerging late in the spring. Dogwood, elm, fruit trees, viburnum, and occasionally other shrubs are attacked, but ordinarily the beetle occurs in small numbers.

Treatment.—Clip off the tips several inches below the girdle soon after wilting occurs, or remove and burn the portion containing the borer at any time before spring.

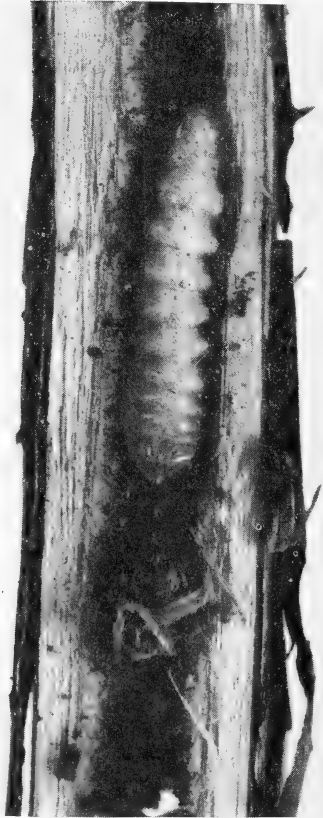

FIGURE 65.—Larva of the dogwood twig borer in a stem. About $2\frac{1}{2}$ times natural size.

Dogwood Club-Gall Midge

The spindle-shaped or tubular swellings, from $\frac{1}{2}$ to 1 inch long, found at the tips or along the stems of small dogwood twigs are insect galls, commonly known as the dogwood club gall (fig. 66). They are caused by a tiny two-winged fly or club-gall midge (*Mycodiplosis alternata* Felt) which deposits its eggs in the tender bark in the spring. The maggot develops inside the resulting swelling and deserts the gall late in the summer. Some of the twigs may be killed above the infested portion and the tree partially deformed if the infestation is heavy.



FIGURE 66.—Twigs showing dogwood club galls. Natural size.

Treatment.—No satisfactory means of preventing infestation is known. On small trees isolated from other infested dogwoods, however, cutting off and destroying the galls soon after they have formed or before the maggots have left them late in the summer will hold an infestation in check.

Dogwood Scale

Trunks and limbs of dogwood heavily infested with the dogwood scale (*Chionaspis corni* Cool.) have a whitish, scurfy appearance from the numerous scale insects attached to the bark. This scale insect resembles the scurfy scale shown in figure 78. The female scales are roughly pear-shaped, grayish, and about $\frac{1}{10}$ inch long, whereas the males are narrow, with sides parallel, and pure white. The winter is passed in the egg stage under the female scales. When numerous, these small sucking insects weaken the trees or kill the heavily infested branches.

Treatment.—Apply an oil spray or a lime-sulfur spray, diluted for dormant spraying, in the spring just before new growth starts. The young usually begin hatching when the leaves are about $\frac{1}{2}$ inch long, and many of them can be killed by making two or more

applications of a nicotine sulfate and soap solution or a single application of white-oil emulsion (p. 100) about 10 days or 2 weeks apart.

Other Pests of Dogwood

	Page
Leafhoppers.....	10
Mulberry whitefly	22
Oystershell scale	56
San Jose scale	57
Melon aphid	90
Cottony maple scale.....	47

EUONYMUS

Euonymus Scale

The euonymus scale (*Unaspis euonymi* (Comst.)) is a widespread and serious pest of both deciduous and evergreen species of euonymus. It also infests bitter-sweet and pachysandra. When numerous, these tiny sucking insects may coat both stems and leaves and seriously weaken or kill the plants. The female scale is flattened, roughly pear-shaped, brownish, and about $\frac{1}{16}$ inch long. The male scale, however, is white and narrow. These white scales often look like frost on the green leaves (fig. 67) and stems. The insect appar-



FIGURE 67.—Leaf infested with the euonymus scale. About 3 times natural size.

ently overwinters as a full-grown scale. In the Central Atlantic States there are three generations, the young of the first usually hatching about the middle of May, the second about the latter part of June, and the third in August.

Treatment.—Apply a dormant-strength oil spray just before growth starts in the spring. Before spraying, remove and burn all heavily infested parts that can be spared. When the young are hatching, as indicated above, spray with a combination of white-oil emulsion and nicotine sulfate (p. 101), or make several applications of a nicotine sulfate and soap solution.

Other Pests of Euonymus

	Page
Bean aphid.....	63
San Jose scale.....	57
Cottony maple scale.....	48
Lilac leaf miner.....	58

FERNS

Florida Fern Caterpillar

In the Southern States a cutworm known as the Florida fern caterpillar (*Callopietria floridensis* (Guen.)) often becomes a serious menace, especially in the larger ferneries. The caterpillar feeds on the foliage and disfigures the plants. Two color phases of the caterpillars (fig. 68) are present when full-

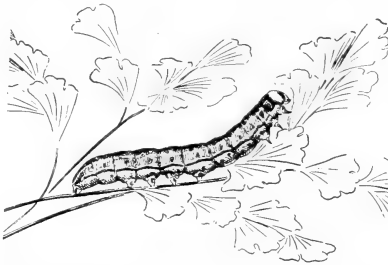

FIGURE 68.—Florida fern caterpillar. About natural size.

grown, one a pale green and the other a velvety black. At this stage they are nearly 1½ inches long. Various other caterpillars, including cutworms (p. 2) and army worms (p. 2), also feed on and injure ferns.

Treatment.—Same control as for cutworms (p. 2). Pyrethrum, used either as a spray or a dust, is also effective against the young caterpillars.

Two-Spotted Spider Mite

The two-spotted spider mite (*Tetranychus bimaculatus* Harv.) infests the fern asparagus in Florida and can cause severe injury. These mites feed in the new shoots and cause them to turn brown and become stunted. The foliage of the Boston type of ferns is also subject to attack by this pest, which causes the leaves gradually to turn brown and die.

Treatment.—Spraying several times with the combination of derris and sulfonated castor oil (p. 99), repeating the application at intervals of a week, is recommended. Frequent syringing with water is helpful.

Prevention.—Keep down all weeds in and around fern plantings.

Hemispherical Scale

Several scale insects attack both indoor and garden ferns, and of these the hemispherical scale (*Saissetia hemisphaerica* (Targ.)) is most often encountered. Like other scale insects, this species feeds by sucking the plant juices. This causes a weakening of the portions that are attacked. The large amount of honeydew which it excretes forms an ideal medium for the growth of sooty fungus. The blackening of the fronds ruins the ornamental value of ferns. In addition, ants and other insects are attracted by the honeydew. This scale insect is similar in size, color, and shape to the soft scale (p. 43), except that it is more swollen so that it has a hemispherical appearance (fig. 69). It varies from a



FIGURE 69.—Hemispherical scale on a palm stem. Three times natural size.

light to a dark brown. It is about $\frac{1}{2}$ inch in length and a little less in width. This species feeds also on arborvitae, ardesia, bachelor's button, begonia, bougainvillea, camellia, chrysanthemum, crape myrtle, croton, cycas, mountain-holly, oleander, palm, rose, and rubber plant.

Treatment.—Spray two or three times at intervals of 10 days with nicotine sulfate and soap or a thio-cyanate solution (p. 102).

Other Scale Insects

Various mealybugs and so-called soft scales may become a serious problem in ferns, especially in flower boxes in the North. In the warmer regions they are troublesome in gardens where ferns are grown for ornamentals.

Treatment and prevention.—Same treatment as given for mealybugs on page 31.

Other Pests of Ferns

	Page
Yellow woolly bear.....	3
Aphids.....	9
Grasshoppers and crickets.....	9
Black vine weevil.....	93

GAILLARDIA

Gaillardia is subject to attack by many of the insects that feed on a wide range of plants. The following, which have been discussed elsewhere, are often encountered:

	Page
Asiatic garden beetle.....	21
Stalk borer.....	34
Four-lined plant bug.....	94
Leafhoppers.....	10
Flower thrips.....	74
Aphids.....	9
Red spiders.....	11

GARDENIA

Citrus Whitefly

In the Southern States, where gardenia, or cape-jasmine, grows well out of doors, the citrus whitefly (*Dialeurodes citri* (Ashm.)) is often a serious pest. The adults and larvae extract the plant juices and cause an unhealthy appearance. They also excrete honeydew, upon which an unsightly sooty mold grows and spoils the ornamental value of the plants. This insect also attacks allamanda, Boston ivy, English ivy, crapemyrtle, laurel, lilac, privet, Osage-orange, smilax, trumpetvine, umbrella-tree, and citrus trees. The adults are very tiny, pale yellow, with white powdered wings, similar to those of the

greenhouse whitefly shown in figure 31, page 18. The larvae are thin, flat, oval, and about $\frac{1}{8}$ inch in diameter. They are nearly transparent, hence are difficult to see on the under sides of the leaves. The pupae (fig. 70) are similar in shape and size and vary in color from yellowish to brownish. They somewhat resemble small scale insects. Other species of whiteflies also attack gardenia.

Treatment.—Same as for greenhouse whitefly (p. 18).



FIGURE 70.—Pupae of the citrus whitefly on an orange leaf. About one-half natural size.

Soft Scale

The soft scale (*Coccus hesperidum* L.), also known as the soft brown scale, is a rather serious pest of gardenia, especially in the Southern States and California. The insect is soft, greenish brown or yellowish green, often with a marbled or ridged effect across the back. It is oval, rather flat (fig. 71), and is nearly $\frac{1}{8}$ inch long. It often resembles the color of the plant part on which it occurs. The soft scale encrusts the twigs and leaves and imparts a lumpy appearance. As a result of its sucking of the sap, the plant growth becomes

weakened and stunted. These insects produce large quantities of honeydew, which drops to the leaves below. As in the case of whiteflies, a sooty fungus develops upon the honeydew, which smuts the foliage and mars the beauty of the plants. The soft scale attacks a wide range of plants, including abutilon, araucaria, bougainvillea, camellia, clematis, ferns, hawthorn, hibiscus, holly, ivy (English), morning-glory, oleander, palms, phlox, pittosporum, poinsettia, rose, wistaria, and others.



FIGURE 71.—Soft scale on the under side of a leaf. About natural size.

Treatment.—Spray two or three times at intervals of 10 days with the white-oil emulsion, as recommended for mealybugs (pp. 31, 101).

Fuller's Rose Beetle

Fuller's rose beetle (*Pantomorus godmani* (Crotch)), while preeminently a greenhouse pest, occasionally becomes a serious menace in the flower garden. Both the larvae and beetles are destructive, the former attacking the roots, and the latter feeding on the foliage, buds,

and flowers, and at times severing the leaves. The adult beetles do most of their feeding at night. The beetles also make the plants unsightly by their deposits of black excrement. The beetle (fig. 72) is brown or grayish, about 3/8 inch long, with a short snout, and a white diagonal stripe across each side. Among the plants injured by this insect are achrysanthes, azalea, canna, camellia, chrysanthemum, deutzia, dracaena, gardenia, goldenglow, hibiscus, lilies, palm, and rose.



FIGURE 72.—Fuller's rose beetle. About twice natural size.

Treatment.—Where only a light infestation exists, jar insects from the plants into a pail containing water and oil. Apply a spray or a dust containing 50 percent of barium fluosilicate or cryolite (p. 97). A pyrethrum powder (containing at least 0.4 percent of pyrethrins) (p. 98) will kill those beetles actually covered by the powder. Lead arsenate spray serves as a repellent.

Prevention.—Large woody plants may be protected from adult feeding by banding them with sticky material or other barriers, since the beetles cannot fly and must crawl up the plant to feed. None of the branches should be permitted to touch the ground.

Other Pests of Gardenia

	Page
Citrus mealybug.....	31
Long-tailed mealybug.....	31
Greenhouse orthozia.....	32
Flower thrips.....	74

GERANIUM

Orange Tortrix

The caterpillar of the orange tortrix (*Argyrotaenia citrana* (Fern.)) webs and often rolls the leaves on which it feeds. It is a flower-garden pest in the warmer climates, especially in southern California. Among the plants it feeds on are asparagus, begonia, geranium, gold-enrod, Jerusalem-cherry, lantana, laven-

der, rose, wandering-jew, and the foliage of various trees. It bores into the rind of oranges. The full-grown caterpillar is a little over half an inch long and varies from greenish white to dark gray. The small adult moth is gray.

Treatment.—Same as for greenhouse leaf tier (p. 5).

Other Pests of Geranium

Greenhouse whitefly.....	18
Red spiders.....	11
Cabbage looper.....	3
Corn earworm.....	29
Oblique-banded leaf roller.....	83
Aphids.....	9
Greenhouse leaf tier.....	5
Mealybugs.....	30
Cottony-cushion scale.....	71
Fuller's rose beetle.....	44

GLADIOLUS

Gladiolus Thrips

The gladiolus thrips (*Taeniothrips simplex* (Morison)) is at present the worst insect pest of gladiolus. The thrips feeds on the corms while in storage, and the fed-over areas become russeted. The infested leaf sheaths become brown and the leaves "silvered," and the bud sheaths dry out and appear straw colored. The flowers (fig. 73)



FIGURE 73.—Gladiolus thrips injury on flowers. Note bleached areas on petals.

have whitish streaks, and in severe cases the spikes never show color but turn brown and appear blighted. The adult thrips is a very tiny insect. It has a brown body and a white band at the base of the featherlike wings. These insects (fig. 74) are not often seen unless the plants are carefully examined, because they usually conceal themselves in the leaf sheaths, although they come to the surface to feed under favorable conditions.

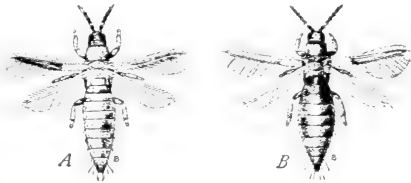

FIGURE 74.—Gladiolus thrips: A, Adult male; B, adult female. Twenty times natural size.

Treatment.—After harvesting the corms, allow them to dry for a month. Then remove the old corms and hulls and treat the clean corms with naphthalene flakes, using 1 ounce (4¾ level tablespoonfuls) for every 100 corms, or 1 pound (1 quart) for 2,000 corms. For small lots, place corms in a tight paper sack and scatter the flakes among them, then fold over and fasten the top of the bag tightly to retain the fumes. Remove the naphthalene after about 4 to 6 weeks and then store the corms in an insect-free place. This treatment may be used at any time in winter, preferably between November 1 and March 1. In southern and warmer regions, apply the treatment according to the cultural program but not until corms have dried at least 3 to 4 weeks after digging. Do not use a covered tin can or other tight container, as the corms will "sweat" and sprout during the treatment and be injured.

If it is impossible to use naphthalene, the corms may be treated with mercuric chloride, preferably just prior to planting, to avoid the necessity of drying out the corms if they have to be returned to storage. Use this chemical at the rate of 1 ounce to 7½ gallons of water (1 to 1,000), and keep the corms immersed in the dip for 12 to 17 hours. If the corms are peeled, a soaking of 7 hours will suffice. See the caution and further instructions regarding the use and handling of this poison as given on page 102.

If infestation develops in the garden

or field plantings, spray when the first sign of injury appears. Spray with a solution made up of 1 ounce (6½ level teaspoonfuls) of tartar emetic, 2 ounces (½ cup) of brown sugar, and 3 gallons of water. Repeat the application weekly until flowering begins. Apply the spray as a fine mist and repeat if heavy rains occur within 12 to 24 hours after the application. If it is necessary to continue spraying during the flowering period, all spikes showing color should be cut for use before each application. If tartar emetic is not available, the paris green formula (p. 96) may be used.

Prevention.—Plant only thrips-free corms. At harvesttime avoid shaking thrips-infested tops over the corms. The corms should be removed from the garden as soon as possible to prevent thrips from reaching them.

Note: Several other species of thrips may often attack gladiolus along with the gladiolus thrips, but the spraying program outlined above will control these also.

Grape Mealybug

Gladiolus corms are often attacked, especially while in storage, by the grape mealybug (*Pseudococcus maritimus* (Ehrh.)). These insects cluster around tender shoots and root buds, where they suck the plant juices. This results in a weakening and stunting of the subsequent growth. When the corms are heavily infested they are literally covered with these insects. This mealybug is similar in habits and appearance to the citrus mealybug (p. 31), except that it does not have the body so heavily coated with the white waxy or mealy covering. It feeds on a wide range of food plants in addition to gladiolus. These include, among others, California poppy, columbine, carnation, grevillea, English ivy, Japanese quince, Japanese yew, palm, and poinsettia.

Treatment.—For bulbs, same as recommended for the control of root aphids on tulip bulbs (p. 87). On growing plants use the remedies given for mealybugs (p. 31).

Other Pests of Gladiolus

Red spiders.....	11
Corn earworm.....	29
Yellow woolly bear.....	3
Blister beetles.....	7
Asiatic garden beetle.....	21
Tarnished plant bug.....	35
Stalk borer.....	34
European corn borer.....	36
Flea beetles.....	8
Aphids.....	9
Tulip-bulb aphid.....	87
Bulb mite.....	61

GOLDENGLOW

Goldenglow Aphid

Goldenglow, or rudbeckia, is often attacked by the goldenglow aphid (*Macrosiphum rudbeckiae* (Fitch)), a large, shining, red or dark-brown plant louse. The aphids gather in large colonies on the tender shoots, leaves, and flowers and cause injury similar to that done by other plant lice. Chrysanthemum, lettuce, goldenrod, ragweed, sunflower, and Fuller's teal are among the other plants which it attacks.

Treatment.—Same as for aphids (p. 9).

Other Pests of Goldenglow

	Page
Asiatic garden beetle.....	21
Stalk borer.....	34
Tarnished plant bug.....	35
Four-lined plant bug.....	41
Fuller's rose beetle.....	99
Red spiders.....	11

HAWTHORN

Thorn-Leaf Aphid

The thorn-leaf aphid (*Anuraphis crataegifoliae* (Fitch)) attacks the young leaves of hawthorn early in the spring. The sucking of the plant juices causes the young leaves to curl and the older leaves to become crinkled. This aphid is usually pinkish or yellowish green. Many of the winged forms migrate to clover and similar plants about mid-summer. They return to hawthorn in the fall to deposit the overwintering eggs. Several other species of aphids may at times also infest hawthorn.

Treatment.—See treatment under Aphids (p. 9). To protect the young foliage, control measures should be applied about the time the new leaves start growing.

Hawthorn lacebugs

Several species of lacebugs belonging to the genus *Corythucha* commonly attack the foliage of hawthorn. These very small sucking insects feed on the under sides of the leaves, where they deposit small spots of dark excrement. When numerous they cause the badly infested foliage to become discolored and fall prematurely. These lacebugs resemble the chrysanthemum lacebug (p. 28) in appearance.

Treatment.—Same as for the chrysanthemum lacebug (p. 28).

Eastern tent caterpillar

The appearance of hawthorn is at times marred by the conspicuous, unsightly "tents," or nests (fig. 75), of the eastern tent caterpillar (*Malacosoma americana* (F.)). These tents are constructed in early spring in the forks or crotches. When abundant, the larvae, or caterpillars, often strip the leaves, thus weakening the trees. Wild cherry and apple are their choice food, although they also feed occasionally on barberry, witchhazel, rose, and other shrubs and trees. The caterpillars are a nuisance late in the spring, when they crawl around in search of more food or a place to spin their cocoons. In early summer the reddish-brown moths emerge and lay their eggs in the form of a dark-brown collarlike band that encircles small twigs (fig. 76). These eggs do not hatch until the next spring. The full-grown caterpillar is nearly 2 inches long, with a black to light-brown appearance, some white and blue markings, and a white stripe along the middle of the back.

Treatment.—Remove the web nest and destroy the caterpillars by crushing them on the ground. Any caterpillars left crawling around the tree or shrub



FIGURE 75.—Larvae and nest of the eastern tent caterpillar. Greatly reduced.



FIGURE 76.—Egg masses of the eastern tent caterpillar on twigs. About natural size.

should be killed. This should be done as soon as the nests are discovered and before the caterpillars have fed much. Spraying or dusting with lead arsenate is another effective means of control.

Prevention.—During the fall or winter cut off and burn the twigs containing the bands of eggs, or paint the egg masses with creosote.

Cottony maple scale

In late spring the white, cottony egg sacs of the cottony maple scale (*Pulvinaria vitis* (L.)) become conspicuous on the twigs of infested trees and shrubs. At this time these small sucking insects somewhat resemble the kernels of popped corn (fig. 77). Although soft maple is most commonly attacked, many other trees and various shrubs, including alder, dogwood, euonymus, hawthorn, ivy, lilac, rose, and spirea, are at times infested. The winter is passed as a partly grown, oval, flattened, brown scale on the twigs and branches. Growth is completed in the spring, and the cottony egg sac is produced under the raised end of the brown scale covering. The insect with protruding sac is $\frac{1}{4}$ inch or more in length. The young are usually hatching in June and July, and some of them may settle on the leaves until fall, when they crawl back to the twigs.



FIGURE 77.—Cottony maple scale on twigs. About twice natural size.

Treatment.—Spraying with a miscible oil or oil emulsion in the spring before the buds open will usually give good control. In the summer, when the young are hatching, many of them can be killed by spraying several times at about 2-week intervals with a nicotine sulfate and soap solution, or a combination of white-oil emulsion and nicotine (p. 101). Where a light infestation occurs on low shrubs, many of the insects can be rubbed off with a brush soon after the egg sacs have begun to form and before hatching has begun. Care should be taken not to injure the bark.

Scurfy Scale

The scurfy scale (*Chionaspis furfura* (Fitch)), (fig. 78), occasionally injures hawthorn. It also infests such trees as apple, ash, elm, and willow. This scale insect is similar to the dogwood scale (p. 41) in appearance and habits.

Treatment.—Same as for the dogwood scale (p. 41).

Other Pests of Hawthorn

	Page
San Jose scale.....	57
Rose scale.....	81
Spider mites.....	11



FIGURE 78.—The scurfy scale. About twice natural size.

HIBISCUS

Japanese Beetle

In several eastern States where the Japanese beetle (*Popillia japonica* Newm.) is abundant, the foliage and flowers may be completely destroyed on many plants. Hibiscus (or shrub-althea), flowering quince, flowering peach, flowering cherry, rose, hollyhock, dahlia, zinnia, and Virginia creeper are the garden plants most likely to be injured. The beetles feed during the warm part of the day, attacking the flowers (fig. 79) or skeletonizing the leaves and causing the remnants to burn brown and fall. The larvae, or grubs, feed on the roots of grasses and certain cultivated plants and often cause serious damage to lawns. The beetle is bright metallic green, with

coppery-brown wing covers, and is about $\frac{3}{8}$ inch long. The sides and tip of the abdomen are marked with white dots. The beetles appear in June and are numerous during July and August.

Treatment.—Spraying the foliage with lead arsenate at $1\frac{1}{2}$ times the usual strength (p. 95) with a suitable sticker such as wheat flour, or repeated spraying with 5 ounces of derris powder plus $5\frac{1}{2}$ ounces of rosin residue added to 10 gallons of water, will usually give some protection. Pyrethrum will kill such beetles as are hit by the spray. Since the Department has several publications on the life history, habits, and control of this insect, anyone interested in obtaining more detailed advice should write directly to the United States Department of Agriculture.



FIGURE 79.—Japanese beetles feeding on rose blossoms. Two-thirds natural size.

Abutilon Moth

The caterpillar of the abutilon moth (*Anomis erosa* Hbn.) somewhat resembles the cabbage looper in appearance and habits, although it does not walk with a looping motion. It is sometimes found in considerable numbers in the flower garden feeding on abutilon



FIGURE 80.—Caterpillars of the abutilon moth on an abutilon leaf. About half natural size.

(fig. 80), hibiscus, and hollyhock. The discussion on the cabbage looper (p. 3) would also apply to this insect.

Treatment.—Same control as for the cabbage looper (p. 3).

Other Pests of Hibiscus

	Page
Corn earworm	29
Greenhouse whitefly	18
San Jose scale	57
Fuller's rose beetle	44

HOLLY

Holly Leaf Miner

The tiny maggots of the holly leaf miner (*Phytomyza ilicis* (Curt.)) mine inside the leaves of American and English holly. Each mine is winding and narrow, but gradually increases in width as the maggot develops. The mines are plainly visible on the upper leaf surface (fig. 81), where the mined tissue turns to yellowish green. The foliage on badly infested trees appears unhealthy and somewhat faded. The maggot, or larva, is pale yellow and about $\frac{1}{8}$ inch long when full-grown. The pupa is brown. The adult is a small grayish-black fly, about $\frac{1}{10}$ inch long. The insect passes the winter inside the infested leaves on the trees. In the spring when the new leaves are only partly grown the adults begin to emerge. Emergence continues for about 2 or 3 weeks, and during this time the flies deposit their eggs in punctures made in the new foliage. This introduced pest is widely distributed in the

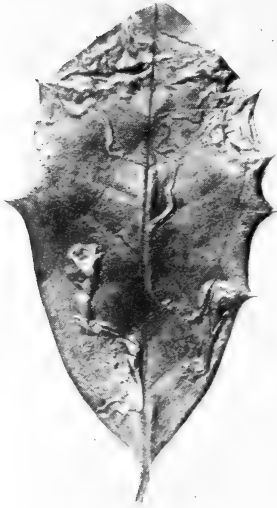

FIGURE 81.—Work of the holly leaf miner. Natural size.

East and also occurs in some States of the far West. In the more northern States it apparently develops only one generation annually.

Treatment.—Picking off and burning the infested leaves in the fall or winter is probably the best method of control on small trees. Spraying has not proved entirely satisfactory. However, several applications of nicotine sulfate spray or lead arsenate spray or nicotine dust during the period of adult emergence in the spring might be of some value. In the case of sprays the flies presumably feed on the poisoned fluids.

Holly Scale

The holly scale (*Aspidiotus britannicus* Newst.) attacks holly in the Pacific Coast States. These tiny sucking insects are found on the leaves, twigs, and berries. When numerous they weaken the trees. The scale is circular and flattened and about $\frac{1}{16}$ inch in diameter. The young apparently hatch during the summer months.

Other species of scale insects may occasionally infest holly in the East, but serious infestations do not appear to be very common.

Treatment.—Spraying with an oil spray in the spring before the buds open

has been reported as giving good control of the holly scale. The miscible oils or oil emulsions should be diluted as directed by the manufacturer for use on evergreens. The same treatment should prove satisfactory for other scale insects found on holly.

Other Pests of Holly

	Page
Citrus whitefly.....	43
Fall webworm.....	51
Spider mites.....	11

HOLLYHOCK

Red Spider

Red spiders are injurious to hollyhock and impart a sickly looking appearance to the plant attacked. In heavy infestations the leaves dry up and fall prematurely. Information on habits and treatment is given on page 11.

Stalk and Stem Borers

The stems and stalks of hollyhock are bored into and killed by the caterpillars of the stalk borer (p. 34) and the European corn borer (p. 36). Their presence is usually not recognized until the stems begin to wilt and break over. Further details on these borers are given on the pages indicated.

Red-Banded Leaf Roller

The red-banded leaf roller (*Argyrotaenia velutinana* (Walk.)) (fig. 82) has the habit of rolling and tying together

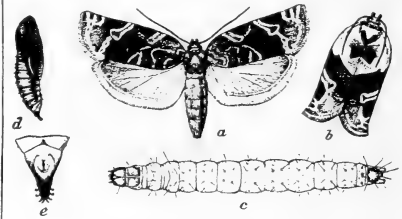

FIGURE 82.—Red-banded leaf roller: *a*, Female moth; *b*, moth with wings folded at rest; *c*, larva; *d*, pupa; *e*, tip of abdomen of pupa, showing abdominal hooks. *a-d*, about three times natural size; *e*, more enlarged.

the leaves and terminal growth. It attacks hollyhock, chrysanthemum, violet, rose, geranium, lobelia, honeysuckle, zinnia, and other plants. This insect has a wide distribution but is most common in the East. The caterpillar is greenish,

and when full-grown is nearly $\frac{3}{4}$ inch long. The caterpillar and its injury resemble those of the greenhouse leaf tier. The moth has red bands across the wings, from which it derives its name.

Treatment.—Same as for greenhouse leaf tier (p. 5).

Other Pests of Hollyhock

	Page
Abutilon moth.....	49
Painted lady.....	25
Yellow woolly bear.....	3
European corn borer.....	36
Stalk borer.....	34
Rose chafer.....	66, 75
Spotted cucumber beetle.....	7
Japanese beetle.....	48
Flea beetles.....	8
Bean aphid.....	63
Potato aphid.....	75
Leafhoppers.....	10
Tarnished plant bug.....	35
Flower thrips.....	74

HONEYSUCKLE

Fall Webworm

The fall webworm (*Hyphantria cunea* (Drury)) is widely distributed and primarily a pest of many shade and forest trees. It occasionally infests woody shrubs, and when food is scarce it may invade the flower garden. The caterpillars spin a tentlike web at the ends of the branches, enclosing the foliage on which they feed (fig. 83). When the cater-

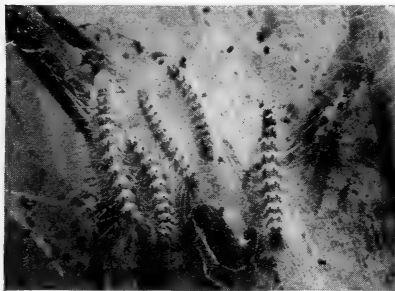

FIGURE 83.—Nest of the fall webworm. Greatly reduced.

pillars are numerous, entire branches may be enclosed in these unsightly, whitish webs. The caterpillar is hairy, with long grayish-brown hairs arising from black and orange spots and shorter hairs between. It is about an inch long when full-grown and has a broad brownish stripe along the back. In the more northern States there is one generation, occurring after midsummer. Farther

south there are two generations, the first late in the spring and the second later in the summer. The thin cocoons are spun in protected locations or in the soil. From these the satiny-white moths emerge and lay their eggs in masses on the leaves.

Treatment.—Cut off the web nests containing the caterpillars while they are still small, and burn or destroy them. If they are abundant, spray or dust with lead arsenate before much of the foliage has been enclosed in the webs.

Honeysuckle Sawfly

The larvae of the honeysuckle sawfly (*Zaraea inflata* Nort.) occasionally strip the leaves from honeysuckle in the spring. The larvae resemble hairless or naked caterpillars and are about an inch long when full-grown. They are somewhat grayish, with several yellowish stripes along the body and a row of black spots down the back. After their feeding is completed they spin cocoons in the soil and remain there until the following spring, when the wasplike adults emerge to lay eggs for a new generation.

Treatment.—Spray with lead arsenate to poison the feeding larvae. Spraying or dusting with derris would very likely be effective against the young larvae.

Angular-Winged Katydid

The angular-winged katydid (*Microcentrum retinerve* (Burm.)), which is one of the so-called long-horned grasshoppers, feeds on the foliage of trees and certain shrubs. It occasionally deposits its eggs on the edges of leaves or on twigs or branches of various plants such as honeysuckle, rose, and aster. The oval, flat, scalelike eggs (fig. 84) are placed in neat rows so that they overlap; they are occasionally mistaken for scale insects. This insect is distinguished from other grasshoppers by its very long "feelers," or antennae. Usually it is not a destructive pest.

Treatment.—Remove and destroy portions of the plants bearing the eggs.

Other Pests of Honeysuckle

	Page
Oblique-banded leaf roller.....	83
Red-banded leaf roller.....	50
Oystershell scale.....	56
San Jose scale.....	57
Flea beetles.....	8
White-lined sphinx (see Hornworms).....	4
Aphids.....	9
Long-tailed mealybug.....	31

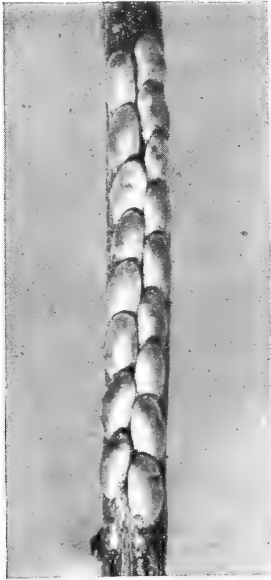

FIGURE 84.—Eggs of angular-winged katydid on rose. Twice natural size.

HYDRANGEA

Several pests occasionally cause injury to hydrangea. These have been discussed elsewhere, as indicated below:

	Page
Aphids.....	9
Tarnished plant bug.....	35
Red spiders.....	11
Rose chafer.....	66, 75

IRIS

Iris Borer

The iris borer (*Macronoctua onusta* Grote) injures the roots (fig. 85) and crowns of iris, including the Japanese and the Siberian types. Decay and blackening (or a tear-stain effect) of the leaves of infested plants are usually good indications of its presence. The injury becomes more evident during July and August. In heavy infestations entire plants are killed. The full-grown worm is usually pinkish, with a brown head, and about $1\frac{1}{2}$ to 2 inches long. Pupation takes place in the soil near the base of the plant. The adults are brownish moths which appear in the fall and lay the overwintering eggs, preferably on dead or dry leaves. The young caterpillars, on hatching in the spring, gnaw their way into the leaves and then work down to the roots, which they hollow out completely.

Treatment.—During the active growing season all plants should be carefully watched, and when injury is observed the appropriate treatment should be applied. The young caterpillars, if detected by the tear-stained appearance of the leaf while they are still mining in the foliage, can be mashed by pressing the infested parts between the thumb and forefinger. Spraying new growth early in the season with lead arsenate or nicotine sulfate at the time the first injury is observed may be of some value. Recent tests have shown that a derris-pyrethrum spray kills the young borers if it is applied as they are eating their way into the leaves or stems and before they have reached the roots. Such a spray may be prepared by mixing $2\frac{1}{2}$ ounces of derris powder (containing 4 percent of rotenone), 4 ounces of an alcoholic extract of pyrethrum, and $2\frac{1}{4}$ teaspoonfuls of a commercial spreader (p. 103) in 3 gallons of water. The method of mixing is discussed on page 99.

If an infestation is not detected until the borers have reached the roots, the plants should be lifted after they have flowered and all infested parts removed and destroyed. If the rhizomes have



FIGURE 85.—Caterpillar of the iris borer tunneling in a root. About half natural size.

considerable rot, the diseased parts should also be cut out and the cleaned divisions soaked in mercuric chloride solution (1 to 1,000) (p. 102) for 10 minutes. The plants should then be reset in a new location if possible.

Prevention.—Winter burning of debris and weeds reduces the possibility of reinfestation the succeeding season, since it destroys the overwintering eggs.

Iris Thrips

The iris thrips (*Bregmatothrips iridis* Watson), a recently introduced insect, is primarily a pest of iris, although it has been found on pokerplant. It feeds on the inner surface of leaf sheaths and on young leaves of many types of iris from May until November, and causes a rusty or sootlike blackening (fig. 86). A varying amount of stunting of the growth may also result. On Japanese iris the flower bracts and petals may be injured and in some cases the flowers become bloated. These insects are very tiny, like the gladiolus and other thrips (fig. 74, p. 45). The eggs are laid in the plant tissue, and the milky-white larvae and pupae are found together with the glistening dark-brown adults. The adult female thrips overwinter in the crown of the iris. Most adults are wingless, but winged ones

appear with the first generation and are present during the summer and early fall. Migration to other plants occurs in June when the winged forms are abundant.

Treatment.—For complete elimination of the thrips, immerse the plants for 30 minutes in water at a temperature of 110° F., when the plants are lifted and freed of soil. This can be done at the time of dividing and resetting the plants. Growing plants in beds may be treated by flooding them with water maintained at the desired temperature and confined in a cylinder pressed into the ground around the plant. Japanese iris should be treated preferably in the spring, but may also be treated in late summer or fall, provided the newly set plants are regularly watered. Bearded irises and southern types of iris should be treated only late in the summer or in the fall.

Satisfactory control may be obtained by spraying with a nicotine sulfate and soap solution, using 2 teaspoonfuls of nicotine sulfate in each gallon of soapy water. Spray eight times at weekly intervals, four times before and four times after the blooming period. The foliage should be thoroughly sprayed, with particular attention to the base of the fan of leaves, where the thrips occur; they are rarely found elsewhere on the plants. The gladiolus thrips (p. 45) also causes serious injury to iris at times. It differs from the iris thrips in that it prefers to feed on the flowers.

Iris Weevil

The iris weevil (*Mononychus vulpeculus* (F.)), while known to breed commonly in the seed pods of blueflag iris (*Iris versicolor*), occasionally attacks the flowers of Japanese, European, and native iris, making numerous small punctures in the seed pods. This causes much disfigurement by the formation of rough, corky, irregular scars. The eggs are laid in the iris ovary. The young fat grubs feed on the seeds and develop and pupate within the seed pods. The adults emerge when the pods burst open. They are about ½-inch long, black above, and covered below with yellowish and whitish scales. There is apparently only one generation annually, and the adults, which overwinter, appear in May or early in June. This weevil occurs in Canada, and in this country as far south as Georgia.

Treatment.—If seeds are not desired, remove and destroy all flower heads as soon as they are past their prime, to prevent the beetles from com-



FIGURE 86.—A, Uninjured leaf sheath of *Iris pseudacorus*; B, leaf sheath injured by iris thrips.

pleting their development within the seed pods. Spraying with lead arsenate may be effective against the adults if applied on the first evidence of injury.

Prevention.—Where seeds are desired, as in the case of choice or expensive varieties, the blossoms should be covered with cheesecloth bags to prevent the weevils from laying eggs in them. Clean up and burn all remains of iris plants late in the fall or early in the spring to destroy the overwintering weevils.

Lesser Bulb Fly

The lesser bulb fly (*Eumerus tuberculatus* Rond.) may sometimes be encountered along with the iris borer in rhizome or root iris, or where plants have become weakened for one reason or another. The maggots do not appear to be responsible for primary injury because they generally feed on injured, weak, or decaying tissue. The maggots (fig. 99, p. 61) are of a dirty whitish color and about 1/2 inch in length. The adult (fig. 98, A, p. 60) is somewhat like a housefly in appearance. This same insect is frequently found in bulbous iris, narcissus, and other flowering bulbs, and is discussed more fully on page 61.

Treatment.—When rhizome iris is infested, cut out and destroy the infested portions at the time the plants are lifted for dividing the clumps. For bulbous iris use the hot-water treatment as given on page 61.

Aphids

Among the aphids encountered on iris are the green peach aphid (p. 88) and the potato aphid (p. 75). In addition to weakening the plants by puncturing the tissues and sucking the plant juices, they serve as carriers for certain plant diseases. The tulip-bulb aphid, or iris aphid (p. 87), feeds chiefly on bulbous iris but sometimes attacks rhizomatous iris.

Treatment.—For aphids on the bulbs or rhizomes see treatment for the tulip-bulb aphid (p. 87). For aphids on the foliage, buds, or flowers see treatment for aphids (p. 9).

Other Pests of Iris

	Page
Red spiders.....	11
Verbena bud moth.....	88
Rose chafer.....	66, 75
White grubs.....	14
Wireworms.....	15
Slugs and snails.....	16

IVY

Oleander Scale

The oleander scale (*Aspidiotus hederae* (Vallot)), also called the ivy scale, often incrusts the leaves and stems (fig. 87) of English ivy, where it sucks the plant juices. It also attacks palms and many other semitropical plants. Heavily infested plants lose their vigor, turn pale, and die. The scales are usually circular, somewhat flattened, and about the size of a pinhead. The tiny male scales are pure white and often more abundant than the females. The females are light buff, with a faint tinge of purple, and from two to three times as large as the males. Several other species of scale insects may at times infest English ivy, especially in the warmer regions.

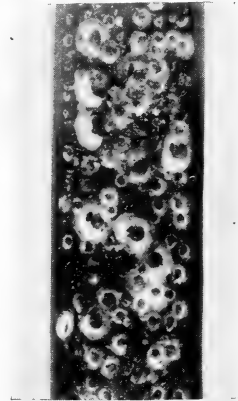

FIGURE 87.—Oleander scale on ivy stem. About 3 times natural size.

Treatment.—Spray several times with a white-oil emulsion (p. 100), preferably during the late fall or early spring. Prune out all severely incrustated vines.

Other Pests of Ivy

	Page
Red spiders.....	11
Leafhoppers.....	10
Aphids.....	9
Mealybugs.....	31
Soft scale.....	43
Eight-spotted forester.....	91
Hornworms.....	4
Cabbage looper.....	3
Puss caterpillar.....	6

JUNIPER

Juniper Webworm

The small caterpillars of the juniper webworm (*Dichomeris marginella* (F.)) web together in masses the needles and tips of junipers (fig. 88). They feed on the surface of the needles, causing the foliage in the webbed portions to turn brown and die. The caterpillars spend the winter in the webbed nests in a partly grown condition and complete their feeding the following spring. They are reddish brown, with lighter stripes along the body, and when full-grown are about $\frac{1}{2}$ inch long. The moths emerge from the webbed nests in the late spring to lay eggs. There is probably only one generation of caterpillars a year in the Northern States, but it is possible that more than one might develop farther south.



FIGURE 88.—Needles and tips of juniper webbed by the juniper webworm.

Treatment.—Spray with lead arsenate about midsummer to poison the young caterpillars. Where the infestation is heavy, additional spraying may be necessary later in the summer and again the following spring. A pyrethrum or nicotine sulfate spray will kill many of the caterpillars if applied with enough force to penetrate the webbed nests and wet the insects. Better penetration would no doubt be obtained if the webbed tips were first separated. Where only small branches are infested these could be cut out and destroyed.

Juniper Scale

Junipers badly infested with the juniper scale (*Diaspis carueli* Targ.)

appear sickly and make poor growth. The foliage may have a grayish appearance where covered with these minute, white, sucking scale insects (fig. 89). Arborvitae, incense cedar, and cypress are also sometimes infested. The scale covering the female insect is round and convex and about $\frac{1}{20}$ inch in diameter. It is white and has a yellow center, which is the shed skin of the young insect. The male scale also is white, but is smaller and narrow and has a ridge down the center. The insect passes the winter in a nearly full-grown condition. The young are usually hatching during the first half of June.



FIGURE 89.—Juniper scale on needles of juniper. About twice natural size.

Treatment.—Spray with a miscible oil or oil emulsion in the spring just before the plants begin to grow. A lime-sulfur spray may be used in place of the oil, but it leaves a yellowish deposit on the foliage for some time, and will also discolor paint. For the young scale insects in late spring, spray with a combination of nicotine, soap, and summer oil (p. 101), or spray several times at 10-day intervals with a nicotine sulfate and soap solution.

Oil sprays may injure certain pyramidal-type junipers, such as *Juniperus excelsa stricta*, because the oil collects in the small cavities or pockets formed by the upright needles. On such trees use lime-sulfur or the nicotine sprays.

Red Cedar Aphid

The red cedar aphid (*Cinara sabinæ* (Gill. and Palm.)) usually attacks the junipers of the type called red cedars. The aphids occur in masses along the twigs and smaller branches, where they

suck the sap for food. Infested branches may be weakened or killed. This aphid is about $\frac{1}{8}$ inch long, reddish brown, and its body is partly covered with a white powdery secretion. The aphids are not easily noticed because their color resembles that of the bark; however, the presence of ants, wasps, and flies about the trees, attracted by the honeydew excreted by the aphids, may call attention to them. Infestations occur in the spring, and the aphids apparently leave the trees before midseason. Frequently the injury is not noticed until after the insects have left, and the only evidence that remains is the sooty appearance of the foliage caused by a black mold that develops in the honeydew.

Treatment.—See treatment for aphids (p. 9).

Other Pests of Juniper

	Page
Bagworm.....	19
Spruce spider mite.....	85

LILAC

Lilac Borer

The lilac borer (*Podosesia syringae syringae* (Harr.)) is the caterpillar of one of the clear-winged moths. The borers tunnel under the bark and into the wood (fig. 90), weakening the stems or girdling



FIGURE 90.—Work of the lilac borer.

them and causing the foliage to wilt. Roughened scars showing the old borer holes may occur on the larger stems at places where the borers have worked for several seasons in succession. The caterpillar is creamy white and about $\frac{1}{4}$ inch long when full-grown. It passes the winter in the tunnels in the stems. The adult moths emerge in the spring and early summer and usually lay their eggs on roughened or wounded places on the bark. In addition to lilac, this borer attacks ash and mountain-ash, and occasionally privet.

Treatment.—Cut and burn before spring the dying and unthrifty stems containing the borers. During the summer watch for evidence of fine boring dust being pushed from small holes in the bark by the young borers and cut these out with a sharp knife. Where the borers have entered the wood they can be killed by injecting a few drops of carbon disulfide (p. 103) into the tunnels. The openings should be closed immediately with some gasproof material, such as grafting wax, putty, or wet clay, and kept closed for a day or two to retain the fumes. The larger wounds may then be cleaned and painted over with shellac or a tree-wound dressing. Sometimes where the tunnels are fairly straight the borer can be killed by probing with a flexible wire, or pulled out by means of a hooked wire to make certain of its destruction.

Oystershell Scale

The oystershell scale (*Lepidosaphes ulmi* (L.)) (fig. 91) is shaped like a miniature oystershell, about $\frac{1}{8}$ inch long and brown to brownish gray. When numerous these small sucking insects often coat the bark of twigs, branches, and smaller stems. The plants become weakened, produce undersized foliage, or may be killed if a heavy infestation continues. This scale insect is widely distributed and attacks many kinds of trees and shrubs, having been recorded on more than 100 different host plants. Among these are ash, boxwood, dogwood, lilac, maple, poplar, tree peony, and willow. Lilac is commonly attacked. One form of this scale also attacks fruit trees. The winter is passed in the egg stage under the female scales. Hatching of the young crawling stage starts in the spring about the time the apple blossoms are falling. A second generation of young is produced late in July and in August in the southern half of the country.



FIGURE 91.—Oystershell scale on a poplar twig. Twice natural size.

Treatment.—Apply an oil spray in the spring before the buds open, although frequently this treatment kills only part of the overwintering eggs. After the young begin hatching, spray several times, at intervals of about 10 days or 2 weeks, using a nicotine sulfate and soap solution, a white-oil emulsion, or a combination of the oil and nicotine (p. 101). On shrubs it is advisable to remove and destroy the dying and most heavily infested portions before spraying.

San Jose Scale

Shrubs and trees heavily infested with the San Jose scale (*Aspidiotus perniciosus* Comst.) have the twigs, branches, or stems covered with a grayish layer of tiny, overlapping, waxy scales. Injury by these sucking insects is usually indicated by dead or dying branches, poor vigor, and thin foliage. This scale insect has a wide distribution and is a common enemy of fruit trees. It also attacks many shrubs and shade trees, including ash, dogwood, hawthorn, honeysuckle, lilac, mountain-ash, and rose. The waxy scale covering the female insect is circular, about $\frac{1}{16}$ inch in diameter, with a slight elevation or nipple near the center, and grayish (fig. 92). The male scale is smaller and more oval. The insects pass the winter in a partly grown condition, and in this stage the scale is nearly black. Growth is completed in the spring, and

the young are then born alive. From two to six generations may be produced annually, depending on latitude and the length of the active season.

Treatment.—Since this insect winters in a partly grown condition it is more easily killed by dormant spraying than the oystershell scale. Spray with a dormant-strength oil spray or lime-sulfur in the spring before the buds open. A strong soap solution (p. 106) used at this time will give fairly satisfactory results. Prior to spraying, remove the dying and heavily infested portions that can be spared. During the late spring and summer, when the young insects are in the crawling stage, many of them can be killed with nicotine sulfate or a white-oil emulsion.

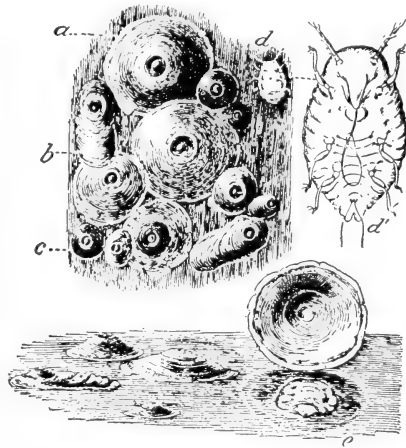

FIGURE 92.—The San Jose scale: *a*, Adult female scale; *b*, male scale; *c*, young scales; *d*, larva just hatched; *d'*, same highly magnified; *e*, scale removed showing body of female beneath. Eight times natural size.

Giant Hornet

The giant hornet (*Vespa crabro germana* Christ) has the habit of gnawing the bark from the smaller branches and stems of shrubs and trees. Irregular patches or rings of bark an inch or more wide may be removed and the branches girdled (fig. 93). The bark tissue is apparently used in building the nest. Lilac is rather commonly attacked, but birch, boxwood, dahlia, mountain-ash, poplar, rhododendron, willow, and probably others are at times injured. Although this European hornet has been in our country for many years, it is still

limited to a few of the Eastern States. The hornet is about an inch long, blackish with yellowish-orange markings, and somewhat hairy. It is often active until late in the evening. The large, dark, papery nest of this hornet is usually built in such protected places as tree cavities, between the rafters of buildings, or occasionally in holes in the ground.



FIGURE 93.—Lilac branch girdled by the giant hornet.

Treatment.—No satisfactory method of stopping the bark gnawing has been discovered. Probably the best method of control would be to trace the hornets to their nest and then destroy the colony. This might be done by soaking the nest with kerosene, by plugging the opening with cotton soaked in chloroform and then destroying the nest, or by injecting about a tablespoonful of carbon disulfide into the nest and closing the opening. Blowing or throwing about a handful of derris powder (containing 4 or 5 percent of rotenone) into the nest should be effective, since this material has proved effective against certain wasps and bees when dusted into their nests or placed where the insects must walk through it. Heavily dusting the portions of the branches upon which the hornet feeds with derris powder would also be worth trying. The treating of the nests preferably should be done during the night while

the hornets are inside. It would be advisable to wear heavy gloves and clothing and a veil to avoid being stung.

Lilac Leaf Miner

The young caterpillars of the lilac leaf miner (*Gracilaria syringella* (F.)) feed for a time inside the leaves, causing blotchlike mines which can be seen on the surface. After several weeks they abandon these mines, roll the leaves or web them together in masses, and feed on the inner surface of the curled foliage. This insect attacks ash, deutzia, euonymus, lilac, and privet. In the Northeastern States there are usually two generations of caterpillars, the first starting to mine the leaves about June and the second late in July or in August. The full-grown caterpillars are about $\frac{1}{2}$ inch long and yellowish. The adults are tiny moths. They lay their eggs in small groups on the leaves.

Treatment.—Spray with a nicotine sulfate and soap solution when the leaf mining starts, thoroughly wetting both surfaces of the foliage. If necessary, make a second application about 2 weeks later, using twice the ordinary amount of nicotine. Lead arsenate spray is useful if applied before many of the leaves have been rolled. Spraying or dusting with pyrethrum, as recommended for the greenhouse leaf tier (p. 5), might also be tried against the caterpillars in the rolled leaves. Where only a few leaves are infested, these can be picked off and destroyed, thus preventing a more serious infestation later.

Other Pests of Lilac

	Page
Oblique-banded leaf roller.....	83
Hornworms.....	4
Citrus whitefly.....	43
Melon aphid.....	90
Cottony maple scale.....	47
Scurfy scale.....	48
White peach scale.....	72
Euonymus scale.....	41

MARIGOLD

Potato Leafhopper

The potato leafhopper (*Empoasca fabae* (Harr.)) is often the cause of a peculiar diseaselike injury on the African marigold. Plants attacked by this insect show a curling and reddening of the leaflets and a stunting and killing of the young tips. Another phase of the injury is the complete wilting (fig. 94) of the tips and the young leaflets on some branches. These leaves become

yellow and dry, and new laterals develop below the point of injury. The adult is about 1/8 inch long and pale green with white markings (fig. 95). Damage to dahlia by this insect is discussed on page 35.



FIGURE 94.—Injury on marigold caused by the potato leafhopper.



FIGURE 95.—Adult of the potato leafhopper. About 6 times natural size.

Another species, the six-spotted or aster leafhopper (p. 20), feeds on marigold and causes the leaves to become stippled, turn brown, and die.

Treatment and prevention.—See leafhoppers (p. 10).

Other Pests of Marigold

Greenhouse leaf tier	5
Yellow woolly bear	3
Blister beetles	7
Cutworms	2
Stalk borer	34
Tarnished plant bug	35
Garden flea hopper	89
Red spiders	11

MORNING-GLORY

Golden Tortoise Beetle

Morning-glory, sweetpotato, and bindweed often have rounded holes eaten in the foliage, and sometimes entire leaves are devoured, by the larvae and adults of the golden tortoise beetle or "gold-bug" (*Metriona bicolor* (F.)). The adult is a beautiful golden-colored, oval, turtle-shaped beetle with black spots, and is about 1/4 inch long. The beetles overwinter in sheltered places, under bark, or in trash, and appear late in the spring. The curious-looking larvae, or grubs, are provided with spines, on which they carry around a shelter of excrement and shed skins.

Several other species of tortoise beetles cause injury somewhat similar to that described, including *Plagiometriona clavata* (F.), which often injures the leaves of Chinese-lantern plants (fig. 96).



FIGURE 96.—A tortoise beetle, *Plagiometriona clavata*, and its injury on a leaf of Chinese-lantern. About 6 times natural size.

Treatment.—Both species are controlled by spraying or dusting with lead arsenate. Usually they occur in only small numbers, so that they may be gathered by hand and destroyed.

Prevention.—Clean culture destroys their hiding quarters.

Morning-Glory Leaf Cutter

The caterpillar of the morning-glory leaf cutter (*Loxostege oblitalis* (Walk.)) injures morning-glory by cutting the leaf stalks and causing the leaves to

hang down and wilt. It also eats large holes in the leaves. The caterpillars hide during the day in shelters made by folding and rolling the wilted leaves. In the evening they come forth to feed. In heavy infestations the plants become unsightly from the drooping and dying foliage. The caterpillar is greenish, with dark spots on the body, and is about $\frac{3}{4}$ inch long when full-grown. It resembles somewhat the garden webworm (fig. 153, p. 90). The adult is a yellowish moth with faint brownish markings. This insect is also recorded as feeding on dahlia, hogweed, peppermint, spearmint, sunflower, violet, wandering-jew, and zinnia.

Treatment.—Spray or dust with lead arsenate to kill the young caterpillars. When the caterpillars are large, hand-picking is often sufficient to control them.

Other Pests of Morning-Glory

	Page
Melon aphid.....	90
Yellow woolly bear.....	3
Spotted cucumber beetle.....	7
Asiatic garden beetle.....	21
Corn earworm.....	29
Four-lined plant bug.....	91
Garden flea hopper.....	80
Greenhouse whitefly.....	18
Red spiders.....	11

MOUNTAIN-LAUREL

Some of the more common insects that attack mountain-laurel also attack rhododendron or azalea and are discussed mostly under those plants or in the places indicated below.

	Page
Rhododendron lacebug.....	73
Mulberry whitefly.....	22
Rhododendron borer.....	73
Azalea stem borer.....	24
Black vine weevil.....	93

NARCISSUS

Narcissus Bulb Fly

Of the several species of bulb flies that attack narcissus and other flowering bulbs, the narcissus bulb fly (*Lampetia equestris* (F.)) is the most important. The maggots of this species usually feed in the center of the bulbs (fig. 97) and are not detected until the injury is well advanced. The foliage turns yellow and is stunted, or at times no growth whatever develops. The legless maggots are dirty white or yellowish and about $\frac{3}{4}$ inch long, whereas the pupae are elongate, grayish brown, and segmented. Normally only one maggot inhabits a bulb, but two or three may be found. Infested bulbs usually feel spongy when squeezed. The larvae overwinter in the bulbs and come forth to pupate at the



FIGURE 97.—Maggot of the narcissus bulb fly and its work in the interior of a bulb. Slightly reduced.



FIGURE 98.—Adults of bulb flies. A, Lesser bulb fly; B, narcissus bulb fly. About twice natural size.

soil surface late in the spring. The adults (fig. 98, B), which appear a little later, resemble bumblebees. Bulbs attacked in addition to narcissus include amaryllis, hyacinth, iris, tulip, and several others.

Treatment.—Cull out all visibly

infested bulbs after digging them, to prevent the larvae from completing their development. A convenient method for the average gardener is to treat the stock for 1½ hours in hot water held at a temperature of 110°–111.5° F., following the procedure given for treating tulip bulbs infested with root aphids (p. 87). Dry the bulbs thoroughly before returning them to storage. Another method is to fumigate the bulbs with calcium cyanide, using the granular form, at the rate of 16 ounces to each 100 cubic feet of space with a 4-hour exposure in a tight fumigation chamber. The bulbs and chamber temperature should be held at about 75° F. during the exposure.

Caution.—Since calcium cyanide and the gas it produces are deadly poison, it should be used only by those familiar with the hazards involved.

Prevention.—There is little that can be done to eliminate an infestation after it has gained a foothold in the growing plants, except to dig up and destroy all weak and sickly looking plants and to dig up all blank spaces, as one is quite certain to find infested bulbs in such spots. Examine the bulbs carefully at planting time and destroy all that are definitely recognized as being infested.

Lesser Bulb Flies

Three species are often referred to as lesser bulb flies, but only one is of major importance, namely, *Eumerus tuberculatus* Rond. The maggots, on hatching, work their way into the interior of the bulb (fig. 99) and usually cause it to rot completely. Although the maggots can injure healthy bulbs, their presence is more often associated with weak, sickly, or decaying bulbs, or stocks that have been previously injured from other causes. Practically all flowering bulbs are attacked, as well as certain vegetable crops, including cabbage, carrot, garlic, onion, parsnip, potato, and shallot. Unlike the narcissus bulb fly, the maggots of this species occur in large numbers within a bulb. The maggots are about ½ to ¾ inch long, dirty grayish yellow, and wrinkled. They pupate in the bulbs or in the ground close to the bulbs. Two or more generations develop annually. The flies (fig. 98, A), which are about the size of a housefly, usually appear late in April or early in May and some are present throughout the summer. They are often found frequenting flowers, especially on bright sunny days. The eggs are laid near the base of the plant.

749493°—48—5



FIGURE 99.—Narcissus bulb showing maggots and injury of the lesser bulb fly, *Eumerus tuberculatus*. Slightly reduced.

Treatment and prevention.—Same as for the narcissus bulb fly, discussed above.

Bulb Mite

Several species of mites may attack the roots, bulbs, and corms of various flowering plants. The more important of these are the bulb mite (*Rhizoglyphus echinopus* Fum. and Rob.) and the bulb scale mite, discussed in the next section.

The bulb mite has many food plants, but narcissus, lily, crocus, amaryllis, dahlia, gladiolus, hyacinth, tuberose, and tulip are among the bulbous plants most frequently attacked. Mite-infested narcissus bulbs become soft and give easily when squeezed. The stem of an infested lily breaks over readily, and in a tuberose bulb (fig. 100) the embryo flower is destroyed. Mites are more of a problem in storage, where, under favorable conditions, an enormous population develops rapidly. Infested stocks, when planted, usually produce weak and sickly plants or no growth at all. This mite is usually considered a scavenger, feeding on weakened plants or plant parts, although it has been observed working in normal tissue. The mites (fig. 101) are very tiny, plump, oval, opaque, white-bodied creatures with reddish-brown legs and mouth parts. They move rather sluggishly.

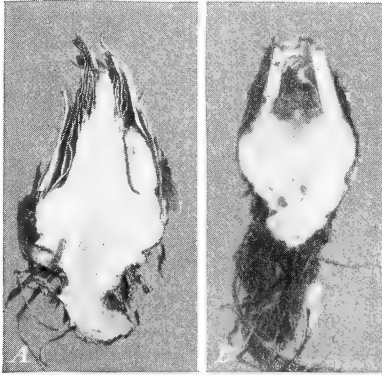

FIGURE 100.—Tuberoses cut in half to show: *A*, Uninjured tissue; and *B*, neck region and embryo flower destroyed by bulb mites.

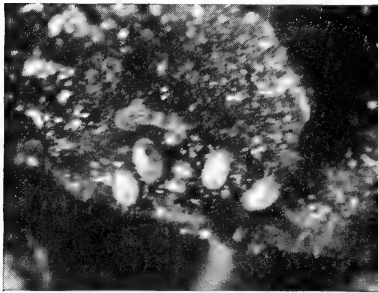

FIGURE 101.—Bulb mites. About 3 times natural size.

Treatment.—Carefully cull and burn or bury deeply all heavily infested stocks at the time they are being cleaned. The remainder of the stocks should be given the hot-water treatment as recommended for the bulb flies, discussed above.

Prevention.—When growing plants become infested, remove and burn them to prevent the mites from spreading to nearby plants. Planting in well-drained soil is recommended.

Bulb Scale Mite

The bulb scale mite (*Tarsonemus laticeps* Halbert) differs from the bulb mite in that it is definitely injurious to narcissus, is not associated with rots, and is closely related to the cyclamen mite (p. 38). Infested bulbs become spongy and soft in the neck region (fig. 102) because the mites work there, feeding between the leaves and flower stem.

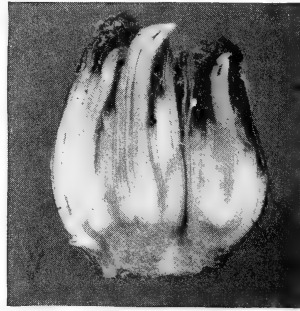

FIGURE 102.—Work of bulb scale mites in the neck region of a narcissus bulb. Bulb cut in half to show streaking of bulb scales.

When the leaves and flower stems grow upward, the fed-over areas show yellowish-brown scarlike streaks, a condition which may easily be confused with that caused by the mosaic disease of narcissus. This mite is chiefly a problem in commercial production but may at times cause serious concern to the gardener and hybridizer. It is so small that it cannot be seen with the naked eye, but small groups of mites look like grains of sand. When magnified, this mite can be distinguished from the bulb mite by the torpedolike appearance of the female and the fact that it moves somewhat faster.

Treatment and prevention.—Same as recommended for the preceding species, the bulb mite. In addition, do not store the bulbs in a warm place for too long a period prior to replanting in the fall; otherwise the mites will build up large populations, and the subsequent flowers and foliage of such bulbs will be severely injured.

Spanish Moth

The caterpillars of the Spanish moth (*Xanthopastis timais* (Cramer)) devour the leaves of narcissus, amaryllis, lilies, and tuberoses. They seem to concentrate their attack on certain spots in the planting and often completely eat the foliage to the ground. There are several color forms of the caterpillars, but usually they are brownish or grayish and smooth, about 2 inches long, and resemble those of cutworms, to which they are closely related. This species seems to occur more often in the Southeastern States, although its distribution range is from Maine to Argentina and in the West Indies. The pupa, which is dark brown, is found in the soil near the plant.

Treatment.—Spray with lead arsenate. The poisoned-bran mash recommended for cutworms (p. 2) may be useful, but its effectiveness has not been demonstrated.

Solanum Mealybug

Paper-white narcissus bulbs while in storage may become infested with the solanum mealybug (*Phenacoccus solani* (Ckll.)), especially in Florida, although the insect also occurs in California, New Mexico, Colorado, Arizona, Utah, and Mississippi. The infestation may become so abundant that the bases of the bulbs become covered with cottonlike masses. It is also a serious annoyance, since the storage crates and the woodwork of the storage houses may at times become covered with masses of mealybugs. This species somewhat resembles those shown in figures 44 and 51, pages 28 and 31. It is recorded from a wide range of plants, including ambrosia, aster, malva, nightshade, pansy, peanut, potato, tomato, and various weeds and shrubs. Apparently it migrates from these to the roots and bases of narcissus bulbs, and the infestation is brought into storage when the bulbs are harvested.

Treatment.—After the bulbs have been harvested and dried for at least 2 weeks, fumigate them with calcium cyanide, using $\frac{1}{2}$ -ounce for every 100 cubic feet of space, with an exposure lasting 5 hours. Follow the same procedure as recommended for the tulip aphid (p. 87). Infested crates should also be fumigated to free them of mealybugs. Spray the woodwork with a 5-percent miscible oil or white-oil emulsion if conditions warrant.

Caution.—Since calcium cyanide and the gas it produces are deadly poisons, this chemical should be used only by those familiar with the hazards involved.

Prevention.—Examine all bulbs carefully as they are harvested, and if infested bulbs are found, segregate these from uninfested ones. As soon as the infested bulbs have dried sufficiently they should be fumigated.

Other Pests of Narcissus

	Page
Red spiders	11
Flower thrips.....	74
Aphids.....	9
Leafhoppers.....	10

NASTURTIUM

Bean Aphid

The bean aphid (*Aphis fabae* Scop.), also known as the dock aphid, is the plant louse most often found feeding on nasturtium. It is small, slaty blue or black, and is seen in clusters on the under sides of the leaves, on the leaf stems (fig. 103), and other parts. The continuous feeding causes the leaves to turn yellow and the plants to become dwarfed and otherwise malformed. This aphid is also common on beans and other vegetable crops. In the fall it migrates to dock, euonymus, and possibly other shrubs. The following season it flies back to the summer food plants.



FIGURE 103.—Bean aphids feeding on nasturtium stem. About 3 times natural size.

The green peach aphid (p. 88) is another plant louse that occasionally feeds on nasturtium.

Treatment.—Same as for aphids (p. 9).

Imported Cabbage Worm

The imported cabbage worm (*Pieris rapae* (L.)), the adult of which is the white butterfly seen so frequently flying about on summer days, often leaves its preferred food plant and travels to the neighboring flower garden, where it feeds on nasturtium (fig. 104), mignonette, sweet alyssum, and several other ornamentals.

The butterfly lays the eggs. The caterpillars, when full-grown, are about an inch in length, with a green velvety body, a pale-yellow stripe down the back, and some yellow spots on each



FIGURE 104.—The imported cabbage worm feeding on nasturtium leaf. About natural size.

side of the body. The winter is passed as a naked chrysalis, or pupa, which may be found attached to various objects, including the boards of buildings.

Treatment and prevention.—Same as for the cabbage looper (p. 3).

Other Pests of Nasturtium

	Page
Greenhouse leaf tier.....	5
Corn earworm.....	29
Tarnished plant bug.....	35

PALMS

Palm Leaf Skeletonizer

The palm leaf skeletonizer (*Homaledra sabalella* (Chambers)), also called the palm leaf miner, attacks many varieties of palms and decreases their value for decorative purposes. The caterpillars feed under a webbing on the upper and lower leaf surfaces and make dark-brown splotches (fig. 105), which eventually cause the leaf to dry up and die. This insect is especially injurious in Florida, although it is likely to occur in other southern States where palms are used for decorative plantings in gardens. Sabal palmetto and Canary Island date palm seem to suffer most. The tiny adult moths are rarely seen, as they are active at night. The female lays her eggs on the interleaf husks. There are possibly five broods of caterpillars annually, and the winter is passed in the egg, larval, and pupal stages.

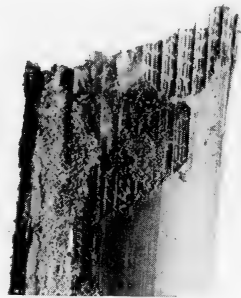

FIGURE 105.—Feeding injury by the palm leaf skeletonizer on portion of palm leaf.

Treatment.—Cut out and burn infested fronds, otherwise the insects therein will complete their development and cause reinfestations. Spray with lead arsenate, with a sticker added to make the spray adhere better to the waxy foliage. To avoid the white spray deposit, a green-colored lead arsenate can be used. Pyrethrum sprays kill such larvae as are reached by this insecticide.

Prevention.—Remove and burn all interleaf husks on plants, as the eggs are laid on such tissue.

Ground Mealybug

In California the ground mealybug (*Rhizoecus terrestris* (Newst.)) is destructive to palms, especially those of the Kentia type. It has also been recorded on acacia, boxwood, chrysanthemum, Shasta daisy, larkspur, marguerite, petunia, privet, fruit trees, and many weeds and grasses. This mealybug occurs on the roots and injures the plants by sucking the juices. It is very small, pale, and thinly covered with a white powdery wax (fig. 106).



FIGURE 106.—Ground mealybug adult. About 7 times natural size.

Treatment.—Drench the soil surrounding the plant with a solution consisting of 2½ teaspoonfuls (12 cc.) of dichloroethyl ether in 1 gallon of water. Usually 1 gallon of the solution is enough to treat a large palm plant.

Prevention.—Examine all plants when they are repotted and see that they are free of mealybugs.

Scale Insects

Several scale insects attack palms that are grown out of doors. These are tiny sucking insects, many no larger than a pinhead, that appear like small, flattened, waxy scales (fig. 107) attached to the leaves, stems, and trunk. Some species are narrow (fig. 108), whereas others are slightly larger and hemispherical (fig. 69). The color may be brown, dirty white, or purplish. When extremely numerous, they encrust the surface of the leaves and stems and seriously weaken the plants.



FIGURE 107.—Coconut scale (*Aspidiotus destructor* Sign.) encrusting a leaf of cycas palm. About 3 times natural size.

Treatment.—Where only one or two small plants are infested these may be scrubbed with a nicotine sulfate and soap solution (p. 97) and a soft brush or sponge. Larger plants may be sprayed with a white-oil emulsion or a thiocyanate spray diluted according to the manufacturer's instructions. Following any of these treatments, the plants should be rinsed with clear water an hour or two later.

Other Pests of Palm

Mealybugs.....	Page 31
Greenhouse orthezia.....	32

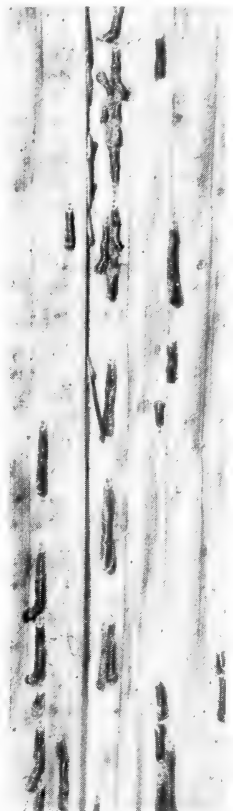

FIGURE 108.—Portion of palm leaf infested with the black thread scale (*Ischnaspis longirostris* (Sign.)). About 3 times natural size.

PANSY

Violet Sawfly

The leaves of pansies and violets, especially in the eastern part of the United States and Canada, are frequently fed upon by the larvae, or false caterpillars, of the violet sawfly (*Ametastegia pallipes* (Spin.)) (fig. 109). An examination of the lower leaves of the plants often reveals some bluish-black, smooth larvae, about half an inch long, conspicuously marked with white spots on the back and sides. In the earlier stages the larvae feed on and skeletonize the lower surface of the leaves and then eat holes in them, usually feeding at night. Later they may eat along the leaf edges and then completely defoliate the plants. Feeding usually becomes most evident late in

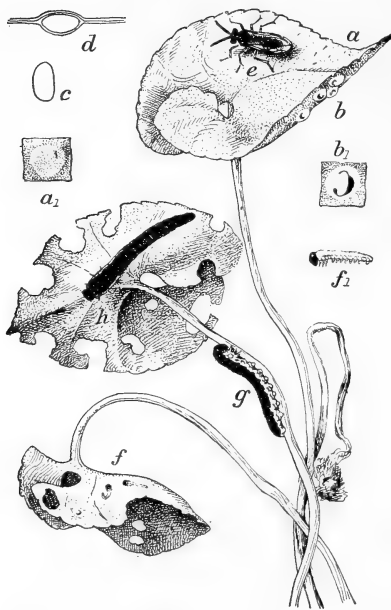

FIGURE 109.—Injury to violet leaves by the violet sawfly: *a*, Egg cells on upper surface of leaf; *a*₁, an egg cell magnified; *b*, cells after escape of larvae; *b*₁, one of same magnified; *c*, egg from above; *d*, egg in situ from side; *e*, female at rest on leaf; *f*, newly hatched larvae on leaf; *f*₁, same enlarged; *g*, active stage of larva; *h*, full-grown larva feeding. *a*, *b*, *e*, *f*, *g*, *h*, natural size; *a*₁, *b*₁, *c*, *d*, *f*₁, enlarged.

May and early in June, although it may be found earlier. The larvae have been reported to pupate in the pithy stems of plants, and the adults emerge in about 2 weeks. In some localities several generations may occur.

Treatment.—Spray or dust with lead arsenate or derris when the larvae are first observed. When only a few are present, they may be hand picked.

Other Pests of Pansy

	Page
Red spiders	11
Cutworms	2
Greenhouse leaf tier	5
Red-banded leaf roller	50
Yellow woolly bear	3
Aphids	9
Flea beetles	8
Wireworms	15
Sow bugs	17
Slugs	16
Solanum mealybug (on roots)	63

PEONY

Rose Chafer

The rose chafer (*Macrodactylus subspinosus* (F.)), although an outstanding pest of roses, is equally destructive to the blooms of peony and iris. The beetles eat holes in the flowers and leaves. The blooms of many other plants, including dahlia, foxglove, hollyhock, ox-eye daisy, and poppy, are also attacked by this beetle. It is a long-legged, yellowish-brown beetle (fig. 110) about $\frac{1}{2}$ inch in length. It often appears rather suddenly in swarms in June or early in July and continues its ravages for a number of weeks. The insect is more abundant in areas having light sandy soil. The larvae feed on the roots of various weeds and grasses and pass the winter in the soil.

Treatment.—No entirely satisfactory remedies are known. Relief may be had by collecting the beetles early in the morning before they become active, or by shaking them into a pail of water covered with a film of kerosene or other oil. Spraying or dusting the beetles with pyrethrum, thoroughly covering them, is of some value. This treatment, however, must be repeated as often as the beetles appear. Spraying the plants with lead arsenate, derris, or bordeaux mixture will protect the foliage but usually will not save the flowers.

Young chickens eat rose chafers readily but are fatally poisoned by relatively small numbers of them. Chickens should, therefore, be restrained from visiting areas infested with rose chafers.



FIGURE 110.—Rose chafer beetles attacking chestnut blossoms. About twice natural size.

Prevention.—In areas where this insect is a serious problem, bringing all waste sandy areas under cultivation will aid in reducing the pest. By this means the breeding areas are disturbed, and by working the soil early in the spring the pupae are killed. Choice plants may be protected against the ravages of the beetle by covering them with a fine netting.

Other Pests of Peony

	Page
Rose leaf beetle.....	76
Stalk borer.....	34
Rose curculio.....	77
Tarnished plant bug.....	35
Four-lined plant bug.....	94
Flower thrips.....	74
Oystershell scale.....	56
San Jose scale.....	57
Ants.....	12

PETUNIA

Potato Flea Beetle

The potato flea beetle (*Epitrix cucumeris* (Harris)) is a serious pest of petunia. It eats small round holes (fig. 111) in the under sides of the leaves, causing the surface above to turn brown and fall away. It also feeds on honeysuckle, primrose, sunflower, and violet, as well as many vegetable crops and the

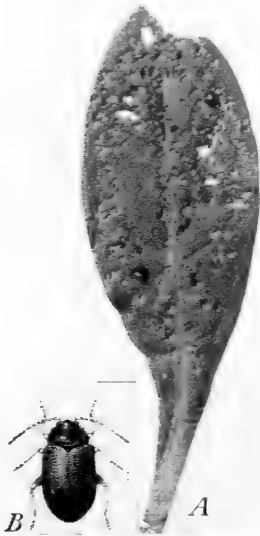

FIGURE 111.—Feeding holes on leaf of petunia caused by the potato flea beetle. Inset, adult flea beetle, 8 times natural size.

leaves of certain trees and shrubs. The beetle (fig. 111) is black, oval, and about 1/16 inch long. Flea beetles in general are discussed on page 8.

Treatment.—See treatment for flea beetles (p. 8).

Other Pests of Petunia

	Page
Yellow woolly bear.....	3
Hornworms.....	4
Spotted cucumber beetle.....	7
Asiatic garden beetle.....	21
Grasshoppers.....	9
Flea hopper.....	86
Tarnished plant bug.....	35
Ground mealybug.....	64
Greenhouse orthezia.....	32
Red spiders.....	11

PHLOX

Phlox Plant Bug

Phlox plants are often attacked by the phlox plant bug (*Lopidea davisi* Knight). The insect feeds in all stages on the upper surfaces of the more tender leaves and buds of perennial phlox. Injured leaves show white or pale-green spots (fig. 112) on the upper surfaces. Often the plant becomes stunted and the blossom head loses its symmetry. In some cases the entire plant may be killed. The adult phlox plant bug (fig. 112) is not over 1/4 inch long, is very active, and may easily be recognized by the dull orange or reddish wing covers and the black stripe on the back. The adults from the summer brood lay their eggs in the fall in the

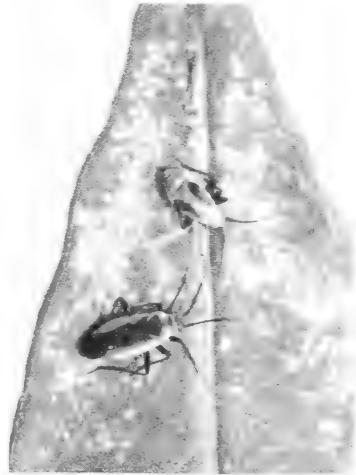

FIGURE 112.—Adult and nymph of the phlox plant bug on an injured leaf. Note whitening or stippling on the leaf. About 3 times natural size.

phlox stems behind the leaf petioles, and the winter is passed in the egg stage. In the vicinity of Washington, D. C., overwintering eggs begin to hatch early in May, and the nymphs develop to adults in a few weeks. Two or more generations develop, and by midsummer all stages of the insect are present.

Treatment.—As soon as growth starts in the spring, watch for the first evidence of their appearance and feeding. Dust the plants with dusting sulfur, or preferably a mixture consisting of 3 parts of dusting sulfur and 1 part of pyrethrum dust (containing 0.9 to 1.3 percent of total pyrethrins) by weight. Apply several times at intervals of a week or 10 days until the insects have been controlled. Spraying with a strong pyrethrum spray is also useful.

Prevention.—Cut and burn the old stalks, preferably after the first killing frost or late in the fall; cut as close to the ground as possible. Avoid splitting the stems, otherwise the eggs are likely to fall to the ground or into crevices where they might get the needed protection against winterkilling. Raking up and burning all debris and weeds in the infested area is also of value. If the old stems are left on the plants, the nymphs will hatch in the spring and attack the new growth during the subsequent growing season.



FIGURE 113.—Introduced pine sawfly larvae (*Diprion simile* (Htg.)) feeding on pine needles. Natural size. (Britain.)

Other Pests of Phlox

	Page
Four-lined plant bug.....	94
Red spiders.....	11
Blister beetles.....	7
Asiatic garden beetle.....	21
Stalk borer.....	34
Corn earworm.....	29
Golden tortoise beetle.....	59
White grubs.....	14
Wireworms.....	15

PINE

Pine Sawflies

The larvae of several sawflies, especially those belonging to the genus *Neodiprion*, feed on the needles of pine. They resemble hairless caterpillars and for this reason are sometimes called false caterpillars. When full-grown these larvae are nearly an inch long. The different species may be pale yellowish or greenish, with broad dull stripes or black spots along the body. They feed in groups (fig. 113), devouring the needles and leaving only the basal portions or bundle sheaths. Their growth is completed in from 4 to 6 weeks, and then they enter the litter or soil to spin cocoons. The wasplike adults emerge

later and deposit eggs in slits "sawed" in the pine needles.

The red-headed pine sawfly (*Neodiprion lecontei* (Fitch)) produces two broods of larvae in the North, occurring in late spring and late summer, and at least three broods during a season in the South. The early broods eat mostly the old needles. The late broods eat both old and new foliage and consequently may entirely strip small trees and thus cause their death. Injury is sometimes increased by their feeding on the tender bark of twigs. Other sawflies have only one generation a year, the larvae being present for a period of about 6 weeks in the spring and feeding on the old needles. A small percentage of the larvae may remain in the soil for 2 years, the adults then emerging to continue the infestation; consequently it is advisable to watch for additional infestation the second season, even though control measures have been applied.

Treatment.—If the infestation is heavy, spray or dust with lead arsenate, preferably while the larvae are still small. Derris powder as a dust or spray is also effective. When only a few groups of larvae occur on small trees they may be picked off, or the infested twigs may be removed and the insects destroyed.

Pine Bark Aphid

An infestation of the pine bark aphid (*Pineus strobi* (Htg.)) can be recognized by spots or patches of white cottony material on the smoother bark of the trunks and branches (fig. 114). White



FIGURE 114.—White pine stem infested with the pine bark aphid. About natural size.

pine is most commonly attacked, although Scotch and Austrian and possibly other pines are occasionally infested throughout the East. Continued heavy infestations probably weaken the trees, and trees in poor vigor may suffer considerably from these small insects sucking the sap. The aphids presumably pass the winter under the cottony masses. At least three generations develop during the season, the young usually hatching in the latter part of

May, the first half of July, and in August. The aphids are very small, oval, and their bodies are covered with a white waxy secretion, which is the white material observed on the bark.

Treatment.—Spray with a miscible oil or oil emulsion in the spring before the buds open. When the young are hatching, a nicotine sulfate and soap solution or a combination of white-oil emulsion and nicotine (p. 101) may be used. These sprays should be applied with considerable force so as to wet the bodies of the insects protected by the cottony material. Many of the insects can be washed off with a strong stream of water. Washing the trees a day or two before spraying might improve the results. On small trees, scrubbing with a brush and soapy water would no doubt give good control.

White-Pine Aphid

The white-pine aphid (*Cinara strobi* (Fitch)) is a comparatively large blackish plant louse that is found in colonies on the smooth bark of twigs and small branches of white pine. Heavily infested branches may show thin or pale foliage, and the bark is usually blackened by a sooty mold that develops in the honeydew excreted by these sucking insects. Young trees may be injured considerably, and in some years the weakened trees may be further damaged by winter injury. The aphid is usually most abundant in spring and fall. It passes the winter in the egg stage, the elongate blackish eggs being placed in rows on the pine needles.

Somewhat similar species of aphids occasionally infest other kinds of pine trees, feeding on the bark of twigs or on the needles. These aphids are often held in check by natural enemies and cause little injury; however, continued heavy attacks may weaken the badly infested branches.

Treatment.—Same as given for aphids (p. 9). On white pine, watch for spring and fall infestations and apply control measures promptly.

Pine Needle Scale

The needles of various species and varieties of pine, especially of Austrian, mugho, and red pines, are often whitened by infestations of the pine needle scale (*Phenacaspis pinifoliae* (Fitch)). The sucking of the plant juices by this scale causes the foliage of infested trees to become weakened, pale, and sickly in appearance. The female scale is white, waxy, pear-shaped, and about

$\frac{1}{10}$ inch in length. The male scale is snow-white, somewhat narrower, and smaller. When the scales are abundant, every needle may become encrusted with these white scales (fig. 115). There are



FIGURE 115.—Pine needle scale on pine needles. Twice natural size.

either one or two generations a year, depending on the locality. Purplish eggs, laid by this scale early in the fall, winter over concealed under old female scales. The young crawlers of the first generation appear in May and those of the second generation in July.

Treatment.—Spray early in the spring, before the buds begin to open, with miscible oil or oil emulsion. Lime-sulfur used as a dormant spray is also effective. A spray of nicotine sulfate and soap solution at $1\frac{1}{2}$ times the usual strength may be used. It should be applied several times at intervals of a week or 10 days during the period when the crawlers appear, in May and July.

European Pine Shoot Moth

The buds on new shoots of pine may be killed by the European pine shoot moth (*Rhyacionia buoliana* (Schiff.)). This insect now occurs in many localities from New England to Virginia and west to Illinois and Michigan, and is gradually spreading. In midsummer the young caterpillars kill the needles at the tips of the twigs by boring into

the needle bases. In late summer or fall they hollow out the buds (fig. 116), causing a small mass of pitch on the outside of the injured bud. The winter is spent in the buds as partly grown larvae. When the new shoots start growing the caterpillars bore into them, usually killing the shoot or, by tunneling along one side, causing it to bend over. Where many shoots are attacked the trees are deformed and stunted. Red pine, mugho pine, and Scotch pine have been most severely damaged, although other pines may be attacked, with the exception of white pine. Young trees up to 20 feet in height suffer the most injury. The full-grown caterpillars are a little over half an inch long and somewhat brownish. They transform to brown pupae in their burrows in midspring. The moths emerge and lay eggs late in June and early in July in New England.

Treatment.—Cut off and destroy all infested shoots in May, before the moths emerge. Most of the young caterpillars can be killed by spraying about the first of July in New England and possibly a little earlier farther south, when the new needles on red pine are half as long as the old needles. Use 6 level tablespoonfuls of lead arsenate or 8 of derris powder (containing 4 percent of rotenone) to 1 gallon of water, and stir in 1 tablespoonful of raw linseed oil, fish oil, or powdered skim milk as a sticker. For larger quantities, use 1 pound of either insecticide and 4 ounces (8 tablespoonfuls) of oil or 2 ounces of the skim milk in $12\frac{1}{2}$ gallons of water. Apply so as to cover especially the bases of the new needles.



FIGURE 116.—Pine buds opened to show work of the European pine shoot moth.

Pine Tip Moths

The tips of the new shoots, including the buds, may be hollowed out and killed by the small larvae, or caterpillars, of the pine tip moths. Short, dead needles near the apex of the new shoots, with partially developed or hollowed-out buds, are typical of this type of injury. Young trees, less than 20 feet in height, are most seriously affected and may become stunted and bushy from continued heavy infestation. Several species of tip moths occur in different parts of the country, the Nantucket pine moth (*Rhyacionia frustrana* (Comst.)) being the common species throughout the East and South, east of the Mississippi River. The larvae are yellowish and about half an inch long when full-grown. The species has one generation in the North, two in the Central States, and at least four in the South each season. The insects pass the winter as pupae in the injured tips. In the northern Great Plains States a variety of this moth occurs which passes the winter in cocoons in the litter or soil. Other species found in the Southwest and West, usually have one generation late in the spring and pass the remainder of the year in the ground.

Treatment.—Cutting off and destroying the infested tips containing the insects is about the only means of reducing the infestation. In the East and South this can be done during the late fall or winter. In the northern Great Plains States and the West, remove the tips as soon as the dying needles become evident and before the larvae have left them. Where ornamental pines are adjacent to native pine timber it is difficult to prevent reinfestation.

Some protection may be had by applying the sprays as suggested for the pine shoot moth, although its effectiveness has not been tested. The first application should be made in early spring when the new growth starts. Additional applications may be necessary, depending on the locality.

PITOSPORUM

Cottony-Cushion Scale

The cottony-cushion scale (*Icerya purchasi* Mask.) is now rather widely distributed across the entire southern part of the United States. It feeds by sucking the plant juices from the leaves, twigs, and stems, and when abundant it weakens or gradually kills the heavily infested plants. This

scale insect has been found on a wide variety of vines, shrubs, shade trees, and fruit trees, including such ornamentals as boxwood, croton, ivy, laurel, pittosporum, and rose. The mature female is somewhat oval and convex, about $\frac{1}{4}$ inch long, and red or yellowish orange. At the time of egg laying a conspicuous, white, cottony cushion, or egg sac, is formed, which elevates the end of the body. This egg sac is ridged or fluted lengthwise (fig. 117), is from $\frac{1}{4}$ to $\frac{1}{2}$ inch long, and



FIGURE 117.—Cottony-cushion scale on rose stem. About twice natural size.

contains a mass of small reddish eggs, which soon hatch. About three generations of the insect develop each year, but there is an almost continuous hatching of young during the growing season. This particular scale insect is capable of moving about on the plant during most of its life, much in the same manner as mealybugs.

Treatment.—Spraying with a miscible oil or oil emulsion during the dormant season will give good control. For summer spraying, use a white-oil-emulsion spray, or this spray combined with nicotine (p. 101), applied several times 2 or 3 weeks apart to kill the young. The thiocyanate sprays may be used for the same purpose, as suggested for the control of mealybugs (p. 31). Where only a few small plants are involved, the insect may be held in

check by rubbing off the large scales as they develop and spraying several times with a soap solution (p. 100) or a nicotine sulfate and soap solution.

The vedalia or Australian lady beetle (*Rodolia cardinalis* (Muls.)) feeds voraciously on the cottony-cushion scale. In areas where this beetle has been introduced and is still present, the scale is usually controlled by the beetle, although a considerable infestation may develop before the predator increases sufficiently to become effective.

Other Pests of Pittosporum

	Page
Aphids.....	9
Mealybugs.....	31
Soft scale.....	43

PRIVET

White Peach Scale

The white peach scale (*Pseudaulacaspis pentagona* (Targ.)), formerly called the West Indian peach scale, occasionally attacks privet. It also infests flowering cherry, lilac, and peach, and sometimes other trees and shrubs. Sometimes the bark is covered with the tiny whitish scales (fig. 118), and the plants are weakened or branches are killed by these sucking insects. The female scale is circular, nearly $\frac{1}{10}$ inch in diameter, and grayish, with a yellow-



FIGURE 118.—Stem of privet covered with the white peach scale. About natural size.

ish center. The male scales are smaller, more oval or elongate, and pure white. Clusters of these white male scales are often noticeable near the base of branches. Several generations develop annually, the number depending on the latitude. They pass the winter evidently in the full-grown stage.

Treatment.—Apply an oil spray at dormant strength in the spring before growth starts. Lime-sulfur will apparently give a fair degree of control if applied during the dormant period.

Privet Mite

In the Southeastern States the foliage of privet is sometimes injured by a tiny mite called the privet mite (*Brevipalpus inornatus* (Banks)). The leaves show a gradual yellowing or fading, but do not have the tiny spots of discoloration on the upper surface which is characteristic of injury by the red spider mite (p. 11). The mites feed on the under sides of the leaves, where they suck the plant juices, and may occur in great numbers. Severe infestations may cause the foliage to drop. Occasionally other plants, such as Boston ivy and goldenrod, may be attacked. The privet mite is too small to be readily seen with the naked eye, being only $\frac{1}{100}$ inch long. When magnified, it appears as a somewhat oval, eight-legged mite, broader at the head end, and the body of the female is crimson. Masses of the minute, blood-red eggs may be observed also on the lower leaf surface.

Treatment.—Spraying with lime-sulfur is an effective control measure. Dusting with a dusting sulfur or spraying with a wettable sulfur would probably also be effective if done several times. The derris-sulfonated castor oil spray (p. 99) that is so effective against the two-spotted spider mite should work equally well against the privet mite, although it has not been tested. The insecticides should be so applied that they will thoroughly cover the under sides of the leaves, where the mites occur.

Privet Aphid

Occasionally the new leaves of privet become tightly curled lengthwise in the spring as a result of infestation with the privet aphid (*Myzus ligustri* (Mosley)). The sucking of the plant juices from the leaves by these small plant lice causes this injury. About midsummer the aphids apparently leave the privet for other host plants, returning in the fall to deposit their overwintering eggs.

Treatment.—See treatment for aphids (p. 10). Begin the treatments soon after the new leaves start to come out and before the aphids are protected in the curled leaves.

Other Pests of Privet

	Page
Lilac leaf miner	58
Lilac borer	56
Red spiders	11
Mealy flata	90
Citrus whitefly	31

RHODODENDRON

Rhododendron Lacebug

The leaves of rhododendron and mountain laurel often become mottled and white-peppered in appearance on the upper surface, with numerous specks of blackish or brownish excrement on the lower surface (fig. 119). The peppered appearance is caused by the sucking of the plant juices by the adults and young of the rhododendron lacebug (*Stephanitis rhododendri* (Horv.)). This species is closely related to the azalea lacebug (p. 22), and although it produces only two generations a year it is still sufficiently like the latter not to require further discussion.

Treatment.—Same as recommended for the azalea lacebug (p. 22).



FIGURE 119.—Work of the rhododendron lacebug on lower leaf surface.

Rhododendron Borer

The stems and branches of rhododendron are often severely injured by the caterpillars of the rhododendron borer (*Ramosia rhododendri* (Beut.)). These caterpillars bore into the stems (fig. 120), usually those about a foot or more above ground. On young plants



FIGURE 120.—Tunnel of the rhododendron borer in a stem.

the foliage may wilt and die or the stems or twigs break off because of the boring. On older branches ugly scars are produced, and later, as the injury continues, the affected branches may die. This insect also attacks azaleas and mountain laurel when these are growing nearby. The larva, when mature, is about half an inch long and has a yellowish-white body and reddish-brown head and legs. The adults are clear-winged moths, which appear in May or June and lay eggs on the bark. The larvae reach maturity in October and overwinter in the burrows. Pupation occurs in the spring. There is only one generation a year.

Treatment.—Cut off and burn all infested parts in late fall, winter, or early spring. Other methods suggested for the lilac borer (p. 56) may also be used.

Pitted Ambrosia Beetle

Rhododendrons and dogwoods, especially those that are heavily mulched or growing in shaded places, are often

attacked by the pitted ambrosia beetle (*Corthylus punctatissimus* (Zimm.)). Other shrubs and young trees may be similarly attacked, including hazel, huckleberry, ironwood, sassafras, sugar maple, and water birch. The beetle makes a number of horizontal galleries in the wood at the base of the stem, causing it to wilt, die, and later break off near the surface of the ground. Heavily infested plantings of rhododendrons soon become ragged and unsightly in appearance, owing to the weakened, stunted, or dying plants. The beetle is dark brown or black, stout, and about $\frac{1}{8}$ -inch long. The grub is small, whitish, and provided with strong jaws for boring.

Treatment.—Cut out and burn the wilted stems. Take care not to break the shoots at the base where the beetles enter the plant; otherwise some of them may escape and infest nearby plants. Remove the surface mulch from around the base of the plants.

Rhododendron Whitefly

The rhododendron whitefly (*Dialeurodes chittendeni* (Laing)) has only recently been discovered in this country. It is a serious pest in the State of Washington, although infestations have also been found in Long Island, eastern Tennessee, West Virginia, and Pennsylvania. The sucking of plant sap by the whiteflies causes a yellow mottling on the upper surface of the leaves, sometimes accompanied by a curling of the leaf margins. As with other whiteflies, the formation of sooty mold fungus on the honeydew which these insects excrete soon ruins the ornamental value of plants attacked. One generation occurs annually in Washington, and the insects overwinter chiefly as second- and third-stage larvae.

In general appearance the adults (fig. 121, A) and the several immature stages (fig. 121, B) are not unlike those of the greenhouse whitefly and other species of whiteflies.

Treatment.—In the Pacific Northwest spraying with a 2-percent white-oil emulsion, preferably in the fall before frost occurs, has proved most effective. It is essential to wet thoroughly the under sides of the leaves where the insects are located. Applications should be made on cloudy days and under considerable pressure. Nicotine sulfate applied as a spray or dust is effective in reducing the number of adults, but is of less value against the immature stages.

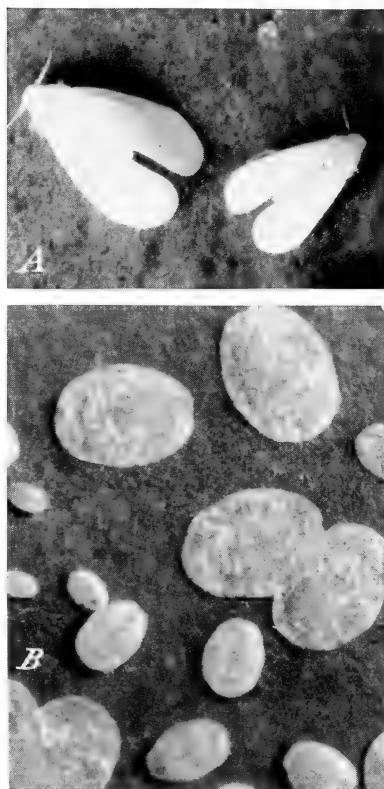

FIGURE 121.—Rhododendron whitefly: A, Adults; B, larvae (two smaller forms) and pupae (larger forms). About 8 times natural size.

Other Pests of Rhododendron

	Page
Azalea bark scale.....	22
Red spiders.....	11
Azalea stem borer.....	24
Black vine weevil.....	93
Fuller's rose beetle.....	44
Oleander scale.....	54
Giant hornet.....	57

ROSE

Flower Thrips

Garden roses are attacked by several species of thrips, of which the flower thrips (*Frankliniella tritici* (Fitch)) is the most important. The thrips enter the developing flower buds and feed on the tender flower parts, causing the petals to become flecked and discolored (fig. 122) and the flowers deformed. Often the flowers fail to open. The

flower thrips breeds in various grasses, alfalfa, vetch, clover, and weeds. These plants are the chief sources of infestation, since the winged thrips migrate from these to roses, peonies, and many other garden flowers. The adult flower thrips is a tiny, slender, brownish-yellow insect with featherlike wings (fig. 123) and is extremely active. The younger stages are lemon colored. If an infested blossom is examined, the tiny thrips may be seen scurrying for shelter among crevices at the bases of the petals. Several generations occur during the summer, and in extremely

hot, dry weather they complete a life cycle in less than 2 weeks.

The onion thrips (*Thrips tabaci* Lind.) and the tobacco thrips (*Frankliniella fusca* (Hinds)) may often be found injuring roses and other flowers along with the flower thrips. The habits and appearance of all these thrips are similar.

Treatment.—Spray with tartar emetic solution prepared as directed for use against the gladiolus thrips (p. 45), repeating the applications twice a week until the insects are controlled. The paris green formula (p. 96) may be used if tartar emetic is not obtainable. Best results follow if the control efforts are community wide.

Prevention.—Cut off and dispose of all blooms that have reached their prime, to reduce the population present in a garden. Do not throw spent flowers on the ground, because the insects will quickly desert such blooms and travel to unopened buds on nearby plants.

Aphids, or Plant Lice

Several species of aphids injure the young and tender growth of garden roses by sucking the plant juices. The potato aphid (*Macrosiphum solanifolii* (Ashm.)) is particularly abundant on roses early in the season. It is green or pinkish and about $\frac{1}{8}$ -inch long. The young develop from overwintering eggs laid chiefly on the stems of roses.

The rose aphid (*Macrosiphum rosae* (L.)) may occur on roses throughout the season. It feeds on and injures the tender leaves, stems, and buds (fig. 124). It is similar in general appearance to the potato aphid. The winter is spent in the egg stage on the twigs and stems.

Another similar species, the green peach aphid (*Myzus persicae* (Sulz.)), at times also attacks roses.

The small green rose aphid (*Capitophorus rosarum* (Kalt.)) is a smaller green or green-and-black species that is found on the leaves as well as on the buds and young shoots.

Treatment.—See treatment for aphids (p. 9).

Rose Chafer

Although the rose chafer is one of the most serious pests of rose blossoms, it is equally destructive to the flowers of peony and iris. This beetle is discussed under Peony on page 66.



FIGURE 122.—Spotting on petals of carnation flower caused by thrips.



FIGURE 123.—The Florida flower thrips (*Frankliniella tritici bispinosa* Morgan). About 16 times natural size. (Watson.)



FIGURE 124.—Rose aphid on stems and buds of roses. Slightly enlarged.

Rose Leaf Beetle

Another serious rose-blossom pest is the rose leaf beetle (*Nodonota puncticollis* (Say)), a small, oval, metallic-greenish insect (fig. 125) about $\frac{1}{8}$ -inch long. It also feeds on iris and peony flowers, as well as on the tender shoots, flowers, and foliage of blackberry, raspberry, strawberry, clover, pear, peach, and plum. The beetles appear late in May or early in June and bore into the buds and partly expanded flowers (fig. 126). Frequently they swarm over the flowers and in a very short time riddle them with shotlike holes. Little is



FIGURE 125.—Adult of the rose leaf beetle. About 4 times natural size.



FIGURE 126.—Rosebud, flower, and leaves injured by the rose leaf beetle.

known about this insect, but it is believed that the larvae live in the soil and feed on the roots of various plants.

Treatment.—No satisfactory control is known. The numbers and injury of these beetles may be materially reduced by jarring them into a pail of water covered with a film of oil, or by picking the beetle-infested flowers and dropping them into the same container. This operation is most effective when done early in the morning or at dusk. Spraying with pyrethrum will kill the beetles actually hit by the spray, but it is difficult to reach those that are within the buds or flowers.

Prevention.—Valuable varieties may be protected by screening with cheesecloth or other material before the buds begin to show color.

Rose Midge

In the last few years the rose midge (*Dasyneura rhodophaga* (Coq.)), although primarily a pest of greenhouse roses, has caused serious injury to garden roses. The first flush of buds may escape injury, but the later ones are often so severely attacked that virtually no flowers are produced. All new shoots and buds, as they appear, become infested with the tiny white maggots.

Their feeding causes infested growths to become deformed (fig. 127) and later to wither, turn brown, and die. The bud stems often become crooked. As the maggots grow they become tinged with red. When fully developed they are about $\frac{1}{2}$ inch long, and at this time they drop to the ground, which they enter to pupate. The pupae of the last generation overwinter in the soil. The adult is a tiny two-winged fly, or midge, about $\frac{1}{16}$ inch long, yellowish, with the head and fore part of the body tinged with brown.



FIGURE 127.—Young leaves and flower buds of roses injured by maggots of the rose midge.

Treatment.—No entirely satisfactory remedy has been developed, but the following procedure will give some control. On the first indication of injury, rake the ground as level as possible to the extent of the branch spread, and then apply a mulch about $\frac{1}{4}$ inch thick of fresh tobacco dust (waste tobacco that is finely ground) containing not less than 0.75 percent of nicotine. Make the application as even as possible so that there will be no exposed spots; otherwise the maggots will be able to enter the soil and complete their development. The surface of the mulch must be kept fresh by raking lightly about once a week and applying a thin dressing of fresh tobacco dust. All new growths should be examined frequently, and if any are found infested, they should be promptly removed and destroyed, preferably by burning, and should not be left on the ground.

Prevention.—Plant only midge-free plants and obtain stocks from sources known to be free of this pest.

Rose Curculio

The rose curculio (*Rhynchites bicolor* (F.)) is a bright-red weevil, or snout beetle (fig. 128), with black legs and snout, and only about $\frac{1}{4}$ inch long. It is widely distributed throughout the United States. With the mouth parts at the end of their beaks the beetles eat holes in the unopened buds, leaves, and flower stem of roses and peonies. Many of the injured buds fail to open, and those that do expand are riddled with holes. The beetles appear on rose bushes and peonies early in June and are gone in August. The eggs are laid in the buds and young rose fruits, or "hips." These hatch in a week or 10 days into white, legless grubs, which feed on the seeds until full-grown. Later they enter the ground, change to pupae, hibernate, and appear as adults the following spring. There is only one generation a year.

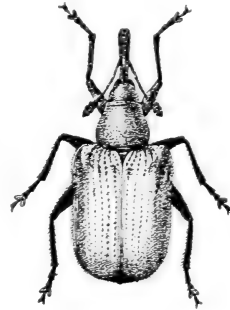

FIGURE 128.—The rose curculio. Five times natural size.

Treatment.—Where only a few weevils are present they may be jarred into a pail of water and kerosene. When they are numerous, spraying with lead arsenate is recommended.

Prevention.—Collect and burn all rose fruits, or hips, soon after they have formed, as these usually contain the eggs. Since wild roses also are attacked, the hips of any such plants growing nearby should be collected and destroyed before the end of August, whenever practicable. Cultivation in the late fall or early spring kills the pupae in the soil.

Rose Stem Borers

Occasionally roses are attacked by stem borers. These are of two kinds, those which attack unpruned and uninjured shoots and those which attack

the pruned and broken ends of stems. In both cases the injured portions wilt and finally die. To the latter group belong the leaf-cutter bees (p. 79) and the curled rose sawfly (p. 80). Among the borers that attack unpruned shoots the three species discussed below are the more important.

The rose stem sawfly, or borer (*Hartigia trimaculata* (Say)), is a wasplike insect occurring in early summer and laying its eggs in punctures made in the rose canes. The larvae hatching from the eggs are whitish and feed within the canes. They bore through the pith (fig. 129), causing the shoots to become stunted and die back.



FIGURE 129.—Young rose shoot cut open to show the rose stem borer mining in the pith. Note the stunted tip resulting from its injury. About twice natural size.

The rose stem girdler (*Agrilus communis rubicola* Abeille) is a small bronze-green beetle about $\frac{1}{8}$ inch long. The adult beetles appear in June and July, feed on the foliage, and lay their eggs on the rose bark. On hatching the flattened, whitish, legless grubs enter the wood and make spiral mines for a short distance, and over these the rose shoot swells (fig. 130). The resting stage is spent in a cell in the pith.

The raspberry cane borer (*Oberia bimaculata* (Oliv.)) is a slender beetle



FIGURE 130.—Swelling on rose stem caused by the rose stem girdler working under bark.

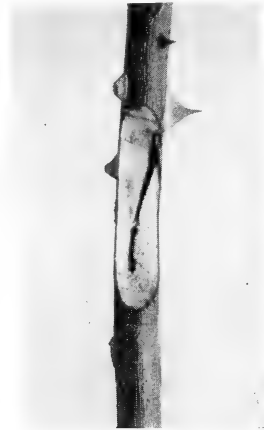

FIGURE 131.—Work of the raspberry cane borer in the pith of a rose stem. Bark cut away to expose tunnel.

with black wings and yellow waist. Although primarily a pest of raspberry, it often leaves its preferred host and feeds on rose. The beetle girdles the tip of the shoot by making two rows of punctures, about an inch apart, around the stem, and between these the eggs are laid. As soon as the cylindrical, whitish, legless grubs hatch they bore into the pith and work downward through the shoots (fig. 131), thus causing the shoots to wilt and die.

Treatment and prevention.—The best way to control these three borers is to cut off and burn the infested shoots as soon as the injury is discovered. Spraying the rose foliage with lead arsenate in June and July will kill many adults of the rose stem girdler, which feed on the leaves during the egg-laying period.

Leaf-Cutter Bees

The leaf-cutter bees, belonging to the genus *Megachile*, frequently attract attention by the circular areas which they cut from the leaves (fig. 132). Rose foliage is most often used for this purpose, although the leaves of locust and other plants are also cut. These pieces of leaves are used in forming a thimblelike cup or cell for the young. These cells or nests are made in the pruned or broken ends of branches or in the pithy stems of plants such as dahlia (fig. 133). As the larvae hollow out the pith of living plants the injured portion is killed. These leaf-cutter bees are of medium size, usually black, brown, or metallic green or bluish. Certain other species of bees and wasps occasionally also have a similar habit of nesting in the pith of various plants.

Treatment.—Wilted or dying shoots containing the nests should be destroyed. The cutting of the leaves is usually not extensive enough to cause serious injury to the plant.



FIGURE 132.—Circular areas cut from rose foliage by a leaf-cutter bee



FIGURE 133.—Larva of leaf-cutter bee in rolled leaves inside a dahlia stalk. Slightly enlarged.

Rose Sawflies, or Slugs

The larvae of three species of sawflies injure roses by skeletonizing the foliage or chewing large ragged holes in the leaves. The larvae are often referred to as false caterpillars, or slugs. The adults are small wasplike insects, and the females deposit their eggs in slits "sawed" in the leaves.

The bristly rose slug (*Cladius isomerus* Nort.), when young, skeletonizes the leaves on the underside, imparting a glazed appearance to the foliage. As the slug increases in size it eats large holes (fig. 134) or the entire leaf tissue, leaving only the larger veins. When full-grown the larva is about half an inch long and is dirty yellowish green with a darker green stripe on its back. The body bears stiff hairs, from which it derives its name. This species has about six generations a year in the neighborhood of Washington, D. C., and overwinters in cocoons in protected places, such as rubbish. The cocoon is a thin, transparent, papery covering which sometimes has a pale-brownish tint.



FIGURE 134.—The bristly rose-slug and its feeding injury. Slightly enlarged.

The rose-slug (*Endelomyia aethiops* (F.)), formerly called the European rose slug, skeletonizes rose leaves from the upper side for its entire feeding period. Its work (fig. 135) produces a characteristic pale-greenish to yellowish, chafed upper surface on the leaflets. The larva is greenish, and when full-grown is about $\frac{1}{2}$ inch long. This species has only one generation a year, passing the late summer, fall, and winter in the ground in cells of cemented particles of sand and earth.

The curled rose sawfly (*Allantus cinctus* (L.)), sometimes referred to as



FIGURE 135.—Rose-slug larvae skeletonizing a rose leaf. Slightly enlarged.

the curled rose worm, eats the entire leaf tissue, usually feeding from a curled position (fig. 136) along the leaf edges. The larva is greenish, with the sides and legs grayish white, and about $\frac{1}{2}$ inch long. This sawfly has two generations annually and spends the resting stage in cells bored in pith, soft decayed wood, or material of a similar texture. When the pruned ends of rose shoots are available it will bore into the pith. It passes the winter in the pupal stage protected within its cell.

Treatment.—Spray or dust with lead arsenate, or dust with a lead arsenate-sulfur mixture (p. 96) if diseases are also involved. Nicotine sulfate and derris are effective against the



FIGURE 136.—Larva of the curled rose sawfly and its feeding injury. Slightly enlarged.

young larvae. Spraying or washing the plant frequently with a stream of water under pressure will wash off many of the larvae.

Prevention.—Clean up and burn all rubbish in the garden to remove overwintering places for the bristly rose slug. Work the soil to kill the pupae of the rose-slug in the ground. For the curled rose sawfly, paint the ends of pruned twigs and remove pithy stems or soft decaying wood that might serve as places for pupation.

Rose Leafhopper

When rose leaves appear mottled, become pale, and drop prematurely, the rose leafhopper (*Typhlocyba rosae* (L.)) may be at work. The injury is done largely by the nymphs sucking the plant juices

from the under sides of the leaves. This insect attacks chiefly rose and apple, although it also feeds on other shrubs and trees. It is found on the foliage most of the summer; therefore all stages are usually present. The adult (fig. 137) is about $\frac{1}{8}$ inch long, narrow, greenish yellow, and very active. The species overwinters in the egg stage under the bark of the plant, and the whitish nymphs hatch about the beginning of May. The other species mentioned in the discussion on leafhoppers (p. 10) may at times feed on and injure roses.

Treatment and prevention.—See treatment for leafhoppers (p. 10).



FIGURE 137.—Rose leafhoppers on the under side of a leaf. About twice natural size.

Rose Scale

Not infrequently rose bushes are found completely encrusted with a snow-white substance. On close examination this material proves to be composed of very small scalelike insects known as the rose scale (*Aulacaspis rosae* (Bouché)), thickly massed or clustered on the twigs (fig. 138). The female scales are nearly circular, dirty white, with an orange-colored dot in the center. The males are much smaller, long and narrow, and snow white. These insects not only spoil the appearance of rose bushes, but their sucking of the vital sap reduces the vigor and health. Raspberry and blackberry canes are often attacked.



FIGURE 138.—Twigs infested with the rose scale.

Treatment.—Remove and burn all heavily infested canes that can be spared. Spray with white-oil emulsion (p. 100) after the leaf drop and again in early spring before the buds begin to swell. For light infestations, spraying in early spring with a strong solution of fish-oil soap or common soap (p. 100) will suffice. Lime-sulfur may be used if the plants are not located near brick work or buildings, since it may soil the objects with which it comes in contact.

Rose Galls

Certain species of insects produce swellings or galls on roses. One of these, the mossy rose gall (*Diplolepis rosae* (L.)), forms a large, globular, fibrous mass, about an inch or more in diameter, on the twigs (fig. 139) early in the season. The galls are light green at first and later they turn purplish brown and are covered with a thick mossy growth, from which they derive their name. The inside is separated into individual cells, which contain the larvae of the tiny gall wasp. There is only one brood a season. The dried brown galls, if not removed, will remain on the bushes.

Another species, the rose root gall (*Diplolepis radicum* (O. S.)), while more often found on wild roses, sometimes attacks cultivated roses at the base or just below the ground. The galls (fig. 140) are rather conspicuous, some reaching a diameter of 1 or 2 inches. The inside is packed full of cells. The adults are

tiny 4-winged gall wasps, which emerge by cutting an opening in the outer wall of the gall. Apparently these swellings do not constitute a serious menace to the plant except that they kill the parts attacked.

Treatment.—Remove and burn the fresh galls before the larvae contained therein can complete their development.



FIGURE 139.—Mossy rose gall on a rose stem. About natural size.

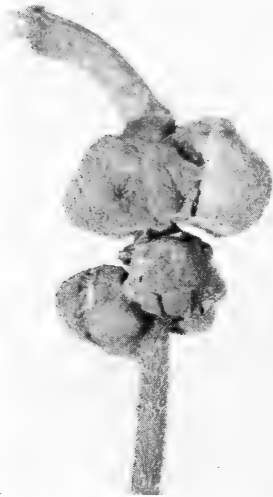

FIGURE 140.—Rose root galls at the base of a rose stem. About two-thirds natural size.

Buffalo Treehopper

The buffalo treehopper (*Ceresa bubalus* (F.)) (fig. 141) makes double rows of curved or crescent-shaped slits in the bark of twigs in which to lay its eggs. Nursery plants, especially rose and various shrubs, and shade and fruit trees are attacked in this manner. This causes the bark to become roughened, somewhat scaly, and cracked in appearance. The attacked twigs never make a vigorous growth. The nymphs that hatch from these eggs late in the following spring feed by sucking the juices from aster, lily, and other plants, and grasses and weeds. The adult, which appears in August, is an active, grass-green, triangular insect having a characteristic two-horned enlargement at the front, and is about $\frac{3}{8}$ inch long.

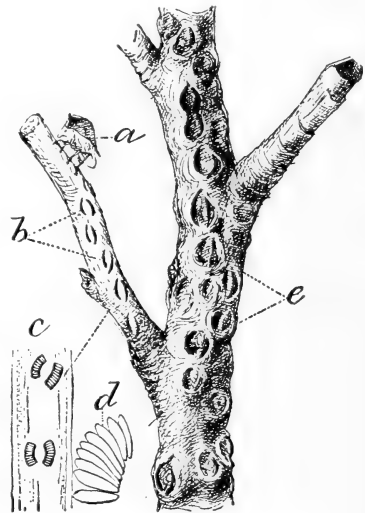

FIGURE 141.—Twig showing work of the buffalo treehopper: *a*, Female at work; *b*, recent egg punctures; *c*, bark reversed with eggs in position, slightly enlarged; *d*, single row of eggs, still more enlarged; *e*, wounds of 2 or 3 years' standing on older limbs.

Treatment.—If fresh egg scars are found on twigs, cut and burn them before the eggs hatch in the spring. Dormant spraying with white-oil emulsions is useful in destroying the eggs.

Prevention.—Clean culture about the garden and destruction of weeds and grassy areas, especially late in July, are of vital importance.

Other Pests of Rose

	Page
Japanese beetle.....	48
Asiatic garden beetle.....	21
Fuller's rose beetle.....	44
Spotted cucumber beetle.....	7
Oblique-banded leaf roller.....	83
Red-banded leaf roller.....	50
Greenhouse leaf tier.....	5
Rose budworm.....	83
Corn earworm.....	29
Eastern tent caterpillar.....	47
Poisonous caterpillars.....	5
Orange tortrix.....	44
Tarnished plant bug.....	35
Four-lined plant bug.....	94
Melon aphid.....	90
Red spiders.....	11
Cottony-cushion scale.....	71
San Jose scale.....	57
White grubs.....	14

SALVIA

Salvia, or garden sage, is subject to attack by a number of insects that feed on a wide range of plants. Those most frequently encountered are the following:

	Page
Tarnished plant bug.....	35
Red spiders.....	11
Asiatic garden beetle.....	21
Yellow woolly bear.....	3
Stalk borer.....	34
Greenhouse leaf tier.....	5
Greenhouse whitefly.....	18
Greenhouse orthezia.....	32

SNAPDRAGON

Rose Budworm

The buds of snapdragon, rose, delphinium, columbine, and other garden flowers are often eaten into by the caterpillar of the rose budworm (*Pyrrhia umbra* (Hufn.)). The adult is known as the bordered sawfly moth. Two distinct forms of caterpillars occur; one is greenish, spotted with black tubercles and prominent, dark, longitudinal stripes, whereas the other has whitish-orange markings on the back.

Treatment.—Remove infested buds as soon as noticed. Spray or dust with lead arsenate if the plants are heavily infested.

Black Stinkbug

The black stinkbug (*Cosmopepla bimaculata* (Thom.)) is a plant-feeding bug which attacks such flowering plants as snapdragon, beardtongue, columbine, and verbascum. By sucking the plant juices this insect stunts bud clusters and deforms individual buds. It is a small, shining bug, about 1/4 inch long, conspicuously colored with black and red. It overwinters as an adult in protected places. The name is derived from its disagreeable odor.

Treatment and prevention.—Same as for tarnished plant bug (p. 35).

Other Pests of Snapdragon

	Page
Red spiders.....	11
Verbena bud moth.....	88
Greenhouse leaf tier.....	5
Four-lined plant bug.....	94
Tarnished plant bug.....	35
Yellow woolly bear.....	3
Stalk borer.....	34
Aphids.....	9
Asiatic garden beetle.....	21

SPIREA

Oblique-Banded Leaf Roller

The foliage and flower buds of roses and the leaves of spirea are occasionally fed upon by the caterpillars of the oblique-banded leaf roller (*Archips rosaceana* (Harr.)), also called the rose leaf tier. This insect also feeds on aster, carnation, geranium, honeysuckle, and verbena. The caterpillar conceals itself by rolling the leaf upon which it is feeding and also ties the terminal leaves together, thus marring the plant and interfering with its normal growth (fig. 142). It varies from yellowish to pale green and becomes 3/4 inch long when mature. Two generations apparently occur annually, one in the spring and the other late in the summer.



FIGURE 142.—Rose leaves rolled and tied together by the oblique-banded leaf roller.

Another leaf roller, *Evora hemidesma* (Zell.), occasionally injures spirea in midsummer in much the same way as does the oblique-banded leaf roller.

Treatment.—Same as for the greenhouse leaf tier (p. 5).

Spirea Aphid

About the time the spireas are through blooming the tender shoots of these plants often become infested with the spirea aphid (*Aphis spiraeicola* Patch). These small plant lice may be found clustered along the new shoots, where they suck the plant juices and stunt the tips. The aphids on the tip appear similar to those shown in figure 124. This aphid, which is also called the citrus aphid, is mostly greenish, but as the winged form develops the fore part of the body turns dark brown. Several other aphids also may at times attack the various kinds of spirea.

Treatment.—Same as for aphids (p. 9).

Other Pests of Spirea

	Page
Red spiders.....	11
Oystershell scale.....	56
San Jose scale.....	57
Cottony maple scale.....	47

SPRUCE

Eastern Spruce Gall Aphid

Small conelike swellings, or galls, may develop on the base of the new-growth shoots of Norway and white spruce, and occasionally on black, red, and possibly other spruces. The galls are usually about $\frac{3}{4}$ -inch long and resemble somewhat a miniature pineapple (fig. 143). They are caused by the eastern spruce gall aphid (*Chermes abietis* L.), which occurs in the eastern half of the United States. Many of the infested twigs die, and the tree may be deformed and weakened by heavy or repeated infestations. Certain individual trees appear to be more susceptible to attack than others. The tiny, bluish-gray, young aphids, or nymphs, spend the winter on the twigs, principally at the base of the buds. In the spring they develop into wingless adults, about $\frac{1}{16}$ -inch long, which become covered with a white cottony secretion and lay groups of eggs. The hatching young begin sucking at the bases of the new needles, causing the needles to swell and form the gall which encloses the insects. In August the galls turn brownish and each cell opens, permitting the emergence of the maturing aphids, which soon develop wings and lay groups of eggs on the needles. These



FIGURE 143.—Galls of the eastern spruce gall aphid at the base of new-growth shoots. About two-thirds natural size.

hatch into the young aphids which overwinter near the buds.

Treatment.—Spray the trees in the spring before the buds begin to swell, taking special care to wet the buds and twigs. A nicotine sulfate-soap solution at the usual strength (p. 97) will give good results if applied on a warm day, and it is safe to use on the trees. A pyrethrum spray would no doubt be equally effective. A soap solution (1 pound of laundry or fish-oil soap in 10 gallons of water) will often give good results. Lime-sulfur at dormant strength is safe and effective, but it leaves a temporary yellowish deposit on the foliage and will also discolor paint. Miscible oils are also effective but may occasionally injure the needles. A combination of 2-percent white-oil emulsion and nicotine sulfate (p. 101) has also been reported as satisfactory. Spraying may be done also in the fall (October) after all eggs have hatched, but since many of the aphids die during the winter, spraying in early spring is preferable. Where only a few galls occur on small trees, the infestation can usually be controlled by cutting off and destroying the fresh galls by midsummer, before the insects have emerged.

Cooley's Spruce Gall Aphid

Cooley's spruce gall aphid (*Chermes cooleyi* Gill.), also known as the Sitka or blue spruce gall aphid, causes a gall, or swelling, 1 to 3 inches long at the tips of the new-growth shoots (fig. 144).

These galls occur on blue, Engelmann, and Sitka spruces in both the West and the East. The infested tips are killed, and the trees may thus be deformed. This tiny aphid has a more complicated life cycle than the preceding species, spending part of its cycle on spruce and part on Douglas fir. On spruce the young hibernate near the buds, and the galls are formed in the spring in the same manner as those of the eastern spruce gall aphid (see p 84). The galls open in July, and the winged aphids migrate to Douglas fir, where they lay groups of eggs on the needles. The young overwinter, mature in the spring, and become covered with a white cottony excretion. They appear as tiny bits of cotton on Douglas fir needles. These produce a summer generation, and some of the adults fly to the spruce trees, whereas others remain on the fir. Some injury may result to the fir needles from the sucking of these insects.

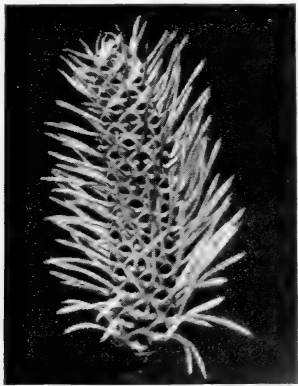

FIGURE 144.—Gall of Cooley's spruce gall aphid at the tip of a new-growth shoot. About two-thirds natural size.

Treatment.—Same as for the eastern spruce gall aphid. However, with this species both the spruce and Douglas fir should be sprayed thoroughly. The planting together of the above-mentioned spruces and Douglas fir should be avoided.

Spruce Spider Mite

Spruce trees, especially blue spruce, infested with the spruce spider mite (*Paratetranychus ununguis* (Jacobi)) have a rusty and unthrifty appearance due to the sucking of the juices by the mites and the accumulation of the webbing which they spin abundantly (fig. 145).



FIGURE 145.—Mottling and webbing of hemlock foliage by a spider mite.

Similar injury may occasionally be caused by the two-spotted spider mite (pp. 11, 42). Older needles are first attacked, and injury is usually first noticed on the lower branches. When young trees are severely attacked they become badly stunted or may even die the first season. In older trees the killing is progressive and death will result after a few years of attack. Arbovitae, cedar, hemlock, and certain pines are also attacked. This mite is particularly injurious and abundant during hot, dry seasons and is often most serious in spring and fall. It resembles the common red spider, the young being pale green, and the adults dark green or nearly black. The mite passes the winter as spherelike eggs laid at the bases of the needles. The young mites hatch early in spring, and several generations occur during the season.

Treatment.—Same as for the red spider (p. 11). Application should be made as soon as growth starts in the spring, to control early infestations.

Spruce Budworm

On ornamental spruces and other conifers the caterpillars of the spruce budworm (*Archips fumiferana* (Clem.)) feed by boring into the opening buds and, later on, the needles, which are cut off and held together with silken threads (fig. 146). The beauty of the trees is temporarily spoiled because as the needles dry they turn brownish. Heavy feeding results in a stunted growth, especially in the tops. While this budworm is primarily a pest of forest

trees, it may attack spruce, fir, Douglas fir, hemlock, and larch in many parts of the country when grown in ornamental plantings around the home. One form attacks jack and Scotch pines in the Lake States and in Ontario, Canada. The overwintering larvae become active about the time that the buds burst into growth in the spring. The mature caterpillar (fig. 146), which is nearly an inch long, has a rather stout, thick, dark-brown body provided with yellowish-white warts. The moth is dull gray, with brownish or reddish markings on the front wings, and is in flight and laying eggs during June or July.



FIGURE 146.—Feeding work, empty pupal skins, and adults of the spruce budworm. Inset, larva, or caterpillar. Natural size.

Treatment.—Spray with lead arsenate as soon as the new shoots begin to develop in the spring, or while the caterpillars are still feeding on the needles.

Spruce Sawflies

Several species of sawflies feed on the foliage of spruce. In general appearance and habits they are similar to the pine sawflies discussed on page 68. The European spruce sawfly (*Diprion hercyniae* (Htg.)) occurs throughout the northeastern part of the United States and produces two or three broods of larvae in a season. The larvae, being light green, are not easily seen among the

needles. Other species occasionally occur on spruce in other parts of the country.

Treatment.—Same as for pine sawflies (p. 68).

Spruce Needle Miners

The small caterpillars of the spruce needle miner (*Taniva albolineana* (Kearf.)) bore into and mine the needles of blue, Norway, and Engelmann spruces. Later they cut off the mined needles and web them together into a nest of silken strands and frass (fig. 147). This species prefers to work near the inner part of the tree. It is widely distributed and is especially injurious on ornamental trees, infesting the entire crowns and causing much disfigurement. The small, brownish adult moths appear in May and June, depending on the locality. The larvae, soon after hatching, bore into the green needles at the base and feed. They continue their work throughout the rest of the summer until early frost. They hibernate as larvae in the hollowed needles within the webbed nests and resume their feeding early in the spring. The mature caterpillars measure about $\frac{1}{2}$ inch and are reddish brown or green, with shiny yellowish-brown heads.



FIGURE 147.—Spruce foliage webbed together by the spruce needle miner (*Taniva albolineana*). Somewhat reduced.

Another species, *Epinotia nanana* (Treit.), occurs in the Eastern States and has somewhat similar habits, except that its webbed nests occur in the more exposed parts of the trees. The dried mined needles webbed together give the tree an unhealthy and unsightly appearance. The full-grown larva is about $\frac{5}{16}$ inch long, the body varying in color from dirty white to reddish. The moth is smoky brown.

A third species, *Recurvaria piceaella* Kearf., is recorded as attacking Colorado blue, Norway, red, and white spruces and is distributed from Maine to Colorado. The full-grown larvae are about $\frac{5}{16}$ inch long, reddish to light cinnamon brown, with a light-brown head.

Treatment.—Washing the webs loose from the trees by means of a forcible stream of water from a garden hose is a very effective way to control these insects. Begin at the uppermost webs on the tree and work downward until all webs and loose needles have been washed to the ground, and then immediately remove and destroy them. This treatment should be given in March before the leaf buds begin swelling or in late fall before cold weather sets in. Spraying in late summer, when the larvae are still small, with lead arsenate or with a combination of lead arsenate and nicotine is also useful.

SWEET PEA

Among the pests attacking sweet pea, which are listed below, red spiders, aphids, and plant bugs are usually the worst. These pests are discussed on the pages indicated.

	Page
Red spiders.....	11
Potato aphid.....	75
Pea aphid.....	9
Root aphids.....	21
Tarnished plant bug.....	35
Four-lined plant bug.....	94
Spotted cucumber beetle.....	7
Greenhouse leaf tier.....	5
Cutworms.....	2
Corn earworm.....	29
Sowbugs.....	17

TULIP

Tulip Bulb Aphid

When the outer scales of flowering bulbs, such as tulip, freesia, iris, lily, gladiolus, and crocus, become shriveled and turn brown while in storage and are covered with masses of grayish waxlike plant lice (fig. 148), the tulip bulb aphid (*Anuraphis tulipae* (Fonsc.)) is usually at work. It also sucks the vital juices from the new and developing shoots



FIGURE 148.—Tulip bulb aphids feeding on an iris bulb. About $2\frac{1}{2}$ times natural size.

that are produced while the bulbs are stored. This causes the subsequent growth to become weakened, stunted, and sickly, so that poor flowers are produced. This aphid is brought into storage when the stocks are harvested, and under favorable conditions it multiplies rapidly, so that an infestation soon spreads over all the stored bulbs.

Treatment.—Immersing the infested bulbs or roots in water at a temperature of 110° F. for 30 minutes is an effective treatment. Calculate the treating period from the time the water regains a temperature of 110° F. after the bulbs have been placed in the bath. Use an accurate thermometer to check the water temperature during the treatment. Maintain an even temperature by adding more hot water as needed. For treating large quantities it is advisable to use apparatus that is specially designed for this purpose and equipped with an agitator and thermostatic control. If the bulbs or roots are not to be planted soon after treatment, they should be thoroughly dried before they are returned to storage.

Dusting the infested bulbs thoroughly with a 2-percent nicotine dust and then covering them loosely with a cloth to confine the fumes for several hours is also useful.

To kill the insects on dormant bulbs, especially when large quantities are to be treated, fumigate them in a tight box or chamber with hydrocyanic acid gas for 2 hours, using 2 ounces of the

granular form of calcium cyanide for each 100 cubic feet of space. A temperature of 60° to 70° F. should be maintained within the chamber during the fumigation for best results.

Caution.—Since this gas is a deadly poison, the calcium cyanide should be handled only by those thoroughly familiar with its use. Where the fumigation box is in a room, provision should be made for adequate ventilation.

Should aphids appear on the foliage, buds, or flowers, spray or dust them with nicotine, pyrethrum, or derris, as recommended for aphids on page 9.

Prevention.—Examine all bulbs carefully before they are placed in storage; and if they are infested, use either treatment recommended above.

Green Peach Aphid

The green peach aphid (p. 75) at times attacks tulip and crocus bulbs while in summer storage, causing damage that results in weakened growth and poor flowering. The aphids of this species, and possibly others, also attack the growing plants and may transmit the virus of certain diseases from infected to healthy plants.

Treatment.—For bulbs in storage, use the treatment for the tulip-bulb aphid, discussed above. For aphids on growing plants, see treatment for aphids on page 9.

Tulip Leaf Aphid

The tulip leaf aphid (*Rhopalosiphoninus tulipaella* (Theo.)) feeds on the foliage of both tulip and iris. The aphids cluster on the leaves and shoots, where they suck the sap. As a result the leaves may fail to open or the plants may be killed. This aphid winters over on the dormant bulbs in the ground.

Treatment.—Where the foliage is infested, spray or dust with nicotine sulfate, pyrethrum, or derris, as discussed under aphids (p. 9). Where harvested bulbs are infested, use the treatment recommended for the tulip-bulb aphid (p. 87).

Other Pests of Tulip

Narcissus bulb fly.....	Page 60
Lesser bulb flies.....	54, 61
Bulb mite.....	61
Red spiders.....	11
Wireworms.....	15
Millipedes.....	17

VERBENA

Verbena Bud Moth

The caterpillar of the verbena bud moth (*Endothenia hebesana* (Walk.)) is about 1/2 inch long, with a dull copper-colored body and a black head. It has many food plants, including verbena, iris, snapdragon, gentian, tigerflower, hedge nettle, mullein, and false fox-glove. The caterpillars bore into the flowers and feed on the contents of the seed capsules (fig. 149). On iris, where they are becoming of increasing importance, the injury seems to be confined to the seed pods. On verbena they often web, tie together, and feed on the flower heads. The insect overwinters as larvae or pupae hidden in the stems or seed pods of the plants. The small, brown adult moths emerge early the following spring. The species is widely distributed. There are from four to six generations annually.



FIGURE 149.—Seed pods of snapdragon bored by caterpillars of the verbena bud moth. Empty pupal skin protruding from pod on right. Below, caterpillars, or larvae; about twice natural size.

Treatment.—On the first sign of injury the flowering buds and tender growth should be sprayed or dusted with lead arsenate and a second application made a week later. Where only a few caterpillars are present they may be removed, or the infested parts picked off and destroyed.

Prevention.—Since the insect spends the winter in the stems and seed pods of its various host plants, it is essential that all plant remains be gathered and disposed of by burning, preferably late in the fall.

Garden Flea Hopper

The garden flea hopper (*Halticus bracteatus* (Say)) is a small bug, about $\frac{1}{16}$ inch long, which looks somewhat like a black plant louse. The adults and greenish nymphs suck the juices from the leaves and stems of various plants, including verbena, chrysanthemum, gladiolus, marigold, morning-glory, smilax, zinnia, and many weeds. This causes small pale or whitish spots to appear in the areas on which the hopper feeds (fig. 150, A). Heavily infested leaves are quickly killed. The species occurs sporadically in gardens and is capable of doing much damage in a very short time. Plants growing in shaded locations seem to be preferred. These insects, especially the short-winged females (fig. 150, B) are often mistaken for flea beetles because of their jumping habit when disturbed. The adults overwinter in trash, and in the spring the females lay their eggs in the leaves and stems of plants.



FIGURE 150.—Garden flea hopper: A, Injured leaves showing whitish spots; B, adult short-winged female, 4 times natural size; C, uninjured leaves.

Treatment.—Spray or dust the insects with nicotine or pyrethrum.

Prevention.—Gather and burn all weeds and trash late in the fall to kill the overwintering adults.

Verbena Leaf Miner

The small larvae, or maggots, of the verbena leaf miner (*Agromyza artemisiae* (Kalt.)), like other related leaf miners, feed between the leaf surfaces



FIGURE 151.—Blotch or blisterlike mines on a verbena leaf caused by the verbena leaf miner.

of verbena leaves. Each maggot feeds singly, making a blister or blotchlike mine (fig. 151), which is evident on the leaf surface. The adult is a tiny two-winged midge, or fly.

Treatment and prevention.—Same as for the burdock leaf miner (p. 30).

Garden Webworm

The garden webworm (*Loxostege similis* (Guen.)), which is chiefly a pest of the vegetable garden, feeds on scarlet verbena and castor bean, as well as on weeds and grasses. The caterpillars spin a light webbing over the plants and feed on the foliage beneath (fig. 152). When disturbed they drop to the ground or crawl down into tubular portions of the webs. The full-grown caterpillar (fig. 153, b, c) is a little over 1 inch long and is light greenish with small darker spots over the body. The adult is a buff-colored moth with grayish markings.

Treatment.—Spray or dust the infested plants with lead arsenate, or paris green or pyrethrum, on the first signs of injury.



FIGURE 152.—Feeding injury caused by the garden webworm.

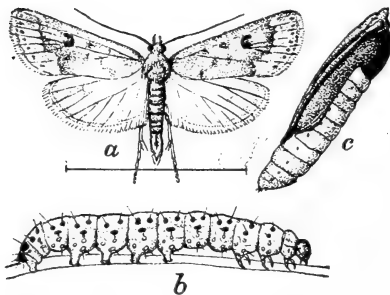

FIGURE 153.—Stages of the garden webworm: a, Adult moth; b, larva, or caterpillar; c, pupa. About natural size.

Melon Aphid

The melon aphid (*Aphis gossypii* Glov.) is a small, greenish to blackish plant louse (fig. 18, p. 90). It attacks many kinds of plants, including aster, chrysanthemum, hollyhock, hydrangea, lilac, lily, morning-glory, poppy, rose, sunflower, verbena, and various vegetable plants and weeds. The aphids are often found clustered on the under sides of the leaves and tender stems. Their sucking of the plant juices causes a stunting of the growth similar to that caused by other aphids.

Treatment.—See treatment for aphids (p. 9).

Other Pests of Verbena

	Page
Green peach aphid.....	25, 88
Red spiders.....	11
Yellow woolly bear.....	3
Oblique-banded leaf roller.....	83
Greenhouse leaf tier.....	5
Morning-glory leaf cutter.....	59
Blister beetles.....	7
Flower thrips.....	74
Greenhouse whitefly.....	18
Greenhouse orthezia.....	32

VIBURNUM

Aphids

When the young leaves of viburnum are badly curled or deformed and discolored by a sooty fungus early in the spring, it is an indication that the snowball aphid (*Anuraphis viburnicola* (Gill.)) is probably infesting the plant. This aphid varies in color from an ash gray to a dark green. Usually the infestation subsides late in June, at which time the winged forms move to other host plants to spend the summer.

Another species, *Aphis viburniphila* Patch, lives on snowball and other viburnums the entire season, although it is most abundant during the early summer. This aphid causes injury similar to that caused by the snowball aphid. The eggs are laid late in August in the leaf stems and between terminal stems.

Treatment.—Spray or dust on the first sign of injury, or when the young leaves are about half an inch long, using the remedies suggested for aphids, or plant lice, on page 9.

Mealy Flata

Viburnum plants may at times become untidy in appearance owing to infestation by one or more species of lantern flies. The mealy flata (*Ormenis pruinoso* (Say)) is often the chief offender. It feeds also on boxwood, catalpa, dahlia, privet, salvia, and other

herbaceous plants and shrubs. This insect feeds by sucking the plant juices, although often it is not especially injurious. The young, however, which are greenish, produce long masses of white woolly matter (fig. 154) which they scatter over the plants. The adult is slightly over $\frac{1}{4}$ inch long and is distinguished by the whitish powdery covering over the dark-purplish or brownish wings. The wings are folded vertically against the sides of the body. Both the young and the adults are very active and often occur in large numbers. The eggs are laid in slits in the bark in early fall and hatch the following spring. There is one generation a year in the Northern States.



FIGURE 154.—Nymph of the mealy flata, covered with white woolly matter, on a stem. About twice natural size.

A closely related form, *Ormenis septentrionalis* (Spin.), with similar habits may occur simultaneously with the foregoing form. The adult is slightly larger, pale bluish-green, and apparently occurs later in the season.

Treatment.—Same as recommended for mealybugs on page 31.

Prevention.—Locate and remove any twigs or branches infested with eggs.

Other Pests of Viburnum

	Page
Hornworms	4
Potato flea beetle	8, 67
Flower thrips	74
San Jose scale	57
Oystershell scale	56
Cottony maple scale	47
Red spiders	11
Dogwood twig borer	40

VIOLET

Violets are subject to attack by many of the same insects that feed on pansy. See insects listed under Pansy on page 65.

VIRGINIA CREEPER

Eight-Spotted Forester

The caterpillars of the eight-spotted forester (*Alypia octomaculata* (F.)) become numerous in some years and devour the foliage of Virginia creeper, Boston ivy, and grape. When these favored foods become scarce the insect may feed on nearby plants. The full-grown caterpillars are about $1\frac{1}{2}$ inches long, with the body smaller at the head end. They often are bluish-white, each segment being banded with reddish or orange, ringed with narrow black lines, and marked with black dots (fig. 155). The young caterpillars are not so distinctly marked. The moths are black, with eight large yellowish spots on the wings. There is one generation of caterpillars in the North, but farther south at least two generations occur each season.

Treatment.—The caterpillars can be killed by applying lead arsenate to the foliage. When not numerous, they may be picked off and destroyed.

Other Pests of Virginia Creeper

	Page
Leafhoppers	10
Hornworms	4
Aphids	9
Red spiders	11



FIGURE 155.—Caterpillars of the eight-spotted forester feeding on a leaf. About half natural size.

WATERLILY

Waterlily Aphid

The waterlily aphid (*Rhopalosiphum nymphaeae* (L.)), which feeds by sucking the plant juices, causes much damage to waterlilies. It disfigures and causes decay of the leaves, distorts the flower stems, and discolors the flowers. Other aquatic plants which it attacks are waterplantain, cattail, pondweed, and knotweed. This aphid is brownish, the winged form having a black head and body. It is also known as the reddish-brown plum aphid, because it is often found feeding in the early spring on the under sides of the leaves or on tender twigs of plum. In June the aphids leave the plum and infest waterlilies and other aquatic plants, on which they live and reproduce during the summer months. In the fall they return to the plum to deposit the overwintering eggs.

Treatment.—In pools or ponds that contain fish it is safest first to remove the fish and lower the water level to expose as much of the foliage as possible. Then spray the infested plants with either pyrethrum (p. 98) or nicotine (p. 97). Before returning the fish, allow the water to run for some time so that there will be a complete change of water.

Where it is not practical to remove the fish, the overflow should be plugged and the pool filled to overflowing. When the water begins to flow over the sides a forcible stream from the garden hose should be played on the infested flowers and foliage. The dislodged aphids will float on the surface and can be washed over the side of the pool to the lawn, where they can be killed by spraying with nicotine sulfate or pyrethrum. It may be necessary to repeat this treatment once or twice during the summer. Weighting down and completely submerging the plants for some time with a hoop or frame will permit the fish to feed on the aphids.

Prevention.—Since these insects migrate from plum to water plants, infestation on lilies can be prevented by controlling them on the plum trees, as soon as their presence is observed in the spring, by spraying with nicotine sulfate or pyrethrum.

Waterlily or Pondlily Beetle

Both adults and larvae of the water lily or pondlily beetle (*Galerucella nymphaeae* (L.)), feed on the leaves and flowers of the yellow and white pondlilies and other water plants. Their

feeding imparts a ragged appearance, and later the leaves turn brown. They are often serious pests in aquatic nurseries and private pools. The beetles (fig. 156) are dark brown, with a dull-yellow thorax, or waist, and are a little over $\frac{1}{4}$ inch long. The larvae, or grubs, are dark brown or blackish above and yellow underneath. At first the young larvae feed in groups on the upper surface of the leaves and flowers. Later they may feed on both surfaces of leaves above water. Two generations occur annually. The second-generation adults overwinter in the dead stems of water plants and other nearby plants as well as under the loose bark of trees and in similar hiding places. They appear in the spring to lay their yellowish egg clusters on the leaves.

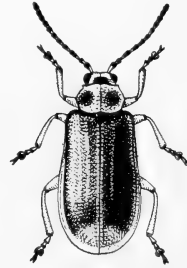

FIGURE 156.—Waterlily or pondlily beetle. About 4 times natural size.

Several species of leaf beetles belonging to the genus *Donacia* also feed on the leaves of waterlilies. These beetles are usually metallic-bluish or brownish and about $\frac{3}{8}$ inch long.

Treatment.—No entirely satisfactory remedy is known. The plants may be dusted or sprayed with lead arsenate, the spray being applied as a fine mist so as not to submerge the foliage and wash off the poison. If fish are kept in the pool, they should be removed while the treatments are applied, and the water should be changed before the fish are returned. If spraying is impractical, attempt to wash off the insects occasionally with a strong stream of water, or submerge the plants for a number of days by weighing them with a hoop. If fish are present, this will enable them to feed on the insects.

Prevention.—In late fall collect and burn all dead plant stems and debris in and adjacent to the pool, thus destroying all beetles that might be hibernating in such material.

Water lily Leaf Cutter

Waterlilies and other aquatic plants are sometimes injured by the water lily leaf cutter (*Nymphula oblitalis* (Walk.)). The caterpillars cut oval pieces out of the leaves and attach these to the upper surface. At times the pieces are fastened together with silken strands to form flattened, oval cases about 3/4 inch in length. These cases serve as protection and are carried about by the caterpillars as they feed. The wind may blow these boatlike cases about the pool and thus spread the infestation. As a result of the continuous feeding of the caterpillars the leaves are soon reduced to a ragged, rotten mass.

A closely related species, *Nymphula gyralis* (Hulst.), injures waterlilies by boring into the stems of leaves and flowers.

Treatment.—A light infestation of the leaf cutter may be eliminated by gathering and destroying the cases as soon as they are observed. In severe infestations the water level of the pool should be lowered sufficiently to permit dusting the plants with a mixture consisting of equal parts by volume of pyrethrum powder and tobacco dust. The application should be repeated 30 minutes later. The first application drives the worms out of their concealment and the second one kills them in their unprotected state. Spraying with lead arsenate is also recommended at times. If fish are present in the pool, they should be removed before either of these treatments and not returned until after the water has been changed.

In the case of the stem-boring species, remove and destroy the infested parts containing the borers.

YEW, OR TAXUS

Black Vine Weevil

The needles of yew, especially on the innermost branches, are bitten off at the tip along one side, or eaten completely, by the adults of the black vine weevil (*Brachyrhinus sulcatus* (F.)). The young, white, grublike larvae (fig. 157) also feed on the rootlets, and later they girdle or strip the bark from the larger roots. Arborvitae, astilbe, fern (maidenhair), gloxinia, hemlock, primrose, rhododendron, tuberous-rooted begonia, and wisteria are among the more than 75 other greenhouse and outdoor plants which this pest attacks. Out of doors this insect usually breeds on strawberry, yew, rhododendron, or on weeds such as dandelion or broadleaf plantain. The adult (fig. 158), which

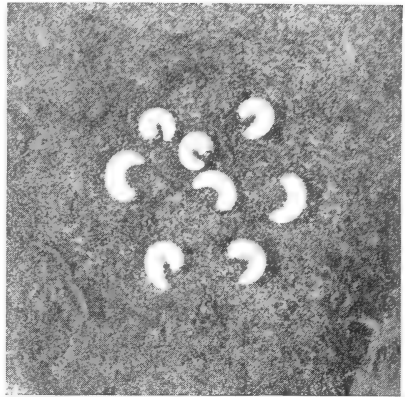

FIGURE 157.—Larvae, or grubs, of the black vine weevil. About natural size.



FIGURE 158.—Black vine weevil adult. About twice natural size.

is about 3/8 inch long, is black with patches of yellowish hair scattered over the otherwise roughened body. The winter is passed mostly as nearly full-grown larvae or pupae. The wingless adult females emerge in June and July. There is only one generation a year.

Treatment.—Spray with lead arsenate late in June or early in July before egg laying begins, or dust with a mixture made of equal parts by weight of calcium arsenate and hydrated lime. A poisoned bait made according to the formula given below is also effective when applied early in the evening.

Bran.....	5 pounds.
Molasses.....	1 pint.
Calcium arsenate.....	4 ounces.
Water.....	2 quarts.

The poisoned-bran bait recommended for cutworms may also be effective, although it has not been tested.

Other Pests of Yew

	Page
Red spiders.....	11
Grape mealybug.....	46
Oleander scale.....	54

YUCCA

Yucca Plant Bug

The foliage of yucca, or Adam's needle, is rendered yellowish and sick-looking from the sucking of the plant juices by the yucca plant bug known scientifically as *Halticotoma valida* Reut. The bugs stipple the leaves and cover them with numerous black specks of excrement, which imparts an unsightly appearance. This insect is also recorded as feeding on cactus. It usually makes its appearance early in May and may be present until frost. The adult, which is about $\frac{1}{8}$ inch long, is a stout-looking bluish-black bug with head and waist reddish brown. It does not fly readily, but it runs to the other side of the leaf or stem or down to the base when disturbed, and is difficult to catch. The younger stages are bright scarlet. They are often so numerous that the leaves are teeming with them. This insect has been known for a long time in Texas, Arizona, and New Mexico, but in recent years it has been frequently found from Washington, D. C., southward. Little is known about its development and habits.

Treatment.—Spray with nicotine sulfate or pyrethrum.

Prevention.—Removing and burning all dead and sickly plant parts late in the fall may be of value.

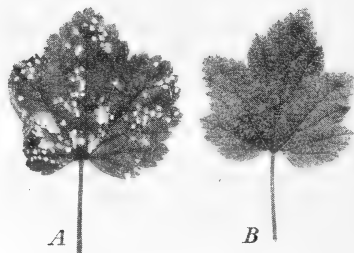

FIGURE 159.—A, Leaf showing spots caused by the feeding of the four-lined plant bug; B, uninjured leaf.

females lay the overwintering eggs in the fall in tender stems of currant and other shrubby plants. The tips of the whitish eggs are left protruding and may be detected on careful examination.

Treatment.—Because of their extreme activity the adults are difficult to control. Spraying in May or June, while the nymphs are present and before the adults develop, using a strong solution of nicotine sulfate, pyrethrum, or derris, with a good wetting agent, is recommended. Dusting with these materials may be used in place of spraying.

Prevention.—Remove and burn all plant remains, and especially any plant stems on which overwintering eggs are detected.

Other Pests of Yucca

	Page
Red spiders.....	11
Flower thrips.....	74
Stalk borer.....	34

ZINNIA

Four-Lined Plant Bug

The four-lined plant bug (*Poecilocapsus lineatus* (F.)) feeds by sucking the juices from the leaves and tender growth of many flowering plants and shrubs. Aster, chrysanthemum, coreopsis, currant, dahlia, goldenglow, heliotrope, peony, phlox, rose, snapdragon, sunflower, sweet pea, and zinnia are among the many plants attacked. The feeding causes small sunken areas on the upper leaf surfaces which appear somewhat like fungus disease spots (fig. 159). In heavy infestations the leaves soon turn brown and drop. The adults, which are about $\frac{1}{4}$ to $\frac{1}{2}$ inch long, are similar in shape to the tarnished plant bug (fig. 57, p. 35), but are greenish yellow with four distinct black stripes down the back or wing covers. The nymphs are bright red to orange. There is only one generation annually. The

Other Pests of Zinnia

	Page
Stalk borer.....	34
Spotted cucumber beetle.....	7
Blister beetles.....	7
Japanese beetle.....	48
Asiatic garden beetle.....	21
Tarnished plant bug.....	35
Aphids.....	9
Red spiders.....	11
Morning-glory leaf cutter.....	59
Leafhoppers.....	10
Flea beetles.....	8

INSECTICIDES

Chemicals in various forms are employed in controlling insects, mites, and related pests. These chemicals, or insecticides, are usually applied in the form of dusts, sprays, or fumigants. Since insects, generally speaking, are provided with either chewing or sucking mouth parts, two classes of insecticides, stomach poisons and contact insecticides, are used to combat them.

When insects of the chewing type, such as leaf-eating beetles and caterpillars, are infesting plants, a stomach poison, such as one of the arsenicals or one of the fluorine compounds, may be used. These insecticides are applied to

the plants, and as the insects devour the tissue they swallow the poison with it and are killed. Certain species of chewing insects, however, may also be killed with contact insecticides.

The sucking insects, which include aphids, scale insects, mealybugs, leaf-hoppers, and plant bugs, as well as plant-feeding mites, are not affected by stomach poisons because they draw their food from within the plant. Therefore they must be combated with insecticides which, on coming in contact with the body, will kill the insects by their burning action, by poisoning them through the breathing apparatus, by suffocating them, or by affecting their nervous system. Among the more important contact insecticides may be mentioned pyrethrum, nicotine, sulfur, soap, certain organic thiocyanates, and oil emulsions. These are applied to the insect and only incidentally to the plant, since it is impossible to hit one and avoid the other. It is essential, however, that contact insecticides be applied in such a manner that the material will come into direct contact with the body of the pest.

Root- or soil-infesting forms, on account of their underground habits, require a different treatment. Some may be killed by working poisons such as lead arsenate into the upper layer of the soil or by fumigating the soil with carbon disulfide, whereas others that come to the surface to feed may be combated with poisoned baits.

Stem- and root-boring insects tunnel through the pith, under the bark, or in the fleshy roots or bulbs of plants. Since these insects are difficult to reach and kill with insecticides, other means must therefore be used to control them. These methods of control are usually given under the discussion of the pest concerned.

Since the preparation of this publication, DDT has become an outstanding insecticide. A brief discussion of the preparation and possible uses of DDT for the control of certain insects has been included in an appendix (p. 110).

There have been developed several other new insecticides about which there is not sufficient information available to warrant recommendations in this publication. Some of the more outstanding of these materials are chlordane, benzene hexachloride, chlorinated camphene, hexaethyl tetraphosphate, tetracthyl pyrophosphate and parathion. These materials will be available on the market and will sometimes be found in mixtures with insecticides that are recommended. Research work underway will provide

information on the uses of these materials and of DDT, therefore you should consult a local entomologist or county agent before using the materials on ornamental plants and flowers.

STOMACH POISONS

Lead Arsenate as a Spray

Lead arsenate is widely used for the control of chewing insects. Two forms are available, acid lead arsenate and basic lead arsenate. The former is by far the more generally used and is the one meant when the term "lead arsenate" is employed. The term is so used throughout this publication. Lead arsenate is available commercially in powdered form and is readily incorporated in dusts or sprays and then applied to the foliage on which the insect is feeding. This poison may also be mixed with other insecticides, such as nicotine or oil emulsions, or with fungicides, such as sulfur, lime-sulfur, or bordeaux mixture. Sprays may be prepared according to the following formulas:

Use $\frac{3}{4}$ ounce, or 3 level tablespoonfuls, of lead arsenate to 1 gallon of water or 1 pound per 25 gallons for larger quantities. Make up a thin paste by adding only a small quantity of water to the powder. Then stir this paste thoroughly into the full quantity of water. For preparing larger quantities see table 1 on page 105. Since lead arsenate settles slowly, it is necessary to shake the container occasionally to maintain a uniform mixture.

Spreaders and stickers are not usually necessary. However, for plants having glossy, waxy, or smooth leaves, the stirring in of $2\frac{1}{2}$ level teaspoonfuls of powdered skim milk, or 6 level teaspoonfuls of wheat flour, or 2 teaspoonfuls of linseed oil or fish oil, or 4 teaspoonfuls of white-oil emulsion, to each gallon, will aid materially in making the insecticide spread and adhere better. Commercial spreaders and stickers should be used according to the manufacturer's directions.

The spray described above is usually tolerated by most plants. It must be remembered, however, that certain delicate plants, and especially brightly colored flowers and tender foliage, are likely to be injured. For certain resistant insects, such as the Japanese beetle and the Asiatic garden beetle, the strength must be increased to 1 ounce (instead of $\frac{3}{4}$ ounce) per gallon.

A satisfactory spray combining the properties of a stomach poison and a contact insecticide may be made by

preparing the lead arsenate solution as directed above and then adding 1¼ teaspoonfuls of 40-percent nicotine sulfate to each gallon of the lead arsenate mixture, without soap.

A spray combining a fungicide, a stomach poison, and a contact insecticide may be made by first preparing a gallon of bordeaux mixture (p. 97) and then adding to this 3 level tablespoonfuls of lead arsenate and 1¼ teaspoonful of 40-percent nicotine sulfate.

One drawback to the use of lead arsenate is its tendency to leave a whitish residue on the sprayed leaves. This should not be stressed as a decided objection, however, since spraying is recommended only when the plants are seriously affected or threatened and the material must be applied promptly. Following an effective treatment and the disappearance of the defoliators, the new leaves which appear as the plants grow will show neither spray residue nor insect injury.

Caution.—All arsenical compounds, including lead arsenate, calcium arsenate, and paris green, are poisonous to man and higher animals and should be clearly labeled "POISON." They should be kept away from food products, and stored in a place inaccessible to children and animals. The arsenicals, except paris green, are usually colored pink to denote their poisonous nature.

Lead Arsenate as a Dust

A dust prepared as follows is useful in controlling many leaf-chewing insects and is easy to mix and apply:

Powdered lead arsenate, 1 ounce, or part by weight.
Hydrated or air-slaked lime, talc, tobacco dust, or kaolin, 4½ ounces, or parts by weight.
Dusting sulfur, 4½ ounces, or parts by weight.

The ingredients are first thoroughly mixed and then sifted several times through a fine-mesh screen or ordinary flour sifter. To apply this dust, use any of the hand dusters or blower guns available on the market.

One-half ounce of 40-percent nicotine sulfate added to the dust at the time of mixing gives it contact-insecticidal properties.

Where sulfur is being used as a fungicide, or if red spiders, plant bugs, leafhoppers, or thrips are infesting the plants along with leaf-chewing insects, lead arsenate may be added to the sulfur and applied as a dust, as indicated in the following formula:

Dusting sulfur, 9 ounces, or parts by weight.
Lead arsenate, 1 ounce, or part by weight.

Caution.—See "Caution" under Lead Arsenate as a Spray, page 96.

Calcium Arsenate

Calcium arsenate is sold in powdered form and is used for the control of chewing insects in much the same manner as lead arsenate. Calcium arsenate, however, is more likely to injure tender plants because it contains more soluble arsenic; consequently lead arsenate is more generally used on flowering plants and shrubs. The addition of three or four times as much hydrated lime, by weight, as calcium arsenate will make it safer to use. The usual strength is 2 to 3 pounds of calcium arsenate in 100 gallons of water. For small quantities use 2 level tablespoonfuls of calcium arsenate and 4 or 5 of hydrated lime to each gallon of water.

When calcium arsenate is used as a dust, it should first be mixed with from 3 to 4 times its weight of hydrated lime.

Caution.—See "Caution" under Lead Arsenate as a Spray, page 96.

Paris Green

Paris green is not being as widely used for spraying as formerly because of its tendency to burn tender foliage and flowers. It is more generally employed in the preparation of poisoned baits to control cutworms, armyworms, grasshoppers, ants, sowbugs, and millipedes, as discussed under the heading "Treatment" for each of these pests.

One ounce of paris green added to 3 gallons of water in which 2 pounds of brown sugar has been dissolved makes an effective spray against certain species of thrips, especially the gladiolus thrips, even though it may cause some foliage injury. This spray should not be used to control thrips except when it is impossible to obtain tartar emetic (p. 45), which is as efficient and does not cause burning.

When paris green is used against chewing insects, the spray is prepared by adding 2 level teaspoonfuls of paris green and 3 or 4 level tablespoonfuls of hydrated lime to 1 gallon of water. The addition of hydrated lime decreases the possibility of burning the plants.

Since paris green settles quickly, it is necessary to keep the spray solution constantly agitated while spraying. It should not be combined with sprays containing lime-sulfur, soap, sulfides, or any fungicide containing ammonium.

Caution.—See "Caution" under Lead Arsenate as a Spray, page 96. Paris green should not be inhaled. The skin, and especially open wounds, should be protected from this compound, or serious poisoning may result.

Fluorine Compounds

Fluorine compounds have limited use as substitutes for arsenicals in the control of flower-garden insects, especially certain beetles and weevils. Cryolite (sodium fluoaluminate) in both the natural and the synthetic forms, is used against blister beetles, flea beetles, Fuller's rose beetle, and the imported cabbageworm. For spraying, it is used at the rate of 2 to 3 pounds in 50 gallons of water. In small quantities use 2/3 to 1 ounce, or 5 to 8 level teaspoonfuls, to 1 gallon of water. For dusting, 2 parts of cryolite is mixed with 1 part of tobacco dust, clay, talc, pyrophyllite, sulfur, or cheap flour. Lime should not be used as a diluent for the fluorine compounds.

Barium fluosilicate and sodium fluosilicate are other fluorine compounds. The former is used in the same manner as cryolite. Sodium fluosilicate, however, is more likely to burn the plants unless used in very dilute form, consequently it has more limited use. It is chiefly used as a poison in cutworm, mole, cricket, or gasshopper baits.

Caution.—All fluorine compounds are poisonous and should be handled with care and kept away from food.

Bordeaux Mixture

Bordeaux mixture is chiefly used as a fungicide for controlling certain fungus diseases. It is also employed, however, as a repellent against attack by flea beetles, the potato leafhopper, plant bugs, and a few other pests, and as an emulsifying agent for oil sprays.

Home-made bordeaux mixture may readily be prepared with the following ingredients:

	For small quantities	For large quantities
Bluestone (copper sulfate).....	4 ounces.	2 pounds.
Hydrated lime.....	6 ounces.	3 pounds.
Water	3 gallons.	25 pounds.

Dissolve the bluestone crystals in hot water in a wooden, earthenware, or glass vessel (never in metal). Dilute with half the total water specified. Then make a paste of the lime in a small quantity of water, and add the rest of the water to this. Next pour the diluted bluestone and lime solution together and mix thoroughly. Finally, strain the mixture through fine cheesecloth directly into the sprayer. This mixture should be made fresh each time it is used.

Manufactured products, both pastes and powders, are also available for making up bordeaux mixture. They

are especially convenient for use in small gardens and are satisfactory under most conditions of moderate infection. The manufacturer's directions should be followed in preparing and applying this material.

Lead arsenate, calcium arsenate, and nicotine sulfate may be combined with the prepared bordeaux mixture.

Caution.—Bordeaux mixture may cause gastric disturbances if taken internally. All unused portions should be disposed of or covered so that they will be inaccessible to children and animals. It is also somewhat irritative to the eyes and skin.

CONTACT INSECTICIDES

Nicotine Sulfate as a Spray

Nicotine, in various forms, is one of the most generally used of the standard contact sprays because of its effectiveness and the ease with which a spray can be prepared. It is used against many sucking and other soft-bodied insects. Besides being available in the form of tobacco extracts, it can be purchased under a number of proprietary names as a liquid containing nicotine sulfate or nicotine itself. Both these liquids, as commercially sold, contain not less than the equivalent of 40 percent of nicotine by weight. Since the concentrations of the commercial products vary, the directions for their dilution, which are usually given on the labels of the containers, should be followed. Concentrates containing 40 percent of nicotine sulfate should be diluted with soapy water as follows:

For small quantities, 1 to 1 1/4 teaspoonfuls to 1 gallon of water.

For larger quantities, 1 fluid ounce to 8 gallons of water.

For more resistant insects it may be necessary to use a little more of the nicotine sulfate.

The solution is prepared by dissolving about 2 rounded tablespoonfuls of soap flakes, or the shavings of a 1-inch cube of some hard but cheap soap, in each gallon of water and adding the nicotine sulfate immediately before spraying. If the prepared spray has stood for some time, it should be mixed thoroughly before being used. For plants with a waxy or glossy surface it may be necessary to add more soap. This is easily determined by looking at the freshly sprayed plant. If the spray draws together in drops, more soap is needed. Fish-oil soap or some of the newer wetting agents (p. 103) may be substituted for the laundry soap. The insects must

be wetted by the spray or they will not be killed.

Nicotine sulfate may be safely combined with most other insecticides.

Caution.—Nicotine and its compounds are violent poisons, and care should be exercised in their use. Exposure to fumes or sprays for any length of time causes acute nausea in some persons. Combinations other than nicotine bentonite are most likely to give this effect. Susceptible persons should protect themselves with a respirator provided with pads saturated with a solution of citric acid.

Acute illness can be caused by the absorption of nicotine through the skin. If concentrated solutions of nicotine are spilled on the skin, they should be immediately washed off with water. The operator should not continue working in outer clothing which has become wet with nicotine-containing sprays, as the body will take up the nicotine from the clothing.

Nicotine Sulfate as a Dust

Nicotine sulfate combined with a dry carrier makes a dust which is useful whenever it is preferable to apply a dust rather than a spray. It can be obtained as a commercially prepared product ready to apply to the plants. For home use, it may be prepared by adding the required proportion of nicotine sulfate to hydrated lime. These dusts are generally used for the control of aphids and other soft-bodied insects, where the temporary whitish deposit on the plants is not objectionable. Strengths varying from 2 to 4 percent of actual nicotine are generally used, depending on the resistance of the insects.

To make a dust containing approximately 2 percent of nicotine (allowing for a slight loss by evaporation), the following formula may be used:

Nicotine sulfate, 1 to 1½ ounces, or 5 to 8 teaspoonsful.
Hydrated lime, 1 pound.

For more resistant insects the proportion of nicotine sulfate should be doubled to make a 4-percent nicotine dust.

The mixture may be prepared by pouring the nicotine sulfate over the dust and then passing it through an ordinary household flour sifter. Be sure that all lumps are broken up and passed through the sifter. Resift at least three times to insure a thorough mixture. Or, place a quart of fresh

hydrated lime in a container which can be tightly closed, add a handful of small stones or marbles, pour in 1 fluid ounce of nicotine sulfate, close the lid, and shake well for several minutes. Remove the stones by passing the mixture through a sifter or screen. Larger quantities may be prepared by placing the lime and nicotine sulfate in a keg or metal drum with a tight-fitting cover, together with several sizable stones or pebbles, and then rolling the drum for about 20 minutes to insure thorough mixing.

A single application is often successful, but the treatment may be repeated as often as is required. It is best to use the dust promptly, otherwise it should be stored in tight metal or glass containers, as it loses its strength rapidly when exposed to the air. The dust should be applied by means of a hand duster, and the application should preferably be made when the temperature is about 65° F., the foliage dry, and the air still.

Caution.—In mixing and applying the dust the operator should be careful to avoid inhaling much of it, for it may cause irritation in the nose and throat. See also caution on this page.

Pyrethrum

Pyrethrum is a contact insecticide that may be safely used as a spray or dust in the flower garden. It is effective against such sucking insects as aphids, thrips, plant bugs, and leafhoppers. It is also effective against certain chewing insects, including the caterpillars and adults of leaf tiers or leaf rollers, and the adults of the Japanese beetle, black blister beetle, Fuller's rose beetle, rose chafer, cucumber beetles, and probably others. The insecticide must come in contact with the body of the insect.

Pyrethrum powder is made from the flower heads of several species of *Chrysanthemum*. The active ingredients or insect poisons are two oily substances known as pyrethrin I and pyrethrin II. The strength of a spray or dust, therefore, depends on the percentage of total pyrethrins contained in the final mixtures. For spraying garden plants the liquid alcoholic extract, containing about 2 to 3 percent of pyrethrins, and diluted according to the manufacturer's directions, is preferable. For dusting, the pure, fresh pyrethrum powder, containing approximately 1.3 percent of pyrethrins may be diluted with 3 parts of such nonalkaline material as tobacco

dust, fine dusting sulfur, pyrophyllite, or talc. A manufactured dust containing 0.3 percent of pyrethrins is recommended for general purposes.

Since pyrethrum products lose their strength rapidly on exposure to the air, they should be kept in tight containers and not mixed until ready to be applied. It may be safely applied to most garden flowers without causing injury. Usually the effectiveness is increased by adding a suitable wetting or spreading agent (p. 103) to the spray; however, many commercial brands already have these materials included. Pyrethrum may be combined with derris or cube, as discussed under Derris (p. 99), and the combination makes a more effective spray against both chewing and sucking insects.

Caution.—Although pyrethrum is comparatively nonpoisonous to human beings and other warm-blooded animals, persons allergic to ragweed in some instances are subject to attacks of hay fever when exposed to pyrethrum.

Derris, Cube, and Other Rotenone Insecticides

Derris and cube powders are made by grinding the roots of certain tropical plants which contain rotenone and other ingredients that kill various insects. They are largely used as contact insecticides, although against some insects they seem to act as stomach poisons or repellents. These materials are effective against such sucking insects as aphids and thrips, and such chewing insects as young caterpillars, the cabbage looper, the imported cabbage worm, the European corn borer, ants, young sawfly larvae, and the adults of the Japanese beetle, cucumber beetles, and flea beetles. When used with sulfonated castor oil or in white-oil emulsion, they are effective under greenhouse conditions against the common red spiders and other spider mites.

The rotenone content of these materials varies considerably, but a good derris-root or cube-root powder should contain from 4 to 5 percent of rotenone and about $3\frac{1}{2}$ to 4 times as much of other extractives. The dust may be stirred into water and applied as a spray, or mixed with some other fine dust for dusting infested plants. For sprays the final rotenone content usually ranges from 0.0056 to 0.025 percent, and for dusts from 0.5 to 1.0 percent. These may be prepared at home, as described

below, or the commercially prepared materials ready for use may be purchased. Liquid extracts of the active ingredients are also available; however, certain of these may lose some of their effectiveness when mixed with water. The derris and cube insecticides are sold under various trade names, and since the strength of the active ingredients may vary in the different brands, they should be used as directed by the manufacturer.

Rotenone-containing insecticides lose their strength on exposure to sunlight and air, and several days after being applied to a plant they are usually no longer effective. All materials should therefore be stored in tight containers, and sprays or dusts should be prepared just before they are to be used.

Caution.—These insecticides are comparatively nonpoisonous to man and other warm-blooded animals, although sometimes they do irritate the tender skin and mucous membranes.

Home-Made Derris Sprays

For the control of cabbage worms, leaf tiers, leaf rollers, and similar caterpillars, and for the spotted cucumber beetle and other cucumber beetles, use a spray made by mixing 2 or $2\frac{1}{2}$ ounces of derris powder, having a rotenone content of 4 percent, in 3 gallons of water, or 2 or $2\frac{1}{2}$ pounds in 50 gallons of water. These proportions give the spray a rotenone content of about 0.02 or 0.025 percent. (See table 1 for methods of preparing different quantities from various strengths of derris or cube, page 105.)

To prepare a spray, first wet the derris powder with a small quantity of water, preferably containing a suitable wetting or sticking agent. Mix thoroughly to make a uniform paste. Then stir this paste into the bulk of the water in the spray tank.

Derris sprays are improved by the addition of a nonalkaline spreader or sticker, such as high-grade liquid or powdered neutral coconut-oil soap, miscible pine oil, one of the sulfonated oils, or one of the proprietary materials now available. These should be used according to the dilutions recommended by the manufacturer.

A derris spray considerably weaker than the formula above, and containing 0.0056 percent of rotenone, is effective against the common red spiders and other spider mites, the cyclamen mite, certain thrips, and the very young stages

of leaf tier and leaf roller caterpillars. It is prepared as follows:

	<i>Small quantities</i>	<i>Large quantities</i>
Derris powder (4 percent rotenone).....	3/8 ounce, or 4 1/2 level tablespoonfuls.	9.5 ounces.
Sulfonated castor oil ¹ (1-400).....	1 fluid ounce, or 2 tablespoonfuls.	1 pint.
Water.....	3 gallons.	50 gallons.

¹ Sodium oleyl sulfate or sodium lauryl sulfate may be substituted for the sulfonated castor oil as a spreader, but should be used according to the manufacturer's directions. White-oil emulsion (p. 100), diluted to give 0.5 percent of oil in the spray water, may also be substituted for the sulfonated castor oil.

By adding 2 fluid ounces of an alcoholic extract of pyrethrum (containing about 2.4 percent of pyrethrins) to the 3-gallon derris formula, or 1 quart to the 50-gallon formula given above, the effectiveness of the spray against thrips and young caterpillars is greatly increased.

Home-Made Derris Dusts

Efficient home-made dusts may be prepared by mixing finely ground derris-root or cube-root powder with various diluents. These diluents should be non-alkaline materials such as finely ground tobacco dust, clay, kaolin, talc, wheat flour, dusting gypsum, diatomaceous earth, infusorial earth, and sulfur. When mixing a derris or cube dust, follow the procedure outlined for nicotine sulfate dust (p. 98), except that lime should not be used.

To prepare a dust containing 1 percent of rotenone, use the following formula:

Derris powder (4 percent rotenone).....	1 pound (1 part by weight).
Diluent.....	3 pounds (3 parts by weight).

To prepare a dust containing 0.5 percent of rotenone, use the following formula:

Derris powder (4 percent rotenone).....	1/2 pound (1 part by weight).
Diluent.....	3 1/2 pounds (7 parts by weight).

If the rotenone content of the derris powder is greater or less than 4 percent, the proportions of the inert diluent must be varied accordingly. For example, 1 part of derris powder containing 5 percent of rotenone should be mixed with 4 parts of the diluent by weight to obtain a 1-percent rotenone dust. Upon request, manufacturers of derris powders will usually supply ground root of a specified rotenone content, which can then be diluted to the desired strength.

Soap Sprays

For such soft-bodied insects as aphids and thrips and the young of scale insects, mealybugs, whiteflies, and leafhoppers, a concentrated solution of ordinary soap may be employed with some success as a spray. Such a solution may be prepared by dissolving 2 rounded tablespoonfuls of soap flakes, or a 1-inch cube of laundry soap, or a rounded tablespoonful of whale-oil or potash fish-oil soap, in 1 quart of hot water. For seedlings and tender plants, use only half the quantity of soap suggested above, since such plants are often injured if the full strength is employed. The white coconut-oil soaps are especially good as insecticides and will work well in hard water. Soap solutions are most effective when applied on calm, humid days, when the rate of evaporation is low.

Soaps are also used to a large extent in preparing emulsions, and also as spreading and wetting agents and as stabilizers for nicotine and pyrethrum sprays. The amount of soap required in a spray mixture is regulated somewhat by water hardness. If used with lead arsenate, some soaps may increase arsenical injury to foliage.

Oil Emulsions

White-Oil Emulsion

Oil sprays are applied to plants in the form of a diluted emulsion, since the undiluted oil cannot be used on plants with safety. The so-called highly refined, or white, oils are preferable for use in horticultural sprays. White oils are made by treating petroleum oils chemically to render them inert and less injurious to plants. The medicinal white oils are examples, although those used for horticultural sprays are usually thinner and lighter. The white-oil emulsion concentrates, also called summer-oil emulsions, are available on the market and have the consistency of thin paste or mayonnaise containing 70 to 85 percent of oil. They contain an emulsifier, such as soap, to make them mix readily with water. These emulsion concentrates are diluted with water so that the final spray contains from 0.5 to 1 percent of oil. A dilution to give 2 percent of oil is sometimes used on the hardier shrubs. These strengths are tolerated by most plants, although sweet peas, ferns, and certain tender plants are readily injured. Such injury may occur because as the water evaporates the oil is left behind in a

rather concentrated form in cavities and depressions, as in certain pyramidal-type junipers. It is advisable to wash or syringe the more tender plants with water an hour or so after applying the treatment. Although oil emulsions can be prepared at home, it is much more satisfactory to purchase the prepared product and use it at the dilutions recommended by the manufacturer.

White-oil emulsions are often used as spreading or wetting agents with other sprays. When so used they increase the effectiveness of these sprays against scale insects, mealybugs, mites, and the common red spiders, because the waxy covering over the insect's body is more easily penetrated and wetted. The toxicity of oil sprays is enhanced by the addition of nicotine, pyrethrum, or derris or cube extracts.

Oil-Nicotine-Soap Spray

The following combination spray may be used on hardy shrubs for the control of young scale insects during their hatching period, and also against lacebugs and probably other sucking insects:

½ pint or 1 cupful of white-oil emulsion (83 percent of oil).

¼ pound or 1½ cupfuls of soap flakes.

4 teaspoonfuls of 40-percent nicotine sulfate.

3½ gallons of water.

Caution.—See “Caution” under “Nicotine” page 98.

Oil-Rotenone Spray

Another spray combination that may be used in controlling lacebugs on hardy shrubs, such as azalea and rhododendron, is as follows:

4 ounces (8 level tablespoonfuls) of white-oil emulsion.

¾ ounce (5 level tablespoonfuls) of derris powder (4 percent rotenone).

3 gallons of water.

Dormant Oil Emulsion

There are also available on the market a number of so-called dormant oil emulsions. These are made of less highly refined oils than the white-oil emulsions, are used primarily for spraying on hardy shrubs and trees during the dormant season, and may be used in place of the dormant miscible oils, discussed below. They should be diluted with water as indicated on the label or in the instructions accompanying these proprietary materials, since the oil content of the different products varies.

Miscible Oils

Several proprietary miscible oils are used in combating scale insects and some other insects on hardy plants. When diluted with water they form a milklike spray mixture. These oils are obtainable under various trade names and should be used as directed by the manufacturers. Miscible oils are primarily used while the plants are dormant. They are usually diluted at the rate of about 1 gallon (or part by volume) of the oil to 15 or 20 gallons (or parts) of water for deciduous shrubs and trees, and 1 gallon to 25 or 30 gallons of water for evergreens. The oil should be well stirred before it is used. The sprayer should be free from alkalis, acids, and other impurities. Soft water should be used when available. The oil should be poured into the tank and the diluting water added to it. The solution should be kept thoroughly mixed to prevent the accumulation of free oil on the surface. As with other mineral-oil sprays, the liquid should not be allowed to puddle about the base of the plants. Dormant oil sprays should not be applied in freezing weather. It is preferable to spray when the temperature is 40° F. or above and there is not likely to be freezing weather until the spray dries. Although dormant spraying may be carried on in the fall, winter, or spring, probably the safest period is in the spring just before the new growth starts.

Sulfur

Dusting Sulfur

Finely ground sulfur, called dusting sulfur, is a contact insecticide and is also used as a fungicide against certain plant diseases. It may be applied as a dust for the control of the red spider (p. 11), the tarnished plant bug (p. 35), the phlox plant bug (p. 67), and thrips. Dusting sulfur is also used in combination with pyrethrum powder against leafhoppers (p. 10) and plant bugs. It may be used in the preparation of nicotine (p. 98) and rotenone-containing dusts.

Sulfur may be used as a diluent for lead arsenate to make a stomach-poison dust mixture. Part of the sulfur may be replaced with such diluents as hydrated lime, tobacco dust, gypsum, kaolin, talc, or cheap flour. Where sulfur is being used, the addition of lead arsenate as indicated in the formulas given under Lead Arsenate as a Dust (p. 96) will control such chewing insects as young caterpillars and sawfly larvae.

Wettable Sulfur

Wettable sulfurs, consisting of finely ground sulfur mixed with a suitable wetting agent, are available on the market. These materials mix readily with water and should be used as directed by the manufacturer. Sulfur may also be prepared as a spray by mixing $1\frac{1}{4}$ level tablespoonfuls of sulfur dust in 1 quart of water, or, for larger quantities, 1 ounce to 1 gallon. Since sulfur does not mix easily with water, it is best to stir the water slowly and thoroughly into the dry sulfur.

Lime-Sulfur Concentrates

Commercial lime-sulfur concentrates (liquid) are very effective against some of the armored scale insects, such as the San Jose scale and the pine needle scale, and mites, when applied as dormant sprays. The concentrates should have a density of about 33° on the Baumé scale. For dormant or winter sprays use 1 pint of the concentrate to 1 gallon of water. For summer spraying liquid lime-sulfur is usually diluted at the rate of 2½ ounces (5 tablespoonfuls) to 1 gallon of water. Since the concentrate may vary, it is advisable to follow the manufacturer's directions.

Concentrated liquid lime-sulfur (32° Baumé) with a spreader added may be used to control the red spider mite on various plants, and also against exposed cyclamen mites on chrysanthemum and snapdragon. The following proportions are used:

	<i>Small quantities</i>	<i>Large quantities</i>
Lime-sulfur (1-400) . . .	2 teaspoonfuls or 9.5 ml.	1 quart.
Wetter and spreader (1-1,000).	$\frac{3}{4}$ teaspoonful or 4 ml.	0.8 pint or $1\frac{1}{2}$ cupfuls.
Water	1 gallon.	100 gallons.

Do not apply this spray during the heat of the day or in strong sunlight as injury may result from the hot sun rays. This spray does not stain the foliage as does lime-sulfur solution without a spreader.

Caution.—Lime-sulfur will discolor paint, brick, or cement work; therefore, either avoid using it on shrubbery against buildings or protect the walls with canvas or other material while spraying. Do not use oil sprays on plants which have recently been treated with sulfur-containing insecticides. In extremely hot weather sulfur should be used with care, since it may burn tender growth.

When using sulfur, especially as a dust, care should be taken to avoid getting it into the eyes. If the eyes are affected, do not rub them. It is well to wear goggles and a respirator.

Mercuric Chloride

Mercuric chloride, or bichloride of mercury, is known commercially as corrosive sublimate. It acts as a contact insecticide against such soil-inhabiting pests as the larvae of fungus gnats, certain root maggots, earthworms, slugs, and snails. This material is used by drenching the infested soil with a solution containing 1 part to 1,000 parts of water. Where only a few plants or small areas are to be treated, dissolve 1 level teaspoonful in 10 quarts of water, or 2 tablets (each containing 7.5 grains) in 1 quart of water. These tablets are obtainable at drug stores. For larger quantities use 1 ounce of the powder to 7½ gallons of water. Since mercuric chloride dissolves slowly, it is advisable first to dissolve it in a small quantity of hot water and then dilute it to the correct quantity with cold water. When it is used as a soil drench, care should be taken that none of the solution gets on the foliage. A solution of the same strength is used to control the gladiolus thrips on the dormant corms (p. 45).

Caution.—Since mercuric chloride is a deadly poison, great care must be taken to keep it, or any seed, corms, or tubers treated in it, out of reach of children and domestic animals. It must be handled carefully, since it will seriously burn the skin when undiluted. Persons who are susceptible to mercury poisoning should wear rubber gloves when handling this poison. Mercuric chloride attacks metals; therefore only wooden, glass, or earthenware vessels should be employed in preparing and handling the solution. These vessels should be thoroughly cleaned immediately after use.

Organic Mercurials

In the last few years several organic mercurial compounds have become available under various proprietary names. Their chief use is for disinfecting seeds and soil, but some of them are also used to control certain insects. Semesan, for example, may be used to control the gladiolus thrips on the corms. The recommendations of the manufacturer should be followed.

Caution.—See Caution under "Mercuric Chloride."

Thiocyanate Sprays

Certain synthetic organic compounds known as thiocyanates have recently been developed for use as horticultural

and household sprays. Most of these sprays are rather specific in their toxic or killing action against certain insects and mites. They are especially useful against red spiders, scale insects, mealybugs, aphids, and certain species of thrips. They are more likely to injure certain plants than are nicotine, pyrethrum, derris, or cube sprays, although thiocyanates are comparatively harmless to human beings. Some of the thiocyanate preparations now available on the market contain other toxic ingredients, as pyrethrum, derris, and pine oil. Some preparations must be used with a suitable wetting and spreading agent, whereas others already have these in the mixtures as purchased. With some of the proprietary sprays it is necessary to wash or rinse the treated plants soon after the spray has been applied, to avoid injury from the insecticide. Since there is such variation in the make-up of the thiocyanate sprays, the directions furnished by the manufacturer should be followed.

Caution.—These compounds are generally considered harmless to man, although some of them are capable of causing dermatitis to humans. Since the hazards are not fully understood, care should be exercised in handling these materials.

SPREADERS, WETTERS, AND STICKERS

Spreaders and wetters are materials that are added to insecticides to make them spread over and wet the leaf surface or the body of the insects to which they are applied, and thus increase their effectiveness. Stickers are added to make the insecticide adhere to the foliage. Soap is an excellent wetting and spreading agent for contact insecticides but has little value as a sticker. These materials are often used with lead arsenate in spraying shrubs and shade trees to insure a better and more lasting coverage of the plant surfaces. Powdered skim milk, calcium caseinate, glue, wheat flour, and soybean flour, and oil emulsions are good sticking and spreading agents, whereas raw linseed oil and fish oil are primarily stickers.

In recent years various sulfated and sulfonated organic compounds have come into use as spreading and wetting agents, especially for use with such contact insecticides as nicotine, pyrethrum, and derris. Some of these are known under their chemical names as sodium lauryl sulfate, sodium oleyl sulfate, sulfated oleic acid, and sulfonated castor oil (the last one is known com-

mercially as turkey red oil). These materials are compatible with hard water and will wet smooth and waxy foliage. Many of them are used in dilutions of 1-1,000 or lower by volume, whereas sulfonated castor oil has been used with derris (p. 100) in a 1-400 dilution. These materials are now generally available and are sold under various trade names. They should be used according to the dilutions and recommendations of the manufacturer.

Do not use so much of the wetting agent that it will cause an excessive run-off of the insecticide from the sprayed plant surfaces; otherwise the effectiveness of the insecticide will be reduced.

FUMIGANTS

CARBON DISULFIDE

Carbon disulfide, also called carbon bisulfide, although ordinarily used for killing insects in stored or manufactured products, is also used as a soil fumigant or as an emulsion in the control of colonies of ants in the ground, root aphids, Japanese beetle grubs, white grubs, and other soil-inhabiting pests. The material can be purchased at most seed and drug stores. It is a clear, heavy liquid with a strong and disagreeable odor. On evaporation it gives off a heavy gas which diffuses through the soil. For best results this soil fumigant should be applied when the soil temperature is at least 60° F. at a depth of 6 inches. The liquid is injected into holes in the soil, the holes being placed about 12 inches apart and several inches deep. The holes should not be closer than 8 to 12 inches from the base of the plants. Pour from 1 to 2 teaspoonfuls of the liquid into each hole, depending on the distance from the plant. Immediately cover the hole with soil (and tamp it down), so as to confine the gas, which soon distributes itself through the soil. For fallow soil, where no plants are growing, use from 1 to 2 tablespoonfuls per hole, in holes spaced 1 foot apart.

To control ants in the soil of the lawn or garden, make the holes 2 to 4 inches deep and pour into each hole from 2 to 3 teaspoonfuls of carbon disulfide. In large anthills it may be necessary to make deeper holes and to pour in more carbon disulfide. It is also important to place the liquid below the roots of the grass; otherwise the grass may be killed.

Caution—Carbon disulfide is inflammable and explosive when mixed with air in certain proportions, and is poisonous. The liquid should be handled with great care and never be exposed near fire in any form. Even hot steam pipes may ignite the gas. The fumes are poisonous and should not be inhaled.

When used as an emulsion, carbon disulfide is effective in controlling the larvae of the Japanese beetle, white grubs, and other soil pests when an infestation is heavy enough to warrant the treatment. An emulsion for use in the garden or lawn is prepared as follows:

	<i>Parts by volume</i>
Rosin fish-oil soap.....	1
Water.....	3
Carbon disulfide.....	10

The soap and water are placed in a closed container and agitated until the mixture is uniform. The carbon disulfide is added and the agitation continued until the mixture becomes creamlike. One quart of this mixture is added to 50 gallons of water (or 4 teaspoonfuls to 1 gallon) and applied to the infested ground at the rate of 3 pints per square foot of surface. For small areas this liquid may be applied with an ordinary sprinkling can.

In treating lawns or garden areas, great care must be taken not to apply more emulsion than the soil can absorb without puddling, for otherwise severe burning of the grass or plants may result. It is well to keep the lawn moist for several days prior to applying the insecticide so as to keep the grubs feeding near the surface, where they can be reached by the emulsion.

TABLE OF MEASURES

The home gardener will find it profitable to obtain a set of measuring spoons, one or two measuring cups, a gallon measure marked into pints and quarts, and a reasonably accurate scale graduated to ounces and pounds for use in weighing and measuring the ingredients needed to prepare insecticides. Many of the department and seed stores have these utensils for sale at a moderate cost. With such equipment it will be possible to prepare the insecticides properly and thus avoid injury to the plants, such as might occur where quantities are guessed at or accidentally used in excess.

Among the measures that will be found convenient for ascertaining the exact quantities of the various materials

when used in small spraying or dusting equipment are the following:

Liquid measure:

- 3 level teaspoonfuls=1 level tablespoonful.
- 2 level tablespoonfuls (6 teaspoonfuls)=1 ounce.
- 29.57 cubic centimeters=1 ounce.
- 8 ounces (16 tablespoonfuls)=1 cupful.
- 16 ounces (2 cupfuls)=1 pint.
- 2 pints (4 cupfuls)=1 quart.
- 8 pints (4 quarts)=1 gallon.
- 2 teaspoonfuls in 1 gallon=approximately 1-400 dilution.
- 1 teaspoonful in 1 gallon=approximately 1-800 dilution.
- ¾ teaspoonful in 1 gallon=approximately 1-1,000 dilution.
- ½ teaspoonful in 1 gallon=approximately 1-1,600 dilution.

Dry measure (approximate):

- 28.35 grams=1 ounce.
- 16 ounces=1 pound.
- 3 level teaspoonfuls=1 level tablespoonful.
- 16 level tablespoonfuls=1 cup.

Number of level tablespoonfuls weighing 1 ounce:

- Derris powder..... 6½
- Pyrethrum powder..... 5
- Lead arsenate..... 4½
- Calcium arsenate..... 5½
- Paris green..... 1½
- Cryolite..... 2½

For the guidance of the grower and gardener table 1 shows the quantities of common insecticides to be used in preparing 1, 3, and 50 gallons of various kinds of sprays.

WHERE INSECTICIDES MAY BE PURCHASED

The insecticide materials mentioned in this publication, as well as many proprietary insecticides, can usually be purchased from local dealers in agricultural supplies, seedsmen, general stores, drug stores, and department stores. If they cannot be obtained locally, information regarding their purchase may be obtained through the county agricultural agent, the State agricultural college or experiment station, or the State department of agriculture.

WHEN AND HOW TO APPLY INSECTICIDES

In some instances, particularly when flower-infesting insects are in question, it is extremely difficult to control the insect and at the same time preserve the beauty of the flower. Insecticides, especially when improperly prepared, are sometimes too strong for tender foliage and delicate flowers, and injury may follow their use. Promiscuous spraying is, therefore, not advised. Insecticides are seldom if ever beneficial to the plant itself, and are useful only insofar as they remove dangerous or destructive pests with a minimum of damage to the plant. Do not spray unless some insect appears as a potential

TABLE 1.—Quantities of common insecticides to be used in preparing 1, 3, and 50 gallons of spray

Materials	With 1 gallon of water	With 3 gallons of water	With 50 gallons of water
LEAD ARSENATE			
Lead arsenate.....	$\frac{3}{4}$ ounce, or 3 level table-spoonfuls.	2 ounces, or 9 level table-spoonfuls.	2 pounds.
NICOTINE SULFATE AND SOAP			
Nicotine sulfate (40 percent nicotine)...	1 level teaspoonful.....	3 level teaspoonfuls....	8 fluid ounces ($\frac{1}{2}$ pint).
Soap flakes or cake soap.....	1 ounce, or 2 level table-spoonfuls of flakes, or a 1-inch cube of soap.	3 ounces, or 6 level table-spoonfuls of flakes, or 3 1-inch cubes of soap.	3 pounds.
DERRIS-ROOT POWDER¹			
Derris powder (4 percent rotenone)....	$\frac{1}{2}$ ounce, or $1\frac{1}{2}$ level table-spoonfuls.	$\frac{3}{8}$ ounce, or $4\frac{1}{2}$ level table-spoonfuls.	$9\frac{1}{2}$ ounces.
Sulfonated castor oil.....	2 teaspoonfuls.....	6 teaspoonfuls (2 table-spoonfuls).	1 pint.
Derris powder (5 percent rotenone)....	$\frac{3}{8}$ ounce, or 1 level table-spoonful.	$\frac{1}{2}$ ounce, or 3 level table-spoonfuls.	$7\frac{1}{2}$ ounces.
Sulfonated castor oil.....	2 teaspoonfuls.....	6 teaspoonfuls (2 table-spoonfuls).	1 pint.

¹ These dilutions give a rotenone content of about 0.0056 percent in the completed spray. To increase the rotenone content to about 0.02 percent, use approximately 4 times the quantity of derris-root powder indicated above but do not increase the quantity of sulfonated castor oil.

enemy of the plant or is found actually injuring it. Where only a few plants are concerned it may be sufficient to pick off the infested leaves or to remove and kill the insects.

It should be remembered that only those parts of the plant are protected that are thoroughly coated with material. Sprays often stick better than dusts and can be applied in light winds. However, dusts are easier to apply, and dusting equipment is less expensive and requires less attention to keep it in working order. For small gardens, therefore, dusting is probably the more satisfactory method.

To get the best results in the control of insects, the spray or dust mixtures must be properly prepared, and the applications must be made promptly and thoroughly with good apparatus. Disregard of these factors will result in waste of material, possible injury to the plants, and questionable results. Do not wait until the plants are seriously injured, but begin the treatment as soon as damage is observed. Using a watering pot or whisk broom is not spraying and is a hit-or-miss method that covers the plants only partially. The ideal spray is a *fine mist*, and the best work is done when the entire plant is thoroughly and evenly covered with very fine droplets. With dusts, also, an even and thin coating of the dust particles over the plant surfaces is desired. Best

results are accomplished by directing the sprays or dusts from below to cover the under surfaces of the foliage and from above to cover the upper surfaces. Stop spraying before the foliage is drenched; otherwise large droplets will form and run off from the plant. Spraying with pressure gives the best results. Keeping the solution agitated while spraying insures a more uniform mixture.

If one application does not give good control, repeat the treatment as often as is necessary. The interval between applications will depend upon the habits of the insects, the weather, and on plant growth.

QUANTITY OF SPRAYS OR DUSTS TO APPLY

For small gardens 1 to 2 ounces of dust mixture or 1 to 2 quarts of liquid spray are usually required for one application to 100 square feet of garden or to 50 linear feet of row. This is roughly equivalent to 25 to 50 pounds of dust mixture or 100 to 200 gallons of spray per acre. Under some conditions the quantity required may be more or less, depending on such factors as the type and size of planting, the insect, the crop, the size of the plants, and the thickness of growth. In extensive plantings of small plants in rows 2 or 3 feet apart,

15 to 20 pounds of dust mixture or 75 to 100 gallons of spray per acre may be sufficient, whereas in thick beds of large plants more than twice this quantity may be necessary to reach all the insects with a contact insecticide.

SPRAYING AND DUSTING EQUIPMENT

Many types of spraying and dusting apparatus and accessories are obtainable for use in the flower garden, and there is sufficient range in price to place some form at the command of every gardener. Certain commonly used types are discussed below.

SPRAYERS

The spraying apparatus should be so constructed that it will break up the liquid into a fine mistlike spray and insure an even coating of the material over the plant surface. When buying equipment, especially of the larger types for use by the commercial growers, see that it is made to permit easy replacement of parts, such as the valves, which are likely to wear out quickly. The container for the liquid should be of wood, glass, copper, or galvanized steel, as bordeaux mixture and some other materials corrode tin and iron. The

use of an angle nozzle aids in applying materials to the under sides of the leaves and other inaccessible parts of plants and shrubs.

Types of equipment suited for use in gardens or estates and by commercial floral nurserymen are as follows:

Hand Atomizers

Where only a few plants are to be treated, a hand atomizer (figs. 160, *A*, and 161, *A*) is very convenient to use, although the under sides of the plant are difficult to reach with it. These are the familiar sprayers used for applying fly sprays in the home. Usually they hold from a half pint to a quart or more of material.

Compressed-Air Sprayers

The compressed-air type of sprayer (figs. 160, *C*, and 161, *B*) is the most satisfactory for the home gardener. By the use of an extension rod, shrubs and low-growing trees can be sprayed with it. Compressed-air sprayers are usually made of galvanized sheet steel or brass and have a capacity of 1 to 5 gallons. The sprayer consists of an airtight tank into which is clamped a pump. In operation the tank is filled with spray to about two-thirds of its capacity, and the opening is closed by a tight-fitting cap. Air is then pumped in by hand

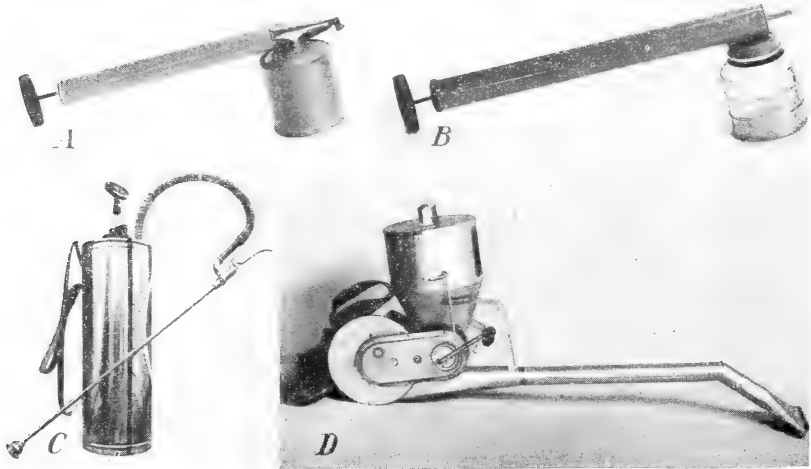

FIGURE 160.—Spraying and dusting equipment: *A*, Hand atomizer; *B*, hand duster (both useful for small gardens); *C*, compressed-air sprayer; *D*, rotary fan or blower type of duster (the last two useful for larger gardens).



FIGURE 161.—Applying sprays: *A.* Spraying with a hand atomizer; *B.* spraying with a compressed-air sprayer.

until sufficient pressure is developed to force liquid through the hose and nozzle. The hose is usually fitted with a spray shut-off and a 1- to 5-foot extension rod with nozzle. The pressure decreases as the spray is forced out, and therefore it is necessary to renew it occasionally by further pumping. Since these sprayers are not provided with an agitator, it is necessary to keep the material well mixed by shaking the tank frequently, although the movement of the operator causes a certain amount of agitation.

Knapsack Sprayer

The usefulness of the knapsack type of sprayer (fig. 162) corresponds closely to that of the compressed-air sprayer, but it can also be employed on larger plants, including taller shrubs and trees. The knapsack sprayer costs more than the compressed-air sprayer. However, the pump in the knapsack sprayer permits the operator to maintain a higher and more uniform pressure than is possible



FIGURE 162.—Knapsack sprayer. Useful for large gardens.

with the compressed-air sprayer. In some types of this sprayer also agitation is provided for by a brass plate inside the tank which moves up and down with the pump handle. A knapsack sprayer consists usually of a force pump with an air chamber fitted to a metal tank and is designed to be carried on the back of the operator. It can be operated by one hand while the other is manipulating the spray rod and nozzle. The sprayer has a capacity of about 3 to 5 gallons and a spraying range of about 25 feet when equipped with a nozzle.

Bucket Pump

The bucket pump (fig. 163) is a useful piece of equipment for the home gardener. It is merely a single- or double-acting pump with an adequate air chamber and equipped with hose and nozzle. The assembly may be clamped or set in

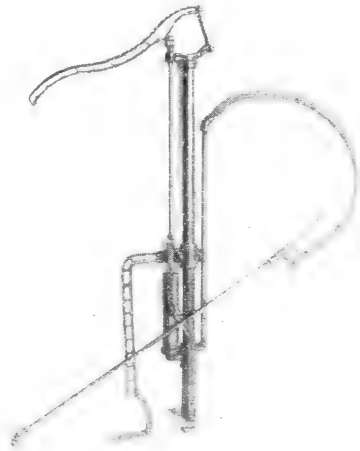

FIGURE 163.—Bucket pump with hose, extension rod, cut-off, and nozzle.

a bucket or tub containing the liquid insecticide. Its chief disadvantage is that the operator must remain stationary while pumping. The most efficient operation of the bucket pump requires two persons—one to operate the pump and the other to manipulate the hose and nozzle.

For more extensive spraying operations, as on large estates and in floral nurseries, the use of larger equipment such as the barrel pump, wheelbarrow type, or small power outfit would be

more practical. Such equipment develops higher pressure and holds larger quantities of spray materials.

Barrel Pump

The barrel pump (fig. 164) has a hand-operated pump attached to a barrel or similar container for the spray. The whole assembly is mounted on a sled or wheels or loaded in a wagon or truck. In certain types, called wheelbarrow sprayers (fig. 165), the container is small enough so that it can be mounted between handles with a single wheel in front and be pushed by the operator. The operation of the barrel pump is laborious, and it is difficult to maintain constant high pressure. Because of these factors a power outfit is preferred.

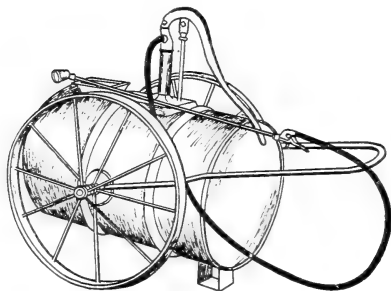

FIGURE 164.—Barrel pump mounted on wheels and equipped with hose, extension rod, shut-off, and nozzle.



FIGURE 165.—Wheelbarrow type of sprayer.

Power Sprayers

Power sprayers are more satisfactory than other types for the commercial nurseryman, florist, or owner of a large estate where extensive spraying operations are often necessary. Numerous types are available, and the individual grower can usually obtain one suited to his particular needs. Power sprayers

are driven by motors, either gasoline or electric, and range in size from the small outfits of 10- to 50-gallon tank capacity, with single-cylinder pumps which maintain a pressure of 150 to 200 pounds, to large rigs for use in orchards and parks.

The small outfits are usually pulled or pushed by a workman, and are useful in small commercial plantings of ornamentals, vegetables, and small fruits, and in greenhouses. The larger types are either horse- or tractor-drawn, or they are self-propelled.

DUSTERS

When a regular duster is not readily available, dust mixtures may be applied to upper surfaces of plants fairly well by the shaker method—that is, the dust or powder is placed in a container such as a quart tin can having holes punched in the bottom from the inside with the point of a 6-penny nail. Simply shake the can over the plants (fig. 166). A piece of cheesecloth or

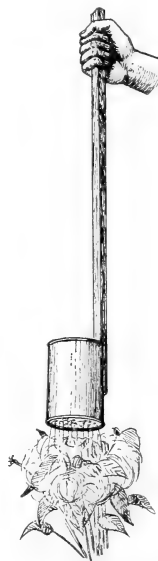

FIGURE 166.—Shaker-can method of applying insecticidal dusts.

burlap folded baglike (fig. 167) can be used in a similar manner. These crude devices are of little or no value in applying the dust to the under sides of the leaves, as is necessary in the control of insects which feed from the under sur-



FIGURE 167.—Applying an insecticidal dust from a cloth bag.

face, as do certain leafhoppers, aphids, and flea beetles. These methods of dusting often result in uneven and excessive application of material, and for this reason dust guns should be used whenever possible.

Plunger Type of Duster

The plunger type of duster (figs. 160, B, and 168), or dust gun, is one of the most common devices for applying insecticides to small areas. Its capacity ranges from 1 to 3 pounds. These dust

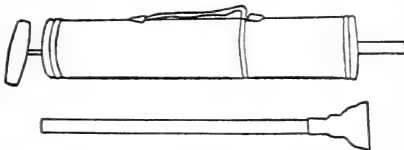

FIGURE 168.—Plunger type of hand duster.

guns are mostly of metal and equipped with metal or glass containers. They usually have a tube and a nozzle attachment that permits the dust to be directed to the under surface of the leaves.

Bellows Types of Dusters

Two types of bellows dusters are on the market. The smaller type (fig. 169) is made like a fireplace or blacksmith bellows and is suitable for treating small areas. It is equipped with special openings to permit applying the dust from different angles. Care must be exercised to avoid discharging too much at one time.

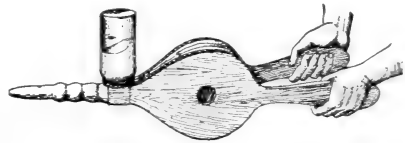

FIGURE 169.—Simple bellows type of duster.

The other type is the knapsack duster (fig. 170), which can be carried on the back like a knapsack. It is satisfactory for applying dusts to both small and large plantings, more especially by commercial growers in plantings where the use of power equipment is not feasible. The dust is discharged in puffs with each stroke of the bellows.

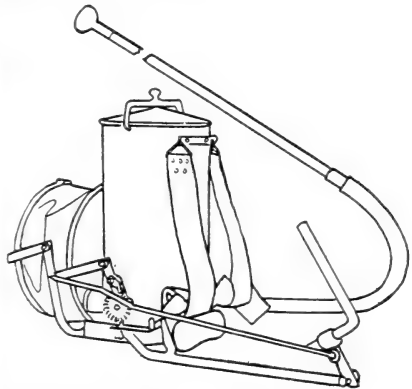

FIGURE 170.—Knapsack-bellows duster.

Fan or Blower Type of Duster

The fan or blower type of duster (fig. 160, D) is satisfactory for both small and large gardens. Since a continuous stream of dust is delivered, dusters of this type are better suited for closely planted crops than for crops where the plants are widely spaced. The knapsack-bellows and fan types are much higher in price than the small plunger and fireplace bellows, but from the standpoint of efficiency of application and long-time service they are a good investment. These dusters will hold from 5 to 10 pounds of insecticide.

Power Dusters

Power dusters are operated by gasoline engines and, like power sprayers, range in size from the small wheelbarrow type pushed by the operator to large horse- or tractor-drawn rigs. Some outfits are mounted directly on tractors. They are best suited for commercial florists and nurserymen.

APPENDIX

DDT INSECTICIDES

The discussion of insecticides in the preceding pages has been confined to well-known standard materials. In 1940 DDT, an organic compound so called from its generic name dichloro-diphenyl-trichloroethane, was discovered by Swiss investigators to have remarkable insecticidal properties. As a result of intensive research by the Bureau of Entomology and Plant Quarantine, it was used effectively in various theaters of war to control the body louse and other important pests of man. DDT is known to be effective against many other insects, and further research may show that it can be used on flowering plants and shrubs in place of some of the older insecticides. Experimental work has not progressed sufficiently, however, for detailed recommendations to be issued for the use of DDT on most of the flowering plants and shrubs mentioned in this publication.

DDT is one of the few chemicals which acts both as a stomach poison and a contact insecticide. It acts chiefly in the latter capacity, causing a paralysis of the nervous system. Affected insects do not die quickly. In fact, they may live for several hours, or even days, after coming in contact with the chemical, but they do not recover. Another feature of DDT is the persistence of the spray deposit, which may make it particularly adapted for the control of insect pests of the flower garden.

Technical DDT is a gray or cream-colored waxy powder, sometimes rather lumpy and sticky, which has a faint floral odor. It is the basic material from which various commercial insecticidal preparations are made, and it is suitable for use as an insecticide only when properly prepared.

Commercial preparations containing DDT are available in five general types: (1) *Dust mixtures* to be applied as a dust as purchased, (2) *wettable powders* that will mix readily with water to form suspensions for spraying, (3) *emulsions* to be diluted with water and applied as a spray, (4) *solutions* to be applied without further dilution, and (5) *aerosols* in containers or "bombs," to be applied by opening a valve to release the insecticide.

The dust mixtures, the suspensions produced from wettable powders, and possibly the emulsions will be satisfac-

tory for controlling insects on flowering plants and shrubs. Experimental data indicate that in these forms DDT will probably be effective against ants, azalea and other whiteflies, the boxwood leaf miner, the cabbage looper, the eastern tent caterpillar, the European corn borer, the fall webworm, flea beetles, the imported cabbageworm, the Japanese beetle, leafhoppers, plant bugs, the rose chafer, rose midge, spittle bugs, the spruce budworm, and thrips. DDT is not effective against mites and certain aphids.

It appears that dust mixtures containing 3 to 5 percent or more of DDT may be used against some of these insects. When wettable powders are employed, a satisfactory dosage is 2 pounds of the 50-percent powder, or 4 pounds of the 25-percent powder, per 100 gallons of water. Indications are that these preparations will not injure the woody shrubs, but they are known to injure some of the garden vegetables, such as squash. Before their use can be recommended generally, it will be necessary to test these preparations on each flowering plant.

In preliminary tests emulsions containing 0.1 to 1 percent of DDT were found to control azalea and other whiteflies, lace bugs, the boxwood leaf miner, the eastern tent caterpillar, the fall webworm, the Japanese beetle, the rose chafer, the spittle bug on pine, and the spruce budworm. To avoid injury on such plants as azalea and boxwood, low strengths should be used. Since the DDT content and formulation of the commercial emulsion concentrates will vary, and since emulsions may injure tender plants, the directions furnished by the manufacturer should be carefully followed.

For many insects the proper formulation to use, the rate and time of applications, and whether or not DDT can be expected to give more satisfactory results than other available materials have not yet been determined. Care should be taken to apply no more than the dosage recommended by the manufacturer.

DDT wettable powders can also be used with the fungicides ferric dimethyl-dithiocarbamate, wettable sulfurs, fixed copper, or bordeaux mixture provided it is of low lime content. Since hydrated

lime greatly reduces the toxicity of the final product, it should not be used in the preparation of dusts and sprays.

The oil solutions are used to control flies, mosquitoes, roaches, and other household pests. **They should not be used on growing plants because they will cause burning.**

The ordinary aerosol bombs that are now on the market are prepared for the control of flies, mosquitoes, and other household insects and should not be used to control insect infestations on plants. Special aerosol preparations, however, have been developed for the control of certain insects in greenhouses, but at present aerosols have not been adapted for the control of insects on ornamental plants and flowers.

Caution.—DDT is poisonous and

should be handled with care. It should be stored in clearly labeled packages and kept away from food products.

When applying DDT to flowering plants and shrubs adjacent to food crops, care should be taken that the material does not come in contact with foliage that is to be marketed or used as food or is to be consumed by livestock. The use of DDT on ornamental plants growing close to fish ponds or streams should be avoided, since there is danger of killing fish and other aquatic life. DDT in oil solutions and emulsions may be absorbed through the skin of man and animals. Persons using it in these forms should take special precautions to avoid repeated or prolonged exposures to the material.

INDEX

	Page		Page
Abutilon moth.....	49	Bulb mite.....	61
Ambrosia beetle, pitted.....	73	Bulb scale mite.....	62
Ants—		Burdock leaf miner.....	30
Argentine.....	13	Cabbage looper.....	3, 110
cornfield.....	13	Cabbageworm, imported.....	63, 110
general.....	12, 110	Calcium arsenate.....	96
Aphids. <i>See under individual names.</i>		Cambium curculio.....	33
Arborvitae—		Camellia scale.....	26
aphid.....	19	Cane borer, raspberry.....	78
leaf miner.....	20	Canna leaf roller.....	26
Argentine ant.....	13	Carbon disulfide.....	103
Amyworms.....	3	Chlordane.....	95
Asiatic garden beetle.....	21	Chlorinated camphene.....	95
Aster bug, black.....	20	Chrysanthemum—	
Aster leafhopper. <i>See Six-spot- ted leafhopper.</i>		aphids.....	27
Australian lady beetle.....	72	lacebug.....	28
Azalea—		spittlebug.....	30
bark scale.....	22	Citrus—	
lace bug.....	22	mealybug.....	31
leaf miner.....	23	whitefly.....	43
stem borer.....	24	Clematis root borer.....	30
whitefly.....	110	Coconut scale.....	65
Bagworm.....	19	Cocklebur billbug.....	37
Barberry—		Columbine—	
aphid.....	24	aphid.....	34
webworm.....	24	borer.....	32
Barium fluosilicate.....	97	leaf miner.....	33
Bean aphid.....	63	skipper.....	34
Bees, leaf-cutter.....	79	Contact insecticides.....	97, 103
Beetles. <i>See under individual names.</i>		Cooley's spruce gall aphid.....	84
Benzene hexachloride.....	95	Corn—	
Billbug, cocklebur.....	37	borer, European.....	36, 50, 110
Blister beetles—		earworm.....	29
black.....	8, 20	root aphid.....	21
gray.....	8	Cornfield ant.....	13
striped.....	8	Cosmos insects.....	34
Black vine weevil.....	93	Cottony-cushion scale.....	71
Bordeaux mixture.....	97	Cottony maple scale.....	47
Borers. <i>See under individual names.</i>		Crickets.....	9
Boxwood—		Crinkled flannel moth.....	6
leaf miner.....	24, 110	Cryolite.....	97
psyllid.....	25	Cube.....	99
Budmoth, verbena.....	88	Cucumber beetles—	
Budworm—		spotted.....	7
rose.....	83	striped.....	7
spruce.....	85, 110	western spotted.....	7
Buffalo treehopper.....	82	Curculio—	
Bulb fly—		cambium.....	33
lesser.....	54, 61	rose.....	77
narcissus.....	60	Cutworms.....	2
		Cyclamen mite.....	38
		DDT insecticides.....	110
		Derris.....	99, 105
		Dock aphid.....	63

	Page		Page
Dogwood—		Insecticides	94-106
borer	39	Iris—	
club-gall midge	40	aphid	54, 87
scale	41	borer	52
twig borer	40	thrips	53
<i>Donacia</i> beetles	92	weevil	53
Dormant oil emulsion	101	Japanese beetle	14, 48, 110
Dusting sulfur	101	Juniper—	
Earthworms	18	scale	55
Earworm, corn	29	webworm	55
Eastern spruce gall aphid	84	Katydid, angular-winged	51
Eight-spotted forester	91	Lacebug—	
Emulsion, white-oil	100	azalea	22, 110
<i>Euonymus</i> scale	41	chrysanthemum	28
European—		hawthorn	46, 110
corn borer	36, 50, 110	rhododendron	73, 110
pine shoot moth	70	Larkspur leaf miner	38
spruce sawfly	86	Lead arsenate	95, 105
Fall webworm	51, 110	Leaf-cutter—	
Fern caterpillar, Florida	42	bees	79
Flannel moth, crinkled	6	morning-glory	59
Flatheaded borers	39	waterlily	93
Flea beetles. <i>See under individual names.</i>		Leaf miners. <i>See under individual names.</i>	
Fleahopper, garden	89	Leaf roller—	
Florida fern caterpillar	42	canna	26
Flower thrips	74	lesser canna	26
Fluorine compounds	97	oblique-banded	83
Forester, eight-spotted	91	red-banded	50
Fuller's rose beetle	44	Leafhoppers—	
Fumigants	103	general	10, 110
Gaillardia insects	43	potato	35, 58
Galls:		rose	11, 80
rose	81	six-spotted	11, 20
rose root	81	Lilac—	
Garden —		borer	56
ant	13	leaf miner	58
beetle, Asiatic	21	Lime-sulfur	102
fleahopper	89	Long-tailed mealybug	31
webworm	89	May beetles	14
Giant hornet	57	Mealy flata	90
Gladiolus thrips	45	Mealybug—	
Goldenglow aphid	46	citrus	31
Golden tortoise beetle	59	grape	46
Grape mealybug	46	ground	64
Ground mealybug	64	long-tailed	31
Grasshoppers	9	Mexican	28
Greenhouse—		solanum	63
leaf tier	5	Melon aphid	90
orthezia	32	Mercurials, organic	102
whitefly	18	Mercuric chloride	102
Ground mealybug	64	Mexican mealybug	28
Hag moth	6	Midge—	
Hawthorn lacebugs	46	dogwood club-gall	40
Hemispherical scale	42	gall	81
Hexaethyl tetraphosphate	95	rose	76
Holly—		Millipedes	17
leaf miner	49	Miscible oils	101
scale	50	Mites. <i>See under individual names.</i>	
Hollyhock insects	50	Morning-glory leaf cutter	59
Honeysuckle sawfly	51	Moths. <i>See under individual names.</i>	
Hornet, giant	57	Mountain-laurel insects	60
Hornworms	4	Mulberry whitefly	22
Hot-water treatment	61		
Hydrangea insects	52		
Imported cabbage worm	63, 110		

	Page	Rose—	Page
Nantucket pine tip moth.....	71	aphid.....	75
Narcissus—		aphid, small green.....	75
bulb fly.....	60	beetle, Fuller's.....	44
lesser bulb flies.....	61	bristly rose-slug.....	79
Needle miner, spruce.....	86	budworm.....	83
Nicotine sulfate..... 97, 98, 100,	105	chafer.....	66, 75, 110
Oblique-banded leaf roller.....	83	curculio.....	77
Oil emulsions—		galls—	
general.....	100	mossy.....	81
nicotine.....	101	root.....	81
rotenone.....	101	leaf beetle.....	76
Oils, miscible.....	101	leafhopper.....	80
Oleander scale.....	54	midge.....	76, 110
Onion thrips.....	75	sawflies.....	79
Orange tortrix.....	44	scale.....	81
Organic mercurials.....	102	slugs.....	79, 80
Oystershell scale.....	56	spittlebug.....	30
Painted-lady.....	25	stem borers.....	77
Palm leaf skeletonizer.....	64	stem girdler.....	78
Palm, scale insects.....	65	stem sawfly.....	78
Parathion.....	95	stinging caterpillar.....	9
Paris green.....	96	Rotenone.....	99, 101
Peach—		Saddleback caterpillar.....	6
aphid, green.....	54, 75	Salt marsh caterpillar.....	4
scale, white.....	72	Salvia insects.....	83
Peony scale.....	23	San Jose scale.....	57
Phlox plant bug.....	67	Sawfly—	
Pillbugs.....	17	curled rose.....	80
Pine—		honeysuckle.....	51
aphid, white.....	69	pine.....	68
bark aphid.....	69	rose stem.....	78
needle scale.....	69	spruce.....	86
sawflies (red-headed).....	68	violet.....	65
shoot moth, European.....	70	Scale. <i>See under individual names.</i>	
tip moths.....	71	Scurfy scale.....	48
Plant bugs—		Six-spotted leafhopper.....	20
four-lined.....	94	Slugs.....	16
phlox.....	67, 110	Slugs, rose sawflies or.....	79, 80
tarnished.....	35, 110	Snails.....	16
yucca.....	94, 110	Snowball aphid.....	90
Poisonous caterpillars.....	5	Soap sprays.....	100
Poisons, stomach.....	95-97	Sodium fluosilicate.....	97
Pondlily beetle.....	92	Soft scale.....	43
Potato—		Solanum mealybug.....	63
aphid.....	54, 75	Sowbugs.....	17
flea beetle.....	67	Spanish moth.....	62
leafhopper.....	35, 58	Spider mites—	
Primrose flea beetle.....	9	general.....	11, 50
Privet—		spruce.....	85
aphid.....	72	Spirea aphid.....	84
mite.....	72	Spittle bugs.....	30, 110
Psyllid, boxwood.....	25	Spreaders.....	103
Puss caterpillar.....	6	Spruce—	
Pyrethrum.....	98	budworm.....	85, 110
Raspberry cane borer.....	78	needle miners.....	86
Red cedar aphid.....	55	sawflies.....	86
Red spiders.....	11	sawflies (European).....	86
Rhododendron—		spider mite.....	85
borer.....	73	Stalk borer.....	34, 50
lacebug.....	73	Stem borer—	
whitefly.....	74	azalea.....	24
Root aphids.....	10, 21	hollyhoek.....	50
		rose.....	77

	Page		Page
Sticklers.....	103	Viburnum (aphids).....	90
Stinging rose caterpillar.....	5	Violet—	
Stink bug, black.....	83	insects.....	91
Stomach poisons.....	95-97	sawfly.....	65
Striped flea beetle.....	9	Virginia creeper.....	91
Sweet pea, insects.....	87	Waterlily—	
Sulfur—		aphid.....	92
dusting.....	101	beetle.....	92
wetable.....	102	leaf-cutter.....	93
Tarnished plant bug.....	35	Webworm—	
Taxus. <i>See</i> Yew.		barberry.....	24
Tea scale.....	26	fall.....	51, 110
Tent caterpillar, eastern.....	47, 110	garden.....	89
Termites.....	13	Weevil—	
Tetraethyl pyrophosphate.....	95	black vine.....	93
Thiocyanate sprays.....	102	iris.....	53
Thorn-leaf aphid.....	46	Western black flea beetle.....	9
Thousand-legged worms.....	17	Wettable sulfur.....	102
Thrips—		Wetters.....	103
flower.....	74	White grubs.....	14
gladiolus.....	45, 110	White-lined sphinx.....	4
iris.....	53, 110	White-oil emulsion.....	101
onion.....	75, 110	White peach scale.....	72
tobacco.....	75, 110	Wite pine aphid.....	69
Tobacco thrips.....	75, 110	Whitefly—	
Tortoise beetle, golden.....	59	azalea.....	110
Treehopper, buffalo.....	82	citrus.....	43
Tulip—		greenhouse.....	18
bulb aphid.....	54, 87	mulberry.....	22
leaf aphid.....	88	rhododendron.....	74
Two-spotted spider mite.....	11, 42, 85	Wireworms.....	15
Vedalia beetle.....	72	Woolly bear, yellow.....	3
Verbena—		Yew insects.....	93
bud moth.....	88	Yucca plant bug.....	94
leaf miner.....	89	Zinnia insects.....	94



