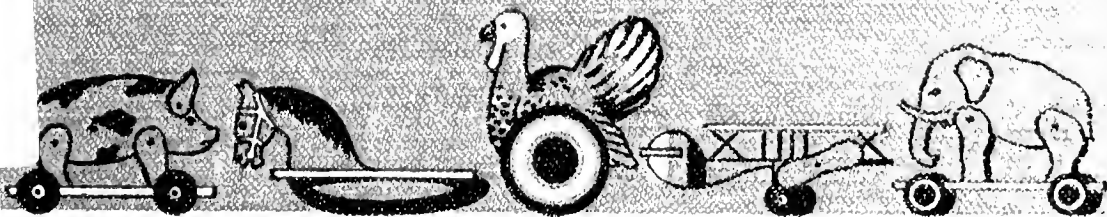


STACK  
ANNEX

5

301

530

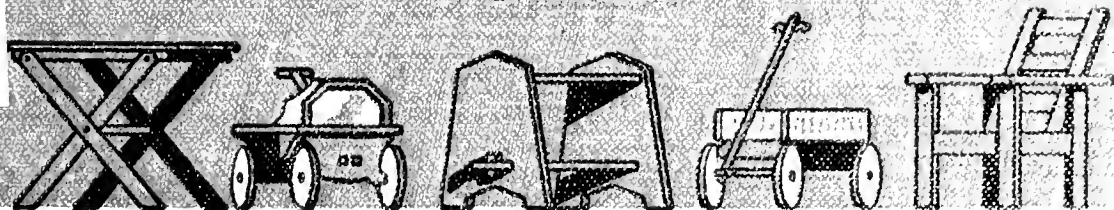


B

0  
0  
0  
0  
0  
3  
2  
4  
6  
6

# HAND CRAFT PROJECTS

## SOLAR









# HAND CRAFT PROJECTS



# Hand Craft Projects

FOR SCHOOL AND HOME SHOPS

FRANK I. SOLAR

Northern High School, Detroit, Michigan

Editor of "Toys and Useful Articles a Boy Can Make", "Practical Construction Work for Home and School Shops",  
"Bird Houses of Simple Construction"

Drawings by the Author and A. M. Cornwell



Book I

THE BRUCE PUBLISHING COMPANY

Milwaukee, Wisconsin

Copyright 1921

**THE BRUCE PUBLISHING COMPANY**



## PREFACE

This book is the first of a series which will include over 2,000 articles. Boys and others interested in working with tools will find them a great convenience. Instead of arranging the articles in one expensive book, they will be written in a series of volumes, additional volumes being published from time to time. Each volume is to be sold at a moderate price and will make an inexpensive but very welcome gift to those interested in hand work.

The projects in this book are not all original, but are things that boys in my classes have made and enjoy making. Many of the suggestions and ideas were brought in by the boys themselves.

The articles describing the projects have been made as short as possible in order that boys need not waste time reading long descriptions.

Many of the models were excellent sellers in the Red Cross sales and considered attractive enough to be made a permanent exhibit at the Detroit Museum of Art.

Money invested in tools is not wasted. A good selection will cost no more than a good bicycle, and if well cared for will last several generations.

Parents who can interest their boys in tools and let them have a shop at home, will know where to find

them evenings and many hours of worry will be saved, as the boys might be out on the streets or in pool rooms. Moreover, the value of the useful articles they might make should be considered. The boy himself, no matter what vocation he follows later, will never regret the time spent in the shop with his tools.

In these articles trade terms are used as often as possible to familiarize boys with their use in real practice.

It has been the author's ambition to have the drawings of the projects so made that very little explanation is necessary.

An effort has been made in formulating the projects to eliminate the old hackneyed problems, and, although the same names are used, an examination of the drawings will show that each one is decidedly different and possesses some originality.

Physical exercise is necessary for good health. Persons engaged in work requiring very little physical effort usually devote some time each day to calisthenics or other artificial exercise. Effort spent on constructive work with tools is more fascinating and is productive of the same results, thereby accomplishing a twofold purpose.

“Keep the faculty of effort alive within  
you with a little gratuitous exercise  
each day.”

—*James.*

# TABLE OF CONTENTS

	Page		Page
Shop Notes and Etiquette.....	7	Small Cart .....	66
Lumber .....	8	Red Cross Ambulance.....	68
Personal Equipment .....	8, 9	Baby's Rocking Horse.....	70
Standards and Conventions.....	10, 11	Jumping Jack .....	72, 73
Construction Problems .....	10, 12	The Hula Dancers.....	74, 75
Common Joints .....	10, 13	Mechanical Duck .....	76, 77
Tools .....	14	Scout Firemaking Set.....	78, 79
Commonly Used Hardware.....	15-20	Bob Sled .....	80, 81
Shop Kinks and Information.....	15, 21	A High Speed Drill.....	82, 83
Bits and Drills.....	21, 23	Crumb Tray .....	84, 85
Brads, Screws and Fastenings.....	23, 24	Flag Holder .....	86, 87
Sandpaper and Finish.....	25	Toy Rabbit .....	88, 89
Finish .....	25, 26	Target Pistol .....	90, 91
Laying Out Tools.....	26-28	Jack Be Nimble.....	92, 93
Saws .....	28, 29	Boy Scouts Heliograph.....	94, 95
Planes .....	28, 30, 33	Ground Scratcher .....	96, 97
Planing and Scoring Rules.....	30, 32, 33	Child's Snow Shovel.....	98, 99
Work Bench .....	34, 35	Kites .....	100, 101
Combination Bench Hook.....	36, 37	Puzzles .....	102, 103
Toy Pig .....	38, 39	Trench Mortar .....	104, 105
Child's Morris Chair.....	40, 41	Straddle Horse .....	106, 107
Cutting Board .....	42, 43	The Bag Puncher .....	108, 109
Toy Cannon .....	44, 45	Low Folding Table.....	110, 111
Bath Room Cup Holder.....	46, 47	Letter Rack .....	112, 113
Skate Sharpener .....	48, 49	Silhouette Camera .....	114, 115
Steam Engine .....	50, 51	Sewing Companion .....	116, 117
Toy Elephant .....	52, 53	Ornamental Garden Sticks.....	118, 119
Feeding Bird .....	54, 55	Mouse Trap .....	120, 121
Flying Propeller .....	56, 57	Boy's Handy Wagon.....	122, 123
Potato Gun .....	58, 59	Traveler's Case .....	124, 125
A Wooden Doll.....	60, 61	Halloween Fun Makers.....	126, 127
A Thanksgiving Gobbler.....	62, 63	Wind Mill Acrobat.....	128, 129
Acroplane Weathervane .....	64, 65	Pin and Ball Game.....	130, 131

	Page		Page
Sail Boat .....	132, 133	Fly Trap .....	144, 145
Chair Lamp .....	134, 135	Plant Box .....	146, 147
Leg Rest .....	136, 137	Submarine .....	148, 149
Bull Dog .....	138, 139	Phonograph Dancer .....	150, 151
Christmas Tree Stand .....	140, 141	Telephone Screen .....	152, 153
Baby Auto Car .....	142, 143		

## HAND CRAFT PROJECTS

### Shop Notes and Etiquette

This work, to be done in the school or home shop, is for the purpose of training the hand to make what the mind and eye picture, and to teach the care and manipulation of common wood-working tools.

All work should be done from working drawings, blue prints or sketches. Never begin a project for which you have no drawing without first making some kind of a sketch.

Shop work is required in some schools for graduation and some credit is given those with good marks wishing to take an engineering course.

To obtain the best results each boy should be furnished with a bench suitable to his height and a sharp set of individual tools. It is then his business to keep them in this condition. Only selfish boys will use tools improperly and dull them for the other fellow to sharpen. It is usually found that boys who do poor work are satisfied to work with dull tools.

Any boy who is careless enough to saw into an iron vise, pound with the point of his plane, chop with a back saw, and bore holes and drive nails into his bench, will not make a valuable man to any employer.

What would a contractor say if a man came to him out with a stool under one arm and his tools under the other? But, how often do we see boys sitting on stool trying to plane and saw, and also trying to do work with a coat on! The first thing a boy does when getting into a game that requires exercise is to throw off his coat, so why not do the same in the shop?

Talking, whistling and other unnecessary noises are not conducive to the best work. They are also annoying to others and distract their attention from their work.

Do not use the try square for a hammer, or a chisel for a screw driver, as others may wish to use the same tool and do not enjoy working with a dull tool any more than you do.

Never use a hammer on a chisel handle, or to drive a piece through the dowel plate. The mallet should be used for these purposes.

While all power machinery should be well guarded in any shop to prevent accidents, it is best when machinery is in operation to keep at a safe distance. Do not depend upon the other fellow to care for your personal safety. You suffer the pain in case of accident.

To avoid repetition, pages in the front of the book will be devoted to general information.

### Lumber

Lumber comes in different conditions known as dressed and undressed. If ordered undressed, it is just as it comes from the saw, rough on both sides and edges. If ordered S2S, (S meaning surfaced), both sides will be surfaced. If ordered S4S, both sides and edges will be surfaced or made smooth by the planer. If it is desired to have it finished further, specify that it is to be sanded on all sides and edges.

When ordering lumber, make out your bill as follows: First, give name of wood; second, number of pieces; third, thickness; fourth, width; fifth, length; and sixth, finish desired. For example:

Red Oak 2 Pcs.  $\frac{3}{4}$ " x  $4\frac{1}{4}$ " x 3' S4S To be sanded  
all sides

Bass Wood 1 Pc.  $\frac{1}{2}$ " x 10" x 10' Rough

Gum Wood 3 Pcs.  $\frac{5}{4}$ " x 8" x 12' S2S

The most common woods used for home and school bench work are bass wood, white pine, gum wood, red and white oak, black walnut, mahogany, red wood, red cedar and cypress. These are all easily worked and take desirable finishes.

Yellow pine, spruce, hemlock, fir, cypress, birch and maple are used in the building trades. Most of these are coarse grained and split easily.

Hickory is straight grained and very elastic. It is good for hammer handles, bows and arrows and other models that must bend without breaking. Other kinds of lumber may be more accessible in other localities. Cypress is a wood that will withstand dampness and is very good for plant boxes, etc., while gum and bass-wood absorb moisture and warp, hence are not satisfactory for outside use.

Composition, wall or beaver board can often be used instead of lumber.

### Personal Equipment

It is quite necessary that a woodworker protect his clothing from dust, dirt, stain, paint, grease, oil, etc., by some manner of covering. Of course, different kinds of work will require different kinds of dress. If possible, old clothing may be worn, in which case the worker's body can easily assume any position and not be encumbered by excess clothing. With most clothing protectors it is not convenient to work in any other than a standing position.

Plate 1 shows five boys differently attired. The first is wearing an apron which is sufficient covering for ordinary bench work; the second is equipped with coveralls which make the best possible covering for any kind of work, especially wood turning where dust, shavings, oil and stain are likely to fly on the shirts, shoulders and collar. It also protects the back of the



Plate 1.

trousers, shirt, etc. The shop coat and cap, number three, are very good as they give nearly as much protection as the coveralls. The second and third give protection to the worker who might back into a painted article not yet dry. The short coat and apron are good but they do not give the protection afforded by the second and third. The short coat, number five, if used with overalls would be good, but when worn alone gives no protection below the waist.

A light weight cloth cap will keep the hair out of the wearer's eyes and also shade them. It will also protect the hair from dust, dirt and oil. The boys in the picture are wearing paper caps given away for advertising purposes.

Each worker should be provided with a lead pencil, not too soft, a pocket knife and a two foot, four fold rule. It is not good practice to borrow pencils.

A towel and some good soap should be kept in the locker.

When on certain jobs of white wood to be varnished, it is quite necessary to keep the hands clean.

To provide good working conditions the shop should be well lighted and not too warm. Sixty degrees is a good temperature.

## Standards and Conventions

It is unfortunate that the schools of the country have not established a standard set of conventions for representing articles by drawings. Those who may use conventions different from those used in the following drawings will have no difficulty in understanding the drawings if they will refer to the standards indicated here.

After an investigation of the standards used in over fifty of the largest and most important factories and institutions in the country, and then compiling a booklet which was submitted to these concerns for criticism, it was found that these standards were most generally used, and so were adopted by the drawing department of the Detroit Public Schools.

The conventional lines are shown on Plate 2 the exact weight, length and spacing they should be made on a drawing, but on the drawings of the projects they will appear lighter in weight due to the fact that they were made the correct weight on the original drawing, but when the cut was made, were reduced.

The illustrations with dimensions show the proper method of dimensioning and indicating notes for different parts. It is proper to make the full or half arrow on the leader lines.

Note that in the section the bolt is not cross hatched. This method should be followed in drawing bolts, nails,

screws, etc., where sections are made to more clearly indicate the construction of a part.

Perspective, isometric and cabinet sketches are used to show the assembled model, and the relation of the parts. These sketches picture the model better than the mechanical drawing.

## Construction Problems

Plate 3 illustrates the methods for making the common layouts used in constructing the parts of the following projects.

The quadrant is 90 degrees or one-quarter of a circle.

The semicircle is 180 degrees or one-half of a circle.

Other constructions show methods for locating centers, finding the lengths of arcs, dividing a line into a certain number of equal parts, and others that will be of use in making this series of models.

The hexagon and octagon are shapes that are commonly used for tabouret tops, lamp bases, etc.

It is often quite necessary to know how to lay out a pentagon, star, oval, ellipse, and to make a polygon of any number of sides desired.

## Common Joints

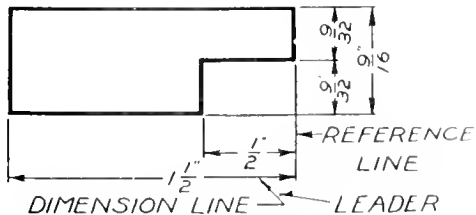
Plate 4 is not intended to give all the different kinds of joints in use, but merely shows the kinds most commonly used and which will be used on the following projects.



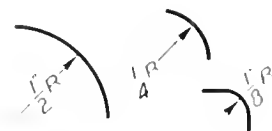
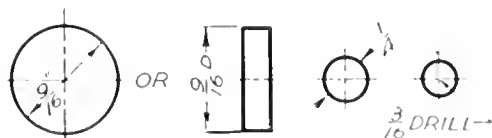
## STANDARDS AND CONVENTIONS

### CONVENTIONAL LINES

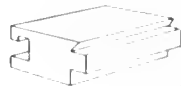
BORDER LINE	HEAVY
OBJECT LINE	MEDIUM
CENTER LINE	FINE
HIDDEN EDGE LINE	MEDIUM
PROJECTION LINE	FINE
CONSTRUCTION LINE	FINE



### DIMENSIONS



### PERSPECTIVE



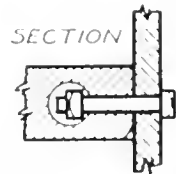
### SKETCHES



### ISOMETRIC



### SECTION



### CABINET



## GEOMETRIC CONSTRUCTIONS.

To Find Center of Given Square



To Find Center of Given Circle



To Find Center of Given Square



DRAW DIAGONALS AB AND CD. INTERSECTION O IS CENTER OF SQUARE

To Bisect a Given Angle



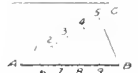
WITH O AS A CENTER AND ANY RADIUS DRAW ARC AB FROM POINTS 1 AND 2 DRAW ARCS INTERSECTING AT 3 LINE O3 BISECTS THE ANGLE

To Draw an Arc Through 3 Points Not in the Same Straight Line



FROM 1 AND 2 DRAW ARCS INTERSECTING AT 4 AND 2 AND FROM 2 AND 3 DRAW ARCS INTERSECTING AT 5 AND 3 THROUGH 4 AND 5 DRAW LINE FROM 1 THROUGH 2 THROUGH 3 THROUGH 4 AND 5 CENTER OF ARC

To Divide a Given Straight Line AS AB INTO ANY NUMBER OF EQUAL PARTS (SAY 5)



FROM A DRAW AC AT ANY ANGLE USING

ANY CONVENIENT MEASUREMENT LAY OFF REQUIRED SPACES AT 1 2 3 4 5 DRAW 5B LINES DRAWN FROM 4 3 2 AND 1 PARALLEL TO 5B DIVIDE AB INTO 5 EQUAL PARTS

An Arc Be Given To Find a Straight Line of Equal Length



DIVIDE ARC AB INTO EQUAL DIVISIONS

SMALL DIVISIONS WILL GIVE GREATER ACCURACY. LAY OFF SAME DIVISIONS ON STRAIGHT LINE AS TO AC EQUAL TO AML AB

Inscribed Figures



To Draw a Hexagon



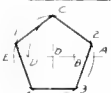
SET DIVIDERS TO LENGTH OF DESIRED SIDE AND DESCRIBE CIRCLE FROM A AND B WITH SAME RADIUS DRAW ARC C CUTTING CIRCLE AT 1 2 3 AND 4 CONNECT THESE POINTS FOR DESIRED HEXAGON

To Draw an Octagon



DRAW ABCD EQUAL TO EN CLOSING SQUARE FIND CENTER O FROM A, B, C AND D WITH RADIUS AO DRAW ARCS CUTTING SQUARE AT POINTS 1, 2, 3, 4, 5, 6, 7 AND 8 CONNECT THESE POINTS FOR DESIRED OCTAGON

To Draw a Pentagon



DESCRIBE REQUIRED CIRCLE FIND CENTER O OF RADIUS OA AT B FROM B WITH RAD OB CUT DIA AO AT D FROM C WITH RAD CD CUT CIRCLE AT 1 AND 2 FROM 1 AND 2 WITH SAME RAD GET 3 AND 4. 1, 2, 3, 4, 5 REQUIRED PENTAGON

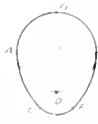
To Draw a Five Pointed Star



DIVIDE CIRCLE INTO 10 EQUAL PARTS

PARTS AS FIVE POINTED STAR

To Draw an Oval



ON DIA AB DLS TRIBE A CIRCLE FROM CENTER C DRAW CD PERPENDICULAR TO AB DRAW AD AND BD FROM A DRAW

ARC BE AND FROM B DRAW ARC AE FROM D DRAW ARC DE. AOBFE IS REQUIRED OVAL

To Draw an Ellipse



AB AND CD ARE MAJOR AND MINOR AXES MAKE OF AND OE = TO AB - CD MAKE OH AND OG = TO 1/2 OF

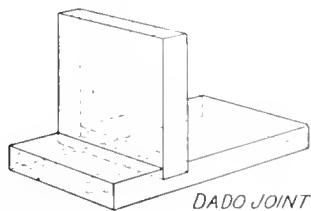
OF DRAW LH4 F O 3 EN1 AND EOE FROM E AND F DRAW ARCS 102 AND A23 FROM G AND H DRAW ARCS 2B3 AND 1A4

To Inscribe a Regular Polygon of any Number of Sides in a Given Circle

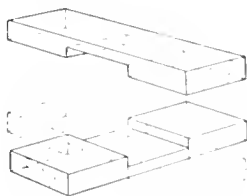


DIVIDE DIA AT INTO SAME NO OF PARTS AS POLYGON HAS SIDES EXTEND DIA CD MAKING CE = TO 1/2 OF CE THROUGH F AND G THE SECOND DIVISION ON AT. DRAW FC CUTTING CIRCUMFERENCE AT G THE CHORD AG IS ONE SIDE OF THE REQUIRED POLYGON

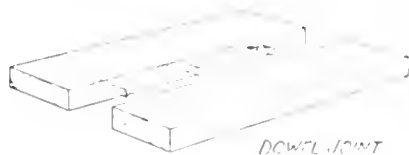
COMMON JOINTS



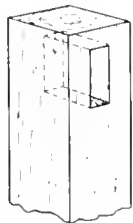
DADO JOINT



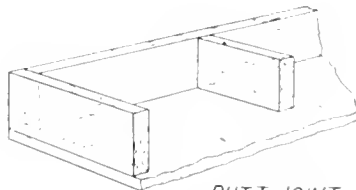
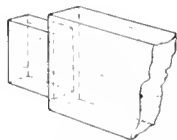
HALF LAP JOINT



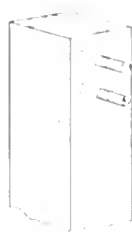
DOWEL JOINT



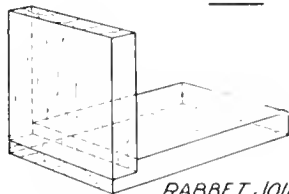
MORTISE AND TENON JOINT



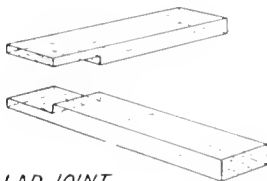
BUTT JOINT



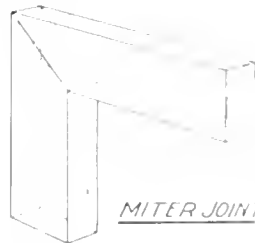
DOWEL JOINT



RABBET JOINT



LAP JOINT



MITER JOINT

The procedure for laying out the joints is not given because there are many volumes in every library entirely devoted to joinery. These should be consulted freely for any information concerning joint construction which it may be necessary to have. The Bruce Publishing Company will at any time be glad to recommend the best and latest volumes on manual arts work.

The dado joint is used in making book racks, setting tabouret tops into the legs, etc. The half lap joint is used in constructing spreaders, making braces, etc. This joint may also be made by making the cutouts on the edges of the pieces as well as on the working faces.

A dowel joint may be used in any kind of a top where several pieces are to be used, or instead of the mortise and tenon joint in joining a rail or a spreader to a leg.

The mortise and tenon joint is most commonly used in table and chair construction.

A butt or rabbet joint is made use of in box construction, and a lap or miter joint in making picture or other frames.

### Tools

Teachers and others who work with boys are often asked by boys and parents, especially around Christmas, to make a list of tools that might be recommended for the home shop. Tools make excellent Christmas

and birthday gifts. The average boy is not familiar with tools, hence does not understand quality, and does not know what to select if the choice is left to him.

Usually the person who does the buying knows little more than the boy. The result is that the gift consists of a nice looking tool box filled with cheap tools—some that may never be used at all and others that were selected more for looks than the practical use that might be made of them.

Expensive tools are the cheapest in the end. The best way to select a set is to inquire of experienced tool workers as to what make is best and then select each tool individually. By adding new tools now and then, and taking good care of them, one soon acquires a complete equipment without noticing the amount of money invested.

The following is a list recommended for the home shop:

1 Jack plane 14"	1 Combination backsaw, rip and crosscut
1 6" Try square	1 Turning saw
1 Cross cut saw 20"—10 point	1 Nail set
1 Rip saw 20"—8 point	1 Pencil compass
1 Steel rule 12"	1 Hammer, Maydole 13
1 Carpenter's square	1 Spoke shave
1 Wood rasp	1 Jack knife

1 Oil stone	1 $\frac{1}{4}$ " Chisel
1 1" Auger bit	1 Marking gauge
1 $\frac{3}{4}$ " Auger bit	1 $\frac{3}{8}$ " Twist drill
1 $\frac{1}{2}$ " Auger bit	1 Ratchet bit brace
1 $\frac{3}{8}$ " Auger bit	1 Rectangular scraper
1 $\frac{1}{4}$ " Auger bit	1 Bit file
1 Rose countersink	1 Screwdriver
1 1" Chisel	1 Pair pliers
1 $\frac{1}{2}$ " Chisel	1 Screwdriver bit
1 $\frac{3}{8}$ " Chisel	1 3 sided saw file

### Commonly Used Hardware

It has been the author's experience that few people know the trade names for common hardware and special tools. Considerable time and parley would be saved in the hardware store if the purchaser knew the trade names of the articles he wished to buy.

One place where this should be taught every boy is in the manual training class. For this reason several pages are here devoted to cuts of hardware and special tools that are found in most households and are used in the average shop some time or other. These cuts, however, show only one article of each variety, using the trade name to identify it. Many of the articles can be purchased in a variety of sizes and lengths.

Plate 5 showing special tools contains a few that will be found very convenient for doing certain jobs. The rotary head glazier's hammer is used for driving

glazier's points. Two coping saw blades are shown, one having a pin in each end for fastening, and the other simply an eye turned. The cornering tool is for finishing corners uniformly, and the tracing wheel is for tracing patterns. Circular snips are used for cutting circular pieces, and pinking irons for making fancy scallops on edges of certain materials.

Plate 6, cabinet trimmings, and Plate 7, hasp locks and hinges, give quite a complete selection of requirements for the amateur craftsman.

It is unfortunate that screw hooks and eyes are not named according to their shape, but instead they are listed by numbers which vary in different catalogs. Plate 8.

Plate 9 shows many different articles in hardware required in different parts of the household.

### Shop Kinks and Information

Use a bradawl to bore for fine brads to prevent splitting the piece.

Do not put water in hot lead—it will explode.

To do soldering the iron must first be tinned. File the point to brighten the surfaces, then heat the iron and rub in a hole on a piece of salamoniac containing a drop of solder. If properly tinned, the iron will appear bright and shiny. The iron must be kept clean and well tinned. A good flux must be used, and the metal to be soldered must be thoroughly scraped and

## SPECIAL TOOLS



WIRE SOLDER



GASOLENE TORCH



TINNERS' GAS FURNACE



CORNERING TOOL



FORCE CUP OR  
PLUMBERS FRIEND



TINNERS' CIRCULAR  
SNIPS



MELTING LAEL



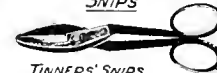
SOLDERING COPPER



PENCIL COMPASS



WING OR COMPASS DIVIDERS



TINNERS' SNIPS



MARKING AWL



WIRE GAUGE



TRACING WHEEL



INSIDE CALIPERS



PINKING IRON



RIVETING HAMMER



HACK SAW



COPING SAW



KEY HOLE SAW



OUTSIDE CALIPERS



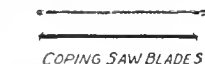
PINKING IRON



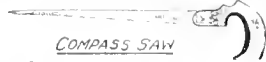
COLD CHISEL



GLAZIERS' HAMMER



COPING SAW BLADES



COMPASS SAW



CARRIAGE MAKERS CLAMP



WOODEN  
HAND SCREW



GLAZIERS' POINTS



BRAD AWL



UPHOLSTERS' HAMMER



GLASS CUTTER



MILLINERS'  
ROUND NOSE SIDE CUTTING PLIERS



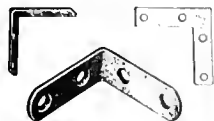
LETTERING BRUSH



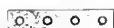
BAR CABINET CLAMP

# CABINET TRIMMINGS

## BRASS BOX CORNERS



CORNER ANGLE IRONS



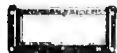
MENDING PLATE



CORNER BRACE



BRASS TRAY HANDLES



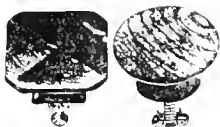
CARD HOLDER



CARD HOLDER & PULL



FLUSH RING



UNFINISHED WOOD KNOBS



GLASS KNOBS



POLISHED BRASS KNOB



BRASS SCREW KNOB



PORCELAIN SHUTTER KNOB



FLUSH DRAWER PULL



CHEST HANDLE



BOX HANDLE



DRAWER HANDLE



DRAWER PULL



DROP DRAWER PULL



BOX PULL



BOX PULL

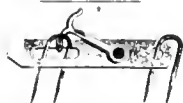
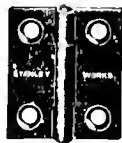


## ESCUTCHEONS



SPRING OR  
FRICTION  
CATCH



HASPSCRATE HASPHINGE HASPWROUGHT HASP & STAPLESHINGE HASPBRASS BOX HASPBRASS BOX HASPSSTEEL HINGE SLIDESHASPS-LOCKS-HINGESLOCKSTRUNK LOCKDESK LOCKTILL LOCKBOX CATCHDRAWER LOCKSUIT CASE LOCKWARDROBE LOCKBOX LOCKSUIT CASE CATCHESHINGESBALL TIP LOOSE PIN HINGET HINGEBRASS BUTTNARROW BUTTFRICTION HINGESSTRAP HINGEFANCY BOX HINGES



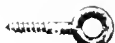
HOOKS AND EYES



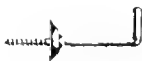
SCREW HOOK



SCREW HOOK



SCREW EYE



BRASS SHOULDER HOOK



BRASS CUP HOOK



KITCHEN HOOK



RING AND STAPLE



HITCHING RING



HOOK AND EYE



BRASS SCREW RING



FLOOR HOOK



RAZOR STROP HOOK



PICTURE HOOK



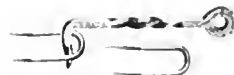
ROBE HOOK



ROBE HOOK



WIRE GATE HOOK AND EYE



WROUGHT GATE HOOK AND STAPLE



WIRE CEILING HOOK



COAT AND HAT HOOK



COAT AND HAT HOOK



ROBE HOOK

## HARDWARE



LINE CLEAT



SHELF BRACKET



DOOR BUTTON



TURN BUCKLE

### ELBOW CATCHES



SPRING COTTER



SHELF REST



CORRUGATED FASTENER



DOUBLE EYE BOLT

### CASTERS



GRIP NECK SOCKET



SQUARE PLATE



SLIDING OR DOME

### WASHERS



WROUGHT



LOCK



CAST WASHER

### AWNING PULLEYS



### SCREW PULLEYS

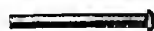


OPEN



INCLOSED

### RIVETS



IRON RIVET



TINNERS' RIVET



COPPER RIVET & BURRS



TUBULAR RIVET



SLOTTED CLINCH RIVET



RIVET SET AND HEADER

sanded, and covered with the flux. To do good work the joint must be heated to the melting point of the solder.

Never use anything but a pencil for laying out a bevel or a chamfer.

When planing a bevel or chamfer, hold the work in a hand screw.

Use a washer cutter for making wooden wheels.

For wheels on small carts use wooden button molds.

When driving screws in end grain, first bore a hole at right angles to the path of the screw and drive a plug in the hole. The threads of the screw must pass through the plug.

Use bank pins for joining toys as they can be obtained in any length.

Before gluing two surfaces, first score with the point of a knife diagonally across the surfaces. This makes an opening for the glue to work into.

Always wipe off surplus glue with a damp cloth before it sets.

When pulling nails with a hammer, place a block between the work and the hammer head.

Place the coping saw blade in the frame with the teeth pointing toward the handle. For best results use  $\frac{1}{8}$  inch pin end blades.

## Bits and Drills

Bits and drills, (Plate 10), are used for making holes in different kinds of material. It seems quite difficult for most boys to tell from the numbers on the shank of the bit what size hole that particular bit will bore. This is very easy if you will keep in mind the following information.

Auger bits are numbered in sixteenths and are graded in size from 3/16 to 20/16 in., or 1 1/4 in. Twist drills or drill bits are numbered in thirty-seconds and range from 3/32 to 18/32 in., or 9/16 in. Drill points are numbered in sixty-fourths and range from 1/64, or 1/16 in., to 11/64 in.

Electricians' bits run in length from 18 to 24 in., and bore 3/8 to 5/8 in. Extensions from 20 to 30 in. can be added to this length.

Expansive bits usually have two sets of cutters and will bore 5/8 to 4 in. in diameter.

Forstner or center bits are used for boring in thin wood that is liable to split. Forstner bits are used for boring holes nearly through a piece where it is necessary that the spur should not come through on the other side.

Countersinks are made in different varieties and cut at different angles to countersink wide and shallow or deep and narrow. A handle to fit the shank of a coun-

### BITS AND DRILLS.



AUGER BIT



SHORT DOWEL BIT



BORING MACHINE BIT



SHIP AUGER BIT



ELECTRICIANS' BIT



EXPANSIVE BIT



CAR BIT



FORSTNER BIT



PLUG CUTTER



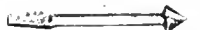
COUNTERSINK GIMLET



CENTER BIT



ROSE HEAD COUNTERSINK



SNAIL HEAD COUNTERSINK



COUNTERSINK FOR IRON



DOUBLE THREAD SCREW POINT



SINGLE THREAD SCREW POINT FOR QUICK BORING



BIT FILE



DOWEL POINTER



SCREWDRIVER BIT



SCREWDRIVER BIT



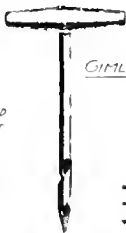
DOUBLE END SCREWDRIVER BIT



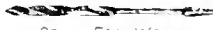
GIMLET BIT



LIGHTNING COUNTERSINK FOR IRON



GIMLET



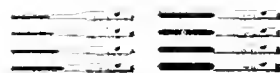
DRILL FOR WOOD



DRILL FOR METAL OR WOOD



TWIST DRILL FOR METAL



DRILL POINTS



WASHER CUTTER



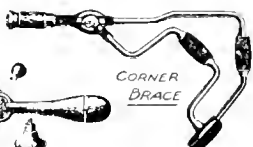
AUTOMATIC DRILL



MAKE SQUARE HOLE IN HANDLE TO FIT BIT SHAFT



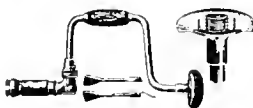
HAND DRILL



CORNER BRACE



DEPTH GAGES FOR BITS



RATCHET BALL BEARING BRACE

tersink, bit, drill or screwdriver is convenient where only a little work is to be done.

Bit files are necessary for sharpening bits and are specially cut, having some sides left smooth. Washer cutters are made for cutting washers and gaskets of leather, rubber and other material, but may be used for making wooden wheels. Bit gages are made in different styles and are convenient as they stop the bit cutting at a certain depth.

Many varieties of braces, hand drills and automatic drills are made for holding bits, etc., for ordinary drilling. Special types are also made to be used for drilling where it is impossible or awkward to use the ordinary common or ratchet brace.

### Brads, Screws and Fastenings

Most fastenings come in different sizes and lengths. For the purpose of determining these sizes, certain gages are made. Plate 11.

It is necessary to know the sizes of nails, screws, bolts, etc., as holes of the proper size must be bored for these fastenings, otherwise small parts will split by having the fastenings forced into them.

Rusty screws, bolts and nuts are difficult to remove. To remove screws, apply a red hot iron to the head of the screw, then use the screwdriver while the screw is still hot. For rusty bolts or nuts, apply kerosene and

allow it to stand until the rust has softened. Try to start with a wrench, but if it does not start easily, rap on one end with a hammer, or a hammer and cold chisel. This will usually start a rusted nut or bolt without twisting off the bolt.

It is necessary to countersink for flat head screws but not for round head screws.

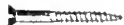
Nails come in different sizes from two penny to sixty penny. Those larger than sixty penny are known as spikes. Following is a list of lengths:

2d 1"	No. 15 wire	10d 3"	No. 9 wire
3d 1 $\frac{1}{4}$ "	No. 14 wire	12d 3 $\frac{1}{4}$ "	No. 9 wire
4d 1 $\frac{1}{2}$ "	No. 12 $\frac{1}{2}$ wire	16d 3 $\frac{1}{2}$ "	No. 8 wire
5d 1 $\frac{3}{4}$ "	No. 12 $\frac{1}{2}$ wire	20d 4"	No. 6 wire
6d 2"	No. 11 $\frac{1}{2}$ wire	30d 4 $\frac{1}{2}$ "	No. 5 wire
7d 2 $\frac{1}{4}$ "	No. 11 $\frac{1}{2}$ wire	40d 5"	No. 4 wire
8d 2 $\frac{1}{2}$ "	No. 10 $\frac{1}{4}$ wire	50d 5 $\frac{1}{2}$ "	No. 3 wire
9d 2 $\frac{3}{4}$ "	No. 10 $\frac{1}{4}$ wire	60d 6"	No. 2 wire

Box nails run from 4d to 10d; casing and finishing from 4d to 1d; flooring from 8d to 16d, and brads from  $\frac{3}{8}$  in. No. 20 to  $\frac{3}{16}$  in. No. 11. Screws run in various sizes from  $\frac{1}{4}$  in. No. 0 to  $\frac{1}{2}$  in. No. 24.

Tacks, staples, lag screws, bolts and nuts come in different lengths and gages. Screws, bolts, set screws, nuts, etc., vary according to the number of threads per inch.

# BRADS, SCREWS AND FASTENINGS.

NAILS.COMMON WIRESMOOTH BOXCASINGFINISHINGFLOORING BRADSHINGLECIGAR BOXBRADSDRIVE SCREW  
OR  
SCREW NAILCHAIR SEATRUBBER HEADFURNITURESCREWSFLAT HEADROUND HEADHAND RAILOVAL HEADDOWELLAGTACKSCUTGIMPWIRECARPETDOUBLE POINTEDWING NUTRUBBER HEADESCUTCHEON PINSSTAPLESWROUGHT STEELFENCEPOULTRY NET BLINDBOLTSMACHINECARRIAGESTOVE BOLTSFLAT HEADROUND HEADIRON CAP SCREWIRON SET SCREWMACHINE SCREWSFLAT HEADROUND HEADFILLESTER HEAD

## Sandpaper and Finish

Sandpaper is made by sifting specially graded sand or other abrasive on paper, the surface of which has been covered with glue. It is used to wear down surfaces and to give a smooth finish. The sand used is graded from very fine, four naught (0000), to  $\frac{1}{2}$ , and coarse from 1 to 3.

Always sandpaper with the grain of the wood. When sanding rough wood it is quite convenient to place the sandpaper on a block. The block may be made of wood, or better still, several thicknesses of beaver or wall board glued together. A block of heavy felt is very good as it will conform to irregular surfaces. The sandpaper placed on the fingers alone should only be used in rubbing down a finished surface. When starting to sandpaper a piece of work, first use coarse paper and finish with very fine. A few drops of oil applied to the last piece used will produce good results.

To preserve wood and other materials from the elements, and to add beauty, they must be treated in some way. This is known to the trade as finish.

As it is quite difficult to apply finish without splashing and spattering during the process of mixing and applying, a special place for the work is necessary. If the work is done at the bench, the bench top should be covered with papers, for it is only a very careless

person who will near the top of his work bench with paint, stain or varnish.

It is not always convenient to wear gloves to protect the hands from the stain, but if soap is forced under the nails by scratching on the bar before beginning the work, the nails will be kept clean. If the nails are clean, turpentine, gasoline or soap and hot water will put the hands in good condition. By using waxed paper, such as comes wrapped about bread, to hold rubbing materials, the hands will be protected.

The nature of the object, the use to be made of it and where it will be placed or used, will determine the kind and degree of finish required.

## Finish

The article may be painted, enameled, stained, shellaced, varnished, oiled, waxed, etc., but the number of coats or polish necessary will depend upon the requirements of the object.

The spreading of paint and enamel, and applying a rubbed or a French polish, requires practice. For information on the mixing, application and the amount of finish, paint catalogs or books on finish should be consulted. Free books can be obtained at most paint stores, and there are many books at the public library.

Most models are finished by first preparing the surface with a plane and sandpaper.

The most simple finish is the oil finish, produced by the application of boiled linseed oil cut with a little turpentine.

Good results have been obtained by using for mahogany, Acme Dark Mahogany No. 36, Acme Walnut No. 35, and Bridgeport R Y Golden Oak Stain. A good walnut or oak stain can be made by mixing the following—3 parts lamp black ground in oil; 2 parts boiled oil; 1 part burnt umber, and 6 parts turpentine.

If provided with cans of the following paint—white, black, red, yellow and blue—any color can be produced. For example, red and yellow make orange; yellow and blue make green, and red and blue make violet. By adding white to any of these colors a tint of that color may be obtained. For example, green plus white gives light green.

Do not paint one color joining another until the first has dried. If you do they will run together.

Always apply shellac to knots before giving the priming coat of paint.

Show card colors dry quickly, and if covered with a quick drying white varnish are excellent for decorating toys.

Paint, striping and lettering brushes should not be left to harden. Wash out in gasoline or gold dust and hot water. If set away, see that the bristles of the brushes are covered with water, oil or kerosene.

## Laying-Out Tools

To do good work easily and rapidly, a workman, be he man or boy, must have tools and they should be good ones. Too often one sees a worker using tools for purposes for which they were never intended.

Rules come in quite a variety of forms but those illustrated are used more than any others. The one foot steel rule is very convenient. Because of its thinness, measurements can be laid off along its edge very accurately. The two foot, four-fold rule folds compactly and can be carried in the pocket.

Work that does not require great accuracy may be marked out with a medium grade pencil, the point of which should be sharp. Where great accuracy is required as in the laying out of joints, a sharp pointed knife is essential. The sloyd knife is convenient but the jack knife can be carried in the pocket and will answer all purposes.

The try square is essential for testing for squareness, that is, to see if adjacent sides are at right angles to each other. It is also used for laying out lines drawn across the grain and for testing evenness of surfaces. *Do not use it as a hammer.* The framing square is larger and is used for work that is too large for the try square.

The bevel is similar to the try square. Unlike it, however, it has a movable blade that can be fastened in

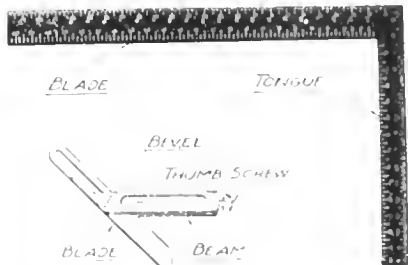


LAYING-OUT TOOLS.

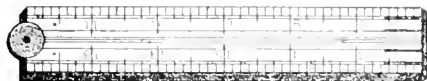
1-FT STEEL RULE



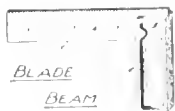
FRAMING SQUARE



2-FT FOUR FOLD RULE



TRY SQUARE



SLOYD KNIFE



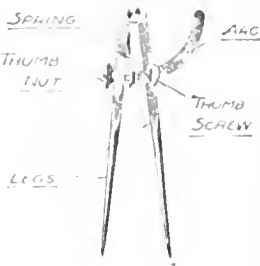
JACK KNIFE



DIVIDERS

SPRING

THUMB NUT



MARKING GAGE

THUMB SCREW

SPUR

HEAD

BEAM

LEGS



any position. It is used for laying out and testing angles.

The marking gage is used for laying out lines along the grain of a piece of wood. The head moves along the beam and can be fastened by the thumb screw at any distance from the spur. As received from the factory, the spur is set accurately with reference to the graduations on the beam, but from use and sharpening it will not remain so. To insure accuracy, the rule should be used to check each setting. It is advisable in school shops to plane off the graduations and require the students to measure the setting.

To lay out arcs and circles the pencil compass and dividers are used. Both legs of the dividers are metal while one leg of the compass holds a lead or compass. The compass can generally be used but for more accurate work the dividers are necessary. Plate 12.

### Saws

A saw has a definite use that no other cutting tool can be put to and accomplish the work as well.

Saws are used for cutting many kinds of material, but the ones considered here are for wood only. They are of two general classes, crosscut and rip. The crosscut is used for cutting across the grain and the rip saw with the grain.

In order to accomplish the different cutting, it is necessary to have teeth of special shapes. Plate 13. In

Figs. 1 and 2 we see the teeth of a crosscut saw from two positions. It will be seen from these figures that the edges of the teeth are similar to a series of knife points, and when forced across the grain the fibers are cut off. Note also that the points are bent alternately to the right and left. The bending of the teeth is called setting, Fig. 5. Note Fig. 3. As the blade of the saw is forced through the wood a saw kerf or cut must be left wider than the thickness of the blade. Otherwise the saw will bind and stick in the wood. The parts cut off called sawdust are carried out of the kerf by the motion of the saw.

The rip saw teeth have a different action to perform, so are of a different shape. The rip saw cuts with the grain instead of across it. The cutting action is quite different. It might be compared to the cutting action of a chisel.

Compare the shapes of the teeth in Fig. 2 and Fig. 8. Examine Fig. 7 carefully as it shows the cutting action.

Fig. 9 shows a handsaw as generally referred to. It may be cross or rip. The saw shown in Fig. 10 is also a handsaw but is referred to as a back saw. The metal strip across the back stiffens it for accurate work.

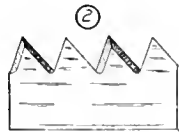
### Planes

The plane is one of the most important tools used in wood work. It is the most complicated and requires

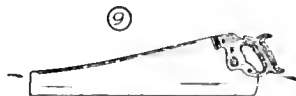
SAWS.



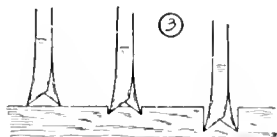
VIEW OF CUTTING  
EDGE OF CROSSCUT  
SAW FROM ABOVE  
AND AT AN ANGLE.



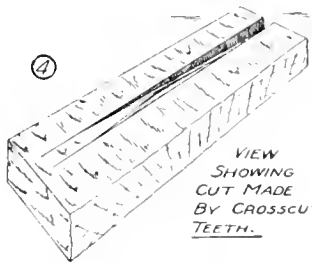
CROSSCUT TEETH,  
SHOWING BEVEL AND  
SHAPE. NOTE HOW  
THEY ARE FILED.



HANDSAW - (CROSSCUT OR RIP).



CROSS SECTION SHOWING  
HOW CROSSCUT TEETH OPERATE  
IN CUTTING.



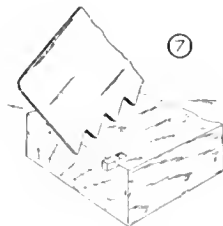
VIEW  
SHOWING  
CUT MADE  
BY CROSSCUT  
TEETH.



BACK SAW.



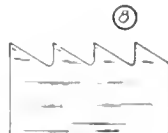
LOOKING DOWN ON BACK  
OF SAW SHOWING SET OF TEETH.



VIEW SHOWING  
ACTION OF RIP  
SAW TEETH.



VIEW OF CUTTING  
EDGE OF RIP SAW  
FROM ABOVE AND  
AT AN ANGLE.



RIP SAW TEETH,  
SHOWING SHAPE, -  
FILED STRAIGHT  
ACROSS.

much skill to use it properly and to keep it in good condition for use.

Old style planes were made of wood and adjusted by striking with a hammer. It was also necessary to joint the face from time to time.

There are many kinds of planes designed for many purposes but the principle of their operation is the same as the bench planes shown in Plate 14. The planes which are most commonly in use are the jack, smooth, jointer and block planes. Should it be possible to have only one plane in your equipment, let it be the jack plane. Buy extra blades for it and sharpen them to shapes to take the place of the other planes.

The use of these different planes may be described as follows: The jack plane is used for removing stock in rather large quantities, that is, for making the first or roughing cuts. It is about 15 in. long. The jointer is from 20 to 26 in. long and is used to straighten surfaces. Being quite long it will only cut on the high spots, thereby gradually bringing an uneven surface to one that is true. The smooth plane is 9 or 10 in. long and used only for smoothing surfaces. It can be used on irregular surfaces on account of the shortness of the bed. The block plane is designed for use on end grain, that is, at right angles to the general direction of the grain.

The construction of the planes is shown by a sectional view showing all the parts in position, and the

smaller parts are shown separately. The plane iron and plane iron cap, when fastened together, are known as the double plane iron. For ordinary work the cap should not be set farther than  $\frac{1}{16}$  in. from the edge of the plane iron. For cross grained wood make the distance less.

The lever cap holds the plane iron in position in the plane proper. Note the cam action when the small lever is forced down into position. The lever cap screw regulates the amount of pressure exerted on the plane iron.

Turning the adjusting nut forces the plane iron in or out according to the amount of shaving it is desired to cut. The lateral adjusting lever adjusts the plane iron across the throat or mouth of the plane so the shaving will be even in thickness throughout its width.

### Planing and Scoring Rules

<i>First Method</i>		6 Cut to length. Square other end. Mark 6
1 Plane broad surface. Mark 1		
2 Plane edge. Mark 2		<i>Second Method</i>
3 Gage width. Plane edge. Mark 3	1 Plane broad surface. Mark 1	
4 Gage thickness. Plane. Mark 4	2 Plane edge. Mark 2	
5 Square one end. Mark 5	3 Plane one end square. Mark 3	

PLANES.



LEVER CAP



PLANE IRON CAP

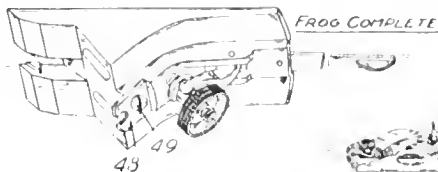


DOUBLE PLANE IRON



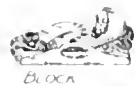
SINGLE PLANE IRON

LATERAL ADJUSTING LEVER



FROG COMPLETE

ADJUSTING NUT



BLOCK



JACK



SMOOTH



JOINTER



CAP SCREW



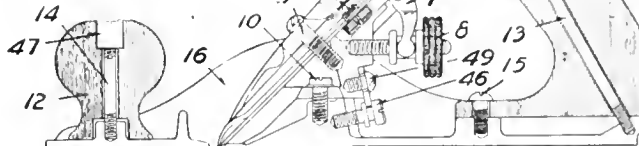
LEVER CAP SCREW



FROG SCREW



ADJUSTING LEVER



SECTIONAL VIEW OF PLANE

- 11-PLANE HANDLE
- 12-HANDLE KNOB
- 13-HANDLE BOLT
- 14-KNOB
- 15-PLANE HANDLE SCREW
- 16-PLANE BOTTOM
- 3-CAP SCREW
- 4-LEVER CAP
- 5-LEVER CAP SCREW
- 7-ADJUSTING LEVER
- 8-ADJUSTING NUT
- 9-LATERAL ADJUSTING LEVER
- 10-FROG SCREW
- 13-ADJUSTING NUT
- 15-FROG ADJUSTING PLATE
- 16-FROG ADJUSTING SCREW
- 46-FROG ADJUSTING SCREW
- 47-HANDLE AND KNOB BOLT
- 49-FROG ADJUSTING SCREW

- 4 Gage thickness. Plane.      6 Gage width. Plane edge.  
 Mark 4                              Mark 6
- 5 Cut to length. Plane end.  
 Mark 5

### Scoring Rules

- 1 Hold beam on 2, draw across 1.      2 Hold beam on 1, draw across 2.
- 3 Hold beam on 1, draw across 3.      4 Hold beam on 2, draw across 4.

To get a piece of wood to certain definite dimensions, it is necessary that the work be done in a systematic manner. To work otherwise will not obtain desired results.

Select the better broad face and plane smooth and true. Plate 15. Test as Fig. 1 and Fig. 2, also diagonally, and lay on a flat surface to test for wind. It should lay flat and not rock. This is called the working face and should be marked 1. It is from this face that all future measuring should be done and on it layouts should be made.

Next plane one edge straight and square with surface number one. To test for straightness hold blade of the try square lengthwise on the edge. For squareness, hold the beam of the square against surface num-

ber one with the blade extending across the edge as in Fig. 3. Mark the edge 2.

Now set the marking gage to the width of the finished piece, and with the head resting against surface number 2 gage a line the entire length of the piece on surface number one. Plane to line, test as for side 2 and mark number 3.

The fourth step is to reduce to thickness. Gage on surfaces 2 and 3 the thickness from 1. Plane off surplus stock and mark number 4.

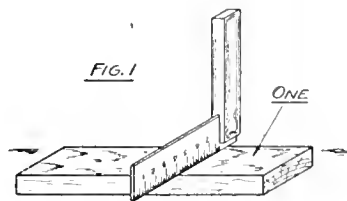
One end should now be sawed. Follow the scoring rules. Hold the beam of the try square against surface number 2 with the blade extending across number 1. With a knife score a line across this surface. Next, holding the beam against the surface number 1, score across 2 and then 3. Then, holding the beam on surface number 2, score across 4. If your work is accurate the lines will meet so as to be continuous around the piece. Saw to line.

Measure the desired length, score around the piece and saw as for the first end.

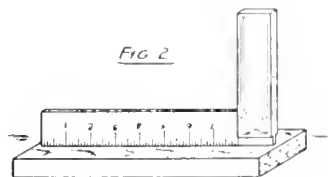
While the first method is generally used, another method that will give very excellent results to beginners is indicated above.

## STEPS IN PLANING.

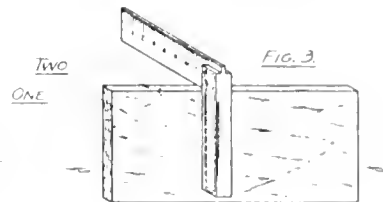
STEP 1—PLANE ONE BROAD SURFACE SMOOTH AND TRUE TEST AS SHOWN IN FIG 1 AND FIG 2. A THIRD TEST IS ACROSS DIAGONALS. MARK ONE.



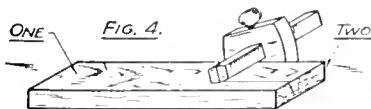
STEP 2—PLANE ONE EDGE STRAIGHT, AND SQUARE WITH ONE. HOLD BEAM OF SQUARE AGAINST ONE, BLADE ACROSS TWO. SEE FIG 3. MARK TWO.



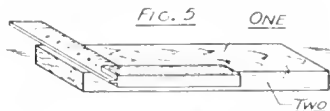
STEP 3—GAGE FOR WIDTH SET HEAD AGAINST TWO AND GAGE ON ONE PLANE TO LINE. SEE FIG. 4. MARK 3.



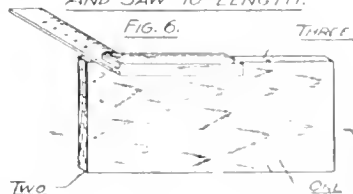
STEP 4—GAGE FOR THICKNESS. SET HEAD AGAINST ONE AND GAGE ON TWO AND THREE. PLANE TO LINE. MARK 4.



STEP 5—SAW ONE END. SET BEAM OF SQUARE AGAINST TWO AND SCORE ACROSS ONE, FIG. 5. NEXT SET BEAM AGAINST ONE AND SCORE ACROSS TWO AND THREE, FIG. 6. SCORE ACROSS FOUR WITH BEAM ON TWO, THEN SAW.



STEP 6—MEASURE FOR LENGTH. SCORE ACROSS SURFACES AS IN STEP 5 AND SAW TO LENGTH.



### WORK BENCH

This bench can be made by the average boy. The vise screw can be purchased at any hardware store for 60 cents. A metal bench stop will be found convenient. The lumber need not be any particular kind, some of the dimensions may be changed to suit lumber you have on hand.

The legs are of the proper length for the average 12 or 14 year old boy, but may be made longer to suit conditions.

After getting the legs to the required size and shape, get out parts I and braces C, parts J and D, and the cross pieces which support the shelf. When these are cut to size, they may be assembled. The shelf may next be cut and fastened to the supports. For the top, get hard wood, cut to size, and attach to the frame, together with the back apron E.

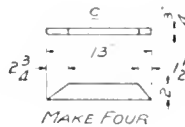
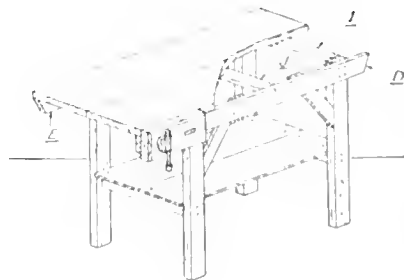
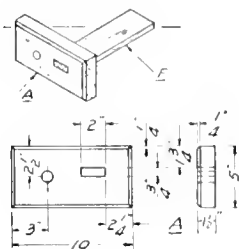
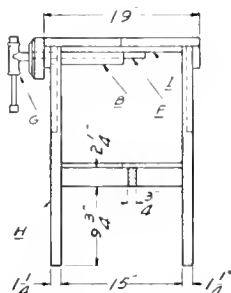
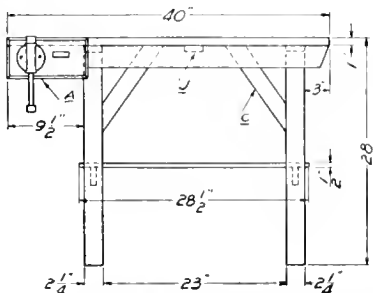
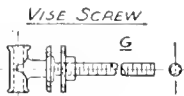
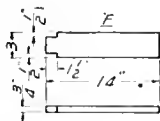
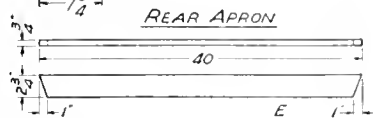
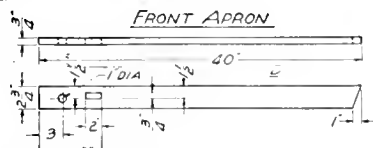
Parts B and F will also give better service if made of hard wood. B is made of four pieces held together with screws. F should be fitted to B before the pieces making up B are finally assembled. Fasten F to A, which should be made of hard wood. Hold the assembled pieces, F and A, in proper position on D and mark on the latter the location for the hole for the vise screw. Bore the required hole, then locate the position of B underneath the top and fasten.

A vise handle can be made from a piece of broom handle. Bore two small holes through the handle near each end, place in position in the vise screw, and secure by driving pegs through the holes.

The bench may be left natural, or it may be painted or oiled as desired.



# WORK BENCH



### COMBINATION BENCH HOOK

Accurate work is absolutely necessary. Every piece must be made to exact dimensions, all corners must be perfectly square, and the various pieces must be located accurately with reference to each other.

Hard wood is the best material to use. Get out all pieces to the dimensions indicated.

First assemble miter box, observing directions on the drawing concerning location of screws. We now have a problem of laying out an angle of 45 degrees. The following method will be found practical and not hard to understand: On the bottom of box lay out *very accurately* a square of a size equal to width of box, commencing at a point  $1\frac{1}{8}$ " from the end. Carry the locations of corners thus established, by means of a try square, across sides of box to the upper edges. Saw from corner to corner *very carefully*. The result should be an accurate miter.

Next fasten parts C and D together. Part B may next be fastened in place, and finally the miter box should be fastened to its position on C.

Part A should be cut so the end grain of the piece will be next to end of miter box. As the length of a piece of wood is always measured lengthwise of the grain, you will have, in this case, a piece wider than it is long. Fasten A in position so the space between it and the miter box will be equal to the thickness of a saw blade.

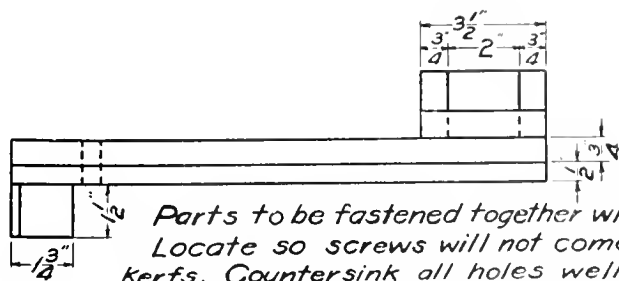
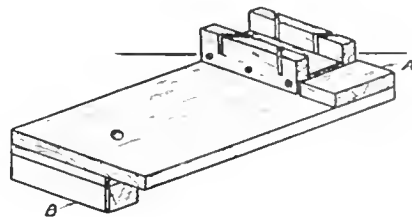
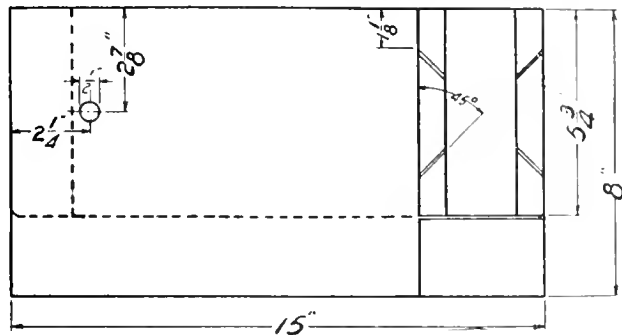
Finally, bore the hole for hanging bench hook up out of the way.

The miter box is not large, but is large enough for a great many uses. It is used for sawing at angles of 45 degrees, such as the joints for a picture frame.

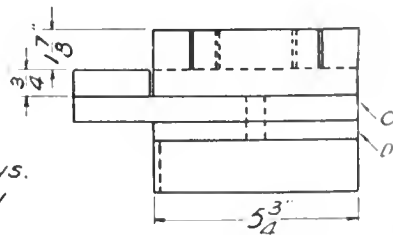
As a bench hook, the device is used for sawing the ends of boards square. Lay flat on bench, as shown in sketch. Place board against miter box. The sawing is done in the space between miter box and part A.

To use as a shooting board, reverse position and turn over. Place stock against B, turn plane on side resting on the ledge. By permitting stock to extend beyond B slightly, and moving plane forward and backward on the ledge, very accurate work can be done.

## COMBINATION BENCH HOOK.



Parts to be fastened together with screws.  
Locate so screws will not come in saw  
kerfs. Countersink all holes well.



### TOY PIG

The first step is to lay out your pattern for the various parts. Use thin cardboard for this. Squares should be laid out as shown in the drawing and the outline traced in so the lines touch the squares in the same places they do in the drawing. When you are satisfied with your outlines, cut to shape with a pair of sharp shears.

The next step is to lay the patterns on the wood from which the pig is to be made, then trace around them. The hardest part will be the cutting to shape, especially the body. A hand saw is the best tool for this, but as most boys will not have one available, the cutting will have to be done with a turning saw, or if you are very, very careful, you may be able to use a coping saw, though the stock is almost too heavy for this tool.

Cut the various parts to shape and bore holes for the screws. Great care must be taken to see that holes on opposite sides of the pieces are exactly in line with each other. Next sand all the parts and then assemble.

At this point make your measurements for the grooves

in the cart. No measurements are given for the reason that the distance between the legs might vary. If the toy is first assembled and the measurements then taken from it, less difficulty will be encountered.

The painting of the toy can best be accomplished by taking it apart and working up each piece separately. Tie a piece of string to each part, then paint and hang up to dry. The color scheme as shown on the drawing is to paint the body white and spot it black. You might paint the body black and spot it white, or red and black may be used. Just paint it to suit yourself, but be sure your scheme will look like a pig.

While these parts are drying the cart may be made. The wheels should be carefully laid out and cut to shape. Other than these, the cart will cause little trouble. Paint the cart red.

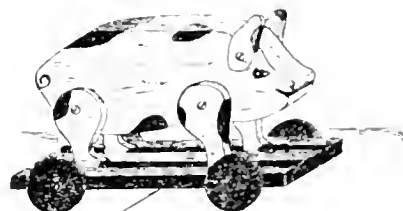
Use washers between all movable parts. This will make them operate more easily and also prevent the marring of the toy by rubbing.

# TOY PIG

MAKE ONE

+ INDICATES LOCATION OF HOLES FOR SCREWS

PAIN T WHITE — SPOT BLACK

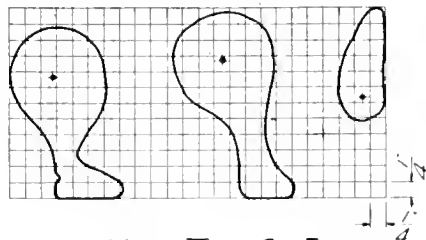
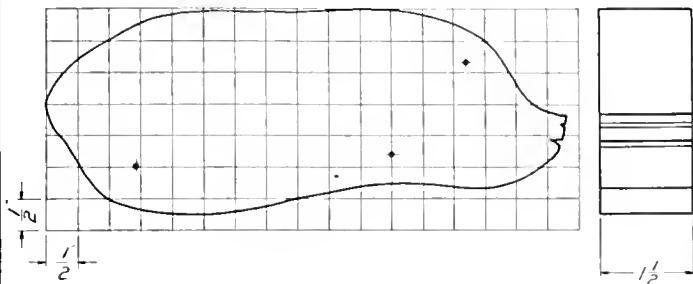


PAIN T CART RED

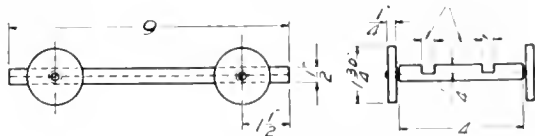
PLACE WASHERS BETWEEN MOVABLE PARTS

FASTEN EARS AND LEGS TO BODY WITH R.H. SCREWS.

THESE DIMENSIONS TO SUIT FINISHED TOY



MAKE TWO OF EACH



### CHILD'S MORRIS CHAIR

One very important thing to remember in making this chair is that all pieces must be gotten out with their ends perfectly square.

The joints are fastened in two different ways. Be sure you thoroughly understand each method before you proceed. Notice the one where holes are bored part way through one member of joint. As the depth of these will depend upon the width of stock, calculate very carefully how far you should bore. As the hole in the other member of joint will run parallel with the grain, some means must be provided to give the screw a better grip than it would have in just the end grain. This is accomplished by placing dowels in such a position that the screw will pass through them, thus getting a good grip crosswise of the grain in the dowel. These dowels are also added to the other form of joints as a means of increasing their strength. Study the details of the joints thoroughly to insure a proper understanding of their use.

When all joints are made and fitted, assemble with the proper screws, then fit and fasten bottom slats in place. Good

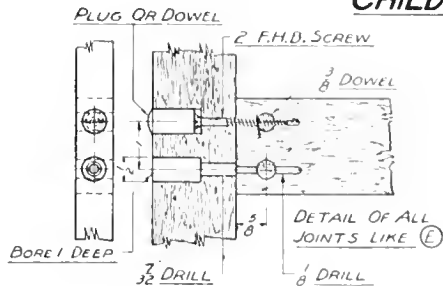
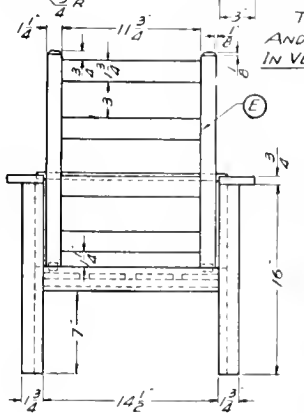
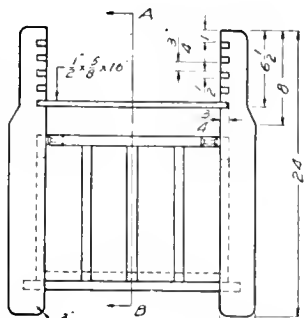
work on this will add a great deal of strength to the chair. Measurements for slats are to be made after chair is assembled.

The holes in the wood, made by boring for screws, should be filled by means of dowels or plugs. Whichever method is used, it is important that the wood from which they are made should match the wood in the chair.

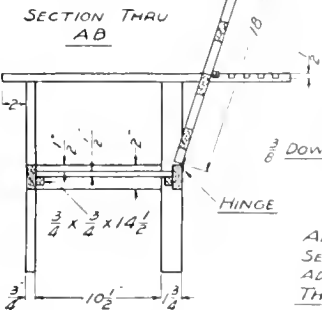
In fastening arms to frame, care should be taken to have them the same distance apart throughout their length. Be sure your chair frame is perfectly square before back is fastened in place. If it is not, the back may not set properly. Should it be slightly out of square, it may be sprung enough to true it up, by adjusting the slats. The back is fastened to the rail by hinges, and is held in the desired position by means of a bar which fits in slots cut in the arms.

A cushion can be made if you secure the help of your mother or sister. Paint or stain the chair according to the lumber you have made it from.

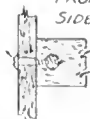
# CHILD'S MORRIS CHAIR.



TO AVOID CONFUSION, FRONT AND TOP VIEWS SHOW BACK IN VERTICAL POSITION



2 R.H.B. SCREW



JOINT BETWEEN FRONT LEGS AND SIDE RAILS, AND BACK LEGS AND BACK RAIL

2 F.H.B. SCREWS

1/2 PLUGS



METHOD OF FASTENING ARMS TO LEGS

ACCURATE FITTING AND FASTENING OF SEAT SLATS WILL ADD STRENGTH TO THE CHAIR



THIS YOUNG MAN IS QUITE PLEASED WITH THE CHAIR HE HAS MADE FOR HIS LITTLE SISTER

### CUTTING BOARD

The board can be made of soft or hard wood, though, of course, the latter will give much better service. Birch or maple are very good woods for the purpose.

The first thing to do will be to square up your board to the overall dimensions. In addition to the working drawing, there are four drawings showing the steps to follow in laying out the board. Figure 1 shows the board after it has been squared to the proper dimensions, and with a center line extending the length of the piece. Figure 2 shows line drawn on each side of the center line and other lines at right angles to the edge of the board. The dimensions for the location of these lines should be determined from the working drawing. Figure 3 shows the two arcs drawn which give the outlines of the greater part of the handle. Figure 4 shows arcs drawn at the corners, and the centers for the one-inch holes located.

The piece is now ready to cut to shape. Bore the one-inch holes at the points indicated, also the  $\frac{3}{8}$ " hole in the handle.

In boring holes, the boring should proceed until the spur shows through on the reverse side, when the bit should be started from that side and the boring finished. Next saw the outline of the handle and round the corners to the arcs drawn.

As noted on the drawing, all edges should be broken. This may be done by slightly planing off the corners and finishing with sandpaper, or it may be done with a spoke shave. Making the edges oval shape by means of the spoke shave gives a very good finish to them and may be tried if desired. This shape is not shown in the drawing, as the board with the edges just broken answers the purpose very well and causes less work to make.

No finish is required for this board. Some people think they add greatly to the board by oiling it, but this should not be done owing to the food absorbing the oil when the board is in use.



STEPS IN LAYING OUT  
AFTER BOARD IS SQUARED UP

FIG. 1



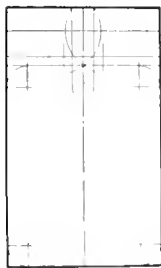
FIG. 2



FIG. 3

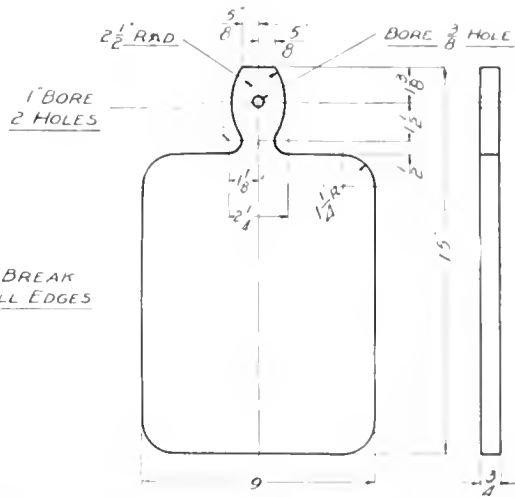


FIG. 4



CUTTING BOARD.

MATERIAL  
HARD, CLOSE  
GRAINED WOOD.



### TOY CANNON

This cannon can be made without the soldiers, but it will be more interesting if the soldiers are made to shoot down.

Begin work on part A. After laying out, the stock can be cut to shape with a back saw, smoothed up a bit with a chisel and finished with sandpaper.

Make B the barrel, and note the chamfers only run part way down the barrel. Great care must be taken to bore the hole straight. Locate the centers on both ends by drawing diagonals, then bore half way from each end.

Next make the axle E and then the wheels. Lay them out with a pair of sharp dividers, scoring rather deeply at the circumference. This will give a good line to work to. Remove stock with coping saw and finish with spoke shave, file and sandpaper. Bore holes at center.

Whittle out the plunger and bore a hole for the rubber band. On part B, as indicated, a tack is driven on each side

over which to loop the rubber band running through the handle of the plunger. The tacks must not extend into the hole in B, or the plunger will not work freely.

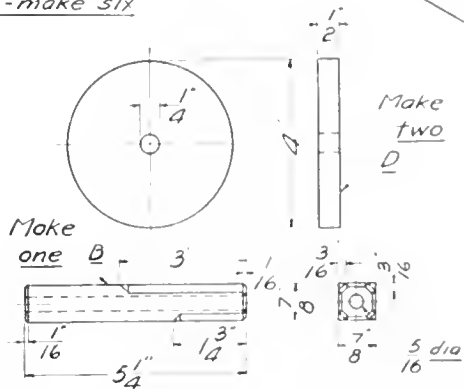
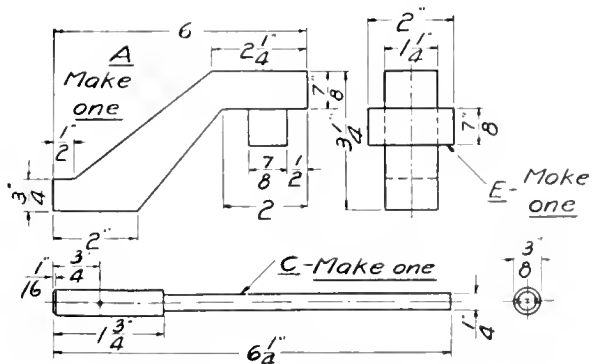
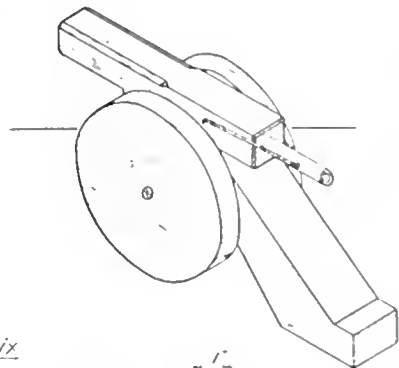
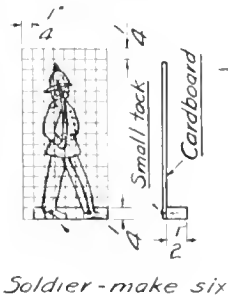
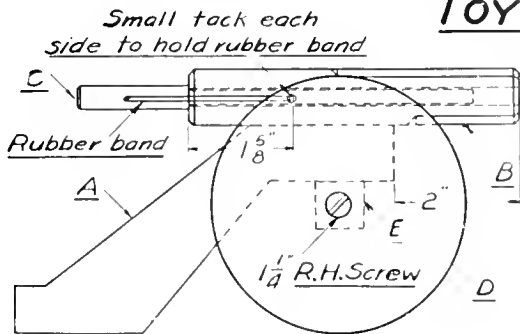
Assemble the parts, using brads and glue to hold them together.

Of course there should be some ammunition. For this use small round sticks about two inches long, of a diameter that will permit them to fit loosely in the barrel.

There should be something to shoot at, too. A plan for a soldier is shown and there should be at least six of them made. The soldiers are cut from cardboard and tacked or glued to blocks of wood to make them stand.

Paint the soldiers, using several colors to make them attractive. Also paint the cannon. It is suggested that black be used for parts A, B and E, and red for parts C and D.

# TOY CANNON.



### BATH ROOM CUP HOLDER

This is a little convenience that mother will appreciate, as it looks very untidy to have a drinking glass or cup setting around with no place for it.

The design shows the shape of the holder octagonal. This can be varied if it is desired to do so. For instance, it might be made round, or hexagonal in shape. There is also plenty of room for an expression of your own ideas in the design of the back piece.

Very little material will be required for this holder. Almost any kind of wood will be suitable for use, as no doubt it will be painted.

If you decide to change the design, make your drawings before you start work. The work on the back piece will be very easy, the other two parts requiring more care. The bracket supporting the octagonal piece should be laid out by the square method, as no compass curves are used. A coping

saw can be used for sawing the bracket, but it will have to be used carefully, as the stock is rather thick for such a small saw.

It is suggested that the part for the holder be laid out but not cut to shape until after the hole is bored. An expansive bit will be necessary to do the best work, though it is possible to do a fairly good job with a gouge. In boring, hold the stock in the vise crosswise of the grain, otherwise the large bit will split the stock. The bottom of the hole will have to be smoothed with a chisel or gouge and sandpaper. After boring the hole the outside should be worked to shape. Bore required holes for fastening together, sandpaper well, then assemble. No sizes are specified for the screws. Use only heavy enough to do the work. Round-head screws will, of course, look better for fastening the holder to the wall. Paint to suit the woodwork or wall to which it is to be fastened.



## SKATE SHARPENER

It is very hard for an amateur to hold the file in the proper position when sharpening skates. This skate sharpener will mechanically hold the face of the file parallel to the face of the skate runner.

Of course there are different ways of sharpening skates. If you wish them hollow ground this sharpener will not do. Take them to an expert skate sharpener and he will hollow grind them with an emery wheel.

The base of the sharpener is  $7\frac{1}{2}'' \times 2\frac{1}{2}'' \times 11''$  and may be made of soft wood, but the two top pieces should be made of oak, maple, birch or other hard wood. These parts receive considerable wear.

Select the file you expect to use in the sharpener and make two thin pieces the thickness of the file. They are to be bradded to the base one on each side of the file.

Now make the two pieces of hardwood, to be fastened over the other pieces and part of the file. A space should be left between these pieces just wide enough to allow the skate runner to pass through freely. Use 1" flat head screws to fasten these pieces. When the pieces wear bore new holes and set them closer together.

To use the sharpener clamp the skate in a vise and push the file across the skate, holding it as firmly as possible. The sharpener should not rock sideways.

Test for sharpness by holding skates in the same position as blades of a pair of shears. If sharp, they should cut tissue paper when worked as shears.

A sharp skate will not slew sideways. Notches filed lengthwise in the end of the blade at the heel will aid in making a quick stop which is necessary when playing hockey.



### STEAM ENGINE

Experimenting with this engine will be great sport, but do not make the mistake that one boy did and think it unnecessary to have a safety valve or make weight too heavy.

Make platform A and nail cleats B to it; also C and D, and fasten to A, but use screws instead of nails.

Find an old bicycle pump for a cylinder. Bore a hole in the handle end. File off finish and solder a piece of brass tube to the end at right angles. The tube also has a hole bored in it, making a passage from the tube into the pump.

Flatten out the end of the plunger rod from the pump. This is to be the piston rod. Bore hole in flattened part for fastening to the connecting rod. Remove plunger from piston rod and cast a lead piston on it, as at M. Make mold by boring hole in piece of wood. Hold rod in hole and pour hot lead around it. File piston to fit cylinder. It must be well fitted or steam will escape past it. Cast a piston on a piece of stiff wire to fit the tube—this is part L.

Cut a piece of tin and solder to cylinder. Carve out a place for the cylinder in E. Fasten cylinder to E by screws driven through the tin. Get a shaft and tube to fit it for a bearing as at N. File ends of shaft square to fit holes made in G, H and O. Solder tin to tube to fasten it to E.

Make fly wheel of heavy wood and bore holes for lead to add weight. Make parts F, J and I. I is to keep J from rubbing on fly wheel and H is a pulley for connecting engine to other mechanism.

Part K is made of hard wood and connected to O with a screw. Assemble all parts. Oil movable parts. Adjust length of wire on small piston or valve so when cylinder piston is at the end of its stroke the port hole will be open for the steam to act against the piston. As the cylinder piston is forced out the valve piston runs past the port, allowing the exhaust to pass out of the tube. Make boiler from any large can and heat on a kitchen stove.





### TOY ELEPHANT

The elephant is a very attractive toy and the cart is a very important part of it, because on it Mr. Elephant can do all sorts of tricks.

All parts of the elephant will have to be cut out with a turning or coping saw. The turning saw is harder to use but will be found more satisfactory on the thick wood.

Lay out your patterns on cardboard by method indicated in the drawing. Transfer them to the wood from which the toy is to be made, being especially careful that all the holes for the screws are accurately located. It is quite important that the holes in the body be located exactly opposite each other. Bore holes, then saw to shape and sand well.

Before painting, the parts should all be assembled and tested to see that they are all properly related to each other.

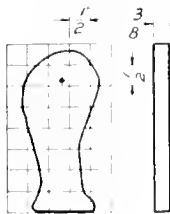
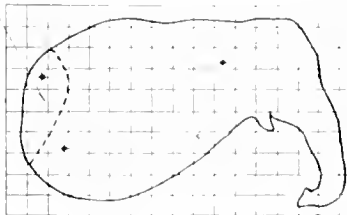
Any necessary alterations should be made at this time. Place washers between movable parts and take measurements for the grooves in the cart.

Make the cart and fit the feet to the grooves. The wheels can be sawed out with the coping saw, or wooden button molds can be used. Wooden button molds make good wheels, as they are nicely sanded and have holes bored for the screws.

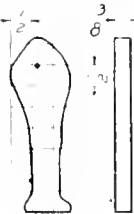
In painting, try to get a color that looks like an elephant. A dirty or muddy gray is the nearest I can describe it. Paint the toes black, the tusks white, the eyes white with a little black around them. Put a bit of red around the mouth and in the back of the eye. The ear should be painted entirely red. All parts should be painted separately, so it will be necessary to take the toy apart to do this.

# TOY ELEPHANT

CUT OUT AS INDICATED  
FOR TAIL



MAKE TWO



MAKE TWO



MAKE ONE

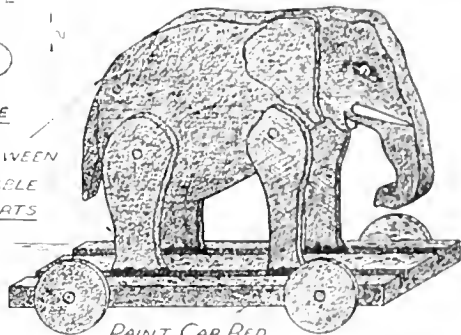
USE WASHERS BETWEEN  
MOVABLE  
PARTS



MAKE TWO

• THIS INDICATES LOCATION  
OF HOLES FOR SCREWS

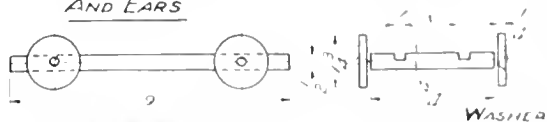
PAINT BODY A MUDDY GRAY



PAINT CAR RED

USE A 1/2" #6 F.H.  
FOR TAIL, AND  
1/4" RH FOR LEGS  
AND EARS

MAKE THESE  
DIMENSIONS TO SUIT  
FINISHED TOY



WASHER

### FEEDING BIRD

This toy can be made from pieces of cigar box or other scrap thin lumber.

Begin by making the bottom, or part A. Square the piece up nicely and with a pencil compass and free-hand curve lay out according to the drawing. Cut to line with a coping saw and finish edges with sandpaper. Bore holes on center line for string.

Make B and fasten to A with cigar box nails. Use a bradawl to make holes for the nails so the piece will not split. Part C is a pill box cover. It is to be fastened to A with a tack, but should not be placed till after the toy is painted.

Two pieces like part D are needed. Lay out from a center line. Bore holes with bradawl for brads to hold the head and tail. Make tail E and head F, after which the irregular part G is required to assemble the bird. Glue G in place between parts D. These parts may be bradded if very fine brads are used. Drive a staple and screw hook in the bird as indicated.

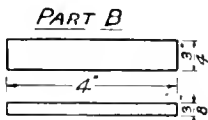
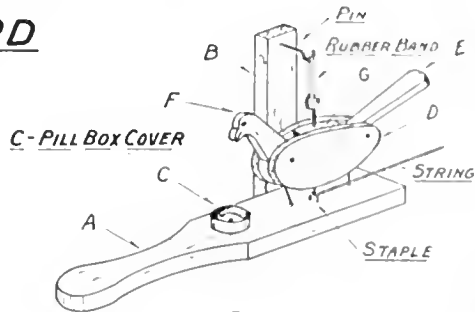
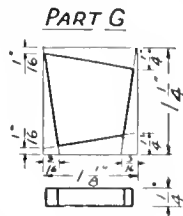
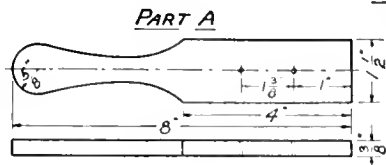
Tie a piece of thread or cord in holes made in neck and tail and thread through holes in A, which should be countersunk to receive knots. Drive staple in A and screw hook in B.

Loop an ordinary rubber band once or twice, as necessary, around hooks in B and top of body. Adjust and knot cord threaded through holes in A. The bird is held in position between these strings and the rubber band.

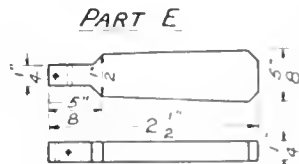
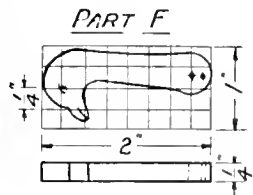
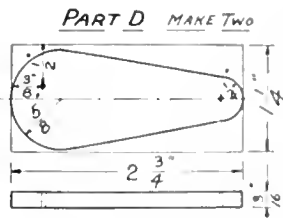
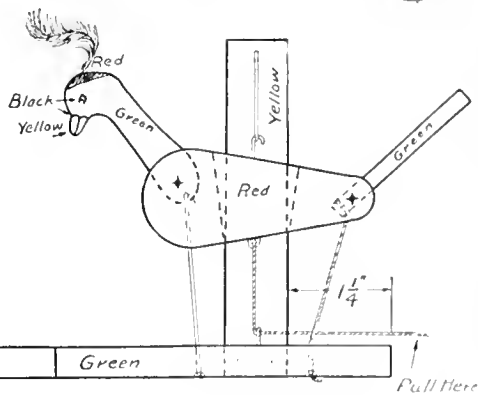
Tie a piece of cord to staple in bottom of body and thread through staple in A. Hold A by handle in left hand and pull cord, making the bird lower his head and tall as if eating.

Colors are suggested for decorating the toy on the drawing, but other combinations may be used. Show card water colors make good paint for this toy. To produce a luster they should be covered by a quick-drying white varnish.

# FEEDING BIRD



† Indicates Holes



### FLYING PROPELLER

This toy is one boys like to make because one can be made in a short time.

The materials needed for making the toy are a piece of broom handle, an empty spool, an eightpenny nail, two 1-inch No. 16 wire brads, a piece of tin and a good strong string.

Cut the broom handle to dimension and with a knife and sandpaper work to form, rounding one end nicely and cutting a shoulder on the other.

Bore a hole in the shoulder end large enough to receive the nail. Drive the two brads in one end of the spool  $\frac{1}{2}$ " apart. File off the heads and round the ends. Place the spool on the nail and drive the nail into the handle. Drive the nail just far enough so the spool will work freely on it.

Lay out the propeller pattern on a piece of paper. A pencil compass may be used for some of the curves. Trace

the pattern on a stiff piece of tin or galvanized iron. Use a scratch awl or sharp nail for marking.

Bore two  $\frac{1}{8}$ " holes with a hand drill or punch them with a nail. If the latter method is used, file off the burr. Cut to line with a pair of tin shears and bend the ends as indicated by Fig. 2.

This toy should not be operated in the house or near a crowd, because when the propeller leaves the spool it leaves with considerable force and is liable to break anything fragile it might strike, or cut a gash if it should strike anyone in the face.

To operate place the propeller on the brads, wind the string about the spool tightly, hold the handle in the left hand, pulling the string with the right. At the same time the string is being pulled raise the left hand with a jerk, throwing the propeller flying into the air.

# FLYING PROPELLER

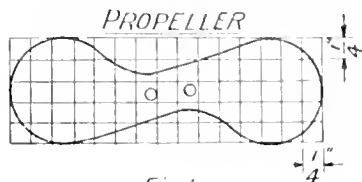
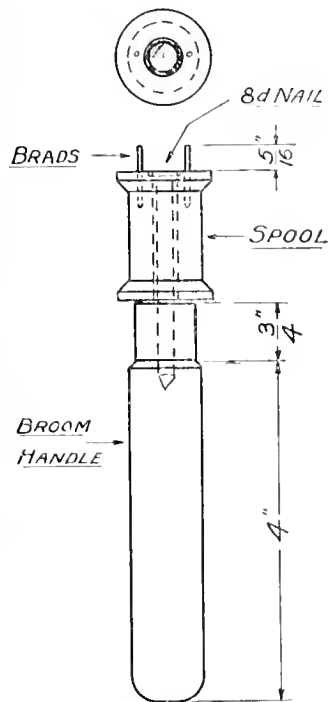
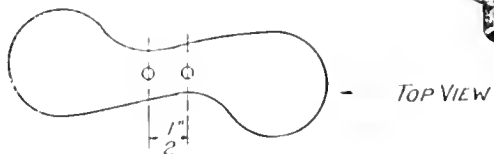


Fig 1

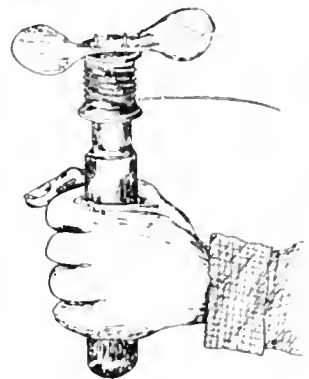


TOP VIEW



FRONT VIEW

Fig 2



### POTATO GUN

The material for the potato or pop gun consists of a piece of tube and a plunger. The tube may be either metal or glass, but the material of which it is made must be very thin so it will cut through the slice of potato readily.

For the tube a piece of  $\frac{1}{4}$ " or  $\frac{3}{8}$ " tubing or a large quill should be found and cut about 4 $\frac{3}{4}$ ". The ends must be cut even, and not have a burr on them. If the walls are not very thin, file sharp at both ends.

Make a plunger to fit the tube. However, it is not necessary that it fit the tube tightly. Whittle the plunger from a piece of wood, making a shoulder at the end of the handle. The handle should be of larger diameter than the tube. The distance from the shoulder to the end of the plunger should be about 1 inch less than the length of the tube. It must not run all the way through the tube when pushing out a load.

Prepare the ammunition for the gun by slicing a good-sized potato into  $\frac{1}{2}$ -inch slices; if thinner the tube will not hold the air. Lay a slice of potato on the table and press the tube through it. When you feel the tube strike the table, twist the tube, making sure the potato is cut all the way through. With the plunger push the pillet to the other end of the tube. Remove plunger, cut another piece in the end of the tube, and then with a quick push of the plunger force the last pillet up to the first. The compression of the air will force the first pillet out with considerable force and a loud pop.

Should the sides of the tube be dented, or there be a crack in the seam, the air will escape and the gun will not shoot.

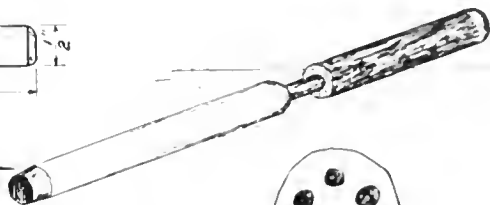


# POTATO GUN

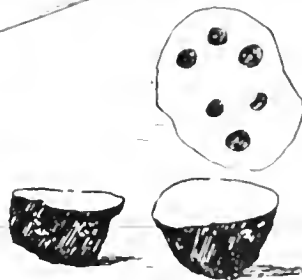
PLUNGER



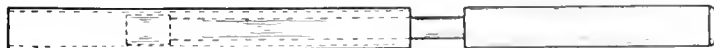
FILE SHARP



TUBE



GUN ASSEMBLED



### A WOODEN DOLL

This doll is just the thing for the little folks because it will stand many tumbles without breaking. It will stand erect, with its arms in many positions, without falling over. It can also sit on the floor, stand on its head or hands, and be placed in many other amusing positions. There is no reason why it should be a boy doll. If you prefer a girl, a skirt and sun bonnet will quickly transform it into a girl doll.

The doll is to be painted, so use any kind of wood. Make the body first. Do all the straight sawing with a common saw, but saw the head with the coping saw.

Now make the legs according to the pattern, rounding the end with a chisel and sandpaper. Bore holes for the screws a little larger than the shank of the screw and counter-sink for the head. If the screw is too tight the movement of the leg will soon turn it out of the body.

The arms are practically the same as the legs, except that the layout on them is not so difficult. The arms should fit well, so the doll will be properly balanced.

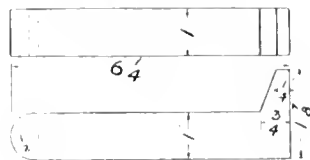
Lay out with a pencil the features, etc., or if you are not very expert at drawing have someone do it for you.

Little children who play with toys of this kind like bright colors, so any combination of bright colors will be desirable. The following combination is suggested: Pants blue, shirt red, face white, hair and features black, shoes black or brown, stockings and tie green, and cuffs and collar yellow. Two coats will be necessary.

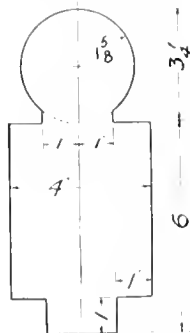
Do not try to paint to a certain line with one color and then continue with another, while the first is still wet. If you do the colors will run together, spoiling the looks of the toy. Let one color dry thoroughly before applying the next.

# A WOODEN DOLL

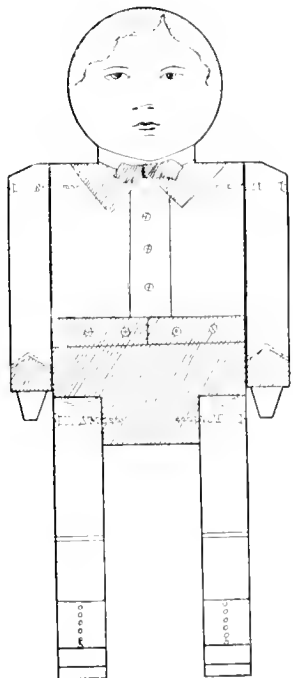
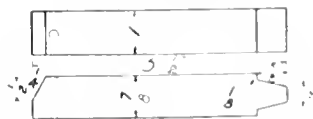
## LEG PATTERN



## HEAD AND BODY



## ARM PATTERN



### A THANKSGIVING GOBBLER

It can readily be seen from the drawing, which shows a staple and string attached to the axle, that this toy is to be drawn along the floor. The weight made of lead fitted into the bottom of the axle causes the turkey to move back and forth, giving it the appearance of walking.

Note the direction of the grain represented by the fine lines on the different parts.

Plane up a piece for the turkey and then trace in the pattern. Cut to form with a coping saw.

Get out the piece for the axle. Be sure the ends are cut square. Bore a hole  $\frac{1}{2}$ " deep for the weight and on the opposite side cut a groove for the turkey.

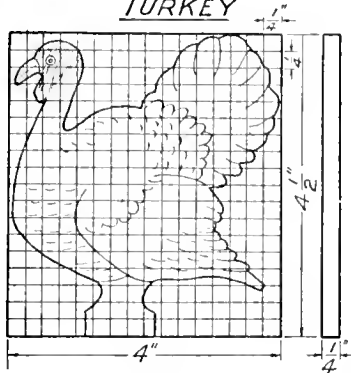
Draw the wheels on stock prepared for them, with a pencil compass, and cut as perfect as possible with a coping saw. At the center bore a hole for the screw to fasten the wheel to the axle. Use a round head screw and place washers on each side of the wheel so it will turn freely.

Sandpaper all parts and glue the turkey in place after driving a staple in the axle. Paint the wheels and axle red, also the shaded part of the head of the turkey. The bill and part between the axle and breast and wing are painted yellow. The rest of the turkey is to be painted brown, or as near to a turkey color as you can mix. After this is thoroughly dry paint the feathers, wing and eye, and line on the bill, black, using a fine striping brush.

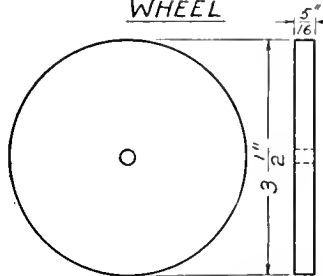
The mold is made of two pieces. Lay one piece on the other and drive brads through one piece and a short distance into the other. Clamp the pieces in the vise and directly on the crick bore a hole with a  $\frac{3}{8}$ " bit  $1\frac{1}{2}$ " deep, so half of the cut will be made on each piece. Take the pieces apart and gouge out as at M. Place the pieces back in the vise and pour the mold full of hot lead. When the lead has cooled, remove the weight, file smooth and force in the hole in the axle. Do not pour water on hot lead because it will explode.

# A THANKSGIVING GOBBLER

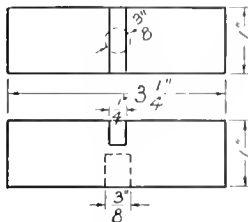
TURKEY



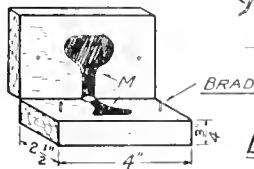
WHEEL



AXLE



MOLD.

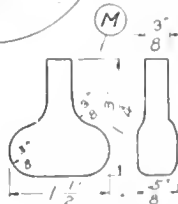
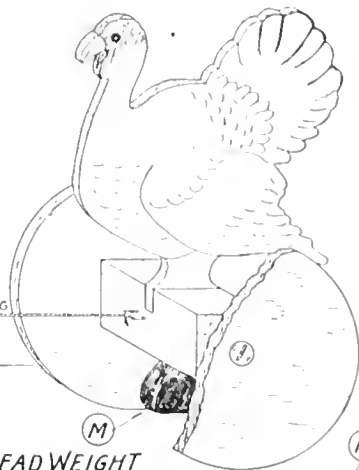


CUT MOLD  $\frac{5}{16}$ " DEEP

STRING

BRAD

LEAD WEIGHT



### AEROPLANE WEATHERVANE

The overall dimensions for body are indicated, but no definite dimensions are given for curve at the back. Make this to suit yourself, but remember there must be sufficient area to keep the vane headed into the wind. Bore hole for screw for the support after plane is assembled.

Cut small slot for the rudder at the back of body. Get the slot exactly the right size so the rudder can be held in place without nailing.

Get out the other pieces according to dimensions. In boring holes in wheel-axle hangers, be careful not to split them. To avoid this, hold in a vise crosswise of the grain. Make axle of quarter inch dowel. Place in position in hangers and nail the latter to body. To make wheels, describe circles with steel dividers. Bore holes in center, then remove stock very carefully.

Cut dowels for supporting the planes, being careful to get ends square. Fasten planes to dowels by driving brads through the planes into ends of dowels. For wiring, use wire that bends easily. Bore holes with brad awl and place wires as shown. Fasten planes to body, then fasten rudder in position.

The propeller will require careful work. Get out a piece  $\frac{3}{8}$ " square then describe a circle  $\frac{3}{4}$ " in diameter and lay out as shown. The propeller will be  $\frac{1}{2}$ " thick throughout its length but the width will vary from  $\frac{3}{4}$ " at center to  $\frac{7}{8}$ " at ends. A sharp knife will be best for forming the part. For fastening the propeller, a round head screw or a nail with large head may be used. Bore a hole through center of propeller that will permit it to turn easily on the nail or screw used. Put in place with a washer between it and end of body.

Balance assembled vane and bore hole for round-head screw at point of balance. This should come for appearance about  $4\frac{1}{4}$ " from front end. Should it not come at this point, secure the balance by attaching a small bit of metal to the lighter end. Suspend from any convenient support by means of the stick indicated. It should turn easily.

Paint machine gray, with red, white and blue stripes on the tail. On upper and lower sides of planes paint the design shown, in good proportion to the space it is placed in.



### SMALL CART

Not a great amount of stock will be required for making the cart, but it is quite large enough to amuse a little boy or girl. If a larger cart is desired, it is only necessary to increase the dimensions on the drawing.

Get out the stock to the overall dimensions, then lay out the curves. Those at the corners on the front and back pieces are parts of a circle and can be made with a pair of compasses. The curves on the side pieces are made freehand. Measure in  $3\frac{1}{4}$ " from one end,  $1\frac{1}{2}$ " from one side, then connect these points with a pleasing curve. Finish one side first and from that lay out the other side, thus getting them alike. Use a coping saw to remove the stock.

In making the wheels, great care should be taken to get them exactly round. Lay them out with a pair of dividers, making a good line in the wood with the point. Saw very close to the line and finish with a wood file and sandpaper.

If this work is done carefully, the wheels can be made very true. Bore holes at the centers for the screws. These holes should be only large enough to permit the wheels to turn freely. Washers should be used between the wheels and the axle as shown in the drawing, and it would be well to use them between the head of the screw and the wheel on each side. The use of the washers in this manner will cause the wheels to run more accurately.

The box is fastened together with brads. The axle and handle are fastened to the bottom of the box with 1-inch flat-head screws. Be sure to locate the axle squarely across the box. Use a small piece of dowel through the end of the handle to grasp it by.

The cart will be very attractive if painted a bright red. Children like bright colors and toys should always be painted to satisfy this liking.





### RED CROSS AMBULANCE

This toy will require careful work.

The body requires a piece of stock  $1\frac{1}{2}'' \times 4\frac{1}{2}'' \times 8''$ . The method of laying out the pattern is clearly shown in the drawing. Remove the stock with a coping saw. The hole for the steering apparatus should be bored before the parts are assembled, and from underneath the body.

Lay out pattern for the fender and cut to shape with the coping saw. Two are needed. The axles are easy to make--two pieces  $\frac{1}{2}'' \times 1\frac{1}{2}'' \times 1\frac{3}{4}''$ .

The wheels should be perfectly round and may be easily made so if these directions are followed: With dividers set to the required radius, describe circles on the wood from which the wheels are to be made. Score deeply with the point of the dividers, leaving a line easy to work to. The stock may be removed with a saw and chisel, finishing with a wood file and sandpaper.

The two crosses are very thin, so be careful not to split them.

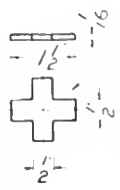
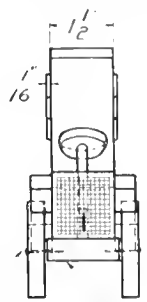
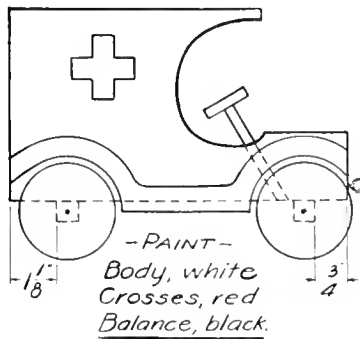
The ambulance is to be painted in three colors and it will be found best to paint parts of it before assembling. The axles can be attached before assembling. They are located  $\frac{3}{4}''$  from the front end and  $1\frac{1}{8}''$  from the rear end. Be sure they are square with the body. Fasten with brads.

The painting scheme is this: The entire body is to be white; the crosses, red; and the axles, wheels, fenders, and steering gear, black. A good way to do the painting is to drive small brads into the pieces, attach strings to them and then paint. As each piece is finished it can be hung up to dry. In driving brads into the wheels, drive them into the centers, as there are to be some driven in later for the wheels to revolve on. Round head screws and washers may be used instead of the brads if desired.

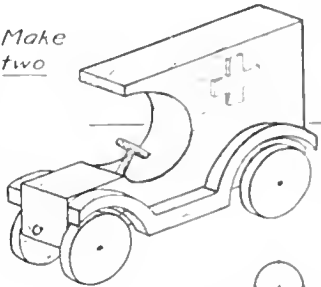
The painting will be easier and will look better if the parts are well sandpapered.

When the parts are dry, the ambulance may be assembled. In doing so, be careful not to war the parts. The result of your work should be an attractive toy.

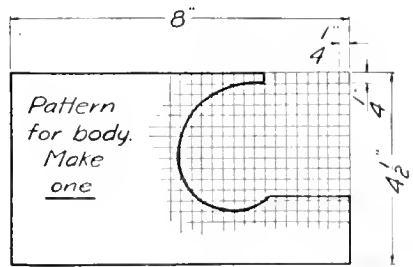
# RED CROSS AMBULANCE.



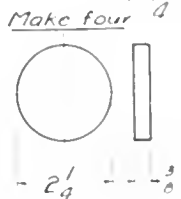
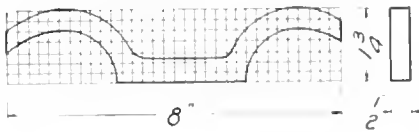
Make two



Axle  
 $\frac{1}{2} \times \frac{1}{2} \times 1 \frac{3}{4}$   
Make two



Pattern for fender  
Make two



## BABY'S ROCKING HORSE

The stock needed for this toy can be obtained from a packing case.

Make seat first. Draw a center line with a sharp pencil the length of board. The other center lines are drawn at right angles to the first line by means of the square, their locations being 5" and 6" from the ends. At the intersections of center lines, place the point of your compass and draw circles of required diameters. Straight lines drawn from one circle to the other, just touching the circumference, give the outside edges of the design. With a turning or coping saw, cut close to outline, finishing with plane, spoke shave and sandpaper. Before removing the long center line, locate, bore and countersink 3/16" holes for the screws used in fastening the head.

For the head, square to dimensions and lay out 1-inch squares. Through these trace the outline according to pattern shown on drawing. Cut to shape and finish in same manner as the seat was finished.

For the rockers make a pattern from cardboard and from it trace the design on the wood. Cut accurately to shape, being sure both rockers are exactly alike.

To fasten rockers to the seat: Bore half inch holes part way through the rocker, boring the rest of the way with a 3/16" drill. Before screwing rockers to seat, round off nicely so they will not mar a polished floor or pick the threads of a rug.

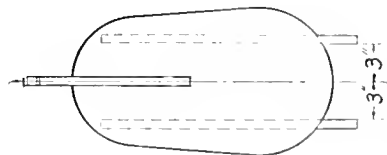
Assemble the parts according to information contained in the top and front views of the drawing.

The painting may be done more easily if the parts are separated. Before separating, however, mark rockers so they may be replaced in exactly the same position they were in before taking apart.

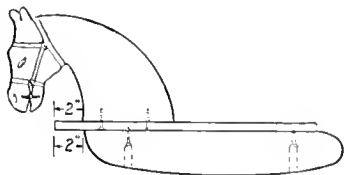
Paint the head and rockers white and the seat red. Each part should be given several coats. Each coat should be thoroughly dry before another is applied, so do not permit your anxiety to finish the rocker cause you to put the second coat on too soon. When the white is dry on the head, paint the eye, nostrils, bridle and mane, applying black paint with a fine brush.

When parts are re-assembled, the horse is ready for use, unless it is desired to add a thin coat of varnish to protect it from dirty fingers.

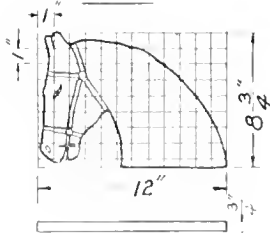
# BABY'S ROCKING HORSE



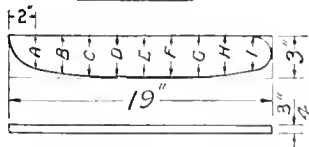
PAIN  
 HEAD - WHITE  
 SEAT - RED  
 ROCKERS - WHITE



HEAD



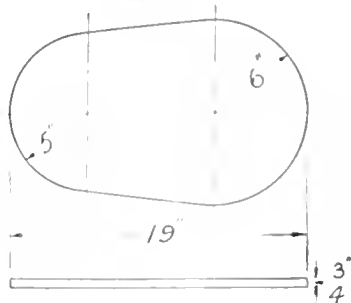
ROCKER



- |                        |        |                        |
|------------------------|--------|------------------------|
| A - $2\frac{1}{8}$ "   | D - 3" | G - $2\frac{15}{16}$ " |
| B - $2\frac{3}{8}$ "   | E - 3" | H - $2\frac{1}{16}$ "  |
| C - $2\frac{13}{16}$ " | F - 3" | I - $2\frac{1}{8}$ "   |

ASSEMBLE WITH  
 2" NO. 10 FLAT HEAD SCREWS

SEAT



## JUMPING JACK

This character will make an amusing toy, but there is no reason why you cannot change it if you desire. It would be interesting to make several toys, each representing a different character. This may be done without changing the operation. All that is necessary is to keep the size of the parts the same as in the drawing. The changing of the shape within these limits will not matter.

In selecting stock, get a piece large enough, if possible, so that all parts may be laid out on it. The patterns may be laid out directly on wood or on cardboard. If several toys are to be made, use the latter method, for then the patterns may be used repeatedly. In either case, lay off squares according to the dimensions shown and trace designs so the lines will have the same relation to the squares as they do in the drawing. By this method, the parts you make will be quite like those shown. If one is skillful in freehand drawing, he may make the designs without the squares, and perhaps according to his own ideas. This would add interest to the

construction. It may be best to follow these designs the first time, after which you may experiment along your own ideas.

When the patterns are drawn, cut out carefully. If they are on cardboard, lay on the wood and trace around them. In placing the design on the wood, be sure to have the grain run the long way of the piece. Cut to shape with a coping saw and sand well.

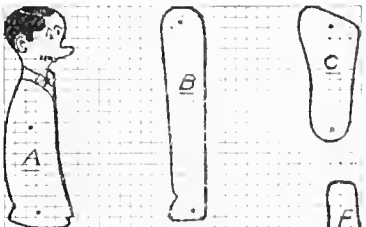
The various parts are held together with pins. Bore holes with a sharp bradawl just large enough for a pin, at the points indicated on the drawing by dots. To assemble, insert the pins in the holes, cut off so the pin extends on the other side about 3-16", and with a pair of round-nose pliers bend the end down with a twisting motion. Do not try to get the parts to fit tightly together—they should work freely.

The toy will look better if it is painted. Use your own ideas. For contrast, the upright should be of a different color than the other parts. One method is to use black paint, leaving the natural wood for the buttons, face, etc.

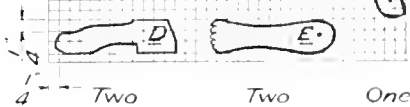
# JUMPING JACK.

— REQUIRED —

One                      One                      Two

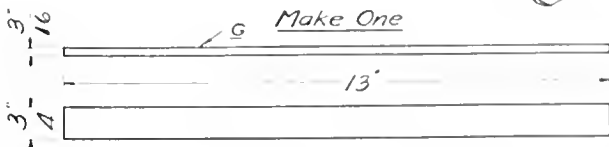
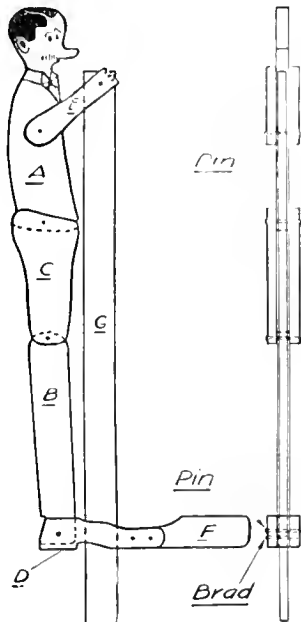
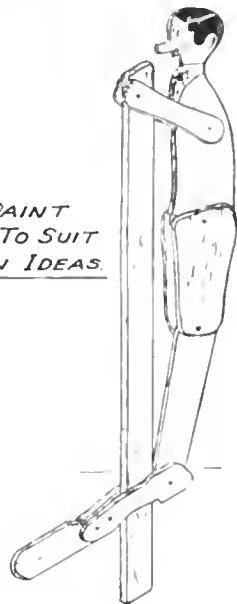


All pieces  $\frac{1}{4}$ " thick



Two                      Two                      One

PAIN  
TOY TO SUIT  
OWN IDEAS.



### THE HULA DANCERS

For the bodies of the dancers select straight grained pine or white wood. Lay out the faces and the location of the nails that hold the limbs in place. With a knife carve the head and face. Pencil or paint in the features.

The arms are cut from a tin can. Locate the holes and punch with a sharp 2" finishing nail. File off the burr caused by the nail.

Fasten the arms to the body with cigar box nails, making sure that the arms fit loosely. Drive the nails until the head is about 1/8" from the body.

Make four legs of heavy cardboard. Lay out a pattern on paper. Trace the design through the rectangles as shown on the drawing detail of the leg. Cut the pattern and trace on the cardboard. Cut to line with a pair of shears or a knife. Fasten the legs to the body the same as the arms were fastened. Painting or staining of the body, legs and arms should be done before adding the skirt and wig.

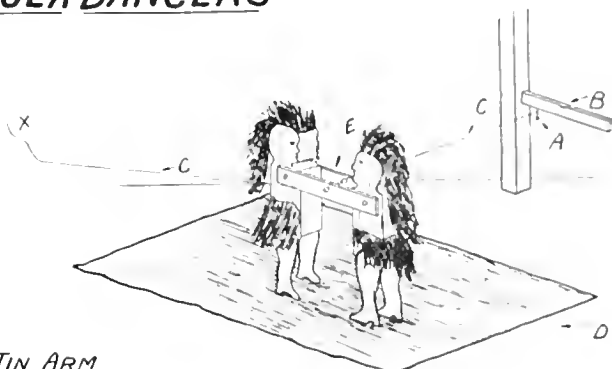
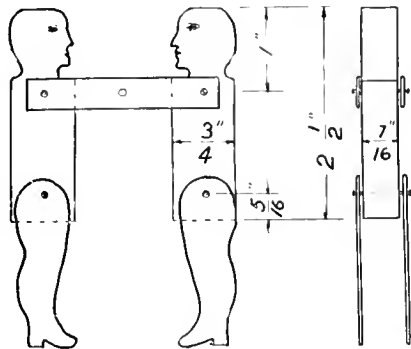
The skirt and wig are cut from scrap black and white fur. Make patterns of paper before cutting the hide. Glue the skirt and wig to the body. About 3/4" of one end of the wig is glued to the top of the head, the rest being permitted to flap while the dancers are in motion. The longer the hair the better will be the result. Rabbit fur is very good.

To operate the dancers, drive a pin in the under side of a chair rail. Tie a piece of black thread to the pin and about two feet from the chair tie the thread through the holes in the center of the arms. Stand about five feet from the dancers, holding the string at X in one hand and concealed from the audience. Jerk lightly and notice the dancing motion transmitted to the dancers.

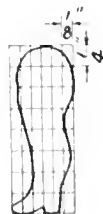
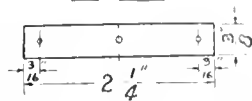
Place a piece of black cloth beneath the dancers' feet so the thread will not be noticed. Practice a few minutes before starting your exhibition.



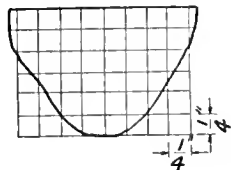
# THE HULA DANCERS



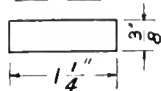
TIN ARM



FUR SKIRT



FUR WIG



- A COMMON PIN
- B CHAIR RAIL
- C BLACK THREAD
- D BLACK CLOTH
- E TIN ARM

CARDBOARD LEG

## MECHANICAL DUCK

As this toy is to be painted, it is possible to use almost any kind of wood.

The body, head and tail being made from wood of the same thickness, select a piece large enough to make all three parts. Lay out the small squares as shown, being careful to make accurate measurements. Next trace the design through the squares, making the lines pass through them in the same relative position as on the drawing. Do not do this hastily—use great care so the outline will be a good representation of a duck. Even greater care will be required in cutting, for no matter how carefully you have traced your lines, unless you cut exactly to them, you will fail. Use a coping saw for this.

Make parts D and E next. Part D will need careful attention. First get out stock to the overall dimensions, then lay out and cut groove. As it is intended that the duck's feet rest in this groove for support, compare the thickness of the feet before you cut the groove to exact size. This is suggested for the reason that in making part C you may have

made it a bit thin. The groove should hold the feet snugly in position. The last operation will be to plane the chamfer which runs only on three sides.

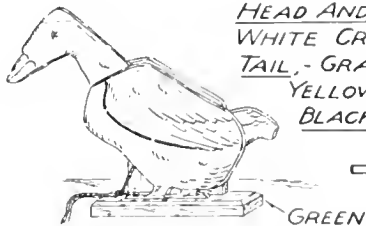
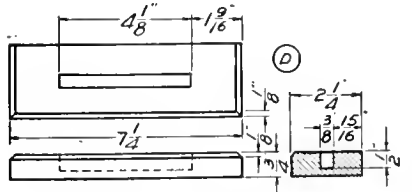
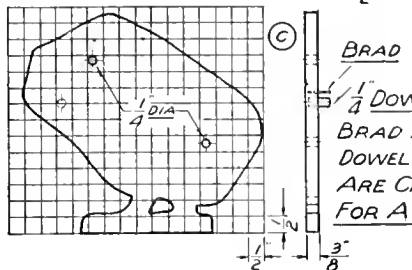
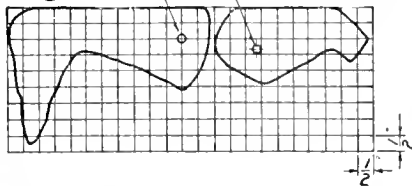
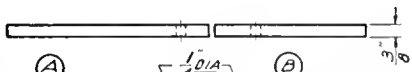
Pay attention to the note on the drawing with reference to location of dowel holes. It is easy to see what difficulty would be encountered if the holes were not opposite each other in the various parts.

When all parts are finished, they should be assembled and tested for proper fitting and relation to each other. The small drawing at the right explains how the parts are fastened in place, and the method of operating. When the test is satisfactory, take the toy apart for painting. While it is possible to paint the parts when assembled, it can be done with greater ease if they are separated. The parts should be well sanded before painting.

When you paint an eye, endeavor to get it to look just as much like an eye as possible, and when you represent the feathers, use the same care. Careful and thoughtful work will produce a toy that will well repay your effort.

# MECHANICAL DUCK.

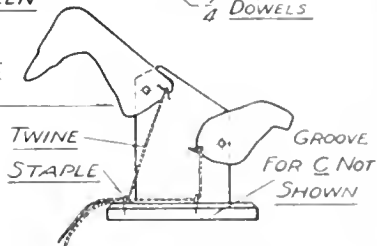
PAINT - BODY, -GRAY WITH WHITE WINGS.  
HEAD AND NECK, -GRAY, RED EYE,  
WHITE CROWN, YELLOW BILL  
TAIL, - GRAY AND WHITE. FEET, -  
YELLOW AND BLACK. FEATHERS, -  
BLACK STRIPES. E, - BROWN



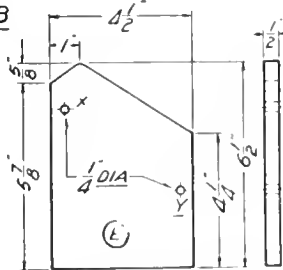
VIEW OF PARTS  
 WITHOUT C IN PLACE



BRAD  
1/4" DOWEL  
BRAD AND  
DOWEL  
ARE CHECKS  
 FOR A-B



LOCATE HOLES ON C  
 BY MEANS OF SQUARES. TO  
 LOCATE HOLES X-Y ON E, PUT  
C IN GROOVE, THEN PLACE E  
 AGAINST C AND MARK  
THROUGH C ON E.



### SCOUT FIREMAKING SET

That this outfit is practical has been demonstrated by users who have won contests for speed in setting fires.

Lay out bow according to detailed drawing. Bore a  $\frac{7}{8}$ " hole to form round part of contour just ahead of hand-hold. With coping, keyhole or turning saw, cut to line of layout. Next make holes for leather or buckskin thong. Finish bow by making all corners round, scraping with window glass, and smoothing with fine sandpaper. Spend plenty of time on this so the handle will be nicely rounded and all parts smooth and free from splinters. Rub bow with linseed or other oil, so if you are caught in the rain with it, the wood will not be affected. Thread the thong through the holes and hold by a brad pushed through leather so it cannot slip through the hole.

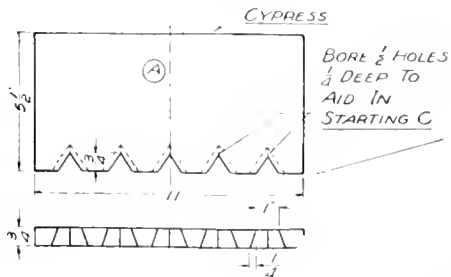
The block D is made of oak. It is chamfered and has a screw driven about 3-16 of an inch below the surface at the center, which acts as a bearing for the head of the round head screw in the end of drill C.

Make drill of cypress, as this material will start the tinder more readily than other wood. It can be made round, left square, or have the corners planed off. One end is nicely rounded and the other has a screw driven half way into it.

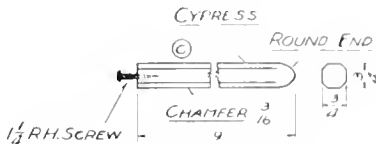
The tinder board is made of cypress. Lay out notches as shown, but before cutting with a saw, bore  $\frac{1}{2}$ " holes  $\frac{1}{4}$ " deep. The holes are to receive the end of the drill.

To start a fire, make shavings of dry wood. Collect some dry grass and twigs. Place board A on ground, and below one of the notches place a bunch of tinder. Wind the thong on the bow about the drill as shown in assembled drawing. Place end of drill in hole, hold block D in the left hand on the screw in the other end of the drill. Grasp bow by handle with right hand, hold part A with whichever knee is most convenient, then saw with the bow, causing drill to revolve back and forth rapidly. As soon as timber begins to smoke, remove board, pick up tinder and blow steadily on it, or swing it, holding in both hands until it begins to flame.

# SCOUT FIREMAKING SET.

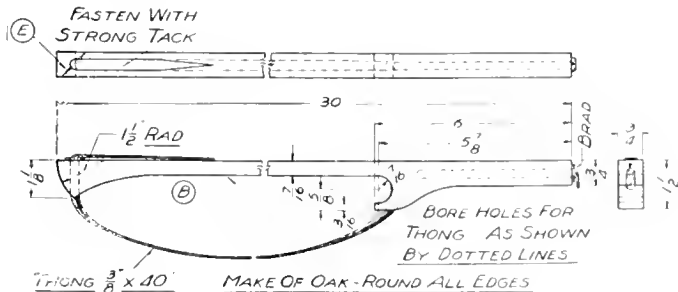


PLACE NAIL THROUGH THONG AT E. LOOSEN OR TIGHTEN THONG BY CHANGING POSITION OF NAIL



TINDER CAN BE MADE BY FRAYING PIECE OF SOFT MANILLA TWINE

PLACE KNIFE HERE



SMALL FM SCREW TO SERVE AS A BEARING FOR C

### BOB SLED

This drawing will require considerable study before attempting to make the sled. It may be made to be pulled with the tongue or a pair of thills may be made for a dog or pony. The thills and tongue may be interchangeable.

Begin by making the box. All the stock is  $\frac{5}{8}$ " thick except the dash, and this is  $\frac{3}{4}$ ". Next make the  $\frac{1}{4}$ " strips that fit over the upper edges of the box.

Get out the stock for the seat and the small cleats that are fastened to the inside of the box to hold the seat in position. Also the strips that fit into these pieces and are fastened to the sides of the seat.

Next get out parts 2 and 3 which fit under the box and are bolted to it; in other words the front and back bolsters. The back bolster is fastened to the box by two eye bolts, and also to part 4, by eye bolts hooked in those running up through the box. This allows the back hob to rock when going over uneven surfaces.

The front bolster is bolted to the box and is fastened to

part 4 by a king bolt that runs through the box, and also part 3 and 4. It is secured by a nut under the hob.

Make parts 4 and note the mortises in these pieces, into which fit the tenons on parts 5.

Parts 5 should next be made and fitted to the parts just constructed, then work can be started on the runners, which perhaps will be the hardest of the work. Lay out the runners as shown by the drawing, cutting the mortises before the runners are cut to shape. Angle irons should be fastened in the corners where parts 4 and 5 are connected. Also iron strips should be screwed to the runners and parts 5.

Make the tongue and spreader to which it is fastened. The latter is fastened to the runners with  $\frac{3}{8}$ " lag screws. Note a spreader is also required for the back hob.

The iron runners or shoes may be put on at a blacksmith shop or you may do this yourself, as it is not difficult. The scheme for painting the finished sled is indicated on the drawing by the letters.



### A HIGH SPEED DRILL

Years ago when the Indians had no matches they started their fires by working a bow and arrow similar to the working of this drill. The Chinese also use a contrivance like this one, with a weight on top of the shaft for drilling holes in dominos.

The drill shaft is round and may be planed from a square stick if you do not have a dowel rod about this size. Taper one end of the shaft to receive the drill point and bore a hole in the other end for the string.

\*

Make the fly wheel of heavy wood, as the heavier the wheel the better the drill will work. Lay out the fly wheel with a pair of dividers or a pencil compass and cut to line with a coping saw. The hole bored at the center should be a press fit on the shaft and should be fastened to it with glue.

Use a piece of hard wood for the movable arm. Lay out the shape from center lines. Bore the hole before shaping

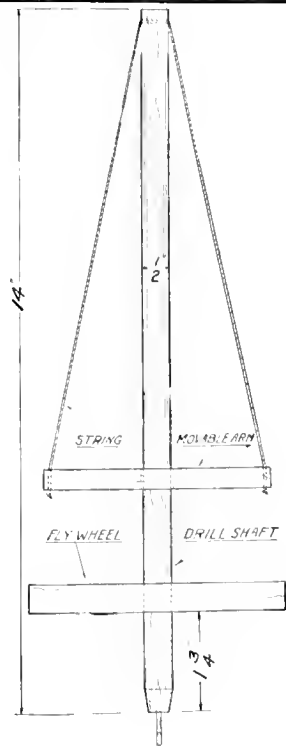
the piece, to prevent splitting. Note that the hole in this piece is larger than the one in the fly wheel.

Fish or chalk line should be used for assembling the movable arm to the shaft. The line or cord used must not be stiff, but very pliable, so it will wrap about the shaft easily. Tie a knot in the cord each side of the shaft to keep it from slipping out of place. Thread the ends through the holes in the movable arm and knot several times.

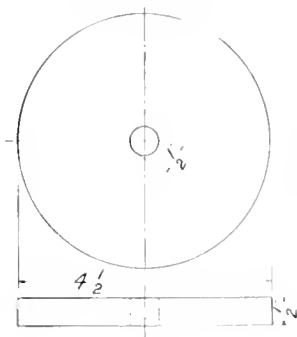
To operate the drill wind the string around the shaft by turning the movable arm on it. Then press down on the arm, releasing the pressure as the arm reaches the end of the downward stroke. This will cause the string to wind in the opposite direction on the shaft, raising the arm for the next stroke. A little soap applied to the shaft will cause the arm to slide easily.



# A HIGH SPEED DRILL



FLY WHEEL

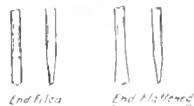


CHINESE DRILLING  
SPOTS ON DOMINOES

MOVABLE ARM



NAIL DRILLS



## CRUMB TRAY

A dark wood will be most suitable for this model. A light wood, if left natural, will soil easily, and if stained, the color will be affected by the dampness on the cloth that must occasionally be used to keep it clean. If made from gumwood, and given two or three coats of linseed oil, you will have a very attractive piece of work.

Get out your stock for the tray to the overall dimensions, then lay out the shape with fine pencil lines. The radius for drawing the arcs from points C and D is  $\frac{3}{4}$ ". The same radius is used for rounding the corners at the back of the tray. No radius is shown for the corners at the front of the tray. These are to be rounded to give a pleasing curve.

To best show the shape of the finished tray, the end view is given as a section on the line AB shown in the front view.

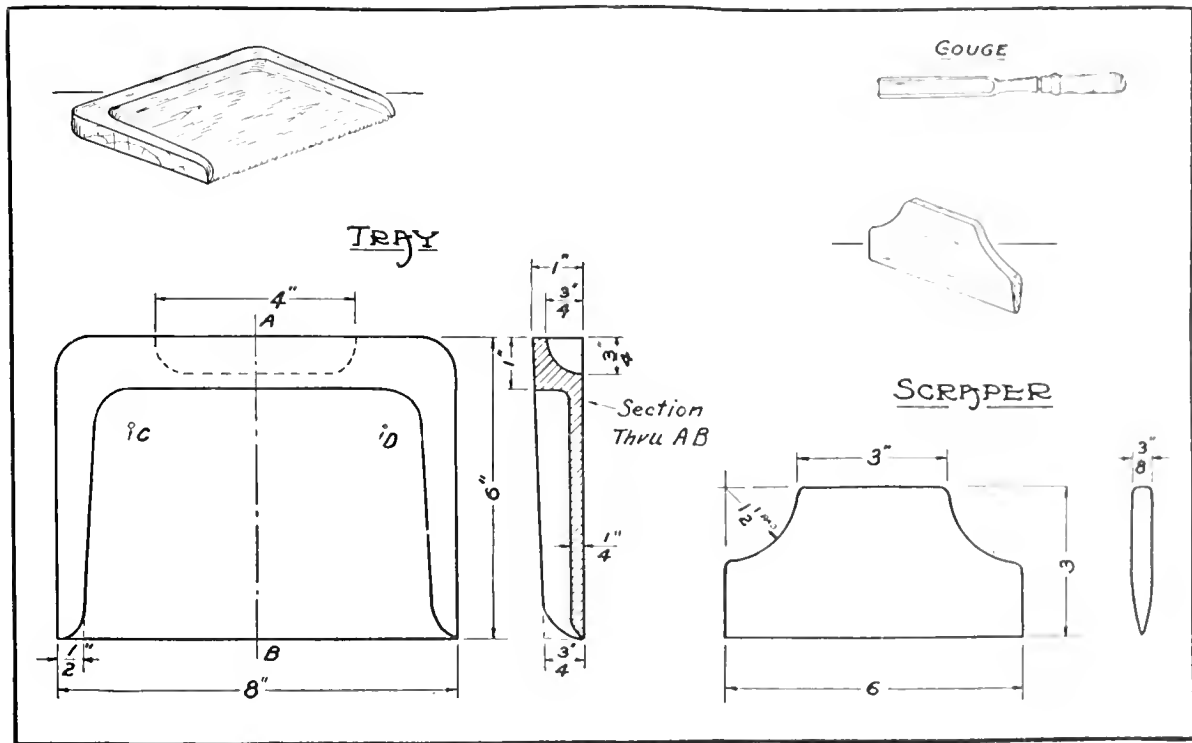
The tool which is used most in this construction is the *gouge*, one having the bevel on the outside. It *must be sharp*. First practice using it on an old piece of wood. Com-

mence removing the waste stock by working from the center to the outside. Keep away from the lines about  $\frac{1}{8}$ " until the roughest part of the work is complete, then finish carefully to the lines. The gouge is not an easy tool to work with at first and you cannot get as smooth surfaces as with a plane. Be careful around the corners.

It is necessary to have some kind of a hand-hold. The end view shows the curve crosswise of the tray and the front view shows the length and the curve at the ends. The tray is thinner at the front than at the back. Shape this after the rest of the work is complete, as it is easier to hold the piece in the vise or clamp if it is the same thickness all over.

Lay out the scraper as shown. Saw the curve with a coping saw.

Sandpaper all the work, and finish as suggested. *Remember that sandpaper does not take the place of the plane, chisel, etc. Use it only after all the tool work is finished.*



### A SIMPLE AND SERVICEABLE FLAG HOLDER

Pine or some other soft wood should be selected for this holder.

Start work on the base. Plane it to the required dimensions, then lay out the locations for the holes H and J. Draw two center lines, as shown, and on the center line running across the piece, mark points  $\frac{1}{8}$ " from each edge for holes marked J. On the center line running lengthwise of the piece mark points one inch each way from the center for the holes marked H. At these points drill  $\frac{3}{16}$ " holes entirely through the piece. Countersink holes marked H on the bottom side of the base to receive a flat head screw.

Next with a sharp-pointed pencil lay out the  $\frac{1}{8}$ " chamfer all around the top edge. Never use a marking gage, as it will make a groove in the wood that cannot be removed unless the chamfer is made larger than is desired.

Plane the chamfer, holding the piece in the vise for this operation. Sandpaper well, being careful to keep sharp edges.

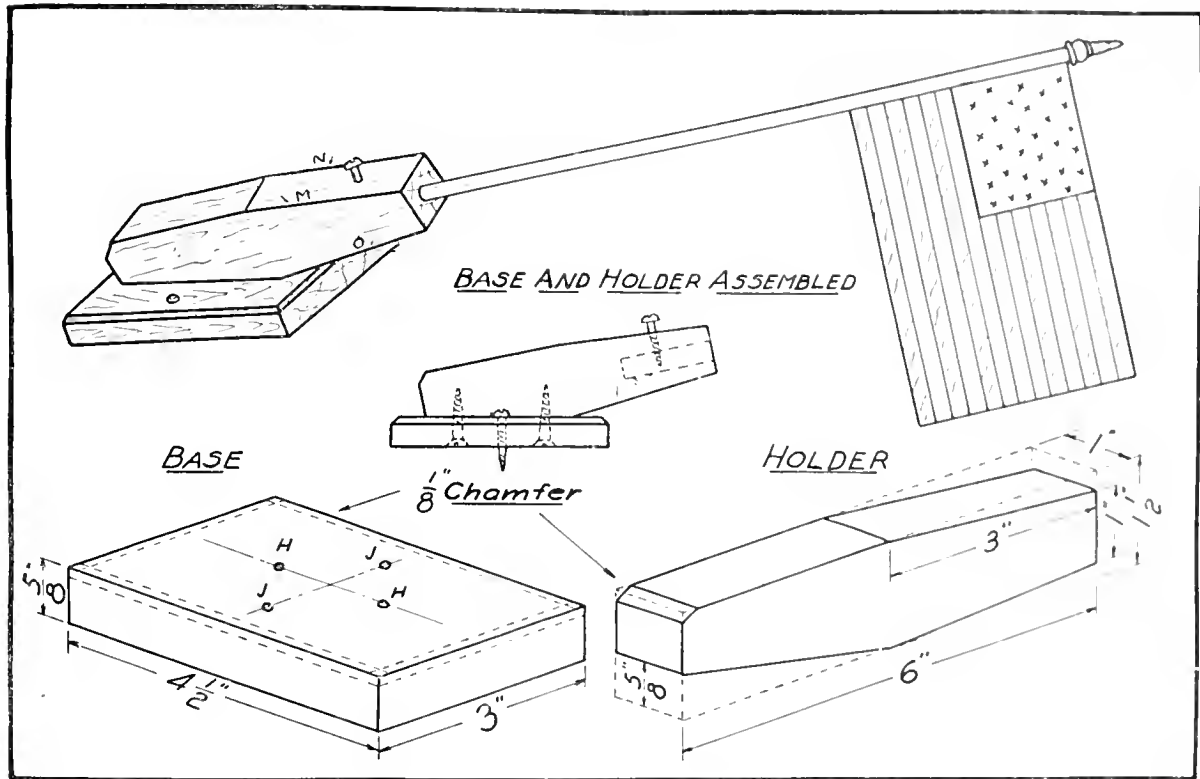
Prepare a piece for the holder next. Bore a hole two inches deep to fit your flag stick. Next lay out, as shown in the drawing, the parts to be removed, which are shown by dotted lines. Remove the parts with a plane.

It will add to the appearance of the finished piece if edges M, N and O are chamfered  $\frac{1}{8}$ " back 3 inches from the front end.

After finishing the holder with sandpaper, the parts are ready to be assembled. They are fastened together with flat head screws through the countersunk holes.

Drive a screw through the top of the holder into the hole to be occupied by the flag stick. This screw should be made to fit loosely, so it may be turned with the fingers, and its purpose is to hold the flag stick in place so it is not blown out by the wind.

A desirable finish is to paint the holder to match the house or other surface it is to be fastened upon.



### TOY RABBIT

A coping saw or a hand saw will be necessary for making this toy. If you have the use of a hand saw, and are properly supervised in its operation, the construction will be much easier. The work can be done well with the coping saw, but it will require a little more effort on the part of the worker.

First lay out your patterns on thin cardboard. Lay out the squares as indicated and trace the design through these squares in the same way as they are traced through the squares of the drawing. Be very careful with this part of the work. You want this design to look enough like a real rabbit so your friends will not ask you where you got your dog. You will find it quite a task to get just the right outline.

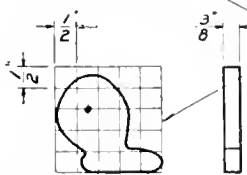
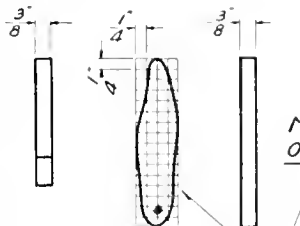
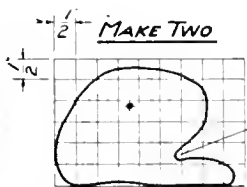
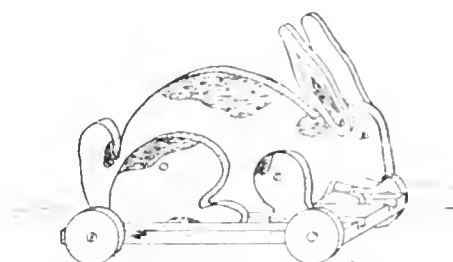
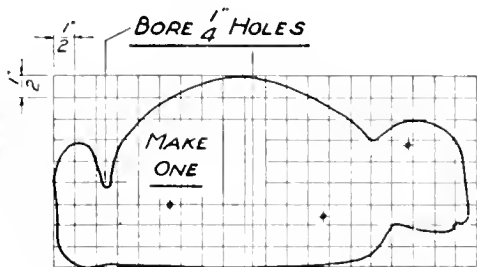
When the patterns are completed to your satisfaction, cut out with a pair of sharp shears. Lay them on the stock from which the toy is to be made and trace around them. Locate the holes with exactness. It is important that the holes on the right side of the body be exactly opposite the

ones on the left side. Before cutting to shape, it will be well to bore the holes for the screws. Select the size screw you wish to use and bore accordingly. When all parts are cut to shape, assemble them to see if they have the proper relation to each other. If satisfied with this test, take them apart, smooth with sandpaper, and paint according to the suggestion on the drawing. Paint each piece separately and hang up to dry by means of small pieces of string.

Make the cart next. Be careful to get the wheels round. The measurements for the grooves in the cart are to be taken from the finished toy. Lay out and cut accordingly. Paint the whole cart red.

Washers should be used between all movable parts for two reasons. First, to make the parts work easily, and second, to keep from marring the painted surfaces. For instance, if the legs were fastened to the body without a washer the movement of the legs would soon wear off the paint.

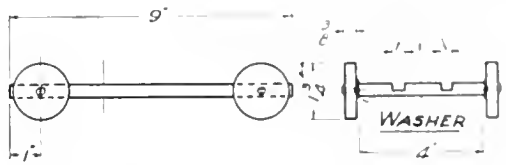
# TOY RABBIT



\* INDICATES LOCATION OF HOLES FOR SCREWS

— PAINT —  
 RABBIT - WHITE,  
 SPOT BLACK  
 OR GRAY.  
 CART - RED

THESE  
 DIMENSIONS  
 TO SUIT  
 FINISHED TOY



## TARGET PISTOL

Begin work by making pistol. Soft wood such as pine should be selected, as there is considerable carving to be done with the jack knife. Plane the piece square and to size, then lay out the form. Bore a  $\frac{1}{2}$ -inch hole through barrel and then, with a smaller bit, cut the opening in which the hammer slides. Note the cut is made deeper at X. Cut to form with a coping saw. Before rounding barrel cut opening for trigger.

Make trigger. Bore holes with a brad awl for pin and rubber band. Fit trigger in place and fasten with a pin.

Drive a tack in the bottom side of barrel and loop a rubber band run through the trigger over it. The rubber band acts as a trigger spring.

The hammer should be made of a piece of hard wood. Thread a heavy rubber band through hammer and loop ends over tacks or screws driven in sides of barrel. Fine springs such as may be taken from an old adding machine may be used with the rubber band, or if they are strong enough no rubber band will be required. Thread a piece of fish or chalk line through hole in hammer, to be used to pull hammer back to cock the gun.

Take pistol apart and round barrel, trigger and handle nicely. Also sand inside of barrel so the bullet will slide out easily.

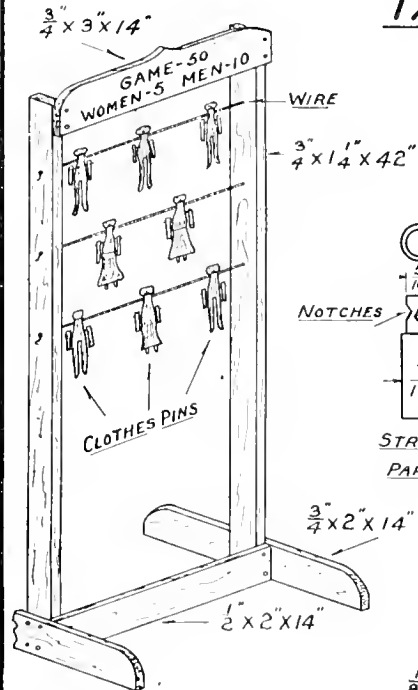
To make bullet, whittle out a round stick, cut a shoulder and notches as at 1. Wrap a piece of wrapping paper around bullet as at 2 and fasten with a piece of string. Stand the bullet in a hole bored in a piece of board and pour paper mold full of hot lead. The lead can be melted in an old spoon. A drop of water poured in the hot lead will cause it to explode, so do not allow water to be put on the lead until after it has set. When the lead has cooled remove paper and file the end round.

The frame for target is well dimensioned so little trouble will be experienced in making it. The dolls are made of clothes pins.

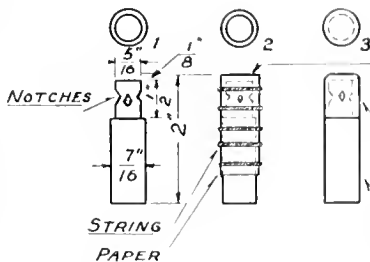
To play the game shoot in turns. The men count 10 and the women 5. The person first making 50 points wins the game.



# TARGET PISTOL

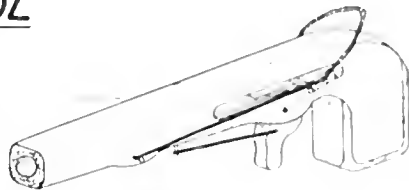
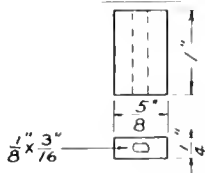


## BULLET

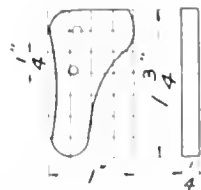


## HAMMER

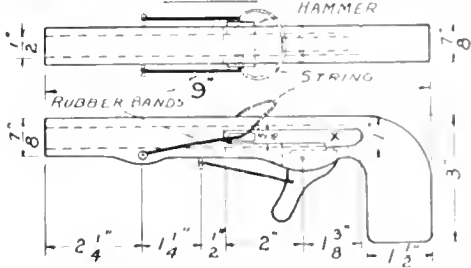
Hardwood



## TRIGGER



## PISTOL



### JACK BE NIMBLE

Every boy has learned this old nursery rhyme in the kindergarten. Here is a chance for you to illustrate it for the little folks. It is to be done with some thin wood, a jack-knife and coping saw.

Make the base B. Next lay out with a pencil compass and rule part A. Before sawing to form, bore a row of 5-16" holes, removing the stock for the cut-out. The cut-out can be made with the coping saw. Finish the sides of the cut-out with a knife, rat-tail file and sandpaper. They must be very smooth so part F will slide easily.

Make C and fasten to B with cigar box nails. Part D is made up of two pieces of wood, one thin and one thick. It is merely a slide and its construction can be learned from the end view. Assemble with cigar box nails.

E is a very thin piece, and receives considerable abuse, so select a good tough piece of cigar box lumber for this part.

It must be made accurately and the edges of the slot and corners nicely rounded and smoothed with sandpaper.

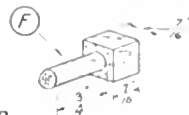
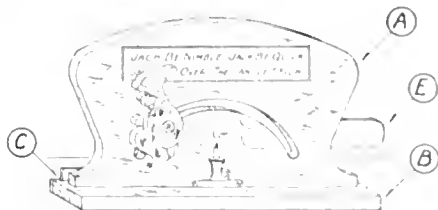
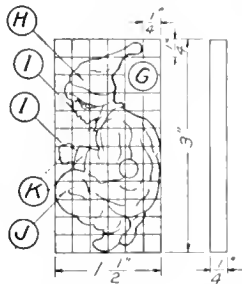
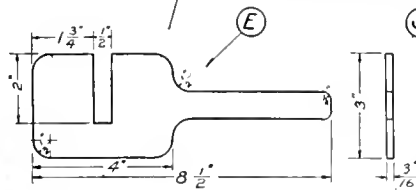
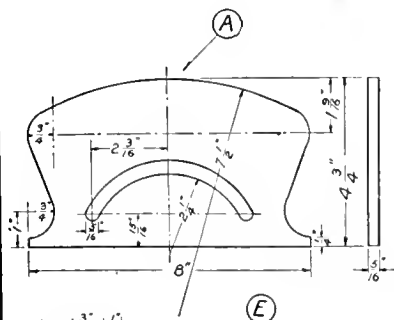
Part F will have to be made with a jack-knife, unless you have a turning lathe.

Jack, or part G, should be drawn on a piece of wood having the grain run at such an angle that the point of the cap will not split off.

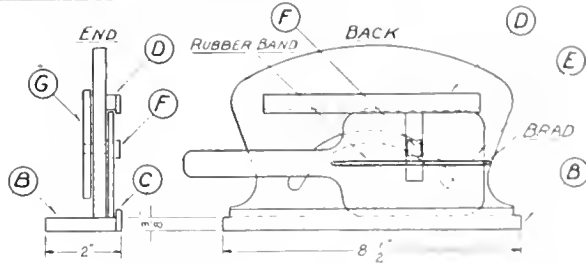
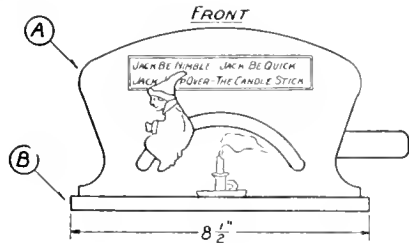
Drive brads for the rubber band and then assemble according to the drawing. It will be found necessary, no doubt, to sand parts here and there so they will work well. A little common soap applied to movable parts will make them work freely.

With a small brush decorate the toy as indicated on the drawing. To operate, hold B in the left hand, grasp the handle on E between the thumb and first and second fingers of the right hand, pull to the right till Jack backs over the candle, release the handle and see Jack jump.

# JACK BE NIMBLE



PAIN —  
 A-B YELLOW H-E RED I-PINK  
 J-WHITE K-GREEN CANDLE-WHITE & RED  
 HOLDER-BROWN SMOKE-GRAY



### BOY SCOUT'S HELIOGRAPH OUTFIT

First get out all pieces of stock to their overall sizes.

Fit to the horizontal part the two pieces which fit just in front and back of shutter frame and which hold the latter in a firm, upright position. Cut notch in central part of frame later. Next cut the angles on upper ends of B and C. First study the drawing, then hold parts as nearly as you can in proper position with reference to pieces to which they are to fit. This should assist you in understanding the drawing. Lay out the angles, but before cutting, compare again. Next locate and cut notches for part X. To do this lay B and C on the floor in proper position, place X on them so it will be 14" from bottom of each piece, then mark. Fasten X in position at once.

Lay out and cut A next. Fasten A, B and C in place with small hinges. When these parts are assembled, the small blocks that rest just back of A, B and C may be fitted and fastened in place. To locate notch to be cut in horizontal part, fold B and C back so X rests upon it, then mark and cut.

Make mirror frame next. The mirror should be one suitable for this size frame and is to be held in place by round-head screws and washers. A 2" round-head screw holds the frame to the horizontal support. Use a washer here also. Turn screw just tight enough to hold frame securely and yet permit it to be turned as desired.

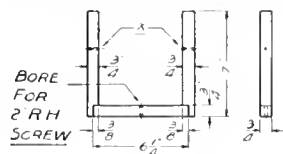
Next make shutter frame. It will be necessary to bore holes for shutter support and to place the latter in position before assembling the parts. Tack shutter in place afterwards. Small cleats are placed in front of shutter at the top, and back of shutter at the bottom to keep it from swinging farther than is necessary. The opening at bottom of frame should be a size that will hold the shutter in a snug position when in use. When carrying from place to place it is removed.

A coat of paint will add to the appearance and also preserve the wood.

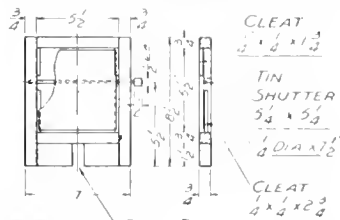
The outfit can be quickly set up and adjusted to flash the signals to any point desired.

# BOY SCOUTS' HELIOGRAPH OUTFIT.

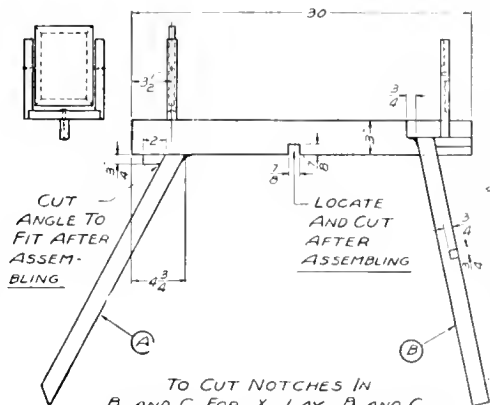
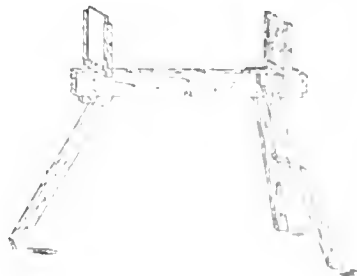
DETAIL OF MIRROR FRAME  
USE MIRROR SUITABLE FOR THIS  
SIZE FRAME BORE HOLES AT X TO  
SUIT USE R H SCREWS AND WASHERS



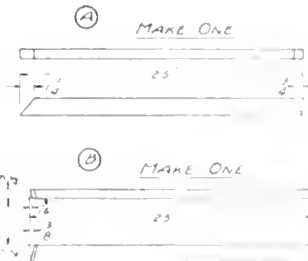
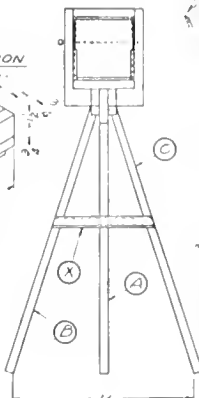
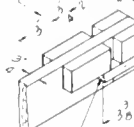
DETAIL OF SHUTTER AND FRAME



CLEAT  
 $\frac{1}{2} \times \frac{1}{4} \times 1 \frac{1}{2}$   
TIN SHUTTER  
 $5 \frac{1}{2} \times 5 \frac{1}{2}$   
 $\frac{1}{4}$  DIA X  $1 \frac{1}{2}$   
CLEAT  
 $\frac{1}{4} \times \frac{1}{4} \times 2 \frac{3}{4}$



RIGHT END CONSTRUCTION



TO CUT NOTCHES IN  
B AND C FOR X, LAY B AND C  
ON FLOOR, PLACE X IN POSITION  
AND MARK X IS 14 FROM BOTTOM

PART C IS SAME SIZE  
AS B BUT UPPER END IS  
CUT JUST OPPOSITE

### GROUND SCRATCHER

This ground scratcher will be found very convenient for those having small gardens. The project is also a good one to make for the practice gained in laying out an irregular shaped object from dimensions given.

The pattern might be laid out on, and cut from a piece of cardboard and then traced on the wood. Plane up a piece of wood to the required thickness and on it trace the pattern. Use a coping saw to cut to form and finish with a file and sandpaper.

Bore a hole in the handle. Bore from both sides so the wood around the hole will not split out. Locate the points at which to drive the brads or scratchers and drive at about

the angle indicated. If the angle at which the brad comes through does not look right it can be bent to suit with a pair of pliers.

Make the thin cap that covers the heads of the brads. This is necessary to keep the brads from working loose and pushing up through the handle. The cap may be bradded in place, but it is suggested that holes be bored and it be fastened to the handle with small round-head screws. Trace the cap from the first part made so it will be exactly the same shape.

With sandpaper round all edges nicely, especially the handle, so the sharp corners will not bother the user while working.



### CHILD'S SNOW SHOVEL

Any material will do for the snow shovel. It is to be painted, so work in any scrap pieces.

Part D should be made of one piece if possible, but two pieces may be used. The strip across the back and metal piece across the front edge will help hold the parts together. Plane part D to size and chamfer front edge as indicated on the drawing of part D.

Make part C next. Note on the drawing that the corners are cut and a cut-out made for the handle. Fasten part C

to D with screws. Bore holes and countersink them, as flat-head screws are to be used.

Now make the handle. It is composed of two parts, A and B. Fasten A to B with one screw and two finishing nails. Also fasten B to C and D with screws.

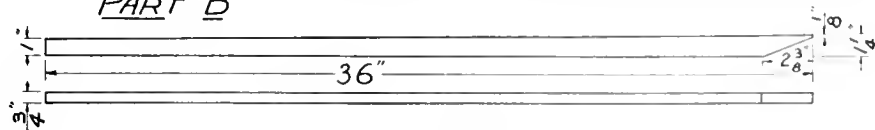
Paint D and front face of C black, the rest of C and the handle red.

Cut a strip of galvanized iron or heavy tin, bend and tack over the edge of D.

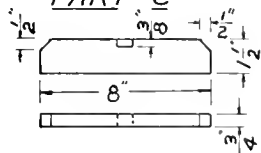


# CHILD'S SNOW SHOVEL

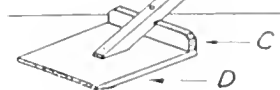
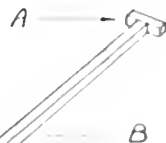
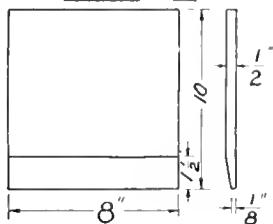
PART B



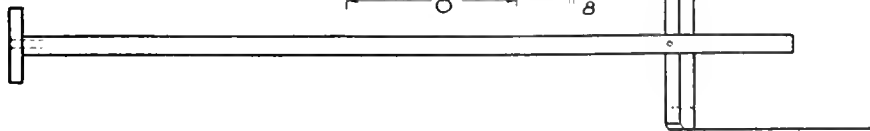
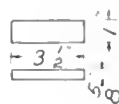
PART C



PART D



PART A



Paint D and front face of C black, the rest of C and handle red.

## KITES

The making of kites like boat making requires considerable personal experimenting to make them perform as desired.

These drawings show a few of the most common kites. The double dotted lines represent the kite sticks and the single dotted lines the string which is stretched from stick to stick and holds them in position. The string is also used to strengthen the paper which is pasted over it.

The first kite is called by boys a two sticker and, like the three sticker, requires a tail. It is impossible to say how long or how heavy the tail must be. It should be just heavy enough so the kite will not dive. The tail can be made of strips of cloth tied together.

A bridle or belly band may vary in length on different kites, but this will have to be adjusted when the trial flight is made.

Sticks for kites can be made from a straight grained cedar post. They will be very light and will bend considerable without breaking. Other light wood will do for the

sticks. To make the sticks from a post split off thin strips with an axe and then plane to size.

Fasten the sticks together where they cross with a fine brad or cigar box nail and bind with waxed cord.

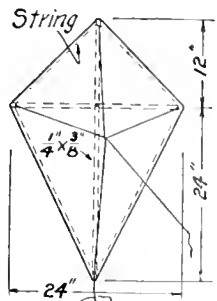
Bend the cross stick of the bow kite as shown at the 6" dimension on the drawing and hold in this position with a piece of fish line. It is great sport to fly three of these kites at one time, although it takes some skill to get them up and a very strong line to hold them.

Kites like the four-stick in the drawing have always won the height contests and are not difficult to make. Cover this kite with linen cloth or tracing cloth.

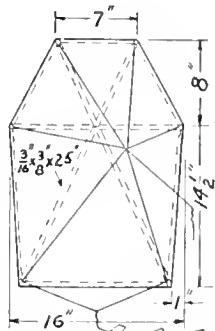
Box kites are also easy to make. The cross sticks can be half lapped or fastened in other ways as the maker may wish.

The best material for covering kites is tracing cloth, heavy colored tissue paper or cloth that will not allow the wind to blow through it. A cooked flour and water paste is as good as any.

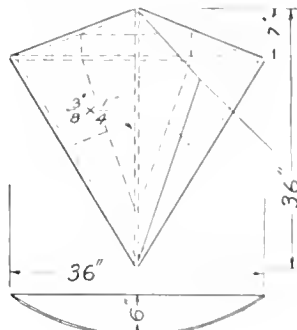
# KITES



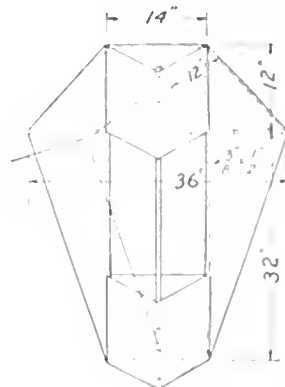
**TWO STICK**



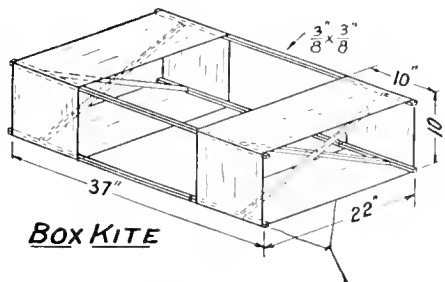
**THREE STICK**



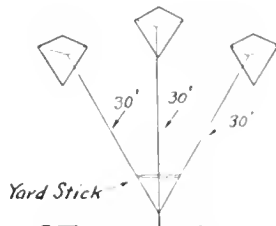
**TWO STICK BOW**  
No tail



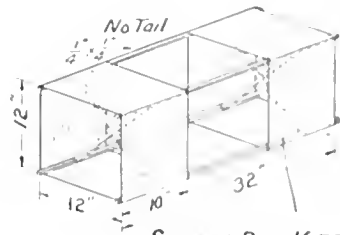
**FOUR STICK**



**BOX KITE**



**3 TWO STICK BOW KITES**



**SQUARE BOX KITE**

## PUZZLES

The first drawing shows "THE MYSTERIOUS STRING PUZZLE." Pull one end and the string is white; pull the other and it is red. A sectional view shows the object cut through the center and one part removed, exposing the interior.

Get out a piece of soft wood and bore a  $\frac{1}{2}$ " hole along the entire length. Augur bits work hard in end grain, so use soft wood. Make a plug to fit the hole from the same wood. It should be made longer than the piece desired so it can be sawed off after being put in place. After sawing, if the plug is still evident it may be concealed by pounding or battering the end with a hammer or paint the whole piece.

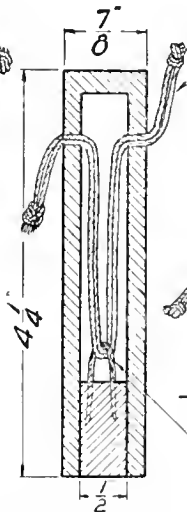
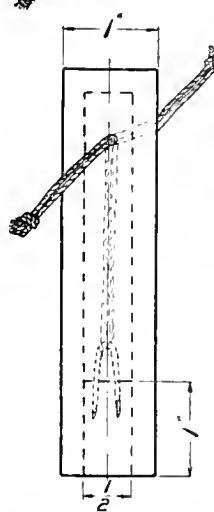
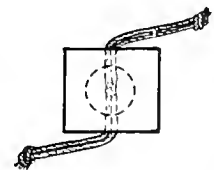
Bore a  $\frac{1}{8}$ " hole crosswise of the piece. Thread a piece of heavy chalk line through the holes—straight across—reach up in the large hole with a crochet hook and draw the cord

down through the hole. Drive a staple in one end of the plug after the cord is placed in position with reference to the staple. Insert the plug into the hole to a depth of 1" and saw flush with the end. Pull ends of string up tight.

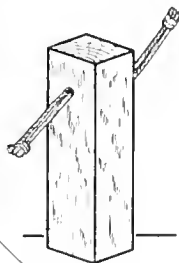
Tie a knot in one end of the cord and color it red for a distance of about 4". Pull the other end of the cord, drawing the red end in as far as the knot will permit. Cut this end off to the same length as the other and tie a knot. Leave this end white.

The other puzzle is rather difficult to solve. Make the piece as shown and tie the buttons in place. Ordinary knots are used at the end, but in the middle the string should be fastened as indicated at A. The object is to get both buttons on one side without untying the end knots.

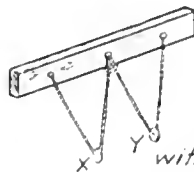
# PUZZLES.



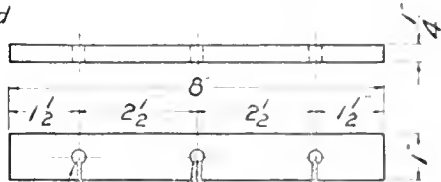
Chalk Line.  
Color one end.  
Leave other end  
white.



Staple



OBJECT—  
To get button  
X on same  
side as Y  
without untierna  
the knots.



1/4 Bore  
3 Holes



Enlarged  
view  
at A



### TRENCH MORTAR

Boys, here is a Fourth of July cannon that will do everything a war cannon will do except kill people. It will boom, shoot a projectile, belch forth flame and smoke and recoil if set on a smooth surface when fired. There is no danger connected with it and it makes the shooting of firecrackers safe. The little folks may use this project as a toy after it has been used for celebrating the Fourth.

Make A the floor and screw wheels in place. Wheels may be cut from a piece of broom handle. Or wooden button molds may be used. Button molds make ideal wheels as they are already bored.

Next make the carriage and fasten to A. Use 1" brads for assembling.

Now make the barrel. Square stock to size and draw diagonals to locate the center. With dividers or pencil compass from the center just located at the muzzle, draw a  $\frac{3}{4}$ " circle. Then bore a  $\frac{3}{4}$ " hole about 1 inch deep in the breach of the barrel. Remove the bit and bore through the barrel

from the muzzle till the holes meet. Use a rat tail file or sandpaper on a pencil to smooth hole.

Draw a line around the barrel two inches from the breach and from this line plane or whittle the barrel round to the  $\frac{3}{4}$ " circle. Chamfer the breach end and fasten the barrel in place with  $\frac{3}{4}$ " No. 7 round-head screws.

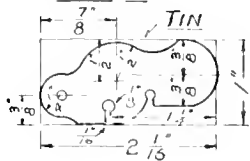
Cut a piece from a tin can and on it lay out part E as detailed. Cut after boring holes and finish with a file. Fasten to end of barrel with  $\frac{1}{4}$ " No. 1 round-head screws or cigar box nails.

Disassemble all parts except the mounting and paint as indicated. Drive a staple or screw a screw eye in the front of part A for a string.

Open the breach by raising the tin, insert a firecracker, leaving the fuse projecting through the hole in the tin. Light the fuse and watch the firecracker, smoke and fire shoot from the muzzle of the gun.

# TRENCH MORTAR

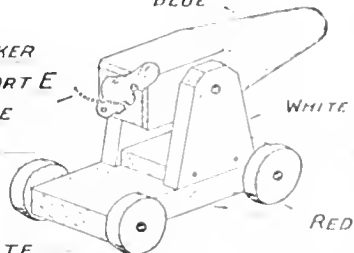
PART-E



NOTE —

PLACE FIRECRACKER  
IN BARREL FASTEN PART E  
LIGHT FUSE

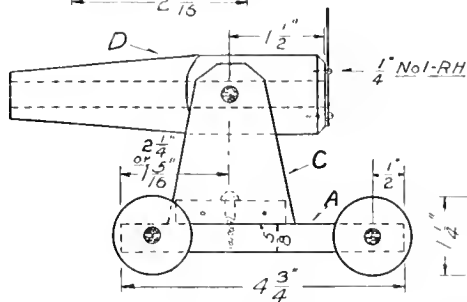
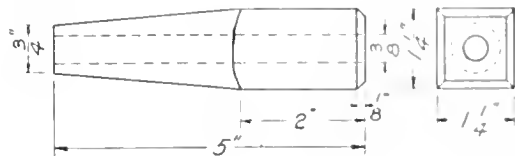
BLUE



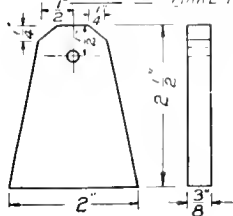
NOTE

CAMOUFLAGE BY COMBINING THE COLORS  
PLACE WASHERS BETWEEN MOVABLE  
PARTS.

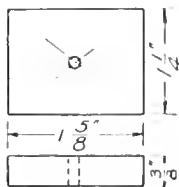
PART D



PART C MAKE TWO



PART B



### STRADDLE HORSE

As the whole of this toy is to be painted, most any kind of wood may be used.

Work might be started on the head. Square up an edge and one end of the piece from which you are going to make it. Draw the squares with the try square from these surfaces. Lay out pattern and bore hole for D. Next lay out patterns for C—the saddle—and saw to shape.

Make part B. In boring hole for axle F, lay out on each edge of B and bore from each edge. In boring from each edge, the error, if any, is greatly reduced. Now make wheel A, bore for axle from each side of piece. The outside of the wheel should be made true. Describe a circle on the stock with a sharp pair of dividers, scoring rather deeply; use this line to work to.

The axle F is one-half inch in diameter. The hole for the axle is also one-half inch in diameter, and to make the wheel turn easily on the axle sand the axle slightly in the middle.

Sand all pieces well. Fasten D and C in place, then fasten E to C with flat-head screws, and to B with round-head.

Before placing wheel in position, paint the parts. A scheme for painting is given on the drawing. Two coats of paint will be necessary to give the horse the real finished appearance, but before giving the second coat, place the wheel in position and paint it fully assembled.

Use washers as indicated, and be sure the wheel turns easily.





### THE BAG PUNCHER

The first piece of this toy to make is the base. Select a good straight grained piece of soft pine. After planing to size lay out the mortise with a marking gage and knife, cut with a chisel.

Drill holes for the wire support to hold the bag. Drill these holes on a line  $1\frac{3}{4}$ " from the end of the piece.

Square up piece for the man and draw squares through which to trace the form of the man. Prepare a piece in the same manner for the arms. Now saw to line with a coping saw and finish with sandpaper. If you are not accustomed to reading drawings, take note of the dotted lines projecting from the forward foot of the man. This indicates that about  $\frac{3}{8}$ " of material is to be left here.

Make a saw cut for the end of the spring or corset stay. Also bore a hole at A for a brad.

Carve out an egg shaped piece of wood for the punching bag with a knife and drive a staple in the top end. Now

with a pair of pliers form from a piece of wire about 12" long the bag support.

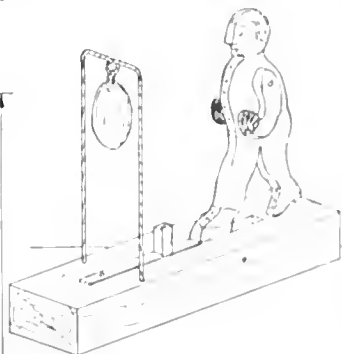
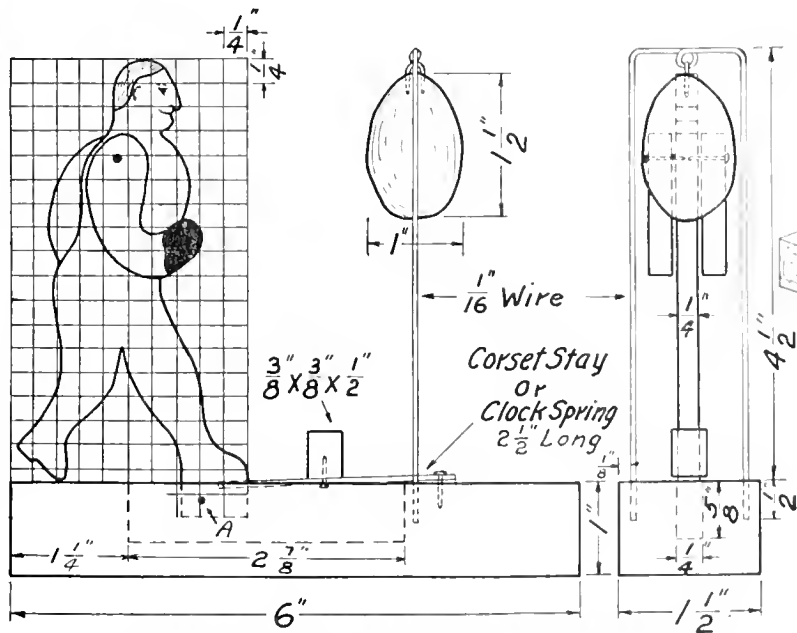
The spring is to be made from a corset stay or piece of clock spring. Punch two holes in it, one to fasten to the bottom block and the other for the block to operate the toy.

Paint the parts as desired. The bottom might be gray, the trousers red, the shirt white, the gloves black and the bag brown.

After the paint has thoroughly dried, assemble the parts. Fasten the arms to the body with cigar box nails. The arms must swing freely. As the body is so thin, the arms should be fastened one a little above the other so the nail points will not touch.

Place the foot in the mortise and fasten with a long brad. Put one end of the spring in the saw kerf in the foot. Fasten the other end to the bottom piece with a cigar box nail. Set the bag support in place and operate by pressing on the little block fastened to the spring.

# THE BAG PUNCHER



### LOW FOLDING TABLE

This table is convenient, as the legs can be folded so the table requires little space for storing. It is just the proper height for a typewriter, and also for playing games that do not require too large a surface.

The top may be made of one piece or of several pieces glued together. In the latter case the edges should be well jointed. Dowel pins may be used, but are not necessary, as the parts D act as cleats.

Make two pieces like part D of hard wood. Plane the boards and lay out the design. Bore  $\frac{1}{2}$ -inch holes as indicated on the drawing of this part and cut to line with a rip saw.

Fasten these pieces to the top with screws. The end view drawing shows the method of boring for the screws, using a  $\frac{1}{2}$ " bit and 3-16" drill. The screw should be of such gage that it will slip through the 3-16" hole easily.

Make parts A, B and C next. The drawings show them square, but this is not necessary. Round pieces of broom

handle might be used. Cut each piece to the proper length and with a saw, knife and wood rasp work the ends round to a diameter of  $\frac{1}{2}$ ". A turning lathe or dowel cutter may be used for forming the ends on these pieces.

The legs should be made of oak or other hard wood. They are practically the same, except that legs N have one end rounded and the holes for the spreaders are one inch farther apart.

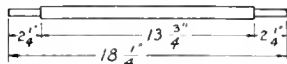
Fasten the legs to the ends of A, B and C with brads or round head screws, but note that legs M are not fastened to C. If you make the mistake of fastening them your table will not fold.

All tenons must fit the holes. If they are too small the table will not stand rigidly when being used.

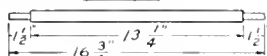
After assembling, sandpaper well, breaking all sharp edges. Paint bright red or finish otherwise.

# LOW FOLDING TABLE

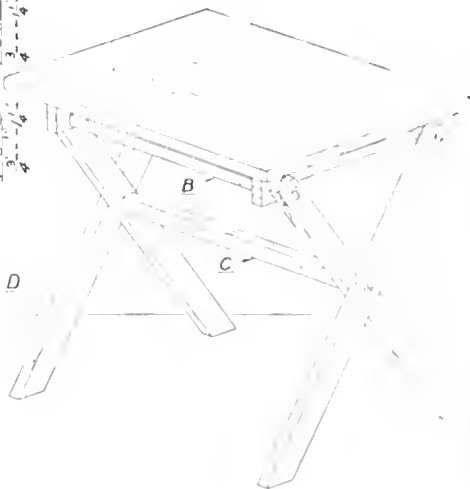
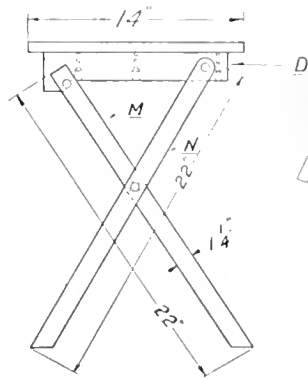
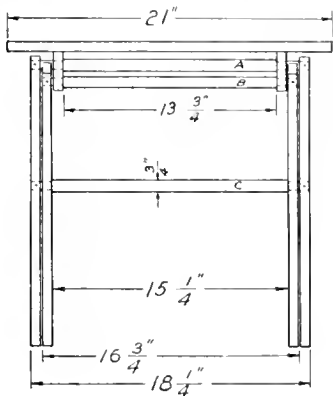
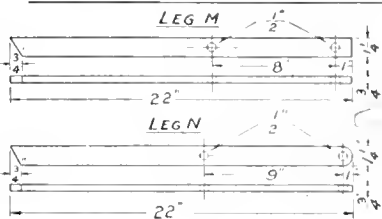
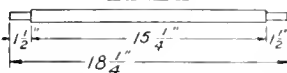
*PART A*



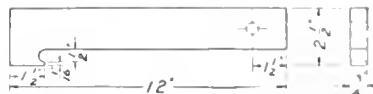
*PART B*



*PART C*



*PART D*



### LETTER RACK

This letter rack will be found very handy on any desk or table. It need not necessarily be used for letters, it is convenient for holding post cards or kodak pictures.

Begin work on the bottom piece first because if you make a mistake on this part it can be used for one of the smaller pieces. After planing to size, draw center line and locate screw holes. Lay out curves at corners with compass and pare to line with a chisel. Bore and countersink holes for screws.

Make partition next, and if it is spoiled it may be used for a side piece. Note that only two corners are rounded on all parts except the bottom piece.

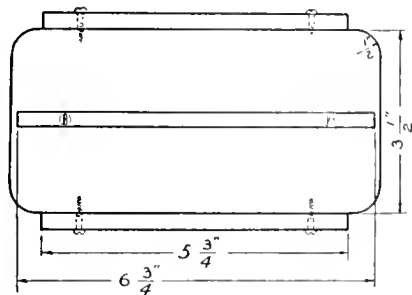
Now make the side pieces and then assemble all parts. Be sure to bore holes for the screws, otherwise the screws will split these thin pieces. Round-head screws are used for the side pieces, so do not countersink the holes for them.

To locate the side pieces on the bottom piece. Draw a line bisecting the center line on the bottom piece. Draw center lines across the bottom edges of the side pieces and hold the parts so these lines meet. With a marking awl, mark through the hole in the side piece the location on the bottom piece for boring for the screw.

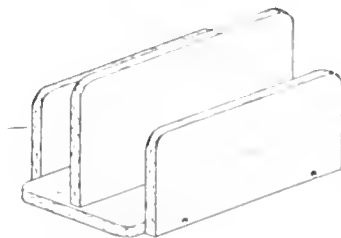
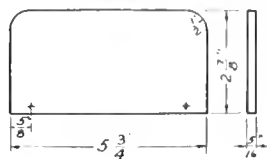
Remove all screws and sandpaper off all scratches and pencil marks. To obtain a good job of sanding put a few drops of oil on the sandpaper.

If gum wood is used it may be stained and given a shellac or French polish; or the piece may be oiled, with boiled linseed oil, thinned with a little turpentine. Give two coats of oil, allowing each to dry for twenty-four hours before applying the next, then finish with wax or merely by rubbing to a polish.

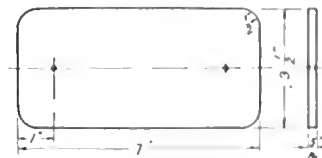
# LETTER RACK



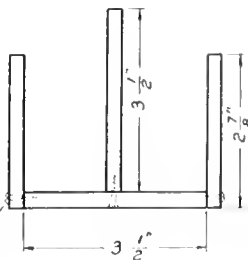
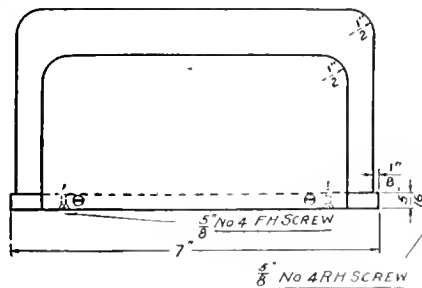
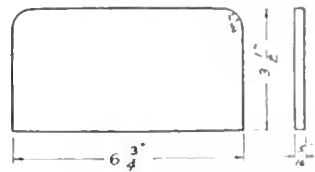
SIDE



BOTTOM



PARTITION



### SILHOUETTE CAMERA

A silhouette is an outline or profile filled in with black. Some persons can cut profiles of people or objects from paper. This work is very amusing and interesting but requires patient practice. With the silhouette camera good results can be produced with little practice.

Start work by making the bottom board, according to dimensions. Make the back or picture plane 8"x8".

The pedestal or 4" piece is for supporting the marking rod. The top edge of the pedestal should be chamfered to allow the marking rod to move up and down freely.

Three braces are needed to stiffen the picture plane and pedestal, which must be made very rigid in order that the device will work well. Fasten the parts together with glue and screws.

The marking rod can be made from a round or square piece. In one end a hole is drilled about 2" deep for a piece of wire. The size of the hole will depend on the size of wire used. If you do not have a drill the size you want, make a drill point from a piece of the wire. In the other end of the

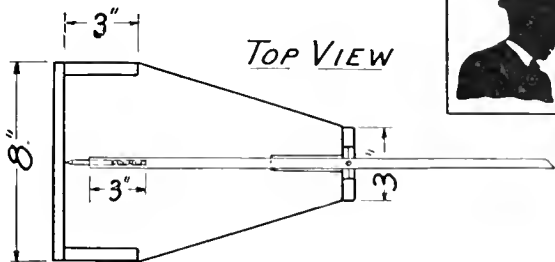
rod drill a hole to fit a pencil, which must not stick in the hole, nor move about, but must be a sliding fit. A spring is to be inserted in the hole behind the pencil. One may be made by winding a piece of spring wire around a peg smaller than the hole. As the distance from the top of the pedestal to the plane varies during the motion of the rod the spring is necessary to keep the pencil point continuously against the plane. Fasten the rod to the pedestal as indicated, giving it a free up, down and sideway motion.

To operate fasten a sheet of paper to the plane with thumb tacks, clamp or hold camera firmly to the table. Seat person in chair so wire can be passed around profile, move wire slowly, touching every depression.

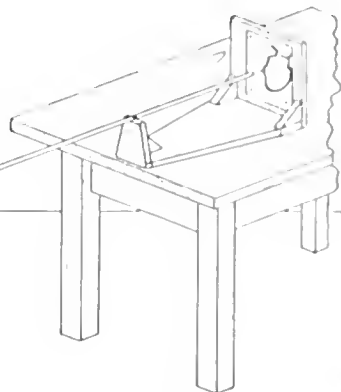
It will be noted that the outline is made upside down. Remove paper from plane, paste a piece of black tissue paper on opposite side from outline. Cut to profile line with scissors and paste on a piece of white mount cardboard. Removing a section of black paper with sharp knife gives appearance of a collar.



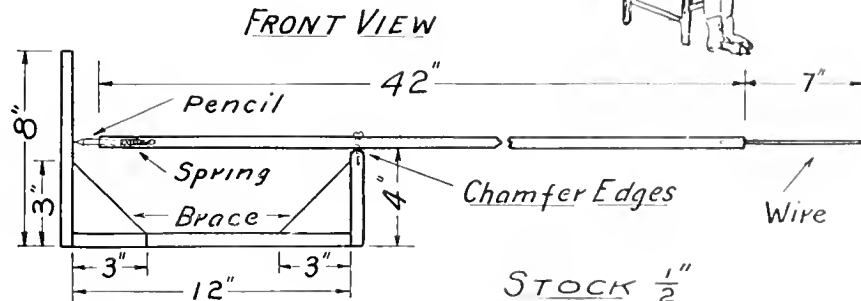
# SILHOUETTE CAMERA



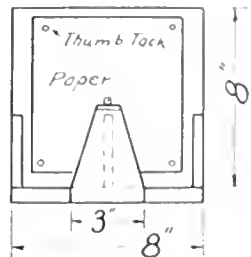
TOP VIEW



END VIEW



STOCK  $\frac{1}{2}$ "



### SEWING COMPANION

Any mother or sister will appreciate this sewing companion. It is a great convenience, made to hold a thimble, several spools of thread and a few needles and pins. Use gum, mahogany, or walnut.

For the bottom plane up a piece  $5\frac{1}{8} \times 3\frac{1}{2} \times 7$ ". When planing, mark working face and edge and make all layouts from these surfaces. Draw the center lines, locate holes for pegs or dowel pins and bore them; also a  $3\text{-}16$ " hole for the screw to fasten part A. Lay out the depression for the needles and pins and work out with a gouge; finish with sandpaper.

Draw the curved lines for cutting the ends and at the same time the  $\frac{1}{4}$ " chamfer. Saw to line with a coping saw, finish with a spoke shave and sandpaper. Never lay out a chamfer or bevel with anything but a pencil. Use a plane for cutting the chamfer. It is convenient to hold the work in a wooden hand screw while removing the stock.

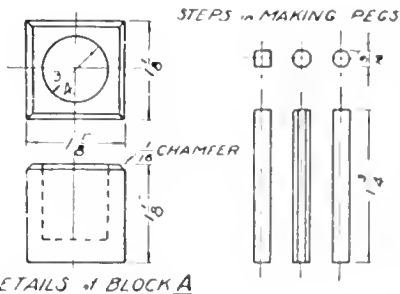
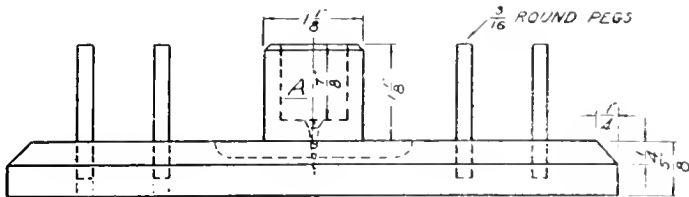
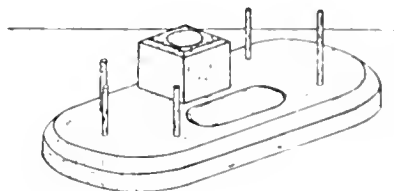
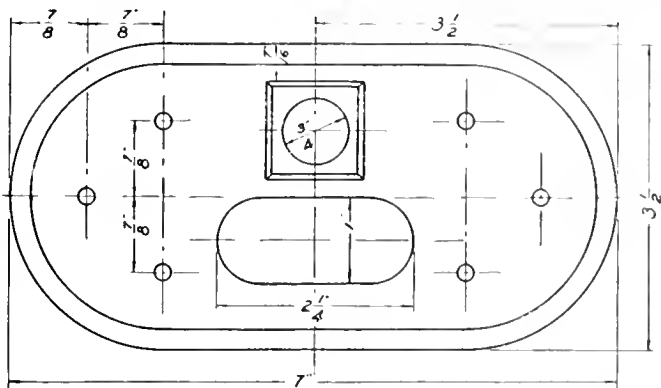
Make block A to hold the thimble. A peg may be mortised into the bottom on which to hang the thimble but the block is more convenient. The thimble can be put in the hole or taken out, as it is dropped in upside down, with one hand while the other is occupied holding other work. The sides of the block can be slanted, forming a truncated pyramid.

Make dowels of same kind of wood. First plane a piece square, then plane off the corners, making it octagonal. Continue planing corners until the piece is round. Bore a  $3\text{-}16$ " hole in a piece of hard wood, if you have not a dowel plate with a hole this size, and drive the round stick through it, smoothing the edges. Cut to length and round end so spool will slip on easily.

Sandpaper all parts with 00 sandpaper and assemble. Put a drop of glue on the end of each peg. If any glue runs over on the bottom piece wipe it off with a damp cloth.

Finish by rubbing with boiled linseed oil, or stain, shellac and wax.

# SEWING COMPANION



### ORNAMENTAL GARDEN STICKS

The use of these garden sticks will add a touch to your flower box or to your flower bed in the yard and will be very interesting to you.

No difficulty will be found in making them. The hardest part is in getting good looking outlines of the birds, and also to get them colored attractively. The designs submitted here are only suggestive. The same may be said of the colors.

Choose the design that best suits you. Select the wood from which the stick is to be made and upon it lay out  $\frac{1}{2}$ -inch squares. Through these squares trace the outline of the bird, being careful that the lines pass through your squares in the same relative position that they pass through the squares of the drawing.

It will be well to bore the hole for the supporting rod before the bird is cut to shape. Be very careful with this

latter operation. No matter how carefully you have traced your outline, if the cutting is not done with equal care, the result of your efforts will not be satisfactory.

Smooth the piece with sandpaper and fasten the upright in place. This latter is to be of a length suitable for the place in which the stick is to be used. For instance, if it is to be used in a flower box, it should be shorter than if it is to be used in the flower bed in the garden.

Paint the bird just as well as you can. It is not necessary to use the colors suggested. If you have different or better ideas, put them into effect.

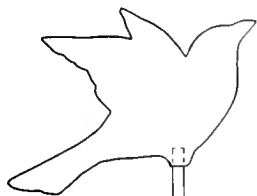
Remember that you can spoil a good job of construction work by a poor job of painting. In other words, there is no place in the making of these sticks that will permit of careless work.

# ORNAMENTAL GARDEN STICKS.

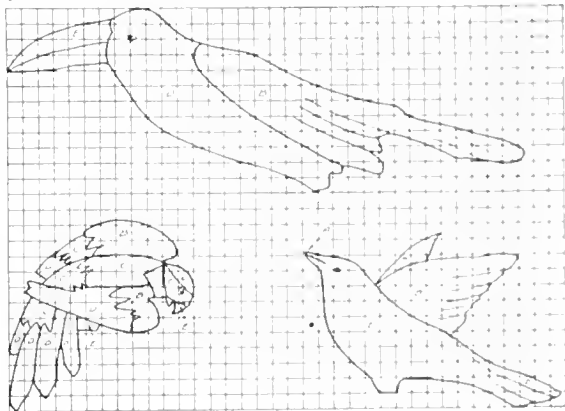
PAINTING SUGGESTIONS

- A - BLACK
- B - BLUE
- C - GREEN
- D - RED
- E - YELLOW

USE BLACK FOR STRIPING  
BETWEEN COLORS



$\frac{3}{8}$  DIAMETER  
LENGTH  
TO SUIT.



### MOUSE TRAP

This simple trap has a bottom, two sides and a door, with a tin can fastened to the bottom between the two sides.

The door is made as shown in the drawing and hinged to sides by two  $\frac{3}{4}$ " brads. The door stop is fastened to the door 1-16" from bottom, with 1-inch brads driven through stop and door and clinched on inside of the latter. A screw eye is screwed into one end of the door stop, another about 1 $\frac{1}{2}$ " from the back of one side, and a rubber band stretched between. This acts as a spring and closes the door when the hook is released by the mouse pulling at the bait. The hook driven in the top of the door is made as follows: Drive a 1 $\frac{1}{2}$ " No. 18 brad in place, cut off the head with a pair of pliers or file, and with the pliers bend as shown.

The information for making bottom and sides can be easily learned from the drawing. Assemble with 1-inch brads.

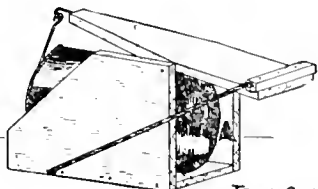
The can used for this trap was a baking powder can, and to fit the dimensions given, must be three inches in diameter

and five inches deep. If you wish to use a larger can, increase the dimensions of the other parts of the trap accordingly.

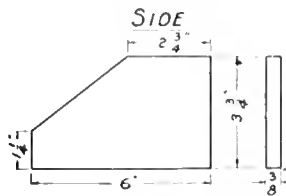
Fasten can to trap by brads driven through floor and can stop, through the can, and clinched inside the can. The can stop is to be fastened to the floor with  $\frac{3}{4}$ " brads.

The bait hook is made of heavy wire, formed as shown. Use pliers to hold wire while bending. Make a hole in the bottom of the can for the bait hook with a wire nail a little larger gage than the wire. The door can be made to close from the slightest touch on the bait hook if the hook driven into the top of the door is adjusted at just the right angle. If a piece of tin is tacked on the door directly in front of the can opening, the mouse will not be able to gnaw his way out through the wood door. A boy who understands how to wire an electric bell can connect one to the trap so he will be notified when the mouse is caught.

# MOUSE TRAP

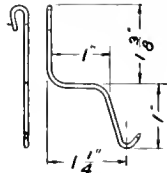


TRAP OPEN

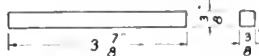


TRAP CLOSED

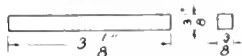
WIRE HOOK



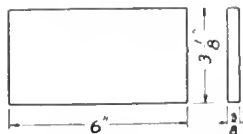
DOOR STOP



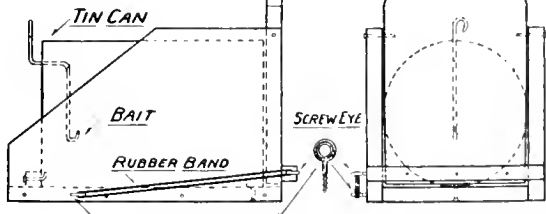
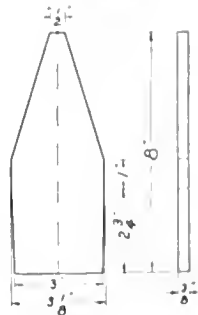
CAN STOP



BOTTOM



DOOR



### BOY'S HANDY WAGON

Any good wood may be used for this project. If you have a choice, use hard wood for the wheels, holsters and axles.

Make the box first. Be sure to get all your corners square. Assemble with sixpenny common nails. Mark center for the hole to be bored for carriage bolt, but leave the boring until other holes of same size are to be bored.

Next get out the holsters and axles, marking the centers of the holes. Part C will require careful work in laying out. Bore hole for the carriage bolt before cutting the tongue groove.

Make the tongue next and mark locations for holes to be bored. The next step can well be the boring of the various holes, the locations for which you have already made. Holes that go clear through a piece should be laid out and bored from both sides. In boring for screws, remember that two sizes should be made—one for shank of screw and the other for diameter at bottom of threads.

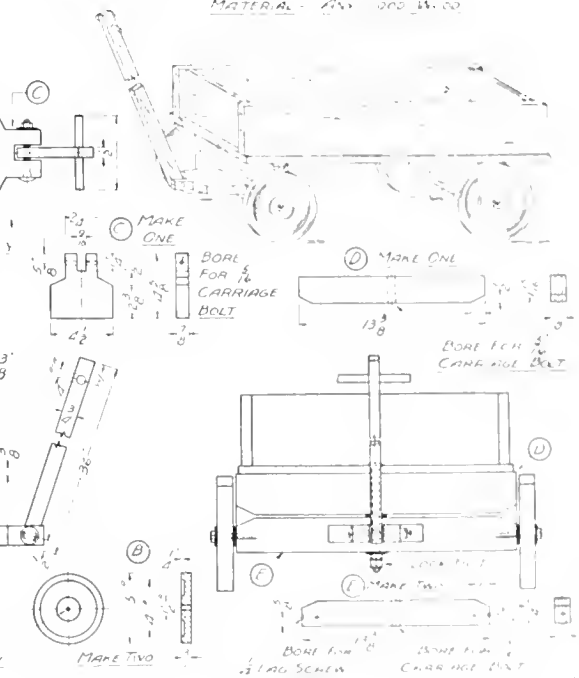
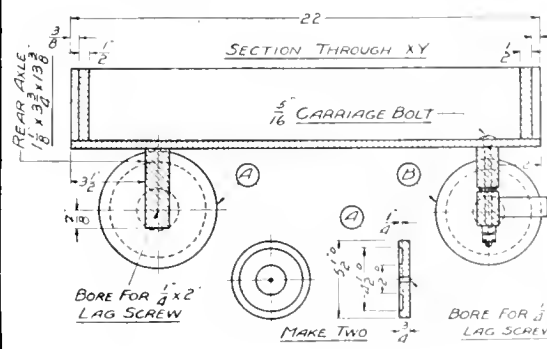
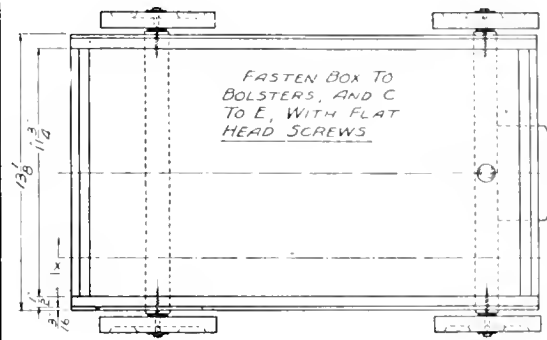
The hardest part of the construction will be the making of the wheels. If you have access to a turning lathe, the work will be easy. Wheels formed according to the drawing look better than those with flat surfaces, but if they cannot be made that way, make them flat. If lathe and band saw are not available, lay out with a pair of sharp dividers, scoring deeply. Saw as near the line as possible, finishing with a rasp. The wheels may be hollowed out with a gouge. Just a bit of patience and care is all that is required. When all parts are made, assemble and test for proper fitting. Take apart and sand well. The painting may be done before or after the parts are finally put together. Sometimes it is more convenient to paint each piece separately.

Give considerable thought to the color scheme you will use. It is not recommended that you use a great many different colors, but your cart will look better if you use at least two. This gives a nice contrast. No color scheme is suggested, as tastes vary a great deal, so this part of the work is left to each individual to solve to his own satisfaction.



# BOYS HANDY WAGON.

MATERIAL - ONE 200 LB. BOX



### TRAVELER'S CASE

The material for this case should be a very good quality of wood. Walnut is very attractive and is recommended for use if it is possible for you to secure it. The application of linseed oil and later a thin coat of shellac, rubbed down with very fine sandpaper, will give a very pleasing finish.

An examination of the drawing will show that the front part of the box is not parallel with the back part. The ends are square with the back, but the front makes a small angle with them. It will require careful work to get good joints, and the attractiveness of the box is dependent upon the quality of your work.

From the drawing it will be seen that the bottom is  $\frac{1}{4}$ " thick, 1 $\frac{1}{2}$ " wide at one end and 1 $\frac{5}{8}$ " wide at the other, and 7" long. The ends are square with the back edge. Reduce this piece to the required dimensions, and then the side pieces, front and back. It will be well to fasten these pieces temporarily in place in order to fit the end pieces. The dimensions for these latter pieces, and for the partition A, are given

slightly oversize in order that you may have a small margin for fitting. Fit them very carefully, remembering the caution given above regarding the attractiveness of the box. Part C will also have to be fitted with care, and to assist you, the dimensions shown are slightly larger on one side. The hole in this part is cut on a slant to give the thimble a better support. No special suggestions are needed with regard to this piece, or with any of the remaining pieces that go to make up the case.

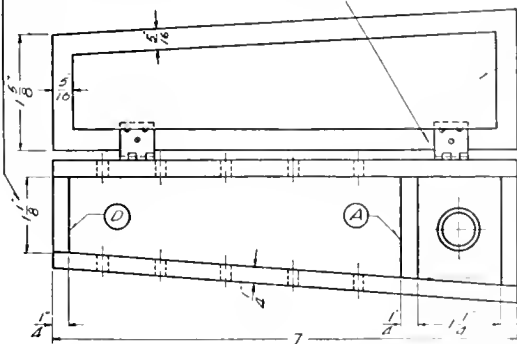
Small hinges are used between the box and the cover, and as the material is so thin, a hinge should be selected that can be fastened in the manner shown on the drawing.

A piece of cardboard covered with velvet and glued to the cover provides the means for holding the scissors and needles.

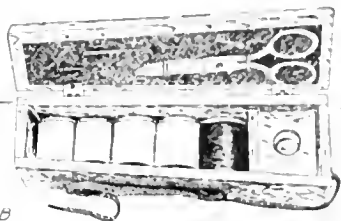
The thread is held in accordance with the explanation given in the note—the small spool at the left end and the others placed in the order of their size.

# TRAVELER'S CASE.

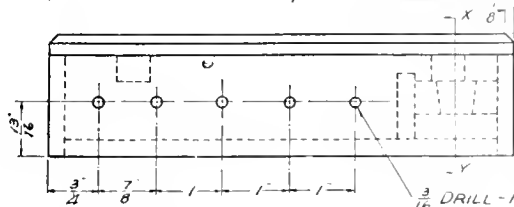
CUT TO THIS DIMENSION FOR D,  
THEN PLANE BEVEL TO FIT HINGE



CARDBOARD  
COVERED WITH  
VELVET AND  
GLUED TO  
COVER



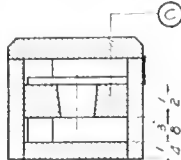
CUT TO  
THESE  
DIMENSIONS  
FOR A AND B.  
THEN PLANE  
BEVEL TO FIT



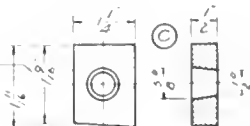
TOP VIEW SHOWS COVER  
TURNED BACK

STARTING AT LEFT END OF  
BOX, PLACE 100, 80, 60 AND 50 COTTON, AND 50 BLACK, IN THAT ORDER

SECTION ON XY



CUT TO THESE  
DIMENSIONS,  
THEN PLANE  
TO FIT



SPOOLS ARE HELD IN  
POSITION BY MEANS OF  
A SILK SHOE STRING  
OR RIBBON THREADED  
THROUGH THEM AND THE  
HOLES IN THE BOX. THE  
COVER IS HELD CLOSED  
BY TYING ENDS OF  
RIBBON AROUND BOX

## HALLOWE'EN FUN MAKERS

Figure 1 shows a spool tick-tack, made by cutting notches on ends of a spool. Fasten to a handle about two feet long. Tie one end of string to spool and wind the rest around it. Hold handle in left hand and end of string in right. Press edges of spool against window pane and pull string, causing spool to revolve, thus making desired disturbance.

Another type is shown in Figure 5. It is fastened to window pane by wetting and pressing against it. The rubber disk can be obtained by breaking neck of old style pop bottle and slipping it off the closing fixture. Use any flat-head screw. Fasten to window pane, then jerk knots between first finger and thumb nail.

Figures 3 and 4 are lanterns, made of paper shoe boxes and tin cans or paint pails. Paste colored paper over nose, mouth and eyes, so candle cannot be seen. Punch holes on back, sides, top or bottom, otherwise candle will soon burn out. Figure 3 shows a method of keeping cover on box and also how to make an eye wink by making a shutter from card board, a rubber band, a paper fastener and a piece of string.

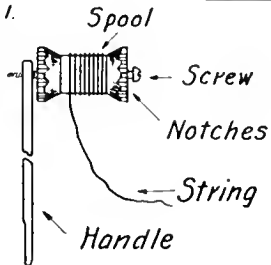
For Figure 6 take a shingle nail and drive through bottom of can at center. Tie a piece of string three feet long to nail. Thread other end through hole from inside of can. Tie knots near end of string and rub rosin into it. Hold can in left hand and draw knots through thumb and first finger.

Figure 7 is the snake trick. Use an old stocking stuffed with grass, and a piece of strong twine. Throw over limb of a tree and drop from above, or draw across sidewalk.

Prepare for Figure 2 before dark. Drive a nail in top of window frame. Tie a piece of black thread to nail, and a button on thread about 18" from nail. After dark climb up in a tree with thread in hand. Let button swing against window. If anyone opens window, draw button up out of sight. The horseshoe nail trick is worked the same as Figure 6, only a longer and stronger cord is required. The end of horseshoe nail is slipped under the edge of clapboard on house, and if plenty of rosin is rubbed on cord, the owner will soon think every board is being ripped from his house.

# HALLOWE'EN FUN MAKERS

Fig 1.



Pumpkin



Rubber Bottle Stopper

Knots



Can

Rosin & Knots

Fig 2.

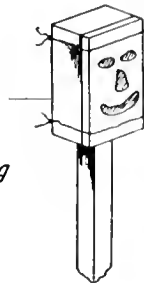
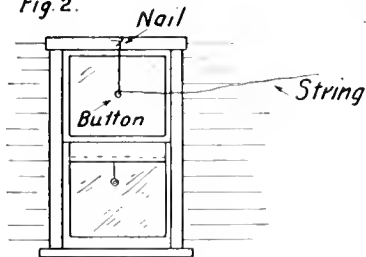


Fig 3



Paint Pail

Fig 4.

Horse Shoe Nail  
String  
Rosin and Knots

Fig 5



Stocking

Fig 7

### WIND MILL AND ACROBAT

A common ten-cent steel saw, a file and a good sharp jack knife are all the tools required to make this toy.

Select two straight grained pieces for the blades. Lay out with a pencil, and after cutting the half lap joints, form the blades to shape indicated. Fasten together with brads, and also brad a block on the back of mill for the small pulley. Drill a small hole at center of mill for a nail or a screw. The hole should be large enough to permit the mill to turn freely. An empty buttonhole twist spool may be used for the pulley, or it can be made. With a jack-knife make grooves for the belt, then fasten to the block. Next make the vane and the piece that holds it. Fasten together with brads.

Make the parts that hold the pulley shaft in place, but do not fasten in position until the shaft is made and fitted to them. The shaft will require careful and accurate work with the knife.

Work out large pulley and make the hole in it such a size that it will make a press fit on the shaft. Assemble parts

just made and fasten in place so pulleys are in line; that is, one exactly above the other.

Make the parts for the man next. These may be made from cigar boxes if desired. Lay off squares and trace in the patterns. Cut to shape with coping saw and fasten together with wire or long bank pins. The parts should fit loosely.

After assembling all parts, mount on the upright piece at the point of balance. A rubber band will make a good belt for the pulleys, as the rain will not affect it. If necessary to use cotton string, rub beeswax or paraffine on it.

All the bearings should be well oiled to produce good action and do away with as much friction as possible. The parts can be painted to suit, but be careful that no paint gets between any of the moving parts.

Mount windmill on the peak of a shed or top of any post that is located out in the open so the wind can get a good chance to turn the blades. The antics will be highly amusing to your friends and to yourself.



### PIN AND BALL GAME

Use any wood you have at your disposal, but get as straight grained wood for the uprights as you can.

Make the base first. The mortises should be laid out and cut from both sides of the piece. Unless this method is followed the mortises will not be straight through.

Parts B are not hard to make. The tenons cut on these pieces are to fit the mortises in A, so lay out and cut them accordingly.

Part C is always easy to make. In laying out all these pieces thus far, remember that they should be laid out according to the way the dimensions read on the drawing; that is, from the center of the piece.

The hardest part of the construction will be the making of the pin. If you have a turning lathe, the job will be very easy, but as most boys do not have one available, it will have to be fashioned by other means. It will not be difficult to plane a piece to  $1\frac{1}{2}$  inches in diameter. On a piece the

required length, describe two  $1\frac{1}{2}$ " circles, one on each end. Also on one end, with same center, describe a circle 1 inch in diameter. Plane off the stock until you have a cylinder  $1\frac{1}{2}$  inches diameter. From this step it will be necessary to work with a good sharp knife. Good work can be accomplished by combining a little patience and care.

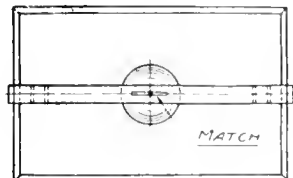
Sand well and assemble. Place uprights in mortises and fasten C to the tops by means of brads. The piece may be stained or painted as desired.

The ball to be used may be a rubber or a wooden one. Insert a screw eye as shown, and adjust string to such a length that the ball will strike the round top of the pin about in the center.

It will very likely seem easy to knock the pin over with the ball, and no doubt it would be easy if the aim was to knock it over on the forward swing. But that is not the idea. The ball is to be drawn toward you, then released so the pin is knocked down on the return swing. Try it.

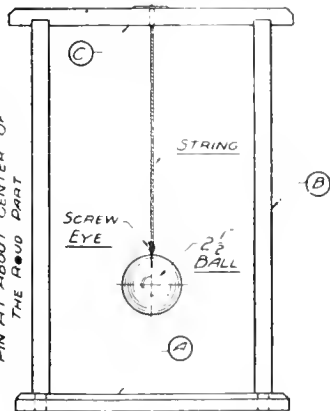


# PIN AND BALL GAME.

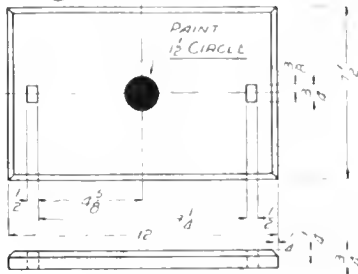


PARTS ASSEMBLED  
BUT WITHOUT PIN IN PLACE

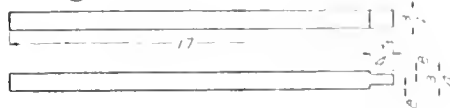
ADJUST STRING SO BALL  
WILL STRIKE THE TOP OF THE  
PIN AT ABOUT CENTER OF  
THE ROUND PART



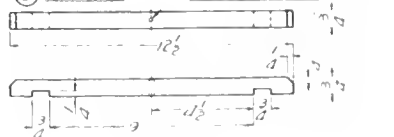
(A) MAKE ONE



(B) MAKE TWO

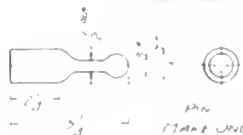


(C) MAKE ONE -- SMALL HOLE FOR STRING



TO OPERATE PLACE PIN  
EXACTLY ON PAINTED  
CIRCLE PULL BALL FOR-  
WARD AND RELEASE  
SO IT STRIKES PIN  
ON RETURN SWING

MATERIAL  
ANY GOOD WOOD



## SAIL BOAT

The making of this model will require the exercise of some individual thought on the part of the maker. The general dimensions are very clearly shown, but the shaping of the hull will require the expression of individual thought.

The making of the hull should receive attention first. Select a light wood, as straight grained as possible to permit of ease in forming to shape. A solid piece may be used, but if this is not available, the hull may be built up of several pieces as shown in the drawing. Get out the stock to the overall dimensions, then lay out the shape. The part to be removed in the center is shown by the dotted lines in the front and end views. The section view will also assist in understanding the shape desired. The removal of this stock will be of material service in lightening the boat. The dimensions for the outline of the hull will be found in the view immediately above the front view. This gives the dimensions for the shape crosswise of the hull. The other necessary dimensions will be found in the other views. When your hull

is shaped to your satisfaction, bore the hole for the curtain rod.

Parts B, F, G and H should be given careful attention. They should be made just as round as it is possible to make them. Do not slight these parts. Part D will be found more difficult than those just mentioned and will require the skillful use of a sharp knife. Part C is made from wire, carefully twisted, as shown in the detail drawing. The rudder post should be made so it will fit the hollow curtain pole, but loosely enough to permit it to turn. The method of holding G and H together is shown right near the assembly of these parts,—by means of a piece of wire twisted to the shape of a figure eight.

The assembling of the parts can be easily understood from the drawing. To preserve the boat, and also to add to its attractiveness, it should be well painted. The color scheme is to be left to the personal taste of the one who makes the boat.



### CHAIR LAMP

This is an exceedingly fine piece to add to the home. The comfort derived from its use will amply repay one for the time spent in its construction.

First, make the upright. Select two pieces of wood of required thickness, getting out the width to about  $\frac{1}{2}$ -inch more than finished size. Smooth one broad surface and square one edge only on each piece. If you have a combination plane, the grooves in the center can be easily made, but as you will not likely have this tool at hand, another method will have to be used. From the edges just squared up, gage lines on the smooth surface the required distance from edge, so the groove will be in the center when finished. Gage deeply as possible. Chisel out the groove to required depth— $\frac{3}{16}$ -inch in each piece. Next slightly roughen the edges that are to join. When ready, apply glue, clamp together and set away to dry.

While waiting for the upright, make a pattern for the supports. Lay out on wood selected for them and with a

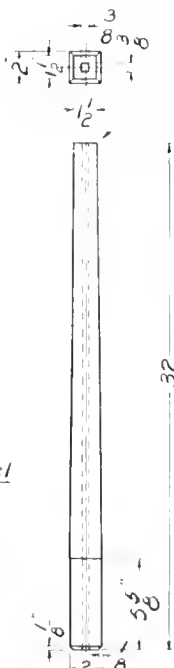
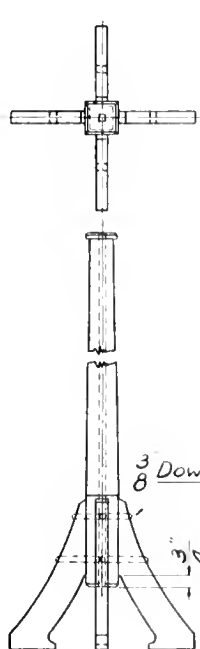
turning saw cut them to shape. It will be well, however, to locate and bore holes for the dowels before the cutting to shape is done. This will give good, sharp edges on the slanting edge.

Next make the cap, then take up unfinished work on upright. First square up to largest dimensions and then lay out and plane taper. Lay out and bore holes for dowels. After this, assemble the parts and make any necessary adjustments at this time. When done to your satisfaction, sand all pieces very carefully.

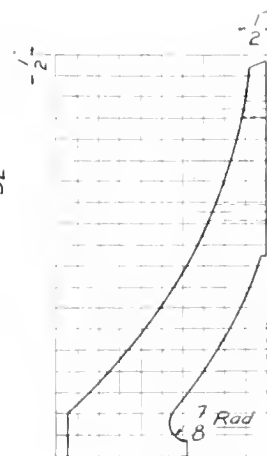
If oak is used, or any other wood that will take a stain satisfactorily, select stain you wish and apply it, finishing with a thin coat of shellac and wax. If soft wood is used, the lamp may be painted.

The electrical fixtures can be secured from any electrical supply store.

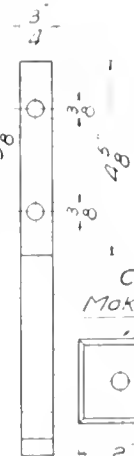
# CHAIR LAMP.



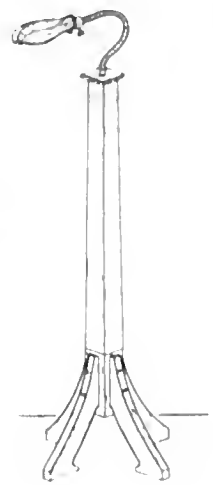
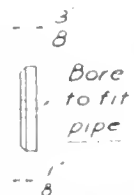
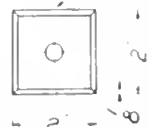
*Staff - make one*



*Support  
Make four*



*Cap  
Make one*



### LEG REST

Two types of joints are used in the construction of this leg rest. Both need careful work in laying out and cutting. The one on part A is called a keyed mortise and tenon, while the one at the top of part D is called a housed or dodo joint.

Make out your lumber bill and proceed to get out your stock to required dimensions. Parts B and C can be reduced to size at once. Part A should be an inch or more longer than the finished piece. Get out part D to length and to the greater width, leaving the taper to be planed later.

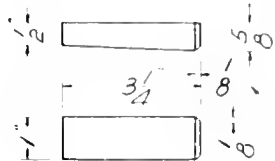
Use a knife and gage in laying out the various joints - the knife across grain and the gage with grain. Lay out the mortises first in part D into which the tenons on part A fit. At the same time lay out the groove for the end of A. Cut first the mortises that go clear through parts D, then cut groove for the housed joint. Mortises that go clear through a piece should be laid out on both sides, to insure the cutting being straight. Next lay out and cut the groove at top of D for the ends of B.

Be careful in laying out the tenon and the small mortise in the ends of A. Remembering that the stock is longer than the finished size, all work should be laid out from the center of the piece lengthwise. After cutting is done and the fit satisfactory, the excess stock may be removed, it being left on to prevent splitting of wood when fitting joint. Examine carefully details relating to joint at Y. No trouble should be experienced with this if drawing of parts is carefully studied.

When all parts have been cut to size, test by fitting them together. When satisfied with them, take apart, lay out and cut the taper on parts D. Next lay out and cut the chamfers which extend entirely around outside edges only. Sandpaper well.

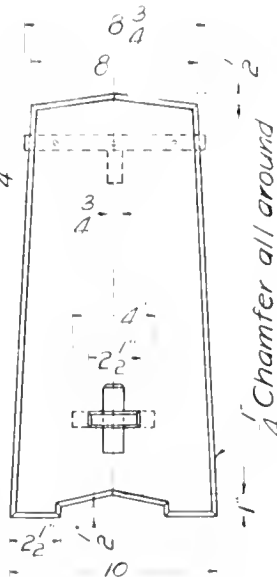
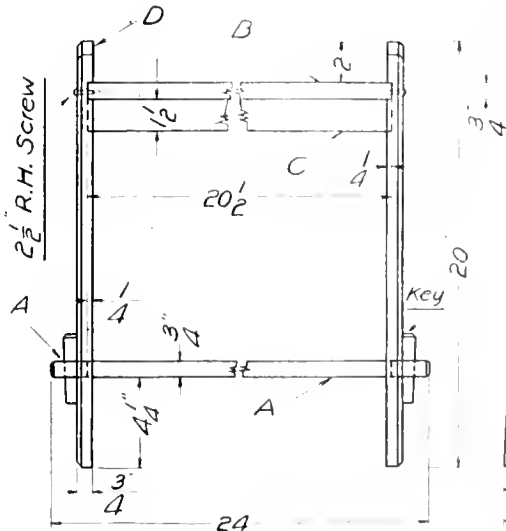
If oak is used, apply stain and finish with a thin coat of shellac and then wax. Should you be fortunate enough to have walnut to make the piece from, apply boiled linseed oil thinned slightly with turpentine, which will make it penetrate better. When dry, apply a thin coat of shellac. Sandpaper slightly and wax.

# LEG REST.

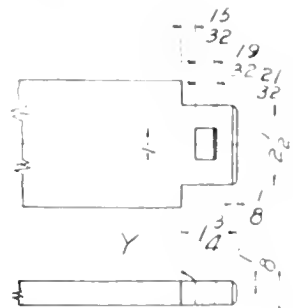
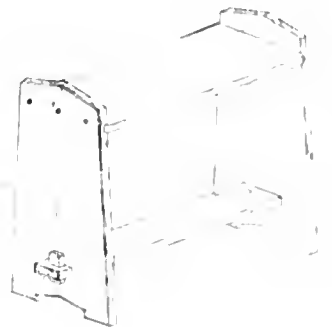


Detail of key

$2\frac{1}{2}$  R.H. Screw



$\frac{1}{4}$  Chamfer all around



Detail of mortise and tenon at A.

## BULL DOG

A coping saw or a turning saw will be needed for this work. A power band saw would permit of the work being done more easily, but most boys have not this tool available.

It will first be necessary to lay out patterns for different parts. This is done by means of the  $\frac{1}{2}$ -inch squares as shown. Make your patterns with care, for successful work will depend upon how well the parts are shaped. Be sure to locate on patterns points at which holes for screws are to be bored and transfer these accurately to the stock itself. In this way it will be possible to have the locations of the various holes made uniformly so that when the legs and ears are fastened in place, they will work correctly.

When your patterns are laid out to your satisfaction, transfer them to stock from which parts are to be made. Next cut to shape, being careful to follow lines of pattern.

Round-head screws are to be used for fastening legs and ears to body. Select size you will use and then bore holes of proper size for them. A double end or dowel screw is used to fasten head and collar to body. Ordinary screws may be

used, but it will be found much more convenient to use double end kind. This is first turned into place in body, then collar is slipped over it and fastened with a couple of brads to keep it from turning, then head is turned on end of screw that projects from body.

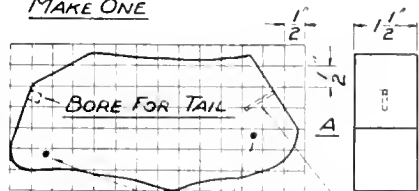
Washers should be used between legs and body, also between ears and body. It will be well to have washers between head of the screw and legs and ears. When all parts are ready, assemble and test. If everything is all right, measure distance between legs. Lay out grooves on cart according to this measurement.

Next make cart, laying out grooves as above stated. The fit of legs in grooves should be snug enough to hold dog in position. Wheels should be carefully laid out and cut, as it is important that they be perfectly round. If desired, large wooden button forms may be bought at a department store and used for wheels. When all parts are well sanded, painting is next in order. Take dog and cart apart for this operation. Use scheme suggested on drawing.



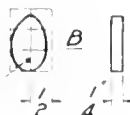
# BULL DOG

MAKE ONE

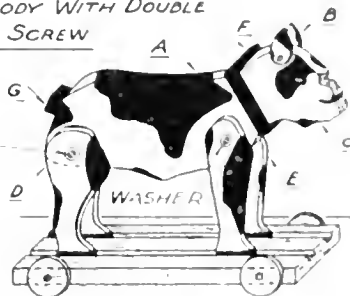


BORE HOLES FOR SCREWS

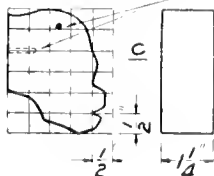
MAKE TWO



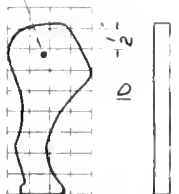
FASTEN COLLAR AND HEAD TO BODY WITH DOUBLE END SCREW



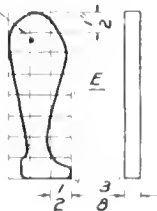
MAKE ONE



MAKE TWO

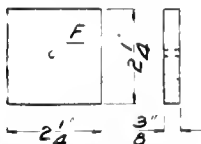


MAKE TWO

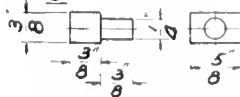


- PAINT -  
DOG - WHITE SPOT BLACK  
CART - RED

MAKE ONE



MAKE ONE



MAKE GROOVES TO FIT COMPLETED DOG



### CHRISTMAS TREE STAND

The Christmas tree stand is to be painted either red or green, and so any scraps of wood may be used—even pieces with knots, as the paint will cover them.

One edge and the end that joins the other part must be absolutely square to produce a good job.

Plane up all four pieces to size, and then cut the corners according to the drawing.

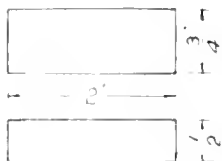
The parts can be fastened together with screws or nails, as you wish.

Plane a piece long enough to make all four feet, part B, and then cut to length. The feet are fastened to the other parts with brads.

If the tree is too large to fit hole, cut so it will fit, and if too small make wedges to fit corners.

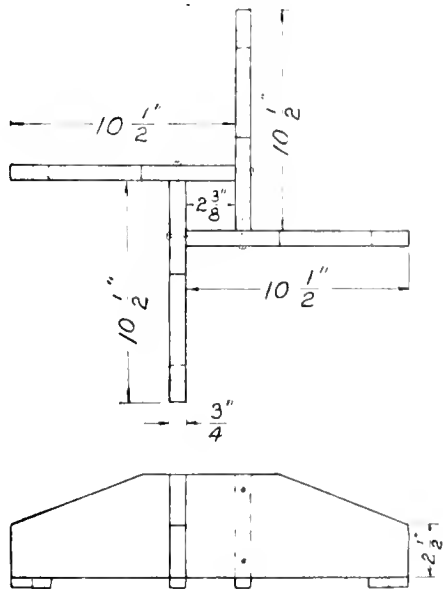
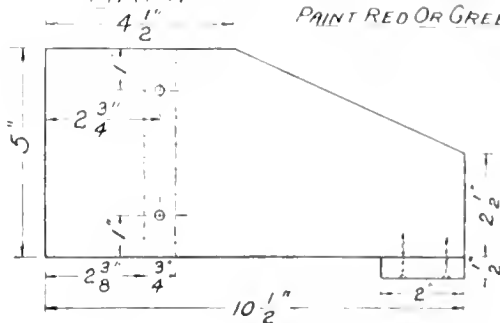
# CHRISTMAS TREE STAND

PART B



PAINT RED OR GREEN

PART A



### BABY AUTO CAR

This car was designed for a small child, especially one who is not old enough to guide the ordinary three-wheeled car without tipping it over. Steering handle of car only allows front wheels to turn a certain distance, because then it strikes the side of hood, and in this position the car cannot turn over.

When being pushed about the living rooms it cannot mar the furniture. The child's legs protect any object the side of the car is likely to touch, the bumper covered with a rubber hose protects objects that the front might come in contact with, and the front wheels are set back of bumper.

A young child soon gets tired propelling a car and by slipping in place the handle fastened with a stove bolt, the attendant can pull the car as she would any cart. As the child grows, the car can be raised by substituting larger wheels.

Soft wood may be used for all parts, but it is suggested that axles and wheels be made of hardwood.

Hole for steering gear can be bored with an expansive bit or cut with a key-hole saw. Fasten together parts of the steering gear and steering handle with screws.

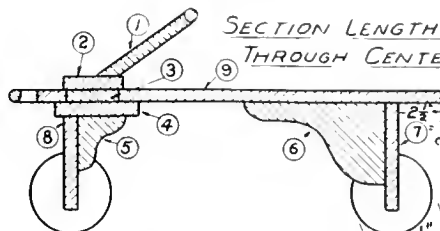
Fasten wheels to axles with  $\frac{1}{4}$ -inch lag screws. Place a washer between head of screw and wheel, also between wheel and axle.

The 36-inch handle is fastened to front axle with common iron angle irons.

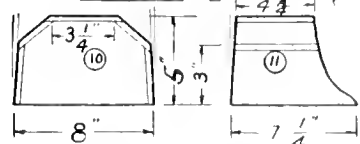
Paint seat and wheels red, hood black and stripe wheels and hood with yellow. Other combinations of colors may be used.

# BABY AUTO CAR

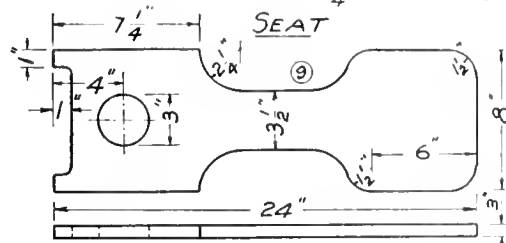
SECTION LENGTHWISE  
THROUGH CENTER



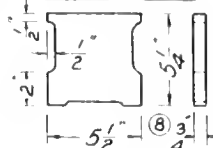
PATTERN OF HOOD



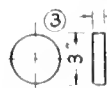
SEAT



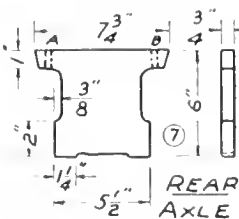
FRONT AXLE



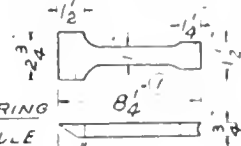
DISK



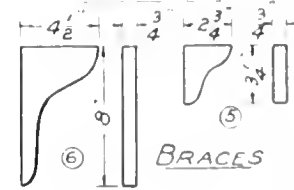
REAR AXLE



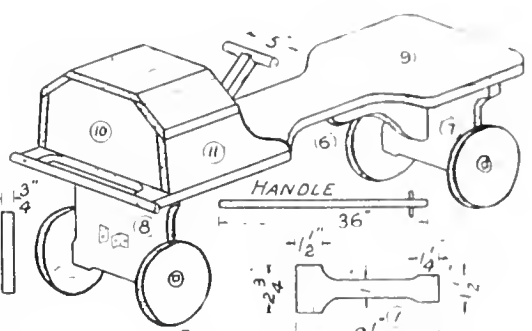
STEERING HANDLE



STEERING PART



BRACES



HANDLE

36"

### FLY TRAP

For the fly trap, first make corner posts which are 15 inches long. Next make the bottom board, cut out center and also corners for posts. Now make the four top rails to be nailed to the upper ends of posts.

Lay out on paper the cone pattern and cut. Place pattern on wire cloth and cut cloth. Lace edges of wire cloth together with a piece of wire drawn from wire cloth, forming cone.

Fasten wire cone to bottom board with tacks. Use a two or three-ounce tack. Nail bottom board in place and then the top rails.

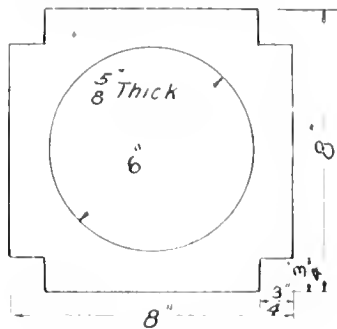
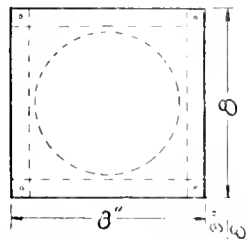
Cover trap with wire cloth, joining the ends on one corner post.

Make the top board. This piece must be fastened so it can easily be removed to empty the dead flies.

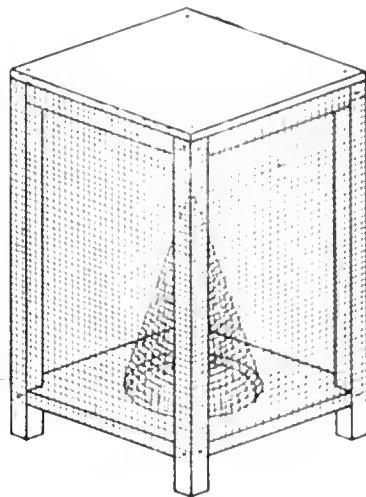
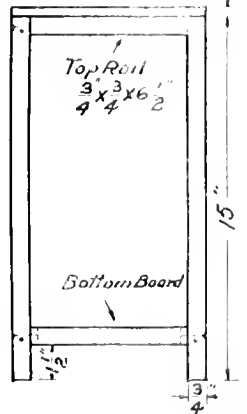
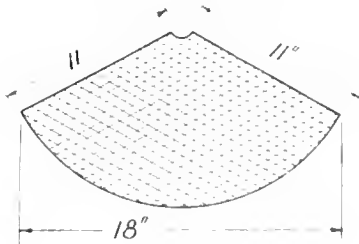
Set trap where flies are noticeable, placing a saucer of sugar and water or other material attractive to flies under opening in the bottom board. The flies will crawl under trap to feed, and after feeding will fly up on cone instead of going out as they came. They will walk up to the small opening in point of cone and through it into the trap. Not being able to find the opening through which they came, they are caught for your disposal.

# FLY TRAP

BOTTOM BOARD



CONE PATTERN



## PLANT BOX

Plant boxes are subjected to the action of much moisture, and for this reason a material should be chosen that will resist this action as much as possible. Cypress more than any other wood will fulfill this requirement, and if it is possible to secure it, should be used.

No great difficulty will be encountered in making this box. The making of two slots in the ends for hand-holds will be best accomplished by first boring holes of the right size for the ends of slots and removing remainder of material with a chisel.

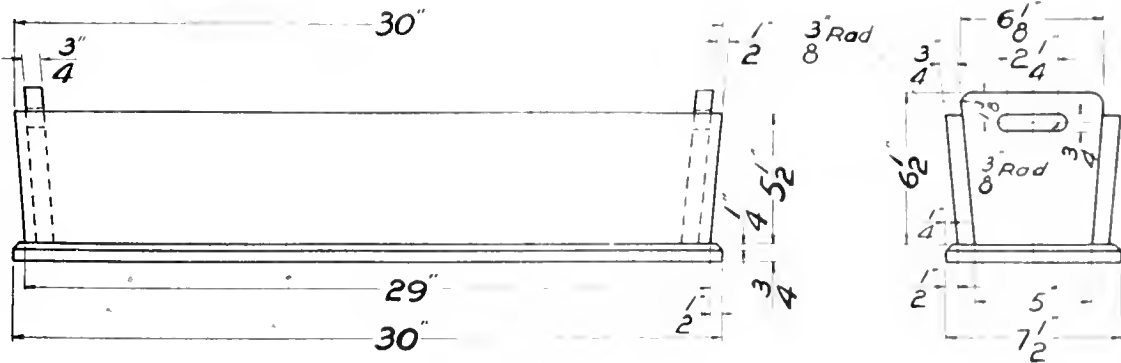
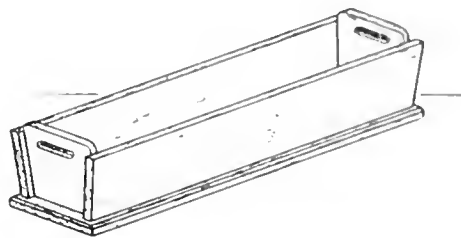
Holes should be bored in the bottom to provide a means for the surplus water to escape when contents of the box are watered.

Assembling should be very carefully done. It is recommended that screws be used for fastening all parts together—flat-head screws for bottom and round-head screws for sides. Notice direction of rings of growth in side pieces and fasten them to end supports so the crown of the board, which will result when it warps, will be out. If it is placed so the crown is in, the warping of pieces will cause top and bottom edges to curl outward, destroying the neat appearance of the box.

Boxes should be painted first, as a matter of appearance and second, to aid in resisting the action of the weather. A dark shade of green paint will give excellent results.



# PLANT BOX.



### SUBMARINE

For the submarine select a soft piece of pine wood. With a good sharp knife whittle parts F and G from a piece about 10 inches long. They can be sawed to proper length after they have been formed, and by cutting them from a long piece enough stock is available for holding while whittling.

Bore hole through part F for wire. Now cut part A from any tin can, bend and tack to parts just made. Make parts C and D of wood and fasten with tacks to A.

Drive brad as indicated by dotted lines in part G and bend head, making hook for rubber band. Bend wire and place in part F, after which propeller is soldered to it. Do

not forget to place glass bead between propeller and part F before soldering propeller to wire. Hook a rubber band to end of wire and also to brad bent for this purpose.

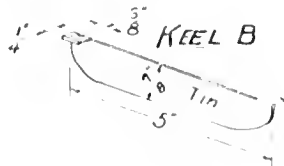
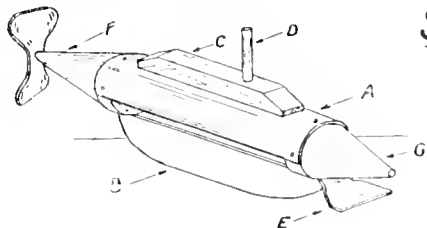
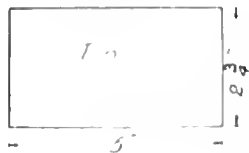
Make keel, part B, and tack in place. Also rudder E.

Paint model to keep tin from rusting and wood from soaking water.

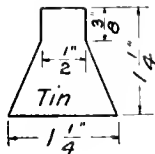
To operate submarine hold in hand and wind propeller by handle. When rubber band is wound tight, and rudder is set, place in water, and it will dive. The angle will depend on the angle at which rudder is bent.

# SUBMARINE

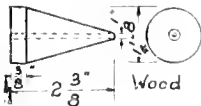
## PART A



## RUDDER E

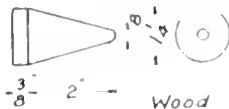


## PART F

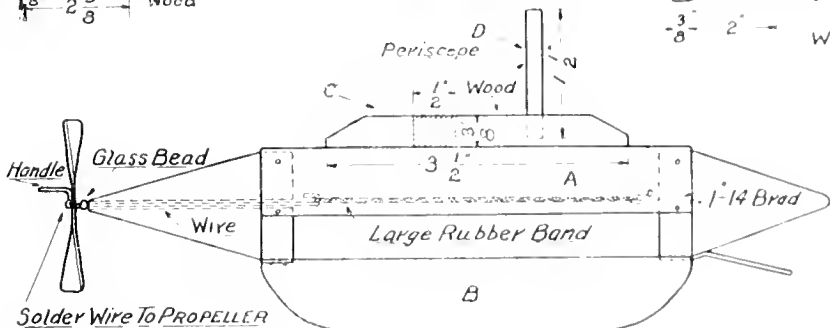
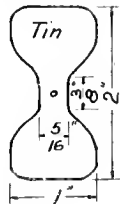


# D-25

## NOSE PART G



## PROPELLER



### PHONOGRAPH DANCER

The phonograph dancer is not hard to make although it must be constructed accurately to work well.

First make board to which blocks are fastened; it may be made of cigar box lumber. Next make blocks and fasten in place with cigar box nails. The blocks are lettered D and E.

Now bore a hole through either a square or round piece C to fit a meat skewer, which usually comes with a roast and is the shape and size of a slate pencil. Bore a hole in the bottom board to receive C and glue it in place.

Make part A, cutting with a jack knife. Bore a hole at center, that fits the spindle that holds the phonograph record,

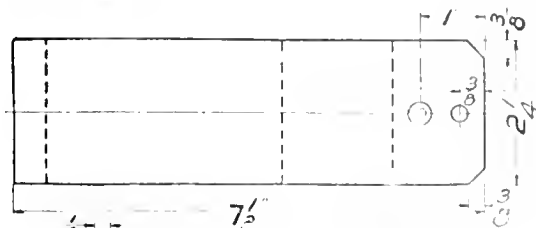
The spindle must fit hole tightly. Make peg B and glue in the bottom board. It must fit in A loosely.

Cut a clothes pin for body of the man as shown in the drawing, and bore a hole in which to glue the skewer stick. Make arms and legs of cardboard and fasten to body with cigar box nails.

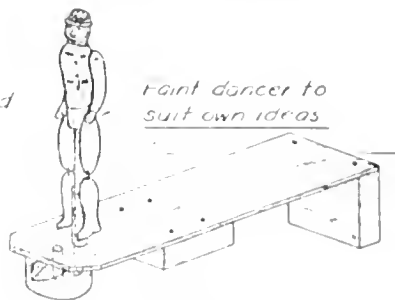
Paint all parts with water colors. A poor job of painting may spoil the appearance of the dancer.

To operate, place record on spindle. Place part A on spindle and peg B in hole with D resting on box outside of revolving record. Now drop end of skewer in C and as the point runs up and down in cuts made in A the man will dance and cut all kinds of funny capers.

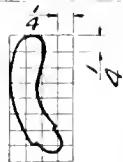
# PHONOGRAPH DANCER.



Plan of platform without dancer and disk A in position.



Paint dancer to suit own ideas



Small Nail

Body circular in shape.



Two of each required

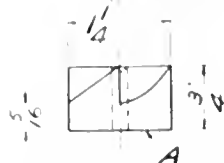
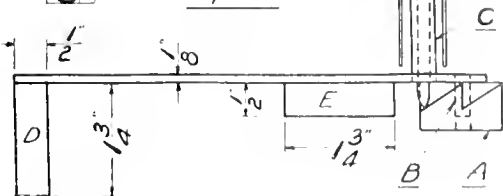


Wire

Make from meat skewer about 4" long.

Bore to fit skewer loosely

Bore to fit spindle of machine



### TELEPHONE SCREEN

An article of this kind should be rather delicate in appearance, and for this reason the stock used is but  $\frac{3}{8}$ -inch thick. This is thin enough to look well, and yet will permit of substantial construction.

The kind of material to be used will depend upon the finish you wish to give it. Staining and painting are both attractive. If it is to be stained, a wood having an interesting grain should be used. If painting is to be the finishing method, a wood with little or no grain may be used.

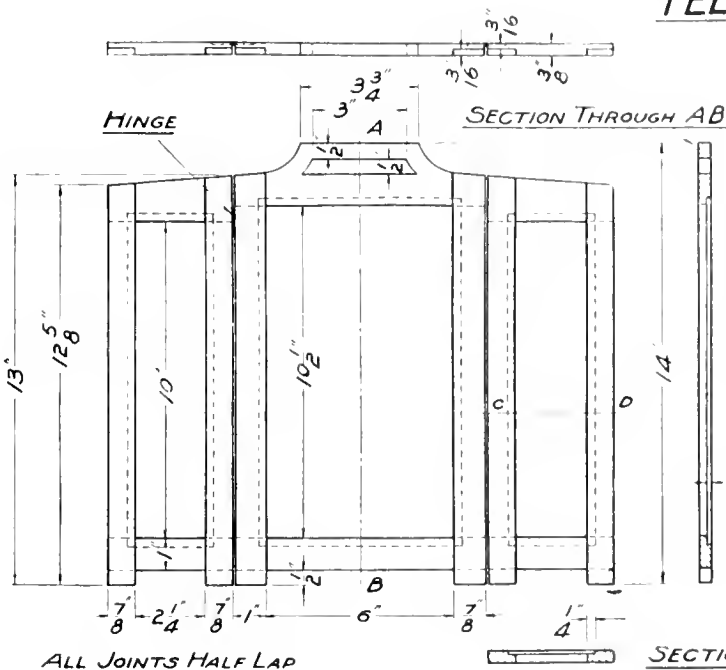
Get out all the pieces to the greatest dimensions indicated. Pieces that have edges that are not parallel to each other should be cut to shape after assembling is done. All joints are to be half lap. These are not difficult to make and good results should be attained. Lay out and cut them very accurately. When you think the work is satisfactorily done, put parts together, and cut out inside corners to fit panels to be used. No dimension is shown for this, as depth of cut will depend upon kind of panel used. For instance, if cardboard

covered with silk is used, depth will likely be less than an eighth of an inch. Decide upon what material you wish to use, and then cut the groove accordingly.

When all parts fit well, sand and glue together. The stock is so thin that brads can hardly be used, so pieces will have to be clamped together until dry. When glue has set, the two side pieces should be cut to match slant at top of main section. Sand any rough places and then fit the hinges. Staining can be done with the hinges in place, or they may be removed.

Finishing should be such as to match the material used for the panels. Staining or painting is satisfactory. The screen from which this drawing was made had a panel of silk with a Japanese effect. There were black spots in design, body being yellow. Black enamel was used on frame and inside of hand-hold at top was painted yellow. The effect was very pleasing. A little study will bring out many possibilities.

# TELEPHONE SCREEN.

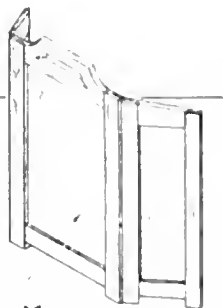


PAINT  
OR STAIN  
FRAME TO  
SUIT KIND  
OF WOOD  
AND PANEL  
USED

PANELS MAY  
BE CARDBOARD COVERED WITH  
FABRIC, OR THIN WOOD

MAKE DEPTH  
SUITABLE TO  
PANEL USED

THIS SCREEN  
SUITABLE TO  
MANY OTHER  
USES



SECTION THROUGH CD





## INDEX

---

- Aeroplane Weathervane, 64, 65.
- Baby Auto Car, 142, 143.
- Baby's Rocking Horse, 70, 71.
- Bag Puncher, 108, 109.
- Bath Room Cup Holder, 46, 47.
- Bits and Drills, 21, 22.
- Bob Sled, 80, 81.
- Boy's Handy Wagon, 122, 123.
- Boy Scout's Heliograph Outfit, 94, 95.
- Brads, Screws and Fastenings, 23, 24.
- Bull Dog, 138, 139.
- Chair Lamp, 134, 135.
- Child's Morris Chair, 40, 41.
- Child's Snow Shovel, 98, 99.
- Christmas Tree Stand, 140, 141.
- Combination Bench Hook, 36, 37.
- Common Joints, 10, 13.
- Commonly Used Hardware, 17-20.
- Construction Problems, 10, 12.
- Crumb Tray, 84, 85.
- Cutting Board, 42, 43.
- Feeding Bird, 54, 55.
- Finish, 25.
- Fly Trap, 144, 145.
- Flying Propeller, 56, 57.
- Ground Scratcher, 96, 97.
- Hallowe'en Fun Makers, 126, 127.
- High Speed Drill, 82, 83.
- Hula Dancers, 74, 75.
- Jack Be Nimble, 92, 93.
- Jumping Jack, 72, 73.
- Kites, 100, 101.
- Laying-Out Tools, 26, 27.
- Leg Rest, 136, 137.
- Letter Rack, 112, 113.
- Low Folding Table, 110, 111.
- Lumber, 8.
- Mechanical Duck, 76, 77.
- Mouse Trap, 120, 121.
- Ornamental Garden Sticks, 118, 119.
- Personal Equipment, 8, 9.
- Phonograph Dancer, 150, 151.
- Pin and Ball Game, 130, 131.
- Planes, 28, 31.
- Planning and Scoring Rules, 30, 33.
- Plant Box, 146, 147.
- Potato Gun, 58, 59.
- Puzzles, 102, 103.
- Red Cross Ambulance, 68, 69.
- Sail Boat, 132, 133.
- Sandpaper and Finish, 25.
- Saws, 28, 29.
- Scoring Rules, 32.
- Scout Firemaking, 83, 75, 77.
- Sewing Comparison, 116, 117.
- Shop Kinks and Information, 1.
- Shop Notes and Etiquette, 7.
- Silhouette's Camera, 114, 115.
- Simple and Serviceable Flag Holder, 85, 87.
- Skate Sharpener, 35, 39.
- Small Cart, 66, 67.
- Standards and Conventions, 10, 11.
- Steam Engine, 50, 51.
- Straddle Horse, 106, 107.
- Submarine, 118, 119.
- Target Pistol, 90, 91.
- Telephone Screen, 152, 153.
- Thanksgiving C. Order, 62, 63.
- Tools, 14, 16.
- Toy Cannon, 44, 45.
- Toy Elephant, 52, 53.
- Toy Pig, 38, 39.
- Toy Rabbit, 88, 89.
- Tray-ler's Case, 124, 125.
- Trench Mortar, 104, 105.
- Wind Mill and Acrobat, 128, 129.
- Wooden Doll, 60, 61.
- Work Bench, 34, 35.

## Contents of Books II and III

Jig Saw	Test Tube Rack	Japanese Chair	Plant Box
Wren House	Fire Side Bench	Fighting Bull Dogs	Sidewalk Coaster
Feeding Tray	Christmas Tree Table	Pea Shooter	Hammock
Easter Chickens	Floor Lamp	Doll Cradle	Foot Bench
Work Bench	Nursery Chair	Tin Can Engine	Bob Sled
Hissing Raven	Box Wheelbarrow	Dancing Jim	Arm Chair
Turning Saw	Mail Box Automatic	Nail Box	Magazine Stand
Easter Toy	Doctor Quack	Newspaper Holder	Dutch Windmill
Baby's Bed	Mule and Rider	Bird Houses	Candle Holder and Bank
Child's Toilet Seat	Toy Wagon	Cold Box	Shoe Polishing Stand
Bow Gun	Salt Shaker Holder	Robin and Wren Box	Bank
Laundry Box	Toy Wheelbarrow	Match Box	How to Cane a Seat
Invalid's Table	Game of Hearts	Piano Bench	Doll Cab
Little Red Hen	Dart Game	Child's Colonial Chair and Table	Tooth Pick Toys
Drawing Table	Flour Box	Marble Game	Game of Hearts
Umbrella Stand	Towel Rack	Aeroplane	Book Trough and Shelf
Fly Swatters	Bread Board	Pencil Box	George Washington Toy
Doll Costumer	Bingo Stick	Window Screen	Christmas Tree Table
Sword and Gun	Wood Pincers	Lemonade Stand	Shoe Brush Holder
Grocery List	String Winder and Cutter	Frame for Child's swing	Watch Holder
Hammock	Scout's Belt Kit	Paint Remover	Ball Holder
Clock Case	Door Weight	Doll Costumer	Sling Shot Glider
Double Windmill	Martin House	Book Trough	Writer Gun
Glider Sling Shot	Sewing Cabinet	Doll's High Chair	Doll Cradle
Jumping Jack	Toy Giraffe	Toy Goat	Window Ventilator
Smoking Cabinet	Drill Press	Baby's Bed	Fourth of July Outfit
Toy Wheelbarrow	Tumbling Toby	String Winder	Sprinkler
Turning Lathe	Caning	Geyser	Doll House
Blue Bird House	Typewriter Table	Match Box	Turning Saw
Bank	Toy Box	Auto Creeper	Tooth Paste and Brush Holder
Dressing Table	Book Ends	Teddy Bear Blacksmiths	Footmobile
Shoe Shine Cabinet	Fireless Cooker Support		Tin Lined Plant Box

## Contents of Books II and III—Concluded

Flag Holder	Sobtaire	Auto Truck	Book Supports
Sewing Companion	Child's Tea Cart	Broom Holder	Milado Puzzle
Fire Side Seat	Scarf Pin Holder	Christmas Decoration	Trolls
Tool Case	Lap Board	Tiboret	Cart and Target set
Child's Wash Bench	Medicine Cabinet	Rat Trap	Doll's Swing
Doll Bed	Picture Frame	Towel Holder	And Pages of Information
Paint and Shellac Can	Armoured Car	Clock Case	

These projects can be had in card form for class work.  
They are put up in sets, a list of which will be sent  
on application.

The Bruce Publishing Co., Milwaukee, Wis.



UNIVERSITY OF CALIFORNIA LIBRARY

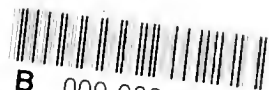
Los Angeles

This book is DUE on the last date stamped below.

---



3 1158 01126 4511



**B** 000 003 246 PL

STACK A