

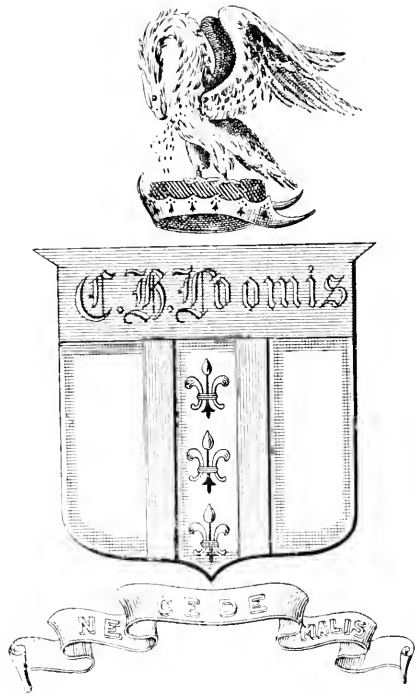

SCIENCE
GOSSIP.



HARDWICK'E'S
SCIENCE-GOSSIP:
1881.

HARDWICKE'S

Science-Gossip:

AN ILLUSTRATED MEDIUM OF INTERCHANGE AND GOSSIP

FOR STUDENTS AND

LOVERS OF NATURE.

EDITED BY

J. E. TAYLOR, PH.D., F.L.S., F.G.S., F.R.G.S.I.

VOLUME XVII.



London :

DAVID BOGUE,

3 ST. MARTIN'S PLACE, TRAFALGAR SQUARE, W.C.

1881.

LONDON:
PRINTED BY WILLIAM CLOWES AND SONS, LIMITED,
STAMFORD STREET AND CHARING CROSS.

10597

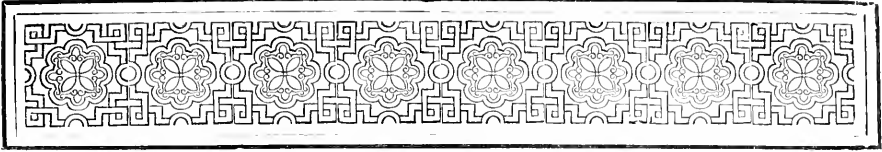

PREFACE.



THE most difficult, and yet somehow the most necessary thing the Editor of a magazine has to do, is to indite a Preface to his yearly volume. He appears year after year before nearly the same audience, to say the same things, and to endeavour to say them in a different way, all the time feeling that the audience is taking a critical note as to whether the act is well done or not!

But this annual custom is not without its advantages. It enables the Editor to issue a personal "Encyclical Letter" to all those with whom he has been brought into contact during the past twelve months, directly or indirectly. There are hundreds of correspondents whose faces he has never seen, and perhaps never will see, with whose hand-writing he is as familiar as if he had known them in the flesh since childhood! From all of these he is in the habit of receiving favours. They communicate to him the results of their reading and investigation; or they generously come forward to help young students and observers with their own richer and fuller knowledge and experience.

This is an opportunity not to be neglected by the Editor for returning to all such *amis de la cour*, his warmest thanks; but in doing so he adopts the worldly motto which declares the sincerest gratitude is that based upon "favours to come!"

We are aware of what many correspondents and subscribers (who know nothing of the endeavour to cram into our monthly issue more than it can possibly hold), may sometimes consider an unexplainable oversight, in not inserting every paragraph or article they send

P R E F A C E .

us. But whilst trying personally to be as kind and courteous as possible, one has to regard the interests of the general readers as a whole. We are not conscious of having failed to do this.

This is the Seventeenth Annual Volume of SCIENCE-GOSSIP, but we are more jubilant as to its future than ever. We are well provided for what we may safely declare is a better intellectual *menu* than heretofore, and the New Year's Volume (already in progress) will not be inferior to the best of its predecessors. Our ability to improve SCIENCE-GOSSIP in every way would be considerably facilitated by an increased circulation, and those warm-hearted friends who take such an interest in it, may do us a benefit by obtaining for the Publisher fresh Subscribers.

In conclusion, we thank our friends all round for useful advice, able help, and generous encouragement and assistance in every way, and we wish one and all A Happy New Year!

LIST OF ILLUSTRATIONS.



- ALCEDO HISPIDA, 28
Ameba, an unusual form of, 226
 Amoeboid cells, 8
 Angler Fish, 174
Arrenurus perforatus, 269
Asellus aquaticus, 85
- BLACKCAP WARBLER, 30
Boarmia consortaria, 201
 Bombyx (Tertiary) restored, 177
 Brain cavity of Alligator, 33
 Brain cavity of *Colymbus torquatus*, 33
 Brain cavity of *Hesperornis regalis*, 33
 Brain cavity of *Ichthyornis victor*, 33
 Brain cavity of *Sterna cantiaca*, 33
Braula caeca, 108, 109
 Brindle White-spot, 200
 Buck-Bean, 197
 Bullfinch, 29
 Bunting, Black-headed, 29
- CALAMITE, SECTIONS OF FRUIT OF, 228, 229
Calopteryx virgo, 36
Callianassa subterranea, 225
Campanularia dumosa, 133
Campanularia geniculata, 132
Campanularia syringa, 133
Campanularia volubilis, 133
 Centaury, 196
Certhia familiaris and nests, 57
 Ceylon, sketch map of, 105
Cinclus aquaticus, 252
Corophium crassicornis, 149
 Crater, Old Granite Arran, 220
Curruca atricapilla, 32
Cyclops vulgaris, 84
Cypris ornata, 85
- Dadoxylon*, 273
Daphnia Pulex, 84, 85
Diphthera Orion, 200
 Dipper or Water Ousel, 252
 Dog-whelk, 4
 Dragon Fly, 36
- EGG OF BLACKCAP WARBLER, 30
Emberiza schauinslandi, 29
Erythraea Centaureium, 196
- FIELD MOUSE, 104
 Fossil Botany, 80, 81, 100, 101, 124, 125, 180, 181, 228, 229, 272, 273
Fringilla oryzivora, 76
 Frog-Spawn *in situ*, 60
- Flustra hispida*, 133
 Fungi, some of our smaller, 8
- Gammarus Pulex*, 85
 Geological Diagrams, illustrating "A visit to a Welsh Stone Quarry," 244, 245
 Geological Diagram, shewing Geology across Yorkshire, 170
 Geological Section of Strata, shewing "Hard Bed Coal," 53
 Germinating Spores of *Sphumaria alba*, 8
 Gnat, Egg enlarged, 56
 Gnat, Larva of, 56
 Gnat, Ovisac of, 56
 Grapple (New), for Ponds or Marine Work, 40
- HALIOTIS TUBERCOLATA, 224
Harpyopsis Nova-Guincee, 32
Helix arbustorum, 205
Helix Cantiana, 205
Helix ericetorum, 205
Helix nemoralis, 205
Helix pomatia, 205
Helix rotundata, 205
Helix rufescens, 205
Helix virgata, 205
- JAVA SPARROWS, 76
- KING-FISHER, 28
- Labrus maculatus*, 173
Labrus mixtus, 173
Laomedea gelatinosa, 132
Laomedea geniculata, 132
 Larva of Dragon-fly, 37
 Larva of *Ephemera*, 84
 Larva of *Sycandra niphantis*, 156
 Lepidodendron, restored, 101
Lepidodendron selaginoides, transverse section of, 100
Lophius piscatorius, 174
- MACROSPORANGIUM, 180
 Macrospore, 181
Mactra stultorum, 4
Maia squinado, 225
Menthanthes trifoliata, 197
 Microsporangium, 180
 Microspores, 181
Mus sylvaticus, 104
- Natica monilifera*, 4
- Neorinopsis sepulta*, restored, 177
Nika edulis, 225
- Ophiocoma neglecta*, 52
 Ormer, The, 224
Orthogoriscus Mohi, 176
 Ovisac of Gnat, 56
- PALE OAK BEAUTY, 201
 Parasite of Cat, 18
Pecten varius, 4
Plumularia obliqua, 132
Purpura lapillus, 4
Pyrrhula vulgaris, 29
- RAZOR-SHELL, 4
 Restoration of a Tertiary *Bombyx*, 177
 Restoration of *Neorinopsis sepulta*, 177
- SECTIONS OF FOSSILS OF FRUIT OF CALAMITE, 228, 229
 Shrimp, Freshwater, 85
Sigillaria vascularis, 124
Sigillaria vascularis, restored, 124, 125
 Skeleton Wheel-Bearer, 112
Solen censis, 4
Sphinx fusiformis, 201
 Sponges, 156, 157
 Spring Clip Board (New), 232
Sphumaria alba, 8, 9
Sternbergia, 272
Stigmaria ficoides, 80
Stigmaria ficoides, transverse section of, 81
Succinea elegans, 152
Succinea Pfeifferi, 152
 Sunfish, Short, 176
- TADPOLE, 60, 61
Tapes pullastra, 4
Tephrosia extorsaria, 200
Thea viridis, 248, 249
Thiu polita, 225
 Tree creeper, 57
Trichodectes subrostratus, 18
Trochus cizyphinus, 4
- Vanessa polychloros*, 148
Vanessa Urtice, 148
 Vesuvius, View of the Crater, 13
 Volcanic Cones, 12, 13
 Volcanic, Old Granite Crater, Arran, 220
 Volcano, Extinct, Isle of Mull, 221
- WATER-MITE, NEW SPECIES OF, 269
 Wrasses, Blue and Red, 173

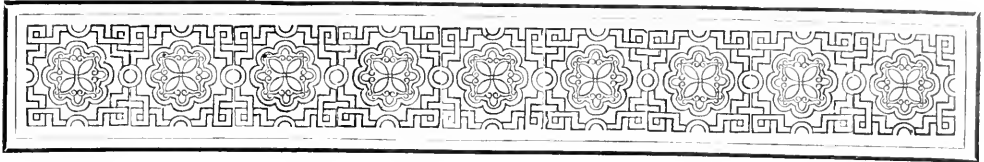

BOTANICAL NOTES FROM THE SWISS HIGHLANDS.

I. GENERAL OBSERVATIONS : LUCERNE.



LMBARRAS *de richesse*—that is the impression not unfrequently made upon the tourist of an “inquiring turn of mind” on his first introduction to the Alps of Switzerland, whether the bent of his inclinations be the pursuit of some scientific hobby, or simply a search after all that they afford of the sublime and picturesque in nature. Where shall we begin?

Which of the many localities which bear upon our particular vanity shall we first undertake? The botanist at any rate will have to regulate the work before him by the season of the year: his lower levels must be done before the higher ones, and the snow-line, generally speaking, reserved for the last weeks at his disposal; otherwise it matters little where he commences. Let us say, then, Lucerne and its neighbourhood. But as a certain resemblance to each other obtains among the mountains and valleys, a few preliminary remarks upon alpine vegetation in general, to avoid repetition, may not be out of place. In the forests which clothe the slopes *Abies excelsa* is the prevailing tree, extending to about 5000 feet above the sea; less frequent is *A. picea*, which stops short at 4000 feet. *Pinus sylvestris* is uncommon in some parts, less so in others; about Thun, for instance, on the Grütisberg, it is frequent. The mountain-pine does not grow above an altitude of 6000 feet. The larch occurs in the

Bernese highlands only as an escape from cultivation; birch and pomaceous shrubs here and there at all altitudes up to the level of the pines. The beech is not seen above 4000, nor the oak above 3000 feet; barley disappears with the one, and wheat with the other. The forest trees are of more varied character about the mountain bases, especially in sheltered situations. Ash, maple, aspen and holly are frequent and extend sparingly to the oak level. By the water-courses in the valleys, black poplars, alders and willows are plentiful; while dwarf willows and *Alnus viridis* are often to be found high up in wet rocky places as far as the limits of the mountain-pine. The elm and *Tilia parvifolia* occur, but are rather scarce in a wild state. Hornbeam is more of a lowland tree;* yew incidental. Broom rarely seen; furze unknown. Hedges there are none away from the towns, whatever may obtain to the contrary in the more open parts of the country; bramble and briar, whitethorn and blackthorn are therefore far less *en évidence* than with us. There are dewberries on the banks of the rivulets, but the most frequent brambles are *R. tomentosus*, *R. saxatilis* and *R. Ideus*. Of the briars *Rosa alpina* may be met with up to the limits of the pine trees.

The first part of an alpine ascent is generally in a steep zigzag for one or two thousand feet through forest, or it may wind in a more gentle rise over prairies and orchards, and enter a pine forest high up. On emerging from this the way will perhaps lead onwards and upwards, over a long stretch of “alpe” or pasturage, interspersed with chalets or cattle-sheds, to the bottom of a steep stony gorge or gully; the rocky slopes or precipices which enclose this on either side are bare, or their nakedness is sparingly relieved by gnarled and stunted growths of

* “As also the vine, which ceases to grow at 2000 feet, and is rarely seen in the Highlands, except in the Rhine and Rhone valleys, but chiefly on the banks of the lakes of Geneva and Neufchâtel, of which the height above the sea is about 1200 and 1400 respectively.”

Pinus pumilio, and low shrubs furnished with small usually oval, entire, often coriaceous leaves—dwarf buckthorn namely, and willow—*rhododendron*, bearberry, and a shrubby or suffruticose *Polygala*. Higher up are exceedingly steep grassy inclines, inaccessible to cattle, more or less flowery; then more rocky ground covered with débris and ending at a glacier or snow-field. The altitude thus attained may be reckoned at about 8000 feet; for the last thousand or so the vegetation has been entirely herbaceous, consisting for the most part of alpine species of *Ranunculus* and *Anemone*, crucifers, violets, small campions, sandworts, pearlworts and allied genera, dwarf vetches, *Alchemilla*, Cinquefoil and *Dryas*, saxifrages, stone-crops, gentians and *Primulæ*, dwarf umbels, composites, and small *Scrophulariaceæ*, together with mosses, alpine sedges, and alpine forms of *Festuca*, *Agrostis*, *Phleum*, *Avena* and *Poa*. These flourish up to the line of eternal snow and ice, say 9000 feet on an average; but a few of them may be collected from crannies and crevices of rocks up to 11,000 in sunny and sheltered situations.

In fixing a 9000-foot altitude as the average snow-line, it will be understood that this would vary with the season, with the latitude, with the nature of the rocks and inclination of their slopes, and is, *ceteris paribus*, always lower on the northern and eastern than it would be on the southern and western side of a mountain. It were almost superfluous to observe that the altitude of a mountain above the plain from which it rises is very different to its actual height calculated from the level of the sea. We need not therefore be surprised to note that a partially sub-alpine flora prevails in Switzerland at apparently low levels, as at Thun, for instance, which is 1750 feet above the sea.

The first jotting a botanist would make in his notebook, supposing him returned from a reconnoitring stroll in the neighbourhood of Lucerne, might be this: wooded hills all around, a lake in front enclosed by them; behind these, rocky heights more or less scarped, and more or less patched with black forest alternating with green slopes and intersected by ravines; beyond all, a loftier range with snow-clad summits; on the left of this lake a group of hills, falling from one point higher than the others abruptly to the N.W.—that is the Rigi. In the opposite direction on the right, and seemingly at no great distance, a mountain of pyramidal form and jagged outline towers naked and precipitous above the pine-clad heights of an intervening upland—this is Pilatus. It is the first week in July, but patches of snow still linger in ravines and hollows near its “cloud-capped summit.”

On further acquaintance with the place it will seem that outside the town both woods and clearings are unenclosed; of arable and garden land there is not much, a rye-field occasionally, otherwise meadows and orchards only; the fruit-trees mostly cherry; the

cherries small, little better than what the tree affords in its wild state; the vegetation rank and herbage coarse,—indications of excess of moisture and summer heat; the unmown meadows white with the inflorescence of umbelliferous plants;—*Heracleum*, *Pimpinella*, &c. *P. magna* is common, and on upland pastures shows itself, with others of its congeners, in handsome form, with flowers of a deep rose colour. In wet low-lying grass-land, yellow rattle and orchids are to the front in the greatest profusion, and especially a narrow-leaved and extremely fragrant *gymnadenia*; *Alchemilla vulgaris* is common, and a tall thistle of a pale lettuce-green colour and whitish inflorescence in compact heads, and blanched stems; *C. oleraceus*; others of the genus, common with us, are here apparently scarce. *Centaurea Jacea* takes the place of *C. nigra*. In the copses and borders of woods, bilberries, *Phyteuma spicatum*, *Veronica urticifolia*, and *Prenanthes purpurea* are general; on damp walls by the Reuss, &c., *Cystopteris fragilis* abundantly. Among other marsh plants of ordinary occurrence, *Senecio paludosus* is a striking object, growing to a height of four or five feet. Of the many Carices one species in particular attracted my attention as identical with some specimens from the fens forwarded to me recently by a correspondent at Ely, a curious variety of *acuta*. Common reeds fringe the margin of these meadows by the lake and line the ditches which drain them, but in general the shore is rocky. The lake itself, an ordinary *Potamogeton* or two excepted, is tolerably free from weedy growth; the water usually transparent, and the bottom covered with a whitish mud or sediment.

E. DE C.

(To be continued.)

FLEAS AND FLEABANES.

I SHOULD be glad to know if, among the various plants said to expel fleas, there are any of proved efficacy. Martial doubts if there is anything *fulice sordidius*, and in some London rooms in summer nights this agile miscreant works trouble very disproportionate to his size. Seeing, then, what a boon it would be to the human race to discover any certain exterminator of these pests, I submit it is an inquiry of no ordinary importance whether any such agent exists in our native flora.

Fuller linked with his worthies the noteworthy plants of their native counties, and denounces the pride and peevishness of men, who, when they have found medicinal plants, disdain to use and apply them.

Three native plants are by name associated with fleas, *Erigeron*, *Inula*, and *Cineraria* (this last being classed among the *Senecios* by some writers). Of these Miss Pratt says that the name of Fleabane, as applied to *Erigeron*, “refers to some exotic species, which by their strong odour annoy, or by their viscid stems and foliage entangle, the insects approaching them.”

The *Inula* leads us into one of those mazes caused by the polyonymy of botanical literature. *Inula dysenterica*, the common fleabane, is by some authors described as *Pulicaria*, while the *Inula conyza* is sometimes termed *Conyza squarrosa*, this latter being the *herbe aux puces* of the French. Anyhow, *pulicaria* best stamps the fleabane as the possessor of the virtues ascribed to it, and the old herbalists agreed that if it were burnt in any place haunted by fleas they would certainly be driven forth by it.

Besides these fleabanes and fleaworts the common wormwood, *Artemisia vulgaris*, was held to be a sovereign expellent.

Julius Cæsar Scaliger insisted that bedsteads made of fir were especially dear to fleas, that they are also much generated among maps and books, but above all in chicken-houses; by way of remedy he says, *Odore Cyprassi fugari, persuasum est.*

In the treatise of John Baptist Porta, concerning the riches and delights of natural magic, he gives a wonderful recipe, *Ut convenciant pulices*, by smearing a stick with the fat of a salted hedgehog; if you place this stick under the bed, says he, all the fleas will gather about it.

JAMES HOOPER.

NOTES ON THE BOTANY COLUMN OF OUR NOVEMBER NUMBER.

FLORA OF DEAL.—There is none published specially of the Deal or Sandwich district, but F. H. Habben will find a good deal of information—showing the locality to be by no means a despicable one—in Cowell's "Floral Guide for East Kent," published in 1839, and now to be picked up for "an old song." Good lists are given on pp. 73-75, many of which, however, F. H. H. seems to have found, along with a few interesting species not mentioned. It was a little foolish of anyone to represent that about Deal there was "little or no work in the botanical way" to be done. Let F. H. H. digest well this fact: good botanical work, perhaps the best, much better than ranging over a wide area, can be done anywhere in the country. Let F. H. H. pick up everything he sees that has vegetable life, all the mosses, scale-mosses, lichens, or small fungi that he may find, and try to name them, or if not adept enough yet to do so, let him wrap each carefully up in a packet by itself, and label with date and exact locality. Hereafter, when he has exhausted the Phanerogams, he may be glad, nay, he will be, that he has done so. Damp hollows, oases of vegetation amongst the sandhills, cannot fail to be prolific, if he take care, searching an acre of bank well, in preference to a mile of shingle less thoroughly. A Flora of Kent is not yet published, and by the time a couple of hundred packets of cryptogamic insignificances have been collected, the eye of the gatherer will at least have been educated to see differences little wotted of; and then, too, any

cryptogamist would be only too glad to have the overhauling and determining of the collection for F. H. H. The items would be available for the future flora, and F. H. H. encouraged by finding he could add something to the granary of botanical knowledge, even in a district despised of some men at least.

Bee Orchis in 1880.—Here in the north, on the magnesian limestone of Wetherby and Bramham, the same scarcity has been deplored as is bewailed for the south midlands and Sussex by J. S. In Yorkshire we have had two years of scarcity: *O. apifera*, plentiful in 1878, few in 1879, only one near Tadcaster and one in Bramham Park in 1880 having turned up to my knowledge. I and others have sought vainly.

Turritis glabra, or *Arabis Turrita*. Others were doubtless surprised besides Mr. Douglas to find Mr. Dillon at page 210, writing of *Turritis glabra* as "not now considered native in any part of Britain." I expected others would remark upon Mr. Dillon's error, but as they seem to have assumed (as Mr. Douglas does) that they and he were thinking of the same thing, perhaps a suggestion from me may help to clear up the matter. Was it not *Arabis Turrita* (Linn.) that Mr. Dillon meant? Though without proof, the misunderstanding lies there, I believe. *Arabis Turrita* (Linn.) has occurred on walls at Oxford, Cambridge, and in Kinross, but only as an introduced plant. One of its book names, which no sensible man, let us hope, ever uses, is said to be "Tower Wall Cress." *Turritis glabra* (L.) or *Arabis persifoliata* (Lamarck), as it is now more generally called, is a native undoubtedly in Britain, occurring as far north as Roxburgh, at least, whence I have specimens, the right thing, from Mr. A. Brotherston, of Kelso. Mr. Dillon must in some way, for some reason, be confounding the two plants. Both are tall slender Crucifers, both have radical tufts of lanceolate leaves with hairs on them; both have somewhat arrow-head-shaped stem-clasping stem-leaves. There are differences, of course, but exactly such as Mr. Dillon may very well have overlooked, especially if his specimen was just towering for bloom. The *Turritis glabra* is very glabrous, the sagittate leaves smooth and glaucous, with a bloom like that on an unripe greengage plum, but only above; the lower leaves, as I have said above, are hairy. Lastly, *Arabis Turrita* grown quickly under certain conditions is much less hairy at one time than at another. Mr. Douglas is quite right about his plant; and Mr. Dillon almost as certainly quite mistaken about his.

Jersey Fern-like Blechnum, but fertile.—The frond in outline like barren *Blechnum spicant*, but with sori on the back, without barren fronds, sounds as if it were the common *Polypodium vulgare*; or was it from some fernery? It is idle work guessing botanical conundrums. Mr. Woolcombe's best plan would be to show his fern to Mr. Druce of 118 High Street, Oxford, or send it to the Editor of SCIENCE-GOSSIP.

F. A. L.

A MARINE ZOOLOGICAL HARVEST.

THEY say it's an ill wind that blows nobody any good, and the same wind which wrecked so many ships on the Yorkshire coast in the last week of October, strewed the shores with a rich harvest of marine spoils for the zoologist. I went down to Redcar the following week, in the anticipation of adding to my collections, and was well rewarded.



Fig. 1.—Razor-shell
(*Solen ensis*).



Fig. 2.—*Tapes fullastra*.



Fig. 3.—Dog-whelk
(*Purpura lapillus*).

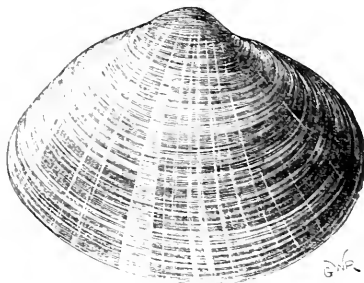

Fig. 5.—*Macra stultorum*.



Fig. 6.—*Trochus zizyphinus*.

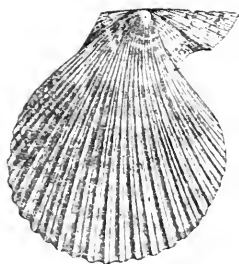

Fig. 4.—*Pecten varius*.



Fig. 7.—*Natica monilifera*.

numbers of the handsome *Cyprina Islandica* of all sizes lay about. *Lutraria elliptica*, with its great siphons, had been torn up in numbers from its muddy home in the Tees, and was eagerly gathered for bait by the fishermen. Very common also were *Tapes fullastra*, *Donax anatinus*, *Macra subtruncata* and *solida*, *Artemis lineta*, and *Lucinopsis undata*. I gathered live specimens of *Psammobia Ferrocensis*, *Venus striatula* and *Cardium echinatum*. Two shells seldom seen on this coast, though common in

The stretch of sand from Redcar to the Tees mouth was at various points covered with deposits of small coal, and among these were a great number of shells, zoophytes, &c., all of them alive. The shore-collector is seldom rewarded with anything but dead shells, but here one might reap the advantages of dredging, minus its unpleasant accompaniments of sea-sickness and expense. Of course live specimens of *Macra stultorum* and *Solen ensis* were in profusion. Great

the south, occurred, viz. *Tapes virginica* and *Artemis exoleta*; *Pholas crispata*, *Saxicava rugosa*, *Syndosmya alba*, *Tellina tenuis* and *fabula*, *Scrobicularia piperata*, *Modiola modiolus*, *Pecten opercularis*, *varius* and *fusio* complete the list of bivalves I obtained.

The univalves were less numerous and interesting. Great live specimens of *Fusus antiquus* were common, and dead ones of *Fusus Islandicus*. *Buccinum*, *Purpura*, the common species of *Littorina*, *Lacuna pallidula* and *vineta* of course abounded. There were many fine live specimens of *Natica monilifera* and dead ones of *Trochus zizyphinus* (not common in Yorkshire) *Turritella communis* and *Patella pellucida*.

A scrutiny of the sand at home revealed *Rissoa far-a* and *striata*, and some small *Cylichnas*. I have also found on this coast *Scalaria Trevellyana*—*Aporrhais pes-pelicanii*, *Rissoa ulva*, *Cyprina Europea*, *Tornatella tornatilis*, *Mya arenaria*, *Synedrymya tenuis*, &c. Besides these shells, there were numerous live crabs. *Corystes Cassideolanius* was in abundance—also *Ilyanaraneus* and *coarctatus*, *Portunus variegatus* and *Portunus defurator*. Sea-urchins and star-fishes abounded, specially *Solaster endeca*—together with a multitude of beautiful marine objects, which I cannot specify—all in that beautiful state of preservation which characterises the objects cast up on this long stretch of smooth beach.

W. E. HILL.

THE NEWER PLEISTOCENE PERIOD IN ENGLAND.

THE following is an abstract of an important paper read before the Geological Society by Searles V. Wood, F.G.S.

The author divided this part of his subject into five stages, commencing with

Stage I. The Red Crag and its partially fluvio-marine equivalent. The Red Crag he regards as having been a formation of banks and foreshores mostly accumulated between tide-marks, as shown by the character of its bedding. The southern or Walton extremity of this formation, which contains a molluscan fauna more nearly allied to that of the Coralline Crag than does the rest of it, became (as did also the rest of the Red Crag south of Chillesford and Butley) converted into land during the progress of the formation; while, at its northern or Butley extremity, the sea encroached, and an estuary extending into East Norfolk was also formed; during which geographical changes a change took place in the molluscan fauna, so that the latest part of the Red Crag proper and the earliest part of the fluvio-marine (both containing the northern species of mollusca and those peculiar forms only which occur in older glacial beds) alike pass up without break into the Chillesford sand and laminated clay, which form the uppermost member of the formation. He also regards the principal river of this estuary as flowing into it from North Britain, through the shallow pre-glacial valley of Chalk, in which stands the town of Cromer, and in which the earlier beds of Stage II. accumulated in greatest thickness. The forest and freshwater beds, which in this valley underlie the beds of Stage II., he regards as terrestrial equivalents of the Red Crag; and having observed rolled chalk interstratified with the base of the Chillesford clay in Easton-Bavent cliff, he considers this to show that so early as the commencement of this clay some tributary of the Crag river was entered by a glacier in the chalk country, from which river-ice could raft away

this material into the estuary. He also regards the copious mica which this clay contains as evidence of ice-degradation in Scotland having contributed to the mud of this river.

In Stage II. he traced the conversion of some of this laminated clay, occupying sheet 49 and the north-east of sheet 50 of the Ordnance map, into land, the accumulation against the shore of this land of thick shingle-beaches at Hale-worth and Henham, and the outspread of this in the form of seams and beds of shingle in a - and originally (from its yielding shells in that region) called by him the Bure-valley bed, and which Professor Prestwich recognised under the term "Westleton Shingle." As the valley of the Crag river subsided northwards as the conversion of this part of the Chillesford clay into land occurred, there was let in from the direction of the Baltic the shell *Tellina balthica*, which is not present in the beds of Stage I. The formation thus beginning he traced southwards nearly to the limit in that direction of the Chillesford clay about Chillesford and Aldborough. The Cromer Till he regards as the modification of this formation by the advance of the Crag glaciers into the sea or estuary where it was accumulated, such advance having been due partly to this northerly subsidence, but mainly to the increases of cold. Then, after describing a persistent unconformity between this Till and the Contorted Drift, from the eastern extremity of the Cromer cliff (but which does not appear in the western) to its furthest southern limit, he showed how the great submergence set in with this drift, increasing much southwards, but still more westward towards Wales. The effect of this was to submerge the area of Red Crag converted into land during Stage I., so that the Contorted Drift lies upon it fifty feet thick, and to cause the retreat of the ice which had given rise to the Till to the slopes of the Chalk Wold; whence masses of reconstructed chalk were brought by bergs that broke off from it and were imbedded by their grounding in this drift, contorting it (and in those parts only) by the process. He then traced, in the form of gravels at great elevations, the evidences of this submergence southwards and westwards, showing it to have increased greatly in both directions, but mostly in the western; and he connects those gravels with the Contorted Drift by the additional evidence of one of these marl masses, in which he found a pit excavated near the foot of Danbury Hill, in the London-clay country of South Essex, and which hill is covered from base to top by this gravel. The gravel which thus covers Danbury Hill, of which the summit has an elevation of 367 feet, rises in North Kent to upwards of 500 feet; to between 400 and 500 feet on the Neocomian within the Weald; to 600 feet in North Hants (where it overlooks the Weald), and also in Wilts, Berks, and the adjoining parts of Bucks: to 420 feet in South Hants; to 540 feet in Oxfordshire; to 400 feet in Cornwall; to upwards of 700 (and perhaps 1000 and

more) in the Cotteswolds ; to 1200 feet in Lancashire, and to 1340 feet in North Wales. Eastwards, through Kent towards France, their elevation falls, and in the North of France appears to be about 130 feet ; from whence the evidences of the submergence are furnished northwards by the Campinian sands and the diluvium of North Germany and Holland.

In Stage III. the author traced the rise from this depression, the increase of the ice from the greater snow interception caused by it on the Pennine chain, and the consequent advance of the glacier- or land-ice. This advance gave rise to the Chalky Clay, which was the morainic mud-bank which preceded this glacier, and was pushed by it as it advanced, and the land rose partly into the shallow sea (where it covered and protected for a time the gravel which was synchronously forming there), and partly on to the land ; and by the aid of maps he showed the islands that were overwhelmed by it. He then showed, by a line on a map, the limit up to which this ice, as it thickened, cut through and destroyed this first deposited moraine and the gravel which it had covered, as well as such beds of Stage II. as were formed there, all this material being pushed on to add to later deposited moraine. Outside this line the gravel, for the most part, remains undestroyed, its contents, particularly in the uppermost layers, showing that it was fed by the approaching moraine. By the level at which the junction of this gravel with the moraine clay occurs he traces the position of the sea-line at this time (towards the end of the formation), and finds it to rise along the south-eastern edge of the clay, from 40 feet in N.E. Suffolk to 160 feet in South Essex, and from that along the south-western edge to upwards of 350 feet in North Warwickshire and the parts of Northamptonshire adjoining, all this agreeing with the original increment of submergence in Stage II. He then showed, from evidence afforded by the Yare and Gipping valleys, that this ice, ceasing to advance in East Anglia, shrank into the valleys of that district, exposing the moraine it had previously laid down to the growth of vegetation, and issued only through these valleys to the sea. The Hoxne palæolithic brickearth he regards as the deposit of a lagoon produced from the interception of the drainage of this surface by the glacier-tongue thus passing through the Waveney valley. The Brandon palæolithic brickearth he regards as connected with the same state of things.

In Stage IV. he described the plateau and cannon-shot gravels of Norfolk as resulting from the washing out of the morainic clay by the melting of this ice, which, though shrunken into the valleys of the East of Norfolk, still lay high and in mass in West Norfolk ; and showed that, by having regard to the different inclination of the land thus traced, the position of this gravel is reconcilable in no other way. The cannon-shot part of it he attributed to

the torrents pouring from this high-lying ice over the west side of the Wensum valley ; and the plateau gravels to the deposition of other parts of the same spoil carried into East Norfolk at the commencement of the process and while the ice had not thawed out of the valleys, this gravel afterwards, as the valley-ice thawed being deposited in them. He also traced the excavation of the trough occupied by the Bain and Steeping rivers in Lincolnshire to the same cause. The finer or sandy part of this material has an extensive spread in South-west Norfolk, forming thick beds ; and in a thinner form spreads over North-west Suffolk, where it wraps the denuded edges of the Hoxne and Brendon palæolithic brickearths.

In Stage V. he traced the line of gravels that overlie that Chalky Clay where this clay entered the sea. This entry to the sea over the Severn drainage-system took place by way of the watershed between the Welland and Avon, and by the valley of the latter. Its entry into the sea over the Thames system was by way of the watershed between this system and that of the Great Ouse in South Bucks, as well as by the valley of the Colne, Lea and Roding, and over the lower part of the watershed in South-east Essex. Its entry into the North Sea was by the valleys of the Blackwater, Gipping, and other Essex and Suffolk valleys, the entry of the Yare and Waveney being far out beyond the present coast-line. He also traced, by similar evidence, the extent to which the sea entered the Trent System after the ice vacated it. This line of gravel (after allowing for the case that the elevation of the junction of the gravel beneath the clay represents that of the sea-bottom, while that over the clay more nearly represents that of the sea-top), he showed to correspond with that of the junction of the gravel beneath the clay so far as this is not destroyed in the parts where the ice did not shrink into the valleys ; and it also agrees with this line, supplemented by the amount of rise in the interval where the ice did so shrink. Along the south-western edge of the clay this line of gravel, subsequent to the clay, falls from near 400 feet in Bucks to 150 feet in South Essex ; from whence northwards along the south-eastern edge it falls uniformly to Ordnance datum in central East Suffolk, and probably continued to fall to 100 feet or so further to the extreme point where the ice from the Yare valley entered the North Sea far beyond the present coast. Along the north-western edge of the formation this line falls northwards in a corresponding way to that on the south-eastern edge, save that, starting there from near 350 feet, it does not fall below, if even quite down to Ordnance datum near the Wash. He then traced the extent to which the sea on the west, deepening in that direction in accordance with the original depression of Stage II., entered the valleys of the area covered by the ice of the Chalky Clay as this vacated it ; the carrying out through the Welland and Avon valleys of the

red and white chalk spoil of the Bain-Steepling trough, and its deposition in the Cotteswold gravel up to the high level, coming from the Avon valley over the Gloucestershire water-parting into the valley of the Evenlode, a part of the Thames System.

All river-gravels north of the point where the line of gravel over the clay sinks below Ordnance datum, he regards as concealed below the alluvium, and at depths proportional to the fall of that line. Examining in detail the grounds for the contrary opinion heretofore held by himself and by geologists in general, that the great submergence succeeded the principal glaciation of England, he rejected that opinion; and no longer regarding the basement clay of Holderness (with its ancient molluscan facies) as identical with the Chalky Clay, but as moraine synchronous with the Till of Cromer, he considered the gravels with shells at extreme elevations in Lancashire to have preceded all glacial clays but these, and to have escaped destruction by the advance of the ice during the rise only at the south end of the western slope of the Pennine chain, those on the eastern having been wholly swept away; but that gravels were deposited on the east side of the Pennine after the dissolution of the Chalky-clay ice up to the reduced height of the sea-level at that time, and so far as the ice of the purple clay allowed the sea to come. He then relinquished the opinion formerly held by him that the passage of the Shap blocks was due to floating ice, and referred this to the land-ice crossing the Pennine chain consequent upon greater snow interception from the progress of the rise; and to the same cause he referred the drift which rises high on the eastern slope of the Pennine ridge north of the Aire. To this crossing of the ice having diverted first a part and then the whole of the ice supply of the Chalky-clay glacier, he attributed first the shrinking of that glacier into the valleys in East Anglia, and afterwards its dissolution by the agencies always rife in the Greenland ice (but which are there balanced by continual reinforcement), when by this diversion its reinforcement by ice from the Pennine chain ceased. The purple clay of Holderness, being thus in its lowest part of Holderness coeval with the valley-formed portion of the Chalky Clay of Norfolk and Suffolk (or "third Boulder-clay" of Harmer), was the moraine of this invading ice, which, after crossing at Stainmoor, divided against the eastern moorlands of Yorkshire; and one branch going north of these moorlands though the valley of the Tees, sent off an arm down their eastern flank, the moraine from which is the narrow belt of purple clay which skirts the Yorkshire coast north of Holderness, and spreads out wider in Holderness. This arm from the Chalky-clay ice not having, in consequence of the westerly increment of depression, descended the eastern slope of the Wolds, found sea there covering the basement clay of Holderness, in which sea it stopped between the Humber and the Wash, by means of which the

lower part of the purple clay up to the level of about 150 feet, contains intercalated in it beds of sand and gravel, and contains shells and shell-fragments, as does the Lancashire clay similarly extruded beneath the sea. The other branch came south along the western flank of the east moorlands and through the Vale of York, where it ended, and became stationary in the sea as this entered the Trent system on the final dissolution of the chalky-clay glacier.

Mr. Wood discovers no trace of anything like the intercalation of warm periods up to the stage with which he concludes this part of his memoir: he leaves the description of the later beds, as well as an examination how far arboreal vegetation and the coexistence of Pachyderms and Proboscideans can be reconciled with the contiguity of extensive land-ice, for the concluding part of it.

NOTES ON SOME OF OUR SMALLER FUNGI.

By GEORGE MASSEE.

IN a work on the order of fungi called *Myxogastres*, or more recently *Myxomycetes*, published by Professor De Bary, during the year 1865, that celebrated mycologist announced as the result of his investigations that these organisms were not plants, but animals, belonging to the Protozoa; since that time the professor has changed his opinion, and at present acknowledges them as members of the vegetable kingdom. In the presidential speech delivered before the British Association for 1879, Professor Allman evidently considers the *Myxomycetæ* as being more closely allied to animals than plants; he says, "They have generally been associated by botanists with the fungi, but though their affinities with these are perhaps closer than with any other plants, they differ from them in so many points, especially in their development, as to render this association untenable." The structure which has given origin to the idea of animal affinity, is, according to the Professor's account, somewhat as follows. When the spores are placed under favourable conditions the cell wall is ruptured, and the naked protoplasm passes out. This speck of protoplasm has a nucleus, with a nucleolus, a vacuole, and possesses the power of locomotion, effected by the protrusion of pseudopodia; it is indeed a veritable *amœba*, feeding on solid organic particles taken into its substance. Eventually several of these bodies coalesce and form a mass of naked protoplasm, known as a "plasmidium," which still possesses the power of locomotion, envelopes solid particles of food, and after a time, breaks up into a number of sacs, or sporangia, containing spores, usually mixed with threads which constitute the capillitium. It is much to be regretted that the Professor did not mention the species pre-

senting such unusual and interesting phenomena. Such exceptional development does at first appear to place the organisms exhibiting it outside the vegetable boundary line, but a little reflection is sufficient to show that the difference is only one of degree. Every vegetable cell, animal also, originates as a naked speck of protoplasm; in phanerogams a cellulose coat is developed so early that the amoeba is imprisoned at once in a comparatively rigid shell which prevents all individual motion. That this early imprisonment of the protoplasm is the only reason for the absence of movement is proved by the fact that in certain instances similar movements have been observed in flowering plants, as by Brown in the "corpuscula" of the Cycadææ, and more recently by Mr. F. Darwin, who has observed the emission of pseudopodia from glandular hairs near the base of the leaf of the teasel. In the vascular

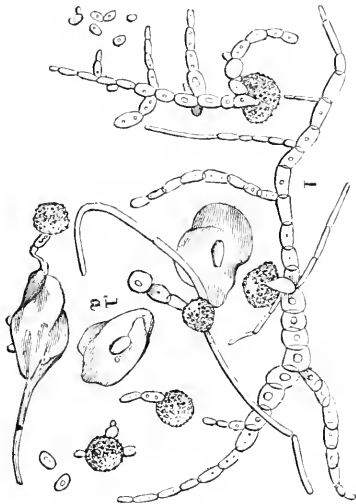

Fig. 8.—Germinating spores of *Spumaria alba*; a, 1, Resting-spores.

cryptogams, motile protoplasm under the form of antherozoids is common, whereas, in the thallophytes, cells devoid of a cell-wall during some stage of their existence, are yet more frequent. There are two types of naked cells met with in the vegetable kingdom, those concerned with reproduction, known as antherozoids, swarm spores, etc., they never envelope solid food, and locomotion is effected by means of cilia or flagelliform appendages; the second and less common is the amoeboid form, which always belongs to the vegetative system, and moves by means of temporary pseudopodia. The best authorities are by no means agreed as to the specific individuality of the protoplasmic bodies classed with the rhizopoda and known as amoebæ; indeed, the bulk of evidence seems to favour the view that they are transitory stages in the development of higher organisms, although at present all the kinds have not been

correlated with the perfect and ultimate form. Taking this view, we may regard an amoeba not as an entity but as the universal starting-point of all organisms, the identification of which, as a species, can only be proved by its subsequent life-history, and the most highly-specialised animal or plant is in reality composed of a collection of imprisoned amoebæ in various stages of differentiation to serve special purposes. In most orders of fungi, the mycelium permeates the matrix for the purpose of absorbing food and its comparative or total absence in the present order accounts for the prolonged amoeboid

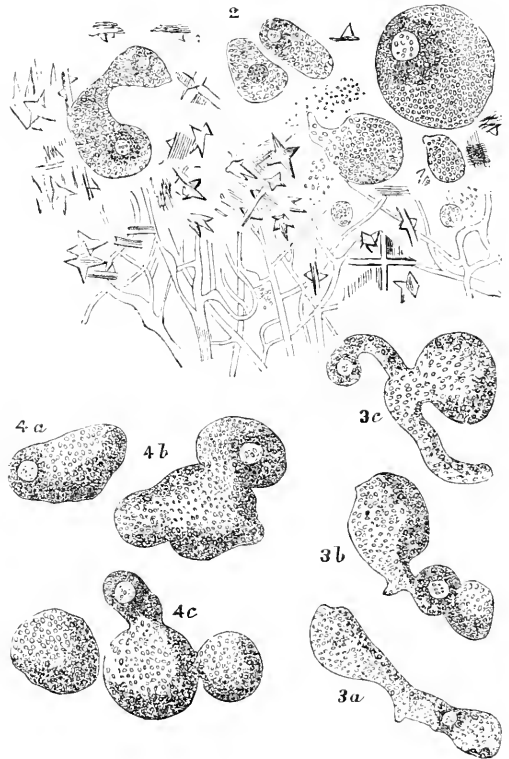

Fig. 9.—Amoeboid cells with crystals and capillitium; 3a, 3b, 3c, The same cell at intervals of five minutes, showing change of shape; 4a, 4b, 4c, The same cell at intervals of half-an-hour, just before breaking up into spores.

stage, the plasmodium being nothing less than the vegetative part of the plant, no food being absorbed or assimilation taking place after the formation of sporangia.

During the autumn of 1879 a quantity of spores of *Spumaria alba* (Bull.), taken from a perfectly fresh specimen, were placed along with damp moss in a small porous vessel, which was sunk in wet sand under a bell jar. On the third day some of the spores had commenced to germinate, and at the expiration of a week all had given origin to branched threads, as shown in fig. 8. The threads, which

usually appear at two or three points on the surface of the spore, were of two kinds; some slender, unbranched, and with very few septa, having the appearance of mycelioid threads, others originated as an oval cell; this gave origin to a second, by gemmation, until a torula-like string was developed. From this chain, branches of a similar structure, increasing in length by additions to the apex, were given off at right angles, always originating from a septum of the main branch. In about two days the oldest cells of the chains contained a very bright, sharply-defined nucleus, the constrictions became deeper, and soon the chains broke up into separate cells, which, in the

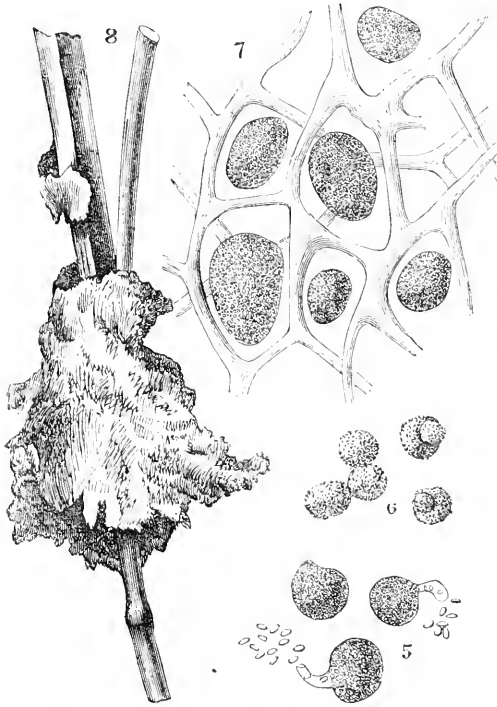

Fig. 10.—5, Cells containing sporules; 6, Spores; 7, Showing origin of capillitium; 8, *Spumaria alba*, natural size; all the other figures magnified 500 diameters.

course of twenty-four hours, had increased to many times their original size; owing to the swelling of the cell wall, the nucleus, or bright speck, so conspicuous before the change, disappeared or became converted into a homogeneous oval body in the middle of the swollen mass; sometimes two oval bodies were present, possibly corresponding to the two nuclei that were present in some of the torula-like cells. The swollen cell-wall was somewhat uneven and hyaline. Not the slightest sign of amœboid movement was observed up to the formation of the large resting-spores last described, which remained unchanged throughout the summer, their progress being noted from time to time by removing a few on

the point of a moist brush rubbed amongst the heap of moss. No change had taken place at the end of August, 1880, when they were examined for the last time, and a few days afterwards small portions of a whitish watery-looking substance appeared on the moss, which kept on increasing in size, until, on the second day after its appearance, it presented the usual characters of immature *Spumaria*. Whether this change was preceded by any movements remains to be discovered. This is the stage at which the plant first shows itself as a mass, consisting of a clear liquid, crowded with very minute whitish granules, exhibiting Brownian movements; very soon a structureless pellicle forms on the outside, which is covered with crystals of lime. The first indication of organization is met with in the cuticle, which presents very minute and imperfect cells, the crystals at the same time increasing in number and size.

The production of these crystals, corresponding to the raphides of flowering plants, proves two things: 1. That the plasma is at first chemically all alike, because when a pellicle has formed and is coated with crystals, if a portion from the centre of the mass be exposed, a skin and crystals again form, and this may be repeated several times. 2. That the first changes in the plasma are due to physical causes, evaporation, by which certain elements holding the salt of lime in solution have disappeared, enabling the crystals to form, and favouring at the same time, the formation of the external pellicle, which remains for a considerable time without trace of organization.

After the formation of the cuticle the internal pulpy homogeneous mass presents numerous bright specks, each being a focus round which a portion of the plasma resolves itself into a large naked cell of irregular shape. This is the "plasmodium," the large cells just formed exhibiting during the first day very active amœboid movements, changing their shape completely within five minutes, the original bright nucleus either disappearing or changing into a large round vacuole, carried along with the most active part of the cell. At the end of the third day all movements had ceased, the cells assumed a spherical shape, bright nuclei appeared amongst the granular contents, and within twenty-four hours of this change the cell wall was absorbed and the mature spinulose spores were free. During the amœboid stage gobular cells, furnished with a long neck, appeared in small quantities; they contained minute oval sporules, which escaped, when mature, through the neck in large quantities; some were kept for a time in a damp cell, but no change was observed.

The capillitium is formed as follows: When the amœboid cells form round the bright nuclei in the homogeneous plasma, they are not crowded, but portions of plasma not used for the formation of the cells remain and constitute the capillitium; immediately after formation the cells shrink consider-

ably, presenting the appearance shown in fig. 10. If pieces of irregular size and outline be cut out of a sheet of paper, at short distances from each other, the removed pieces would correspond to the amœboid cells, and the remaining part of the paper to the capillitium.

In *Fuligo varians*, Sommf. (= *Æthaliium septicum*, Fr.), the spores on germination send out threads, on which the branches are arranged in irregular whorls or tufts, and from the tip of each branchlet a nucleated cell is abstracted, which probably changed into a resting-spore, but that it does so has not been observed. Threads have also been noted as the first product of germination in other species, but in not a single instance out of a considerable number of species experimented upon have motile cells been observed to originate directly from a spore, yet, according to the best authorities, such is the rule; nevertheless, we would suggest the possibility of mistaking that stage at which the plasmodium first shows itself, which in *Spumaria* is the motile period, as the immediate result of the germinating spores. The spores of both species mentioned above, when taken immediately after their formation, germinate readily on a glass slide in a damp atmosphere, but if they have been allowed to dry germination is much retarded, or altogether checked.

(Concluded.)

NATURAL HISTORY IN A CLAY-FIELD.

By CHARLES FRANCIS YOUNG.

THE following notes were made during a short walk in a Manchester clay-field, and may be of interest as showing what may be done in the study of nature under the most unpromising circumstances. For, although a hard clayey soil, such as that which existed at our place of observation, may justly be considered most unfavourable for the production of animal and vegetable life; it will be found on examination to abound in many of Nature's treasures, however barren it may seem.

We were not long on the scene of our evening stroll, when we might have been seen poking among some stones lying at the margin of a large pool of water, or rather small pond. Of course we found under them beetles; for example, that little black fellow with light yellow legs, *Anchomenus pallipes*, scuttled about in considerable numbers. It is to be met with in nearly all wet places, fulfilling some good purpose, or it would not be there. Multitudes frequently congregate among the stones and débris of dried-up ditches, &c.; indeed this situation will generally be found—as we can aver from experience—very fruitful in insect life, especially in spring. And here, it may be mentioned, we have often taken the beautiful sparkling-green *A. marginalis*, which is a characteristic inhabitant of clay-fields.

Another yet smaller insect, belonging to a large genus of fierce little beetles, called *Bembidium littorale*, dashed about, after the manner of its kind, at a marvellous speed on being discovered. Several species of what are popularly known as "ground beetles" were somewhat numerous. These, like *littorale*, do good service in keeping within due bounds the multiplication of certain insects. Coming forth at night they find wherewith to appease their appetite in the various nocturnal visitors to the water's edge. They comprise chiefly the genera *Pterostichus* and *Carabus*, although the latter was not represented in our field. Of the former that were present may be named the species *niger*, *madidus*, and *diligens*. Large numbers of perhaps the most common of ground beetles, *Nebria brevicollis*, were met with; almost every stone we lifted exposed at least one specimen. In early spring it appears with the first *Geodephaga*, when white and soft individuals—those that have just emerged from the pupa case—are frequent.

Turning our attention to a few of the inhabitants of the pond itself on the banks of which we have hitherto been standing, the most conspicuous animals are the Entomostraca. First comes the curious-shelled *Cypris*, which swarmed in countless millions and coloured submerged objects rust-red. The body in this genus is enveloped in two shells or valves hinged together, and into the shelter thus formed the animal suddenly retreats on the slightest possible alarm or imagination of alarm. We should advise our readers to keep some of these queer creatures in a glass of water, to watch their funny ways. Thus if one be touched or even approached with a stick when merrily spinning through the water, instantly its legs disappear, and something like a minute mussel sinks to the bottom! This resemblance is owing to the two valves being exactly similar to those of a young mussel, only smaller, and tightly closed in the same manner. The female deposits some twenty or more tiny round eggs on water plants, fastening them by means of a glutinous secretion. In twelve hours she completes her arduous task. After four and a half days the eggs hatch, and the young issue forth to seek their fortunes in the happy world of waters.

The pond contained immense numbers of water-snails, and it may not be out of place here to inquire into their uses in Nature's realm, for assuredly they exist not so plentifully in every pond without fulfilling some definite object. In the first place they are the great scavengers of ponds, ditches, and other collections of fresh water, devouring all manner of putrescent vegetable matter. Secondly, their enormous quantities of spawn serve as food for fish as well as for aquatic beetles, larvæ, &c., also when dead they are eaten by the former. Again—they secrete lime from the water, convert it into the material of shell (carbonate of lime) which after the death of the mollusc falls to the bottom, decomposes, and

nourishes the ground for water plants, or if the pond dries up, as often happens, leaves a soil more suitable for land vegetation. The most abundant species was *Limnaea stagnalis*, with its elegant spiral shell.

The numerous water-beetles that were paddling about in search of prey next demand our notice. For example, that brightly-coloured insect *Polyphus variegatus* was seen swimming in its own peculiar fashion, or rather the general fashion of little aquatic beetles. It is remarkable that the brightest specimens of *variegatus* occur in clear rapid streams, while the duller brethren are found in muddy water. Then there was the common little *Cnemidotus cœsus*, painted more elaborately than the last, although only one-sixth in. in length. The punctured elytra are worthy of being well examined with a strong lens, when details otherwise unrecognisable are clearly brought out.

Only one other inhabitant of this pond can be described—the Caddis-worm. The species was *Phryganica grandis*, whose large case is made of equal-sized pieces of leaves, &c., arranged spirally, and so as to form a regular cylinder. Many old cases of larvæ which had perhaps become perfect flies, lay on the muddy bottom. We have found the winged insect on some palings near the water.

Having seen some of the population of this pond, we proceeded a short distance and came to a sort of ditch about eighteen inches wide, overgrown with vegetation. The most conspicuous plant was the tall Water Plantain (*Alisma plantago*) with its delicate white flowers standing eighteen inches above the water. And as might be expected the American Water Weed (*Anacharis alsinastrum*) was not absent. The well-known Pond Weeds (the *Naiadaceæ*) also grew in abundance, sheltering, together with the American weed, vast multitudes of different aquatic beings, such as the Entomostraca, insects larval and perfect, and animalcules. Considerable numbers of horse-leeches abode in this ditch; some might have been seen gracefully making their way through the water by a peculiar serpentine motion of the body; others were crawling upon the bottom, or over obstacles, while many lay lazily in the mud, apparently doing nothing but sleeping, for, be it remembered, a leech has an extraordinary appetite, and finds it necessary to indulge in long periods of inactivity to digest the enormous meal it takes at one occasion. The common Horse-leech (*Aulostoma gulo*) lives upon grubs, snails and earthworms. Contrary to the popular belief, this species (the commonest of British leeches) cannot inflict a wound on the skin, nor suck the blood. Sometimes it voluntarily leaves the water, and is found on the pond's edge in the mud, or under stones lying near.

The ditch contained newts and frogs; it also harboured the water-scorpion (*Nepa cinerea*). Of the beetle inhabitants we cannot do more than mention two which were plentiful—*Agabus bipustulatus*, and

A. paludosus. Then there were snails, but some species have already been treated; the Cypris, which has also been given; while Water Boatmen darted rapidly through the water with their oar-like hind legs, making quite a commotion in the still fluid; which in some places was coloured deep green with algae and swarmed with living objects for the microscope.

Leaving this ditch we walked on a few yards and reached a collection of flat stones on the clayey ground, which always prove to be storehouses for the Geodephaga. First comes the lively and elaborately-carved *Notiophilus biguttatus*, recognised by the flat polished band and circular mark on each elytron. Its length is only about one-sixth of an inch. The active *Anchomenus dorsalis* with its long reddish legs was abundant; the thorax and head are of a metallic green lustre; the elytra dull green with a patch of red near the base of each, so that it is rather a pretty insect. *Clivina fessor*, *A. pullifex*, *P. madidus*, *N. brevicollis*, &c., are some more examples of what beetles we found. Slugs abounded here, and frogs were numerous, while spiders and earthworms complete the list of ground-dwellers, except some larvæ which we could not identify.

Near this place was to be seen a miniature bog overgrown with dozens of fine water-plantains; the bed, so to say, of the bog itself being quite choked up with flourishing bog-moss, save where the water was appropriated by myriads of a species of Cypris.

Here we reached the terminus of our journey of about two hundred yards in as barren a locality as we could well have selected, and sauntered home, having, however, seen objects sufficient to engage the attention during the leisure time of several succeeding evenings. And it must be distinctly understood that we have only described some of the animals we chanced to meet during the walk in question, and do not intend this to represent the entire fauna of clay-fields in general, which, in truth, is more extensive than might be imagined. If such, then, be the abundance of life in as sterile a place as that named in our title, what shall we say it is in regard to country lanes, fields and forests?

BORAGO OFFICINALIS.—In a recent number of SCIENCE-GOSSIP, Miss Colson impugns the correctness of my statement as to this species not being indigenous, but Bentham appears scarcely to accept it as such when he says it is found in "waste grounds, indigenous to the east Mediterranean region, but long cultivated in European gardens, it has become naturalized in many parts of central and western Europe, and is said to be fully established in several counties of England." Again, Trimen in his "Middlesex Flora," and H. C. Watson do not consider it so truly naturalized as many species in the same category. Milne, in 1793, first recorded it as such.—*S. Dillen*.

ON THE ORIGIN AND STRUCTURE OF VOLCANIC CONES.

By DR. H. J. JOHNSTON-LAVIS, F.G.S., &c.

It is observable in certain volcanoes that the lava frequently strewn around after an eruption contains more or less perfect spheres, consisting of a hard external coat and more scoriaceous contents, and these from their resemblance are known as volcanic bombs. Their contents may be divided into two classes :

1. Scoriaceous vesicular lava, identical in composition with the external shell.

2. Miscellaneous, such as altered masses of lapilli, loose blocks of foreign materials caught up in the current of lava. These balls are generally considered

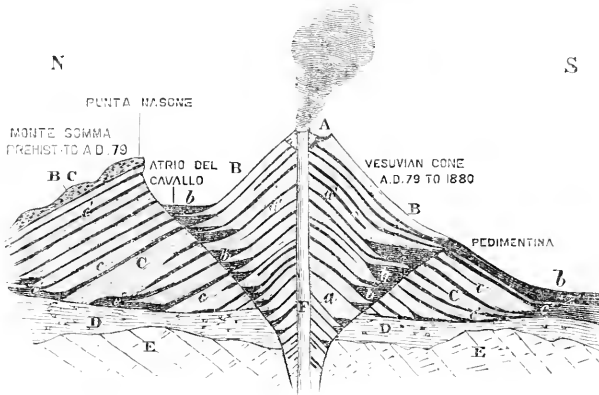

Fig. 11.—A, Cone of eruption built up in the crater of 1873; B, Vesuvius proper, this cone composed of alternate lava streams *b*, and lapilli *a*, built up since A.D. 79. It occupies the crater of Somma; C, This is composed like the latter, of alternate beds of lava *a'* and lapilli *c*; B, C, Deposits of pumice and trachytic fragments, &c., capping all exposed parts of Somma derived from the eruption of A.D. 79; D, Beds of late tertiary period containing shells existing at present in the Mediterranean; E, Basis, consisting of denuded surface of Apennine limestone (cretaceous ?); F, Chimney or vent.

to be formed by the masses being ejected to great heights and cooling as they whirl through the atmosphere.

This seems improbable, as on falling they would inevitably smash into a thousand fragments. It would appear more likely that they are simply concretionary in structure around a nucleus of low temperature, solidifying on the surface a layer forming a crust of lava. Let us now direct our attention to the minor particulars, such as the changes of the crater, and metamorphism, or alteration of the already-ejected materials. If the volcano has already reached some considerable dimensions, effected by one or many eruptions, we shall find that certain definite changes have taken place in the chimney. The eruption is reduced in force, there are spasmodic puff-like ejections of lapilli, and occasionally small streams of lava emitted. Before entering farther into our

subject we must return a step or two. It has been mentioned that the inclination of the outer slope of the cone is that of the "angle of repose" of the rock fragments. We should therefore conclude that the inner or chimney side would be much the same. This, however, is not generally the case, the inner retaining a greater slope than the outer. It is due chiefly to the fusion, or cementing together of the fragments by the intense heat and the presence of lava, which, so to speak, solders each mass to its neighbour. Each is retained in position by the fluid column occupying the internal cavity, and when this has disappeared the temperature is necessarily lowered, and thus there is formed a lining to the tube by the semifusion of its superficial components. Nevertheless, the upper edges crumble away, falling into the vents, thence to be again ejected. This process

continually repeated will result in the majority of the lapilli falling on the outer slope, leaving the chimney of the form of a true funnel, that is to say, a cavity whose sides descend for a certain distance at a moderate angle, say roughly 45° , and then suddenly increasing to nearly a perpendicular. The consequence of this is a basin-like cavity of sloping walls with the volcanic vent situated at its centre. The materials now ejected by the volcano, supposing it to be in a comparatively quiescent state, will tend to build up a fresh cone occupying this basin. It is not a thing unknown for such a concentric arrangement of cones and craters to be extended to many repetitions. Let us take for example the crater of Somma (fig. 11) occupied by the cone of Vesuvius, and this again enclosing within its own walls, the little cone of eruption, A. We may perhaps represent it thus:—

A : B : : B : C. Such a repetition is recorded as being quadruple, thus giving to the mountain near its apex, a step-like appearance.

From various irregularities and accidents, the vent may shift its position and become excentric, and thus produce an overlapping of the newer cone upon the older. This is well illustrated by the island of Vulcano at this moment. In fact, the little hill of scoria surrounding the active bocca, or mouth, of Vesuvius is situated right away to the E.N.E. of the crater, and consequently, the lava streams are more abundant on that side of the mountain (fig. 12).

The escape of the lava and vapour is the next thing to require our attention. Little more, however, has to be said. The lava rarely mounts the edge of the cone of eruption, generally escaping near its foot, by forcing itself a passage through the loose materials or some pre-existing fissure according to hydrostatical laws. The vapour is the real agent in keeping a

vent clear, as the vast bubbles rise through the viscid mass, bursting at its surface, thus keeping up the temperature of the lava column which it has traversed by the heat brought up from below, and at the same time preventing any permanent stagnation therein. The vapour is generally to be seen carried away by the wind in beautiful white clouds. When, however, the eruption is of a more intense kind, these vast volumes mount into the air at great heights, appearing like a column of fire by night, carrying with

an irregular imbricated roll-like appearance to the exterior. The surface is rapidly covered by brilliantly-coloured sublimates, and the fumarole then presents a very pretty spectacle. The author lately was able to thoroughly watch the formation of such a fumarole some 20 feet high, its decadence and disintegration extending over a period of eight months. On passing the arm down the central tube (i.e. the fumarole was extinct) it could be felt very regular and smooth, and having a pretty uniform bore of about nine inches.

After one slight eruption, the fumarole in question presented a very curious phenomenon. Immediately (about two to three seconds) after the explosion from the main vent, there came three terrific bangs, with a spout of vapour from its apex, the last one shooting out small fragments of still liquid lava.

This continued without variation for six hours that the author remained in the crater. The spire-like form may be varied according to surrounding circumstances. If the escape take place along a fissure it will assume on occasions a mitre-like form. There are many other varieties in form, depending on the variability of surrounding circumstances.

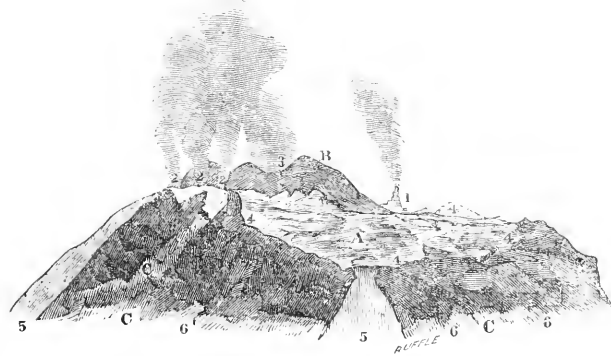

Fig. 12.—View of the crater of Vesuvius as seen from the highest point of Monte Somma, on July 1st, 1880. A, Crater; B, Cone of eruption; C, Slopes of cone. 1, Spire-like fumarole; 2, Irregular fumaroles along a fissure; 3, Bocca Grande, or vent; 4, Edges and walls of crater (full); 5, Ash beds composing cone; 6, Cooled lava streams all thrown out since November, 1879.

them lapilli and ash often thousands of feet above the mouth of the volcano, then suddenly spreading out these vast clouds give rise to the well-known appearance of the Italian pine-tree. At the same time, from every available fissure are seen to issue little columns of vapour, adding their small share to the grandest visible display of force that nature has provided for our amusement or peril.

This brings us to the next point of interest, the formation of fumaroles, which may be considered as the effect of these two agents last spoken of acting together. In fig. 12 are seen two varieties, one assuming a spire-like form. These may make their appearance anywhere on the volcano, but are usually situated in close proximity to the vent. Their size varies from twelve inches in height upwards; generally from three to thirty feet. They are commenced in the major number of cases in the fissured crust recently formed over still flowing lava. Here the vapour escapes in spasmodic puffs, and by its force, a small quantity of lava is forced up and spread out around the aperture, which rapidly cools. It is followed by another puff, and another oozing of lava above and around the aperture of the first. In this manner, layer by layer is built up, thus giving

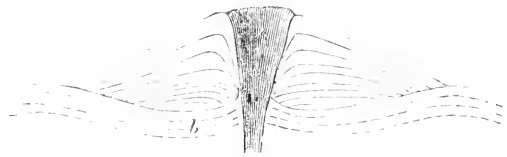

Fig. 13.—Crater of deposition.

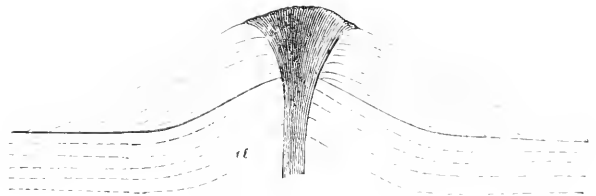

Fig. 14.—Crater of upheaval.

It is now necessary to draw attention to the great difference of opinion which has been expressed upon a point for which we have very little data to support either of two views of the question.

Vulcanologists were for a long time divided into two schools, which often waged war against each other with considerable fierceness.

The so-called *upheavalists* were led by such eminent men as Von Buch, Elie de Beaumont, and Humboldt, whereas those who held the opposite view, which will be immediately explained, claimed

as their adherents Sir Charles Lyell, Poulett Scrope, and others.

In figs. 13 & 14 are diagrammatic representations of the two theories.

The upheavalists believed that the earth-crust actually surrounding the vent was bodily lifted up by the subterranean igneous forces into a dome-shaped or bubble-like mass, thus forming the main mass of the cone, of which the centre was the point of fracture, and therefore the vent. The ejecta were therefore considered to form only a thin superficial crust covering this. The subjacent rock which had been elevated would thus have a quaquaversal or periclinal dip away on all sides from the chimney, fig. 14.

The opponents to this view attribute the entire bulk of the mountain to the ejecta, as seen in fig. 13, the only change in the basement beds being those produced by pressure and excavation, both of which tend to make them dip towards the vent, thus producing quite a converse effect to the former.

This latter view certainly seems the most feasible, and after a careful examination of many of the old craters brought forward by the upheavalists as evidence, one becomes satisfied that they have wrongly interpreted facts, which the more advanced state of knowledge at the present day and the collected experience of subsequent observers make easy to our perception. On the other hand, it would be undoubtedly rash to conclude that all craters were formed entirely on one or the other model. Jorullo in Mexico, for instance, has many points about it to support the upheaval theory. David Forbes, that clear observer, mentions many facts about South American volcanoes that should deter us from admitting the formation of cones and craters by the deposition of ejecta only.

The rapidity with which a volcanic cone may be raised is a point of great interest. We hear every now and then of some small island appearing and again disappearing below the sea almost as rapidly as it rose. Probably, however, the best illustration is that of Monte Nuovo, 456 feet high, situated in the Campi Phlegraci, about eight miles west of Naples. This was raised from a marshy plain almost level with the sea in about four days, commencing on September 30th, 1538.

The whole hill is therefore the product of one eruption. It is an interesting fact no stream of lava was developed. It would seem that the explosions were so intense that the fluid rock was entirely broken up and ejected in a fragmentary condition, of which there are great quantities forming the slopes.

The cone of Vesuvius proper, 1500 feet high above the lowest edge of the crater of Somma, has entirely been built up of the ejecta thrown out at the time of and since the memorable eruption of A.D. 79, in which Herculaneum, Pompeii, Stabia, &c., were destroyed. Besides the bulk of the mountain now seen,

we must not forget the vast quantity that has been required to fill up the crater of Somma, much enlarged by the eruption spoken of. It is said that no lava ran from Vesuvius till the tenth century, this probably would be explained by the fact that all the earlier streams were occupied in filling up the great crater. See fig. 11.

URSINE FOLKLORE.

By JOHN WAGER.

"A grype and grimlie beast."

THE bear, the largest beast of prey in Europe, is king of the northern forest, a mighty potentate in his dusky realm. Like some other despotic rulers who have existed in the world, honoured in proportion to the evil they were prone to inflict, he, though less cruel and brutal than they, has been held in divine regard, and has received the worship of those who would not scruple to take his life. Castrén ("Föreläsningar i Finsk Mytologi") informs us that the bear was thus regarded by the Ostiaks and Yakuts, who sought to win his favour and forbearance by styling him "Father" and "Grandfather." The Finns, also, in early times, similarly honoured and flattered the surly monarch, hoping to conciliate him and avert his depredations from their herds by the use of endearing epithets, such as, "The beautiful honey-paw," "the forest's apple," "the pride of the wilderness," and "the old man who had descended from the regions of the sun and moon;" They also addressed him coaxingly in song, "My dear old man," "My little bird," "My beautiful golden friend." A sacred regard and respectful epithets were also applied to the bear by the pagan Laplanders; and both these related peoples formerly observed peculiar festive ceremonies on the occasion of hunting and killing the bear. The Lapps, when they had eaten a bear, used also to bury its bones with singing and other rites. The Buratos and other Mongolian races worshipped the bear; a bear's heart was offered to the sun by the Karagus, a nomadic race of Siberian Tartars; and we learn from Tylor's "Primitive Culture" that the Ostiaks at the present day swear in the Russian courts on a bear's head, believing that the bear will know and slay them if they tell a lie; and yet with strange apparent inconsistency, they not only kill the bear, but before setting up its stuffed skin as an object of worship will kick and spit upon it. According to the same work the North American Indians offered a similar grotesque mixture of worship and mockery to the bear while feasting upon its flesh, with its head set up before them; the Kamtchadals also worshipped it and other powerful and cunning animals, refraining from the mention of their proper names, and using

set formulas to propitiate them ; the Vogulitza, when they have killed a bear, use their best casuistry to convince it that the iron of the Russians is alone guilty of the murderous deed ; the Yakuts praise the bravery and generosity of their "beloved uncle" in prose and verse, bowing reverently towards his favourite haunts ; and the Samoyedes, though they kill and eat the polar bear, have at least equal veneration for it, and swear even by its throat. The god Tezcatlipuk, to whom the Mexicans used to offer the burning hearts of sacrificed men, was represented with the face of a bear.

Amongst the Scandinavians, if the bear was never worshipped, we have proof that he was formerly held in honour and superstitious regard. Björn (bear) is a frequent surname in Scandinavia, and according to the old sagas, was assumed by Odin himself once when he visited the earth. It is a common saying among the peasants of Sweden and Norway, that the bear has the wit of two men and the strength of twelve ; and in those countries, as in Finland and other parts, if the flocks and herds are not to suffer, he must never be spoken of by his proper name, but addressed by some friendly or respectful title, such as "Gaffer," "Grandfather," "Golden-paw," or "Twelve-men-strong." Different provinces have their special by-names for the bear ; but "Nälle" in Sweden, and "Bamsen" in Norway, like our "Bruin," are terms in general use. "Bingsen" is the feminine of "Bamsen."

Of the reputed wit or wisdom of the bear, with other traits of his daily life and conversation, we find marvellous accounts in Pontoppidan's "Natural History of Norway," published in 1752. Yet the author, Bishop of Bergen, informs us that he has exercised great caution, and from the extensive mass of information, collected especially during the visitations of his wide and wild diocese, has related facts only that are credible, being supported by the concurrent testimony of numerous informants. Nevertheless, many of his statements will be acceptable as curiosities of folklore merely, and not as contributions to the natural history of the bear.

Dame Bingsen, we learn from the bishop, carries her young but one month, and when the two or three little Bingsens and Bamsens come forth, during January, into a cold world, they are (as stated also by Pliny) naked, blind, small as mice, and shapeless as clumps. But the mother, by continual licking, develops them into form. Yet they never, it may be observed, for all her plastic art, exhibit any remarkable growth in grace. It is only when rearing their cubs that bears, if not molested, are usually dangerous to man ; but let women, when in an interesting condition, at all times beware of them ; for the bear, according to our author, either instinctively or by scent, knows their state, and becomes quite ravenous to secure the precious burden they are blessed with—especially if it happens to be a boy. A clergyman's

wife assured the bishop that she was once besieged in her bedroom by a bear thus incited, and would have been torn to pieces except for the timely arrival of her husband, just as the voracious creature, which had failed to leap in at the window, was roaring, ramping, and tearing most furiously at the door. This remarkable propensity of Bruin serves, however, one good purpose ; constituting him, as the bishop remarks, a kind of rural police, a guardian of virtue among the herd-girls who tend the cattle during summer amid the forests and mountains which are his accustomed resorts.

He has even been known, it is said, to take upon himself the care of the herds ; as at Bordue, in Røgsund, where "an old grass-bear for many years regularly attended the herd like its watcher, and often stood quietly by when the girls were milking ; always drove the wolf away, and only in autumn, shortly before retiring to his winter retreat, took a goat or a sheep as tacitly-accorded payment for his summer's work." The bishop reasonably surmises that not many bears so laudably discreet were to be found, but adds, as a reported certainty, that the forest monarch will levy only one contribution on each man whose flocks and herds are located within the limits of his own proper domain.

Of the numerous asserted proofs of the bear's discernment and circumspection none appear to the bishop more savoured with thoughtful deliberation than the selecting from a whole herd of cows that which bears the bell, and thus by her running gives warning to the rest. This bell, it is said, excites his utmost wrath and indignation. He tears it off, casts it to the ground, and, if malleable, batters it quite flat with his paws, so that the detested sound may never again tingle in his ears. If the bear chances to take a hunter by surprise, this surprising animal instantly seizes and fires off his gun ; and when assailed by a party of two or three hunters, if the foremost of them misses fire, or only slightly wounds him, he instantly grasps the defenceless man in his paws, and retreats backwards on his hind legs, holding the man before him as a shield. Eventually he flings his prisoner down a steep bank, and leaves him living or dead. But sometimes both bear and hunter fall dead in mutual embrace. When mortally wounded, knowing that the hunter is covetous of his skin, he strives to disappoint him by seizing a heavy stone and sinking himself in deep water if such happens to be within reach. When hard pressed by the hunters, he will set his back against a tree, and throw stones at the little dogs with which they seek to distract his attention while they take aim. If fatigued in crossing a lake or fjord, he will sometimes, at the risk of having his forepaws chopped off, attempt to get into a boat ; and, if permitted, will sit quietly and timorously down.

(To be continued.)

MICROSCOPY.

FINISHING MICRO-SLIDES.—I have read the sensible remarks of Mr. Ford with interest, and quite agree that Canada balsam dissolved in benzole makes a good cement for finishing purposes when no coloured rings follow. If, however, coloured cements are used on Canada balsam (as is the practice with most mounters of the present day) there is considerable risk of the benzole (which all these coloured cements seemed to be made with) softening the balsam ring and insinuating itself beneath the cover: at least this has been my experience after using it—and also the same occurs with dammar dissolved in benzole. I have mounted a very large number of slides, and have tried all cements recommended to prevent running in—with more or less success. What is wanted for the first coat is something that does not easily dissolve the balsam. Some short time since a small pamphlet fell in my way, published by Mr. Ward of Manchester, being a paper on Mounting read before the Science Association at Manchester, where the author recommended a “brown cement” or anti-running-in cement. I wrote for a shilling bottle. I have given it an extensive trial and have found it to supersede all other cements that I have tried. The solvent used has evidently little or no effect on balsam, and dries hard in five or six hours, when coloured cements to any thickness may be added. I have tried it immediately after mounting an object in benzole balsam with equal success. It is also a useful cement for cementing covers in dry mounts, being very adhesive and drying quickly. I can strongly recommend it to all who are in want of a good cement to prevent other cements running in.—*H. Munro, Lyme Regis.*

AMBIGUOUS PHRASEOLOGY.—I should feel obliged if any of your readers would inform me what is the numerical equivalent of the following expressions (which I observe in many works on Microscopy), viz: “enlarged,” “much enlarged,” “very much enlarged,” “magnified,” “much magnified,” “very highly magnified?” A moment's thought will reveal to every microscopist the ambiguity and vagueness of such terms, and the desirability of employing some more precise mode of expressing the difference between the magnified sketch and the natural size of the object. The difficulty can easily be surmounted; all that is needed being, either a statement of the linear magnifier represented by the sketch (if it be drawn to scale); or, an indication of the focal depth of the object glass and number of the eyepiece used. Thus, it would be little trouble to add to the description of any sketch such words as: “300 linear,” or “ $\frac{1}{4}$ in. No. 2 e.p.,” or “ $\frac{1}{8}$ in. No. 3 e.p.” If this were done, it would, I believe, much facilitate the work of such microscopists who sought to verify the results

detailed in any article or work on microscopy. The lack of this information very much detracts, in my opinion, from the usefulness of Dr. Carpenter's work on the Microscope, and many other books on the same subject. Science is nothing if it lack precision.—*F. J. George.*

TRICHINA IN PIGS.—I think it will interest some of our microscopic friends to see the result of the compulsory examinations of pigs for trichina, before the meat is allowed to be sold, for the town of Berlin, from the 1st of October, 1879, to the 30th of September, 1880. The number of pigs examined, 179,981; from which were killed, in public slaughter-houses, 51,687; in different parts of the town, 119,294. Out of these 143 were found to contain trichina—that is 1 in 1195. The number of public examiners in October, 1879, was 243; at the end of September, 1880, 184.—*Dessau.*

FINISHING AND MOUNTING SLIDES.—In Mr. Ford's communication on “Finishing Slides,” I take it that he claims that the ring of Canada balsam dries very quickly so that the slide is “ready for the cabinet within a few minutes;” if so, I must say that this is quite contrary to my experience. I have finished some dozens of slides in the manner described by Mr. Ford, but always found it necessary to dry the slides off by placing them for some days in a warm place. I have not tried it myself, but I understand that pure gum dammar and benzole is a much better varnish for finishing off slides than Canada balsam in any form, as it dries much more quickly without heat. This plan of finishing slides is a safe one for amateurs, but after all I must say I much prefer the “white cement” which I now invariably use when practicable. With regard to “mounting objects in fluid for the microscope,” whilst agreeing in the main with Mr. Lovett's remarks and method, yet I cannot say I am enamoured with his “fluid,” which being composed half of absolute alcohol is really as strong as “proof” spirit. What is going to contain this volatile liquid? I must confess that I am doubtful about the marine glue, seeing that a large bulk of the same is made up of shellac, which also enters largely into the composition of sealing-wax; and the solvent of sealing-wax varnish is alcohol—aided it is true, with a little warmth. But why use alcohol or any other volatile fluid for a permanent slide if other preservatives can be found? The proportion of glycerine in Mr. Lovett's fluid would, I take it, answer his every purpose, glycerine itself acting as a preservative, but if the same be used *per se*, on account of its density, it is apt to produce distortion of the cell contents; this, however, I understand can be avoided by placing the objects to soak in a weak solution of glycerine, and gradually increasing its strength from time to time by adding pure glycerine. Of course if Mr. Lovett can mount slides in a strong alcoholic fluid which will last any

length of time, his "practice" will then upset my "theory." I, in common perhaps with others of your readers, would be glad to hear whether the slide of ova of one of the mollusca mentioned at the end of his communication, was mounted in a strong alcoholic solution or otherwise, as unless it was so, it cannot fairly be brought forward as an example of durability. I note that very many of your correspondents speak of "zinc white" cement; unless they prepare it themselves they cannot speak positively as to its composition; but my belief is that in very many instances this cement is really a "flake white" which is incomparably the better "drier." I make my own white cement and write from experience.—*L. M.*

MOUNTING DIATOMS, &c.—In Mr. Hardy's translation of Professor Brun's "Natural History of Diatoms" are certain directions for the preparation of diatoms for microscopic examination of those organisms; I am about to give what is probably a needless piece of advice, viz. don't try them, as most of the processes are old and worthless. The plan of burning on the cover has long been known, and if carefully conducted is of use, as it shows the natural position of the valves in the filamentous and stipitate conditions of the Diatomaceæ; but if the preparer possesses the "magic of patience" a much better preparation may be made by macerating the diatoms in strong methylated alcohol, which extracts the endochrome; the stained alcohol should be poured off from time to time and replaced by fresh (the last addition should be pure spirit); the diatoms should then be washed with pure distilled water, and when mounted should be dried on the cover or slide and not burnt. Professor Brun's directions for cleaning diatoms possess no advantage over the usual plan of boiling in nitric acid, &c., the *modus operandi* of which have frequently been described in this journal. The preparation of balsam objects would result in a failure if the directions given by Professor Brun are followed: in the course of a few hours or days the frustules would have an "air bubble" or vacuole, and even detached valves would be in the same predicament. In confirmation of this, let a drop of, say, *Melosira varians* in filament, be dried on the slide or cover and essence of turpentine (terebinthine) be dropped upon it until the frustules are filled, and a smaller quantity of Canada balsam in a viscid state be placed upon it; if this is at once hardened the turpentine is drawn out of the frustules and a so-called air-bubble is the result. The turpentine simply fills the frustule, and if the balsam is boiled the turpentine is vaporised and is driven out and combines with the hardened balsam, which becomes too viscid to take its place within the frustule. I am not aware that a prism could be used for the purpose of picking out, or that magnification could be obtained by means of a prism; another, and I think insuperable, difficulty in the use of glycerine is

the impossibility of detecting delicate forms when immersed in that medium, its refractive index being nearly the same as that of the diatom valve. Professor Brun, in his remarks on the reproduction of diatoms, says "that numerous observations have proved that their reproduction takes place, first, by germs (sporules); second, by direct deduplication; and third, by reproductive sacs (spores) which result from the deduplication." It is by no means proved that reproduction ever takes place by means of germs (sporules), and in the succeeding paragraph he states that "the spores are so minute that they have hitherto escaped the eye of observers aided by the best immersion lenses." Their existence is therefore at best but hypothetical, and not a proven fact. His third method is not easy to comprehend, but I suppose it to mean the production of a sporangial frustule, but the result of this is not the production of sporules, but of a frustule many times larger than the parents. My remarks of course apply to Mr. Hardy's translation, as I have not seen the original paper, but I have no doubt as to its substantial correctness. I notice that the sign + is used instead of ×, the usual sign for magnification, and "slender" instead of "thin" covers, but the meaning is easily understood.—*F. Kitton, Hon. F.R.M.S.*

TUBES FOR CONVEYING MOIST SPECIMENS, DIATOMACEA, MUD, &c., BY POST.—A thin membrane of gutta percha, such as used by surgeons, cut to the required size; the joint made by dipping a camel-hair brush in chloroform, drawing it along the edge, say half an inch wide, then placing the part to be joined to it before the chloroform has evaporated; the operation is simple. Do not fill your tubes quite full, say three parts; this will allow of a little pressure, should it occur in transit. The cover made by rolling brown paper over a ruler or other suitable form, fastening with paste, as fire-work cases are made, allowing to dry, then cut to lengths required; attach label with address and stamps.—*J. J. M., Tredegar.*

ZOOLOGY.

PUGNACITY OF THE CATERPILLARS OF ANTHOCHARIS CARDAMINES.—Although I have had various species of larvæ of butterflies and moths crowded together in boxes, and although in one instance at least I was not without suspicions of cannibalism when the natural food ran short, I have not noticed any actual combativeness except in the case of the caterpillars of *A. Cardamines*. On one occasion I saw two of these in conflict. One was attached by the posterior half to the upper extremity of a twig, the tail being uppermost and the anterior portion of the body dependent and arched, serpent-like, in antagonism to the similarly arched head and neck

of another caterpillar which was ascending the same twig and was similarly attached by the posterior half of its body. They hovered about and "struck" at one another like snakes, and I could see their mandibles biting at one another in the air. These were nearly full-grown; but on another occasion I was witness of a severe battle between two that measured only from $2\frac{1}{2}$ to 3 lines in length. They also struck at one another like snakes, and I had to separate them at last. Whether they ever do each other any serious injury, I do not know; but it is possible that a sort of hernia in the dorsal thoracic region, from which they sometimes perished, may have been occasioned in this way. This combativeness probably arises from a limitation of their food—it is a fight for the young pod of the flower. This is the part preferred (see Newman's "British Butterflies," p. 157), though the larger caterpillars at least will eat the whole plant, stem and all, if needful. In most instances only one egg is laid on a plant, affixed to the pedicel of a flower-bud, though in the case of larger racemes there may be more. Thus, for example, of sixteen plants having eggs on them, gathered on the 20th of May, 1879, eleven had only one egg; two had two each; one, three eggs; and two, four eggs on the same raceme—in two instances two eggs being attached to the same pedicel—a condition however, which might be regarded as arising to some extent from a failure of instinct. I have found the eggs of *P. Napi* in great abundance on the same plant, laid on the underside of the leaves—as many as thirteen on one plant, and sometimes four or five on the same leaflet. These caterpillars do not show any disposition to attack each other, or manifest any preference for the seed-pods.—*J. A. Osborne, M.D., Milford, co. Donegal.*

PARASITE OF THE CAT (*Trichodectes subrostratus*).—During the month of September I procured

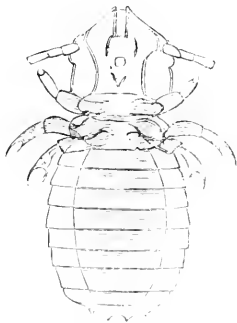

Fig. 15.—Parasite of Cat (*Trichodectes subrostratus*), female.

a number of parasites from a cat and her kitten, but on referring to Denny's "Anopla," I find he gives no figure of the species, the reason being he had sought for it in vain. He says "that this species is a native of Britain there can be little doubt;" he gives the specific characters from Burmeister's Handbook, "clypeus elongate, triangular, apex bituberculate."

The late Mr. A. Murray in his "Economic Entomology" published about 1875, mentions that this species "infests the cat on the Continent; not yet recorded in

Britain." The characters just given agree with the specimens in my possession, as may be seen from the accompanying figure, which is magnified 25 diameters, the actual length being three-quarters of a line. Considering the large number of cats that are wandering about in all stages of destitution, it appears strange if this parasite has never been recorded up till this time. Perhaps some of the readers of SCIENCE-GOSSIP can give some information on this point.—*J. Lambert, Edinburgh.*

THE HESSIAN FLY IN AMERICA.—In a very elaborate and lengthy paper by Dr. H. A. Hagen, which appears in the last number of the "Canadian Entomologist," the author gives the following reasons for believing this insect not to have been imported into America from Europe, and shows—(1) It is impossible the fly could have been imported by the Hessian troops; and (2) It is very probable that the fly was in America before the War of Independence.

REMEDY FOR CABBAGE-WORMS.—Dr. Riley in the last part of the "American Entomologist" says that the use of *pyrethrum* will prove a most satisfactory remedy against these creatures, which are said to be rapidly spreading throughout the United States.

NATURAL HISTORY TRANSACTIONS OF NORTH-UMBERLAND, Durham, and Newcastle-upon-Tyne.—Part ii. of vol. vii. (new series) of these Transactions has just been issued to the members, and as usual contains much valuable information. This part commences with the Presidential Address of the Rev. R. E. Hooppell, LL.D., F.R.A.S., and gives a résumé of the meetings held and the work done for the year ending May 2, 1878. Dr. Hooppell is not a convert to the Evolution theory and, towards the end of his address, quarrels with Mr. Darwin and Professor Tyndall for their "thoughts, fancies, and speculations." Next follows a well-written article by the Rev. W. Howchin, F.G.S., on a "Find of Prehistoric Implements in Allendale and some of the adjoining Districts." A memoir of the life of Mr. W. C. Hewitson, F.L.S., a native of Newcastle, and up to the time of his death one of the Vice-Presidents of this society, is by Dr. Embleton. Mr. Hewitson bequeathed by his will among other legacies 10,000*l.* to the Newcastle Infirmary and 3000*l.* to this society. A short memoir of the life of Thomas Belt, F.G.S., by Joseph Wright, keeper of the Newcastle Museum. Then the address of the President, Dr. Embleton, for the year ending May 2nd, 1879, who said there appeared to be a lack of young observers devoted to our pursuits. I think the worthy doctor might have justly attributed the falling-off in the work of the field-meetings to another cause, viz. the objectionable arrangements of these meetings; the extent of ground that the members have generally to walk over at each meeting completely prohibits them from examining the objects of interest with that care

and attention necessary for becoming acquainted with them. Mr. Hugh Miller, F.G.S., of H.M. Geological Survey, contributes a very elaborate and highly interesting article occupying sixty-nine pages of the Transactions on "Tynedale Escarpments, their Pre-glacial, Glacial and Post-glacial Features," which is illustrated by a number of wood-cuts. "Notes on the Breeding of the Stock Dove (*Columba oenas*)," by Mr. John Hancock, Newcastle. "Preliminary Note on the discovery of old Sea-caves and raised Sea-beach at Whitburn Lizards: and on the so-called sculptured Rocks of North Northumberland," by Mr. Richard Howse, Curator of the Newcastle Museum. Upwards of half a century ago a number of curious concentric circles were observed on the Sandstone rocks, near old Berwick and similar ones were also found in the neighbourhood of Wooler and Ford by members of the Berwickshire Naturalists' Field Club. From time to time the attention of scientists has been directed to these markings, more especially by Dr. Johnston, in his "Nat. Hist. Eastern Borders," the late Mr. George Tate, F.G.S., and the Rev. Canon Greenwell, the eminent antiquary. Dr. Johnston was of opinion that they were made by the Roman soldiers "in relief of idleness, &c." Mr. Tate said their family resemblance prove that they had a common origin and indicate a symbolic meaning, representing some popular thoughts, and since they are associated with the last remains of Celtic heroes and sages, they tell of the faith and hope of the aboriginal inhabitants of Britain. Canon Greenwell thought their import is religious; their connection with burial, always a most sacred rite, and closely joined to the religion of all races, points most distinctly to a sacred purpose. Now, Mr. Howse, who has examined the markings with great care on more than one occasion, rejects the opinions of the eminent gentlemen and of others who have written on the subject, and does not ascribe them to human agency at all, but to a more humble and simple origin, that is to the growth of vegetation, and his views are supported by arguments which will be difficult to controvert. He says where the rock-surfaces at an early period were bare, after the last Glacial period they were exposed to the growth of lichens. The spores of some lichens are known to bore into the rock in which they select to grow, and by so doing loose the particles of sand of which the sandstone is composed. Many lichens grow in a circular form, and radiate, or rather send out rings of growth periodically, the central part dying and decomposing very nearly in the same way as the mycelium of some fungi forms the rings which are commonly called fairy rings. The strongest argument, I think, adduced by Mr. Howse, to prove that these markings are not the work of human hands, is where he shows that whenever the circles are traversed by a narrow vein of iron-hardened sandstone, the furrows are not continuous, but the vein remains permanent and disfigures the symmetry of the pattern. Mr. Howse's

paper concludes as follows: "Would any workman disfigure his pattern because he had a little harder material to cut through? It is no disgrace to a cryptogamic plant, or the wind, or the rain, that they cannot always cut an exact circle; but a sun-worshipper who could not outline the shape of his god perfectly ought to sink in our estimation below the visible horizon, and a symbol-master who could not perfect his design would expose himself to contempt."—*Dipton Burn*.

KENT'S "MANUAL OF THE INFUSORIA."—We have received Part ii. of this splendid work, published by Mr. David Bogue, 3 St. Martin's Place, Trafalgar Square. It is, if anything, superior in finish and general appearance to the first part, which we felt bound to praise so highly. The letterpress is taken up with a most thorough and exhaustive chapter on "The Nature and Classification of the Sponges," which is followed by another on the "Systematic Description of the Infusoria Flagellata," and descriptions of all the genera and species, to illustrate which there are eight exquisitely-engraved plates crowded with objects. Microscopists should lose no time in subscribing to this important work.

BOTANY.

TERMINATION OF ORDINAL BOTANIC NAMES.—These have very commonly no separate meaning detached from the root-word which they end. In your November number, Mr. W. Woollcombe asks for the signification of the endings *-aceæ* and *-ææ*. *Aceæ* is the tail (implying plurality) usually tacked on to the names of representative genera of plants ending in *a*, as *Nymphaea*, to denote an assemblage of forms all having some character in common with that one made the type. Thus *hydraceæ* means ivy-like; and *Papaver-aceæ* the whole group of poppy-like plants. The termination carries with it the idea of assemblage and likeness as well: a plant not like a poppy in certain structural points would not be one of the poppy-*aceæ*. I write from memory of Mr. Woollcombe's note, but I believe he remarked on the want of uniformity to be seen in our various botanical handbooks. So far as ordinal terminations go, the differences may be undesirable; but they are not very numerous, and arise generally—at least in the case cited by Mr. Woollcombe, viz., the writing of *Lentibulaceæ* for *Lentibulariaceæ*—from a desire to dock scientific words of superfluous syllables. *Lentibulaceæ*—the butterworts—is correctly formed however, from *lenticula*—a little lentil seed, like which in shape, are the air-bladders of the principal genus *Utricularia*. The sense is not lost by shortening the word, as it would be, were we to style *Campanulaceæ*—the order whose species in their blooms resemble little bells—*Campanaceæ* instead. The termination is not *-inææ*, but *-aceæ*, contracted to

œc, in such cases as Plumbaginæ, Borraginæ, and Berberidæ, the root of each of the words being the Plumbagin, Borragin and Berberid, of the genitive case of Plumbago, Borrago, and Berberis respectively. The termination *-idæ* is usually one given to tribes (not the larger orders), e.g., Rosidæ, the descendants of some common stock, the tail-piece implying a closer family relationship than that of the generic integers of an order.—*F. A. L.*

PRIMULA SCOTICA.—In the September part of SCIENCE-GOSSIP which I have only just received, I notice that Mr. West, under the head of "Developed Primulas" says Watson mentions that "in Sutherlandshire there has been found a variety of *Primula Scotica*, having the umbel sessile so that the elongated pedicels appear to be one-flowered peduncles, as in the common primrose." In Caithness I have often noticed that peculiarity. Sometimes the stalk of the umbel is so short that it is difficult to say whether there is any or not. There are generally four or five flowers on the umbel, and sometimes a solitary flower, so that it resembles the scape of an ordinary primrose, greatly elongated. The length of the scape varies from 0 to six inches. I have tried growing the *P. Scotica* under a glass shade, and find that the flowers become very large and beautiful, somewhat like a small Auricula. Roots have been sent from here to be planted on the Berwickshire coast, but the experiment did not succeed. The old boulder clay pastures seem to be peculiar to it. As Syme mentions, it has three flowering seasons; this year I find that I marked its first appearance on the 5th of May; second, the 4th of July, and the 31st of August. I shall be happy to forward to any of the readers of SCIENCE-GOSSIP a specimen of this beautiful and rare little plant.—*James Grant, Wick.*

"FERNS AND FERNERIES."—Under this title a sixpenny pamphlet has been issued by Marshall Japp & Co., London. It is by the author of "Anatomy of an Earth-worm," &c., and we cordially recommend it as the best little brochure on ferns we have yet seen. Its merits far exceed those of much larger and more pretentious works.

CURIOUS GROWTH OF "CARDAMINE PRATENSIS," var. flore pleno. Last summer I found several of the above at a place called Bishport Bottom, Bedminster, near Bristol, which I brought home and planted. A few weeks ago I was agreeably surprised to find the curious, and (to me) entirely unique method two out of four had shown in propagating themselves, which was as follows: At each leaflet of the pinnate leaves, was a miniature plant throwing out rootlets similar in texture to those of common watercress. These leaves I pegged down (without separating them from the parent plant) with verbena pins, and they seem to have struck well into the soil, as they are much increased in size.—*J. F. Hopkins.*

"THE CHARACEÆ OF AMERICA." By T. F. Allen, M.D., &c.—We have received parts 1 & 2 of this magnificent work from the publishers, Messrs. S. E. Cassino, Boston, U.S.A. The plates, of which there are three to each part, are nicely drawn by the author himself. The letter-press description gives the botanical diagnosis, American localities, varieties, &c. The work is of a most important character, and one that cannot fail to be almost of as much interest to European as to American botanists.

TURRITIS GLABRA.—This species does not seem now to grow at the station near the bridge over Kale at Hownam, where it was found in 1860 by Mr. Douglas; at least I have not succeeded in finding it there lately, the growth of the young wood in the ravine having perhaps choked it out. But I have seen it growing in two places in the neighbourhood, one near the village of Morebattle, four miles off, and the other two miles nearer Hownam. The stream may have brought it down to Morebattle, but the other station is high above the stream, and the presence of the plant there cannot be accounted for in that way. I see no reason for believing that it is not indigenous to the district. The theory that it is an escape from Hownam Manse garden rests on no foundation, and is extremely improbable, as I could show at length.—*D. P., Roxburgh.*

NAMES OF PLANTS.—I would suggest that contributors to our botanical gossip should give the English as well as the Latin botanical name of the plants to which they refer. The Latin name is undeniably useful as being that by which the plant is universally known and recognized; the English name would be useful to enable those who have not yet acquired the Latin names to at once identify the plants referred to, and would have the additional advantage of recording some of the curious local names which obtain in many parts of the country. Thus, for instance, *Verbena officinalis* is known to some as holy vervain, to others as holy herb, and to others as Simpler's Joy; *Linaria vulgaris*, as yellow toad-flax or butter-and-eggs; *Veronica Chamædrys*, as Germander speedwell, eyebright, Paul's Betony, or fluellin; *Viola tricolor* as heart's-ease, love-in-idleness, Pink-o'-my-John; *Caltha palustris*, as marsh marigold, water-blobs, or May-blobs; *Digitalis purpurea* as foxglove, fairy-thimbles, or fairy-bells; *Verbascum Thapsus*, as great mullein, Aaron's rod, flannel flower, and so on.—*F. H. Habben, B.A.*

PRESERVATION OF FUNGI.—Dr. Herpell, of St. Goar, has just perfected a process for preserving fungi for the herbarium. It is said to preserve them in their natural colours, and to be altogether the most satisfactory process that has yet been adopted. A brief abstract of Dr. Herpell's book, which is in German, will appear in the next number of the "Journal of the Royal Microscopical Society."—*Frank Crisp.*

"THE BRITISH MOSS FLORA."—Part iii. of this book has just appeared, dealing with the family Polytrichaceæ, and illustrated by five beautifully-got-up plates. We can pass no higher eulogium upon the present part than by saying that it is in every way equal (and we think some of the plates are even superior) to those which have already appeared. It is published at 5s., by the author, Dr. R. Braithwaite, F.L.S., at 303 Clapham Road.

GEOLOGY.

THE GLACIAL BEDS OF THE CLYDE AND FORTH.—Mr. T. Mellard Reade, F.G.S., has reprinted a paper on the above subject from the Proceedings of the Liverpool Geological Society. The paper, which deals with the glacial beds of Scotland, is intended by the author as the sequel to investigations previously made in the contiguous glacial beds of Ireland. Mr. Reade concludes: "that there has been a tendency among geologists to unnecessarily complicate glacial phenomena, to raise every gravel bed into a "formation," or bed of sand into a "period," and that the Scotch "Till" is the geological equivalent of the lower part, if not the whole of our English marine boulder clays and sands. That, in fact, as the land subsided the materials brought down by glaciers were scattered over the sea-bottom in distant localities, forming our marine boulder clays; whilst nearer the source, in front of and probably under the glaciers while in a state of semi-flotation, the unfossiliferous "Till" was formed. The stones and heavier material would be shed more profusely near the land, and the finer materials would be taken farther out and deposited in the sea.

ABNORMAL GEOLOGICAL DEPOSITS IN THE BRISTOL DISTRICT.—An important paper on this subject has just been read by Mr. Charles Moore, F.G.S., of Bath, before the Geological Society. The author remarked that the Frome district shows numerous unconformable Secondary deposits and "vein-fissures" resting upon or passing down through the Carboniferous Limestone. He especially described the occurrence of Post-pliocene, Liassic, and Rhætic deposits in the Microlestes-quarry near Shepton Mallett. Here the lower part of a fissure is filled with a brown marl, containing crystals of carbonate of lime, and numerous remains of *Arvicolæ*, frogs, birds, and fishes. The jaws of *Arvicola* were very abundant. He then proceeded to describe the occurrence of similar phenomena in the Bristol area, as at Durdham and Clifton Downs, in the gorge of the Avon at Clifton, at Ashton and Westbury-on-Trym, in the Yate rock, in Nettlebury quarry, at Clevedon, and on the Thornbury railway. He noticed the occurrence in the infillings of fissures traversing the Carboniferous

Limestone of these localities of fossil remains belonging to various geological ages; and he especially called attention to the presence in different deposits of an immense number of small tubular bodies of doubtful origin, for which, should they prove to be of organic nature, he proposed the name of *Tubutella ambigua*. By different authorities these little bodies have been assimilated to *Serpulæ* (*Filograna*), insect-tubes, and the casts of the fine roots of plants. With regard to the age of the fissure-deposits, the author remarked that although in some fissures the infilling shows a mixture of organisms, in most cases each "vein" appears to have an individuality of its own, and thus the veins represent intervals of geological time clearly distinct from one another, different fissures showing infillings of alluvium, Oolite, Lias, Rhætic and Keuper beds. The presence of his *Tubutella* he considered to indicate freshwater conditions. Mr. Moore also referred to the discovery of *Thecodontosaurus* and *Palæosaurus* many years ago at the edge of Durdham Down, and discussed the age of the deposit containing them, which was originally supposed to be Permian, and was referred by Mr. Etheridge to the Dolomitic Conglomerate at the base of the Keuper. The author stated that he had found remains of the same genera in Rhætic deposits at Holwell and Clifton Down, and had hence been led to refer the two genera to that age. He stated, however, that he had since discovered teeth of *Thecodontosaurus* identical with those of the Bristol area in a deposit belonging to the middle of the Upper Keuper at Ruishton near Taunton, and recognised certain differences between these teeth and those of the same genus from the Rhætic beds of Holwell; hence he was led to give up the notion that the former were of Rhætic age, and to refer them to the Upper Keuper; but he remarked upon the interesting fact that, while most of the generic forms of the Keuper are represented in the Rhætic, the species differ.

NOTES AND QUERIES.

STARLINGS AND SKY-LARKS.—Writing from Carmarthenshire, I notice with much regret that the sky-larks have all but disappeared from these parts. The absence of this prominent and familiar bird causes a void to be felt in the domain of nature, the effect of which on my mind is little short of that produced by the removal of old and valued friends. Some observers charge the starling as being at the root of all the mischief, that he has a quick eye to detect their nests, and does not scruple to help himself to the eggs. This assertion may be gratuitous; not supported by sufficient evidence. But it would give me much pleasure if some of your correspondents, residing in various parts of the British Islands were to take the matter up and discuss it in its various aspects. By comparing notes in this way we could ascertain whether the scarcity of these very interesting birds of song of our native country is general or only partial.—*Meyler Daniel*.

QUERY AS TO CANDLES.—I shall be glad if any of the readers of SCIENCE-GOSSIP can give a reason for the following: If an ordinary composite candle that has been burning for some little time, and has a well-ignited wick be blown out from beneath, it will be found that the wick will smoulder for but a very short time; but if from above, the wick will continue smouldering until but very little be left; yet in both instances at the very instant of the candle being blown out the wick appears exactly similar, with an equal amount of incandescence at the end. I find this fact is pretty generally known amongst the female portion of the community, but I have heard no reason given for its being a fact.—*H. Morland.*

MALE BIRDS INCUBATING.—It appears that the following male birds assist the females in incubation: 1. Blackcap, very frequently; both male and female occasionally sing when sitting; 2. Linnet, Red, occasionally; 3. Bullfinch, 4. Greenfinch, 5. Robin, frequently; 6. Rook; 7. Swift; 8. Swallow.—*G. Dewar.*

WHITE VARIETY OF HERB ROBERT.—Last August, at Chilworth, Surrey, I found a white variety of Herb Robert (*Geranium robertianum*). Have any of your readers ever met with the same change of colour in this species?—*H. L.*

COCKS AND CHICKENS.—Passing some chickens, a few days ago, when it was raining, I saw a bantam cock brooding over four young bantams while the hen was contentedly picking up food. On inquiry from the owner, I was told that the cocks of this variety usually peck their young, but that this particular bird always looked after the young when hatched. Does this show weakness on the cock's part, or only strong paternal affection?—*A. M.*

THE PHYSICAL HISTORY OF THE CHALK FLINTS.—SCIENCE-GOSSIP for last January contained a brief notice of a paper on this subject, read by Dr. Wallich before the Geological Society. Will you allow me to make a few observations on his result? No. 6, "That the stratification of the flint is the immediate result of all sessile protozoan life being confined to the superficial layer of the muddy deposits." If we are to understand by this, that flint strata are formed on the surface of the mud, on which the waters rest; and if it is intended that these strata are formed from the organisms that lived on this surface, I do not think that this dogma can hold good. I will confine my reasons for this objection to a few facts. The soundings of the "Challenger" on the Globigerina ooze were very numerous, fine sedimental matter was brought up, but no flint. There is then no evidence of a surface flint nodule or layer in the labours of the "Challenger." We know that sea water contains silica in solution, and that it is appropriated by many organisms; some of these may be called fixtures on the sea bed, some are moveable bodies at various depths; when these creatures die their substance is decomposed, and the component parts return to their elements. The red clay is deposited where the condition of water motion permits of it, the calcareous ooze is carried on by the almost imperceptible current, and is deposited in still water, the silica is deposited with it. There are seasons of deposit and rest. From the moment when the deposit of one season ends, its surface gradually hardens; when the next deposit commences it is soft, and the material begins to rearrange itself. There may or there may not be sponges, or other substances on the surface of the old deposit, but whatever body may be there, it is liable to form a nucleus for the percolating silica to collect upon. If, as Dr. Wallich

teaches, these nodules and sheets formed on the depositing surface, we could not have horizontal layers, because the heavy nodule would sink into the light ooze; but if the liquid silica permeates through this, till it reaches the hard surface of the old ooze deposit, it is at once arrested in its percolation on the horizontal bed, and necessarily forms a stratum conformable to that bed. All flint nodules and flat sheets were once in a state of liquidity, they attained the condition in which we find them by slow degrees. A layer of chalk is not deposited at once, it comes slowly on upon the pulsation of the ocean, and as the whole mass is gathered in its season, so the siliceous separates itself from the calcareous by its own liquid density. Every nodule assumes such a shape as the surrounding matter allows. If other evidence were wanting, this would be enough to prove a once liquid condition. There are many of these flints which have formed round other substances that have decomposed and vanished; some hollow flints are so clear inside that they seem to have formed on a globule of air, and some masses have formed without any nucleus solid siliceous all through. I came to this percolation system some years ago, it is mentioned at p. 258 of "The Biography of Dust," 1877, and it has never been controverted. The only difference between Dr. Wallich and myself is that I draw my supply of silica from vast surrounding areas of ocean, while he limits the supply to the growths on the spot; he thinks the strata are formed on the surface, I say that the flint strata are formed by percolation. Perhaps you, Sir, or some of your readers, will act as umpire on the subject.—*H. P. Malet.*

WASP PREYING ON LARVA.—When "S. B." saw a wasp preying on the larva of a cabbage butterfly he saw nothing unusual. During the summer which is just past, when wasps were so numerous with us in the West of Scotland, several times I saw the same thing take place. And not only larva, but I have frequently seen them attack full grown specimens of the "daddy-long-legs," and demolish them in a trice; and on more than one occasion I saw one attack a honey bee, whereon a tough battle ensued, the wasp however, always being victor in the end.—*W. M. L. Brown.*

CLIMBING POWERS OF THE TOAD.—Mr. Parfitt never could have so misunderstood the nature of my note on "The Climbing Powers of the toad," in SCIENCE-GOSSIP for July, page 165, as to imagine I meant that "rough surface of a toad," when I distinctly said "perpendicular rough surfaces, such as a low garden wall, or a couple of door steps." The idea is too absurd, and as I most certainly never stated that the toad possessed any "rough surface," I cannot possibly reply to his question, and give him any "idea," as to "How the rough surface of a toad, and the surface of a roughly-built garden wall are going to adhere." I still say I have seen toads climb rough surfaces.—*Helen Watney.*

"CAN A PARROT REASON?"—I really think so, at least to a certain extent. I had a rose-crested cockatoo (*Cacatua Goffini*) for several years that seemed to understand the sense of the words he was saying, for instance, when one of my children came into the room "Paul" (as we called the bird) would immediately descend from his perch, and making a snapping noise with his beak and tongue, hold out his head to be scratched, and cry, "Oh you pretty dear! You pretty little dear!" But if a stranger came, all his feathers would bristle up, and he would shout at the top of his voice, "You rascal!" or

"You bad boy!" and positively spit at the intruder. At dinner-time he would call incessantly for "Potato!" and never rest until he was supplied; but he never made use of the word at any other time. If he was scolded, he immediately replied, "You bad boy!" and sometimes, "Shut up!" One morning one of my canaries got out, and as I was in a hurry, I did not stay to catch it, but left the door of its cage open for it to return, thinking it would probably do so when hungry. On coming in again, however, in a couple of hours' time, I could not find the bird anywhere, and thought some one had let it fly away, but on looking about, I noticed some feathers on the table, and on further examination discovered the mangled remains of the poor bird at the bottom of the cockatoo's cage. "Paul" himself was sitting with ruffled feathers on his perch, and instead of greeting me with "How are you?" spoken in a friendly manner, as he usually did, kept on muttering to himself, "Oh you bad Polly! Oh you bad bird!" as if conscious of the enormity he had committed. The poor canary must have passed through the bars of his cage to look for food, been caught by the cockatoo and killed; and the murderer seemed perfectly aware that he had done what he had no business to do. I could give many more instances of this bird's intelligence, but must not take up too much valuable space. "Paul" was thirteen years old when I presented him last year to the Zoological Gardens, where he is now one of the inmates of the Parrot House, and apparently in the best of health.—*W. T. Greene, M.D., Peckham Rye.*

TENACITY OF LIFE IN FRESHWATER MOLLUSCS.—It has long been a matter of wonder to me that freshwater molluscs should continue to exist in ponds and ditches which are repeatedly dried up during the summer months. An accident to some young specimens of *Limnaea stagnalis*, which I was rearing from the egg, has however thrown some light upon this subject, and which I think may be interesting to some of your readers. One of the earthenware pans in which they were kept was so placed upon a shelf that they were overlooked, and as no fresh water was supplied to them, the small quantity in the vessel was soon evaporated. How long the water had disappeared, I am not prepared to say, but it is perhaps two months since they were discovered in this dried-up state. They have been left during this time, still dry, in a cold greenhouse, until a week ago, when it occurred to me that there might still be some life in the apparently dead and dried up little shells. I accordingly filled the pan with water, and allowed it to stand for a few days, and now find that a great number (not all by any means) have swelled out and are, to all appearances, as well as before, but, as unfortunately I did not retain those which were kept in their normal condition, I cannot compare them and say how much they have been retarded in their growth. I may add that the majority of those which have been revived are the smallest and less developed, while those which were older and larger show no signs at present of returning life and activity.—*John L. Hawkins, Reading.*

YELLOW ARCHANGEL (*Lamium Galicobdolon*).—May I beg to inform Mr. Le Tall that the above plant grows on the banks of the Eden, a few miles from here, thus extending the northern limit assigned by him.—*W. Duckworth, Stanwix.*

ERRATA.—Page 277, "Porbeagle," for *Blairmor* read *Blairmore*. The second one caught was a female also, and was sent to the Hunterian Museum.—*J. M. Campbell, Kelvingrove, Glasgow.*

NOTICES TO CORRESPONDENTS.

TO CORRESPONDENTS AND EXCHANGERS.—As we now publish SCIENCE-GOSSIP a week earlier than heretofore, we cannot possibly insert in the following number any communications which reach us later than the 8th of the previous month.

TO ANONYMOUS QUERISTS.—We receive so many queries which do not bear the writers' names that we are forced to adhere to our rule of not noticing them.

TO DEALERS AND OTHERS.—We are always glad to treat dealers in natural history objects on the same fair and general ground as amateurs, in so far as the "exchanges" offered are fair exchanges. But it is evident that, when their offers are simply disguised advertisements, for the purpose of evading the cost of advertising, an advantage is taken of our *gratuitous* insertion of "exchanges" which cannot be tolerated.

WILLIAM HILTON.—There was no trace of an insect in your pasteboard box, which had got severely crushed in the transit.

E. C. AMES.—If you will look over our "List of Assisting Naturalists" for the past year you will find the names and addresses of several gentlemen who have offered to name diatoms, &c., if sent to them.

J. L. (Ceylon).—Send us your notes on birds; also the vignettes of the same you spoke of in your letter.

C. H. WOOD.—See chapter in "Notes on Collecting and Preserving Natural History Objects," on "Bones," for the information you require.

W. G. WOOLLCOMBE.—Perhaps the following list of books may be of use: *Biology*—Dr. Nicholson's "Introduction," published by Blackwood, 5s., is a capital introductory book; "Zoology," 12s., by the same author, is one of the best advanced text-books in the English language. *Vegetable Anatomy and Physiology*—Thome's "Structural Botany," 6s., translated from the German by Bennett, and published by Longmans; also Prantl and Vine's "Text-book of Botany," published by Sonnenschein & Allen. *Lepidoptera*—Nothing can compare with Newman's "Butterflies and Moths." *Coloptera*—Rye's "British Beetles," 10s. 6d., published by L. Reeve, coloured plates. *Arachnida*—Staveley's "British Spiders," 10s. 6d. *Land and Freshwater Shells*—Rimmer's, published by David Bogue, 10s. 6d., is all that can be desired for an amateur. *Microscopical Work*—"How to Work with the Microscope," by Dr. Lionel Beale, 21s., Churchill; Davis "On Mounting," published by Bogue, 2s. 6d.; "A Thousand Objects for the Microscope," 1s., by Dr. M. C. Cooke, published by Warne, are all excellent.—W. Barrett Roué, M.B., M.S., Bristol.

EDWIN E. TURNER.—Your fungus is the "candle snuff fungus," so called because of its general resemblance to the blown out or snuffed Wick of a tallow candle. Its botanical name is *Xylaria hypoxylon*.

W. H. SYMONDS.—Get Nicholson's "Elementary Zoology," 3rd edit., published by Blackwood. For Entomology you cannot do better than procure Staveley's "Insects," or Wood's "Insects at Home"; afterwards get Newman's "Butterflies and Moths."

J. A., JUN., AND OTHERS.—We are commencing the new year by publishing SCIENCE-GOSSIP on the 22nd of the month, and hope to do so throughout the year. Hence much of the correspondence received this month necessarily stands over. Exchanges should be received at our office not later than the 8th to secure insertion.

J. T. A.—The substance you enclosed is a portion of one of the round nodules of iron pyrites very abundant in some parts in the Kentish chalk. From their radiated appearance when broken they are sometimes mistaken for aerolites.

W. H. SHREBSOLE.—Your specimens are as follows:—1. *Caprella linearis* (a not uncommon crustacean at the mouths of estuaries). 2. A species of Squilla. 3. *Unicula irrorata*. 4. *Pallene pygmaea*.

R. WOOD.—The honeycombed specimens you sent us are the egg-cases of a species of water-mite, probably of *Hydrachna globulus*.

J. A. C. (Rugby).—Your shells were not well packed, and they reached us in quite a smashed up and unrecognisable state.

J. F. R. AND A. A.—Your communications reached us too late for notice in the present number.

L. S. G.—Your specimens are as follows:—1. *Cellularia reptans*. 2. *Farinaria salicornia*. 3. *Valkeria imbricata*. Lonsborough's book would be a capital guide for you.

R. T. R. inquires whether Java sparrows ever breed in this country under ordinary conditions, and whether in winter, or, like our native birds, in spring and summer. Perhaps some of our bird-fanciers will answer.

EXCHANGES.

WANTED to exchange Cassell's "Popular Educator," 36 parts, and Cassell's "Technical Educator," 24 parts, for specimens of British butterflies and moths in good condition.—A. W. B., 443 Edgware Road, Maida Hill.

COLLECTION of 37 coins, three silver, the rest copper; what offers in eggs? Send for list to W. F. Clark, 27 Willow Grove, Beverley.

WILL exchange the following for books or slides: "Homes without Hands," Rev. J. G. Wood; "Technical Training," Twining; Withering's "British Plants," 7th edit. 4 vols.; "Malacology"; "Classification of Animals"; "Taxidermy"; "Animals in Menageries"; "Birds," vol. I.; "Fishes, Amphibians and Reptiles," 2 vols.; "Insects," Swainson; "A Natural History; containing many not common Observations," Sir Thomas Pope Blount, 1693; "Synoptical Catalogues of British Birds," Forster; "The Actual Process of Nutrition in the Living Structure demonstrated by the Microscope," Wm. Addison (with Michael Faraday's autograph); "Symbolism," Haig; "Metamorphosis et Historia Naturalis Insectorum," 1662, plates; Richardson's "Geology and Palaeontology."—W. Ernest Milner, 47 Park Road, Haverstock Hill, N.W.

Two green tree-frogs (living) in exchange for well-mounted microscopic slides.—A. T. Hall, 1 Grosvenor Terrace, Beverley Road, Hull.

SELECTED Diatomaceæ (*Pleurosigma attenuatum* and *angulatum*, and others) offered in exchange for other good slides or good diatom gatherings.—E. C. Ames, Cleavelands, Lyme Regis, Dorset.

WANTED, fossils from chalk, or offers, in exchange for a collection of 49 foreign coins (copper), also parts 1 to 10 of Cassell's "Science for All," unbound.—J. Rewcastle, Clutton, Bristol.

WANTED, the "Entomologist" for September, 1879, No. 106, also the other numbers up to the present time, for microscopic slides or cash.—C. F. George, The Grove, Kirton Lindsey.

OFFERS wanted for a collection of British moths and butterflies, containing over 1200 specimens. With option of taking fine oak cabinet and bookcase, 36 glass top drawers, folding doors, 6 ft 6 in. high, 3 ft across, 18 in. deep. Cash required.—A. C. Style, 33 High Street, Southampton.

WANTED, Blackdown fossils. Will give good Haldon fossils and corals in exchange. Wanted also good Silurian trilobites, and other Silurian fossils. Will give in exchange British first-class shells, Haldon fossils, minerals, Red Crag fossils, or slabs of Polish madreporas.—A. J. R. Sclater, 23 Bank Street, Teignmouth, Devon.

FIVE hundred British wild plants, many very rare, correctly named, date and locality. What offers?—C. A., 15 Bloomsbury Street, London, W.

WANTED, a good specimen of *Pentactinites Briareus*, of *Apoecrinites rotundus*, and of *Enicurus filiformis*; in exchange for good British land and fresh-water shells, with varieties.—Miss Jessie Hele, Fairlight, Elm Grove Road, Cotnam, Bristol.

I HAVE several good recent starfish, &c., to dispose of by exchange or otherwise. Desiderata, side-blown British birds' eggs, or books on natural history.—"Science," 165 White Ladies Road, Bristol.

Limnea peregra, var. *Burnetti*, *L. glabra*, *Vertigo aculeata*, *Cochlicopa tridens*, &c. Wanted, other British land and fresh-water shells, especially varieties.—Miss Donald, Stanwix, Carlisle.

L. C. 7th ed. Nos. 164, 550, 842, 843, 844, 1287, 1301, and 1416, for other rare plants.—F. C. King, 181 Havelock Street, Preston, Lancashire.

FOUR hairs of sea mouse (*Halithoa aculeata*) mounted or unmounted (beautiful opaque object) send other object of interest, slides preferred, to A. T., care of Mrs. S., 21 London Road, Brentford, Middlesex.

FIRST-class slides offered for heads of tape worms "human, and animal," fresh or in spirit.—C. Q. Jackson, Hill Fold, Bolton.

SKULL of dolphin, with fine pair of jaws, to be disposed of cheaply for cash or exchange.—E. Wilson, 18 Low Pavement, Nottingham.

DUPLICATES: Polychloros, cardamines, edusa, cardui, linea, hyperanthus, sylvanus, potatiana, dispar, maura, filipendula, suffusa, &c., many common species required.—J. B. Pilley, 2 High Town, Hereford.

AFTER 22nd inst. send object of interest for specimen of *Gloeopaga*, *oscillatoria*, *spirogyra*, or nostoc ground glass slips.—W. G. Woodcombe, 13 Museum Terrace, Oxford.

In exchange for microscopic slides, beach floatings from Port Adelaide, containing *Banksia varia* (and other microscopic shells), foraminifera, especially large forms of rotalia, polyzoa, &c. Also the Bengal moth (*Saturania mytilia*), six inches across wings, and *Madrobrytha cinctata* from the Friendly Isles.—M. Medhurst, 2a Dell Street, Holt Road, Liverpool 1.

OFFERED.—Carb. fishes, &c., for fishes, enclinites, &c.—T. Stock, 16 Colville Place, Edinburgh.

WANTED, a good monocular or binocular compound microscope and accessories. Will give cash in exchange. Apply with full description, maker's name, prices (cost and selling), to D. J. Wilson, 7 Kelly Street, Greenock, Scotland.

For well-mounted transparent slide of *Puccinea arundinacea* (quite distinct from *P. Graminis*) send other well-mounted slide to John G. Patterson, 2 Dalrymple Crescent, Edinburgh.

THE following shells for exchange: *Natica Alderi*, *Chiton marginatus*, *Zonites cellarius*, *Tapes virgineus*, *Venus ovata*, *Helix ericetorum*, *Trochus tumidus*, *Bulimus acutus*, *Venerupis Inus*, *Trochus cinerarius*, *Venus fasciata*, *Helix cantiana*. Desiderata, microscopic slides, or a work on natural history.—Joseph Anderson, jun., Chichester, Sussex.

SUPERIOR double action air-pump, by Griffin & Sons, London, cost £4, for cash or offers. Wanted back volumes of "Scribner's Magazine."—R. Smith, 39 Great Russell Street, Bedford Square, London.

THREE guinea microscope (nearly new), "Davies on Mounting," "Mrs. Ward on the Microscope," "A Thousand Objects for the Microscope," turntable, materials, and over 100 slides. What offers?—Rev. W. H. Skan, 49 Mayfield Road, Dalston, E.

A SET of 3 chisels and 5 gouges for wood-turning, SCIENCE-GOSSIP for 1879 and 1880, and the first 12 numbers of "The Sea." Wanted books, a small cabinet for shells, or cash.—F. W. Styan, 23 Upper Bedford Place, Russell Square.

TOURMALINE with 12 polarising minerals mounted in cork, in case, worth 30s., exchange micro-injected slides.—P., 76 Blackman Road, Leeds.

ASTRONOMICAL telescope (2½ inch), brass pillar and claw, 4 eye-pieces; also plate electrical machine, &c., in exchange for micro objectives above ½-inch, of best makers only.—H. W., 10 Evering Villas, Clapton, E.

PINE tray cabinet of geological specimens, including 40 different species, some very rare; also a small cabinet of fossil minutia, including 15 different species mounted on card. Will give both for a 3-inch objective glass, ½, or 1, or any reasonable offer of microscopic apparatus, or books on the microscope.—F. W. S., 3 Western Buildings, London Road, Stroud.

GOOD marine material, and also Eocene Tertiary fossils. List sent. Exchange minerals, or primary or secondary fossils, or sell cheap.—G. W. Colenutt, 48 Union Street, Ryde, I.W.

Volvox globator, fine specimens, mounted, for good slide of diatoms, foram., or spicules.—W. Dunn, 57 Heath Street, Birmingham.

WELL-MOUNTED sections of endogenous and exogenous stems, indigenous and exotic, single and double-stained, for other objects of interest, particularly parasites, insects' eggs, sponge spicules, and selected diatoms.—W. Blackburn, Woodlands, Chorlton-cum-Hardy.

BOOKS, ETC., RECEIVED.

"Siberia in Europe."—By H. Seebohm. London: John Murray.

"The Movements of Plants." By Charles Darwin, LL.D., F.R.S., assisted by Francis Darwin. London: John Murray.

"Peruvian Bark." By Clements R. Markham, C.B., F.R.S. London: John Murray.

"Richardson's Smaller Modern Geography." By John Richardson, M.A.

"Inorganic Chemistry." By Dr. W. B. Kemshead, F.R.A.S., F.G.S.

"The British Moss Flora." By R. Braithwaite, M.D., F.L.S. Pam. IV.—Polytrichaceæ.

"Manual of the Infusoria." By W. Saville Kent, F.L.S., F.Z.S., F.R.M.S. London: David Bogue.

"Fancy Pigeons." London: "Bazaar" Office.

"The Practical Fisherman." Ditto.

"The Book of the Rabbit." Ditto.

"Science." November.

"Annual Report of the West London Scientific Association and Field Club."

"The Oologist." October and November.

"Bulletin of the Torry Botanical Club." October.

"Good Health." (New York.) November.

"Canadian Entomologist." November.

"Land and Water." Ditto.

"Feuille des Jeunes Naturalistes."

"La Science pour Tous."

"The Midland Naturalist." December.

"Boston Journal of Chemistry." November.

"Journal of Science." November.

&c. &c. &c.

COMMUNICATIONS RECEIVED UP TO 8TH ULT. FROM:—
W. O. H.—W. J.—F. J. H.—J. R.—W. E. M.—J. S.—
A. W. B.—J. E. R.—W. R. G.—J. W.—A. G. L.—F. L.—
J. C. A.—F. H. B.—A. R. B. W.—W. H.—E. C.—W. B. R.—
W. T. G.—J. R. S. C.—E. S. W.—J. T.—J. H.—G. F. G.—
J. L. H.—E. M. O.—C. A.—D. E.—E. E. T.—F. H. H.—
A. C. S.—J. C. W.—H. B. L.—W. L.—F. C. K.—L. S. G.—
C. F. S.—E. F. W.—C. L. J.—E. L.—E. W.—A. A.—J. B. P.—
J. W. T.—W. G. W.—I. S.—M. M.—F. C.—J. A. C.—T. W.—
T. J. A.—P. K.—J. G. P.—J. A.—F. M.—C. G. M.—
J. H. S. C.—R. S.—W. H. S.—F. W. S.—E. L. A.—R. T. R.—
W. D.—J. P. K.—F. W. S.—H. J. H.—J. F.—G. S.—W. B.—
P. S.—G. W. C.—J. F. R.—W. H. S.—&c.

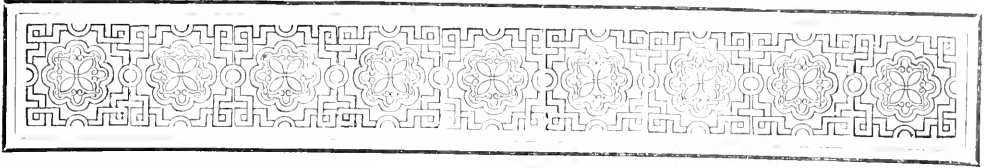

“SCIENCE-GOSSIP” BOTANICAL EXCHANGE CLUB REPORT FOR 1880.



WE are again glad to report success in our efforts to enable each member of the club, or in fact our readers, to found good, as well as reliable herbaria.

Fifteen of our members have sent us parcels for distribution, all of which are worthy of praise, as representing local floras. The majority of working naturalists are unable to leave home to gather the

rarities of well known, though, in many instances, distant localities, but they allow nothing whatever to escape their notice within a few miles of their own residences. A mechanic who has each year sent in large parcels of excellently-selected specimens, is compelled to be out by 2 A.M., in the summer morning, so that he may lose no time from his employment. Week after week he spends in the open air, only reserving Saturday and Sunday evening for his own bed; he is thus enabled to collect largely, for not unfrequently he finds himself more than twenty miles away from home, by nine o'clock in the evening; then, generally snatching a few hours' repose in some quiet woodland nook, he is again at work as soon as the day breaks, searching the bogs, &c., for rare species. It is to such men as these we are indebted for our best specimens. We have sent out nineteen parcels, i.e. nineteen members are enrolled on our register. We are deeply sorry to record that three or four of them have not been able, owing to protracted sickness, to send their usual contribution of specimens. We give such our heartiest sympathies,

which we feel we shall be cordially joined by the whole of our readers.

Space forbids we should do more than merely mention a few of the species we have had the pleasure to send out this season. One old correspondent, as usual, sends a parcel of novelties. We should have been still more delighted if there had been more duplicates for distribution. We now refer to Mr. Curnow. Long may he live to help his brother collector. In his selection we find *Mentha rubra*, now found as a Land's End specimen. *Mentha citrata*: about this he remarks, "it is more glabrous than the Lamare plant, and less hairy about the calyx; the smell too seems to be retained when dry, when in a growing state the perfume is identical." *Mentha viridis*, Mounts Bay, Cornwall: "this variety is the plant used in Cornwall for lamb's sauce, it is more hairy than the type." *Zostera marina*, a broad-leaved form from St. Mary's Sound, Scilly Island. *Scirpus carinatus*, Calstock, on the Tamar.

The Rev. W. H. Painter sends *Polygonatum officinale*, from Leigh Woods, Bristol. "This species did not flower this season here. *Convallaria majalis*, growing on the same spot, flowered very sparingly, although not so generally recognised or known, yet in any season, if wet and cold during autumn, the following summer will show but few flowers, the gardener knows well this law, for he is looking out for fruit. 'Non flores, non fruges.'" Mr. Turner forwards *Sagina nivalis*, Fr., Ben Lawers, added to the Br. Fl. within the past few years; *Cystopteris montana*, Link, Fynarum, Perthshire; *Potamogeton Zicii*, M. & K., Cauldshiels Loch, Perthshire.

Mr. Rossall, *Vicia Bithynica*, Exmouth; *Orobanche Hederae*, L., Torquay. We well remember finding this species on Conway Castle in our youth, we then gathered it with joy as a great prize, since which we have never seen it in a living state. *Lotus hispidus*, Torquay.

Mr. Watkins sends *Bromus Benckenii*, collected at Downton, Salop, with many more valuable plants. Mr. Bennett again makes up a good selection, foremost of which we find a series of the little understood

Chara and Nitella, gathered near Woking, Surrey. The Rev. H. H. Slater remits *Thalictrum Kochii*, Fries, collected in Patterdale. This species deserves more attention than it appears yet to have received from British collectors; in the "Student's Flora," it ranks as a sub-sp. of *T. minus*, L., it however, bears but little resemblance to that species. Mr. Wilkinson notices *Ilyosyamus niger*, L., thus: "this plant has grown wild in my garden for a dozen years. The place was once a common, and after my having the ground dug deep, this and about ten other uncommon plants made their appearance spontaneously." This we believe to be the experience of other observers in various parts of the kingdom.

Mr. Shrivell has dried a few well-marked specimens of *Sambucus laciniata*, a variety we but seldom meet with; whilst Mr. Duncan sends a large number of the rare orchid—*Malaxis paludosa*, L., from Bannachie. All our members will be interested in the numerous, as well as carefully dried specimens sent by Mr. Bailey. Amongst others, also noteworthy, are the following:—*Viola Curtisii*, Fost., Barmouth; *Spergularia marginata*, Boswell, Barmouth; *Poterium flatylobium*, E. Bot., Kenilworth; *Oenanthe fucivatile*, Coleman, Navan, Co. Meath; *Euphorbia Esula*, *a. genuina*, Kenilworth; *Nepeta parviflora*, Benth., a variety of *N. Glechoma*, very distinct, and worthy of studious notice, Leamington; and *Chrysanthemum maritimum*, Pers., Conway.

The above are but a few species taken promiscuously from the parcels, but sufficient to indicate to our readers the useful nature of the SCIENCE-GOSSIP Botanical Club. We trust it will also tend to increase the interest in our work.

URSINE FOLKLORE.

By JOHN WAGER.

[Continued from page 15.]

THE bear's broad paws, so well adapted for hugging hunters and paddling over lakes, have, it is said, a much more remarkable property, for "although he lies in his den the whole winter through without eating or drinking in the least, he is, nevertheless, according to all accounts, at the fattest in early spring, when he emerges from his retreat, solely, as the saying is, from having sucked his paws"—Olaus Magnus says, from sucking the right paw alone. With so much sucking, his paws are naturally tender at first when he again essays to walk. His stomach too feels squeamish, but is presently set right by the combined tonic and purgative effects of an ant-hill, which, before taking other food, he prescribes for himself and swallows at one dose.

Leaving the good bishop's pseudo-natural history, we may remark that folklore seems scarcely consistent in ascribing more than human sagacity to the

bear, and at the same time delighting to tell how easily he allows himself, like a great lubberly clown, to be befooled by the knavish fox. Everybody knows how the bear lost his tail. North American Indians, Scandinavians, and Laplanders, tell the story much in the same way, though a different tailpiece is appended to it by the Lapps. According to their version, as related by Professor Friis ("Lappisk Mythologi, Eventyr og Folkesagn"), the bear once when taking his depredatory rounds in the forest, met the fox with a fish, and asked where and how he had got it. "I stuck my tail in a well down yonder where man-folk dwell, and let the fish hang upon it," said the fox. "Couldn't I get a fish to hang on my tail?" asked the bear. "Thou couldst not endure what I endured," answered the fox. "Pooh," growled the bear, "couldn't I endure what thou hast endured, old fox fool?" "Yes, yes, then, grandfather," said the fox, "so thou also mayest stick thy tail into the manfolk's well and try, I will show thee the way!" So the fox led the bear to a well, and said: "See, grandfather, here is the well where I caught my fish." So the bear stuck his tail down into the well. Meantime, the fox skulked about a little, while the bear's tail was in course of being frozen fast. Then, when the right moment had arrived, he shouted: "Come hither, manfolk, with your bows and spears. There is a bear here, sitting and polluting your well!" So the people came running with their bows and spears; and when the bear saw them, he hobbled up with such haste that his tail broke short off; but the fox sprang into the forest, and crept under the root of a fir-tree.

Besides the ordinary Scandinavian version of the affair, some of the Swedish peasants have another, which I translate from the "Wärend och Wirdarne" of Hylten-Cavallius:

The fox found a humble-bees' nest, and would fain get the honey. So he stretched out his tail, and all the bees settled upon it; he then ran off with them, and afterwards turned back and ate the honey. Rambling a little farther, he met the bear: "Thou art licking thy lips," said the bear; "I know thou hast been eating honey." "Yes, that I have," said the fox. "Where didst thou get it?" said the bear. "Well, I did so-and-so," said the fox. "Thou art alway ingenious," said the bear; "good would they be who would show me where I also might get myself a little honey." "Oh, that is easy enough," answered the fox; "if thou wilt only follow me; I happen to know of another bees' nest in the forest."

But the fox thought only of a roguish trick, as he never was anything else but a rogue. He therefore led the bear to a great log which lay cloven in the forest, with the wedge in. "Stick thy tail in here now," said the fox; "it is full of bees, and here thou wilt find honey." But when the bear had stuck his tail in, the fox was ready, and took out the wedge. "Now thou hast them," said the fox. "Jerk now

quick!" So the bear jerked with such force that the tail, being fixed fast in the log, was jerked off. And the bear has been tailless from that day.

In Bornou, Africa, the hyæna lost his caudal appendage through a similar sly trick, played by the weasel.

Another story in the same work also contrasts the simplicity of the bear with the arch cunning of the fox. A bear and a fox once joined in a rye-field, and after shearing the rye, took it home to thresh. Then said the fox, "Thou art not good at striking so that the straw may lie still." So the bear struck harder and harder, and the more he struck the more hopped the straw.

When the threshing was over they had to winnow. Then said the fox, "Whether wilt thou have the great heap or the lesser heap?" "I will have the great heap," answered the bear. Yes, the fox winnowed, and when all was ready the bear took the chaff. But the fox, poor fellow, he contented himself with taking the lesser heap.

Stories of wild beasts suckling and rearing children have been current from remotest times; the Romans borrowed their legend of Romulus and the she-wolf from the Etruscans, who brought it, perhaps, from Mongolian lands, where a version of it yet survives among the Chinese (see Taylor's "Words and Places"). Orson, the hero of French romance, was suckled by a bear, and thence derived along with the name a goodly portion of the bear's reputed strength and wit:—

"To more than savage strength he joins
A more than human skill;
For arms no cunning may suffice
His cruel rage to still."

His ursine aspect too would have quailed the heart of any knight less valiant than Valentine, his brother, unknown, for:

"His unkempt hair all matted hung
His shaggy shoulders round;
His eager eye all fiery glow'd;
His face with fury frown'd.
Like eagle's talons grew his nails,
His limbs were thick and strong;
And dreadful was the knotted oak
He bare with him along."

That she-bears should nurture human children is remarkable enough, but more so that a paternal bear should be the ancestor of a royal house; such, however, according to legendary lore, was the origin of a line of Danish kings. The circumstance was related by Saxo Grammaticus, in the eleventh century, and repeated by Olaus Magnus, with apparent trust, in the fifteenth; but the following account is derived from the "Saga-Häfder" of Afzelius, the Swedish historian, recently deceased. The author introduces his narrative with the remark that in country districts the knowledge is yet retained of the olden sagas respecting magic that could transform human beings into the shape of wild creatures, such as wolves and bears. These enchanted persons could resume their

own shape at midnight; but at cock-crow, before daybreak, they were compelled to retake the animal form, and run off to the forests and waste ground. Lapp and Finn witches and wizards were especially gifted with this remarkable endowment, being supremest of sorcerers.

Once, says an old chronicle of the royal Danish families, a rich man dwelt in Sweden, who had a daughter, gifted with the rarest beauty and most agreeable disposition. Near the village lay a green and pleasant spot, where the young often went to amuse themselves. It chanced one day when the beautiful daughter of the rich peasant was there with her playmates, a bear suddenly rushed amidst them out of the forest, and seizing the girl in its fore-paws, hastened with her to its den, far within the forest's depths. There, however, it showed her the greatest kindness, provided her every day with game and fruits, and let her want for nothing. But as the bear, for his own food, killed many cattle in the district, the people collected, gave chase, and effected his death. The peasant's daughter was then found again, and soon after gave birth to a son, which they called Björn (Bear). He grew up, stronger than other men, both in body and in mind; in this it was thought he took after his father, for it is an old saying, "The bear has twelve men's wit and six men's strength." This bear's grandson was Ulf Jarl of Scania, who, with the brother's consent, took to wife Estrid, sister to the Danish king, Knut the Rich. Ulf saved Knut and his fleet from falling into the hands of the enemy near the island of Helgé; yet the king never freely accorded him his friendship, and shortly afterwards, when they had quarrelled over a game of chess, and Ulf had fled from offended majesty to sanctuary in Lucius church, he was murdered before the altar by a man whom the king had sent for the purpose.

In the plenitude of his power, Knut the Rich paid little regard to the old maxim that evil deeds bequeath a sorrowful inheritance; but so it proved. After his death the people of Denmark and Norway fell off from the Sköldunga family, to which his sons belonged; and Ulf's son, Swen, surnamed Estrids-son, who on the murder of his father had gone to his relatives in Sweden, was finally, by the aid of the Swedes, placed upon the Danish throne. Some suppose that the ancestor of his dynasty was a robber-chief, who, clad in bear skin, had carried off the beautiful peasant girl to his wild, secluded den. According to Pennant, "Ulva," one of the Hebrides, derives its name from this son of a Swedish bear.

The bear is rarely mentioned by Herodotus, but in one instance appears in his pages associated with animals some of which are even more surprising than Bruin himself. After describing a very hilly part of Libya abounding with forests and wild beasts, he adds: "This is the tract in which the huge serpents are found, and the lions, the elephants,

the bears, the aspicks, and the horned asses. Here, too, are the dog-faced creatures, and the creatures without heads, whom the Libyans declare to have eyes in their breasts; and also the wild men, and the wild women, and many other far less fabulous beasts."

Sundry superstitions and popular notions appertaining to the bear prevail in Scandinavia and other countries. In Norway it is a common saying, that on mid-winter day, January 12, winter rolls over on his back, and the weather and the bear also turn themselves on the other side. The belief that he will never injure a child accredits him with some degree of susceptibility; and though not gifted with a musical voice, his gentlest tone being usually a gruff and surly growl, he is by no means insensible to the "concord of sweet sounds," if it be true, as believed in the pastoral forests of Sweden, that he will stealthily approach and listen with charmed soul to the modulated notes of the rustic finger-pipe, while it is well known that he flees, as with a sore ear, from the harsh clangour of the cow's horn. Olaus Magnus, who wrote full three centuries ago, informs us that the hero Hialtho grew strong from drinking the blood of a huge bear, which his redoubtable companion Biarcho had slain. That bear's grease is a great nourisher of silken locks is, or was, an article of faith with all young ladies, though boar's grease, called by its name, commonly did duty in its stead. The Laplanders, Acerbi tells us, believe bear's grease a sovereign remedy for pains in the limbs; but Bamsen's unction must be applied for a man's ailments and Bingsen's for those of a woman, or no good will result. In the south of Sweden, too, a medicament supposed by the purchaser to be bear's grease is, or used to be, sold by the apothecaries to the peasants for similar purposes. Sinews of the potent bear were a constituent of the mighty cord, stronger than the cable of a Thunderer, made to bind the wolf Fenrir, whose terrible jaws endangered the sun and the moon. To insure fierce house-dogs, Swedish peasants used formerly to feed the whelps with wolf's flesh and bear's paws; a bear's paw also formed part of a Scandinavian midwife's clinical outfit; and, in our own country, one of the many fanciful remedies for whooping-cough is riding upon a bear's back. In Norway it is quite as unlucky as in any other country to meet a hare in the morning, but if you meet a bear or a wolf it is a more favourable omen, and you may pursue your journey without alarm. Norwegian peasants also believe that the bear when mortally wounded, flees, if possible, to the nearest tarn or river, where he dives, and bites himself fast to the bottom that he may die there and disappoint the hunter of his warm hide and delectable hams.

Finally, Bruin, though not so much of a Solomon as some have supposed, has nevertheless suggested the following items of proverbial wisdom to the Danes and the Swedes. 1. Danish proverbs: "The bear's skin bites not. There are claws in the bear's skin. The bear bites where he is bound. It is dangerous for a whelp to play with bears' cubs." 2. Swedish proverbs: "At home like a bear, abroad like a shot eagle. Soon enough to sell the hide when the bear is shot. Man should not wake a sleeping bear. They who tear with the wolf should have bears' claws. If no 'if' had come between, the old woman had bit the bear, and not the bear the old woman."

A BROOKSIDE RAMBLE IN SEARCH OF EGGS.

EARLY one fine morning in the latter part of May, I started in company with a friend on a nesting expedition, to the haunts of some of the rarer species of birds to be met with in the neighbourhood of Goosnargh, near Preston.

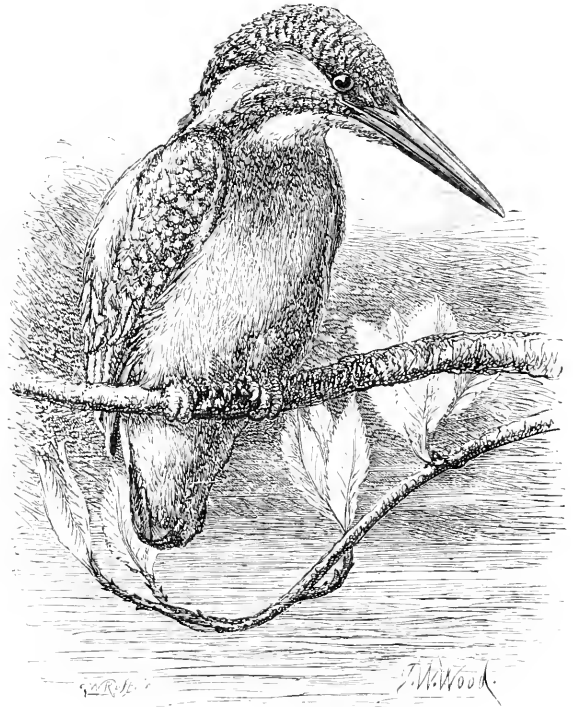

Fig. 16.—The Kingfisher (*Alcedo hispidus*).

Our intended hunting ground lay along the banks of a large and beautiful trout stream called Middleton-Brook, which runs close to Middleton Hall, once the country residence of the Rigby's.

Arrived at the stream, we at once struck into the woods which fringe its banks on both sides, and were soon in the full enjoyment of the quiet seclusion

they afforded—for now we were in a part seldom traversed by any one but the game-keeper, but from this dread personage we had nothing to fear, being on the best of terms with him, and, besides, we had free range over these preserves. Very soon our ears were gladdened by the well-known note of the sandpiper (*T. hypoleuca*), as a pair rose from a gravel bed, and sailed away, on extended wing, up the stream, uttering their ringing cry of “Willy Wicket, Willy Wicket”—a cry I always hear with pleasure, for this lively little bird is a particular favourite of mine, and I like to see it paddling about in the shallows, or running briskly along the water’s edge, uttering its plaintive whistle when apprehensive of danger to its nest or young if its domains are invaded by man. We now began to search for the nest, and found it on the bankside, close to the water, with its full quota of eggs—four. So small is the cavity made by this bird for its nest, and so closely do the eggs assimilate with the surroundings, that only by great practice can it be readily discovered. Sometimes, but very rarely, I have found the nest on the sand-beds, and have always noticed that eggs laid in this situation are of a light stone colour, profusely dotted with small rusty and brownish

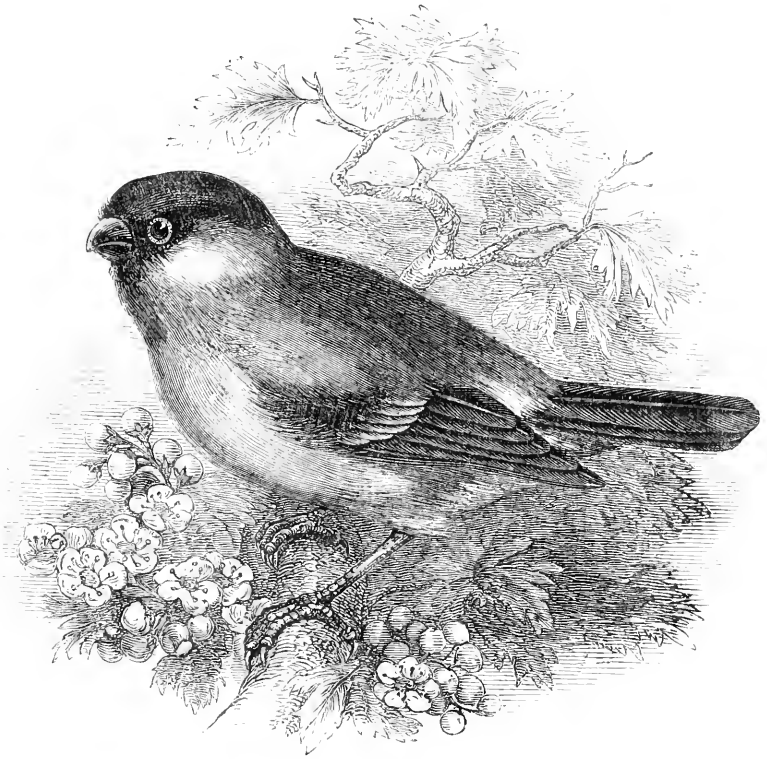

Fig. 17.—The Bullfinch (*Pyrrhula vulgaris*).



Fig. 18.—Black-headed Bunting (*Emberiza schoeniclus*).

black spots, and when the full number are laid, with their small ends placed downwards, and completely filling the slight cavity of the nest, you may easily crush them underfoot unnoticed. When placed on the bankside, where I most frequently find them, the eggs are generally very much blotched at the larger end, so as to resemble the dead leaves and grass, &c., amongst which they are usually placed. I have found the nest 300 yards from the waterside. The young ones run as soon as hatched, and are bonny little creatures, and the parent birds use the various stratagems common to the tribe, in order to entice intruders away from them—tumbling along close to your feet as if they were seriously injured, and striving to induce you to run after them. We made the acquaintance of many of these pretty little birds during the day's ramble, and found several nests.

In the side of a steep "scar," where the bank had

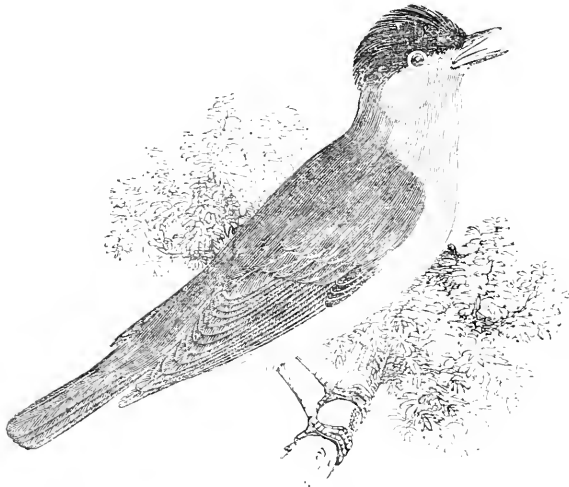

Fig. 19.—The Blackcap Warbler (*Curruca atricapilla*).

been undermined by the water, and a considerable portion had slipped down, we found a colony of sand-martins (*H. riparia*). The nests were from two to three feet deep in the bank, and before cutting into one or two, we examined with great interest the masses of fleas (*Pulex hirundinis*) basking in the sun at the entrance of many of the holes. The poor birds must have an uneasy time of it with so many of these little pests to share their homes—indeed, sometimes they forsake both nest and young because of them. In several holes where the fleas were more numerous than usual, the pure white eggs were thickly dotted all over with minute black spots, which I used to think were the natural markings, but found that they were but the excrement of the fleas. A pair of sparrows (*P. domesticus*) had taken possession of one of the holes.

A little farther on we discovered the first of three

nests of kingfisher (*A. hispida*), found during the day. It was tunnelled about three feet deep into the sandy bank, near the top of a "scar," and a considerable distance above the water—sloping gradually upwards, so that by measuring the depth with a stick, we were enabled, by cutting out a small sod, to lay bare the nest. It was made of the usual heap of disgorged fish-bones, which emitted a "most ancient fish-like smell," and lying in the cavity on the top of them, were the seven beautiful pinky-tinted, semi-transparent white eggs. It is a pity this tint should be lost in blowing, as it is caused by the yolk showing through the shell. My friend placed his hand in the hole, and greatly to his surprise the old bird, which had remained in it, flew into his hand. He brought it carefully out, and after we had admired its beautiful plumage, he liberated it, and away it darted, to return in a few moments accompanied by its mate, and together they dashed past us, gliding along like two living meteors. The kingfisher breeds not uncommonly with us, and I have never had any difficulty in procuring what eggs I required. In searching for the nest, one's nose is as good a guide as anything, and should be poked into every likely



Fig. 20.—Egg of Blackcap Warbler.

hole, and if the smell inhaled therefrom be but offensive and "fishy" enough, you may pretty safely conclude that you are on the right scent.

We were rather too late in the season to find any eggs of the lively dipper (*C. aquaticus*) but found several empty nests from which the young had flown. An-

other one was built on the end of a moss-covered stump, which projected over the water, and although it was plain enough to see when you knew of it, we should have passed it by as being merely a part of the stump, if an unintentional rap with a stick had not caused a troop of nearly fledged young ones to tumble helter-skelter out of the nest into the stream, where they instantly vanished from view. I have taken the dipper's eggs as early as the 1st of March.

We saw several grey wagtails (*M. boarula*) mostly young ones of the year. It is a bird but rarely met with here, but a season seldom passes without my finding one or two nests. It appears to breed very early, for I have always found the eggs early in March; and, in every instance but one, they were very "hard-sat" when found. In connection with the nesting of this species, I have noticed a circumstance, which I have not seen mentioned by any

writer, and that is, that a large proportion of the eggs are usually addled ones. This season I found a nest built on the side of a weir, containing a young one just breaking through the shell, and five unhatched eggs. On trying them, I concluded they must be addled, but left them in the nest a week longer, and on again visiting it, was not displeased to find my conjecture right, for they were still unhatched, and addled. They were almost as easy to blow as freshly laid ones, so I carried them off as a prize worth having. I am inclined to think that the fact of so many eggs being unproductive may to some extent account for the scarcity of this pretty little bird. Perhaps, some other ornithologist may have noticed this circumstance and will kindly report upon it.

About noon we arrived at a little glade, thickly overgrown with briar and bramble bushes, which we knew as being a favourite haunt of the grasshopper warbler (*S. locustella*), and we were not long before we heard the peculiar stridulous note of this curious bird, which, from its retired habits, is far oftener heard than seen. We spent a considerable time in searching for its nest, but without avail; for although we several times got a glimpse of the bird itself creeping amongst the long grass and bushes, the undergrowth was so dense, that finding the nest would have been a case of accident. I have usually found the cup-shaped nest, with its six or seven pinky-white eggs, speckled with spots of a reddish hue, at the foot of a bush, or amongst long grass. I consider it one of the most difficult nests to find; and all I have seen have been found by going at dusk, or when the bird is sitting, and carefully watching for it flying off, whilst you beat the bushes gently with a stick. I have often been struck with the wonderful ventriloquial powers of this bird. Although it may be but two or three yards from you, its note will sometimes seem fifty yards away, now in front, and then behind you, so that it is difficult to make out exactly where the sound really comes from. This power is most noticeable when the bird is alarmed, and is doubtless intended as a means of protection.

In this place we found nests of blackheaded bunting (*E. schanielus*), lesser whitethroat (*C. sylviella*), blackcap (*C. atricapilla*), and bullfinch (*P. vulgaris*), and other commoner ones.

During the day we found a nest of jay (*G. glandarius*) snugly concealed in the fork of an ivy-covered tree; two nests of kestrel (*F. tinnunculus*), and one of sparrowhawk (*A. nisus*); both these latter breed rather commonly with us. We also found several nests of magpie (*P. caudata*), ringdove (*C. palumbus*) and snipe (*S. gallinago*), besides scores of nests of the commoner species, which we scarcely deigned to notice.

Having now explored the banks of the stream for a considerable distance, and night approaching, we

retraced our steps homeward tired enough—but well pleased with the various treasures we had procured, which in years to come will, I hope, serve to remind us of our pleasant “brookside ramble.”

Goesnargh, Lancaster.

R. STANDEN.

A NATURALIST'S EXPLORATION OF NEW GUINEA.

NEXT to the pleasures of exploring new regions, and seeing for the first time wonderful and strange forms of animal and vegetable life, comes the interest in reading of them, and thus it is with confidence we can draw the attention of readers to a handsome new book on the “terra incognita” of New Guinea by Signor D’Albertis, and published by Messrs. Sampson Low & Co.

Perhaps less is known of the great island of Papua than of any other part of the world, with the exception of Central Africa, and hitherto its fauna and flora have, like the golden apples of the Hesperides, hung out as a rich reward for the daring adventurer who should first reach them. At the back of the world, the great forest-clad island has been out of reach of naturalists who could not devote much time and energy to its treasures, and even when the explorer approaches it he finds the coast is girt by that grim guardian of many of the most lovely spots of the tropical world—the deadly fever and malaria. So when the author enthusiastically sets out for a five years’ voyage of discovery “to the land of ever verdant primeval forests, a region of perpetual ecstasy,” we follow his record with much interest, though we fear that the “perpetual ecstasy” will be considerably modified before the task is done.

Signor D’Albertis belongs to the class of explorers, of whom Dr. Livingstone was a bright example, who win their way in wild countries and among hostile natives rather by gentleness than force of arms, and are ready rather to give up their most cherished objects than spill human blood unnecessarily, even although it be only the blood of “savages.” Thus, though frequently attacked, and constantly treated with contempt by the natives, only on two occasions, and in actual self-defence, did the author find bloodshed absolutely unavoidable.

Once landed it does not take him long to modify his enthusiasm at the primeval jungle, and having established a base of operations at the island of Sorong, he makes his first expedition to the river Ramoi, and encamps some distance up the stream in a forest, the description of which is most fascinating. But though a good place for collecting, the natives are afraid of the white man, and will not bring him any food; besides this, the whole party get fever, and in fourteen or fifteen days are only too glad to escape from the very lovely but deadly spot.

Another expedition, inland, is more successful,

and D'Alberis, with a long retinue of friendly natives, penetrates from the north-east coast up the delightful rhododendron and fern-clad Arfak mountains to the highland village of Hatam, never before reached by any European. Here he makes his first great prize, a lovely *Parotia sexpennis*, one of the most beautiful and rare birds-of-paradise, of which only one or two badly prepared skins have ever found their

his name of *sexpennis* is derived, and to raise and lower a small tuft of white feathers above his beak, which shone in the rays of the sun like burnished silver; he also raised and lowered the crest of stiff feathers, almost like scales, and glittering like bits of bright metal, with which his neck was adorned. He spread and contracted the long feathers on his sides, in a way which made him appear now larger and again

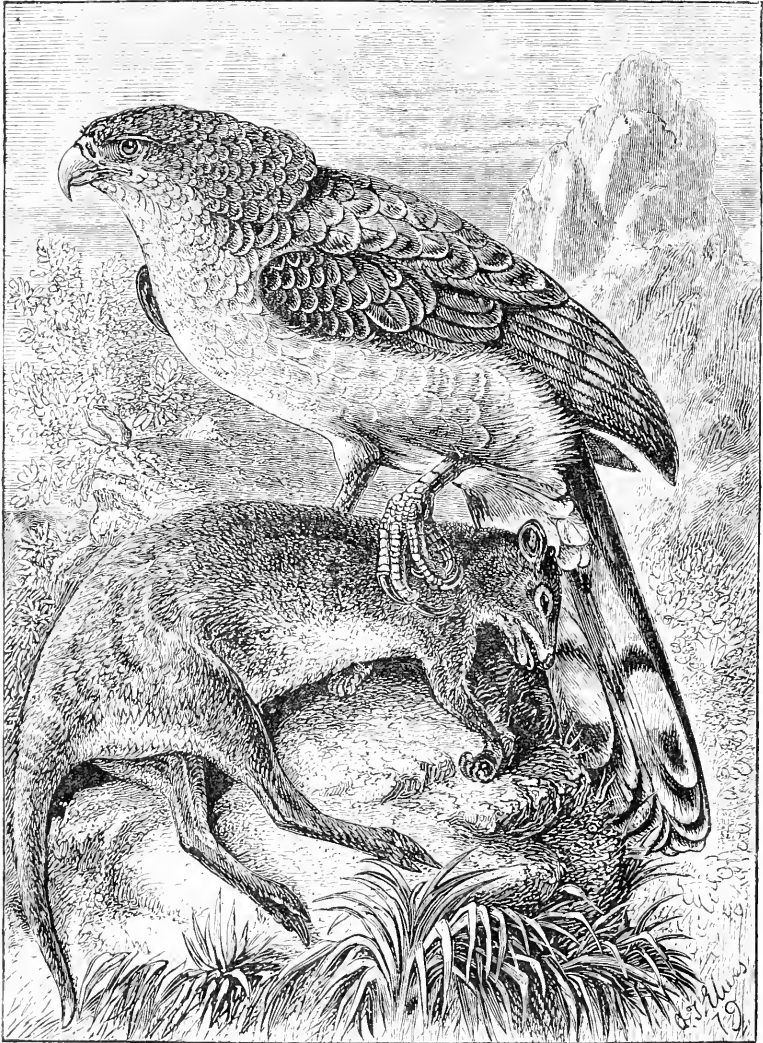

Fig. 21.—*Harpyopsis Nova-Guineae* attacking a small Kangaroo. From D'Alberis' "New Guinea."

way to England. Wandering one morning in the quiet groves of delicate flowers and giant ferns on this unknown mountain, he suddenly hears the musical call of a strange bird, "and after standing some moments in the middle of the little glade," D'Alberis writes, "the beautiful bird peered about to see if all was safe, and then he began to move the long feathers of his head, six in number, from which

smaller than his real size, and jumping first on one side, and then on the other, he placed himself proudly in an attitude of combat, as though he imagined himself fighting with an invisible foe." But his life ends there and then, and the jewel-like prize is carried home in triumph.

For so ardent an ornithologist, this region is a paradise, and here he secures many new species

many hitherto totally unknown, and skins and prepares them outside his little hut, amidst a circle of admiring natives. He has fever slightly, but it is forgotten in the excitement of adding new birds to his collections every day. Amongst others, he records another new bird of paradise (*Drepanornis Albertsii*) with a curved hoopoe-like bill, and the male of which has a purple gorget, flame-coloured greaves, and a head-piece of burnished brass, while his mate is clad in modest brown and grey.

But after a considerable stay, this fertile region has to be left, as the natives will not supply food, and believe the white man brings them misfortune; so he has to return to the low lands, and subsequently explores the southern coast of Papua, and makes sundry expeditions to the villages in the neighbourhood of Yule island, and enriches his collections with rare birds and insects. To what an extent he was successful, we may judge when we are told he brings away from one inland village "twenty thousand coleoptera, seven hundred reptiles, and a great number of fish, mammalia, and birds!"

The second volume is taken up with the account of two interesting voyages of discovery made in a small steam launch up the Fly river, the largest stream of New Guinea, and which, rising in the centre of the island, flows in a meandering course through mighty jungles and broad prairies, past the villages of many wild tribes and peoples, until it passes out amongst a hundred islands into the broad Gulf of Papua. The possibility of finding gold in this region, and the certainty of a great future before it, makes this part of the book very interesting, but it is impossible to follow the author through all his adventures on the Fly river, and we must refer readers to the book itself, confident they will appreciate the excellence of the engravings, and agree with us that it is a valuable contribution to our stock of information of a little known land.

BIRD STUDIES IN CHALK.

(After Marsh.)*

By AGNES CRANE.

SOME years have elapsed since palæontological circles were startled by the announcement of the former existence in America of birds, unlike all other birds in structure, because they were furnished with teeth. We accepted the birds with teeth, and have since heard with complacency of their co-existence with aerial reptiles (Pteranodons) without teeth, and that toothless Ichthyosaurs represented their predaceous race in the Cretaceous oceans of that continent, where it seems almost as though generic dentary characters were usually reversed. All these

* "Extinct Toothed Birds (Odontornithes) of North America," by O. C. Marsh, Vol. 1. of the "Memoirs of the Peabody Museum of Yale," Newhaven, Conn., 1880. 34 plates and 40 woodcuts.

facts, and many others of like interesting import, have been in the main revealed through the indefatigable exertions of Professor O. C. Marsh of Yale, who, a true knight-errant palæontological, has inspired and led many a crusade into the far West, amid difficulties, great hardships, and no little danger, and in spite of tropical heat, Arctic cold, and unsympathetic Indians on the war path, has brought to light the remains of nearly a thousand new species of extinct vertebrates. All of these, now safely housed in the cellars of the Peabody Museum of Yale, await full description and illustration at the hands of their discoverer.

But Professor Marsh, like Alexander, apparently

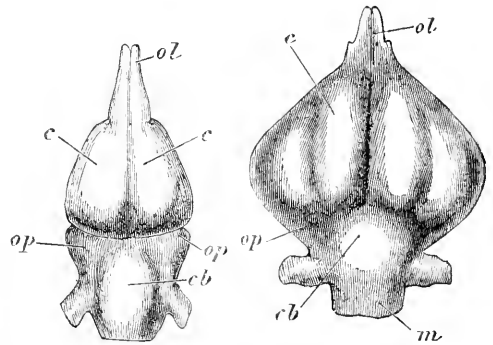

Fig. 22.—Brain cavity of *Ucsperornis regalis* (Marsh). 2/3 natural size.

Fig. 23.—Brain cavity of Loon (*Colymbus torquatus*). Natural size.

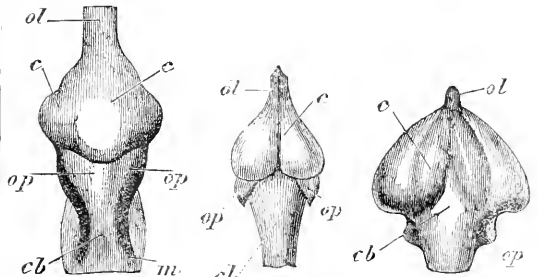

Fig. 24.—Brain cavity of young Alligator. Natural size.

Fig. 25.—Brain cavity of *Ichthyornis vic-tor* (Marsh). 2/3 nat. size.

Fig. 26.—Brain cavity of *Sterna cantiaca*. Natural size.

ol. Olfactory. c. Cerebral hemispheres.
op. Optic lobes. cb. Cerebellum.
m. Medulla. (After Marsh.)

still sighs for fresh worlds to conquer, and is unable long to refrain from prosecuting his active researches in the field. Hence it is that eight years have elapsed since the discovery of the first bird with teeth, during the second of those memorable expeditions into the Western territories, and their full history and that of other new forms has remained unwritten. Brief records of the most significant characters of their structure have appeared from time to time in the "American Journal of Arts and Sciences," and thence have been incorporated into general scientific literature. We have now to welcome the appearance of the first volume of the "Memoirs of the Peabody

Museum of Yale ;" and the announcement that much of the material for the completion of others is in an advanced state of preparation. The initial volume of what promises to be a most remarkable series, is devoted exclusively to the Odontornithes, or toothed birds. In method of treatment it can be compared only with the classical contributions of M. Alphonse Milne-Edwards to the history of fossil birds, while for typographical excellence, and the number and beauty of the finely-executed plates, it stands pre-eminent, even among the many fine palæontological works that have been issued in America.

During the publication of the justly celebrated "Recherches pour servir à l'histoire des oiseaux fossiles," the existence of Mesozoic birds was unproven, if suspected, and for long after the world-famed Archaeopteryx of Solenhofen, now represented by a second and more perfect specimen in the Museum of the University of Berlin, was the sole representative of its class. A few subsequently discovered fragmentary remains from the Greensand proved the fact of the persistence of the group through the Cretaceous epoch. Now we know that nine genera and twenty species existed in America alone during the deposition of that series. Most of these were discovered in soft marly deposits of middle Cretaceous age on the eastern slopes of the Rocky Mountains in Kansas and Texas. They occurred, associated with the remains of Plesiosaurians, toothless Pterodactyles, mosasauroid reptiles, and numberless species of fishes and mollusks.

Professor Marsh describes two widely separated avian types as co-existing in one region at that period. These, however, possessed one character in common—jaws set with teeth so unbird-like and sauroid in shape, mode of implantation and reproduction, that they might readily be mistaken for those of true reptiles if discovered unassociated with the remains of the avian skeleton. The Odontornithes or "toothed birds" are divided into two groups. The type genus of the Odontolæ, those with grooved jaws, being that remarkable wingless, "Western" bird (Hesperornis) which bore most resemblance to the grebes. It stood over three feet in height, and almost incapable of movement on land, was a powerful diver and swimmer, with a long flexible neck and robust limbs, especially adapted for swift propulsion in the water and a broad tail of nearly beaver-like proportions. This genus possessed the saddle-backed articulation of the vertebræ characteristic of almost all known birds. The structure of the rudimentary wings, keelless breast, shoulder girdle, and skull recalls that of the ostrich, and its very robust hind limbs exhibit as much specialised modification for an exclusively aquatic life as those of that genus for swift running on land. In fact Hesperornis led an essentially aquatic life, fed on the fishes of the Cretaceous ocean, resorting to the nearest land, a low series of islets now the site of the Rocky Mountains, only in the breeding season.

The second group of Odontotormæ comprises a number of small keel-breasted short tailed flying birds referable to the genera Apatornis (one species) and Ichthyornis. These also led an aquatic life, and the teeth which were sunk in distinct sockets in their slender saurian jaws enabled them to catch and hold with dexterity the fish on which they fed. "Ichthyornis in many respects probably resembled the modern terns in its mode of life. The powerful wings and small feet suggest similar habits in flight and rest. That Ichthyornis was provided with feathers, is proved beyond a question by the tubercles for the attachment of the quills in the forearm. It lived at a time when the only other denizens of the air at present known to have inhabited the same region were the toothless Pterodactyles." This genus differed from all its known contemporaries and successors in possessing vertebræ concave at both ends like those of fishes, and therefore devoid of the curious saddle-shaped articulation characteristic of all other birds, the origin of which was hitherto veiled in mystery.

In the third neck vertebra of *Ichthyornis victor* Professor Marsh detected a clue to his peculiar modification and the development of the modern style of avian vertebra from the fish-like biconcave form. All the other vertebra of that genus resemble those of fishes, and the anterior articulation retains its cup-shaped form. But the third cervical of *I. victor* presents intermediate characters, and "we catch nature in the act as it were of forming a new type by modifying one form of vertebra into another." This change Professor Marsh concludes was originated by increasing movement in a vertical plane. This deflected the upper and lower margins of the circular cup, produced vertical constriction, and at the same time left the side margins projecting. The change began and was first perpetuated at the bend of the neck where most movement was possible, and being advantageous to the birds was extended to the successive cervical, dorsal, and sacral joints of the vertebral column. The fact that the saddle-shaped articulation in existing birds is most marked in the anterior regions, where full and free movement is not arrested by the ribs and neural spines, supports this conclusion as to its development in this manner from the primitive fish-like concave form of vertebra.

Professor Marsh's bird studies have also revealed the interesting fact, that the very significant law of progressive brain growth known to be characteristic of the Mammalia is equally applicable to the birds. This conclusion is based on the evidence afforded by the skulls of Cretaceous genera, described in the memoir which show that the avian brain at that period was small and reptilian in character. The cerebral hemispheres in Hesperornis are about one-third less than those of the loon, a bird about the same size and habits, and the same disproportion is noticeable between the brain cavity of Ichthyornis and that of the tern, its nearest ally. We reproduce Professor

Marsh's figures, showing that in recent birds the cerebral hemispheres have largely increased, while the prominence of the olfactory and optic lobes, a marked reptilian character, is greatly diminished.

The structure of the *Odontornithes* throws considerable light on the origin of birds and the genealogy of the race. Their history makes it evident that two types, each differing widely from the other, were contemporaries in an aquatic paradise of the tropical ocean of the chalk epoch in Western America. In one the primitive form of biconcave vertebrae, clearly pointing to an ancestry even lower than the reptiles, was associated with a skeleton resembling that of existing keel-breasted birds; the other exhibited peculiarities now found only among the scanty survivors of the Ratite race—the flat-breasted ostriches, and their congeners, the most reptilian of all living birds. Both these types were united by the possession of teeth, which separates them from all existing species, and it is possible that some other of their contemporaries were alike distinguished by this peculiarity. For no less than nine avian genera, represented by twenty species, are now known to have existed in America during the deposition of the chalk. All these, however, Professor Marsh points out, were aquatic species, and therefore peculiarly liable to be preserved in marine deposits.

The solitary *Archæopteryx* of the European Jurassic is the only known example of a Mesozoic land bird. (?) A second specimen of this remarkable genus was discovered in the same locality, by the son of the fortunate finder of the first example—that now in the British Museum. This was purchased by Dr. Siemens, of Berlin, for 20,000 marks (800*l.*), with a view to its retention in the Fatherland, it was subsequently bought by the Prussian Government for 18,000 marks, and is now in the possession of the University of Berlin. According to Karl Vogt, the hind limbs only are avian, the other portions of the skeleton being entirely reptilian. The breastbone is keelless, and there is no "merry-thought." From the osseous structure of the fore limbs, terminating in three free fingers, it would be impossible to describe the animal as a bird, had no feathers been preserved. These are, however, well developed on the neck, legs, and wings, and the presence, even of the underlying down, is indicated. Hence, it was concluded that the body was naked, as no feathers occur on its surface. Was it moulting at the time of its entombment in the fine mud of the Solenhofen seas? But Professor Owen has suggested that the absence of the soft body feathers is not absolute proof of their non-existence, as it is just on that portion of the body, they would first become detached from the carcase as it floated on the water; the stronger roots of wing and tail plumes retaining them longer in position, and thus protecting the underlying down. But whether half naked, or wholly feather-clad, the pre-

servation of the wing and tail coverings proves that those usual accompaniments to hot blood and an aerial existence were fully developed at an early Mesozoic age. Two minute teeth have been detected in the upper jaw of *Archæopteryx*, and Professor Marsh believes that eventually this genus will be found to possess the biconcave form of vertebrae.

Such is the complex structure of this feathered lizard, or reptilian bird, capable of quadrupedal locomotion. Its occurrence in the Jurassic, and that of the aquatic ostrich, *Hesperornis*, and the fish-like *Ichthyornis* in the Cretaceous epoch, Professor Marsh holds to be proof of the extreme antiquity of the race of birds thus early represented by three such differentiated types. He further suggests that the ancestral forms of primeval arboreal birds—feathered limbed, and even more reptilian in structure—may yet be discovered in America in some of the old land areas of Triassic, or possibly of Permian age. Who, remembering the twenty species of cretaceous birds, which, utterly unknown a few years back, now form the subject of his splendid memoir, shall venture to define that anticipation as too sanguine?

CHAPTERS ON BRITISH DRAGON-FLIES.

NO. I.

By E. B. KEMP-WELCH.

WHEN first commencing, some years since, the study of these insects, I found considerable difficulty in identifying my captures, as there appeared to be no work obtainable treating of the British species, nor, I believe, has this want been supplied up to the present time. Latterly some queries have appeared in *SCIENCE-GOSSIP* as to names of specimens taken, and it occurs to me that a short description of the various species inhabiting Britain may, at any rate, be of some assistance to beginners in the study of these insects.

The system of classification followed is that of Dr. Hagen, whose descriptions of species I propose also to adopt in the case of species not in my collection, or of which I have no figures. Before commencing I will give a few diagrams, a reference to which, from time to time, will assist beginners in understanding the technical terms used to distinguish the various parts.

British dragon-flies are easily divided into two groups, distinguished as follows:—

FIRST GROUP.

Wings dissimilar in shape; the hinder wings being dilated at the base.
Eyes more or less contiguous.

FAMILIES.

<i>Libellulidæ</i>	} Lower lip, or labium, smaller than the palpi.
<i>Corduliidæ</i>	
<i>Gomphidæ</i>	} Lower lip, or labium, larger than the palpi.
<i>Aschnidæ</i>	

SECOND GROUP.

Wings similar in shape.
Eyes projecting and more widely separated.
Abdomen very slender.

FAMILIES.

Calopterygidae: Antecubital nervures numerous.
Agriionidae: Two antecubital nervures only.

(The measurements given are those of Dr. Hagen.)

LIBELLULIDÆ.

Genus *Libellula* (Linn.).

A. With 10-16 antecubital nervures.

at base of hind wings, and a brown bar in middle of base of front wings; thorax brown and hairy; abdomen very broad and much depressed, spotted with yellow on the sides; powdered with cobalt-blue in the male, brown in the female; accessory membrane white. England, Scotland, and Ireland; but local. Length 19 lin.; exp. 32 lin.

L. fulva (Müll.). Brown line and triangular spot at base of hind wings, and brown line at base of front wings; pterostigma black; thorax rusty-brown, hairy; abdomen broad, brown in the ♀, powdered blue in the ♂; has a black band at the apex;

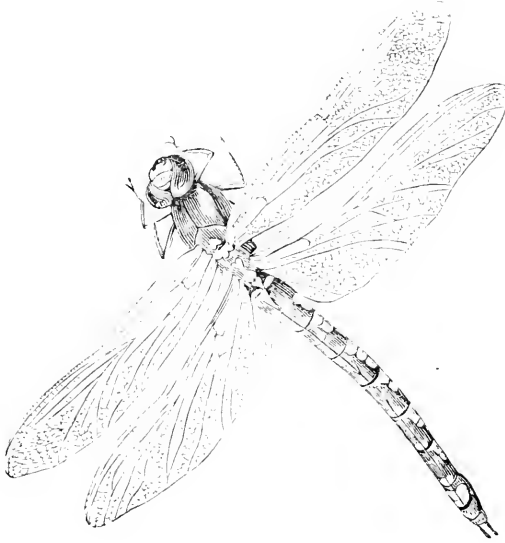

Fig. 27.—Dragon-fly.

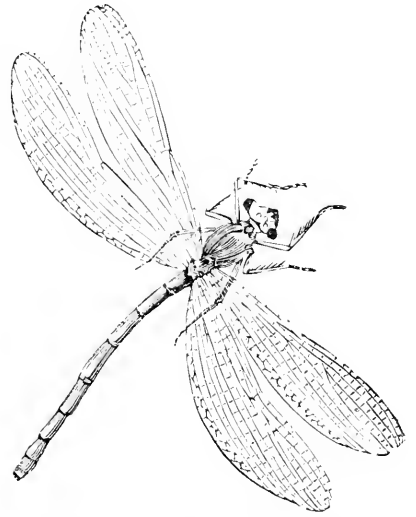

Fig. 28.—Virgin Dragon-fly. (*Calopteryx virgo*).



Fig. 29.—Labium of *Libellula*. L, the labium, or lower lip. P, the palpi.



Fig. 30.—Anal appendages of *Aeschna*, viewed laterally. A, upper, B, lower, appendages.



Fig. 31.—Anal appendages of *Libellula*, viewed from above.

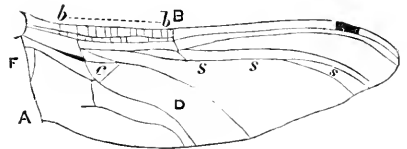

Fig. 32.—Hind wing of *Aeschna*, showing only the principal nervures. A, anal angle; B, cubital point; C, stigma, or pterostigma; b, b, antecubital nervures; a, triangle; F, the accessory membrane; S, the subnodal sector.

L. quarimaculata (Linn.). Wings with four rows of post-trigonal cells. Colour brown, covered with pubescence; thorax rather yellow at the sides, with black marks; abdomen rather broad and conical, with tip black; a triangular brown patch at the base of the hind wings; a brown spot in the middle of the costal margin of all the wings; pterostigma black. General in the British Islands. Length 19 lines; expanse of wings 32 lines. A variety has the tips of the wings also brown.

L. depressa (Linn.). Three rows of post-trigonal cells; pterostigma black; triangular brown patch

accessory membrane dark. England; local. Length 19 lin.; exp. 32 lin. A variety has brown tips to the wings.

L. cancellata (Linn.). The wings clear, without spots; pterostigma black; accessory membrane blackish; abdomen broad, brown with two black longitudinal bands; powdered blue in the ♂; England; local. Length 19 lin.; exp. 32 lin.

L. cerulescens (Fabr.). Wings clear; in ♂ tinged with yellow at the base; pterostigma reddish (♂), yellow (♀); accessory membrane white; thorax (♂) dark (with bluish bloom, easily rubbed off), with

two longitudinal lighter stripes; in ♀ brown, with similar stripes, lighter; abdomen narrow, flattened, keeled in the middle; in ♂ covered with powdery cobalt-blue; in ♀ brown. Inhabits England, Scotland, Ireland; but local. Length 16 lin.; exp. 26 lin.

B. With 6-8 antecubital nervures.

Legs black, externally yellow.

L. flavola (Linn.). Wings unspotted, but the base tinged with yellow (the hind wings to a third

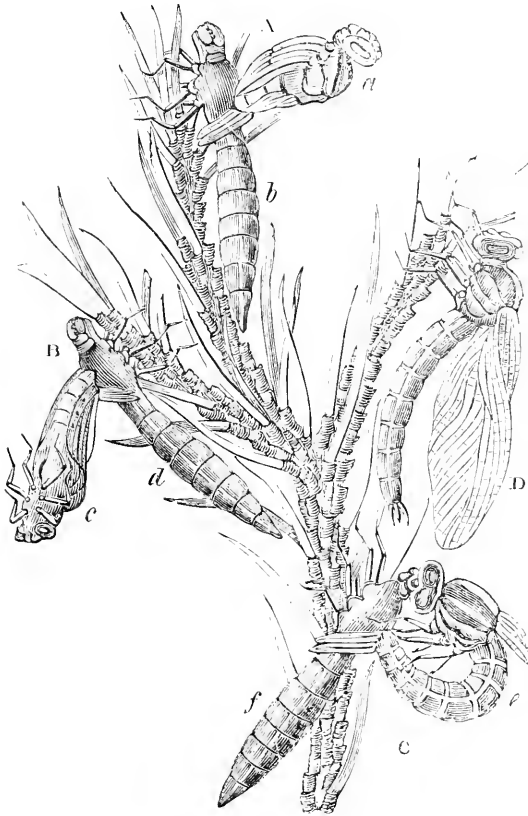

Fig. 33.—A, Dragon-fly, scaping from pupa-case; a, insect; b, pupa-case; B, the process, further advanced; c, the insect; d, pupa-case; C, Dragon-fly nearly free, and forming an arch whilst it extricates the body; e, the insect; f, pupa-case; D, Dragon-fly with wings nearly developed.

of their length); pterostigma short, yellow; thorax and abdomen reddish-yellow; anal appendages of the male straight, nervures of the wings blackish. England and Scotland; local. Length 16 lin.; exp. 26 lin.

L. Fonscolombii (Selys). Wings clear; base tinged with yellow; pterostigma large, yellow; hinder tibiae of the male black on the outside; thorax and abdomen yellow or reddish-yellow; the upper anal appendages of the ♂ slightly elbowed; most of the nervures of the wings reddish. Inhabi-

tat near London; scarce. Length 17 lin.; exp. 28 lin.

L. meridionalis (Selys). Wings clear, but slightly tinged with yellow at the base; pterostigma narrow, yellow; thorax and abdomen yellow; the sides of the thorax without markings. Found near London; scarce. Length 16 lin.; exp. 26 lin.

L. striolata (Charp.). Wings clear, but little tinged at the base; pterostigma of the ♂ dark, of the ♀ reddish; thorax blackish, the sides with three oblique black streaks; abdomen of ♂ reddish,

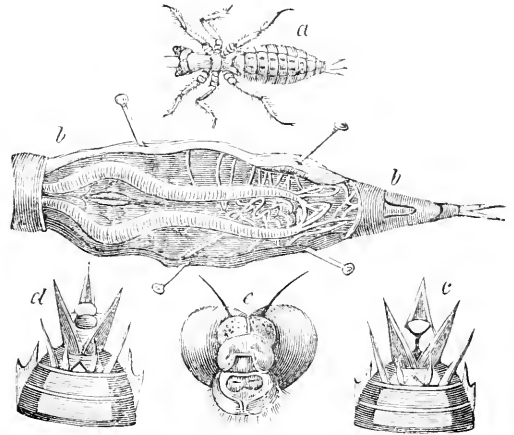

Fig. 34.—a, larva of Dragon-fly; b, the abdomen, laid open to show the respiratory organs or tracheae; c, the pumping apparatus (shut); d, ditto, open; e, head of Dragon-fly.

of ♀ yellow-brown with two small yellow dots on each segment. England, Scotland, Ireland. Length 17 lin.; exp. 28 lin.

L. vulgata (Linn.). Wings and colours as in *L. striolata*, but abdomen without yellow dots. Once taken near Hull. (Hagen.) Length 17 lin.; exp. 28 lin.

Legs black.

L. sanguinea (Müll.). Wings with the base tinged with yellow; pterostigma reddish; thorax olive-brown, with the under side, behind the legs, of the ground colour; abdomen with a lateral black band; colour, red in the ♂, yellow-brown in the ♀. England; local. Length 16 lin.; exp. 26 lin.

L. Scotica (Donov.). Wings of the ♂ clear; those of the ♀ tinged with yellow at the base; pterostigma square and black; thorax blackish or olive-brown; under side, behind the legs, with three yellow spots forming a fleur-de-lys; abdomen short (rather club-shaped in the ♂); with two yellow streaks on each segment. Sometimes the ♂ is nearly entirely black. Frequent England, Scotland, and Ireland. Length 14 lin.; exp. 23 lin.

L. dubia (Van der Lind.). Wings with a blackish spot at base of wings (larger on the hinder wings);

pterostigma reddish; thorax black spotted with orange, hairy; abdomen slender, spotted with orange as far as the seventh segment; front of face white, lower lip black; upper lip of ♂ white, of ♀ black; anal appendages black. England, rare. Taken near Dorchester. (Hagen.) Length 15 lin.; exp. 26 lin.

(To be continued.)

NOTES ON TERMINAL AND SUB-TERMINAL BUDS.

WHEN a leaf-bud terminates a stem and survives the winter, it is that the stem may be continued by it in the following spring. This happens frequently in the horse-chestnut and other trees. But the final termination of a stem is in the flower or a stalk bearing flowers on its sides. Thus, when we speak of terminal buds, we commonly mean flower-buds. The inflorescence of an apple-tree is an umbel with a central flower. This flower, which is truly terminal, is the first to open in a regular way. If, however, the outermost flower of the umbel should dispute with it for precedence, we may be sure that as the lateral flowers open centripetally, that which is next below the centre will not expand so soon as the central flower itself, which does not belong to the lateral series. In the corymb of the pear the same order of expansion is observed, the terminal flower opening first, and that which is next below it last. Botanists who classify the forms of inflorescence under the names of cymose and racemose might dispose of several puzzling cases by calling them corymbose, taking that of the pear-tree as the typical form. More or less resemblance to it is found in most rosaceous plants. When a cluster of bloom is found at the end of a long branch of the apple or pear-tree instead of being on a spur, such a position can hardly be called abnormal, for it may be regarded as the primary condition in which such flowers would appear. No plant can flower at all till its nutritive system shall have attained something like maturity. Then its first flower may be expected on the summit of a stem. Lateral branches may bear flowers afterwards, but as the plant grows older, they will tend to be shorter. A short branch is, however, of the same nature as a long one, from which it differs chiefly in its shorter internodes or fewer leaves. The flowers of some plants commonly appear in axillary fascicles, but any plant which is in the habit of producing lateral clusters, each having a central flower, has an inherent right which it will sometimes assert of producing a flower on the summit of a well-developed stem. An annual plant of the labiate order (*Galopsis Ladanum*) sometimes has a central flower on the top of its main stem. Why, then, do some of the best botanists imagine that a central flower crowning a raceme is formed by the fusion of

two or more lateral flowers? It is because of the tendency of such terminal flowers to be synanthic. Such a condition may be regarded as an exaggeration of what commonly takes place in the rue, whose terminal flower commonly has five petals, and each of the lateral flowers only four.

If I may venture on a hypothetical explanation, I may say that when flowers are collected in a cyme, as of *Sambucus* or *Viburnum*, the stem having attained its full length, its vital energy, no longer able to push onwards, tends to lateral expansion, giving origin to a whorl of branches instead of the pair which might have been in the axils of opposite leaves. In like manner an ordinary flower has its leaves in whorls, not solitary or in pairs like foliage leaves. When, without the intervention of an involucre, or a whorl of branches, a stem which bears a raceme of lateral flowers is abruptly terminated by a central flower, the same tendency to lateral expansion operates more forcibly on all the floral organs, and tends to increase their number. Thus a species of *Eranthemum* may be found in cultivation with a central flower, sometimes having two or three times as many stamens as any of its lateral flowers.

In the Canterbury bell (*Campanula Medium*) such a phenomenon has been observed in connection with what looked like fasciation of the stem. It is perhaps not surprising if such a terminal flower, which is apparently formed of two or more flowers on the same level, and collateral in their relation to each other, should be taken to belong to the series of lateral flowers below them. Such a mistake proceeds from overlooking the facts that a terminal flower, perfectly normal in structure may be frequently found in the same species, and that the synanthic flower bears the same relation to the lateral flowers as is observed in the central flower crowning a corymb of the pear, which contains nothing mysterious or abnormal. If we regard the synanthic flowers as terminating a fasciated stem, then if we separate in imagination the fasciated stem into its component parts, each of them would be crowned with a terminal flower which would be the first to open, as the subterminal flower would be the last. The real or apparent fasciation of the stem, and consequent fusion of the several flowers, does not interfere with the order of expansion in which the synanthic flower or head of flowers opens first, and the flower immediately below it last of all the lateral flowers in the same series.

It is worth knowing that the fusion of several flowers in this manner does not impair their reproductive energy. From a capsule proceeding from such a terminal synanthic flower of the Canterbury bell I took a portion of the seeds, and saving them, raised about two hundred plants, which were generally more vigorous than twenty-seven plants raised from seeds of the capsule produced by the sub-terminal flower. The seeds having been ripened in

1878, and sown in 1879, six of the plants from the synanthic terminal capsule flowered last summer. Each of them had flowers of the character common to its kind without synanthly. None of the others having flowered yet, I have still two hundred plants on which to make observations next year.

JOHN GIBBS.

PARASITES AND THEIR FUNCTIONS.

A NOTE upon the subject of the parasite of the honey-bee appears at page 277 of SCIENCE-GOSSIP, December, in which the writer further implies that it relates to the queen in particular, and in respect of which he solicits the attention of readers and certain information.

Without now entering fully into the subject of health and disease, or the purposes and uses of the lower organisms in the economy of nature, of which he desires to be informed, it may be remarked that parasites are not always to be regarded as being injurious to health; not unfrequently they are conducive to comfort and longevity. Those that kill are simply natural checks to excessive multiplication, while many others are present as sanitary agents only. Parasites, therefore, cannot necessarily be regarded as evils, always contributing as they do, directly or indirectly, to the benefit of man, and to harmony in the universe.

Members of the family Pediculida seldom remain long upon a victim after its death, but more generally leave the body on the approach of dissolution. On this account the ignorant in all ages have superstitiously—though with good reason—regarded their sudden appearance, in cases of sickness, as the harbingers of death.

Confounding the orders Diptera and Anoplura creates some little confusion in the statement of the writer. Would the insect in question, if parasitic, which I doubt, belong to the order Strepsiptera? Members of the family Hippoboscidae, intimated, derive their nutrition from living animals. Unless Mr. Horsenaill should describe the "specific characters" of his insect, an answer to his important questions, which might be useful to his friend, can scarcely be expected; but it may be remarked that we should scarcely be justified in calling the vulture a parasite of an animal on which it may be found feeding.

It is not perhaps so curious that the queen alone should have succumbed to the ravages of the marauders (?) of Mr. Pettitt's apiary. Preference and antipathy, in respect of taste, is very strikingly displayed by insects as is well known, not only to entomologists, but also to schoolboys, who never fail to select certain localities and plants when in search for particular insects; and as the constitution, habits, manners, uses, secretions, and excretions of

the queen, differ so essentially from all other bees in the hive, there is nothing surprising that she should have been selected by some fastidious suctoria, that may have intruded itself into the community, should such untoward event really have taken place. (?)

It would be desirable to know how the discovery of the death of the queen was made. What were the circumstances and conditions under which she was found? What is the proof that she alone was parasitically, or otherwise, affected? How long since she was removed from her country home? How came the colony to select a diseased and dangerous governess for the perpetuation of their race? Instinct is undoubtedly occasionally at fault, but it is perhaps not rare for a community of bees in full possession of their instinctive faculty to behave with due regard to the laws of hereditary transmission.

I have not an opportunity of seeing the paper, 1870, referred to, but assuming it is a "Paper," and knowing Mr. Taylor's extensive acquaintance with so great a variety of subjects, as also his great care as Editor of SCIENCE-GOSSIP and other valuable publications, to admit only what is valuable and reliable, I am disposed to believe that the statements and descriptions of Mr. Packard were true.

Perhaps Mr. Horsenaill will be pleased to describe more particularly, for the subject is full of interest, and should there have been anything not previously observed, it is desirable that the facts should be further elucidated.

J. FEDARB, B.E.

Examiner, Privy Council.

LIST OF ASSISTING NATURALISTS.

[Continued.]

YORKSHIRE.

Sheffield. James E. Westby, 83 Barber Road, Crookes Moor Road, *Local Field and Fossil Geology.*

GRAPPLE FOR POND LIFE OR MARINE WORK.

A SMALL grapple for collecting pond life, is, I believe, used by some naturalists, and from its construction I should think that if it fouled anything at the bottom, nothing could prevent its being lost. But by having such an instrument as that figured above, it will be seen that, by having the main cord (with a breaking strain of say 5 lbs. for a small one, and 40 lbs. for a large one for marine use) fastened to a ring below the hooks, and by having another cord with a breaking strain of a much less weight connecting the top ring of the grapple with the main cord, as shown in the cut, it will follow that when the grapple fouls any rock, root, or snag of timber, as the

case may be, a sharp and powerful jerk will break the weaker line, when the bearing will immediately reverse the position of the grapple which will free itself from what it has come in contact with, and may be hauled up and the broken line replaced ready for work again at once. The small piece of cork will keep the slack line from fouling the hooks when the grapple is being lowered over the stem of a boat. In bays where large growths of algae are met with,

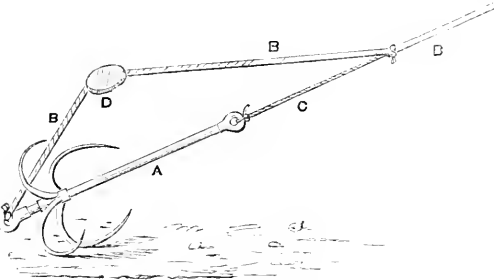

Fig. 35.—Position of grapple at work: A, grapple; B, main cord of ditto; C, safety-cord of ditto; D, cork to keep B from fouling the hook.



Fig. 36.—Position of grapple after being freed by the breaking of safety-line.

the grapple of about a foot or so in length would prove a handy apparatus for the collection not only of many species of Crustacea, but also of Echinodermata, Mollusca, and other forms; and where the risk of loss is reduced to a minimum it conduces greatly to the advantages of such a portable and effective means of collecting specimens of marine zoology.

Holly Mount, Croydon.

E. LOVETT.

SCARCITY OF HOLLY BERRIES.—Several correspondents have noticed the remarkable scarcity of hawthorn bloom and fruit last season. I would like to know if the same is the case with the holly. My district lies along the south of Lough Neagh, and has always been noted for an abundant growth of indigenous holly. A lake in the parish is called Lough Guillion, which means the lake of hollies, but this year I cannot see or hear of a bush on which are any berries.—*J. H. Lott, M.A.*

MICROSCOPY.

CLEANING GLASSES.—In the "Royal Microscopical Journal" for June last I saw a chemical way of cleaning glass which I have found so useful I think it should be more widely known. Take 2 oz. of bichromate of potash, 3 fluid oz. of sulphuric acid, and 25 fluid oz. of water, and mix together. These are the proportions; of course a much smaller quantity would be enough. Soak glass slips in the liquid for some hours, and wipe or drain on blotting paper. Thin covers are best put into a bottle of the fluid, shaken up to separate them now and then, left for some hours and then taken out, well rinsed, and either kept in water, to be wiped gently when wanted, or else wiped or drained and put away for use. It saves, I find, a great deal of trouble and breakage.—*W. Locock.*

THE POSTAL MICROSCOPICAL CLUB.—We have just received the report of this useful club—always a well written and welcome brochure. A copy can be obtained for 7*d.* of the Hon. Sec., Mr. Alfred Allen, 1 Cambridge Place, Bath.

THE QUEKETT MICROSCOPICAL CLUB.—The November Journal of the above club contains the Address of the President, Dr. T. S. Cobbold, F.R.S., and papers on "The Histology of Pitcher Plants," by W. H. Gilbert, F.R.M.S.; "Receipts for Microscopists," by Julian Delz, C.E., F.R.M.S., "On some Peculiarities of a Flea," by R. T. Lewis, F.R.B.S., and "On a Swinging Sub-stage for the Microscope," by James Mackenzie. Some of the above papers are accompanied by beautifully executed plates.

NEW ROTIFER.—At a recent meeting of the Royal Microscopical Society, Dr. Hudson read a paper on a new kind of rotifer found in Loch Lundie, the trochal disk of which forms a link between that of *Melicerta* and *Ceistes*.

"MANUAL OF THE INFUSORIA," by W. Saville Kent, F.L.S.—Part iii. of this splendid work was issued early in January. The highest praise we can say of it is that it is fully up to its predecessors. The entire scientific press of Europe and America are agreed in lauding this "Manual," and there can be little doubt that when completed it will form an epoch in microscopical science. The parts are being issued with great regularity, considering the vast labour entailed on seeing a work like this through the press. The engravings are exquisite. The present part is devoted to a description of all the genera and species in the families *Heteromitidae*, *Trepomonadidae*, *Polytomidae*, *Pseudosporidae*, *Spumellidae*, *Trimastigidae*, *Tetramitidae*, *Hexamitidae*, *Lophomonadidae*, *Catalactidae*, and to the order of *Choano-flagellata*, whose characters are fully described.

ZOOLOGY.

TRANSPARENT BURNET MOTIL.—When in Cornwall, in 1865, I obtained several transparent Burnets (*A. Mimos*). They were captured by a friend near the ruins of Tintagel Castle, where he saw them in great numbers; he put them in a fusee-box and gave them to me after they had been in his pocket during a long ride. At the time I thought they were common six-spot Burnets much rubbed during their journey. Some time ago, observing the narrowness of the border of the hind wings, I came to the conclusion that they were specimens of *A. Mimos*, and, seeing that Stainton gives no English locality for this species, I thought it advisable to record these Cornish captures for the benefit of the readers of SCIENCE-GOSSIP.—*W. Gain, Tuxford.*

METEOROLOGY AND INSECTS.—The recent Martinmas summer of clear skies and surprisingly spring-like temperature, rendered grateful with the voice of the song birds and gentle breathing of the west wind, has exerted an influence not a little marked in prolonging the activity of insect life on the Surrey Downs. Various common Muscides are to be seen at noon buzzing around tarred palings. I have noticed especially, *Musca vomitoria*, *Sarcophaga carnaria*, and *Musca domestica*, so engaged; indeed one of the first mentioned flies is at this very moment making a pitiable effort to gambol, as has been her wont, from the ceiling of the room in which I write back to the window pane. Then, as the shadows fall on the lanes, the monotony of a brisk winter's walk among the feathery clematis is not a little pleasantly alleviated by the wheeling whiz of the numerous stercorarius beetles that are stained beneath with every transition from a dark ordinary amethyst-violet to the most stark and staring of golden-greens, and which appear to belong uniformly to one species, the *Geotrupes sylvaticus* of Stephens; while a return home by the outlying gas lights, has at times revealed quite an unusual number of fitfully lethargic winter moths (*Cheimatoba brumata*) there segregated, and apparently basking on the iron framework and glass shade. It is indeed often possible to get a dozen or so from one lamp by means of a walking stick. Later on, when the orange glow has turned to grey in the sky and the evening lamp is lit, there arise from the quarter of the kitchen and rain-water butt, various species of *Culex*, *Psychoda*, and other minute flies. On one occasion, there descended from out of a dusty nook on to my open book a dark banded speck of burnished gold; I took it for a *Lithocolletis messaniella* that had lasted out the blackberry season, though as I did not catch it, the supposed moth may have been a hemiptera, or something else rare and beautiful, imported from abroad by mischance; it made me think of the Isle of France, and Paul and Virginia,

and that is why I say so. At times I have been inclined to attribute this singularly late activity of insect life to that higher winter temperature that Professor Balfour Stewart has led us to associate with the notion of a maximum in the sun spots, but then I remember in 1876, when very opposite conditions prevailed, how, when strolling one calm December morning, past the spot where Louis Philippe and his ladies disembarked on the Calais jetty, I there found the wooden rails quite covered with blow-flies, sand flies, their orange stercorarius relatives, with a fair sprinkling of Tipulariæ, and how on arriving in England the same year, the begrimed Geotrupi in this locality were all out of their subterranean hibernaculi on the 16th of December last, at which date I observed one to fly to light.—*A. H. Swinton.*

NOTES ON THE COLLECTING OF CRUSTACEA.—A systematic working of these animals on various parts of our coasts would no doubt result in some very valuable information regarding their distribution, even in so limited an area as these islands; for I hope to show in some future notes how extremely local and how limited in distribution some so-called "rare" species are. Considering how easily and with what interest these animals can be collected and preserved, it is to be hoped that many of our natural history workers who are conveniently situated, viz. on our coasts, may give the subject some of their attention. In rocky localities, a first-rate trap may be devised out of a hamper or a box; the latter should have wire gauze let into large holes cut in the sides. The open top should be finished on the principle of a lobster pot, so as to make ingress easy and egress difficult or impossible. These traps must be weighted with stones, or by other means, and lowered into sheltered rocky nooks duly baited. As regards the question of bait it is, I have found, very difficult to induce a fisherman to try anything he is unaccustomed to, but I should be inclined to think that there are more killing baits than pieces of fish; for instance, in the capture of the freshwater craw-fish (*Astacus fluviatilis*) I have used bullock's liver, which certainly is as unnatural a food to them as to marine crustacea, and the results were, *cæteris paribus*, always good, for often I have pulled up a net with a perfect heap of craw-fish struggling to get at the bait; from this I should imagine that such a bait would repay a trial in the collection of crustacea on our shores. There is no doubt that many good things are constantly caught and thrown away as rubbish by fishermen, particularly trawlers and dredgers, and it would be a great advantage to enlist the services of such men, selecting the most intelligent, and showing them, from specimens, what would be worth putting aside. I should be very glad to exchange notes with, or give information to, any seaside dweller who may be desirous of forming a collection of these interesting forms.—*Edward Lovett, Holly Mount, Croydon.*

EARED SEALS, ALIAS SEA LIONS.—On looking over the back numbers of SCIENCE-GOSSIP, I have just noticed the very interesting article on the Eared Seals, by Mr. Thomas Southwell, F.Z.S., page 79 of the volume for 1877. In this article, Mr. Southwell, after describing Steller's sea lion, refers to the pair at Brighton Aquarium as specimens of this species. At the time this article was written, it was generally allowed that this was correct; but many naturalists were doubtful about it. One very strong point against it was the very small size of these lions compared with all the descriptions published, and yet these were adult specimens, as proved by the birth of several young ones. The point was cleared up some time since, but I believe has not been corrected in SCIENCE-GOSSIP. Though their size threw some doubt on the question, it is by itself a very uncertain character in almost any aquatic form of life; the only positive means of identifying these creatures being the dentition, and formation of the skull. At the time the article was written, there were living in the Southport Aquarium a pair of the same species, caught at the same place from the same herd. The accidental death of the female, and subsequent pining to death of the male, enabled the point to be clearly proved. I had the pleasure of comparing the skulls with those of other species in the Hunterian Museum at the Royal College of Surgeons, in company with Professor Flower. Mr. Flower, who is allowed to be one of the first authorities on these creatures, had no difficulty in assigning them to the much smaller species *O. Gillespie*, or in satisfying me that he was right in doing so. The skeleton of the male is now in his collection, and can be examined by any one interested in the matter. Some day, if you have room for it, I may say something about the very curious habits of *O. Gillespie* as observed at Southport. I believe, however, Mr. Flower is preparing a paper for the Zoological Society on this subject, and until that appears, I do not want to rush into print further than I have done now.—*C. L. Jackson, F.L.S., &c., Naturalist Director of Southport Aquarium.*

THE BASKING SHARK (*Scalche maxima*).—This shark takes its name from its habit of floating on the surface of the sea, and basking in the sun. It is one of the largest of the sharks, sometimes measuring as much as 36 feet in length, and between 20 and 30 feet in circumference, the weight being from 8 to 10 tons. During the second half of the year, it appears in large numbers on the coast of Donegal and the west coast of Scotland, and as many as 500 of them have been captured in a single season. They are killed in the same manner as the whale, with the harpoon. Although yielding a large profit to the fishermen, from 35% to 50% each, yet the carcass is generally converted into manure, the principal profit being derived from the liver, which sometimes weighs as much as two tons, and contains a vast quantity of

oil, generally from 6 to 8 barrels. The liver of one 27 feet long yielded 165 gallons of oil, and was sold for 16*l.* 10*s.* Two were caught at Broadhaven, 30 feet long each, and yielded nineteen barrels of oil, eight of which go to the ton. This shark has more than once been taken for that mythical creature, the sea serpent. They generally swim in pairs, one behind the other, the dorsal fin rising 3 or 4 feet high, and as they would in this position give a length of 70 or 80 feet or more, a very fair specimen of the sea serpent would thus be represented.—*Dipton Burn.*

THE LATE PROFESSOR RYMER JONES, F.R.S.—The death of this veteran naturalist took place just before Christmas. Many of his works will be well remembered, for there can be little doubt some of these were naturalist-making books, such as his "Aquarian Naturalist," "General Outline of the Animal Kingdom," &c.

THE LATE MR. FRANK BUCKLAND.—There are few naturalists who will not hear with regret of the death of Mr. Frank Buckland, at the comparatively early age of 54 years. Mr. Buckland died at his residence on December 19th. His genial manner endeared him to all his fellow-naturalists, whilst his pleasant style of writing has possibly attracted many young people to the study of natural history. His best and widest known books were the "Curiosities of Natural History," although he was author of many other volumes, dealing chiefly with Ichthyology. He was also well and widely known as editor of "Land and Water."

NATURALIST'S AND SPORTSMAN'S POCKET-BOOK. A strong, useful, and charmingly got up pocket-book for 1881 has just been issued at the "Bazaar" office, 170 Strand, under the name of "The Country Pocket-Book." It is a capital work of reference on most things connected with sporting matters.

"THE FISHES OF GREAT BRITAIN AND IRELAND."—We have received part i. of a work on this subject, to be completed in nine parts, published by Williams & Norgate. No zoological work is more needed than one on British fishes, marine and freshwater, for Yarrell's book is sadly antiquated. The present undertaking is in the very best of hands, those of Mr. Francis Day, F.L.S., whose splendid work on the fishes of India is well known to all naturalists. It will comprehend a scientific description of every species of fish known to inhabit the seas and fresh waters of the British Islands, and will include remarks on their economic uses and various modes of capture. We like the first part much; it will please both naturalists and sportsmen alike. The figures are excellently drawn, more attention being very properly paid to accurate and scientific detail than to artistic picturesqueness. The part contains 64 pp. of letterpress, and 27 really beautiful plates.

BIRDS OF THE ISLE OF MAN.—The hon. sec. of the recently founded Isle of Man Natural History Society, Mr. Philip Kermode, is engaged in a most useful and laudable work, that of cataloguing the birds of the island; and at a recent meeting he presented a list of all well-authenticated species noticed up to that time, which amounts to one hundred and forty-two species. The list includes the snowy owl, golden oriole, mountain finch, hoopoe, grey plover, bittern, grey phalarope, and Manx shearwater. The black guillemot breeds near Peel, and (it is said) also in the south of the island.

NORWICH SCIENCE-GOSSIP CLUB.—This flourishing society recently celebrated its tenth anniversary, and now publishes abstracts of the useful various and frequently elaborate papers read at the fortnightly winter meetings.

THE EVOLUTION THEORY.—At a recent meeting of the Zoological Society of London, Professor Huxley read a paper on the Application of the Laws of Evolution to the Arrangement of the Vertebrata, and particularly with reference to the Mammalia.

BOTANY.

THE USE OF FUNGUS-GROWTHS TO DESTROY INSECTS.—In the "American Naturalist," Professor A. N. Prentiss has a paper on the above subject. After reviewing the observations made by previous writers, and detailing the direct and indirect results of several experiments, Mr. Prentiss concludes that the result of these experiments, as a whole, indicate plainly that yeast cannot be regarded as a reliable remedy against such insects as commonly affect plants cultivated in greenhouses, rooms, and parlours. Moreover it is more than probable that the yeast would injure many kinds of plants, by spotting and soiling the leaves, and inducing fungoid growths upon the jars or soil in which the plants are grown.

HELIO-TROPISM.—On p. 132 of Professor Ramsay McNab's Physiological Class Books, this theory is laid down: "Light exercises a retarding influence on growth." This influence, he proceeds to explain, causes the bending of plants to the light; but, in the course of the next page, this sentence occurs: "The side of the organ away from the source of light, receiving less light than that turned towards it, has its growth retarded." Surely this is a manifest contradiction of the theory laid down in the preceding page. The part away from the light would have its growth accelerated by the want of light, and such is really the fact, for when the stem bends to the light, the part away from the light is longer than the part turned towards the light, for, if two curved lines both turned the same way, the outside line is the longest. Is it a misprint, or a misinterpretation on my part?—*J. P. K.*

DEVELOPED PRIMULAS.—When I brought my specimens home from Thurso, I was unable to name them myself, but was told they were *P. farinosa*, and I quite thought they were, until I saw Mr. A. Craig Christie's remarks in your December issue. After examining them again I have concluded they must be *P. Scotica* (Hook.). Hooker says *P. Scotica* is "perhaps only a sub-species of *P. farinosa*, but smaller." I suppose the sessile umbel is not common in either case.—*W. K. McGhie.*

GEOLOGY.

THE GEOLOGY OF EAST CENTRAL AFRICA.—A recent number of "Nature" contained a short article on the above subject, by Mr. Jas. Thomson, fellow-traveller with the late Mr. Keith Johnston in the Geographical Societies' African exploring expedition. Speaking of the route to Nyassa and Tanganyika, Mr. Thomson refers first to the low-lying country bordering the eastern coast of Africa, which is formed of two or three raised beaches, consisting chiefly of brick-red sands and clays overlying coral rock. The former have been derived by denudation from the coast ranges. The sands are of value as containing the well-known "gum copal." Geologically, these formations are recent, as none of the insects found embedded in the copal are extinct. The next formations found imply an immense gap in the geologic record, being evidently of Carboniferous age, thus indicating the immense period during which Central Africa has been dry land. These formations extend to the base of the mountains, and we pass abruptly from them to highly metamorphosed rocks, consisting of schists, gneiss, and hornblende, whose exact place in the geological series is doubtful. These form the mountain range flanking the great central plateau which extends from Abyssinia to the Cape, and rises to a height of 7000 feet. Leaving this range we next pass over a great stretch of granitoid rocks, extending to near the lakes, and marked by undulating hills and valleys. This tract is terminated by an abrupt rise, forming apparently a second and higher plateau. The sudden change in level, together with the alteration in the internal structure, and the presence of intrusive rocks at the base of the mountain, seem to point to the existence of a fault of considerable magnitude. The rocks composing this high tract consist mainly of clay slates. On approaching Lake Nyassa we observe evidence of much disturbance, till at about ten miles from the lake we come upon the ancient pipe of a volcano, and about five miles farther on enter amongst a series of volcanic porphyrite, tuffs, and agglomerates, forming jagged peaks, sharp yawning valleys, and irregular rocks, notched sides. The series of volcanic rocks, forming the magnificent mountains round

the north end of Lake Nyassa, probably belong to the same period as a similar series which characterise Cape geology. The latter have been assigned to the Trias, and it seems that in Triassic times a great line of volcanic action stretched from the Cape by Nyassa, Ugogo, and Kilimanjaro, to Abyssinia. At the north-west of Nyassa we have evidence of later volcanic activity, in the presence of a number of isolated cones, situated in the plain through which the river Jumbaka winds to the lake. Leaving Nyassa and proceeding to Tanganyika we rise again to the top of the plateau, cross over mountains 8000 feet high, and then descend to a general level of from 4000 to 6000 feet, passing over clay-slates and schists with intruded masses of granite. Nearing the south of Lake Tanganyika we pass abruptly from these ancient rocks to red and variegated sandstones much hardened and broken. Along the western side there is an almost sheer precipice lowering the altitude from 5000 to 3000 feet. This, and other appearances, indicates the presence of a great fault, of which the one previously noticed is probably an easterly extension. Still proceeding along the lake, and after crossing the Tehansa mountains, the sandstones in the country of Ugenha are more seen. These sandstones, which have an extension over a large area, were probably formed in an enormous lake. A similar lacustrine series of rocks, occurring in Cape Colony, have been assigned to a period not later than the Trias, and the Tanganyika sandstones probably belong to the same era.

LIVERPOOL GEOLOGICAL SOCIETY.—Part ii. of vol. iv. of the Proceedings of the above Society has been published, containing the following papers, in addition to the Address of the President (Mr. William Semmons), "On the Carboniferous Limestone near Skipton, and in North Derbyshire," by Mr. Ricketts, M.D., F.G.S.; "The Glacial Beds of the Clyde and Forth, by Mr. T. Mellarde Reade, C.E., F.G.S.;" "Notes on Human Skeletons and Traces of Human Workmanship found in a Cave at Llandudno," by Mr. Eskrigge, F.G.S.; "Memorandum on the Remains found in the same Cave," by Professor Dawkins, F.R.S.

OCCURRENCE OF THE OPHIDERPETON IN SCOTLAND.—At a recent meeting of the Natural History Society of Glasgow, Mr. John Young, F.G.S., exhibited a curious comb-like organism from the black-band ironstone shales of the Airdrie coal-field. It was identical with the "Kamplattin," of Professor Fritsch, recently figured and described in his Monograph of the gas coal and limestone of the Bohemian Permian formation, and referred by him to the genus *Ophiderpeton* of Huxley. Should this identification be verified by finding other portions of the skeleton, this will be another addition to the fauna of the Lanarkshire coal-fields.

A SCIENTIFIC DISCUSSION.

A BRAVE Dublin professor would e'en make a trial
To trip up those "duffers," believers in Lyell;
The subject he chose—he knew how to time it—
Was Bournemouth and its Eocene climate.
For a Gardner—just the reverse of supine—
In its rocks had discovered a Moreton Bay pine,
Or, to speak more exactly, it was his *belief*,
If not quite a *tree*, yet he'd spotted a *leaf*.
The clever professor sees proof in *these trees*
The climate was hotter full twenty degrees;
For this pine will not flourish nor even keep green
Unless it has seventy degrees as a *mean*.
"A thermometer, 'self-registering,'" I strictly opine
Is this wonderful *species*, the Moreton Bay pine!
No redistribution of land or of sea
Will ever account for this wonderful tree!
But Duncan! he heard it!—it was not a knell—*
No, as he expressed it, 'twas naught but a "sell";
So, writing to Haughton, says "Sir, you may view
Just under my window a clump of bamboo.
Now this to the future geologist known,
Will prove that we lived in the torrid zone!"
Says Haughton to Duncan, "Your reasoning is horrid;
'Tis the *species* will say if the climate was torrid;
Your proof of my figures, sir, cannot be finer,
For bamboos, let me tell you, are common in China."

So raged the discussion, in dogmatic fever,
When down comes a letter from Ingram of Belvoir
To say, in this place, in proportions fine
Is growing this truly remarkable pine.
Thus the learned professor, as all now must see,
Is pretty considerably "up his own tree!"

—A *Conifer*.

THE CONSTITUTION AND HISTORY OF GRITS AND SANDSTONES.—An important paper on this subject has just been read before the Geological Society, by Mr. J. A. Phillips, F.G.S. The author described the microscopic and chemical structure of a large series of grits, sandstones, and, in some cases, quartzites, of various geological ages, noticing finally several sands of more or less recent date. The cementing material in the harder varieties is commonly, to a large extent, siliceous. The grains vary considerably in form and in the nature of their enclosures, cavities of various kinds and minute crystals of schorl or rutile not being rare. The author drew attention to the evidence of the deposition of secondary quartz upon the original grains, so as to continue its crystal structure, which sometimes exhibits externally a crystal form. This is frequently observable in sandstone of Carboniferous, Permian, and Triassic age. Felspar grains are not unfrequently

* "Hear it not, Duncan; for it is a knell
That summons thee to heaven or to hell."—*Macbeth*.

present, with scales of mica and minute chlorite and epidote. Chemical analyses of some varieties were also given. The author then considered the effect of flowing water upon transported particles of sand or gravel. It results from his investigations that fragments of quartz or schorl less than $\frac{1}{30}$ " in diameter retain their angularity for a very long period indeed, remaining, under ordinary circumstances, unrounded, but they are much more rapidly rounded by the action of wind. It is thus probable that rounded grains of this kind in some of the older rocks, as, for example, certain of the Triassic sandstones, may be the result of Æolian action.

THE NAINA TAL LANDSLIP.—Mr. R. D. Oldham, of the Geological Survey of India, has just reported on the geological causes of the above fatal occurrence. Naina Tal stands on imperfectly cleaved clay slates, which are liable to a decomposition penetrating deep into their mass, and it appears to have been the cover of loose decomposed detritus which slid down the hill, after being thoroughly saturated with water from the heavy rains.

NOTES AND QUERIES.

BATS.—As I was passing down Great Windmill Street, on my way to the Haymarket, last Saturday, the 13th December, I saw one of our small English bats hunting up and down the street near St. Peter's Church, no doubt seeking food. The morning was mild, sky overcast, temperature 59° in the shade. Was not this an unusual thing so late in the season?—*J. Hall.*

BROAD STOPPERED BOTTLE.—Some few years ago I bought some useful bottles, about 1½ inch high, and of the same width, with glass stoppers and straight sides—no shoulders to them. I have found them very useful for soaking objects in turpentine for mounting, but can get no more. Can anyone tell me where I could get them? They would be more useful a little broader and not so high.—*Rev. W. Locoek.*

OPHRYS APIFERA, &c.—In the November number of SCIENCE-GOSSIP, p. 258, J. S., Luton, inquires, "Have any of your numerous correspondents observed a scarcity of *Ophrys apifera* this season?" The bee orchis occurs on landslips from the New Red Sandstone cliffs near the mouth of the river Exe. It is not associated there with yellow wort (*Chlora perfoliata*). It flowered in abundance in 1879, but this year not above half-a-dozen plants came into flower. The locality was frequently examined. Some other plants have flowered but sparingly this season. In the only station in England (the Warren, a narrow strip of sandy pasture between the mouth of the Exe and Dawlish) where the *Trichonema columnæ* occurs, although many specimens might have been gathered in 1879, not one was found in flower in the present year, although frequent and careful search was made. Probably the great want of sunlight and heat in 1879 influenced the maturing of the bulbs.—*D. S., Exmouth.*

SCARCITY OF BEE ORCHIS (*Ophrys apifera*).—With regard to the bee orchis (*Ophrys apifera*), I can corroborate what your correspondent, J. S., Luton, has recorded as to the non-appearance of this plant in localities where it had been previously found, both on the downs and on flat wastes. I have failed entirely in finding it where it was plentiful the year before. In one case on the downs it was absent for several years in a spot where I had previously found it plentiful, but since then I have found it sparingly in the same place, and have been much puzzled to account for the irregularity.—*William Jeffery.*

WHITE PEDICULARIS.—In the same number of SCIENCE-GOSSIP, p. 246, B. B. Le Tall mentions having gathered a white louse-wort (*Pedicularis sylvatica*). I may mention having also found one on the 23rd of June, 1879, on a marshy common near Belstone, and another this autumn in the valley of the Taw to the south of Belstone. Along that valley the overhanging banks of the river (there a mere streamlet) are in many places fringed with the *Campanula hederacea*, and in one spot where sand had accumulated its flowers were pure white.—*D. S., Exmouth.*

STORMY PETREL (*Procellaria pelagica*).—A very fine specimen of this bird was shot in the suburbs of Carlisle on Saturday, October 30, two days after the great storm on the east coast, thus adding another instance to the many that have occurred of the petrel being taken so far inland.—*W. D., Stanwix.*

BIRDS AND FRUIT.—My brother informs me that on October 20 last, he saw a blackbird busy picking at the berries of *Arum maculatum*. Whether it swallowed them or not he cannot say, but on going to the plant he found several of the berries gone, and others lying loose on the ground.—*W. D., Stanwix.*

TENACITY OF LIFE AMONG BIRDS.—Can any of your readers tell me which English bird they think the hardest to kill? Of Ceylon birds, I take the liberty of giving my experience, in hope that it may interest somebody. A kestrel which I managed to wing, bolted off with a pin through his head, and in half an hour after, a friend of mine brought him back still alive; but as he had shown fight, my friend destroyed the bird by breaking its head with the ramrod of his gun. A kingfisher that I fired at, at about twenty yards was blown completely under water (as I had heavy shot in my gun at the time), and flew away on coming to the surface. An owl that I managed to wound in the shoulder lived for three days without food, which it refused even when put in its mouth, and to the last it showed signs of fighting. Two woodpeckers showed a greater tenacity of life than any of the foregoing. One that I wounded in the wing absolutely devoured corrosive sublimate, and lived for more than an hour on this strange diet, till in mercy I put its torment to an end. The second I hit with a No. 4 shot in the head. When struck it clung to the tree, and remained there for nearly five hours when it fell, and was brought to me alive five hours later by one of my servants when I had it destroyed. On removing the skin from the head, I found the shot had gone into the brain, and had further split a considerable portion of the skull. Parrots I have found hard to kill, and also hawks, and "Jungle Crows" (ground cuckoos), but I have never met any bird to "top" a red woodpecker.—*F. L., Ballangoda, Ceylon.*

A CURIOUS MOUSE.—A mouse was killed in a field at Yatton (Somersetshire) in colour and size like an ordinary mouse, except that the tail measured only an inch in length, the head rather larger, and the ears large and open, the curious and interesting part being the mouth. From the upper jaw projected two tusk-like teeth curving inward towards the mouth, and two much longer ones from the centre of the under jaw, curving round one side of the head. These last measured more than an inch in length. Is not this something very unusual?

DRAGON-FLIES.—Your correspondent says, in your issue of November 1, under this heading: "I have read of a Chinese dragon-fly with scarlet on the wings, but never of a red-bodied English one." I have often seen and taken adult males of the very common *Libellula striolata* (Charp.), whose bodies were of a beautiful orange-scarlet, the colour being quite sufficiently pronounced to make the insect appear bright red in the sunlight. Unfortunately, the hue soon fades in the dried specimens, and it is to me a matter of great regret that the colours of these most beautiful insects cannot be more fully retained. I would ask any of your correspondents interested in this subject to favour your readers with any hints as to their experience of the best way of setting and preserving dragon-flies.—*Abbott G. Laker.*

FOOL'S PARSLEY.—In the "Pharmaceutical Journal" for November 27, is an interesting article by John Harley, M.D., in which the Fool's Parsley (*Ethusa cynapium*) is declared and proved to be, not only not poisonous, but a desirable herb for salad purposes. I believe that the majority of botanists have regarded this plant as very noxious, even dangerous. Babington in his Manual says, "Herb poisonous." Henfrey mentions it, in a list of the poisonous plants of the Umbelliferae, in his "Elementary Course of Botany," and other authors, too numerous to quote, are unanimous in their opinions as to its baneful nature. It certainly cannot be very active, as in one instance, Dr. Harley gave as far as eight fluid ounces of the expressed juice to a patient without any effect; and he chewed portions of the root himself with impunity. Have any of your readers tested it, or experienced any of its ill effects?—*J. A. Wheldon.*

ANAGALLIS CÆRULEA.—I found one solitary plant about six years ago, curious enough, in a shady part of my garden (where ferns now grow) full in bloom. I have never seen it since anywhere; it never made its appearance the year following.—*J. W., Tottenham.*

SHEET LIGHTNING.—In reply to C. B.'s query in a recent number on this subject, I offer him an explanation thereon. First, the cause of sheet lightning is electric discharges taking place between clouds at such remote distances from each other as to be below the horizon, and too far from the observer to permit of the accompanying thunder being heard. Hence the reason that thunder is very seldom heard after this kind of lightning. Secondly, the difference in shape between sheet and forked lightning is caused by the resistance of the air, which varies in its resisting powers, to the passage of the fluid to the earth, or to another cloud. 1. When the air offers great resistance to the fluid; it (in fluid) then takes the course that offers least resistance to its passage, and takes any shape to find those places. This would be called forked lightning. 2. When the air offers little or no resistance to its passage it takes a straight and broad course. This would be called sheet lightning.—*Scientia.*

THE VELOCITY OF SOUND IN THE PHOTOPHONE.—Can any of your scientific correspondents throw light upon this? What is the rate at which sound travels in (the photophone? We know that the velocity of sound increases in proportion to the elasticity of the medium through which it travels. Ether, through which the waves of light undulate, must be the most elastic medium with which we are acquainted. Therefore are we justified in surmising that sound can travel with the velocity of light? Is Professor Bell's discovery altogether new? There is something very like it in Dr. Tyndall's first lecture upon sound. And in a note on p. 16 he writes, "It is recorded that a bell placed on an eminence in Heiligoland failed, on account of its distance, to be heard in the town. A parabolic reflector, placed behind the bell so as to reflect the sound-waves in the direction of the sloping street, caused the strokes of the bell to be distinctly heard at all times."—*H. E. L.*

PRESERVING CRUSTACEA.—I see that your correspondent J. A. Wheldon uses corrosive sublimate in his process for the above. Now this is no doubt a valuable preservative, but how does it affect the colour? for bichloride of mercury would certainly result in anything but a satisfactory way. On the carbonate of lime of the carapaces of these animals its effect would be to turn them yellow or red, I think.—*E. Lovett, Croydon.*

COMMENSALISM. (SCIENCE-GOSSIP, No. 192, p. 279).—Such cases are not uncommon. Wagtails are generally to be seen preying on flies as they settle on cows feeding in fields, and nearly every flock of sheep round here is attended more or less by starlings.—*C. F., Eastbourne.*

DULNESS IN OBJECTIVES.—I observe in the current (December) issue of SCIENCE-GOSSIP, a note from Mr. W. G. Woolcombe, intimating that he has discovered the cause of the dimness of the field of his $\frac{1}{4}$ in., to be a film deposited on the surface through changes of temperature, which requires to be cleared off occasionally. It will, I apprehend, be interesting to microscopists generally, but more especially to those who ventured to suggest a possible cause of such dulness as he mentioned, to learn by what process Mr. Woolcombe had revealed to him its real cause. Would it not seem to be no more than just to such as sought to help him out of his difficulty, for Mr. Woolcombe to give fuller details of his discovery? for at present there is an apparent inconsistency between his statement of the case in the May (1880) issue, and that which now appears in the December number of SCIENCE-GOSSIP. In the May part, Mr. Woolcombe says: "I have taken it (the objective) to pieces, and rubbed it with chamois leather, but with no avail;" whilst in the current number (December) the dulness is attributed to the fact that "changes of temperature cause a film to be deposited on the surface which requires to be cleaned off occasionally." Now, Sir, if this last sentence of Mr. Woolcombe's be an accurate statement of the fact, there at once arises the question: "If the dulness of the objective can be prevented by having its surface occasionally wiped, why was the rubbing with chamois leather of no avail?" For the sake of others who may be in a similar difficulty, I trust Mr. Woolcombe will, at an early date, explain the matter a little more fully than he has yet done.—*F. Jar. George, Chorley, Lanc.*

PEAR-TREE IN BLOSSOM.—We have near us a pear-tree, which has been in blossom since November, and is still in bloom. (Dec. 9th.) Is this a common occurrence?—*A. Fildwick, jun.*

WATER-HEN SIMULATING DEATH.—While plant-collecting, in July, 1880, on shore of Lough Neagh, I and my children found a water-hen's nest close to the water, composed entirely of freshly-plucked *Lythrum Salicaria*, the eggs in which were warm. When we had gone some ten yards farther, my son discovered one of the birds lying on its side, partly in water, its head concealed by one of the large loose stones which lay about the spot. Thinking it was dead, he took it by the tip of one wing, and holding it up, showed it to me; as the limbs were relaxed, I considered it to be decomposed, and was just telling him to drop it, when the supposed dead bird suddenly stiffened its wings, and to our great astonishment flew away. I have frequently seen wild ducks, sand-pipers, lapwings, titlarks, and wagtails, exercise their reasoning powers, and endeavour to draw off intruders, by pretending to be wounded as they fluttered before one; but this case of feigning death was different in its object. The water-hen had doubtless been watching us so intently that we had got too near for it to escape by running or flying, and hoped by simulating death to be passed by us.—*H. W. Lett, M.A.*

DO MICE KILL BIRDS?—We had a goldfinch which appeared to have been pecked or injured about the bill, and which, after being removed from the aviary (which is in a room on the top of the house) was taken back and placed in a compartment separate from the others. It did not perch, but remained on the floor. In the morning we found evidence of a struggle; the head of the bird crushed, and the brains eaten. The wires are too close for anything but a mouse, or something equally small, and nothing else entered the room, or could have done the mischief. Can you explain the matter? We have no rats that I know of, and a rat could not have passed through the wires.—*John Giles.*

LAMIUM ALBUM.—During the past few days of exceptionally mild weather, I have noticed a considerable quantity of *Lamium album* in full bloom along the hedges. Having observed this plant among the earliest to bloom, and now finding it thus late, I should like to know if it is usual for this one species to be so late—every other species of nettle being dead—and whether this is a second growth this year?—*L. A.*

THE MILD SEASON, &c.—Up to the present time (Dec. 14th), the season has been wonderfully mild here (Andover, Hants). About three weeks ago, I discovered a wren's nest, about half built, in a cowshed. In February, 1878, a wren (probably the same) built on precisely the same spot (vide SCIENCE-GOSSIP for July, 1880). On Sunday I found a good many primroses (*Primula vulgaris*) in bloom, in the young underwood. Three kinds of ferns grow about here: (1) The common brake (*Pteris aquilina*); (2) the common polypody (*Polypodium vulgare*); (3) the male fern (*Lastrea Filix-mas*)—the latter two kinds are still flourishing. Stock doves and wood pigeons (*Columba Eneas* and *Palumbus*) have not yet collected in vast flocks, as they generally do in this locality early in November. Rock doves (*Columba livia*) are also found about here in the winter months, congregating with the stock and ring doves; the country people call them "blue

rocks." These immense flocks feed on the tender tops of swedes and turnips. Some people fancy that they also feed on the roots; but I am quite assured that this is incorrect. Later on the ivy-berry affords them food, as it does also starlings, song and missel thrushes (called about here "whine thrush"), greenfinches, sparrows, &c. Jays keep together during the winter in flocks of about half a dozen. Carrion crows (*Corvus corona*) also feed and roost together. I have counted upwards of three dozen of these birds in the evening, searching about for a warm place to roost in. Jesse, in his "Gleanings," says that he once disturbed quite a "bunch" of magpies roosting in a wood. Wrens and various small birds crowd together for warmth in cold weather. I once found thirty huddled together in a thatched barn. Woodcocks alone are stirring in the night in search of their food, the common earthworm (*Lumbricus terrestris*). Keepers say that they live by the "suction of the ground," and snipes too. They do not live entirely on worms, for I once found quite a large beetle in the crop of a woodcock just shot. Soon after dusk they may be seen flying to their feeding grounds. Rabbits breed at all times; in the middle of the winter, provided the weather be sufficiently mild. Several "stops" have been found about here lately, containing young.—*G. Dewar.*

DISTRIBUTION OF FUNGI, &c.—During my country walks, I so often come across fungi, both microscopic and other, that I should be glad to make it known, in some way, to microscopic mounters, fungologists, &c., as I would send them a specimen of all I find, postage free (if I knew how to preserve them for the purpose, and the best way of packing them), in return for their names. I saw at least a dozen different sorts this damp day on bark, and growing on the grass, &c., in the woods, and though I do not know the names, I know which are common, or rare; and if I numbered the specimens, and got the names, I should soon know a good deal more about it. But I know that there is often a want of material amongst town mounters, which I should be glad to supply.—*W. Garrett, Camerton Court, Bath.*

NOTICES TO CORRESPONDENTS.

TO CORRESPONDENTS AND EXCHANGERS.—As we now publish SCIENCE-GOSSIP a week earlier than heretofore, we cannot possibly insert in the following number any communications which reach us later than the 8th of the previous month.

TO ANONYMOUS QUERISTS.—We receive so many queries which do not bear the writers' names that we are forced to adhere to our rule of not noticing them.

TO DEALERS AND OTHERS.—We are always glad to treat dealers in natural history objects on the same fair and general ground as amateurs, in so far as the "exchanges" offered are fair exchanges. But it is evident that, when their offers are simply disguised advertisements, for the purpose of evading the cost of advertising, an advantage is taken of our *gratuitous* insertion of "exchanges" which cannot be tolerated.

J. E. R.—Only four kinds of newts are known in England. See Cooke's "British Reptiles."

W. PENN.—There can be no question as to the leaf being that of the betony. The objects you took to be "spore-cases" on the back were parasitical fungi, called *Puccinia Betonicæ*.

Mac.—Your zoophyte is the "lobster's horn coralline" (*Antennularia antennaria*). See Taylor's "Half Hours at the Seaside," page 102.

E. SHAKER.—The "Botanische Zeitung" is a German periodical, resembling SCIENCE-GOSSIP in some respects, but devoted to botany. It might be obtained through Mr. W. Wesley, natural history bookseller, Essex Street, Strand.

L. BENNETT.—You can obtain no better popular book than Dr. Cooke's "Microscopical Fungi." The work on "Fungi," by the same author (in conjunction with the Rev. M. J. Berkeley), which forms one of the volumes of the "International Scientific Library," ought to be read. Dr. Cooke's best and most exhaustive work is his "Handbook of British Fungi," in two volumes, published by Messrs. Macmillan, at (we believe) one guinea. It contains descriptions of all our fungi, microscopic and otherwise.

C. KINGSFORD.—The Infusoria are single-celled animalcules, and the substance of their bodies is pure protoplasm, which is composed of carbon, oxygen, hydrogen, and nitrogen, with constant traces of sulphur and phosphorus. Living protoplasm, however, is always in a state of change, or chemical instability, owing to new food being constantly assimilated, and other parts being wasted or used up.

I. B.—The fragments of dried herbs you sent us were covered with the spores of a species of white rust (*Cystopus*).

T. W. AND OTHERS.—The "Oologist" is a monthly journal devoted to the study of birds and their eggs, and is published at Rockville, Connecticut, U.S.A.

T. LAMBERT (Edinburgh).—Will you kindly send us your full address?

W. WHITE.—We shall be very glad to accept one of your slides.

F. A. L. (Ceylon).—Two of your articles are to hand, and shall appear as soon as possible. We have recently received such a large number of excellent articles on such a variety of popular and attractive subjects, as to make us wish SCIENCE-GOSSIP were double the size, so that we might submit them the sooner to our readers.

C. R. L.—You will find full descriptions of the Derbyshire "Toadstone" in the Rev. J. Mello's "Geology of Derbyshire," (published by Bemosse, Derby). See also Rutley's "Study of Rocks," 4s. 6d., published by Longmans & Co.

G. A. L.—Your fossils are as follows: the fibrous-structured fragments of shells are remains of *Inoceramus Cucicri*, very common in the chalk. The other portion is probably a fragment of fish-bone. You had better consult Dr. Mantell's books ("Medals of Creation," &c.) for popular descriptions of chalk fossils and how to prepare them.

E. L.—We were obliged to close our correspondence earlier than usual this month, but exchanges, &c. stand over till our next number.

EXCHANGES.

WANTED, Bermuda or Barbadoes diatomaceous deposit for cash. Send particulars of price and quantity to C. H. Schill, Faircox, Didsbury, near Manchester.

Will exchange magic lantern and 12 slides (cost 16s.) and small microscope in case (cost 10s.) for polariscope, or air-ump, or an objective.—E. Ward, Lisburn Villa, Merton Road, Southsea, Hants.

WANTED, Stephen's "Entomology," Mandibulata, vol. vi., pages 57 to 64, and pages 185 to 193. Will give other parts of the same book. Cash or exchange.—Bryan Hook, Silverbeck, Churt, Farnham.

A QUANTITY of fossils for exchange.—C. L. Lord, 1 Burlington Crescent, Goole.

OFFERED, Montagu's "Ornithological Dictionary," 2nd edit., by Rennie, 1831, published 21s., with illustrations, and E. Newman's edition of same work, published 1866, at 12s., good as new, in exchange for Rye's "British Beetles," Tate's "Land and Freshwater Mollusca," Rimmer's "Land and Freshwater Shells," or other natural history works.—William Jeffery, Ratham, Chichester.

FOR exchange, the following Uranias: Fulgens, Leilus, Sloanus, and Kiphaeus, for Professor Westwood's observations on these insects in the "Proceedings of the Zoological Society," or will give cash; copy with coloured plates required.—Joseph Anderson, jun., Chichester, Sussex.

FROM 12 to 15 very handsome South African birds, all prepared for stuffing. What offers?—W. P., 65 Cricketfield Road, Lower Clapton, London, E.

OFFERED, *Pisidium pusillum* and *P. fontinale*, var. *cinereum*. WANTED named varieties of British shells; also several volumes of "Popular Science Review," to exchange for parts of "Annals and Magazine of Natural History," or conchological works.—J. D. Butterell, 2 St. John Street, Beverley.

Two eggs of redbacked shrike, 2 pied flycatcher, 2 spotted flycatcher, 2 missel-thrush, 2 hedge-sparrow, 2 redbreast, 2 redstart, 2 sedge, 2 reed and 1 blackcap warbler, 2 common and 2 lesser whitethroat, 1 Orphean warbler, 2 nuthatch, 2 blackbirds (quite blue), 2 great tit, 2 pied wagtail, 1 yellow wagtail, 1 tree pipit, 2 meadow pipit, 2 skylark, 2 black-headed and 2 yellow bunting, 2 curl bunting, 2 goldfinch, 2 bullfinch, 2 jackdaw, 1 magpie, 2 swallow, 2 sand martin, 2 c. martin, 1 turtle-dove, 2 pheasant, 2 c. French partridge, 2 great plover, 1 golden plover, 2 lapwing, 2 greenshank, 2 redwing, 1 wild duck, to exchange for other good eggs not in collection.—R. Darling, Eyke Rectory, Woodbridge, Suffolk.

Some good eggs not in collection in exchange for others, also

good microscope 1 and 3-inch powers, live-box trough for animalcules, and other accessories. For eggs.—Sidney E. W. Dowall, 4 Butter Market, Ipswich.

DIATOMS (mineralised) found in the London clay, very beautiful diatoms in situ (*Isthmia everais*), crystals of milk sugar, all beautifully mounted; ground-edge slides, blue and white raised rings, in exchange for other rare diatoms or slides.—A. Smith, The Laboratory, Essex Road, Islington.

I SHOULD like to correspond with a southern entomologist with a view to exchanges during coming season. Please address—J. Black, 47 Bridson Street, Weaste, near Manchester.

WANTED, L. Cat., 7th ed., 4s. 6d., 162, 247, 374, 600, 826, 845, 920, 1028. Other rare plants in exchange.—F. H. Arnold.

WANTED, Hobkirk's "Synopsis of British Mosses," "Midland Naturalist," for 1880. Botanical micro-slides, showing structure of flowering plants, ferns and mosses. Exchange micro-slides, or state lowest cash price.—J. R. Murdoch, 24 Blenheim Place, Leeds.

SCIENCE-GOSSIP for 1885, and eggs of lesser black-backed gull, rook, pheasant, coot, and others, in exchange for British eggs.—C. Candler, Harleston, Norfolk.

A PERFECT ivory palette, 9 in. X 6, for Rimmer's "Land and Freshwater Shells."

BRITISH Coleoptera. Correspondents wanted for exchange.—J. Walkden, 183 Broad Street, Pendleton, Manchester.

Will some one mount advertiser's mosses for microscopic investigation, in exchange for the rarer species of the said mosses and roots of foreign ferns?—Miss Ridley, Hollington House, Newbury.

STELLATE hairs, arranged in various designs; makes beautiful polarising objects; have many varieties to exchange for unmounted material. Fragments of sponges, gorgonias, holothuria, synapta, chirodota, &c., wanted.—W. White, 7 Warden Place, York Street, Nottingham.

WANTED, micro-slides and material in exchange for insect cases, micro-slides, &c.—F. S. Lyddon, 2 Oakland Villas, Redland, Bristol.

BOOKS, ETC., RECEIVED.

"A Manual of the Infusoria," by W. Saville Kent, F.L.S., &c., Part III., London: D. Bogue.

"A Monograph of the Silurian Fossils of the Girvan District," By Professor Nicholson and E. Etheridge, jun. Fasciculus III. London: W. Blackwood.

"Insect Variety." By A. H. Swinton. London: Cassell & Co.

"The Natural Conditions of Existence, as they affect Animal Life." By Karl Semper. London: C. Kegan Paul & Co.

"Practical Botany for Elementary Students." By D. Hous-ton. London: W. Stewart & Co.

"Botanic Gardens." By Bernard Hobson.

"Transactions of the Epping Forest and County of Essex Naturalists' Field Club." Part I.

"Proceedings of Liverpool Geological Society." Part XII., vol. iv.

"The Scientific Roll." Conducted by A. Ramsay. Part I., No. 1.—Climate.

"The Entomologist." January.

"The Midland Naturalist." January.

"The Scottish Naturalist." January.

"Land and Water." January.

"The American Journal of Microscopy." December.

"The American Monthly Microscopical Journal." December.

"The American Naturalist." December.

"The Canadian Entomologist."

"Science Observer." Boston.

"Science." November and December.

"Good Health." December.

"The Boston Journal of Chemistry." December.

"Les Mondes." December.

"La Science pour Tous." December.

"Journal de Micrographie." Nos. 4 and 5.

"Feuille des Jeunes Naturalistes." &c. &c. &c.

COMMUNICATIONS RECEIVED UP TO 6TH ULT. FROM:—
W. G.—E. H.—W. K. Mc. G.—H. W. L.—L. E. A.—R. M. S.—
A. H. S.—H. H. S.—H. M. M.—B. W.—C. H. S.—W. P.—
E. H.—M.—E. H.—H. P. M.—E. B. K. W.—E. L.—F. L.—
H. R. T.—C. L. L.—W. J.—L. A.—E. E.—G. D.—R. E. H.—
J. A.—L. B.—E. G.—Dr. R.—J. F. R.—E. L. A.—J. T.—
J. G.—B. M. W.—P. C. K.—W. R.—E. L.—C. P.—
P. F. L.—Dr. W. T. G.—T. M. R.—D. B.—W. B.—G. A. L.—
W. B. H.—H. W. K.—C. F. Y.—C. S.—W. A. P.—P. Z.—
W. B.—E. S.—R. D.—F. C.—H. J. L.—B. L.—A. S.—
S. E. W. D.—B. P.—B. H.—J. W.—J. S. L.—R. B. M.—A. P.—
A. E. P.—F. H.—W. B. T.—S. M.—B. M. O.—F. A. L.—
J. P.—J. S.—C. R. L.—C. C.—R. S.—R. D.—J. R. M.—E. S.—
F. H. A.—C. F. F.—J. B.—E. L.—&c.

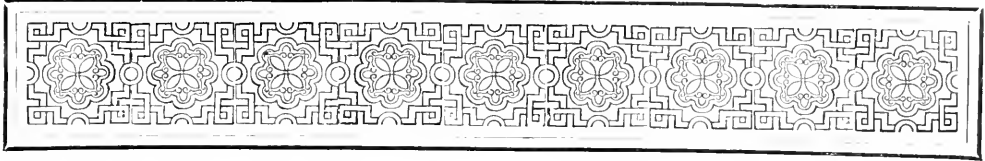

BOTANICAL NOTES FROM THE SWISS HIGHLANDS.

II. ZONES OF VEGETATION: THE RIGI.



E distinguish between a vegetation of the plains and one of the hills: similarly there is a difference between a subalpine flora and that which is purely alpine. But it is difficult to draw exact lines of demarcation between any fixed number of botanical zones, which shall coincide without exception with those which we may agree to regard as correlative

geographical ones. The zones overlap each other. We must therefore meet the difficulty half way by supposing a conical figure, which shall represent a high mountain rising from a low level, upon which botanical zones are described as proceeding obliquely from side to side and intersecting diagonally the horizontal geographical ones.

In considering the subject generally, due account must be taken of difference of latitude. Thus a plant—*Azalea procumbens*, for instance—rarely found on the Swiss Alps under 6000 feet of altitude occurs on the Scottish Highlands at 4000. These figures, therefore, would be equivalent terms, in this sense. Crossing the Brunig Pass some years ago, we found this plant on a boulder near the summit. The pass is under 4000 feet; we may infer, therefore, that the boulder had been detached at some past time from an overhanging height.

Let the beech limit be assigned to the hilly zone of Switzerland, that of the pines to the subalpine one, and the upper regions of prevailing cloud and mist to that which is truly alpine; or thus, to be

more precise: hilly zone, 2500–4000; subalpine, 4000–5500; alpine, 5500 to snow-line.

Although genera of plants occur in these upper regions which are peculiar to them—*androsace*, *biscutella*, *oxytropis*, for instance—the difference nevertheless is for the most part merely one of species—perhaps in some instances one of starved, stunted, abnormally hairy or pubescent variety—while a much larger proportion of plants, both generic and specific, alien to our British flora, such as *arnica*, *bellidistrum*, *cerinthe*, *coronilla*, *cynanchum*, &c., are restricted to the hilly or subalpine zones of which they are denizens. On the other hand, plants regarded as strictly alpine are occasionally found low down the flank or at the base of a high mountain. In such cases they are either of boulder origin, or their seeds have been washed down by torrents and deposited in localities otherwise congenial for their germination, where they flourish and display not unfrequently under these new conditions of existence a luxuriance of growth foreign to their highland habit: thus, *Bupleurum ranunculoides*, a humble little plant, three or four inches high on the grassy declivities above the pines, will attain proportions of two and a half feet; and the same remark applies to *Cochlearia saxatilis*, *Thalictrum alpinum*, *Athamanta cretensis*, and others. Even the *rhododendron* may occasionally be gathered at the foot of a mountain. One locality of the kind is low down a promontory of the Beatenberg, on the northern shore of the lake of Thun.

A line drawn from the point where the Rhone enters the lake of Geneva to that where the Rhine falls into the Bodensee will traverse the central lakes of Switzerland. Let this be regarded from a geographical point of view as a subalpine belt, with an average width of twenty miles or so, which shall serve as a boundary line between the hilly zone on the one side and the alpine one on the other; a chain of mountains which forms as it were an advanced guard to those snowy ranges which attain their greatest elevation along the southern frontiers of the country. It is within the confines of this belt

that the botanist will note the greatest variety and abundance of hilly and subalpine plants, together with many alpine species on summits which, at several points, attain an elevation of from one to two thousand feet or more above the pine limits—Mount Sentis, for instance, Pilatus, the Brienz Rothhorn, the Faulhorn, Niesen, &c.; and, presuming as a rule that the botanical brotherhood are not insensible to such matters, it may be added that in the opinion of many tourists “in search of the picturesque,” more extensive and more pleasing prospects may be enjoyed from these summits than from far higher ones within the radius of the snow and glacier fields, of which the ascents are too arduous and tedious to admit of much lingering to collect *en route*, and which, after all, will not be found to yield anything which may not be gathered at lower levels to reward one for the fatigue experienced. *Campanulaenisii* grows on the Pic de Grivola at 12,000 feet; *Ranunculus glacialis*, *Armeria alpina*, *Pyrethrum alpinum* on Monte Viso at 10,500; and *Saxifraga bryoides* with *Androsace glacialis* elsewhere at 11,500. The highest flowering plants observed by Mr. Whymper in his ascent of the Matterhorn (summit 14,700) were *Gentiana Bavarica*, *Saxifraga muscoides*, *Silene acaulis*, *Thlaspi rotundifolium*, *Veronica alpina*, and a *Potentilla*,—*frigida*, perhaps. Most of the above-mentioned plants may be gathered at 7000 feet, and no one need cross the snow-line for the others.

The lake of Lucerne is, as has been already observed, enclosed by hills and mountains wooded on their lower slopes, where these are not too precipitous for vegetation. Such a mountain is the Rigi, collectively speaking. Viewed from the lake, the high, bare, rocky face of the south front has a violet or purplish tint of colour, and the rocks are seen to be disposed in parallel strata inclined at an angle of about 25°. They appear to crown the wooded belt below; but from this they are separated, in fact, by a shelf of fields and pasturage.* These strata are composed of pudding stone or conglomerate, and sandstone; the rounded, water-worn component elements—granite, gneiss, porphyry, &c., of all sizes—are set in a reddish cement of sand and lime. Huge fragments—rocks, in fact, some of them—covered with moss and other plants, which have been detached from time to time, are observable everywhere in the forests on the lower flanks of the mountain. But

* It is here that a railway has been constructed on an incline corresponding with that of the strata. It extends from the village of Vitznau to the Kulm, or summit, and is there in connection with a similarly constructed line, which winds up an interior gully from Arth, on the lake of Zug, on the other side of the mountain. This marvel of engineering skill is effected by means of a strong central cogged wheel, which works upon a central cogged rail. There is only one carriage, the seats tilted upwards to correspond with the incline, to each locomotive, and they are not coupled; in the a-cent the engine is behind the carriage, in the descent it is in front and supports or retards it; the progress made is the same either way, three miles an hour. There is also a branch line from the station Kaltbad, two-thirds up, to the eastern or Scheideck summit.

from the Kulm to the Scheideck granite is evident, while many of the easternmost heights are mainly composed of calcareous rock; over all are erratic blocks of granite—evidence, the whole formation, of glacial action on a vast scale in a very remote age with disruption and displacement by some convulsion of Nature at a subsequent period. Geological speculations are, however, no part of the present notice, although there is one item connected with the subject of some little importance, which must not be overlooked, and that is the nature of the subsoil. The elevations being equal, there is, for example, a difference, to an appreciable extent, in the vegetation respectively of a calcareous and of a granitic subsoil. Certain plants are found on one mountain, or on a part of it, which are not found on another mountain, or on a part of that. *Rhododendron hirsutum* affects ground of a limestone character, while the other Swiss species, *R. ferrugineum*, though not restricted to it, is more generally seen on primitive rocks.

The Rigi group is between thirty and forty miles in circumference. There can be no very great objection to its being described as a peninsula. Besides the railway, there are mule-paths leading to the summit from several points. That known as the Kulm is not much under 6000, other summits from 200 to 600 feet lower. The upper surface is everywhere clothed with pasture.

The under-mentioned plants are enumerated as likely to be regarded with interest; a few of them old acquaintances, though of uncommon occurrence, more or less so, with us.

1. By the roadside between Weggis and Brunnen. *Andropogon ischæmum*, dry banks. *Arabis turrata*, dry banks. *Buphthalmium salicifolium*, grass plots; a composite with flowers like those of the yellow chrysanthemum. *Cynanchum vincetoxicum*, stony and bushy places; an asclepiad. The flowers are small, yellowish-white, fragrant; inflorescence, interpetiolarly, racemose. We have met with it in Normandy, near the sea. *Carex tomentosa*, swamps near Goldau. *Gentiana pneumonanthe*, marshy field by the Muotta near Brunnen. *Hypericum coris*, an elegant little plant with linear involute leaves, on rocks. *Hieracium Florentinum*, dry banks. *Isatis tinctoria*, sunny corners. *Leucocjum vernum*, *Laserpitium siler*, rocks, Kindlesmord. Three or four species of this umbel occur on the Swiss mountains. One of them, *L. or Gaya simplex*, is alpine. The genus is characterised by a many-rayed inflorescence; slightly compressed fruit, the secondary ridges furnished with membranous wings; involucre bracts many, persistent; corollas in two of the species yellowish, with a purple border. In *Gaya* the chief distinction lies in the calyx, teeth and membranous wings being rudimentary. *Oenothera biennis*, roadside. *Seseli libanotis*, dry banks. *Tuercium montanum*, rocks and banks; common, more

frequent than *T. scorodonia*. Flowers somewhat like but corolla tubes shorter and inflorescence different. *Trifolium montanum* and *rubrum*, banks. *Viola mirabilis*, bushy places.

E. DE CRESPIGNY.

(To be continued.)

OPHIOCOMA NEGLECTA.

EVERY ONE who has ever been down to the seashore, and made use of his eyes as he has wandered among the rockpools, knows what a brittle star is—an odd-looking creature indeed, unlike anything to be met with in the fields and hedgerows, unless we conceive five lively centipedes with their tails tied into a Gordian knot, all persistently endeavouring to free themselves. But even as “there be land rats and water rats,” so are there brittle stars and sand stars; and possibly the majority of persons to whom these are by no means unfamiliar objects, would on finding a specimen be a little puzzled to say to which section it belonged. Now, as a matter of fact, they are very easily distinguished. In *Ophiura* (sand star) the rays are prolonged into the disc on the upper side, or, in other words, the periphery of the disc is interrupted by the insertion of the rays; in *Ophiocoma* (brittle star) the rays are not prolonged into the disc, therefore the periphery is entire. On the under side the distinction is even more evident: at the junction of the rays, alternating with and separating them, there are five scale-like plates. These plates in *Ophiura* are large and conspicuous, rather narrow and shield-shaped; in *Ophiocoma* they are small, short, broad, and somewhat pentagonal. Only two British *Ophiure* are known, whilst *Ophiocoma* is represented by ten or twelve indigenous species. Of the latter genus the most common, in fact the brittle star *par excellence*, is *O. rosula*. It is extremely variable in colour, and some of the varieties are remarkably pretty.

Less generally known, though probably scarcely less abundant, at least along the southern coast, is *Ophiocoma neglecta*, a diminutive species with rays half an inch long at most, and a disc not more than one-sixth of an inch in diameter in adult specimens. They are easily overlooked, although in favourable localities often abounding among the corallines and small algae that fringe the rockpools, as well as under stones. Sometimes you will find them in a tangled mass of *Laminaria* which has been fiercely wrenched from its ocean bed in the mighty struggle between wind and waves and cast upon the beach. At Lymington, in Hampshire, almost close under the sea-wall, at the higher part of the mud-flats which stretch out far into the Solent, I used to find *O. neglecta* in such vast profusion that I believe I could have collected several hundreds in a very short time. They appeared to have a strong predilection for

Fucus vesiculosus, which certainly looked remarkably uninviting and unwholesome just there, and I have seen on a single slimy, mud-coated plant quite fifty specimens of this little brittle star of all sizes, from full-grown individuals down to tiny little fellows scarcely visible without a lens.

Now I strongly suspect that, microscopically speaking, the specific name of this *Ophiocoma* is vastly appropriate; and in writing these notes my desire is simply to direct to it the attention of those readers of SCIENCE-GOSSIP belonging to that large class of unpretending, but sincere microscopists who having neither opportunity nor leisure for “taking up a subject and going deeply into it,” are always glad to add somewhat to their stock of knowledge concerning the common objects of the seashore, and to take home an interesting and instructive souvenir of a summer holiday at the seaside.

No British echinoderm will so well repay the trouble of mounting as *Ophiocoma neglecta*, for, owing to its small size, even full-grown specimens may be displayed on a slide of ordinary dimensions. I would recommend, however, the selection of medium-sized individuals, because the larger ones have mostly been “in the wars,” and have suffered in consequence. Kill the specimen by immersion in fresh water for a minute or two, then transfer it to a little saucer of liquor potassæ, where it must be allowed to remain for some hours; the length of time has to be determined by experiment: if too short, the mucus will not have been dissolved, and if too long the limbs will be tender, and readily part company. The smaller the specimens, the less time must they remain in potash. Wash well, and mount in balsam. When examined under a low power, either with or without dark field illumination, few objects will prove more attractive both to scientific and non-scientific observers. The lower side of the disc, detached from the upper, with the rays severed at their insertion, is strikingly beautiful, and shows the oral aperture with its surrounding plates; while the upper side, treated in the same way, exhibits the rosulate arrangement of the scales and the characteristic geminate plates which lie at the base of the rays. The form and relative position of these large geminate plates are of the utmost value in discriminating the various species of *Ophiocoma*; in fact they constitute one of the main specific characters. *O. rosula* and *O. neglecta* are the only two in which these plates are contiguous throughout their length—in the former they are triangular, in the latter oblong. One of the rays of a large specimen, when a perfect one is selected, should also be mounted singly, as it may be made to show the arrangement of the scales and spines better than in an entire specimen.

Nor have we even yet, in these various preparations, discovered all the points of loveliness that ornament this tiny denizen of the deep. Quite unsuspected, and therefore the more surprising, is the diversity of

form and exquisite beauty of the individual bonelets or ossicles which compose its calcareous skeleton. It is quite beyond my power to describe them, but I may say that in variety of outline and sculpture they surpass the ossicles of any other species I know. There is a lightness and elegance about them which is wanting in almost all the others. The method of obtaining these, detached and clean, is simple in the extreme. Put one or more of the starfish into a test-tube (mutilated specimens unfit for mounting will do just as well), pour in some liquor potassæ, boil for a few minutes, wash in pure water, *et voilà tout*.

It will be seen from these few remarks that a series of slides illustrating the structure of an *Ophiocoma* may be mounted with very little trouble, and by consulting a few books when leisure permits, much valuable knowledge will be acquired; and when

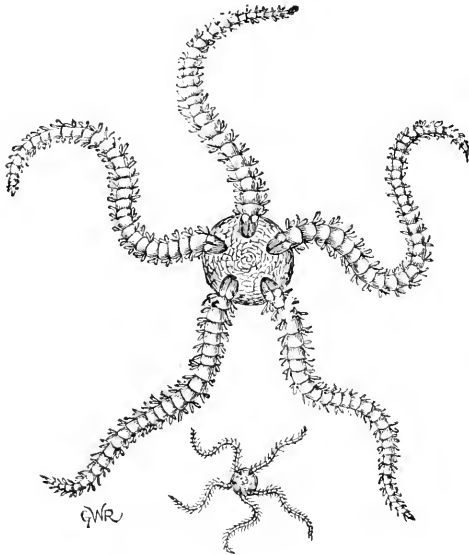

Fig. 37.—*Ophiocoma neglecta*. (Natural size, and enlarged.)

your neighbour drops in one evening and says, "My boys are going to set up an aquarium, and they want me to bring them some brittle stars from Brighton; I never saw one that I know of: what are they like?" you can adjust your microscope, screw on the two-inch objective, take out half-a-dozen slides, and entertain him for ten minutes with a simple, agreeable, free-and-easy lecture on the subject; and, who knows? perhaps some day his "boys" may return your kindness by giving you an account of the singular metamorphoses which *Ophiocoma neglecta* undergoes before acquiring the bony framework which you have mounted, and in other ways helping you to solve some of the great problems of life in the mighty ocean,

"Where things that own not man's dominion dwell."

Penance.

E. D. MARQUAND.

THE FOSSIL FLORA OF THE HALIFAX HARD-BED COAL.

No. I.

By JAMES SPENCER.

I PROPOSE to bring before the readers of SCIENCE-GOSSIP a series of short articles on the above subject, which will be illustrated by original sketches of fossil plants from my own cabinet, and which are the result of my own labours in this most interesting repository of fossil plants. My object will be to endeavour to give short popular descriptions of the fossil plants, and thus to aid in spreading the knowledge of these beautiful fossils over a wider area than they have hitherto been known.

Before proceeding with the description of the coal-plants, it will be advisable to give a brief account of the geological surroundings of the Halifax hard-bed coal. The series of strata in which it occurs lie between the rough rock (the uppermost member of the millstone grit series) and the Elland flagrock. The average thickness of this series in the neighbourhood of Halifax is a little over 500 feet. Two workable coal beds occur in it, namely, the hard bed, the subject of this paper, and the soft bed, the former being 2 feet 3 inches, and the latter 1 foot 4 inches in thickness; besides these there are five or six others which are too thin to be worked for the coal alone, but most of them are worked in various places in conjunction with the fire-clay or seat earth underlying them. Indeed the seat earth forms in this neighbourhood a much more valuable commodity than the coals, and is largely worked for the manufacture of fire bricks, which are extensively used in the construction of gas retorts, and furnaces, &c., and in conjunction with the clayey shales of the series, it is used in the manufacture of all kinds of bricks for building purposes, sanitary tubes, chimney-pots, &c.

The coal beds in the neighbourhood of Halifax have been worked from time immemorial. There are deeds extant which prove them to have been used for upwards of three hundred years, and very probably they were worked at a much earlier date. These strata are known all around the outcrop of the Yorkshire coal-field, as the Halifax beds, which seems to indicate that these coal beds were first worked in the neighbourhood of Halifax, and that the workings gradually extended on either hand from Halifax.

The section of Beacon Hill on the east of Halifax, will give a good idea of the succession of the different beds composing this group. Crowning the hill we have the valuable sandstone rock known as the flagstone rock, which is so extensively quarried all around the outcrop of the coal-field from Leeds by Bradford, to Halifax and thence to Elland, Huddersfield and Penistone. It is termed by the geo-

logical surveyors the Elland flagrock and Greenmoor rock. Underlying the flagrock in descending order, there are about 120 feet of shale and raggy stone, then the 80 yards band coal which is only about 6 inches in thickness, then about 100 feet of more shales and rag, followed by the 48 yards band coal of about 10 inches in thickness, then 36 feet of more shales followed by the 36 yards band coal, having 3 to 4 feet of seat earth under it, which forms one of the most valuable fire-clays in the neighbourhood. Then follows about 100 feet of more shales gradually merging towards the base into fossiliferous marine strata, then comes about 8 to 10 feet of shales highly charged with calcareous nodular concretions, generally coated with pyrites, and containing a rich and varied assortment of marine fossils such as *Goniatites Nautili*, *Orthoceras*, *Aviculo-pecten*, and many other

lime, pyrites, calc-spar, and vegetable remains. They are nearly always thickly coated with pyrites and are often very difficult to break open, an ordinary hammer being of little use for this purpose, and too frequently the whole ball is one mass of pyrites. In composition and external appearance they much resemble the nodular concretions which occur in the marine strata above the coal, but there is a total difference in their fossil contents. The coal balls contain fossil plants exclusively, while the baum pots contain marine shells and fish remains, and occasionally fragments of the fossil pine, called *Dadoxylon*, which have evidently been drifted into the sea in which this bed was formed, from some neighbouring land.

The hard bed coal rests upon the very peculiar rock called gannister, which varies in thickness from



Fig. 38.—Enlarged section of beds 1, 2, and 3 of "Hard Bed." 1. Marine beds with "Baum pots," containing *Goniatites Listeri*, &c., *Nautili*, *Orthoceras*, *Aviculo-pecten*, &c., also occasionally fossil pine wood (*Dadoxylon*), showing structure; 2. "Hard Bed" with "coal balls," containing a great variety of coal-plants, as *Leptodendron*, *Sigillaria*, &c.; 3. Gannister rock and seat earth.

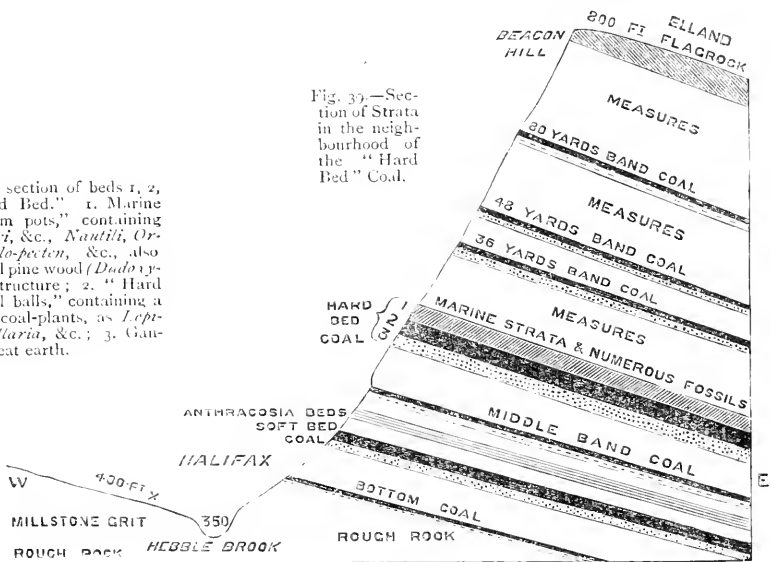

kinds of fossil shells and fish remains. Immediately underlying the marine strata is the hard bed coal, containing in many places those remarkable nodules called coal balls. These coal balls are found in the coal itself, and in some places the whole bed is occupied by them with only a little admixture of coal, but generally they seem to be scattered throughout the coal seam at irregular intervals. Some coal pits yield them more abundantly than others. We have traced them all round the outcrop of these strata from Denholme in the north, by Halifax, Elland, Huddersfield, Hepworth, to near Penistone, where they appear to approach their southern limits. They are found also at about the same geological horizon on the Lancashire side of the Pennine chain, in the neighbourhoods of Bacup, Todmorden, Rochdale, and notably about Oldham. The materials composing the coal balls consist of carbonate of

limestone, in the neighbourhood of Halifax, to 3 feet in the neighbourhood of Penistone. Underlying the gannister there is a bed of seat earth, and both seat earth and gannister are full of stigmarian rootlets, while some of the best specimens of the ordinary stigmarias are met with in the gannister rock. About 75 feet below the hard bed coal, the soft bed coal is met with, and midway between them occurs another thin seam called the middle band coal; underlying it, there is a valuable bed of fire-clay, which is extensively worked in this district. Midway between the middle band and the soft bed coal, there are three layers of shale which are literally full of *Anthracosia*, separated by black shale containing *Spirorbis carbonarius*. The strata below the soft bed coal contains nothing noteworthy in the Halifax district, but in the neighbourhood of Huddersfield occur what are called the soft bed flags, and under

them certain layers of shale containing fossils such as *Avicula-pectens*, *Goniatites*, and fish remains. At the bottom of the series is a bed of coal of about 6 inches in thickness, having under it the usual seat earth, these lie conformably upon the rough rock. Having now given a brief description of the geological surroundings of the hard bed coal, I will describe in my next paper some of the plant remains found in the coal balls.

(To be continued.)

CHAPTERS ON BRITISH DRAGON-FLIES.

No. II.

BY E. B. KEMP-WELCH.

CORDULIDÆ.

Eyes slightly prolonged posteriorly.
Triangle of front wings inequilateral,
enclosing a transverse nervure.
Abdomen club-shaped.

Genus *Cordulia* (Leach).

C. ARCTICA (Zett.). Wings clear; pterostigma black; colour bronze-green; a yellow spot before each eye; face spotted with yellow; anal appendages of the ♂ closely approximated, with three teeth beneath, semicircular at the extremity. Habitat Perthshire in July. Length 21 lin.; exp. 30 lin.

C. anca (Linn.). Wings clear; accessory membrane reddish; pterostigma black; colour bronze-green; face not spotted; upper anal appendages of the ♂ sub-cylindrical, the points turned outwards; lower anal appendages forked. According to Charpentier (Lib. Eur. pl. 14) the wings of the ♀ are of a clear brown colour. Habitat England; local. Length 20 lin.; exp. 30 lin.

Triangle of front wings equilateral without included nervure.

C. Curtisi (Dale). Wings clear; pterostigma black; colour bronze-green, face of same colour; abdomen cylindrical (♂), compressed (♀) with dorsal yellow spots; anal appendages of ♂ subcylindrical with a spine inside at base. Found in the New Forest, and near Bournemouth. Length 20 lin.; exp. 30 lin.

Labium, or lower lip, larger than the palpi.

Eyes remote, labium rounded at the tip.

Genus *Gomphus* (Leach).

G. vulgatissimus (Linn.). Wings clear; accessory membrane yellow; pterostigma black; costal nervure black outside; legs black; thorax yellow, with six broad straight black stripes arranged in a pattern; three green spots between the wings;

abdomen black with a suddenly-narrowing yellow dorsal stripe, terminating at the seventh segment; eighth and ninth segments with yellow patches laterally; anal appendages of the ♂ spear-shaped, diverging widely. Local in England and Ireland. Length 22 lin.; exp. 28 lin.

G. flavipes (Charp.). Wings as above; legs yellow, streaked with black; thorax yellow, with six curved black stripes; abdomen black, with a dorsal yellow stripe continuous through all the segments; anal appendages of ♂ cylindrical, pointed, widely divergent. Has been taken at Hastings (in August). Length 24 lin.; exp. 33 lin.

G. forcipatus (Selys.). Wings clear; accessory membrane clear; pterostigma black; legs black, posteriorly yellow on the femur; thorax black, with a yellow pattern; abdomen black, with dorsal lanceolate yellow spots; (the ♀ has also yellow lateral spots); upper anal appendages of the ♂ curved round like forceps, the points bifid; the lower contiguous, straight and pointed. Has been taken in England. Length 23 lin.; exp. 28 lin.

Eyes more nearly contiguous.

Labium cleft at the tip.

Genus *Cordulegaster* (Leach).

C. annulatus (Latr.). Wings clear; pterostigma (♀) black, (♂) lighter; costal nervure yellow externally; back of the head yellow; upper lip yellow; thorax black, with eight yellow stripes; abdomen (strongly clubbed in the ♂) black, with a yellow band at the middle of each segment. England, Scotland, and Ireland generally. Length 32 lin.; exp. 42 lin.

Eyes quite contiguous.

ÆSCHNIDÆ.

A. Anal angle of hind wings acute (♂), and rounded (♀).

Genus *Æschna* (Fabr.).

Æ. pratensis (Müll.) Wings clear, rather tinged towards the base with yellow in the ♀; nervures reddish; pterostigma long and narrow, reddish; accessory membrane small; anal angle of hind wings (♂) not very acutely angular; thorax brown, hairy, with two yellow bands on the shoulders; abdomen cylindrical, brownish-black, spotted with blue in the ♂, and yellow in the ♀; anal appendages of ♂ long, triangular, hairy, and curved inwards. England, Scotland, and Ireland, generally. Length 26 lin.; exp. 34 lin.

Æ. mixta (Latr.). Wings clear (♂), uniform light brown (♀); accessory membrane darkish; pterostigma dark; thorax brownish-black, with two spots on the front, and two bands on the sides, yellow; abdomen slender, cylindrical; in the ♂ contracted near the base; brownish-black spotted with dark blue in the ♂, and with yellow in the ♀; anal appendages of ♂ long, scalpel-shaped; the lower long and triangular

England and Scotland; local. Length 28 lin.; exp. 36 lin.

A. borealis (Zett). Dr. Hagen's description of this species is as follows: "Brown, thorax with two small bluish lines in front, and two narrow bluish bands at the sides; abdomen slender, cylindrical, coarctate behind the base in the male, spotted with blue (♂), or yellowish (♀); accessory membrane of a uniform cinereous; anal appendages of the ♂ long, leaf-like, their end pointed, an inconspicuous basal tubercle beneath; the lower broad, triangular. *A. borealis* is easily recognised, because it is the only one of which the subnodal sector is simple" (see fig. 32), "and not bifurcate at the end; the subnodal sector is the fifth longitudinal nerve from the costa, counting that as one, in the end of the wing. Habitat Scotland. A single male in the cabinet of M. de Selys. Length 26 lin.; exp. 34 lin."

A. juncea (Linn.). Wings clear, costal nervure ochreous; pterostigma black in ♂, rather ochreous in ♀; accessory membrane blackish, growing lighter towards base; thorax blackish (♂), more brown in (♀), with two nearly straight yellow stripes in front, interrupted in the ♀, and two sloping yellow bands at the sides; abdomen slender and cylindrical, contracted near the base, more especially so in the ♂; colour (♂) black, with two blue spots on each segment, and yellow markings at joints of segments; in the ♀ brown, with similar spots in yellow, and similar yellow markings; and appendages long and leaf-shaped, ends pointed. British Islands generally. Length 32 lin.; exp. 46 lin.

A. cyanea (Müll.). Wings clear, costal nervure brownish externally, pterostigma short, black in ♂, ochreous in ♀; accessory membrane short, white; thorax in both sexes brown, with two large oval yellow green spots in front; sides yellow-green, divided by dark lines; abdomen slender, cylindrical, sharply contracted near the base in the ♂, in which sex the ground colour is blackish-brown, with two green spots dorsally on each segment as far as the seventh, and blue spots on the remaining segments and apex, as also all along the sides of the abdomen; in the ♀ the spots are all yellow-green; anal appendages of ♂ long and leaf-shaped, the ends turned inwards. British Islands generally; common. Length 32 lin.; exp. 46 lin.

A. granis (Linn.). Wings clear, of a transparent red-brown tint; nervures ruddy; accessory membrane opaque white; pterostigma red; thorax red-brown, with two yellow bands at the sides, no markings in front; abdomen cylindrical, contracted near the base in the ♂ (only); colour red-brown; markings, four blue spots at base of wings, two oblique yellow stripes and two blue spots immediately following, common to both sexes; the ♂ has the remaining segments marked at intervals with blue; the ♀ no further marking. British Islands generally. Length 32 lin.; exp. 44 lin.

A. rufescens (Van der Lind.). Wings clear, rather red-brown in tint; accessory membrane large, dark-tinted; pterostigma ochreous; thorax brown, with two yellow bands at the sides, none in front; abdomen cylindrical, contracted near the base in the ♂, brown, with a single conical yellow spot dorsally near the base, the remainder unspotted, in both sexes; anal appendages of ♂ long and leaf-shaped. Local in the south of England. Length 30 lin.; exp. 40 lin.

B. Anal angle of hind wings rounded in both sexes.

Genus *Anax* (Leach).

A. formosus (Van der Lind.). Wings clear, broad; accessory membrane dark in the narrow part, white at base; pterostigma very narrow, dark in ♂, ochreous in ♀; thorax bright green; abdomen rather broad and depressed, contracted in ♂ near the base; colour bright blue with a dorsal black pattern; anal appendages of the male more spatula-shaped, truncated at the apex. Local in the south of England; occurs near Bournemouth. Length 34 lin.; exp. 46 lin.

NOTE.—Fig. 32—Reference-letter C omitted in figure: should be inserted over the black spot towards the upper tip of the wing; c. (triangle) in figure should be c: D is the post-trigonal space. The figures 27, 28, 33 & 34 are not mine, and were doubtless inserted from a friendly wish to enliven a dry description of species; but I am bound to anticipate probable criticism by remarking that the venation of wing in fig. 27 is very hazy, while that of fig. 28 is altogether erroneous.

(To be continued).

A FEW REMARKS ON GNATS' EGGS.

WHILE examining some water from a pond containing *Plumatella*, &c., I observed a small round transparent ovasac (fig. 40) the like I had not seen before. It contained more than 300 eggs, one of which I have shown enlarged in fig. 41. I placed the ovasac in one of my shallow cells, anxious to witness the hatching out of the eggs. The ovasac was a quarter of an inch in diameter and so perfectly transparent that every egg could be distinctly seen and the young creatures within them. Two red eye-spots were visible (fig. 41 a). I could observe little or no motion in the egg. In about four days some of them had escaped from the egg, leaving a perfectly transparent shell. As soon as they were clear of the shell, they elongated to three times the length of the egg, in the form of fig. 42; they were perfectly naked at first, and moved very quickly, throwing and wriggling themselves about violently in a figure of S fashion, and endeavouring to escape from the ovasac into the surrounding water. This they ultimately accomplished; then they formed a gelatinous tube open at both ends, wherein they dwelt,

and which they attached to the weeds. The tube soon became covered with extraneous matter. In this tube they kept up a continual waving and undulating motion, by which water was pumped through, and there was sufficient room for the creature at times to turn round so that the head protruded where the tail was, and *vice versa*. Having many times seen these creatures both in their naked state and in the tube, I had wondered where they came from and to what they belonged; now, having seen them developed from the egg, one question is answered, as to their being a larva of some sort. By referring to Mr. Edward Cox's paper, entitled "A Few Words about a Little Gnat," in SCIENCE-GOSSIP, vol. xiv. p. 269, the other question will be answered, as he has witnessed both the transformation of the larva to the pupa, and from the pupa to the imago. The little sketch given at the head of his paper I think will

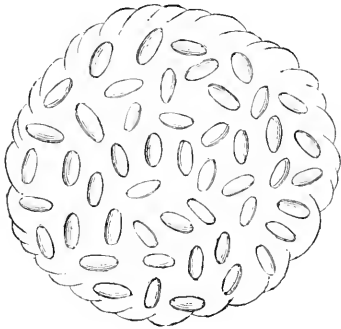

Fig. 40.—Ovasac of Gnat.

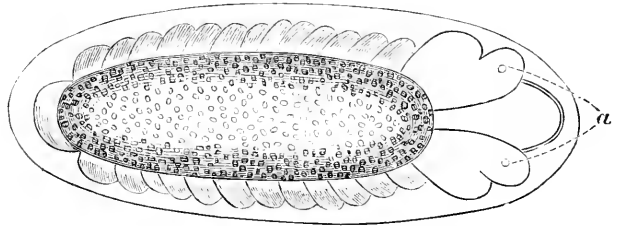

Fig. 41.—Egg (enlarged): a, red eye-spots.

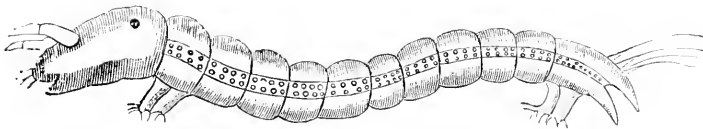

Fig. 42.—The Larva from the Egg.

prove it to be the same as fig. 42. I am sorry he was not able to obtain the name of the gnat, as I should also like to have known it. His description of the larva is very good, and corresponds with what I have been enabled to observe of it. Perhaps some of the readers of SCIENCE-GOSSIP can give the information required.

Canterbury.

JAMES FULLAGAR.

GERANIUM.—I met with white-flowered specimens of this plant in Worcestershire and Herefordshire in 1877, and at or near the same spot in Herefordshire in 1878. Mr. A. D. Melvin tells me he also found it near Worcester some years ago. I think the plants I have seen are larger and more vigorous than those of the usual colour. Is this generally so?—R. F. Towdrow.

THE TREE CREEPER.

By W. H. WARNER.

THERE is a certain inoffensive little brown bird haunting an adjoining orchard at the present time (March) whose habits have afforded me some little amusement during leisure moments. This little creature is only about five inches in length, is of slender build, and like all other objects of the Creation, is beautifully fitted for the life it leads. Being never seen on the ground, and gaining its livelihood entirely on the trunks of old trees, posts, and walls, it has all its members specially adapted for such a life. For climbing and clinging purposes, it has long and sharp claws; as a support when so engaged, its tail feathers are very stiff, and on these the bird rests; and for collecting its food

it has a long, curved, slender bill, which is particularly useful in capturing those tiny specimens of the entomological world which lurk in the crevices of the bark. Seen at a distance, this little climbing, clinging bird appears clothed in a plain brown and white garb; but examine a specimen in your hand, and you will find that its upper plumage is finely mottled with different shades of brown both rich and sombre, and that its white under-parts seem to have a silvery appearance. After this preamble we introduce a bird well-known to every schoolboy—the tree creeper (*Certhia familiaris*).

A very appropriate name this little bird bears. See it when you will (which is not very often, unless you have sharp eyes and know how to use them), it is climbing or creeping up the trunk of some tree, and sedulously hunting for all those tiny creatures which find their homes in and about the bark. An

old lichen-covered, rough-barked apple-tree with tufts of moss here and there is a fine hunting-ground for the little creeper. Orchards seem especially favoured by this tiny bird, and any owner of one may soon become acquainted with the habits of *Certhia familiaris*, if, as I said before, he has tolerably observant eyes, and by practice has learnt how to use them to the best advantage. For the subject of our sketch, be it remembered, is of a very shy retiring disposition, and generally contrives, when engaged in its search for insect-food, to keep the trunk of the tree between itself and the spectator. Apart from this, the brown tints of the upper parts often accord so exactly with the hue of the bark against which the bird is climbing, that an ordinary observer might easily be excused for mistaking the latter for some excrescence of the bark. Generally speaking, the creeper climbs with its head upwards; but on one occasion I saw a pair together in a sycamore tree, hunting for food, one of which descended a branch head downwards, but only for a little distance. To see a pair of these birds hunting for food together is also a somewhat uncommon occurrence, as *Certhia familiaris*, except at certain seasons, is of solitary habits.

The creeper is a resident among us all the year and braves our occasionally severe winters in common with that fairy-like little bird, the gold-crest, the hardy little tits, and so on. In March its song commences. Yes! this little bird has a song, though I have never seen the fact mentioned, as yet, in any work on ornithology. Indeed one author says its note amounts "to no more than an occasional cheep;" but this I must certainly deny, as I have heard the bird sing many times when standing close by, and am positive that the sound came from no other performer. I noticed this first several years back, but did not register the fact in my diary till

about five years since. The song is a sweet though rather feeble little strain, and reminds one very forcibly of the song of the willow-wren (*S. trochilus*) and also that of the bluetit (*P. caeruleus*). When musically inclined, which is only in the months of March and April, the little creeper chants its simple song most perseveringly. This it will repeat several times when ascending the trunk of a tree, turning its head aside as it proceeds and breaking out into song.

In March, too, we often see pugilistic encounters in the air between creepers; but whether this is the act of pairing, or the usual rivalry between the males at this time, I have not been able to ascertain.

The nest of the creeper is placed in the hole of a tree, or else in some gaping aperture of the bark outside the tree. Pollard trees—willow or ash—are very favourite nesting-places of the creeper. The nest is usually completed at the end of April, or the beginning of May. It is a very inartificial structure composed of scraps of bark, dry grass, moss and twigs with a lining of feathers. The eggs vary in number from five to eight, or nine, and are white, with red spots, the latter being generally collected in a kind of zone, or band, at the blunt end of the egg.



Fig. 43.—Tree Creeper (*Certhia familiaris*) and nest.

The young creepers remain with their parents for some time after they leave the nest and are diligently cared for. It is very amusing to watch the various ways in which young birds are fed after leaving the nest. The young rook, for instance, swaying about on the twig of some elm is a most greedy fellow, and when his patient mother has just popped a fine fat morsel into his clamorous beak, croaks louder than ever for more. The little wagtail, too, running after its mother on some dewy lawn is quite as difficult to satisfy as the young rook. When its busy mother approaches with some scrap of insect food, it is amusing to see how eagerly the junior receives it in

its gaping bill, shivering its wings and tail in the greatest excitement. Last year there was a great hulking cuckoo about our garden and orchard, quite big enough one would think to take care of himself; but no, he preferred to perch himself comfortably on a rail, and open his great orange mouth every now and then to receive the bounty of a poor little hedge-sparrow which had to hoist itself up on tiptoe, and crane its neck to reach the widely-gaping mouth of the great glutton. One day in June, I noticed a small party of creepers in a row of spruce fir-trees busily hunting for food, and was considerably amused to see one of them (apparently a young bird) quietly clinging to the branch of a fir, and waiting patiently till one of the others brought it food. This was effected in what I considered a very curious fashion, for the parent in ascending the tree would turn aside its head as it neared the youngster, and with its long bill would insert some scrap into the mouth of the latter. This novel mode of feeding was repeated several times while I was standing a short distance off.

I have seen creepers in small parties as late as the middle of September.

During the winter the creeper's sole occupation is in collecting food from morning till night. When the weather becomes severe, the poor little bird is often rendered remarkably tame. This was especially the case in the unusually severe winter just gone by. February 1st of the present year, was a wintry day indeed. In the afternoon of that day a little creeper came flying around me two or three times, seeming quite oblivious of my presence. The ornithologist had great facilities for making many valuable notes on his favourite pursuit during the long-to-be-remembered winter of 1878-9.

Standlake, Witney, Oxon.

NOTES BY A NATURALIST IN MAURITIUS AND GREAT BRITAIN.

By WILMOT H. T. POWER, B.A., M.R.C.S.

THESE notes were taken during a residence of more than four years in Mauritius, and added are a few notes taken at home:

Destruction of a Beetle indirectly by the frailty of the flowers of a Tree, directly by Ants.—A beetle of the size and characters of the English rose beetle, but of a purplish black colour with white spots, used to haunt a small tree growing in the back yard of my hut at Port Louis; the yard and hut were densely populated by several kinds of ants; the beetles would fall from the tree so frequently on their backs, and rest there kicking helplessly, till an army of small black ants soon came on the field, and carried off the helpless insect—to them a giant.

The useless Claws of a Crustacean.—A macrurous

decapod (*Mymnocera elegans*), which I found rarely in holes amongst the corals, of a very handsome cream-colour, spotted with a few large peacock-like ocelli on the body and claws, these latter were flat, thin and flexible as paper, the nippers being at the top and inner edge, and were so small as to be of little use for any purpose.

Protective imitation by Colour in a Crustacean.—Macrurous decapod—a trypton, probably a new species—in size and shape very like the common sand-hopper, I found only among the spines of the echinus common on the reef; the spines were marked by a few longitudinal stripes, alternately of a rich brown and darkish purple; the trypton was marked exactly in the same way.

Curious habit of a swimming Crab.—This crab (*Achelous granulatus*) was common enough in water between the shore and reef, and was about an inch across the carapace; it used to swim rapidly towards my feet when out wading, and there bury itself in the sand. I never saw it swim away from me, and can only suppose it did so, because the stirred-up sand at my feet made the water rather turbid.

A marine Happy Family.—I found in holes in the coral a macrurous decapod (the specimens were lost, so I do not know its name) about the size of a large shrimp, always in pairs, male and female, and with them one or two brittle star fishes, and a large species of sea mouse (*Aphrodite*).

Differences in characters of O. episcopalis on the leeward and windward coasts of the island.—At Black River, on the leeward coast, the reef was a long distance from the shore, and the bay protected from the prevailing trade-wind by lofty mountains; the bottom was dark (a contrast to the usual white coral sand bottom) from the deposit of vegetable débris brought down by the river during the rainy season. Here we had comparative darkness and tranquillity, and the olives (I fished up several hundreds of them) were large with a somewhat thin shell, and much varied in marking (but all of a darkish tinge), from some that were a deep brown, through others with dark brown rings and blotches, to the ordinary colour with roundish brown dots on a yellowish-white ground. On parts of the windward side where the reef was close to the shore, or where there was no reef at all, heavy seas playing on it for most months of the year, flying before the trade-wind, the olives were much smaller, thicker, and of an almost uniform colouring, viz., yellowish-white with small dark spots; the sea-bottom and shore too here were of the usual white coral débris, so it would seem the thickness was due to the violence of the sea, and the colour to the light-coloured bottom, and the shallowness of the water allowing greater penetration of light.

Identifying the bones of the extinct bird the Solitaire from the island of Rodrigues.—I do not know whether this has been described as it actually occurred, or is generally known, but as an interesting episode in the

history of the extinction of a large bird in modern times, and also possessing a good account of its habits when still existing, I write these lines. Some time in 1865, I think, Mr. E. Newton, then of the civil service of Mauritius, sent some men to Rodrigues to collect bones, all they could find, as no one acquainted with osteology could get away. They were sent to me to sort, as I then had plenty of spare time, and he could come down at any odd chance to see how all was going on. In a broad, upstairs-verandah, I rigged up a table of planks on trestles, and weeded out the greater number, being those of the large tortoise, besides a number of bones of some small birds, the remaining bones were undoubtedly those of a large bird; but some six or seven pinion bones struck me as peculiar from a small round ball of bone in them, the first two or three I took to be mere bits of coral débris, &c., but here all were at the same part of the bone! Mr. Newton came and looked at them, turned to Leguat's book, and read his description of the birds when alive, and especially when fighting, that they struck with their wings beneath which was a lump of bone of the size of a musket ball; so wrote Count Leguat, and fortunate it was that he was a keen observer and good describer, and that, under circumstances of much misery.

(To be continued.)

FROG SPAWN AND ITS DEVELOPMENT.

By M. H. ROBSON, Hon. Sec. North of England
Microscopical Society.

THE season is now near when the interesting experiment detailed in the following paper can be repeated; it is one which can be carried out by almost any person willing to bestow a little care and attention daily for a few weeks.

Little difficulty exists in obtaining frog spawn; usually it is within easy reach, being frequently deposited at the shallow margins of ponds or ditches, where it may be seen floating in gelatinous masses during the early spring months.

A dozen or so of the ova are amply sufficient for the purpose of maturing: these are readily separated from the mass in which there may be some hundreds. Each ovum forms a central speck of inky blackness, $\frac{1}{12}$ inch in diameter, in a transparent albuminous globule, having a diameter of nearly half an inch; the whole is invested in a delicate membrane attached to the general mass (fig. 49).

The spawn intended for observation should be placed in a shallow vessel containing water, and covered with glass to exclude dust, having previously put in a liberal supply of aquatic plants, preferably callitriche, millfoil, chara, or nitella, as being most likely to afford the tadpoles a sufficiency of Infusoria, upon which they seem to subsist to a considerable

extent after devouring the gelatinous egg mass which appears to form their first food. They are thorough scavengers, and any decaying matter, either animal or vegetable, is eagerly eaten. In confinement, however, nothing putrid must be permitted to pollute the water in which the tadpoles are kept, otherwise they soon die. The live tadpoles do not suffer their default relatives to be altogether lost, but, as cannibals, speedily utilise them.

On March 3rd, 1878, I procured a supply of freshly-laid spawn; this was very early in the year; but the weather had been open and mild for some weeks before, and this day was singularly warm and spring-like, vegetation was quite a month in advance of the average season, and the batrachians moved actively in the shallow pools. The vessels intended to receive the spawn were placed in the window of a room having a north-east aspect, and without a fire, the blinds were kept undrawn, in order to imitate natural conditions as closely as possible with reference to temperature and light.

The freshly-gathered ovum when crushed between two slips of glass and examined in water under a quarter-inch objective is seen to be composed of irregularly-shaped granules enclosed in a delicate integument which, on being ruptured, lay in folds amongst the corpuscles, these varied in size as in shape, the larger granules measured $\frac{1}{200}$ inch in diameter with the suspicion of a nucleus.

In appearance the ova changed little until the fifth day, but the integument gradually thickened and became so tough that it was now necessary to cut it open in order to liberate the contents of the ovum. These had become aggregated into small spherical masses, the granules evidently nucleated, and from the currents perceptible amongst them, it appeared that ciliary action was in existence, although I could not just then locate it.

On this day also a cleavage or segmentation of the ovum was observed, as in fig. 45, and the interesting fact became apparent that the embryo frog, unlike birds, or the mammalia, does not originate in a single vesicle or sac on the surface of the yolk, but in common with toads, newts, and some other reptiles, the whole substance of the yolk becomes transformed or moulded into the nascent tadpole.

Figures 46 and 47 show the progress of cleavage on the sixth and eighth days respectively. On March 12th, this being the ninth day from the deposition of the spawn, a striking change was manifest; the embryo had assumed the form shown in fig. 48, where A represents the natural size of ovum, as in preceding figures, and B the same magnified four diameters; at *a* are the rudimentary external gills; the inner circle *b* surrounding the embryo is the vitelline sac or zona pellucida, itself an object of singular tenuity and crystalline transparency; and at *c* is the protruding tail.

A change was now perceptible daily; the gills and

tail grew rapidly ; the nostril became conspicuous, and on the fourteenth day (March 17th) a rapid energetic motion (the embryo bringing head and tail together with a jerk) was first observed. Figure 49 A, enlarged at B. The next day a few tadpoles had emerged and were lying upon the gelatinous egg mass occasionally indulging in a vigorous wriggle. This action seemed to clear them of the albuminous investing globule upon the débris of which they continued to lie and probably feed until its disappearance.

the protuberance *c* (the immature mouth), from which, judging by the movement of floating particles, the water was driven backward in a current to the gills. The smaller figures represent the dorsal aspect at this stage.

Figure 52 represents the tadpole on the twentieth day. The gills now extended almost to the tail, and the membranous sheaths through which the posterior limbs protrude were plainly visible through the transparent cuticle at *d*.

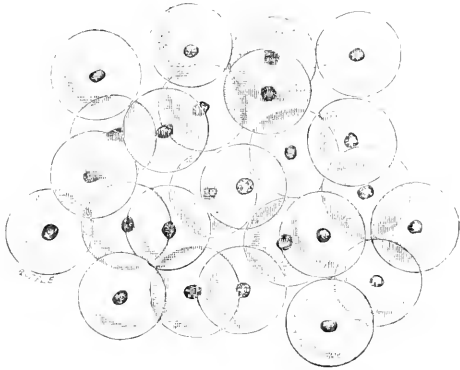

Fig. 44.—Frog Spawn *in situ*. March 3rd.

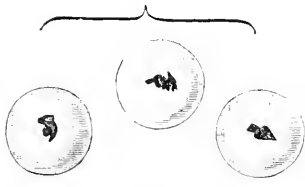

Fig. 46.—Cleavage or segmentation of Eggs (sixth day).



Fig. 47.—Cleavage or segmentation of Egg (eighth day).

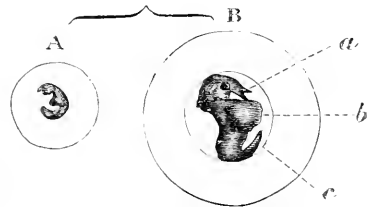

Fig. 48.—Cleavage or segmentation of Eggs (ninth day).

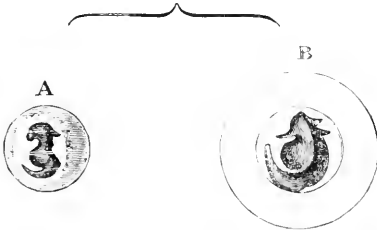

Fig. 49.—Segmentation of Egg (fourteenth day) B, enlarged.



Fig. 50.—Tadpole emerged (sixteenth day); length $\frac{3}{16}$ inch. Right-hand figure magnified 3 times.

Figure 50 represents the appearance of a tadpole after emergence, its length being $\frac{3}{16}$ inch, together with an example magnified about three diameters.

A vigorous circulation passed through the gills (a fig. 51 magnified about eight diameters). On the seventeenth day (March 20th) these had increased in volume and were prettily branched under a one-inch objective, the membranous sides of the tail appeared speckled with pigment cells ; the nostrils *b* were well developed and a rapid ciliary action was apparent at

Cold weather now intervened, and during its continuance tadpole development was arrested. The first important change occurred on April 5th, when the eyes could be distinguished only, however, as bluish filmy specks, far too rudimentary for distinct vision. The weather having become warmer, growth went steadily on ; the external gills became absorbed, and they now breathed by the secondary or internal gills fish-like. The mouth seems adapted to exert a scraping as well as a sucking action upon the animal's

food, being surrounded by a thick serrated lip, within and upon which are several rows of black spines pointing to the triangular mouth also fringed with them. On April 15th, the blue filmy specks had become perfect eyes; from this time until May 10th no great change took place beyond increased size and activity. Their bodies were beautifully speckled with a golden-yellow colour, and the black pigment cells assumed an irregular stellate form.

The membranous sheaths were now projected from each side of the tail near the body, through which the posterior limbs are pushed. These appeared ten days later, and from their extreme transparency,

is suddenly broken through, and the limbs at once become exposed.

In some young toads undergoing metamorphosis at the same time, the action of the fore-limbs could be seen through the translucent skin, moving in unison with those posterior, and ultimately emerging as with the frog.

When furnished with fore-limbs, they endeavour to leave the water and rest upon the aquatic plants on the surface. If compelled to remain in deep water they soon become asphyxiated.

The perfect frog is developed somewhat suddenly at the end of its metamorphosis. The tadpole tail

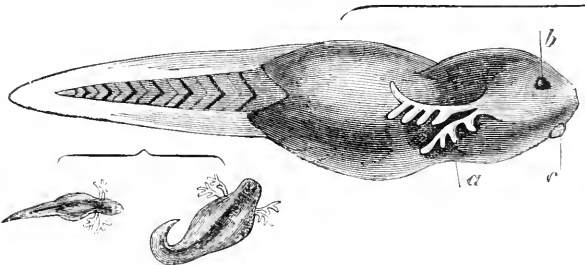

Fig. 51.—Dorsal aspect of Tadpole, nat. size and magnified (seventeenth day). In this figure and 52, *a* shows external gills; *b*, nostril; *c*, rudimentary mouth having rapid ciliary action.

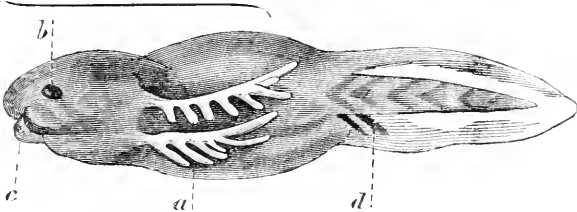

Fig. 52.—Dorsal aspect of Tadpole (twentieth day) magnified; *d*, first appearance of membranous sheath through which the posterior limbs protrude.

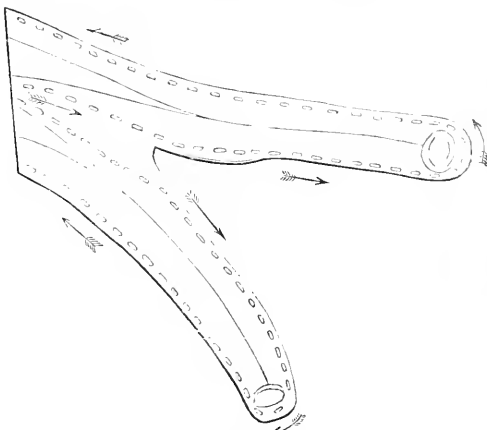

Fig. 53.—Lobe of external gill (magnified) showing circulation of blood (twentieth day).

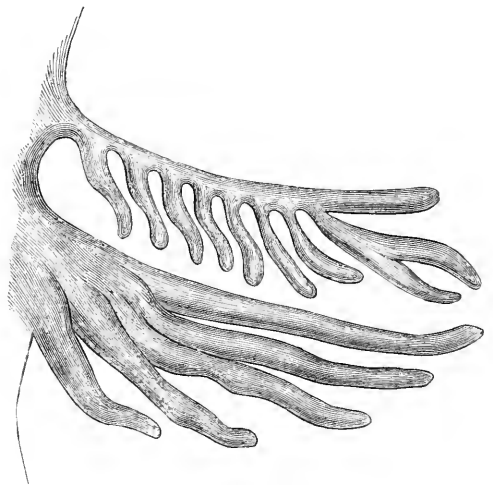

Fig. 54.—External gill (magnified), March 23rd.

together with the tail and margin of the body, exhibited the blood circulation to perfection.

I found that the tadpoles lie quietly enough for examination upon a glass slide when partially covered with wet cotton-wool; this saves the compression and probable destruction of the object.

Tadpole vigour and activity increased with the warmth of June. They frequently breathed from the surface, and now used their limbs in swimming. Those anterior began to bud (the toes had been previously remarked beneath the cuticle), but unlike the posterior limbs are not protruded through a membranous sheath; they elbow their way out beneath the gill openings; the attenuated integument

assumes an extreme length and tenuity, then it as quickly becomes absorbed together with the lips and secondary gills, and finally, the body is shrunk to a frog shape.

Some of my captives completed their wonderful series of life-changes and became lung-breathing batrachians on June 27th, thus occupying one hundred and seventeen days in their development from the deposition of the spawn. A warmer and more equable temperature would, I think, have accelerated the process. Light appears principally necessary as a stimulus to the growth of vegetation and production of Infusoria, upon which they seemed chiefly to subsist. Any animal food put beside them was usually

neglected and had to be removed to avoid fouling the water. During intervals of cold weather the tadpoles lay amongst the aquatic plants in a semi-dormant state, and growth seemed arrested. This was also the case (with their growth) when placed solely amongst filamentous algae, from which it was soon evident they could not obtain sufficient nutriment. The treatment described induced a wonderful degree of transparency in the tadpoles without subjecting them altogether to "water diet," and the details of the circulatory system could, at all times, be well observed.

A GOSSIP ABOUT NEW BOOKS.

"A NEW book by Darwin" is sure to cause a little stir in the scientific world. *The Power of Movement of Plants*, by Charles Darwin, LL.D., assisted by Francis Darwin (London: John Murray), is another of those contributions of experimental scientific research which would have made the name of the author famous, apart from the brilliant theory with which it is popularly connected. The chief movement to which Dr. Darwin more particularly calls attention is that of "circumnutation," in which he shows how highly sensitive to external influences is the growing tip of the roots of plants. The physiologist in general, and the botanist in particular, will study this book with the impression that it is one of the most extraordinary, from the nature of the facts set forth, and the manner in which they are formulated, which has yet appeared from the pen of the author. Dr. Darwin concludes as follows: "It is hardly an exaggeration to say that the tip of the radicle thus endowed, and having the power of directing the movements of the adjoining parts, acts like the brain of one of the lower animals."

Siberia in Europe, by Henry Seebohm, F.L.S. (London: John Murray), is a most entertaining book of ornithological travel and adventure, in which, however, sport so largely predominates over science, that the true naturalist feels somewhat pained in reading the detailed chronicles of bird-slaughter here registered. The author and a friend paid a visit to the lower valley of the Petchora, in North-East Russia, which appears to be quite an ornithological paradise. Many rare birds and their eggs were obtained. Mr. Seebohm is most acceptable when he speaks of the geographical distribution of birds; and his chapter on the hibernation of birds, their migrations, and the possible origin of that habit is profoundly interesting. Not less so, and even more picturesque in its portrayal, is the extraordinary description of the appearance of migrating birds at certain times of the year in Heligoland. The illustrations in this book are exquisite specimens of woodcutting art.

The Natural Conditions of Existence as they affect

Animal Life, by Professor Karl Semper (London: C. Kegan Paul & Co.) is one of the well-known volumes of the "International Scientific Series," and one of the most important and interesting of any yet issued. Whilst accepting in a great measure the doctrine of Natural Selection, the author thinks, with Jaeger, that enough of philosophising has for the present been done by Darwinists, and that the task now before naturalists is to apply the test of exact investigation to the received hypotheses. The biological student will here find a perfect crowd of facts illustrating how animal forms are affected by natural conditions of every kind.

History of North American Pinnipedes, by Joel Asaph Allen (Washington: Government Printing Office). This is another of the miscellaneous volumes issued under the direction of the United States Geological and Geographical Survey of the Territories, and its author is the best man in America to deal with the subject. The book is, in short, a Monograph of the Walruses, Sea-lions, Sea-bears, and Seals of North America. Many zoologists will object to Mr. Allen denominating the well-known walrus family *Odobenidae*, as an unnecessary zoonomial complication. Indeed the new generic names which replace the well-known older ones will at first tend to confuse the student. These, however, are comparatively trivial matters, hardly affecting the full and thoroughly scientific value of the work. Mr. Allen adds his protest, to that of all naturalists who have studied these animals, against the profligate and cruel destruction of seals on the hunting ground. It is high time that civilised nations took joint action in this matter, with a view to arrest it.

Insect Variety: Its Propagation and Distribution, by A. H. Swinton. (London: Cassell, Petter, Galpin, & Co.) This work is by a well-known and frequent contributor to our pages, and in many respects it is a very remarkable book. It gives evidence of an enormous range of reading and study on the part of its author, who is also evidently gifted with a keen appreciation of the beauties of nature. Our readers will find it most comprehensive in its grasp of details affecting insect life in all and every circumstance, and there are not lacking original reflections which agreeably diversify the narrative.

A Polar Reconnaissance, by Captain Markham. (London: C. Kegan Paul & Co.) This is a very lively account of the voyage of the "Isbjörn" to Novaya Zemlya in 1879, and as Captain Markham is the chief observer and director we may be sure that no point of natural interest was ignored. Thus we learn that Novaya Zemlya is composed largely of carboniferous limestone rocks which, in three of the localities visited, were exceedingly rich in fossils exactly like those we find so abundantly in the same formation in Derbyshire and North Wales. The birds, however, appear to have been the chief objects of study, although collections of plants, crustacea,

mollusca, and other marine animals were made, and we find remarks on them in the appendix by the scientific authorities in whose hands they were placed for examination.

Fossil Sponge Spicules from the Upper Chalk, by George Jennings Hinde, F.G.S. (Munich), is a short Monograph on the results of a careful examination of a few ounces of chalk found inside one of the flint *Paramoudras* or "Pot-stones" of Norfolk. It is illustrated by fine plates, each crowded with details of sponge spiculæ, and the work is a good proof to the student of what can be done by careful observation, and how the most unpromising ground may be made to yield both something interesting and something new. This book cannot fail to still further increase the reputation which Mr. Hinde has already gained as a careful and diligent geologist.

A Monograph of the Silurian Fossils of the Girvan District, by Professor H. A. Nicolson and Robert Etheridge, jun., F.G.S. (London and Edinburgh: W. Blackwood & Sons). We are glad to welcome this, the third fasciculus of the work, dealing with the fossil annelida and echinodermata, corals, &c., of the richly fossiliferous Silurian district of Girvan, in Ayrshire. When completed this work will be a most important one to the geologist, for the numerous plates are exquisitely executed.

A Smaller Manual of Modern Geography, Physical and Political, by John Richardson, M.A. (London: John Murray). A capital school manual, carefully prepared, the geography of all that relates to the British Empire being treated with the especial fulness and clearness which the subject demands.

Natural Philosophy, by Ganot, translated and edited by Professor E. Atkinson, F.C.S. (London: Longmans & Co.). We have received a fourth edition of the above excellent work for students, which, as many of our readers may be aware, is an adaptation and abridgment of Ganot's *Éléments de Physique* in a more elementary and popular form. About twenty-five pages of new matter and sixteen additional illustrations will be found in this, the latest addition.

A Simple Treatise on Heat, by W. Matthieu Williams, F.R.A.S., &c. (London: Chatto & Windus). We confidently recommend this well got up little book as the best elementary modern treatise on the science of heat we have yet seen. No previous knowledge of a very complex science is required to master the general details and laws. It is just the very book for science classes.

Steam, and the Steam Engine, by Henry Evers, LL.D. (London, Glasgow, and Edinburgh: W. Collins). This work is a new and revised edition of one of "Collins's Advanced Science Series;" and as we see by the title-page it is numbered "twenty-sixth thousand," we must accept it as a successful and much required book. It deals with all kinds of steam engines, land, marine, and locomotive, and this new

edition has been thoroughly revised and brought up to date, and a new chapter added on "Compound Engines."

Organic Chemistry, by Dr. W. B. Kemshead (London, &c.: W. Collins), is one of the new and revised editions of "Collins's Elementary Science Series," capitably adapted for the use of students preparing for the South Kensington and other elementary examinations.

Conscious Matter, by W. Stewart Duncan (London: David Bogue), is intended to repel certain objections against the progress of modern psychology. The author regards Nature as a living whole, conscious as well as active. It is a very thoughtful, well-written little book, well worthy of careful study.

Unconscious Memory, by Samuel Butler, author of "Erewhon," &c. (London: David Bogue). We are sorry, for the sake of Mr. Butler's reputation, that he has written this book, and still more so that he thinks it necessary to suspect Dr. Darwin of having treated him unfairly. On reading it we are only still further confirmed in the impression received from the perusal of Mr. Butler's previous book—that he has not had the requisite scientific training to enable him to get the necessary mental grasp of modern biological theories. Whatever Mr. Butler writes is sure to be well and attractively written, and this book is no exception to the rule.

Peruvian Bark, by Clements R. Markham, C.B. (London: John Murray). We have here a popular account of the introduction of chinchona cultivation in British India, 1860 to 1880. The title-page, however, gives no idea of the lively narrative of the travels and adventures of Mr. Markham and his assistants, which this book records. It was a brave, patriotic, and humane work, and Mr. Markham very modestly but very feelingly and interestingly relates the story of the successful plantation of chinchona trees in India. Some of the chapters give picturesque zoological, botanical, and physical descriptions of the regions of the Andes. This is emphatically a good and highly readable book.

The Guests of Flowers, by C. E. Meetkerke. (London: Griffith & Farran). This charmingly got up brochure is intended as a botanical sketch for children, very clearly and ably setting forth the relations between insects and flowers. It will form an admirable gift-book for young folks.

Plant-Life (London: Marshall Japp & Co.) is an unpretending book whose contents cover a very great extent of botanical ground, particularly those parts which are new and interesting. Thus we have chapters on microscopic plants, fertilisation, predatory plants, remarkable flowers and leaves, folk-lore, mosses, &c., all abundantly and well illustrated, proving the author to be a man of thorough botanical culture, and possessing much grace of literary style. A few errors require correction, such as figuring a fuschia with *ten* stamens.

Practical Botany for Elementary Students, by D. Houston (London: W. Stewart & Co.), is a small but compendious elementary work, which, with the aid of actual dissection of a few common flowers, cannot fail to enable beginners to get a real knowledge of botany. It is an excellent "beginners' book," and as such we cordially recommend it.

Easy Lessons in Botany (London: Marshall Japp & Co.) is a sixpenny primer, by the author of "Plant-Life" above noticed. It is numerously illustrated, clearly written, with a good deal of matter packed with much dexterity into a small space.

LIST OF ASSISTING NATURALISTS.

[Continued.]

HAMPSHIRE.

Bournemouth. Thos. J. Lane. *Mammalia, Aves, Reptilia, and Amphibia* (British).

YORKSHIRE.

York. Rev. W. C. Hey, 24 Portland Street (Curator of Conchological Department of York Museum). *Conchology; British Coleoptera*.

MICROSCOPY.

MOUNTING WITHOUT PRESSURE.—Can any of your readers give me particulars of the process employed in preparing heads of insects, &c., without pressure, as transparencies in balsam?—*R. J. C.*

LIVERPOOL MICROSCOPICAL SOCIETY.—The annual meeting of this society was held on January 21st, Dr. Hicks, the retiring president, in the chair. Dr. Carter, the president-elect, delivered his inaugural address. In some preliminary remarks he criticised unfavourably the presumed universal diffusion of a single substance of uniform composition which serves as the physical basis of life. What at most could be meant, unless evidence was to be disregarded, was "protoplasm" (plural)—*i.e.*, the substance special to each kind of organism on the presence of which its vital manifestations might depend, and not a single protoplasm of undeviating composition, which lay at the root of all vital manifestations whatever. He drew attention then to the influence exerted by a number of agents on vegetable cell development, and more especially of light and darkness, pointing out simple apparatus by which the action of rays of light of different refrangibilities could be studied; of oxygen, carbonic acid, iodine, and ether. He gave illustrations in growing seedlings of the retarding effect exercised on vegetable cell development of even very minute quantities of alcohol, one part in 400 often preventing development altogether, while a

markedly retarding effect was produced by even one part in 3200. He also drew attention to the strong inherent vitality of the vegetable embryo of even the more highly organised plants by the power which it possessed of surviving even severe mutilation, illustrating the fact by a number of actively-growing seedlings reared from seeds which had been cut into various pieces and otherwise injured. A very interesting fact, which seemed to be established, was that light, either alone or in conjunction with moderate warmth, was not sufficient to develop chlorophyll in etiolated plants. Specimens of seedlings in illustration of this proposition, which is contrary to the generally conceived opinion, were exhibited.

"THE NORTHERN MICROSCOPIST."—We are glad to welcome a new sixpenny monthly venture, which has just appeared under the above heading. Its headquarters are at Manchester, but it bears the name of David Bogue as its London publisher. The aim of this well-edited journal is "to keep a record of the proceedings of the chief microscopical societies in the north." We believe such a magazine is wanted, and that it will be the means of stimulating new societies into existence among the active and densely populated districts of the North of England.

FLUID MOUNTING.—As the remarks of H. M. with regard to my article on Fluid Mounting may lead many to suppose that such work entails great risk and want of success, I wish to say a few words more on the subject. I can still say that in no case have I yet had a slide burst, although the presence of minute globules of marine glue showed that it could not be depended upon for permanence; this led me to make further experiments, and I am now using a cement which hardens in spite of everything (it must be made as required), but the composition of which I prefer to keep till I have still further tested it. I have submitted slides mounted in this way to a far greater range of temperature than we ever experience in the British Islands naturally, and the test was admirably stood although of long duration. I also find that there will be not only a greater safety, but also other advantages by preparing the objects in the fluid already described, but mounting them in distilled water four parts, abs. alcohol one part and glycerine one part.—*Edward Lovett, Holly Mount, Croydon.*

FORMULA WANTED.—Will any reader give me some information as to the use of two preparations mentioned in the "Micrographic Dictionary" as suitable solvents for vegetable structures in microscopic mounting, *viz.* (1) copper turnings, dissolved in solution of ammonia; (2) chromic acid, with addition of sulphuric acid. I want to know the proper formula in each case, and for what kinds of tissues the two preparations are respectively fitted. I have looked in many books, but cannot find the precise information I require.—*C. E. C.*

FINISHING MICRO SLIDES, &c.—Apropos of the many letters on this subject, I should like to ask if any of your numerous readers have had any experience with “gold size” as an anti-running in cement? I myself have been in the habit of doing my own mounting for the last thirteen years, and have had a little experience, and lately have found that a light ring of gold size run round on the top of the ring of zinc white (of course the zinc white must be fully set) and allowed to get tacky, and cover glass, carefully put on, will be found to answer well.—*E. H. Wagstaff, Birmingham.*

ZOOLOGY.

GREAT GREY SHRIKE (*Lanius excubitor*) in North Lancashire.—A fine specimen of this bird was shot by Mr. Miles Berry, of Fishwick, early in the month of November last. It had been noticed as frequenting certain fields for some days before being shot, associating with the flocks of starlings and fieldfares. This species is a very rare visitor with us, and this is the first instance of its capture that has come under my notice. This specimen is to be added to the collection of Mrs. Knowles. Mr. Gillett, a well-known Preston taxidermist, who has stuffed the bird, tells me he has only known it to occur once during his long experience, and that is thirty years ago.—*R. Standen, Goosnargh, Preston, Lancs.*

MR. ALFRED RUSSELL WALLACE.—Naturalists throughout Great Britain will be delighted to hear that her Majesty has granted a pension of £200 per annum to this distinguished naturalist and fascinating writer.

NORTH STAFFORDSHIRE NATURALISTS' FIELD CLUB.—At a recent meeting of this well-known society, papers were read as follows: by Dr. M'Aldowie on “The Natural Sciences in Relation to Beauty and Sublimity,” and by Mr. F. M. Sexton, F.C.S., on “The Food of Plants.”

BURNET MOTH (*Anthropera minus*).—Your correspondent, Mr. W. Locock, speaks of this species being transparent, and of its being captured by a friend of his near the ruins of Tintagel Castle. Allow me to observe that the species *A. minus* is not transparent when in good condition, and that Stainton's giving no English locality is tolerable evidence that it does not occur in England, its only known locality in the British Isles being the West of Ireland, and the probability is, that the moth your correspondent has seen is not *minus* at all. I shall be very much obliged if he will send me a specimen of the insect captured, and I will endeavour to determine the species, and return it with an example of the Irish insect.—*Edwin Birchall, Douglas, Isle of Man.*

GNATS WITH TWO KINDS OF WIVES.—In “Nature,” we find an abstract of a paper by Fritz Müller on a gnat called *Pallstoma torrentium*, found at Hajah, under stones, &c., in streams. The male is described, and then the females, of which there are two kinds, one a honey-sucker and frequenter of flowers, and the other a blood-sucker. The two females are quite unlike each other.

INSPECTORSHIP OF FISHERIES.—This post, worth £700 a year, vacant by the death of Mr. Frank Buckland, has been offered to, and accepted by, Professor Huxley. Professor Huxley was engaged on the Fisheries Commission several years ago.

EARED SEALS OR SEA-LIONS IN THE BRIGHTON AQUARIUM.—In reference to Mr. C. L. Jackson's remarks in February number on the pair of sea-lions in the Brighton Aquarium, I may observe that the recent death of the male under circumstances recorded by me in “Nature,” January 13, will afford naturalists the requisite opportunity of absolutely determining by means of the skull and dentition the vexed question of the exact species to which this fine specimen belonged. As stated by Mr. Jackson, it had been referred first to *Otaria Stellaris* and subsequently by Professor Flower to *O. Gillespiei*. Furthermore, the question has been mooted whether the female was of the same species as her mate on account of the extreme difference in appearance between them. Jack measured 8 feet 5 inches in length, had a maximum girth of 5 feet 3 inches, and was probably eleven or twelve years old at the time of his sudden death after six years' existence in the Aquarium. He was the parent of the first cub born in captivity in Europe—young “Prince”—who is still an inmate of the institution. Ament the article “Bird Studies in Chalk,” in the same number, I shall be glad if you will allow me to take this opportunity to correct an obvious clerical error therein, and substitute £1000 instead of £800 as the approximate equivalent in value of 20,000 mark.—*Agnus Crane, Brighton.*

BOTANY.

BOTANICAL GARDENS.—Under the title of “What to Observe in the Conservatories of the Sheffield Botanical Gardens,” Mr. Bernard Hobson, of Tapton Elms, Sheffield, has published a well-written botanical and general description of such exotic plants as are usually to be found in botanical gardens and green-houses. With characteristic generosity, Mr. Hobson has offered to send a copy to any reader of SCIENCE-GOSSIP who will forward an addressed halfpenny newspaper wrapper to him for it. A copious vocabulary and glossary of plant-name derivations accompanies the text.

FLEA-BANES.—In addition to the flea-banes mentioned by Mr. Hooper in the current number of SCIENCE-GOSSIP is to be added, *Pyrethrum carneum*: regarding which the following appears in my "Domestic Botany" (p. 348, published 1871), "Flea Powder. *Pyrethrum carneum*, *P. roseum* and *P. purpureum*. Natives of Caucasus. They are perennial plants with much divided leaves, and probably forming only one species, varying in the colour of their flowers, as indicated by their names. A preparation was at one time made from the leaves, and extensively used throughout Russia for the destruction or rather driving away of fleas and other vermin of like nature. About forty years ago it became very popular, and still continues to be used in Germany." Another flea-bane noticed in the same work is *Sarchonanthus camphoratus*. It is a large shrub, often assuming the appearance of a small tree, 10-15 feet high. Native of South Africa. Its leaves smell like camphor, and it is considered highly efficacious in driving away fleas, hence its name "African flea-bane."—*J. Smith, Kete.*

JERSEY FERN.—The fern from Jersey mentioned by W. G. Woolcombe in your November number, is, no doubt, *Blechnum spicant* v. *anomatum*. It grows in several parts of the United Kingdom. I have found it in the following places: Lake District, Great Langdale, Scotland, the South of Arran, Glen Lochy, and near Ben Lawers; but it is in North Wales that I have found it the most common, round about Snowdon, especially near Beddgelert, also near Festiniog, and Dolgelly. I have purposely omitted giving exact localities, for reasons which will be obvious to most botanists.—*J. Morley.*

PRESERVATION OF FLOWERS.—I find it stated that flowers soaked for a quarter of an hour in a solution of equal parts of water and spirits of wine retain their colour and appearance of freshness for a considerable time. Is this really a fact, and would it be possible to furnish an herbarium with flowers so treated?—*P. H. Habben, B.A.*

PRIMULA SCOTICA.—In several numbers of SCIENCE-GOSSIP I have observed a discussion in reference to this plant. Although closely related botanically, *Primula Scotica* is very distinct in external appearance, when growing, from *Primula farinosa*. Having a friend who resides near Dunett Head, I frequently have received considerable numbers of plants of *P. Scotica*, in turfs cut and sent per ship to Berwick, each turf containing a dozen of plants. Drifted sea-sand seems to be the staple of the soil these turfs are composed of. I expect I am the individual referred to as having endeavoured to introduce it on the Berwickshire coast. I have never tried to do so, but grow the plant, which is a great favourite, as an alpine, and have always a considerable stock. I have also raised it from seed—which is very minute

—and tried, as yet ineffectually, to get a cross between *Scotica* and *P. cortusoides*. The Siberian species, which in some degree resembles *P. Scotica*, in the colour of the flower, &c. (*Primula farinosa*), grows in Scotland in only one locality, as far as I know. Boggy ground, above Woodhouselee, West Lanton, Edinburgh. Teesdale in Yorkshire is its great habitat, where it covers acres, High Force viâ Castle Barnard. When grown as an alpine in peat, it attains a size four times as large as *P. Scotica*, and is a great gem. I have it with white flowers, from near Darlington; also with deep magenta flowers, from Mr. Backhouse, of York (*Primula farinosa superba*). It is common in Switzerland, with white flowers. Perhaps some of your readers may have observed that in Smiles' interesting biography of Dick, the Thurso naturalist, *Primula Scotica*, the representative plant of Caithness-shire, is never once mentioned—surely a grave omission.—*Charles Stuart, M.D., Member of the Scottish Alpine Botanical Club.*

HELIOPTROPISM.—After reading J. P. K.'s observations on the mistake in Professor Ramsay McNab's Class Book, I referred to my copy, and found that I had, two years ago, underlined the passage quoted, which is certainly a mistake.—*Wm. West, Bradford.*

GEOLOGY.

"THE ARCHÆAN GEOLOGY OF ANGLESEY."—A paper on this subject has just been read before the Geological Society by Dr. C. Callaway, F.G.S. The author discussed the stratigraphy and lithological characters of the rocks in the following areas:—The border of the Menai Strait, the Llangefni region, and the central zone, at out Bodafon, Llangwyllog, Llanerchymedd and Paris Mountain, which, he considers, establish the following conclusions:—(1) that in Anglesey there are two Archæan groups, the slaty and the gneissic; (2) the slaty is composed of slates, shales, limestones, grits, conglomerates and chloritic schists in which at present a definite order has not been ascertained. The gneissic group is composed of the following, in descending order—granitoidite, chloritic and hornblende schists, grey gneiss, quartz-schist, and hällflinta; (3) the slaty series is occasionally foliated, but is usually in a partially altered state; the gneissic group is thoroughly metamorphosed; (4) the slaty series has closer lithological affinities with the St. David's volcanic group, the Charnwood rocks and the Lilleshall series than with the Bangor group; (5) the slaty series is undoubtedly Pebedian, the gneissic series may, with some probability, be referred to the Dinetician. The microscopic structure of the principal varieties of the rocks mentioned in the above paper was described by Professor Bonney. In the discussion which followed, Dr. Hicks agreed with Dr.

Callaway that there are two Pre-Cambrian series in Anglesey. He differed from the author, however, in regarding the so-called granitoidite as constituting the lowest and not the highest member of the series of Pre-Cambrian rocks. He stated that some of the breccias associated with the *hällflintas* contain pebbles of the granitoid rocks, and are therefore of younger age than the latter. He admitted, however, that some of the points must be regarded as in an unsettled state, owing to the faulted condition of the district. Professor Ramsay argued against the principle of identifying rocks as of different ages by their mineral characters as studied by the microscope. He argued that the altered rocks of Anglesey are the metamorphosed representatives of the Cambrian, because the unaltered Cambrian are found striking directly towards the altered strata, and both are overlain by the Arenig.

THE PHYSICAL HISTORY OF THE CRETACEOUS FLINTS.—I have to-day seen Mr. H. P. Malet's observations on the above subject in this month's SCIENCE-GOSSIP, and thank him for stating his objection to my hypothesis in so concise and courteous a manner; as I am inclined to believe the difference between us to which he alludes, is, after all, rather imaginary than real. I am now engaged in the completion of a second paper on the Flints, which will appear in the February number of "The Annals and Mag. Nat. Hist." As this will supply a good deal of additional information on all the material points of my hypothesis, I trust you will agree with me in thinking it better that I should not enter on the question here.—*G. C. Walllich.*

"A DAY'S ELEPHANT HUNTING IN ESSEX."—Under this title a capital paper appears in the first part of the Transactions of the Epping Forest and County of Essex Naturalist's Field Club, from the able pen of Mr. Henry Walker, F.G.S. No more attractive descriptions of the Thames Valley gravels and their elephantine fossils could be desired.

YORK MUSEUM.—The fine collection of 12,000 specimens of fossils made by the late Mr. E. Wood, F.G.S., of Richmond, Yorkshire, chiefly from the Carboniferous Limestone formation of the neighbourhood, has been purchased by Mr. W. Reed of York, and by him presented to the well-known museum of that city. Mr. Reed had previously presented to the York Museum his fine collection of red crag fossils, second in value only to those in the Ipswich Museum.

SIBERIAN RHINOCEROS.—"Nature" states that the body of a colossal rhinoceros has been discovered in the Werchojanski district, imbedded in the bank of a small river. A good deal of the body was subsequently washed away, but the skull was sent to St. Petersburg. It is said to belong to a species intermediate between the *Rhinoceros lichorhinus* and the living rhinoceros.

THE OLD RED SANDSTONE AND THE CARBONIFEROUS FORMATION.—In a paper published in the Quarterly Journal of the Geological Society, Mr. J. Nolan, M.R.I.A., of H.M. Geological Survey of Ireland, states that from evidence adduced, more especially with regard to the old red of the North of Ireland, in his opinion the old red sandstone should be considered rather as the base of the carboniferous system, than a distinct formation.

PROCEEDINGS OF THE GEOLOGIST'S ASSOCIATION.—Nos. 8 and 9, vol. vi., of the Proceedings of the above Association are to hand, containing (in addition to the accounts of the various excursions), papers on "The Fish Fauna of the Yorkshire Coal Field," by James H. Davis, F.G.S.; "The Geology of the Bristol District," by Professor W. J. Sollas, F.G.S.; "The Geological and Other Causes that affect the Distribution of the British Flora," by G. S. Boulger, F.L.S., F.G.S.; "The Classification of Rocks," by the Rev. J. F. Blake, F.G.S.; "A Petrological Classification of Rocks," by Professor E. Renevier, F.C.G.S.; and "The Geology and Physical Features of the Bagshot District," by the President, Professor T. Rupert Jones, F.R.S.

THE GREAT SNOW-STORM OF JANUARY 18TH., 1881, AND ITS GEOLOGICAL LESSONS.—The recent severe weather has not been without its practical lessons in more ways than one, and many of its results must have attracted the notice of geologists to the manner in which the "glacial period" acted upon the land in leaving those evidences of its existence which are so frequent in the northern part of these islands. In one chalk-pit in this locality, I was noticing one day when the temperature had risen several degrees above freezing-point, that there was not an interval of a minute between the falling of fragments, riven from their bed by frost, some of them large and heavy, from the sides of the pit. These fragments fell for the most part upon a large drift that had collected in the shelter formed by this ridge, and which had become hard and compact from the small grains of the snow which composed it, and the slight rise and fall of the succeeding temperature. This model glacier did not apparently slide, as it was not of sufficient weight, but at its lower end there were small caverns, into which a cat might have entered, and from these there flowed small streams of water, rolling in their course minute fragments of chalk and débris washed out of the slope over which they ran. These little blocks were deposited in model "moraines" at the point where the force of the streamlet was insufficient to carry them further, in fact the lower end of this melting snowdrift scattered over with pieces of chalk from the overshadowing ridge was a perfect model of an existing glacier, and was thus of great interest in, to a certain extent, illustrating the action of these powerful engines of erosion and transportation. Another remarkable phenomenon was the formation

of "ripple marks" on the surface of partially sheltered snow; during the height of the storm; owing to the fineness of the flakes they were driven so rapidly up the windward side of the declivity and so filled up the hollows on the leeward side equally rapidly, thus causing the whole surface of "ripple marks" to move onward in a most remarkable degree joining and disconnecting, and changing their whole direction upon each temporary shift of the gale.—*E. Lovett, Holly Mount, Croydon.*

NOTES AND QUERIES.

TRAP-DOOR SPIDERS.—I have been watching with great interest for some little time past, both here and at Mentone, the ways and habits of these ingenious little creatures. A few days ago I found a peculiarity in the nest of a *Nemesia Eleanora*, quite new to me, and, as far as I am aware, never yet noticed by any one. I was digging out a very large wafer-door nest, which proved to be that of a *Nemesia Eleanora*; as I soon came upon the second door without a branch, about an inch and a half or two inches below the second door, I found a very small cavity or groove (about an inch long) in the wall of the tube, separated partly from it by a silken filament, and completely filled with the husks of small red ants. At the bottom of the nest I found the spider, a very large one. There were no remains of ants at the bottom of the nest, such as one often finds. I cannot learn that such a storehouse or larder has ever been observed in the nest of this spider, and therefore feel it a duty to make the fact known. Hoping that some of the readers of your journal, better informed than myself on the subject, will be able to enlighten me on the point in question.—*M. L. Faulder White, San Remo.*

MR. H. B. SHARPE ON CUCKOOS.—This well-known ornithologist, in a lecture recently delivered before the Birmingham Midland Institute, said: The ground cuckoos, unlike the tree cuckoos, built their nests, but they were not very far advanced in the art of nest-building. As they reared their own young, and did not foist their eggs upon other birds they would, if the audience liked, call them the "respectable cuckoos." If one were asked to name the principal characteristic of the common cuckoo, a reply would no doubt be given, "It does not make its own nest, but lays its eggs in other birds' nests." Why did it do that? Many theories had been started upon that point. He believed the reason why the female cuckoo never built a nest of her own was because she never had the time to make one. The cuckoo was what they called a polyandrous bird. She had a good many husbands. The proportion of males to female cuckoos had been represented as twenty-five of the former to every one of the latter. From his own experience he was led to think that that was an exaggeration, but he believed there were at least five males to every one female cuckoo that visited this country. They would therefore see there were four unfortunate male cuckoos who could not find a wife, and the consequence was the female bird was continually chased by every one of the males, requesting her to marry them, and build a nest. In America there were not so many male birds in excess of the females, and the result was the cuckoos in that country built their own nests. There was a time when they did not know how to build

them. The American cuckoos did not lay their eggs and hatch them all at once, like some English birds did, but would lay them at intervals, leaving the young birds first hatched to hatch the remainder. It was somewhat curious that after June or July the cuckoos were seldom heard in our own country. Their stay here was exceedingly short, with the exception of the young birds which were hatched in England. Those remained a little longer. The idea that the cuckoo sucked the eggs of other birds was all rubbish. When they considered that ninety-two different kinds of birds were known to be selected by the cuckoo as suitable foster-parents for their young, they could well imagine the great many kinds of nests for the bird to choose. They could accept as a fact beyond dispute that the hen bird laid her egg upon the ground, and then picked it up and carried it to the nest of the foster-parent.

PHOSPHORESCENT CENTIPEDES.—On the night of December 8th, I captured a phosphorescent centipede, which I take to be *Geophilus subterraneus*, described in "Nature," No. 579, p. 99, where the correspondent says that a couple of these animals produced an effect "like moonlight through the trees," and that he was enabled to read a letter by the illumination. The illuminating power of my specimen was about equal to the effect produced on the roughened side of a fusee box on which a fusee has been struck in the dark. I secured the animal by the light of a lantern, and he shone in my hand quite as brilliantly as he did before he was disturbed. I put him in a small glass tube, and watched him in the dark for some time. The light extended nearly three-quarters of an inch, or about half his length from his head backwards, and seemed to shine in two lines parallel to the animal, but not quite close to it. Wishing to preserve it, I filled up the tube with spirit, which caused the animal to shrink somewhat, and turn a darker brown. When alive, the animal was a very light colour for a centipede, and a good deal narrower in proportion to its length. It may not be so uncommon as might be supposed, escaping the general notice, both from its subterranean habits, and when met with in the daylight, bearing a pretty close resemblance to its non-luminous brethren.—*L. Adams, Maidenhead.*

LIGHTNING.—Being very much interested in things electrical, I waited with an enthusiastic impatience for the replies to C. B.'s query with reference to sheet lightning. Turning to all the books I could lay my hands upon the subject, I could find nothing very satisfactory. As stated by Mr. Woolcombe, Ganot says that sheet lightning is supposed to be produced in the cloud itself illuminating the whole mass. In an article on Lightning in the latest edition of the National Encyclopædia, I read that when the electric discharge permeates generally the surrounding masses of weakly electrized vapour, the appearance then is that of a sudden and wide illumination, as in summer, or sheet lightning. Then we have that other theory mentioned by E. Parfitt, of the flash not having acted strongly enough upon our retinas to produce a visible image of the fork. As these theories are very conflicting, I shall be glad if any of the readers of SCIENCE-GOSSIP can throw more light on the subject, and also explain the cause of globe lightning. Guthrie says such meteors, or "fireballs," which may properly be called thunderbolts, appear to avoid contact with the earth. Ganot says they often rebound on reaching the ground; at other times they burst and explode with a noise like that of the report of a many cannon. Some four-

teen years ago, in the month of February, I think it was, there passed over my native village (Fyvie) at 7 A.M., a terrible thunderstorm. The lightning was in the form of balls of fire. These struck the parish church, and overthrew the steeple, entered the church by the clock wire from the bell, ran along the ceiling, throwing down most of the plaster, and finally escaped by completely shattering the two front windows below the steeple. A gentleman of my acquaintance was an eye-witness of the destruction, and said the balls struck the steeple. There was very little thunder, with the exception of one tremendous peal not to be compared with any that I have heard since. Would this have been the bursting of any of the balls already referred to?—*A Reader.*

SHEET LIGHTNING.—Several of your correspondents have given their explanations of "sheet lightning." As none of them seem to be satisfactory to me, I will try my explanation, for others to judge what it is worth. Imprimis, I suggest that there is no such thing as sheet lightning as different from spark lightning. What we see is merely a lighting up of visible clouds by a spark, so far distant from the observer that the spark is from the curvature of the earth invisible to him; and so distant that sound is inaudible. Such illumination of the visible clouds may happen from discharge fifty or sixty miles distant, depending on the elevation and distance of the illuminated cloud or sky, and of the illuminating spark. When next your correspondents note this effect, if they will make due inquiry, I predict that they will learn there was spark lightning at the moment in the proper direction.—*Charles Stodder.*

BREEDING JAVA SPARROWS.—Java sparrows are not at all difficult to breed in this country, if a pair can be secured, but as the sexes exactly resemble each other, this is difficult. I had two that I kept in an ordinary canary breeding-cage, and they made themselves a nest of the stalks of groundsel which I gave them to eat, and laid a number of eggs, on which both sat assiduously. No young ones resulted, and I afterwards ascertained that they were both females. I tried a number, but did not then succeed in getting a cock bird. After a while, however, I obtained one, and thinking they would be more likely to succeed in a large aviary, turned them into one, where they built a nest of hay, lined with feathers, in a hollow log, and laid, but were disturbed by mice, and I had no young ones from them. I then gave over keeping them, as they are not interesting birds, and are so cheap they are not worth the trouble of breeding. The eggs, which are usually five in number, are about the same size as those of a canary, and pure white. A friend of mine who has bred them without difficulty, tells me that they must be supplied with boiled rice, ants' eggs, and chopped fowls' eggs, when they have young ones, in addition to their ordinary fare. They begin to lay in January, if kept warm, but about April if in a cold room. They have the advantage of being very hardy.—*W. T. Greene, M.D., Peckham Rye.*

CLIMBING POWERS OF THE TOAD.—Some years ago, I and a friend went to visit a friend, Mr. Nathan Cronshaw; he had just finished potting his auriculas the day before. I noticed one which had the soil disturbed, and the plant up and almost out of the pot. I called his attention to it, and on his looking for the cause, behold! there was buried in the soil a very fine toad; he pulled him out, saying the plant was too valuable for a toad's lodgings. He trimmed up the plant again, and in about half an hour, going

by the same place, the toad had got in the same pot again, displacing both soil and plant just as before; he pulled out the toad and put him over a high fence at the bottom of the garden, thinking he had done with him. However, the next day Mr. Toad was in the same pot again; he pulled him out again and sent him a field or two off, but he never came again. Here is an instance of the climbing powers of the toad, and also selecting the same pot and plant three times in succession. The pot was six inches high, and worse to get up than a cylinder would have been, being an inverted frustum of a cone.—*William Bentley.*

HAWTHORN, ORCHIS, &C.—Like many of your correspondents, I too can testify to the great scantiness of hawthorn blossom last year. I live in an agricultural district where all the hedges are made of hawthorn, of which there are scores of miles, and during all my walks I only saw four thorns with bloom on them. Moreover, I had fifteen scarlet thorns in my garden, but I had not one bunch of bloom on them all together. Some ten or twelve years ago I remember the same thing happening, but that year I only saw one in bloom. But apples and pears have been just the same with us; we have had very few blooming this year, a large number not having a single bunch on, and some of them which cover a house end of ten or twelve yards in breadth. Now it is very easy to find the cause of this: it was the very dark, cold and wet season of 1879, as it was in the autumn of this year 1880, that the bloom buds were made or ought to have been, and all plants which make the bloom bud the autumn preceding the spring in which they bloom have been subject to the same climatic influence. Rhododendrons have been the same. Orchis, tulips, &c. are no exceptions to the same influences, but differently affected, as tulips have bloomed very well this year generally, but the Orchis class are known to bloom in fits; you go one year and cannot find one, and the year after they will be abundant. I have a few more notes for you which I will forward you when I have leisure.—*William Bentley.*

ENGLISH CORMORANTS.—The query of J. K. in the October number (p. 237) relative to the English species of cormorant is suggestive of many thoughts and speculations. Waterton expressly affirms in his Essay that "the crested cormorant, with a white spot on each thigh, is merely the common cormorant in his nuptial dress." There is no doubt that the crested cormorant of Bewick's "History of British Birds" is in reality the black species in spring apparel; and if this be the bird to which the excellent old squire alludes, no doubt his view is correct. There is no doubt also that the vast majority of ornithologists recognize two different species of British cormorants. It must be admitted, however, that the structural and other difference between them is comparatively insignificant. There exists some slight difference in the number of the tail feathers, in the shape of the back and wing feathers, in the presence of a whitish band on the throat and thighs, and in the total length and breadth of the body. Are these diversities sufficient to constitute a specific distinction, or a variety merely? The genus is a very widely distributed one, and therefore subject to great variation, arising (shall we say?) from the diverse physical conditions which its species encounter in different parts of the world. But there are other differences between the black cormorant and the shag which seem to indicate a fundamental feature. The latter resides and breeds chiefly in caverns and fissures of the rocks, it is not easily tamed, and does not commonly visit fresh-water or ascend far up

channels or estuaries. The former bird, on the other hand, rests mainly on headlands and rugged insular crags, is more easily tamed, and advances far up harbours and bays. These circumstances tend to prove that the crested is much more shy and timorous than the black species. How can these mental differences be explained; and are they in any manner connected with the aforesaid physical or structural differences? Consider, too, that the black cormorant was formerly sometimes tamed in England to be employed in catching fish, as it still is in China; and it thus having become useful to man, varieties (some naturalists say) will almost certainly be found recorded. However, upon reviewing all considerations, reflecting more especially that only two genera of the great family of the Pelacaniidae occur in England, and that the British coasts do not exhibit extreme diversities of feature, it will be gathered that considerable difficulty stands in the way of regarding the green as a mere variety of the black cormorant, and not a distinct species. If the shag be regarded as an incipient but not yet fully-formed species, who can furnish the reason of its departure and divergence from the originally created parent type? But viewing the matter in a practical light, it is barely necessary to observe, that the term "species" is most difficult to define. In the main, however, and substantially, naturalists regard species as a constant succession of individuals similar to and capable of reproducing each other; and it is by the light of this definition that original discoverers are principally guided (however dimly and unconsciously) when constituting or naming a new group of animals. Hence, the main practical difficulty to solve respecting the subject under review is, can the black cormorant reproduce the crested cormorant, or *vice versa*? No doubt both species nestle in the same localities in caverns and on precipices; but until it be unquestionably proved that an egg laid by a black cormorant has hatched and ushered in a crested cormorant, or *vice versa* (as the case may be), we must, at least until some more precise definition of the term "species" be established, steadfastly refuse to chime in with the narrow theory of old Waterton, most excellent naturalist and most capital writer although he was.—*P. Quin Keegan.*

WHITETHROAT IN DECEMBER.—I saw a specimen of this bird on the 15th of December, and had a good opportunity of noticing it as I was within three or four yards of the bird. Is it not very unusual for the whitethroat to remain so long with us?—*William Bennett, Clehonger School, near Hereford.*

CARDAMINE PRATENSIS.—Your correspondent J. F. Hopkins calls attention in the January part of SCIENCE-GOSSIP to the curious method of propagation observed in this plant. I have never seen any reference to this peculiarity in books, though it is of quite common occurrence. I have noticed quantities of this plant on Wimbledon Common exhibiting this mode of increase. If the ground be damp, pegging down is unnecessary, and specimens may be seen surrounded by quite a large family of young plants, all connected with the radicle leaves of the old plant. If a leaf, or portion of a leaf, be broken off and thrown into water it will soon develop roots and buds and become a complete plant. In fact asexual propagation is almost as easily effected in this species as in Anacharis.—*E. Step.*

WHITE GERANIUM.—A white *Geranium robertianum* grew last autumn close to Selborne in Hampshire. Bentham mentions it as occasionally found, but Sowerby and Hooker do not refer to it.—*Benjamin Lomax.*

WHITE GERANIUM.—The white variety of *Geranium robertianum* occurs in a copse in this parish (Weald of Kent, near Tunbridge Wells), where I have picked it in two or more seasons.—*M. E. Pope, Paddock Wood, Kent.*

QUERY AS TO CANDLES.—The solution of the query as to Candles in SCIENCE-GOSSIP of January is very simple. If the flame is blown down the wick, although the flame is extinguished, a larger portion of the wick becomes ignited, and will take longer to go out, which gives time for the candle to cool, and the wick naturally becomes dryer, and the drier it gets the more it will smoulder, and *vice versa*, when the flame is blown from the candle.—*C. Kingsford.*

STARLINGS AND SKYLARKS.—In reply to Meyler Daniel I beg to say that I have resided in Argyshire for upwards of fifteen years, and have annually observed with deep regret the decrease in the numbers of the skylark. Last year (1880) I discovered three skylarks' nests, each containing five eggs. I visited them every other day, and one day was surprised to find a cuckoo's egg in two of the nests. Shortly after there appeared two young cuckoos in the nest alone, the skylarks' eggs having disappeared—whether the skylarks themselves destroyed the eggs to make room for the cuckoo I cannot say. I am inclined to think the starling is innocent as regards the destruction of the skylark, his habits being somewhat different—the former confining himself to houses and fields adjoining, the latter always being found in the open country.—*J. H. T.*

A NARROW ESCAPE.—I have just set up a fine old male sparrowhawk (*Accipiter nisus*) to which is attached a singular story. While the gamekeeper of the Breeclay estates was out shooting in the last week of December, he observed a hawk flying towards him, bearing a small bird in its claws. The hawk, on seeing the keeper, immediately turned to make off, but too late—a shot brought it to the ground; when, strange to relate, the little bird which it carried flew away, apparently quite uninjured by either the shot or the talons of the hawk.—*R. McIlldowie, Aberdeen.*

NOTICES TO CORRESPONDENTS.

TO CORRESPONDENTS AND EXCHANGERS.—As we now publish SCIENCE-GOSSIP a week earlier than heretofore, we cannot possibly insert in the following number any communications which reach us later than the 8th of the previous month.

TO ANONYMOUS QUERISTS.—We receive so many queries which do not bear the writers' names that we are forced to adhere to our rule of not noticing them.

TO DEALERS AND OTHERS.—We are always glad to treat dealers in natural history objects on the same fair and general ground as amateurs, in so far as the "exchanges" offered are fair exchanges. But it is evident that, when their offers are simply disguised advertisements, for the purpose of evading the cost of advertising, an advantage is taken of our *gratuitous* insertion of "exchanges" which cannot be tolerated.

TO CORRESPONDENTS.—We have received an unusual number of communications this month, and are compelled to defer publication of the greater part of them.

T. S. (Hull).—The coloured spots on leaves were not brands, but merely marks as on autumnal leaves.

J. T. (Stockport).—You have sent an excellent example of one of the blights, probably the *Sphaerotheca pumosa*. It is difficult, as you have already found out, to mount these.

J. C. WHITE.—You are quite correct, it is the bean rust (*Trichobasis fabae*, Lev.), or very likely the early state of bean brand; they have been thought to be both similar.

J. C. W. (Salterton).—The plant is a specimen of *Hieracium*, but too shrivelled to identify surely.

B. H. (Sheffield).—The smaller specimen, No. 3, is *Lycopodium denticulatum*. The ferns are, No. 1, *Adiantum cumatum*, commonly known as maidenhair; No. 2, is *Phlegopteris depratium*, or *Aspidium*, Sw.

R. G.—Write to Mr. W. P. Collins, 157 Great Portland Street, London, W., for his catalogue of Microscopic Literature. You will there find a list of nearly all the works on Microscopy extant, with prices, &c. The catalogue also includes all the chief works in other departments of science.

W. R. WELLS.—Stark's "History of British Mosses," published by Routledge, at 10s. 6d., is the best introduction to the study; or, Cooke's "British Hepaticæ," is published by David Bogue, illustrated, in a very cheap form. Hobkirk's "Synopsis of British Mosses," published by L. Reeve, at 10s. 6d. (without illustrations), is a capital handbook when the student is further advanced. You should take in Praithwaite's "British Moss Flora," now being issued in 2s. 6d. parts by the author. It contains beautiful illustrations.

R. A. E.—"Srelt" is an inferior kind of wheat grown in France and Flanders. Its botanical name is *Triticum spelta*.

J. S. WATKIN.—There is no doubt that the worm you mention is the hair worm (*Gordius aquaticus*), concerning which ignorant people hold it is derived from horse hairs. It is the type of the order Gordiaceæ, and passes its earlier stages as an internal parasite of aquatic insects. For a full account of this creature (with illustrations), see vol. of SCIENCE-GOSSIP for 1865, page 107.

C. F. YOUNG.—You will find the subject of the attachment of *Epistylis* to *Cyclops* fully debated in SCIENCE-GOSSIP two or three years ago. Mr. Saville Kent also refers to it in the first part of his "Manual of the Infusoria."

R. ELLIS.—You will find the questions you ask concerning the different characteristics of fungi, lichens, and algae, most definitely and clearly stated in Thorne's "Structural and Physiological Botany," translated and edited by A. W. Pennett, D.Sc., and published by Longman. Dr. M. C. Cooke's book on "Fungi" (one of the International Scientific Library Series) is the best of its kind. It is published by C. Kegan Paul at 5s.

E. A. BRUNETTI.—You had best obtain the British Museum Catalogue of Diptera.

R. BEALFLEW.—"The Oologist" is an American publication, published at Rockville, Connecticut.

H. HUNSON.—There are numerous papers on the Geology of Liverpool, published in the "Transactions of the Liverpool Geological Society."

M. DIXON.—Get "Notes on Collecting and Preserving Natural History Objects," published at 3s. 6d., by D. Bogue, and study the chapters on "Flowering Plants," &c.

J. R.—You may get the "American Monthly Microscopical Journal" through any scientific bookseller, such as Mr. W. P. Collins, or W. Wesley.

G. BALDWIN.—We should think you will find all the directions respecting ornithological, &c., classification in the excellent "Zoological Classification" of Mr. F. P. Pascoe, F.L.S., published by Van Voorst.

A. JENKINS.—Woodward's "Manual of the Mollusca" still is, and is likely to be for a long time, the best general work on the subject in our language.

R. CROSSLEY.—To preserve birds' nests they should first be placed in a hot dry oven, to destroy the moth and eggs.

N. E. BALLOU (Sandwich).—Mr. E. J. Lowe (Highfield House Observatory, Nottingham) has recently published a series of records and observations on cold, hot, rainy seasons, &c., from the commencement of the Christian era to the present time. The Registrar-General publishes monthly health- and death-rate reports.

EXCHANGES.

A SPLENDID old Damascus steel sword, handle embossed with gold, also a good old sabre, for good birds' eggs.—R. Darling, Eyke Rectory, Woodbridge, Suffolk.

BRITISH birds' eggs.—A small but choice collection—including golden eagle—in exchange for scientific apparatus. List sent. Offers requested to Dr. Webb, Brougham Terrace, West Derby Road, Liverpool.

WELL-MOUNTED slides and unmounted material (fungi, starches, &c.) to be exchanged for mounted slides. Also well-mounted selected diatoms for other diatom slides, or good diatom deposits.—P. Z., Lilly Villa, Victoria Park, Manchester.

DISSECTING-CASE of instruments, cost 18s., exchange good physiological micro slides. P., 76 Blackman Road, Leeds.

SUPERIOR small cabinet, suitable for butterflies, moths, &c.,

13 drawers 8" X 5", cost £2 10s., exchange physiological micro slides.—P., 76 Blackman Road, Leeds.

LEPIDOPTERA in exchange for pupæ.—W. K. Mann, Wellington Terrace, Clifton, Bristol.

I WILL give a clean copy of "Leidy's Rhizophods" in exchange for a copy of either "Micrographic Dictionary," or "Pritchard's Infusoria."—H. F. Atwood, Rochester, N.Y., U.S.A.

DUPLICATES of numerous species of Lepidoptera in exchange for others, or good British shells, or birds' eggs.—S. Smith, Castle Street, Walmer, Kent.

WANTED, a work on Paleontology, will give "Introductory Text-book of Geology," Page; "Rudimentary Geology," by Lieut.-Col. Portlock; and "The Geological Examiner," Page.—G. H., 5 Risen Lane, Lincoln.

DUPLICATES: *C. diffinis*, *C. affinis*, *C. trapezino*, *A. suffusa*, *V. ferruginea*, and a few others. Desiderata numerous. Lepidoptera; or (named) Coleoptera. W. Mackonochie, 47 South Molton Street, Grosvenor Square, W.

"FRENCH Grammar," "Latin Primer," "Greek Extracts," and Dalzel's "Analecta Græca Minora," all rather worn. Exchange for entomological works, or offers. W. F. Clarke, 27 Willow Grove, Beverley.

PRIMARY or secondary fossils wanted, in exchange for Eocene tertiary fossils, or will sell cheap; list sent. Also sand from Mediterranean, containing foraminifera; exchange as above.—G. W. Coleman, 38 Union Street, Ryde, I.W.

WANTED, during the summer and autumn, good specimens in flower, or fruit of any Potamogeton, except *densus* and *crispus*. Will give specimens of rare species in the same genus, or other rare British plants.—A. Tennet, High Street, Croydon.

SLIDES of diatom (*Synedra*) in exchange for uncommon insects, plants, or material.—G. Bryan, Fitzwilliam House, Cambridge.

WANTED, cuttings of clematis (any varieties), and other climbing plants, rooted or otherwise, in exchange for flower seeds or Lepidoptera.—R. Laddiman, Upper Hellesdon, Norwich.

LARGE cylinder electric machine for exchange. Wanted good microscope, or offers.—H. W. Wager, Middle Street, Stroud, Gloucestershire.

FOR slide of golden-tail moth, and slide of bramble-brand fungus—both well mounted on wood slides—send other slide to J. Boggust, Alton, Hants.

SCIENCE-GOSSIP complete to this number, first 6 years bound in half morocco, for connoisseurs suitable for Beck's popular microscope, offers.—George Whitehouse, junr., 4 Marshall Place, Cheetham, Manchester.

I HAVE numerous unmounted seeds, forming beautiful opaque objects for the microscope, such as *Eceremonocarpus*, *Nycteria*, *Cineraria*, *Rampion*, *Poppy*, *Antirrhinum*, *Eitoca*, *Petunia*, *Thunbergia*, *Orache*, *Calliopsis*, *Hembane*; which I shall be glad to exchange for mounted objects.—W. H. Newberry, Elm Grove House, Exeter.

EGGS of dipter, oystercatcher, common tern, dunlin, red-shank, &c., for other hatched specimens not in collection.—H. Patrickson, junr., 51 English Street, Cumberland, Carlisle.

BOOKS on entomology, microscopy, entomology, and other branches of natural history, including Cassell's "European Butterflies and Moths" (up to present month), in exchange for works of general literature. For particulars apply to W. Lewis, Mansfield Grove, Nottingham.

FOR hairs (unmounted) of black rat, flying fox, weasel, mole, hedgehog, and squirrel, send stamped and addressed envelope to H. C. Brooke, Sutton Valence School, Staplehurst, Kent.

WANTED a rough cabinet specimen of amber. Shall be glad to give micro slides, zoological specimens, or marine objects, in exchange.—E. Lovett, Holly Mount, Croydon.

WANTED to exchange monthly for reading—SCIENCE-GOSSIP for "Midland Naturalist."—A. G. Wright, Newmarket.

FOR exchange new, Wood's "Naturalist's Handbook," and Davies "On Mounting," both new; also a quantity of well-mounted slides and unmounted material, for other good material and microscopical apparatus. Want a microscope lamp.—J. Blackshaw, 57 Cross Street South, Wolverhampton.

A SMALL quantity of cleaned diatomaceous material, also tuft of *Fuustria Joliacea*, will be forwarded on receipt of stamped envelope, or object of interest.—F. Combridge, 2 Courtney Terrace, Portslade-by-Sea, nr. Brighton.

WANTED, Taylor's "Aquarium." Will give in exchange "Strange Stories of the Animal World," 2nd edit. (gilt edges, new).—A. Fieldsend, Silver Street, Lincoln.

ROCK specimens (Cornish and foreign), minerals, fossils, algae, and marine zoological specimens, offered in exchange for books on natural history, microscopic apparatus, slides, or offers; back vols. of "Nature" and SCIENCE-GOSSIP especially desirable.—J. S. Islesy, Trevethen Terrace, Falmouth, Cornwall.

WANTED two or three cray-fish (alive for aquarium). Will give Liassic fossils.—W. D. Carr, St. Edmonds, Lincoln.

A FEW rare eggs, for others not in collection.—J. T. T. Reed, Ryhope, Sunderland.

SEVERAL numbers of the "Transactions and Proceedings of the Zoological Society" for exchange. Wanted Lyell's "Principles of Geology." A. King, 10 De Crespigny Park, Denmark Hill, S.E.

WILL give four vols. "Races of Mankind," handsomely bound in two (half calf), for latest edition of Sowerby's "Wild Flowers" (coloured plates).—Edwin E. Turner, High Street, Witham, Essex.

WANTED Quekett, Carpenter, Beale, or some other good work on microscopic subjects. Will give 2-inch English objective (no name).—E. Wittington, Balliol, Oxford.

Pupa umbilicata, var. *alba*, in exchange for other specimens of land and freshwater shells. Micro slides of grain gold, silver, and copper (pure), well mounted, slides in ex., for other micro slides of interest.—W. H. Boland, 23 Paxton Road, All Saints, Birmingham.

WANTED, 6 small Venus chione, 2 large trilobites, 6 good fossils from Black Down, 6 fossil crabs, any bed, 6 good fossil shark teeth. Will give for each of the above, 12 British shells, rare sorts, or 6 to 8 beautiful Polish slabs of Devon corals, worth 1s. to 1s. 6d. each.—A. J. R. Slater, Bank Street, Teignmouth, Devon.

WANTED, recent British or foreign shells, land or water, in exchange for about 100 British birds' eggs.—T. J., care of F. Wotton, 13 Moira Crescent, Cardiff.

FOREIGN shells wanted. Will give in exchange a number of rare and local British plants, British shells, or Lepidoptera.—Wm. Jordan, Cockfield, Sudbury, Suffolk.

FOR exchange, stuffed hooded crow, and chaffinch, in case, several bird and animal skins (British). Wanted micro slides, or magic lantern slides, or offers.—Jas. Ingleby, Eavesstone, Ripon.

BRITISH marine, land and freshwater shells, for exchange. Lists exchanged.—R. Ley, St. Leonard's Lawn, Exeter.

ABOUT 200 foreign stamps, in two blank books, with room for eight times the number, mostly common, but all different, one half of them being unused. Will take 15s. for all, or exchange all or part for exotic (diptera or longicornia preferred) insects. List of stamps sent. Only specimens in fair condition accepted.—E. A. Brunetti, 14 & 15 Lower Grosvenor Place, London, S.W.

WHAT offers for SCIENCE-GOSSIP, unbound, in good condition, for the years 1875, 1876, 1880, and July to December 1879, inclusive?—G. S., Elm Grove, Ealing, W.

OFFERED to exchange, for other British birds' eggs, grasshopper, reed, sedge, and wood warblers, lesser whitethroat, blackcap, crested tit, white wagtail, snow bunting, bullfinch, red-winged starling, downy and golden-winged woodpecker, yellow-billed cuckoo, passenger pigeon, quail, pheasant, partridge, Virginian colin, killdeer plover, Bartram's and spotted sandpipers, curlew, whimbrel, Egyptian and Canada goose, eider-duck, com. guillemot, com. and Arctic tern, herring, and lesser black-backed gull.—R. Turnbull, 3 Cemetery Road, Crewe, Cheshire.

I HAVE some good, named, foreign shells, and some first-class inferior oolite fossils to spare. Would like good skins of British birds, or any of Darwin's works, in exchange.—Science, 165 White Ladies Road, Bristol.

GILBERT WHITE'S "Natural History of Selborn," with 200 illustrations, and notes by Rev. J. G. Wood (new). I have only read it through. What offers? Fossils, botanical specimens, another Natural History, or anything.—Jno. Watson, Old Trafford, Manchester.

SLIDES of *Urania rhipheus*, *Prepona*, *Demophon*, *Papilio buddha*, and diamond beetle, for other well-mounted and interesting objects. The above are of exquisite beauty, and *Demophon* and *Buddha* very rare. Specimens of the *Uranias*: *Rhipheus*, *Sloanus*, *Leilus*, and *Fulgens*, or British lepidoptera, for Professor Westwood's "Observations on the *Uranias*," in the Transactions of the Zoological Society. Copy with coloured plates required, or would give cash.—Joseph Anderson, junior, Ayle Villa, Chichester.

OFFERED, British and foreign shells for British crustacea and foreign land shells.—Rev. W. Hey, 24 Portland Street, York.

Will exchange a good collection of 170 silver and copper coins and medals (mostly British), for minerals, fossils, or a magic lantern. Also for exchange a good microscope and good rock specimens. What offers?—Hy. Hunson, 153 Great Horner Street, Liverpool.

A PERFECT ivory palette, 9 x 6, for Rimner's "Land and Freshwater Shells"; also 500 British wild plants, some very rare. What offers?—E. M. C., 76 Trafalgar Road, Old Kent Road, London.

SCIENCE-GOSSIP, parts for 1870, 1871, 1877, 1878, and 1880, in good condition. What offers in natural history specimens?—A. Foster, Roger Street, Anstruther, N.B.

FOR exchange: redshank, dunlin, oystercatcher, black-backed gull, common tern. Wanted live birds for aviary, goldfinches, siskins, crossbills, hawfinches, and many other commoner species.—Geo. Dawson, 6 English Street, Carlisle.

HAIR of *Ornithorhynchus paradoxus*, mounted in balsam, for other good slide; also several slides, in exchange for books, shells, &c.—Mrs. Skilton, London Road, Brentford.

WANTED a small compound microscope, suitable for field work, in exchange for six-barrel revolver, mutual approval.—J. K. Marten, 4 Eastgate Row, Chester.

GOOD collection of West Indian products (spices, &c.), in exchange for fossils, or micro slides.—Edward Oliver, 11 Alma Road, Canonbury, N.

ETHER herbarium of 120 species of British mosses, or 120 species of British phanerogams, in perfect condition, offered for Gray's "British Seaweeds" (published at 10s. 6d.). Good slides of insects wanted in exchange for good botanical and other slides.—X, 14 Sherborne Road, Bradford.

SPLENDIDLY preserved, and correctly named, specimens of Swiss Alpine and other plants, to be had, from single specimens to any number, at 6d. each.—D. B., care of Editor, SCIENCE-GOSSIP.

WANTED, first-class mounted and unmounted microscopic objects for other microscopic objects, mounted and unmounted.—The Secretary, The Birmingham Exchange.

WANTED, the Christian Knowledge Society's set of botanical diagrams. Roots of foreign ferns in exchange, or state wants.—Miss Ridley, Hollington House, Newbury.

DUPLICATES of Tortrices, Tineinae, Pterophorinae, and other Lepidoptera, in exchange for other species. Send lists.—Sidney Smith, Castle Street, Walmer, Kent.

WILL exchange (1) Lubbock's "Prehistoric Times" (1878), (2) Slack's "Marvels of Pond Life," (3) Newman's "Insect Hunters" (2nd edit.), (4) Lockyer's "Spectroscope" (Nature Series), (5) Theodore Hook's Humorous Works, (6) "Responsibility in Mental Disease" (International Series), all as good as new, for books on Natural History, or for cash. Wanted especially Cook's "Handbook of British Fungi," 2 vols. (last edit.), Leighton's "Lichen Flora," &c.—W. G. Woolcombe, 13 Museum Terrace, Oxford.

WILL exchange my collection of about 400 (species) Lepidoptera for Coleoptera (individually or collectively). Lists sent. Also wanted to exchange correspondence with Coleopterists, with view to mutual assistance.—H. B. Pim, Leaside, Kingsford Road, Upper Norwood.

FOR a beautiful double-stained section of cat's tongue, well mounted and finished, send a good object of interest, also mounted.—J. Edwards, 39 Bridge Street, Wednesbury.

BOOKS, ETC., RECEIVED.

- "General Physiology of Muscles and Nerves." By Dr. I. Rosenthal. London: C. Kegan Paul & Co.
 "Land and Water." February.
 "The Midland Naturalist." February.
 "Entomologist." February.
 "Transactions of the Epping Forest Naturalists' Field Club." Part II.
 "Proceedings of the Geologists' Association." Nos. 8 and 9.
 "Natural History Notes." No. 2.
 "Etudes des Coupes de Diatomées." Par W. Prinz. Bruxelles.
 "American Monthly Microscopical Journal." January.
 "Canadian Entomologist." January.
 "Boston Journal of Chemistry." January.
 "The Homing Pigeon." January.
 "The American Journal of Microscopy." January.
 "Science." January.
 "Medical Herald." January.
 "Illinois State Laboratory of Natural History." Bulletin No. 3.
 "Botanical Gazette." January.
 "Revista." February.
 "La Science pour Tous." January.
 "Le Monde de la Science." January.
 "Feuille des Jeunes Naturalistes." January and February.
 "Procès-verbal de Société Belge de Microscopie."
 &c. &c. &c.

COMMUNICATIONS RECEIVED UP TO 9TH ULT. FROM:—
 J. B.—R. W. S.—F. L. R.—N. E. B.—T. J. L.—C. V. R.—
 J. S.—G. D. W.—R. W. R.—H. W. W.—L. G. B.—
 E. B.—W. E. D.—G. W. C.—W. K. M.—A. E.—H. H. W.—
 J. S. W.—H. W. L.—H. B.—R. E.—R. I. C.—A. M.—W. G.—
 H. L.—J. G. W.—A. W.—M. P. M.—M. J. A. O.—H. S.—S.—
 F. W. M.—R. A. B.—A. C.—H. F. A.—J. A. O.—T. M. K.—
 E. H. W.—E. B. K.—F. R.—S.—J. A. W.—W. G.—H. P.—
 F. W. D.—G. D. J.—F. G.—C. W.—H. W.—P. L.—E. D. M.—
 G. W.—J. H. W.—H. C. B.—F. P.—W. H. N.—J. L.—
 E. B.—W. S.—D. B.—W. G.—T. L.—T. W.—W. W.—
 J. H. K.—M. E. J.—W. B.—R. C.—J. R. M.—G. T.—C. H.—
 M. S.—F. W. E.—S. E.—W. B.—R. E.—S.—P.—Z.—T. J.—
 B. J. G.—H. J.—W. J.—J. W.—J. I.—R. L.—G. S.—J. K.—
 E. A. B.—R. T.—E. M. E.—W. J.—J. W.—J. A.—C. S.—
 C. E. C.—J. G.—W. C. H.—J. S.—W. W.—J. B. M.—H. H.—
 L. S. G.—B. M. O.—A. F.—R. B.—G. D.—J. N.—A. G. W.—
 W. T. G.—J. B.—J. H. H.—T. C.—J. P.—A. F.—M. D.—
 J. S. H.—A.—W. D.—C. A.—B.—J. T. T.—R.—H. J. T.—
 A. K.—W. H. B.—E. W.—E. E. T.—G. E. B.—A. J. R. S.—
 E. L.—A. W.—J. C. C.—S.—Miss R.—H. W. S. W.—
 S. J. H.—W. F. H.—J. B.—&c.

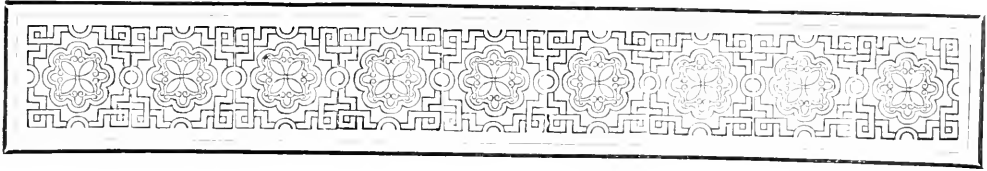

CONTRASTS BETWEEN THE COLOURS OF FLOWERS AND FRUITS.



THAT there are marked contrasts between the prevailing colours of flowers and succulent fruits, is patent to the most casual observer, and it may interest the readers of SCIENCE-GOSSIP to have a few of the facts relating to the subject briefly presented to them. Many of the following observations can be verified in one's ordinary walks by the

hedge-rows, during the autumn and winter.

Confining our attention to the British flora, we find that the least frequent colours that occur in flowers are black and scarlet. Of the former hue, there appear to be none whatever, a partial exception may be made with reference to *Papaver hybridum* (hybrid poppy), which possesses the peculiar character of black discs, associated with scarlet petals, one at the base of each of these organs, and hence not very conspicuous. That such a sombre hue as black should be well-nigh absent from corollas is not surprising when it is considered that brilliant colours are so important as accessories to cross fertilisation, inasmuch as they appeal to the colour-sense of insects whose offices are so necessary to ensure this result.

Of scarlet flowers, which are so abundant numerically in the cultivated fields of some districts, there are but three genera, which belong to as many natural orders. These are pheasant's-eye (*Adonis*, N.O. Ranunculacæe); poppies, four species (N.O. Papaveracæe) and poor man's weather-glass (*Anagallis*

arvensis, N.O. Primulacæe). The first of these is probably introduced, and is not widely distributed in these islands. The poppies, if not truly native, are perfectly naturalised, and occur in too great profusion in many localities; and it is worthy of note that all three of these genera grow only in such places as are exposed to full sunlight. In the bog-pimpernel (*Anagallis tenella*) the colour is softened down to a delicate rosy hue.

In striking contrast to the rarity of the colours just referred to, it is remarkable that nearly half of our British succulent fruits and coloured seeds are black, and about forty per cent. are red or scarlet. In verification of this, it is necessary to refer only to the well known glossy black fruits of blackberries (*Rubi*), buckthorn, sloe, elder, privet, juniper, and the less frequently seen herb paris (*Paris quadrifolia*). Of scarlet and red fruits, every one is familiar with the haws of whitethorn, the fruits of rowan tree, bitter-sweet, cherry, cotoneaster, and white bryony. With these should also be included the succulent receptacles (false fruits) of rosa, and strawberry. In the latter, the true fruits are distributed over the exterior, and in the former over the interior, of the special modifications of the flower stalks, which are popularly styled fruits.

Passing from these extreme hues, it will be noticed that there is a marked prevalence of white flowers, and it sometimes happens that those which are normally blue or red present white varieties. These are distributed through many natural orders, and the intensity of the whiteness appears to be increased in those that are fertilised by night-flying insects. As examples of white flowers may be mentioned water-crowfoot, many crucifers, stichworts, evening lychnis, cherry, woodruff, privet, frogbit, and lily of the valley. Reverting to fruits, it will be noticed that white ones are very rare; the most familiar is probably the mistletoe, the white berries of which gleam amongst the yellowish-green foliage. The only other British example that one can find in Hooker's "Student's Flora" is *Smilacina bifolia*, a near ally of the lily of the valley, but this might almost be excluded, as it has been found in only two or three

stations. A plant with opaque white fruits called snowberry (*Symphoricarpos*) is common in shrubberies, and has been introduced from North America.

Taking Hooker's "Student's Flora" as a standard for our guidance in reference to these colours, it appears that yellow is very rare among fruits. The only examples given are ivy, "rarely," and crab apple, but even in the latter case the hue is not very conspicuous. Of orange-yellow fruits, there are apparently only three, viz. barberry (*B. vulgaris*), cloud-berry (*R. chamaemorus*), and sea buckthorn (*Hippophae rhamnoides*), none of which are widely distributed. A solitary instance of an orange-coloured ovary is furnished by *Saxifraga aizoides*. In marked contrast to this is the presence of yellow flowers, especially of the large group of ligulate Compositæ, which are so abundant in the autumn, of which the sow-thistles and hawkbit are well-known types. In addition to these, buttercups, charlock, and many of the Primulaceæ may be mentioned.

Crimson appears to be rare both among flowers and fruits. The drooping thistle (*Carduus nutans*) is an example of the former, and the berries of honeysuckle of the latter. The only other crimson fruit is the capsule of the spindle-tree (*Euonymus Europæus*), with which is associated the curious orange-yellow arilode, which together form such a combination of colour as is probably never seen in any British flower.

Green is a hue not infrequent with flowers, especially such as have petaloid calyxes: but as many of them are inconspicuous, they are probably often unnoticed. Examples of these are furnished by black bryony, spurge laurel, many of the spurges (*Euphorbiaceæ*), and the more striking green hellebore. Of green, succulent fruits, probably the only kind indigenous to Britain is the gooseberry.

Some noteworthy differences also exist between the colours of flowers that produce succulent fruits and those that are succeeded by dry fruits, as capsules, achenes, &c. There does not appear to be any instance of a British edible fruit that is resultant from a blue flower. The large majority of those that are cultivated forms of indigenous stocks, or are edible although truly wild, are produced from white flowers, or that range from white, through pink to purple. Of these may be instanced, apple, cherry, medlar, huckleberry (*Vaccinium Myrtillus*) and strawberry tree (*Arbutus Unedo*). In contrast with this there are whole groups of plants such as campanulas, gentians, and borages, in which blue flowers are frequent, that have only dry fruits, as capsules or nutlets.

Brilliantly coloured seeds are almost entirely limited to monocotyledons. Of these there are but a few, and probably the following brief list is complete. The red ones are crocus and fetid iris. In the latter the rows of brilliant seeds in the glossy,

green opening capsules form an attractive display of colours. The yellow, but one, *Gagea lutea* (yellow star of Bethlehem); white, but one, the snowdrop; green, also, one, a dicotyledon,* the yew. Black seeds are much more numerous, and are found in at least sixteen species of monocotyledons, and probably only one dicotyledon, namely the box (*Buxus*). Most of the black seeds are, however, not succulent.

The foregoing facts doubtless furnish sufficient evidence to prove that there are strongly-marked contrasts existing between flowers and the parts pertaining to fruits. The reason of this dissimilarity of colouring between two sets of associated organs has been suggested by our editor in "Flowers: their Origin, Perfumes, &c.," p. 301. For the two distinct purposes of pollination and of the distribution of seeds, there are required the agencies of two classes of creatures, namely, insects and birds. It is admitted universally that the brilliant hues of flowers appeal to the colour-sense of insects, and is it not equally reasonable to suppose that another set of contrasting hues may appeal to the colour-sense of birds? At least it will be admitted that the prevailing tints are so different, that they will be easily distinguished from each other by two classes of creatures whose offices are required by each respectively, and for whose attraction these colours are displayed.

The matter is also further simplified by the fact that insects are most numerous when flowers are so, and fruits are most abundant in the autumn and winter, when they are so necessary as food for birds.

A difficulty may suggest itself with reference to black fruits, which scarcely seem adapted to appeal to the colour-sense of birds. It is worthy of note, however, that almost the whole of them are glossy, and the few remaining ones are covered with a delicate bloom. Nearly all are ripened before the foliage falls, and thus show in contrast against the green leaves of late summer, and the coloured foliage of the autumn. Moreover, nearly all such fruits, which are produced by deciduous and herbaceous plants, perish before the winter, i.e. *Rubus*, *Sambucus*, *Atropa*, and such as persist on evergreens, as ivy and privet, are easily distinguished amongst the green leaves. With reference to scarlet fruits, many of them remain long after the foliage has fallen, and are conspicuous objects amongst the leafless branches. As examples, may be mentioned rowan tree, hawthorn, bittersweet, black bryony (*Tamus communis*) and the hips of roses.

The forementioned facts are doubtless sufficient to prove that there are strongly-marked contrasts between flowers and the parts pertaining to fruits, and the inference seems fairly legitimate, that they are the results of efficient causes, and are not merely fortuitous coincidences.

* *Tamus* "cotyledons, 2 short."—*Hooker*.

The following is an approximately complete list of the various colours :

	Fruits.	Seeds.	Receptacles.	Ovary.	Totals.
Red	29	2	8	0	39
Orange	3	0	0	1	4
Yellow	1	1	0	0	2
Green	6	1	0	0	7
Blue-black	2	0	0	0	2
Black	24	17	0	0	41
White	2	1	0	0	3
	<u>67</u>	<u>22</u>	<u>8</u>	<u>1</u>	<u>98</u>

Luton.

J. SAUNDERS.

BREEDING FOREIGN BIRDS IN ENGLAND, A PLEASANT AND PROFITABLE INDUSTRY.

By W. T. GREENE, M.A., M.D., F.S.S., &c.

IF it be true, as Xavier Lemaistre in one of his inimitable romances, has declared, that "the inauguration of a new industry is a praiseworthy achievement," some modicum of credit may, doubtless, be granted to the individual who not exactly introduces, but brings into more prominent notice, an occupation which has not been followed to any great extent in this country, notwithstanding the interest with which it is replete, and the success which is sure to ensue, when the details are carried out with intelligence and care.

It has for some years been the custom, in Antwerp and other Continental cities, to breed large numbers of different kinds of foreign cage-birds, chiefly for the English market; and though we cannot, in these smoke-begrimed isles, boast of the climatic advantages enjoyed by our neighbours *d'outre mer*, it is nevertheless quite practicable, even here, to emulate their success; and the reward of our endeavours will be twofold—not only profitable, but full of pleasure.

Although, at first sight, it does seem impossible that the gorgeous denizens of dense tropical and sub-tropical forests should ever be induced to live, much less to breed, in our English climate, experience has proved that many different species of Australian and American birds can be acclimatised in our aviaries without the slightest difficulty, are very much more easily reared than the noisy, shrieking, uninteresting canary which, until lately, was almost our only exotic cage-bird, and are not, in fact, one whit more delicate than our native tits and sparrows.

The prospective breeder will of course endeavour to ensure the most favourable conditions possible for carrying out his experiment, in the shape of suitably constructed aviaries, or rooms appropriately furnished with a southern, or at least a south-western aspect. A garden-aviary may very readily be built against a south wall, and be constructed of the small meshed wire-netting obtainable of any ironmonger: a portion of the

aviary, which, altogether, should not be less than six or eight feet in length, by four to six feet in width, and as high as possible, for each pair of birds, must be of wood covered with felt, and be furnished with a glass window, which can be replaced by a wire frame in the summer; a small doorway, with a trap attached that can be raised and lowered at the owner's pleasure, will afford the birds a ready mode of ingress and exit from the open to the covered-in portion of their abode; the nest boxes must be placed in the latter, and the inmates must not be crowded, if success is to be achieved; for the larger the space at their disposal, the healthier will be the birds, and the more likely to lay and rear their young.

Except in the case of some of the smaller finches, it will be useless to plant trees or shrubs in the aviaries, for the birds pick them to pieces directly, but the uncovered part of the enclosure should be laid down with grass, and bundles of dry birch branches (pea-stakes) may be advantageously disposed about the place. So much for general directions: as we proceed, I shall briefly indicate the most suitable nesting appliances for each of the few species I propose passing in review, as best adapted for commencing amateurs.

The budgerigar, or undulated grass-parakeet, is a deservedly popular favourite, no less from its beauty than its great docility, and the readiness with which it adapts itself to its novel surroundings, often breeding under the most unfavourable conditions. It is quite hardy, and may be wintered out of doors with perfect safety. It breeds four or five times in the year, producing from three to six young ones each time; and as these birds are readily sold for 15s. a pair, it will be seen that a few couples will amply pay for their keep, which consists of canary and white millet seed, a few oats, some soaked bread, and plenty of green food, such as grass, lettuce, &c. Fresh water must be supplied daily, or better still, where practicable, a small stream be conducted through the aviary; nor must lime rubbish, or pounded cuttle-fish shells be forgotten, and this remark applies equally to all kinds of cage-birds. The budgerigar prefers a cocoa-nut husk for a nesting-place, this should have a small hole made at one end and be suspended as high up in the aviary, or room, as possible, to keep it out of the way of the mice. The budgerigar makes use of no nesting material, and returns to the same husk time after time if undisturbed. If more than one couple be kept in the same place, it will be necessary to supply three husks to each pair of birds, otherwise there will be quarrels, and the chance of rearing young birds seriously jeopardised. The male budgerigar can be readily distinguished from his mate by his blue nose; that of the female being white, or buff, according to the age of the specimen.

Among other Australian parakeets which are hardy and desirable inmates of the aviary, I may mention

the particularly jolly, but quaker-plumaged cockateel, which is very prolific, and must be fed and treated as the budgerigar. A good cockateel is worth from 12s. to 15s., and is altogether a very nice bird, though perhaps a trifle noisy. A candle-box with a hole at the top and a handful of sawdust inside, makes a first-class nest for this bird, as well as for the turquoisine, red rump and rosella, all very desirable birds, and perfectly hardy. I would recommend, however, that only one species of these parakeets be kept together, as the different kinds quarrel among themselves, in which case success in breeding them can scarcely be looked for.

Although a native of Brazil, there is, perhaps, no bird that better accommodates itself to the vicissitudes of our changeable climate than the red-headed cardinal, whose scarlet crown, pure white breast, light grey back and black tail, no less than his bold, not to say martial carriage, render him such a conspicuous object in a collection. He lives and thrives out of doors in this country to a marvel, seeming as happy and contented when hopping about in the snow, as when threading his way through the birch-branch furniture of the aviary on the hottest summer-day.

A true finch, though a large one, his eminence will live on canary and hemp seed (though the latter is apt to discolour his beautiful plumage) but he will not, on such diet, enjoy the same amount of robust health as when supplied with a sufficiency of animal food. Black-beetles are a readily procurable dainty, but caterpillars are his favourite food. He, or rather his wife, builds a nest like our thrush, in a bush, or a wire-basket hung up in some quiet corner; the eggs resemble those of our blackbird, and are four or five in number; the young are hatched in thirteen days,

and may be readily reared on chopped egg, minced veal, or other white meat (cooked), and such insects as can be procured. There are usually two broods in the year, the birds fetching from 15s. to 20s. each when adult. The sexes resemble each other, but the male is brighter-coloured, and has a bolder and more upright bearing; his song is not unlike that of the thrush.

As these birds are very quarrelsome, only one pair can be kept in the same enclosure, which may also be tenanted by a pair of the larger parakeets. Nothing would be easier than to acclimatise the red-headed cardinal, which would be a most desirable addition to our fauna, and an acquisition to farmers and market-gardeners, as he is not a fruit-eater, but lives chiefly on insects, particularly caterpillars, of which he will devour his own weight a day.

The Virginian nightingale, from the Southern States of North America, is a kindred species to the foregoing; it is of a brilliant red colour, verging to brown on the wings and tail, and a sweet singer, but is not as hardy as the cardinal. I have not succeeded in breeding this species, but know some amateurs who have, and speak very highly of it, as a quiet, peaceable bird that never quarrels, unless with another pair of the

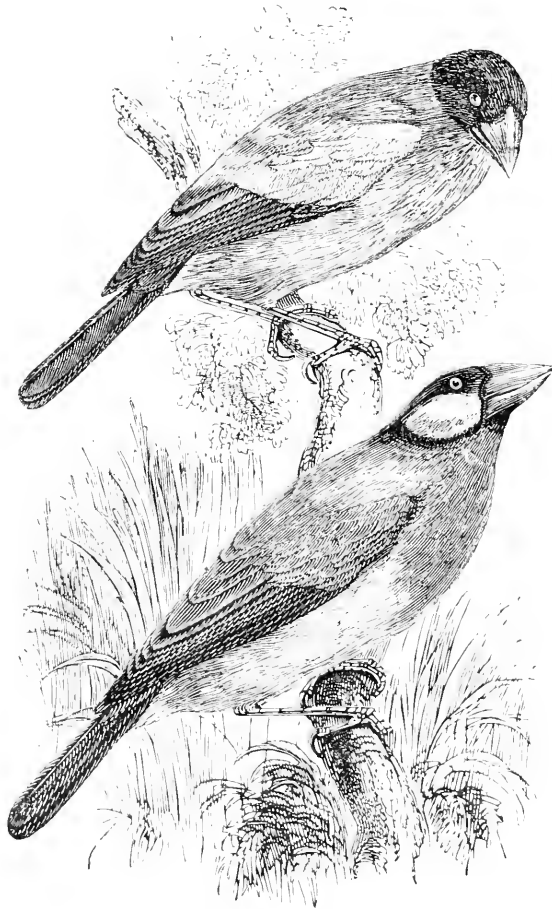

Fig. 55.—Java Sparrows (*Fringilla oryzirora*).

same kind during the breeding season, so that it will be necessary to isolate each couple, if they are to do any good in the breeding line. The female is brown, and sings as well as the male, some people say better than he does. The Virginian nightingale is to be fed in the same way as the cardinal, adding ripe fruit and green peas when in season. An escaped pair of these birds nested, and reared a brood of four young ones in a wood near Berlin; but it is scarcely a desirable subject to accli-

matise, as our gardeners have plenty of native pests to contend against, without adding another to their number.

The pretty and lively little zebra-finch is a native of Australia; it is tolerably hardy, and may be wintered in an out-door aviary, providing that it is supplied with a snug retreat in which to spend the night; but on the whole it will be safer to keep it in the bird-room indoors; under either condition, however, the zebra finch breeds very freely, and several pairs may be kept together, if there be plenty of nesting accommodation, which may be small boxes, cocoa-nut husks, small cages, hollow logs, or any nook in which the birds can deposit a mass of hay, fibre, &c. The eggs are about the same size as those of an English wren, quite white, and vary from three to seven in number; the young are fed on chopped egg, soaked sponge cake and ants' eggs. At one time these little birds were worth from 15s. to 20s. a pair, but can now be bought for 6s. or 8s. a couple; still, as they are hardy and very prolific, I can recommend them to the attention of amateurs.

Java sparrows and cut-throat finches are also hardy birds, breeding freely in captivity, but as they can be purchased for a trifle, it is scarcely worth while breeding them. Bengalees, however, are charming little birds from Japan, about the same size as the zebra finch, but as they are decidedly delicate they must be kept indoors. A pair in a common canary breeding-cage will soon make themselves quite at home, rearing a numerous progeny, which may be fed as already recommended for young zebra-finches. As these little birds command a good price, perfectly white specimens fetching 30s. a pair, they are well worth the little extra trouble they will require, and on the whole are not much more difficult to breed than the canary.†

Saffron-finches are charming birds, breeding freely in the indoor aviary; they make their nest in a cocoa-nut husk, lay an egg like that of our sparrow, are fed as indicated above, and are worth above 20s. a pair.

Blue robins, and Pekin robins, or nightingales, are delightful creatures, especially the latter, they belong to the class of birds called "soft-billed," and are a trifle more troublesome to cater for than the finches; but amply repay their owner for his care by their beauty, docility, and charming song. They do very well out of doors during the summer in a well-wooded aviary, but must be taken indoors before winter, as they are rather susceptible to cold; or a pair may be kept in a conservatory, where they will do no harm to the plants, but on the contrary keep the place clear of insects; if the conservatory be heated during the cold weather, these birds will live there very happily all the year round, and will certainly breed, a consideration to the amateur, as they are worth from 20s. to 30s. a pair. I know of no more delightful birds (always excepting my friend the cardinal), they are fed on a mixture of grated bread

crumb, carrot, and crushed hemp-seed, and as many insects as possible; ants' eggs, dried or fresh, forming a valuable addition to the bill of fare; flies and gentles are objectionable, the latter especially seeming to disagree with these birds.

Many of the tiny finches, such as the silver-bill, the orange-cheek, and orange-breasted waxbills, the St. Helena waxbill, the pheasant-finch, the diamond sparrow, and others have been bred in captivity, but as with the exception of the last, they can be bought for a trifle of the importers, and require a great deal of attention to induce them to build and rear young, it is not worth the while of a beginner to make the venture. The diamond sparrow, however, is a beautiful Australian bird that always commands a good price, and an exception may be made in his favour, but he is a horribly quarrelsome fellow, and he and his wife must have a house, and a good-sized one too, all to themselves, it being not unfrequently necessary to remove my gentleman when madam has laid her complement of eggs, as, annoyed apparently by the loss of her society, he is very apt to pull the nest to pieces, and smash the little white eggs on which his owner's hopes of profit depend.

Without having more than very slightly glanced at a subject about which volumes might be written without exhausting it, and which offers a wide field for experiment to the amateur gifted with leisure and a love for the most beautiful portion of the animal creation, and who, at the same time, is not above combining pleasure with profit, I cannot conclude without a word of admonition to the sanguine, who may fancy that in this case, as in many others, they have nothing to do but to "come, see, and conquer," they must be prepared for disappointment, which is too often the order of the day, for, in spite of every care "the best laid schemes of birds and men gang aft agley:" but, as in more serious matters, so in the breeding of cage-birds—

"Experience joined with common sense
To mortals is a providence."

NESTING OF SWIFTS.—In the volume on Ornithology, in Jardine's Naturalist's Library, the following remarks regarding the nesting of the common Swift occur: "We now find its resting-places only in ruined towers, or old buildings, where lapse of time has formed holes or rents;" and "We are not aware of any natural station for this bird, which we would be prepared to find in the clefts and rents of rocky precipices." No doubt the greater number do select the first-mentioned sites for their nests, but in an escarpment of the Cleveland Hills, near Bilsdale, Yorkshire, I last year observed hundreds of swifts flying in and out of the fissures in the rocks, which were also tenanted by a colony of jackdaws and pigeons. Although I did not look for the nests, I have little doubt of their having nests in the holes from which they issued.—*J. A. Wheldon.*

CHAPTERS ON BRITISH DRAGON-FLIES.

NO. III.

BY E. B. KEMP-WELCH.

SECOND GROUP.

Fore and hind wings alike in shape.

First division.—*Antecubital nervures numerous.*

CALOPTERYGIDÆ.

Genus *Calopteryx* (Leach).

C. VIRGO (Linn.). Male, wings broad, deep blue, the reticulation very fine; head, thorax, and abdomen, deep metallic blue; no pterostigma traceable. Female, wings brown, but clear; pterostigma clear, placed comparatively far from tip of wing; thorax and abdomen metallic green or copper. British Islands generally. Length 17 lin.; exp. 21 lin.

C. splendens (Harris). Male, wings more narrow, deep blue, or black in the centre only, the base and tips being clear, and the reticulation not so close as in *C. virgo*; no pterostigma; colour as above. Female as that of *C. virgo*, but the pterostigma more nearly apical. British Islands generally. Length 17 lin.; exp. 21 lin.

It is noteworthy, that although these two species are about equally common, they seldom or never occur together in the same locality.

Second division.—*Two antecubital nervures.*

AGRIONIDÆ.

(*The wings of this family, being uniformly clear and hyaline, will not need to be described.*)

A. *Tibie dilated.*Genus *Platycnemis* (Charp.).

P. pennipes (Pall.). Male blue or whitish; a black band across the head between the eyes; two longitudinal bands, and two lateral lines (black) on thorax; an interrupted double black line down the abdomen, or two black dots on the hinder end of each segment; pterostigma clear. Female green, with yellow thorax; markings otherwise the same; pterostigma ochreous. In both sexes the tibie of the middle and hind legs dilated. England and Scotland. Length 12 lin.; exp. 16 lin.

B. *Tibie cylindrical.*a. *Pterostigma large, oblong.*Genus *Lestes* (Leach).† *Back of head bronzed.*

L. viridis (Van der Lind.). Bronze-green; thorax with three narrow yellow lines in front; joints of abdominal segments marked with yellow; pterostigma large, pale light red; upper anal appendages of male like pincers, with a basal tooth, and toothed towards

the ends. Doubtfully British. Length 15 lin.; exp. 18 lin.

L. nymphæ (Selys). Metallic green, powdered with blue (♂), stout, of variable size; pterostigma smaller, black; upper anal appendages like pincers, with two pointed teeth, internally rather far apart; the lower ones long, dilated at the end. England, Ireland. Length 12 lin.; exp. 14 lin.

L. sponsa (Hans.). Metallic green, tinted with blue in the ♂, and copper reflections in the ♀; pterostigma not very large, black; upper anal appendages pincer-like, with two internal teeth, nearer together; the lower ones not dilated at the end. England. Length 12 lin.; exp. 14 lin.

†† *Back of head yellow.*

L. virens (Charp.). Metallic green; more slender than the preceding; pterostigma reddish (Hagen), black (Charp. Lib. Eur. pl. 34); thorax underneath with three black spots on each side; upper anal appendages pincer-like, with a small basal tooth, and dilated a little in the middle internally; the lower short, converging at the end, which is rounded and hairy. England, local; New Forest. Length 12 lin.; exp. 14 lin.

L. barbara (Fabr.). Metallic green, stout; pterostigma, one half dark, the outer half yellow; thorax without spots underneath; upper anal appendages pincer-like, with a small tooth at the base, and slightly swelled at the middle inside; the lower short, ends slender and diverging. Ireland? (one specimen in Dublin Museum. Hagen.) Length 12 lin.; exp. 17 lin.

b. *Pterostigma small, rhomboidal.*Genus *Agrion* (Fabr.).† *Head without spots behind the eyes.*

A. najas (Hansem). Dark bronze-green, light underneath; pterostigma darkest in the centre; thorax unmarked, or with a narrow yellow line at each side; abdomen (♂) tipped with blue on the two last segments; anal appendages of male leaf-shaped, turned outwards. England and Ireland. Length 13 lin.; exp. 18 lin.

A. minium (Harris). Deep red; pterostigma dark; thorax dark bronze, with a lateral stripe, red or yellow, on each side; legs black; abdomen has the segments towards the apex banded with dark bronze; anal appendages of the male long, rather curved; the lower bifid at the tip. British islands generally. Length 13 lin.; exp. 17 lin.

A. tenellum (Villers). Red; thorax dark bronze, without markings; legs red; anal appendages of male very short; the upper with a truncate tubercle; the lower simple. Local in the south of England. Length 12 lin.; exp. 14 lin.

†† *Head with a round spot on each side behind the eyes.*

A. fumilio (Charp.). Thorax black, with two blue lines in front; hind lobe of prothorax elevated, rounded; abdomen black, ninth segment blue (♂), and dark (♀); pterostigma (♂) dark in the centre. England, Ireland. Length 10 lin.; exp. 12 lin.

A. elegans (Van der Lind.). Thorax black, with two blue lines in front (according to Charpentier, these lines in the ♀ are yellow); hind lobe of prothorax narrow, much elevated; pterostigma dark in the centre; abdomen black, incisures of segments spotted with yellow, eighth segment all blue; British islands generally. Length 12 lin.; exp. 14 lin.

N.B. *A. fumilio* and *A. elegans* have each a variety of the female of an orange colour, the thorax without anterior dark stripes. (Hagen.)

A. pulchellum (Van der Lind.). Thorax dark bronze, with blue lines; posterior margin of the prothorax divided into three lobes, the middle one the narrowest and longest; pterostigma dark in centre; abdomen dark bronze, with short blue intervals; second segment (♂) blue with a forked dark spot reaching the hinder edge; abdomen of ♀ with two blue spots at the end of each segment. British islands generally. Length 12 lin.; exp. 14 lin.

A. puella (Linn.). Thorax dark, with blue lines; prothorax divided as above, but with the middle lobe sinuate; pterostigma dark; abdomen (♂) blue with bronze spots, a detached forked spot on the second segment, and eighth segment all bronze; in ♀ bronze, spotted at joints of segments with lighter tint of ground colour. British islands generally. Length 12 lin.; exp. 16 lin.

A. mercuriale (Charp.). Thorax dark; pterostigma dark; posterior margin of prothorax rounded; abdomen (♂) blue, spotted longitudinally with bronze; second segment with a peculiarly-shaped trifid spot reaching the hinder edge; in ♀, all bronze; tenth segment in both sexes with a broad notch. England. Length 10 lin.; exp. 14 lin.

A. cyathigerum (Charp.). Thorax blue; posterior margin of prothorax rounded; abdomen (♂) blue spotted with bronze; second segment with a heart-shaped spot reaching the hinder edge; eighth segment nearly all bronze; (♀) also spotted with blue, but bronze predominating; eighth segment with a stout spine on the under side. British Islands generally. Length 12 lin.; exp. 16 lin.

FREEZING OF BOILED AND UNBOILED WATER.—At Sheffield some of the ponds have been flooded during the late frosts with hot water, to give them a good surface for skating on. Can you or any of the contributors to SCIENCE-GOSSIP kindly tell me why water which has been boiled, freezes sooner and harder than unboiled?—*Thomas Winder.*

RECREATIONS IN FOSSIL BOTANY. THE FOSSIL FLORA OF THE HALIFAX HARD BED COAL.

No. II.

By JAMES SPENCER.

I PURPOSE to give a series of short popular sketches of the fossil plants found in the above coal-bed in the Halifax district. Every student of geology is acquainted with the external appearances of the common coal plants, but comparatively few know anything about their internal anatomy. The literature of the subject is not very extensive, and chiefly confined to high-priced memoirs, for the most part beyond the reach of the ordinary student. The chief authorities on this subject in England are Professor W. C. Williamson, F.R.S., of Owens College, Manchester, Mr. Carruthers and Mr. Binney. I can speak from personal experience of the value of Professor W. C. Williamson's Memoirs, published in the Transactions of the Royal Society. They are invaluable to the student of fossil botany, and too much praise cannot be given to the learned Professor for the scientific accuracy of his descriptions and the remarkable fidelity of his drawings. My object in writing these papers is not to attempt such full and elaborate descriptions as the above writers have done, but simply to give a brief and popular account (the result of my own labours) of the fossil plants found in the Halifax hard bed coal.

STIGMARIA.

Stigmaria is one of the oldest known fossil plants, and was formerly believed to have been a distinct plant, but it is now well known to have been the root of sigillaria and also of lepidodendron. Stigmaria is one of the hardest and most durable of fossils, and has withstood the action of denudation, even more than the rocks in which they were originally enclosed, and consequently its remains are found in the drifts, clays, and rainwashings, abundantly distributed through the carboniferous formation. I have occasionally seen its water-worn fragments clustered together in sandstone quarries, in such a position as to leave little doubt that they had been fossilised, and afterwards had been rolled about in the waters of the ancient carboniferous period, before being deposited in the sand-bed.

The natural home of the stigmaria is the seat-earth found under nearly all coalbeds, but not exclusively so, for the examination of these coal balls has shown that stigmaria formed no inconsiderable proportion of the coal itself. Its stems and rootlets penetrate the substance of the coal balls in all directions, being by far the most numerous fossils found in them; in fact, the rootlets are so numerous as to become the *bête noire* of the student. They turn up in all sorts of places,

among the tissues of all kinds of plants, filling up crevices and hollow stems, and sometimes causing such confusion among the various tissues as to sadly perplex even the wisest of us. So that it is necessary for the student to study their varied forms in order that he may be able to detect their presence wherever he may come across them.

When it is found *in situ* in the seat clay, the stigmata is seen to be a more or less cylindrical body of various thicknesses, and covered with long rootlets, which ramify through the clay in all directions. When dug out of the clay the rootlets fall off, leaving the dot-like markings which characterise the stigmata.

Neither main root, nor rootlets, in the ordinary

vessels, arranged in radiating lines, and here and there are lenticular spaces filled with muriform cellular tissue passing through the ligneous zone to the rootlets. These latter are the medullary rays of Brongniart, Hooker, and Williamson. These two different kinds of tissue are intimately related, and a fine muriform tissue surrounding the ligneous zone is the pseudocambium layer of Williamson. Then follow a series of laminae composed of both woody (prosenchymatous) and cellular (parenchymatous) tissues, the whole being enveloped by the thick epiderm.

This epiderm is composed of two distinct layers, the outer one having somewhat smaller cells than the inner one. The space between the ligneous zone and the epidermal layer is very frequently found filled

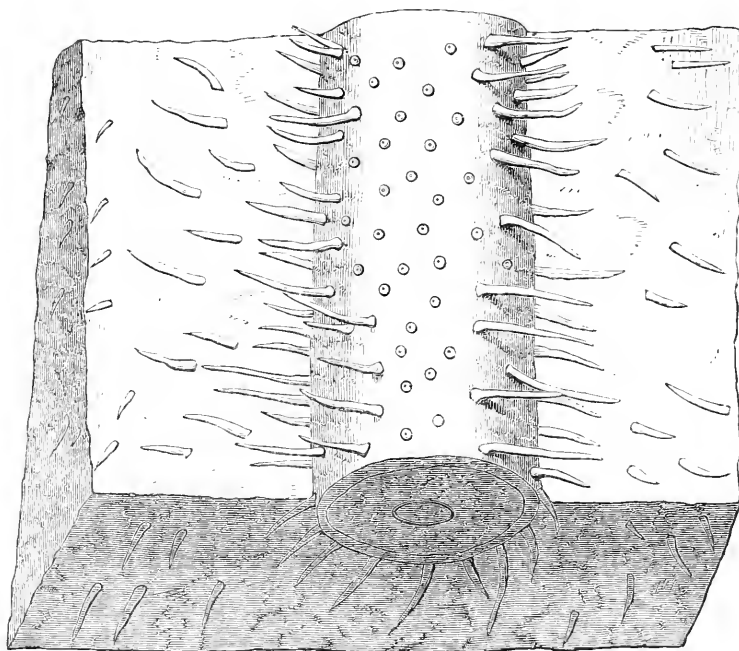

Fig. 56.—*Stigmaria fcooides*.

state of fossilisation show the original structure of the plant, but when they are preserved under peculiarly favourable conditions, such as obtain in the coal balls, their original structure is preserved in a most wonderful manner.

A well-preserved stigmarian root consists of a woody cylinder, composed of scalariform vessels which are arranged in radiating wedges, and a thick bark composed of both woody and cellular tissues, but chiefly the latter. The bark, however, is but rarely preserved in its entirety; its outer layer or epiderm is generally the only portion preserved, and even this is much less frequently met with than the woody cylinder. (Fig. 58.)

This woody cylinder is composed of large barred

with calcite, and with other stigmarian rootlets as the original tissues are rarely preserved. Herein lies one of the real difficulties that the fossil botanist has to contend with in studying the structure of the coal plants. In order to do this properly, it is necessary to examine a large series of specimens, for in one specimen one set of tissues may be preserved, and in another, another set. It is very rare indeed to find a fossil plant with all its tissues equally well preserved.

Stigmarian rootlets. Among the vast multitude of stigmarian rootlets met with in the coal balls, there are many varieties. Well-preserved specimens of some of these are most beautiful objects under the microscope, reminding one of the marvellous beauty of the transverse sections of some of the fossil fern stems.

I have a great variety of transverse and longitudinal sections of Stigmarian rootlets, some just emerging from the epiderm, and others after leaving the epiderm. In all these sections the outer of the two layers forming the epiderm of the main root is seen to be the one which forms the epiderm of the rootlets. The inner and more prosenchymous layer does not take any part in its formation. In many rootlets the outer layer seems to be again divided into two layers, having a dark line between them.

A true rootlet of *Stigmaria ficoides* consists, according to Professor W. C. Williamson, of a vascular axis of barred vessels surrounded by a layer of very delicate parenchyma and an epidermal layer, the place

REMARKS ON NORTH-AMERICAN PLANTS

DOG'S-BANE.

THIS plant (*Apocynum androsaemifolium*) is very common here along the banks of the Maumee River, generally growing best on the steep banks where but few other plants can retain their hold; but it is not confined to these situations, as it grows in borders of fields, and especially in cultivated ground. It attains a height of from one to five feet, and is much branched, this feature giving it the name of "Spreading Dog's-bane." The leaves are ovate, entire, and slightly petioled, opposite on the branches, which are red on the side towards the sun. The flowers are

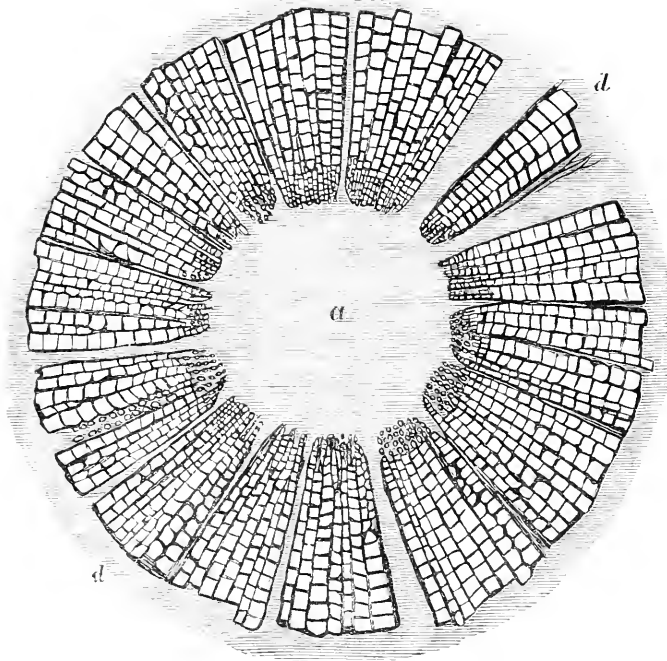

Fig. 57.—Transverse section of *Stigmaria* (mag. 35 diam.), showing radial arrangement of the vessels of the ligneous zone. *a*, Place of medullary pith; *d*, woody or ligneous zone.

between them being always destitute of tissue. But there are many other rootlets which have this space filled with tissue. The rootlets are not always found round, but they occur in all shapes and sizes up to a quarter of an inch and more in diameter. Their habit of insinuating themselves into all sorts of places caused them to modify their form according to circumstances.

(To be continued.)

THE WHITE GERANIUM (*G. robertianum*) has grown in a lane at Claverham, near Yatton, for many years, and now seems to be extending its growth to other parts.—*M. E. Winter.*

bell-shaped in a loose terminal cyme, somewhat nodding, nearly white, tinged with purple.

It commences to blossom in May, and blooms till late in August, at which time the mature fruit and all its intermediate stages can be seen. The fruit is a pair of long slender follicles slightly united at the tip, they contain numerous seeds. The whole plant abounds in a milky juice, which exudes in abundance wherever the plant is wounded. This juice is intensely bitter, and I would infer from the author of "Canadian Notes," p. 225, October SCIENCE-GOSSIP, that it contained strychnia, but no authority I have at hand speaks of this fact. The back of the root and the whole root is used in medicine. In large doses it acts as an emetic and cathartic, in small as a toni-

Its strength is much diminished by drying and keeping, especially the emetic property which is very marked in the fresh root much resembling ipecac. I once chewed a small piece of fresh root, and its nauseating effect lasted several hours. Its medicinal effect is due to the bitter principle, which is probably analogous to Apocynin, the active principle of the nearly related plant *Apocynum cannabinum*, L., and the effect of the plants is almost the same. The bark of the plant is tough and fibrous, and has been suggested for similar purposes to the common hemp, but I do not know if any use is made of it in this country. The bark also yields a dye.

About the middle of July last I came upon a number of the plants with ants examining the flowers in great numbers in search of the nectar. The ants would climb over the edge of the corolla and search the flowers very rapidly. I saw some flowers repeatedly visited in the course of a few minutes, but could see no change in the position of the petals. There were a great many small flies and gnats sticking to the flowers, and also many in the withered flowers. The day was cloudy and I did not get a chance to watch any bees visit the flowers. Good, in his "Family Flora" says, "Bees and other insects collect this honey, but small flies are often caught by inserting their proboscis between the fissures of the anthers, whence it is not so easy for them to extricate it; they are often seen dead in that confined situation after unavailing struggles."

The plant has many common names, as bitter root, dog's-bane, flytrap, catchfly, wandering milkweed, ipecac milk, &c.

Toledo, Ohio.

JAS. A. SANFORD.

NOTES BY A NATURALIST IN MAURITIUS AND GREAT BRITAIN.

By WILMOT H. T. POWER, B.A., M.R.C.S.

[Continued from page 59.]

THE so-called Smallpox in Chickens.—In Mauritius large numbers of the chickens are reduced to mere skeletons, with a dry scaly eruption on the skin, leaving more or less bald patches especially about the head and neck. I found this was due to the presence of Lumbrii in such numbers that the interior of the intestines was so irritated as to be as red as a soldier's tunic; emaciation and eruption were due simply to starvation. At one station we kept our poultry in a large enclosure covered over with a net, and taking care none but clean water, and frequently changed, was given them. We had no disease, and fine chickens. About 100 yards off at a lighthouse, it was always present, but the poultry there drank from a very dirty small pool. I feel inclined to say Mauritius had degenerated from being the land of the Dodo, to the land of the Lumbrii.

Affection of a Chicken.—The above heading may seem rather absurd, but, as an instance of quick appreciation of a benefit, I preserved it. A soldier found a chicken of almost eatable size lying insensible in the sun one hot morning; as a matter of course, it was brought to me. I had just finished my bath, so I dipped it into it several times, occasionally swinging it in the air; it recovered and would not leave me. Shortly after I was skinning a sea-fowl, the chicken hopped on to the arm of the chair, and then perched on one wrist, and quietly pecked away at morsels of flesh, enjoying the meal much. However, it became so troublesome that I had to send it away; it would have nothing to do with any one but me.

Occurrence of Helix aspersa in Mauritius.—I do not know if this has been recorded. One morning, about the year 1865, in a garden up among the hills, we came across three or four of these snails, under some shelter. My two companions—one the owner of the garden, and both naturalists—had never seen this species before in the island. There were European vegetables growing, and as the temperature and moisture were quite suitable, the only question was by what means they got there, though we know the snails can live for long sealed up and dormant.

The Omnivorous Rat.—Besides finding the common Hanoverian rat in bird's nests, &c., I killed several, and found their food was small Crustacea, different species of which abound on the Mauritius shores.

The Gaps in Seychelles Pigeons.—The body of one of these was sent to me to find out cause of death—the symptoms had been simply gasping for breath—there were a number of worms (*Scelerosoma syngamus*), adhering to the trachea. A second was sent me with twenty worms; a third was so far gone that it died while I was opening the windpipe, it had ten worms; a fourth bird was sent before the suffocation had gone too far. I opened the passage, and with a pair of curved forceps drew out some worms, and with a simple blowpipe sucked up the rest, they being caught in the tube. As I had no tube to fasten in, I had for some fifty hours at intervals to suck up the blood through the blowpipe. The bird was sent home well. Various remedies had been tried, and I myself tried such as garlic, tickling with a feather, &c., but they were of no avail. The birds came from a spacious and well cared-for aviary.

The scent of the Hare.—Kingsley in his "Glaucus" asks for some one to explain the mysterious laws of scent. I merely give one or two instances connected with it, very likely noticed before; if so, they may strengthen previous observations. Twice when hunting with foot-beagles, the scent having been strong in the morning vanished in the afternoon, though we ourselves felt no change in the weather, but in the evening a very severe frost set in on both occasions—here the scent was early affected by the coming cold. Again, on a bright summer day with a cold dry wind,

the scent was very faint on the grass and heather, but strong in some very dirty lanes; here dry dust held the scent. At Gosport (an east wind prevailing) several times, when the scent had been very cold over plough and grass, it was strong along a strip of shingly beach. This puzzled me for a long time, but I think it was due to the pebbles being moist from the encrusted salt, or their absorbing any moisture in the air. Of course if it be an east wind with damp, then the scent would be excellent.

Effects of characters of food and water on fresh-water fish.—No doubt an old story, but perhaps worth recording. Near the Curragh Camp, Ireland, was a large pond through which a very small stream ran. The trout in it were splendid in colour and flavour; there was clear water and plenty of American weed with caddis worms. Near Waterford, was a bog with good-sized pools (from former excavations of peat) and the river at times flooded it. These pools were full of American weed, on which were herds of caddis-worms. The water was perfectly clear, though dark-looking in the pools from the colour of the soil. The roach here, for example, had no trace of the so-called muddy flavour. Indeed, on one occasion, salt fish not being procurable, they were served up in fillets with bread-crumbs, and a guest well versed in the good things of the table thought he had been eating soles.

NATURAL HISTORY IN WINTER.

THE FROZEN-OVER PONDS.

PONDS and ditches ever swarm with living creatures in various forms—even during the hardest frosts just as in the warm months of summer. The following notes on some examples of these beings may be useful or interesting to your readers.

Many species of aquatic insects live through the winter in a state of hibernation, burrowing in the mud and among the roots at the bottom of ponds, &c. When frosty weather sets in they are found snug in their hiding-places, and while the water above is converted into a vast sheet of ice they are beneath safe from the cold. Then when the red winter sun sends forth his warm rays these insects are seen through the ice swimming about in search of the now scarce food. They are chiefly beetles and the various species of water bugs or boatmen (Notonectidæ). The latter especially are plentiful, they are found throughout the whole winter and seem capable of sustaining unharmed a considerable amount of cold, although I have frequently seen great numbers lying dead upon the ice. They also congregate (and notably those of the genus *Corixa*) among the water weeds, and are easily obtained by taking up pieces of ice into which are frozen large masses of aquatic plants and shaking them over brown paper. Indeed, I find it remarked by Mr. Westwood that he has seen numbers under

the ice, apparently torpid, grasping each other with their legs. While treating of these insects it may be well to mention that their semi-transparent elytra form admirable microscopic objects for winter examination. They are easily mounted in Canada balsam, not being liable to air bubbles. Under a low power the surface is seen to be covered over with beautifully-designed circular patterns. A variety of good slides may be made any winter's evening from one of these common insects. And I know of no more productive situation for obtaining objects for the microscope during the barren months than a breach in the ice covering a vegetation-grown pond or ditch. In an aquarium they are also interesting creatures to watch; I usually have a vessel of water set apart for their own special benefit. It is most amusing to watch their merry gyrations and to hear the constant "tick! tick!" produced by their hard heads striking against the sides of the vessel. Of course they are obliged to come to the surface to breathe, and frequently they float upon their side as if they were dead. Water bugs—some of which are extremely small, and others nearly an inch in length—have the power of emitting a very sickening and lasting odour. I find them very sensitive to light, for on suddenly bringing a burning candle near them at night, they immediately start from their hiding-places and dash about as if at some material foe. They soon however become accustomed to the unnatural brightness. *Notonecta glauca* is a common boatman often seen under the ice. The much-dreaded *Ranatra linearis*, closely allied to the water scorpion, is sometimes met with in a similar situation.

Passing to beetles, the common whirlwig (*Gyrinus natator*), at all times a very social creature, is met with in companies beneath an icy covering. In summer the surface of ponds are often black with their numbers: when any individual takes alarm the entire colony scatters; some of their black forms are seen to disappear below, while others seek shelter among the water plants. There are several species of Gyrinidæ that congregate on sunshiny mornings where the ice is broken or melted. Of the numerous other hibernating beetles may be named the large *Dytiscus marginalis*, often found beneath the ice in a torpid condition. *Agabus bipustulatus* and *A. paludosus* are even more common in the same situation.

Of aquatic larvæ that are plentiful, a good example is that of the May-fly (*Ephemera vulgata*)—a beautiful object for the microscope. The flat plates attached by slender pedicles at each side of the body, the gills of the larva, are well worthy of examination. When the creature is not actually swimming—and by the way, it swims by a lateral vibration of the body exactly like a tadpole—these gills keep up a sort of to-and-fro motion. Through the transparent body is seen the long alimentary canal

with the tubes comprising the respiratory system on each side, ramifying into the gills.

The *Skeleton*, or *Phantom larva* (that of a fly, *Corethra plumicornis*) is also found in winter, notwithstanding its fragile nature. The popular names given to this strange creature well agree with its weird and ghostly aspect: nothing can be imagined

The water of almost every pond, ditch, and stream contains countless little creatures—some hardly visible to the naked eye—swimming about with great rapidity, known as Entomostraca. All workers with the microscope, and all such as search after the secrets of pond-life, are familiar with the commoner species. The common Cyclops (*Cyclops quadricornis*)

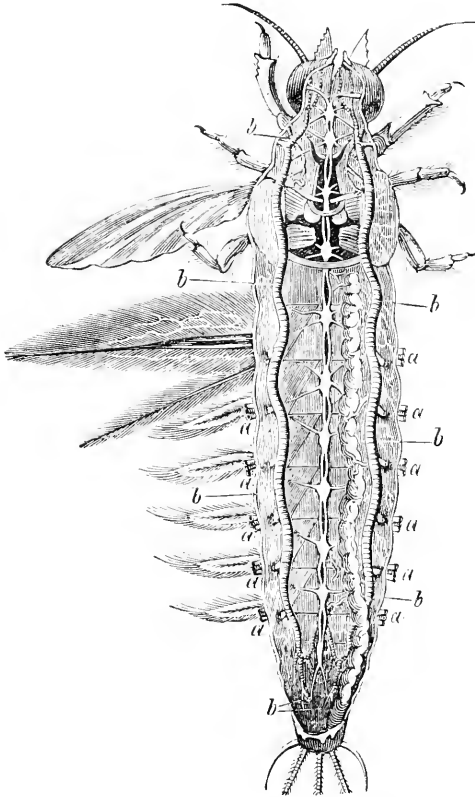

Fig. 58.—Larva of *Ephemera*. *a, a, a*, Spiracles; *b, b, b*, lateral tracheae; the chain of nervous ganglia is seen running up the middle.

more like an aquatic phantom than the shadow-like form of its almost fluid body, while it is the very picture of the skeleton of a larva. Despite its apparent delicacy, it is armed with a formidable mouth-apparatus, for its food consists chiefly of the lively little Entomostraca, which it seizes by imperceptibly twisting its little body up to the intended victim and then making a dart.* Another notable larva is that of the dragon-fly: an enormously cruel life-destroyer, almost as voracious as that of *D. marginalis* and far more cunning. Passing over this larva, together with those of many flies, gnats and water beetles, we come to a class of animals differing much from the preceding, and well suited for microscopic study.

* A very full account of this curious larva, with accurate figures, will be found in SCIENCE-GOSSIP for 13-3.

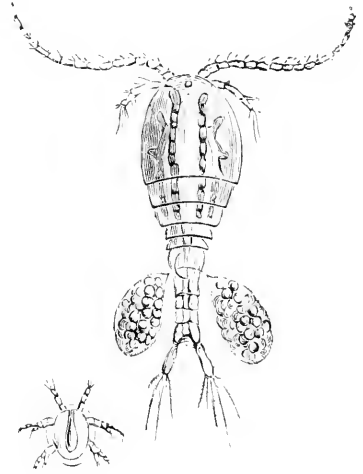

Fig. 59.—*Cyclops vulgaris* (female, and young).

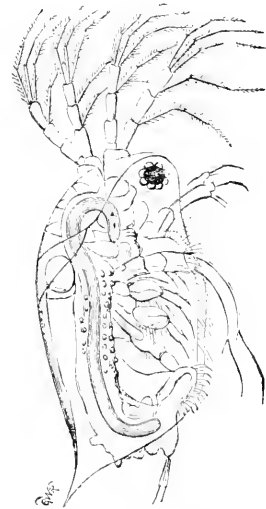

Fig. 60.—*Daphnia pulex* (male, magnified).

is perhaps the most abundant species of this numerous tribe. All the year round it occurs in nearly every stagnant pond, as well as in the clearest spring-wells; even in winter its multitudes swarm in water containing duckweed (*Lemma*). The female is much more plentiful than the male, from which she is distinguished by the long antennae, which are smooth

and tapering, while those of the male are shorter, thicker, and clubbed at extremity. The female, also, bears (except during a part of winter) large external egg-sacs, each containing from thirty to forty ova.

that it was long thought to be a distinct species. Almost as prodigiously prolific as the Cyclopidae are the merry little water-leas (Daphniadae). There are at least seven known British species, of

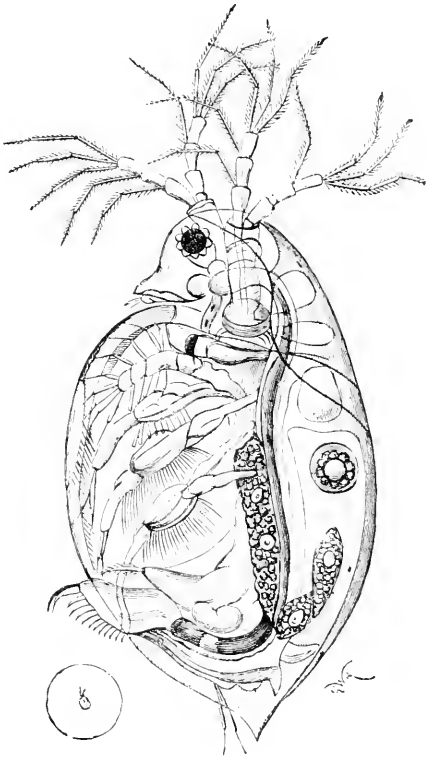

Fig. 61.—*Daphnia pulex* (female). The small figure within the ring shows the nat. size.

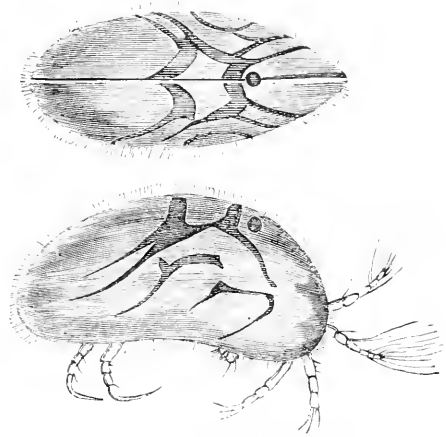

Fig. 63.—*Cypris ornata* (magnified).

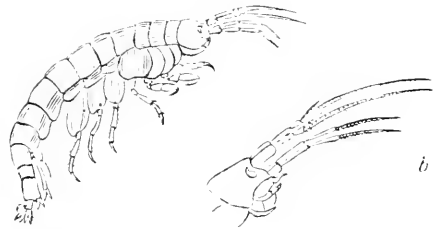

Fig. 64.—Freshwater Shrimp (*Gammarus pulex*).
b, Head of *G. pulex*.

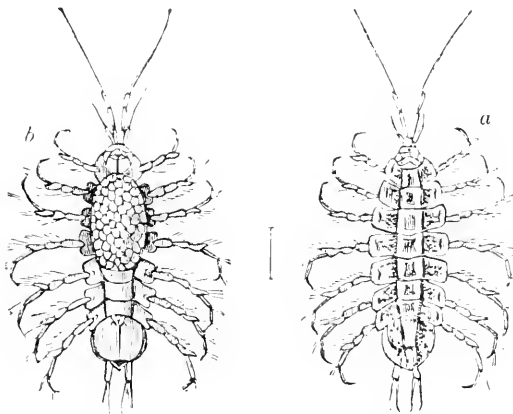

Fig. 62.—*Isolus aquaticus*. The line between the figures indicates the nat. size. a, upper side; b, under side.

These do not become larger while in the sac, but they alter in colour until, in from two to ten days, according to temperature, &c., the queer-looking young Cyclops issues forth so totally unlike its parent

which *Daphnia pulex* is the commonest, and is to be taken all the year round. Sometimes *pulex* is seen in horse-ponds, &c., in such multitudes that it forms a rust-red cloud which moves about in the water, guided

by some mysterious impulse, and may completely wheel round the pond. The food of the Daphniadæ, as well as of the Cyclopidæ, probably consists chiefly of animalcules, although the former doubtless eat vegetable matter also. *Cypris* is another genus of interesting Entomostraca. Dr. Baird describes fifteen British species. Nothing can be more curious than the characteristic way in which they spin through the water, and then suddenly sink motionless to the bottom, when they can hardly be distinguished from minute mussels. *Chydorus sphericus* is hardly visible to the unaided eye, just appearing as a white speck moving or rolling about in the water. In winter it is very common in some ponds, and of course during summer more so. Pritchard asserts that the young swim to the mother when danger is near; she permits them to enter her shell, and then closes it.

The water bog-louse (*Asellus aquaticus*) is another Crustacean found in stagnant ponds in winter. Leisurely does it crawl along the bottom, but if alarmed it runs with considerable speed, sometimes tumbling over objects in its haste. The freshwater shrimp or freshwater screw (*Gammarus pulex*) hibernates whenever cold deprives it of food.

All the freshwater Molluscs may be obtained during winter. The pond snail (*Limnaea stagnalis*) for instance in some ditches almost completely covers the bottom. *Planorbis cornus* and its smaller relation, *P. vortex*, are also found. Omitting the numerous tribes of small worms, I shall only mention one other example of the animals any person may study during the cold weather by hunting for them in any pond or ditch. The common leech (*Aulostoma gulo*) generally chooses for winter quarters either the mud at the bottom or under the stones near at hand. As it lives chiefly upon the earth-worm (*Lumbricus terrestris*) which burrows deep in the earth beyond the reach of the frost when it comes, it is content to fast as long as the weather remains cold.

C. FRANCIS YOUNG.

BOTANICAL NOTES FROM THE SWISS HIGHLANDS.

III. ZONES OF VEGETATION: THE RIGI.

By DR. DE CRESPIGNY.

[Continued from page 51.]

2. MIDDLE and lower forest belts. *Anthriscum ramosum*, a straggling plant, with grass-like leaves and white stellate flowers; rocks and banks. *Amelanchier vulgaris*, a pomaceous shrub, rocks and banks. *Asperula laurina*. *Adenostyles glabra*, a coarse-looking plant, with burdock-like leaves, and inflorescence, especially in bud, like Eupatorium. *Andromeda polifolia*, N.W. ascent, on the Seeboden pasturage in swampy places. *Aconitum napellus* and

lycotonum, former on pasturage; latter, bushy places. This has yellow flowers smaller than those of the ordinary species. *Allium alpinum*. *Arabis ciliata*, above Gersau. *Bellidiastrum Micheli*, like a very large *Bellis*, wet places; flowers sometimes of a purple tinge. *Carex tenuis*, Klösterli. *Carex fulva, dioica, pauciflora*, Seeboden pasturage. *Carex humilis* and *ornithopodioides*, on rocks. *Cyperus longus* and *flavescens*, Kussnacht. *Crepis blattaroides*, Seeboden pasturage. *Corydalis cava*, near Kussnacht. *Cyclamen Europeum*, ascent from Kussnacht (plentiful on the Axenstrasse near Fluelen, among barberry and other bushes; here, also, on dry, grassy places, *Salvia pratensis*). *Cochlearia saxatilis*, rocks. *Campanula pusilla* (= *caespitosa*), rocks. *Campanula urticifolia*. *Cypripedium calceolaria*, above Vitznau. *Colonyaster vulgaris* and *tomentosa*, rocks and banks. The latter has larger leaves, white beneath. *Coronilla emerus*, a straggling shrub, with yellow flowers; pods curious; long, narrow-jointed. *Digitalis lutea*, dry banks; flowers yellow, half the size of our species, and the representative of it in habit of growth and in frequency. *Digitalis grandiflora* (= *ambigua*), bushy places; flowers not larger than those of *purpurea*; yellowish corollas, faintly spotted. *Dianthus superbus*, flowers large, petals pale pink, deeply fringed; dry banks. *Dentaria digitata*, flowers rose-coloured, but smaller than in our species; ascent from Arth. *Epipogium Gmelini*, beechwood above Weggis. *Eptactis fallens, ensifolia*, and *rubra*, here and there on the south slope; flowers small, of a dingy red colour in the last-named species. Seems to correspond with *E. ovalis* of the London Catalogue. *Euonymus latifolius*, ascent from Kussnacht. *Eriophoron alpinum*, marshy places, Seeboden. *Festuca sylvatica*. *Geranium sylvestris*. *Galium sylvaticum*. *Gentiana lutea*, pastures, plentiful on the ascent from Vitznau. A tall plant of widely different habit to its congeners; three feet high or more, with large opposite ovate connate five-nerved leaves, which are translucent and beautifully reticulated. Flowers yellow, subsacciate, verticillate, terminal and axillary, corollas deeply 5-9-fid; segments narrow, spreading; of great repute as a bitter tonic. *Gentiana asclepiadiacea*, somewhat like *G. pneumonanthe* in habit; leaves ovate, acuminate. *Gentiana ciliata*, this has a four-cleft corolla. *Heptatica triloba*, plentiful in damp places among the boulders; ascent from Weggis. *Heracium rigidum*, here and there. *Hordeum sylvaticum*. *Impatiens noli-me-tangere*, damp places, frequent. *Lonicera nigra* and *xylosteum*, both frequent. *Laserpitium latifolium* (= *glabrum*). *Lucula nivea*. *Mentha sylvestris*, frequent in wet places, mentioned merely to introduce the remark that the species is more often met with than any other on the Alps. *Melampyrum sylvaticum*, up to the beech limits. *Orobanchis*, species uncertain, on rocks, ascent from Vitznau. *Polygala chamaebuxus*, a somewhat suffruticose plant, occurs also high up, in company

with rhododendrons; has yellow, rather large papilionaceous-looking flowers, and oval or elliptical entire leaves with a mucro at the point. *Parnassia palustris*, frequent. *Pinguicula vulgaris*, wet, grassy places, common. *Pyrola media*, ascent from Kussnacht. *Pyrola minor*, Klösterli. The species of wintergreen most frequently met with in the pine woods at low elevations is *P. secunda*. *Pyrola rotundifolia*. *Rhynchospora alba*, Seeboden. *Ranunculus lanuginosus*. *Sambucus racemosa*, berries red. *Spiraea aruncus*, a handsome shrub with pinnate leaves and a large spreading inflorescence; worthy of cultivation. *Salvia glutinosa*, banks; flowers yellow; stamens and calyx glutinous; leaves rough, cordate. *Saxifraga aizoides*, mountain rills. *Saxifraga aizoon*, rocks. *Saxifraga mutata*, mostly below Kaltbad. *Saxifraga rotundifolia*, wet places; a tall plant with white stellate flowers, but the leaves are more reniform than rotund. *Stellaria nemorum*. *Spiranthes autumnalis* and *estivalis*. *Semprevivum tectorum*, *Sedum dasyphyllum* and *album*, rocks. *Thalictrum aquilegifolium*; flowers rose-coloured, handsome; damp places. *Tofieldia calyculata*, common. *Tozzia alpina*, wet, rocky places under the Schnee Alp; ascent from Arth-Goldau; a small, slender annual, with pale yellow axillary flowers. *Thesium alpinum*. *Veronica tripteris*, up to 3000 feet. *Veratrum album*, ascent from Goldau. *Vicia sylvatica*, above Gersau.

3. Generally on the upper parts of the mountain of which many may be met with by the ascents onwards from Kaltbad. *Alchemilla alpina*. *Androsacea chamaejasme* and *villosa*, small plants of the primrose order; rocks; generally in company with one another. *Athamanta Cretensis*, stony places. *Astrantia minor*, a slender plant with digitate leaves; umbels and florets small; involucrel bracts large in proportion, persistent. *Arbutus alpina*. *Arenaria ciliata* and *saxatilis*. *Anemone alpina*, rocky places. *Anemone narcissiflora*, inflorescence in terminal umbels of three to five flowers. *Arabis alpina* and *bellidifolia*. *Arnica montana*, pasture above Kaltbad; flowers deep orange-yellow; much used in medicine by continental doctors, mostly as an external remedy. *Aster alpinus*, ligulate florets blue in a single row. *Agrostis alpina* and *rufestris*. *Bartsia alpina*. *Campula linifolia*. *Cerastium alpinum*. *Crepis aurca*, very common. *Chrysanthemum montanum* and *cornopoliolum*. *Dianthus sylvestris*. *Dryas octopetala*. Kulm. *Draba aizoides*, rocky places. *Erica carnea*. *Epilobium alpinum*. *Erinus alpinus*, corolla small, pale purple with darker lines. *Erigeron alpinum*. *Festuca alpina*; *pumila*, scarce; *Scheuchzeri*, *Halleri*. *Globularia nudicaulis*, rocky places; flowers in heads; dull blue, like *jasione*. *Gentiana verna* and *Bavarica*. *Gentiana punctata*, flowers yellow like *lutea*, and translucent, faintly spotted; a smaller plant; pasture above Kaltbad. *Gentiana acaulis* and *nicialis*, scarce. *Geum montanum*, flowers rather large. *Gnaphalium dioicum*. *Hydysarum obscurum*. *Hieracium alpinum*,

Scheideck; *caesium*, Staffel; *amplexicaule*, *villosum*, *glaucum*. *Ilabenaria albida*, pastures frequent; *viridis*. *Homogyne alpina*, a plant with the habit of colts-foot; leaves very small, petioles short, capitula on long stalks; involucrel scales purplish. *Leontodon croceum*, Scheideck. *Lonicera alpigina*, Vitznau stock. *Myosotis alpestris*. *Orchis globosa*, pastures. *Plantago montana* and *alpina*. *Primula farinosa*; *auricula*, corollas yellow. *Polygonum viviparum*, pastures, common. *Potentilla aurata*, frequent; *caulescens*, Urmiberg; *Salisburgensis*, rare. *Pinguicula alpina*. *Pedicularis foliosa*, *verticillata*. *Phleum alpinum*. *Poa vivipara* (= *alpina*); *distichophylla*, Scheideck. *Rumex arifolius* and *scutatus*. *Rhododendron hirsutum* and *ferrugineum*, under surface of the leaves in one species ferruginous from the scale-like glands which cover it; under surfaces in the other also scaly, but not to the same degree; margins hairy and corollas of a paler shade of rose. *Rosa alpina*, sepals remarkably long, slender, and persistent; petals crimson. *Ranunculus montanus*, highest pastures; *alpestris*, a small plant with white petals and 3-5-partite leaves; wet places, but terrestrial; no multifid leaves. *Sveertia perennis*, marshy places, Dossen; a gentian, but differing from its congeners in having a rotate corolla, greyish-blue; each segment furnished with two nectariferous pores. *Sibbaldia procumbens*, stony places. *Saxifraga stellaris*; *oppositifolia*, near Kulm. *Spergula saginoides*, Kulm. *Sedum atratum*, Kaltbad. *Sonchus alpinus* (= *Mulgedium*), wet, grassy places, rare. *Salix retusa*. *Soldanella alpina*. *Trollius Europeus*. *Trifolium badium*, heads of flowers yellowish. *Veronica aphylla*, *alpina*, *saxatilis*, rocks. *Veronica fruticulosa*, rocks, less frequent. *Viola biflora*, flowers yellow, more usually single than in pairs. *Vaccinium Vitis-Idæa*. Ferns nothing out of the common. Mosses, many to be noticed hereafter.

A frequent service of steamers on the lake admits of ready access to every place of resort on its shores. But any one wishing to collect in the neighbourhood of the Rigi, will find Brunnen more conveniently situated than any other place for exploring the Axenstrasse and many secluded nooks on the bay of Uri, as well as for making excursions on the mountain itself. The comparative mildness of the climate in many of these sheltered recesses fronting the south is apparent in the luxuriance of the walnut-trees, figs, and Spanish chestnuts which have been planted there.

(To be continued.)

LIST OF ASSISTING NATURALISTS.

[Continued.]

MIDDLESEX.

London. R. E. Holding, 12 Charlton Road, Harlesden, N.W. *Mammals and Birds*; also *Skins, Skeletons, Skulls*, &c.

MICROSCOPY.

MOUNTING STARCHES.—Few objects when viewed by polarised light are more lovely than the starches. They are generally mounted in the same way that algae, mosses, &c., are prepared for examination, viz., by placing a small quantity on a slide and then applying the balsam; but if the following method be adopted slides may be obtained, which, for freedom from air bubbles and the even distribution of the component particles, cannot be surpassed. Pour into a test tube a sufficient quantity of Canada balsam to mount as many slides as may be required, and heat over the flame of a spirit-lamp. When the balsam becomes thin, dredge into it, through muslin, the starch to be mounted. The air bubbles which will then appear must be caused to burst, either by again heating the balsam, or by diluting it with turpentine. The starch may then be mounted by taking up a small quantity with a dipping tube and placing upon a glass slip, and covering with a thin circle or square previously warmed. I have never seen this mode described in any work, it being my own; but I am sure if those who study the science of microscopy will give it a trial, they will use it in preference to any other.—*A. J. D.*

PRESERVING FLUID.—Having been engaged in examining and preserving animalcula, I find the following fluid keeps and instantly kills all living species, so as to preserve the natural and life-like forms: 25 grains of alkaline nitrate of chlorine, 10 grains cobalt chloride (this preserves the green colour), 15 grains of aniline com., 15 grains of spirit of wine, 2 grains of carbolic acid, 40 grains of distilled water. Shake and filter; keep in well-stoppered bottle.—*R. Atkins, F.R.M.S.*

A NEW VIVARIUM.—Mr. J. D. Hardy has introduced a new vivarium to the members of the Quekett Club, the particulars of which will be published *in extenso* in the Quekett Club journal. It consists of one or more indiarubber rings cemented on to one piece of glass, which is then covered with another piece, and the whole is held together by springs, either of indiarubber or steel. It is made to be quite watertight, and the vivaria will be obtainable of Mr. Stanley, of London Bridge. Mr. Hardy has recently written to us as follows: "My attention has been called to a 'live cell' very similar to mine in 1879 (p. 38). I was quite ignorant of this when I contrived mine, but it will be found on comparison that the two cells have quite different uses. Mr. A. Smith's is nothing more than a compressorium, whereas mine is really a 'live cell,' growing cell if you like, as the object can be placed in a beaker of water and kept alive the same as in the ordinary trough. I can see at once—from experience—that Mr. A. Smith's cell is almost useless, as filling the cell before putting

on the cover glass would completely disarrange most objects. My vivarium combines many other uses not to be found in any other arrangement that I know of. It is but right that you should be made acquainted with this fact (the similarity of construction), in any comment you might make. I am, however, quite content to let it live or not on its merits."

THE CRUST ON TEETH.—The soft, white, pap-like substance, which collects about the roots of the human teeth, is seen under the microscope to consist chiefly of immense numbers of rod-like filaments. What are these?—*E. J. H.*

DULLNESS IN OBJECTIVES.—I think the dullness is caused by what is termed "sweating." That is to say, certain kinds of glass are always covered with a film of moisture on exposure, i.e., they appear to be hygroscopic and in time lose their lustre. The defect is to be attributed to an imperfect composition of the glass. J. H. Dallmeyer, F.R.A.S., in an article on the subject says, "I would remark that in our present state of knowledge glass may be described as a mechanical mixture, i.e., a silicate of at least two metals belonging to different groups, one of which must be an alkaline metal; and there can be no question that the nearer these ingredients approach atomic proportions the better is the resulting glass." But the point of saturation of the silicate varies with the temperature of the furnace, and hence it results that no two pots, even of optical glass, are precisely alike in composition. To ascertain the defect of sweating it is only necessary to wipe a glass, then to expose it in a comparatively even temperature in a room, and observe whether after the lapse of a few days the passing a finger across it indicates a film of moisture.—*E. A. Brown.*

MR. BOLTON'S "PORTFOLIO."—We are pleased to acknowledge the receipt of the now well-known "Portfolio of Drawings," containing descriptions of the living organisms (animal and vegetable) illustrative of Freshwater and Marine Life, which have been sent out with the living specimens by Mr. Thomas Bolton, F.R.M.S., of 57 Newhall Street, Birmingham. It contains well-executed plates, and good descriptions of the following: in the vegetable kingdom—desmids and diatoms, *Æcidium urtica*, *Zygomma cruciata*, *Vallisneria spiralis*. In the animal kingdom—*Acinetus*, *Dendrosoma radians*, *Choano-flagellata*, *Bursaria truncatella*. Marine infusoria—*Nassioda ornata*, *Spirostromum teres*, *Cordylophora lacustris*, *Lucernaria auricula*, &c. &c.

FLOSCULARIA, &C.—From a pond in this neighbourhood (Canterbury) I procured last week some beautiful specimens of *Floscularia campanulata*. One of the creatures has ova in a very advanced stage of incubation. I found them adhering to some *Nitella flexilis*. Is not this remarkable, considering the time of year and severe weather we have?—*Tom B. Rosseter.*

MANCHESTER MICROSCOPICAL SOCIETY.—This young and prosperous society held its first annual *soirée* on February 26th, when the Rev. J. G. Wood, M.A., F.L.S., delivered a lecture on *Unappreciated Insects*. He said that if he were to describe all the insects that were unappreciated he should have to include the whole of Entomology; he therefore selected three of the most intensely disliked, namely, the cockroach, the earwig, and the gnat. Having intimated that he was about to give a "sketch lecture" rather than a lecture as generally understood, he proceeded to sketch on the blackboard with variously-coloured chalks, figures of the insects as he described their structure and related their natural history. The president of the society proposed a hearty vote of thanks to the lecturer, which Professor Williamson seconded, remarking that Mr. Wood's was a model of what a popular scientific lecture *should* be. There was a very extensive exhibition of microscopes and microscopic objects, both living and mounted. Among the live specimens of pond life may be mentioned a fine example of the Bell-flower animalcule.

ZOOLOGY.

"A LIST OF BRITISH BIRDS."—Mr. H. W. Marsden (Gloucester) has compiled a list of British birds, with, as an appendix, the "Graduated List" for labelling eggs. This "list" has been put together with the view of giving to ornithologists and oologists a trustworthy catalogue of the birds of Great Britain and Ireland, resident and migratory, and occasional or accidental visitors. It offers also the advantage of enabling one to determine at sight to which of the great divisions, just enumerated, any bird may belong; and in addition the habitat of each occasional or accidental visitant is affixed. The authority for each scientific name is given, not only each specific name, but for the generic name also. The appendix, which is printed on specially prepared gummed paper, ought to be in the possession of every egg collector.

BRITISH NEWTS.—I notice in SCIENCE-GOSSIP for this month in your answers to correspondence, this statement: "Only four kinds of newts are known in England. See Cooke's 'British Reptiles.'" Perhaps you will allow me to refer you to a note in the "Zoologist," vol. iii. p. 61, wherein it is stated that from an article by M. Ferrand Lataste, "it appears that the supposed fourth species of British newt, Gray's banded newt (*Ommatotriton vittatus*) of Cooke's 'Reptiles' may be altogether removed from the British catalogue." "It was first introduced into the British list by Jenyns, 1835, on the faith of some specimens found in a bottle in the British Museum by the late Dr. Gray, which, being associated

with some British newts, were supposed to have been obtained in the neighbourhood of London." "It now turns out, from M. Lataste's researches . . . that the so-called *Triton vittatus* is no other than the *Triton ophryticus* of Berthold, an eastern species of newt which is found in Syria and Asia Minor. The British newts are now therefore reduced to three in number: the crested newt (*Triton cristatus*), the smooth newt (*Triton tenebrosus*) (both of ordinary occurrence), and the rarer palmated newt (*Triton palmatus*)."—"Nature," 28th November 1878. Perhaps in a future number you may inform J. E. R. of this.—*Oliver T. Aplin.*

BIRDS FEIGNING DEATH.—I have never heard of the water-hen feigning death, as described by Mr. Lett, but I have heard of its not very distantly allied relative, the landrail, doing so. I read some time ago in an ornithological work, the name of which I do not now remember, of a bird of this species, supposed to be dead, allowing itself to be handled and examined and finally placed in the pocket of its captor, from which it soon afterwards escaped and flew away as if nothing had happened. This was evidently a case in point. Another correspondent asks which English bird is "the hardest to kill." Some mowers who were cutting hay sliced off the head of a landrail on her nest; the decapitated bird immediately flew across the field—a distance of one hundred yards I believe—and striking against a wall, or some railings, fell down dead.—*J. H. G., jun.*

THE WILD BIRDS PROTECTION ACT.—On March 1st the Wild Birds Protection Act, 1880, came into operation, and until the 1st of August it will be illegal to kill or take any wild bird in Great Britain. Only owners and occupiers of land or any person authorised by them are allowed to kill or take wild birds on such land that are not included in the Schedule of birds attached to the Act. The Schedule includes, besides a large number of sea birds, the following land birds—cuckoo, goldfinch, kingfisher, nightjar, nightingale, owls, plovers, woodpeckers, &c. The penalty for any person (not an owner or occupier of land or authorised by such owner or occupier) for killing or taking any wild bird not in the Schedule is 5s. for each bird and costs. Any one, whoever he may be, killing or taking a bird mentioned in the Schedule is liable to a penalty of 1*l.* for each bird. The Royal Society for the Prevention of Cruelty to Animals announce their intention of enforcing the statute, and notice of an infringement of the Act should be given to the police or to the Society. We hope all genuine ornithologists, rich and poor, will do their best to educate the people up to the morality of respecting all kinds of wild birds, during their breeding season, at least.

NOTE ON HYALINA DRAPARNALDI BEING FOUND IN ENGLAND.—For some time I was perplexed over a large hyalina (*Zonites*) that I found at Clifton and

Torquay some three years since. My friend, Dr. O. Boettgen of Frankfort has kindly examined specimens for me, and pronounces them beyond doubt to be *Hyalina Drafarnaldi* of Beck. I find that Albers gives England as a locality for this shell (which is usually found more to the south of Europe), but I am not sure that any English author has admitted it into the list of British shells, although it is larger and far handsomer than any of the other British species. I can now give three localities for this beautiful shell, Clifton, Torquay, and Guernsey. I heard from a gentleman at Berlin, a short time since, that it has been found in the Palm Gardens there, brought, it is supposed, with shrubs and plants from the south, and so colonised. He sent me specimens, but they are not equal in beauty to those of Britain. Mr. G. Jeffrey does not separate *hyalina* from *zonites*; there is a difference in the animals, although not in the shell. *Zonites* possess a porous membrane in the foot that *hyaline* has not.—*J. Fitz-Gerald, Folkestone.*

A NEW LEAF-CUTTING ANT.—In the February number of the "American Naturalist" Mr. K. G. Morris has a short article describing a new species of leaf-cutting ant, obtained last July at Island Heights, on the New Jersey Coast. The worker is a fraction over an eighth of an inch in length. The male and female are nearly of a size, and but little larger than the workers. The head is rugose and dark, and a dark band runs down to the point of the abdomen. The entire body surface is rough and hard.

RARE VISITANTS.—Many of our ornithological collections may have been enriched by the memorable snow-storm of the 18th January. In the neighbourhood of Tralee a beautiful species of the North American red-headed pochard (*Fuligula rufina*) was procured the day following. The bird appears to have been only the second of the kind found in this country. There were also a few other rarities procured, among which were a few crested widgeon and a blue-winged spoonbill.—*W. Benner.*

A NEW SOCIETY, called "Scarborough Scientific Society and Field Naturalists' Club," has been organised at Scarborough; President, John Woodall, Esq., M.A. The first of a course of lectures by the secretary, Mr. G. Masee, was delivered on Saturday the 26th of February.

THE LAUGHING GULL (*Larus atricilla*).—A specimen of this somewhat rare bird recently made its appearance in the neighbourhood of Newmarket, and of course got shot.

THE SCOTCH PRIMROSE.—I regret that I have been unable to comply with all the applications I have received for specimens of *P. Scotica*. Will those who have been disappointed remind me in May?—*James Grant, Wick.*

BOTANY.

SWISS PLANTS.—Dr. B. has forwarded to us specimens of the dried and pressed Swiss Alpine plants he offers in our exchange column. We can conscientiously say they are the most beautifully preserved specimens we have ever seen, and strongly recommend those who wish to make up sets of Swiss Alpine plants to take advantage of the offer.

BORAGO OFFICINALIS.—Referring to the discussion lately taking place as to the above plant being indigenous or not, the balance of opinion is certainly on Mr. Dillen's side. In addition to the authorities he quotes in your January number, Sir J. D. Hooker speaks of it as being found "near habitations" and as "rare," while in Sowerby's "English Botany" we find it is "rather rare, but widely distributed, though not native," St. Aubin's Bay, Jersey, and Hunstanton being the only places where it has been thoroughly naturalised. Miss Colson's statement in your November number (that she has seen it at Corfe Castle for forty years), proves nothing, as that ruin is hard by a populous village with many gardens, whence it probably escaped. On the other hand, I found the plant not only at Corfe Castle, but also at Lulworth, St. Alban's Head, and other places in Dorsetshire in 1879, far away from any dwellings, and I have also taken it in similar situations in the counties of Berks, Bucks, Monmouth, Gloucester and Derbyshire. In 1880 I found it in the pass of Llanberis at a considerable distance from habitations of any kind. The specimens found in Monmouthshire were in full flower on the 27th of March. The strong probability is that it is very rapidly becoming a naturalised specimen, and that it will in course of time be found abundantly as one of our common wild flowers.—*H. W. S. Worsley-Benison.*

POISONOUS HERBS.—When I was a boy I remember reading an article in the "Penny Cyclopædia," written, I think, by Professor Lindley, on the fool's parsley, *Aethusa Cynapium*, which was described as dangerously poisonous, and the characters in which it differs from true parsley indicated, with so much precision that it could not afterwards be readily mistaken for the well-known culinary herb. Since then I have never felt any appetite for it, nor any such doubt about its properties as would induce me to experiment on it. My want of curiosity was perhaps intensified by the result of an experiment on another poisonous herb, which I tasted once when I was a very young man. Recovering from an attack of fever I was walking in a garden, where I pulled up a plant of sun spurge (*Euphorbia Helioscopia*), speaking of it as poisonous, but the person I addressed would not admit the fact, and said that it was hot to the taste, at the same time suggesting that I might taste it.

Thereupon I broke the stem and applied the broken end to my tongue, which took off the drop of white fluid exuding from it. Soon I felt a burning in my throat, by reason of which I lay awake all night. Being visited next morning by my medical attendant, who had not yet given me up as cured, and finding me worse than I had been on the day before, he said that I must have eaten something which had disagreed with me. My mother, who was then living, assuring him that I had eaten nothing worse than a rasher of bacon, he would not admit that to be the cause of the unfavourable symptoms he observed, and I felt it my duty to confess what I had done, which was accepted as an explanation of my relapse, from which, however, I soon recovered. Since then, I have not met with any person who has suffered from the same cause, and I have been credibly informed that the plant which was injurious to me may be eaten with safety by rabbits. Thus it appears that what may be safely eaten by another animal may be very dangerous to man, and that what one person may partake of innocently, might be the means of suicide for another. Let your readers meditate on this before they venture on experiments with fool's parsley.—*John Gibbs.*

GEOLOGY.

THE PERMIAN, TRIASSIC, AND LIASSIC ROCKS OF THE CARLISLE BASIN.—At a recent meeting of the Geological Society a paper on this subject was read by Mr. T. V. Holmes, F.G.S. The district discussed in the author's paper was worked over by him when engaged on the Geological Survey, and consists of those parts of Cumberland and Dumfriesshire which adjoin the Solway. Its southern boundary is, approximately, a line ranging from Maryport to Rose Castle on the river Caldew, and touching the Eden about two miles above Wetheral. On the east and north-east its limits are the immediate neighbourhoods of the junction of the rivers Eden and Irthing, Hethersgill on the Hether Burn, Brackenhill Tower on the line, and the Border boundary on the rivers Esk and Sark; and in Dumfriesshire the small tract south of a line ranging from the junction of Scots Dyke with the Sark on the north-east, to Cummertrees on the south-west. The lowest bed in this area is the great Upper Permian or St. Bees Sandstone, which occupies a belt of country in the neighbourhood of the outer boundary. Directly above St. Bees Sandstone, in the west of the district, lies a formation consisting of shales with gypsum, which, though 700 feet thick in the neighbourhood of Abbey Town, is nowhere visible, but is known solely from borings, the country west of the Caldew, and of the Eden below the junction of the two streams, being thickly drift-covered and almost sectionless. In the east of the district the

St. Bees Sandstone is overlain directly by a soft, red, false-bedded sandstone, called by the author Kirklington Sandstone, from the locality in which the rock is best seen, as well as its relations to the under- and overlying beds. But while there is no evidence of any unconformity between the St. Bees Sandstone and the overlying gypseous shales in the west, there is evidence of a decided unconformity between the St. Bees and Kirklington Sandstones in the east. In Carwinley Burn (for example), which runs into the Esk at Netherby, only from 200 to 300 feet of St. Bees stone was seen below the outcrop of the Kirklington, instead of the 1000 to 1500 feet which probably exist about Brampton on the one hand and in Dumfriesshire on the other. Yet Carwinley Burn affords an almost continuous series of sections, from the (non-faulted) Permian-Carboniferous junction to some distance above the outcrop of the Kirklington Sandstone. As, in addition, the shales underlying the St. Bees Sandstone are gypseous, both near Carlisle and at Barrowmouth, close to St. Bees Head, the author classed the (Upper) gypseous shales as Permian, and the Kirklington Sandstone as Bunter. Resting unconformably on the Kirklington Sandstone, in the district between Carlisle and Kirklington, are the marls seen on the Eden, between Stanwix and Beaumont, and on the line between Westlinton and Cliff Bridge, Kirklington. Their unconformity is shown by the fact that on the line they rest on the lower, or red, beds, and between Stanwix and Beaumont on the upper, or white, beds of the Kirklington Sandstone. The marls have therefore been classed as Keuper. So far as the evidence goes, they appear to be very thin and to extend but a very small distance south of the Eden. Lastly, the Lias appeared to the author to be unconformable to all the beds below, and to rest partly on the gypseous shales, partly on the Kirklington Sandstone, and partly on the Keuper Marls. Of the existence of Rhætic beds there was no evidence, all fossils hitherto found having been determined by Mr. Etheridge (President) to be Lower-Lias forms. But the Lias sections are so small and few in number, and the ground so persistently drift-covered, that only a boring could settle the question.

THE LATE PROFESSOR TENNANT.—A familiar figure in English geology has just passed away. Professor James Tennant, whose mineralogical shop in the Strand was for years a house of call for all young country geologists who visited London, has just died at the good old age of seventy-three.

AQUARIA.—“Rita” would be glad to know the way to start aquaria, both fresh and sea water, for microscopic work, and if there is any book published specially devoted to this subject. General books on aquaria do not treat of animalcules.

NOTES AND QUERIES.

GNATS AND THE FROST.—While skating in this neighbourhood on the 22nd January I captured a solitary specimen of *Tipula plumosa* fluttering quite merrily through the mist which prevailed at the time. The temperature was two or three degrees above freezing-point for the first time for about a fortnight. As I believe the larva of this insect is aquatic, I am curious to know where it can have come from. It is very unlikely that there was any open water about, as the temperature had been below zero only a few days before, and had remained very low. Do any of these insects live through the winter months?—*W. Goodwin.*

THE SEVERE WEATHER OF JANUARY.—An account of the severity of the weather in this district (N. Haunts) may interest some of your readers. Vast flocks of larks frequent the swede and turnip fields, where they feed on the tender leaves of the grass; thousands of sparrows, greenfinches, yellow-hammers, and chaffinches (male and female) frequent the farmyards—even jays are quite tame, and gladly avail themselves of crumbs of bread flung out into the yard; wagtails have disappeared. I shot a sedge-warbler yesterday in a farmyard and saw several others; the county people call them "black-caps." Yarell says that the bird has only been once noticed in winter (v. "British birds"). When the stable doors are left open, robins fearlessly enter. I heard one singing, perched on a horse's manger. In the winter of 1878 great flocks of pigeons frequented the woods: there are very few this year, probably on account of the scarcity of acorns here this winter. Rabbits mostly keep to their burrows during the day, feeding at night on the bark of the hazel, hawthorn, &c., which they nibble off as high as they can reach; a few, however, get under dead fern or brambles. The last three terrible frosts have quite covered up the laurels.—*G. Dewar.*

GROSBEAKS.—On December 29th last the male and female grosbeak or hawfinch (*Loxia coccythrausters*, Linn.) were observed at Cotham, Newark-on-Trent. The hen bird was shot, and answered minutely to the description of Bewick. As I believe this is of rare occurrence in England, migrating from the north only in severe weather, I give the following description, as other readers of SCIENCE-GOSSIP may not be familiar with the bird. Length, under seven inches. Bill, horn colour and remarkably thick and blunt; eye, ash colour; throat, black; head, reddish-chestnut, ringed with soft grey; wings blue-black, curiously curled at the edge; breast rich brown, shading off to ash; tail black, with a few grey feathers. The male bird was the more brilliant in plumage, and had a slight crest. The pair were extremely handsome, and have never been seen previously in the neighbourhood. Bewick states that they visit Great Britain occasionally. The crop was full of laburnum seed.—*C. Parkinson, F.G.S.*

ANAGALLIS CÆRULEA.—On January 2nd I found two plants of a blue pimpernel in flower in a garden in this neighbourhood. The leaves were in whorls of three and four, the petals crenate and fringed with minute hairs; in other respects the plants and flowers agreed with the description given of *Anagallis cærulea* in Babington's Manual. It is included in the published Flora of this district, and therein stated to have been found four times.—*Ernest Bullmore, Falmouth.*

BIRDS OF THE ISLE OF MAN.—In the February number of SCIENCE-GOSSIP (p. 43) my list of birds has been kindly noticed, but, to prevent the chance of a false impression, I would like to add a few words of explanation. The rule followed is, that each bird whose name appears on the list should certainly have been seen in a wild state, at least once, in the Isle of Man. Of those mentioned in the notice, I would say—that, of the golden oriole, I know only one instance (25th April, 1879) and, would set it down as accidental; the grey phalarope is a great rarity; the snowy owl is a very occasional visitor, and so is the hoopoe; the mountain finch appears to be a regular visitor, though only seen in small numbers. The black guillemot seems to be more plentiful round the west and south coasts of the island; I hope to learn more of his habits before summer. Several other birds in the list are rarely seen here, and many are becoming yearly more scarce, and in all probability will soon cease to be numbered in the Manx Avifauna. Already the bittern, the quail (known as "Wet-my-lip"), and the woodpecker, have almost disappeared; the raven, the chough, and the bonny kingfisher, become visibly less frequent; the goldfinch is doomed to follow; and if there be any other bird, remarkable for bright plumage or for cheerful song, he must reconcile his heart to the prospect of solitary confinement in a dark and narrow cage, or to the expectation of adorning some fair one's attire.—*Philip M. C. Kermod.*

BIRDS IN LONDON.—Doubtless it is well known that a number of our forest birds were during the intense frost of January driven into London in search of food, and it would be interesting to hear from your readers the names of birds that have visited their gardens. My garden, which is situated about half a mile west of Bow church, was visited by blackbirds, redwings, thrushes, starlings, robins, blue-tits, the oxeyed-tit; and I believe there were others, as I frequently saw the sparrows chasing small birds. I have also a very fine specimen of the hawfinch, which was caught during the frost (with the lime twig) on the skirts of Victoria Park.—*Chas. J. W. Rudd.*

STARLINGS AND SKYLARKS.—I can confirm from my own observations the remarks of Mr. Meyler Daniel in the January number of SCIENCE-GOSSIP. In this locality fifteen years ago, skylarks were to be seen in large numbers, but there were few starlings. Then the latter increased and the former almost disappeared, and now there are again large numbers of skylarks and but few starlings. I have never been able to obtain direct proof that the starling injures the eggs of the skylark.—*J. T. T. R., Ryhope, Durham.*

SKYLARKS IN SCOTLAND.—In reply to your correspondent Meyler Daniel, in the January number of SCIENCE-GOSSIP, I should like the following extract from "Bell's Weekly Messenger" to be more widely known: "Ornithological observers in Scotland and the northern counties of England have for some time past been complaining of the enormous decrease of skylarks during the past few years. In many districts this year they have disappeared altogether. Mr. Edwards, the Banffshire naturalist, has just published a short paper on the subject, in which he condemns the popular theory that starlings, which have increased in corresponding ratio to the decrease of skylarks, cause the mischief by breaking the eggs in the nest and by killing the young. That the bill of the starling is capable of destroying the egg he

admits, but he ridicules the idea of its destroying the young, and he does not believe the starlings are to blame. He attributes the evil chiefly to the increase of cattle and the taking in of waste ground for agricultural purposes. 'As a rule,' he says, 'larks do not breed among hay, corn, or barley. For one nest I have known in such places, I have, I may safely say, found in meadows, on pasture-lands, and on waste ground, now, for one cow or ox that there was one year ago, there are about a score at present. Is it not possible that the great increase of these animals may have something to do with the decrease of the lark, by trampling on their nests or maltreating them? I have myself while searching in clover fields for moths, and in grazing grounds for beetles, come across numbers in recent years so destroyed. Pheasants, partridges, and other breeding birds also suffer severely. Besides, we have cattle and sheep now, but more particularly the latter, put into woods and plantations to eat down the herbage there.'—*R. E. Schrake.*

SCARCITY OF SKYLARKS.—I regret to have to add my testimony to the complaints of the gradual decrease in the numbers of these favourite birds which have already appeared in the pages of SCIENCE-GOSSIP. For a number of years they have gradually but surely become fewer in this locality. It is now becoming quite a rarity to hear one, and people will stop and look up, when one is heard carolling high overhead, and tell of it as something unusual. I used to find their nests commonly enough eight or ten years ago, but last season I only found one, and heard of two others. A circumstance connected with the one I found, seems to corroborate the suspicion that the quick eye and sharp beak of the starling may have not a little to do with the diminished numbers of the skylark. I discovered the nest in a pasture field, early in the morning, and during the afternoon of the same day I took a friend to see it. As we approached the nest a number of starlings rose from its immediate vicinity, and when we reached it we found the eggs broken and their contents partially eaten. To all appearance the damage had been done by the voracious beak of a starling, which we had interrupted before it had completed its feast. In this neighbourhood the starlings have increased wonderfully during the past few years. Another reason, which, I think, has before been mentioned by one of your correspondents, is the fact of most of the ploughed lands hereabouts having been turned into pastures, thus giving rise to the danger of the eggs being destroyed by the sheep and cattle treading them underfoot, several instances of which have come under my own observation. And, again, in the meadows, where they are most likely to be unmolested, the practice, now generally adopted by our farmers, of "brush-harrowing" the manure spread upon the meadows in spring, in order to pulverise it, and which is nearly always done just about the time the skylark is incubating, has, I know, the effect of destroying many eggs and young. During the arctic weather in January I was much interested in a pair of skylarks which frequented an adjoining farmyard, associating quite tamely with the numerous sparrows, etc., driven by hunger to seek food near the house. Be the reason of the scarcity of these charming songsters what it may, I am very sorry indeed to find their numbers so greatly lessened, thereby causing quite a loss to myself and many another ardent admirer of nature, who, during our rambles along the countryside, have often had our pleasure enhanced, and our hearts gladdened, by listening to the joyous notes poured

forth from the throat of our friend the skylark.—*R. Stauden, Gosnargh, Preston, Lancs.*

THE ABERDEENSHIRE WEAVER AND BOTANIST.—May I venture to direct the attention of readers of SCIENCE-GOSSIP to the appeal made by Mr. Jolly, II. M. Inspector of Schools, Inverness, on behalf of James Duncan, the Aberdeenshire weaver-botanist. Poor James, in his declining days (he is in his 87th year), has been compelled by adverse fate to accept pauper relief. His story was told two years ago, in "Good Words," by Mr. Jolly. His herbarium of nearly 1200 British plants was recently presented to the University of Aberdeen. Mr. Jolly will no doubt take care of any contributions.—*J. G., Wick.*

OPHRYS APIFERA.—I have had an excellent opportunity of watching the irregularities in the growth of the bee orchis, as it grew freely in a plantation close to our vicarage garden at Grendon, Northants, and for many years I have noted and marked the precise spot where it came up. It never appeared two consecutive years, and never in the same place, and what is still stranger, about fifteen years ago they were found only at the top of the plantation, and have since gradually worked their way down to the bottom (a distance of about 300 yards), disappearing entirely from the upper part. In 1876 there were several groups of about twenty together, those on the outside in a perfect circle. A neighbouring botanist tried several times to transplant it, but the attempt never succeeded, although a quantity of soil was removed with the root; he was equally unsuccessful in raising it from seed. The year before last I noticed a great number of robust plants growing on the chalk downs near the Culver cliffs, in this island, while last year I searched in vain for a single specimen. Can any of your readers account for these irregularities? I should also be glad to know if there is any means of retaining the colour of the beautiful *Melanopyrum arvense* when dried. Though I have taken considerable pains, the whole plant always turns perfectly black. It grows in great profusion in the cornfields above the Undercliff at Ventnor.—*F. A. Brent, Ryde, I. W.*

FROZEN LARVA OF EPHEMERA RETURNING TO LIFE.—On Friday, January 21st, I found my little aquarium completely frozen. Looking at it again on Sunday I found the larva of Ephemera and some snails completely frozen in the ice. I had heard of fishes being frozen for months and then returning to life. So I thought the same possibly might apply to larva of Ephemera and snails. I commenced thawing, first over a spirit lamp until the larva was free, with the exception of its tail, which still remained firmly embedded in the ice. The larva seemed dead, but on its tail being freed by the friendly heat of the fire, showed decided signs of life by conveying itself about by that elegant and now liberated appendage. It was in a very weak condition, as might be expected, and easily caught and conveyed to another place of abode. I did not see it use its legs, and fear that possibly paralysis might have set in. The snails themselves were dead, so I took the liberty of adding their late homes to what I designate "my collection."—*John Alex. Ollard.*

HOLLY BERRIES.—Your correspondent, H. W. Lett, M.A., in the February number refers to the absence of holly berries in the district south of Lough Neagh. I am sorry to add that in this neighbourhood I have only seen one bush on which they are to be found this winter; and in that instance, very sparingly.—*J. H. H., Lisbellaw, Co. Fermanagh.*

MALE BIRDS INCUBATING.—G. Dewar may add to his list of male birds that assist in incubation, the blackbird, as I have frequently observed him so occupied; also the ring and stock-dove, and domestic pigeons generally. On one occasion I saw both male and female swift on the eggs together, and in order to secure one of the eggs I removed both birds with my hand.—*Thos. J. Lane.*

QUERY AS TO COCOON.—Digging at the foot of a large birch-tree in January, I came upon numbers of a cocoon, an inch or less below the surface, quite undistinguishable from the cases of the oak egger, but perhaps rather smaller. They nearly all had a hole in the side, near the end, but not quite at it, through which the perfect insect may have emerged. The perfect cocoons on being opened were shrivelled. Can any of your correspondents identify the species?—*Jos. Neale.*

MOUNTING ENTOMOSTRACA.—I wish to make a collection of the larval forms of Entomostraca and other minute Crustacea; in what medium should I mount them? In what month do Entomostraca first appear in the ponds? How are mosses in fruit best mounted—dry or in glycerine?—*W. G., Glasgow.*

BRITISH DRAGON-FLIES.—Mr. E. B. Kemp-Welch in his "Chapter on British Dragon-flies," in SCIENCE-GOSSIP for last month, states "that some years since, there appeared to be no work obtainable, treating of the British species, nor, I believe, has this want been supplied up to the present time." Although I know of no work on the subject, it may interest your readers to learn that there is an excellent "Synopsis of the British Dragon-flies," by Dr. Hagen himself, in the Entomologists' Annual for 1857.—*J. H. K.*

SHORE LARK.—A party of five members of the Rotherham Naturalists' Society, being on a specimen-collecting expedition to the Farn Islands, obtained on the 13th instant, a fine specimen of the shore lark (*Alauda alpestris*). As the bird is a very rare visitor to England, perhaps you will kindly give the event a notice in your columns. The bird was shot by William S. Bennett, the curator of the society, and was a female in good condition. We obtained many other specimens, but the above was the most remarkable.—*F. W. Dickinson.*

SUCTION IN THE HOUSE-FLY.—If any of your readers would kindly give a full explanation of the process of suction in the house-fly, I should be very much obliged. Whether there is any connection of the tracheal system with the throat admitting of a true inspiration, or if the liquids are conveyed by alternate contraction and expansion of the tubes of the proboscis; if by the latter means, would it account for the distending fibrils of the tube not completing the circle?—*L. S. G.*

RED FROG.—When I was in the North of Wales about three years ago, I saw something hop by the side of a gushing stream. After a smart chase I succeeded in capturing a small frog about two inches in length, and of vermilion above, but pure white beneath. It could cling to a rush stem as easily as a grasshopper. I kept it for several days, when it escaped.—*H. C. Brooke.*

SLOW-WORM (*Anguis fragilis*).—A short time ago, I had two slow-worms. Instead of having dark stripes, as is usual in these reptiles, one was nine inches long, gray, with three blue spots on each side of the shoulders; after about a month they increased to five. The other; thirteen inches long, was pinkish-brown,

with seven blue spots. They became very tame. One died while I was away; the other (to save its life) was put into the garden; it has not been seen since. If any correspondent wishes to obtain any further information, I will gladly answer any queries.—*H. C. Brooke, Staplehurst.*

ROUGH-LEGGED BUZZARD IN YORKSHIRE.—I have in my possession a fine rough-legged buzzard that was captured in Billsdale, North Yorkshire, last December. When first obtained it was very surly and stupid, and refused to eat, and the meat had to be forced down its throat. But it soon got tame, and will now take its food readily, with two or three spectators. It is very fond of live birds. It generally pulls two or three feathers out of the wings and breast, and then either eats the entrails first, or swallows the bird whole.—*J. A. Wheldon.*

ORNITHOLOGICAL NOTES FROM BOURNEMOUTH.—I find the neighbourhood of Bournemouth is in exactly the same state as Meyler Daniel finds Caermarthen with regard to the scarcity of skylarks this season. I have walked miles without being able to flush a single individual. I have studied the habits of the starling for some years, but have never found him guilty of plundering nests, and I have known of many sky and titlarks' nests in fields regularly frequented by him in the breeding season. The state of the feathered tribe this winter is vastly different from that of the two previous ones. The starling, song thrush, robin and duncock are to be heard on all sides indulging in their varied songs, not having as yet experienced any lack of food. I have not observed a single redwing nor fieldfare in my rambles, in consequence, I suppose of the mildness of the weather hitherto. In the last week of December I witnessed a rather unusual sight, viz. an assemblage of half-a-dozen sparrows busily engaged in washing themselves in a pool of water in the road. Two of them were so wet as to be able to fly only with considerable difficulty.—*Thos. J. Lane.*

BATS.—In reference to the bat seen by Mr. F. Hall near St. Peter's church, I beg to inform you that bats are seen in Cornwall every month in the year, and are quite common. Couch, the author of "British Fishes," states, in his "Cornish Fauna," "they fly at all seasons of the year if the thermometer be not much below 50°." It awakes in a few hours after the weather has become mild, and is not uncommonly seen abroad in the middle of a fine day." It is probably the species *Scotophilus pipistrellus*.—*Hamilton James, Truro.*

A CURIOUS MOUSE.—The mouth of the mouse described in SCIENCE-GOSSIP for February certainly presents a condition both unusual and interesting. Instances of a like condition have, however, from time to time been met with, especially, I believe, in rats and rabbits, which sometimes die from its effects, the great length and abnormal form of the front teeth preventing their possessor from obtaining proper food. The following appears to explain the occurrence of the condition described. In animals of the rodent order each jaw carries a pair of long, chisel-shaped front teeth, or "incisors," those of one jaw working over their antagonists in the other, after the manner of the blades of a pair of shears. To compensate for the great and incessant wear to which it is subjected, each of these four teeth goes on growing throughout the life of its possessor; and in order to relieve from pressure the highly sensitive pulp from which additions are made to its base, each tooth is curved, so as to form a segment of a circle. Now, if a tooth be

lost, its antagonist, though no longer subject to wear, goes on growing, forming a larger and larger segment of a circle, and if, from some slight deformity, the teeth of the upper jaw do not meet those of the lower, each pair goes on growing, producing the condition met with in the mouse under consideration: in this case, the lower teeth appear to have been deflected to one side of their proper position. This strange state of things has been observed in other animals besides rodents. The *Sus babiroussa*, a wild pig confined to the Malay Archipelago, possesses enormously long recurved "canine" teeth in both jaws, which grow "persistently;" and the upper canines sometimes grow until their tips re-enter the skull of the animal and cause death; the lower, in like circumstances, recurring till they penetrate the jaw. The hippopotamus, which has constantly-growing front teeth, has been known to be subject to a similar abnormality; the museum of one of our London scientific societies contains the lower "incisor" of a hippo which, being relieved from wear by the loss of its antagonist, went on growing till its tip, curving back into the mouth, pierced the jaw, and entered its own growing base, thus forming a complete, and very singularly perfect circle.—*J. B. M.*

NOTICES TO CORRESPONDENTS.

TO CORRESPONDENTS AND EXCHANGERS.—As we now publish SCIENCE-GOSSIP earlier than heretofore, we cannot possibly insert in the following number any communications which reach us later than the 8th of the previous month.

TO ANONYMOUS QUERISTS.—We receive so many queries which do not bear the writers' names that we are forced to adhere to our rule of not noticing them.

TO DEALERS AND OTHERS.—We are always glad to treat dealers in natural history objects on the same fair and general ground as amateurs, in so far as the "exchanges" offered are fair exchanges. But it is evident that, when their offers are simply disguised advertisements, for the purpose of evading the cost of advertising, an advantage is taken of our *gratuitous* insertion of "exchanges" which cannot be tolerated.

FORMULA WANTED.—I cannot tell C. E. C. what his formula No. 1 is, but No. 2, or chromic acid, with addition of sulphuric acid, is employed in animal histology, in cases where a calcareous tissue is to be softened by dissolving out the lime. Thus, to examine a section of bone and periosteum, the preparation softens the bone and hardens the gelatinous or organic remains besides the periosteum itself.—*H. J. Johnston-Lavis.*

Would any reader kindly recommend a good Swiss Alpine Flora (small and portable if possible) and oblige?—Henry J. Ryder, Physician, &c.

W. HORLEY.—Your specimen is a variety of the common field mouse (*Mus sylvaticus*). To be found living in an office is an unusual place. We should be glad to see the male.

STELLA.—Your moss is a fragment of *Hynum tamariscinum*.

J. T. A.—See Whitaker's "Guide to the Geology of London and the Neighbourhood," 3rd edit., price 1s. (London: Edward Stanford), for a full account of the drifts near the metropolis. Professor Geikie's "Geological Map of Scotland" is portable, and made for the knapsack. It is published by W. & A. K. Johnston. You will find full instructions for drying plants in "Notes on Collecting and Preserving Natural History Objects."

A. L. wishes the address of the Naturalists' Field Club nearest to Old Kent Road. He will find an article on "How to start a Natural History Society" in SCIENCE-GOSSIP for 1878, page 201. He will find hints for a shell cabinet in Professor Tate's paper in "Notes on Collecting and Natural History Objects."

S. BROWN and FRED BATES.—You may procure animals for your aquarium at King's "Sea Horse" House, Portland Road, London. See Taylor's "Aquarium: its Principles, Structure, and Management," 2nd edit. (just out), for details as to other parts of your question.

C. F.—Hymenophyllum may be grown from spores like any other fern. The best plan is to sow the spores and cover with a small bell glass until the prothalli are developed.

C. H. WOOD wishes for the names of Entomological, Botanical, and Geological clubs in the north of London.

R. B.—You cannot do better than read Green's "Physical

Geology" after studying Lyell. Thome's "Structural Botany" edited by Dr. A. W. Bennett, might follow Oliver; or Hefnrey's "Botany," edited by Dr. Masters. For British botany, Dr. Hooker's "Student's Flora of the British Islands." You will find all necessary hints for constructing a freshwater aquarium in Taylor's "Aquarium," published by Bogue, 3 St. Martin's Place, Trafalgar Square, W.C.

H. H. S.—We think you had best get Dr. Marsh's little work on "Section-cutting," published by J. & A. Churchill, for full details as to various kinds of section cutters. The best and simplest and cheapest botanical section-cutter we ever saw was made by Mr. C. Bailey, F.L.S., of 85 Withington Road, Whalley Range, Manchester, who might be prevailed upon to send sketch and description.

F. C. KING.—Many thanks for your well-mounted slide. The object is a species of Jungermannia, or "Scale moss."

R. ROGERS.—Your specimens are—(1) the candle-snuff fungus (*Xylaria hypoxylon*); (2) *Lycopodium pyriforme*; (3) a lichen (*Cetraria*).

NERO.—Your specimen is not a seaweed at all, but the empty tubes of a zoophyte, called Tubularia; see "Half Hours at the Seaside," page 86, published by Bogue, 3 St. Martin's Place.

J. B. C. may obtain silkworms' eggs of Dr. Wallace, Colchester. Living specimens of *Dionca muscipula* may be obtained of Mr. Wm. Bull, F.L.S., King's Road, Chelsea.

H. W. B.—Mr. P. Kermode's address is Hon. Sec. Natural History Society, Ramsey, Isle of Man. We make no charge for Exchanges, unless they are over three lines in length.

T. LAMB.—You will see the query as to what is Tennyson's "Sea-blue bird of March," answered in past numbers of SCIENCE-GOSSIP. There is no doubt it is the kingfisher.

E. A. BROWN.—Casell's "Book of Birds," edited by the late Professor Rymer Jones, was issued in 7d. monthly parts, and may still be obtained. Casell's "Natural History," now in course of monthly part issue, is by far the best and most comprehensive popular work which has yet appeared.

G. T. BAKER wants the name of a first-class German work on European Lepidoptera. Is he aware that Casell's are issuing in monthly parts an illustrated "European Lepidoptera," edited by Mr. W. Kirby?

W. J. R. inquires if there is any monograph written on the Entomology and Geology of East Cornwall, more especially with regard to Bude; or if there are any Natural History Societies therealout which publish transactions?

EXCHANGES.

DOUBLE-STAINED sections of stem of dog-rose (*Rosa canina*) and blackberry (*Rubus fruticosus*), in exchange for other stained vegetable sections, or for parasites.—Arthur J. Doherty, 26 Leamington Street, Manchester.

FIVE hundred American plants (Phanogamia and Vascular Cryptogamia) correctly named, and in fine condition. What offers of British plants?—C. D. Fretz, M.D., Sellersville, Pa., U.S.A.

RICH diatomaceous earth from Unterliss offered for good micro mounts or good material.—E. J. Marks, 21 Canynge Square, Clifton, Bri-tol.

WANTED, a cabinet suitable for natural history objects, in exchange for 5 vols. "Illustrated Travels," cost £3 15s., or offers.—Alfred Draper, 275 Abbeylead Road, Sheffield.

WANTED, "Popular Science Review" for 1879 and 1880; exchange Darwin's "Origin of Species," last edition.—R. Bielby, 16 Blake Street, York.

NEW mosses in 2nd ed. of L. C. Offered, *Autocentrum turgidum* and *Tinnia norvegica* (foreign). Wanted, Microbryum, Trichodon, Tayloria, Myurium, and Taltonia.—R. Wood, Westward, Wigton.

A PINWOOD cabinet (21 in. by 11 in.), previously used for large microscope, and a gravitating-tube on stand, for selection of Diatomaceae, in exchange for good micro slides, or apparatus, or a good 1½ or 2-inch objective. What offers?—Rev. J. Fimmemore, F.G.S., Summerset, Manchester.

CASSELL'S "European Butterflies and Moths" (up to present month), in exchange for Newman's "British Moths" (copy in good condition required).—Henry Lamb, 35 Bower Lane, Maidstone.

WANTED, specimens of Characeae during the summer and autumn, named or unnamed; Characeae, or rare British plants, in exchange.—A. Bennett, High Street, Croydon, Surrey.

A FEW fossil bones from South Carolina offered in exchange for recent foreign shells and crystals.—Miss F. M. Hele, Fairlight, Elm Grove Road, Cotham, Bristol.

FOR exchange, about 500 foreign stamps, for pupae of British Lepidoptera, all in one lot, or by fifties all different.—T. M. V., 16 Merrion Square South, Dublin.

GOOD specimens of British land and freshwater shells, named and localised, offered for pill boxes with glass tops.—Alpha, 82 Abbey Street, Faversham.

ARSENOPYRITES and Mispickel in exchange for Zeolites, or other minerals. Lists exchanged.—J. McKenzie, Nursery Cottage, Huddersfield.

WANTED, Thorpe's "British Marine Conchology," illustrated

by Sowerby, and Dante's "Inferno and Purgatorio," illustrated by Doré, for volumes or numbers of "The Geological Society's Journal," or "Proceedings of the Geological Association," containing articles on Lias or Oolites.—E. W., 21 West Bar Street, Banbury.

GOOD geological cabinet required in exchange for a new and beautiful threefold screen, cost £10.—E. Walford, 21 West Bar Street, Banbury.

"FENNY Cyclopaedia" (with appendix), recently purchased in uncut parts, and bound in cloth in 16 double vols. Would exchange for good astronomical telescope.—The Master, Danbury School, Chelmsford.

SKELTON; human, in perfect condition, with ring from skull to suspend by; telescope, by Dixey & Son, New Bond Street, 30 inches long when open, 14 when closed, 14 in. objective glass, leather cover, caps and sling, brass work all dead black; one pair of roller skates, two pairs ordinary skates; fishing tackle; medical works, suitable for student, all modern—list sent if required. Wanted, 3 or 4 objective, by good maker, B, C, or D eye-pieces; portable microscope (such as Murray & Heath's); SCIENCE-GOSSIP, Nos. 13, 69, 106, and 107, also vols. 10, 11, 12, 13, 14.—R. C. J., Robin's Nest, Blackburn.

MOUNTED slides of anchors and anchor plates of *Synapta Gallienica*, arranged in patterns—in exchange for good unmounted material. Wanted good forms of spicula, &c.—W. White, 7 Warden Place, York Street, Nottingham.

BINOCLAR microscope with polariscope and objectives, cost £25; exchange good astronomical telescope.—S., 75 Blackman Road, Leeds.

SMALL superior cabinet, containing 13 drawers, 7" X 5", suitable for moths, &c., cost £2 10s.; exchange good physiological slides.—S., 75 Blackman Road, Leeds.

BELLAMY'S "Natural History of South Devon," and many other books, in exchange for works in natural history.—W. Macmillan, Castle Cary, Somerset.

WANTED, a cock canary, must be healthy, under 4 years old, of good breed, and nicely coloured. I will send in exchange, carriage free, my splendid, perfectly new, unused and complete, "Myriograph" (an excellent apparatus for producing a large number of copies from one writing) 10s., i.e. letter size (9½ in. by 7½) with ink and full directions. (It is inadequate to my requirements on account of size.)—A. F. Kitching, Prospect Street, Hull.

WANTED, microscopic slides; will give in exchange scientific books, store cases, &c. Send list.—F. S. Lyddon, 2 Oakland Villas, Redland, Bristol.

FIFTEEN diagrams, good as new, on "The Literary History of the Bible," each 3 feet by 4, coloured on cloth, cost £1 15s., will exchange for micro objects, or offers.—E. Tye, Stony Stratford, Bucks.

WANTED, exchange correspondents in British Coleoptera.—T. Wood, 5 Selwyn Terrace, Jasper Road, Upper Norwood, S.E.

WANTED to exchange, British land and fresh-water shells, for ditto, birds' eggs, minerals, and fossils.—H. Pollard, Philosophical Hall, Leeds.

MOUNTED hairs of Polar bear, mouse mole, in exchange for other slides.—John Moore, 12 Porchester Street, near Clifford Street, Birmingham.

WANTED, slide of *P. angulata* and fossil nummulites; will send slide of foot, trapdoor spider, foraminifera, unnamed grouped, or anything I have.—G. Bryan, Fitzwilliam House, Cambridge.

OVER 1000 British Plants, 850 mounted (some very rare). Offer.—L. Tetlow, 19 Radcliffe Street, Oldham.

WANTED, micro slides, British birds' eggs, or coins not in collection, Darwin's works, or a 2-inch objective, for an excellent collection of vertebrate and invertebrate animals in spirit.—G. A. Widdas, Swiss Cottage, Bond Street, Leeds.

WANTED, in fruit, *Bryum inclinatum*, *W. arvense lacustre*, *Barnesi*, *Morratti*, *uliginosum*, *intermedium*, *pallidum*, *Sauteri*, *turbinatum* and *roseum*; also *Leskea rufescens*, and any species of *Thasium*.—Miss Ridley, Hollington House, Newbury.

I HAVE some micro material and duplicate micro slides. I will be glad to exchange for micro objects, particularly those of geological interest. Lists exchanged.—William Gray, Mount Charles, Belfast.

FOR exchange Oppen's "Postage Stamp Album," nearly new, containing over 600 British and foreign stamps, many of them very rare, and with space for several hundreds more. What offers in micro slides, or back vols. of SCIENCE-GOSSIP in parts, *ante*, 1873?—Rex, 108 Eroogrove Road, Sheffield.

Will exchange parasites and animal hairs for other objects of natural history; butterflies preferred.—T. Pickin, 83 Fridge Street, Manchester.

SPLENDIDLY preserved and correctly named Swiss Alpine and other plants, including grasses, sedges, &c. Sets of not less than three specimens sent post free for 6d. each specimen.—Dr. B., care of Editor SCIENCE-GOSSIP.

LONG series of several species of beetles from Madagascar, in exchange for good eggs. Pupil of Lepidoptera or unsect beetle butterflies.—W. K. Mann, Wellington Terrace, Clifton, Bristol.

COMPLETE set of tools, &c. for drawing and engraving on wood, comprising 14 gravers, pad, eye-glass, oil-stone, Chinese

white, Indian ink, printing ink, dabbers, special pencil, saucers &c. and engraver's globe, all except the globe in rough box with fittings. Wanted in exchange good microscopic objects (physiological preferred) or human skull.—Frederick Greening, 50 New Street, Kennington Park Road, London, S. E.

WANTED microscopic material of all kinds, especially soundings, cleaned Foraminifera, Polycystina, diatoms (the large kind) in exchange for varnish (black, white, red and green), glycerine, balsam, gold size, spring clips, &c. Lists to—E. W. Wilton, Northfield Villas, Leeds.

WANTED the seeds of a young plant of tobacco (*Nicotiana glauca* preferred).—F. Proud, Binchester Lodge, Bishop Auckland.

WELL mounted slides of *Myxotrichine chartarum* and Lycopodium spores, for other well-mounted objects.—W. S., 7 Rowland Street, Trafford Road, Salford.

"INSECTS ABROAD" by Rev. J. G. Wood. "How to work with the Microscope," 4th edit. by Lionel S. Beale; 2 vols. and six first numbers of 3rd vol. of "Midland Naturalist," all almost new in exchange for rare or very good diatomaceous material in quantity or offers.—J. Temperley, Storrington, Sussex.

WANTED, a pocket spectroscope by Downing; must be in perfect order and cheap. Apply F. I. V. S., Raby House Bath.

FOR exchange, shells, minerals, birds' eggs (in original sets, side-blown with description) fossils, and marine specimens. Wanted in exchange, shells, eggs and rare minerals; would like shells, especially Helices from any country foreign to the United States. Specimens must be in prime condition. Parties wishing to exchange will please send lists and receive mine.—Charles O. Tracy, Taftsville, Windsor County, Vermont, U.S.A.

LAND, fresh-water and marine shells of the U.S., W. Indies, cretaceous, carboniferous, Silurian and Devonian fossils of the U.S. to exchange for recent or fossil species of any other region. List of 500 species of duplicates sent upon application. Will make no exchange without having first seen list of species offered.—Berlin H. Wright, Penn Van, New York, U.S.A.

A COMPOUND achromatic microscope by Crichton on firm brass tripod stand, with 6-inch, 5-inch, 4-inch, 3-inch, 2-inch, 1-inch, 4-inch and 4-inch in objectives, stage forceps, live box, bull's-eye condenser, spherical silver reflector, &c. and 100 best-mounted objects in exchange for a good microscopic stand (monocular or binocular) by any good English maker; address, in reference—Arthur Doherty, 25 Leanington Street, Oxford Road, Manchester.

BOOKS, ETC., RECEIVED.

"Report of United States Commission of Fish and Fisheries for 1878." Washington: Government Printing Office.

"General Physiology of Muscles and Nerves." By Dr. Rosenthal. London: C. K. Paul & Co.

"Uncle Remus, and his Legends of the Old Plantation." By J. C. Harris. London: D. Bogue.

"Bulletin of the Essex Institute." Vol. XII.

"Science." February.

"American Monthly Microscopical Journal." February.

"British Lichens: How to Study Them." By Wm. Phillips, F.L.S.

"Journal de Micrographie." Decembris 1888.

"Revista." March.

"Journal de l'Agriculture." March.

"Land and Water." March.

"Journal of Applied Science." March.

"The Midland Naturalist." March.

"Northern Microscopist." March.

"Natural History Notes." March.

"The Natural History Journal." March.

"Ben Brierley's Journal."

"Good Health."

&c. &c. &c.

COMMUNICATIONS RECEIVED UP TO 6TH ULT. FROM:—

J. B.—W. J. R.—W. G. W.—E. J. W.—J. E.—J. F.—

O. V. A.—H. B. P.—J. S.—J. H. G.—P. W. K.—R. S.—

J. E. H.—J. D. H.—M. H. R.—F. A. B.—G. T. B.—H. W. B.—

C. J. W.—R. J. W.—R. W. C.—R. A.—J. D. H.—W. H.—

H. W. M.—A. J. D.—A. C. S.—J. H.—M. P. M.—F. L.—

F. M. R.—J. F.—C. D. F.—G. H. F.—B.—J. G.—A. D.—

R. T. R.—H. A. F.—W. W. R.—H. H.—F. M. H.—H. F.—

C. F. W.—F. R.—T. A.—C. F. V.—C. F. W.—T. W.—

J. M. V.—W. W. R.—G. M.—W. G.—J. A. W.—H. L.—

H. P. M.—A. B.—W. S.—A. W.—P. O. K.—E. C.—

F. J. R.—H. J. J.—L.—C. A. H.—H. P.—R. B.—L. T.—

S. B.—G. A. W.—F. B.—R. J. M.—G. H. B.—R.—C. F.—

H. W.—A. F. K.—F. S. L.—R. R.—C. W. B.—E. T.—

J. W.—E. B. P.—W. M.—F. B.—J. B.—P. J. L.—W. H.—

N.—R. E. H.—J. F.—W. G. W.—E. J. W. J. T.—P. S.—

E. W. A.—E. W. A.—F. C. K.—R. F.—A. L.—J. O. B.—

C. H. S.—W. G.—G. B.—H. J. R.—W. A. P.—J. P.—

H. H. S.—W. G.—T. F.—R.—&c.

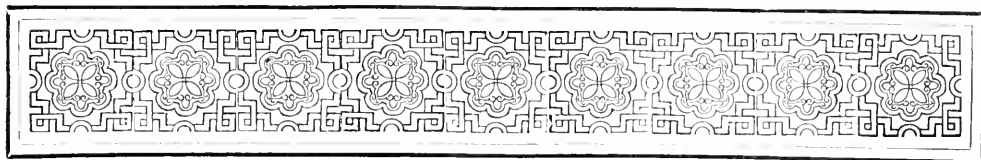

ON COLLECTING MICRO-FUNGI.

BY CHARLES F. W. T. WILLIAMS, ST. JOHN'S COLLEGE, CAMBRIDGE.



subject. I have recently thought, however, that a few remarks on the subject of collecting may be of use to those readers who, like the writer, are amateur collectors, and investigators, of that interesting tribe of plants—Fungi—and, more especially, that division of them called Micro-Fungi. As during the present year I hope to be able to give from time to time, in these pages, an account of the various micro-fungi to be met with in and around the neighbourhood of Bath—just in the same manner as I endeavoured to describe, though very imperfectly, some of the plants to be found near the city*—I thought a paper on collecting might form, so to speak, a preface to my work.

It cannot be too often repeated and impressed on lovers of nature, how comparatively few are the workers in this particular branch of study, and consequently how vast a field is before one for research and discovery.

The work is, I contend, important and interesting.

IN my paper on mounting Micro-Fungi (*SCIENCE-GOSSIP* 1879, p. 3), I did not enter into details regarding the collecting of specimens, on the mounting of which I was treating, and it will be seen on reference that I advised those readers whose knowledge on that head was somewhat obscure to consult a well-known and valued text book on the

Important, because, not only is it well that we should have as perfect a knowledge as possible of such minute structures as the micro-fungi; but also because the subject is of great importance, when we consider the effect these minute forms must in most cases have on the tissues of the phanerogamic plants, on which they are for the most part found. Now, in both cases the works on the subject, and the knowledge so far gained, is, comparatively speaking, small.* Interesting, because the forms are varied and beautiful, and the search for them takes us into the most beautiful haunts of nature.

I suppose few of those who take up this study are absolutely ignorant of other branches of Botany, because it seems to me, that a knowledge of our flowering plants is of importance in our research, and I would endeavour to impress on the minds of beginners the great benefit they would derive in their rambles after micro-fungi, from a previous knowledge of taxological botany.

The apparatus required for collecting is neither numerous nor expensive.

What will be wanted are the following four things; (1) a pocket lens; (2) pair of forceps; (3) pair of scissors; (4) a box of some sort, or what is better, a satchel containing many boxes.

As regards the boxes, small cigarette- and large pill-boxes will be found most useful.

Do not mix your specimens; keep them apart, and remember that it is quite sufficient to cut off with your scissors the leaves on which the Fungus is located. To pull a plant up by the roots, to take a few of its leaves, and fling the rest away (as I have seen done), is, I maintain, neither a scientific way of proceeding, nor does it show the proper feeling and regard that naturalists should cherish for all the works of nature.

The next point for us to consider in collecting is, Where are we to go?

My answer is, Everywhere. Every locality where plants flourish must be good hunting ground. Sunny

* See "Carpenter on the Microscope," 5th edit. p. 395; see p. 394. Cooke's "Rust, Smut, Mildew, and Mould," 3rd edit. p. 185. Balfour's "Outlines," 2nd edit. p. 424.

* See *SCIENCE-GOSSIP*, 1880, pp. 229-274.

banks by rippling brooklets, damp thickets, shadowed over with excess of growth, highways, hot, and dusty, 'neath the summer sun—all and each will furnish you something for your trouble. Beware of going over too much ground; a small space, well examined, will reward you better than a walk of many miles. One of the greatest secrets of fortunate "finds" is a quick eye, which comes by practice alone. Always be on the look-out for specimens, even when you are not out for that purpose alone. It is useless to examine sickly leaves only, or the lowest; many specimens grow on perfectly healthy leaves. Examine therefore all.

Collecting may begin from early spring, and continue till October, or even later.

The *Æcidium* will be the first forms you will probably meet with, and you will first find *Æ. ranunculaccarum*, on that pretty harbinger of spring, *R. ficaria*. Some forms of *Puccinia* will appear in April, and after that you will find your hands full; no golden rule as to time, however, can be laid down, much depending on the weather.

As regards naming your specimens, and knowing where to look for them, you must have a book of some kind to guide you, and the best book on the subject is, as I remarked in a former paper, Dr. Cooke's "Rust, Smut, Mildew, and Mould," published by Mr. David Bogue. Those who are working at this subject, of course, have the book, and those who are about to begin, should purchase it at once.

Lastly, let me urge on all, the importance of getting an accurate knowledge of the micro-fungi of their own district, with a view to adding their information to the general supply, and thereby helping on, it may be, the study of an important and deeply interesting order of plants.

SCIENCE IN THE PROVINCES.

AT a recent meeting of the Natural History Society of Glasgow Mr. John Young, F.G.S., read an important paper on the fossil genus *Synocladia*, a beautiful group of fenestrated Polyzoa, found in the limestone strata of the Glasgow district, with a description of a new species from the Blantyre limestone shales. Mr. Young stated that the genus *Synocladia* was a genus established by Professor King for a form of Polyzoa first found in the Permian formation of England. Two species from the carboniferous strata of West Scotland had been doubtfully referred to it, and the new species now before the society which Mr. Young has provisionally named *Synocladia fenestelliformis*, forms a third. On carefully comparing the carboniferous forms with Professor King's description of the Permian species, Mr. Young is inclined to think that the former could not be identified with it, as they differ in the possession of minute pores, or foramina, occurring amongst the

ordinary cells of the poriferous face of the polyzoon. In these characters the carboniferous *Synocladia* agrees more with the Permian genus named *Thamniscus* by Professor King. Mr. Young is also of opinion that with the help of better preserved specimens, and more extended knowledge, the genus *Synocladia* ought to be revised and the carboniferous forms separated from those of the Permian. The new species *Synocladia fenestelliformis* is distinguished by its larger size, more uniform thickness of the interstices and regular form of the fenestrules, as well as the presence of numerous cells of the normal type placed somewhat irregularly on the lower edges of the interstices, and bordering the fenestrules. Mr. Thos. King also read a paper "On the Structure of an Orange," in which he stated his opinion that the "liths" of which an orange is composed, and which can be separated from one another without injury, are evidently carpels enclosing the seeds, and that the outer rind does not belong to the carpels, but is an axial formation, a prolongation upwards of the receptacle, forming as in the case of the rose hip, a large cavity filled with carpels. A paper "On the Natural History of the Cetacea" communicated by the chairman, was contributed by Mr. Thomas Southwell of Norwich, who, it will be remembered, formerly published some valuable articles on the above subject in SCIENCE-GOSSIP. Mr. Southwell has made the Cetacea a special study, and is well-known as a hard-working naturalist. The chairman, Mr. John A. Harvie-Brown, F.Z.S., communicated some "Ornithological Notes," dated from 2nd October last, in which he mentions the importance of the facts collected by the lighthouse-keepers and others concerning the appearance of birds, as bearing on their times of migration, &c. This has been recognised by the British Association at their last meeting in appointing a committee to collect and supervise these facts.

We have received from the author, the Rev. W. Howchin, F.G.S., a pamphlet reprinted from the Natural History Transactions of Northumberland, Durham, and Newcastle-on-Tyne, entitled "Notes on a Find of Pre-historic Implements in Allendale, with notices of similar Finds in the surrounding District."

The county of Northumberland is not so rich in objects of pre-historic archaeology as some of the southern and eastern counties of England, and has yielded only a few small flint implements or an occasional hatchet; but we have here the record of a true surface-find of a very rich and interesting character.

The "find" is located in the south-western portion of Northumberland, on the tops of a ridge of fell land lying between East and West Allen and about two-and-a-half miles distant from Allendale Town. The site is marked by two smelting chimneys, the sulphurous gases from which have totally bared the

ground, for many acres around, of all vegetation. When the grass is thus destroyed, a bed of peat is laid bare of about one foot in thickness. This peat is rendered so rotten by atmospheric decomposition that when dry it blows away as a fine dust, and in this manner has been entirely denuded in many places. The implements are found on this new surface. They are manufactured from both greenstone and flint.

Several of the implements have been manufactured from fine black flints, which seem unmistakably to belong to the noted layers of this material in South England, and the Rev. Mr. Howchin asks whether the presence of these flints on the Northumbrian hills carries us back to a remote period, when the population of this country consisted simply of a few petty tribes, wandering from end to end of our island; or does it prove a state of inter-tribal commerce, when the raw flint of the south was exchanged in barter to the northern tribes for some corresponding advantage?

Mr. Howchin also records some minor "finds" consequent upon the Allendale find, and concludes with a list showing at a glance from whence the objects have been gathered.

The catalogue of our mycological flora is scarcely so numerous that we are not glad to notice additions to it. We have just received an important contribution in a list of the Hymenomyces of Shropshire, compiled by Mr. William Phillips, F.L.S. It is reprinted from the "Transactions of the Shropshire Archaeological and Natural History Society," and contains a series of plates, kindly lent by Dr. M. C. Cooke, illustrative of the principal genera.

The "Transactions of the Eastbourne Natural History Society," for Jan. 21, 1881, contains an interesting paper on "The Ancient Buildings of Wilmington Priory and Church," by the Rev. W. A. St. John Dearsly, and the first part of a paper by Dr. G. W. Royston Piggott, F.R.S., entitled "The Limits of Human Vision and Touch compared."

The Epping Forest and County of Essex Naturalists' Field Club is in a thriving condition, as we gather from the epitome of its past and projected work, in the President's (Mr. Raphael Meldola, F.R.A.S., F.C.S.) annual address, published in Part III. of their Transactions. We have no doubt the club will fulfil all its original aims.

The monthly proceedings of the Isle of Man Natural History and Antiquarian Society, which has been recently founded, exhibit a healthy activity. Two papers have been contributed; the first by Mr. Spanton, entitled "Plant Lore," the second by Mr. E. Birchall, F.L.S., entitled "Tropical Vegetation."

The annual report of the Nottingham Naturalists' Society is to hand, and contains papers on the "Triassic Rocks of Cheshire, and their equivalents at Nottingham," by Mr. James Shipman; this is accompanied by a figure of a section in Beverley

Street, Nottingham, showing the Keuper resting on an eroded surface of Bunter Pebble Beds: and also a paper on "The Natural and Commercial History of Cotton," by C. T. Musson, accompanied by a plate. Mr. Musson concludes by giving some cotton statistics referring to the total imports of raw cotton into Britain in the different years, and the amount of the United States crops.

The "Annual Report" of the North Staffordshire Naturalists' Field Club and Archaeological Society contains some interesting papers—one, by Mr. Alfred Smith, entitled "A Second Paper on Butterflies and Moths," being in chief an account of the various methods adopted by insects to elude their enemies; also "Notes on some Fossil Trees in a Marl Pit at James's Square," by Mr. J. Ward, F.G.S. The sectional report on Entomology shows that no less than seven species have been found, not before recorded as belonging to this district. Mr. Clement L. Wagge, F.M.S., communicated a paper "On the Summer of 1879 in the vicinity of the Staffordshire Moorlands and Churnet Basin." The observations were taken at Farley, near Cheadle, and one is accompanied by a diagram showing the wind force, barometric height, rainfall, thermometer scale, &c., during the months of June, July, and August, 1879.

W. B. H.

RECREATIONS IN FOSSIL BOTANY.

LEPIDODENDRON.

NO. III.

By JAMES SPENCER.

LEPIDODENDRON is one of the most common of the fossil plants. Its remains are found in almost all kinds of strata, throughout the length and depth of the great carboniferous formation. The casts of its stem and branches are frequently met with in sandstones and ironstones, where they generally retain their original rounded forms, their beautiful scale-like markings, running spirally round the stem, which characterise the lepidodendroid plants, being often most exquisitely preserved. The shales overlying many coal beds are crowded with their impressions, and in some places, where there is a suitable matrix, all the various parts of the plant—stem, branches, leaves and cones—may be seen matted together, in abundance.

The lepidostrobus is well known to have been the fruit of lepidodendron. The common form which occurs so abundantly in all these coal shales, is about six inches in length, though some are longer, and some much shorter. They are generally in a flattened state, and do not show their original internal structure.

I have one in my cabinet which I obtained at Low Moor, which is in its natural rounded form. I found

it in the hollow stem of a plant, which accounts for its peculiarly good state of preservation. The specimen was about six inches in length and nearly an inch in diameter. One end of the cone was rounded and marked with the small imbricated leaf scars which pertain to these fruits, while the other end was continuous with the branch, a portion of which was attached. This specimen illustrates the manner in which many of these lepidostrophi were formed, viz., by a thickening of the terminal end of a branch.

For many years I preserved this beautiful and rare cone in my cabinet intact, being afraid of cutting it up for fear that it would, like most of its fellows, show

The thorn-like fossil known under the name of halonia, was formerly taken to be the root of lepidodendron, but Professor W. C. Williamson has shown, as the result of a very careful examination and dissection of a number of specimens of Halonia, that the knob-like projections so peculiar to this plant had their origin in the bark and not in the pith as they would have done had they been the bases of rootlets. He therefore came early to the conclusion that Halonia was a fruit-bearing branch of lepidodendron.

Some time after this conclusion was arrived at, a lepidodendron was found which bifurcated into two branches in the usual way, but while one of them

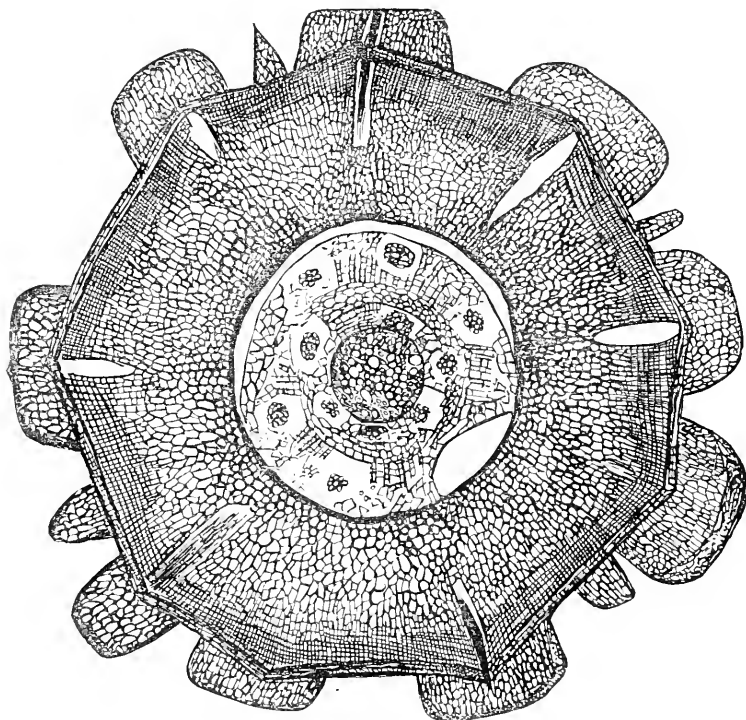

Fig. 65.—Transverse section of *Lepidodendron selaginoides* (magnified).

no internal structure, but at length yielding to the urgent solicitations of a dear brother "chip" I committed it to the untender mercies of the diamond wheel, a sacrifice which I soon regretted, for it turned out as I expected it would do, to be far more beautiful externally than internally. Upon cutting it open I found that its original internal structure was gone, with the exception of a portion of the central axis, and here and there a bract that had originally borne sporangia. But sporangia and spores were gone and their places were filled with yellow iron pyrites, one of the worst substitutes that could possibly have been found, from a micro-lapidary point of view.

bore the same markings as the parent stem, the other was a true halonia, thus confirming the conclusion which Professor W. C. Williamson had already arrived at.

Much controversy has taken place concerning the nature of ulodendron. This most singular but beautiful fossil is distinguished by having two rows, one on each side of the stem, of large round scars which are placed close together and running the whole length of the stem. These scars had always been understood as being the bases of cones, but a few years ago Mr. Carruthers, F.R.S., gave a description of Ulodendron, in which he described the scars as the bases of aerial roots which descended to the

ground, after the manner of those in the celebrated banyan tree. Ulodendron was therefore a root-bearing branch, according to this very high authority on Fossil Botany. Such a notion was very repugnant to the feeling of many geologists, who did not like to see a royal plant like ulodendron being debased to the level of a root-bearing branch, but the decision of so eminent an authority as Mr. Carruthers was generally loyally accepted. Here

but, on the contrary, all the facts tended to show that these scars had been the bases of cones. The cones were not necessarily very large ones. When ulodendron was producing its cones, it was probably only a small branch, and in support of this opinion I may say that I have sometimes met with ulodendron not more than an inch or two in diameter. But after the plant had ceased to form cones on the ulodendron branches, those branches would continue to

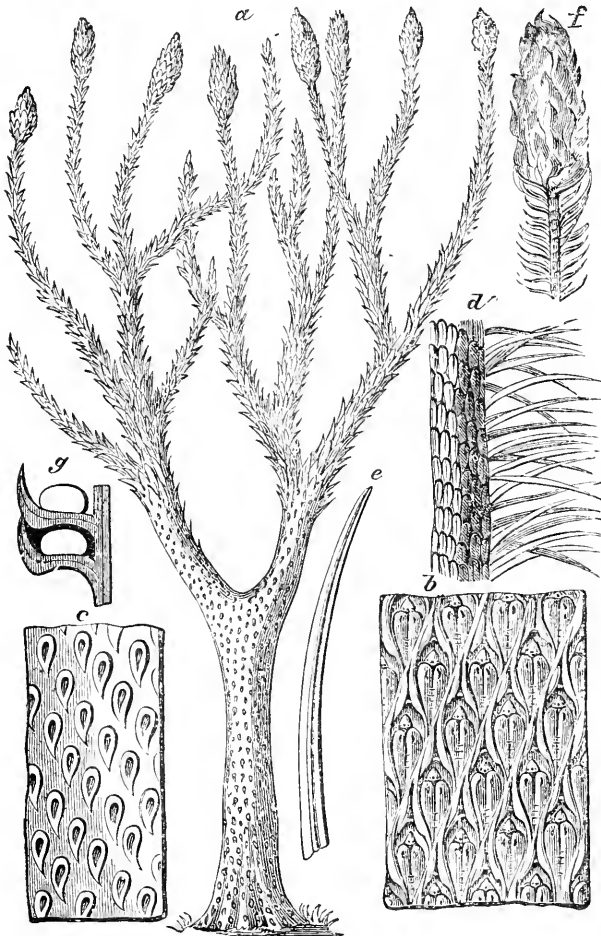

Fig. 66.—*a*, *Lepidodendron* (restored); *b* and *c*, impressions on bark; *d*, stem with leaves; *e*, leaflet; *f*, fruit of *Lepidodendron*, called *Lepidostrobus*; *g*, showing spores in bracts of fruit.

again the superior facilities for studying the fossil plants which Professor W. C. Williamson enjoys proved invaluable to him and to science, in settling once for all what was the true nature of ulodendron.

By the aid of a number of good sections of this plant, he was enabled to show that the scars of ulodendron were entirely belonging to the bark, that they did not owe their origin to the pith, as they must have done had they been the bases of roots;

grow, and of course these scars would continue to enlarge.

So we find casts of ulodendron of all sizes from an inch to a foot or more in diameter. Professor W. C. Williamson has again had the good fortune to have his opinion on this point confirmed by the actual finding of a ulodendron with the cones attached by Mr. D'Arcy Thompson.

The cones were not very large ones, but had a broad base, though the actual point of attachment to

the stem was small. As the cones grew, they seem to have had a depressing action on the leaves of the stem, and thus to have formed the well-known scars of ulodendron. Halonia and ulodendron are, therefore, both cone-bearing branches of Lepidodendron.

Several species of lepidodendron are found in our coal balls, the most common being *Lepidodendron selaginoides*. *L. Harcourtii* is less plentiful, but *Sigillaria vascularis* (Binney) or, as Professor W. C. Williamson prefers to call it, *Lepidodendron vasculare*, is moderately common.

Lepidodendron selaginoides. The specimen from which fig. 65, is taken is about half an inch in diameter and is remarkably well preserved. All its various tissues, with the exception of a small portion of the inner bark, which is rarely met with, are as perfect as they were when the plant was living. The pith is formed of barred cells and vessels. Surrounding this vascular axis is a small zone in which are a number of vascular bundles proceeding from the pith to the leaves. These bundles may be seen here and there in the space beyond. This zone is also occupied by very fine cellular tissue and bounded by a layer of parenchyma, formed of rather larger cells than those within the zone. From the latter layer proceed in a somewhat radiating manner, a number of cellular laminae, which break up into regular parenchyma before reaching the periphery of the space. These tissues are, in the great majority of specimens, entirely absent, owing probably to their very delicate nature, and even in the specimen now being described, they are in places much shrunk and shrivelled. Surrounding the pith there is a thin layer of prosenchyma, composed of very small vessels, which cannot be distinguished in transverse sections from the rest of the small vessels composing the rim of the pith, but which can be plainly seen in the longitudinal section.

This is the layer from which proceed the vascular bundles which go to the leaves. Surrounding this is the delicate parenchyma, forming what Professor Williamson calls the pseudo-cambial layer (*g*), and forming the innermost layer of the inner bark. The inner bark is seldom found preserved as in this specimen, there being generally a zone between the pith and the middle bark filled with calcite and stigmarian rootlets. The middle bark, which is almost always preserved, is composed of rather large cellular tissue, interspersed with the vascular bundles proceeding from the pith to the leaves. These bundles were originally surrounded by delicate parenchyma, the decay of which has left spaces in the bark destitute of tissue. These spaces have become filled with calcite during the process of fossilisation, and form a conspicuous feature in many sections of lepidodendroid plants. The large cells of the middle bark gradually merge into the smaller vessels of the bast layer. In most specimens the outer portion of the bast layer has broken off from the inner portion, and in this state the specimens are some-

times said to be decorticated, whereas they have simply lost their epidermal layer. We often find portions of the epiderm in the material separate from the other parts of the plant. Most of our common lepidodendroid fossils found in sandstone, shale, &c., are either casts of the epiderm or of some other part of the bark.

HOW TO CLEAN DIATOMS.

IN the December (1880) part of the "American Monthly Journal of Microscopy" Professor H. L. Smith writes in glowing terms of the use of soap in the preparation of diatoms, and describes his method of procedure, which we give in his own words. The material operated upon was a gathering of marine diatoms from the Hawaiian Islands; they were dried and matted together, but the gathering was rich in diatoms. "I put the dried material into a large test tube and covered it well with nitric acid, and left it for an hour (the time is not material). After this I boiled it, adding a little more nitric acid, and dropping in two little bits of bichromate of potash again boiled for a minute or two. The tube was now filled with rain-water and the whole mixed by inverting, &c. As soon as the mass (flocculent enough) had settled, the discoloured and acid water was poured off, and the tube filled with rain-water (it is better to use soft water). After settling, the water was again poured off and the deposit once more washed. (So far this is the old method, which generally ends here, only washing out as best one can the lighter forms and broken frustules.) . . . Pour off the supernatant water and adding a little clean soft-water I now put in a small piece of yellow soap the size of a pea and again boiled the deposit for a minute or two, after which the tube was filled with clean rain-water; some fifteen or twenty minutes after the yet milky fluid was poured off (it contained but few and very minute diatoms, which one can save if so disposed by keeping the poured-off fluid for a longer time). The tube, with the heavy deposit at the bottom, was again filled with rain water and shaken, and now a brilliant, sparkling display of colours showed that the flocculent matter was gone, and only clean diatoms, sponge spicules, and possibly some sand remained. Finally distilled water and alcohol was added, and after this washing pouring off all the finer forms which remained in suspension after five minutes, and which were saved with those of the other washings, little else remained except clean diatoms.

If after this any one exhibits a slide of diatoms full of flocculent and dirty deposit peculiar to the old method of treatment, we can only say, as in Miss Edgeworth's story, "What, no soap!"

Professor Smith says at the commencement of his paper that the use of soap for cleaning diatoms is not a discovery of his own, but that he cannot remember

when or where it was first breathed to him, for he has known it for some years.

The application of soap for the above purpose seems to have suggested itself to Dr. Stolterforth, who says (Journal of the Quekett Microscopical Club, August 1880, p. 95) that the idea occurred to him when trying to clean some of the Welsh deposits. His *modus operandi* is as follows: I place in a test-tube (6 in. long by 1 in. wide) a portion of the earth or mud about $\frac{1}{4}$ in. in depth, and pour in water until the tube is a quarter full; into this I drop a piece of yellow soap about the size of a small pea, and then boil gently over a lamp. When the diatoms are clean I fill up the tube with water and let it stand, then wash in the usual way until all trace of the soap is removed. Dr. Stolterforth omits all other cleaning, either with acids or alkalis, and he finds that soap alone is all that is necessary for all kinds of fresh or salt-water deposits. E. H. Griffiths, Esq. ("American Monthly Journal of Microscopy," April 1880, p. 88) also advises the use of soap (which he says he learned of Professor Smith) and afterwards, if necessary, nitric acid and carbonate of potash to bleach.

I have myself tried this method of cleaning, and can to a certain extent endorse what has been previously stated as to its use. I first tried it on a subpeat deposit from New Zealand, which, however, required acid treatment before it was sufficiently clean for mounting. I also tried it on a recent fresh-water gathering from the same locality with similar results. My next trial was upon some Peruvian guano. I found that the soap very much assisted in getting rid of a lot of colouring matter, and materially reduced the quantity of the crude material. I may here remark that, after pouring off all that did not subside in one hour, I again boiled in soap and water, which further reduced the quantity; but the residue was totally unfit for mounting until further cleaned with nitric acid and chlorate of potash, and a final wash with liquor ammoniæ. On the marine deposits, such as those from Virginia, California, Barbadoes, &c., soap seems to have but little if any effect.

To those who may be desirous of trying the soap process the following hints may be useful.

- 1st. Carefully avoid hard water.
- 2nd. Use the best yellow soap (the ordinary soap often contains oil).
- 3rd. If soap is used after the acid, remove all traces of the latter with soft or distilled water.
- 4th. Dissolve the soap in the water and pour it on the material, so as to make sure that no portion of it remains undissolved.

The soap process does not seem to possess (in my opinion) any advantage over liquor ammoniæ in eliminating flocculent matter. The preliminary boil in soap and water, by getting rid of a portion of the non-diatomaceous material no doubt reduces the quantity of acid required, but it will not supersede the use of it.

F. KITTON.

NOTES ON POND-SNAILS (*LIMNÆA*).

TO be able to see with the eye the beginning of a living creature from the very embryo, is one of the most amazing and instructive sights the powers of the microscope can reveal, and one which opens the mind to wonder and admiration, giving the observer an immense field for thought and conjecture. Now that the spring is on, this can be seen by any of your young readers microscopically inclined, who use the instrument as a means of learning more of the world they live in, and who are fond of studying its smaller and more insignificant inhabitants, which some people, who "care for none of these things," would pass by as worthless and beneath their notice. By searching any freshwater stream or pond they will be sure to find, without much difficulty, attached to the weed at the edge, or to the stem and leaves of plants growing in the centre, a lot of small oblong masses of a transparent jelly-like substance; these are the ova sacs of the *Limnæa* or freshwater snails. All they have to do is to take these home and keep them in a shallow trough, convenient for placing on the stage of the microscope at any moment. At first when examined this gelatinous substance will be found to contain a number of small oval-shaped eggs filled with a perfectly clear homogeneous substance, with a small dark speck in each (the nucleus); if this is watched from day to day, the development is extremely interesting. The nucleus is seen to enlarge gradually up to the eighth or ninth day, when the embryonic animal commences to move in the interior of the ova in a rotatory manner; in a day or two more the rudimentary eyes can be observed, and also a strong ciliary action, close to the edge of the egg, very like the fringe of cilia on a common vorticella, by which I suppose a motion of the fluids in the egg are kept up. The embryo still enlarges until it breaks through the shell and comes forth a living animal—the whole process of development occupying about a month. I have only given a rough sketch, the minutiae of it would occupy too much valuable space. I only hope it will be the means of directing some attention to these animals.

The egg walls being so transparent, there is no difficulty in watching the whole operation. The pleasure derived from a short study of the embryonic life of those freshwater molluscs well repays the time spent upon them, and can be obtained at a minimum of trouble.—*P. B.*

SKYLARK.—One day in March this year, I saw and heard a lark (*Alauda arvensis*) singing while settling on a heap of ashes in a market-garden near this town. The song was prolonged, as it is when this bird is soaring. I have noticed this habit of the skylark before.—*Henry Lamb, Maidstone.*

THE ENGLISH FIELD-MOUSE.

THE long-tailed field-mouse (*Mus sylvaticus*), though comparatively well known to scientific observers, is not, I think, so familiar to people generally as one might suppose, considering its abundance.

Its habitat being chiefly the bottoms of hedges and banks covered with herbage, its burrows are not easily detected, nor is the mouse itself, for it rarely ventures beyond the runs; it works among the tangled grass till darkness has fairly set in, and all is quiet. Then it sallies forth in quest of food, sometimes wandering to a great distance from its home.

The food of this little animal consists of the succulent stems and roots of various plants, nuts and grain, it is also particularly fond of beans and peas, as the



Fig. 67.—Field Mouse (*Mus sylvaticus*).

gardener knows to his cost, for often does he find whole rows of carefully planted peas, scratched out and devoured in a single night by these little animals just as the shoots began to appear above ground. In the autumn it ascends the hedges in quest of nuts and haws, and like the dormouse is very fond of making a vacated bird's nest its dining-room.

Fleming, in his work on Natural History, states that this mouse becomes torpid at a temperature of 43° Fahr. This statement is, however, incorrect, for I have on many occasions caught them when the temperature has been considerably below 32°.

A friend of mine whilst walking through Talbot Woods near here, on the evening of January 9th, noticed a mouse run across the path in front of him; following it, he had no difficulty in capturing it, for the ground was covered with snow. It proved to be a nearly adult specimen of the present species. It is now in perfect health, and as it is at this moment by

my side, I will, before concluding the remarks, point out a few of its leading characters. But before doing so I would state that I am much surprised that it is not more frequently kept as a pet, for it is most easily tamed as a rule, very amusing, and has the great advantage over its near relative, the favourite white mouse, of being almost entirely devoid of any unpleasant smell.

To effect its capture all one has to do is to go to a bank bordering a ditch, or at the bottom of a hedge and pull aside the grass, when its well-formed runs will be detected; in one of these place a mousetrap (ordinary penny ones are most useful), baited with a piece of bread, adjust the grass over it, and leave it alone till morning. On revisiting the spot you are nearly sure to find it contain either a long-tailed field-mouse, or field or bank vole, generally the first named. Some few individuals prove obstinate and untractable, others seem naturally docile, and may be handled with impunity at the moment of capture.

The most striking features of our little friend are its large, prominent dark eyes, unsurpassed in brilliancy, and its fine delicate ears. Its colour on the head, back, sides and tail, is a rusty grey, plentifully intermingled, especially along the back, with darker hairs. This colour is prolonged down the outside of the legs as far as the feet, near which it is of a lighter and warmer tint.

Below a line drawn from the meeting of the two maxillary bones round the body to the end of the tail, placed horizontally and dividing it equally, the fur is externally of a pure white, excepting the leg prolongation before mentioned; the base of the hairs is, however, of a bluish-black colour. The upper surface of the feet is of a delicate flesh colour, the lower red, and furnished with six tubercles on each. It is about half as large again as the common house-mouse, and far more attractive in every respect.

THOMAS J. LANE.

UNCLASSIFIED NOTES ON THE INLAND BIRDS OF CEYLON.

By F. L.

INTRODUCTORY REMARKS.

AN apology is rarely a good preface, but an explanation is often of some advantage to the reader, as well as a satisfaction to the writer. This being my case, I wish it to be clearly understood that the following notes have been collected purely from my own observations, and every measurement and remark from a specimen that has fallen to my gun, during a period of six years' ramblings in Ceylon.

Owing to the imperfect state of my notes, I have not attempted to place my birds in anything like

correct order—a labour that I trust I may yet be spared to perform, for I have only been able to explore certain parts of the country, as will be seen by a glance at the rough sketch-map that accompanies these pages.

Of water birds, or, more correctly speaking, wading birds, I have only been so fortunate as to secure but a very few, as my ramblings have been, with few exceptions, confined to the hills; hence I have considered it advisable to head the present series of papers as above.

In every instance where I have been able to give the classical name, I have done so, and also native names; but as I have not always had the means of getting my birds identified, I have given only such names as I can depend upon.

The system that I have followed, is exactly the same as that in the late Dr. Kelaart's "Prodromus Faunæ Zeylanicæ," while the nomenclature is according to the various writers that I have been able to consult.

As space will not admit of a lengthy notice of each bird, I have condensed my observations into as small a space as possible concomitant with the subject. The extreme difficulty, and I may add, scarcity of nests, has rendered it beyond my reach, in all instances, to give remarks on building habits, but where I have been able, they are duly shown.

It must be understood that a very considerable proportion of the Ceylon birds are migrants, arriving in the north-east monsoon, and retreating with the south-west monsoon; but in the absence of any direct information, it is impossible to say from whence our migrants come, and it may yet be found that the birds alternately come and go from various parts of the island with the changes of the monsoons. But it would be out of place to give speculations as to migration in these pages, and I leave it to those who have direct information to give upon the subject, to clear up what is at present an uncertainty.

The various changes of elevation, and accordingly temperature, make it very difficult to give any particular time of the year as the breeding season for Ceylon birds, so much so, that breeding may be observed at any time of the year; consequently but little can be said as to a definite period for incubation. The hot season is of course the most natural time, but usually at this period, the nights are marked with extreme cold on the hills, and not unfrequently are followed by frost in damp localities.

A more equal period begins from the end of March, which is succeeded by the burst of the south-west monsoon in April and May, continuing to the middle of October, when the arrival of migrants may be considered at its height. Building is often carried on in the months of October and November, but I think the month of April may be considered the best time, though I am not prepared to give it as an actual rule.

ACCIPITRES.

1. The Crested Eagle (*Limnaëtus cristatellus*), Temm., *vide* Holdsworth, "Catalogue of Ceylonese Birds," P. Z. S. 1872, p. 411, No. 11.—*Sפיאטוס לימנאטוס*, Horsf., *vide* Kelaart. "Ookoosar" of the Singalese, and "Pranthu" of the Tamils.

Distribution.—This eagle occasionally visits the hills at elevations of 4000 feet and upwards, but is not common. The one I secured was in Dickoya district (4800 ft.), and had descended upon my poultry when I shot it.

Size.—Length 2 ft. 2 in.; span 4 ft. 4 in.; wing 1 ft. 4 in.; tail 1 ft.; tarsus $5\frac{7}{10}$ in.; height 1 ft. 5 in.

General colour.—Brown above, tinged with a shade



Fig. 68.—Sketch-Map of Ceylon. The shaded parts indicate the Author's Collecting Grounds.

of cream colour. Cream below, with darker shadings upon individual feathers. Wings and tail crossed with broad bars of brown, that are visible both on the upper and lower sides; under sides of the wings pale, except where marked as above. Legs and tarsi clothed with short feathers, exposed parts yellow; bill dull black; irides golden yellow; claws dull black. Of these the hinder claw is extremely large, being no less than $2\frac{1}{4}$ inches in circumference, from the toe joint to the point.

2. The Black Eagle (*Nepus Malaiensis*), Reinw., Holdsworth. *Ictinaëtus Malaiensis*, Temm., Kelaart. "Ookoosar," or "Kaloo Ookoosar," of the Singalese. "Pranthu," or "Karipü pranthu" of the Tamils.

Distribution.—Frequents the lower hills up to

3000 feet, but rarely above that point. Common in the Western and North-western Provinces.

Its food consists of snakes, birds, and even rats, one of which I found nearly entire in the stomach of a specimen I secured.

Size.—♀ length 2 ft. 2 in.; span 5 ft. 4 in.; wing 1 ft. 8½ in.; tail 1 ft. 1 in.; tarsus 3½ in.

General colour.—Very dark brown, tinged with shades of a rusty tint; under parts paler than above; irides warm brown; feet yellow; claws black; bill horny at the tip, bluish at the base; cere yellow.

3. The Ceylon Eagle (*Spilornis bacha*) Daudin, Holdsworth. The Crested Serpent Eagle, Legge (Journal Royal Asiatic Society. Ceylon branch, 1874). *Hematornis Cheela* of Kelaart, who also calls it the Cheela Eagle. "Rajaleea," or "Ookoosar," of the Singalese. "Pranthu" of the Tamils.

Distribution.—Common throughout the whole of the upper hill country, and also in the flat low country of the Western and North-Western provinces. It devours snakes and small reptiles, as well as birds, if obtainable, but it appears to be most partial to snakes.

It may frequently be found in pairs, and when on the wing it utters its long and mournful note.

Size.—♀ length 22 in.; span 46 in.; wing 15 in.; tail 10 in.; tarsus 4 in.

Colour.—Iris golden; tarsus and foot yellow; bill horny at the tip, bluish at the base.

Note.—I am unable to give further details as to colouring, as at the time I secured the above I was changing quarters, and the skin got lost.

4. The Kestrel (*Tinnunculus alaudarius*) Gmelin, Holdsworth, Kelaart and Legge. Sometimes "Cooroolar goyar" of the Singalese. "Lavoodoo pranthu" of the Tamils.

Distribution.—This kestrel visits the hill country about November, leaving again by about May. During the time of its visit it is pretty widely spread from 2000 to 7000 feet above the sea, but never in very large numbers, pairs usually. Other writers say it is found near the sea, as well as inland, but I have never remarked it much below 2000 feet. Food consists of reptiles and vermin, mostly, and even large insects and small birds.

Size.—(?) Length 13 in.; span 27 in.; wing 10 in.; tail 7 in.; tarsus 2 in. ♂ Length 13 in.; span 28 in.; wing 9½ in.; tail 6¾ in.; tarsus 1⅞ in.

General colour.—Light brownish, inclined to rusty brown, with deep brown triangular spots, on the whole of the back and upper parts generally. Head ashy gray, with darker centings on the feathers. Breast and sides of the same colour as the back, only of a paler shade, and with blot-like splashings down the middle of each feather, growing smaller towards the vent. Legs nearly cream colour; tail light grey above, banded with dark brown and margined

with white. Wing feathers brown on the outside, and pale white below, with triangular white markings on the inner webs; iris dark brown, bill black at the tip, faint blue at the base; lower mandible yellowish at the base; orbits and cere yellow; tarsus and foot orange in some, yellow in others.

(To be continued.)

BOTANICAL NOTES FROM THE SWISS HIGHLANDS.

IV. MOUNT PILATUS.

BY DR. DE CRESPIGNY.

[Continued from page 87.]

A THOUSAND feet or so higher than the Rigi, and far more prolific, both in quantity and variety of alpine plants, is Mount Pilatus, a long serrated ridge with several culminating points of nearly equal altitudes, although its pyramidal form viewed from the town affords no indication that such is the case; so steep and rugged as to have been till very lately inaccessible to all but the most daring and experienced climbers. At present there are inns on both sides of the ridge, with mule paths leading up to them on either side. A footpath connects them. Other paths, carried along the face of the precipice and partly blasted in the rocks, afford safe access to the highest summits.

The undulating hilly base and lower flanks of the range cover an area of thirty miles in circumference, and are more or less clothed with pine forest, too dark almost for undergrowth, except on the borders and in the clearings, and too gloomy perhaps for animal life. Not a bird is to be seen there, nor the song of any to be heard. Very little original forest is said to be extant on the Alps, and that only on the most inaccessible slopes; nevertheless, there are few indications, except near the towns, of any planting on a regular plan—its reappearance after having been cleared off is a natural and spontaneous phenomenon. The pine will grow anywhere below a certain elevation on these mountains, spreading its roots over the surface, and flourishing apparently on all but naked rock. In some places there is certainly evidence of conservation—thinning out, cutting, trimming, &c.—proof that the village communal system is dying out; for what was once communal land, forest as well as pasture (an object, therefore, of nobody's concern in particular) is now fast becoming the private property of members who have accumulated capital by innkeeping or otherwise, and are fully alive to whatever affects an individual and separate interest. An excursion from Lucerne through these forests over the Hochwald to the Bründelalp on the flank of Pilatus—swampy, peaty ground in this direction—and back over the Stöss, Hergotts, and Schächen forests, will afford

a very fair notion of their character, and prove not unsatisfactory with regard to interesting "finds." A long and a hard day's walk; an early start desirable; take a fiacre to Kriens. The under-mentioned plants may be met with in their respective appropriate localities:

1. *En route*:—*Arnica montana*; *Carex canescens* (= *curta*), *alba*; fruit globular with a short truncate beak; bracts scarious, sheath-like. *Davalliana*, fruit with a long beak reflexed when ripe; *pauciflora*; *Dentaria digitata*; *Eriophoron alpinum*; *Hyoscyam rigidum*; *Lycopodium annotinum*; *Luzula flavescens*; *Maianthemum bifolium*; *Oxycoceus palustris*; *Pyrola uniflora*; *Pinguicula vulgaris*; *Polypodium calcareum*; *Ranunculus lanuginosus*, near *acris*, stems shaggy, with deflexed hairs; *aconitifolius* and *platanifolius*, petals white; wet and shady places. *Rosa alpina*; *Sedum villosum*, flowers rosy white; inflorescence corymbose in dichotomous cymes; peaty ground. *Vaccinium uliginosum*.

2. Bründelalp, and ascent thereto.—*Arctostaphylos alpina*, rocks above. *Amelanchier vulgaris*. *Cirsium spinosissimum* (= *Cnicus*, *Carduus*). *Carex firma*. *Geum montanum*. *Juncus triglumis*; *alpinus*, near *obtusiflorus*, but panicle erect; fewer flowered; perianth and capsules black. *Lonicera alpigena*, flowers geminate, sessile at the end of long peduncles; berries red, connate. *Lilium Martagon* (frequent on the Alps). *Oxytropis montana*, flowers bluish-purple on long peduncles, subcaulescent. *Orchis globosa*. *Potentilla Salisburgensis*. *Rhamnus pumila*, rocks above; dwarf, stem tortuous, unarmed; leaves alternate. *Swertia perennis*. *Scheuchzeria palustris*. *Tozzia alpina*.

The ascent from Hergyswyl is up over meadows and orchards for three miles, and then through forest for as much more, and lastly, for another three miles, by a winding path over rocky débris along the northern face, the "Nauen," of the mountain. Notwithstanding the unpromising aspect of the ground viewed from below, on a nearer approach patches of rhododendron scrub and coarse herbage are met with higher up, and the stony soil, well watered by springs, will be found to yield interesting plants in plenty. Ample time should be allowed for a thorough examination of this locality and of that in the vicinity of the Klimeshorn hotel and peak. Collectors, therefore, will do well to secure a room, and reserve the summits and descent to Alpnacht for the next day's work.

3. Mt. Pilatus, upper section, 5500–7300 feet. i. The "Nauen":—*Arabis alpina*, frequent. *Astrantia minor*. *Adenostyles albifrons*, leaves in this species covered with a white tomentum on the under side. *Alchemilla alpina*. *Arnica scorpioides* (= *Aronicum*), heads pale yellow, larger than those of *montana*. *Bartsia alpina*. *Carex ferruginea*, stems long, slender, leaves linear, spikelets linear on long peduncles. *Cochlearia saxatilis*, radical leaves rosulate, stems

long, flexuose, inflorescence a compound or paniced raceme, silicles globose, *Crepis aurea*; *blattaroides*. *Chrysanthemum Halleri* (= *coronifolium*); *montanum*. *Erinus alpinus*. *Festuca violacea*, this pretty grass is common on the débris; sheaths glumes and lower glumella coloured as indicated. *Galium Helveticum*, a neat little plant, branched and spreading, flowers in small compact axillary and terminal umbels. *Homogyne alpina*. *Hutchinsia alpina*, elegant, leaves pinnatifid, petals pure white and longer than in *petraea*; also on the Bründeln. *Linaria alpina*, stems many, spreading, leaves linear glaucous, flowers in compact racemes, blue with orange throat. *Myosotis alpestris*. *Machringia mucosa*, also low down. *Narcissus poeticus*, plentiful in some places, out of flower. *Oxyria digyna*. *Plantago alpina*; *montana*, spikes almost globular in the latter, leaves linear in the former species; structural difference is in the seed, which in *montana* is grooved like that of *laucolata*. *Pinguicula alpina*. *Petasites foliosa*; *verticillata*; *versicolor*; flowers yellow in this species. *Polygala Chamæbuxus*. *Phaca astragalina*; *frigida*, flowers yellow. *Poa distichophylla*. *Phleum alpinum*. *Primula farinosa*. *Polystichum Lonchitis*. *Ranunculus alpestris*. *Rhododendron*, both species. *Salix retusa*; *myrsinites*. *Saxifraga stellata*. *Trifolium badium*. *Trollius Europæus*. *Thlaspi rotundifolium*, another Alpine beauty, leaves somewhat fleshy, radical ones rosulate, stems several, flowers mauve, in short umbellate racemes; also on the Bründeln. ii. Klimeshorn (6300): *Athamanta Cretensis*, stems many, rays 6–10 unequal, involucre scales 3–6; diachenes rough with spreading hairs. *Arctostaphylos alpina*. *Arenaria verna*. *Anemone narcissiflora*, also on the Nauen. *Achillea atrata*. *Abies viridis*. *Carex nigra*. *Erica carnea*, a variety perhaps of *cinerea*, and its representative on the Alps; flowers paler and leaflets four in a whorl. *Festuca Halleri*, panicle short, narrow, branches short, single; *pumila*, pretty, stems slender, leaves capillary fasciculate, panicle variegated green and violet, glumellas scarious violet. *Gentiana Bavarica*, stems cæspitose, single-flowered, throat of corolla naked. *Hedysarum obscurum*. *Phytocuma betonicaefolium*, *hemisphericum*, leaves of this linear, and the length of the stem. *Trifolium cæspitosum*. *Valeriana montana*; *tripteris*, stem leaves ternate, terminal lobe large. *Veronica asphylla*, stems leafless.

(To be continued.)

HAWFINCH.—The hawfinch is not such a rare visitant with us as it appears to be with your correspondent C. Parkinson. A winter seldom goes by without some specimens being seen or shot, and on more than one occasion it has bred in this locality. A female bittern has occurred recently near Hungerford. Of course it was shot.—*John L. Hawkins, Jr., Reading.*

BRAULA CÆCA—AND ITS RELATION TO THE HONEY BEE.

TO become obstructive to the dissemination of false impressions and erroneous opinions, is happily pardonable in scientific life, and perhaps there is no greater mystery and misconception on any subject than that which prevails respecting parasitic agents and their ultimate effects.

From all ages the produce of the bee has been made subservient to the wants of man, and therefore its culture has been the study alike of the naturalist and the peasant. It has also been observed that the bee has many parasites, and that its honey and its wax are in request not only by man, but by various insects not truly parasitic. But with *Braula* only we have now to do.

The effects of the braula upon the useful operations of the bee have long been known, though less generally understood; its history, therefore, may be better studied through that of the bee, while there

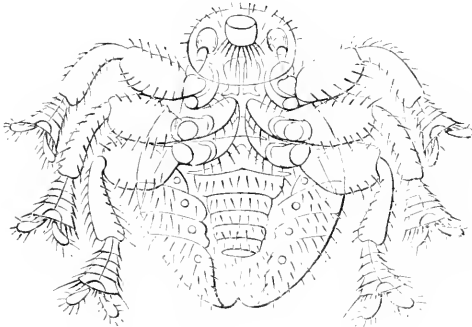

Fig. 69.—*Braula cæca* (ventral aspect, magnified).

can be no doubt that when braula has been more observed, it will be found that more is attributed to it than it deserves, seeing the extent of ravages and consequent loss to cultivators occasioned by other hidden guests, while many deaths attributed to cold or floral dearth are really due to food supplied in substitution by the owners.

No doubt that braula is annoying, but where it is injurious, the hive is like the house when pestilent with fleas, but where braula does so exist its effects are but too apparent, for the restless and excited state of the colony is such as to interfere most seriously with the industrial habits of the insects and so to lessen the quantity of honey produced as to render the entire stock unprofitable.

It has been represented and still is being (vide SCIENCE-GOSSIP, December), that the bee louse (*Braula cæca*) is the parasite of the "queen" of a colony, and examples so labelled and named are distributed. The error is very great, as every entomologist and intelligent observer well knows, and the error cannot be too early corrected. If the

attacks of braula were confined to the person of the "queen," such general disorder in the hive would not prevail, while the remedy would be easy, it being only the substitution of another queen, to whom the bees would readily pay their homage. Such happy termination of the evil, however, is not so easy, for the removal of any particular bee, or bees, other than those annoyed, is insufficient to restore the order of the hive, for the insects are indiscriminately attacked, irrespective of function, or sex. The parasite of the "queen," therefore, can never be accepted. There may be no evidence that braula is parasitic upon other families of the Hymenoptera, yet it is not improbable that, under certain circumstances, it may have been present in other conditions unobserved or unrecognised, as is known to be the case with many of the parasitica, otherwise their very occasional appearance in the hives of bee masters is scarcely to be explained. But other reasons readily present themselves. It rarely happens that a single bee has scores upon its body, never when a healthful state prevails, while the deportment of the insect outside



Fig. 70.—Rudimentary wing of *Braula* (magnified).



Fig. 71.—Pulvillus of *Braula* (magnified).

its dwelling, the length and quantity of its hair, the affinity, in respect of colour, the close attachment of the parasite, and other reasons, are quite sufficient to explain why braula may be unperceived, even if present.

According to palæontological researches, it seems pretty safe to infer that braula may have had a very ancient origin. The Hymenoptera have been found to have existed even as far back as the Mesozoic age, towards the close of which epoch the bee is known to have lived. But because its remains were first discovered in those particular deposits, it is not necessary to suppose that the insect was not in existence, even at a much earlier period; for as the flora of the ancient world developed, correlated insects undoubtedly appeared. And because we have no reason to believe that the plan of creation has differed in any way since the first, so we are justified in assuming that all those conditions necessary for the retention of the bee in its place in the world were provided, and that, therefore, its antagonists were not absent. Nor is it at all improbable that even braula may have passed unrecognised

among the fragmentary remains of Palæozoic time, impossible of identification. I think the earliest evidence of the presence of Hymenopterous insects in the British Isles is found in the deposits of the middle Eocene age, and with them also is found a largely extended flora, consistent with the general law of harmony, as flowers developed. Anthophilæ appeared, and thus we find presumptive evidence of the bee in Britain. But where was *braula*? Perhaps he had not yet elected to possess terrestrial trachea.

According to my own observations, and these are corroborated by others, the London clay, even at its base, is strewn with organisms far less favourable for preservation than the chito-coriaceous skins of *Braula cæca*. It is true that, geologically considered, the gap between these periods is incalculably great, but observation shows that, conditions being present, time is no preventive of the preservative process, so that, analogically, there seems no reason for the exclusion of the epizoa during these

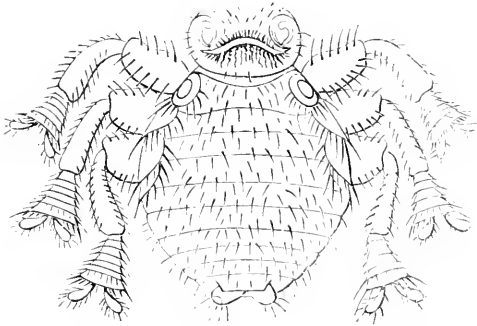

Fig. 72.—*Braula cæca*, dorsal aspect (magnified).

remote periods of the world's history. Nor is the presence of palæontological insectivora any reason for the total absence of palæontological parasitica.

In passing from pre-historic to historic time to the order of creation as it now exists, we find the bee an item of vast commercial importance, and of no less scientific interest, attracting the attention of men, the most learned of their day, whose work now forms the basis of all our studies. The most ancient of historic writers tell how well the bee was known and how much studied early in man's history on earth; while Philiseus, Aristomachus, Aristotle, and others, all naturalists of high repute, were great observers, not only of the Hymenoptera, but of *Mellifica* in particular, while the family may be found basking and flitting from line to line in the beautiful effusions of Virgil and Dryden. Were not those keen men aware that the bee was not exempt from those common ills to which the whole insect population were then, and still are, liable? But though *braula* is not mentioned, the omission is no proof of absence in creation.

And nearer even still, was Swammerdam, an early Westwood, and all his followers, who take us back two hundred years, and Huber and his devoted friend—his indefatigable and literary son—his scientific wife, to each of whom we also owe so much of what we know of bees. Did they know *braula*? otherwise their observations were incomplete and untrustworthy. Nor can we think the rustic wife that tends her bees with assiduity, who knows all she knows from observation—not from books—does not know *braula*. If so, her entomology is little better than her neighbours', but not knowing *braula*'s name, she calls it "louse."

The cultivated bee of Britain is not the same as that domesticated in certain parts of Italy, so that *braula* being found with us, and among the Germans, as we are told, if Italy were its birthplace, its predilection cannot be exclusive. The probability, therefore is, that the parasite is far more greatly distributed than has been supposed, and its acclimatisation may far precede our own most ancient history.

Few men have obtained that influence over the



Fig. 73.—Tarsus of *Braula* (magnified).

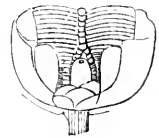

Fig. 74.—Rudimentary trophi and gula of *Braula* (magnified).

bee that was possessed by Wildman, and fewer still perhaps would dare to venture on his familiarities, seeing the insect's not unfrequent antipathy to certain individuals, or even to the same individual under varied conditions. Why this, the bee best knows.

Braula, as being parasitic in common with the members of the family to which it is allied, derives its support from the juices of living animals, and we know when death occurs in the higher animals, important changes take place in the more delicate tissues, and in the nutrient vital fluids in particular, so that their parasites, if present, instinctively depart in search of more suitable conditions. There is no departure from this natural law.

At a first glance, one is struck with the great resemblance of *Braula cæca*, Mitzich (*B. cæca*, Otto) to the sheep tick (*Melophila ovina*, Mitzich, *Melophagus*, Latr.). Their difference, however, soon becomes apparent when compared, in respect of Lice (*Pediculida*), there is no affinity. Like *ovina* and some members of the *Pulicidæ*, the antennæ are contained in eye-like

cavities, that give the creature a remarkable appearance. The trophi, more or less rudimentary, are contained in the oral cavity, but the mouth differs essentially, both from *ovina* and *Pulex*, as it has neither the long, bristle-like seta, and double-valved jointed sheath of the one, or the lancet-like appendages, accompanying the suctorial organ of the other, while its base is furnished with a tuft of stout, curved spines, like those produced from the margin of the mesothoracic spiracles.

The rudimentary wings consist of two cirro-membranous, striated appendages, with excavated tegula terminating their base in the striæ, representing the nervures of the fully developed wings of the order. The episternum is divided, and forms two large, cone-like bodies into which the trochanters are inserted, and which in connection with the oral tuft, and spines of the mesothoracic spiracles,—the cones acting as suckers—serve to ensure the closer and firmer attachment of the parasite to the body of the bee, so as to prevent its disturbance and displacement by the deportment and habits of the insects. In common with the order, the prothorax is depressed for the reception of the head. The fine jointed, spinous tarsi, are elegant objects for the microscopist, their large terminal joints being furnished on their inferior extremity with a beautiful pectinate fringe, and a pair of elegant, papillated, brush-like bodies, the structure of which, as also of the striated internal pad formed by the expansion of the tendinous termination of the muscles of the limb, cannot fail to interest and instruct the intelligent student, for the member is a remarkable example of the varied modifications of the foot of the Muscidae. The abdomen is terminated by pygida, and each pygidium is furnished with four stout spines, and also with a number of smaller hairs; from its base is an appendage, at the extremity of which is the vaginal orifice. *Braula* being pupiparous, its ova are never seen, and its larva, in its early colourless stage, seldom. It however undergoes a complete metamorphosis, the earlier of which is rapidly passed.

J. FEDARRE, B.E.,

Examiner, Privy Council.

ANIMAL TERATOLOGY.—I enclose a drawing of a chicken (made by myself), having four legs, four wings, two necks and one head, or rather, two whole chickens with one head; they are joined breast to breast from the base of the breastbone to the end of the necks where there is but one head, with the top turned to the side; so had it lived, it would have eaten from one side. We often hear of chickens having four wings or four legs, and sometimes two heads, but I never heard of one like the above, which was hatched in Clay County, Mo., in 1876, and is now in alcohol in my collection at Kansas City.—*Sid. J. Hare, 1017 Grand Ave. K. C., Mo.*

SOME SHORE-HAUNTING FISHES.

No. I.

By P. QUIN KEEGAN, LL.D.

SAVE during the spawning season, the vast majority of the great class of fishes frequent the open sea or the profound depths of the ocean; but a few species of this most interesting group love to permanently haunt the shallows adjacent to the shore. Spacious rock-pools, or tiny channels rent in the coast line by storm-vexed seas, or dim and cloistral ocean caves frequently swarm with shoals of little fish instinct with life and beauty. Some secluded basin among the rocks replenished by every tide with freshly aerated sea-water, and fringed with long waving tresses of sea-wrack, or decked with tufts of laver and coralline—a beauteous submarine garden affording shelter, nutriment and a salutary obscurity, is a favourite abiding-place. There, if we peer into the green and shadowy depths, amid a comprehensive array of vegetable and animal organisms, we can readily discern the vigorous and vivacious antics and gambols of sundry sticklebacks, gobies, blennies, bull-heads, pipefishes, &c. Amid the crystal silent water, or in among the seaweed drapery they dart to and fro with playful random and energy, now progressing slowly with acrobatic contortions, now turning sharply at an angle, or halting with head downwards, fidgeting with the snout, or as if afflicted with palsy, or absorbed in some object of fascination. They are carrying on the business of life, and fulfilling as is meet their function in the creation. Again, in sandy hollows, we may observe innumerable young congers, gobies, &c., flopping and floundering about in the lucid, shallow water with all the exuberant playfulness of a mature activity. But even the desolate, tide-abandoned sands are not destitute of piscine life. If sufficiently and dexterously probed and investigated, they will disgorge myriads of sand-eels, &c., immured therein as an abiding-place of safety and concealment. Generally speaking, the intellectual calibre of fish is not great (the brain is small); their senses and faculties seem obtuse and limited; with some notable exceptions, they are not endowed with any wondrous instinct; and their life career is chiefly occupied in catering for subsistence or in shielding themselves from enemies. But on the other hand, they yield to the philosophic student of zoology a rich harvest of suggestive facts: their anatomy, their embryology, their histology, their nervous structure exhibit phenomena which furnish data, evidence, or proof for some of the grandest speculations in the science of animal life.

Perhaps the commonest, the most numerous, and the most widely distributed of the peculiarly shore-haunting fish now adverted to are the various species or rather varieties of stickleback (*Gasterosteus*). These are picturesque little fish; generally of a green

colour above, and silvery white below; but they have a chameleon-like facility in adapting the colour of their coats to that of surrounding objects. They are of a well-rounded and beautiful shape, especially towards the tail, which is admirably cut, and in its motions gracefulness itself. Every amateur aquarium-keeper is familiar with the aspect of these creatures—their big eyes, chubby lips, and supple tail, and their extraordinary pugnacity and destructiveness. Most seaside little boys are aware of the extensive predominance of a certain species thereof, in rockpools or tiny inlets of the coast; and most microscopists are experienced in their illustrative excellencies in the way of exhibiting the general or the particular characteristics of piscine blood circulation. These sticklebacks gormandise voraciously on worms, the fry and roe of other fishes, but they worry and devour other small fish that come in their way, nibbling heartily at their tail and fins, even at those of their own species. The skin is without scales, but lavishly furnished with areolæ filled with a coloured oil; whereby the colour of the surface may be varied at will, or rather, according to the involuntary excitement of certain dermal nerves. The sides of the body are, however, encased in a more or less complete armature of bony plates; the head and face are also enclosed in a bony buckler of plates stoutly soldered together, and the bone beneath the eye is especially developed. The first dorsal fin is represented by a number (three to fifteen) of detached spines; and a single stout spine represents the ventral fin. The habits of these most vivacious creatures are extremely interesting. The marine species exhibits a "beautiful" illustration of Darwin's views concerning the "Struggle for Life," the "Survival of the Fittest," &c. About April or May, some mature male stickleback aspires to procreate a family of little sticklebacks, selects some special position—some "coigne of vantage" among the rocks. There among the screening fronds of fucus and coral-line seaweed, he proceeds with tremendous energy and signal architectural skill to construct a nest as follows: Some of the pendent tufts of seaweed in his vicinity are, by means of his snout, neatly arranged and bound round and throughout by a very long silk-like thread lavishly ejected from his body, until a pear-shaped mass (like a small jam-roll) is formed about eight inches long. The top is then constructed, and a small hole is left therein, or at one side, in order to permit access within. The male now in full dress goes a-courting, and presently some coy and confiding female stickleback, after a vivacious demonstration of caressing and solicitation, is induced to enter into the snug weed-woven nest. In a few minutes the spawn is laid, and the female immediately decamps by a side-door pierced by her own snout. And now comes the tug of war. The male stickleback after impregnating the spawn, forthwith "mounts guard" over the nest. In the performance

of his nursery duties he exhibits a lavish prodigality of life-energy. With invincible assiduity he watches the cradle, removing all obstruction, ever on the alert, prying into the hole to see if all's right inside, poking about with his snout, repairing and trimming up the precious structure, occasionally fanning it with the pectoral fins so as to aerate the contents thereof, and lastly, stoutly repelling every attack of the enemy. It is in sooth a case of "the struggle for life;" for frequently, with virulent animus and true pugnacious energy, will a colony of breeding sticklebacks attack one another. Very beautiful they are at this time, and they ought to show better manners. But the eggs are exceedingly tasty and luscious, so that a perpetual struggle (see Darwin) is carried on to make a dinner of each other's spawn or fry. The "mills" are frequent and ferocious, the sparring being conducted with much "science" and vigour (colours glow, teeth and spines ply energetically), until eventually either party "comes up smiling," or "throws up the sponge." In about three weeks the fry are hatched, and then the vigilance of the parent become doubly redoubled. He spars and brawls with his neighbours more obstreperously than before, he checks the premature wanderings of the fishlings, bringing back the truants to the nursery in his mouth, and conducts himself generally as a veritably full-commissioned, though excessively fussy, and officious parent or guardian. From June till the winter the fry in various stages of size and development may be observed in rock-pools or under stones between tide-marks.

(To be continued.)

MICROSCOPY.

NEW ZOOPHYTE TROUGH.—When in London at Christmas to obtain a special form of microscope, I saw, amongst other apparatus, at Watson's, 4 Pall Mall, a form of zoophyte trough that was quite new to me. I have used it since then, and I find that it works admirably, and is suitable for everything except the largest objects. Its advantages are that it is very light, is pleasant to work with, does not slip readily from the fingers, and can bear a fall without breaking. The only breakable parts are two slips of glass, and they can be replaced for almost nothing. It can be cleaned with the greatest ease. It is very cheap at 3s. 6d. when compared with the zoophyte troughs which cost in many cases about double; above all, when it is considered that with almost no trouble it can be made to do the work of an entire set of the medium and small sizes. It consists of two thin slips of plate glass, ground edges, 2 in. by 1 in., which form the back and front of the trough; the bottom and sides are formed of half of an indiarubber ring, which is placed between

them; by using rings of varying thickness, the trough can be made a large or a small one at will. When examining a very small quantity of water, I have used thick blotting-paper, cut into a semicircular form, in place of an indiarubber ring. The trough is made water-tight by being placed between two plates of vulcanite, 3 in. by $1\frac{1}{2}$ in. by $\frac{1}{8}$ in. thick. The plates are bound together by three brass screws with milled heads; the screws serve to keep the glass slips in position when placed between the plates; by tightening the screws, the plates are made to press evenly on the slips, which in turn press firmly on the indiarubber between them, and thus a water-tight trough is at once formed. When it is necessary to clean it, all that is required is to loosen the screws, pull out the slips, separate and dry them, replace the indiarubber and the slips in position, and screw up again. A semicircular part is cut out of the vulcanite plates to allow the glass trough to be visible. It is very neat in appearance, and its production is a step in the right direction, as there is so little glass about it to get broken, or brass to get tarnished. It can also be used as a coarse compressorium.—*J. Campbell Christie, Hamilton, N.B.*

FAILURE IN MOUNTING.—A few days back I attempted to mount a portion of a frog's ovary for the microscope. I examined the ova on a slide with a drop of water, and their structure was clearly displayed. Lacking a certain knowledge as to what was the best medium to mount them in, I placed a portion of the ovary in glycerine for two days and then mounted it in the same, but on examination I found that the structure of the ova was all but destroyed, and that the germinal spots had turned to a dark brown colour and seemed much distorted in shape. Can any of your readers inform me the reason of my failure? Did I employ the wrong medium, or must it have been some defect in the manner of mounting?—*H. Fox.*

ÆCISTES JANUS.—At a recent meeting of the East Kent Natural History Society, Mr. Rosseter exhibited a Melicerta he had obtained from a pond in this neighbourhood. On examining it we found that it was not one of the usual sort of Melicerta we had been accustomed to find hereabouts, and we were at a loss to make it out, never having seen just such a one before. Whilst we were consulting about it, Colonel Horsley came in with the February "Journal of the Royal Microscopical Society," and in that was a description of a new rotifer, with drawing of the same, discovered by Mr. J. Hood of Dundee in the Loch Lundie in September of last year, which appears to answer exactly to that exhibited by Mr. Rosseter. No doubt we shall be able to procure from the same pond more specimens, when I shall be able to examine them with greater care and to compare notes with the account in the Journal. It is there named *Æcistes Janus*.—*James Fullagar.*

THE SKELETON WHEEL-BEARER (Ceratophyllum).—Examining some Rotifera, collected during the month of January and kept in a separate vessel, I found a Ceratophyllum, or skeleton wheel-bearer, fig. 75. It will be observed by those who are acquainted with this beautiful and rare rotifer that it is in a few particulars differently constructed from its usual representation in drawings or in other living specimens

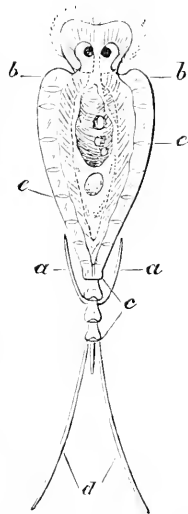

Fig. 75.—Skeleton Wheel-Bearer (Ceratophyllum).

I have seen. If any of your readers who may possess "Ponds and Ditches" will refer to page 170, and will compare with my sketch, they will perceive the different peculiarities. The spines springing from the first joint of the tail, *a*, are turned towards the head of the creature and not towards the extremity of the tail, as usually represented. The shoulders of the sheath, *b*, are rounded, not pointed. These two differences in the creature lead me to suppose that it is another species of Ceratophyllum. The three joints, *c*, fit into each other like draw tubes. It is not only amusing, but a wonderful sight, to see the creature draw them up, bring the long spines, *d*, that are attached to the last joint, well forward, fix them securely to the glass, and then by a violent effort jerk itself forward and then lie motionless, as if enjoying the act of propulsion. Being a good swimmer, it reminded me of the pleasure one derives from back-swimming after drawing up the legs and propelling oneself forward—how delightful the sensation is of travelling through the water in this position. The sheath of the creature is very strongly ribbed, *c*, and the creature can protrude or withdraw itself at pleasure.—*T. B. Rosseter, Canterbury.*

QUEKETT MICROSCOPICAL CLUB.—The March publication of the above club contains the following valuable papers: "On certain Immature forms of Diatomaceae," by C. C. Karop, M.R.C.S. "On a Method of Dry Mounting for opaque Objects," by Mr. H. J. Roper. "On mounting opaque Objects with Bees-wax," by Mr. H. Morland. "On the Use of Arabin in mounting Microscopical Objects," by H. J. Waddington. "On a simple Growing-slide," by T. Charles White, M.R.C.S. (President). "On some Desmids new to Britain in 1880," by M. C. Cooke, M.A., LL.D., F.L.S., "On a new Vivarium," by J. D. Hardy, &c. Mr. H. J. Waddington, in his paper "On the Use of Arabin in Mounting Microscopical Objects," gives the following method

of obtaining pure arabin from ordinary gum-arabic, which should be selected as clear and white as possible. "This is to be dissolved in distilled water to the consistence of thin mucilage. It should then be filtered, and the filtrate poured into rectified alcohol, and well shaken. The arabin immediately separates as a white pasty mass, and the whole becomes semi-solid. It must be placed on filter-paper, and washed with alcohol, until the washings are perfectly free from water, and the alcohol comes off as pure as it went on. The arabin may now be allowed to dry spontaneously. The edges of the surface of the mass will probably be found to be viscid, owing to the absorption of water from the atmosphere or from alcohol, but the remainder will be a perfectly pure white powder. This should be shaken off the filter and preserved."

DIATOMACEÆ IN COAL.—Professor W. C. Williamson, F.R.S., in his paper "On the Organization of the Fossil Plants of the Coal Measures," has the following remarks on Count Castracane's supposed discovery of diatoms in coal. "This discovery, if real, was valuable, hence its verification or the reverse became desirable. My colleague, Professor Roscoe, kindly allowed Mr. Smith, one of his able assistants, to subject numerous specimens of coal to Count Castracane's process. The coals thus experimented upon were the following Yorkshire and Lancashire ones—Bradford, Worsley (16 samples), Middleton, Yorkshire (4 samples) Australia (3 samples). The result of these investigations was to obtain a series of preparations of a very diversified character, but in no one example did I discover the smallest fragment of a diatom. Mr. F. Kitton, of Norwich, informs me that he had also examined many samples of coals from Durham and Newcastle as well as from inland collieries, but did not find a trace of a diatom. My friend the Rev. E. O'Meara of Hazelhatch, Dublin, says he has examined specimens of coal from Whitehaven, but could not find any diatoms; he also informed me that the Rev. G. Davidson, of Logie Coldstone, Aberdeen, had also examined a series of coals with the same negative results. I can only conclude that Count Castracane has been mistaken as to the source of his diatoms."—*Philosophical Transactions of the Royal Society*, 1880, vol. clxx. part ii. p. 519.

MICROSCOPICAL SOCIETY OF LIVERPOOL.—At a recent meeting of this society, Mr. Mayall, jun., F.R.M.S., gave a paper on "Brass and Glass." Mr. Mayall said it might be in the recollection of many then present that about a year ago he had the honour of addressing a few remarks to the Society on the subject of immersion objectives, with particular reference to the increase of aperture which the immersion system developed over the maximum apertures of dry objectives. By "Brass and Glass" must be understood that part of microscopy concerned with the development of the microscope as an instrument, apart

from its applications to this or that special branch of study. Mr. Mayall said that it had recently been most ungenerously stated in public that the "Brass and Glass" party among the microscopists cared for nothing but the mere display of elaborate apparatus, that they vied with each other in encouraging the manufacture of more and more expensive instruments for the gratification of their personal whims and fancies, and without the slightest reference to advancing any scientific branch of microscopy. It was no part of his programme to explain in detail what really was expected to be gained by encouraging opticians to construct stands, objectives, condensers, &c., which from their elaboration must necessarily be costly, but might point generally to the fact that the most conspicuous developments in recent microscopy—particularly the delineation of microscopic objects by means of microphotography—were absolutely dependent on the perfection of the instrument. Now the improvement of the instrument itself was by no means so "petty" a subject as it had been sought to insinuate; he (Mr. Mayall) thought that a thorough investigation of the principles upon which the improvement of the instrument depended was by no means an unworthy or idle task; and he thought that if those principles were more generally appreciated, much more rapid strides would be made, and certainly there would be far less publicity given to crude and erroneous interpretations, the ground, would in fact, be cleared of much mere controversial verbiage. Taking as an example the prevalence of erroneous views with regard to the meaning and function of aperture he would endeavour to lay before the meeting a clear statement of the old theory of this matter, and meet it point for point by the newer views of which Professor Abbé of the University of Jena was the originator. Then by means of a large number of diagrams which he drew on the blackboard illustrating his subject, Mr. Mayall dealt at considerable length on the main features of what he termed the "aperture controversy," concluding his remarks on that branch by an earnest appeal to all present if they had any difficulties to suggest, to suggest them forthwith, as it was the ardent desire of himself and those with whom he was associated in the controversy to have every point of difference thoroughly explained, their sole motive being the promulgation of accurate views. Mr. Mayall also exhibited and described in detail several specimens of "Brass and Glass," some of which he commended to the notice of the meeting.

WEASEL OR STOAT?—Will any of the readers of SCIENCE-GOSSIP kindly inform me if the animal usually known as the weasel, in the North of Ireland, is properly so-called? I read some years ago in a work on natural history that it is the stoat, but have no opportunity of verifying the statement from my own observation.—*J. H. H.*

ZOOLOGY.

PARASITES ON HYDRA.—While examining an unusually large specimen of *Hydra fusca* the other day, I was surprised to notice that the tentacles and body of the polyp were infested with what I suppose to be parasitic infusoria. These creatures are concavo-convex, shaped like a mussel-shell, and have numerous vacuoles. They move rapidly all over the body and tentacles by means of cilia which are of large size and beautifully evident. Although I watched them for some time I did not observe any leave the body of their host, nor could I find any trace of them in the surrounding water. I have examined many hydra obtained from various sources, but have never come across these parasites before. Perhaps some microscopic reader will be kind enough to give me the name of this creature, or, at any rate, tell me if they are of frequent occurrence. I might mention that the hydra were by no means incommoded by their guests, but appeared quite indifferent to their presence; so that when the parasites glided over the extended tentacle that delicate organ remained outstretched, but instantly contracted when an animalcule of smaller size came in contact with it.—*J. O. B.*

NOTES ON FROG-SPAWN AND TADPOLES.—The following notes extracted from my day-book of last year may form a useful addition to Mr. Robson's interesting article on frog-spawn in SCIENCE-GOSSIP for March. Frog-spawn was first seen early in the morning of March 13th; the thermometer through the day was $49\frac{1}{2}^{\circ}$ F. The average weight of an ovum when found was about $5\frac{1}{4}$ grains. The tadpoles when they emerged (March 19th, in open air) measured $\frac{1}{3}$ of an inch, and weighed 1 grain; the breadth across gills to their ends $\frac{1}{10}$ of an inch. So soon as they escaped from the glairy egg they sank to the bottom and looked as if dead, but when touched merely curled themselves up into a ball of the same size as that seen in the advanced ovum. Soon, however, they became extremely active, swimming vigorously about, but were unable to sustain themselves long in mid-water. They ate very little of the albumen of the egg, but soon began to devour decomposing algæ, and then decaying water plants, &c. Pretty bright eyes appeared at the end of March, when the tadpoles measured $\frac{3}{8}$ of an inch in length. Some fortunate, or rather unfortunate tadpoles, developed into perfect little frogs before the others, were seized upon and immediately devoured by the latter—no doubt from jealousy. The rapidity of the development of the frog from the egg is in exact proportion to the temperature of the water—supposing abundance of food to be supplied.—*C. Francis Young.*

WHITBY FIELD NATURALISTS' CLUB.—This newly-formed club has already started, and has had a weekly list of papers since the first of January. We wish the members success.

A LIST OF EUROPEAN BIRDS.—A List of Birds of the Western Palaearctic region has been compiled by Mr. H. E. Dresser, F.L.S., F.Z.S., as a checklist for labelling, and for reference in making exchanges of birds and eggs. As no such list previously existed, there is no doubt that the present one will prove very useful.

THE WEATHER OF 1880.—Last year we noticed "The Weather of 1879," by Mr. Edward Mawley, F.M.S., we have now the satisfaction of noticing the continuation of the work. It is the author's intention to publish his report annually. The present pamphlet is upon the same plan as last year's, and is evidently carried out with great care. To agriculturists, gardeners and meteorologists generally it is of great value.

INJURIOUS INSECTS.—The "Report of Observations of Injurious Insects," edited by L. A. Omerod, F.M.S., &c., for 1881 is to hand. The great insect attack of the year was that of the larvæ of *Tipula oleracea*, commonly known as "daddy longlegs." There was also severe damage in some localities from the larvæ of the carrot fly and onion fly; the chief injuries of the season being from larvæ of the order Diptera, which are known to be most prevalent in wet vegetation and in wet ground, such as was caused generally throughout the country by the continued rain of 1879.

TRANSPARENT BURNET MOTIL.—The moths mentioned in SCIENCE-GOSSIP for February, having been sent for inspection to Mr. Birchall of Douglas, that gentleman says: "They are certainly not the Irish form, viz. *Nubigena*; it is possible they are examples of the typical European *Minos*." Perhaps some reader collecting in the neighbourhood next summer (should we fortunately have one) may be induced to visit the spot.—*W. Gain, Tuxford.*

THE LAUGHING GULL.—The bird recently killed in the neighbourhood of Newmarket and recorded as the Laughing Gull (*Larus atricilla*) proves to be the common Blackheaded Gull (*L. ridibundus*); see "Field" for 26th of March. Premature announcements of this kind are greatly to be regretted, as it is impossible to correct them in all the numerous publications into which the report is copied, and the confusion and uncertainty thus created can only be appreciated by those who in after years have to run these phantoms to earth. The present instance seems more than ordinarily inexcusable, happening so near Cambridge, where some of our best ornithological authorities reside, who I am sure would willingly have determined the species if at all doubtful.—*T. S.*

LIVERPOOL SCIENCE STUDENTS' ASSOCIATION.—The Inaugural Meeting of this recently-formed Society was held towards the end of March, when a telling address was delivered by the President, Mr. A. N. Tate, F.I.C. The Society is really a field club in connection with the Botany and Physiography Classes of Liverpool.

HOW SNAKES CAST THEIR SLOUGH.—Gilbert White, in his "Natural History of Selborne," thinks that snakes "crawl out of the mouth of their own sloughs, and quit the tail part last, just as eels are skinned by a cook-maid." But my friend Captain N—, who has served thirty years in the army in India, and has kept tame snakes (one a Cobra de capello, and another a rock-snake), and watched the operation in the case of one of his pets, describes the process thus: For some days before casting the slough, the snake appears to suffer in health (as do birds before and during moulting), and, in the instance witnessed by Captain N—, the creature chose his (the captain's) bed for the purpose. The snake had got its head beneath the pillow, and partly cast the skin when first observed. By alternate contraction and expansion of the muscles, the skin was pushed over the head, the creature gradually *backing out of the slough* through the orifice at the tail. The task took eight hours to accomplish, and the snake was then of a glowing red colour, and highly sensitive to the touch for the first twenty-four hours after leaving the old skin, at the end of which time it had gradually become darker and darker until it regained its natural blackish colour. Captain N— was known among the natives as the "Samp-Wallah" or Snake-man, and the snakes proved a most efficient guard for his quarters.—*John Heath, Southsea, Hants.*

POPULAR NATURAL HISTORY.—"The Natural History Journal and School Reporter," conducted by the Natural History Societies in the Friends' Schools, is a capital illustration of how practical observation can be combined with ordinary school work when schoolmasters are themselves naturalists.

BOTANY.

MERCURIALIS PERENNIS.—In looking through the herbarium of my friend, the late Mr. W. J. Smith of Worcester, I found a monoecious form of this plant, which I have not seen described. It is more robust than the type, with longer and more deeply serrate leaves; the female inflorescence terminal, and the male in axillary spikes. The specimens were labelled "The Grove, Little Malvern," and last season I searched this spot, where the typical *M. perennis* is abundant, but without finding the monoecious form. I should be glad to know if any readers of SCIENCE-GOSSIP have met with it, or have seen it described in any work.—*A. D. Melvin.*

EPILOBIMUM ROSEUM.—In Babington's "Manual" this plant is described as having "buds nodding," and in Hooker "buds inclined." The plants found by Mr. R. F. Toun̄drow and myself in this district have always erect buds. I sent a specimen to Professor Babington with a note to this effect, and he says in the experience of himself and friends the buds do nod. Will some of your readers kindly observe this epilobium during the coming season, and let me know the result.—*A. D. Melvin, North Malvern.*

BEE ORCHIS.—The uncertain and fitful method of appearance of the bee orchis (*Ophrys apifera*) was well exemplified within the last two years in this neighbourhood. In 1879, I found this orchis in such large quantities all over a rough meadow with a poor subsoil of Forest Marble clay, that I gathered a large handful to ornament my study, and at the same time from the same meadow I got specimens of *Lathyrus Nissolia*, *Lotus tenuis*, and *Ervum (Vicia) tetraspermum*. During last year I went to gather my favourite orchis, but it had entirely disappeared, and as it is a common plant around the district I sought it in several well-remembered localities and almost without success. Years ago we have been interested by the same fitfulness in the appearance of the bee orchis in our old Gloucestershire hunting grounds.—*James Buckman, Bradford Abbas.*

A LOCAL FLORA.—Another addition to the "local floras" of Britain has appeared in the form of a "Hand List of the Plants occurring within seven miles of the United Services College, Westward Ho." It has been printed for the use of the College Natural History Society, but will also be of great service to other observers in the district. As this list is only the result of one year's observations, every other page has been left blank for the insertion of additions.

HELIOPTROPISM.—What I. P. K. says in regard to the paragraphs in McNab's botany is correct, but I venture to suggest that he puts a wrong construction on them. Light no doubt retards growth—of this we have plenty of examples in our alpine flora; but we are told that it is often marked by increased assimilation, so also does darkness retard growth because the plant cannot assimilate. But in this particular case retardation is marked by increased nutrition, in one direction a kind of hyponastic growth takes place. The growth of the dark side of the stem "depends upon nutrition which only affects the mechanism" of growth in a secondary degree. Thus we see the growth in this case is lateral on the "light" side, and longitudinal on the "dark" side. I should like to see the opinions of some others of our botanical friends on this subject.—*R. Astley, Hulme.*

LIBERIAN COFFEE.—In the coffee-growing world a new impulse has been given to the trade in the

extensive cultivation of the Liberian coffee-tree. This tree bears somewhat larger beans than the Arabian coffee, and its productive power is much greater. The shrub is much larger, growing to the height of forty feet. Mr. D. Morris, F.G.S., M.A., director of the Public Gardens at Jamaica, has published a pamphlet, entitled "Notes on Liberian Coffee," bearing on the above subject. The author gives an epitome of the past history of coffee cultivation, and then describes the cultivation of Liberian coffee in Liberia and the East and West Indies. These remarks are followed by a description of the coffee itself, and the various conditions of climate, temperature, soil, &c., affecting it. The comparative yield of Liberian coffee trees is given, and the commercial value of their produce.

THE DISTRIBUTION OF THE BRITISH FLORA.—Professor G. S. Boulger, F.L.S., F.G.S., recently communicated a paper on "The Geological and other causes that affect the Distribution of the British Flora," to the Geologists' Association. Professor Boulger prefaces his special remarks on the British flora by an outline of the general conclusions arrived at as to geographical distribution. After reviewing the work done in this branch of science, which dates from the time of Humboldt, Professor Boulger proposed to geographically divide the English flora, (which is mainly an extension of the Germanic area of temperate flora) into nine botanical provinces dependent on the position of the great watersheds of the country, that being in Mr. Boulger's opinion the most obvious and convenient. The following are the different divisions: 1. The Thames and south-east westward to the axial watershed and that between the Axe and Otter—a province entirely Neozoic. 2. East Anglia, the valleys of the Blackwater, Stour and Yare. 3. East Fen and Secondary, the valleys of the Wash and Humber. 4. The vale of Severn, including that of the British Avon, but not the more mountainous one of the Wye. 5. The Peninsula of Devon and Cornwall. 6. The Welsh mountains, including the Wye valley, but not that of the Dec. 7. The lowlands of Cheshire and Lancashire. 8. The Lake Mountains, with the valley of the Kent. North-umberland and the valley of the Tees.

GREY GANNET (*Lanius excubitor*).—I see the occurrence of this bird is noticed in North Lancashire by one of your correspondents. This winter two specimens were secured in the vicinity of Scarborough, both of which I saw just after they were shot. One of them was procured at Hackness. The other is in the possession of Mr. Thompson, naturalist, of this town, and I believe was shot here by himself. Several fine specimens of the gannet have also been obtained a little way out to sea, being captured by the sailors towing a fish-hook astern, baited with a dead fish.—*J. A. Wheldon.*

GEOLOGY.

THE ST. GOTHARD TUNNEL.—The following notes are taken from the pamphlet of F. Giordano, Inspector of the Corps of Miners, Rome. The tunnel was bored through 9 miles 3 furlongs of hard rock in seven and a half years. The experience gained in the Mont Cenis greatly expedited the work. It connects the Canton of Uri with the Ticino Valley. The physical history of the work was entrusted to Maurizio Stafff. The southern entrance at Arido is 1145 metres, and the northern at Goschenen 1109 metres above the sea level, or 36 metres lower on the Swiss than on the Italian side. The height of the tunnel is 6 metres, the breadth 8 metres. The rocks met with in the boring are shown in a diagram and in a table; they may be reckoned at 18 in all, of which 8 are purely siliceous and oxygenic, the others more or less calcareous with some clay. The latter is supposed to be a decomposition of felspar; there is, however, no reason why this clay should not have been deposited in its present state as it is now deposited on the ocean bed. This rock is called "Anfibolische," its effect was noticed as an important phenomenon. It pressed continually into the works in spite of walls; but it is hoped now that the difficulty is overcome. This inception of plastic matter into the tunnel was doubtless caused by the tapping of a clay stratum, upon which the upper strata were pressing. When this plastic mass began to move, it necessarily continued, till the clay had vanished, or till it had escaped from the pressure. Thirty-two minerals of sorts were found in the excavation, of which 12 were in the Finsterahorn, 15 in the Conca d'Ursen, 23 under the St. Gothard, and 23 in Conca del Ticino; the southern part was therefore richest in minerals. The temperature of the tunnel was examined with much care and ingenuity. The mean of air external, and water internal temperatures were found by very patient experiments. The northern entrance gave + 7° 90, the southern + 8° 3 (Centigrade). At 1000 metres from north end the temperature was 19° 7; at 2500 metres 22° 7; at 3500; 18° 1 (the mountain was lower here, and pressure not so great); at 7200 metres it rose to 30° 8, but at 7200 metres sank with similar pressure. The temperature fell to 30° 2 at 6000 from south end; under a lesser pressure it rose to 30° 4; at 2500 it fell to 25°, and reached 8° 3 at the southern entrance. Great pains were taken to exclude artificial heating of water, or of the testing-holes. With the latter it is impossible, because wherever a thermometer can be placed the air must have access; and the water is no criterion of general temperature, because no one knows what local causes of heat may have been passed through. With lamps, steam, dynamite explosions, and a number of men working in a cul-de-sac, where air fit to breathe was supplied from the exterior, it is almost

wonderful that the heat was not greater in the centre bores. A curious thing is mentioned. The explosions in the southern boring were heard in the northern through 400 metres of rock. The details are very interesting. The pamphlet is of fifty pages; it is an extract from "Bolletino del R. Comitato Geologico, for 1880, Nos. 9, 10;" Roma, Tip. Barbèra.—*H. P. M.*

THE UPPER GREENSANDS AND CHLORITIC MARL OF THE ISLE OF WIGHT.—Mr. C. Parkinson, F.G.S., has just read a paper on this subject before the Geological Society of London. The author described the Upper Greensand as exposed at St. Lawrence and along the Undercliff. At the base of the St. Lawrence cliff there are hard bands of blue chert from which astaciform crustacea have been obtained; and quite recently, in a large boulder of the same material lying on the beach, there were found the remains of a Chelonian, referred by Professor Owen to the family *Platynota*, and named by him *Platynota lata*. The presence of these freshwater organisms was thought to imply a connection with the Wealden continent. The chert-bed, two feet thick, was regarded by the author as marking the boundary between the Gault and the Greensand. Above it the author described 56 feet of compact red and yellow sands, of which the first 20 feet are unfossiliferous, the upper 32 feet show traces of organic remains; between them there is a fossiliferous zone 4 feet in thickness, containing *Ammonites inflatus*, *A. auritus*, and species of *Panopæa*, *Cucullæa*, *Arca*, *Trigonia*, and immediately below this a separate band containing an undetermined species of *Anmonite*. These sands are followed by 38 feet of alternate beds of hard chert and coarse greensands, having at the bottom 6 feet of inferior building-stone, surmounted by 5 feet of freestone. The latter contains *Ammonites rostratus*, and the cherts various fossils, chiefly bivalves. *Clathraria Lyelli* also occurs at this level. Above the greensands come 6 feet of chloritic marl:—the upper 3½ feet fossiliferous, with a base of hard phosphatic nodules containing crushed specimens of *Pecten asper*; the lower 2½ feet compact, with darker grains and few fossils.

A REMARKABLE EXTINCT REPTILE.—Professor Owen, in describing the skeleton of an extinct reptile called *Platypodosaurus*, remarks that "of all examples of pelvic structure in extinct reptiles this departs farthest from any modification known in existing types, and makes the nearest approach to the mammalia pelvis."

POLEMONIUM CÆRULEUM.—I should be much obliged if any one who has found specimens of this plant, Jacob's ladder, south of Derbyshire, would kindly mention the localities in which it has been found.—*C. W. Holgate*.

NOTES AND QUERIES.

EXCRESCENCES ON TREES.—About Enfield and Edmonton (Middlesex) I have noticed several trees with a very remarkable protuberance at the bifurcation of the trunk. The trees appear as though they had swelled out tremendously, and then small shoots had sprouted all over the excrescence thus formed, but from what I can make out (not having seen them in summer), these twigs are some parasite. I have noticed trees with the swelling in several stages of growth, from those just forming to one which could be seen an immense way off and struck one as peculiar immediately. The trees grow on a thin stratum of soil over gravel, and are situated in the middle of different parks.—*A. Bennington, York.*

LEPIDOPTEROUS NAMES.—I shall feel greatly obliged if some one will kindly inform me of the authors of the following list of Lepidopterous names: 1. *Anthocharis cardamines*; 2. *Leucophasia sinapis*; 3. *Pieris brassica*; 4. *Pieris crategi*; 5. *Pieris napi*; 6. *Satyrus semele*; 7. *Satyrus megera*; 8. *Vanessa cardui*; 9. *Vanessa atalanta*; 10. *Polyommatus corydon*; 11. *Polyommatus adonis*; 12. *Polyommatus agestis*. It will save room if the figures, with the authors' names against them, are only inserted.—*J. P.*

SUSSEX CLAY.—I find in Murchison's Geological Maps of England and Wales, that the strip of country lying to the south of the chalk escarpment of the South Downs is marked as Eocene. In the neighbourhood of Littlehampton there is a clay, worked for making bricks. Also on the coast, about a mile north of the town, there are low clay cliffs rising to about six or seven feet in height. In this clay stones (chiefly flints, both angular and rounded) are very numerous, and scattered through the mass in a very irregular manner, and at all angles. There can also be seen on the coast, pockets of chalk, two feet in diameter, in the clay. To a stranger coming from the north, where boulder clay is so common a feature, he cannot but be struck with the similarity which sections of this Sussex clay present to the glacial clay of the northern counties. [I have no access here to the maps of the Geological Survey, or to books that might aid me in the matter; I therefore appeal to you, Mr. Editor, or your numerous readers, for information. Is this surface-clay Eocene, or is it some superficial deposit of a much more recent date? I have hesitated to call it glacial, as I have understood there are no glacial beds to be seen south of London. I shall be glad to receive clearer views than I at present possess on the local geology. I might add that the clay is of no great thickness in the places referred to, being not more than from six to nine feet thick, and is undulated by irregular heaps of gravel and white sand.—*W. H.*

"FLOODS: THEIR CAUSES, MITIGATION AND CURE."—The author, who signs himself "Aquarius," has forwarded us a pamphlet bearing the above title. The immediate subject is the efficient drainage of the Lower Yare, Waveney, and Bure valleys, the entire prevention of floods in these parts, and the improvement of Yarmouth Harbour, by the deepening of the water at the bar. The means by which this is to be effected is the placing of lock-gates at some point between Yarmouth Bridge and Breydon Water, in order to have a control over the tides. Those who are interested in the subject can obtain a copy from Fletcher and Son, Norwich: price 3*d.*

FRESHWATER DEPOSITS.—The recent flooding of the Thames in the neighbourhood of Maidenhead has brought down an immense quantity of land and freshwater shells and deposited them along the banks among the sticks, leaves and other rubbish, which form a sort of high-water mark, now left dry by the abatement of the flood. In some places where the flood has washed into a corner of the bank, an immense heap, composed entirely of shells, may be found. On the side of a wooden shed there is a band of shells marking the greatest height of the waters. The greater part of this jetsam and flotsam consists of dead and worthless shells, but among them are fresh and even live specimens of desirable species. I have noted down as many as 23 different species of freshwater and 24 land, among which are the following good ones: *B. Leachii*, *Z. fulvus* and var. *Mortoni*, *H. pulchella* and var. *costata*, *P. marginata*, var. *pygmaea*, var. *dentulata*, *Achatina acicula*, *C. elegans*, and *Acme lineata*.—*L. E. Adams, Maidenhead.*

PRESERVING FLUID.—In last month's SCIENCE-GOSSIP, Mr. Atkins has published a formula for a "Preserving Fluid," and gives an "alkaline nitrate of chlorine" as one of the ingredients; I should esteem it a great favour if Mr. Atkins would kindly inform me what this may be and how it can be prepared? After reading in one of our leading "dailies" that the dying Emperor of Russia was subjected to the influence of "sulphate of oxygen," one begins to think that wonderful as the advancement made in chemistry has been during the last few years, the new compounds produced in 1881 bid fair to outnumber those isolated in previous years.—*J. O. B.*

TENACITY OF LIFE.—May I express regret which I am convinced is shared by the great majority of your readers, at the insertion (in a recent number) of F. L.'s query and notes on "Tenacity of Life?" However unintentional, it can hardly escape the appearance of inculcating cruelty, and raising an unjust prejudice against the fair name of naturalists and of this popular journal. The infliction or prolongation of agony requires at least some useful or important scientific aim to justify it.—*J. Eardley Hall.*

HAIR BELL OR HARE BELL.—I find *Campanula rotundifolia* is written by some as hairbell and by others as harebell. I should have presumed that the former was correct—the name being apparently derived from the wiry and hair-like stems which characterise the plant, and have imagined that the latter had no *raison d'être* except a poetic one, or have placed it amongst the numerous fanciful corruptions which exercise our wits in plant nomenclature; but happening to refer to Britten and Holland's "Dictionary of English Plant Names," I find it stated that "the spellings hairbell or airbell are quite modern, and seem to have been adopted in accordance with a fancy derivation of the name which, however, is quite without authority. The name itself is unexplained." If the plant has really no lupine affinities and the name harebell is unexplained, is it quite certain that hairbell is the more modern, and that it was not at some early date supplanted by harebell, and that in modern times it is not seeking to regain its place?—*F. H. Habben, B. A.*

THE WEATHER AND THE BIRDS.—In addition to blackbirds and thrushes, the late severe weather brought wrens, tomitts, robins, and coletits into the garden.—*W. T. Greene, Pechham Rye.*

WHITE GERANIUM.—I have found this plant several times at Maidstone.—*Henry Lamb, Maidstone.*

STRANGE FLIGHT OF OWLS.—A flight of owls, upwards of twenty, was lately seen daily in a field of Mr. Dighton's (at Kirklington, near Ripon). The field contains a large quantity of thick grass, and here they take up their abode in the daytime.—*W. Gregson.*

"BLUE ROCKS."—Is your Andover correspondent confident as to the "blue rocks" he speaks about being found so far inland? Large flocks of wood-pigeons (*Columbus*) are now busy in the turnip fields and young clovers mixed with stock doves (*C.enas*) called here generally "blue rockers," but of course erroneously, and although I have killed numbers of them it has never been my lot to get a rock dove amongst them. A few years ago, before game preserving was carried to such a pitch, I could have shown your correspondent a "magpie roost" of perhaps 200 or 300 birds, and fine fun I have had with them on a bright moonlight night, as when disturbed they would fly straight up and settle down almost in the same spot. Carrion crows roost much together during autumn and winter on the borders of Exmoor. I knew one "roost" of over five hundred birds, which shows either that they are very plentiful or else fly a long way to it, as they only remain in pairs during the day.—*G. Turvill.*

QUERY AS TO LARVÆ.—Can any readers of SCIENCE-GOSSIP tell me what are some larvæ that I have? They are of a dirty-white colour, getting blackish towards the end; their heads are light brown; they have very long thoracic legs, but no claspers that I can see, whatever. They feed on rotten wood.—*C. H.*

STRANGE FREAKS OF AN EEL.—While standing with a friend one day on the banks of the Ythan, we saw an eel catch a small trout, but, instead of despatching its victim at once, we were surprised to see it "grapple and bite and turn it about," evidently to have it in a more suitable position; then, seizing the fish by the tail, it swallowed that end, "then dashed the other several times against a stone," after which it reversed the fish and swallowed it. Whether that strange proceeding was to kill the fish, or to crush its head and prepare it the better for digestion, we could not tell. Perhaps some of your readers may have witnessed similar occurrences!—*W. Sim, Eyrie.*

SHEET LIGHTNING.—In reply to Mr. Stodder's explanation of this phenomenon, I must say that I entirely agree with him that "there is no such thing as sheet lightning different from spark (forked) lightning," also that it is merely a lighting up of clouds by a spark, and I also uphold his prediction that at the moment of discharge a spark occurred. But his explanation that it is produced by discharges at long distances, beyond the reach of sound, I cannot agree with, as in this form of lightning (sheet) a clap is often heard coming from clouds not far off. If Mr. Stodder be mistaking for sheet lightning "summer lightning" (which is by some supposed to be silent discharges between clouds, &c., in the upper and more rarefied, and hence less resisting strata of the atmosphere) I may state that it has been observed when no thunderstorm was anywhere near the observer's station. I may also add that I consider that forked lightning occurs when the barometer is high, that is when the atmosphere is dense and resisting, and sheet lightning when the reverse is the case.

Hence the spark in sheet lightning travels exceedingly rapidly to the earth, while in forked lightning it travels slower. In answer to "A Reader" on the same subject, I may say that the tremendous peal mentioned was due to the bursting of the balls. From the fact of these "fireballs" exploding so violently and retaining their electricity, they have been compared to Leyden jars, but how the principle is carried out in them I cannot say.—*Edward B. Parfitt.*

SHEET LIGHTNING.—In confirmation of the explanation given by C. Stodder in your number for March, I would ask your correspondents also to observe how frequently when sheet lightning is seen in one direction, a thunderstorm, with forked lightning, shortly afterwards comes up from the same quarter of the sky. Is not the sheet lightning, the exhibition of which precedes the storm, the illumination of clouds above the horizon caused by the spark playing in the storm which is coming up, but has not yet reached that part of the atmosphere above our horizon?—*C. A. Houghton.*

SHEET LIGHTNING.—In the March number of SCIENCE-GOSSIP, p. 69, I notice a communication, signed Charles Stodder, on "Sheet Lightning," which has brought to my recollection an account by Arago, the French astronomer, of the most continuous sheet lightning he had ever seen; that confirms your correspondent's opinion. It stated that he was at Palermo a day or two afterwards, and ascertained from some Neapolitan seamen, who had come in there, that a violent storm of two or three hours' duration was raging at the time, about 60 or 70 miles off, in the direction at which he noticed the lightning from where he then stood. It was a translated letter that went the round of the English newspapers.—*R. T. Rca.*

COMPOSITE CANDLE-WICKS SMOULDERING.—The following explanation of the effect upon the wick of a candle by the light being blown out from above or from below, appears to be sufficient to account for the difference. If the flame be blown out from below a current of tallow flows along the wick and extinguishes the light; if it be blown out from above the current is retarded in its course, and the wick smoulders down to the tallow. Whilst on this subject it may be well to remark that there is no necessity to blow the light out from below in the case of composite candles, as by blowing in the direction of the bent portion of the wick, the wick will be extinguished and smouldering prevented.

BIRDS AND FRUITS.—The benevolent notion that wild fruits are always provided in increased quantities as a provision for the small birds in a hard coming winter, has this past season been dispelled in a rather rude fashion, as may be gathered from the following notes: In 1880, nuts of all kinds were scarcer by far than we ever remember to have noticed. Whitethorn was unusually shy of flowering, and consequently of fruiting, haws thus being conspicuous by their absence. Sloes fruited very slightly indeed, which is curious, as it was by no means a bad year for plums. Indeed, but for these the poor wasps would have had but a sad time of it, as apples, pears, and wall fruits were far from plentiful. The only hedge-plant that bore even a moderate crop of berries was the privet, which could hardly have been designed to eke out the food of the small birds, as but very few of these care for privet berries.—*James Buckman, Bradford Abbas.*

NOTICES TO CORRESPONDENTS.

TO CORRESPONDENTS AND EXCHANGERS.—As we now publish SCIENCE-GOSSIP earlier than heretofore, we cannot possibly insert in the following number any communications which reach us later than the 8th of the previous month.

TO ANONYMOUS QUERISTS.—We receive so many queries which do not bear the writers' names that we are forced to adhere to our rule of not citing them.

TO DEALERS AND OTHERS.—We are always glad to treat dealers in natural history objects on the same fair and general ground as amateurs, in so far as the "exchanges" offered are fair exchanges. But it is evident that, when their offers are simply disguised advertisements, for the purpose of evading the cost of advertising, an advantage is taken of our *gratuitous* insertion of "exchanges" which cannot be tolerated.

H. P.—You will find all information respecting the size of South American shrubs, trees, leaves, &c., in the "Treasury of Botany," published by Longmans.

Dr. H. J. RYLER.—The following books are recommended for Swiss botany: Bouvier's "Flora de la Suisse," published by A. Picard, 82 Rue Bonaparte, Paris, price about ten francs; Weber's "Alpenpflanzen," in 2 small vols., with 400 coloured plates, price about 36s.; "Excursionsflora für die Schweiz. Nach der analytischen Methode bearbeitet, von A. Gremli. Dritte verbesserte Auflage," Aarau (Christen), 1878, 8vo., size 7 × 44 × 578. Dr. Louis Bouvier's "Flora de la Suisse et de la Savoie" is also an excellent work, and of a very convenient size, price 10 francs, published by Picard, Paris.

W. H. S.—SCIENCE-GOSSIP is now published on the 25th of each month.

W. D.—You may obtain sets of exotic Lepidoptera from Watkins & Doncaster, 35 Strand. Drury's and Westwood's books are usually advertised in the Natural History Catalogues of W. Wesley, bookseller, Essex Street, Strand. Write for catalogue.

W. G. W.—Article to hand. "Natural History Notes," edited by F. J. Rowbotham, is a very useful, practical, and unpretending little serial.

AQUARIUM.—You will find details as to various cements for Aquaria, &c., in Taylor's "The Aquarium: Its Principles, Structure, and Management," published by D. Bogue, 6s.

G. H. MURRAY.—You may no doubt get Mr. Mellard Read's paper on "The Glacial Beds of the Clyde and Forth" from the secretary of the Liverpool Geological Society.

J. GUARDIAN.—You cannot do better than obtain "A Course of Instruction in Zoology," by J. Jeffery Parkes, published by Macmillan & Co. It is a first-rate work on the subject, and will afford you all the information you require.

C. J. SCOTT.—The green objects found among waterweeds are Planarians.

A. W.—You may obtain a copy of the rules of the SCIENCE-GOSSIP Botanical Exchange Club by applying to 3 St. Martin's Place, Trafalgar Square.

R. BEATLEY.—The best English locality for green floor spar is Alston Moor, Cumberland, where it occurs in the Carboniferous limestone. You may obtain good specimens at the shops of any of the mineralogists who advertise in SCIENCE-GOSSIP.

R. BAKER.—We will try your fluid for mounting. Thanks for the bottle. Write to the manager at the office, 3 St. Martin's Place, for scale of advertisements.

F. GREENING.—The strength of the solutions of liquor sodæ and liquor potassæ, may be seen by referring to the "Pharmacopœia." Some prefer 1 drachm of the stick potash, sold in shops, to one fluid ounce of water.

W. A. H.—Bowerbank's "Monograph of British Sponges," in 3 vols., published by the Ray Society. Dr. Johnston's "History of British Sponges," published in 1842.

G. T. BAKER will find Berge's "Schmetterlingsbuch" an excellent German book on European Lepidoptera. It contains 50 coloured plates, each containing figures of about a dozen insects, published by Julius Hoffmann, Stuttgart, price about 20 marks (£1).

H. A. FRANCIS.—We should be pleased to receive a specimen.

C. J. HURT.—You cannot do better than procure Messer's "New and Easy Method of studying British Wild Flowers by Natural Analysis," which contains sketches enabling a student at once to assign every British plant to its natural order, published by D. Bogue, 3 St. Martin's Place, Trafalgar Square, London, W.C. Hayward's "Botanist's Pocket-book" is an excellent book for a field botanist. Toad spawn occurs in neck-bead-like strings, and frog spawn in masses.

EXCHANGES.

ALL numbers of "European Ferns" and "European Butterflies and Moths" to date, in good condition. What offers?—*J. Badcock, jun., 270 Victoria Park Road, E.*

PERFECT, though dead, specimens of *Achatina acicula* for

exchange. Desiderata: *L. involuta*, *B. montanus*, *P. secalis*, *C. bicipitata*.—Lionel E. Adams, Victoria Park, Manchester.

A COLLECTION of about fifty marine and land shells from Tenby, on sale, including many rare species. What offers in exchange? List will be sent on application.—X. Y. Z., care of J. Fellowes, the Post Office, Brooklands, Sale, near Manchester.

UMBELLIFERÆ.—Wanted, *Petroselinum sativum*, *Eupatorium aristatum*, *Conanthe silaifolia*, *Daucus gummifer*, and *Coriandrum sativum*. Many rare plants to offer in exchange.—A. W. Preston, St. Philip's Road, Norwich.

DUPLICATES: *Leptus spinibarbis*, *Pterostichus nigrita*, *Dichirotrichus obsoletus*, *Necrophorus vespillo*, *Trox scaber*, *Cionus thipicus*, *C. pulchellus*, *Strangalia gnarofasciata* (1), *Donacia bidens*, *D. dentipes*, *Chrysolina hyperici*, *C. didymata*, *C. Banksii*, *Cassida equestris*, and others. Desiderata: rare Coleoptera, or standard works on Coleoptera, must be in good condition.—H. F. Collett, 12 Springfield Road, St. Leonards-on-Sea.

DIATOMS, mineralised, found in the London clay, beautifully mounted; send other good slide of diatoms.—A. Smith, The Laboratory, Essex Road, London.

WANTED, unstained mounted slides of *Trichina spiralis*, or fluke.—A. Smith, The Laboratory, Essex Road, London.

WANTED, in exchange for other natural history objects, well-preserved skins, recent, sexed and dated, of various British birds; also eggs of a number of birds, when possible in "clutches."—H. W. Marsden, Regent Street, Gloucester.

OFFERED, a large larva-breeding-cage, two compartments, quite new, and a number of common sea-shells, in exchange for Miss Evans, Witley, Surrey.

WANTED to exchange, Milner's "Gallery of Geography," 2 vols., half-calf, new, cost 30s., for a collection of chalk fossils; also Johns' "British Birds in their Haunts," for a good work on Palaeontology.—G. W. H. Murray, 16 The Parade, Leamington.

WANTED, a small quantity of the spawn of the edible frog (*Rana esculenta*) in exchange for human bones. English spawn preferred to foreign.—Edward J. Gibbins, 20 Bootham, York.

WANTED, a few male and female plants of *Marchantia* bearing the inflorescence. Also living specimens of *Jugermannia* and *Anthroceros*, with inflorescence or fruit. First-class botanical slides in exchange.—C. V. Smith, Carmarthen.

I WILL give cabinet fossils, named and located, or good microscopic slides, in exchange for Smiles's "Life of Dick," condition of binding no object.—"Science," 165 White Ladies Road, Bristol.

WANTED, a good slide of *Trichina spiralis* in human muscle in exchange for other slides.—"Science," 165 White Ladies Road, Bristol.

WANTED, English silver and copper coins, tokens, and medals, in exchange for fossils and natural objects.—F. Stanley, 6 Clifton Gardens, Margate.

OFFERED, good specimens illustrating borings of *P. dactylus* and *S. lividus* (urchin), suitable for a museum. Wanted, fossils.—T. Stock, 16 Colville Place, Edinburgh.

WANTED, vols. 57 to end of Curtis's "Botanical Magazine," or I would exchange the first 56 vols.—Mrs. Jessop, 3 Cornwall Road, Bayswater, W.

WANTED to exchange, a two-feet reflecting telescope, on pillar and claw stand, a student's microscope with usual apparatus, Lardner and Donkin's "Handbook of Astronomy," Lardner's "Popular Astronomy," Dick's "Practical Astronomer," Mitchell's "Orbs of Heaven," "The Telescope," by Hon. Mrs. Ward, "Half Hours with the Telescope," by Proctor, Mann's "Guide to the Knowledge of the Heavens," Quekett "On the Microscope," Hogg "On the Microscope," White's "Selborne," Kirby and Spence's "Entomology," 1 vol. edit., "The Book of Butterflies, Spingies, and Moths," by Capt. Thomas Brown, 3 vols., coloured plates, Lardner's "Museum of Science," 12 vols., Wood's "Common Objects of the Seashore" and "Country" coloured plates, and 4 vols. of Hugh Miller's works, &c., for a good microscope and apparatus, or what offers?—T. H. Waterer, 7 Devonshire Street, Newington Causeway, S.E.

FOR exchange, a well-finished binocular microscope, stand, with mechanical and rotating stage and sub-stage, polariscope, and glass shade, cost over £20 when new; will take a first-class spectroscopic of equal value.—W. H. S., 2 Queen's Terrace, St. John's Wood, N.W.

WANTED, rare starches, guaranteed genuine; will give in exchange other starches carefully prepared, mounted or unmounted. Send lists.—W. H. S., 2 Queen's Terrace, St. John's Wood, N.W.

A FEW various unmounted objects, including zoophytes, for good slides.—G. H. Bryan, Fitzwilliam House, The Avenue, Cambridge.

OFFERED, a number of parts of Sowerby's "English Botany," and several vols. of "Popular Science Review." Wanted, good cabinet, suitable for shells, or any of the following works: "Micrographic Dictionary," Kimmer's "Conchology," or parts of "Annals and Magazine of Natural History," and French "Journal de Conchyliologie," to equal value.—J. D. Butterley, 2 St. John's Street, Beverley.

WANTED, aquatic plants, frogbit (*H. morsus-ranae*), *Villarsia nymphoides*, water violet (*H. palustris*), water soldier (*S. alvodes*); rooted rhizome of Killarney fern, or microscopic slides in exchange.—E. de B. Meyrick, Laurel Villa, Ballybrack, Co. Dublin.

OFFERED, well-mounted slides of Charlton (Mass.) and Antrim earths, in exchange for others or material. Exchange to close on 20th.—H. A. Francis, 12 Sion Hill, Clifton, Bristol.

BEALE'S "How to work with the Microscope," 4th edition, equal to new, offered in exchange for a recent copy of "The Microscope in Medicine," in equally good condition.—J. C. S., 18 Chaucer Road, Herne Hill, London, S.E.

DOUBLE and triple stained sections of exogenous tissues in exchange for other well-mounted object.—Arthur J. Deherty, 26 Leamington Street, Oxford Road, Manchester.

SOME good eggs, side-blown and otherwise, to exchange for others not in collection. Send list.—S. E. W. Duvall, 4 Butter Market, Ipswich.

FIRST-CLASS air-pump, by Griffin & Son, London, in excellent condition. What offers?—A. Alletsee, 11 Foley Street, London, W.

FOR exchange, 2 vols. of the "Tatler," in good condition, date 1754; 4 vols. of "Nature Displayed," illustrated with copper plates, date 1757. What offers in books, slides, or any thing of interest.—J. Boggest, jun., Alton, Hants.

SPORES of *Lycopodium* (unmounted), in exchange for other objects of interest, diatoms preferred.—C. H. S., Fairoak, Palatine Road, Didsbury, near Manchester.

WANTED, foreign postage-stamps, rarer kinds, from Australia, Africa, Persia, islands of tropical seas, &c.; British land and freshwater shells offered in exchange.—Miss F. M. Hele, Fairlight, Elm Grove Road, Cotham, Bristol.

SPLENDIDLY preserved and correctly named Swiss Alpine and other plants, including grasses, sedges, &c. Sets of not less than three specimens sent post free for 6d. each specimen.—Dr. B., care of Editor of SCIENCE-GOSSIP.

WANTED, Bell's "British Reptiles," latest edition, for cash (cheap), or exchange.—W. H. Warner, Standlake, Witney, Oxon.

A FEW side-blown duplicate eggs to exchange for others not in collection. Also a collection of foreign stamps, mostly in duplicate (many very rare), for an aquarium, Coddington lens, or side-blown eggs. Lists sent.—E. F. Bell, Portland House, Carlton Terrace, Botcherby, near Carlisle.

BOOKS, ETC., RECEIVED.

"The Boko of St. Alban's." By Dame Juliana Bernas (Reprint). London: Elliot Stock.

"Anthropology." By E. B. Tylor, F.R.S. London: Macmillan.

"Practical Photography." By O. E. Wheeler. London: "Bazaar" Office.

"Practical Fishermen." By J. F. Keene. London: "Bazaar" Office.

"Bulletin of the United States Geological Survey." Vol. VI, No. 1.

"The Rocky Mountain Locust." By C. V. Riley.

"Report of the North Staffordshire Field Club," 1880.

"Report on Carboniferous Polyzoa." By G. R. Vine.

"Journal de Micrographie," 1881.

"Northern Microscopist," April.

"The Midland Naturalist," April.

"American Monthly Microscopical Journal," March.

"Science," March.

"Canadian Entomologist," March.

"American Naturalist," March.

"Scottish Naturalist," April.

"Feuille des Jeunes Naturalistes," April.

"Le Monde," March.

"Le Monde de la Science," March.

"La Science pour Tous," April.

"Land and Water," April. &c. &c. &c.

COMMUNICATIONS RECEIVED UP TO 8TH ULT. FROM: A. J. D.—W. K. M.—E. H. W.—J. B.—A. D. M.—F. G.—E. W. W.—J. H.—U. C. J. D.—J. W. P. E.—R. L.—F. P.—R. A.—W. S.—W. W.—C. P.—J. T.—E. B.—E. W. A.—H. W. M.—D. B. K.—J. B.—A. H.—F. K. L.—E. J.—B. H.—G. R. V.—J. A. T.—E. J. B.—G. B.—D. B. K.—F. L.—E. H.—J. P. G.—L. E. A.—J. F.—A. W. P.—W. D.—H. F. C.—A. S.—R. J.—W. T. G.—R. W. S.—E. B. K. W.—G. H. M.—C. P.—J. E. S.—S. W.—R. H. N. B.—F. C. M.—W. H. S.—W. G. B.—D. J.—W. H. W.—F. M. H.—S. W.—J.—J. H.—J. H.—J. H. W.—E. J. G.—C. W.—J. A. C.—W. G.—C. V. S.—H. P. M.—T. S.—J. A. W.—F. S.—H. L.—H. P.—R. T. A.—L. A.—C. W. H.—R. T. R.—J. C. T.—T. L. B.—C. S. S.—J. B.—J. S.—A.—A.—G. P.—C. J. H.—R. B.—A. S.—J. O. B.—J. H.—A.—J. D.—E. F. B.—H. A. F.—F. G.—A. B.—E. B. M.—W. H. W.—C. H. S.—C. J. H.—J. B. B.—S. A. B.—J. H. P.—A. H. S.—W. H. S.—&c.

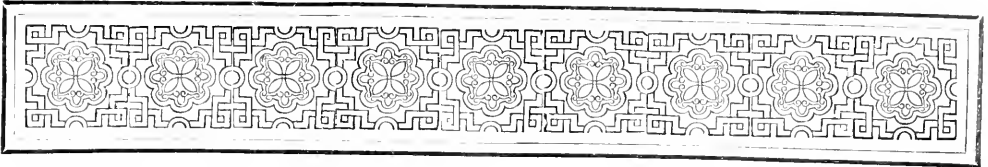

ON CERTAIN PHENOMENA CONNECTED WITH ATMOSPHERIC ELECTRICITY.

By WALTER G. WOOLLCOMBE, B.A., F.L.S.

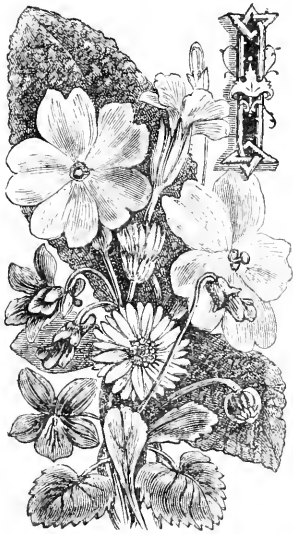

PROPOSE to offer a short résumé of the most generally received theories with respect to certain branches of atmospheric electricity.

First, as to the origin of atmospheric electricity. Though we are still far from knowing the causes that immediately produce it (chiefly, I should say, from our ignorance of the nature of electricity and from the fact that its

relations with other forms of energy are only just beginning to develop into definite shapes), there are two or three more or less plausible theories as to its origin.

1. That it arises from the effects of the thermo-electric action of the sun, to which probably is due the distribution of magnetic force on the earth's surface. From the analogy of electricity to magnetism we might allow this to be a possible cause, although in our present state of incomplete knowledge the relation between dynamic electricity, so produced, and the static electricity of the atmosphere cannot as yet be formulated.

2. That it arises from the chemical action of the sun. This theory, as far as I am aware, is asserted by every one to be inadequate to the explanation of the enormous quantity of electricity we observe at times in the atmosphere, but we may reasonably suppose that the various forms of this chemical action liberate a certain portion.

3. That an enormous amount of electricity is produced in the interior of the earth is shown by the highly-charged vapour and ashes that are poured forth from volcanoes, and doubtless a large quantity of atmospheric electricity is due to their eruptions.

4. The chief source, however, is supposed to be evaporation from liquid surfaces. Now, if evaporation were shown to liberate electricity unconditionally, the oceans and seas would afford a large enough evaporating surface for the production of an enormous quantity. But, relying on the results of certain experiments, M. Reiss states that the electricity produced at the moment of evaporation is due chiefly, if not wholly, to friction between drops of water drawn along with the evaporating vapour, and that, in order that liberation of electricity may accompany the act of evaporation, the fluid must be subject to limited conditions, non-existent in the case of the ocean. There is every reason to suppose, however, that evaporation of water, more especially sea-water, is intimately connected with the production of atmospheric electricity, and De la Rive seeks a more ultimate cause. He says "it is due to continuous chemical action taking place on the interior surface of the solid crust of the globe, arising, not only from local actions, but also from the infiltrations of sea-water, and, in accordance with the known laws of electro-chemistry, this water is charged positively and the solid earth negatively. Vapours arising from the sea are thus charged with positive electricity and carry it away to the upper regions. This phenomenon occurs much more extensively in tropical regions, and after the vapours have risen, they would be carried into the two hemispheres by the tropical currents of the higher regions of the atmosphere." Probably all these theories as to the origin of atmospheric electricity are more or less true, and all the causes mentioned above play a proportionately important part in its formation.

M. de la Rive's theory well accounts for the normal

distribution of electricity over the surface of the earth and in the atmosphere. M. Peltier states that sea-water is invariably charged positively, and all experiments (with exception of one very doubtful one) go to show that the surface of the earth is invariably negatively charged. It is known, too, that the atmosphere is charged positively when the sky is serene, and no disturbance of its condition produced by clouds, storms, fogs, &c. The natural supposition is that the positive electricity in it is produced by the vapour rising from the sea.

M. Quetelet states that the existence of electricity in the air begins to be manifested at a distance from the surface of the earth from one to ten yards, according to the place of observation, and, the higher we rise, the greater is its intensity, though in the same horizontal plane we get diurnal maxima and minima as well as monthly variations. Though we consider the earth for a few miles around us at zero potential, yet we find by connecting two points on its surface some distance apart by a conductor that a transference of electricity from one point to the other ensues, thereby showing that at different points of the earth's surface, the intensity of its negative charge varies, sometimes even to the extent of hundreds of "volts."

Thus the distribution of atmospheric electricity is analogous to the distribution over a Leyden jar, the earth's crust being the inner armature, its negative charge being held on its surface by the positive charge of the atmosphere, forming the outer armature, the lower part of which acts as the dielectric.

When, however, clouds arise we have a disturbance of the normal electrical state of the air, and manifestations of negative electricity occur. These may be due to clouds, similarly charged by being formed near the earth, or of vapours rising from the surface. M. Quetelet, however, denies the formation of negatively charged clouds, and attributes these manifestations solely to the induction produced on a neighbouring cloud by one more strongly charged with positive electricity.

"We must not," says De la Rive, "think that a cloud is in electric properties analogous to a metallic conductor where the electricity only is superficial, but as an agglomeration of distinct electrified globules of water which preserve their individual electricity, beforehand distributed among the particles of vapour of which each globule is formed. Thus in order to understand the electrical phenomena of clouds, it is necessary to be familiarised with the idea of individualities of each of the composing globules; many globules form a flake; many flakes form a 'mamilla;' many 'mamillæ' a cloudlet; many cloudlets a cumulus; many cumuli a nimbus. Thus each has its own peculiar and independent electric sphere in equilibrium of reaction between themselves and with the general exterior sphere of the cloud."

This theory explains very well certain phenomena connected with thunder, on which limited space forbids me to dwell, and bearing it in mind, we shall be able to understand two of the principal forms of lightning.

(To be continued.)

BOTANICAL NOTES FROM THE SWISS HIGHLANDS.

V. MOUNT PILATUS.

By DR. DE CRESPIGNY.

[Continued from page 107.]

EXCURSION from hotel to the "Tomlishorn,"—7300—highest point, five miles there and back, along a safe but giddy path; here and on the adjoining crag: *Arenaria saxatilis*. *Gnaphalium leontopodium*, but rather scarce. The well-known edelweiss, remarkable for the large woolly involucre of its capitula, whole plant hoary and tomentose. *Erigeron uniflorus* differs but slightly from *alpinus*, florets more rose-coloured than purple, involucre more woolly than hairy.

The path upwards to the "Oberhaupt," a toilsome zigzag, over loose rocky debris, will require a good steady pull of about three-quarters of an hour to accomplish. Fine view—clouds permitting—on emerging from the "chimney,"* somewhat similar to that from the Tomlis; good path onwards to the upper inn and Esel. On the right a steep slope of pasturage, left a rocky wall, affording glimpses here and there of the awful precipices which overhang the Nauen, and which are fully revealed on ascent of the Esel—to be done in a ten-minutes' climb up steps roughly hewn along the face of its outer escarpment. Here, on the "band," on the upper pasturage, and on the rocks and debris by the mule path downwards, the following good things (besides many of the others already mentioned) may be looked for with every probability of their being, most of them at any rate, met with and consigned to the vasculum. *Arenaria ciliata*, Esel. *Alsine Villarsii*, Esel. *Anemone vernalis*, radical leaves pinnate, involucre silky; *alpina*, radical leaves bi-tripinnate; flowers larger, petals in both species white, more or less tinged with violet externally; the former in seed; of the latter, the var. *sulphurea*, petals yellowish, is not uncommon. *Arabis pumila*, Esel, in fissures; *bellidifolia*. *Alchemilla pentaphylla*. *Androsace chamaejasme*; *Helvetica*; (= *bryoides*) Band, leaflets hairy, densely imbricated; flowers subsessile, solitary, terminal. *Allium Victorialis*; debris; stem bifoliate, leaves sessile, flowers greenish-white; the alpine representative of *ursinum*. *Avena distichophylla*,

* The "Kriesloch"—a natural hollow in this overhanging crag, thirty feet or more, high and perpendicular. It is now ascended by means of a ladder; formerly adventurous mountaineers had to climb it chimney-sweeper fashion—by their knees and elbows.

Band. *Azalea* (*Loiseleuria*) *procumbens*, southernmost peak. *Biscutella levigata*, a crucifer, petals yellow; silicles round, winged. *Bupleurium ranunculoides*, umbels 3-4 rayed, involuclcs 5, leafy, oboval, larger than the umbel. *Cherleria sedoides*, Esel (= *Alsine Cherleri*, Fenzl). *Cerastium alpinum*; *Carex tenuis*, resembles *ferruginea*, but a shorter plant, leaves setaceous, fruit elongate; *atrata*. *Crepis montana*, Widderfeld, capitulum single, large; *alpestris*, Tomlisalp, smaller, heads 1 or 2; differs structurally from preceding in its achenes. *Chamaeorchis alpina*, a small orchid, flowers in a short spike, greenish-yellow, lip yellow, bracts long linear. *Chrysanthemum alpinum*; stems almost leafless, monocephalous. *Campanula linifolia* (= *Scheuchzeri*); *barbata*, flowers rather large, pale blue. *Dryas octopetala*. *Draba aizoides*; *tomentosa*, leaves rosulate, tomentose, hairy; Esel, fissures; *pyrenaica* (= *petrocallis*), leaves rosulate, coriaceous, shining, trifid at the points, Oberhaupt. *Elyna spicata* (= *Kobresia*). *Erigeron alpinus*. *Festuca varia*; rocks, leaves more setaceous and rigid than in *pumila*; *pulchella* (= *Scheuchzeri*) radical leaves plicate, fasciculate; *alpina*, simply *ovina*, dwarfed. *Geum montanum*, Tomlis and Matt Alps. *Globularia nudicaulis*; *cordifolia*, stems naked or furnished with a scale or two, in this respect resembling *nudicaulis*, but the leaves are different, usually emarginate, sometimes tridentate at the apex, rocks. *Gnaphalium dioicum* *Carpathicum*, also dioecious; leaves longer; involuclral scales brownish. *Gentiana acaulis*; *nivalis*; *purpurea*, akin to *lutea* and *punctata*; flowers yellow, sessile in a terminal verticillate fascicle; *pumila* (= *brachyphylla*), a dwarf form of *Bavaria*. *Haabenaria alba*. *Helianthemum alandicum*, very like *canum*, which is perhaps merely a hoary variety of it. *Hieracium alpinum*, heads 1-2, puberulent; whole plant furnished with white hairs, the black involuclre inclusive; Widderfeld; *villosum*, densely villous, heads large, 1-3. *Hypochaeris uniflora* (= *Helvetica*), heads very large; involuclral scales brownish. *Imperatoria Ostruthium*. *Lonicera alpigena*. *Mahringia polygonoides* (= *arcuaria*), calyx and pedicels angular; *Meum athamanticum*. *Nigritella angustifolia*, an orchid, with flowers of a purplish-black colour in a compact spike; fragrant. *Oxytropis Halleri* (= *Uralensis*). *Potentilla aurea*. *Papaver alpinum*, petals white, with a yellow base. *Primula auricula*; *farinosa*, dwarf form; like *Scotica*—there is not much difference. *Rosa Pyrenaica*, a mere variety of *alpina*; peduncles and calyx glandular, hairy; they are smooth in *alpina*. *Ranunculus montanus*; *Villarsii*, dwarf plants allied to *acris*. *Rumex scutatus*. *Sagina nivalis*. *Silene acaulis* and var. *excavata*, plentiful on ascent to the Kriesloch and elsewhere. *Spergula saginoides*. *Sedum atratum*, moist rocks; blackish with branched stems; inflorescence a cymose corymb; petals dingy white with a green nerve. *Saxifraga oppositifolia*; *casia*, leaves rosulate, 'glau-

cous, furnished with several pores; petals white, many-nerved; *androsacca*, tufted; radical leaves spathulate; flowers white; *bryoides*, a dwarf form of *aspera*; tufted, stems one-flowered; *cuneifolia*, leaves rosulate; stems slender, inflorescence panicle; petals white, with a yellow spot at the base. *Trifolium alpinum*: Widderfeld; peduncles radical, flowers large, purple, leaflets narrow. *Thesium alpinum*, *Veronica alpina*; *saxatilis*; *fruticulosa*. *Viola calcarata*; stems single-flowered, flowers large with a spur of equal length; also var. *flava*; on the Band; *Cenisii*, spur shorter, usually of a pale yellow colour, without streaks; *biflora*.

The descent to Alpnacht is for the first three miles over debris, between the Tomlis and Matt Alps; the path to the left between the Esel and Mattalp leads to the steamboat pier. At the chalets of Hinter Fracmund there is a steep footpath to the Musfluh and Widderfeld summit; it passes the Mondmilch loch *en route*, a cavern so called because of the water saturated with chalk which issues from it; near this cavern, growing on rotting pine stems, in a mossy copse, is *Corallorrhiza innata*; beyond and above *Arctostaphylos uva-ursi*, *Coronilla vaginalis*, *Potentilla caulescens*; inflorescence corymbose; petals white. *Rhamnus pumila*, &c. &c. From Hinter Fracmund downwards with frequent turnings through interminable stretches of pine forest, and lastly over meadows to the village.

(To be continued.)

RECREATIONS IN FOSSIL BOTANY.

SIGILLARIA.

NO. IV.

By JAMES SPENCER.

SIGILLARIA is one of the most abundant and one of the most characteristic of the fossil plants of the coal formation. About forty species are known: of this number about a dozen species are commonly met with in our Yorkshire coal strata. It appears to have been a tall, straight, and unbranching tree, often attaining the height of 60 or 70 feet (Lyell). The stem was fluted longitudinally into ridges and furrows, and in some species was covered with long, narrow leaves. These leaves were arranged on the ridges in various ways, sometimes one leaf, and, in other cases, two or more springing from the same base, and as the tree continued to grow higher, the leaves fell off, leaving their various forms of insertion to adorn the bare lower part of the trunks which then exhibited a great variety of patterns, which along with variations in the size and form of the ridges and furrows, have in the fossil state given rise to the various species.

There is no plant known in the whole of the vegetable kingdom at the present day which can

be compared with the ancient sigillaria. Its external appearance may be roughly compared to one of our large, straight pine-trees shorn of its branches, and in their places the upper part was thickly studded

of this strange plant, and about its true position in the vegetable kingdom, for notwithstanding the vast number of specimens of portions of its trunk and of its roots (stigmaria) extant, yet the true form (or

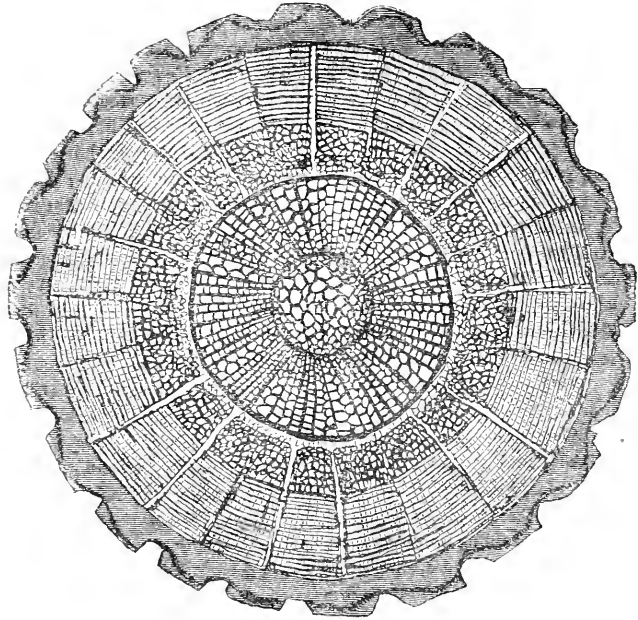

Fig. 76.—*Sigillaria vascularis* (Diagrammatic section).¹

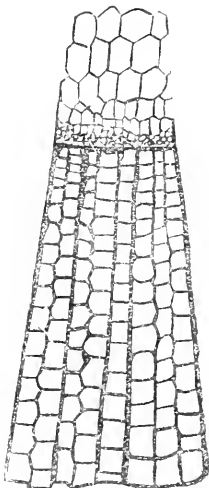

Fig. 77.—Small segment of fig. 76, magnified 85 diameters, showing form and arrangement of vessels and cells.

with long, narrow leaves, while the lower part was bare, but richly ornamented along the ridges with the markings left by the fallen leaves. There has been considerable discussion concerning the morphology

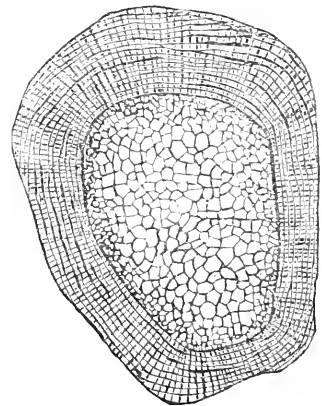

Fig. 78.—*Sigillaria vascularis* (showing medullary pith and ligneous zone).

forms) of the terminal portion of the stem is still unknown.

Some species are supposed to have had a crown of fern-like fronds after the manner of our modern tree-ferns. But this is not supported by facts, no such fern-like fronds having ever been found actually attached to sigillaria. Other species are supposed to have borne branches, these branches having been formed in the peculiar manner called by botanists

“dichotomy,” which is so well illustrated in the branching of lepidodendron. The stem of lepidodendron after attaining a certain height divided almost exactly into two branches; these branches after growing awhile divided in a similar manner, and this bifurcating went on until a crown of branches was formed.

The sigillaria, however, appear, so far as my

side by side with sigillaria, the former may frequently be met with in a branching condition, but the latter, never. If dichotomy ever did take place in sigillaria, some examples of it must have been met with in our coal-fields, and it is quite possible that other observers may have met with such. If so, they would confer a boon upon students of this subject by making the facts known. Every little

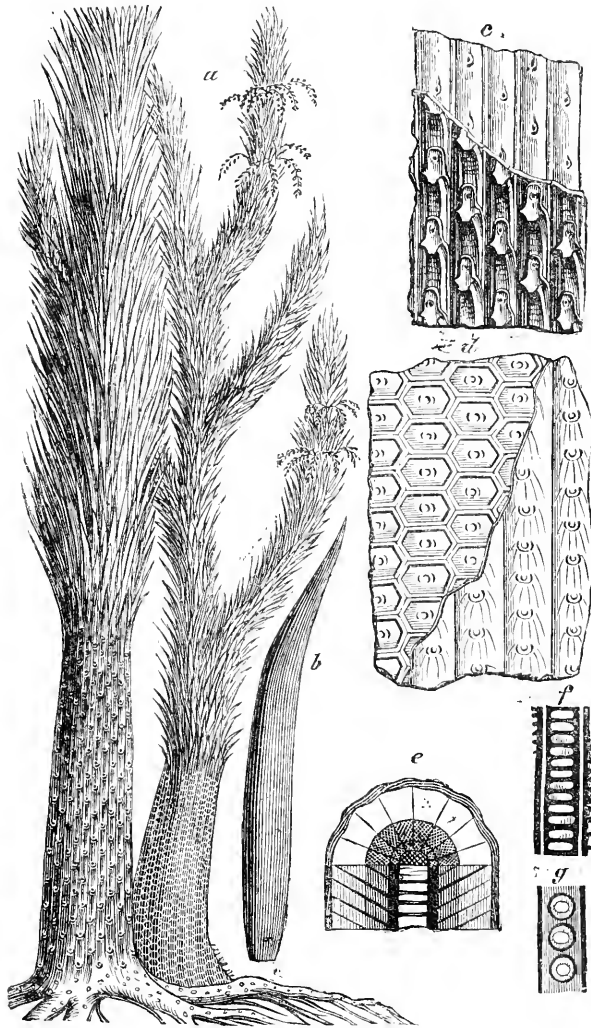

Fig. 79.—Sigillaria (restored); *b*, leaflet; *c* and *d*, impressions of leaves left on bark; *e*, section of stem; *f*, portion of cylinder.

experiences go, to have very rarely branched—so rarely, indeed, that I have never succeeded in finding a single case of dichotomy in any real sigillaria from our Yorkshire carboniferous formation, although I have been on the look out for it for many years, and have examined hundreds of specimens of sigillaria *in situ*, and in private and public museums. In our coal balls, where lepidodendron lies often

fact in connection with this singular plant is worthy of being recorded, for notwithstanding the fact—of which we have abundant proof—that sigillaria was one of the chief coal-producing plants, and that its fossil casts are found plentifully in all the great carboniferous formations, yet we know comparatively little about its internal organisation, or indeed of its external appearance, with the exception of its

trunk and the various forms of its flutings and leaf scars.

Our knowledge of its fructification is also extremely limited and uncertain. Mr. Carruthers, F.R.S., one of our great authorities on fossil botany, thinks that its fruits assumed the form of spores, which were borne at the bases of its long, narrow leaves, but this conjecture, I think, needs further corroboration; and with all due respect for so high an authority, I have reasons for thinking that its fruits, when undoubted specimens are met with, will be found to assume the form of cones, like the rest of the lepidodendroid plants.

In our coal strata I have occasionally found cones with long, narrow leaves attached, these being quite different from the ordinary cones (lepidostrobi) of the lepidodendron, and it is not improbable that they may turn out to be the fruits of sigillaria. The lepidostrobus is clothed with the same kind of thick scale-like leaves as its parent, lepidodendron, and in like manner we may expect to find that the fruit of sigillaria will be clothed with the same kind of leaves as the stem. For the present, however, we must leave it an open question until we have obtained more decided proofs.

Much diversity of opinion prevails among fossil botanists, concerning the botanical affinities of sigillaria. M. Brongniart, M. Grand'Eury and other French authors and Dr. Dawson of Canada, place it among the Gymnosperms, while Dr. Hooker, Mr. Carruthers, Mr. Binney, Professor W. C. Williamson, and other English authors regard it as a cryptogam representing the highest form of lepidodendroid type of vegetation.

These differences of opinion are probably in a great measure due to the very imperfect state of preservation in which specimens of sigillaria, showing structure, have hitherto been found. Even in our coal-balls, where we meet with fragments of sigillaria not unfrequently, yet we rarely find anything but the epidermal layer, the inner structure being rarely preserved. This is all the more singular, as in the very same material we generally find the lepidodendron in a good state of preservation.

Much of this diversity of opinion probably is owing to the different views which obtain among writers concerning the correlations of the various forms of tissue existing in the ancient cryptogams with those existing in modern exogenous plants. Some authors seem to forget that the lepidodendrons and sigillarias and their allies, filled the place in the vegetable world in the coal period, that our modern forest trees do now, and that while in regard to their histological parts, especially their reproductive organs, they undoubtedly belong to the cryptogams, yet in order to meet the extra requirements of their large growth and tree-like habits they were built upon exogenous principles. Some authors

deny the existence of medullary rays in these plants, and refuse to recognise the tripartite arrangement of the tissue; of their stems into, central medulla, ligneous cylinder and bark. But Professor W. C. Williamson with, in my opinion, a far better knowledge and appreciation of the homologies of the various tissues existing in these ancient plants and in their modern representatives, following in the footsteps of the illustrious Brongniart, fully recognises the existence of medullary rays, and does not hesitate to employ the terms, medulla or pith, wood or ligneous cylinder, bark and epidermal layer, "because," he says, "I am convinced of their existence in the fossil plants." Following the lead of such excellent guides I shall make use of the same terms in my descriptions of these plants. M. Brongniart was one of the first to describe and figure specimens of sigillaria. He describes the stem of his *Sigillaria elegans* as consisting of a central cellular axis or medulla, surrounded by a vascular cylinder, which is invested by a thick cortical layer of cellular tissue. This description almost exactly agrees with one of the stems which Mr. Binney has described under the name of *Sigillaria vascularis*. In that memoir Mr. Binney gave figures of two or three different plants. One of these has been recognized and described by both Mr. Carruthers and by Professor Williamson as the *Lepidodendron selaginoides* of Sternberg (see fig. 65 of my May paper). Another is a similar plant to that from which other figures are taken, which Professor Williamson thinks may be a sigillaria, and he has given this form the name of *Diploxyton vascularis*, for reasons which I shall explain farther on; for the present, however, I shall retain the older and more familiar name of *Sigillaria vascularis*. This plant is frequently met with in our Halifax coal-balls. It has a central medulla, composed of cellular and vascular tissues, surrounded by a woody cylinder, formed of scalariform vessels, which are arranged in radiating laminae, this again being invested with a thick bark composed of cellular tissue and a greater proportion of prosenchyma or woody tissue. From the examination of a great number of specimens of this plant, I am able to endorse Professor Williamson's opinion that it is a sigillaria of the diploxyton type. The ordinary form of diploxyton also occurs in our coal-balls, but here, as elsewhere, it is rather rare.

The centre of a diploxyton stem consists of a vascular cylinder, which is formed of large scalariform cells and vessels, enclosing a hollow space. Surrounding this vascular or "medullary cylinder," is the ligneous or woody cylinder. The centre of this plant is therefore formed of two woody cylinders; hence its name diploxyton or double wood. Professor Williamson says that Brongniart's specimen of *Sigillaria elegans* belongs to the Favularian type, and that it exhibits a central axis, the structure of which is "nearly identical with" one of his figures of

"diploxyton." "Diploxyton again shades off into the ordinary forms of *Lepidodendron*, which have lost the central portion of their medulla." He also says, in another place, in reference to a series of specimens of this plant from Burntisland, "*Lepidodendra* are the twigs and branches of the diploxyton stems." It will be seen from the above remarks that diploxyton and *Sigillaria vascularis* are alike in their internal structure, with this exception, that in the former, the tissues of the centre of the medulla are absent, while in the latter they are present.

This difference may possibly be a specific character, or it may be a mere accidental feature due to the varying processes of fossilisation. But it is important to note that both these plants occupy a midway position between the lower forms of *lepidodendrons* on the one hand, and the more highly-organised *sigillaria* on the other. I have already observed that specimens of the real ribbed *sigillarias*, as distinct from the *Favularian* type, are exceedingly rare. Some time ago, however, I had the good fortune to come across a real *sigillaria*, of which I shall now, in conclusion of this paper, give a brief description.

Sigillaria reniformis. This well-known plant is occasionally met in our coal-balls, but generally, like all the other species of true *sigillaria*, it is only represented by its epidermal layer. This specimen was in a fair state of preservation, although somewhat compressed, and the centre badly pyritised, so as to render it doubtful whether I could grind a section of that part transparent enough for the microscope. The specimen was about $1\frac{1}{2}$ inches square by $\frac{3}{8}$ inch thick. In order to make the most of it, I cut it up into four pieces, two of these I reserved for longitudinal sections of the bark, one for transverse, and the other for longitudinal sections of the centre. I managed to prepare a good series of longitudinal sections of the bark and then proceeded with great caution to cut transverse sections of the centre. I managed to cut three sections, one of which flew into pieces in cutting, another I ground slowly away without being able to get it transparent. The last section, notwithstanding the greatest care, wasted away till only one half of the central portion was left, before I succeeded in reducing it sufficiently thin for microscopic examination. At length I obtained my object, and although the section is here and there somewhat obscured by black spots of iron pyrites, yet sufficient remains to show the structure of the central medulla and the ligneous cylinder. The centre of the medulla is composed of cellular tissue, and this is surrounded by a "medullary cylinder" which is composed of vascular tissues. This is surrounded by a ligneous cylinder, formed of scalariform vessels.

This is the only undoubted transverse section of the centre of a true *sigillaria* that I have seen, yet in no respect does it differ from what obtains in *Sigillaria vascularis*.

Indeed so exact is the resemblance, that I have not

deemed it necessary to give a drawing of it, as figs. 76 and 77, representing a transverse section of *Sigillaria vascularis*, will also equally answer for this transverse section of *S. reniformis*.

I have a tangential section of the same plant, showing two of the "ribs" or ridges. Before I began to grind the specimen down to a level surface, the well-known pairs of kidney-shaped markings so characteristic of this species were plainly visible, but as these cicatrices are slightly raised above the level of the ridges, and invariably go into one a little below the surface, it is almost impossible to obtain these reniform markings in our preparations, especially in a small plant like this. In larger plants of course and under favourable conditions, we might succeed in making a section a single ridge, showing one or two pairs of these markings. I have such a specimen in my cabinet.

The main fact which this specimen is intended to show, is that it is a real *sigillaria* of the ordinary kind, having the usual ridges and furrows and markings peculiar to these plants. The next point is to show the long fusiform or the spindle-shaped vessels, which overlap one another in such a way as to leave no space between them, and thus form a true prosenchyma or woody tissue. I have already pointed out that the outer part of the bark or bast layer, in *Lepidodendron selaginoides*, consists of the same kind of fusiform vessels. In *Sigillaria vascularis* the greater portion of the bark is formed of them, and in these sections of *Sigillaria reniformis* the whole of the bark seems to be composed of these fusiform vessels.

The centre of the medulla is composed of barred cells, on each side of which are the vessels forming the medullary cylinder, which is again enclosed by the ligneous cylinder.

I have a section across the ligneous zone, showing the manner in which the medullary rays are interspersed among the long barred vessels composing it. The medullary rays originate in the small spiral vessels forming the "medullary sheath" and pass through the ligneous zone on their way to the leaves.

(To be continued.)

CHELONIA CAJA.—Sometimes, although rarely, two broods of this insect will occur in one year. It happened so once in my experience. Owing to a mild winter and spring, the "woolly bears" underwent their transformation into "tiger-moths" earlier than usual. The caterpillars produced from the eggs which the first brood of moths laid grew rapidly, and having attained their full size spun up about the 15th of September; the first moth came out upon September 27th, the others in October, and (one) the beginning of November. They were all much smaller than the usual size of this insect, measuring from one inch ten lines to two inches one line in expanse of wings.

—Albert Waters, B.A.

MY EXPERIENCE OF MARINE AQUARIA.

PERHAPS a statement of my recent experience in starting a Marine Aquarium may be of service to "Rita" and others.

Wishing to observe the development of some marine microzoa, I obtained a confectioner's glass cake-cover, eight inches in diameter, inverted it upon a block of wood in which was a hole to receive the knob, and on the bottom, put a layer of fine gravel previously washed quite clean. Then I collected a few pebbles to which healthy fronds of *Ulva* and some of the smaller algae were attached.

These were well rinsed in sea-water, and placed in position among the gravel. The only other necessary operation was to get some more sea-water, let it stand till quite clear, and then to fill up the glass to about an inch from the top. This was soon done, and the aquarium was complete and in working order for minute forms of life.

I stood it on a window ledge, where it is exposed to direct sunlight (when there is any) for several hours daily.

It will probably be necessary to lessen this exposure as the summer advances.

On the algae were colonies of various species of polyzoa and other parasitic life which have thriven well. At once, I noticed tiny crustaceans darting about, and soon many other forms made an appearance.

Every few days I discovered something fresh and highly interesting.

During the severe weather, the aquarium was frozen several times, but the only ill-effect noticed was the destruction of a host of discoidal germs that were dotted all over the interior surface of the glass. Occasionally I have added other objects collected during my rambles along-shore, and they have also grown and multiplied. As a microscopist I can say that this aquarium, with others of varying size, from ten inches in diameter down to finger-glasses that I have started since, have afforded me an immense amount of enjoyment, whilst the expense has been merely that of the cost of the glasses.

Even without the microscope, I have found much to observe and admire.

With a pocket-lens the habits of many of the animals can be studied.

Spiders that appear to be all legs and no body can be seen twining themselves among the stems of *Tubularia* so as hardly to be distinguished therefrom. The comical *Caprella* may be noticed gripping a stem with the three pairs of strong claspers at its hindmost extremity, and waving its grotesquely attenuated body about in singular fashion. Or it may be that one sees a small crab (*Ilyas araneus*) perched in a branching plant, as in a bush, hardly perceptible at first sight because of the miniature forest of algae and filamentous diatoms growing upon its back.

Though apparently motionless, the curious little fellow is causing a current of water to flow past his mouth, so that he gets a plentiful supply of food without the trouble of running after it.

Then there are beautiful worms crawling about, or else swimming in graceful sinuosities. Or the out-flowing current from some of the miniature craters of a sponge colony may be detected throwing out grains of sand or perhaps its own gemmules.

To assist some winkles in keeping the glass clear of vegetation, I put in a small slug, *Eolis alba*. One day, I was astonished when I found that this animal had deposited a host of eggs enclosed in a gelatinous tube, and arranged in a symmetrical flat spiral coil upon the glass. At intervals, other clusters of ova appeared, and I have had the gratification of watching the progress of the embryos through numerous changes, to me at once novel and wonderful.

Each transparent capsule, at one stage, contains several individuals, and it is very curious to see them twirling and rolling about within, apparently causing mutual discomfort. Some that were more exposed to solar influence than the others, became so active a few days ago, that they burst their prisons, and started in life independently. Now they have a glassy shell, somewhat nautiloid in form, into which they can withdraw their ciliated lobes when tired of roaming.

Other changes must of necessity ensue before they attain to nudibranchiate maturity, and these I hope to observe with increasing interest.

W. H. SHRUBSOLE, F.G.S.

Sherness-on-Sea.

A CHAPTER ON ROSES.

SO long have roses experienced the loving care of man that it is not known when they became garden plants, and so far back as the hanging gardens of Babylon they were there carefully cultivated for the pleasure of Queen Amytes. They dislike excessive cold and heat, preferring to make their homes in temperate climates. Pure air and shelter from the winds they must have; smoke is death to them; whilst nearly every species (and they are almost innumerable) requires a particular soil and particular treatment. They are to be found in Europe, and parts of Asia and Africa, but have not extended their travels to Australia, which does not possess a single wild rose. In Gerarde's time, London must have been beautiful with roses, for he speaks of nearly all the kinds he describes as "growing in our London gardens." It was probably in his own garden at Holborn that he tried the experiment of "grafting a wild rose on a broome stalk," and therefore declines to credit the report that the yellow rose was so originated. Lete, a merchant of the metropolis, introduced the yellow rose from

Turkey. The dog rose (*R. canina*), as we know, wanders at its own sweet will over our hedges and undergrowth of woods, and in France and Italy, *R. Gallica* is found in the same situations. But although there are a few wild, or semi-wild kinds, in its full beauty the rose is essentially a flower of cultivation. In that state it is still most valuable to the botanist as affording examples of metamorphosis, and showing the analogy of parts, for in some cultivated roses are to be seen how carpels and stamens have become petals; and in others how sepals and carpels have been transformed into true leaves.

If the date of the introduction of the rose to the garden is lost, poets are quite certain as to the origin and destination of the first one. They tell us that it sprang from the blood of Adonis, and was given by Cupid to Harpocrates to induce him not to reveal the doings of Venus, and to this tradition some ascribe the old custom of suspending a rose over the table at convivial meetings, as a hint that all there said and done was not to be spoken of out-of-doors. The moss rose we owe to Cupid, for Venus having begged her son to make her favourite flower still more beautiful, he sportively flung around it a handful of moss taken from the bank on which they rested. Again, there is a pretty fable that the rose was once a lovely woman, whose charms were so great that people gazing on her forgot to worship elsewhere, and the temple of Diana became deserted. The irate goddess called Apollo to her aid, and he, indignant at a slight shown to his sister, transformed the beautiful Rhodanthe to a rose-tree. The admiring crowds, who adored at a distance, were changed to thorns, whilst the more deeply smitten still fluttered around their divinity as butterflies.

The Romans valued most the roses of Capua and Præneste, with which they decorated their rooms (Cleopatra had a carpet of roses prepared for Antony at one of her festivals) and ornamented their dishes by sprinkling the juice over or covering them with the petals. The flowers they wove into chaplets and perfumed the clothes of their guests with rose-water—a practice still continued in India at weddings—and Nero is said to have spent £20,000 on roses for one of his suppers. Pliny also speaks of the ashes of burnt roses being used to trim the eyebrows. Gerarde says that rose petals were sometimes eaten as a salad with pepper, vinegar, and oil; and a preserve used to be made of the “hips” of the dog rose. Both Greeks and Romans made an ointment from the leaves and flowers for dressing wounds, whilst syrups, infusions, and confections were given for nearly all the ills that mortal flesh is heir to, and kept their place in pharmacy for many ages. Culpeper says that to write of all the virtues of the various preparations of the rose would fill a volume, yet he prefaces his chapter with the peevish exclamation, “What a pother have authors made with roses!

What a racket have they kept!” The ripe fruits of the dog rose (*R. canina*), the dried and fresh unexpanded petals of the red rose (*R. Gallica*), and the fresh expanded petals of the cabbage rose (*R. centifolia*), still figure in the British Pharmacopœia. Professor Bentley, in “Medicinal Plants,” says that *R. centifolia* “is grown at Mitcham, Fulham, &c., in small quantity, the great cultivation being carried on at the flower-farms in the south of France.” *R. Gallica* is grown near Mitcham, in Surrey, Oxfordshire and Derbyshire; in places in Holland and near Paris, and he states “that it has been computed that 2000 flower-buds of *R. Gallica* yields about 10 pounds of dried, or 100 pounds of fresh petals.” The pharmaceutical preparations of roses are mildly astringent, and are not much depended upon as therapeutic agents, their chief use being to serve as vehicles for more active drugs. The *R. Damascena* is the species that is chiefly cultivated for perfumery purposes, and at a distance of seven miles from Ghazepoor, India, where they are largely grown, the odour can be distinguished. The quality of otto of roses seems to depend more upon the climate of the country in which the flowers grow than upon any one particular species. The roses, with or without their calyces, are distilled with water. The product is allowed to stand at a certain temperature for a day or two, when the oil (otto) that rises to the surface is skimmed off. It is often much adulterated with “oil of geranium.” To purify the mosque of Omar in Jerusalem, after the departure of the Christians, Saladin used five hundred camel-loads of rose-water. Estates have often been held by the tenure of a rose—a red one—at times being stipulated for, and these floral tributes generally had to be paid on St. John the Baptist's Day. For the castle of High Head, held by Lord Brougham in capite of the Queen, a red rose had to be given every year at Carlisle, and the manors of Blakenhall, Buerton, Bebington, Doddington, and Seddington in Cheshire, were respectively held by the families of Venables, Poole, Bebington, Delves, and Fytton by such tenures. When these estates changed hands by purchase or otherwise, the payment of the rose devolved on the actual holder of the land, thus: the above manor of Bebington passed by marriage to the Minshulls of Minshull in 1478, and in 1585 Richard de Minshull was then holding it “in socage by red rose to be rendered on St. John the Baptist's Day.” In 1569 the quarry at Shrewsbury was leased by the corporation, for a red rose yearly, to a person who also engaged to bring the water from Brodwell, near Crou-Meole. For Brook House, Langsett, Yorkshire, it is said that a rose had to be provided at Christmas, and a snowball at Midsummer, and as evidently there would often thus be much difficulty in paying the rent, we are probably correct in surmising that in this case a money fine was the alternative.

The Golden Rose, blessed annually by the Pope on 4th Sunday in Lent (Rose Sunday), and given in these times to some august lady of known devotion, is much prized and eagerly sought for. Among the ladies who have been so honoured are the Queen of Spain, who received it in 1868, and the Queen of Naples. It is said to be one of the many disappointments of the life of the Empress Eugénie, that she also has not been made a recipient. The consecration of this rose or rose-tree, for such it really is, having perfumes in one of its upper blossoms, is thought to have been instituted by Leo IX., although some believe the ceremony to be of greater antiquity. A French writer says that it was, in the first instance, sent to the Pope by the grateful abbess of St. Croix, in acknowledgment of the privilege he had granted to her order. In the beginning it was merely carried through the streets of Rome, and there deposited with the prefect; gradually the custom arose to present it to some steady supporter of the papacy, and Falk, Count of Anjou, in the Pontificate of Urban II., was the first foreigner of importance who thus received it; ultimately its bestowal became a mere question of policy, and it was given quite as much as a bribe as a reward, as at first it was sent to our Henry VIII. A Devonshire knight, Sir Reginald de Mohun, founder of Newnham Abbey, received the rose from Pope Innocent IV., and was at the same time created Earl of Somerset, because till then the rose had not been given to any person under that rank. Sir Reginald does not seem to have used the higher title in England. The tribute of roses was instituted by Blanche of Castille, widow of Louis VIII., and consisted of the presentation of a basket of roses, by the youngest peer, to the French Parliament on May Day. The queen overheard a lady rebuking her lover for singing love songs in the rose garden, where he ought to have been devoting himself to a cause in which he was interested. Stung by her reproaches, the count left lady and roses, "read up" most energetically, and of course gained the suit, a wife, and the favour of the queen, who then inaugurated the ceremony. The privilege of presenting the roses was much prized, and led to a dispute in 1541 between the Dukes of Montpensier and Nevers, that took the most learned lawyers of the country to decide—ultimately in favour of the Duc de Montpensier. The custom was abolished in 1589, and although in the reign of Louis XIV. an attempt was made to revive it, it was ineffectual.

Besides being the national emblem (there is an engraving of a shield where James I. had the rose and thistle conjoined under a crown) the rose figures in the arms of the dukes of St. Albans, the earls of Rosse, and other families. The collar of the order of St. Patrick is formed of roses and harps joined by knots, and the rose is one of the adornments of the collar of the Bath.

Against the cathedral at Hildersheim grows the oldest rose-tree known, tradition referring its origin to the time of Ludwig, son of Charlemagne. In the "Illustrated London News" of 1850 there is represented a large rose-tree, which was then to be seen in the nursery grounds of Mr. Buckton in Wandsworth. It was 28 feet high, 20 feet in circumference, and had 2000 roses in bloom; is stated to have been a standard of the species Fulgians, variety Hybrid, China.

For the title of Rose of Jericho (*Anastatica hierochuntina*) *Lycopodium involvens* and *Mesembryanthemum Tripolium*, which has capsules like a button half an inch in diameter, that expand in water, are all aspirants, but the first named has the support of the chief botanists. It grows on sandy soils in Palestine and Egypt, and its properties of shrivelling up when dry, and uncoiling when placed in water, are well known. The flower intended by the "rose of Sharon" is also another matter of dispute among learned men, some urging the claims of *Polyanthus narcissus* to be so considered, and indeed the weight of evidence seems to be in favour of this plant; whilst others name the crocus and "mallow."

Instances of miraculous transformations into roses are not uncommon. St. Elizabeth of Thuringia was generous as well as pious, and loved to supplement her words of comfort with substantial aid, but in her works of charity she was much hindered by her husband, who did not share her views, and at last peremptorily told his wife that there must be an end to her almsgiving. When, therefore, some time after whilst carrying supplies of food to a poor family, she met the margrave, her heart failed her, and she stood mute and trembling, as he asked what she had in her basket. But when he raised the covering, lo! bread and meat had disappeared, and in their place lay white lilies and clusters of fragrant dewy roses. At the martyrdom of a maiden at Bethlehem, white roses sprang from the unlighted wood piled round her, and red ones from the quenched faggots. The sacred fire of the Parsees takes its origin from the attempted sacrifice of Zoroaster, when an infant. The wood on which he was laid, at the moment of its being lighted, was transformed into a heap of roses, and a portion of this fire being saved, it was carefully tended and not allowed to die out. Some Mohammedans aver that roses sprang from the blood of Mohammed. Old legends also say that till sin and sorrow came into the world, all roses were white and without thorns, but Cary writes, that Eve, one day, enchanted by the pure beauty of a rose, delightedly kissed its leaves, when, "straight it drew, from beauty's lip the vermeil hue." The gradual approach of dawn has been compared to the unfolding of a rose, and Keats described a sunset as "like a rose in vermeil tint and shape;" but the poets have chiefly used the red rose as an image of youth, beauty, and swiftly-passing pleasures! The white rose

symbolises sadness and purity. Superstition holds that if a rose falls to pieces in the hand, some misfortune is near, and among the many divinations used by curious maidens to gain an insight into the future, was the practice of walking backwards into the garden at midnight, on Midsummer Eve, plucking a rose and carefully placing it in paper, to be left undisturbed till Christmas Day. Then it was to be worn, and the future husband would, of course, put in an appearance and beg for it.

It was a sad time in English history, when roses became the body badges of fierce factions, and, torn from the garden, were carried into all the horrors of the battle-field. To a Yorkist, the white rose was not only symbolical of "the truth and plainness of his case" but of the apprehensions of his enemy, "whose cheeks did counterfeit" his flower "for pale they looked with fear," and probably Richard Plantagenet was not alone in his savage longing to "dye his rose in the lukewarm blood of Henry's heart." Not less ready was the Lancastrian with the retort, that the paleness of his antagonist's flower "bewrayed the fainting of his heart," whilst he boasted that the red rose's thorn was "sharp and piercing to maintain his truths." Henry VI. might well bewail the "fatal colours of our striving houses." In later days the white rose again became a party badge, and June 10th being the birthday of James III., was a favourite day for its display by Jacobites. In Tudor architecture the rose was frequently introduced, and a rose-bud, with the stem broken, is often seen sculptured on the tombs of the young. From all times these flowers have been strewed over graves, and a merchant of London, Edward Rose, left 20*l.* per annum to the parish of Barnes, Surrey, on condition that his grave in that churchyard should be kept planted with rose-trees.

R. M.

A WEEK AMONG THE MARINE ZOOPHYTES.

ISLE OF WIGHT.

By C. PARKINSON, F.G.S.

THE southern coasts of England have long been famous for zoophytes, and it would be impossible to pitch upon a better locality than the back of the Isle of Wight from Ventnor to Shanklin. Experience teaches us that there are two seasons of the year especially favourable for the collector, early spring, and after the equinoctial gales of September; at other times nothing but the commoner forms are likely to be met with, and very few in a living state. Under the general term zoophyte we include all hydroids and polyzoa; certain Actinidæ may always be found in the shelter of rocky pools left by the ebbing tide, but the minute polyzoa and microscopic

hydroids can only be found in perfection at the two periods indicated. After the force of the September gales has abated, the rocky coast off Ventnor is certain to be thickly covered with half the sea-weeds known to inhabit the British seas; year after year the shore receives its covering, sometimes piled up a couple of feet at the base of the cliffs. Among this chaos of weed, a great variety of the zoophyte class is generally included, either attached to the algae, or parasitical on each other; from the common *Flustra* to the most delicate *Campanularia* scores of beautiful forms may be gathered—if you can find them. The *Sertulariadae* are, for the most part, easy to detect, but for many of the smaller genera it requires a trained eye to discover the slightest indication of life. Frequently as we have scrutinised a clear pool, with pickle-bottle hard by, and heads bent close down, have we been accosted by inquisitive strangers with the question "What are you looking for?" The answer has invariably been, "For what you cannot see." But in time the eye becomes accustomed to the work, and learns to detect very minute structures.

Every species named in this paper has been found by the writer in the immediate neighbourhood of Ventnor; in a week, about the beginning of October, with diligent search, all the seventy odd species can be collected, for the most part in a living condition. Any naturalist interested in the practical study of this deeply interesting class, will never regret spending a few days at Ventnor; if October or November cannot be the time chosen, March and April are equally good.

In order to have a clear understanding as to the essential differences between hydrozoa and polyzoa, which are often similar in external form, the following definitions are extracted from Johnston's "History of British Zoophytes," a work which is within the reach of many who cannot afford to buy the splendid books on the same subject by the Rev. J. Hincks.

Hydroids have no nervous system, and no organ of sense that can be identified as such; no organ exclusively appropriated to the functions of respiration, no circulatory system, nor vessels for carrying digested food through the body; the water simply flows over the external surface and through the general cavity, whence the polyp derives oxygen sufficient for life. They may be said to be simply developments of a common central, fleshy mass, identical with it in structure and texture. Polyzoa exist, each individual, as a separate organism, although connected one with the other. Johnston has aptly expressed it, hydrozoa are like a chain, each link of which is welded together, while the polyzoa may be compared to beads strung together by a percurrent thread. In organisation the polyzoa are nearly allied to the mollusca, although the latter never protrude from the cells in the same manner

as the polyp. They never occur in a separate or naked form, as some hydroids do, but are always in a polypidom or cell, which is either calcareous or membranous. The tentacles of the polyp are ciliated, by means of which particles of food are drawn into the mouth. The stomach and a narrow intestinal

rocks, facing the full force of the waves, we discover a colony of tiny rose-coloured creatures, no larger than the head of a pin; this is the *Clava multicornis*, an uncovered hydroid zoophyte, somewhat club-headed, and having about twenty-five tentacula. At certain seasons a mass of ovarian capsules are

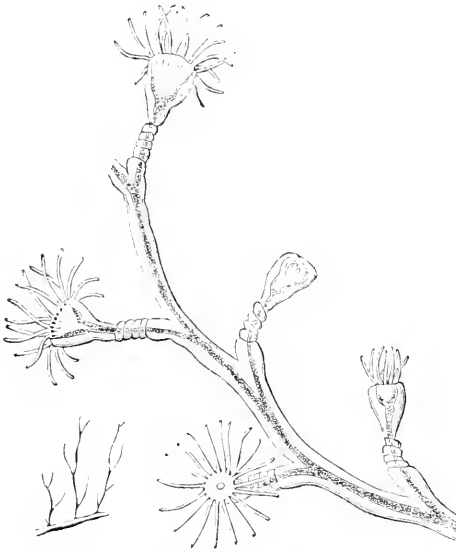

Fig. 80.—*Laomedea geniculata*. The small figure shows the nat. size.



Fig. 81.—*Campanularia geniculata*. The small figure shows the nat. size.

canal are developed in polyzoan forms; there is no organ of sense, though the polyps are sensible of external impressions. Left undisturbed in still water, the polyps protrude and disport themselves freely, but if the water is shaken, the animal instantly retires, remaining hidden from view for some minutes. If one polyp is suddenly touched with a sharp instrument it retires, the rest taking no notice, apparently unconscious that anything has happened.

Starting at half-tide, as the waters ebb, we can get to work within five minutes among the Ventnor rocks with the certainty of being richly rewarded after two hours' search. On the edge of greensand

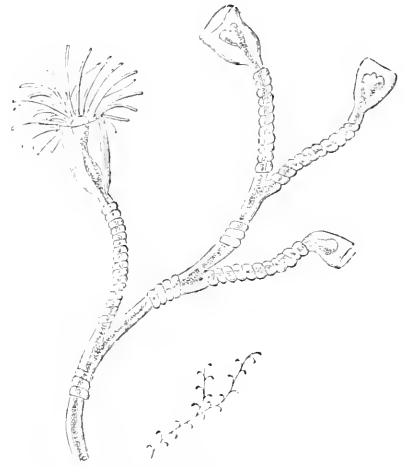

Fig. 82.—*Laomedea gelatinosa*. The small figure shows the nat. size.

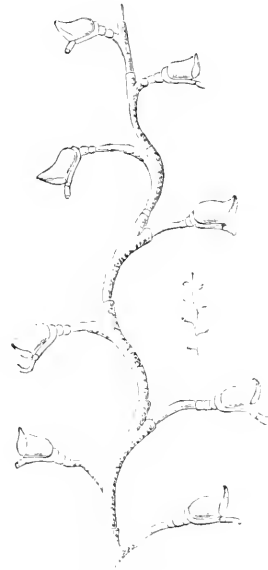

Fig. 83.—*Plumularia obliqua*. The small figure shows the nat. size.

grouped at the base of the tentacles. Placed in a sea-water trough, such as can be purchased for one shilling from Mr. Bolton, 17 Ann Street, Birmingham, the clava, and indeed most other zoophytes, make beautiful objects for microscopic observation. The *Hydractina echinata* we found on a fusus thrown out

from a crab-pot; it was unfortunately the dried crust only, the polyp being most certainly dead.

Attached to the dark fronds of a polysiphonia the thread-like *Coryne fusilla* may be looked for in Steep-hill Cove, a few hundred yards westward of Ventnor; it is sometimes two inches long, with alternate branches, but an insignificant little zoophyte, which is easily overlooked or thrown aside as a bleached sea-weed. Under the inch power the Coryne is readily identified by the beautiful cable-like stem, and the club-shaped polyps, with short and thick tentacula, which move only in the slowest and most clumsy fashion. Of Sertulariadae many species abound—*S. fumila* grows in vast quantities at the roots

Antennularia antennina, with cells much broken and disfigured. While the Sertulariae are usually pale brown colour, the Plumularia are of a decided yellow tinge; *P. falcata* and *cristata* are both abundant at Ventnor, infesting the stems of the coarser brown algae in dense masses. A third species we figured as *Laomedea obliqua* after Johnston, but on referring the living specimen to Rev. J. Hincks, he placed it among the Plumularia on account of the structure known as the "Sarcotheca," an organ very imperfectly understood. Supporting each polyp cell is a tubular continuation of the stem ending in a cup enclosing protoplasm, and thread-like appendages which can be protruded and retracted at will. These



Fig. 84.—*Campanularia dumosa*. The small figure shows the nat. size.



Fig. 86.—*Campanularia springa*. The small figure shows the nat. size.

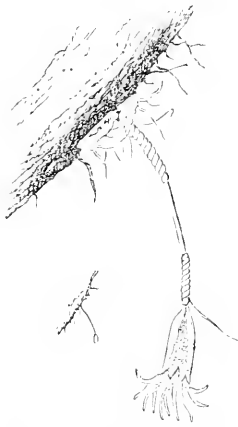

Fig. 85.—*Campanularia volubilis*. The small figure shows the nat. size.

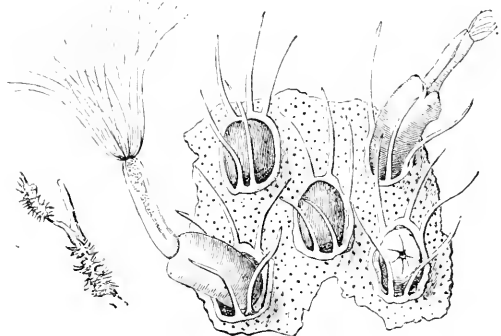

Fig. 87.—*Flustra hispida*. The small figure shows the nat. size.

of the common Fucus: a fragment, half an inch long, may be examined at any time with a score of polyps playing about. It is possible to cut the spray into three or four pieces, and still the polyps continue to disport themselves. *S. polyzonias*, *rosacea*, *nigra*, *abietina*, *filicula*, *operculata*, *argentea* and *cupressina*, may all be collected at Ventnor. *Cupressina* differs slightly from *argentea*, the bracelets all gracefully bending downwards, while with *argentea* they stand out at all angles; the vesicles also differ in shape, and, if present, afford the surest means of defining the species. The exquisite form of *rosacea* surpasses all other Sertulariae in beauty. Amid all the wealth of Sertulariae we could only find a single dead bit of

filaments hang over the surface of the polyp cells, possibly, as Mr. Hincks suggests, for purposes of nutrition. This *Plumularia obliqua* is evidently the same zoophyte figured by Johnston as *Laomedea obliqua*, and it would be useful if other naturalists would study the singular process mentioned (fig. 83). The Campanulariadae are the most graceful of all hydroids, of delicate and fragile construction. Both *Laomedea geniculata* and *gelatinosa* are met with at Ventnor, the specific characters of the two being difficult to separate. *Geniculata* is frequently forked, has short stems to each polypidom, and ovarian capsules contracted at the rim; *gelatinosa* has much longer foot stems, which are more prominently ringed;

this zoophyte is not usually branched. Owing to the uncommon transparency of the cells each polyp may be observed, whether it expands or not (fig. 81). Among the Campanulariæ proper, *C. verticillata*, *dumosa*, *syringa* and *volvubilis*, may occasionally be found; *dumosa* and *syringa* we are certain of, but *verticillata* and *volvubilis* are so named because they more resemble the two species so called by Johnston. All marine zoophytes appear to be liable to slight variety, for this reason the two in question are identified with Johnston's species. *Alyconium digitatum*, the common "dead men's fingers," will be found either adhering to oysters or cast up among the loose sea-weeds, and is chiefly on the Bonchurch beach. Among Actinidæ, *A. crassicornis*, *coriacea*, *mesembryanthemum* and *Anthea crevus* may all be collected; *A. alba* only at dead low water. The Lucernariadæ of the Isle of Wight were described and figured in SCIENCE-GOSSIP (June, 1880): it is therefore unnecessary to go over the ground again. This completes the hydroids which have absolutely come before the notice of the writer; possibly most of the other genera might be detected with a more systematic search.

The polyzoa are just as abundant as the hydroids. *Tubulipora patina* is plentiful at Bonchurch, but the polyp has never, at least up to Johnston's time, been detected. To the naked eye it has the appearance of a slightly concave, silvery-white plate, firmly attached to algæ. *T. hispida* is also occasionally washed ashore on the same beach. The bleached thread-like clusters of *Gemellaria loriculata* abound at Ventnor. It is so constructed that each pair of cells appears to spring from the one beneath. It is not common to find a living polyp. It expands at some distance from the cell, having a long stem beneath the tentacular arrangements. *Crisidia cornuta* differs from the *Crisia* genus, having cells only on one side, and a long spine from the base of each cell. *Crisia churnea* and *denticulata* are both plentiful, but *C. aculeata*, well defined by the amber-coloured joints between the cells, is exceedingly rare. *Notauria bursaria*, the shepherd's-purse coralline, grows attached to *Ceramium rubrum* and other seaweeds. *Cellepora fumicosa* encrusts weed on the Bonchurch beach with a thick calcareous membrane, but we have never seen a polyp. The Lepraliæ are enough to test the patience of Job, although it is unlikely that the worthy gentleman ever suffered this particular form of temptation. *L. implex*, *unicornis*, *ciliata*, *spinifera*, *trispinosa*, are among the species identified at Ventnor. Many others we have probably overlooked.

Membranipora filosa infests every pond, and is plentiful all the year round. It assumes such a variety of form that inexperienced collectors invariably have the inclination to make several species from the various forms. *Cellularia reptans* grows at the roots of *Laminaria*, and a rare species, *C. Hookeri*,

may be gathered at Bonchurch. The spines which spring from some of the cells of the latter species have a power of movement evidently dependent on the polyp. The "bird's head" cellularia we have never been able to find in the Isle of Wight. *Flustra foliacea* and *truncata* are common enough, and a curious zoophyte, called by Johnston *Flustra hispida*, which is not a *Flustra*. From the fig. (see p. 87) it would appear nearly allied to *Alcyonidium* or *Sarcochitum*, but is probably a separate genus. It is very common at Ventnor, encrusting algæ with a rich, brown-coloured fleshy substance, which is one of the finest of all zoophytes. The cells are larger, and profusely armed with spines. The polyp protrudes like a telescope, unfolding in an extraordinary manner, and having at least thirty finely-ciliated tentacles. The ovarian capsules are at times attached to the spines; at other periods none are visible. The polyp is tenacious of life, and can be cut off the flat frond of a *Fucus* with a sharp pen-knife, so as to be sufficiently transparent for a thorough microscopic observation. It will be found that in cutting a section some polyps are killed, while others remain vigorous. Those that are killed are forced to expand at the moment they die, and remain permanently exposed. This ought to be a useful hint for mounting specimens. The sponge-like *Alcyonidium gelatinosum* may be found at low tide about Steephill Bay, Ventnor. *Pulicellina chinata* we have familiarly dubbed "Nine-pins," because their occupation in life appears to be knocking each other down. In the course of this warlike proceeding the head frequently is lost, leaving the living stem, from which a fresh head is soon developed. *Vesicularia spinosa*, *Bowerbankia imbricata*, *Valkeria pustulosa*, *Farella repens*, and *Serialaria lendigera* are all occasionally met with at Ventnor. The rare *Beania mirabilis*, stated to grow in the Isle of Wight, we have never been able to detect.

LIST OF ASSISTING NATURALISTS.

[Continued.]

CAMBRIDGESHIRE.

Cambridge. *Change of address.* Mr. Albert Waters's present address is Mill Road, Cambridge.

LEICESTERSHIRE.

Leicester. John Hamson, treasurer of the Leicester and Leicestershire Science Association, 67 Welford Road, or "Daily Post" Office, Humberstone Gate, *Phanerogamic Botany; and Geology.*

YORKSHIRE.

Whitby. F. J. Mead, 12 Baxtergate. *British Butterflies*, as well as on collecting and preserving the same; correspondents please enclose a stamp.

MICROSCOPY.

EUGLENA VIRIDIS.—I have much pleasure in being able to acquaint you with the fact that I have again been fortunate enough to observe all the phenomena pertaining to the *Euglena viridis*, to which I drew your attention last year; viz. bulbous termination of the flagellum, contractile vacuole, etc. This seems to me the more important, as the organisms have been drawn from a different locality from any of those examined last year. In many cases, the bulb is more fully developed in this year's growth than in those of last year, which permits it to be seen with a less powerful combination than was necessary in previous cases. I enclose sketch (drawn by means of the camera lucida) showing the organism as seen through a Beck $\frac{1}{4}$ inch, with No. 2 eyepiece (giving an enlargement of 360 diam.). The stunted appearance results from the animal being partially contracted when killed by a solution of iodine.—*F. Jas. George.*

MOUNTING STARCHES.—The method recommended by A. J. D. in a recent number is not a good one. Heat alters the form of all starches. When required for polariscope objects, thin dammar and thin balsam are perhaps the best media, used cold and left to harden spontaneously. By this process wheat starch and many others which do not polarise under ordinary circumstances, show well. For ordinary examination I find a weak solution of ammonia one of the best media.—*Edward Hunter.*

NEW ZOOPHYTE TROUGH.—Mr. J. Campbell Christie, of Hamilton, N.B., is rather behind the times in his discovery of the new zoophyte trough he writes about in your issue for May. The trough he describes was invented seven years ago by Mr. C. Botterill, of Liverpool, one of the most active and successful members of the microscopical society of this city, and bears his name. I believe that the first were made in vulcanite, but experience showed that that substance was not stiff enough to give an equal pressure when screwed down, and Mr. Botterill improved upon his first invention by substituting brass for the vulcanite, and in this improved form they may now be had of Mr. J. C. Thompson (Thompson & Capper), Lord Street, Liverpool, Hon. Sec. of the Microscopical Society, also of Mr. J. J. Marr, optician, Moorfields, Liverpool. I have seen many notices of this invention, the credit of which has been given to one or another, but not to Mr. Botterill. Some claim it as their own, and others ascribe it to American ingenuity; but this and several other things, adding to the convenient manipulation of the microscope, are the result of his experience and ingenuity, and to him belongs the honour. The cost of the brass trough, I think, is 3s. each.—*John J. Horwell.*

PARASITES ON HYDRA.—On the 10th of April I obtained some weed from a pond on Ealing Common, and amongst it I subsequently found a few fine specimens of *Hydra vulgaris*. About a week afterwards, when looking at one of them through a pocket lens, I observed that it was infested by minute parasites (?) and accordingly I brought the fact and the specimens before the members of the West London Scientific Association at their next meeting (April 26), but no one present was able to give me any information on the subject; nor could I, either then or subsequently, find any mention of such in any book whatsoever. Two days afterwards I received my copy of SCIENCE-GOSSIP, and was glad to see that some one else was in difficulties as to what these infusoria might be. To the accuracy of J. O. B.'s general description of these little creatures I can fully testify. Unfortunately my specimens perished before I could find the time to fully investigate them; but as far as I could make out, their lateral aspect very closely resembled that of *Stichotricha secunda*, figured in Pritchard's "Infusoria" (3rd edit. 1861, pl. xxviii. fig. 43); whilst seen from above they appeared of an oval shape, and most like the dorsal view of *Kirona mytilus*, figured in the "Micrographic Dictionary" (3rd edit. 1875, pl. xxiv. fig. 27). When detached from the Hydra they progressed at a fair rate through the water, rotating the while. Like J. O. B. I watched them for a long time, but could not see that they did anything but glide over the body of the Hydra, or venture occasionally on to the tentacles; still, I have a kind of feeling that they bode no good to their host, and think they must have received notice of the approaching dissolution of the Hydra, or why, of two Hydras stationed within half an inch of each other, should one be infested and the other not?—*B. B. W.*

INSECTS AND PRIMROSES.—My attention having been attracted this season by the large number of a minute insect (a species I believe of Thysanoptera) frequenting the corolla of Primroses, I was led to examine a number of the flowers attacked by the insects, and ascertained the following facts, from which it would appear that they play a not unimportant part in the self-fertilisation of those flowers of the primrose not already cross-fertilised. 1. The insects in question are to be found almost exclusively on the short-styled form. 2. They feed only on the stamens or the portion of the corolla immediately adjacent to them, and never seem to eat any portion of the pistil. 3. By their nibbling at the stamens, the pollen and occasionally an anther itself, is loosened and falls to the bottom of the tube, i. e. towards the stigma, which in its descent it can scarcely fail to fertilise. But for this insect agency the narrowness of the tube (which is increased by the anthers themselves blocking it up) would be a great preventive to self-fertilisation. In the long-styled form since the stamens are situated

below the stigma, it is clear that the loosening of the pollen would be useless as a help to fertilisation, and as above stated these insects seem but seldom to attack this form, although occasionally found on it. 4. They chiefly frequent the smaller-sized flowers, which it is evident would be more dependent upon self-fertilisation since the bees and other cross-fertilising agents are attracted by the size of the flower, and would be more likely to visit and consequently to cross-fertilise the larger-sized flowers.—*T. W. B.*

THE CRUST ON TEETH.—In consequence of the inquiry of E. J. W. in *SCIENCE-GOSSIP* for April last as to what are the rod-like filaments found in the substance which accumulates around the bases of the teeth, I allowed my teeth to remain unbrushed for three or four days, and then examined the accumulated matter. There was an abundance of the filaments, which I have no doubt are some species of *Oidium*, being very similar to, if not identical with *Oidium albicans* found on the mucous membrane of the mouth in adults and children suffering from aphthæ (known also as thrush, white mouth, and Le Muguet). I found also great numbers of spirillæ, longer than I ever saw before, bacteria, which, by the way, appear to be everywhere, and, to my great surprise, great numbers of an infusorian of which I send you a fairly representative sketch, and a few of another shape. They were very lively, each contained a vacuole and granular matter, and they were capable of changing their forms in order to accommodate themselves to the space in which they had to move—in fact, were exactly similar to those found about plants growing in stagnant water but for the absence of coloured contents. They were easily made out with a one-fifth objective and No. 1 and 2 eye-piece. It would be very interesting to know more about them, and I write this in the hope that some microscopist with more time than I can command may take the subject in hand, and if possible, work it out.—*D. Bradley, L.R.C.P. Edin. &c.*

PRESERVING ZOOPLANKTON.—While in Dublin about a month ago, I gathered some *Sertularia* covered with *Campanularia* and *Carchesium*. I have, on previous visits to the seaside, tried to preserve them for the microscope with the tentacles exerted, but failed. This time I had another try, but, as they did not exert themselves well, I did not take much notice of them, but killed them with spirit, and dropped them into pure glycerine, as they are well preserved. I intend the next time I am at the seaside (in a few weeks), to place some in a small tube, and when exerted, kill them with spirit, then pour off the spirit and water and refill with pure glycerine, till I have time and opportunity of mounting them. The tentacles of the *Sertularia* or *Campanularia*, also the *Carchesium*, are preserved in that which I have by me.—*E. W. Burgess.*

NOMENCLATURE.—I think it would be much more edifying to observers at Microscopical soirées and meetings, if exhibitors followed the example set by the President of the Quekett Club at University College on Friday the 29th of April, that is, that after placing the name of the object he had under the microscope, on a card he gave the

Class
Order
Genus

I may mention he added a drawing of the object, but this might be expecting too much from most people. I am quite sure that many people at soirées do not know whether they are looking at animal, vegetable, or mineral; they see a long name, say "How pretty!" and pass on. I think that exhibitors should give more information for "casuals."—*H. K. Warrington.*

ZOOLOGY.

THE PHYSIOLOGICAL UNITY OF PLANTS AND ANIMALS.—Professor Boulger, F.L.S., F.G.S., recently delivered a lecture on the above subject before the Sunday Lecture Society. Professor Boulger showed the parallelisms existing between plants and animals, and how plants and animals are identical in their ultimate chemical constituents. Professor Boulger directed attention to the striking analogies between the higher forms of both groups, showing how closely related are the three main physiological functions, nutrition, relation and reproduction. The function of respiration, subsidiary to nutrition, is absolutely identical in both groups, i.e. oxygen is inhaled and carbonic acid exhaled, the ordinary assimilation of carbon from the atmospheric carbonic acid, not being respiration in the physiological sense of that word. The function of nutrition at first sight seems to be entirely contrary; in the two groups, animals being unable to build up the complex compound of which they consist, from inorganic materials. This contrast does not, however, hold universally. Fungi, and all parasitic plants depend, in a great measure, on food already assimilated, and the other plants termed carnivorous may in many cases be said to have true digestive organs, which bear comparison with those of the higher animals. The functions of relation are motion, sensation, and nervousity. Some few animals lose the power of motion from place to place, a power only possessed by the lowest plants. The higher plants, however, in many cases possess as much power of relative power, as many animals, such being circumnutation, the irritability of stamens, the revolving motion of tendrils. Motion is also effected by pseudopodia in the myxomycetes and other thallophytes, as much as in the lowest animals, and by

cilia in somewhat higher members of both groups. Muscles are as absent in the protozoa as in plants. Most physiological definitions of sensation presuppose the existence of nerve-ganglia. These occur in no animals lower than the jelly-fish; yet most naturalists would rather look at protoplasm as a diffused nerve-matter. Would not, then, the instantaneous reaction of the secretion in *Drosera*, its becoming acid, be classed as one with animal sensation? The presence in the leaf of a normal electric current similar to the one in the human muscle, the deflection of which when the "vibrissæ" are touched, causes the leaf to coil up and enwrap the insect, is also cited. The different ways in which the function of reproduction is performed, are all parallel, namely, fission, gemmation, and ovulation. But in sexual reproduction, the most striking parallelisms occur.

"THE SEALS AND WHALES OF THE BRITISH SEAS." (London: Jarrold & Sons.)—Under this title Mr. Thomas Southwell, F.Z.S., hon. sec. of the Norfolk and Norwich Naturalists' Society, has republished, with considerable additions both in text and plates, the admirable essays on the subject which appeared from his pen a few years ago in the pages of SCIENCE-GOSSIP. We know of no other naturalist who is better capable of dealing with this subject than Mr. Southwell, and those of our readers who enjoyed his papers will hasten to obtain this handsome volume. Mr. Southwell has dealt with this subject just in time, for we fear that a few years will see the end of many of the species here figured and described. A great deal of research is brought to bear respecting the natural history of a very interesting group of marine animals, whose life-histories and habits are here very charmingly described.

GROSBEAKS.—*Loxia coccothraustes* or *Coccothraustes vulgaris*, mentioned in the April number as of rare occurrence in England, is occasionally seen in this neighbourhood. One was shot while in the act of eating cherries, June 26th, 1878, the head and wings of which are in my possession. Morris says, "it is said to depart again in April," having arrived at the beginning of winter. Sterland, in his "Birds of Sherwood Forest," says that it "doubtless breeds with us." The close season of the Wild Birds Preservation Act will, it is to be hoped, increase the numbers of our rare visitors, and so tend to prevent their otherwise probable extermination.—*John N. Dufy, F.G.S., Tuxford, Notts.*

ISLE OF MAN NATURAL HISTORY AND ANTIQUARIAN SOCIETY.—The annual meeting was held at the Rectory, Ballaugh, 5th April, 1881, the Rev. W. Kermod, Rector of Ballaugh, in the chair. The Rev. T. Talbot was elected President for the ensuing year. The chairman spoke of the importance of recording and determining the origin of our

place-names before they were lost. The Rev. E. B. Savage read a paper on "Notes on the Parish Register of Kirk Michael, Isle of Man." Among many new and interesting specimens exhibited, were the remains of some cinerary urns from the neighbourhood, on which the chairman gave some interesting remarks. They were of small size, simple designs, and appeared very ancient. There were also exhibited some stone implements found in the neighbourhood.—*P. N. C. Kermod, Hon. Sec.*

RANGES OF LAND SHELLS.—A few months ago, among a packet of shells received from Clifton, I found some named *Z. cellarius*, v. *major*. This I immediately recognised as *Zonites lucidus* (Drap.) a common shell here. I was therefore much interested in the note on this shell in your April number, and I think the following remarks may interest other conchologists. The English specimens are exactly the same size as the finest Mentone ones, but the latter differ in having the spire flatter, the suture deeper, the colour darker, and the striæ fainter. Neither the English nor the Mentone shells attain the size of that figured by Moquin-Tandon. On referring to this writer's "Histoire naturelle des mollusques terrestres et fluviatiles de France"—the standard work on the subject, I find the following particulars. Draparnaud, in his "Tableau des mollusques terrestres et fluviatiles de la France," 1801, described the species in question as *Helix lucida*. Beck, in the "Index molluscorum præsentis ævi, musæi principis augustissimi Christiani Frederici," 1837, described it as *Helicella Draparnaldi*. Therefore Draparnaud's name ought to have the precedence. Moquin-Tandon describes it as a distinct species, but observes in a note that he suspects it to be only a southern variety of *cellarius*. He distinguishes *lucidus* chiefly as being larger, and also as having the spire more convex, the last whorl increasing more rapidly, and the mouth being more oval and more oblique. Now it seems to me that the first characteristic is simply the consequence of a more genial climate—you observe that the three localities given by J. Fitzgerald are all noted for their mild winter; the second distinction cannot be relied upon, for I have found specimens as flat as and flatter than the typical *cellarius*, and I expect the third, fourth, and fifth would on examination prove equally fugitive. This shell is stated to range as far north as Lyons and the Jura, and to inhabit the south of France and Corsica. *Z. cellarius* is not the only British shell which increases in size as it wanders southward, for I find here the variety of *H. ericetorum*, called *H. cæspitum* (Drap.) by the French "splitters;" double the size it reaches at home, and a large southern form of *Cyclostoma elegans*, named *C. Lutetianum* by Bourguignat. So I would suggest that the new British form discovered by J. Fitzgerald should be called *Zonites cellarius*, var. *lucidus*.—*Charles Hedley, Mentone.*

LARUS ATRICILLA v. LARUS RIDIBUNDUS.—T. S. in SCIENCE-GOSSIP for May is somewhat severely down upon the authors of the mistake in naming the gull killed in the neighbourhood of Newmarket recently; but in giving the Latin synonyms of the Laughing Gull and the Common Blackheaded Gull he makes the mistake of calling the former *L. atricilla*, and the latter *L. ridibundus*.—*J. D.*

ENTOMOLOGICAL SOCIETY OF THE PROVINCE OF ONTARIO.—We have received the Annual Report of the above society. It contains, in addition to the president's (Mr. W. Sander) annual address, many valuable papers, dealing not only with entomology as a general science, but chiefly in its relation to agriculture. Papers treating of the chief pests, and insect attacks of the last year, on the ants, migratory insects, &c., are to be specially mentioned.

A NOVELTY AT THE ZOOLOGICAL GARDENS.—It is with much pleasure we call attention to the new building established by the Zoological Society for the exhibition of insect life in its earlier stages, and called "Insectorium." A great variety of all orders of insects in the larval and pupal form is already collected for public exhibition.

OCCURRENCE OF CAPROS APER (THE BOAR-FISH) AT EASTBOURNE.—Four specimens of this interesting visitor have recently come under my notice, having been taken on the shore here; in three cases alive.—*C. F., Eastbourne.*

BOTANY.

TERATOLOGICAL NOTES.—I have noticed for several seasons that flowers with an abnormal number of organs are especially frequent in the common primrose (*P. vulgaris*). The most common departure from the normal form is a flower having calyx and corolla six-parted. Specimens of this form I have met with during each of the last four or five seasons; but in looking over, at this moment, a bunch of blossoms brought from Morse's Wood, Leith Hill, I have obtained a more interesting collection. From less than 50 flowers I picked out 4 distinct forms. No. 1 possesses a 3-lobed calyx, and a 4-lobed corolla; stamens 4. No. 2, calyx 6-lobed, corolla 6-lobed. No. 3, calyx 4-lobed, corolla 6-lobed, stamens 6. No. 4, calyx 8-lobed, corolla 7-lobed, stamens 7. No doubt a careful search among the growing plants would give a greater variety still. In March 1880 I obtained two specimens of *Crocus vernus*, which have the perianth 8-lobed, stamens 4, of which 2 are aborted. In the following month I found a specimen of the daffodil (*Narcissus pseudo-narcissus*), in which the scape was 2-branched at the summit, each branch bearing a flower. One of these was of the normal size and form, and had the orthodox number of

divisions in the perianth, but the other was smaller, and had perianth-leaves 4, corona 4-segmented, stamens 4, stigma bi-lobed. From these few instances it will be seen that there is a good field for the monstrosity-hunter among our common spring flowering plants.—*E. Step.*

"THE BRITISH MOSS FLORA."—Dr. R. Braithwaite, F.L.S., has just issued part iv. of this admirable work, in which the family Fissidentacea is described. It is illustrated by three beautiful plates. The price of the part is three shillings.

IN taking a walk some time ago near Totnes I found a double primrose (*Primula veris*). The calyx was 10-toothed, the limb of the corolla 10-lobed, the tube not quite round; ten anthers, all perfect; two ovaries, two styles and stigmas. The flower was rather large, the peduncle was somewhat flattened at the top. I should be glad to know if any readers of SCIENCE-GOSSIP have met with it.—*E. Bally, Totnes, South Devon.*

A DICTIONARY OF ENGLISH FOLKLORE.—Our old correspondent Mr. James Britten is engaged, with Mr. G. L. Gomme, upon a work which will bear the above title. He will be very grateful to any of our readers for assistance in this, or in the Dictionaries of Plant and Animal names upon which he is engaged for the English Dialect Society. His address is 3, Gumley Row, Isleworth, Middlesex.

GEOLOGY.

THE MICROSCOPIC STRUCTURE OF DEVITRIFIED ROCKS FROM BEDDGELERT, SNOWDON, AND SKOMER ISLAND.—A paper on this subject has just been read by Mr. F. Rutley, F.G.S. The first specimen described was found about a quarter of a mile from Beddgelert, on the Capel Curig road. Examined microscopically, it showed traces of perlitic structure, with small spherulites, both isolated and in bands, not exhibiting radial structure, but apparently composed of very minute chlorite and a garnet, probably spessartine. Hence the rock must be a devitrified obsidian or pitchstone. The second specimen is a banded greenish-gray "felsstone," at Clogwyn du'r Arddu, of Bala age, which also has probably been vitreous. The third specimen, from near Pont y Gromlech, is a schistose felsitic rock. This was compared microscopically with an obsidian from Hungary and a rhyolite from Gardiner's River (N. America), and was shown to have been probably once a glassy rock. In conclusion the author discussed the limits of the terms felsstone, rhyolite, trachyte, and obsidian. An appendix was added upon the microscopic characters of some rocks from Skomer Island, off the coast of Pembrokeshire. These were shown to be devitrified obsidians, some of them exhibiting spherulitic and perlitic structures.

EOZOÖN CANADENSE.

Is it a fossil or only a stone?
 A difficult question to answer I own;
 First found by Logan—the subject of strife—
 Dawson and Carpenter brought it to life.
 Was it, oh, was it the chambered abode
 Of animal jelly, or living sarcode?
 Protruding itself through shell nummuline
 In young pseudopodia? Oh, it was fine;
 In form so perfect it filled with surprise—
 This foraminifer of wonderful size!
 'Twas no use to doubt, they cut up so rough
 And air'd their authorities, this was enough.
 Though you felt in your secret heart it was stuff.

Carpenter, F.R.S.—not a mechanic—
 Stuck to his guns—it was surely organic.
 Two Galway professors, King and Rowney,
 Held just as stoutly 'twas merely stony.
 And under the microscope could divine
 Nothing but calcite and green serpentine.
 Vitruvius “ophite”—a very good name!
 Oh! fighting it was for truth or for fame!
 Cracks meant “canals,” the “nummuline layer”
 These pundits thought was not at all clear;
 “Asbestiform,” or something or other
 It was—one word 's as good as another
 To the unlearned public, who thought it odd
 Such strife should be stirred by extinct Rhizopod.

At last, as some thought not one whit too soon,
 The world scientific killed *Eozoön*,
 So sing those savants who can see by us
 Or through the eyes of Monsieur Mœbius.
 The creature of Dawn got its quietus
 When he to the last discourse did treat us.
 So geologists now will merely just mention
 This fossil *extinct* found in the Laurentian.

A. Conifer.

SEA-BEACHES ON HILLSIDES.—At a meeting of the Geological Society of London, Mr. D. Macintosh, F.G.S., gave a sketch of the progress of discovery connected with the Moel Tryfan deposits. He then described certain phenomena connected with these deposits, to which little or no attention has been devoted by other observers. After identifying the local stones and indirectly local erratics, he traced the derivation of the far-travelled erratics which came from the N. and N.W. He drew particular attention to an extensive exposure of slaty laminæ, the edges of which have been bent by a force assailing the hill from the N.W.; and as these edges have been shattered so as to form parcels of slate-chips covered by, or rolled up in laminated sand, along with parcels of clay, he endeavoured to prove that a stranding of the floating ice which must have brought part of the erratics (including numerous chalk-flints), will alone account for the phenomena. After describing patches of gravel and sand in other

parts of Carnarvonshire, referring to the Three-Rock Mountain deposits in Ireland (which must have come from the N.W.), and briefly noticing the drifts on Halkin Mountain, Flintshire, he entered upon the main subject of his paper, namely the discovery of an extensive series of marine drifts, including (besides deposits on flat ground) about twelve hillocks or knolls, consisting of rounded gravel and sand, and, in at least two instances, containing gravel-pits with numerous shell fragments. They extend along the east side of the northern part of the mountain-range which runs between Minera and Llangollen Vale, and are situated at levels between 1100 and 1300 feet above the sea. The gravel is largely made up of rounded Eskdale-granite pebbles, and during his last or fourth visit to the district, he found a large granite boulder on the axial summit of the ridge, about 1450 feet above the sea, showing a submergence of the mountain to at least that extent. He went on to assign reasons for believing that the sea lingered longer at the level of the sand and gravel knolls than lower down and higher up, so as to allow time for the extra rounding of the pebbles, accumulation of erratics, and multiplication of Mollusca; for he could discover no reason for supposing that the mollusks which left the shells did not live on or near the spot in the littoral or sublittoral zone. He then described a small exposure of high-level rounded gravel and sand near Llangollen, and dwelt on the remarkable fact that the marine deposits on Moel Tryfan, Three-Rock Mountain (Ireland), Minera Mountain, and in Macclesfield Forest, occur at about the same altitude above the sea-level. After proposing a provisional classification of the drift-deposits of North Wales and the Pennine hills into zones, showing probable variations in the rate of submergence, he concluded by discussing the question whether the submergence was caused by the subsidence of the land or the rising of the sea, without venturing to express any decided opinion on the subject, but inclining to the former idea.

PROCEEDINGS OF THE GEOLOGISTS' ASSOCIATION.—Part I. of vol. vii. of the proceedings of the above association contains, amongst other matter, the following: Address by Professor T. R. Jones, F.R.S., &c., at the opening of the session, 1880-81; papers on “Some Recent Researches among Pre-Cambrian rocks in the British Isles,” by H. Hicks, Esq. M.D., F.G.S.; “The Zones of the Chalk,” by Professor Morris, F.G.S., &c.

GOLDFISH.—Those of your readers who keep goldfish may be glad to hear that they are very fond of frog spawn, and eat greedily the common hornwort, *Ceratophyllum*. These fish, in order to be kept in good health, require plants growing in the aquarium, and to be fed occasionally on small red worms.—*S. A. Brennan, Clk., Allan Rock, Co. Tyrone.*

NOTES AND QUERIES.

ANECDOTE OF A DOG.—The following happened not long ago at Shiveloung, in the Mongwa district of this province. Major G., the deputy commissioner, Mr. M., the assistant commissioner, and Mr. P. H., the director of public instruction, were strolling along the river bank when a pariah dog ran up to Mr. H.'s Newfoundland dog, and both began to growl at each other. The pariah being disposed to show fight, the Newfoundland gradually, and in the most calm and deliberate manner, edged the pariah down the bank and into the water. He then swam round the pariah whose head he "ducked" under the water every time the drowning dog came to the surface. And this the Newfoundland continued to do until the poor pariah was drowned. The above was told to me by Mr. M., the assistant commissioner, who saw the whole process.—*Arthur Hough, Prome, British Burma.*

BIRDS DURING WINTER.—Acting on the suggestion of Mr. Charles J. W. Rudd, in *SCIENCE-GOSSIP* of April last, I have sent you a list of the birds seen to visit, and receive food in my little garden at Fulham, during the severe weather in January last: blackbirds, thrushes, redwings, starlings, chaffinches, one robin, also the large and small blue-tits. Our method of feeding was first to remove as much snow after each fall as was considered necessary, then to scatter the crumbs of bread, potatoes, all bones of fresh meat and such-like refuse of each repast three times daily. Should more be needed, which was very frequently, bread was broken up into pieces of about the size of walnuts, as we found when broken up into fine crumbs, much was lost in the interstices of the snow. There is another advantage gained by it, it prevents fighting, which often takes place, especially if robin-redbreasts be present. Many often take their choice pieces to some retired corner to enjoy their share at leisure and in peace, scraps of toast, bread (buttered of course) were much sought after. Seeing this, we often cut up fat to give them with their other food. One great drawback to the enjoyment of the few birds we have left us is the large number of homeless cats always prowling about for food. The sparrows do not mind them, but they are a great scare to other birds who only visit us occasionally.—*J. H. M.*

EARLY SWALLOWS.—A friend of mine writing to me from Staffordshire on March 21, says: "To-day I was several times covered with snow, and saw two swallows take refuge in the station (railway) at Madeley. The porter very thoughtlessly turned them out into the cold." Is not such a circumstance worth putting on record? Is it possible these two little creatures crossed the stormy ocean thus early in 1881? Or does it not favour the view—the oft-reiterated view—of White, in his "Selborne," that some of the Hirundines pass the winter in this country in a torpid state, from which they emerge by the influence of fine weather? Such weather we had enjoyed for several days prior to the 21st. P.S. No Hirundine seen in this locality yet, March 28th, 1881.—*John E. Stephens, Southampton.*

EELS.—One morning in the month of August last, when two fishermen in Upper Lough Erne commenced their usual task of examining their eel lines, which they had set the previous evening, they found entangled on one of their hooks an old boot. This they disengaged and carelessly threw into their

"cot" (or flat-bottomed boat). What was their astonishment a few minutes afterwards to see emerging from the boot, an eel?—*J. H. M.*

THE HEN-HARRIER.—A fine specimen of this species (*Circus cyaneus*) was shot on the 19th of last January (the day after the memorable storm) on Rushmere Heath near Ipswich. The wing only had been injured, and it can now fly about its place of confinement. The present specimen has its legs, toes, and base of the bill a bright yellow, the eyes brown, the plumage a reddish-brown varied with buff, and the rump white. I should be glad to know how to tell whether it is a female or a young male. The authorities I have consulted vary as follows, and therefore do not help me much: Gould gives the irides of the male brown, and of the female hazel, but in the plate the irides of both are coloured yellow. Morris gives the iris of both male and female yellow, and of the young bird dark brown. Yarrell, the irides of the male yellow, and of the female and young bird reddish-brown. I should also be glad to know of any marked difference in Montagu's harrier as compared with the hen-harrier. I have (presumably) a hen-harrier in my collection which is smaller than the living specimen mentioned above, especially the legs and toes; the face from the eye to the end of the beak is also much shorter, but it has the white rump, which an old bird-stuffer once told me was the distinguishing feature of the hen-harrier.—*Hugh Turner.*

STRANGE APPEARANCE OF A RAINBOW.—The following remarks are upon a rainbow, seen by me at Ballaugh, 28th of February; about 2.10 P.M. when first observed, duration about twenty minutes. The afternoon was fine, sky quite clear, sun shining brilliantly, wind northerly. I had some difficulty in making any good observation, owing to the strong effect of the sun's light. The rainbow was situated almost overhead; its centre would, as well as I can guess, be directly over me—the shape was a crescent, or somewhat resembling the blade of a sickle, as one point, the northern, was a little shorter than the other, the southern. The curve was towards the sun. Between this bow and the sun was a second, but very faint in colour and outline, and evidently a reflection. As before stated, the bow was seen on a blue sky. I could not perceive any cloud. All I could make of it was the small sickle-shape of various colours, which were not so brilliant as when backed by a rain-cloud, but were very beautiful. In a few minutes I noticed a change; the colours faded, and where I had seen nothing but blue sky, it became covered with a mist which soon took the form of a cirrus cloud. The rainbow had now disappeared, except that one end or edge of the cloud (the part nearer the sun) still retained a portion of the colour. The cloud slowly moved south, and the rainbow dispersed.—*F. K. Walton.*

VORACITY OF A PYTHON.—The following recently happened at the public gardens at Prome, where three pythons are kept in a cage. The smallest python seized a rat and proceeded to swallow it head first. Upon this, another and much larger python seized the tail end of the same rat. The swallowing process on both sides went on, but the larger snake completely overwhelmed his antagonist (about 6 feet long) and swallowed him. The keeper then appeared just in time to take hold of about four inches of the tail of the unfortunate snake, the rest of whose body was inside that of his conqueror. A man held the tail of the large snake, another pulled at the bit of tail which

dangled out of the mouth of the large snake, and a gentle but continuous pull soon separated the animals—the smaller one, rat and all, was withdrawn from the stomach of the larger one. A few dashes of cold water and then a warming in the sun soon revived the small snake, which appeared to be exhausted, and he then finished swallowing the rat, to which he had held on with remarkable tenacity.—*Arthur Hough, Promé, British Burma.*

GNATS AND THE FROST.—The interesting little dipterous insects ranged under the general term, gnats, are among the few flies that live through the weary winter months, concealed from view, and only brought to light in full activity whenever the sunshine tempts them from their safe retreat. At the end of autumn they bestir themselves to secure suitable winter lodgings, taking good care that the situation be such that they can emerge without delay, when a flood of sunshine, an increase of warmth, or drizzling rain succeeded by moist, warm weather, indicated that their health might be improved and their little frames strengthened by a hasty dance in the pure winter air. So far as I have observed, their hybernacula consist in the crevices in old walls and in bark of trees; beneath ledges in palings and buildings, cellars and out-houses; and among moss growing on walls and such-like places. Your correspondent, Mr. W. Goodwin, took *Tipula plumosa* so early as January 22nd last; I saw gnats playing about in the sunshine, on January 31st, i.e. the first time this year. Gilbert White in his excellent calendar gives January 6th as the earliest date of his observing these merry little flies. The life-history of gnats in general is well known, at least the broad facts of their mode of metamorphosis; at the present time the larvæ, in various stages of development according to the species, are exceedingly plentiful in the mud of ponds and ditches. I believe that dipterous larvæ, especially the smaller kinds, when found in the water taken from ponds for microscopical examination are frequently passed over as worms—i.e. true worms of low organisation. A little attention, however, to the structure of the so-called worms in question will at once reveal the distinctive characteristics of insect larvæ, and it is quite astonishing how large a number of distinct species may be obtained from any pond by a single dip of the net. These larvæ, it may be remarked, form beautiful objects for the microscope, for being so small and transparent, the wondrous operations of their internal mechanism may be easily watched. It is much to be regretted that no popular handbook in English exists (that I am aware of) on the Diptera—a much more interesting order of insects than is generally thought. True, it is a troublesome group to entomologists, but then there are so many extremely common and well-defined species of flies that a small treatise on their habits and structure would, I believe, be very acceptable to the reading public.—*C. Francis Young.*

INCUBATOR FOR PUPÆ.—Could any of your numerous readers give me a few hints as to how to make, at a moderate cost, a sort of incubator for pupæ of Lepidoptera, how long it generally takes, and what temperature should be continually kept up? Any information will oblige—*A Beginner.*

DIATOMS IN OYSTERS.—I purchased a tin of Thurber's oysters, and in them I found a quantity of most beautiful diatoms quite different from anything I had ever seen before. Will any of your readers kindly inform me what kind they would most likely be?—*R. Jones.*

DISAPPEARANCE OF SKYLARKS.—In addition to the causes enumerated by correspondents to account for the scarcity of skylarks, I think the epicures of the metropolis are not guiltless in the matter. Last winter every poulterer's shop, the "Stores" included, contained hundreds, in some cases thousands, of these beautiful songsters. Who eat skylarks? I, for one, do not envy the feelings of the gastronomist who could be guilty of such an enormity.—*W. T. G.*

SCARCITY OF SKYLARKS.—I am afraid that the scarcity of skylarks may be accounted for by other means than by the agency of starlings. In numbers of poulterer's shops in London may be seen quantities of larks deprived of their plumage and strung up. They are sold at about 1s. to 1s. 6d. a dozen. Think of the number of poulterer's shops in the metropolis, and that in every shop there are from two to three hundred of these little birds on view each day! Is it any wonder that larks should yearly decrease in numbers, not only around London but throughout the country? These birds may not be all larks; there are robins, finches, linnets, and others of our little feathered friends murdered wholesale in this way. One can hardly tell their species, because they are all deprived of their feathers; but I think, that, with such wide-spread destruction before our eyes, there ought to be something done to prevent the sale of these tiny birds.—*P. S. Taylor.*

STARLINGS AND SKYLARKS.—I think the evidence thus far brought against the starling causing the destruction of the eggs of the skylark is weak and unsatisfactory; and several of your correspondents have given other reasons far more probable. Unless the bird can be taken in the act, it is unjust to lay such heavy charges against it. The nearest approach to a proof is the case mentioned by Mr. R. Standen, in which a flight of starlings arose in the vicinity of a lark's nest, and the eggs were found to be broken. But this is far from conclusive, as there is no evidence that the eggs were broken by the starlings. I cannot but think that if the starling were really guilty of such a misdemeanour, cases would long ago have been brought to light. I believe the real causes of the decrease of skylarks in certain parts, may be found in the enclosure of waste land, and its conversion into pasture-land; increase of the number of cattle grazing therein; brush and other methods of harrowing, in order to spread the manure; and last, but not least, the large numbers of birds annually captured by bird dealers for cage birds. But in the neighbourhood of Northallerton (N. Yorks), I do not find any appreciable decrease in their numbers; but rather the reverse, as last year I found more nests of this species than in any season before. At the same time, starlings were never more abundant than now; every old tree having one or more nests in it. I once found four pairs breeding in the same tree; and a gentleman's gardener, upon whose truthfulness I can rely, told me that last summer he destroyed over two hundred starling eggs in his pigeons'-cote, in one day. He gave as his reason a commonly-believed idea, that they destroyed the eggs of the pigeon. Yet although they were so numerous, he confessed to not having found any sucked eggs. If the starling does any injury to the cote, it only arises from its taking up the nesting-holes to the exclusion of their rightful owners.—*J. A. Wheldon.*

QUERY AS TO LARVÆ.—The larvæ mentioned by C. H. are evidently those of beetles, possibly one of the chafers, from the short description given.—*C. F., Eastbourne.*

SCARCITY OF BIRDS IN SPRING.—I beg to announce the scarcity of birds here this spring; blackbirds, thrushes, redbreasts, wrens, hedge-sparrows and bullfinches, seem especially to have suffered from that fearful weather in January. I have as yet found only one blackbird's nest, and two song thrushes'; a long-tailed titmouse's nest yesterday contained nine eggs. I have also found a red linnet's nest ready for eggs, and a greenfinch's. Golden-crested wrens are more numerous than I have ever known them to be here before—willow warblers were here on the 9th—I heard a nightingale on the 13th, and several on the 14th. On the 12th I saw a pair of redstarts; and a male blackcap on the 16th, and this evening I have seen three swallows, hibernated specimens of the "small tortoiseshell," "sulphur" (all males) and "peacock" are very abundant. I have also seen one "large tortoiseshell" (polychoros). I have seen several vipers about, they may be seen in March, if the weather be warm, and as late as the middle of October. Vegetation is backward. The birch (*Betula*) is bursting into leaf, and the whitethorn, the wild cherry is in bloom, and horse-chestnuts most forward of trees.—*G. Dewar, Doles, Andover.*

BIRDS AND FRUITS.—I just wish to add a little to what your correspondent, W. D., says in your February issue (p. 45) under this heading. White, in his "Natural History of Selborne," says, in the fifteenth letter to Mr. Pennant, "I have remarked for years that the root of the cuckoo-pint (*arum*) was frequently scratched out of the dry banks of hedges and eaten in severe snowy weather. After observing with some exactness myself, and getting others to do the same, we found it was the thrush kind that searched it out. The root of the *arum* is remarkably warm and pungent." I think this bears out W. D.'s statement a little. They probably eat both the root and the berries.—*C. F. Worters, Grafton House, Forest Hill.*

PIGEONS FEEDING ON TURNIP-ROOTS.—As your correspondent, G. Dewar (see SCIENCE-GOSSIP for February last, p. 47), appears to doubt that pigeons and doves eat the bulb of the turnip, I wish to state my experience on the subject, with a view to elicit facts from others towards the settlement of the question. Some eight or nine winters ago I was staying at a farm on Laindon Hills, Essex, and had a good opportunity of watching a turnip field of a few acres in extent, the crop on which was being considerably damaged, as every one on the farm was persuaded, by a flock of common wood pigeons (*Columba palumbus*). That the birds ate the root of the turnip as well as the leaf there seemed little room for doubt, for though I never actually observed a pigeon pecking at the bulb of a plant, yet the bulbs were in numberless cases scooped out in such a manner as could be ascribed to no other agency but the beak of a bird. I feel quite convinced that the pigeons fed on the roots, and this they did, not by necessity, but by choice, for there was plenty of leaf remaining on the turnips, and no scarcity of other green food. For instance, as soon as any one appeared in the turnip field with a gun, the pigeons would betake themselves to a clover ley at the foot of the hill, and they fed off the clover almost as clean as sheep would have done.—*G. B.*

WEASEL OR STOAT.—The stoat (*Mustela erminea*) commonly, if not invariably, goes by the name of weasel in Ireland, whereas the true weasel, *Mustela vulgaris*, is believed by naturalists to be rarely, if ever, found in the country.—*John Galcombe.*

WEASEL OR STOAT.—In Vol. 4 of "Natural History of Ireland," Wm. Thompson writes: "The Weasel (*Mustela vulgaris*). I have never met with this animal in Ireland, nor do I consider that the species has yet been satisfactorily proved to be native, although it may be so. The "stoat," which passes under the name of *weasel* in this country, is common throughout the island. In the counties of Antrim and Armagh I have frequently during the last thirty years obtained and examined specimens of the stoat, but I never met with an instance of a weasel. The stoat or ermine has lately changed its scientific name, being now called, according to Dr. Duncan in "Cassell's Natural History" (vol. ii.) *Putorius erminea*.—*H. W. Lett, M.A.*

HAWFINCHES.—In reply to Mr. Parkinson's note on the Hawfinch, I may state that this bird is not so rare in England as he thinks. Their nests are found nearly every year in the neighbourhood of Hitchin, Hertfordshire. During the last few years I have found five nests, and have known two others taken by village lads. I have also found their nests in Huntingdonshire.—*G. J. Buller, Hitchin.*

NOTES BY A NATURALIST IN MAURITIUS AND GREAT BRITAIN.—Occurrence of *Helix aspersa* in Mauritius. Mr. Power will find record of this occurrence in Pike's "Subtropical Rambles," page 213. This reference is to the Moka district. I have also found specimens in Plaines Wilhems, and, if my memory serves me, near Vacoas, not far from the Tamarind Falls. Had Mr. Power consulted Mr. Bewsher, of the Oriental Bank, Mr. Caldwell, or other collectors in the island, I do not fancy he would regard the occurrence as remarkable.—*H. H. S.*

BREEDING FOREIGN BIRDS.—I shall feel obliged if the writer of an article on "Breeding Foreign Birds" will kindly let me know the best place to obtain (purchase) the birds to which he refers.—*M. Pullar.*

POISONOUS HERBS.—The idea that *Aethusa Cynapium* is poisonous will not hold good after Dr. Harley's experiments on this herb. A short summary may be interesting (for a full report see an article in "St. Thomas's Hospital Reports," vol. x., reprinted in "Pharmaceutical Journal," 27, 1880). He, after expressing the juice of plants before flowering and when in green fruit, says, "Being thus provided with carefully prepared juices of the young plant in its most succulent condition, and of the same generation of plants in their fully matured condition, I exhausted my supply upon four patients: one, a little girl six years old, who took them in quantities ranging from two to four fluid ounces; and two other adults who were the subjects of spasmodic torticollis. These two took one or other of the juices, ranging from one to eight fluid ounces. Effects were carefully looked for, but there were absolutely none in either case after any one of the doses. Further detail is superfluous, and I may say in conclusion that the *Aethusa Cynapium* of Sussex, Kent, Surrey, Essex and Hertfordshire, is not only absolutely free from the noxious properties attributed to it, but that it is pleasant all, to sight, smell, and taste, and in the absence of the more fragrant and succulent plants might well be used as a pot-herb or a salad. If any one should think differently of the plant of his locality, I will be ready to indulge his scruples, to test the matter with him, and satisfy him, as I have no doubt I shall be able to do, that my conclusions are independent both of locality and season, and that the only influence

which these conditions have on fool's parsley, as on hemlock, is to increase or diminish its succulency."—*F. W. E. S.*

DYTISCUS MARGINALIS.—For some time during the past summer I kept the larva of one of these creatures. It was exceedingly fierce, and would fight a piece of stick or anything else that was put into the glass it was kept in. On one occasion it caught my finger and drew blood from it with its powerful jaws. I fed it on raw meat which it worried as a cat does a mouse. But it was troubled by a hairy mould about $\frac{1}{4}$ inch in length. Could any of your correspondents tell me what caused this?—*J. A. C.*

CONTRAST BETWEEN THE COLOURS OF FLOWERS AND FRUITS.—Mr. Saunders seems to think that the two classes of creatures, insects and birds, are attracted to plants by two prevailing tints. One can easily understand the advantage derived by plants whose brightly-coloured flowers attract insects, because the visits of the latter ensure cross-fertilisation. But I fail to perceive the benefit accruing when birds are attracted by another kind of colour to consume the fruits and seeds, for in that case I should have imagined the chances of the plant being able to perpetuate itself would be considerably diminished. Does Mr. Saunders mean to infer that the seeds or fruits which are most liable to destruction are subject to the least competition among themselves, and therefore those which are not destroyed stand a better chance of being perpetuated? Or does he think the seeds which are eaten are not necessarily digested, but being cast out with the feces, are in a good position to be sown and manured at the same time? An answer to the first question in the affirmative might be correct to a great extent, but the suggestion conveyed in the second question, I believe, has been frequently tested by experiment (see chapter on Geographical Distribution, Mr. Darwin's "Origin of Species") and has held true only to a very limited degree. My view of the contrast of colour displayed between flowers and fruits would have been, that whereas in the former it attracts insects (or birds), in the latter it acts as a protection. Hence the variety of brilliantly-coloured seeds compared with those of a more sombre hue would, in my idea, render the majority of them less conspicuous, and thus tend to counteract the exterminating effects accompanying the depredation of small birds.—*John Hanson.*

NOTICES TO CORRESPONDENTS.

TO CORRESPONDENTS AND EXCHANGERS.—As we now publish *SCIENCE-GOSSIP* earlier than heretofore, we cannot possibly insert in the following number any communications which reach us later than the 8th of the previous month.

TO ANONYMOUS QUERISTS.—We receive so many queries which do not bear the writers' names that we are forced to adhere to our rule of not noticing them.

TO DEALERS AND OTHERS.—We are always glad to treat dealers in natural history objects on the same fair and general ground as amateurs, in so far as the "exchanges" offered are fair exchanges. But it is evident that, when their offers are simply disguised advertisements, for the purpose of evading the cost of advertising, an advantage is taken of our *gratuitous* insertion of "exchanges" which cannot be tolerated.

G. WRIGHT.—Yes. Cassell's "Natural History" is much better than the work you mention, which entails reading a text that is frequently erroneous and nearly always unscientifically arranged, and then the foot-notes, which usually contradict or set the text right. Human life is too short for so roundabout a way of acquiring knowledge.

H. M.—See paragraph in our May number respecting the occurrence of diatoms in the Coal Measures.

B. Hook wishes to know of a good means of whitening small bones of birds, &c.

LEPIDOPTEROUS NAMES.—In answer to J. P. the authors are 1-9 Linnæus, 10 Scopoli, 11 Ochsenschleimer, 12 Ochsenschleimer, also Hübner.

J. O.—Most water contains a certain amount of lime, either as the carbonate or the sulphate. Now it is well known that water holding salt in solution freezes at a very much lower temperature than pure water, as may be seen from sea water, which contains sodium chloride. The water is boiled to get rid of the carbonate of lime (boiling does not affect the sulphate), and so freezes sooner than it would do if the lime were present. Boiled water is often used by chemists for this reason, when distilled water cannot be got.

J. P. requests the authors of the names of some Lepidoptera. The following list is to be found in Morris's "British Butterflies": 1 Boisduval, Godart; 2 Linnæus, Lewin, Donovan, Harris; 3 Schrank, Latreille, Boisduval, Zetterstedt; 4 Schrank, Latreille, Boisduval, Stephens, Curtis, Duncan; 5 Schrank, Latreille, Boisduval, Zetterstedt; 6 Latreille, Boisduval, Duponchel; 7 Latreille, Boisduval, Duponchel; 8 Godart, Hubner, Latreille, Meyer; 9 Fabricius, Stephens, Curtis, Duncan, Westwood; 10 Stephens, Curtis, Duncan, Westwood, Wood, Latreille, Jermyn; 11 Stephens, Curtis, Wood, Duncan, Westwood; 12 Stephens, Wood, Duncan, Westwood, Jermyn.—*H. K. P.*

H. LAMB.—Your specimen is a white variety of *Geranium molle*.

J. A. WHELDON.—Apply to No. 3, St. Martin's Lane, Trafalgar Square, for regulations of Botanical Exchange Club.

E. H. SMITH.—Obtain one of the half-holiday handbooks called "Geological Rambles round London," published at a very cheap price by Marshall, Japp, & Co., London. It gives you very clear instructions, how and where to go for metropolitan geologising.

H. A. FRANCIS.—Accept our best thanks for the mounted specimens of earth. *Helicoborus viridis* is not an uncommon plant in England, although sparsely distributed.

W. W. RUST.—Hewitson's "Eggs of British Birds," in 2 vols. published by Van Voorst, gives beautiful coloured, or rather tinted illustrations of the eggs of every species of British bird.

W. H. B.—We do not undertake to return rejected MSS.

J. B.—The specimen you forwarded is not a grass but a sedge, called *Carex pulla* (variety). For instructions as to mounting, &c., read Mr. Britten's paper on "Collecting and Preserving Natural History objects," published by D. Bogue, 3 St. Martin's Place, Trafalgar Square, at 3s. 6d.

SWISS ALPINE FLORA.—The most portable general Flora of Switzerland is the "Flora Analytique de la Suisse," par P. Morthier. It has 451 pages, and measures 5½ in. by 3½. The publishers are Sandoz & Fischbacher, Paris; Jules Sandoz, Neuchâtel. Mine is a copy of the second edition, 1872. I do not know whether there is any Flora restricted to the Alps of Switzerland except those of large size with illustrations of the species.—*J. T. J.*

H. H.—In 1877 there was a new section-cutter exhibited to the Quekett Microscopical Society by Mr. H. F. Hailes, which obtained high praise for its simplicity and practical utility. Perhaps some correspondent may be able to say where this is to be obtained, and what is its cost.—*J. T. J.*

EXCHANGES.

WANTED, Newman's "British Moths," and Newman's "British Butterflies." Offered, fossil micro slides in great variety.—*A. B. C.*, Post-office, Kilwinning.

WANTED, all the back numbers of "Grevillea," bound or unbound, except the first two volumes.—*E. D. Marquand*, Hea, Madron, Penzance.

OBJECTS for marine aquaria, comprising some of our most beautiful anemones, zoophytes, algae, etc.; also several kinds of the rarer British marine shells, and other objects in natural history, land and marine. Wanted, scientific books, or instruments.—*J. Sinel*, "Bagot," Jersey.

WANTED, in fruit, species of Fissidens, all except Bryoides; also species of Phascum. Exchange of fern plants.—*Miss Ridley*, 7 Cambridge Square, London, W.

WANTED, fine chalk fossils for fine and perfectly-preserved crystals of the following: Celestine, Dolomite, Smoky, Amethystine, and other quartz; and Fluor spores of all forms and colours from Durham, Cumberland, Cornwall, Devonshire, the Hartz Mountains, and elsewhere.—*A. Butt*, Vine Cottage, Perry Vale, Forest Hill, London.

DR. MORSE'S "Zoology" (published by Kegan Paul), quite clean, for microscopic apparatus or mounted objects. Stamp for list of several other books.—*M. B.*, 49 Mortimer Street, W.

WANTED, SCIENCE-GOSSIP, 1871-1876 (inclusive). Offered Taylor's "Aquarium," Cassell's "Science for All," vols. i. ii., (vol. i. bound half Morocco), or exchange odd parts of SCIENCE-GOSSIP of above dates.—H. E. Bishop, 2 Godliman Street, E.C.

For well-mounted slides of Foraminifera from West Indies, Turkey, West of Ireland, send other good slides.—G. H. Bryan, Fitzwilliam House, Avenue, Cambridge.

I SHALL be glad to receive during the summer any good gatherings of desmids, and will return in exchange mounted specimens of the varieties received.—C. V. Smith, Carnarthen.

VOLS. iii. to viii. of the "Intellectual Observer," and vols. i. to v. of the "Student" (11 vols in all), handsomely bound, what offers?—W. M. Watts, Giggleswick Grammar-school, near Settle, Yorkshire.

WANTED, full clutches of various kinds of eggs, carefully prepared, with dates and locality. Exchange a good insect cabinet worth about £10, and other eggs; only suitable offers responded to.—W. Mark Pybus, 7 Poplar Crescent, Gateshead-on-Tyne.

VALUABLE series of geological specimens, also geological and biological diagrams offered in exchange for astronomical diagrams or photographic or microscopical apparatus or material.—E. Wilson, 18 Low Pavement, Nottingham.

WANTED, vols. 15, 24, 29, 30, 35 "Sowerby's Botany," 1st edition, Sole's "British Mints."—James Cunaock, Helston, Cornwall.

STEEL-PLATE engraving of Mr. Darwin, "Nature Series," published price 5s. Three plates by Ruskin, "Studies of Wayside Flowers," and one plate from "Laws of Fescodes," published price (together) 3s. Also Ruskin's "Frondes Agrestes," 3s. 6d. What offers? Wanted any of Mr. Darwin's works or Standard ones on botany (Hooker's or Lindley's), geology (Lyell's Student's Elementary) biology, or agriculture.—J. Watson, Old Trafford, Manchester.

WANTED, two death's-head moths for a correspondent in the U.S.A.; offered, American lepidoptera.—T. Stock, 16 Colville Place, Edinburgh.

LARVÆ of *Pomina*, *Potatoria neustria*, *Chrysothraea*, *Auriflua grossularia*, and pupæ of *Trifolii* and *Pilipendula*, in exchange for other pupæ and larvæ.—Address Sidney Smith, Castle Street, Walmer, Kent.

WANTED, Bell's "Crustacea," Forbes's "Starfish," Couch's "Fishes," Pritchard's "Infusoria," Gosse's "Marine Zoology," vol. ii., "Popular Ornithology," &c., in exchange for Virtue's Bible, Bowerbank's "Fossil Fruits, &c. of London Clay," Rymer Jones's "Birds," &c.—C. Grimes, Dover.

WANTED, Newman's "British Moths" and Newman's "British Butterflies." Will give fossil microscopic slides in exchange.—J. Smith, Post-office, Kilmanning.

RARE mosses, 30 species, each found in one province only, L. C. 2nd ed. offered for 25 occurring in one, two, or three provinces. Lists on application.—R. Wood, Westward, Wigton.

OYSTER mud rich in diatoms, etc., foraminifera from chalk; spines, bristles, and hairs of sea-mouse (*Aphrodita aculeata*); spines of brittle starfish, all unmounted, in exchange for well-mounted slides or diatomaceous deposits.—J. Temple, Storrington, Sussex.

WANTED, a good ringing table, will give in exchange twelve well-mounted and carefully finished slides of diatoms, double-stained sections of exogens, &c.—A. J. Doherty, 26 Leamington Street, Oxford Road, Manchester.

WANTED, all kinds of unmounted microscopical material in quantity, especially Foraminifera, diatomaceous earths, Echinodermata, insects, zoophytes, sections, &c., listed exchanged and correspondence invited.—F. R. Martin, Clevedon, Somerset.

WANTED, micro mounting materials, especially insects, for mounting whole, in exchange for slide media, &c.—E. Wade Wilton, Northfield Villas, Leeds.

WANTED to correspond with botanists in England and abroad for the exchange of specimens, &c.—A. B. Gibbs, St. Albans.

Will send some *Nitella translucens* living (shows cyclois in cells) on receipt of mount or material.—E. B. L. Brayley, 2 Burlington Buildings, Redland Park, Bristol.

FIRST VOL., 20 numbers unbound, "Familiar Garden Flower," coloured plates, for work on botany.—Address K., 52 Portland Street, Manchester.

SCIENCE-GOSSIP, 1879, 11 numbers, 1870 complete, bound cloth, 1878 complete, unbound. First 18 numbers "Circle of the Sciences," cost £1 15s. What offers in books?—Rex, 19 Lorne Street, Carlisle.

WANTED, number nine of the "Quarterly Journal of Microscopical Science." Please communicate with the Rev. S. A. Renan, Allan Rock, Dunganon, Co. Tyrone.

WANTED, Yarrell's "British Birds," old edition; Boisduval's "Histoire des Chenilles," and vols. 9-14 of SCIENCE-GOSSIP. What offers?—W. H. Newberry, Elm Grove House, Exeter.

WANTED, Moore's "British Ferns, Nature Printed," two vols., Bradbury & Evans, publishers. For exchange.—E. Bally, The Mansion, Totnes.

GOOD fossils, micro slides, and eggs, in exchange for other eggs.—A. D. Hall, Manchester Grammar School.

HAVE some shells from the Post-Pliocene clay, also foraminifera, in exchange for diatomaceous earth, or other good microscopic mounting material. Fine series of rocks, in exchange for minerals of other districts.—G. Patterson, care of Mrs. Hamilton, 17 South Street, Greenock.

WELL-FINISHED micro slides, and unmounted material, in exchange for microscopical and natural science books.—J. C. Blackshaw, 57 Cross Street South, Wolverhampton.

WANTED, from $\frac{1}{2}$ to 1 ounce of the cement-stein from Mors, Jutland, containing diatoms. Will give in return san monia, or electro-silicon, mine Nevada, or Lake Valencia, S. America.—Galloway C. Morris, East Tulphocken St., Germantown, Philadelphia, U.S.A.

LARGE specimens of *Anodonta cygnea* and *Unio tumidus* to exchange for other British land or freshwater shells.—H. Ulyett, Folkestone.

SUPERIOR mahogany cabinet, suitable for butterflies, moths, &c., 13 small drawers, cost £2 10s. Exchange good microscope or telescope to value.—S., 3 Cobden Place, Leeds.

WANTED, *Fontinalis antipyrretica* in fruit for *B. ligulatum*, or stamps.—W. Walker, Buckingham.

WANTED, Smith's "Synopsis of the British Diatomaceæ," in perfect condition.—W. Walker, Buckingham.

For exchange about 300 British and foreign stamps in blank album, many of them very rare. What offers? Should like a urntable and "Davies on Mounting."—W. E. Watkins, 32 Huntington Street, Barnsbury, London, N.

WANTED to exchange tongues and stings of bee and palate of whelk for other good slides or material.—J. E. Read, Pottergate Street, Norwich.

WANTED, larvæ of *C. fraxini*, pupæ of *D. orion*, *Dominula*, *Batis*, *Minos*, *Apiformis*, *Nerit*.—J. Bates, 19 Orchard Terrace, Wellingborough.

BOOKS, ETC., RECEIVED.

"The Seals and Whales of the British Seas." By Thomas Southwell, Esq., F.Z.S. London: Jarrold & Co.

"Sight." By Joseph Le Conte. London: C. Kegan Paul & Co.

"Second Report on the Rocky Mountain Locust." By Messrs. Riley, Packard, & Thomas. Washington Government Printing-office.

"Rambles of a Naturalist round Folkestone." By Henry Ulyett, B.Sc. Folkestone: J. English.

"Book of the Rabbit." Parts VIII., IX., X. Bazaar Office.

"Transactions of the Cumberland Association." 1879-80.

"Geological Rambles round London." London: Marshall, Japp.

"Transactions of the Birmingham Natural History and Microscopical Society."

"Proceedings of the Belfast Naturalists' Field Club."

"Proceedings of the Bristol Naturalists' Society."

"Antiquary."

"Land and Water."

"Midland Naturalist."

"Northern Microscopist."

"American Naturalist."

"Science."

"Revista."

&c. &c. &c.

COMMUNICATIONS RECEIVED UP TO 8th ULT. FROM:—
C. F. V.—E. W.—F. W. E. S.—G. W.—B. H.—E. F.—J. H.—
M. P.—R. E.—J. S. W.—H. H. S.—J. N.—W.—G. J. B.—
R. W. C.—E. H.—J. C. C.—W. W.—E. W. A.—H. P.—E. H.—
J. T.—W. H. H.—P. F. L.—A. W.—A. F. K.—J. M. C.—
W. J. V.—V. G. J.—E. E.—P. K.—C. H.—C. V. R.—A. B.—
J. B.—W. B.—A. S.—R.—J. W.—F. N. H.—J. H. M.—
T. M. R.—J. S.—W. T. G.—W. J. S.—J. B. L. M.—E. S.—
W. H. B.—G. D.—F. H. A.—E. E.—F. J. G.—H. M.—E. D. M.—
H. M.—J. A.—O.—E. E.—R. W. C.—C. G. W.—J. N. D.—
G. W.—W. M.—J. W. C.—A. D. M.—M. L. W.—H. A. F.—
H. M.—W. H. N.—W. W.—J. B. L. M.—A. L. L.—J. C. L.—
F. L.—A. G.—J.—S. A.—E.—J. T.—W. T.—G. E.—J. G.—
W. L. S.—W. S.—R. E.—D.—E. J. W.—H. R. W.—J. M.—
J. E. L.—E. B.—R. W.—G. H. C.—A. H. S.—W. G. W.—
F. E.—B. B. W.—J. G.—A. E.—G.—J. A. W.—W. T. L.—J. S.—
J. T.—H. E. B.—E. W.—W. A. K.—H. W. L.—H. L.—
E. B. L. B.—C. F. E.—W. C.—T. W. B.—A. F.—F. C. T. H.—
D. B. K.—G. H. B.—J. C.—J. D.—F. R. M.—A. J. D.—
C.—A. G.—S.—T. S.—J. R.—W. M. P.—E. H. S.—J. J. H.—
C.—V. S.—J.—W.—R.—F.—J. M.—G.—P.—J. C. B.—A. D.—
E.—W. B.—A. D. H.—R. W. C.—H. N. P.—D. B.—J. S.—
D. M.—J.—V.—C. F. W. L.—W.—G. D. B.—W. H. T.—
F. A. H.—J. B.—E. W.—F. A. S.—W. W.—F. H. H.—
G. C. M.—P.—S.—R.—J.—J. E. R.—A. C. S.—H. U.—
W. G. S.—G. S.—E. J. C.

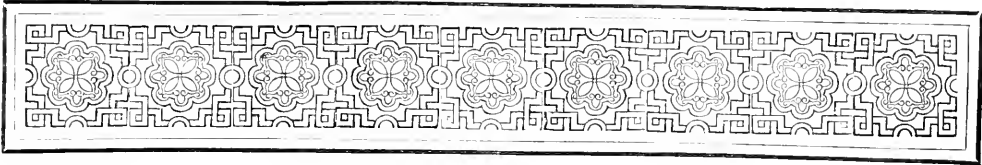

SOME SHORE-HAUNTING FISHES.

No. II.

By P. QUIN KEEGAN, LL.D.

[Continued from page 111.]

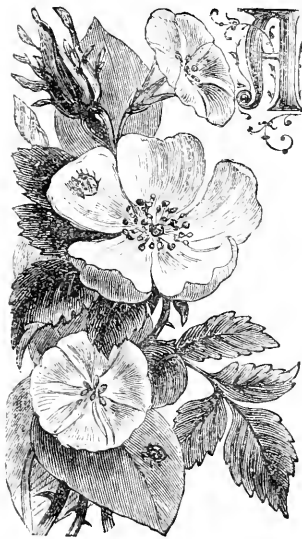

AT low-water mark, just let us capsize this moderately large stone that we see here bristling with acorn-shells, limpets, and dog-winkles, and decked with a flowing dishevelled profusion of bladder-wrack, &c., away wriggles and shuffles some lithe and supple small fish with a most tell-tale array of bluish-black spots along his back.

He is too slippery

a customer for our smooth-skinned digits. He has certainly "slipped away" into some secret, inaccessible nook among the rocks or stones. Touch but his tail, and such a spluttering you never heard; try to secure him, and you might as well attempt the "tug of war" feat with a greasy rope. This slimy, agile, and bespotted creature is the gunnel or butter-fish (*Muraenoides guttata*). You perceive the small head, and the jaws snapping impotently in anger, and the thin and lengthy contour of body with the dorsal fin projecting along the whole length thereof. The skin seems smooth, but when magnified, minute scales are seen imbedded in the derm. The presence of this fish under the high and tide-forsaken stone, would indicate the fact that it can subsist for several hours out of water. And here be it observed, that in order that a fish may remain alive when withdrawn out of its native element it is necessary that it should be provided with a large

branchial chamber having small outlets. If sufficient water can be retained therein to float the gill-plates, then oxygen adequate for purposes of respiration can be supplied to that water directly from the air; so that there can be little doubt, that a fish constructed thuswise, is fully capable of remaining out of the pale of Neptune's sway for several weeks. In the calm and clear rock-pools the gunnel can disport itself with ease and agility, helping itself to marine worms, and the spawn and fry of other fish. Occasionally it creeps into some narrow crevice or miniature cavern in the rocks, concealing itself there with a veritable hermit-like predilection. The conspicuous spots which decorate the dorsal fin vary in different specimens from nine to thirteen in number, sometimes they are wholly wanting. Under the microscope they are observed to consist each of a congregation of coloured dots or granules, and not of a uniform mass of coloured matter, the effect thus being seen to arise from the presence of pigment probably in minute cells or areolæ rather from partial absorption of light. The mucous secretion of this little fish is evolved in vast quantity and thickness; and, as in some way directive of its emission, it has been supposed that the sides of the body are furnished with considerably sensitive nerves of touch.

In various rents and crevices among the rocks, under stones in rock-pools, or crouched beneath some wave-worn boulders of the sea-beach, may frequently be found a lavishly fin-decked little fish with very beautiful eyes, and about five inches long, called the shanny or smooth shan (*Blennius pholis*). Provided with large chubby lips, with long and firm incisor teeth, and a gormandising appetite, it works considerable havoc amongst the edible morsels which frequent its chosen haunts. Limpets, mussels, &c., are dexterously chiselled from the rocks, and devoured wholesale. Like most shore-hunting fish it is perpetually encompassed by innumerable enemies, avian or piscine; but it is very strong, considering

its size; and frequently when chased in a pool, it will charge the invader's hand with a force equal to that of a blow from a stone. When escaping from pursuit over moist gravel, it exhibits a marvellous amount of energy and agility; and it has been observed, that when thus harassed, the creature invariably, with unerring instinct, shapes a direct course towards the sea, never away from it. When the tide returns, it creeps by its ventral fins into some place of shelter and security; in fact, this fish exhibits a special predilection for snug and cosy retreats amid the realms of the sea. With remarkable tenacity of life and a capacious gill-chamber, it leads a sort of amphibious career between the tideless shore and the rock-strewn floor of the adjacent ocean. The shanny spawns during the summer. The ova are deposited in a tiny sea-hall—a species of rock-hewn nest situated near low-water mark; and the fish guards and watches the progeny with indefatigable vigilance and assiduity. A lavish exuberance of fin-rays clothes the body of this fish. The dorsal fin has usually 31 rays; the pectorals 13; the ventrals 2 only, but of eminent service; the anal has 19, and the caudal about 11 or 13. The colour of the skin varies extremely according to the habitat, &c., of the creature.

(To be continued.)

ON CERTAIN PHENOMENA CONNECTED WITH ATMOSPHERIC ELECTRICITY.

By WALTER G. WOOLLCOMBE, B.A., F.L.S.

[Continued from page 122.]

I. *ZIGZAG Lightning* is a veritable electric spark either between two clouds, or more often between a cloud and the earth. This grand spark is able to divide or bifurcate into two, seldom three, branches, hence the names of "chain"* and "forked" lightning. It proceeds from clouds in which the globules are packed so close as approximately to form compact masses, and the electricity on their surface is brought most into play. This is but a particular case of De la Rive's theory of clouds.

To account for the form we have two theories: one stated by me in *SCIENCE-GOSSIP* for December, 1880, and given by Ganot amongst others, viz., that the lightning seeks to take the path of least resistance; † the other is that its form is due to the fact that, in its journey through an electrically-strained medium intervening between the two clouds, the lightning proceeds from one particle of the vapour disseminated in the atmosphere to another, and the zigzag appearance results from the irregularity of the position of these particles.

* "Nature," xviii. pp. 260, 302.

† By the way, I might add that Herbert Spencer shows that the law of least resistance is followed under every condition to which matter is subject, and even in sociological phenomena.

2. *Sheet Lightning*.—De la Rive's theory of clouds gives a very beautiful explanation of this form, viz., that the discharge in this case appears to be made among all the individual components of the cloud with accompaniment of light, thus illuminating either the whole or only the boundary of the cloud, whose different components are like so many spangled panes. Some say, as noted by me, that sheet lightning is the result of brush discharges from the surface alone, others that it is the reflection of an actual flash which is not visible to us owing to the interposition of clouds or to its taking place below the visible horizon.

[The theory of Mr. Parfitt given in the December number, namely, that sheet lightning is an image on our retinas produced by a flash of forked lightning which has taken place too rapidly to form a distinct impression of its form, seems to me to fail entirely. The outline of the flash would not be distorted, the only result of its taking place too rapidly being to diminish our idea of its brightness. In fact the brightness of every flash of forked lightning is comparable to that of the sun, and would produce a grand illumination of the surrounding country if it did not vanish too quickly for us to receive a true impression.]

I do not understand what "Scientia" means in his note in the February number, where he states that sheet lightning is an electric discharge taking place between clouds at such a remote distance from each other as to be below the horizon. Surely the fact of being below the horizon is not a condition that clouds should be at a remote distance from each other, or *vice versa*. I presume he means that they are at such a remote distance from us as to be below the horizon. With reference to his explanation of the form, how does he explain the fact that sheet and fork lightning are sometimes seen almost simultaneously in adjacent regions of the atmosphere where the air could not offer at once the two extremes of "great" and "little or no resistance"?

Under this head comes another sort of lightning called "heat lightning," after which thunder is never heard. This form was supposed to be due to a very distant storm, but, as it has been observed overhead in a serene sky, the best explanation is that it is due to discharges between masses of vapour existing in portions of the atmosphere in greater quantities than elsewhere.

3. *Ball Lightning*.—The cause of this is totally unknown.* The globes of fire that are seen may be masses of moist vapour powerfully electrified, and becoming luminous by brush discharges all over

* Professor Tait, in a lecture on "Thunderstorms," refers to those who try to get out of the difficulty by denying the existence of Ball Lightning. One of these is the author of a pamphlet on "Electric Meteorology" lately published in this town, in which pamphlet the main argument is based on the supposition that electricity "by its lightness" can render buoyant particles of water! and in which certain physical ideas are strangely confused!

their surface. They are generally visible from one to ten seconds, and travel from the clouds to the earth so slowly that we may watch their passage with the eye. They sometimes divide, strike the earth, and rebound with a sharp explosion.

4. *Volcanic Lightning*.—The clouds of dust, ashes, &c., that are poured forth from volcanoes are accompanied by luminous electric discharges "due to the rapid condensation of the vast volumes of heated vapour" and to friction of the emitted materials.

Besides the above enumerated forms of lightning we have brush discharges from tops of edifices, masts of ships, &c., called St. Elmo's fires,* caused by the accumulation of electricity at projections and points under the influence of a passing thunder-cloud.

One sign of an approaching hurricane, mentioned in the "Handbook of the Laws of Storms," is said to be lightning of a columnar character shooting up in stalks from the horizon with a dull glare.

I have attempted to explain the different plausible theories as to the origin and distribution of atmospheric electricity, and as to the forms which lightning assumes, so that your readers may choose those which are most in accordance with their own observations. A great deal of the subject is at present involved in mystery, but we must hope that the comparatively new science of meteorology, aided by experiment, will in time solve the difficulties.

Before I end I should like to allude to a note in SCIENCE-GOSSIP for 1878, p. 237, in which the writer wishes to know whether lightning has ever been seen passing from the earth to the clouds. I may refer him and other inquirers to a lecture delivered by Professor Tait, and chronicled in "Nature," vol. xxii., wherein is the following paragraph:—

"A remark is made very commonly in thunderstorms which, if correct, is obviously inconsistent with what I have said as to the extremely short duration of a flash. The eye could not possibly follow movements of such extraordinary rapidity. Hence it is clear that when people say they saw a flash go upwards to the clouds from the ground or downwards from the clouds to the ground they must be mistaken. The origin of the mistake seems to be a subjective one, viz., that the central parts of the retina are more sensitive by practice than the rest, and therefore that the portion of the flash which is seen directly affects the brain sooner than the rest. Hence a spectator looking towards either end of a flash naturally fancies that end to be its starting point."

* The word "Elmo" is supposed to be derived from Helen, who, with her brothers, Castor and Pollux, appeared as "lucida sidera" after storms, according to ancient superstition.—*Vide Hor. Carm.* iii. 2.

A STUDY OF THE VARIATION OF THE SMALL TORTOISESHELL BUTTERFLY (*Vanessa urticae*).

By A. H. SWINTON.

PART I.

THE gradual adherence of naturalists to the modern or Darwinian school in place of the old Linnæan and cruder Fabrician, will doubtless, as was long since surmised, lead to the eventual substitution of synthetical methods for the present prevailing analytical ones. The student of nature will be directed to trace out the living and ever-springing branches of the tree of descent, by means of certain ancestral and common features, and certain ancestral and common laws; and rather than attempting minute scrutiny and exact definitions, which by the law of fluxion can but prove an eventual *reductio ad absurdum*, he will now be more fully led to distinguish by type and most characteristic form. To illustrate the biological reason for this enunciation, I propose to transplant from German soil a few fundamental facts that seem immediately to postulate the gradual evolution and specialisation of butterflies and moths, and which yield fair promise of opening up fresh fields of research.

Let us take for example the small tortoiseshell (*Vanessa urticae*). What butterfly is more familiar and deserving of study than this earliest harbinger of our English spring and latest spirit wanderer over the fallen russet of autumn? Who recalls not with delight the sharp autumn hour when he first heard its wings beating up the window pane; or who retains not the memory of that strange sentiment that arose, when the dark-winged intruder was afterwards dislodged from some snug parlour corner or cobwebbed out-house when the snow lay at Christmas? Of all bright life, this being that flies so puzzlingly about the heliotropes and gravelled walks, communes most with our better aspirations and incites most the curiosity. Even as I write, while the cold wind soughs drearily in the chimney and the boughs lie bare in the late spring, there exists a secret pleasure in the thought that, three weeks ago, a bevy of tortoiseshells and brimstones were to be seen fluttering out at warm noonday on the metropolitan coach road. They are all back now to their sleep of beauty beneath the ivied wall and clematis-twined porch, and I, their meditative historian, draw my chair closer to the hearth to escape the chill and rheums of a windy equinox.

But what is better than a picture to recall the absent, and how can a picture be sweeter than when it portrays nature encompassed with the grace and illusions of the morning? Of all observers the late Edward Newman could perhaps best appreciate the line of beauty in *Urticae*, and on re-opening his great work on butterflies I find the desired likeness in a

very remarkable and striking aberration, coquettishly tricked out by a broad black band on the fore wing, not a little suggestive of the crape bandage worn by officials on their uniform to indicate mourning. To a certain class of collectors, I know such a feature will doubtless convey no idea, present no meaning. Light and airy things like butterflies, they will say, are ever prone to vary, as human faces are, or as the fluttering leaves of a tree when compared are never found perfectly alike. Yet had one of these empirics of nature left the infatuations of units and number, for an afternoon's stroll among the natural wood on the brooding of the Surrey Downs; when during the past autumn the late and perhaps only annual brood of tortoiseshells were floating about the stem-

the latter sort from their nettles on the Downs and reared them, I found I obtained a certain percentage of the butterflies with indications of black bands. On the other hand, the caterpillars with lines I did not notice at all on the elevated land during the past year, but my friend Mr. Kidd sent me some he had discovered in the valley around Godalming.

Although the billowy crests of the Downs, where at Newland's Corner their motionless undulations look over to the towers of Sydenham, do not rise much in the excess of some 500 feet; yet analogy with what we know of variation on the slopes of the Alps and Pyrenees, would serve to raise a strong presentiment in mind that even here we have the all subtle influences of altitude at work; and if so,

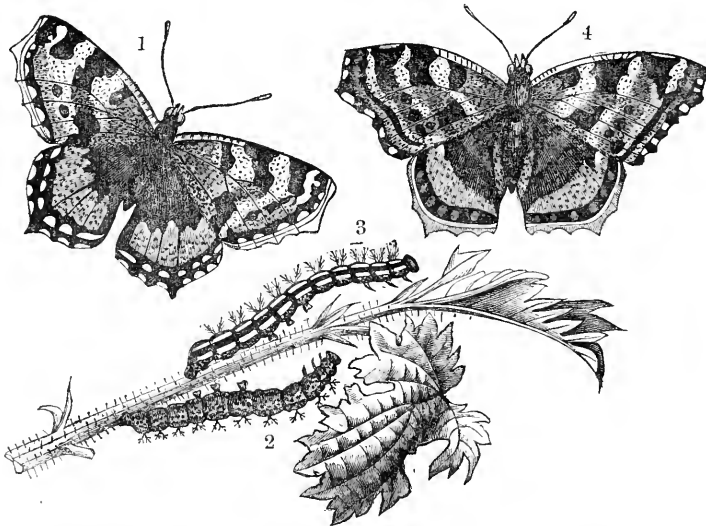

Fig. 88.—1. Aberration of the small tortoiseshell butterfly (*Vanessa urtica*) reared on willow, with a band of black irrorations joining the second black spot on the costa to the blotch on the inner margin; 2. Diagram of caterpillar from which it was bred; 3. Diagram of the more ordinary form of the caterpillar of *Urtica*, with yellowish lines; 4. Dwarf of the large tortoiseshell (*Vanessa polychloros*) obtained from dieting the caterpillars on willow. The example has additional spots on the fore wing, and is shown with the light shining through it, when four bands may be faintly traced crossing the surface.

less thistles and clover heads;—had he there and then marked the prevalence of a certain shade blurring on their wing; in some individuals but faint, and resembling a faded ink-stain, in others pricking out in a rash of black points, a well-defined band proceeding from the second of the spots on the costa to the corresponding dark blotch on the inner margin;—he would certainly have marvelled at the repeated embodiment of a natural phenomenon which seemed to visibly evoke law out of apparent lawlessness.

What renders the matter yet more interesting is the fact of there existing in the same district two distinct forms of caterpillar that produce this butterfly, the one (3) enhanced by four conspicuous longitudinal yellowish lines, and the other (2) dark with no yellow lines; and when I brought home some of

in these and similar cases we must turn our eyes to high latitudes for corroboration of the assumption. Now Dr. Standinger, when recapitulating his captures on his return from Finmarken in the extreme north of the Scandinavian peninsula (Stettin, Ent. Zeit. 1861, p. 345), tells us, that individuals of *Urtica* appear among the herbaceous willows and dwarf birches of that hyperborean locality about May 29th, and that during July the nests of young caterpillars are found, which reproduce the butterfly towards the middle of August; and he then adds: Of this single annual brood, the examples are generally somewhat darker than the German, and the black spot on the inner margin is notably connected more or less with the middle costal spot by means of black atoms.

These few facts adduced will be sufficient to show that the spots on a butterfly's wing may, under certain lugubrious conditions of climate, resolve themselves into lines, the stars on the scutcheon becoming stripes; and if we now look southward towards the little island of Corsica, basking in an increase of sunlight off the southern coasts of Europe, we shall witness in its insular variety of the tortoiseshell (*Ichnusa*) the converse of this phenomenon, and find that the two small discal wing-spots may entirely vanish, so as to confer a new appearance on the butterfly. Dr. Standinger, the greatest authority on such matters, tells us the caterpillars of this variety are likewise dark, and he adduces the singular coincidence, that in the year 1859, when several nests of unusually dark caterpillars appeared in the vicinity of Dresden, a local collector took a corresponding aberration of the small tortoiseshell without the two discal wing-spots more freely than heretofore. This

the black setting inlaid with sapphire, we shall have a fundamental form with four black stripes on the upper wing (fig. 88-4). Although it would be premature to affirm whether such a Vanessa, as is here foreshadowed, does, ever did, or ever can, embody itself as an entity, it is, nevertheless, certain that the pattern (like the first few strokes of an accomplished draughtsman) underlies the superficial mosaic which distinguishes our indigenous species, and that it rules and influences their variation to such an extent that aberrations from time to time start up on whose alar surface we fancy we see visibly depicted as sudden a metamorphosis, and as wild, as any portrayed in mythological lore. It is thus we find figured in Newman's "Entomologist" an immaculate Camberwell beauty (*V. antiopa*) with certain possible rudiments of the false ocellus on the fore wing of the peacock butterfly (*I. Io*), and conversely a peacock retaining its row of purple spots along the margin of the front

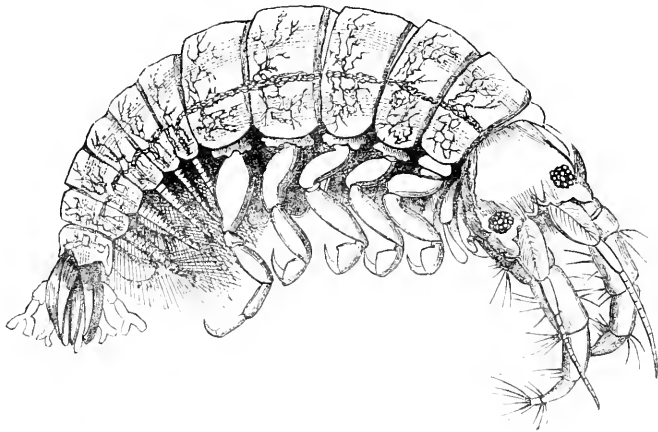

Fig. 89.—*Corophium crassicornes* × 25.

aberration, it may be remarked, has been also noticed in Switzerland, France, Belgium, and even in England, and it really remains a subtle question whether it be indeed differentiated from its Corsican brother.*

Supplementing this central band in examples of the small tortoiseshell, there may often be observed a few irrorations, proceeding from the costal blotch next in order towards the wing tip in the direction of the two discal spots, that afford indications of a second band parted from the outer by an obsolete yellow ribbon, most marked at the inner margin; and, although rarely noticeable on the upper surface, if we turn over the wing we shall observe the third blotch similarly produced to the hind margin of the wing, so that if we add to these three virtual bands

wings, but having the flaunting eyes that arise out of them obsolete; while in the Transactions of the French Entomological Society, there may be seen a figure of a dark tortoiseshell of a madder brown tint with a well-defined embroidering to the wing margins, recalling the Camberwell beauty, to which is superadded a quasi ocellus on the fore wing. Peacock butterflies likewise occur that show black spots, faint bands, and supplemental marginal eye specks appearing on the hind wing in a line with the great purple eyes.

(To be continued.)

QUEEN WASPS.—These insects are very numerous in this locality. This month of April I have killed already fourteen and expect to kill many more, as I have seen numbers flying about. Have any of the readers of SCIENCE-GOSSIP noticed the same fact? —S. A. Brennan, Allan, Rock, co. Tyrone.

* "Soc. Ent. de Belgique, 1873," p. 409. Two forms of this aberration are figured by Newman in "British Butterflies," the second more melanic type will also be found coloured in Herrich Schäffer ("Syst. Bear. der Schmet. von Europa").

H.M.S. "HYDRA" AND MARINE ZOOLOGY.

FROM the study of fossil remains, I have recently become greatly interested in natural history. Marine life at present is that to which I devote as much time as a retail tradesman can afford in this co-operative age.

The littoral zone of the Sheppey coast yields a great variety of microzoa, as well as plenty of larger forms. I do but refer to these now, as I wish principally to call attention to the rich zoological harvests that may be gathered from the hulls of vessels when in dry dock. In Sheerness Dockyard, opportunities of this nature often occur, and by the kindness of the resident officials, I have been enabled to observe and search as closely as I pleased. H.M.S. "Hydra"—a very powerful turreted iron-clad, sometimes irreverently called a "flat iron"—was recently taken into dock here, and I, loaded with bottles and jars, was on the spot when the 50-horse power engine began to pump out. First of all, as the water lowered, I observed that crustaceans and other small fry in abundance were leaving the ship's side and going with the stream, evidently aware that their surroundings were abnormal and that something unusual was about to happen.

A rough glance at the exposed portion of the hull below the water line showed immense patches of good sized mussels (*Mytilus edulis*), from amongst which protruded the straw-like horny stems of Tubularia in such quantity as to present somewhat the appearance of a grass meadow scorched by summer heat, or perhaps more nearly that of a stubble-field. The polypites that had formerly crowned each stalk had nearly all disappeared, though it may not be before having thrown off hosts of medusiform buds that had started on their own account as "Jelly-fishes." Still some remained, and it certainly seemed to me to be a fitting arrangement that the "Hydra" should have carried a full complement of Hydrozoa parasitic upon her sides.

In gaps here and there, and also in places where there were no mussels, I noticed large cakes of mud about an inch thick, that had the appearance of having been kneaded and plastered into position. Looking closer with a lens, I found that this mud was closely pierced with holes. Therefore I concluded that it was inhabited, and consequently put a good handful into a jar with some water to take home for after observation. As I glanced along the ship's side, I noticed a continual waviness, as of something agitated by the wind. This I found was caused by a multitude of the singular-looking *Caprella linearis*, which were holding on by their hind claspers, and swinging their gaunt forms about as if in an extremity of grief. Every spot was alive with them. I put a few hundreds into a jar, and they gripped one another so tightly that in a few minutes they were all dead in an almost solid mass.

Of course there were plenty of barnacles, but being very young they were scarcely to be perceived by the unassisted eye.

Then there were some very interesting Annelids, Polynoe being the most abundant.

A species (probably new) of Phoxichilidium, as well as some other sea-spiders, were crawling about in their usual lazy way. These creatures, which are really very nearly "all legs and no body," present, in their movements, a very striking contrast to their terrestrial relatives.

Let me now revert to the mud that I brought away. When it subsided, I found that the water above was crowded with a small species of crustacean, that apparently combined in itself the characteristics of the woodlouse and the shrimp. These then were the creatures that had coated the ship with mud in spite of the patent anti-fouling composition laid on less than a year before. They must have caught mineral particles floating by and used them in the construction of their homes and hiding-places. I was afterwards confirmed in this opinion by finding that all of them I put into an aquarium at once made places in which they could hide.

Some took small filamentous Algae and felted them into a neat tube which they attached to the glass. Others appropriated spaces between pebbles, over which they fastened a vegetable covering in default of anything else to work with.

In whatever way they were housed, they kept up a ceaseless current with their false feet, and thus obtained all that was necessary to existence. This ship, on which there must have been an almost incalculable number of these crustaceans, had only been out of Sheerness harbour for a few hours since her hull was thoroughly cleaned less than twelve months before.

In the face of this fact, it is amusing to find it stated by Spence Bate and others that this little creature, identified as *Corophium crassicornis*, is "a rare species in British seas"!

It is remarkable that there was no vegetation associated with this mass of marine life. I expected to find some diatoms, at least. There is much more that I should like to say; but perhaps I have written enough to induce some others, who may have the opportunity, to look for themselves.

I shall be glad to send specimens of the *Caprellæ* taken from the "Hydra" to any who care to send a tube and a label, with address and stamp.

W. II. SHRUBSOLE, F.G.S.

Sheerness-on-Sea.

FUNERAL PLANTS.—Can any of the readers of SCIENCE-GOSSIP tell me the name of the plant the Jews used to carry at funerals, and to stick in the grave when the burial took place hastily, and when the body was not interred in stone?—*E. Edwards.*

UNCLASSIFIED NOTES ON THE INLAND BIRDS OF CEYLON.

By F. L.

[Continued from page 106.]

5. THE Rufous Falcon. I am unable to give the classical name, as my specimen has not been identified.

Distribution.—Scarce in the hill country, and I have only been so fortunate as to secure a single example. Its food consists of "blood-suckers," so common on all coffee estates.

Size.—Length $13\frac{1}{2}$ in. ; span $29\frac{1}{2}$ in. ; wing $9\frac{3}{4}$ in. ; tail $6\frac{1}{2}$ in. ; tarsus $1\frac{1}{2}$ in.

General colour.—The upper parts (as far as the tail coverts) in general, and a portion of the breast, is a light brownish-red, or rufous cream-colour, with bars as far as the nape of brown, which begin with a triangular spot of the same colour near the tip of each feather, which is edged with white, thus leaving alternate stripes of the ground colour between the bars, that vary in number according to length. The centre of the feathers upon the head are varied by the brown mark, being the entire length of the feather itself, and the same peculiarity of marking extends to the breast, after which the remaining under portions become a pale creamy-white colour. The legs have a few triangular or oval splashings upon them, but farther down upon the vent the colour is nearly pure white. Wings above light brown, edged with pale white, and with the inner webs dashed with alternate stripes of brownish cream-colour, fading into white, but more distinct towards the body. Tail pale ashy cream-colour, closely barred with light brown. Iris a rich chocolate-brown ; orbits greenish-yellow above, faint orange below ; bill leaden at tip, extending into black, and with a greenish-yellow base ; cere yellowish ; tarsus bright yellow ; claws black.

6. The Ceylon Goshawk (*Astur trivirgatus*), Temm., Holdsworth, and Kelaart, also the "three-streaked Kestrel" of the latter. "Cooroolar goyar" of the Singalese.

Distribution.—Appears to be wide ; during the north-east monsoon I secured four, and all were, strange to say, females. One I shot at 4500 feet and the other three about 2000. They live upon reptiles and small birds, but mostly the former. They vary considerably in size.

Size :

Length.	Span.	Wing.	Tail.	Tarsus.	Shot at
♂ 13 in.	$24\frac{1}{2}$ in.	$7\frac{1}{2}$ in.	$6\frac{3}{4}$ in.	$2\frac{1}{2}$ in.	4500 ft.
♀ 13 in.	24 in.	7 in.	$6\frac{1}{2}$ in.	2 in.	2000 ft.
♀ $15\frac{1}{4}$ in.	28 in.	8 in.	$7\frac{1}{2}$ in.	$2\frac{1}{2}$ in.	2000 ft.
♀ 14 in.	25 in.	8 in.	7 in.	2 in.	2000 ft.

General colour.—Upper part, from the centre of the crown to the tip of the tail, including the wings, is sepia brown, the tips of the feathers being pale cream-colour, succeeded by a shade of the general hue. The primaries and tail feathers on their upper

sides are barred with bands of brown, visible also on the under surfaces in places, with spaces between each of pale white. The breast and under parts of the body are cream-colour, more or less blotched with brown, forming into bars upon the legs. The markings of brown follow pretty regular lines upon the throat. Eye golden ; feet and tarsus yellowish. Bill horny above or bluish, and the latter colour below. Claws black. The eye in some examples buff inclined to yellow.

7. The Indian Sparrow-hawk (*Micronisus badius*), Gmelin, Holdsworth and Legge. The "Shikra." *Accipiter badius*, Brown's Sparrow-hawk, of Kelaart.

Distribution.—Widely distributed in suitable localities. The neighbourhood of grass lands, or "patenas" I have found a favourite resort. Food, mostly reptiles.

Size.—♂ length $11\frac{1}{2}$ in. ; span $22\frac{1}{2}$ in. ; wing $6\frac{8}{10}$ in. ; tail $6\frac{1}{2}$ in. ; tarsus $1\frac{1}{10}$ in.

General colour.—Deep slate-brown over the upper parts, lighter on the edges of the wings and tail (except at the tip of the latter, which is white), and darker on the head, scapularies and back. Checks ashy, shading into slate upon the neck, and rufous-brown on the sides. Throat white, with a few dark markings, fading upon the breast. Under parts pale white, closely banded with bars across each feather of a rich brown colour, that become closer upon the sides. Legs and vent white. The under sides of the wing and tail feathers have six or eight bars of brown across them ; which are less distinct upon the outer than the inner surfaces. Bill black at the tip, bluish towards the base ; iris orange-yellow ; orbits pale yellow ; tarsus and foot yellow ; claws black.

Note.—I have not been able to have this species identified, but I think it is unmistakable, and have hence given the names as above.

8. The pale Harrier. Probably *Circus Swainsonii*, A. Smith, Kelaart and Holdsworth.

Distribution.—Wide, but the bird is probably a visitor, visiting the hills about the middle of the year, when it may be found in pairs hunting over grass lands, swamps and paddy lands. Its peculiar manner of suspending itself in the air and fluttering over one spot, or "stopping," as it is called, is very striking. This is done by depressing the expanded tail, and beating the air with a flicker (if I may use the word) of the wings. The food of this Harrier consists of snakes and reptiles, and probably vermin.

Size.—♂ length 12 in. ; span 33 in. ; wing 10 in. ; tail 5 in. ; tarsus $1\frac{3}{10}$ in. ; shot at 3000 ft. ; ♀ length 13 in. ; span $32\frac{1}{2}$ in. ; wing $10\frac{3}{4}$ in. ; tail $5\frac{1}{2}$ in. ; tarsus $1\frac{3}{10}$ in. ; shot at 4500 ft.

General colour.—The back is ashy brown, with white tips to each feather. Upper wing-coverts black, with a greyish tinge. Upper portions of the wings and tail grey, with light tips to the feathers. Breast cream-colour, shading into pure white on the

belly, vent and sides, including the under wing-coverts and tail feathers; under sides of the wing dark brown, nearly black; iris and cere yellow. Bill and claws black; tarsus and feet yellow.

9. The large Ashy Falcon or Harrier. Unidentified, but possibly Montague's Harrier (*Circus cinerescens*).

Distribution.—I have only been able to procure one specimen, and am inclined to think the bird is only an occasional visitor. My example was shot in some grass land, in the Puselawa district, at an elevation of about 3500 feet above sea level.

Size.—♂ length 18 in.; span 41 in.; wing 13½ in.; tail 9¼ in.; tarsus 2¾ in.

General colour.—Ashy all over the upper parts, darker on the back, and paler on the forehead and upper tail-coverts. The feathers of the crown, having a dark centre to each, give that part rather a mottled look. The eye is surrounded by a circle of brown-



Fig. 90.—Jaws of *Succinea elegans*.

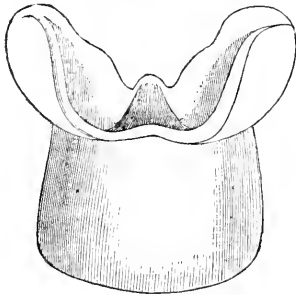

Fig. 91.—*Succinea Pfeifferi*.



Fig. 92.—Jaws of *Succinea Pfeifferi*.

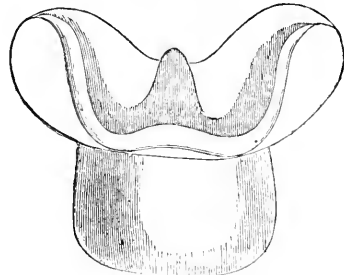

Fig. 93.—*Succinea elegans*.

ish feathers, that extend also upon the ear, and add much to the beauty of the bird. A portion of the breast and chin is pale ashy white, ending in pure white upon the remainder of the under parts of the body. The tail, which contains twelve feathers, is crossed by five or six bars that go across the first four outer ones, and on the inner web of the next, having the two central feathers pale or ashy; the whole margined with white, with a tinge of cream-colour. Irides golden-yellow; cere yellow; bill black at the tip and leaden at the base. Inside of the mouth also leaden; tarsus and feet yellow; claws black.

(To be continued.)

EARLY FLOWERING MILKWORT.—I do not know whether the flowering of milkwort (*Polygala vulgaris*) in Epping Forest, so early as April 18, is worth noting or not; at any rate I found the plant in full bloom on that day.—*W. Mawer.*

NOTES ON THE SUCCINEAS.

HITHERTO there has been some doubt as to whether *Succinea Pfeifferi* is to be found in England. I am happy to be able to solve the doubt. It is found in this neighbourhood (Folkestone) and also its variety *Ochracea*.

In the past summer, my attention was particularly directed to this genus by finding a small form on the mud of a stream partly run dry.

The animal appeared dark and the shell thick, both more so than any I had before found. On comparing them with drawings of *Succinea elegans*, and also with specimens from Continental localities, I was persuaded that they were not the "elegans" of Risso—and on looking over my entire collection I felt doubt as to whether I had the true shell amongst them. I wrote to some of my correspondents, soliciting help, and Mr. Philip Mason, of Burton-on-Trent, kindly

placed the whole of his collection at my disposal. I selected from this and my own and sent them to Mr. Hazay, of Budapest, who is a great authority on this subject. He has carefully examined and named all that I sent. Pfeiffer gives a distinct difference in the jaws of *S. Pfeifferi* and of *S. elegans*. Mr. Hazay does not find it a permanent difference, but in the shape of the jaws and general characteristics of the shell. I enclose sketches copied from both of these authors for me by Dr. Boettger, of Frankfurt, in which the difference of form is plainly shown.

Added to this amongst the shells I found last summer in abundance here, Mr. Hazay has discovered a new variety of *Succinea putris*, which he has courteously named after me "Fitz-Geraldian." His description of this shell is this: "Its flat windings, its pointed top, short slender shape, its strange reddish-yellow tint with lighter stripes." Mr. Hazay has found it in Mr. Philip Mason's collection and in mine, and it is well authenticated amongst Con-

tinental authorities, who have hitherto not known it to be in England.

FIRST GROUP of *Succinea putris* (Linné), round form. *S. putris* (Linné), Folkestone, Yorkshire; var. *subglobosa* (Pascal), Cambridge; *charpy* (Bandon), Dulwich; *Charpentieri* (Dumont), Notts, Yattoo; *olivula* (Bandon), Charlton; *stagnalis* (Gassies), Ipswich; *globuloidea* (Clessin), Cambridge. *Succinea putris* (Linné), long form. *S. putris* (Linné); var. *grandis* (Hazay), Hammersmith; *limnoidea* (Picard), Dublin, Folkestone, Lincoln; *Ferussina* (Moq. Tan.), Matlock, Yattoo, Folkestone; *Fitz-Geraldiana* (Hazay), Folkestone.

SECOND GROUP of *Succinea elegans* (Risso), and of *Succinea Pfeifferi* (Rossm.). *Succinea elegans* (Risso), Yorkshire, Deal; var. *Bandoniana* (Hazay), Yorkshire; *S. Pfeifferi* (Rossm.), Folkestone, Bristol; var. *profinqua* (Bandon), Hammersmith; *ventricosa* (Bandon), Bristol; var. *elata* (Bandon), Cornwall, Yorkshire; *ochracea* (Belta), Bristol, Folkestone; *contortula* (Bandon), Yorkshire; *parvula* (Pascal), Southgate.

THIRD GROUP, *Succinea oblonga* (Drap.). *S. oblonga* (Drap.), Swansea; var. *humilis* (Drouet), Cork.

It would be possible to increase the list of varieties *ad infinitum* on slight foundations, but the above are well defined. Collectors, as a rule, do not pay sufficient attention to taking only full-grown specimens, and this leads to making varieties out of what are only juvenile forms. The months of August and September are the best for collecting *Succineas*, as they are then mostly full grown.

Folkestone.

J. FITZ-GERALD.

ORCHIDS ON THE NORTH DOWNS.

AS several correspondents recently have given notes of or inquired concerning British orchids, an account of my "captures" during the past season in eight excursions may not be uninteresting. These excursions were confined to the North Downs in Surrey and Kent and the adjacent lowlands on the southern side.

My first excursion was to Penshurst, Kent, during the Whitsun holiday. There *Orchis mascula* and *O. Morio* were to be found in such profusion as to quite outnumber the "buttercups and daisies." Not in a solitary field, but in every piece of land laid down for grass, they were in the same abundance. The spikes were mostly large, some with six inches of flowers. The colour varied greatly, from very pale (and in one specimen almost white) purple to a dark, rich purple. I should also mention that on the same occasion I found the wild hyacinth of every intermediate shade from dark blue to pure white.

One specimen had its flowers white with a tinge of a most delicate green. The majority of pure white

specimens were found in a hedgerow skirting a hop-garden, within an area of a couple of yards, outside which not a single white one was to be found. Apparently the original white variety had reproduced others with a tendency to white flowers and a certain amount of stability had been given to the variety. I intend again visiting the spot and removing a few of the bulbs, to ascertain whether they will continue to produce white flowers.

Towards the end of June, two friends and I went to Knockholt Beeches, Kent, specially to search for orchids, and well were we rewarded, filling our bags almost exclusively with specimens of the following nine species; *Habenaria albida*, a few; *Cephalanthera ensifolia*, plenty; *Aceras anthropophora*, two dozen spikes; *Ophrys muscifera*, a dozen specimens; *Orchis mascula*, a few; *O. maculata*, abundant. *O. pyramidalis*, plenty; *Gymnadenia conopsea*, abundant; and the curious parasitical *Neottia Nidus-avis*, abundant, under beech-trees only. The whole of these were found in an area not exceeding a quarter of a mile broad, and a mile long. The situation shady, facing the south-east. We failed to obtain *Ophrys apifera*, although we met a collector who had about twenty specimens. The only other plant worth recording we obtained was *Daphne laureola* in fruit.

We noticed a remarkable singularity in general appearance of *Ophrys muscifera* to a small sedge, whose black, ripened seed heads much resembled the "flies" of the orchid, amongst the rank grass. In similar situations *Aceras anthropophora*, closely resembles the seed heads of various grasses. The colour of *Neottia Nidus-avis* is the same sombre hue as the dead beech leaves which cover the ground around it. It was only by the most careful search that we secured so many specimens, going over the same ground again and again.

My next five excursions were all in the neighbourhood of Red Hill, Surrey, about the end of July and beginning of August. All the above species I obtained again, except *Ophrys apifera*, of which not a single spike could I find even where I had seen plenty last year.

Listera ovata was abundant, but had nearly finished flowering. *Gymnadenia conopsea* was most abundant, giving the air a delicious fragrance; one specimen measured fully two feet in height, of which quite a third was one mass of blossom. *Cephalanthera grandiflora* was found in plenty at the bottom of a dark damp wood on the northern slope of a hill, and with it abundance of *Circea lutetiana* (enchanter's nightshade).

Remembering having seen some years ago, when an enthusiast in entomology, a very curious plant in one of my favourite localities, I revisited the spot, and to my intense delight discovered fifteen magnificent spikes of *Epipactis latifolia*. One of these measured three feet eight inches in height, with leaves which my hand could not cover.

My last excursion was to Tunbridge Wells, late in August. Of course this being on the Weald is not an orchid locality. I noted a vast abundance of *Orchis mascula*, many still in flower, but mostly seeded.

Regarding orchids and the mild weather which we experienced at Christmas, I must state that on Christmas Day I noted *Aceras anthropophora*, *Orchis mascula*, *O. maculata*, *Gymnadenia conopsea* and *Listera ovata*, showing their foliage in a situation facing the north-east where they had been planted last summer. *Allium ursinum* was also coming up.

I am only a young beginner in botany, but may my success incite others to take up the study of plants. Nothing, I can assure them, is more health-giving and pleasurable than the glorious rambles which this branch of science necessitates.

Camberwell.

H. F. TURNER.

RECENT RESEARCHES ON THE METEORIC DUST OF THE SCIROCCO.

FROM time to time fine dust, having nearly the same composition as certain meteorites, has fallen upon various parts of the earth's surface. Arago writes—"L'observation attentive des chutes des poussières fait présumer qu'elles ne diffèrent pas essentiellement des chutes d'aérolithes ordinaires." Prof. Silvestri, of Catania, recently collected some dust which fell in Sicily, and found it to contain not only metallic iron, but also nickel and various silicates and phosphates such as are commonly found in meteoric stones. He is, therefore, inclined to believe either that the dust has been abraded from meteorites, or that it circulates in space, and is attracted to the earth's surface when it penetrates within the atmosphere.

Professor Tacchini, who has exchanged the observatory of Palermo for that of the Collegio Romano, in Rome, has recently published a lengthy memoir entitled "*Sulle polveri meteoriche di Scirocco raccolte in Italia e segnatamente in Sicilia.*" He was assisted in his researches by Professor Macagno and Ricco, and a résumé of the results at which they arrived was recently read before the meteorological section of the French Association for the Advancement of Science at Algiers. The memoir contains some beautifully-executed microscopic drawings of the appearance of the meteoric dust when highly magnified, and by a series of small maps showing the barometric curves for the periods during which the dust fell.

The chemical examination of the dust which fell in 1879 in various parts of Sicily and Italy gave the following result. Water, alcohol, and ether had a scarcely sensible action upon it; but from some specimens alcohol dissolved out a greenish colouring matter—the chlorophyll contained by the vegetable matter of the dust. The ordinary mineral acids

produced a considerable effervescence, due to the escape of carbonic anhydride. A certain quantity of the substance remained undissolved by aqua regia. The complete analysis of a greyish-red dust which fell at Palermo on May 17th, 1879, was made by Professor Macagno.

Hygroscopic water	2'221
Organic matter	19'762
Carbonic acid	10'672
Sulphuric acid	3'670
Phosphoric acid	0'903
Potassium oxide	1'481
Sodium oxide	0'915
Calcium oxide	5'542
Magnesium oxide	2'018
Aluminium oxide	0'167
Metallic iron	0'296
Sesquioxide of iron and metallic iron	1'215
Oxide of nickel	0'046
Oxide of cobalt	0'005
Silica	49'982
Loss	1'074
	100'000

The specific gravity was found to be 2'344. If the proportion of iron to nickel be taken, in 100 parts it is found to be

Iron	87'84
Nickel	12'16
	100'00

Zenite contains

Iron	85'00
Nickel	14'00
	99'00

A notable feature revealed by the analyses was the similarity of the composition of the dust collected from various localities and at different epochs. Thus the specific gravity of fifty specimens collected within such wide limits as Genoa, Palermo, Padua, Syracuse, Naples, and Potenza, varied from 2'31 to 2'71; the organic matter from 19'76 to 22'00, the oxide of calcium from 4'92 to 6'00, and the silica from 47'90 to 53'14. From this Macagno and Tacchini are led to observe in an emphasised paragraph: "*Questo fatto, mentre ci induce ad ammettere costante l'origine di queste polveri, potrà forse portare qualche luce sulla storia delle correnti aeree che le hanno trasportate.*"

A microscopic analysis revealed the presence of transparent and opaque polygonal crystals, black granules of metallic iron, and of magnetic oxide of iron, feldspar, carbonate of calcium and sand, various vegetable substances and spores were observed, *Palmella cruenta*, *Protooccus nivalis* v. *fluviatilis*, and *Discerca purpurea*.

Professor Tacchini considers that the dust is of terrestrial origin, and that it is brought from the Sahara, being raised into the higher regions of the atmosphere by cyclones and whirlwinds, where it may remain suspended during transport for several days. A barometric depression invariably accompanies the fall of the dust.

A notable deficiency of oxygen in the air was observed by Macagno during the prevalence of the scirocco at Palermo: Thus on March 20th, 1879,

it was found to be 19'994 in 100 parts of air, and on April 15th 19'998. Tacchini suggests that as the Sicilian scirocco is undoubtedly a wind coming from the African desert—a vast area devoid of vegetation—and as the ordinary Palermitan air is from a district highly cultivated and with abundance of vegetation, it is presumably that as the supply of oxygen to the air is dependent upon the decomposition of carbonic acid by plants, the deficiency in the air of the scirocco is due to the absence of plants in the Sahara.

As to the metallic iron, Tacchini cites the well-known occurrence of native iron in Greenland and elsewhere, and he considers that the iron dust of the Sahara may result from similar causes to those which have provided iron elsewhere. Iron would rust very slowly in the dry air of the Sahara; moreover if it received a superficial coating of rust it would be more or less protected from the action of the air. Bunsen considers that native metals have sometimes been reduced from their ores in the earth by hot volcanic hydrogen. This would account for the presence of metallic iron in various parts of the earth.

In the concluding remarks Tacchini sums up the results obtained by himself and his colleagues, as follows:—

Granules of metallic iron, of diameters varying from '009 to '041 mm., were found in the scirocco dust of 1879. Chemical and spectral analysis also revealed the presence of nickel, cobalt, and abundance of the alkaline metals. The similarity of the composition of this dust from various localities compels us to assign to it a common origin. It was always brought to the surface of the earth by a small descending cyclone, and a barometric depression always preceded its fall. The wind had a very high temperature, sometimes as much as 45° 4' C. (104'9° F.). Its velocity varied from 19 to 69 kilometres per hour. Finally, without attempting to decide whether the metallic iron in the dust has a cosmic or telluric origin, the phenomena of the dust storms of Sicily is *puramente terrestre*, and due to a cyclone which transports the dust from the African desert.

G. F. RODWELL.

NEWTS NEAR LONDON.—I shall feel greatly obliged if any one can tell me of a locality not too far from the City where I could catch specimens of some of our newts. I have tried Clapham Common and Blackheath. I can get plenty of water snails and sticklebacks at both places, but not any newts or beetles. At Southampton Common, where I have been living, I could procure them by hundreds, and I do not like to see my aquarium without them now. I know I can buy them, but bought specimens are not to me like my own collecting.—*S. Roberts.*

THE STRUCTURE AND LIFE-HISTORY OF A SPONGE.

By PROFESSOR W. J. SOLLAS, M.A., F.R.S.E., F.G.S., &c.

THE presentation of a tolerably complete account of any single species of sponge is a matter of considerable difficulty, since, notwithstanding the existence of many hundreds of species of sponge, which have been made known to us by excellent figures and descriptions, there is not one of which the complete life-history is known. That of which the history makes the nearest approach to completeness is the calcareous sponge, now known to naturalists under the name of *Sycandra raphanus*.

General Form.—This little sponge, not more than three or four mm. (i.e. $\frac{1}{8}$ th of an inch) in height, presents us with a variety of forms, being sometimes spindle-shaped, fig. 95, sometimes ovate, at others, turnip-shaped, and occasionally almost spherical. Sometimes it is supported on a short stalk, and sometimes it has no stalk, or is sessile. Internally it is hollow, like a sac, the walls, or sides of the sac, being 2 mm. thick, and the internal cavity about 2 mm. across. The sac is closed below, but opens above by a circular or elliptical mouth, which is surrounded by a graceful fringe of slender needle-shaped spicules, composed, like the rest, of the spicules of the sponge, of carbonate of lime, and an organic substance known as "spiculin."

The spicules of the fringe, or corona, are sometimes seen in movement, now diverging from each other till they give to the corona the form of an inverted cone, and again approaching one another to form a cylindrical tube. The surface of the sponge is covered all over by erectly projecting spicules, which render it hirsute.

General Movements.—With the exception of the movements of the spicules in the corona, the sponge gives very few signs of life, so that at first sight one might almost regard it, as indeed the older naturalists did regard it, as a plant. It is, however, in every respect a true animal, lively enough in its way, and of wonderfully complex structure.

That it is not quite so inert as it seems may be easily shown by putting a little finely-powdered indigo into the water in which a healthy specimen is confined. The particles of colouring matter will then be observed to make their way towards the general surface of the sponge, over which they spread themselves, and then disappear below it. After being lost to sight for a little while they reappear, not over the surface where they went in, but streaming out of the central mouth in a powerful current. From this we may infer that minute currents are entering the sponge through its general surface, passing through its walls into the central cavity, and then outwards by way of the mouth.

General Structure.—So far the sponge has been regarded simply as a hollow sac, but the walls of the sac possess a somewhat complicated structure, which we must now describe. Commencing from the inner

and conical at the other end, and except that it is hexagonal in section, somewhat similar in form to a chemist's test-tube. These tubes radiate from the gastral ostia to the exterior of the sponge, and constitute, lying side by side, joined close together, the greater part of the sponge wall. By holding together a number of test-tubes, and supposing them to be joined along their lines of contact, we shall gain a fair idea of this arrangement. Further, it will be seen that, however close the test-tubes lie to one another, narrow three-sided canals will remain between them, one such canal between every three mutually adjacent tubes. Precisely similar canals are left between the tubes of the sponge,

and are known as inter-canals, whilst the tubes themselves are termed radial tubes. The radial tubes have not continuous walls like those of a test-tube, but are perforated all over by a number of minute apertures, or pores. Those pores which occur over the projecting conical ends of the tubes open immediately to the surrounding water; those which occur along the sides of the tubes, where they are not in contact, open into inter-canals, and so indirectly into the outer water, while those finally, which occur along the line of union of the radial tubes serve as a means of communication between these tubes, and do not open into the outer water at all, except, of course, by way of the stomach through the mouth.

Histology.—The proper wall of the stomach, and alike of the radial tubes, consists of three layers of tissue, an outer, or ectoderm; an inner, or endoderm; and a middle, or mesoderm.

The *ectoderm*, which, as it forms the outer layer of the sponge, extends over the exterior of the radial tubes, and so lines the inter-

canals, consists of a single layer of plate-like polygonal cells, 0.015 to 0.025 mm. in diameter. Each contains a circular cake-like nucleus, bounded by a nuclear membrane, and full of watery fluid, in which

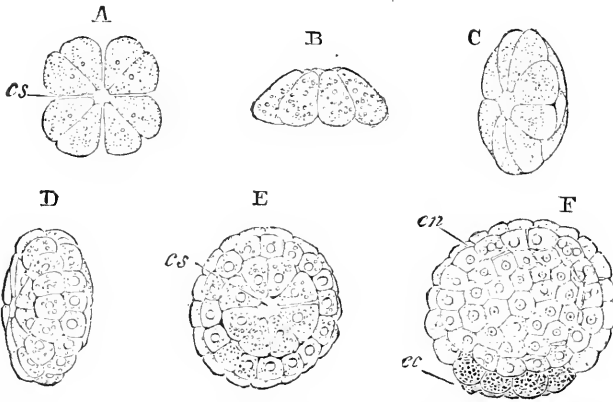

Fig. 94.—Successive stages in the segmentation of *Sycandra raphanus*. (Copied from F. E. Schulze.) A, Stage with eight segments still arranged in pairs, seen from above; B, side view of stage with eight segments; C, side view of stage with sixteen segments; D, side view of stage with forty-eight segments; E, view from above of stage with forty-eight segments; F, side view of embryo in the blastosphere stage, eight of the granular cells which give rise to the ectoderm of the adult are present at the lower pole; *cs*, segmentation cavity; *ec*, granular cells, which form the ectoderm; *en*, clear cells which form the endoderm.

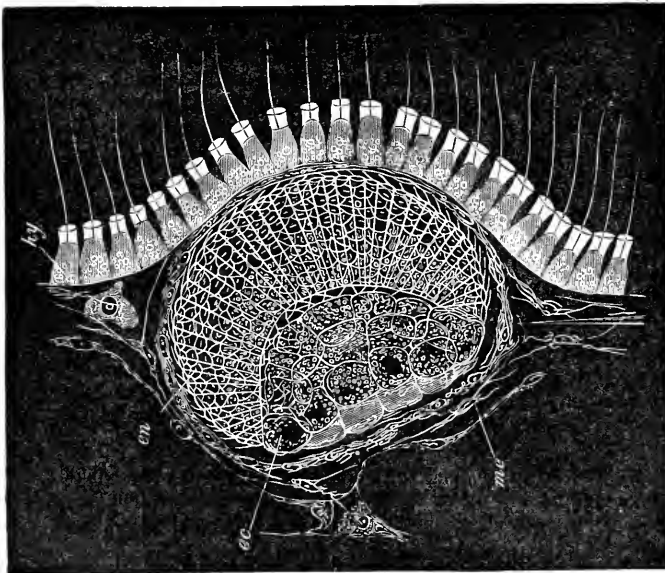

Fig. 95.—Larva of *Sycandra raphanus* at pseudogastrula stage, in situ in the maternal tissues. (Copied from F. E. Schulze.) *me*, Mesoderm of adult; *hy*, collared cells, or endoderm, of adult; *en*, clear cells of larva, which eventually become involuted to form the endoderm; *ec*, granular cells of larva, which give rise to the ectoderm; at this stage they are partially involuted.

face we find first a membranous lining, perforated by a great number of small holes, which are called mouths, or ostia, and because they open into the stomach, stomachal mouths or gastral ostia. Each is the open end of a thin-walled tube, which is closed

are suspended two or three very refractile granules, or nucleoli; the protoplasm in the centre of the cell, surrounding the nucleus, is more or less granular, but towards the margin perfectly clear.

The *mesoderm*, which succeeds, is of a very different nature: the great mass of it consists of a clear trans-

cells pass into others of a simpler form, by losing their branching processes, and becoming fusiform. The fusiform cells so produced are of considerable length, and lie in parallel bundles concentrically round the edges of the gastral ostia; and since they have the property of shortening in the long

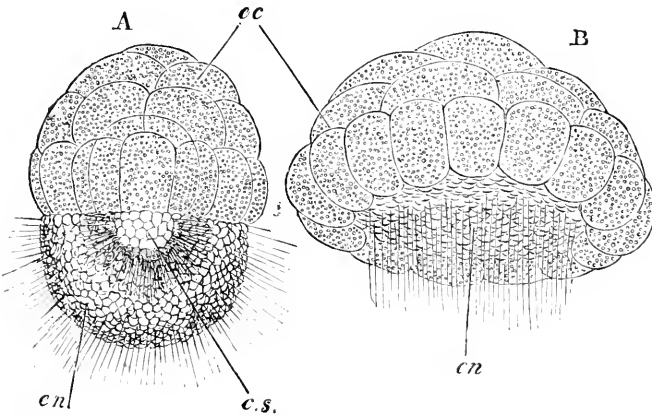

Fig. 96.—Two free stages in the development of *Sycandra raphanus*. (Copied from F. E. Schulze.) A, Amphiblastula stage; B, a later stage, after the ciliated cells have commenced to become invaginated: *cs*, segmentation cavity; *ec*, granular cells which form the ectoderm; *en*, ciliated cells, which become invaginated to form the endoderm.

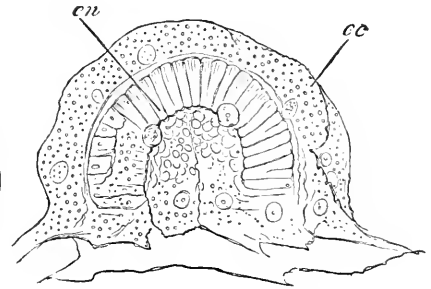

Fig. 97.—Fixed gastrula stage of *Sycandra raphanus*. (Copied from F. E. Schulze.) The figure shows the ameboid ectoderm cells (*ec*) derived from the granular cells of the earlier stage, and the columnar endoderm cells, lining the gastral cavity, derived from the ciliated cells of the earlier stage; the larva is fixed by the ameboid cells on the side on which the original mouth opening is situated.

parent jelly-like material, which does not stain with carmine or other colouring reagents; dispersed through this jelly-like matrix are numerous cells of branching form. Each contains in the middle a long oval nucleus, with spherical nucleolus, and is surrounded by finely granular protoplasm, from which are produced a number of fine irregularly branched filaments, which anastomose with similar filaments from similar adjacent cells. In general terms, therefore, this tissue may be said to consist of a network of protoplasmic cells immersed in a quantity of clear indifferent jelly; the jelly, in all probability, being derived from the contained cells by metamorphosis. Altogether the tissue most closely resembles the jelly-like tissue of the disc of the medusa, or jelly-fish, and is also related to the embryonic connective tissue of the higher animals.

The matrix of the mesoderm serves as a medium for two other forms of cells, in addition to the stellate or branched ones; in some parts of it, particularly in the neighbourhood of the gastral ostia, the stellate

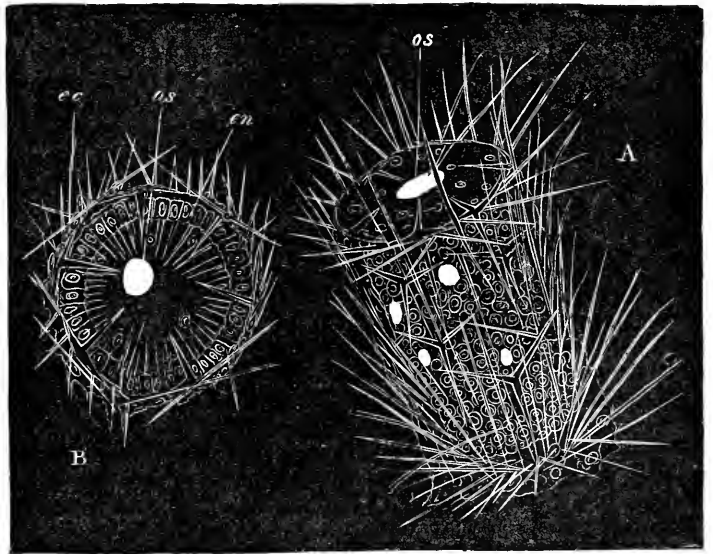

Fig. 98.—The young of *Sycandra raphanus* shortly after the development of the spicules. (Copied from F. E. Schulze.) A, View from the side; B, view from the free extremity; *os*, osculum; *ec*, ectoderm; *en*, endoderm, composed of ciliated cells. The terminal osculum and lateral pores are represented as oval white spaces.

direction, and broadening in the transverse direction, under the influence of a stimulus, they serve as muscular sphincters to the ostia, closing them when irritated and opening them again on relapsing into their normal state. The third kind of cell found in this tissue is probably the least differentiated, and is

possibly the parent form of the others ; it is a little mass of protoplasm, containing a nucleus and nucleolus, and closely resembles an ordinary amoeba, or nucleated blood-corpuscle, thrusting out pseudopodia in various directions during life, and moving freely by their means through the surrounding medium.

The innermost layer, or *endoderm*, forms a continuous lining to the inner wall of the stomach and radial tubes, meeting at the edges of the pores and mouth, the outer layer of plate-like epithelium or *ectoderm*. It consists, except over the stomach, where it has the same structure as the *ectoderm*, of more or less flask-shaped cells, each having a nearly spherical body, flattened below, where it is seated on the inner face of the *mesoderm*, and rounded above and prolonged into a long neck or *collum*. Near its end the *collum* is surrounded by a delicate collar of transparent sarcode, which gives it the form of a wine-glass. From the end of the *collum* is produced a long filament of hyaline protoplasm, known as the *flagellum*, because it flagellates the surrounding water.

The cell, in general, consists of a more fluid granular central protoplasm, or *endosarc*, surrounded by an outer firmer transparent contractile layer, or *ectosarc*. It is the *ectosarc* which is extended to form the collar and *flagellum*, which we may regard as highly specialised derivatives of pseudopodia. In the *endosarc* is a conical nucleus, surrounded by numerous granules, and some little blebs of watery fluid, known as vacuoles. Altogether the cell closely resembles some forms of infusoria, and it is of such cells, arranged close together, side by side, that the *endoderm* of the radial tubes is wholly composed.

Before describing the remaining tissues of the sponge, it will be convenient to introduce here a short account of its physiology, so far as the knowledge we have now attained of its structure makes it possible.

The flagella of the endodermic cells, which, as we have already noticed, form a continuous lining to the inner wall of the radial tubes, are almost always in motion, bending downwards with a rapid movement in one direction and then returning to their position of rest, and doing this so rapidly that the eye cannot follow them in the active state, so that usually they are quite invisible. Each movement of the flagellum "flicks" the water, as it were, in one direction, and the rapid successive movements of the almost infinitely numerous flagella drive the water out of the radial tubes into the stomach of the sponge, from which it emerges, as we have already stated, in a powerful stream through the mouth. But as water is driven out of the radial tubes the pressure within them is diminished, and to restore equilibrium,—to supply the place of the water which has been expelled,—fresh water flows in from the interior through the pores at the ends of the tubes, and also, after passing down the inter-canals, through the pores at the sides of the tubes.

The circulation thus established from the pores through the radial tubes into the stomach, and so out through the mouth, is the means through which, as we shall now see, the nourishment and respiration of the sponge are carried on.

The water in which the sponge lives is inhabited by a large number of infusoria and other minute forms of life, and contains, besides, many small particles derived from decaying organisms ; these enter the sponge, borne along with the inflowing currents of water, and are seized upon by the flagellate cells of the *endoderm*, as they pass through the radial tubes.

The manner in which the flagellated cells extract their food from the water is worth noticing ; it is precisely similar to that in which the flagellated monads, which so closely resemble these cells, feed. No sooner does a little particle of food touch the edge of the delicate collar which surrounds the *collum*, than it adheres to it and is carried down by currents that circulate up one side of the collar and down the other to the end of the *collum*, in which, along with an accompanying drop of water, it becomes at once engulfed. If the particle should come directly in contact with the *collum* itself, it is engulfed in the same way. The included drop of water, enclosing its particle of food, travels down the *collum* into the base of the cell, where it forms a little "bleb," which we have already noticed as a "vacuole." The food of the vacuole undergoes digestion, and when all the "goodness" has been got out of it, the indigestible residue is extruded from the cell, through an extemporised aperture, to be forthwith swept away in the torrent of the circulation, through the stomach, and then out by the mouth. In this way each flagellated cell eats and drinks, living to itself. It also breathes, the water which conveys its food containing dissolved oxygen, which passes into the cell by osmosis. Thus with food for fuel, and oxygen to burn it, the cell is provided with energy, which it expends in maintaining the water circulation, from which it obtains food and oxygen again. Though each cell lives its own life, yet the different cells all work more or less in unison ; thus when they have taken enough food to satisfy their wants for the time, they frequently rest together to digest it ; more or fewer of them cease to lash the water, the ostia and pores are closed by the contractile sphincters, which also seem to be in sympathy, and the circulation goes on feebly, or, for a time, altogether stops, to begin afresh when digestion is completed, and hunger urges the cells to renewed activity. Though the flagellated cells live each, as has been stated, their own life, yet it is no less true that each lives for the rest of the organism, as indeed must happen in all organised communities. The nutrition received is, under favourable circumstances, more than enough to make good the loss of substance involved in work, and the surplus leads to that increase in size which is termed growth.

But to increase in size there is in every individual

a limit, which overpassed usually leads to division, and thus soon after the flagellated cell has passed its full size, a constriction makes its appearance transversely round the basal part, and extends inwards till the lower part of the base is completely severed from the rest; in this way the single cell becomes two, one of which retains its original character, while the other resembles an amœba, and making its way into the mesoderm lives a wandering life, possibly like a colourless blood corpuscle, serving as a food-carrier to the rest of the organism. This is the origin of the third kind of cells which we mentioned as forming a part of the mesoderm. The splitting or fission of the flagellate cell is not always transverse; sometimes it is longitudinal, and then produces two similar flagellated cells, instead of a flagellated and an amœbi-form cell. It is by longitudinal fission that the endoderm grows in extent, correspondingly with the growth of the surface it covers.

(To be continued.)

RECORDS IN RIME OF THE GREAT ICE AGE.

IF you'd study human nature
E'en when science is the teacher,
Read review in "Nature's" page
Treating of the "Great Ice Age,"
And of "Europe Prehistoric"
Writ in language simple Doric!
Can we wonder Doctor Geikie
Thought the language rather "cheeky,"
Or that his temper got as hot
As ice in a Carnelly pot?

Dawkins said things rather spicy
Of the age called "Great" and "Icy."
True; ever since the great Agassiz
Lesser lights would make a fiz.
First and foremost there is Croll
Would clap a cap on either pole,
So big it scarce could ever melt
If as improved by Mr. Belt.
And certainly we've had our fill
Of grand moraine and Scottish till,
Till mention of the great ice age
Puts non-believers in a rage.
Or even the incessant finding
All things due to glacial grinding
Of shells of ocean landed flop
Upon the highest mountain top.
Can ice the ocean floor clean?
Go tell it to a "horse marine,"
Or to the rainproof Macintosh,
Who discounts subaerial bosh.
Thus high imagination soars
With big or little glacial bores;
For in this subject scientific
Men's brains get subtle and prolific,

And when of frozen waters treat,
You'd think it was an age of *heat*.

Dawkins thought it rather creekie,
Pet theory of Doctor Geikie.
Jamie Geikie thought that Dawkins
Had better far restrict his talkings
To things he understands—say bones,
Or adopt politer tones!
But neither of them can unravel
The mysteries of river gravel:
Post, præ or *inter*, which is true
Depends upon your point of view.
Should "upper" glacial overlap
Its *inter*-glacial gravel slap;
But if the "upper" overlies,
It quickly to *post*-glacial flies.
If "lower" glacial cap, we're free
To stick the gravel down as *præ*.
So as we use these symbols mythic,
Flint implements are *neolithic*,
Or *palæo*—or in a span
We get to *inter*-glacial man.
For in this way the icy sages
Split the beds with glacial wedges,
And easily escape the trammels
Of the great post-glacial mammals.
But which is which if Nature mask,
"Lower" or "Upper"? you may ask.
We answer in the softest voice,
"You pays your money and takes your choice."

Boyd Dawkins places under ban
The ice renowned Tiddeman;
And Tiddeman, upon his mettle,
Tries his antagonist to settle.
Not with post-tertiary stone,
But with *one* pre-glacial bone—
A *human* bone discovered where
It got completely mixed with *bear*.
Lord! how such a bone is nosed
By any one that's *præ*-disposed.
At all events, Boyd thinks it "rum"
Or *perfervidum ingenium*
Of industrious Tiddeman
To fondle his pre-glacial man.
Still, no doubt, if he *were* there,
He is and was a *settler*!
How difficult to end our verses
On these *endless* controversies!
Ice theorists in their profusion
Leave us in profound confusion,
To please the sage geologist,
Whose brain is up in cloud and mist.
From all the like great Jove defend,
Oh! bring this ice age to an end;
And where their confluent glaciers meet,
Just wrap them in their *winding* sheet.

A. CONIFER.

MICROSCOPY.

MOUNTING STARCHES.—A. J. D. should have warned persons who adopt his plan of mounting starches that an excess of heat will cause the granules to burst, and that if that should take place nothing will be visible in the balsam. The safest plan is the old one, that is to mix the starch with a little cold water, place a drop of the mixture on the slip, and then let it dry thoroughly. Before applying the balsam it may be well to place a drop of turpentine on one side of the patch. By tilting the slide, this will run into it and facilitate the combination of the balsam.—*J. V. J.*

PRESERVING FLUID.—The recipe given by R. Atkins is not very intelligible. What is "alkaline nitrate of chlorine," and what "aniline com.?"

THE CRUST ON TEETH.—A great deal of information on the subject will be found in a paper by Dr. Arndt (Virchow's Archiv, 1890, p. 76) who, amongst the numerous other organisms (Bacteria, Bacilli, Vibriones, &c.) discovered *Spirochate denticola*, consisting of spirally coiled threads about 0.01-0.02 μ in diameter and 5-20 μ long. The number of coils varies from 1-10, and they have a uniform vermiform motion. The complete history of the organism is at present unknown, but Dr. Arndt regards it as probably a stage in the development of true Bacteria. Mr. H. T. Butler in the "Proceedings of the Royal Society," xxviii. p. 484, also describes his examination of the fur on the tongue, of which schizomycetes forms the essential constituent. The slime around the teeth was found to consist of nearly the same fungi.—*Frank Crisp.*

IMPROVED ZOOPHYTE TROUGH.—Mr. J. J. Howell's note, which appeared in the June number of SCIENCE-GOSSIP, contains one or two errors which I wish briefly to correct. I invented the trough in question about three (not seven) years since, and after sufficient trial brought it before the Liverpool Microscopical Society. Some time afterwards it was brought before the Royal Microscopical Society and the Quekett Club (but not by myself), and was figured in the Journal of one or both. Subsequently an "improved" form of the trough, in which vulcanite plates were substituted for brass ones, was brought before the Royal Microscopical Society by Messrs. Beck. I have not tried vulcanite, which no doubt has advantages in some cases, as for instance where marine organisms are under examination, but for general use I prefer brass, as it allows thinner plates to be used, and a flatter bevel consequently to be obtained; this is an advantage when higher powers than the one-inch are used. The "improved" troughs I find are fitted up with thick glass, which is a mistake, as by using thin glass for both back and front a half-inch objective will focus to the back of the trough, and high powers, say up to the one-

sixteenth immersion can be used to examine objects on or near the front glass. Thin glass also allows a much better dark ground to be obtained with paraboloid or achromatic condenser. For keeping the glass apart I have found the "extra thick" india-rubber bands the most generally useful; and in putting the trough together care must be taken to have india-rubber and glass perfectly dry, as otherwise there is danger of a capillary leak and consequent disappointment.—*Charles Botterill, Liverpool.*

"MANUAL OF THE INFUSORIA."—Part iv. of this invaluable work to microscopists has now appeared, and there is no doubt that each instalment raises its reputation in the opinion of competent judges. This part brings the letter-press up to page 576, and, like all former parts, it contains eight large and exquisitely-finished plates, on which are displayed about four hundred figures of Infusoria, in addition to woodcut illustrations distributed through the text. We heartily congratulate author and publisher on the success of this great undertaking.

"THE NORTHERN MICROSCOPIST."—The June number of this ably conducted magazine contains several capital articles on "Aerial Spores" (illustrated), "Double Staining," and very full notes of the proceedings of the northern microscopical societies.

"PORTFOLIO OF DRAWINGS."—We have received No. 5 of Mr. Thomas Bolton's admirable series of drawings, accompanied by short life-histories of the microscopic objects he is in the habit of sending out to his clients. They include *Protococcus nivalis*, *Ophrydium*, *Clava squamata*, *Syncoryne frutescens*, *Caprella lobata*, *Bowerbankia imbricata*, *Pedicellina*, *Alcyonidium*, &c.

ZOOLOGY.

THE SKELETON WHEEL-BEARER.—Your correspondent Mr. Roseter, in sending you the description and sketch at p. 112, SCIENCE-GOSSIP, May, 1881, has quoted Cooke's "Ponds and Ditches," and in doing so has copied a mistake in that work. The references to notes 2 and 3 at p. 170 of "Ponds and Ditches" should be reversed; it will then be seen that the skeleton wheel-bearer is a *Dinocharis*, of which Cooke mentions two species, "*D. Pocillum*" and "*D. detractus*," while *Ceratophyllum*, or hornwort, is a weed among which these small Rotifera are found. If the note (2) against hornwort in text be altered to (3), and the note (3) to (2), it will be right, but SCIENCE-GOSSIP should have the correction also, as there is no such Rotifer as *Ceratophyllum*.—*G. D. Brown, Ealing.*

PARASITE OR HYDRA.—In reference to the paragraph in the May number of SCIENCE-GOSSIP

concerning some parasites found upon *Iydra fusca*, your correspondent may be interested to know that on Good Friday last I found, in a pond at Epping Forest, several specimens of the above zoophyte, and on all of them parasitic Infusoria. I had no doubt at the time that the Infusorian was the *Trichodina pediculus*, and I found on referring to the Micrographic Dictionary (article Hydra) that my surmise was correct, and that both *T. pediculus* and *Kerona polyporum* are sometimes found upon hydra, and considered to be an indication of want of vigour and imperfect health. I must say, so far as my specimens were concerned, I saw nothing to warrant this conclusion.—*J. A. S.*

HYALINA DRAPARNALDI.—In reply to your correspondent Mr. Charles Hedley, of Mentone, I beg to say that after my sending the notice that appeared in April of my having found *Iyalina Draparnaldi* (Beck) in England, I received a letter from Mr. Gwyn Jeffrey, in which he claims that the Clifton shell is his variety compacta of *Zonites cellarius*. If therefore it is to be called a variety of cellarius at all, it had better rest under his name. But as all Continental authorities consider it a distinct species, and it is published under the name of *Iyalina Draparnaldi* in all catalogues, books, &c., it seems to me a great pity to add to the many complications of conchology by giving it another name. I have been told by good authority that it proves itself quite distinct from cellaria, and is the type of a little isolated group. For further information on the subject, I can refer Mr. Hedley to Herr Clessin, of Ochsenfurt, or Dr. Boettger, of Frankfort-on-the-Maine—both are courteous and learned men and have gone deeply into the subject.—*J. Fitz-Gerald, Folkestone.*

LARUS ATRICILLA v. LARUS RIDIBUNDUS.—Under the above heading J. D. in your last issue says in giving the Latin synonyms of the laughing gull, and the common black-headed gull, I “make the mistake of calling the former *L. atricilla*, and the latter *L. ridibundus*.” I did not enter into the synonymy of the two species, but used the name by which each is best known to British Ornithologists, and I fail to detect the error to which J. D. refers. With regard to the strictures referred to in previous communication, I cannot think them too severe; such instances have become so frequent of late, and want of accuracy in such records is so misleading, that it behoves the recorder to take every precaution before publishing the occurrence of any species the identity of which it is at all difficult to determine.—*T. S.*

TURBELLARIA.—In many ditches and sluggish streams are to be seen multitudes of little black moving objects, which when touched, or taken out of the water, immediately contract into what looks like a drop of black jelly. They glide over the surface of the soft mud, or on the surface of the water

with their backs downwards, by a slow steady movement, but how this locomotion is effected is not seen. Close examination, however, leads us to conclude at once that it is due to a succession of minute contractions and elongations, which ordinarily are quite imperceptible. They have a sucker at one end, and are extremely like microscopic leeches—to which indeed they are closely allied, for I take them to be Turbellaria. In size the common species vary from that of a good-sized Rotifer to about half an inch in length. It is said that some species attain the length of several feet.—*C. Francis Young.*

BOTANY.

PETALS, A DEGRADED FORM OF LEAVES.—In Mr. J. E. Taylor's valuable book upon flowers, there is much that is exceedingly interesting and suggestive of thought with respect to petals being in fact degraded or modified leaves, with suppressed internodes and an arrangement in whorls. Mr. Taylor's arguments appear in the present condition of our knowledge to satisfactorily demonstrate the truth of this theory; but there is one circumstance which seems worthy of consideration, namely, that so little resemblance exists between leaves and petals as regards form. Maybe the degradation or modification affects the form as well as the colour and other characteristics, but I do not see it anywhere suggested that such is the case, and it would, I think, be a greater and less easily explicable effort of modification to alter the forms of leaves than to alter their colour or arrangement.—*F. H. Habben, B. A.*

DAFFODIL.—On Easter Monday, the 18th of April, I gathered in Eastnor Park, near Ledbury, a curious form with only five perianth segments, and five stamens, the crown being split to the base, and rolled back, from which protruded the apparently metamorphosed sixth stamen, a long tongue-like appendage, lobed and crisped of the same colour as the corona, springing from its inner base, and extending about half an inch beyond it.—*A. D. Melvin.*

FERNS PROPAGATED BY CUTTINGS.—Is it generally known that ferns may be propagated from cuttings of the fronds? At the instance of an acquaintance I made the experiment with about three inches of a bipinnate frond. The pinnæ of one side were cut off, the rib laid lengthwise, with its extremities a little deeper in the soil, and an inverted tumbler put over it to keep it moist. In a short time small fronds were developed from the base of the remaining pinnæ.—*Duncan Adamson, Motherwell.*

FLORA OF WARWICKSHIRE.—We are glad to see that Mr. J. E. Bagnall is continuing his contributions to the “Midland Naturalist” on this subject.

PERIDERMUM PINI, CHEV.—This rare fungus has appeared in considerable abundance upon some Scotch fir-trees near King's Lynn during the present month (June). For the past ten years I have been looking out for it but without success, until the present occasion. As far as I know it has hardly, if at all, been found in England, during the past five-and-twenty years. The Rev. M. J. Berkeley, in a note in the "English Flora," says, "occasionally occurring in England, especially in young plantations." The variety which has occurred here grows upon the leaves and is the *Peridermium acricolum* (Link). Cooke, Micro-Fungi, p. 124. As many of your readers take an interest in leaf fungi, it would be very interesting to know whether this fungus has appeared elsewhere in England; and if so to what extent.—*Charles B. Plowright.*

Erratum.—At page 123, 26 lines from bottom, for "dwarf form of *Bavarica*" read "dwarf form of *verna*."

GEOLOGY.

FOSSILIFEROUS PEBBLES IN THE DRIFT IN WARWICKSHIRE.—The Rev. P. B. Brodie, M.A., F.G.S., has just read a paper on this subject before the Geological Society. The author notices some previous remarks upon these pebbles, which, in Warwickshire and elsewhere, either occur in the Trias or have been derived from it. To account for these, he supposed that there had been a more northerly extension of Silurian rocks than can now be detected in central England. The Lickey quartzite has been supposed to have contributed some of these; but the author states that he has not found any one well-defined Llandoverly species, but that the most characteristic are Lower Silurian. These pebbles are most abundant south of Birmingham, towards Warwick and Stratford-on-Avon. They agree lithologically with the Budleigh-Salterton pebbles; these, as it has been shown, are partly Lower Silurian, partly Devonian, partly Carboniferous. The author gives a list of species collected by him from the Warwickshire pebbles. Sixteen are present from the twenty-four Lower Silurian forms found in Devonshire. Notwithstanding their identity, physical considerations forbid the supposition that they have been derived directly from that locality or Normandy, so that it is probable these Lower Silurian quartzite rocks once extended much farther to the north. In the discussion which followed, the president remarked that the subject was a difficult one, but the species, as stated by Mr. Brodie, were no doubt correct. At Budleigh-Salterton it was easy to tell from whence many of the pebbles had been derived; but in the Midland counties it was most difficult. Mr. Ussher said that the occurrence of the same fossils did not

prove that the pebbles were from the same area, and that the drift of the paper was not quite clear from its title. Professor Bonney thought it a most valuable addition to our knowledge, and was glad that such a contribution had been evoked by his own slight paper. He thought it almost certain that there were two sources for the quartzites, and that all the fossiliferous specimens could not have come from the Lickey, as some had been found at Nottingham. Probably ancient rocks had extended to the north-east of England, beyond those discovered in borings at Northampton, and to the north-east of those exposed at Charnwood.

ON THE ORIGIN AND FORMATION OF CHALK FLINTS.—In reference to my letter in SCIENCE-GOSSIP for January, and Dr. Wallich's in March, I beg to say that this gentleman has kindly forwarded to me extracts of his paper from the "Annals and Magazine of Natural History." I cannot accept his theory of flint and chalk, partly for the reasons given in January, and because I find that he makes liquid silica, which is a primary matter, dependent on protoplasm, on slime which is called by himself a residuum. Dr. Allman, as president, gave the history of this Bathybius to the British Association at Sheffield, and told the assembly that the scientific men in the "Challenger" found no trace of it all round the world. Dr. Wallich allows that no light was thrown by those investigations on the formation of the flints on the sea bottom. I used that fact as evidence that they were not formed on the surface as Dr. Wallich says they were. Again, this gentleman seems to think that what he calls the Amoebiform shape of flints was a voluntary action. I say the flat sheets, the round balls, the various casts, and the varied shape nodules were all involuntary forms, given by the pressure of the surrounding mud or by moulds that the silica fell in with, to its percolating matter. While admiring Dr. Wallich's ingenuity on the subject, I must adhere to the system first laid down in chap. x. of "The Circle of Light on Dhamallgen," in 1869, and say again that the flint layers are formed by the percolation of liquid silica through the new deposit on to the face of the old deposit. It is the only way in which the two formations could be parallel.—*J. P. Malet, Florence.*

NORWICH GEOLOGICAL SOCIETY.—The last number of the "Proceedings" of this society contains a very able address by the president, Mr. J. H. Blake, F.G.S., dealing chiefly with the geological position of the common forest bed.

"CLOUD HILL."—By this title a paper has been published by Mr. W. H. Goss, F.G.S., written for the North Staffordshire Naturalists' Field Club on the occasion of their recent excursion to Cloud Hill, near Congleton. It is an able disquisition on the "Origin of the Millstone Grit, Clay, and Ironstone; on the

Geology of the Cheshire Plain, and on the Disposition of the Flora of the Carboniferous Period in the Coal Measures."

ICE ACTION IN WALES.—A few mornings ago, when close to the Little Orme's Head, on the Llandudno side, I noticed a large mass of the carboniferous limestone of the district, that appeared to have been detached from above by wave action, and to have fallen on to the beach, two of the surfaces of which block were distinctly and largely striated by ice action, while part of the surface was planed over comparatively smooth, in the usual form. One groove was about sixteen inches long, another about nine, both large and deep; very many, and some minute striæ passing along the faces. It would seem to have been in the line of ice action, when probably high up on the Little Orme which is now being slowly reduced by power of the sea. I am not aware if other similarly marked masses of the rock are there to be seen, having but once or twice visited Llandudno, and then only for a short time. While upon this subject, I may mention the largely planed-off lower slopes of the mountains sinking down into the valley of the Dwyryd, where the waters of various valleys unite to drain the southern slopes of Moel Wyn and the Manods chiefly, planed off, mainly in broad flat surfaces, not found by the eye from similar distance in any part of the great and frequently precipitously steep sides of Moel Wyn, and presenting a marked contrast to ordinary water action, so well seen near here in the grand bed of the torrent Cynfael.—*Horace Pearce, F.G.S.*

NOTES AND QUERIES.

AN APPEAL.—There are few fields in which the microscope rewards the observer more richly than the study of botanical objects. They abound on every side, and only require as a rule low magnifying powers. As botany is the one branch of science with which I have any acquaintance, it has naturally been my chosen study for the microscope. I wish however to ask the sympathising aid of any of your readers who may be devoting themselves to the same pursuit, and have overcome some of the technical difficulties with which it is beset. The popular works on microscopy do not as a rule give practical help in the matter. They point out in a most attractive way the objects to be selected, but do not enter sufficiently into the particular mode of preparing special objects. May I enumerate a few which I have failed to prepare, and ask for practical advice from your readers? *Deutzia* leaf, stellate scales on cuticle &c. I have boiled in nitric acid, but find that it makes the cuticle too tender to handle, and does not remove the chlorophyll from the scales. Wanted a satisfactory solvent for this and other leaf tissues, leaving the cuticle clean and entire. Spiral vessels: the books give beautiful pictures of spiral vessels from lily, ringed vessels from rhubarb, &c. How can these be got clean and entire? Wood-cells also form a prominent feature in such books. How are they to be treated? I have seen various

solvents suggested, such as copper turnings dissolved in ammonia, and chromic acid with addition of sulphuric acid, for these purposes. What I want to learn is what solvents should be applied to the different classes of objects and how to prepare them. Possibly the subject may have been treated of in past numbers of SCIENCE-GOSSIP; if so a reference to such numbers would oblige. Also the name and price of any book which gives exact information on the subject. Or you might think it a matter of sufficient general interest to prepare a special article upon it. I doubt not that many who, like myself, are struggling alone with the elementary difficulties of this branch of microscopy, would feel grateful for such assistance.—*Beginner.*

ASELLUS AQUATICUS.—Can you or any of your readers tell me whether this is the same as *A. vulgaris*? Judging from the picture of it in SCIENCE-GOSSIP for April (fig. 62), I am inclined to think it is. I have constantly found large numbers of *Rotifer vulgaris* attached to it, as well as the common vorticella.—*J. A. C.*

THE GREAT TIT.—I wonder why it is that people, great authorities on birds too, seem all agreed to describe the great titmouse as having nothing but harsh and disagreeable notes. These birds are great favourites of mine, and I think so differently of them that I should like to say a few words in their favour, being particularly roused to do so now by having just read an interesting article on birds by the Rev. J. G. Wood, where, to my astonishment I find it stated that the great tit utters "nothing but a single sharp grating cry," and that its voice is "peculiarly discordant to human ears." What a strange statement from so great an authority! It may seem too daring of a "small unknown" like myself to venture to controvert what Mr. Wood says, but "seeing is believing," and I have so often both seen and heard these little oxeyes uttering a number of different notes, all sweet and tuneful to my ears, that I do not like to hear them so traduced, and feel sure there are many persons who enjoy listening to them as much as I do. Quite early in the year, often in January and always in February, their sweet ringing notes are to be heard. I have listened to and watched them for years, and have never been able to hear that dreadful note like "the setting of a saw" that I read about in books on birds, unless it means a churning noise that is sometimes tacked on to the end of the other notes, but I cannot fancy that being called the distinguishing note of the bird. The other sweeter notes are louder and much more often repeated, and there is such a variety of them that I tried in vain last year to count how many different sounds there were! At the end of the paragraph about the great tits, Mr. Wood says "Even human ears are differently affected by sounds, and strange as it may appear, there are human beings who like the bagpipes." I must confess that I am one of these strange beings (if the pipes are Irish and not too near), so this will explain to Mr. Wood the reason why I differ so much from him in my opinion of the voice of the Great Tit! But I hope other champions of the Tit will come forward who will be without that unhappy bias for the bagpipes. Bird-lovers may like to hear that flocks of Siskins come here (north-west of Donegal) in winter, and some stay and breed. I have not found their nests, but have been told of them.—*Unknown.*

RAT'S NEST.—A few days ago a friend of mine, in moving some bundles of straw in his barn, discovered

a nest of young of the common brown rat, and in close proximity to it, the dead bodies of six or seven full-grown black rats (*M. rattus*). Can any of your readers account for this, or have similar cases come under the observation of any of them? I may add that the "Black rat" is more common in this barn, and the neighbouring farm-house, than is his congener.—*J. Snel.*

RATS CLIMBING TREES.—The common brown rat (*Mus decumanus*) is very abundant in Castle Eden Dene, a beautifully wooded ravine, several miles in length, in the magnesian limestone. In September last I saw two full-grown rats in a yew-tree, about seven feet from the ground. They had evidently climbed the yew in search of the fruit, which was then ripe. The gamekeepers assure me that they frequently do this, and that they occasionally climb into hazels for the same purpose. This habit of the brown rat is not mentioned in Bell's "Quadrupeds," and does not appear to be generally known.—*R. Morton Middleton, jun., F.L.S., Castle Eden, co. Durham.*

APPARATUS FOR POND-LIFE.—As the season for field meetings is fast approaching, I think that the following description of an apparatus for obtaining pond-life, especially Entomostraca, will be interesting to your readers, and enable some of them also to have help in their fishing expeditions. Having found, for a long time past, the cumbrousness and general inutility of the strained handnet for obtaining Entomostraca and water-beetles, &c., because when one has caught them, it is exceedingly difficult to get them off into a bottle readily, I have, I may say, "invented" the following apparatus, which I venture to think will supersede all forms of nets for the purpose. It does not require that one should put the net over the bottle, and dash the water up, and so draw off the animals, nor is a separate vessel required in which to immerse the net to get them off. I have adopted three-ounce wide-mouth cork-stoppered bottles, with box tops for my receptacles, as this is a very convenient size, and gives plenty of water and room for an immense quantity of live stock, as also not being too cumbersome (still, perhaps, two ounces may be thought large enough by some); however, whichever size is used, the following directions are to be observed. I have a tin tube $1\frac{1}{2}$ inches diameter, and $2\frac{1}{2}$ in. long, with its front end turned over for strength and tinned; the other end tapered in $\frac{3}{4}$ in. long to the size of the cork of the bottle 2 oz. or 3 oz. employed, and a short length of about $\frac{1}{2}$ in. of tin tube, soldered therein to fit the cork, thus making the whole apparatus about $3\frac{1}{2}$ in. long, in the inside, rather more than halfway down the large tube. A ring of strong wire is soldered and tinned, a brass gas nipple is inserted from the outside, and a ring of tin $\frac{3}{8}$ inch in width is made to fit rather tightly. On the mouth of the tube I place a small piece of fine net, and with the ring press it into the tube equally all round, and cut off all projecting parts of the net above the ring. The *modus operandi* is as follows: Having inserted the net as just described, I screw the apparatus on to my walking-stick (which may have a plain end or a screwed nipple and cap), and with both ends open, I wave it through the water of the pond or ditch, at any depth I wish; the water entering by the larger end escapes by the smaller, leaving the crustacea on the surface of the net. I then insert the cork of the bottle in the smaller end and take up some water from the pond, which will then by its reverse action wash off the animals into the bottle. The use of the cork of the

bottle obviates the necessity of a spare cork for the purpose, which is very apt to get lost. Experience has taught me not to fish too quickly, or you may get comparatively little as the large quantity of water cannot get through the net; also take care to fill the apparatus with water slowly, and not up to the brim, or you wash out what you have caught; and also let the apparatus, if possible, go into the water mouth downwards when seeking for animals, or the contained air will not be a help but rather a hindrance, especially at first when the net is dry. Of course any stick will do for the purpose, provided it is large and strong enough. I enclose drawings illustrating the apparatus. Its portability cannot be questioned, nor can its cost be beyond any collector's pocket. If a fixed net is desired it should be made of brass wire, and all parts should be well tinned to prevent rust. I think that the bottles may be conveniently carried in a belt as cartridges are. If this apparatus is of any use to the lovers of natural history in this branch, they are welcome to use my patent for nothing.—*R. T. Andrews, Castle Street, Hertford.*

BRITISH NEWTS (p. 89):—Being greatly interested in the British reptiles, I should like to ask Mr. Oliver W. Aplin whether he has seen Mr. M. C. Cooke's reasons for including *vittatus* among the British reptiles, for in the volume written by the last-named gentleman entitled "Our Reptiles," I find it expressly stated that the specimens in question were certainly taken by Dr. Gray himself in the neighbourhood of London. In a letter to Mr. Bell Dr. Gray says: "The species is found in Holland and Belgium as well as here. It must be very local in this country, as I have seen no specimens since those I caught some thirty years ago."—*W. H. Warner, Standlake.*

HABIT OF CATS.—Can any of your correspondents give any explanation of the fact that when a cat settles down for a comfortable snooze she nearly always lifts up and sets down her two forefeet alternately for a considerable number of times, the movement gradually becoming less marked?—*H. M.*

NOTES ON ANTS.—A few days ago, I put some common black garden ants into a glass with some earth, and placed it upon a tile in a pan of water, to prevent their escape. This afternoon I found some large reddish ants in the garden, and put some into the glass with the black ones; a pitched battle between one of each species ensued, in which the black proved the victor. The red ants in their hurry to escape climbed over the edge of the glass, and some fell into the water. Trying to rescue them with a straw, I inadvertently pushed one under, close to the tile, when to my astonishment, he ran along it, and continued to do so under water for ten minutes, when I lifted him out, as apparently he could not push through the surface (if one may put it so) of the water. He afterwards ran under water again of his own accord, and seemed to revel in it. On dropping a black ant into the water, he immediately sank to the bottom (whereas the red always floated), and standing on end, appeared to be seized with convulsions, and could not rise to the surface, neither could he cling to the tile. I shall be glad to know if any of your readers have witnessed these (to me) extraordinary proceedings, or whether they are already known to those who make ants a study.—*Arthur G. Wright.*

IS FOOL'S PARSLEY (*Aethusa Cynapium*) POISONOUS?—Your correspondent John Gibbs seems to take it for granted (in the April magazine) that this herb is

poisonous, whereas that idea seems, by recent research and experiment, found to be a long-standing error, both vulgar and scientific. An article written by John Harley, M.D., was published in the "Pharmaceutical Journal," November 1880, and copied, it appears, from the "St. Thomas's Hospital Reports," vol. 10, in which he says, "Here we witness on the one hand, the animus of an ancient prejudice, and a deplorable ignorance of *Aethusa Cynapium*. From my study of the plant, I was led to the conclusion that it was perfectly harmless. Shall we say that three hundred years of horror, loathing and hate, cast upon this now innocent plant, have at last purged it of its vice?" Dr. Harley then proceeds to give details of the extraction of the juice of the plant, "obtained before flowering," from the plant "in green fruit," and on the juices of the "immature and mature plants," after which he continues, "Being thus provided with carefully prepared juices of the young plant in its most succulent condition, and of the same generation of plants in their fully matured condition, I exhausted my supply upon four patients: one, a little girl six years old, who took them in quantities ranging from two drachms to two ounces; myself, who took them in quantities ranging from two to four fluid ounces; and two other adults, who were the subjects of spasmodic torticollis. These two took one or other of the juices in doses ranging from one to eight fluid ounces. Effects were carefully looked for, but there were absolutely none in either case after any one of the doses." "I say in conclusion that the *Aethusa Cynapium* of Sussex, Kent, Surrey, Essex, and Hertfordshire, is not only absolutely free from the noxious properties attributed to it, but that it is all pleasant, to sight, smell and taste, and, in the absence of the more fragrant and succulent plant, might well be used as a potherb or a salad." Dr. Harley's article, in which he reviews the previous scientific errors and quotes authorities who had misrepresented this plant as poisonous, would occupy some six or seven columns of the SCIENCE-GOSSIP, and I have therefore only quoted a few of his sentences and summing up on the whole question, from which it appears fully established that the fool's parsley is not a poisonous plant.—*W. Budden, Ipswich.*

THE CUCKOO.—Last autumn, a young cuckoo was taken at Westbourne, and carefully cherished during the past severe winter. It was allowed to fly about in an open hall, and has become so tame that it will perch on the finger and permit itself to be stroked. It will also occasionally sit on a cat's back. It is fond of boiled egg, and delights in the caterpillars of the "woolly bear." Jenyns observes that the orbits of the mature bird are orange-yellow; these are of a pale citron. The irides, as he describes them, are at present liver brown. Its cuckoo cry has not yet been heard. Can any one tell me if this belongs to the mature bird only?—*F. H. Arnold.*

HEAD OR TAIL.—Gilbert White is right, according to my observations, when he says that snakes "crawl out of the mouth of their own sloughs and quit the tail part last, just as eels are skinned by a cook-maid." A "cook-maid" would find it hard work to skin one if she began at the tail. My English snakes always cast their sloughs by going under the water-pan, and crawling out the other side, leaving the slough under, turned wrong side out. But foreign snakes may do different. Nature often has two ways of performing the same end. But if Mr. Heath or any one else were to get some English snakes he would find that they cast their slough

by beginning at the head, and not the tail. I always find it easier when pulling my stocking off, to begin at the mouth and not at the toe.—*A. Fieldsend.*

SLOWWORM CASTING ITS SLOUGH.—I possessed a slowworm which cast its slough, and I noticed that it came out of the head-end. I have the tail part of the skin now preserved in methylated spirits, and there is no aperture at the tail-end.—*A. Dixon, Haileybury.*

LEPIDOPTEROUS NAMES.—The following list of names, copied from Morris's "British Butterflies," will perhaps be of use to J. P.: 1. Boisduval; 2. Stephens; 3. Schrank; 4. Schrank; 5. Schrank; 6. Latreille; 7. Latreille; 8. Godart; 9. Fabricius; 10. Latreille; 11. Stephens; 12. Jermyn.—*C. F., Eastbourne.*

THE SPELLING OF HAREBELL.—Mr. Habben writes to you about the purer spelling of the hare-bell, which he thinks may be really hair-bell, as it has certainly been sometimes spelt, but, without doubt, erroneously, being founded only on the difficulty of explaining hare-bell. Professor Skeat, in his "Etymological Dictionary," tells us that it does not appear among the Anglo-Saxon names of plants, but it was an old custom to name plants from animals, and he gives instances of several which have been formed from words joined to "hare," e.g. "hare's foot," "hare's lettuce," "hare-thistle," &c. The word is found in Shakespeare's *Cymbeline*, act iv. scene 2, and I quote the passage from the famous first folio edition of 1623, reprinted in reduced facsimile by Chatto and Windus in 1876:

"With fayrest Flowers
Whil'st Sommer lasts, and I live heere, Fidele,
He sweeten thy sad graue; thou shalt not lacke
The Flower that's like thy Face, Pale-Primrose, nor
The azur'd Hare-bell, like thy Veines; no, nor
The leafe of Eglantine, whom not to slander
Out sweetned not thy breath."

It is unfortunate that in some books on botany a species of hyacinthus most usually called, in common speech, the blue-bell, is denominated hare-bell as well as the *Campanula rotundifolia*, the true hare-bell, and of course a very different kind of flower.—*W. T. Lynn, B.A.*

HAIR BELL OR HARE BELL.—It may interest Mr. Habben, B.A., to know that although Miss Pratt, "Flowering Plants of Great Britain," says of *Campanula rotundifolia* that "this plant, the harebell of the poets" is by modern botanists restored to the old orthography, Lindley and others call it harebell. Dodonæus alludes to *A. nutans* (wild hyacinth) as generally known by name of "harebell." Gerarde calls the same plant "blew harebell," and in a fine copy of Hudson's "Flora Anglica" 1st ed., 1762, now in my possession, the name harebells is given to the wild hyacinth, and *C. rotundifolia* named "round-leaved bell flower." Shakespeare, in a reference to *A. nutans*, uses "azured harebell;" while Tennyson evidently refers to *C. rotundifolia* as "frail harebell."—*James Bowker, F.R.G.S.I.*

BRAULA CÆCA.—I have been reading the article in the May number on *Braula cæca* (p. 108) and beg to point out one or two discrepancies: the figures first. In fig. 69 the tarsi are composed of five joints, whereas in fig. 72 they vary from five to seven. In the same figures, no indication of the rudimentary wing is shown, and the pulvilli, which are so much developed in figs. 69 and 72, are not shown at all in

Fig. 73; in fact, no one would recognise the two as being meant for the same things, and I think to an entomologist's eye fig. 74 is anything but plain. Would it not have been better to mention the various parts of the mouth which this figure is supposed to represent? I should very much like to know whether the various figures were drawn from life, death (dried up, or in balsam), works of foreign authors, &c.—*Not a Brawler.*

HAWKS, HOLLY BERRIES, ETC.—I have three large and old thorns; last season they had only about half their usual quantity; they generally bear abundantly; all my hollies, which are mostly variegated, had none. At Christmas the cry was holly with berries on it; it was a rare article. I have a large variegated holly, 40 feet high and about 100 years old, which scarcely bore a berry. January, 1874, was particularly mild, and that tree was loaded to excess. Contrast the mild weather at that season and the quantity of berries with the cold this season and no berries. I have a mulberry-tree, 100 years old or more; last autumn we never put a ladder into it; the summer before it had but few; it generally has been a great bearer—fruit in general was scarce. **BIRDS**—I have seen 33 starlings on my lawn at the time. The pied wagtail, although a constant visitor, I never see now, and the yellow ones appear very scarce. The fieldfare has been a rare bird here this winter. Wild fowl—we have had a good share. Two bitterns were shot about a mile from here, so they are not quite extinct. The *Tipula oleracea*, or daddy-longlegs, we had but very few last season, that is, close here. We cannot always account for the change of place of these things; they inhabit a place for a time and then disappear for a while; sometimes the snails and slugs how abundant they are. **FISHES**—my grandfather caught two Fordwich trout or hookbill, the two weighing 48 lb., but that must be many years ago, perhaps 80 or 90. My father one season caught three eels, weighing 21 lb. the three. We commonly get one every season weighing 7 lb., the largest I know of caught here weighed 8 lb. I have never seen a lamprey only about 17 inches long. A man about a mile below here caught on the tip of his scythe a lamprey nearly 3 feet in length and weighing about 4 lb. I speak quite locally.—*Thomas Kingsford.*

QUERY AS TO LARVÆ.—In reply to C. H. they are evidently the larvæ of one of the Coleoptera, but the description is not sufficient to say to what species they belong; very probably they are the larvæ of the stag beetle (*Lucanus cervus*).—*Hm. Low Serjeant.*

OWLS.—Your correspondent, W. Gregson, mentions in SCIENCE-GOSSIP what he considers a "strange flight of owls." I have no doubt that one of the numerous flocks of the short-eared owl (*Otus brachyotus*) has reached Ripon. They appear on the east coast every autumn in flocks—immediately taking to some such cover as is afforded by a turnip-field or stubble. They are much more diurnal in their habits than the other British owls. A few remain to breed, but the great majority depart before spring sets in. They seem to have been unusually abundant this winter; some flocks getting as far west as the county of Pembroke. It would be interesting to learn from other correspondents in various parts of the country if they have been met with elsewhere.—*Edw. J. Gibbins, Neath.*

WEASEL OR STOAT?—In reply to J. H. H.'s query, I can verify the statement from my own observation that the weasel is to be found in the North of

Ireland; at least was as common as the stoat about Cushendun, in the year 1869 when I was living in the Glens of Antrim, and I see no reason why it should have disappeared. W. Thompson, in his Nat. Hist. of Ireland, writes that it has been found at Forstead, which is in the same locality. The game-keeper of Mr. Lowry Pomeroy has also trapped it.—*S. A. Brennan, Rector of Altedesert, Pomeroy.*

CRAB, SHRIMP, AND LOBSTER LORE.—Mr. Lord, in his useful little work, published some years ago under this title, makes no mention of crustacean animals being able to exist for a lengthened period without solid food, and I have seen no statement to this effect in any other book on the natural history of the class, except with reference to the annual shedding of the shell, which takes place in or later than the month of August, and previous to which operation the animal goes without food, and mopes in retirement for some time. Réaumur, who watched the process of exuviation in the river crayfish, says that the creature previously abstained from all solid nourishment "for a few days." From the 23rd of December last to the 2nd of May, I kept a small Lobster (measuring $5\frac{1}{2}$ inches from the front of the head to the extremity of the tail) alive; and during the whole of that period it took no solid food. I constantly tempted it with fish, both fresh and stale, and even with fish offal, which is found by fishermen to be most attractive bait for lobsters; with meat, both raw and cooked; with oyster, mussel and shrimp: but all were alike refused. Any food placed within reach of the lobster was speedily taken in its claws and deposited on the highest ledge of stones it could find, as though to indicate unmistakably its refusal. The growing seaweeds kept in the vessel were not eaten. During the whole of the period above mentioned the lobster was kept in the same water, in a large glazed earthen crock. From time to time I took out my pet, poured off the water, washed the crock and the stones, rectified the density of the water, and restored the lobster to its home; and I fear that its death may have been occasioned by this needless operation being delayed too long. In no other way can I account for its decease. Certainly it did not die of starvation, for finding it dead, I had it boiled in order to ascertain its condition, and, on opening it, I found every part of the shell entirely filled with solid, healthy-looking flesh. The lobster was lively enough in its captivity, and, whenever I approached its prison, would come to the edge and spread out its claws in droll fashion. At night it was particularly active, and frequently amused itself by re-arranging to its own liking the stones which I had built up into a cave-like recess for its accommodation.—*Sibert Saunders, Whitstable-on-Sea.*

"MAGPIE ROOSTS" AND "CARRION CROW ROOSTS."—Your correspondent in last month's SCIENCE-GOSSIP, who signs himself G. Turvill, relates a matter of such extraordinary interest when he speaks of having been personally acquainted with a "magpie roost of perhaps two hundred or three hundred birds," and of a "carrion crow roost of over five hundred birds," that I trust he will gratify my curiosity and, I doubt not, that of many other readers of SCIENCE-GOSSIP, if he will kindly give us further particulars, especially in regard to place and date of these his valuable experiences. I can only say for myself that I have never heard anything like it, and would travel a long distance to see such a glorious sight, and shall be truly grateful for further information. I should add

that I am well aware that both the magpie and carrion crow are apt to collect in parties at their several roosting quarters, but I never before heard of their associating in such astonishing numbers. Perhaps I should confine these last observations to England; for in Northern France the magpie may be seen in unlimited numbers, and in Norway I have found the carrion crow (the hooded variety) to be equally numerous, but both magpie and carrion crow are getting very scarce in this country.—*A. C. Smith, Yatesbury Rectory, Calne.*

SHEET-LIGHTNING.—Kundt, of Zurich, examined spectroscopically more than fifty flashes of lightning and found that forked flashes gave spectra of lines while sheet lightning yielded spectra of bands. The lines indicate a greater degree of heat than the bands, and hence it is concluded that zigzag flashes are electrical discharges between the clouds and the earth, and sheet flashes, merely brush discharges between clouds. The latter are more frequent than the former, the numbers being, according to Kundt, as 11 : 6. Summer lightning, or, as it is often called, heat lightning, is probably due to the reflection by the clouds above the horizon of discharges which are taking place below it. Many years ago I witnessed an example of this. On a perfectly serene night I noticed the eastern horizon brightly illuminated every few seconds. No thunder was audible. I afterwards ascertained that on the same night a severe thunderstorm was experienced about fifty miles to the north-eastward of the place where I was staying.—*J. A. B. Oliver.*

SHEET LIGHTNING.—On what grounds does Mr. Stodder believe that sheet and forked lightning are identical manifestations of electrical discharge? If the cases of sheet-lightning which he has observed can all be explained as he states, the number of his observations must be very limited. How can he account for sheet-lightning accompanying a thunderstorm of small range, while it was subsequently ascertained that the sky surrounding the thunderclouds was clear for many miles? When next your correspondents note this effect, if they will make due inquiry, I predict that they will learn that veritable sheet-lightning is totally independent of forked lightning in any direction. I grant that some of the flashes we see may be the reflections of distant sparks, but as they are not due immediately to the discharge they do not constitute veritable sheet lightning. When there are certain conditions, under which sheet lightning occurs, which allow only the explanation that it is a brush discharge, why should we deny the possibility or probability of Nature, with all her magnificent store of energy, producing on a far grander scale a phenomenon which we can easily produce in our laboratories? The habit of getting out of difficulties by denying the existence of phenomena which we cannot well explain indicates a cramped mind and one which does not fully realise the complex grandeur of Nature. To such men let Hamlet say,

“There are more things in heaven and earth, Horatio,
Than are dreamt of in our philosophy.”

—*Walter G. Woolcombe.*

RANUNCULUS ACRIS.—I should be glad if any of the readers of SCIENCE-GOSSIP could give me the distinguishing features of *Ranunculus acris* var. *tomophyllus*, and of the three forms of *Brassica rapa*, which are given in the seventh edition of the London Catalogue.—*J. A. Wheldon.*

DOUBLE FLOWERS.—Whilst botanising in the district of Abram, near Leigh, Lancashire, on the 28th of May, I found in a swamp near Plank Lane Collieries, *Caltha palustris* (marsh marigold) quite double, the flowers resembling trollius, but darker in colour. In the next field I got *Cardamine pratensis* (ladies' smock), double also. Will some readers of SCIENCE-GOSSIP please say if they have met with either of these, double, in the Manchester District before?—*John Slater.*

PIN-EYED DOUBLE PRIMROSE, ETC.—In reply to E. Bally, I found a “pin-eyed” flower of the primrose “double”—as described by him—at a wood near here (Cambridge) last year; this year I found a similar abnormal development in a “thrum-eyed” flower of the same species. I have also found the primrose, oxslip, and cowslip growing together in the same locality, associated with various transitional forms; on the one hand flowers not differing in size and colour from those of the primrose, but on a stalked umbel, on the other, flowers much smaller than those of the ordinary oxslip. There is also some variation in the size of the corolla in different flowers of the primrose, and a small beetle appeared abundant in them. In a corner of our garden the *Robert geranium* is growing with white flowers this year; I also found white *Lamium purpuraceum* a little while ago.—*G. H. Bryan.*

NOTICES TO CORRESPONDENTS.

TO CORRESPONDENTS AND EXCHANGERS.—As we now publish SCIENCE-GOSSIP earlier than heretofore, we cannot possibly insert in the following number any communications which reach us later than the 8th of the previous month.

TO ANONYMOUS QUERISTS.—We receive so many queries which do not bear the writers' names that we are forced to adhere to our rule of not noticing them.

TO DEALERS AND OTHERS.—We are always glad to treat dealers in natural history objects on the same fair and general ground as amateurs, in so far as the “exchanges” offered are fair exchanges. But it is evident that, when their offers are simply disguised advertisements, for the purpose of evading the cost of advertising, an advantage is taken of our gratuitous insertion of “exchanges” which cannot be tolerated.

E. POORE.—Your plant is the ivy-leaved toad-flax (*Linaria cymbalaria*). For instructions as to preserving and drying plants, see chapter on that subject in “Notes on Collecting and Preserving Natural History Objects,” published by Bogue, 3 St. Martin's Place, at 3s. 6d.

E. HALSE.—Your article is in hand, and will appear shortly.

G. P. TOWNEND.—If Keating's Insect Powder has failed to destroy your cockroaches it is difficult to suggest any other remedy. We have heard that foxglove leaves strewn about the rooms infested by these pests will get rid of them. You had best try the experiment.

G. W. BRADY.—The leaves are not attacked by a fungus, but by a species of Cynips, an insect which produces galls and other excrescences on leaves and buds.

DOAD.—Get the 2s. 6d. vol. published by the Christian Knowledge Society, by the late Professor Ansted, called “In Search of Minerals.” Also the cheap work on mineralogy published by Collins Co., Glasgow. Dana's “Manual” is by far the best book of the kind for a beginner who means earnest study. You will there find what implements, &c., are necessary.

J. S. A.—Write to the Secretary of the Geological Society of Edinburgh, who will, we have no doubt, give you all the information you seek.

F. A. DICKENS.—The name of the hornet is *Vespa crabro*. It belongs to the same genus of hymenoptera as the wasps.

E. POORE.—You will find articles in the last two or three volumes of SCIENCE-GOSSIP giving details as to how flowers should be pressed, &c., so as to preserve their colours. Particularly look for articles by J. W. Buck.

E. O. COX.—The extracted chlorophyll reached us in a high state of decomposition, and it was quite impossible to detect any fungi.

A. W. STOKES.—Accept our best thanks for your kind offers. We hope to avail ourselves of them.

J. W. S.—It is a very common fossil, often found in the drift beds, into which it has been re-deposited from the lower oolite. It is called *Gryphea incurva*.

J. P. asked if some one would inform him of some authors of lepidopterous names. We give the following: 1 Boisdual, Godart; 2 Stephens, Boisdual, Duncan; 3 Schrank, Latreille, Boisdual, Zetterstedt; 4 Schrank, Latreille, Boisdual; 5 Schrank, Latreille; 6 Latreille, Boisdual, Duponchel; 7 Latreille, Boisdual, Duponchel; 8 Godart, Latreille, Meyer, Hubner; 9 Fabricius, Stephens, Curtis, Duncan, Westwood; 10 Latreille, Stephens, Curtis, Duncan, Westwood; 11 Stephens, Curtis, Duncan, Westwood.

EXCHANGES.

EXCHANGE, vol. 3 of "Magazine of Art," bound in publisher's case, worth 10s. 6d., quite new, offered in exchange for second-hand cabinet for shells, or offers.—F. S. Atkinson, Thornbury House, White Cross Road, Hereford.

For well-mounted slide of bread taken from an Egyptian mummy—found in tomb at Thebes—send other well-mounted slide of wood-sections stained. Diatoms, desmids or list to J. Boggust, jun., Alton, Hants.

FRESH collected examples of *Chrysofenium alternifolium*. Alternate-leaved golden saxifrage, unmounted but pressed and dried ready for mounting. Offered in exchange for microscopic slides or eggs not in collection.—G. Garrett, 13 Burlington Road, Ipswich.

OFFERED, "United States Coast Survey Reports" from 1852 to 1876 (all issued so far); "Annals of Harvard College Observatory," vols. 7, 8, 9, 10, 11, 12, vol. 8 in half morocco. Wanted, Watt's "Dictionary of Chemistry," Phillips's "Metallurgy," or books of that nature.—H. Poole, 121 Franklin Street, Buffalo, N.Y., U.S.A.

NIAGARA River (U.S.A.) filterings, mounted or not, for any good slides.—H. Poole, Buffalo, N.Y., U.S.A.

WANTED, slide unstained of *Trichina spiralis*, or injected preparations, diatoms from London clay or mounting medium (an excellent preparation) sent in exchange.—A. Smith, The Laboratory, Essex Road, Islington.

ANTHERS, dry, unmounted, of *Fritillaria meleagris*, *Lathraea squamaria*, *Scilla nutans*, and several others; also trifid stigmas of fritillaria. Botanical slides wanted.—T. C. Vize, Cotteswold School.

LIVING specimens of *Coronella levis* to exchange. Wanted, either John's "Forest Trees," Taylor's "Aquarium," or other work on, natural history.—S. Anford, 15 Commercial Road, Bournemouth.

WANTED to exchange, a live specimen of barn owl for eggs of sea-birds (exchange), or offers.—G. Forden, Sandon, Stone, Staffordshire.

WANTED, diatomaceous earths from old and new Nottingham, Bermuda, Barbadoes, and other localities (one ounce at least), state what required in exchange.—G. Tempere, Storrington, Sussex.

I WOULD offer specimens of woods from New York for minerals, fossils, stereographs, or almost any curiosities, or cash.—L. L. Lewis, Copenhagen, New York.

WANTED to exchange, 3 vols. of SCIENCE-GOSSIP, 1874, 1875, 1876, strongly and uniformly bound; 2 vols. of "Manchester Science Lectures," and collection of 22 British Fossils, in case named, with locality; for Darwin's "Origin of Species," "Voyage of a Naturalist," and "Animals and Plants under Domestication," must be clean and in good state.—W. Jacobs, 41 Macfarlane Road, Shepherd's Bush, W.

OFFERED, SCIENCE-GOSSIP, 1879, 1880, unbound, for first 16 parts of Cassell's "Butterflies."—Nathan C. Haring, 112 Upper Brook Street, Manchester.

BRITISH land, freshwater, and marine shells, named and localised, and perfect specimens of British lepidoptera, in exchange for carved bracket, of oak, walnut, or mahogany.—O. M. A., 82 Abbey Street, Faversham, Kent.

WANTED, two last vols. of Sowerby's "Botany," smaller edition, in numbers or bound.—Mrs. Bishop, The Platts, Watford.

WANTED, offers for Dr. Chénu's "Coléoptères," 2 vols., well found in dark green morocco. Also I shall be glad to exchange Edusa, Cardui, Euphrosyne, ulmata, N. Rubi, and a few others. Send lists.—Rev. E. J. Barry, Beverley.

AMERICAN eggs, including Bartram's sandpiper, black-billed cuckoo, and others occasionally found in Europe, which I should like to exchange for European eggs; not in collection; those wishing to exchange please send lists.—Wm. R. Wharton, Germantown, Philadelphia, Pa., U.S.

CLUSTER-CUPS on leaf of coltsfoot and *R. ficaria*, in exchange for unmounted object of interest.—J. M., Porchester Street, near Clifford Street, Birmingham.

WOULD like to exchange an Oppen's Postage Stamp Album, containing 530 stamps, many very rare, and having attached to the fly-leave the flags of all nations. What offers in side-blown eggs properly classified?—John N. Blair, 79 Third Street, Brooklyn, New York, U.S.

WANTED, some seeds (for sowing) of Hepaticus, Snowflake, *Scilla sibirica*, *Helleborus maximus*. Will give good plants

of the fern *Asplenium Adiantum-nigrum* in exchange.—M. L. W., the Vicarage, Whalley, Lancashire.

HANDSOME mahogany 45-drawer entomological cabinet, with solid folding doors, for sale or exchange, with packing-case complete.—F. Savage, University School, Hastings.

LARVÆ of Gipsy (*Fl. dispar*), full grown, offered in exchange for other larvæ or ova.—Geo. Thompson, 131 Wayman Street, Monkwearmouth, Sunderland, Durham.

WANTED in fruit, species of Phascum and Splachnum, also Antirrhiza cirtipendula. Exchange in mosses or fern roots. Miss Ridley, 7 Cambridge Square, London, W.

WANTED, a few good anemones, and other objects for marine aquaria. Polariscopes and other crystals of the highest excellence offered in exchange.—H. W., 253 Evering Road, Clapton, London, E.

TELEGRAPH galvanometer, Henley's, in first-class condition, very delicate. Will exchange for 7-in. object-glass, by Crouch, Beck, or any first-rate maker.—A. H., 1 Tamworth Villas, Hornsey Road.

WANTED, Foster and Balfour's "Elements of Embryology," part i.; also Geikie's edition of Jukes's "Manual of Geology."—John H. Coulson, Dixon Road School, Birmingham.

DUPLICATES: Parthenias, flavicornis, maculata, bidentata, atomaria; females, irrorata, myrtilli, Corydon, Euphrosyne. Desiderata: ova, larva, or pupa, of Machaon, sinapis, *C. album*, hairstrakes, and others. Send list.—Fred. Frohawk, Haddon, Upper Beulah Hill, Upper Norwood.

WANTED, a live mole or shrew. Will give fair price in money for one to any one who will write and state terms, &c.—H. C. Brooke, Sutton Valance School, near Staplehurst, Kent.

WANTED, good Trilobites from various districts; also good specimens of hard crystals, fluor spars, and double-reflecting crystals of carbonate of lime, in exchange for good polish specimens of Devonshire corals (madrepores) British shells, fossils, or minerals, and fine sections of Devon corals for the microscope, unmounted, worth from 2s. to 24s. per dozen.—A. J. R. Selater, 23 Bank Street, Teignmouth, Devon.

WANTED, recent shells of *Hemipecten Forbesianus*, *Pleurotomaria Adansonii*, or *Pleurotomaria Onyquia*, in exchange for fossils, &c.—M. H. F., Worden, Preston.

CASSELL'S "Popular Natural History," 4 vols., in good condition, published at £2 2s., what offers in micro slides?—F. C. Long, 20 Lorne Street, Burnley, Lancashire.

BOOKS, ETC., RECEIVED.

- "Illusions," By James Sully. London: C. Kegan Paul & Co.
 "Smithsonian Report," 1879.
 "Journal of Conchology."
 "The Midland Naturalist."
 "The Northern Microscopist."
 "The Scientific Roll."
 "Manual of the Infusoria." Part IV. By W. Saville Kent. London: D. Bogue.
 "Bulletin of the Essex Institute." Vol. XII.
 "The American Naturalist." June.
 "The American Microscopist." June.
 "Science." June.
 "Revista." June.
 "Report of the East Kent Naturalist Histological Society." 1880.
 "Proceedings of the Norwich Geological Society."
 "Transactions of the Hertfordshire Natural History Society." March and April.
 "Proceedings of the Bristol Naturalists' Society."
 "Botanical Gazette."
 "La Science pour Tous."
 "A Guide to the Popular Natural History Clubs of London." By H. Walker, F.G.S.
 "The Aquarium, its Inhabitants, Structure, and Management." 2nd Edition. By J. E. Taylor. London: D. Bogue.
 "Land and Water."
 "Ben Brierley's Journal."
 &c. &c. &c.

COMMUNICATIONS RECEIVED UP TO 8TH ULT. FROM:—
 F. L.—G. G.—M. C. C.—J. A. B. O.—E. B.—H. F.—E. G.—
 T. C. De V.—L. L.—R. C.—H. N.—G. F. R.—C. C.—Dr.
 de C.—R. S.—F. L.—T. M. R.—J. A. G.—E. P.—J. N.—
 T. K.—J. H. B.—T. B.—T. P. D.—A. W. S.—H. C. B.—
 H. F. H.—W. G. W.—F. A. D.—J. S.—J. N. E.—W. H. S.—
 R. F. A.—H.—E. D.—C. P.—D.—A.—E. H.—J. A. W.—J. S.—
 T. S.—J. B.—R. M. M.—T. M. R.—J. A. G.—C. B. M.—
 T. C. V.—E. P.—J. S.—F. A.—B.—M. A. O.—J. S.—G. P.—
 F. C.—N. C.—H.—W.—J.—J. T.—A.—J. H. C.—H. B.—T.—
 F. Y.—L. L.—J.—T.—W.—J.—M.—A.—J. H.—G. F.—B.—
 C. B.—E. J. B.—S. B. A.—S. A.—A.—H.—G.—H. B.—H. I. W.—
 J. B.—M. R.—G.—T.—C. B.—H. P. M.—W. R.—W.—
 W. F. P.—J. M.—H. P.—G.—W.—B.—H. L.—E.—F. W. S.—
 M. L. W.—J. M.—J. C.—G.—W.—E.—C.—M. H. F.—J. S.—
 A. S. T.—A. J. R. S.—F. C. L.—C. B. T.—H. M. W.—&c.

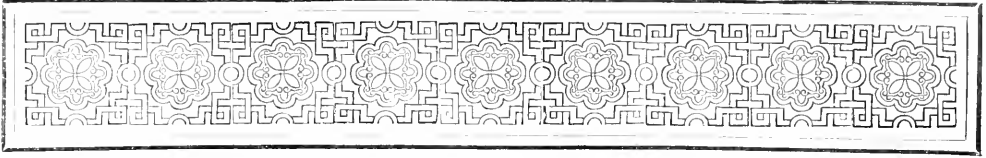

THE GEOLOGY OF YORK AND THE NEIGHBOURHOOD.

By C. FOX-STRANGWAYS, F.G.S., &c., I.L.M.'s GEOLOGICAL SURVEY.

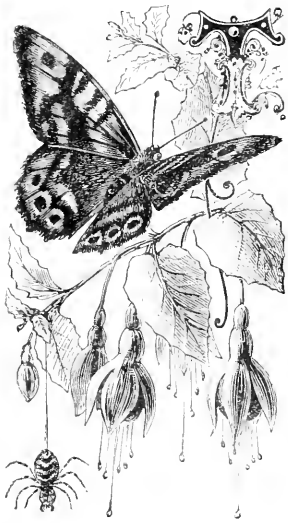

THE British Association has decided to hold its annual gathering this year at York, where fifty years ago its first meeting was held, and there is little doubt that the occasion will be taken to trace the progress made in geological science during the half century that has passed; but this, however, we may leave to abler hands, our present object being to

give a short sketch of the geological structure of the district, such as may assist the members of the Association in understanding and appreciating the geological excursions which always form so interesting and important a part of these annual meetings.

Since the Association visited York in 1831, much has been learnt and written on the geology of the county—in fact a complete list of all the publications would occupy many pages of letterpress; we cannot, however, leave unnoticed a few of the most important and best known works relating to the subject; of these perhaps the most widely known is Professor Philip's "Illustrations of the Geology of Yorkshire," the first part of which, that relating to the eastern part of the county, originally appeared in 1829, and has passed through three editions, the last of which was issued in 1875. Of other works we may mention "The Yorkshire Lias," by Messrs. Tate and Blake; "The Yorkshire Oolites," by W. H. Hudleston in the Proc. Geol. Assoc.; and also several papers by various authors which have appeared in the "Proceedings of

the Yorkshire Geological and Polytechnic Society," and other publications.

Unfortunately the publications of the Geological Survey for the whole county of Yorkshire, and more particularly for the immediate neighbourhood of York, are not quite completed, although the majority of the maps that now remain are in the hands of the engraver.

The city of York, as may be seen from any general geological map, such as Philip's map of Yorkshire, or Ramsay's map of England, stands about half-way across the great central valley which traverses the county from the Tees in the north to the Humber in the south, and divides it into two more or less equal halves; the western portion, containing the Palæozoic rocks, including the Carboniferous Limestone, Yoredale beds, Millstone Grit, Coal Measures and the Permian formation; the eastern half the Mesozoic rocks, including the Lias, the Oolites and the Cretaceous rocks.

The city of York itself stands on some portion of the Trias, probably the Keuper sandstone, but as there is a great thickness of glacial deposits in the neighbourhood it is not easy to determine the exact nature of the solid rocks below. The nearest place that any member of the Trias is exposed is in a cutting on the Harrogate railway near Cattal station; it is here a soft red sandstone similar to the usual character of the Bunter sandstone. The Keuper division of the Trias is not exposed until we nearly reach the foot of the chalk wolds at a distance of from nine to twelve miles from York; it consists of red marls, sometimes variegated, containing beds of gypsum and thin sandstones.

Although the city of York stands on the Trias, it has been seen that there are no sections in the rock in its own immediate neighbourhood; it therefore behoves us to inquire what is there of geological interest to be seen in the immediate vicinity of the town. The superficial deposits, consisting of boulder clay and gravel, and the alluvial or warp clay and sand attain a considerable thickness, being met with in various

wells in the city to a depth of over 70 feet below the surface. The boulder clay with its accompanying sands and gravels—in which some fine sections showing most curious contortions were exhibited at the time the new station was being built—is now unfortunately only exposed in a few railway cuttings, and these are not of any particular interest, so that we must pass to the more recent deposits which are so well seen near York. The warp, or lacustrine clays, with their intervening sands, are exposed in several fine sections in the numerous brickpits to the south and east of the town; they consist usually of two beds of clay with an intervening bed of sand, the lower clay being always finely laminated.

York being thus situated between the two regions of greatest geological interest, and at some considerable distance from either of them, it will best suit our purpose, and also of those who wish to join the excursions of the Association, to describe the two districts separately. Firstly, the Palæozoic formation, which comprises the range of hills in the western half of the county; and secondly, the Mesozoic rocks, which include the moorlands of north-east Yorkshire and the wolds in the East Riding.

The first of these districts, which is entered at

limestone proper, and in many cases when the calcareous matter has been exposed to air and moisture has the appearance of pumicestone.

The Millstone Grit, which next succeeds the Yoredale beds, is also well seen in this neighbourhood, the lowest portion (the Kinderscout) Grit occurs in three separate beds, and is exposed in the railway cutting to the south of the town and also in the romantic hillside of Birk Crag; but perhaps the most peculiar outcrop of the rock is that at Almes Cliff, some little distance to the south-west, where a mass of the rock devoid of vegetation, stands up in a very conspicuous manner above the surrounding country. This curious rock may be seen from York, and even from much greater distances, where it has rather the appearance of a stumpy volcanic cone than a grit escarpment. Above the Kinderscout Grit are one or two beds known as Follifoot Grit; they are associated with a seam of coal, but are not of particular note, although they underlie an interesting little bed very full of fossils, an unusual circumstance in beds of Millstone Grit age. The Plumpton Grit, the uppermost bed of the Millstone Grit in this district, is more largely developed than any of the foregoing; it is noted for the peculiar and fantastic

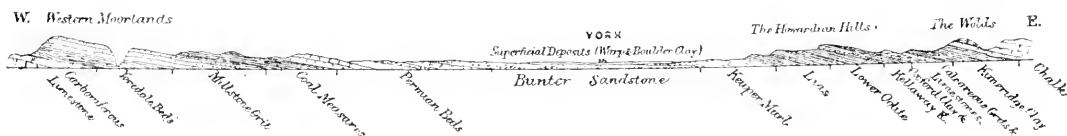

Fig. 99.—Diagram showing geology west to east across Yorkshire.

about twelve miles from York, is composed almost entirely of Carboniferous rocks, with a narrow belt of Permian measures on its eastern margin. The Carboniferous rocks are divided into Carboniferous Limestone, Yoredale Rocks, Millstone Grit, and Coal Measures; the Permian Measures include an upper and a lower limestone, with two or three beds of marl associated with them.

The lowest beds of the Carboniferous series lie mostly to the north-west of the county and at too great a distance from York to come within the scope of this notice, although perhaps an excursion may be arranged to visit the celebrated cliffs of Malham and Gordale which have been produced by that large dislocation known as the Craven fault, the throw of which is estimated to be under Ingleborough not less than 3000 feet.

The Yoredale beds may be seen at Harrogate, where they are brought up along an anticlinal axis ranging north-east and south-west; they consist principally of shale with bands of cherty limestone associated with a massive bed of grit. The limestone, which is locally known as "roadstone," is a peculiar rock containing the remains of Encrinites in great numbers, the rock frequently being rather an aggregated mass of the silicified skeletons of these creatures than a

shapes which the weathering of the rock causes it to assume. Plumpton Rocks and Brimham Crag are both formed by this grit, and perhaps there are few excursions to the north-west of York which will better repay a visit from the Association than to these romantic spots. At Knaresborough this grit crops up in the bed of the river and is overlaid by the Magnesian Limestone, the unconformable junction of the two being well seen in the picturesque gorge below the Castle. The grit is frequently of a reddish colour, and was at one time thought to be the equivalent of the Rothliegende of Germany, and consequently to belong to the Permian formation.

The Permian Measures consist of an upper and lower bed of limestone with an intervening bed of marl or soft sandstone, and occasionally an upper marl over the top limestone, and also, although very rarely, a third bed of marl below the lower limestone. The Lower Limestone, however, is the principal rock of the series, and forms a narrow tract of country extending by Conisborough, Pontefract and Knaresborough to the neighbourhood of Ripon, which from its gentle undulating contour and steep wooded banks is singularly beautiful.

To the east of the Permian Measures we enter upon the great vale formed by the Trias, which in the

neighbourhood of York has a breadth of over twenty miles, but contracts considerably to the northward. The lower member of this formation, the Bunter Sandstone, rises to a slight elevation above the general flat of the valley and may be seen at several places along its western margin, one of the best sections in the rock as mentioned above being the railway cutting near Cattal station on the York and Harrogate railway.

This concludes the list of rocks found in our western district, the first formation that is seen on the east of York being, as we have said, the Keuper Marl, which is first exposed at about nine miles from the city, the whole of the intervening space, a distance of eighteen miles, being completely covered by superficial deposits.

The Keuper Marl is, like the other members of the Trias, from its containing no fossils, not of particular geological interest; it, however, contains thin beds of sandstone which have on their surfaces pseudomorphous crystals of salt, showing that the rock was formed near the edge of brackish water. The Keuper Marl forms a series of low hills or ridges to the east of Stamford Bridge, which are not much above the general level of the valley, the first rising ground being formed by the Rhætic and Lias. The first of these formations forms a narrow outcrop at the base of the hills, but is usually much hidden by drift, so that it is very rarely we get an exposure of the beds except in the neighbourhood of Northallerton, where the streams to the east of the town give some good sections. The Lias throughout its range from Cleveland to the Humber forms a steep bank at the edge of the great Triassic plain and separates it very distinctly from the ranges of hills formed by the Oolites and the chalk. The three divisions into which the Lias is separable are usually as well marked physically as they are paleontologically; the lower portion, consisting principally of clay, with thin bands of limestone, does not present any very striking features, but forms low undulating hills, which are more or less masked by drift; the Middle Lias, consisting of harder beds, such as sandstone and ironstone, forms a well-marked feature or terrace above this, and is succeeded by the soft shales of the Upper Lias, forming a steep bank below the escarpment of the Oolite. The lower portion of the Lias may be studied with most advantage at Redcar, where extensive reefs of these shales crowded with fossils are exposed at low water; they are also well seen in the pits which have been dug for marling the sandy land at Cliff to the south of Market Weighton. The Middle and Upper Lias are best seen in the magnificent sections on the coast at Peak, Robin Hood's Bay, Hawsker Bottoms, Whitby, Staithes, and Boltby, all of which places are well worthy of a visit from those in search of geology or the picturesque.

The Oolites in that part of their outcrop nearest to York, the Howardian Hills, consist of three main

divisions, Upper, Middle, and Lower, the two latter of which are capable of subdivision into several minor groups, having very distinct lithological characters.

The Lower Oolites consist in the main of a great series of estuarine beds separated by thin, but well-marked limestones, namely the Dogger, the Hydraulic Limestone, the Millpore Bed, the Grey Limestone, and the Cornbrash; the latter of these, however, has not been found in the Howardian Hills, apparently having thinned out in this part of its course, as also is the case with each of the other beds, which disappear in some part of their extended outcrop across the county.

One of the most marked features in the geology of north-east Yorkshire is the Trap Dyke, which, starting from beyond Cockfield Fell in Durham, crosses the Tees, and ranges thence by Stainton, Great Ayton, along the valley of the Esk to the Goathland and Fylingdales Moors, where it finally disappears a short distance before reaching the main branch of the Derwent. Its total length is about sixty miles, but it does not reach the surface in all parts of its course, and in the valley of the Tees is hidden by vast accumulations of Drift. This great subterranean wall of basalt has a thickness of about sixty feet, but contracts somewhat towards its eastern end. The rocks which it traverses are the Carboniferous Limestone, Millstone Grit, and Coal Measures in Durham, and the Trias, Lias, and Lower Oolite in Yorkshire, and all of these are more or less baked and altered in the vicinity of the dyke.

The Middle Oolites consist of an alternating series of thick sandstones, slate, and limestones, which are frequently liable to pass into one another without any very marked lines of division; the names of the several divisions and the order of succession of these beds commencing from the bottom is Kellaway Rock, Oxford Clay, Lower Calcareous Grit, Passage Beds, Lower Limestone, Middle Calcareous Grit, Upper Limestone, Upper Calcareous Grit. The whole of these divisions are, however, not always present; thus, in the Howardian Hills there is only one bed of Limestone above the Lower Calcareous Grit, and farther south the whole of the Middle Oolites is represented by a thin band of Calcareous Grit or Kellaway Rock. The Kellaway Rock, apart from the coast section, is best seen in the romantic gorge to the north of Pickering, through which the railway to Whitby runs; it here forms a series of natural cliffs on either side of the line between Levisham and Goathland stations, forming one of the grandest scenes in this part of the country.

The Oxford Clay and Lower Calcareous Grit constitute the northern edge of that great range to which the name of the Tabular Hills has been given, which, starting from the coast at Scarborough, strikes across the country in a bold escarpment facing the north to the Hambleton Hills above

Northallerton, where it attains an altitude of over 1300 feet above the sea; from this point the outcrop turns to the south and forms the magnificent scars or inland cliffs of Boltby, Whitestone Cliff and Roulston, the latter of these, with the outlier of Hood Hill a little to the left of it, is the most striking object seen in the landscape on looking from York to the northward. From Roulston Scar the outcrop turns round to the eastward, and, keeping still at a considerable elevation, passes to the north of Coxwold, Byland Abbey, and Oswaldkirk; between this and Gilling these measures are interrupted by the great east and west valley faults which bring in the Kimeridge Clay between these places: on the southern side of the valley the great escarpment formed by the lower portion of these beds is, however, continued in a more or less interrupted course from Gilling by Hovingham and Castle Howard to Malton.

The series of limestones and sandstones above the Lower Calcareous Grit do not form any very marked features; they lie on the dip slope or inner edge of that rock and vary considerably in composition, presenting quite a different aspect in the Howardian Hills to what they do in the northern range.

The Upper Oolite, or Kimeridge Clay, occupies the whole of the great valley stretching from the coast at Filey to Helmsley, known as the Vale of Pickering, it is also let in, as we have observed, between the two large faults at Gilling which throw the outcrop as far west as Coxwold, and which have been the main cause of the formation of the valley through which the railway between those places runs. At Malton the Kimeridge Clay is again let down by faults to so great a depth that deep borings made near the town have failed to reach the base of the formation. Beyond this the Kimeridge Clay may be traced for some distance beneath the chalk escarpment until, from the unconformable overlap of that formation, it disappears, together with the other divisions of the Oolites in the neighbourhood of Acklam. The Kimeridge Clay, however, reappears again, together with some of the Oolites below in the neighbourhood of Cave, and, crossing the Humber, passes into Lincolnshire.

The Chalk Wolds constitute a distinct range of hills which form a very conspicuous feature in the landscape on the east when viewed from York. They are composed wholly of White Chalk, with at the base a few feet of a peculiar bed known as the Red Chalk; this latter, although only a few feet thick, is very persistent in its outcrop across the county; in that part nearest to York it contains large lumps of oolitic ironstones and other rocks bouldered in a matrix of red chalk. The White Chalk is not a very interesting formation, and does not call for any particular notice, although the graceful contour of its winding valleys has a charm not possessed by any other county.

In conclusion, let me observe that any one wishing to obtain a general idea of the geological position of the city of York and its surroundings cannot do better than mount the central tower of its venerable cathedral on a clear day, where, from this elevated position, nearly 200 feet above the plain, he will see on the west the range of hills comprising the Palæozoic rocks which form the great Pennine chain, and is frequently called the backbone of England; on the north the valley formed out of the softer beds of the Trias and the Lias, these being surmounted by the Oolites rising in the conspicuous objects of Hood Hill, and Roulston Scar, and the fine wooded escarpment of Brandsby and Castle Howard; on the east the range of hills having a more rounded outline which comprise the Chalk Wolds, beneath which the lower range of hills formed by the Oolites may be seen to disappear, and are overlapped by the unconformity of that formation to reappear again farther to the south in the low range of hills about Cave, near the southern margin of the county.

SOME SHORE-HAUNTING FISHES.

No. III.

By Dr. P. Q. KEEGAN.

[Continued from page 146.]

THERE is a very singular fish called the angler or fishing frog (*Lophius piscatorius*), which grovels in the mud and slime, or sand or shingle of our coasts, and occasionally hops about after the retreating tide. He is prodigiously ugly, but singularly "cute." He has very "catching ways" about him, and fails not to gorge his capacious maw with fishy food procured in a very strategical manner. He does not spin a web like the spider, nor dig a pitfall like the larva of the ant-lion, but on the top of his head there are planted two or three long and slender appendages, the foremost one of which, lavishly furnished with sensitive nerves, impends over the huge cavernous mouth, and is uncommonly like a small angle with bait attached used by fishermen. Its free extremity is thickened out just as if it bore a bait of a shining silvery brightness (in some species this portion is phosphorescent). The other end of this appendage is articulated to the skin bones of the head by a very free and easy sort of hook and eye joint, and affixed thereto by some twenty-two muscles, so that absolute freedom and suppleness of movement in every direction are secured. Now mark the astute procedure of this "artful dodger." Grovelling in some shallow part of the water near the shore, the angler (chameleon-like) immediately changes the colour of his skin so that it will be similar in tint or shade to that of the sand, shingle, &c., which surrounds him. Now, keeping as quiet as a cat before a mouse

hole, he elevates and raises above his head the aforesaid fishing-rod-like appendages with an alluring, fascinating, and withal graceful motion. The smaller fry of the sea, the heedless, unsophisticated sticklebacks, small herrings, plaice, gurnards, &c., which swarm in the shallows, charmed by the lively, captivating movements of this organic angling rod,

among shore-fish. His aspect is absolutely hideous and repulsive; neither grace nor beauty is perceptible anywhere. A loose, clammy skin covers the fish almost without scales; although it may be observed, that the angle-like appendages with their spines, as also the cephalic tentacles, &c., belong properly to the dermal skeleton. The head is tremendously

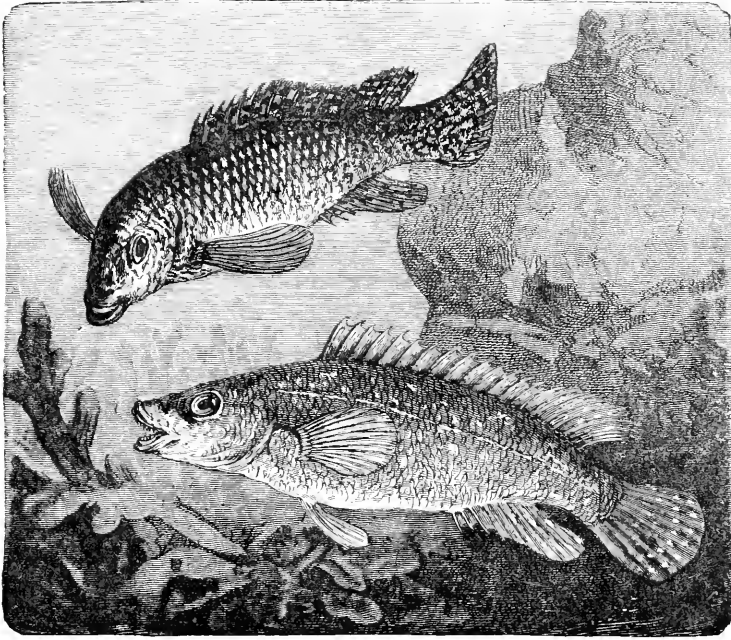

Fig. 100.—Blue and Red Wrasse (*Labrus mixtus*), male and female.

or more probably agreeably excited thereby, stop to examine and inquire, when lo! a prodigious, unsuspected pitfall yawns beneath them, and ere they know what they are about, they are engulfed in the merciless, ravenous, wide-gaping maw of the hideous flat fish lying at the bottom. The creature is by no means fastidious as to his diet; in fact, unlike an epicure, he does not seem to know what he is eating. Skates a yard long, gurnards ten inches long, mullet, a whole live widegeon, the butt end of a whip, and even a human leg have each been seized or devoured by this unsqueamish fish. On contemplating this multifarious assortment of victuals we feel induced to suspect that this creature is possessed of a kind of instinctive predilection for the seizing bodily of any solid object whatever which happens to come within the influence of his jaws.

The angler may be styled the "heavy villain"

large, and flattened out like a thick pancake; and although attached to a thin slim body, is capable of independent movement. The two dorsal fins are united beneath the skin, and are seemingly of little service for purposes either of balance or progression. The pectorals are enormously broad and thick, like large flippers or scrapers, with the carpal portion projecting freely from the body, and no doubt possessed of a fine sense of touch. The ventrals which are placed underneath the head before the pectorals are small, but they aid the latter or-

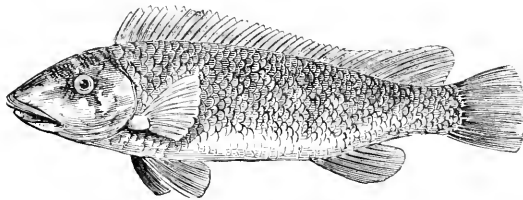

Fig. 101.—Ballan Wrasse (*Labrus maculatus*).

gans in enabling the animal to promenade along the sea-bottom. The mouth is extremely wide and spacious. It commonly measures about a foot broad, although the case of one a yard broad is on record. It is furnished with a potent armoury of sharp, conical, incurved teeth, the whole being fully competent to tuck in all at once, and to securely retain (the latter a not unim-

portant matter) a rather large quantum of victuals. Some of these teeth are attached to the jawbone by a sort of spring-trap joint. The outer base of the tooth is free, but the inner part of the base is fixed to the jaw by an elastic ligament, so that the whole tooth works like the spring-catch of a dog-hook, readily permitting ingress but absolutely forbidding egress. By this ingenious dental contrivance when food is taken into the jaws of the fish, most of the teeth are thereby bent backwards towards the gullet, whereby it will be seen that the swallowing process is immensely facilitated, and the escape of the morsel prevented. The eyes of the angler form the sole redeeming feature of his personal appearance. They are very large, very bright, of eminent power, and, though placed rather close together, they are each capable of separate, independent movement. The nostril tube has at its upper end a kind of cup, the bottom of which is divided into projecting leaflets on which the ultimate branchlets of the nerves of smell are distributed. It would thus appear that this fish can not only smell the grateful effluvia of his prey, but can actively search about for the delectable odoriferous impression thereof. The whole fish measures about three feet in length by fifteen inches in

breadth, but hideous and formidable monsters of five feet long have been captured.

On contemplating the singularly crafty and ingenious habits of the angler, I hear somebody singing out, "What an intelligent animal! Surely here is reason (a very loose phrase) equal to that displayed by man!" But we may rejoinder—does the creature, when he waves his organic bait in order to decoy fish, actually know what he is about, i.e. is he actually conscious that his angle-like filament is calculated or competent to seduce and allure rash and heedless fry to their destruction? We profess ignorance as to the Darwinian view of the matter; but you may depend upon it, that this hideous sea-devil swallows his dinner with as much gusto as any other creature, and he doesn't trouble his head further about the business. The fishing-rod upon his cranium is waved backwards and forwards, front-

ways and sideways, this way and the other way, the gluttonous, green-hearted fry are seduced to explore, the cavernous mouth engulfs it down, and that's all. This fish is an uncommonly practical individual indeed, especially about dinner-time, but he is by no means either a mechanic or a philosopher. The fact of the matter is, however, that the angler, although crafty, astute, and apparently intelligent, is furnished with a notably small prosencephalon—a department of the brain supposed to represent the cerebrum of the higher vertebrata. There are a few anatomical features about this fish which it may be proper to enumerate here. The bones are specially soft; of all osseous fishes this one presents the simplest vertebral column, the abdominal vertebrae have no ribs, their transverse processes are mere rudiments, and they interlock with each other in a

sort of dove-tail manner; the branchial chamber is very large, and extends back to the hind part of the abdomen; the gill-cover rays are of enormous length, the muscle which operates to admit water to the gills is enormously developed, and the outlets of the branchial chamber are very small (all these respiratory provisions are, as we have seen, exceedingly ancillary to a shore-haunting career); further, the radius and ulna

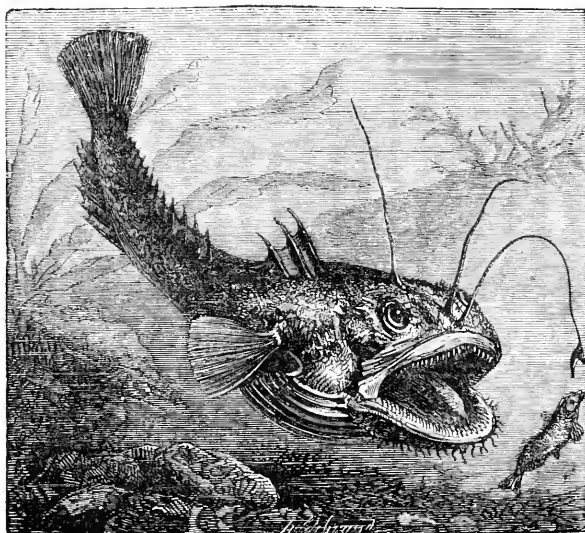

Fig. 102.—Angler Fish (*Lophius piscatorius*).

are connate with the coracoid bone, and the carpal portion of the hand projects freely from the side of the body, by which device the creature is enabled to vault and hop about with considerable acrobatic agility.

Of a quick-glancing, bright, and silvery colour is the common sand lance, sometimes called the sand or horn-eel (*Ammodytes lancea*). It doesn't mind soiling its beautiful coat a little when the tide retires, for presto! as quick as thought, it buries itself from half a foot to two feet or so deep in the soft sand. There it remains imprisoned till the waters return again to the flood, when it stealthily emerges, and keenly searches about for marine worms, &c., by way of food. The jaws are very movable, very sensitive, and sharp at the point, and in conjunction with the small head, the square and slender body, the swift-moving muscles of the body, they prove of

eminent service in enabling the fish to effectually shelter itself from undesirable observation. Its movements are of lightning-like agility. It has been described as the swiftest moving creature in the whole sea; and in sooth it requires a tremendous nimbleness to have any chance of escape from the onslaughts of its innumerable ferocious and indefatigable enemies. In fact, the fish is perpetually encompassed by hordes of murderous enemies; and of its ever-pending danger it seems to be fully conscious. The beautiful mackerel, the sea-trout—indeed nearly every big fish is always ready to pounce upon the launce, whether fry or mature, and consume it with immense relish. The light shuttlecock-like terns with unparalleled celerity hawk at and pierce it with their sharp bills. Cormorants, allergansers, &c., mercilessly disentomb it from the tideless sand, and devour it with an unequivocal gusto. The grand and beautiful black-backed gull, sweeping with predatory intent nigh the shore, immediately spies it out, and hesitates not to forthwith break his fast. The wallowing, somersault-throwing porpoise, with a huge yawn, engulfs wholesale mouthfuls of these luscious little fish; and even the renowned Irish pig on some parts of the Irish seaboard resorts to the sands at low water and, allured by the mouth-watering qualities of the eel, explores its haunts with a sniffing, grunting snout. Lastly, but perhaps not leastly, even to the highly-organised human palate this fish furnishes a morsel by no means distasteful or unwholesome; and accordingly by delving in the sand, or by a kind of rake, or by means of a kind of trawling net, men and women capture whole bushels and cartfuls of this excellent article of food; and again, by using it as a bait, fishermen artificially utilise these savoury qualities, for there are very few fish indeed which can resist the fascination of a dangling piece of sand-eel.

The skin of the sand-eel is thin, but it is amply furnished at the sides with scales, one margin of which is buried deeply in the derm, while the opposite margin, which presents a net-work structure, projects upwards into the superposed portion of the epiderm. The body and head are elongated; the dorsal fin (51 rays) extends nearly the whole length of the back; the anal fin (25 rays) is also long; the tail fin (15 rays) is distinct and forked, not joined to dorsal and anal as in the true eels (*Anguilla*); there is no ventral fin and the pectorals (13 rays) cover a large gill aperture; the eyes are small; the whole fish, which measures 5 to 8 inches long, is of a light-brown sandy hue variegated with a silvery bluish-green tint on the sides and back.

In addition to those now delineated, there are various other shore-haunting fish, many of which are singularly beautiful and interesting. Some of these congregate in the rock-pools, while others swarm helter-skelter under the shadow of some beetling cliff or surf-skirted sea-wall of rock. For example,

there is the ballan wrasse (*Labrus maculatus*) with its wondrously constructed jaws and teeth, its lavish decoration of scales, and its exceeding versatility in respect to colour, which is sometimes exquisitely beautiful; the two-spotted goby (*Gobius Ruthensfarrri*) with its daintily beautiful coat mottled with brown and blue, its bright eyes, and active movements; the freckled goby (*G. minutus*) partial to sandy shores, sometimes sheltered under large scallop or other shells; the worm pipe-fish (*Syngnathus lumbriciformis*) with its lengthy snout, its armour of indurated plates, and its limited locomotive powers dependent on its sole fin—the dorsal one; the father-lasher (*Cottus bubalis*) with a name suggestive of a ludicrous circumstance in its serial life as yet unverified; the atherine (*Atherina presbyter*) with its beautiful striped body, and astounding fecundity, &c.

NOTES FROM WEST KERRY.

SHORT SUNFISH OR MOLEBUT (*Orthogoriscus Mola*).

SOME years since I met with a specimen of this fish, not unfrequently found near the Irish coast. One or two particulars connected with it may be worthy of notice.

On cutting through a thick tough membrane attached to the eyeball and fixed all round to the edge of the orbit, shutting in that cavity, a considerable quantity of clear fluid gushed out; rather surprised, I removed the eyeball perfect, thereby proving that the escaped fluid had been exterior to it. I subsequently met with a second specimen of the fish, of which both eyes were uninjured. Bearing in mind my former experience, and having provided a graduated measuring-glass and twelve inches of very narrow india-rubber tubing, I perforated the membrane already described as attached to the eyeball and orbit, and having inserted one end of the tubing through the perforation, I applied suction to the other end, and then curving it downwards to form a siphon, received, freely flowing into the glass, nearly two ounces of a thin transparent fluid, slightly saline to the taste. Shortly afterwards, in the presence of two well-known gentlemen, I repeated this operation on the other orbit of the fish with a like result. The idea of an eyeball moving in a liquid medium seemed to me so strange and novel, that I merely took note of the occurrence, reserving remarks till I could consult authorities on the subject. Some time afterwards I found that the late Mr. William Andrews had published a paper on *Orthogoriscus*, in which he says, "I have observed as to the very prominent form of the eye: in the projecting or very convex cornea, it would seem that it (the animal) was afforded a kind of periscopic vision which is a necessary power to animals whose movements must

be decidedly slow. The late Rev. Lansdowne Guilding, who held the office of colonial chaplain at St. Vincent's, has described a new genus of the sunfish tribe, which has been named *Pedalion gigas*. Guilding first observed the remarkable characters in the eye of the sunfish, its construction being conical and versatile, enabling the fish to look different ways at one time, or have an exceedingly wide range of view." Mr. Andrews further remarks that *Orthogoriscus* is related to the Syngnathidæ or Pipe-fishes by the versatile structural arrangement of the eyes; and by several authorities it is stated that the eyes of Hippocampus move independently of each other, as in the Chameleon, the eyes of which "are remarkable objects, large, projecting, and almost entirely covered with the shagreen-like skins, with the exception of a small aperture opposite to the pupil; their motions are completely independent of each other: It adds to the strange and grotesque appearance of this creature,

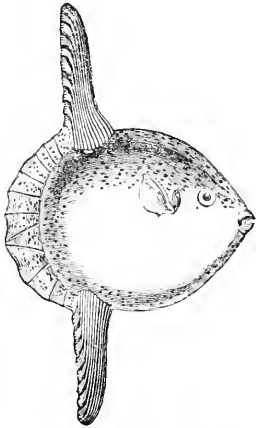

Fig. 103.—*Orthogoriscus Mola*.

to see it roll one of its eyeglobes backwards, while the other is directed forwards, as if making two distinct surveys at one time."

Now I venture to suggest, and so far as I know the suggestion is original, that this versatile motion of the eyes of *Orthogoriscus* does probably depend very much on the watery fluid with which the eyeball is surrounded, and that perhaps the like versatility in the Pipe-fishes and Chameleon may depend on a similar cause.

The late Dr. Jacob of Dublin published a paper on the anatomy of *Orthogoriscus Mola* in the "Dublin Philosophical Journal," to which I have not access. It would be very strange if he could overlook the fluid existing in the orbit. Dr. Cobbold ("Intellectual Observer," vol. ii. p. 85) states that in the year 1856 a large specimen was anatomised by the Professor of Anatomy in the University of Edinburgh, but who he was, or whether he published his observations, I do not know. Dr. Bellingham, a skilful and

devoted anatomist, published in the "Dublin Magazine of Natural History," 1840, a description of a specimen he had dissected: his reference to the eye is as follows: "The aperture of the eye is somewhat oval, $2\frac{1}{2}$ inches by 2 inches in the long diameter from before, backwards; the eyes have a deep blue colour; the iris silvery white, $\frac{1}{8}$ inch wide; when the eyeball was pressed inwards, a white membrane, resembling the *membrana nictitans* appeared and could be made completely to cover the eye." My observation was that there was no *membrana nictitans*, nor anything resembling it, but that when the eyeball was pressed inwards the membrane closing the orbit, becoming corrugated, folded over the cornea and was capable of quite concealing it.

A few words about *Cecrops Latreillii*, a parasitic Crustacean found on the gills of *Orthogoriscus Mola*. I took nearly thirty specimens from the gills, and to remove thick adherent slime placed them for a short time in weak solution of potash. They were afterwards washed in several changes of fresh water, and left immersed, supposed to be dead. On inspection after a few hours all the females had become very much enlarged posteriorly, the ova (I suppose) having absorbed some portion of the alkaline fluid, and in nearly every case a male was found attached to each, legs to legs as in mutual grasp. I separated some with a fine pointed forceps and examined them individually. What necessity, instinct, stimulus or attraction, under such unfavourable circumstances, caused the union of these moribund parasites, I cannot attempt to conjecture.

J. W. BUSTEED.

Castle Gregory.

A STUDY OF THE VARIATION OF THE SMALL TORTOISESHELL BUTTERFLY (*VANESSA URTICÆ*).

By A. H. SWINTON.

PART II.

[Continued from page 149.]

AS butterflies sometimes mate with species that are not in any way allied, and butterflies even pair with moths, we might hereupon conjecture with a shudder that such jackdaws in peacock's feathers might have something in common with minotaurs, mules, and angels. But as it is, we recognise a much more general and widespread agency insensibly working on European areas, originating in the retardation and acceleration of metamorphosis; and this when caused by change of climate or season we know gives rise to varieties and races. In the present instance I may quote the case of the black tortoiseshells. As the story goes, one day about the year 1858, a friend called on a certain entomologist with a box of small tortoiseshell butter-

flies, whose prodigiously dusty wings ornamented with large spots of an intense black at once commanded attention. The friend was forthwith interrogated, and he then stated that they were the progeny of caterpillars gathered during the late autumn, and that they had had their development retarded by being kept in an icehouse.

So much being established, it would be interesting to look abroad on the wing patterns of butterflies that gladden the eye of man, and furnished with this clue, proceed to unravel the warp and woof of loveliness; but here, alas! the writer's command of his subject is necessarily circumscribed. If we move on to the recent subdivision of the genus, recent we believe in nature as on the page of synonyme; we at least find that black painted-ladies (*P. cardui*) with rows of dark or white marginal spots occur from time to time in this country; one such variety was figured in 1872, to my certain knowledge, and two were figured in 1879. And since these years also mark memorable periods of butterfly migration to our

wise in other groups as the Geometers and Pyralidina, where they have long been known as the half-line, inner line, elbowed line, and subterminal line of technical lore. Then as regards time. How far back the present mutations in the patterns on the wings of butterflies and moths can be traced, the imperfect preservation of fossil kinds forbids to say. To date it from the abnormal meteorological conditions of the last glacial period would be erroneous, as we find existing even in tertiary ages butterflies and moths with the identical design of spots and lines we have been considering. As a passing illustration of this important point, I venture to give above a restoration of a fossil butterfly found in the gypsum rocks of Aix in Provence, preserved in the cabinet of the Count de Saporta, together with a little moth from the same strata I myself sketched in an idle hour at the Marseilles Museum. The butterfly, although its markings resemble somewhat those of the tortoiseshell, is attributed to the family of the Satyridæ; the moth is perhaps a bombyx, with the ordinary four

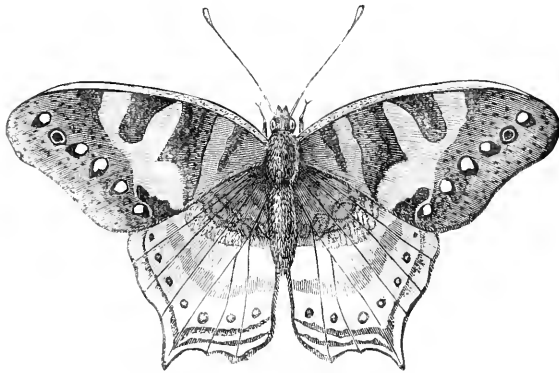

Fig. 104.—Restoration of *Neorinopsis sepulta*, after Dr. Scudder. Aix.

shores, we may reasonably hope with a more perfect record of varieties captured to be eventually in a position to connect this phenomenon with meteorological conditions, and to establish the seasonal character of the transformation.

Passing from the robust Vanessæ to the slender branch of the nearly allied Fritillaries, we find in the silver spotted group, *Selene* and *Euprosyne*, on North German areas running to sports that have black bands on the fore wings from the coalescing of the wing specks; and in their sister genus similar aberrations have been noticed in this country, and are figured by Newman. Many butterflies, it is unnecessary to say, have naturally four black lines plainly marked on their wings, sometimes supplemented by subordinate ones; and on bringing this matter last year under the observation of the Entomological Society, the remark was made by the president in the chair, Mr. Stainton: Why, these bands you have shown are those of the Noctuidæ. And not alone are they found in the night moths, but like-

bands filled in with dark and light as may be observed in recent examples.

Besides conferring the insignia of the black ribbon, altitude as it would seem has some tendency to dwarf the small tortoiseshell. Isolation, however, in the island of the tailless cats has accomplished this more thoroughly, and Edward Newman tells us Mr. Birchall sent him quite a series of Lilliputians from Manx localities. Slight shades in tinting are likewise observed in this butterfly, and singular to say, northern, Alpine, and southern examples are severally found to have a more fiery or redder colour; pointing as one might infer to the variation of the species on the confines of possible existence. But as it is yet possible some of these changes may be after all dependent on diet, I would here call the attention of naturalists residing in the country to the exceedingly interesting question of dwarfs and erratic colourings arising from an insufficient, or an unnatural food. The results obtained by a system of artificial rearing founded upon such data have been scarcely hitherto



Fig. 105.—Restoration of a Tertiary *Bombyx*? (thorax restored). Aix.

sufficiently decided to recommend this matter to the trade, but speaking for myself I may state, that when extraneous matter had been eliminated from the records of two years' trial, I could fairly attribute to this source variations in size, and in cases a decided abstraction of the ordinary colouring principle, so as to confer what the Germans designate a clear look to the wing. Thus tiger-moth caterpillars, when supplied with lettuce leaves, I found fed up rapidly and produced large moths; while those fed on herb Robert (*Geranium robertianum*), an uncongenial food, produced small and colourless ones.

The proper manner to proceed on the analysis of the constitution of the organic frame, is doubtless, if possible, to obtain the ova of a butterfly or moth and to rear them from this stage on a food plant affected by another individual of the same genus, or otherwise; but as this will be often impracticable, the caterpillar itself may be obtained and tried with an unusual food; and even if it does not readily take to it, there is no need of despairing, as the transference may be at times accomplished by mixing the new diet with the usual nourishment. For example, I found the caterpillars of the small tortoiseshell were not naturally partial to hop leaves, but by means of a judicious mixture of hop and nettle, I finally induced them to quit their proper food and partake of the amber juice of intoxication, and a certain percentage of clear coloured individuals resulted. One of these is shown (1) fig. 88, in the former portion of this paper, where for "willow" read "hop." On proceeding, however, to surmise that a little rouge might be detected mingling in the sallow complexion of these fallen ones, one of my correspondents took exception; and of course, as regards change of colour, some may go yet further, and fancying this might be negated by some physiological conception of a unity of organic principle in the circulating fluid, raise a question forthwith how change in food can affect the capabilities of the secreting glands: I do not think nevertheless that certain medicinal practice, inoculation for instance, at all favours this idea of homogeneity; and if we descend from the regions of theory to those of fact, we have it emphatically recorded that Mr. Gregson obtained a percentage of black tiger-moths from a diet of coltsfoot, and more recently we find the same authority recommending beetroot as a cosmetic ("Zoologist," 1861). Mr. Gregson found *Pyg. Buccphala* fed on sycamore, fine and dark; *Xylo. polyodon*, fed upon heather, always dark; *Hadena adusta*, do.; *Acrony. Menyanthidis*, fed on willow, on the contrary, produces the variety of Curtis *Salicis*, fed on heath it is light. *Cidaria populata*, fed on *Vaccinium Myrtillus*, is light, on *V. Vitis-Idca* darker; *Ith. defoliaria*, fed on birch, better marked than when reared from elm. *Eup. venosata*, fed on inflated catchfly, is almost white, on shore catchfly, larger and almost lead colour; *Noctua festiva* fed upon thorn, rich red; on grasses, light yellowish; *N. triangulum*, fed on thorn, dark

and rich; *Ab. Grossulariata*, fed upon currant, produce a light brood; on wild plum, a dark or yellowish one.

The potency of food to produce change is not confined to the wings of the butterfly, we are led to surmise, but exerts its influence from the larval stage. Thus for example, at page 279 of the sixth volume of the "Entomologist's Monthly Magazine," Mr. Buckler records the discovery of two forms of caterpillar producing the painted-lady butterfly in England; the one densely covered with pale grey hairs found on mallow (*Malva sylvestris*), and the other "clothed with spines alone" feeding on thistle: so that here then as in the case of the small tortoiseshell already noticed we have the following interesting problem presented us. Determine the distribution of the spiny and hairy sorts, and examine their relations to their progeny. But to return. When species are dwarfed, certain erratic elements arise in the patterns of the wings. As is known from a passing notice in Coleman's little book of butterflies, dwarf examples of the large tortoiseshell may be obtained by feeding their caterpillars on willow, an unnatural food. Some years back I had a number of these in London, and no food near at hand, save the leaves of a very grimy willow that overhung the road from a neighbouring garden. The result was I bred not a few cripples and a goodly series of dwarfs; one of the more striking aberrations having among other singularities an extra spot on either of the front wings, appertaining evidently to the third of the bands. See (4) fig. 88, in the former portion of this paper.

Starving likewise has a similar effect to an unnatural food. It was about the same time, in the spring or autumn of the year 1876, I think, that I met with the late Mr. Ramsey Cox "who caught Newman all those pale clouded yellow butterflies at Margate;" and we had a pleasant chat together while the train proceeded from Brockenhurst station to Waterloo. He had been entomologising in the New Forest, and I remember among other items of information he mentioned that he had recently obtained some curious dwarfs of the species of *Vanessa* by simply starving the caterpillars. One peacock, as he elsewhere describes, had no ocellus to the hind wings, one small tortoise-shell possessed a brownish patch (indicating the central band), and another had black wing veins. Mr. J. B. Hodgkinson, some ten years earlier, relates a similar experience, and speaks of examples of the tortoiseshell obtained from caterpillars "that had been let starve or eat the band-box;" as having black nervures, wanting the discal spots, or being of a buff variety. ("Ent. Mon. Mag." 1867. "Entomologist," vol. 1876, pp. 58, 252.) Such facts may eventually point out that some of the seasonal or climatic races of butterflies found on mountain slopes and in northern regions, and intrinsically due to retardation of metamorphosis,

may in some measure owe their existence to the stunted and sparse vegetation of these bleak situations.

Turning from a consideration of the wings to the mutation of the parts of the body, we find that these either participate in the diminution when the species may be termed a true dwarf, or that they have their usual dimensions while the wings alone have been arrested in expansion: examples of either process are common enough in most cabinets. The tortoiseshell butterfly has yet another remarkable mark of evolution in common with its tribe, to be found in those tassel forelegs that hang down like grass tails in front, and which, similarly to the feet of a Chinese beauty, give good evidence of being diverted from their true use. This cramping and abbreviation of the member is not, however, like wing expansion dependent on climate, as is rendered evident from the wide dispersion of these old soldiers over the earth's surface; neither as in the possible case of a tiger moth bred from lettuce dipped in chalk and water, which emerged with the merest rudiments of feet or tarsi to the forelegs, and with the articulations of the second pair soldered together; can this be the result of a particular soil? No, ridiculous though it may appear to us short-sighted mortals who see not the days of the elephant or swan, it yet rests on common observation, that when certain Lepidoptera settle for long together on the ground, they rest on their four hinder legs, and raising the front pair, allow them to dangle down, so that muscle and nerve may never in the lapse of centuries be brought into play. Of all butterflies, none are more conspicuously sedentary than the tortoiseshells that sun themselves on our roads and garden blossoms the livelong day, and no old cripples, therefore, if these premises be correct, can afford better example of the punishment of effeminacy in the war with the environment.

RECREATIONS IN FOSSIL BOTANY.

REPRODUCTIVE ORGANS OF LEPIDODENDROID PLANTS.

NO. V.

By JAMES SPENCER.

THE Halifax coal-balls [have yielded a great variety of other coal plants besides Lepidodendrons and Sigillarias, some of which I hope to describe on future occasions, but perhaps their most interesting novelties consist in the abundance of cones, sporangia, and spores, and other reproductive organs, found therein—the very parts of fossil plants which are so often wanting.

The fossil ferns, for instance, which are said to form one-third of the total number of species of fossil

plants and which are so profusely scattered up and down the shales, sandstones and ironstones of carboniferous age, are generally devoid of all traces of fructification. I am aware that Lyell, in his "Elements of Geology," mentions the finding of fossil ferns in Coalbrookdale, and in Maryland in America, having the markings of the sori plainly to be seen. But in these Halifax coal-balls the annulus of fossil ferns, often containing spores, are found in great profusion, and as beautiful and perfect as those on the back of recent ferns. There are two kinds of lepidodendroid spores, one being very much larger than the other, and is called the macrospore or female (fig. 108), and the other one is called the microspore or male-spore (fig. 109).

The macro- and microspores are not all alike, they most probably vary according to the species of plants to which they belonged, yet they have all a great family likeness. They are sometimes found enclosed in little bags, which are termed sporangia, and these sporangia are also sometimes found in a cone, called lepidostrobus. A perfect cone therefore contains sporangia, and these again contain the spores. Some sporangia contain macrospores only, others contain only microspores. The microsporangia, both in the fossil cones and in the modern representatives, are generally situated at the upper part of the cone, while the macrosporangia occupy the lower part; but there are important exceptions to this rule in both the recent and fossil state. In our coal-balls we meet with a great number and variety of both macro- and microspores; the most common macrospore is a comparatively large one, being about $\frac{1}{50}$ in. in diameter. (Fig. 108.) It is covered with hair-like appendages which, in transverse sections, form a beautiful fringe around the spore. These caudate appendages occur both single and branched, and are simple prolongations of the thick spore-wall.

We frequently find these macrospores containing small bodies called endospores, which are almost always round in form, but by no means uniform in size; some macrospores containing a few large endospores, others containing a large number of small ones, others again containing both large and small ones.

One of my sections shows a macrospore, which contains a number of these endospores, most of which are again enclosed in mother spores. What these small bodies are, I will leave for other and better qualified writers to say. I have macrospores containing a network of cellular tissue which is the nearest approach to a true prothallus that I have seen in connection with them.

The normal number of macrospores in each sporangium is four, but they are rarely met with enclosed in a sporangium; when such is the case, three macrospores only are visible, though sometimes a small portion of the fourth can be seen. The reason why we only see three spores in any section is

owing to the fact that they occur in groups of four which are arranged in a triangular manner, three at the base and one at the top, so that whichever way you cut through them only three spores are visible, in any one section.

Spores which occur in groups of four are termed tetraspores.

Microsporangia containing microspores are much more commonly met with than sporangia containing macrospores; this is probably owing to their much smaller size. The microspores are generally triangular bodies, with raised convex ridges, though some are somewhat oval in form. They, too, occur in groups of four, and hundreds are contained in each microsporangium. Considering the vast number of these macrospores and microspores contained in our coal-ball material, it is surprising how rarely traces of the original cones to which they belonged have been seen. While cones belonging to other species

strata, but the "unexpected always happens," and the result is this little insignificant-looking cone which Professor Williamson estimates would not exceed an inch in length when perfect.

I have several slides containing these macro- and microsporangia, and in one slide I have them associated with a small portion of the original cone.

Fig. 106 shows the form of the macrosporangia containing three macrospores and a small part of the fourth one. The sporangium is attached to a bract or leaf of the cone, and its wall is composed of a single layer of rectangular cells.

Fig. 107 is a tangential section of a microsporangium containing microspores, which occur in groups of four, although, as is usually the case with these tetraspores, only three are visible in each group. Some of the groups are broken up and the free spores are scattered about in the sporangium. The specimen also shows the network arrangement of the cellular

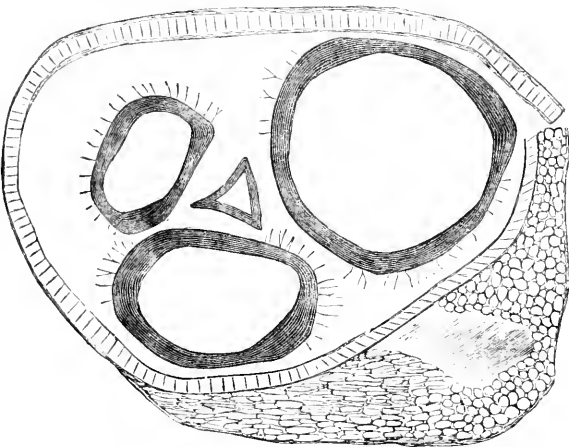

Fig. 106.—A macrosporangium with macrospores, enlarged 60 diameters

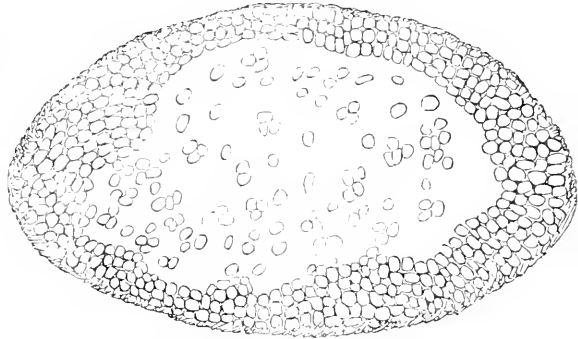

Fig. 107.—Tangential section of a microsporangium, showing microspores, X 112 diameters,

of lepidodendroid plants are not unfrequently met with, yet this one has only been found in one instance. This was discovered by Professor Williamson, in a slide belonging to Mr. Isaac Earnshaw of Oldham, and from material which he (Mr. Earnshaw) had obtained from Elland, near Halifax.

The specimen was shown to me by Professor Williamson; it is about one-third of an inch in length, and contains both macrosporangia and microsporangia—the macrosporangia being interspersed irregularly amongst the microsporangia, (which is also the case in the recent species, *Selaginella Martensii*).

This was a very different cone from what we had been expecting to find. We had long been on the look-out for the cone to which these large macrospores belonged, fully expecting to find one of those magnificent cones of about five or six inches in length, similar to some of those which occur in the Lowmoor coal

tissues forming the outside of the sporangium wall. A transverse section across the centre would have shown a similar arrangement of oblong cells as that which is seen in fig. 108.

The formation of beds of coal by spores.—Some of the shales and coals of the coal formation are remarkably rich in lepidostrophi and spores. The shales overlying the Lowmoor Better Bed coal form a rich repository of both, and the macrospores are so large that they can be seen by the naked eye. These are the spores which were alluded to by Professor Huxley in his lecture "On a piece of Coal," as forming the bulk of the "Better Bed Coal," and other similar coals. But the learned Professor must either have been misled or those who are most familiar with that coal are strangely deceived. Being well acquainted with the Better Bed coal and its surroundings, when we had read the lecture we accused ourselves of carelessness in not having observed that it

was so rich in spores, for they are so large that it scarcely needs the microscope to determine that point. So taking the first opportunity, I set out with a brother geologist to try to settle the point. We spent a long day at Lowmoor, rambling from pit to pit, examining specimens of coal. The result was a sad disappointment, so far as finding the coal so rich in spores as we were led to imagine by the professor's lecture. We brought away with us a number of specimens of the coal and submitted them to the test of microscopic examination, with not much better results. That the coal does contain a large number of spores there can be no doubt, but they are not so numerous by any means as to form "the bulk of the coal." Overlying that coal in some places is an impure earthy coal, called by miners "trub," of from two to four inches in thickness, in other places the celebrated "fish bed" takes its place; both these layers contain a large number of the macrospores.

But it would not be correct to say that even these layers were mainly composed of spores and fruits.

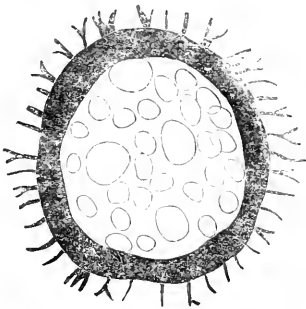

Fig. 108.—Macrospore with endospores, $\times 50$ diameters.

Yet they are far richer in them than is the bulk of the underlying coal.

It is worthy of note that these large macrospores are so common in many of our house coals, that any one who wishes to see them may find them by examining the coals in his coal scuttle. They are most abundant on the faces of the dull slaty varieties, and may be detected by the naked eye, but by the aid of a pocket lens they can be seen to better advantage. By the aid of a lens they are seen to be flat, round bodies of a dark brown colour, and covered with wart-like protuberances with a slit on one side from which the endospores have escaped, but they appear to be destitute of those hair-like appendages which characterise the Halifax macrospores.

So far as I am able to judge from the examination of a large number of microscopic preparations of different kinds of coals, I believe that our coal-balls are as rich in spores as, if not richer than, any other coals in this country, yet it would be a great mistake to suppose that these spores formed the bulk of the coal-balls. There can be no doubt that these balls contain a fair sample of the plants which formed the

coal in which they are enclosed, and also of the manner in which they were aggregated together. The sight presented by some of these balls when broken is very curious and interesting. Various kinds of plants may be seen mingled together in great confusion, lepidodendroid stems, leaves, fruits and spores; calamites, ferns, astromyelons, lepidodendroid tissues, and other vegetable remains may often be seen standing up in bold relief on the slab before us.

The balls which present this curious medley of fossil plants in "bold relief" are generally highly pyritised, and on that account the specimens are worthless for microscopical purposes, but make good cabinet specimens. A large number of balls contain fragments of large *Lepidodendrons* and *Sigillarias*, some of which are above a foot in width and originally formed parts of trees of considerable magnitude. A less proportionate number contain fragments of smaller plants such as ferns, calamites, astromyelons, young branches, twigs and leaves of lepidodendrons, &c. &c., mixed with a large number of spores of various kinds. Some balls contain a large proportion of spores, but even in these the spores do not form half the contents. But a far larger proportion of the balls are mere lumps of pyrites in which the structure of the



Fig. 109.—Microspores (greatly enlarged).

plants is almost completely destroyed. Although all these coal-balls contain plant remains, yet it will be seen from the above that really good material forming a suitable matrix for the fossil plants in which they are preserved in the wonderful manner that we now and then find them, is of rare occurrence. As in other branches of geology the collecting of these coal plants entails much healthful exercise in the open air, rambling from coal-pit to coal-pit for many miles away, over a rough hilly district. But there is an indescribable charm in unearthing these precious "medals of creation," that to us is irresistible, so that each fine Saturday afternoon finds us ready to start on our ramble equipped with hammer and bag, and sundry other little creature comforts, such as a pipe and a pouch well-filled with the "fragrant weed," &c. It must not be supposed, however, that the latter are necessary adjuncts to the geological kit, but we fancy that the pipe helps to cheer the sometimes long tramp homewards.

(To be continued.)

ASELLUS AQUATICUS.—In reply to J. A. C.'s query this crustacean is the *Asellus vulgaris* of Latreille, Desmarest, Milne-Edwards, and Cuvier.—*J. M. Campbell.*

HOW TO OBTAIN CUTICLES OF PLANTS.

IN reply to "Beginner's" appeal for information how to obtain the cuticles of leaves, &c., I think that he will find the following method will, with a little practice, enable him to prepare satisfactory slides of the cuticles of *Deutzia*, *Onosma*, *Alyssum*, *Hippophaë*, *Equisetum*, scalariform and spiral vessels, &c. The apparatus required is not expensive or numerous, a small porcelain cup or saucer holding about an ounce, a spirit-lamp, a large watch glass, two or three mounted bristles (I prefer a rabbit or cat's whisker), the bristle should be about three-quarters of an inch beyond the handle, a human hair mounted so as to form a small loop, a "lifter" made of a "thick" thin glass cover about three-quarter inch diameter (this is more convenient, if three of its sides are squared), this I cement to a piece of glass tube $\frac{1}{4}$ inch diameter and $\frac{1}{8}$ bore in the following manner; by filling about a quarter of an inch with broken shellac, this must be carefully melted, and then placed on the square edge of the cover which should be hot. Chemicals: nitric acid and chlorate of potash, and of course distilled water.

The *modus operandi* is as follows: select, say a medium-sized *Deutzia* leaf (I prefer the leaf or stem fresh), cut out a square, or in fact, any shape you please, but take care to leave none of the margin, half fill your cup or saucer with equal parts of nitric acid and water. To this add a small pinch of the chlorate of potash and gently boil over the lamp, carefully watch the leaf, and when the upper and lower cuticles begin to separate, remove them by means of the lifter into a watch glass filled with distilled water; the two cuticles will sometimes separate of themselves, but much more frequently require a little manipulation with the bristle to separate them. This may be done by carefully inserting it between them; when separated, float the lower cuticle on a thin cover, and with the hair loop gently scrape off any remains of fibre, &c. The upper cuticle may be cleaned whilst floating by scraping the under surface with the loop, when clean float on to a glass slip (by upper and lower cuticle I mean that which may be upwards or downwards in the cup). I may here explain my reason for this, I usually find it very difficult to turn the cuticle over, and as it is always desirable to have the external surface uppermost, it is necessary to mount one on the cover and one on the slide. A more difficult but better plan is to leave one of the margins of the leaf intact, and when clean float both cuticles on to the slide; when dry place the cover or the slide in turpentine, and mount in Canada balsam. The siliceous cuticles of *equisetum* stems, barley straw, cane, rice-husks may all be obtained by this process, but they will not bear drying, they must therefore be removed first to strong methylated spirit, and then ether, and lastly, turpentine. F. KITTON, Hon. F.R.M.S.

ENGLISH PLANTS IN JAMAICA.

PERHAPS it may interest some of the readers of SCIENCE-GOSSIP to learn how luxuriantly the English wild strawberry (*Fragaria vesca*) blooms and fruits during the greater part of the year on the high mountains of Jamaica. At the Government Cinchona Plantations (from five thousand to six thousand feet high, on the slope of the Blue Mountain chain) the strawberry is the most plentiful weed, and costs the Government many pounds yearly to try to eradicate it from amongst the cinchona plants: but it soon shows its head above ground again, and looks so pretty, with its pendent luscious fruit, gleaming red and ripe in the bright sunshine, that it scarcely seems like a weed, and it is almost a pity, such a pretty plant and delicious fruit has to be hoed up to give way to the cinchona.

It is a delicious fruit when newly gathered, but it quickly loses its fresh flavour, which is not unlike that of the cultivated strawberry, but a little more acidulous. Of course the fruit is not so large, though I have gathered some of extraordinary size, for a wild fruit.

At this elevation we also find the English buttercup (*Ranunculus acris*), the gorse (*Ulex Europæus*), the chickweed, wild pansy, groundsel, black-berried elder, nasturtium, white clover, sweet violet, the English oak, and the ubiquitous bracken-fern in large quantities, the latter being used to shade the young Cinchona plants, in the nurseries and when newly planted out; and yet from the lawn in front of our house, we can look down upon Kingston and Port Royal, basking in the full blaze of the tropical sun, with their groves of cocoanut-palms and expanses of mangrove swamps.

With all the English friends mentioned above, in spite of the view over mountain-tops of the hot plains, it can almost be imagined one is still an inhabitant of a cooler clime, and often, about Christmas-tide, sharp walks, tennis and brisk rides are not sufficient to warm oneself, and it is very pleasant to return home to the fire of cedar logs, burning brightly on the hearth, and giving off a delightful odour, and fires are especially grateful during the wet seasons, when the sun hides his usually bright face behind dense clouds, and he is again gladly welcomed after his short absences; and then again with double interest and renewed vigour, we watch the beautiful effects of his red and golden setting rays, reflected on the masses of fleecy white clouds lying in the valleys at our feet, gradually creeping up the mountain slopes, or putting a graceful snowy night-cap on the head of Blue Mountain Peak and other highlands in the neighbourhood.

DAISY MORRIS.

Jamaica.

UNCLASSIFIED NOTES ON THE INLAND
BIRDS OF CEYLON.

By F. L.

[Continued from page 152.]

SUBORDER ACCIPITRES NOCTURNI, OR OWLS.

10. **T**HE Chestnut-winged Owl (*Athene castaneo-nota*) Blyth, Holdsworth. *A. castanotus* of Kelaart, who also calls it the Ceylon chestnut-winged owl. "Bassar" of the Singalese. "Sinn Anthey" of the Tamils.

Distribution.—This little owl is peculiar to Ceylon, and widely distributed from 100 up to 6000 feet above the sea level. Its peculiar call may be heard in the day, when the bird frequents the deeper forests, or comes to the edges in search of food. They may be found from one to a dozen, but in the latter number only during the early mornings, or at sunset.

They are fond of reptiles, small birds, and in confinement eat raw meat with avidity.

Size.—♂ length $8\frac{1}{2}$ in.; span $15\frac{1}{2}$ in.; wing $4\frac{1}{2}$ in.; tail $2\frac{3}{4}$ in.; tarsus 1 in. Shot in Maskeliya, 4500 ft.; ♀ length $7\frac{1}{2}$ in.; span 17 in.; wing 5 in.; tail $2\frac{1}{2}$ in.; tarsus 1 in.; shot at Dickoya 4800 ft.; ♀ length $7\frac{1}{4}$ in.; span $18\frac{1}{2}$ in.; wing 5 in.; tail $2\frac{1}{2}$ in.; tarsus 1 in.; shot in Ballangoda, 2000 ft.

General colour.—Upper parts chestnut-brown with light brown bars across the feathers. Head, neck and throat marked with narrow white bars, and a like marking is also upon the wings and tail, only slightly darker; breast and sides brownish with white bars across the feathers; belly and vent white dashed with brownish-coloured markings; the tarsi are feathered down to the toes, which latter are hairy. Iris golden; bill bluish, green above and darker below, in some examples horny; feet greenish-yellow.

Remarks.—The note of this bird is peculiar, usually beginning with a sort of purring note, and ending with sharp sounds like the words "korhork, korhork, kook," repeated once or twice. When startled, it makes a sound not unlike the squeak of a field mouse.

11. The "Devil Bird" Owl (*Syrnium indranei*), Sykes of Holdsworth and Legge. The Brown Wood Owl, Legge. The Oulama Owl. *Syrnium indranei* of Kelaart. "Oolamar" or "Bucka moonar" of the Singalese. "Singala Pizarsie," or Singalese Devil of the Tamils.

Distribution.—Wide; the bird chiefly inhabits heavy forests, from the low country up to the hills, but I am inclined to think it is only a visitor to the colder climes.

Size.—♀ length $19\frac{1}{2}$ in.; span $45\frac{1}{2}$ in.; wing 13 in.; tail $8\frac{1}{2}$ in.; tarsus $2\frac{1}{10}$ in.

General colour.—Brown above, pale below, with

close bars across the feathers. Bill horny, green; foot ashy; iris chocolate-brown. I am unable to give further details of colouring, as unfortunately I parted with my specimen before taking further notes.

Remarks.—There appears to be some doubt as to the identity of this owl with the so-called devil-bird. It is from a native superstition that the name devil-bird is given, but it might be added with justice, that the bird's fiendish cries entitle it to no ordinary title. Both the Tamils and Singalese look upon its call as an ill omen, and on one occasion I had considerable trouble in quieting a servant who heard one, from the belief that he or I would die immediately, as one of these owls had chosen a tree close to my bungalow as a spot from whence to pour forth its agonising cry. The note is without a doubt truly horrible, and past description, as at times it combines hoots, with a fearful strangling, sobbing, and hysterical scream, sometimes accompanied by sobs, and at others by a sort of laugh. It is only necessary to hear the creature once to agree to its title.

In closing my notes on the above orders, I must remind the reader that there are a considerable number of both suborders that I have left undescribed, for the reason that I have not been so fortunate as to secure them in my ramblings.

According to Mr. Holdsworth's catalogue, I have left undescribed: *Falco peregrinus*; *F. peregrinator*; *Hypotriorchis severus*; *Accipiter virgatus*; *Aquila pennata*; *Nisaetus Bonelli*; *Limnaetus Nipalensis*; *Pandion Haliaetus*; *Haliaetus leucogaster*; *Circus melanoleucos*; *C. aruginosus*; *Haliastur Indus*; *Milvus Govinda*; *Fernis ptilorrhynchus*; *Baza lophotes*; *Elanus melanopterus*.

Of owls: *Strix indica*; *Huhua pectoralis*; *Kitupu Ceylonensis*; *Ephialtes bakkamuna*; *E. Sunia*, and *Ninox hirsuta*.

F. L.

LIST OF ASSISTING NATURALISTS.

[Continued.]

YORKSHIRE.

Whitby. S. P. Dotchon, 29 Esk Terrace, Whitby. *British Birds and Butterflies*, also on collecting and preserving insects, shells, zoophytes, &c. Any information on British ferns and the allied plants. Also on the habits of song-birds, zoophytes, insects, and crustacea. Correspondents please to enclose a stamped and directed envelope for reply.

Whitby. Henry B. Thornton, 11 Esk Terrace. *Collecting and Preserving Natural History Specimens, British Alga*. In every case correspondents are requested to enclose stamped envelope.

Llandudno. Wm. Jones, 3 Trinity Buildings, Mostyn Street, *British Flowering Plants, etc.*

MICROSCOPY.

THE HIGHBURY MICROSCOPICAL AND SCIENTIFIC SOCIETY closed its sixth session on Thursday, the 9th of June, with a conversazione at Harecourt Hall. It was numerously attended. Amongst the objects exhibited the marvellously-arranged diatoms of Dr. Dempsey, and the anatomical preparations of Mr. Herbert Williamson, were particularly noteworthy.

MOUNTING VESSELS, &c.—In reply to your correspondent "Beginner," I may state that I have found the following process for separating spiral, scalariform, and annular vessels, answer admirably. Cut about an inch of the stem containing any one of these vessels, and immerse it in solution of potash for two days, then wash well in water, and digest in very dilute hydrochloric acid, so as to get rid of all the alkali; then put the softened stem between two glasses and disintegrate it by pressure; it will then yield a soft mass of pulp; this should be stirred up in a glass of clear water, when the vessels will be seen floating about like threads, and can be easily picked out with a hooked needle. I find it best to stain them with anilin and mount in balsam. Spiral vessels may be found in the petiole of the Pelargonium, annular vessels in that of the rhubarb, and scalariform in the stipe of the brake fern. Maceration for a short time in alkali will destroy almost any parenchymatous structure, leaving the prosenchyma and vascular tissue untouched. Wood-cells are not so easy to isolate, but may be admirably seen in a longitudinal section of a piece of deal. I am sorry I cannot help "Beginner" as to *Deutzia scabra*, for I have never tried to mount that object. I always obtain mounts of stellate hairs from Malvæ and Alnææ by shaving them off with a sharp razor. The exotic fern *Nephobolus pertusus* gives an exquisitely beautiful stellate hair.—*J. O. B.*

CERATOPHYLLUM.—I have found another of those peculiar-formed *Ceratophyllum* or "Skeleton Wheel-bearer," in the same pond as I found the one reported by me and figured in the May number of SCIENCE-GOSSIP. This tends to prove my idea that it is another species of the genus *Ceratophyllum*.—*T. B. Rosseter.*

"THE FUNGOID ORIGIN OF EPIDEMICS."—This is the title of a lecture delivered before the Keswick Literary and Scientific Society by M. W. Taylor, M.D. It is a very thoughtful and condensed epitome of the germ theory of disease, and so far is a useful pamphlet for students. In it such would find all the stock arguments in favour of this theory. We judge from its perusal that Dr. Taylor is quite unacquainted with Dr. Drysdale's address on this subject, delivered before the Literary and Philosophical Society of Liverpool, about a couple of years ago, and afterwards published as a shilling pamphlet. After reading

that we think so highly of Dr. Taylor as to believe he would alter many of his opinions as to the fungoid origin of some epidemics, if not all.

"THE MICROGRAPHIC DICTIONARY" (London: Van Voorst). We are glad to welcome the reappearance of an old and trusted friend, in the shape of Part I. 4th ed. of this invaluable work. It is being issued, revised and corrected, in half-crown monthly parts.

ZOOLOGY.

RAT'S NEST. BLACK RATS.—As the present distribution of *Mus rattus* in Great Britain is a matter of interest to zoologists, will Mr. J. Senel kindly inform us the locality of the farm premises in which he finds this species more common than *Mus decumanus*?—*T. S.*

BUFFON'S SKUA.—A specimen of *Lestrea Buffonii* was captured at Tuxford and kept a fortnight, but on Tuesday last, having apparently recovered its health and strength, it flew away. One wing was cut, so that it will probably be recaptured. Mr. John N. Dufty, of the Grammar School, will be glad to hear of it, or will give particulars to inquiring naturalists. Morris mentions eight occurrences in England, and Atkinson says "this skua can only be considered a rare and accidental visitor." I believe this is the first recorded instance in Notts.—*John N. Dufty, F.G.S.*

PARASITES ON HYDRA FUSCA.—It would be interesting to learn upon what evidence the editors of the Micrographic Dictionary based their opinion that the presence of parasites on *H. fusca* indicated failing health; and, also, what they would consider to be infallible signs of perfect health in *H. fusca*, and kindred organisms. I have frequently obtained these zoophytes from the canal running through Preston; but in no instance have I seen them free from parasitic life, *Trichodina pediculus* being always present. Yet the Hydra never appeared the least inconvenienced by them, but went about its business with the most apparent unconcern, contracting and expanding its tentacles in a most lively manner. If the presence of parasites really indicates lack of health, then disease is the rule, and health the exception; not alone in the microscopical world, but also in the higher, yea, even in the highest orders of nature.—*F. J. George.*

PEA-GREEN MOTH (*Tortrix viridana*).—The oak-trees in this neighbourhood have suffered very much from the ravages of the larvæ of this moth, being in many places entirely stripped of their foliage, thereby giving a strangely wintry aspect to the landscape. During May the caterpillars suspended themselves by fine silken threads from the branches and proved

most unpleasant to those passing under the trees. The perfect insect appeared at the end of June in countless thousands, nearly every oak-tree having its own swarm. It is a pretty little moth, with bright green upper wings. I do not know whether it has been equally destructive in other localities, but during a long residence at Basset, I have never seen the oaks so completely divested of their leaves before.—*A. G. Rogers, Basset, Southampton.*

DUMB ANIMALS.—Professor J. Woodroffe Hall has just published two able lectures on “The relative positions of the higher and lower creation,” which are intended as a plea for dumb animals. We heartily commend the work to all genuine lovers of animals.

THE EAST KENT NATURAL HISTORY SOCIETY.—The twenty-third report of this old-established society contains (among others) papers on the following subjects: “Phosphates and Superphosphates,” by Mr. W. H. Hammond; “On Spongidae,” by Colonel Cox; “On the changes which have taken place in East Kent in the coast and river valleys since the Roman occupation of Britain,” by Mr. G. Dowker, F.G.S.; “On the development of the *Trematoda*,” by the same, &c.

THE NATURAL HISTORY CLUBS OF LONDON.—We have been frequently asked to give information on this subject, and we are now glad to draw attention to a twopenny “Guide” which has been drawn up by Mr. Henry Walker, F.G.S. (than whom we know of nobody more competent), and published at Water's Library, 97 Westbourne Grove, W.

THE HERTFORDSHIRE NATURAL HISTORY SOCIETY.—Parts 3 and 4 of the Transactions of this vigorous society are to hand, containing (among other interesting papers) “Notes on Sponges,” by H. Gilbertson; “The post-tertiary deposits of Hertfordshire,” by J. V. Elsdon, B.Sc.; “Observations on Rotifers,” by F. W. Phillips; “Meteorological Observations,” by John Hopkinson, F.L.S. (hon. sec.); “Report of Rainfall in Hertfordshire,” by the same; “Phenological Observations in Hertfordshire,” by the same; “Notes on Fluke in Sheep,” by A. T. Brett, M.D., &c.

THE BRITISH ASSOCIATION meets this year at York, on the 31st of August, under the presidency of Sir John Lubbock, Bart., F.R.S., when the fifty-first year of its existence will be celebrated. One of the best meetings for many years is anticipated, as all the presidents of sections are past presidents of the Association. The number of excursions arranged for, conversaciones, exhibitions, &c., is unusually great, and we hope that the sketch of the geology of the neighbourhood of York we give this month will prove useful.

CIRENCESTER MICROSCOPICAL AND NATURALIST SOCIETY.—We are glad to notice that a new society has been formed as above. The society already numbers twenty members, under the presidency of E. J. E. Creese, F.R.M.S.; Mr. T. C. Vize, son of the Rev. J. E. Vize, the well-known mycologist, is hon. sec.

BIRDS OF CEYLON.—I notice a few errors in the spelling of the names of places in the sketch map that you made, which for the sake of accuracy should be corrected as follows: for Gampora read Gampola; for Pustlana read Pusellawa; for Rotmalu read Kotmalee; for Muara Elluya read Newara Elliya.—*F. L., Ballangoda, Ceylon.*

BOTANY.

CRATEGUS OXYACANTHA (Hawthorn).—Commonly called May, as it usually comes in flower early in that month. In seventeen years at my present residence I have not been more than three years without gathering at least a few sprays on the first of the month; this year, however, it flowered in very small quantity, as late as the twelfth. Last year it was difficult to find any in flower by reason of its scarcity, but what there was was early. This season it has flowered as profusely as we ever remember to have seen it, and I have been curious to note the fact that while pink May has been more than usually brilliant in colour, even the white May as a rule assumed a more or less pink hue. Haws promise to be very abundant this year; let us hope that they may this time really presage a mild winter.—*James Buckman, Bradford Abbas.*

ILEX AQUIFOLIUM.—The holly flowered very abundantly this year, and at the present moment the trees are very thickly laden with berries, which promise well for the lovers of berried holly for Christmas decoration. Last winter a small spray with a few berries was charged highly, for such a commodity, by the greengrocer. Some years I have known mistletoe berries to be very scarce, but it is very unusual for such to be the case. When it is so it causes even greater disappointment than a scarcity of holly berries, as the latter is so much made up for by artificial holly sprays.—*James Buckman, Bradford Abbas.*

In contrast to the lateness in the flowering of the hawthorn, I may mention that this year in this warm district whole fields of wheat on my farm had fairly shot ear as early as the 5th of June. This is a week earlier than I have before observed it in my seventeen years of occupation.—*James Buckman, Bradford Abbas.*

SWISS ALPINE FLORA.—Referring to the notice to a correspondent on this subject at page 143 of

SCIENCE-GOSSIP for June, there is a Flora limited to the higher Alps, in German "Botanischer Taschenbegleiter des Alpenclubisten: eine Hochalpenflora der Schweiz und des alpinen Deutschlands," von Dr. R. Theodor Simler; Zurich, 1871, (Schabelitz'sche Buchhandlung), pp. 167, $5\frac{1}{4} \times 3\frac{1}{2}$ inches (measuring the type only). The work is cheap, about two francs, if I remember rightly, and seems well done. There is a similar small book by the same author on Swiss mineralogy, called "Petraea," by Simler, 1866; Muri (Keller) and Aarau (Sauerländer).—*G. M. C.*

OBJECTS OF SEX, AND OF ODOUR IN FLOWERS.—A paper on this subject was read by Mr. Thomas Meehan, before the American Association for the Advancement of Science, at Saratoga. Mr. Meehan is of opinion that sex in nature is not primarily for reproduction, but to ensure variation.

ORCHIDS.—We have received a "Catalogue of Orchids" grown by Mr. Erastus Corning, near Albany, U.S.A., containing thirty-two pages of lists of all of these beautiful flowers, which have been successfully grown by him.

FERNS PROPAGATED BY CUTTINGS.—Mr. Adamson does not mention the name of the fern he succeeded in propagating. Many ferns may be propagated by laying portions of fronds in damp mould, and maintaining a proper amount of light without sun, heat, and moisture. Examples of ferns which may be so treated are *Lastrea angularis*, var. *prolifera*, *Scolopendrium vulgare* (base of stalk here produces bulbils), *Campylopus flexuosus* (plantlet from tip of frond), *Asplenium bulbiferum* and *A. viviparum* (buds on pinnæ and pinnules), &c. This list is capable of great extension.—*Henry J. Ryder, L.R.P.C.E., &c.*

PERIDERMIIUM PINI.—If Mr. C. B. Plowright will refer to the July number of SCIENCE-GOSSIP, 1879, page 168, he will find I offered this fungus for exchange at that time, having found it in large quantities in the spring of that year. But few availed themselves of the chance of possessing specimens of this rare fungus, though any one can still have specimens, by sending a stamped addressed envelope to me.—*Charles F. W. J. Williams.*

GAELIC NAMES OF PLANTS.—Mr. J. Cameron is continuing his papers in the "Scottish Naturalist" on this subject. They are very interesting, and important from the fact that in a few years a task of this kind will be next to impossible.

ORCHIDS ON THE NORTH DOWNS.—Mr. H. F. Turner in SCIENCE-GOSSIP for July mentions *Habenaria albidula* and *Cephalanthera ensifolia* as found by him near Knockholt Beeches, Kent. The first of these is extremely rare in the south of England, only certainly known to occur in Sussex, and there in a

single locality on the Weald. The *Cephalanthera* was not known for certain to Mr. H. C. Watson in his "Topographical Botany," but I possess a specimen from North Kent. If Mr. Turner would send to Mr. J. G. Baker, at the Kew Herbarium, specimens of the two plants he gives, I am sure Mr. Baker would tell him if they were rightly named. Perhaps Mr. Turner intended to write *H. viridis*? If it is albidula it is a most interesting find. He may well write with enthusiasm of these Downs, and I give a few additions to his list. *Orchis ustulata* occurs in great quantity on Betchworth Hill, with *Ophrys apifera* and *Aceras*. *Herminium monorchis* near Caterham and Box Hill, and many years ago *Orchis militaris* was found near Mickleham. *Epipactis violacea*, Den Dug, grows near Box Hill. *Ophrys arachnites* may be found in Surrey (the plant so called in the "Flora" is only a form of *apifera*). *Ophrys aranifera* may also be refound, as both occur in plenty in Kent. On the Oxfordshire Downs, a few years ago, I was delighted with the sight of twenty-three specimens of the rare *Orchis simia* in full flower on the bushy borders of a wood.—*A. B., Croydon.*

GEOLOGY.

"THE SCIENTIFIC ROLL."—No. 3 of this learned and industrious compilation has appeared (conducted by Mr. Alexander Ramsay, F.G.S.). This part deals with "Climate," and contains an elaborate bibliography of all books, papers, &c., on this subject since the year 1855.

THE IRON ORES OF ANTRIM.—We have received a copy of a paper on this subject by Mr. J. D. Kendall, F.G.S. (reprinted from the "Proceedings of the North of England Mining Engineers"), in which the mode of occurrence of the ore, origin of the deposits, and age of the deposits, are briefly but effectively treated upon.

"THE GEOLOGICAL DISTRIBUTION OF ENDEMIC GOITRE."—Professor G. A. Lebour has recently published a paper on this important subject, in which he notices the distribution of goitre on the different rocks of France and England, showing where it is present and where absent. He concludes there is a striking sameness in the geological distribution of the disease in the two countries; and quotes the words of Dr. de St. Lager, "that endemic goitre coincides with metalliferous deposits," &c.

REMAINS OF PLANTS AT THE BASE OF THE DENBIGHSHIRE GRITS, NEAR CORWEN.—This is the title of a paper recently read before the Geological Society by Henry Hicks, M.D., F.G.S. Traces of vegetable remains were first observed in 1875 by the author in Pen-y-glog quarry, about two miles E. of Corwen. Further research has resulted

in the discovery of more satisfactory specimens, which have been examined by Messrs. Carruthers, Etheridge, and E. T. Newton. Among them are spherical bodies resembling the *Pachytheca* of Sir J. D. Hooker, from the bone-bed of the Ludlow series, supposed to be Lycopodiaceous spore-cases; also numerous minute bodies stated by Mr. Carruthers to be united in threes, and to agree with the forms of the microspores of Lycopodiaceæ, both recent and fossil; and some fragments, which may belong to these plants, and others, probably belonging to plants described by Dr. Dawson from the Devonian of Canada under the name of *Psilophyton*. The above testify to the existence of a very rich land-flora at the time. Mixed up with these, however, are numerous carbonaceous fragments of a plant described also by Dr. Dawson from the Devonian of Canada, which he referred to the *Conifere*, but which is, according to Mr. Carruthers, an anomalous form of *Alga*. The former called it *Prototaxites*; the latter renamed it *Nematophycus*. Numerous microscopical sections, showing the beautiful structure of this interesting plant from the specimens found at Pen-y-glog, have been examined by Mr. Etheridge and Mr. Newton, and their conclusions agree with those of Mr. Carruthers. The evidence seems to show that at this mid-Silurian period the immediate area where the plants are now discovered must have been under water, and that the mixture of marine and dry-land plants took place in consequence of floods on rapid marine denudation. The author indicated that the land-areas must have been to the south and west, chiefly islands, surrounded by a moderately deep sea, in which Graptolites occurred in abundance. The position of these beds is about 2000 feet below the true Wenlock series, and about the horizon of the Upper Llandovery rocks.

“THE DIAMOND-FIELDS OF SOUTH AFRICA.”—A paper on this subject has been read before the Geological Society by Mr. J. Dunn. The passes or necks of decomposed gabbro, &c., at the Kimberley, Bulfontein, and other diamond-mines have now been excavated to a considerable depth, and have allowed excellent sections of the sedimentary beds through which they have broken to be examined. These are generally but little disturbed, and may be traced over an area of many square miles. Immediately beneath the surface are, generally, yellowish shales, with remains of small Saurians; and beneath these a mass, certainly more than a hundred feet thick, of black carbonaceous shales, with occasional thin bands of coal. It is found that the diamonds are more abundant and of better quality when the level of the black shales is reached. It seems, therefore, not improbable that the carbon requisite for the formation of diamonds was obtained from these shales. Some other points of minor interest were also noted in this paper.

“FERTILITY.”—By this title Dr. J. B. Lawes has published a *brochure* (London: D. Bogue) of seventy pages, in which is concentrated a really voluminous mass of experimental information relating to agricultural chemistry. Dr. Lawes' chief endeavour is to show the value of latent nitrogen in soils. We very cordially recommend this little work to every one who is in any way interested in agriculture.

PREHISTORIC HACKNEY.—London seems to be the last place to look for prehistoric interest, but both geologist and archæologist are aware how full its neighbourhood is of this kind of association. Mr. J. E. Greenhill has recently read a paper with the above title before the Hackney Microscopical Society, in which all that is geologically interesting about the locality is very ably and clearly set forth.

NOTES AND QUERIES.

BIRDS IN NORTH AMERICA.—I would like much to know what bird your correspondent, W. T. Greene, can mean by “the Virginian Nightingale from the Southern States of America,” as mentioned in *SCIENCE-GOSSIP* for April, 1881. I have spent much time in our Southern States and thought I was familiar with all the song birds and most of their “local” names. The mocking bird (*Turdus polyglottus*) is frequently a delightful night-singer both in his native freedom and in captivity—but Dr. Greene can certainly hardly mean this, for he speaks of its scarlet colour, &c., and also says, “but it is scarcely a desirable subject to acclimatise, as our gardeners have plenty of native pests to contend against without adding another to their number.” The mocking bird could never be a pest—except in taking a few cherries, &c.—it delights in spiders, caterpillars, grubs, and is a most delightful bird whether in captivity or free. I have often wondered that it has not been acclimatised in England. It would certainly thrive with the open-air treatment that Dr. Greene speaks of, it would live anywhere the thrush would with you, and would be no more of a pest than thrushes. I am almost tempted to say that I will furnish a young pair delivered in Liverpool during September next if Dr. Greene will undertake the experiment—with the understanding that the young birds as soon as able to fly shall be set free and attended to for a while with a view to their thorough acclimatisation, if possible. I know of no bird worthy the name night-singer that at all corresponds with Dr. Greene's description. There is too much ignorance of natural things in these two countries of ours, and we Americans sometimes see in your papers some things ridiculous to us. As a case in point allow me to quote from the London “Daily Telegraph” of Nov. 27th, 1877, when I was in England and cut the article out of a copy of that paper. The article was on acclimatisation and is a long one. The part which seemed so ridiculous to us was the following sentence: “In like manner the citizens of New York thought it would be advantageous to introduce the English sparrow into their new Central Park, with a view to killing the kabydias and other insects of the caterpillar tribe with which the green trees of the United States swarm and are vocal during the hot nights of summer.” The funny

part of this is that the kabydias should be classed with caterpillars. The kabydia (*Platyphyllum concavum*) belongs among the grasshoppers rather more closely than any other insects familiar to the English people and is not an objectionable insect except for his noise at night. None of our caterpillars in this country are musical or vocal. The English sparrows were brought to this country to destroy caterpillars which infested the trees planted along the streets of our cities (our native birds being frightened out of the cities as they became closely built up). This same English sparrow has become entirely acclimated and has spread rapidly through the country, and now makes his principal food on vegetables—leaving to our native birds the insects. He is often much complained of, and is increasing so rapidly as to call many maledictions on his head.—*E. C. Morris.*

THE DIMINUTION OF SMALL BIRDS.—The late severe winter seems to have played sad havoc with those of our smaller birds which remain with us all the year, and any one who has paid any attention to the subject will endorse the opinion that their ranks have been terribly thinned. Chief amongst the sufferers seem to have been the thrush tribe. During the frost I found many lying dead. In this neighbourhood, where the woods and groves formerly resounded from morn till night with the vocal melody of the thrush, blackbird, and missel thrush, scarcely one is now to be heard or seen. The yellowhammer, wren, robin, and even the hardy tits, have also suffered and their numbers are but scanty. Sparrows and chaffinches, which resorted in great numbers to the farmyards for food and shelter during the cold weather, seem fully as numerous as heretofore—but all other commoner species are sensibly lessened in number. Until the arrival of our migratory visitors, which was later than usual this season, I sadly missed the cheery “voices of the woods” which herald the approach of spring. Apropos to the scarcity of the skylark, which has excited the attention of many observers, and various theories regarding which have already been discussed in the pages of this journal; the following extract from a recent letter in the “Preston Guardian” will be interesting to those who, like myself, take an interest in the subject:—“Bird-catchers are now more numerous and more efficient in their calling, have greater demand for birds, and stronger inducements to take them than ever they had. In April last year I met with one who had been plying his art in taking skylarks. He had gone over the fields a distance of two miles, and had taken seventeen birds, all of which he affirmed were males. On asking him how he knew they were all males, he replied, in nearly every field there are a pair—a male and female—and the cock bird appears to think that no other male has a right to sing in his field, or near his nest, and therefore when I put ‘Jack’ down (a tame lark which I have in a little cage) about the middle of a field, he begins to sing, and then the male lark comes in a fury to drive him away, alights on the top of the cage, sticks fast in the bird-lime, and is at once a prisoner. Each of these birds had a mate and a nest, and had they been left alone each pair would at the least have reared eight young ones, and the seventeen 136. Why the cruelty of separating the males and females at the beginning of the breeding season? Why the destruction in reality of so many birds? This cruelty and destruction was perpetrated that the bird-catcher might have 1*s.* 8*d.* apiece for his birds, and the bird fanciers of Manchester, to which place they had to be sent, might keep the wonderful songsters, which should

have been free to answer the end of their creation, close prisoners all their days.” Doubtless the writer of the above refers to the Fylde district, the extensive arable lands of which afford to the skylark better protection than the pasture-lands in this locality, from the various causes assigned for its decrease, other than the one attributed to “bird catchers.” Through part of this district I myself passed on the 8th of May, and was delighted, as I walked along the pretty country lanes of Whestby and Wrea Green, to hear several larks trilling out their sweet notes as they hovered over the corn and clover fields.—*R. Standen, Goosnargh, Preston, Lancashire.*

NEWTs NEAR LONDON.—S. Roberts inquires for a locality near London where he can obtain newts. South of the Thames there are numerous ponds where they are plentiful. The ponds on Wandsworth Common swarm with both cristatus and punctatus, so do some of the ponds on Putney Heath. In Croxted Lane, Dulwich, a rural spot two or three years ago, but now given up to the builder, there is a sluggish stream which flows through the railway embankment. In this stream, at the point where it leaves the roadside for the railway, newts abound. This locality may be reached by train from Ludgate Hill to either Herne Hill or Dulwich stations. If it will suit S. Roberts better he may take the train from Ludgate to Nunhead Junction. On leaving the station turn to the left and keep along the left side of the cemetery, cross the field and make for a railway arch on the left. Passing under the railway, he will see a broken-down fence, still on the left, and in the centre of the field a pond. Besides being a locality for newts, this pond is also a station for the ivy-leaved duckweed (*Lemna trisulca*). All these ponds contain, in addition to the newts, numbers of water-beetles with their usual companions, the water-bugs and snails. Many other ponds might be mentioned, but I think these will satisfy your correspondent.—*E. Step.*

NEWTs NEAR LONDON.—S. Roberts will find the large- and smooth-water newts in the ponds on either Wandsworth or Tooting Commons. I have found Tooting Common the better, when collecting beetles.—*Walter A. Pearce.*

NEWTs NEAR LONDON.—In reply to the question of “Newts near London,” put by Mr. Roberts in your last number, he will find plenty of them on the marshes near Walthamstow. The train from Liverpool Street to Hoe Street station, is the best way of reaching this locality.—*Wm. Talbot King, M.D.*

HABIT OF CATS.—Your correspondent H. M. enquires why cats alternately lift up and set down their two forefeet preparatory to a “snooze.” The question is an interesting one, inasmuch as it refers to an action which is hereditary, and which is one of many that exist in domesticated animals, and which may be traced back for their origin to the state of the animal in its wild and therefore natural condition. The wild cat, the antecedent of our domesticated animal, performs this operation in order to make its bed flat and comfortable in the hollow tree, where moss, dead leaves and decayed wood form its couch. Our domestic cat does the same thing on the Persian rug, not because it is necessary, but in accordance with a semi-reflex action, which is the existing proof and trace of the origin of our domesticated and “civilised” pussy. Our dogs, of many breeds, still retain an interesting habit which is also to be traced back to the animal in its wild or normal condition.

This habit is that of turning themselves round and round several times, preparatory to lying down, and they will often do this even on the smoothest carpet; and yet this action is derived from that of the wild dog, which in order to prepare himself a bed in the tangled growth of the plain or prairie, turns himself several times to bend down the dried grass till it is comfortable to lie upon. These actions seem more referable to *instinct* than *reason*, for if they were impelled by the latter, surely cats and dogs would not *consider* it necessary to perform the same action on a carpet that their antecedents did in the wilds.—*E. Lovett, Holly Mount, Croydon.*

RANUNCULUS ACRIS, *alias* buttercup, may be known by its slender cylindrical flower-stalk and spreading calyx. Bulbous crowfoot, *Ranunculus bulbosus*, is known by its furrowed flower-stalk, bulbous root and reflexed calyx, whilst the creeping crowfoot, *Ranunculus repens*, is distinguished by its creeping scions, spreading calyx and furrowed flower-stalk.—*H. E. W.*

MILKWORT IN BLOOM on the 18th of April must have been unusually early, for it generally flowers much later. It was formerly called *Crosse Floure* and *Gang Floure* because it came into bloom about the time of Rogation week, and according to Gerard, the maidens who walked in the "procession" were wont to make garlands and nosegays of it.—*H. E. Watney.*

HELIX POMATIA.—Can any one tell me the best food for the great Roman snail? I took a pair at Box Hill the other day, and wish to keep them alive.—*J. O. B.*

HAIR BELL, OR HARE BELL.—May not hare be only a corruption of haere, haer, haire, all of which means hair? Hooker and Arnott in their "British Flora" have hairbell, as has also Babington. In Withering's "British Plants," 1880, he gives the names Heath Bell, Hare Bell, Witches' Thimble. In the 1841 edition, corrected and condensed by William Macgillivray, the harebell is referred to *Hyacinthus non-scriptus*. Mr. Lynn if he had turned to "Cristoffel Plantains Kruydtboeck," 1581, would have found a plant called Hares Balloches in addition to the other flowers associated with the Hare.—*F. K.*

"FREEZING OF BOILED AND UNBOILED WATER."—This query in the April number, by T. Winder, has, I believe, not been answered. Pure water freezes at 32° Fahr., but if any compounds be dissolved in the water, these prevent it freezing at that point, and lower its freezing-point. Also water containing dissolved air or other gases does not freeze, till these are first expelled. By boiling the water certain salts such as the carbonate of lime are precipitated, and the gases expelled, thus leaving the water to freeze at a higher temperature than before, and at a quicker rate. The ice produced is harder, because it is free from air bubbles. These are produced in the rapid freezing of unboiled water thus:—The upper surface of the water being frozen, the lower surface commences then to freeze, but before doing so it begins to part with its contained air. This air is prevented from rising to the surface by the film of ice already formed, hence it remains below in small bubbles and ice forms round it. Such ice is of course more brittle than that which is free from these bubbles of air.—*Alf. W. Stokes.*

COW SUCKLING LAMBS.—At Horden Hall, near Castle Eden, there may be seen the curious spectacle of a heifer, deprived of her calf, suckling four lambs. The lambs are the progeny of four ewes, each of which has had triplets, the remaining two of each family being suckled by the mother sheep.—*R. M. M., jun.*

CAJA.—In the June part of SCIENCE-GOSSIP a correspondent refers to "Caja" being occasionally double-brooded, and "A Beginner" requires an insect "incubator." I may state that a friend of mine reared five broods of the great tiger from one spring to the next, his only "incubator" being pretty close proximity to the kitchen fire, and plenty of good fresh food. The object of the foregoing was to try the effect of various plants in producing dark varieties—the broad-leaved dock being the most successful.—*G. T.*

PARASITES ON FLIES.—Whilst sitting at work to-day, two house-flies alighted on my desk; by the accompanying vibration of their wings, there was scattered around for a space at least eighteen inches, what I at first took to be a light brown dust; but, judge of my astonishment, when I discovered the said brown dust to be myriads of parasites! Yes, sir, absolutely myriads. Of course I immediately annihilated the whole; for an idea struck me that they might prove a troublesome pest to man (said man, of course, being myself). I should like to know if such would be the case, and also if the incident above related has ever been before noticed; likewise if you would kindly let me know the name of the parasite; lastly if it is figured in SCIENCE-GOSSIP.—*Henry R. W. Levin.*

INCUBATION BY A CAPON.—Having never heard of or met anything like the following, and fancying that such an occurrence must be very rare, if it is not absolutely unique in the annals of science, I am induced to reproduce it in substance below, and ask if any of your readers can supply me with a parallel or other adequate explanation of the fact or phenomenon it implies. As an aid to any or such search as the curious reader may undertake I will add a few references to other cases of castration, and then inquire how far emasculation and hybridity interlace or counterbalance one another in the lower animals. That this process, when carried out in early life, modifies the appearance, as well as the other outward attributes of the human male has been known since the days of Juvenal, but its effects on the "inward man" are not so clear, and I know of no book that exhausts the subject. Hence my inquiry, and I shall be glad to hear that the subject is not considered irrelevant in or unsuited to these pages. Describing the great scarcity that was caused in Gibraltar by the blockade to which that fortress was subjected, by a combined French and Spanish fleet, &c. in 1779-1783, Drinkwater says, "History," page 41, and I summarize the narrative as much as possible to economise space: "A singular mode of hatching was about this time successfully practised . . . The eggs were placed with some cotton wool or other warm substance in a tin case of such construction as to be heated either by a lamp or hot water . . . and (in this way) the eggs were commonly hatched. A capon, however strange it may appear was then taught to rear them. To reconcile him to this trust the feathers were plucked from his breast and belly. He was then gently scoured with a bunch of nettles, and placed upon the young hatch, whose downy warmth afforded such comfort to the bared and smarting parts that he from that period reared them up with the care

and tenderness of a mother." The only equivalent to this, if such it can be called, that I can find is that of a Brahma hen mentioned by Mr. Romanes, "Brain," by Bastian, p. 233, which after sitting on dummies for about a "month, took almost immediately, remaining for rather more than a fortnight with three orphan ferrets." But there is this great difference between the two performers in the drama, that one was actually and truly a full-fledged hen, while the other was—well, let us put it mildly, only half a cock, if so much, and there is as far as I know, no instance on record of the male of the domestic fowl taking to hatching so kindly as this capon is said to have done. It is, however, but right that I should add that I have little or no practical knowledge of such matters, and that I am a seeker after rather than a giver of information in this letter. On the other hand, a well-known observer has said, "The Obstetric Memoirs and Contributions of James Y. Simpson, M.D.," edited by Priestley and Storer, vol. ii. p. 276 that when an animal is castrated before it has reached the time of puberty the distinctive characters of the male are in general never developed, and . . . their want of masculine energy and vigour assimilate them more in appearance and habits to the female than to the male type." And this latter approximation may serve to divest, if it cannot explain, the strange freak mentioned above of much of its strangeness and individuality. Again, there is nothing more wonderful in a capon incubating than there is in a man suckling, and numerous instances of this feat are, *pace* the cloud of witnesses, mentioned by physiologists and others. I have collected several of these myself in a paper on metastasis I published a few years ago, in the "Indian Annals of Medical Science," and I was more than once at fault, during the early part of my residence in that country (India) as to the sex of the nondescript creatures who prowl for nameless purposes in many of its bazaars. Mr. Darwin alludes to some length to this peculiarity in his "Animals, and Plants under Domestication," vol. ii. pp. 51-4. And after observing that "the flesh of rats and native dogs was highly relished" by the Maories, Dr. Thomson says, "The Story of New Zealand," vol. i. p. 155, that "some of the males (of the latter) were castrated to increase their size and improve the flavour of their flesh" and, some Brillat Savarin of the future may possibly thank me for the hint. Whether any similar procedure is enforced at Otaheite, where dog is an equally favourite relish, I have been unable to learn. But the subject has, at least, a culinary interest, and anyhow its considerations may enable us to realise the truth of the old distich which says that—

"Our own blue smoke is warmer than their fire.
Domestic food is wholesome though 'tis homely.
And foreign dainties (are) poisonous though tasteful."

—*W. Curran, Ashton-under-Lyne.*

POLEMONIUM.—In answer to a request for information by C. W. Holgate in the SCIENCE-GOSSIP of May, the *Polemonium caruleum* is growing at Llandaff, not quite wild, for it is in the garden, but it is growing and spreading in spite of the gardener, and refuses to be exterminated.—*E. M. Pursons.*

BLACKBIRDS AND ADDERS.—Walking on a common, on a warm day last April, I noticed a blackbird fluttering on the ground; it flew away unwillingly on my near approach, and at the same time a large female adder crawled away—no doubt the poor blackbird was "charmed" by the adder, and, had I not approached in time would have been swallowed. I may add here a few notes about the

adder, or viper. They rarely hiss except after a slight sun-shower of rain, when they delight to come out of their holes and crawl about; their hissing arises, I believe, simply out of their enjoyment of life as the song of birds, or the chirp of the grasshopper. All the rustic people in North Hampshire believe that they will swallow their young on any threatened danger; many trustworthy labourers have told me that they themselves witnessed this curious sight. They frequently hibernate in faggots of wood, appearing from their winter quarters in March, if the weather be warm and sunny.—*G. Dewar.*

STOATS.—On the 9th of May two friends and myself discovered the nest of a stoat in what I think must have been a very unusual place. She had taken possession of a jackdaw's nest in a hollow bough of an elm, the trunk of which was quite perpendicular, and without anything to assist the animal to ascend, the nest being fifteen feet from the ground. After considerable trouble we dislodged the stoat, and then found in the nest ten young ones, part of a great spotted woodpecker, a starling, the wings of two jackdaws, and the remains of the jackdaw's eggs. The stoat went to ground, but was caught in a trap later in the day; it was a doe of very large size.—*W. Wells Bladen.*

HAWFINCHES.—Referring to the notes from several of your correspondents respecting the occurrence of these birds, I may say that I have found their nests in Sandon Park, Staffordshire, within the last two years; and some friends who have resided in the neighbourhood longer than I have, inform me that they have frequently found the nests and seen the birds in the same place.—*W. Wells Bladen.*

SNAKES SLOUGHING.—As far as my experience goes, having kept several species of snakes British and foreign, the operation of casting their slough is always begun at the head, leaving the slough turned wrong side out. I have a beautiful slough of an African colubrium snake over four feet long. With my slow-worms, on the contrary, I have never got a perfect slough, mine having always cast theirs piecemeal, except an inch or two of the tail, which slipped off like a sheath. I shall be glad to know if this has been the experience of any others who have kept these pets.—*J. M. Campbell.*

A CURIOUS WASP'S NEST.—I have just seen, July 5, a very remarkable phenomenon. A colony of wasps have built their vespiary on the wall of a stone villa residence in the suburbs of this town. The nest, which is a large one, is built under the shelter of the pediment surmounting a porch constituting the front entrance, and is placed in the angle where the pediment forms a junction with the wall. The nest is about eighteen feet above the level of the road. It is of a dull, dark, slaty colour, and has a series of concentric grooves which, from their ribbed appearance, are evidently designed to afford security and strength to this singular and ingenious structure. Ingress and egress is obtained by an aperture of one inch diameter at the base of the nest. The entrance seems to be carefully watched, a number of the insects acting as sentinels and guards, while other members of the community come and go in active performance of various duties. The gentleman who lives in the house only discovered the nest three days ago, and consequently had no opportunity of observing these singular creatures at work. A neighbour, however, on the opposite side of the road had seen a number of wasps in his garden apparently

very busy with his pea sticks. After driving them away he found that the wasps were peeling off the thin outer bark in long narrow strips. One piece was left behind and was covered with a viscous substance, and rolled up like a bandage ready for a surgeon's use. It was reported that the insects were hornets, but after examining the nest and watching them by the aid of an opera-glass I am satisfied they are not hornets (*Vespa crabro*), but are of the rarer species of vespidae occasionally seen in this country. Certainly it is not *Vespa vulgaris*.—*Thos. S. King, Sheffield.*

TENACITY OF LIFE.—I beg to express my thanks to Mr. J. Eardley Hall for his criticism on my remarks on the above subject; but I wish to point out for his satisfaction, that in none of the instances recorded, can intended cruelty be shown, or the wilful "prolongation of agony." It has always been my practice to destroy the life of every specimen I collected if I chanced to wound anything; unless the probability of recovery was fair, in order to preserve a living example; and it was in these cases, that I observed the remarkable tenacity in the instances I recorded. I beg to apologise for making use of so much space, but to "prevent unjust prejudice against the fair name of naturalists, and of this popular journal," I trust my explanation may not be out of place.—*F. L., Ballangoda, Ceylon.*

ACHÆUS CRANCHII.—Dredging at the Isle of Man a week or two ago, I captured a fine female specimen of *Achæus Cranchii* with eggs. The depth of water was twenty-one fathoms, the bottom was weedy. A single specimen of this crab has been recorded as taken at the Isle of Man before, but it seems a very rare species. The curvature of the last joints of the legs, and the tubercles on the eye-stalks render it unmistakable. I should be glad to know whether this species has become more common since the publication of Adam White's useful little work.—*L. Adams, Manchester.*

LAPWINGS.—On Thursday, the 30th of June, whilst crossing some moors between Calectock and Perranzabuloe, my attention was attracted by the cry of a single lapwing plover (*Vanellus cristatus*), which I soon after observed. At first I thought it must be one that had been wounded during the winter, and had remained in the locality and recovered. Seeing, however, the bird did not leave the neighbourhood of the moors, I planted myself under a bush and narrowly watched it. After a time it settled in the moor some few hundred yards from me when I made in the direction and flushed it, although at some distance from me. On repairing to the spot it appeared to rise from, the bird seemed very disturbed and flew past and around me, uttering cries of distress. It was shortly after joined by three other plovers, two of which appeared this year's birds. Although I did not find a nest, I am convinced the birds had bred in the moor, and most probably had a nest there then. They continued their cries until I left the moor, and then returned to the neighbourhood of the spot from which I rose the first one. I have walked across country in West Cornwall, thousands of miles, and taken out a shooting licence for several years past, but I never knew or heard of the lapwing plover breeding in this part of Cornwall, nor in the county even. I have asked one or two veteran sportsmen, and they never observed a similar case. May not this be another instance of a new introduction in the county of Cornwall, as in the case of the starling and woodpecker, or could it be accounted for from the fact of the exceptionally severe winter we have

just experienced?—*Clement C. Carlyon, Truro, Cornwall.*

DANEL'S DEN.—The den is formed in my dining-room window, looking east, so it is cool, with the exception of the morning sun. It may interest some readers, so I will briefly give an explanation of its construction. The sides are formed of wood, at the outer edge of which the sash works up or down in a groove; the boards are covered with rough virgin cork, fastened with zinc nails. The box containing the earth, &c., is of zinc, four inches in depth, with a pipe going through the woodwork of the window outwards, to carry off the surplus water. The earth is mixed with sand and stones, the surface covered with moss. Being in its winter garb, it is not so attractive as it may be a couple of months hence. *Polypodium vulgare*, *P. angulare*, *Scolopendrium*, and one of the *Lastrea* family are survivors of the winter. I have had *Athyrium*, *Asplenium Ruta-muraria*, *viride*, *Trichomanes* and *A. nigrum*, *C. officinarum*, *B. Spicant*, *Cystopteris regia*, *P. Robertianum*, *P. Dryopteris* and *Osmunda* flourishing during the warmer months, some doing better than others, owing to the soil, situation, drainage and a colony of worms for the use of the occupant, Danel, a frog just completing his ninth year. He is sociable, musical, and particularly thoughtful. His pond is a stoneware basin about ten inches in diameter; a stump made of cork, the edges brought together and fastened with copper wire, and filled with mould. There are some holes in the sides through which *P. vulgare* and *A. Trichomanes* thrust their fronds. Some fantastic rockwork completes the den. It is open at the top to facilitate watering; the sash can be raised to perform any other duties; the inside measurement, four feet in length, eleven inches wide, and about two feet six inches high.—*John F. Morgan, Tredegar.*

WHITE POLEMONIUM.—Last week a white variety of *Polemonium ceruleum* was sent to me; gathered from the river-side, near Derby. I could find no mention made of any white variety of this plant, except in an old edition of Withering, in which he speaks of the blossom being sometimes white. Greek Valerian (Jacob's Ladder) is to be found at Malham Cove, Yorkshire; at the Lover's Leap, Buxton; near Bakewell, Gordale, Yorkshire; near also to the plantations under the Ochre Pits at Shotover Hill, Oxfordshire.—*E. Edwards.*

NOTICES TO CORRESPONDENTS.

TO CORRESPONDENTS AND EXCHANGERS.—As we now publish SCIENCE-GOSSIP earlier than heretofore, we cannot possibly insert in the following number any communications which reach us later than the 8th of the previous month.

TO ANONYMOUS QUERISTS.—We receive so many queries which do not bear the writers' names that we are forced to adhere to our rule of not noticing them.

TO DEALERS AND OTHERS.—We are always glad to treat dealers in natural history objects on the same fair and general ground as amateurs, in so far as the "exchanges" offered are fair exchanges. But it is evident that, when their offers are simply disguised advertisements, for the purpose of evading the cost of advertising, an advantage is taken of our *gratuitous* insertion of "exchanges" which cannot be tolerated.

B. E. W.—Euckton's "History of British Aphides," of which two volumes have already appeared, published by the Ray Society, would answer your purpose. Every species is there figured on coloured plates. You had better offer to exchange specimens in our exchange column. We insert these exchanges gratuitously if they do not exceed three lines of print.

"MUCKROSS."—We are sorry to say that, owing to a removal, your specimens have been mislaid; please send others. We take this opportunity of apologising to others who may have sent us objects to be named. Our time has been so taken up, that for any delay we crave a little indulgence.

H. WELLS.—The leaf you sent us is attacked by the white rust.

J. A. O.—A fourth edition of the "Micrographic Dictionary" is now being issued, in 25. 6s. parts, by Van Voorst.

J. H. WATSON.—You cannot do better than go to the neighbourhood of Castleton, Derbyshire, to hunt for fossils of the carboniferous limestone series. In Trecliff, Cave Dale, and the quarries on the road to Tideswell, there are very rich harvests to be gleaned.

B. J.—Your specimen is wavellite (a phosphate of alumina). We sometimes get it in coal shales.

MISS THOMSON.—The egg you sent us is that of the quail.

C. L. A.—The monstrosity in terminal part of the floral spike of foxglove (*Digitalis purpurea*) is not uncommon. See Dr. Masters's "Teratology," p. 40.

H. HANNARD.—It is impossible to identify the reptiles from your description.

T. STOCK.—Accept our best thanks for donation of seeds of *Erinus alpinus*.

F. J. GEORGE.—Your photograph is an appreciated addition.

R. J. M. and VARIOUS OTHERS.—We have received specimens of caterpillars from various contributors in Burnley, Blackburn, and Clitheroe, all of which are those of the grass moth (*Chorax Graminis*), an insect which feeds on grass in its earliest stage, as its specific name implies. See notice in Newman of this caterpillar affecting the grassy slopes of the hills about Keswick. It appears to have been very abundant this year on the hilly pastures near Clitheroe.

G. H. C.—You cannot do better than procure the volume of "Cassell's Natural History" (edited by Professor Duncan), dealing with reptiles, for information concerning both British and foreign species.

A. H. B.—The plant you sent us from Devonshire, where it goes by the name of "money-pennies," is the navel-wort (*Cotyledon umbilicus*). Please send us any notes on plant folklore you may have by you.

EXCHANGES.

ENGLISH shells, between fifty and sixty named varieties, also small collection of minerals. What offers?—P. Ross, Kersal Dale, Manchester.

WANTED, cabinet suitable for conchological specimens. Books, or micro slides of Molluscan palates, offered in exchange.—J. D. Butterell, Beverley.

FRESH-COLLECTED specimens of cluster-cups *Acim. rubellum* on the dock and sorrel, *R. Filaria* on pilewort, *Acim. urtica* on the nettle, offered in exchange for kingfishers' or nightingales' eggs, side-blown.—G. Garrett, 13 Burlington Road, Ipswich.

FIFTEEN coloured diagrams, printed on cloth, 5 feet by 3 feet, on the literary history of the Bible, nearly new, cost £2 10s., do well for lecturing. Will exchange for micro slides, or books on geology.—E. Tye, High Street, Stony Stratford.

STAMP album, containing 230 stamps, all different, some good sorts. What offers?—E. Tye, High Street, Stony Stratford.

WANTED to exchange mounted diatoms and crystals for anatomical preparations, mounted.—A. Smith, The Laboratory, Essex Road, London.

FOR a bottle of mounting medium, good, send two good anatomical slides.—A. Smith, The Laboratory, Essex Road, London.

WANTED in exchange for other natural history objects, British mammals in the flesh, or good skulls of the same, bats, shrews, voles, and mice; also nest of harvest mouse.—J. M. Campbell, Kelvingrove, Glasgow.

WANTED, on approval, Newman's "British Moths," in good condition, and clean. Exchange insects, or give cash.—A. S., 624 King's Road, Fulham, S.W.

I SHALL be happy to send a specimen of *Salicornaria farcinoides* to any one desiring it upon receipt of stamped address.—E. Lovett, Holly Mount, Croydon.

BRITISH and foreign birds' eggs to exchange for others not in collection.—J. T. T. Reed, Ryhope, Sunderland.

LEPIDOPTERA to exchange for a "setting-house."—J. M. Crossley, Castle Gate, Lewes, Sussex.

WELL-MOUNTED slides of *Cyclostoma elegans* in exchange for other well-mounted microscopical objects (ground glass slips).—M. Farhall, 3 St. John's Road, Dover.

A FEW sections of spur of Ornithorhynchus, mounted; also slides of membrane from dorsal fin of albacore captured at

Dab-el-Mandeb. Exchange for British mosses.—Dr. H. J. Ryder, 141 Romford Road, Essex, E.

WANTED, marine algae in fructification, any kind, in exchange for well-mounted slides, or good material. Wanted also specimens or pieces of British Gorgonia for identification.—J. Tempère, Storrington, Sussex.

OFFERED, a number of named varieties of Gorgonia spicules for other slides not in collection. Geological preferred.—J. E. Fawcett, Rawdon, near Leeds.

"WILD Life in a Southern Country," and the "Amateur Poacher," by the author of "The Gamekeeper at Home," in exchange for works on natural history.—Tom Duckworth, Paradise Court, Castle Street, Carlisle.

FOR exchange or sale, a 24-inch plate electrical machine, a 12-inch ditto, and 18-inch cylindrical ditto; also a quantity of electrical apparatus.—T. C. Maggs, Yeovil.

SCIENCE-GOSSIP for 1883, unbound, also few odd numbers previous dates, exchange for few slides of anything useful.—F. C. M., 3 Alexandra Road, Sheerness.

LONDON CATALOGUE, 7th ed., Nos. 1261, 1265, 1266, 1280, 1282, 1297, 971, and *Althaea hirsuta*, in exchange for other good plants.—T. James, Tovil, Maidstone.

WANTED, Balfour's "Botany," or good medical Botany; will give in exchange other natural history works.—G. Forde, Sandon, Stone, Staffordshire.

WANTED, Thripp's "Mosses," 2 vols., coloured plates, bound, and in good condition, second-hand.—13 High Street, Watford, Herts.

WANTED, first-class micro slides of photographs of statuary or scenery, selected marine diatoms, desmids, and other freshwater algae, dichromatic chemical crystals for polariscopy, bird and animal parasites (balsam); in exchange for British land, freshwater, marine, and foreign shells, named and localised, and perfect specimens of British lepidoptera. O. M. A., 82 Abbey Street, Faversham, Kent.

OFFERS wanted for Weissmann's "Entwicklung der Dipteren."—Fourteen double copper plates.—F. Savage, University School, Hastings.

ANY of the following fossils for ones I have not got:—Vertebrae of the Ichthyosaurus; *Ammonites mutabilis* and *cordatus*; *Trigonia gibbosa*; *Rhynchonella concinna*; Terebratula; *Ostraea Columba*; Belemnites, and others. Apply to E. Syc, Stony Stratford, Bucks.

BOOKS, ETC., RECEIVED.

"On the Indian Hills." By E. L. Arnold. 2 vols. London: Sampson Low.

"Volcanoes." By Professor Judd. London: C. Kegan Paul & Co.

"Proceedings of the Literary and Philosophical Society of Liverpool." Vol. XXXIV. 1880.

"How to Make the Best of Life." By Dr. J. M. Granville. London: D. Bogue.

"Studies in the Theory of Descent." By Dr. A. Weisman. Part II. London: Sampson Low.

"Synopsis of the Freshwater Rhizopods." By R. Hitchcock, New York.

"Journal de Micrographie." April.

"Micrographic Dictionary." 4th edition. Part I.

"Midland Naturalist." July.

"Northern Microscopist." July.

"Land and Water." July.

"Good Health." July.

"American Naturalist." July.

"Scottish Naturalist." July.

"Revista." July.

"Feuille des Jeunes Naturalistes." July.

"The American Monthly Journal of Microscopy." July.

"La Science pour Tous." July.

"The Antiquary." July.

"Proceedings of the Liverpool Naturalists' Field Club."

&c. &c. &c.

COMMUNICATIONS RECEIVED UP TO 8TH ULT. FROM:—G. A. L.—H. R. W. L.—P. R.—E. T.—W. C.—G. N.—R. C. P.—T. S. K.—W. F. M.—W. W. B.—E. M. P.—A. S.—E. S.—W. P. II.—L. L.—F. B. R.—B. P.—J. O. E.—G. M. P.—J. B.—J. H. H.—W. H. W.—T. S.—C. M.—G. D.—S. B.—A. B.—J. H.—G. G.—F. K.—J. N. D.—A. S.—J. M. C.—C. P.—C. F. W. T.—J. A. B.—O.—C. F. P.—J. O. C.—E. E.—V. G.—G. F.—J. T. T. R.—G. T. H.—E. L.—H. P. M.—H. J. R.—H. E. W.—A. C.—A. G. R.—W. A. P.—G. J.—J. C. M.—F. J. G.—J. E. F.—J. T.—D.—T. S. K.—F. I.—F. C. M.—A. B.—H. II.—E. R.—F.—B.—W. T. K.—B. W. W.—J. R.—G. F.—T. J.—T. C. V.—H. W.—L. A.—C. C.—T.—A. H. B.—T. S.—W. S.—E. T.—T. S. K.—Dr. R. H.—A. J. B.—W. W. W.—E. E.—A. J. B.

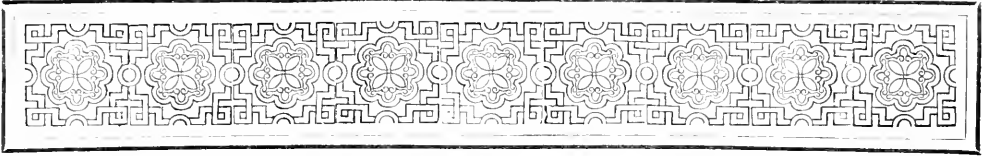

THE STRUCTURE AND LIFE-HISTORY OF A SPONGE.

BY PROFESSOR W. J. SOLLAS, M.A., F.R.S.E., F.G.S., &c.

[Continued from page 159.]



E will now resume our description of the structure of the sponge.

The Skeleton.—The soft tissues of the sponge require some kind of support, and this is afforded by the hard parts, or skeleton. This consists of needle-shaped, tri-radiate, and quadri-radiate spicules, disposed in a definite manner. The proper wall of the stomach is furnished

with three and four-rayed spicules, and three of the rays of the quadri-radiate, and all those of the tri-radiate spicules, lying in the substance of the wall, parallel to its surface, while the fourth ray of the quadri-radiate spicules projects with a gentle upward curve into the gastric cavity, carrying the gastral membrane with it.

The radial tubes are furnished with tri-radiate spicules, arranged in successive, concentric, or transverse rows. The form of each spicule is such that two of its rays, those including the largest angle, may be taken to form a pair, the third ray being therefore "odd;" and they are so arranged that the paired rays lie concentrically, while the odd ray lies longitudinally, in the wall of the tube. The paired rays, which form the basal or proximal row of each radial tube, lie back to back, as it were, with the spicules of the stomach wall, which is thus doubly strengthened.

The outer ends of the radial tubes are furnished in addition with colossal fusiform spicules, each often

3 mm. long; these are imbedded at one end in the tissue of the tube, and at the other project freely beyond it; about the base of each colossal spicule there is usually a pencil of similar, but smaller spicules, and a few large grapple-like spicules are also present. The spicules, large and small, thus projecting from the end of the tube in the form of a brush or pencil, give to the surface of the sponge the hairy appearance to which attention has already been directed.

The spicules of the corona are partly colossal spicules similar to the foregoing, partly tri-radiate and quadri-radiate spicules, with three rays of the latter and two of the former imbedded around the mouth, the remaining ray in each case projecting vertically upwards.

This nearly completes our account of the structure of the sponge; that which remains, the nature of the reproductive organs, will form a natural introduction to the account of its life-history.

Certain amœboid cells have already been described as inhabitants of the mesoderm, and the origin, or probable origin, of these cells has also been pointed out. What the subsequent history of them all may be we do not yet surely know, but some of them, at all events, continue for some time wandering through the mesoderm, and instead of contributing food to the rest of the sponge, obtain their nutriment from it, like parasites; thus they grow big, at the same time they become lazy, and at length cease to move about at all; then they assume a spherical form, and remain stationary in a cavity of the mesoderm. If they now retain their simple cell-form, simply increasing in size, they are known as *ova*. Some of them, however, undergo a structural change (at least, so we infer, for this is one of the stages in the history of the sponge which has not yet been directly observed), and as a result of this change, the nucleus of the cell disappears, and the cell itself becomes fibrillated, the fibres all radiating from the centre of the cell to the exterior. It is now called a *sperm-ball*. When it becomes mature, the fibres within are set

free; each consists of a little highly-refractile conical head, with a long tail, which vibrating rapidly, propels the *spermatozoon*, as the structure is called, head foremost through the water.

The *spermatozoon* is the male element, the *ovum* the female element of the sponge. Both occur in the mesoderm. It is a singular thing that the male elements have not yet been discovered in *Sycandra raphanus*, but they have been seen in various other sponges; in some species occurring in the same individuals as contain the ova, in others in different individuals, so that some sponges are hermaphrodite, and others bisexual.

If the ova and spermatozoa be kept from each other nothing remarkable will happen, each will lead its own life, and die a natural death. But they do not as a rule remain apart; the spermatozoa when set free on the disruption of the sperm-balls, are carried away in the out-flowing water from the radial tubes of one individual, to enter along with the incurrent water the radial tubes of another. Should this latter contain ova, the spermatozoa on approaching an ovum swim towards it like so many tadpoles, and striking it head foremost, with their tails streaming outwards, remain for a while radiately disposed about its circumference. Finally they enter the substance of the ovum, are absorbed and disappear. The ovum is then said to be impregnated. Unfortunately this process, though it has been witnessed in many other sponges, has not been observed in *Sycandra raphanus*. As a consequence of the fusion of the spermatozoa with an ovum, the latter undergoes a remarkable series of changes, which end in producing a fresh sponge like the parent. First of all the nucleus disappears, and after awhile two fresh nuclei appear in its place; a constriction then occurs round the exterior of the ovum, as a shallow furrow, which deepens, extending inwards between the two nuclei till it actually divides the ovum into two parts, each of which has the value of a true cell. The direction in which this division takes place is constantly from the top of the ovum (that side facing the endodermal layer), to the bottom, or, as we may briefly formulate it, perpendicular. The cells resulting from the division are flattened below and also against each other, but rounded off towards the top, thus diminishing in size from the base upwards. They soon undergo the same kind of change as the parent ovum, the nucleus of each disappears, and is replaced by two fresh nuclei, each is then furrowed by a constriction, and eventually divided into two cells. The plane of division is still perpendicular, but at right angles to the previous one. The four cells thus resulting resemble the parent cells in being broad and flat below, and narrower towards the top; they are likewise flattened against each other, but rounded off along their inner perpendicular edges, so as to leave a small cavity or canal in the axis of the group. This canal is the beginning of what we shall

know hereafter as the cleavage cavity. Division again takes place, and still in a perpendicular direction; each of the four cells is divided into two from top to bottom, and thus eight cells arise, which form a ring (fig. 94 A), surrounding the cleavage cavity (ib.), and narrowing from the base upwards. After these three perpendicular divisions, which have given us first two, then four, and finally eight, cells, a fourth one occurs, which is horizontal, and so at right angles to all the preceding ones. As the tops of the cells, previous to this division, were, as stated before, smaller than the bottoms, so it follows that the eight upper cells above the median plane of division are smaller than the eight lower cells beneath it. The embryo consists now of sixteen cells in two rows (fig. 94 C), an upper or apical row, and a lower or basal row, of eight cells each, surrounding the cleavage cavity, which opens by a wide lumen below, and a much narrower aperture above. The embryo exchanges now its plano-convex, or cake-like, for a cushion-like, or biconvex, form. Two more divisions, also in a horizontal direction, now succeed, severing each ring into two, and thus producing a four-ringed form; one ring is apical, one basal, and the two between may be called equatorial. The cells of the equatorial rings are again divided, and this time vertically, in a meridional direction, we might say; in this way each equatorial row comes to contain sixteen cells. The embryo now is a cushion-like sac, the wall being composed of a single layer of similar cells, forty-eight in number, sixteen in each equatorial ring, and eight in each polar ring. The number of cells is further increased by division, the sac becomes more spherical in form, and the apical end of the cleavage cavity closes up. The next stage in the development is a differentiation of the cells, the eight which surrounded the basal opening of the cleavage cavity, and which are larger than the rest, acquire a dark appearance, owing to the development of a great number of dark granules within them. The remaining cells are much clearer, and multiplying in number, are converted into elongated small prism-like cells, radially arranged. The basal end of the cleavage cavity now closes up, and the dark granular cells increase in number. The next stage is either abnormal, inconstant, or in any case subsequently reversed; in it the layer of granular cells becomes flattened, depressed, and then pushed into the cleavage cavity, which is thereby diminished, or even almost obliterated, the granular cells applying themselves to the inner face of the prismatic layer (fig. 94). The form so produced is similar to the gastrula of other animals, but it is not permanent, the granular cells withdrawing themselves, and subsequently resuming their former position.

We may, therefore, return to the larva, where we left it in the normal course of development. The embryo is now more or less egg-shaped; the smaller

end consists of the numerous small clear prismatic cells, which are now furnished with flagella, projecting from their outer ends; the larger end consists of the fewer (thirty-two) larger, rounded, dark, granular cells, sixteen of which are arranged to form a girdle round the equator, next to the prismatic half. The cleavage cavity still exists as a more or less spherical space in the middle, bounded half by the pigmented ends of the prismatic cells, half by the granular cells. By the movements of its flagella the larva now is liberated from its encapsuled cavity in the mesoderm, passes through the endodermal layer, into the radial tube, and so borne along by the outflowing currents of the circulation out of the sponge into the surrounding water, where it spins about in a lively whirling kind of dance. As it grows, the little "blastula," as it may now be called, becomes less ovate and more spherical, and then commences to pass through one of the most important stages of its existence; the flagellated layer begins to lose its spherical contour, becomes flattened, depressed, and is at length drawn quite within the hemisphere of granular cells; it then applies itself to the inner face of this layer, entirely obliterates the cleavage cavity, and thus gives rise to the true *gastrula* form. It will be seen that the embryo is now somewhat beehive-shaped, its wall is double, consisting of an outer ectodermic layer of granular cells, and an inner endodermic layer of prismatic cells, the cleavage cavity has disappeared, and a new cavity with a widely-open aperture below has arisen by invagination. This aperture is bounded by the row of sixteen granular cells, which previously formed the equatorial girdle of the embryo, they now grow radially inwards towards the centre of the aperture, and thus diminish its area, till it becomes reduced to a comparatively small opening; it is the larval mouth, as the cavity produced by invagination is the larval stomach. So far the larva has led an active, if not an industrious, existence, with the continual promise of better things; it now proceeds to a step, which, in the history of animal development, has generally proved fatal to further progress of importance, and has indeed often led to change in a backward direction. Settling down on some fixed object, such as a bit of stone, or the stem of a seaweed, it exchanges a free for a fixed and stationary existence. The granular cells surrounding the mouth grow inwards towards its centre, and completely obliterate it, at the same time they grow outward over the surface of attachment in transparent, irregular, jagged, pseudopodia-like processes, which solder the young sponge securely to its seat (fig. 97).

By the absorption of a part of their granules, the granular cells lose, to a great extent, their opacity, so that one can see the layer of prismatic, or cylindrical cells, through them. They have, evidently, at this stage, lost their flagella. By excretion, or

alteration, of the granular cells, a thin layer of jelly-like material is formed between the two layers of the embryo; this is the beginning of the future mesoderm, and in it the spicules as delicate needle-shaped forms first make their appearance. As they grow they soon enter the outer, or ectodermic, layer.

The larva grows in the direction of its axis, and so elongates into a cylindrical or conical body, the distal end flattens, and becomes perforated by a hole which puts the stomach cavity into communication with the surrounding water. This hole is the adult mouth, the endodermal cells retreat from it, leaving the ectodermal layer alone around it, as a clear thin membrane terminating the gastral cavity. Little round spaces open in the side-walls of the sponge and form the pores, the endodermal cells acquire their characteristic collar and re-acquire their flagella. Simultaneously with these changes additional spicules appear. The double-pointed needle-like spicules projecting obliquely upwards and outwards, form a sort of tube, extending from the base to the summit; immediately round the basal edge and the summital edge, they project outwards at right angles, forming a kind of collar. Mingled with the basal spicules are those with toothed ends, before alluded to as grapnel-like spicules. Between the needle-like spicules are tri-radiate ones, all similarly arranged, two rays being directed more or less concentrically, and the third longitudinally and downwards. Quadri-radiates also make their appearance, and first round the terminal edge, two of their rays lying in the edge, one being directed longitudinally downwards, the other radiately towards the mouth, and serving as a support for the oral or terminal membrane. They are usually four, six, or eight in number at first, and are always symmetrically arranged.

(To be continued.)

RUSTIC BOTANY.

No. II.

IN connection with a former paper, "On Rustic Botany," we proceed to consider: Plants used in domestic medicine, for their real or supposed virtues, omitting such plants as enter into our materia medica, and such as were formerly used, upon the principle of "signatures," that is, the doctrine that the medical virtues of plants are indicated by some outward signature, or markings, colouring, &c.

Parsley-piert (*Alchemilla arvensis*) is a lowly little plant, more admired for the pleasant green of its foliage, than for the showiness of its golden green flowers; this is used by surgical magnates of no insignificant authority. It is astringent, and perhaps slightly mucilaginous. *Alchemilla* is from the Arabic, *Alkimlyek*, alchemy; on account of its pretended alchemical virtues. (Theis.) The buck-bean, or marsh trefoil (*Menyanthes trifoliata*) is a beautiful plant, and good as a bitter. Linnæus

mentions that the leaves were used in Sweden as a substitute for hops, and a like use is made of them in Silesia and other parts of Germany.

Withering tells us that the powdered root has been known to cure sheep of the rot; but though goats eat it, sheep seldom do. Cows, horses, and swine refuse it. The centaury (*Erythraea Centaurium*) and yellow-wort (*Chlora perfoliata*) are both used as good bitters. Withering speaks of the common centaury as being "extremely bitter," and as the basis of the famous Portland powder. In Cheshire it is not uncommonly called Sanctuary, which is a corruption of centaury. The yellow-wort, besides being used as a tonic, also dyes yellow.

The purging flax (*Linum catharticum*) is frequently used in the moorlands, and its name expresses its quality, which is often harsh.

Solomon's seal (*Convallaria multiflora*) is one of liliaceous, but not bulbous plants. It is used for black eyes, and "fast" young men are said to keep a piece of the root ready for that use.

Amongst other plants standing high in public opinion, though a medical friend says he never found out its good qualities, is the common agrimony (*Agrimonia eupatoria*). Dr. Thornton speaks of it as a mild astringent, and good for cutaneous diseases, for which he says "it has obtained much reputation."

In the "Treasury of Botany" we are informed that the foliage is aromatic and astringent, and an ingredient in several herb teas. Tormentil (*Tormentilla officinalis*) is also a strong astringent and styptic. The root is the part of the plant used medicinally. The name potentilla, now given to it, is derived from Latin, potent, powerful, on account of the medicinal virtues attributed to some of the species. The water crowfoot, celery-leaved crowfoot (*Ranunculus sceleratus*), a plant found in shallow water on ditch banks, is used by beggars to ulcerate their feet and legs, which they expose in that state to excite compassion. Sceleratus, wicked, applied to the celery-leaved crowfoot on account of the extreme acidity of its juices.

In connection with medicinal plants, we would mention calamint (*Thymus calaminta*), which makes an agreeable tea; germander, wood betony, and melissa, have similar properties, but we would, with our French neighbours, choose the flowers of the lime, and the roots of two grasses, *Triticum repens* and *Panicum dactylon*. The latter three are much used on the continent.

Scurvy-grass (*Cochlearia*) was in request in old times for sea scurvy. It grows on rocks and muddy shores, and is very common by the seaside, as well as by salt rivers.

Common milkwort (*Polygala vulgaris*) may be used as an expectorant. Linnaeus found it to possess the properties of *P. Senega*. An infusion of the herb, which is very bitter, taken in the morning fasting, promotes expectoration, and is good for a

catarrhus cough. Some of the milkworts possess milky juice in their roots, hence the generic name.

Yarrow (*Achillea Millefolium*) recommended as a medicine, by the late Sir B. Brodie; a friend to whom it was named was so delighted with its effects, that he planted it on his grass-plot, but in the "struggle for existence" it destroyed his grass. The flowers yielded an essential oil. Nettle (*Urtica dioica*) was a plant formerly used as an astringent. Paralytic limbs have been recovered by stinging them with nettles. The young shoots are gathered early in spring to boil in broth or gruel. We have known them boiled as greens, also with the addition of *Galium aparine*, they make a delicious and wholesome kind of beer, much esteemed by our poor neighbours, as a great purifier of the blood.



Fig. 110.—Centaury (*Erythraea Centaurium*).

The leaves are cut in pieces to mix with the food of young turkeys and other poultry.

The stalks may be dressed as flax, or hemp, for making cloth and paper. The poet Campbell says in one of his letters: "I have slept in nettle sheets, and dined off a nettle table-cloth, and I have heard my mother say, that she thought nettle cloth more durable than any other linen." Woollen stuffs may be dyed a beautiful and permanent green with the use of nettles only. The roots boiled with alum will dye yarn a yellow colour.

Shakespeare makes twelve different allusions to the nettle.

Bryony (*Bryonia dioica*) is a very elegant plant, especially in autumn, when it adorns the hedges with its brilliantly coloured fruit. The root is medicinal, but [requires] care in using; it is employed as an

application to bruises. From the severe action of the root when taken internally, the French call it "Devil's turnip." Its acidity is due to a chemical substance called Bryonine. Amongst other medicinal plants, is the willow (*Salix*). The bark of several species abounds with salicine, and therefore may well be used for its medicinal virtue. We would mention particularly *Salix pentandra*, which, from its handsome appearance and fragrance, may be entitled the "moorland Bay." The tree referred to in Psalm cxxxvii. is the weeping willow (*Salix Babylonica*). Many years ago, the well-known poet, Alexander Pope, who resided at Twickenham, received a basket of figs as a present from Turkey. The basket was made of the supple branches of the weeping willow, the same species under which the captive Jews sat when they wept by the waters of



Fig. 111.—The Buck-Bean (*Menyanthes trifoliata*).

Babylon. Pope untwisted the basket and planted one of the branches in the ground. Happily it grew, and soon became a tree. From that one branch all the weeping willows in England are said to be descended" (?)—Kirby's "Trees."

We will now briefly notice a class of plants whose properties are of a miscellaneous description.

Grass-wrack (*Zostera marina*). When dried it is used as material for packing, especially in France. A friend has been shown a beautiful silky fibre obtained from it. Bedstraws, Galium (*G. vernum*) yields a good dye, the root red, the plant generally yellow. Goose-grass or cleavers (*Galium aparine*), from the prickly leaves, may be employed painlessly to draw blood from any delicate inflamed surface, upon the eye or the tongue. The seeds are said to be a substitute for coffee. The juice of the goose-

grass when expressed, is an excellent purifier of the blood, and a famous village medicine. Wild madder (*Rubia peregriua*) is a plant of the same order as the galium, which it much resembles; it is useful as a dye. A friend has found it about Conway. It is said if poultry or other animals eat this plant it imparts a red colour to their bones.

Our next plant, the thistle (*Carlina vulgaris*), by its opening and closing makes a hygrometer, as does the wild oat (*Avena fatua*) by its twisting and untwisting. The carlina preserves its hygrometric properties for a long period, and is sometimes gathered and suspended in the house to serve as a natural weather-glass. Oliver de Scores says "that this plant received its generic name after the famous Charlemagne, whose army was cured of the plague by using it medicinally." The wormwood (*Artemisia absinthium*), another plant of the Compositæ family, is a powerful bitter, much extolled by Haller as a stomachic. The plant is thought to drive away insects from clothes and furniture, for which purpose it is often laid in drawers and chests in the country.

The difficulty in the above list is to select. We have not attempted to write a herbal, and have in a great measure chosen such plants as we could say something about, perhaps not generally known. A few of the cryptogamic plants may be enumerated, as for instance the male fern, the virtues of which are fully admitted by legitimate doctors, and therefore in accordance with what is said before, we only mention it for its very bulky and remarkable root requiring considerable pains to unearth. The common club-moss is a handsome and durable ornament in cottage grates in summer, and its sporules are used to imitate lightning.

The Dutch rush (*Equisetum hyemale*) is used for scouring on account of its flinty cuticle. Mosses can be used for many purposes; the most interesting we know of was that one which a botanical friend adopted. He chose the sphagnum for the bedding of his first infant. It may also be used to stuff birds, &c.

The services of sea-weed in diet would require at least an essay to themselves. On the coast of South Wales people gather the purple laver to make into cakes to be sold in Swansea market; this as well as the green Ulva is much used as a vegetable, the latter being the slocum of the Manx.

The fuci (*Laminaria Halymentia*) &c., dulce, and tangle, are also much eaten, especially by our northern neighbours.

E. EDWARDS.

FORMIC ACID IN ANTS.—In several specimens of ants I have noticed that the quantity of formic acid differs considerably. Does this quantity differ with the variety or with the sex?—A. J. B.

GEOLOGICAL LESSONS AMONG THE SANDHILLS.

By T. MELLARD READE, C.E., F.G.S., &c.

AS enabling the student of geology to realise some of the phenomena of physical geology, observations among the sand dunes may be of considerable use. A residence near the sea, on land as it were reclaimed from the desert, a stretch of blown sand extending along the coast from Liverpool to Southport, has directed my attention more particularly to the subject. I will proceed to classify and describe some of the miniature examples of geological action that have come under my observation.

River action.—The sandhills, here loose, there held together with “bent” or starr grass, or covered with a growth of dwarf willow on the inner plateaux or “flats,” form a rampart which holds up the contiguous inland drainage. This rampart is only broken by streams having their rise in the “uplands” beyond the confines of the sand belt—such as the rivers Alt and Douglas and some smaller streams. In very wet winters such as the last months of 1880, when 4'50 inches of rain fell in October, 4'01 in November, and 5'63 in December, the rainfall unable to escape by saturation, evaporation and soaking through the sand on to the shore, ponds up in considerable flashes. On two occasions only during a residence of thirteen years, I have noticed a considerable stream of water issuing from between the sandhills at a place that is usually dry. Following up the course of this stream I found it winding about among the valleys between the sandhills, cutting out vertical bluffs and perfect cañons which showed on their sides the stratification of the sand due to wind action. In some places it was quite narrow and winding, in others it opened out into miniature valleys. To a Lilliputian it would have appeared a mighty river! Eventually I traced it to its source, a lake, formed by the rains, which had risen sufficiently to burst its banks and by its flow cut out the “scenery” I have described. Since the frost came on, the stream no longer flows; in its bed is ice, covered with snow, and the frozen sand stands out in tiny rugged cliffs simulating rock to perfection.

A waterfall.—Thornbeck Pool is a stream flowing from the “uplands” of Great Crosby. It drains about 1480 acres, and has made a way for itself through the sandhills into the river Alt, where the latter winds about for several miles on the shore flowing southwards towards the mouth of the Mersey. The river Alt itself is an interesting phenomenon. It flows from the uplands of West Derby, and at Sefton enters the moss country, winding through it until it reaches the Altcar-rifle range, which is a plain bordered by sandhills on the sea side, and by the river Alt on the landward side. The range itself has been to a large extent reclaimed from the

sea, by the Alt commissioners, protecting their river from blowing sand by hurdles and furze, and the sand getting deposited seawards of these obstructions. The old Crosby lighthouse stands a lone object on the banks of the river, looking on a small scale more like an Egyptian monument by the Nile than anything else. Where the Alt flows through the moss land, it has built up its banks by continual overflows (before the last embankment works were carried out) and by the deposition of alluvium near to the river. The course of the Alt on the shore, within the last few years has altered very considerably, it bends in now with a great sweep towards the shore at the point where the Thornbeck Pool joins it. The effect on the latter is striking. Formerly the stream trickled over the shore in a shallow channel, but of late years it has been cutting its way back from the Alt in a deep trough, the stream tumbling over a vertical cliff of blue clay capped with hard peat, like a veritable Niagara. The resemblance of this tiny waterfall to the colossus of the American continent does not cease here, for the spray of its fall combined with the effect of the tide, eats away the soft clay beneath, leaving the peat overhanging as a shelf until it can support itself no longer, when down it goes into the gulf below in masses to be gradually washed away. In this way it has cut a deep gully reaching nearly to high-water mark. In November 1877 1'75 inches of rain fell in twenty-four hours. I have a coloured sketch I made of this waterfall on that day, it presented so remarkable an appearance. It has been receding at the rate of $5\frac{1}{2}$ yards per annum during the last two years.

Wind, Drift, and Denudation.—From having had occasion to determine the boundaries between the townships of Great and Little Crosby, my attention was specially directed to the course of the Thornbeck Pool in old times. According to the maps reaching back to the year 1702 it formed the boundary between the two townships. A new cut was made, and the stream turned down a culvert some fifty years ago. Since then the old stream course has been buried in blown sand, though some of its former effects are recognisable even now, and account for some of the surface features which before were a mystery to me. By digging at a particular point we came upon a bridge which was shown on the original maps, thus verifying their accuracy. Before this stream was culverted, I have no doubt it would act like the little river among the sandhills first described. That is, the land drainage would back up in the low part, forming the moss land which exists on its course, and though the drainage area would be sufficient to keep it always more or less open, I have no doubt it would fluctuate, pond up, and then burst its banks again.

The form of the sandhills is due to the wind, which alternately heaps up the sand and cuts it down again. The origin of the sand is the seashore.

Here it is very flat, the tide going out so far that one hardly expects it to come back again! A strong westerly wind brings up the sand in great force. It is very singular to see it travelling like streaks of smoke over the flat wet shore. The wind denudation often cuts away the sand of the shore to perhaps $\frac{1}{2}$ inch deep, leaving little protuberances of the form of a thorn wherever there is a shell or shell fragment to protect it. These I described in the "Geological Magazine" (1875, pp. 587-S) under the name of "colites." Some of these sandhills are very recent, for we find, not far from their base, interstratifications of cinders and matter thrown up from wrecks. Further inland it is surprising how few shells there are in the sandhills; I imagine they must decay from the percolation of water. I have made many excavations for houses and sewers and had abundance of opportunities of observing, and these are my experiences. The folly of building houses upon sand has been proverbial these nineteen hundred years. Here the folly is perpetrated every day! I have erected large houses with heavy walls actually upon sandhills, without settlement! The fact is that siliceous sand is one of the most incompressible of substances. The Truant Industrial School of the Liverpool School Board at Hightown, of which I was the architect—a heavy building—is erected upon blown sand which lies on a bed of peat underlain by fine silt. Part of these foundations were as soft as gruel, through saturation with water. Below a certain level, which fluctuates according to the season and rainfall, the sand is universally quicksand, and in putting in sewers it is necessary to close pile the trenches. Saturation with water makes the previously hard, dry sand into quicksand, which will run through a very small opening.

Vegetation, such as dwarf willows, often protects patches of sand from denudation, leaving them as islands standing in a denuded plain.

Although some of the sandhills are so recent, the whole of the blown sand must have taken a long time to form; it is 22 square miles in area to 16 lineal miles of coast. It is impossible to make anything like an exact calculation, but from observations of the accumulation of sand during many years on measured plots facing the sea, with every condition favourable for its accumulation, I estimate that it must have taken *not less* than 2,500 years for the whole of this sand to accumulate, but probably much more. I purpose laying these details before the public at a future time.*

In places the wind simulates the ripple-marks of water in the moving sand. Under the microscope there is no appreciable difference in the roundness of the grain between the sand of the shore and that of the sandhills.

Water Supply.—The mode of obtaining water for supplying the houses, where they are not as in many cases connected with the town main, is by shallow wells. The practice is to sink a well about five feet diameter as deep as the seam of sand at the bottom will allow, which as a rule is not more than five or six feet below the line of saturation. If the well is kept constantly pumped from day to day the water is clear and good, but if allowed to remain stagnant without pumping, it becomes more like rotten eggs from the sulphur in solution. The circulation of the water in the sand is of a very simple nature, the sand forming an extended sponge. In the New Red Sandstone, on the contrary, a well usually draws its supply from a much larger area through the tapping of fissures which act as ducts, carrying the water sometimes, in the case of deep wells, for miles.* Still the sand contains a great deal of water in its interstices, and in the case of a sewer I constructed entirely in it, about a mile long and about twelve feet average depth, the subsoil water was constantly running; of course the amount fluctuated, but it never ceased even in the driest weather.

Chemical Action.—All drainage from the sand deposits a flocculent ochreous precipitate. The "Links" of the West Lancashire Golf Club are intersected in places with open drains, and this deposit of flocculent ferric oxide is a great trap for the golf balls, which once in cannot be found, to the great benefit of the professional ball-makers. Like the "burn" at St. Andrews it is the ball-makers' providence! Rain water contains a small quantity of carbon dioxide in solution; the ferric oxide coating the grains of sand, probably previously converted into ferrous oxide by decaying vegetation, is washed out by the percolating water, which on exposure loses its carbon dioxide, and is precipitated again as a flocculent ferric oxide. The water from the sand is also hard, showing that it has taken up lime in solution. When peat lies upon sand, the sand is universally white, from the iron being discharged through the chemical action, according to M. Julien, of the Humus acids.†

Sea action: Coast erosion.—Through certain alterations in the currents and channels of the estuary, prevalent winds, etc., the line of coast erosion changes from time to time. The deposits of sand formed by wind action gets eaten into at places, while at others the land grows out seawards by accumulated wind drift. It appears as if the land were really a constant quantity; what is taken away here is deposited there. This erosion produces, for the time being, precipitous cliffs of sand, showing the internal stratification of

* See my report "On the South Lancashire Wells," British Association Report, on the circulation of underground water, 1877.

† "The Geological Action of the Humus Acids," by Alexis A. Julien, "Proceedings of the American Association for the Advancement of Science," Vol. XXVIII., Saratoga Meeting, August 1879.

* This has now been done in my paper "The Date of the Last Change of Level, Lancashire," and the next number of the "Quarterly Journal of the Geological Society" will, I expect, contain the figures and details.

the beds.* Every exceptionally high tide leaves its mark for a few days in a low cliff of sand, where before it was sloping shore. The wind soon obliterates this line of cliff, and brings things back to their normal condition.

Ripple-marks.—In walking on a sandy shore one is struck by the difference it presents in its appearance at different localities, and at different times. At one place are to be seen beautiful ripple-marks perfect in their ribbed regularity; at another, the sand is a perfect plane without a marking on it. On one occasion—I have never seen it before nor since in such perfection—a beautiful expanse of shore was covered over with delicate tracings in the most intricate convolutions interlacing in all directions. A close examination showed that these markings were raised from the surface of the sand plain, but so slightly as to be hardly detectable. It appeared as if imprinted from the edge of the foam as it floated over the shore. On another occasion I noticed extremely fine striations running in the direction of the dip of the shore, appearing for all the world like glacial striae. Last winter, while skating over a flash of water on the Links, I was much interested in observing through the transparent ice, all over the bottom, most perfect ripple-marks, in some places brought out more clearly by the hollows being partially filled with a dark deposit. It was as if the ripple-marks had been carefully preserved for exhibition in a museum by placing a pane of glass over them. From crest to crest, I should judge the ripples to measure about $1\frac{1}{2}$ inches, and these had been formed at a foot or more below the surface of the water. They showed the direction of the wind, which had been blowing freshly from the north-west a few days before the frost came on. It was doubly interesting, as proving that the impression of the minute waves is propagated so far below the surface.

I have now finished my observations, which have necessarily been brief, but I trust I have shown to my readers, that it is not requisite to go far from home to study nature. To the willing student she is always close at the door, and to those who cultivate the art of seeing an apparent trifle abounds with interest. What can appear more unfruitful in suggestions than sand? Yet among the sandhills, as I hope I have shown, some very good geological lessons may be learned.

SUN-BURNING.—Is the appearance called “sun-burnt” which we acquire after exposure to the sun’s light and heat, due to the action of the former or the latter, and if the latter, is it due to the presence of “osmazone,” the substance which gives cooked meat its brown colour, or is it due to a chemical change in the juices of the skin?—*Roland Ellis.*

* See “Eolian Sandstone,” “Geological Magazine,” May, 1851.

A VISIT TO THE NEW FOREST.

AS many of your entomological readers are at the present season at the point of deciding on some locality wherein to pursue their favourite pastime, a few notes of a visit (from which I have just returned) to the New Forest might be acceptable.

Without any exaggeration, it may be called the very best hunting ground in England, and should these notes succeed in drawing to it a few more students of Nature, they will not have been penned in vain. From what I observed, I feel convinced there is ample scope for discovery, and the advent of strangers might stimulate others on the spot to emulate them, a thing much needed, for I hear there is danger of losing access to some of the favourite haunts of insects. I mean the enclosures—



Fig. 112.—*Diphthera Orion.*

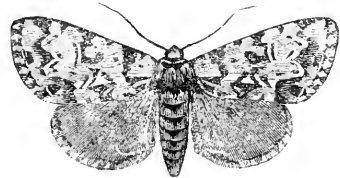

Fig. 113.—*Diphthera Orion.*

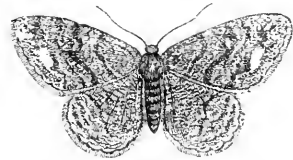

Fig. 114.—The Brindle White-spot (*Tephrosia extersaria*).

for it is whispered in high quarters that the visits of flycatchers are not looked on favourably by the official eye. At the present moment no steps in the direction of further encroachment on public rights are being taken, so nothing is to be feared by intending visitors.

In 1875, when a select committee of the House of Commons heard evidence with respect to the preservation or disafforestation of the forest, the artists of Great Britain, represented by the then President of the Royal Academy and others, entreated the House to do nothing which should in the least degree destroy the character of a domain, “absolutely unique in its extent and variety, and embracing nearly every constituent of pictorial beauty, presenting unexampled opportunities for the study of Nature in perhaps her

grandest and most picturesque forms." To this might safely be added her smallest or most minute forms, for as the resort of insect life the New Forest stands pre-eminent.

All I intend doing in this paper is simply to record those insects that struck me the most; so, first, I must mention *consortaria*, a great gray geometer, spread out flat on the bark of fir-trees that stand in rows along the sides of the enclosures. *Extersaria* also, though less conspicuous, was equally visible, from its habit of taking to the wing more readily; it was no uncommon thing to see half-a-dozen fluttering in front of you at the same moment. It is hard to give an idea of the profusion of insect life that revels in these lovely spots, but it is a fact that in a single enclosure one may walk along miles of rides amid a perfect swarm of these geometers, if only an occasional tap with a stick be given to the trees in passing.

In Rhinefield enclosure *S. fuciformis* flies freely

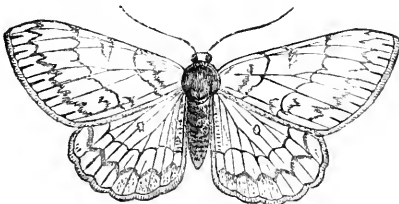

Fig. 115.—The Pale-Oak Beauty (*Boarmia consortaria*).

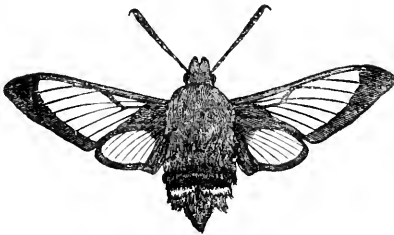

Fig. 116.—*Sphinx fuciformis*.

among the azaleas and rhododendrons. *Piniaria* dances among the topmost boughs of the pines in most parts, and on Emery Down Orion clings to the trunks of oaks and beeches, while in the glades cool damp and grassy, *sinapis* is not unfrequently met with. But the great climax of the entomologist's happiness is at night.

It was, I think, on the 24th of June, that I saw a sight unsurpassed by anything I had ever seen before (though not a novice, having naturalised in every quarter of the globe). The sugar had been spread, but scarcely had this been done when a general scramble of Lepidoptera ensued; they swarmed from every quarter, and although there was such a general demand for places at sugar, I noticed that Orion occupied some sixty places or more, and Turca and Thalassina seemed quite capable of taking care of themselves.

With regard to the plants they are mostly so well

known I will not trouble you with the names. Suffice it to say, that *Gladiolus Illyricus* was abundant, but it requires some perseverance to hit the exact spot.

I was fortunate on settling the question about *Cicada hæmatodes* being a native of these islands, but here I must mention the name of W. G. Tate, who took it in the larva state and bred it this spring; the specimen is in my possession. From a few hints I gave him, having taken it myself in America, I do not doubt he will have more to dispose of before the end of the season.

Should any one feel inclined to try his luck in this neighbourhood I would recommend him to call on the above-mentioned entomologist, also on W. J. Gerrard, in the High Street, Lyndhurst, both of whom did their best, in the most friendly manner, to put me on the track of the local insects.

B. PIFFARD.

THE EXTINCTION OF RARE PLANTS.

WILL you allow me, through the medium of SCIENCE-GOSSIP, to call the attention of its readers, particularly its botanical readers, to the extermination of rare indigenous forms by unscrupulous collectors? I have long been hoping to see this subject taken up by some able contributor, but as no one appears to have noticed it, I venture to direct your readers' attention to the fact myself.

It is our native ferns that suffer most from the hands of these collectors, as will appear from the pages of a recent number of "The Bazaar," in which I notice fourteen advertisements offering "Lovely Devonshire ferns," "Native Devonshire ferns," "Lake ferns," &c., for sale; and some of the advertisements hint at the wholesale destruction of these lovely wildings, for instance, one advertiser offers "Native Devonshire ferns, one, two, or three dozen roots post free for 8, 14, or 20 stamps;" another has a dozen of our rare ferns from the Lake district for fifteen stamps; still worse in my opinion is the one who offers fifty roots of *Osmunda regalis* for 2s. 9d. from a Lake station. I wonder do these iconoclasts ever feel any twinges of conscience when pursuing their nefarious occupation (for it is nothing else)?

It is not the sending of a few specimens of rare ferns to a fellow admirer that the writer objects to, but the fact that, for the miserable increase to the year's income of a few shillings, there are those who will persist in destroying localities for ferns that are already becoming rarities. When I instance such ferns as *Asplenium viride*, *Allosorus crispus*, *Polypodium robertianum*, *P. phegopteris*, *P. dryopteris*, &c., occurring in the above advertisements, your readers will, I think, admit that my indignation is not without reason.

If Parliament does not deem our native songsters beneath its notice, surely botanists need not regard the objects of their especial study as unworthy their

protection! Would it be too much to expect the formation of a society for the protection of rare British plants?

Further, I find that our ferns are not the only sufferers at the hands of these people, for another advertisement in the same paper offers "English orchids," including "the rare bee orchids." This plant, as the pages of SCIENCE-GOSSIP testify, is already becoming rare, but without some check can be laid on the rapacity of these collectors we may soon hear of its becoming extinct.

Botanists themselves may do a great deal to aid in the preservation of our rare forms by omitting in their botanical papers the precise locality of a rare plant. I am convinced that no true botanist or lover of Nature will knowingly assist in the extermination of a rare form; he will take enough for his own herbarium, and probably for that of a friend, but unnecessary waste is a sin that I cannot think any one calling himself a student of Nature would be guilty of.

I shall be glad to assist, as far as possible, in any scheme that may be advanced for the protection of our rare ferns and wild flowers; and trust that the readers of SCIENCE-GOSSIP will not consider this matter unworthy their notice.

GEORGE T. HARRIS.

BOTANICAL NOTES FROM THE SWISS HIGHLANDS.

VI. THE FAULHORN AND THE BRIENZ ROTHORN.

By DR. DE CRESPIGNY.

[Continued from page 123.]

INTERLAKEN, inferior to Lucerne in some respects as regards the attractions of its *entourage*, is for botanical purposes much better placed, as a central or headquarter station for excursions; while for the general tourist, from its close proximity to the giants of the Bernese Highlands and other interesting sites, there is probably no locality in all Switzerland to be compared with it; combining as it does these advantages with those of an agreeable place of residence, one which will bear a not unfavourable contrast with some gay German watering-place, or other similar fashionable resort.

It lies midway between the lakes of Brienz and Thun, in a valley or little plain, two miles broad by three in length. Mountain ranges, of five or six thousand feet and more high, extend from east to west on either side of the lakes and plain. There is a break or gap in the southern chain, opening into a valley of which the vista is closed by the famous "Jungfrau." Invert the letter T, and the situation of the town would be where the vertical line joins the horizontal one. On a level with the lakes, which are connected

by a river, there is no view of either except from some adjoining height.

We soon discover that the mountains on both sides of the Lake of Brienz are higher and more precipitous than those bordering the other and larger Lake of Thun, and learn that the chain on the north shore is called the Brienzer Grat, and that the highest point of this ridge is the Brienzer Rothhorn—to distinguish it from other Rothorns;—a peak of lower elevation on the north shore of the Lake of Thun for one, called the Sigryswyl Rothhorn;—and that the Faulhorn is not the highest mountain of the range on the opposite or southern shore of the lake, but the one usually ascended by travellers for the sake of the prospect to be enjoyed from its summit; the Schwarzhorn is higher. The view from the Rothhorn is also admirable, and being easier of access from Interlaken, may be recommended in preference should an excursion to the Wengern Alp be intended. The botanist, however, must "do" them both.

We cannot fail to note also in connection with the surroundings of the Lake of Thun, first a pyramidal mountain on the southern shore, uncommonly like Pilatus, except that its outline is smooth not serrated; and secondly, a chain of lower elevation beyond it, with one odd-looking peak in particular, among other culminating points. The pyramidal mountain, and the queer truncated cone on the chain beyond it, are the Niesen and the Stockhorn respectively.

The ascent of the Faulhorn is usually made by a good horse-path from Grindelwald, or by those coming from Meyringen and Rosenlaui from the inn on the top of the Scheideck pass; good climbers, firm of foot, and not subject to giddiness may make it from the Lake of Brienz either from the Giessbach Hotel or from a point nearer Interlaken at Sengg, or Iseltwald, via the Battenalp. The first-mentioned path mounts by the side of the celebrated waterfall, and is somewhat longer than the other, but a trifle less arduous and precipitous; it first leads up to the Hippoden pastures—two hours' climb—thence in another hour to the Alp Tsingelfeld; the onward ascent, afterwards slippery and tedious, is up steep slopes of débris, and over narrow ridges requiring sure stepping and a judicious use of the alpenstock; the worst places are the Bonerngrättli, the Gerstigrath and the Ueberstick—trifling affairs to a practised mountaineer. The path is a mere track, and unless, as was contemplated, a horsepath has been constructed, a guide is indispensable; but as many plants grow on the northern face which will not be met with on the ascent from Grindelwald, the fatigue will be amply compensated by good finds, not to mention the agreeable surprise which will be felt at the sudden unfolding of a fine view of the Bernese Alps on reaching the summit: (an inn here, but usually crammed with tourists). The descent to Grindelwald is by a good zigzag path down the ridge into a rocky hollow and round the lower flank of the Semelhorn to the

Bachalp tarn and so on to the Bachalp pasture huts ; patches of snow lie all through the summer in this hollow, as well as on the upper part of the north slope. The last two-thirds of the descent is over pasture and through forest to the meadows above the village.

The ascent may also be made from Interlaken, through beech and pine forest and over a grassy slope, to the Schynige Platte, whence there is a good bridle-path, recently constructed, onwards.

To the summit of the Rothhorn (an inn here is newly rebuilt), there is a good horse-path direct from the Bear Hotel at Brienz. The first part of the way is precipitous and laborious ; higher up, through forest—beech, &c., below, pine above—to the Planalp. The last part is over rocky débris. Pedestrians coming from Lucerne may make the ascent from the other side, following a foot-path which leads from the village of Gyschyl, and just above the Sarnen Lake, over the mountains to Sorenberg. The path is fairly good for the first part of the way, till you descend into the Marienthal, above Sorenberg, thence on by a track, left, to the Staffalp, and Schuttwalden ; beyond on the left is the Maissee ; the rocky height on the right is the Nesselstock, as rich in rare plants as the Rothhorn itself.

There is an inn at Gyschyl ; but better quarters are to be had at Lungern, a little farther on (at the foot of the Brunig), where there is a good hotel. The view of the Bernese Alps is not so fine as that afforded by the Faulhorn, but in other respects the prospect is superior. Pilatus makes a prominent figure in the landscape ; to the right is the Titlis range, with Mt. Glärnisch the Tödi and Säntis in the distance ; on the left, among others, Napf and the Schratzen, a mountain full of vast cracks, crevasses and caverns, and one which offers striking evidence of stupendous upheavals and overturnings in geological times. The whole country immediately north of the Brienz Lake belongs to the same nummulitic limestone formation as that already referred to in connection with Pilatus. There is no lack of marine fossils in some places, on the crest of the Widderfeld (a peak of Pilatus) for instance, in particular, however scarce they may be in the metamorphic strata.

Faulhorn, upper section, 5000–8800 feet. Geological character, a dark friable calcareous schist.

Achillea atrata, 7000. *Anemone sulphurea* ; above the Bachalp. *Aquilegia alpina* ; stems 1–3-flowered, large, handsome ; N. ascent near the Battenalp. *Arabis ciliata*, var. of *alpestris* according to Bouvier, (= *hirsuta incana* of Gaudin) ; N. ascent 5500–6000 ; *pumila* ; near summit ; dwarf, radical leaves rosulate, covered with bifid and trifid hairs. *Alchemilla hybrida* ; a dwarf form of *vulgaris* ; *fissa*, near the Bachalp tarn ; *pentaphylla*, near the tarn ; also above the Battenalp, N. side. *Astrantia minor* ; near the Bachalp. *Aronicum scorpioides* ; near tarn ; also on

débris, N. slope. *Androsace pubescens* (= *alpina* of Gaudin) ; leaves close set, in rosettes at the ends of the branches, flowers solitary ; *chamaejasme* ; *obtusifolia*, near tarn. *Anthericum serotinum* (= *Lloydia ser.*) near tarn. *Agrostis rupestris*. *Avena subspicata*, panicle oval or cylindrical, spikelets close set ; near summit, both slopes ; *distichophylla*, leaves distichous, stems many, decumbent, much branched ; *Scheuchzeri* (= *versicolor*) stems erect, panicle oboval, short, branches geminate ; cæspitose : all three species are pretty grasses, florets of a greenish-violet hue, and growing high up above 6000 feet. *Azalea procumbens* (= *Loiseleuria*) ; *Cardamine bellidifolia*, near tarn ; *resedifolia*. *Cherleria sedoides*, near tarn ; *Crepis montana*, N. face ; *grandiflora*, above the Bachalp. *Campanula rhomboidalis*. *Cerinth glabra*, a boraginaceous plant, with large glabrous glaucescent oval obtuse leaves ; inflorescence in leafy racemes, corollas greenish-yellow banded with violet ; singular. *Carex microstyla* (= *lobata* of Kunth) an androgynous sedge, cæspitose, spikelets in a dense spike ; N. face at 6000 ; *fatida*, near *incurva*, spikelets many, in an ovoid globular head, leaves as long as the triquetrous stem ; *leporina* (near, if not = *lagopina*, v. Br. Fl. ; Hooker and Arn. Stb. ed. p. 502) ; 6–7000 ; *curvula*, leaves setaceous, spikelets androgynous contracted into a compact oblong spike, stems curved ; slopes both sides ; 7000 ; *atrata* : bract by no means invariably shorter than the lower spike, and fruit certainly not purplish-black ; they are green in our specimens ; both slopes at 7000 ; *nigra*, abundant ; *irrigua*, wet rocky places, above the Bachalp ; *firma*, leaves short rigid, ♂ spike 1, ♀ 2, fruit dark brown lanceolate, beak bifid ; *ferruginea* ; *capillaris*. *Cystopteris alpina*. *Chamaorchis alpina*, N. face, above the Battenalp. *Cerastium latifolium*, near the summit ; *strictum*, a var. of *arvense* ; (= 203 b. London Cat.) stem and leaves glabrous, 7–8000 ; *trigynum* (= *Stellaria cerastioides*) ; 5–6000. *Draba tomentosa* ; radical leaves rosulate, hairy and tomentose ; hairs both simple and stellate ; between tarn and summit, on rocks ; also N. face above 7000. *Erigeron uniflorum*, 7500. *Empetrum nigrum*. *Eriophoron Scheuchzeri* (= *capitatum*) ; heads globose ; wet places above the Battenalp. *Elyma spicata* ; differs from *Kobresia* merely in its simple spikelet of two florets. *Festuca alpina*, 6000 (var. of *ovina*) ; *Gaudini* ; N. face above 7000 ; *Halleri*, dwarf, leaves setaceous with involute margins, panicle short contracted ; rocky fissures above 7000 ; *nigrescens*, cæspitose, leaves fascicled, radical ones capillary ; panicle long, lax, narrow ; glumes and glumellas violet as in *violacea* ; *pumila* and *pulchella*, 6000. *Geranium lividum* (= *phæum* or the variety thereof) ; N. slope. *Geum reptans* near the summit ; differs from *montanum* in being stoloniferous, leaves more deeply incised and toothed. *Gaya simplex*. *Galium Helveticum* ; above the Bach and the Batten Alps. *Gymnadenia albida*. *Gentiana tenella* ;

(= *glacialis*) summit and near the snow, N. side; *nivalis*; *brachyphylla* near summit; *alpina*,* a form of *acaulis*; but differs in its gregarious habit, smaller size, and colour of a yellowish-green. *Hypochaeris helvetica*, near the Bachalp. *Hieracium alpicola*, hairy, stems 1-leaved, peduncles 2-3, one-flowered, flowers pale yellow; leaves lanceolate; S. ascent, 7000; *angustifolium* (= *Auricula*; var. γ corresponds with fig. 2368, Eng. Bot.; according to Gaudin); N. slope above the Battenalp; *aurantiacum*, 5000; *alpinum*, a mono- or dicephalous species (? = No. 776-7 London Cat. 7th ed.); *piliferum* (= *Schraderei*) covered with a stellate silky pubescence, monocephalous, leaves large, oval, obtuse, all radical; between the Bachalp and the tarn. *Juncus filiformis*, near the Bachalp; *Jacquini*, stems naked, radical sheaths short and mucronate, flowers in terminal heads furnished with an involucre leaf; N. ascent 6-7000. *Kobresia caricina*, rare; Bachalp at 6000. *Liliastrum album*, S. slope at 5000. *Leucanthemum alpinum* (= *Pyrethrum*), 6-7000. *Leontodon Taraxaci* (= *montanum*), *Lucula flavescens*; *spicata*; near Bachalp. *Nigritella angustifolia*, 5000. *Oxytropis campestris*, débris; N. face. *Oxyria didyma*. *Phaca frigida*, stem branched above; flowers, pale yellow; N. ascent near the Battenalp. *Phaca australis*, stems diffuse, procumbent; flowers white or pale yellow, with the keel violet; peduncles longer than the leaves; between the tarn and the summit. *Phyteuma hemisphaericum*; *betonicifolium*. *Primula viscosa*, near the lake; a small plant of a blackish-green colour; leaf margins furnished with glandular hairs; flowers umbellate, 2-5, purplish; *integrifolia* (= *Candolleana*) dwarf; leaves fleshy, entire; margins furnished with glandular cilia; flowers sessile 1-3, rose-coloured. *Phleum alpinum*; *Michellii*, débris, N. face. *Poa laxa*, near the summit; *minor*, ditto on N. side. *Polystichum rigidum*, débris N. slope. *Ranunculus glacialis*, a stouter and larger plant than *alpestris*; leaves somewhat fleshy, petals often tinged with rose-colour; nectariferous, the scale bifid. *Rosa alpina*. *Rhododendron hirsutum*, descends to the borders of the lake on the N. slope. *Rumex nivalis*, 8000, near the snow on the N. face before you come to the last climb; *scutatus*, rocky débris, N. face; *arifolius*, above the Battenalp; these three species of *Rumex* have all hastate or hastato-sagittate leaves, and are true sorrels. *Silene rupestris*, S. ascent. *Sagina saxatilis* (= *Spergula saginoides*), S. ascent at 6000. *Sibbaldia procumbens*, S. ascent at 6-7000. *Sedum saxatile*, rocks, Bachalp. *Semprevivum tectorum* and *montanum*, S. ascent. *Saxifraga oppositifolia*; *planifolia*, leaves rosulate, strongly imbricated; stems many; peduncles 2-3-flowered; N. face near the summit; *androsacea*, ditto and near the tarn; *Seguirii*, left of the path before coming to the tarn; also N. face

near the summit; stems shorter than in the last species, 1-3-flowered, pedicels very short; *moschata* (= *muscoïdes*) a variable plant; *Bryoides*, a form of *aspera*, stems 1-flowered; sterile ones spreading; leaves in closely-set rosettes, 6-7000. *Senecio Doronicum*, stems mono-dicephalous, heads large; leaves oblong, with a winged petiole, upper ones sessile lanceolate; this plant has more the habit of a hawk-weed than a ragwort; N. slope above the Battenalp; *aurantiaca*; a species without scales at the base of the involucre, N. ascent. *Soldanella pusilla* (= *Clusii*) near the tarn. *Thlaspi rotundifolium*, near the tarn. *Trifolium capitosum*, 6-7000. *Valeriana montana*. *Veronica alpina*; *fruticulosa*; *saxatilis*; *bellidioides*, near the tarn; *aphylla*, N. face, near the snow.

The Schwarzhorn affords also *Androsace pennina*; *Arabis carulea*; *Arenaria polygonoides*; *Semprevivum arachnoideum*, &c. The mountain is 800 feet higher than the Faulhorn; guides and a rope requisite. The neighbourhood of the Rosenlaur glacier is a good locality; the rocky débris at the foot of the Wellhorn, and the rhododendron scrub on the lower slope of the Engelhorn, left as you approach the glacier, especially so; while the wet rocks, &c., beyond the baths towards Meyringen are rich in good mosses. There is not much on the Scheideck pass; *Trifolium alpinum*, however, is plentiful a little over the eastern ridge, also *He dysarum obscurum*, and near the ridge, as one ascends from the westward, *Dianthus sylvestris*, *Hieracium lanatum*, *Eriophoron Scheuchzeri*, by a pool close to the inn there, &c. That beautiful composite, *Astrantia major*, is plentiful in the meadows a mile or so above Grindelwald. About the Lutschine from the glacier downwards, in sandy nooks and stony corners several good things may be unexpectedly met with; *Myricaria Germanica* is abundant there, and some *Salices*.

(To be continued.)

ADDERS HISSING.—G. Dewar states, he believes that the hissing of the adder, or viper, arises simply out of their enjoyment of life. My own observations have been that they only hiss when disturbed, and I doubt whether they are enjoying their lives, when being poked out of a bush by a stick. Whenever I have seen the viper in Epping Forest, it has generally been within a short distance of some small isolated thicket, into which it glides at your approach, and when quietly watching it, as it lies coiled up against some stumps, I have never heard it hiss until I have disturbed it with a stick. In watching a viper I had in captivity, when hissing it drew the lower lip, down to the point of the left fang, which would be extended; and it produced two different sounds, one at inspiration, the other at expiration, that which accompanied expiration being the loudest.—Walter A. Pearce.

* Equal to *pumila*, Haller, not Jacquin; *G. verna brachyphylla*, Schult. Hegetschw.; *verna* β , DC. Jacquin's plant has narrow lanceolate leaves and no filiform stolons.

A CONCHOLOGICAL EXCURSION ON THE GLOUCESTERSHIRE HILLS.

O! how it rained on the 3rd of October, 1879! A steady determined downpour all day long. Still, as I looked out of the window and saw the drops chasing each other down the panes—the

for the slugs and snails will all be out and thoroughly enjoying themselves." The morning came; the rain had ceased, and a thick mist enveloped everything. This, however, was all in our favour, and so we—my wife and self—set off, well provided with boxes, bags, and bottles, and full of hope that some conchological prize would fall to our lot before the day was out. Having left the city of Gloucester about four or five miles be-



Fig. 117.—*Helix arbustorum*.

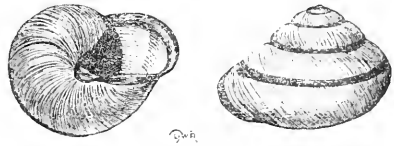
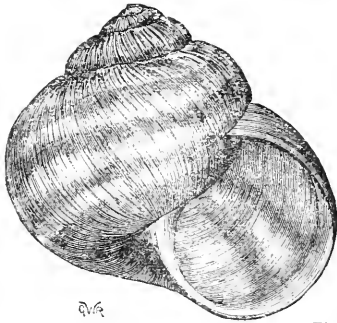

Fig. 118.—*Helix nemoralis*.



Fig. 119.—*Helix Cantiana*.



Figs. 120, 121.—*Helix pomatia*.

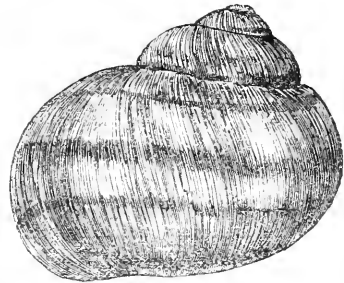

Fig. 122.—*Helix virgata*.



Fig. 123.—*Helix ericetorum*.



Fig. 124.—*Helix rufescens*.



Fig. 125.—*Helix rotundata*.

gutters in the street turned into miniature mountain-torrents, and the passers-by hurrying on under umbrellas which illustrated the dripping well at Knaresborough, only with a better assortment of drips, I thought to myself, "Well, the old proverb is right which says 'Tis an ill wind that blows nobody any good,' and if it will only cease raining before to-morrow it will be all the better for our excursion ;

hind us, and turning into a beech wood which clothes the sides of one of the spurs of the Cotswold range, we commenced our researches amongst the fallen leaves. Here we found several beautiful specimens of the common *Helix nemoralis*, of a bright crimson or almost scarlet colour (especially near the aperture) which showed out in marked contrast the dark brown medial band or bands in each whorl. Here

too, crawling on the dead leaves or wet stones, were many *Cyclostoma elegans*, both the light and dark variety, one of the most elegantly shaped of all our British land shells. Then carefully examining the trunks of the beech-trees, we took many specimens of *Bulinus obscurus*, so covered over with a gray-green coating of lichen that in many cases they looked like mere knots or excrescences of the tree: here and there, but rather sparingly, we saw the variety *albida*. In the same locality, *Clausilia laminata* was abundant, shining out with its bright, glossy, horn-coloured shell, while its two varieties *albida* and *pellucida* were only to be added to the store at long intervals. The variety *pellucida* is a beautiful shell, looking like transparent porcelain. Here we had a patient search for *Clausilia Rolphi*, and every now and then we fancied we had been successful, but on a closer and more careful inspection, the specimens turned out to be those of *Clausilia dubia*. Since this we have had several shells of *Clausilia Rolphi* sent to us from the same neighbourhood so that some time or other we must have another search, and I hope a more successful one. Sometimes "local shells," though rare in other parts, are abundant in the localities where they are found, and here we took *Bulinus montanus* (a local shell) from the trunk of almost every tree, descending from its summer quarters amongst the top branches and tender buds of the beech-trees, and preparing to look out for snug quarters for the winter. Its variety *palescens* was by no means infrequent. Coming out of the wood into an open space on the hill we found *Helix rotundata*, *H. concinna*, *H. hirsuta*, *H. rufescens*. Of the last many of the specimens are of a most beautiful brown-red colour, while others were almost pure white. *Helix cricetorum* was abundantly creeping over the wet grass, and timidly shrinking into its shell immediately on being touched. Under the stones in small colonies, we came upon *Pupa secale* and *Pupa umbilicata*.

Turning into a deep depression in the side of the hill, in which the common blackberry grew in luxuriance, we spied a variety of *Helix nemoralis* which we had never been fortunate enough to have taken before, but of which a few specimens had been kindly sent to us by Miss F. Hele, of Bristol. The bands upon the whorls were entirely destitute of colour and perfectly pellucid. In the "Conchological Journal" the name given to the variety is *arenicola*, why or wherefore it is difficult to make out, as this name does not seem to specify any peculiarity either in its shape, colour or habitat.

Knowing that we were in the locality for *Helix pomatia*, we asked a little rustic maiden, about twelve years old, who was out on the hills gathering sticks, if she saw any of the very large snail shells. She, however, evidently knew more about the matter than we had suspected, and said, "Do you mean the Roman

snails?"—"Yes," we replied; "what do you know about Roman snails?" She answered, pointing to some cottages about half a mile distant, "I got twenty of them last week to put into our garden there, for father says as they will drive the other snails away. And last summer a young gentleman as was very ill, came to live at one of them houses and I used to get him twelve of them big snails every day for him to eat; the doctor said as how they would cure him." "Whereabouts did you find them?" we asked. "Oh," she replied, "all among the nettles in the bottom of the hedges down there." "Thank you, little maiden," we said, and giving her a small present for her information we set off in search of *Pomatia*, and found him too, with his large, brown-banded, globose shell, and beautifully shaded creamy grey foot. Returning homeward we boxed several specimens of *Helix lapicida*; these were larger in diameter, of a much darker colour, and with the markings more distinct, than any we had taken before. Crawling on some palings were *Helix Cantiana*, *Helix nemoralis* var. *minor*, and many other varieties, *Helix arbustorum* and its variety *flavescens*, *Helix virgata* (some specimens of which were remarkably conical in shape), and several of the commoner kinds of slugs. We reached home well laden with spoils, after one of the most enjoyable conchological excursions we had ever spent.

H. MILNES.

NOTES ON JURASSIC FORAMINIFERA.

By DR. RUDOLF HAEUSLER, F.G.S., &c.

THROUGH the microscopical investigation of the Swiss Jurassic rocks many interesting facts respecting the distribution of Foraminifera were obtained which may interest your readers, and assist them in working out this group in the English Jurassic strata. The total number of species of Swiss Jurassic Foraminifera is about three hundred and fifty, with countless varieties. Their distribution in different divisions is not equal throughout the country; while certain limestones are crowded with their shells, others are almost devoid of them. Even in the same strata they are not equally common in different localities, and many species are not even restricted to only one locality. The mode of preservation often does not allow of the determination of specimens, their chemical character being changed by pseudomorphoses. As besides it is often only possible to find them by preparing their sections, it is evident that a great number are still to be discovered. By comparing the Swiss species with those obtained from other countries, it is surprising to find that most of them are different, although it is evident that the general character of the fauna changes with the petrographical habitus, it is yet not uncommon to meet with the same species in lithologically different strata with

entirely different "paleontological" appearance, so that, for instance, deep sea species occur accidentally in littoral deposits, which is perhaps not surprising if we consider the enormous number of individuals, which, with the smallness of their shells, makes it probable that many are carried off by currents, storms and tides, or in the stomachs of animals into parts of the sea in which they could not exist. For instance, we find over ten species of the deeper sea beds of the lower Aargovian group (zone of *Ammonites transversarius*) in the hard limestones of the upper Aargovian with littoral fauna. Even some of the *Dentalina* and *Rotalina* of the Callovian appear again in deep sea and littoral deposits of the malm.

Some kinds range through almost the whole Jurassic formation, for instance *Cristellaria communis* Kùb. in almost equal abundance, others are found in several zones, but most of them only in one. Amongst the latter, *Globigerina Helveto-Jurassica*, Hr., was only observed in the hard limestones with *A. transversarius* north of the Aar valley, while in equally fossiliferous parts of the canton it is wanting. The Rhætian group is by far the least favourable, as the shells are always in a very bad state, which does not allow to determine the genera. In the lower Sine-murian (*Am. Eucklandi*), they are represented by numerous species belonging to the genera *Cristellaria*, *Fronicularia*, *Lagenulina*, *Vaginulina*, *Marginalina* and *Cornuspira*. The relation of numbers of genera is about the same throughout the whole Aargovian Lias. With the Dogger *Ophthalmidium* becomes most abundant and characteristic. Certain beds of the Balhonian are crowded with them, but also *Cristellaria*, *Fronicularia*, *Nodosaria* and *Cornuspira* are still numerous. Towards the upper limit, *Textilaria* and chiefly *Rotalina* and *Liticola* are represented by many species. It may be noted here that in the upper Bayocian oolites I met several times with very minute navicula-like or discoidal silicious bodies, which I should refer to diatoms, if not, by partial chemical changes, the surface was rough, and therefore no pallerus visible. Already in the yellowish clay limestones with *A. Lamberti*, the *Rotalina*, *Textilaria*, *Dentalina* and *Cornuspira* become prevalent, until they reach the maximum of their development in the lower malm. In the limestones the shells are as a rule partly destroyed by pseudomorphoses; so that, for instance, I meet often *Globigerina* with calcareous or silicious shells, or their casts of glauconite pyrites or hydroxide of iron, all lying close together. Almost all the species of the lower Sequanian (zone of *Am. bimammatus*) are met with again in the hard limestones of the Kimeridgian; but none of them seem to be identical with those from English upper Jurassic strata. After the characteristic species it is possible to divide the Jurassic sediments in numerous distinct Foraminifera-zones, which will be easier to draw up, as even so-called unfossiliferous beds are generally rich in Foraminifera. Of course these divi-

sions will be somewhat different in every country, but we hope that further researches will complete the list of the characteristic Foraminifera, and thus give a new mean of comparing deposits in different countries where the microscopical fauna is often so entirely changeable.

A RAMBLE IN HAYLING ISLAND.

ON one of those lovely days in August, which we had in the pleasant summer of 1880, an outing at Hayling was determined on. In the southern part of the island were clover fields in abundance, and a beautiful track of Lucerne (*Medicago sativa*) with flowers of varying hues, from very pale lilac to deep purple. These leguminosæ being the favourite haunt of the clouded yellow (*Colias Edusa*), its capture there was hoped for, but not an example could be seen. In North Hayling, however, some half-dozen were subsequently observed flying rapidly, with the wind, over the barley. We soon met with the roast-beef plant (*Iris fetidissima*) with its leaves of peculiar odour, but none of its pretty-striped blossoms, or even of its coral-like fruit, could be found. It occurred in several places. On the shore we saw abundance of the marsh samphire (*Salicornia radicans*) with its tawny stems growing with the common species, *S. herbacea*. Thus intermingled they could be readily distinguished. The golden samphire (*Inula crithmoides*) probably grows at Hayling, as it has been noted near Printhead and at Bosham. Proceeding to the shingle, we sought in vain for the true or sea samphire (*Crithmum maritimum*) which we found there some years ago; but according to an old Flora, it is rare on this part of the coast, and loves lofty cliffs, as those of Dover, where it grew in Shakespeare's days.

"Dizzy 'tis to cast one's eyes so low;
The crows and choughs that wing the midway air
Show scarce as gross as beetles. Half-way down
Hangs one that gathers samphire, dreadful trade!
Methinks he seems no bigger than his head.
The fishermen that walk upon the beach
Appear like mice."

It was as difficult of attainment as the Edelweiss, yet may still be occasionally met with in Sussex.

Old Gerard, who lived in Queen Elizabeth's reign, has some quaint observations on the samphire's occurring on the south coast. "Rocke Sampier," he says, "groweth on the rockie cliffs at Dover, Winchelsey by Rie, about Southampton, the Isle of Wight, and most rockes about the west and north-west parts about England. It flourisheth in May and June, and must be gathered in August to be kept in pickle. Eaten in sallads, with oil and vinegar, it is a pleasant sauce, agreeing with man's body, and stirreth up an appetite to meat." And the "golden sampier" he accurately describes as "bringing forth

many stalks encompassed about with a multitude of fat leaves, at the top whereof come yellow flowers."

We noted next the pretty lilac-blue sheep's-bit (*Jasione montana*) scarcely an inch high, and then a plant which, from its blossoms having been attacked by some insect, was at first extremely puzzling. It proved to be a variety of the bitter-sweet (*Solanum Dulcamara*) with thick fleshy leaves, the *S. maritimum* of Syme. The lesser dodder (*Cuscuta Epithyllum*) was here too observed, not only feeding on the furze, but also on the wood sage about which it twined its deadly and mal-odoriferous heads of florets. It here seemed to have an especial liking for that labiate.

The bright yellow petals and glaucous leaves of the horned poppy (*Glaucium luteum*) were very conspicuous, mingled with plenty of that curious prickly plant, the sea holly (*Eryngium maritimum*), then in perfection. Among the shingle peeped up the downy heads of the hare's-foot trefoil dwarfed to an unusual degree, and occasionally to be seen were some early blooms of the pretty little ladies'-tresses (*Spiranthes autumnalis*) amidst the sand which one would have thought too arid for this demoiselle of the British Orchis to have chosen for her dwelling. While traversing the shore we came on that deceptive-looking composite, the carline thistle (*Carlina vulgaris*) which resembles so much a brown, withered flower, that those who had not before seen it, deemed it dead and discoloured. On our return through North Hayling we made no floral finds worth notice, excepting that of both the wild mignonettes (*Reseda lutea* and *R. luteola*) growing together on a heap of chalk and rubbish.

It may be added that the flora of Hayling seems to resemble that of the Isle of Wight, especially as to the littoral kinds of grapes which were then out of flower. We gathered the single glumed fescue, (*Festuca uniglumis*), the sea cat's tail (*Phleum arenarium*) and the marram (*Psamma arenaria*), but the rarer nit-grass (*Gastridium lundigerum*)—obtained in the early summer, and which occurs also at Thorney had then disappeared. The ramble in Hayling was by all, who thoroughly enjoyed it, voted well worth repetition.

F. H. ARNOLD, LL.B.

THE MOCKING BIRD is often called Nightingale in the United States, but it is not unlike in plumage to our thrush, and one species in the Southern States (the Carolina mocking bird) is occasionally termed the Robin. American robins are not like our red-breasted gentlemen, they are a bluish-grey colour, with some amount of white, or at any rate light feathers. I was very disappointed when my American friends pointed out their "Robin" to me.—*I. E. II.*

MICROSCOPY.

BUBBLES IN GLYCERINE JELLY.—Can any of the readers of SCIENCE-GOSSIP give me any explanation of the spontaneous appearance of bubbles or "vacuoles" in glycerine jelly? I have mounted several slides in this medium, and in many cases have been positive that the objects have been perfectly free from air, but after an interval of days, sometimes of months, I have found the objects disfigured by a perfect network of bubbles, branching in all directions, and sometimes even resembling trees, corals, and ferns in their various forms. Now, unless there is some remedy for this, no reliance can be placed on glycerine jelly, and the sooner its untrustworthiness is made known the better. I should be very glad if correspondents would inform me whether they have had the same experience; if not, how they use the jelly, and if so, would they suggest the cause of the evil, or a way of preventing it?—*G. H. Bryan.*

"SYNOPSIS OF THE FRESHWATER RHIZOPODS."—Mr. R. Hitchcock, the President of the New York Microscopical Society, has just published a valuable condensed account of the genera and species of North American rhizopods, founded on Professor Leidy's recently-issued monograph upon the same subject. Copies may be obtained from Mr. Bogue, 3, St. Martin's Place, price 4s.

ASTHMATOS CILLARIS.—Professor Leidy is of opinion that the infusorian which goes by this name is nothing else than the epithelial cell of the air passages. It will be remembered that this infusorian has been found in the mucus of asthmatical persons.

MICROSCOPIC TEST FOR POISON.—To test fluids for such minute qualities of certain alkaloids as would not answer to chemical procedure, Professor Rossbach places, uncovered, on a slide, a drop of water containing Infusoria, which being carefully examined, a little of the suspected fluid is applied. If organic poison be present the Infusoria become a formless sediment. 1-15,000,000 of a grain of atropine may be thus detected.

GUTTA-PERCHA CELLS.—Dr. Phin finds these become granular and brittle. If held together with shellac, or other varnish or cement, they may last a long time.

WAX CELLS.—These are recommended by Mr. Walmsley, for mounting in fluid, glycerine, &c. A wax ring is bedded in one of white zinc cement and receives successive coatings, as the last becomes hard. Then a thin coating is applied; the cell is filled, the object arranged, a cover glass adapted, a clip attached; and the slide is washed with clean water and a pencil and wiped. After a time another ring is made and the cell is finished off.—*J. R. M. S.*

WHITE ZINC CEMENT.—Take one part, by weight, of mastic tears, and three parts of dammar, dissolved in benzol. To three pints add 1 lb. pure French oxide of zinc, ground in linseed oil. Stir thoroughly; also when in use. If too thick add benzol.—*J. R. M. S.*

OCCURRENCE OF DAPHNIA BAIRDII AND DIAPTOMUS CASTOR.—Your readers will, I have no doubt, be glad to hear that the two Entomostraca *Daphnia Bairdii* and *Diaptomus castor* have been captured here in considerable numbers. Some few weeks ago, I got a few specimens of these interesting animals from a large reserve mill-pond. Since then I have procured them in great numbers, although on an intermediate occasion, when the sun was shining brightly, I failed to get any. *Daphnia Bairdii*, or *Hyalodaphnia Kahlbergensis*, as I presume it ought to be called, is a beautiful animal, and one well worthy of study. Mr. Forrest, the delineator of Mr. Bolton's portfolio of drawings, states that he never found a female of *Hyalodaphnia* with more than two eggs, and suggests that this may account for the fact of the animal being so rarely found. I may say that the first female I examined had six ova, and since then I have found females with no fewer than eighteen ova, so that the animal is rather prolific. What is the distinguishing feature of the male? *Diaptomus castor* very plentiful in same reservoir. Mr. Forrest's drawing of it very faithful, as all his drawings are. By the bye, my males all have that peculiar form of antennæ (right) which he terms abnormal. From the fact of these Entomostraca having been found at places so far apart as Olton reservoir (Birmingham) and North-East Lancashire it is very probable that they are not so rare as was at first supposed, and I hope that naturalists in all parts of the country will keep a sharp look-out, not only for these animals, but also for other rarities, and report to you.—*John E. Lord, Rawtenstall.*

A NEW COLLECTING BOTTLE.—In the July number of the "American Microscopical Journal," a Mr. C. E. Hanaman, describes a form of collecting-bottle which he has in use. It consists of an ordinary wide-mouthed bottle, having a number of holes, half an inch or more in diameter, bored through one-half, at a distance from the bottom, corresponding to the capacity of the bottles in which the collector intends to bring home his material. Over the holes and around the bottle is tightly laced a piece of fine muslin, which should be at least three times as wide as the diameter of the holes. Over the muslin, both above and below the holes, a rubber is placed so as to make all watertight, except at the points corresponding to the holes. Any quantity of water may be poured into the bottle, and will rapidly run out through the muslin covering the holes, leaving the organisms which it contained in the bottle; together with so much water as the lower part of the bottle,

below the holes, will hold. This can be poured into smaller bottles for transportation by inclining the collecting bottle so as to allow its contents to run out on the imperforated side. This bottle is a modification of Wright's form, with the advantage of doing away with the inconvenient funnels.

AMERICAN MONTHLY MICROSCOPICAL JOURNAL.—The current numbers of the above journal contain a series of valuable articles on the "Detection of Adulteration in Food," by the aid of the microscope. In the July number the special subject is Tea, and we here learn the interesting fact, that to render heavier the cheap and medium-priced teas they are dusted when damp with a substance which can in no way be distinguished from a blue clay. In specimens of cheap teas were found grass stalks, pieces of the stem of some pithy weed, &c., all evidently soaked in an extract of tea, and a good many fragments of a blue colouring matter soluble in water.

ZOOLOGY.

"ANIMAL DEFENCES."—Under this suggestive title the address of the President of the Liverpool Naturalists' Field Club (the Rev. H. H. Higgins, M.A.) appears in the last number of the Proceedings. The address deals with the defences of all kinds of invertebrate animals, from rhizopods to insects.

THE AMERICAN ASSOCIATION for the Advancement of Science was held at Boston on August 17.

THE EPPING FOREST NATURALISTS' FIELD CLUB.—Part IV. of vol. ii. of the Transactions of this vigorous club is to hand, containing eight papers, of which four are bearing on local geology, entomology, &c. Professor Boulger's "Evolution of Fruits" is a thoughtful and original contribution. Mr. R. Meldola's paper, on "The Developmental characters of the Larvæ of the Noctuæ, as determining the position of that Group," will be read with great interest by all philosophical entomologists.

THE ROYAL SOCIETY OF TASMANIA.—The monthly notices of Proceedings of the above society for 1879 are to hand, illustrated by some excellent plates of fossils, &c. Among other communications we have one on "The Habits of the Platypus;" on "The First Secondary Fossils found in Australia," by R. Etheridge, F.G.S.; on "New Species of Helices," another contribution to our Tertiary Geology of Table Cape; on "Some Tasmanian Trochidæ;" on "Tasmanian Land Shells;" "Census of the Plants of Tasmania;" Meteorological Reports, &c.

"THE BOOK OF THE RABBIT."—Part XI. the last of this work, has just come to hand, published at the "Bazaar" Office, 170 Strand, London, and edited by Mr. Leonard W. Gill, who is well fitted to deal with

the subject. The book itself is well got up; the type is good, and it is embellished with a goodly number of woodcuts.

“BRITISH BEE-KEEPER'S GUIDE BOOK.”—Under this title Messrs. Houlston & Sons have published a capital little book, price one and sixpence, written by Mr. T. W. Cowan, F.G.S. The author is the chairman of the British Bee-Keepers' Association, and author of several books on apiculture. We cordially recommend this little work.

THE VIRGINIAN NIGHTINGALE.—Permit me to inform Mr. E. C. Morris that the bird called “Virginian Nightingale” in my paper published in SCIENCE-GOSSIP for April, 1881, is also known by the name of Cardinal Grosbeak (*Cardinalis Virginianus*, *Loxia Cardinalis*, *Coccothraustes Cardinalis*, &c.), and is a native of the Southern States of the Union, though penetrating northwards during the summer. The description of it in my paper is derived from personal acquaintance with the bird and its habits. I have no knowledge of the American mocking-bird, though I have seen it in several of the London dealers' shops. Mr. Morris must be a stranger indeed, or he would not speak of letting foreign birds loose in our suburbs with a view to acclimatisation. The article in the “Daily Telegraph” of April, 1881, to which I presume he alludes, was a *réchauffé* of my paper in SCIENCE-GOSSIP, though the source from whence it was mainly derived was unacknowledged, and it was interspersed with original paragraphs, almost all as sensible as that quoted by Mr. Morris, for whose information I may add that the sparrow (*Passer domesticus*), when full-grown, never eats insects, although it feeds its young, while in the nest, upon caterpillars, moths and flies. It is a mischievous bird, and as much disliked in Australia and New Zealand, as it appears to be in America; it is as great an adept at eating cherries and shelling peas as the Virginian Nightingale, whose song, by the bye, will not bear comparison, by a long way, with that of *Luscinia Philomela*. In conclusion, I cannot help saying that we are very frequently amused by American blunders about us and our belongings, and know, perhaps, quite as much about our cousins over-sea as they do about us: ergo, “Those who live in glass houses should not throw stones.”—*W. T. Greene, M.D.*

ACMEA LINEATA, var. SINISTRORSA.—On the 6th of March, 1880, I went to Heywood, Yorkshire, to a place where I have been in the habit of obtaining *Acma lineata*. On this occasion I only found a few, but when I had taken them home, I discovered amongst them a specimen of the very rare shell, *Acma lineata*, var. *sinistrorsa*. It is a fine shell, good and perfect, and living when found. This is the first that has been taken in Yorkshire, and the second in England.—*Joseph Whitwham*. [The first

specimen of this shell was found among the refuse of the Avon at Bristol. It is a monstrosity, having the spire reversed.—*W. B. H.*]

CORMORANTS.—In vol. i. of Mr. A. M. Sullivan's “New Ireland,” page 290, the following passage occurs in a description of Lough Cooter, co. Galway. “The lake covers an area of nearly eight square miles, and is studded with wooded islands. One of these has been for years the home of innumerable herons and cormorants; *perhaps the only instance on record of an island in a fresh-water lake being inhabited by the latter birds.*” (The italics are mine.) Presuming that Mr. Sullivan is right as to his facts, will any of the readers of SCIENCE-GOSSIP, whose opportunities of observing the habits of these birds may be greater than mine, kindly inform me if he is also correct in his theory; or if there are other places of the same kind, where cormorants are to be found “at home”?—*J. H. H.*

LARUS RIDIBUNDUS v. L. ATRICILLA.—T. S. is perfectly right in calling the common black-headed gull *Larus ridibundus* and the American laughing gull *L. atricilla*. J. D. might take exception to the generic name perhaps, but certainly not to the specific.—*J. H. Gurney, jun.*

THE BUTTERFLIES OF EUROPE.—We have received Part II. of the above valuable work, which will be further noticed in a future number. It is by Mr. H. Charles Lang, M.D., F.L.S., and, at present, we can only say that the descriptions are lucid, and the plates, which well illustrate larva and pupa in addition to the imago, are very beautiful.

TRYPHÆNA PRONUBA.—This moth is extremely abundant this year. At sugar it literally swarms, and even in the house it is often disturbed from the rooms. In the country you cannot walk across a field without rousing a lot from the grass, it is also to be seen flying in the brightest sunshine.—*Geo. F. Wheldon*.

THE BLACK RAT.—In reply to your correspondent T. S., I may say that I know of three localities for the black rat in this island. Two of these are farm premises at Longueville, about two miles from St. Helier's, and distant apart about a mile. I find, however, that in one of these extermination has been attempted, and has almost proved successful, very few remaining; the other, and I think most populous locality, is a warehouse, or rather a series of store-rooms, in St. Helier's, about the centre of the town.—*J. Snel, Jersey*.

HELIX POMATIA.—Your correspondent J. O. B. will find that *Helix pomatia* thrives immensely on lettuce leaves. I have often kept them on this food, and have a couple now on that diet.—*W. C. Hey*.

BOTANY.

A RAMBLE OVER THE COTSWOLDS.—It was a lovely morning at the latter end of August that I started from Cheltenham for a walk over that part of the Cotswold Hills called Leckhampton Hill. Having for the last two years botanised only in the south of Herefordshire, I was not long before meeting with plants entirely fresh to me. Climbing over the hedgerows, and hanging in graceful festoons, were *Clematis vitalba* and *Bryonia dioica* (traveller's joy and red bryony); and soon after leaving the road for the steep hill lane, I found *Centaurea Scabiosa* among the loose, rolling stones. A wild, waste field looked so tempting that I became a trespasser, in order to become acquainted with its botanical treasures. I was well repaid, for the bee orchis (*Ophrys apifera*) soon greeted me, and sharing the same field the yellow-wort (*Chlora perfoliata*) over an old stone wall, and then the steep hillside with its floral beauties rose before me. I had not climbed far before I found *Orchis pyramidalis* plentifully. Something blue growing from the side of the cliff attracted my attention, and after a hazardous climb among loose falling stones, I found that it was the handsome viper's bugloss (*Echium vulgare*) growing profusely on the face of the precipitous rocks. I had now gained the top, and looked on the wild moorland tract that stretched so invitingly before me. At my feet was the beautiful *Gentiana amarella*, and not far off *Campanula rapunculus*, while, gracefully bending to every breeze, the *Scabiosa columbaria*. The carline thistle (*Carlina vulgaris*) and the musk thistle (*Carduus nutans*) were both frequent. Although no conchologist, I could not pass by some very large snail shells that I found frequently among the rocks, and which, from the woodcut in Dr. Taylor's "Green Lanes," I had no difficulty in recognising as the apple snail (*Helix pomatia*). Growing everywhere, creeping over the grey rocks and expanding its beautiful yellow corollas in the sunshine, was the rock-rose (*Helianthemum vulgare*), and not far off some fine heads of *Anthyllis Vulneraria*. Far away in the distance was the long range of the Malvern Hills; on my right hand Cleeve Hill, with its downs and Roman encampment, and at my feet Cheltenham and its avenues of trees. I left the wind-swept hill-top and commenced my journey home. Half-way down the hill I turned aside into a fir-wood and gathered some magnificent specimens of *Epipactis latifolia*. *Habenaria viridis* (the frog orchis) was my last "bag" that day.—*Thos. G. Harris.*

QUERY ABOUT ELM-TREES.—For the last few days I have been in Bedfordshire, where I have observed in all directions a remarkable phenomenon amongst the elm-trees, which I do not remember to have seen before. Many of them, and those by no

means the weaker or more sickly trees, have sundry smaller boughs already withered, and embrowned. Their otherwise rich and flourishing foliage is frequently relieved by these small brown patches, often a foot or two in diameter, and scattered irregularly over the tree. I do not think I anywhere remarked a single one of them undergoing the usual golden process of early decay; but the work was completely and effectually done. I should be glad to know in what way this unusual change is to be accounted for.—*C. J. Bingham, Athenæum Club.*

PLANT NAMES.—The following names for wild-flowers are used in this part of Kent. The cowslip (*Primula veris*) is called "Lady-Keys;" wild hyacinth (*Ilyacinthus non-scriptus*) "Blue-bottle;" water figwort (*Scrophularia aquatica*) "Water Betony;" pansy or heart's-ease (*Viola tricolor*) "Kitty-run-the-street;" early purple orchis (*Orchis mascula*) "Poor man's blood;" red campion (*Lychnis diurna*) "Bachelor's button;" ox-eye daisy (*Chrysanthemum Leucanthemum*) "horse-daisy."—*Henry Lamb, Maidstone.*

ANACHARIS ALSINASTRUM.—The male plants of this species that I discovered in a pond on the Braid Hills in August, 1880, began to flower about the end of July this season, and as the flowers are far more plentiful than they were last year, I hope to dry a few for distribution. The pistil is extremely variable, no two specimens being alike, but I may point out that the enlarged figures illustrate description of the plant in SCIENCE-GOSSIP for October, 1880. Fig. 142, page 229, is hardly correct, and apt to mislead. The surface of the lower part of the pistil is merely rugose, without the scale-like appearance shown in the figure. The figure also showing a top view of the flower (fig. 141 A) has too many anthers, as twelve may be seen, while in reality the flowers have but nine. The others fairly represent the plant.—*D. Douglas.*

GEOLOGY.

THE GEOLOGISTS' ASSOCIATION had a capital tour in the Lake District, commencing on July 18th and extending to July 23rd. All the chief sections and fossil-collecting localities were visited.

NOTES ON THE SOUTHERN DRIFT OF ENGLAND AND WALES.—Mr. Mellard Reade, C.E., F.G.S., has published a paper on the above subject. As the result of his observations in various places, all of which are given, he arrives at the conclusion that the apparently diluvial deposits of the middle and south of England are the result of subaërial rearrangement, denudation, and attrition of the deposits laid down during the same period that produced our marine boulder clay and the Scotch fossiliferous and unfossiliferous till.

NOTES ON THE LITHOLOGY OF GAS COALS.—A second edition of the above valuable *brochure* has just been issued. The analyses of coals have been materially added to but the letterpress remains unchanged. This little work is of undoubted value to all gas engineers, and all practical men who deal with the subject.

THE GEOLOGICAL MAGAZINE.—The August number of the above interesting and valuable journal contains the following articles: "Notes on Palæozoic Entomostraca," by Professor T. R. Jones F.R.S.; "On the Archaic Rocks," by Dr. C. Callaway; "The Megaceros in Ireland," by W. Williams. The above three articles are all illustrated. Also, "The Glaciation of the Shetlands," by Mr. B. N. Peach, F.R.S.E., and Mr. John Horne, F.R.S.E.

NOTES AND QUERIES.

BOTANICAL NOTES FROM KENT.—On a beautiful morning, at the beginning of August, I started from Bexley Heath, and turning down the road leading to Bexley, I found on the right-hand side *Verbascum Lychnitis* (white mullein) and *Prunella vulgaris* (self-heal). After having got through Bexley, I turned to the left and went up a rather steep hill, leading to Dartford Heath. On the side of the road I found *Ononis procurrens* (trailing rest-harrow), *Campanula rotundifolia* (harebell), *Scabiosa arvensis* (field scabious), *Cichorium Intybus* (succory). On Dartford Heath I found *Galium verum* (yellow bedstraw), *Lotus corniculatus* (bird's-foot trefoil), *Erica tetralix* (cross-leaved heath). Going straight across the heath, I turned down a lane leading to the Dartford road, the side of which was red with *Papaver Rhaas* (corn poppy); keeping straight on, I did not find anything worth mentioning, till I had gone through Hawley and Sutton-at-Home, and going under some railway arches, I turned to the left. On the side of the railway, which is very high, I came upon *Rosa lutea* (mignonette). Turning to the left again, I went up a hill past the Little Boys' Home, and keeping straight on, I found on the side of the lane the beautiful little *Helianthemum vulgare* (rock-rose), and in a field I saw *Centaurea scabiosa* (great knapweed), or *Acinos vulgaris* (basil thyme), *Polygala vulgaris* (milkwort). Keeping round the road and making my way to some woods I saw, I found *Verbascum Thapsus* (great mullein), *Linaria vulgaris* (toad-flax), a lot more *Ononis procurrens* (trailing rest-harrow), *Galeopsis Ladanum* (red hemp-nettle) *Bartsia Odontites* (red eye-bright), *Ephelium roseum* (smooth-leaved willow-herb). In the wood I found *Erythraea Centaurium* (centaury), *Hypericum dubium* (St. John's-wort), *Gnaphalium Germanicum* (cudweed), *Lysimachia nummularia* (money-wort), and *Stachys ambigua* (woundwort).—*H. P. Russell.*

THE DAGGER MOTH.—I am inclined to think that the theory will not avail to prove the identity of the two species of *Acronycta*, *Psi* and *tridens*. There is a difference between the perfect insects; and men of large discrimination, such as Messrs. Doubleday and Newman, can isolate the one from the other; it is found that these correspond to the two very distinct larvæ. It is quite possible that further investigation will enable us to discover other circumstances

in their life history, which will make their distinctness more decided. It must be remembered that instances are not rare where very different larvæ produce imagoes nearly identical in appearance, and yet no one doubts that both are good species. So is it with *Cuculla Verbasci* and *Scrophularie*, in the larva of one the spots being distinct, in the other they are confluent; the imagoes resemble each other very closely.—*J. R. S. C.*

ANIMAL v. VEGETABLE LIFE.—I am almost afraid E. Smilie has presented an insoluble problem, especially when it is the case that so vivacious a creature as the horseleech is the animal to be kept under as opposed to aquatic vegetation. In an aquarium of glass, experiments might be made by raising the temperature of the water gradually, and watching its effects, as thus one might kill off animals without seriously affecting plants, but this plan would not be applicable to the fountain mentioned by your correspondent. It has been stated, however, that plants will take no harm in water containing a certain proportion of the pure solution of ammonia, whereas this would be destructive to most aquatic animals, I presume. Then again, it is said that plants will thrive in camphorated water (not too strong); this drug is not favourable to the health of most animals, though I don't know whether horseleeches might not defy it.—*J. R. S. C.*

TAMENESS OF A SPARROW.—I have noted recently another instance of the fact that animals injured in any way become more trustful in man than those of their kind possessing the usual vigour. A young sparrow, that had received some hurt, perhaps through a fall which did not entirely disable it, but obliged it to hop with difficulty, used to attend with its companions at a morning levee, where crumbs and sopped fragments of bread were freely distributed in a garden in a London suburb. It was soon noticed that the bird would approach much nearer than its companions, looking up at the feeder, as much as to say, "You wouldn't have the heart to meddle with me." Certain prowling cats were usually on the watch for birds at these times, and the little cripple showed much dexterity in avoiding them. After awhile, it got bold enough to perch on the window-ledge, and peep through, in anticipation of the customary dole of food. It was observable that the bird was not spitefully treated by its companions, as is said sometimes to be the case.

APHIDES AND THE POTATO DISEASE.—The disease has, as already noted, been about this autumn partly made more injurious by the persistent determination of some cultivators to leave the tubers in the ground long after they should be dug up. I have not found that in Kent its appearance was either preceded or followed by any abundance of aphides. On inquiry, I was told that insect enemies, aphides especially, had not been common on the patch last spring. The rainy season which acted unfavourably upon the vegetable, was for the most part equally prejudicial to the insect foes of the potato. On some plants that had suffered severely, I saw a number of small beetles in September, seemingly some species of *Otiorhynchus*. Should, however, the diseased haulm be left some time on the ground, it soon displays a variety of fungoid growths.

KEEPING PARROTS.—The common grey parrot is of exceedingly tough constitution; individuals of the kind more frequently die from asthma than from any other cause, though they will live many years with this

disease. It is a curious fact that most we receive in this country turn out to be females. Sopped bread is usually their staple food—water they do not require; the bread may be moistened with milk, or occasionally with ale. A little hemp seed now and then, or Indian corn, is recommended. I have not found that they eat the sand or gravel, as do the smaller cage birds, but it helps to keep the bottom of the cage sweet. These birds are also fond of raw meat; to give this too frequently is injurious, though it does no harm in moderation.—*J. R. S. C.*

STRAY LEAVES ON TREES.—In the months of winter those living in the country, or even in a town suburb may notice that there are few trees or shrubs, even of the deciduous in character, that are entirely denuded of their leaves. Here and there, as in the case of pollard oaks and beeches, a tree will retain all its old leaves till the new foliage shows itself; but it is not to such I refer. I mean the straggling leaves remaining apparently by chance, on trees which display for the most part bare boughs and twigs. To some it would be a sufficient explanation to say that these leaves retained more vitality than their brethren, because they came forth later, or chanced to escape the wind and rain of autumn. But the truth is, in a great many instances, these solitary leaves are each the abode of some insect, it may be in the pupal stage, or not unfrequently in that of the larva, and they have been secured from falling by a fastening of silken cord. When little besides can be done, an examination of these relics of the summer will often repay the entomologist.

NEWTs NEAR LONDON.—In answer to S. Roberts: Newts are to be found in ponds north of Highgate. A school-boy of that locality would be a good guide.

A FINE METEOR.—At 10.40, on the night of the 19th of July, 1881, a very grand meteor shot from the zenith and passed between the Great Bear and the comet; there was a thunderstorm blowing from the north and the meteor was lost behind it. This meteor seemed to be in our atmosphere. I had only seen one before with so long a flight, the noise of that was very audible, its course a broad flame. The meteor now seen had a thin line of light and gave no sound.—*H. P. Malet, Homburg, Germany.*

L. SIBYLLA.—While sitting in my garden on Saturday, the 16th of July, I was surprised at the appearance of *L. Sibylla* sailing round a cloth which had been lately saturated with sugar and water in front of some bee hives. Where could it have come from? I imagine it is long since one has been seen so near the metropolis, and so far from its sunlit forest glades.—*Windsor Hambrough, Worcester Park, near Wimbledon.*

TURBELLARIA.—In answer to an article on "Turbellaria" in July SCIENCE-GOSSIP, Mr. Young has fallen into a common error respecting the anatomy and relations of Turbellaria, and I hope he will excuse me for venturing to correct the error. From his description of the habits and mode of locomotion of the animals he noticed, I should say that they were planarians, and are the best known members of the order. Locomotion can hardly be said to be effected by definite muscular contractions (for the muscular tissue is of such a low grade of development as to be incapable of regular contractions), but by a regular flow of the body substance, like the flowing of the protoplasm of an Amœba. The body

is abundantly supplied both internally and externally, with vibrating cilia; cnidæ, or nettle-cells, are also present, like the nettle-cells of medusæ. The statement that Turbellaria have suckers is incorrect; for the chief characteristics of the order are absence of suckers and hooklets, neither are they in any way related to the leeches. The differences between them are sufficiently marked. 1. In the greater number of turbellaria the alimentary canal terminates in blind pouches. 2. The nervous system consists of two ganglia, placed in front of the mouth, and connected by a cord. 3. Respiration is effected by the general surface of the body; and 4. The body does not show distinct segmentation. In the leeches, on the other hand, 1. the intestinal tract is always terminated by a distinct anus; 2. the nervous system consists essentially of a double chain of ganglia placed along the ventral surface of the body, each segment of the body having one pair; 3. respiration is effected partly by the general surface of the body, but principally by means of special organs termed segmental organs or respiratory pouches, formed by involutions of the integument; and 4. the body is distinctly segmented. These characters sufficiently indicate their position in the scale of animal life; the indistinct segmentation, the branched and closed intestines of the turbellaria show their relationship with the flukes; both orders belonging to the sub-kingdom Annuloida; on the other hand the distinct segmentation and the straight alimentary tract, the more highly developed apparatus, and the form of the nervous system indicate that the leeches and earth-worms are closely allied, and in fact both these orders are branches of the sub-kingdom Annulosa.—*G. Forden.*

NOTES ON HAILSTORMS.—May I ask you to request any of your readers who have opportunities of observing hailstorms to oblige me by sending their observations to me? The points to be particularly noted are as follows:—1. Date, and hour of the day. 2. Area of the storm. If it assume the tornado form, give (a) length of the course, (b) breadth, (c) direction of motion, (d) rate of progression. 3. Physical features of the locality, (a) elevation, (b) mountains and plateaux, (c) rivers and valleys, (d) forests, &c. 4. Temperature, (a) before the storm, (b) after the storm, and if possible, (c) changes during the storm. 5. Barometrical readings. 6. Wind, (a) direction near the earth's surface, (b) direction of upper current as indicated by the cloud motion, (c) force. 7. Preceded or followed by rain. 8. Aspect of the clouds. Note if there be any appearance of two separate strata at different elevations. 9. Electrical phenomena. Should there be lightning, note the relation between the discharges and the fall of the hail, whether the lightning precede the hail, or *vice versa*. 10. Duration of the storm at one spot. 11. Sound. Note if a peculiar noise precede the descent of hail. 12. Conformation and size of the hailstones. 13. General character of the weather before and after the storm.—*J. A. B. Oliver, Athenæum, Glasgow.*

JACOB'S LADDER, &c.—In reply to C. W. Holgate, respecting the localities south of Derbyshire in which "Jacob's Ladder" (*Polemonium ceruleum*) is to be found, we beg to say we have in our herbarium specimens from the High Tor, near Matlock, and Haddon Hall, also from Ashford, near Bakewell. Both these places, namely, Haddon Hall and Ashford, as well as Matlock, are in Derbyshire. We have not met with this rare plant elsewhere. We also had gathered for us, by a friend, the milk-wort (*Polygala vulgaris*) about the same date, April 18, as men-

tioned by W. Mower, SCIENCE-GOSSIP, page 152. It seems to have flowered early this year, and to be very fine. I believe this is not an unusual occurrence. We have had sent us this week, Monday, June 27th, specimens of the wild pink (*Dianthus plumarius*), gathered from the top of Ludlow Castle. We venture the following remarks in reference to the questions asked by A. J. Wheldon, SCIENCE-GOSSIP page 167, in reference to *Ranunculus acris* var. *tomophyllus*, and the three forms of brassica. Bentham only mentions in reference to *R. acris*, that in mountain pastures the above species is often small, with only one, or very few flowers, but Bentham gives it no distinct specific name. As regards the three forms of brassica given in the seventh edition under *Brassica napæ*, we are not *au fait* on this point. Bentham classifies (*B. Rapa*) the rape seed, or Colza, under the head of *Brassica campestris*, and considers *B. Rapa* one of the cultivated varieties of *B. campestris*, which also includes the turnip (*B. Napus*). *B. Rapa* is probably also applied to the Swedish turnip.—*E. Edwards*.

SCARCITY OF WASPS.—Up till the present time there has been with us a marked scarcity of wasps. Has this been generally noticed? Last year at this season we were remarking upon their great abundance, as many as sixty nests occurring in one park. One would imagine that this season, being so hot and dry, would have been favourable for them.—*John L. Hawkins, Reading*.

ADDERS HISSING.—Your correspondent G. Dewar in his note on Blackbirds and Adders in SCIENCE-GOSSIP for August, says "They [adders] rarely hiss except after a slight sun-shower of rain . . . their hissing arises, I believe, simply out of their enjoyment of life as the song of birds," &c. These statements are not quite correct. I have observed adders under many conditions, and cannot say that their hissing seemed to be affected by any atmospheric change. So far from hissing being an indication of their enjoyment of life, at no time will an adder hiss more vehemently than when menaced by an enemy, which is not an enjoyable position with any animal, and which would at once silence any song-bird or grasshopper.—*J. M. Campbell*.

EDIBLE SNAILS.—J. O. B. will find his *Helix pomatia* feed well on cooked meat, though snails in general live mostly on vegetable food; but the Romans, who kept this species in *Cochlearia* enclosures or parks, fed them on flour boiled to a paste in wine and on dressed meat.—*Allen E. Watney*.

HELIX POMATIA.—SCIENCE-GOSSIP, No. 200, page 189. *Helix pomatia*.—J. O. B.—I obtained one of these molluscs in October, 1880, which immediately hibernated, cementing a piece of brown paper to its epiphragm. It rested comfortably in a chess box till March last, when it resumed its former activity. Since then I have kept it in a bell-glass and its food has been living nettles and a fresh cabbage once a week and it is in fine condition. It is now turning ashy-grey through loss of epidermis, which seems to prove the suggestions of Mr. Rimmer respecting var. *albida* in his excellent work. I have no doubt if one lived near its habitat it would prefer a selection of such plants common to the neighbourhood. J. O. B. should put a little lime, say pieces of chalk, amongst the mould in the floor of its home. Cabbage seems to do for the whole family of land shells, and watercress for the freshwater if other water-weeds are not procurable.—*Chas. D. Sherborn*.

HELIX POMATIA.—This noble snail is like other snails, somewhat omnivorous. I had a large colony of them once upon a time, and found the best diet for them to be tender lettuces and vine leaves.—*Shirley Hibberd*.

AN UNUSUAL SITE FOR A SWALLOW'S NEST.—The other day my attention was called to a swallow's nest in the middle of a pear-tree, in which the old birds were busily feeding their young. The nest looks very like a goblet of mud placed upon the upper surface of a small branch not more than three inches in circumference. It is a nest of this year, and I should think very likely the dry season has helped to mislead the birds into taking the tree, which is very thickly covered with leaves outside and very spacious inside, for a shed. As I can find no one who has met with a swallow's nest similarly placed, I think it may be interesting to some of your readers to hear of it.—*C. W. Sessions Barratt, Wallingford*.

HABENARIA ALBIDA ON THE NORTH DOWNS.—A small form of *Gymnadenia conopsea* with white flowers may be met with occasionally and be easily mistaken at first sight for *H. albida*. I once gathered three or four specimens of this white-flowered variety on a bank adjoining Farthing Downs, near Coulsdon, Surrey.—*E. de C.*

INCUBATION BY A CAPON.—In reference to Mr. W. Curran's discursive note, mentioning among other points, the capon's feat of hatching chickens, as related in Drinkwater's "History," &c., it may not be out of place to extract the following lines from a poem entitled, "The Capon's Tale to a Lady, who feathered her Lampoons upon her Acquaintances," by Dean Swift, published 1747, wherein he says:

"Yet tender was this hen so fair,
And hatched more chicks than she could rear.
Our prudent dame bethought her then
Of some dry-nurse to save her hen;
She made a capon drunk, in fine
He ate the sopps, she sipped the wine;
His rump well pluck'd with nettle stings,
And claps the brood beneath his wings.
The feather'd dupe awakes content,
O'erjoyed to see what God has sent.
Thinks he's the hen, clacks, keeps a pother,
A foolish foster—father—mother."

—*J. A. K. C.*

POISON GLANDS IN FROGS.—In the "Semaine Française" for July 30, it states that in frogs there is a poison in the neck which produces ophthalmia if it touches the eyes, and also is strong enough to kill a small bird instantly if injected into it. It is of course a well-known fact that toads have poison glands, but I shall be much obliged if you will tell me whether this poison is peculiar to French frogs, or if it is also found in the common English variety.—*J. R. T.*

POLECAT.—Perhaps it may interest some of your readers to hear that a short time ago, I captured a young living polecat (*Mustela putorius*) in Kent. I was walking along in a small wood, accompanied by a dog, when it rushed down a tree and scampered off in front of me. The dog gave chase, and caught it, at the expense of a bite in the lip, holding it across the loins. In a day or two it was perfectly familiar, it took food from my hand, and played with my hand, rolling on its back like a puppy. But the evil odour which it caused in the yard where its cage was, induced me to take it to the Zoological Gardens, where it is now, unless it has died since.—*H. C. Brooke*.

HAIR BELL OR HARE BELL.—In your August number, F. K. suggests that there is no real difference here, but that the word "hare" is only a corruption of an older spelling of "hair." Speculations on what "may be" are of little or no weight in etymology, which can only be founded on what actually has been, when such can be known; otherwise and provisionally, as in other sciences, analogy forms some guide. Hence the immense value, over all its predecessors, of Professor Skeat's "Etymological Dictionary," arranged on an historical basis. I believe there is no instance of "hair" having ever been spelt "hare," and, at any rate, when followed by an *s*, it can hardly mean anything but the quadruped. Professor Skeat gives several instances of plants having been named after animals, and in particular from words combined with the hare, out of which I selected a few; F. K. quotes one new to me from an old Dutch work. It is rather beside the point that several botanists have adopted the spelling hair-bell, since it is well known that that is often used; the question is whether it is etymologically correct. In your July number, Mr. Bowker appears to think that the harebell mentioned by Shakespeare in "Cymbeline" refers not to the *Campanula rotundifolia* but to the *Hyacinthus nutans*, usually in English called bluebell, but sometimes harebell. I venture to think that he is wrong, for surely the colour of the latter can hardly be compared to that of the human veins. Though often of a very deep blue (too much, in fact, for this comparison), it is not always blue at all, which I suppose is the reason that bluebell is not its universal designation. Of the English names of the *Campanula rotundifolia*, heath bell is perhaps the most appropriate. (In the third line of my quotation from "Cymbeline," the printer has accidentally substituted "He" for "I'll.")—*W. T. Lynn.*

REARING BOMBYX PERNYI.—My success in getting these moths out of the pupa has not been what I anticipated, and I attribute my failure to the cocoons having been kept too dry, therefore I give this hint to future rearers. I was of course aware that the cocoons should be protected from frost, and secured for them a uniform winter temperature, but from the shrivelled aspect of the non-emerged insects, it would seem that if they do not require actual damping, a moist atmosphere helps on their development. Also I note that almost immediately it quits the puparium, the moth of *B. Pernyi* discharges a glutinous fluid, which clogs and entangles the feet, interfering with its extrication. This circumstance suggests that it might be advisable to remove the pupa from the cocoons, and place them on moss, or any substance that would give them a good foothold.—*J. R. S. C.*

REARING YOUNG LARVÆ.—An account of a very ingenious apparatus for this purpose is given in a small shilling volume on "British Moths," by Rev. J. J. Wood (Routledge). The troublesome and really extraordinary propensity most of them have to wander about is a bar to successful rearing. Some have been reared in glass tubes or cylinders, closed at each end with corks, and twigs of the required plant being introduced, the larvæ will live several days without need of a change, the glasses being kept in a cool place. They will thrive at that early age, with less air than they subsequently require. Also small jam-pots or gallipots covered with fine muslin have been tried with some success, or the plants or twigs may be stuck in narrow-necked bottles of water, and these made to stand in saucers, the edges of which are slightly greased, so that if any drop, they cannot escape over the edge.

A MAGGOT COMBAT.—A short time ago I witnessed a combat between two maggots, which had been taken out of separate pea-pods: an account may not be uninteresting to your numerous readers. Each was about a quarter of an inch in length; one was brown, its atral end was comparatively large and bulky, and it tapered towards the head; it could elongate itself at pleasure with a peristaltic action, and its movements were sudden and rapid. The other was green, and exactly similar to a hairless caterpillar both in appearance and movement. It was somewhat difficult to raise their ire, but when they once began to "enter into conflict dire," they went at it in right good earnest. They twisted and twirled round each other like two snakes, one evidently endeavouring to get the better of the other; the green champion was the stronger though not so agile as the brown, which made several ineffectual attempts to get away. The struggle continued for at least from fifteen to twenty minutes, when I observed that the green champion excreted from his left side an almost invisible glutinous web which he contrived to twist round the middle of his opponent, speedily depriving his atral half of movement; when he had succeeded in his purpose, I saw a swelling on his left side: the conqueror was now much exhausted, and his powers of locomotion were seriously impeded. The vanquished now succumbed to the injuries received; how long the other lived I do not know, as it was unfortunately thrown away. I merely send this short, and I am afraid, imperfect account, in order to inquire of your readers if anything of a similar nature has ever come under their notice.—*E. Marlett Boddy, F.R.C.S.*

VARIETY OF THE BRIMSTONE BUTTERFLY.—The individual described by H. M. is not a hybrid, but belongs to a variety not of uncommon occurrence in this country, and which is not akin to the Continental form of the brimstone called *Rhodocera Cleopatra*, and regarded by some as a distinct species. The extent of the orange streak varies in different specimens, and is not always alike in the corresponding wings.—*J. R. S. C.*

NOTICES TO CORRESPONDENTS.

TO CORRESPONDENTS AND EXCHANGERS.—As we now publish SCIENCE-GOSSIP earlier than heretofore, we cannot possibly insert in the following number any communications which reach us later than the 8th of the previous month.

TO ANONYMOUS QUERISTS.—We receive so many queries which do not bear the writers' names that we are forced to adhere to our rule of not noticing them.

TO DEALERS AND OTHERS.—We are always glad to treat dealers in natural history objects on the same fair and general ground as amateurs, in so far as the "exchanges" offered are fair exchanges. But it is evident that, when their offers are simply disguised advertisements, for the purpose of evading the cost of advertising, an advantage is taken of our *gratuitous* insertion or "exchanges" which cannot be tolerated.

PHILIP BARKER.—Messer's "New and Easy Method of Studying British Wild Flowers by Natural Analysis," published at 10s. 6d. by D. Bogue, is one of the best books you could obtain by which to easily diagnose British plants.

E. HALSE.—Your paper is in type, and will appear shortly.

H. P. MALET.—Will you please supply us with your present address, that we may return you the paper you speak of.

HENRY J. ALLEN.—The "Natural History" edited by Professor Duncan, now being published by Cassell's, and which has reached its fifth volume, is by far the best which has yet appeared. Each department has been entrusted to a specialist, some writer distinguished for his acquaintance with the subject. The illustrations are both numerous and good.

G. JONES.—Marine animals and plants for the aquarium may be obtained at Sea Horse House, Portland Road, London.

T. S. KING.—We should be very glad indeed to possess a specimen of the insect for microscopical purposes.

C. F. W. T. WILLIAMS.—Both your papers on micro-fungi are in hand.

V. G.—"Hay fever" is caused by the abundant pollen thrown into the atmosphere whilst various grasses are in flower. The immediate cause of the catarrh is the possession of a chemical principle called Coumarin by the pollen grains. The idea of animalcula causing hay fever is nonsense.

F. JOHNSON.—You should consult the Transactions of the Epping Forest Naturalists' Field Club for matters relating to the natural history of the forest. Write to the Hon. Sec., Mr. Cole.

F. J. GEORGE.—Accept our thanks for the very curious specimen of 5-petalled stellate strawberry.

J. H. PAYNE.—We have examined the so-called "growth" in a solution of aluminous salt under the microscope with $\frac{1}{2}$ -inch power, but consider it as perhaps only a flocculent precipitation of organic matter.

L. L.—Get Dr. Günther's "Introduction to the Study of Fishes."

W. P. HENDERSON.—We can cordially recommend the following books on the subjects you mention: "Origin and Metamorphoses of Insects," by Sir John Lubbock, Bart. (one of the "Nature" series of vols.), published by Macmillan; "Transformation of Insects," by Professor Martin Duncan (Cassell's); "Guide to the Study of Insects," by Professor Packard.

W. H.—You will find all that can be said concerning *Drosera* in Darwin's "Insectivorous Plants" (London: John Murray).

M. N. S. C.—The antennæ of insects are the seat of a special sense, of which we can scarce form any conception. By them they communicate with one another, they recognise objects, and seem to distinguish with their aid, their friends from their foes—by instinct or "hereditary knowledge."

R. B. and B. W.—Your queries will be answered in next month's issue.

EXCHANGES.

FOSSILS.—Wanted good trilobites, silurian, devonian, chalk fossils, or offers in exchange for good series of cretaceous, oolitic, liassic, rhætic, and carboniferous fossils. Fine specimens of stems of fossil wood and root of *Zamia* from Portland stone, Isle of Portland. List sent.—F. Sumner, West Park, Bristol.

A FIRST-CLASS lantern, 4-inch condensers, double achromatic front lens with rackwork; Newton's triplex lamp; Pumphrey's safety jet for fine light; retort purifier for micro-objects, or apparatus.—Mr. H. Beech, Lincoln Road, Peterboro.

WANTED, Nos. 175 to 189 inclusive, SCIENCE-GOSSIP. Good exchange.—W. Macmillan, Castle Cary, Somerset.

A TURNTABLE and a few well-mounted slides in exchange for other slides or material.—T., 1 Harleyford Road, Vauxhall, S.E.

WANTED to exchange a Professor Henslow's dissecting microscope, worth 15s., for Anne Pratt's "British Wild Flowers," or Darwin's "Origin of Species."—G. Forden, Sandon, Stone, Staffordshire.

WANTED to exchange, stamp album, containing nearly 700 different foreign stamps, some very rare, for books on Geology, or of American travel, &c.—W. Benner, 9 Bridge Street, Tralee.

FINE slides of rock sections in exchange for good diatomaceous earths or deposits; also well-finished slides in exchange for good unmounted material marine algae—zooephytes preferred. Send lists to J. Tempère, Storrington, Sussex.

WANTED, micro slides and material: give slides, apparatus, books, &c., in return.—F. S. L., 2 Oakland Villas, Redland, Bristol.

WANTED, *Ancylus lucustris* var. *albida* and *Helix lamellata*. Offered *Helix pomatia* eggs in exchange.—Address, Miss Fanny Hele, Fairlight, Elm Grove Road, Cotham, Bristol.

SIDE-BLOWN eggs of the grasshopper warbler, and others, also rare lepidoptera for eggs of Dartford warbler, woodlark, ciril bunting, merlin, capercaillie, or others.—Thos. H. Hedworth, Dunston, Gateshead-on-Lyne.

WANTED, two death's-heads and hawk moths, and 20 or 20 British butterflies; will give good American butterflies and moths.—Fletcher M. Noe, Naturalist, 130 East New York Street, U.S.A.

L. C., 7th ed., 63, 97, 144, 209, 238b, 376, 383, 386, 455, 612, 663, 773, 814, 816, 1043, 1125, 1127, 1163, 1384, 1423, 1459, 1504, &c., for other rare plants.—J. A. Wheldon, 9 South Street, Scarborough.

WANTED, in good fruit, *Selligeria tristicha*, *Trichodon cylindricus*, *Eucalyptus*; any species of *Splachnum vesiculosum*, and any species of *Funaria* except *hygrometrica*. Exchange in other mosses.—Miss Ridley, Whitehaugh, Alford, Aberdeenshire.

SOME breast-bones of rare British birds, correctly named, but not bleached, to exchange for any British bird skins.—J. H. Gurney, jun., Northrepps, Norwich.

WANTED, a good microscopic lamp, such as Collins's Bockett lamp. Will give in exchange four dozen first-class objects, well mounted and finished, in polished pine cabinet with trays.—A. J. Doherty, 26 Leamington Street, Manchester.

WHAT exchanges in British land and freshwater shells for some specimens of *Achatina acicula*?—E. M. Brockbank, 20 Bootham, York.

WANTED, a critic for an amateur botany club.—F. L. St. A., 108 Cambridge Street, Eccleston Square, London, S.W.

STAMP album, containing fine collection of above 800 stamps, all different and many very rare, also a few specimens of *Erbia blandinia* (Scotch Argus butterfly). Wanted, in exchange for either of above, larvae or pupæ of British butterflies or moths. H. J. Murray, Mrs. Melrose, 21 Thornbank Street, Galashiels.

EGGS of R. W. starling, spotted sandpiper, common gull, lesser black-backed gull, eider duck, guillemot, golden-winged woodpecker, and several foreign species. Desiderata: jay, dunlin, wryneck, swift, landrail, jackdaw, and kingfisher.—J. T. T. Reed, Ryhope, Sunderland.

WANTED, New Zealand shells, also Cape of Good Hope shells, for minerals, fossils, British sea and land shells, rare slabs of Polish corals, sections of corals.—A. J. R. Sclater, Dank Street, Teignmouth.

I SHOULD like to correspond with an entomologist living at Barnet or near Hadley Woods, with a view to exchanges during the remainder of this season.—E. P. Dyball, 54 London Street, Norwich.

WANTED, any small British mammals, especially bats, stoats, weasels, water moles and harvest mice; also nest of harvest mouse. Write, before Sept. 12th, to H. C. Brooke, 45 Union Grove, Wandsworth Road, London, S.W.

DIATOMS (*Synedra ulna*), hair of camel (*C. bactrianus*), spores of *Lyceopodium* and several pollens (all mounted) for others.—Send list.—G. H. Bryan, Trumpington Road, Cambridge.

WANTED, NO. 1. "Journal of the Northampton Natural History Society," also SCIENCE-GOSSIP for 1872, 1873, and 1874. Cash or exchange.—A. Lockyer, Tavistock Road, Snaresbrook, Essex.

HAVING a large number of carboniferous fossils, should be pleased to exchange a number of same for those of other formations.—J. F. Crowder, Cumberland Street, Macclesfield.

FOR a second-hand bicycle, 54 or higher, 27 vols. on Geology, &c. (Harting's "Subterranean World," Cassell's "Popular Recreator," &c.); a number of fossils and rocks, Iceland spar, and bloodstone and nerine, &c., and a 20s. 6d. set of mathematical instruments, nearly new, in rosewood box. List on application to F. S. Atkinson, Thornbury House, White Cross Road, Hereford.

WANTED to exchange, a few mosses, Hepaticæ, and Lichens.—J. McAndrew, New Galloway, N.I.

FOSSILS from strata (tertiary to carboniferous limestone), in exchange for coins, tokens, war and other medals.—F. Stanley, Margate.

LIBERAL exchange offered for a clean pure gathering of *Folvox globator*, also *Draparaldea* and *Hydrodictyon*. Please communicate first—if intending to supply.—E. Wheeler, 48, Tollington Road, Holloway, N.

BOOKS, ETC., RECEIVED.

"The Book of the Rabbit." 1 vol. London: Bazaar Office.

"Catalogue of the Phaenogamous and Vascular Cryptogamous Plants of Michigan." Lansing, U.S.: W. S. George & Co.

"Butterflies of Europe." Part II. London: L. Reeve & Co.

"Entomologist's Monthly Magazine." August.

"Journal of Botany." August.

"Annals and Magazine of Natural History." August.

"Journal de Micrographie." May.

"American Naturalist." August.

"Revista." August.

"Geological Magazine." August.

"American Monthly Microscopical Journal." July.

"Les Mondes."

"Northern Microscopist." August.

"Midland Naturalist." August.

"Botanical Gazette." August.

"Le Monde de la Science." July.

"Feuille des Jeunes Naturalistes."

"Land and Water."

&c. &c. &c.

COMMUNICATIONS RECEIVED UP TO 8TH ULT. FROM:—
W. M.—W. H.—R. E.—M. S. C.—H. P. M.—P. B.—H. B.—
F. J.—G. H.—J. H. P.—F. J. G.—F. S.—Dr. W. T. G.—
C. F. W.—G. R.—F. S. L.—T. T.—F. T.—G. F.—
W. A. P.—T. C.—J. L. H.—J. H. H.—W. B.—J. W.—T. H. H.—
J. A. W.—H. E. W.—C. W. B.—J. H. G.—M. F.—S. F. B.—
C. N. G.—R.—C. W. S. B.—W. S.—J. F. C.—A. J. D.—
E. M. D.—G. T. B.—G. H. B.—H. C. B.—E. P. D.—F. C.—
H. L.—A. J. R. S.—D. D. E.—de C.—H.—J. M.—J. T. R.—
E. L. St. A.—C. D. S.—A. L.—E.—E. E.—J. A.—W. T. L.—
E. W.—H. C. B.—J. S.—G. F. W.—B. W.—F. S.—J. A. K. C.—
F. D. A.—J. Mc A.—G. H.—H. R. P.—S. H.—&c.

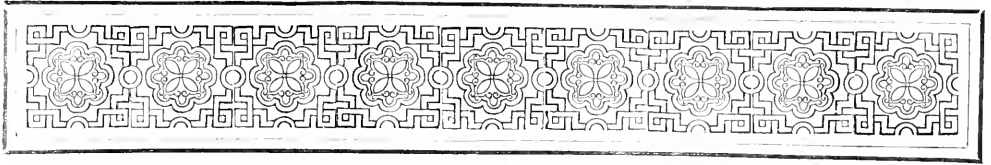

THE STRUCTURE AND LIFE-HISTORY OF A SPONGE.

BY PROFESSOR W. J. SOLLAS, M.A., F.R.S.E., F.G.S., &c.

[Continued from page 195.]



THE description of the young sponge is so far complete ; it consists of a sac, with a mouth at one end and pores at the sides, spicules to support it, and with three layers of tissue composing the wall, the ectodermal covering of plate-like cells, the jelly-like mesoderm in the middle and the flagellated endodermal cells within. But, as yet, there is no trace of the radial

tubes. Some sponges (*Olynthus*) which have the same developmental history as *Sycandra*, up to this point, remain persistently in the stage now reached by it ; in the young *Sycandra*, however, budding now begins to take place from the stomach wall, little hollow processes jut out from it ; as if pushed out by a finger ; these grow outwards, till they acquire exactly the same characters as the sac from which they proceed ; the open gastrula ends correspond to the mouth of the stomach, and the outer ends of the tubes to the base of the stomach. These are the radial tubes, and at first they are separate from each other, not united ; this stage in the history of the sponge remains permanently throughout life in a related species (*S. coronata*) ; in our sponge, however, they soon become united by transverse bars of tissue, which cross from one tube to another. The ends of the tubes, however, always remain free as little conical protuberances, but in another sponge (*S. capillosa*) development proceeds

the one step further, and the tubes become joined right up to their extremities. The fact here illustrated, that a stage which is transitory in the history of one animal is persistent in another, is one of the strongest arguments "for Darwin."

After so much pure description one may fairly be allowed to indulge in a little speculation : at one time people who thought at all about the matter were accustomed to believe that the young animal was produced from the adult all at once, at a single stroke ; it commenced as a minute germ, a more or less exact likeness of the parent in miniature, which had nothing to do except to grow big. Such, however, is as we can see, the very opposite of being the case, a vast number of phases of development intervene between the fertilised ovum and the young sponge. What, then, is the meaning of these phases, why all this complicated process, instead of the simple impress of the parental image on a young germ ? The explanation which has the merit of being at once the simplest and the most rational, is that the various stages in the development of the individual mark the various stages in the history of the species ; they present us, in the course of a few days, with a summary very much abridged of the successive steps by which the organism, as it at present exists, was evolved in the course of ages from some simpler form of life. Thus to confine ourselves to the history of the sponge which we have now made our own, we may assume that its earliest ancestor was a simple cell, closely resembling an ordinary amoeba ; this amoeba, after leading a wandering life, feeding and growing big, became stationary, folded its arms, to speak symbolically, withdrew them into itself, and formed a spherical ovum ; this either with or without fusing with another individual previously, split into two, as amoebas in such circumstances do at the present day, but the resulting twins, instead of separating from one another, as ordinary young amoebas do, remained in contact, for no obvious reason that one can see unless to keep each other warm ; they

grew up till the time came for them to split as their parent did, and thus four cells were produced, and so the process continued, all the young cells sticking together on the principle of co-operation. But co-operation by itself will not produce very great results; it frequently, however, leads to something much more important, and that is the specialisation of function and the differentiation of parts; here, in the cluster of young amebæ, such a specialisation took place, some became set apart as food providers and agents in locomotion, their pseudopodia becoming converted into flagella, the others served some other purpose, perhaps of secretion, perhaps as storers of nutriment, and perhaps as reproductive agents. So far the corals, sea-anemones, and such-like creatures (Cœlenterata) appear to have travelled along very much the same road as the sponges, but now they part company; the Cœlenterata originated in the growth of the ciliated cells over the cilialess cells, so that the latter formed the digestive lining inside the resulting *gastrula*, as we have agreed to call the sac formed by the invagination of the preceding form or blastula; in the sponges, on the contrary, as we have seen, the ciliated cells withdraw into the cilialess layer, which thus becomes a protecting, instead of a digestive, layer. But now it is worth while recollecting that though this is the normal process with the sponge, yet that the opposite one is frequently passed through as a transitory stage, preliminary to it, and thus we may conjecture that the larva which becomes a sponge now, by invagination of the ciliated layer, is a descendant of a form which used to become a coral by the invagination of the other layer; that is, that a form on the way to become a Cœlenterate, took the wrong turn for once, and so ended in a cul-de-sac, and became a sponge. Thus the abnormal kind of invagination in *Sycandra* may be an instance of what is termed "reversion to the ancestral type"; on the other hand it may simply indicate the balancing play of forces on the young organism, so that it looks as if it could not make up its mind, and was undecided as to whether to turn the flagellated layer inside and become a sponge, or outside, and become a Cœlenterate. Between these alternative possibilities we cannot decide; the day has not yet come when the development of an animal may be represented by a mathematical formula, and that wonderful man, the mathematical physicist, has not yet taken the matter in hand.

To resume our history. The young *gastrula*, which we believe to have led an independent life, a free swimmer in the sea, whose parent lived and died a *gastrula*, took another step in development by becoming sessile, and here again its contrary disposition was displayed, for instead of settling base downwards as the Cœlenterate *gastrula* did, when it similarly resigned a free existence, it, on the contrary, attached itself by the mouth, which, by subsequent growth, became obliterated. Hence the origin of pores, and

the vent which we conventionally call the mouth. We have already stated that some sponges remain their whole life through in the simple stage now reached, giving rise to other sponges, which no more pass beyond it than their parents did; yet in the history of the sponges, there must have been a time when one of these simple Olynthi progressed a step further, and produced the additional complication of radial tubes. These are simply so many repetitions of the young Olynthus budded out from its sides, and thus again we have co-operation, a number of young Olynthi, remaining attached together to form the wall of the *Sycandra*. But they all perform the same functions; the succeeding and more important step, the acquirement, by some of the tubes, of one set of functions, and by others, of another, has not yet taken place; some day, perhaps it may; the future is infinite with possibility, and *Sycandra* may even yet be destined to a brilliant and successful career.

THE OLDEST VOLCANO AND MOST RECENT LAVA STREAM IN ARGYLESHIRE.

DURING a succession of summers pleasurable gone, having visited nearly the whole of Argyleshire and southern Perthshire, devoting my energies to the study of the antiquities, rocks, flowers and insects, that I came across; I should, for the benefit of future tourists, desire to direct attention to certain bold volcanic phenomena that have especially incited my curiosity, and which have doubtless hitherto escaped the attention of specialists, even among those who have tasted the flask and tinnie of mountain water, enjoyed the phantasy of a blanket of Scotch mist, and slept away the sunshine among the crags and ferns of the Highlands.

Although I have since relearnt my geology on the dreamy shores of the Neapolitan bay, picked up lapilli at Pompeii, and bits of trachyte on the flanks of Monte Nuovo, a mountain so inconspicuous and so unlike the *beau ideal* of Lyell's "Principles," that a looker on naively inquired of me "Where is it?" although I have since looked out of my window above the olive trees, on Ischia, the home of earthquakes, and Vesuvius, the abode of fire, until my head, eyes and pencil, were fairly wearied out—for all such machinery and world manufacture of beautiful Parthenope and her land of labour, give me to enjoy that grandeur of conception that arises when the all silent hills of Arran and smokeless cones of Jura first loom on the sea mist.

This undefinable feeling of majesty and isolation akin to that experienced when the earth turns its side to the starry vault without, is mainly due to a conception of the lapse of time; and it springs equally in the breast when we turn our regards to the glacial phenomena of Caledonia. What, after all, is the

Alpine snow wreath and moving ice, when we dissociate it from the erroneous conception of eternity; what but a frozen mass of water inspiring certain chemical notions and inscribed over with certain illustrious names? How poorly when the sunlight is within the cloud does it affect the imagination, in comparison with those round smooth bosses among the heather bloom, and those U-shaped gullies with their terminal rubbish banks and perched boulders, so long the source of an unfathomable mystery. The same work of ice you feel is here, but the genius has flown, and in place of the soft voice of the falling snow crystals a rich carpet of verdure now clothes the strath interspersed with spare Alpine blossoms.

Few of the world of dilettanti but have visited the Island of Arran, to dredge for starfish in Brodick Bay, to seek out the royal and hart's-tongue ferns—(Note: the only example of the *Scolopendrium vulgare* I ever saw in these parts was a singular broad-leaved and dock-like variety, found on the coast near Fairlie; quite unlike the south of England type)—to hunt vainly for the Arran brown butterfly, to analyse the rocks or sketch the little fishing-coves which impart a life to the prevailing desolation. Yet how few of these probably have ever grasped the complete isolation of this beautiful island they so much admire and the tameness of the surrounding scenery; or ever thought to seek the reason, in the antiquity and violence of the volcanic outburst that formed its wild rocks! Nor is this at once realised. I had myself looked towards the fantastic and splintery peaks of this little gem from the coasts of Ayre and of Bute, from above Roseneath, and from various points of vantage along the Kilbrannan Sound. I had mused over its granite monsters under every circumstance of light and shade, as now they lay sweltering in summer mist, and now wrapped about with driving scud; still from no point of view was I really impressed with their true character, until I one evening climbed the gentle undulations that rise along West Loch Tarbet. From these grassy slopes the entire northern portion of the island lies in prospect as a single group of huge craters, which when their cups or corries lie sharply pencilled against a clear autumn sky, are quite as hideous as anything to be seen in the Gallic group of Puy. Indeed they have a remarkable resemblance to those more modern caldrons as depicted in Louis Figuier's "World before the Deluge"—(Note: has any one ever proved from the Vulgate, Septuagint, or Chaldee text, that the Biblical Deluge was a Glacial Period? I have fancied sometimes a fluvial inundation is indicated)—and taken as would seem from a similar western aspect. To the north lifts the bold and splintery hollow of Tornidneon, where the white thunder-clouds repose when they rise to a height of 1500 feet, exactly as in the other case towers as I take it the conical Dôme. To the south in either

view, lay two fine old furnaces well-known to the eagle and lammergeyer, but rarely visited by the autumnal tourist. The Puy, like old dragons yawning black and threatening in the bright sky, their older coarse grey granite prototypes, seamed and chiselled by frost and mist and beggared of the rough garb of plant life on the summits around, unveiling their craters bald and barren, the embodiment of ages of desolation.

After my first discovery of this physiographically artistic point of sight, I had from time to time, as the mountain rainfall permitted, gone to take the view of these wizards of the north, until one day determining to have a drawing of the finest before leaving, I mounted the return post cart from Whitehouse, and drove over to Skipness, which lies just under them on the opposite shore. The afternoon, at the commencement of the grouse season, was fine, and the driver of course intelligent; as the hills had to be walked up, I was enabled to collect some pieces of peat from bog cuttings and cottage stacks to examine for beetle elytra, and these when dissected at leisure, proved the bare sheep-fed knolls through which I drove were once rustling with groves of silver birch, long since burnt up by the cottars for firewood. I also remarked that where the damp grass around had been drained by cultivation, the common heather was appearing in patches; the gramineæ and ericaceæ here evidently owing their respective distribution to the moistness of the ground. On arrival at my destination I found a bed in the telegraph box, where an elderly matron gave me Gaelic for French; the language spoken in Paradise, as the native preacher pleasantly denominates it, having about as much in common with polite Parisian as the kindred cries of the Bedouin Arab have. I learnt, however, bhàta was bateau, and Usige, Usk, (the name of a town and river in Wales) was water; neither of these words appearing in Necker's Tables ("Voyage en Ecosse," t. 3, p. 325); and then my mind wandered back over the "whusky toddy," to the low German salutation on the road of a drougthy day, until I fairly tucked myself into a sweet dream of antiquity beneath the gloom of the eternal hills.

When the sunlight and patter of the "lassie wiring" awoke me, I wandered out in the quiet of the morning up towards the ruined castle, where I pricked my fingers among some furze bushes, a plant often noticed from the deck of the pleasure steamers as forming a yellow zone at some altitude on the slopes of Loch Fine, and the Gare Loch, and yet somewhat strangely termed by Hooker, who ought to know, rare in the Scottish Highlands; in Sweden, of course, this obstruction of the flycatcher does not occur. The rest of the morning was occupied among the seawrack at the water's edge, making the very prosaic sketch of my crater which heads this article. On completing the same I ventured to inquire its name, but the obliquity of the Highland mind that arises

out of the confusion of tongues, having failed to assure me whether it might be the Lachan an Damh, or the lovely and secluded Corrie-an-Lachan (Hollow of the Lake) mentioned in the geology of Clydesdale and Arran, I gave up the very laudable endeavour and strolled on towards Clonaig, where exists a seemingly artificial mound; and hard by a whisky shop, a most remarkable V-shaped chasm, running in an easterly and westerly direction, that confers an impression of its being freshly torn open by an earthquake. And still, although European commotions yet find their seismograph in the hill of Comrie, the line of the Caledonian canal, and maybe in the waters of Loch Lomond, that shake with periodic ague (guide-book to Comrie), no historical

whin dyke; and so fresh-looking that it would appear to have run flaming only yesterday. Let us set out from Loch Gilphead for a morning's drive to the secluded bay of Carsig, and stop where its solitary kirk and manse look over the sound. The rowan berries about here ripen as well for preserves as they did in the days of the sea-kings, a basket of wild raspas may be found in the shade or blaeberris picked on the rocks. Alpine flowers and insects do not meet the sight as in Perthshire, although the Scotch Argus and darkish mountain variety of the green veined butterfly move among the willow herbs in the glens; and then two of these glens are glens, glens of erosion cut out of the solid rock by the action of ice as uniform as a railway cutting. One



Fig. 126.—Old Granite Crater, Arran. From the north-west.

earthquake, as far as I know, has been heard to growl among the contorted schists of this secluded bay, where the herring fisher would probably laugh at the conjecture.

Volcanoes, however, are rarely found from which lava streams have not flowed, granite ones seeming among the exceptions, as nothing is seen near my antique crater but certain veins penetrating the old mud, politely termed slate, at Tornidneon. The darker whin dykes that lie around its feet are all of the succeeding age; forming smooth hard promontories very convenient for a header off of a sultry noon, and very interesting to trace across country to their probable outbreak. But if we leave the island of Arran for the western shore of Cantyre, we may find a far more appalling lava stream than a common

coming down on the south of the bay to whose head I have frequently wandered when the moths began to flit to visit a dairy farm for milk, a good Scotch mile off with a bull on the road: another tumbling down more precipitously on the north, with a queer miscellaneous moraine heap at the bottom, and rounded and scratched rocks not a few; an enjoyable clamber there is up it in the mountain air to watch the sun set ruddy behind the Paps. But in order to visit my lava flow you must leave the glaciers, take boat and ply the oar to the low islets running up to the bay's mouth and visit the first at the entry of the inlet, lying nearly north and south. Here is its sketch made under the disadvantage of a little wind and Highland shower with the stores packet in the offing.

To the left lies the transported boulder of *reddish Mull?* granite under which I sheltered resting on the erupted rock which is of two sorts. That fronting the bay, much resembling gutta percha in appearance, rises into cindery heaps full of large pores like boiling tar, soup, or other seething viscous matter; the rest smooth and compact, represents the lower portion of the flow cooled without contact with the atmosphere; and subsequently laid bare. In either case, the fantastic pyramidal shape of the upper or decidedly columnar form of the lower portion, may be remarked; the former seeming to indicate the stream has welled up at the spot. The contraction of the entire mass into rectangular masses is likewise noticeable, but the exact analysis of the trachytic rock I

for the waves to channel fresh beach lines with white "chucky stones," where around their already terraced flanks so many a shell has mourned its parent sea? The Phlegrean fields resound to the work of the Cyclops. Vesuvius smokes or Ischia shakes; the shore at Puzzuoli subsides; Monte Nuovo too has arisen in 1538; but the wild braes of Aigyleshire no longer tremble to the earthquake forces that gave them birth. Has the line of disturbance gone eastward where the shores emphatically rise and sink, and where, off the rugged coast of Norway, a volcano sprang from the sea in 1783; but if so, why has it also lost its intensity?

Regarding the very origin of earthquakes and volcanoes, of the undulations of the earth's surface

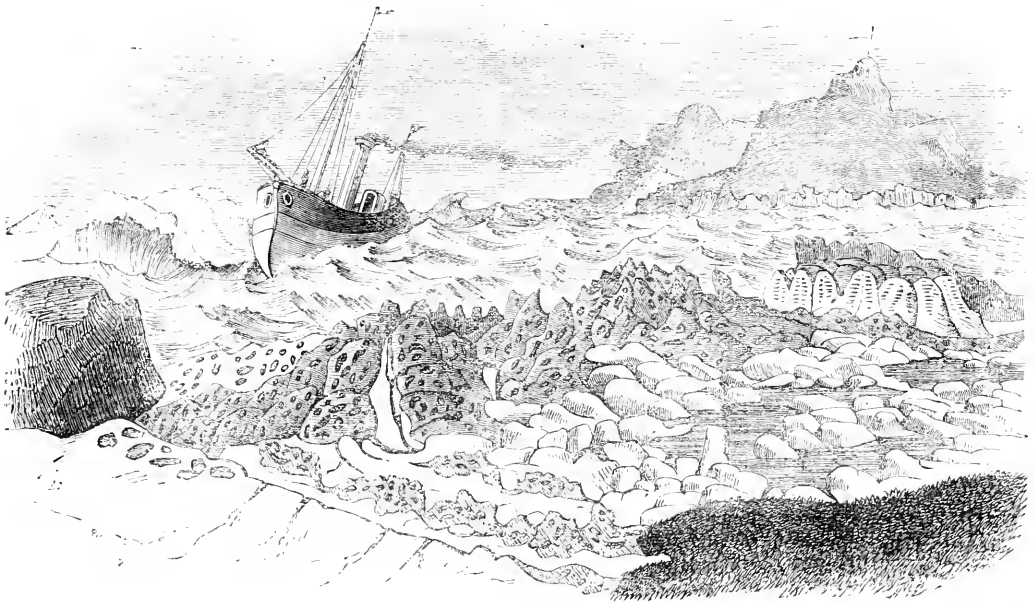

Fig. 127.—Extinct Volcano, Isle of Mull.

must leave to those who make a speciality of the thing. Then what is its age? Older than the time when the boulder was brought and perched on it, I think it must be, and here is the glacial epoch; but must we wander back in thought to the earlier period when that wondrous lava-stream boiled out at Staffa, or its counterpart pouring through the chalk formed the Giant's Causeway? This, I think, is not proven.

But who that has walked over a lava stream, can resist a feeling of awe as the cinders break like slag beneath his feet, or can quench that desire to penetrate deeper into the mystery? Why, one is tempted to exclaim, do earthquakes shake so feebly this spot once their own; why do they not break forth in floods of lava as heretofore, or heave up the flanks of Jura

marked by raised shore line, sunken valley, and hill and mountain, what sad discrepancy of opinion still exists! The chemist pretty well since the time of Lucretius has talked much and long of ignition or oxidation, of chemical unions, of the explosion of percolating water, and expansion of air or gases generated within. The cosmologist since the days of Humboldt at least, has occupied himself with the contraction of the scum on the surface of a molten globe that is continually cooling and squirting out as it contracts; eliminating in his investigation a variable element in a thin expansible crust, affected by the sun's heat and unaffected by that of the interior, and not exceeding 100 feet in thickness. The astronomer has found a still newer theory in that of M. Cordier ("Principles of Geology," v. II, p. 433-441)

regarding the moon as moving a tide of molten matter and welling it up in volcanoes; where he may eliminate the variables of perigee, nodes and orbit, giving periods of nine, nineteen and a million years. The meteorologist since the days of Galileo, or shall I say of Schwabe of Dessau? has discovered the sun-spot cycles ruling the atmospheric conditions in periods of about eleven years. And if it be true, allowing the disturbing cause of craters choking up, that earthquakes and eruptions as a rule visit our hemisphere in the spring and autumn, and that they are likewise felt about the same time in the same isotherms or latitudes; there seems no reason this sun and weather theory should not in its development run neck and neck with the lunar; representing as it does the variable element in the cosmical theory, and explaining the origin of the earth waves and fissures in the fluctuations of solar heat.

Still, whatever be the fond bias to individual theoretics, it will, I think, eventually appear that the existing discrepancies may all disappear by a due subordination. Thus I might suggest it has been lately argued by certain correspondents to the "English Mechanic," and with much semblance of truth, that eruptions and earthquakes are explosions following on the adventitious percolation of water down to the heated nucleus of the earth; a circumstance very naturally following on the fissuring of the earth's crust during expansion or contraction. Then the eventual resolution of the philosophy, as far as it affects mankind, will doubtless be found in the Railway and Guide Book system of tables and a plan. Paper and instruments to register and compare earthquakes and irruptions, to determine their periodicity and register their paroxysms; to mark the direction of earth waves, from east to west as seems the rule, or otherwise; to mark the direction of earth rents, and note accompanying meteorological phenomena. Plans to signalise the dangerous districts which have varied little in all time; the crystalline granite, and darker trachyte, being poured out after the interval of vast ages around the same mountain tracts; earthquakes shaking down the same cities century after century, like card houses man has as recklessly rebuilt. One good has already accrued to this practical method in the establishment of lines, centres and sympathetic centres of disturbances (Page's Text-Book, ed. 1872, p. 125); and in the determination of lines of great cracks in the crust: one of these running up the western shores of America, and coming down the east of Asia, and another starting from Iceland, and waving down the west and south of Europe to meet it in the China Sea (Sir John Herschel, Physical Geography). These lines trend their curves to the passage of the sun from east to west, and that which passes through the Old World seems to have shown a disposition to move northwards in historical time, as we first hear of it in Southern Palestine.

Lastly, it does seem strange, and passing strange, that, while the press is establishing the periodicity of earthquakes, river inundations and landslips, so little heed is taken by the victims of these calamities who have their houses on the sand. Cannot Science who here sits in honour regulate the structures and induce a gradual emigration from the tracts of ill omen, giving them up for a season to the shepherd and the ploughman?

A. H. SWINTON.

FOOD FOR PARROTS.

IT is a great pity that persons whose only knowledge of a subject is evolved from their own consciousness should always be so anxious with advice, which is certain to be useless and is very often injurious.

The treatment of parrots recommended by J. R. C. S. in the September number of SCIENCE-GOSSIP is a case in point, to which I hasten to supply the antidote; premising that I am not speaking on my own responsibility only, but in accordance with the recommendations of our chief authorities on the subject; among whom I may mention the Rev. J. G. Wood, Mr. A. Wiener and Mr. C. W. Gedney. J. R. C. S. says "sopped bread is usually their staple food—water they do not require." (!) And then he goes on to say that they "more frequently die from asthma than from any other cause; though they will live many years with this disease."

Poor things! no wonder, on such starvation diet, which is not improved by the recommendation to give raw meat, even with the qualification "to give this too frequently is injurious."

When one comes to consider what is the food of the parrot in its native country, it will be readily seen that no bird fed as recommended by J. R. C. S. can continue in health.

In their wild state the grey parrots live on seeds and fruit—maize and the seeds, or fruit, of the coucourite palm chiefly; and if it is desired to keep a favourite parrot in health, the above diet must be imitated as closely as possible, viz., maize (boiled and dry) hemp seed, canary seed, dry biscuits, nuts, figs, and ripe fruit, a lump of sugar now and then, and a piece of boiled potato or carrot. To say that parrots do not drink is an absurdity, and to deprive them of water the height of cruelty: why, parrots are nearly always captured by the professional bird-catchers at their drinking places, to which it is their custom to resort night and morning. It may be that parrots unnaturally fed on "sop" do not swallow small stones or gravel, but I can answer for it that such as are more naturally treated do. There is no doubt that wild parrots often nibble a fat grub when they are boring in a decayed tree to make a

nest, and a good substitute for this is a well-picked chicken-bone, given very occasionally, but it must be borne in mind that "meat" raw or cooked will cause the bird to pluck out its feathers. A bird fed as recommended by the authorities whose names I have mentioned will live for a great number of years without asthma or any other complaint; and there is no doubt that a pair of them would breed, if provided with a suitable nesting-place in the shape of a hollow-tree, or even a barrel partially filled with sawdust, placed in an empty room or a strong iron aviary of convenient size.

An acclimatised grey parrot is very hardy, but like all other birds is very impatient of draughts. Vast numbers of these birds soon after being landed in this country die of consumption, induced by overcrowding during the voyage, and dirty drinking-water. As a rule parrots are very fond of bathing, though some individuals cannot be induced to wash themselves in a cage, and as a consequence become scurfy and rough as to their plumage; these should be gently sprinkled with tepid water from a garden syringe, or the rose of a water-pot, once or twice a week in the summer, and then placed out in the sun to dry themselves.

W. T. GREENE, M.D.

Moirs, Peckham Rye.

INSECT SWARMS.

THE abnormal profusion some years of certain kinds of insect life, their sudden appearance, and equally sudden disappearance, must often have created much astonishment. The causes operating in this development are by no means easy to account for; still the fact remains, and is so patent as to attract, not that alone of the entomologist, but general attention.

At one time plants and trees are infested with swarms of Aphides; the beans in our gardens are black with *Aphis rumicis*; the flowers in our conservatories are covered with what is popularly known as the "green-fly," and the hedges drip with the frothy distillations of *Aphrophora spumaria*. Another year we have to lament the injury by the larvæ of the saw-fly (*Nematus ribesii*) to the gooseberry and currant bushes, which are stripped by them almost bare of leaves (to plants both as stomach and lungs) so that the fruit never comes to perfection. The usual habit of the larvæ is to attack the lower branches first, and work upwards till the whole bush is defoliated, and presents a curiously grotesque appearance of interlacing thorns.

Sometimes the air, in spring and summer, teems with the two species of cockchafer (*Melolontha vulgaris* and *Rhisotrogus solstitialis*), which buzz in our faces, and apparently delight in annoying our-

selves, horses, cows, and other animals, with their persistent assaults.

A.D. 1877 will long be remembered as the *Colias Edusa* year; this uncertain butterfly then appeared in the utmost profusion throughout the length and breadth of the land, being more common even than the garden whites (*Pieris brassicæ*, *P. rapæ*, and *P. napi*) since which we have had only a few stragglers here and there; and it is now a long while ago that its congener, *C. hyale*, has favoured us with a visit.

In the same year the apple trees suffered considerably from the large numbers of the gregarious larvæ of *Bombyx neustria*. In the earlier stage when the young caterpillars feed together under a web, it is not very difficult to get rid of those within reach, and a neighbour of ours adopted the ingenious device of firing with powder only into the trees, and so blowing off those higher up; afterwards when more grown they disperse, and are more troublesome to remove.

In the year following, the larvæ of *Vanessa polychloros* swarmed on the elms (*Ulmus campestris*) surrounding our house; curiously enough, neither caterpillars nor imagines have since been noticed.

The altogether unprecedented abundance of *Plusia Gamma* in 1879 will not soon be forgotten. I saw whole fields of peas which the larvæ had left almost without a leaf; the larvæ themselves could have been collected in thousands. This season there are comparatively speaking no gammas; their place however has been supplied, though more locally, by immense swarms of *Charax graminis*, which in the larval state, are reported in Lancashire to have played sad havoc with vegetation. The moth does not occur to my knowledge in this district; but *Tryphana pronuba* has done its best to rival it and the gammas of 1879. They were to be seen hovering over every flower, and proved a complete pest at sugar.

The present season too has produced swarms of insects of another order. In the spring the pendulous racemes of the sycamore (*Acer pseudo-platanus*) were well-nigh hidden with a black dipteron (*Dilophus febrilis*), looking as if dipped in ink. They were eventually dispersed by the high winds which prevailed towards the close of May.

Now we may fairly suppose that all these vast numbers of insects must have deposited a corresponding quantity of eggs. What of these: did the greater part perish, or are they only waiting favourable conditions to bring them forth in swarms again?

Some species of Lepidoptera, such as *P. cardui*, *C. Edusa*, and *C. hyale* seem to come out at something like regular intervals. Two hypotheses appear reasonable to me for accounting for this, and the exceptional development at times of other insects. In the one case we will imagine that the insects are born in this country; in the other, that they are immigrants from some foreign lands. This idea

which originated with the late talented Edward Newman has been proved to be correct; the swarms of *P. Camma* and *P. cardui* having been traced hither in their course from north-west Africa, and passengers on vessels have frequently seen large clouds of butterflies crossing the sea; the "blown over theory," therefore, can no longer be laughed at, and will explain at least the abundance of certain species of Lepidoptera. But we cannot doubt that in many cases the insects were natives, and the extraordinary profusion of particular species is to be attributed, I cannot help thinking, to the fortuitous combination of degrees of heat and moisture, exactly suiting the ova of these species. That the weather plays a most important part in the production of insect life, is a fact recognisable by all. The little *Thrips cerealium* is an example. They are known to every one as thunder blight; and the minute, tiresome creatures are always especially numerous in hot windy weather, and usually betoken thunderstorms, proving the aptness

sustenance and comfort, they would speedily drive man himself and all other animals from the very face of the earth.

JOSEPH ANDERSON, JUN.

Chichester.

NOTES ON THE NATURAL HISTORY OF JERSEY.

By EDWARD LOVETT.

FEW localities offer a finer field to the working naturalist, and few are so completely adapted to the requirements of the student, or natural observer as Jersey.

Its insular position gives it, so to speak, a compact natural history of its own, where, although intermingled with genera and species common in England and the Continent, the fauna and flora may yet be found to contain isolated cases that mark the former

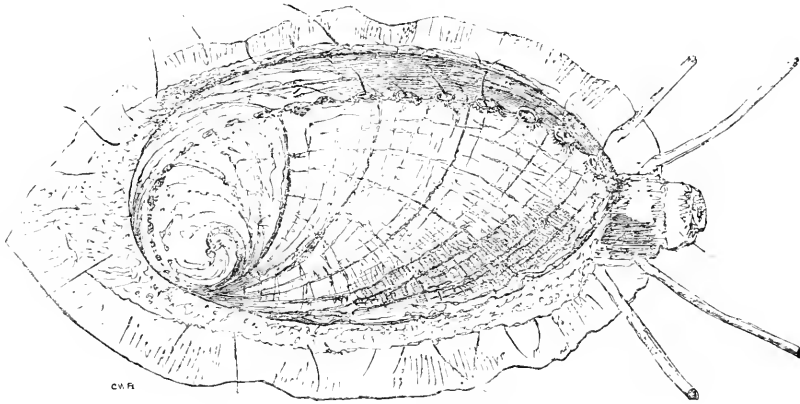

Fig. 128.—The "Ormer" (*Haliotis tuberculata*).

of the name bestowed upon them. The furniture in our rooms was covered with their dead, tiny carcasses during the last week in July. Their life is apparently very short (it may however be a merry one), as they die in a few hours, at all events after they have entered the house.

The subject is certainly not without interest, the more so that so little is known about it. In these few observations I have been able only to touch upon it, my remarks having been confined to that which takes place immediately under our eyes. Much might be written concerning the swarms of insects abroad, the dreadful ravages for instance of locusts; nevertheless these few notes may be useful in eliciting opinions and information from others. We are apt to regard insects as puny and contemptible; but they only want the fiat of the Creator to become the most mighty agents of destruction, and directly, by personal attacks, or indirectly, by destroying every green thing in the vegetable kingdom, which ministers to their

continental distribution of species, whose last stand was made amongst the sheltered coves, valleys, or rock clefts of this picturesque island. Another advantage, particularly to the geologist or marine zoologist, which its insular position obtains for it, is its large and varied coast line, and consequently rich series of geological sections, and abundant variety of sea beds and rock pools.

The variation in the fauna and flora in different parts of the island, situated with different aspects, and with a somewhat different geological character, is as marked as it is in other and wider localities; so that there are "good places" for "spiders," i.e. *Maia squinado*; for "ormers," i.e. *Haliotis tuberculata*, and so on, to the fisherman, as there are "good localities" to the naturalist for the various branches of study in which he may be interested. These "good localities," as regards marine life, are chiefly where, owing to the shelving nature of the shore, the tide recedes for some distance, leaving,

on the south-eastern shores of the island, at low spring tides, as much as fifteen square miles of ledges, rock pools, and miniature caverns teeming with ocean life such as is seldom seen on our less favoured English coast.

It is not our intention to compile a catalogue of the zoological and botanical life that belongs to Jersey, as such a list would require years of careful work, and would, moreover, be out of place in "Notes"; but in referring briefly to the various localities and their special features, we intend to mention species which are either of interest in themselves,

certain species are often limited, and in no place have we observed this peculiarity so well as in Jersey.

Away down among the luxuriant pools of *la grande Sambue* is occasionally met with, a perfect colony of a species which one may hunt for for hours without success; and such crustacea as *Thia polita*, *Nika edulis*, *Callianassa subterranea*, and many others are seldom found by chance, but require a knowledge of their particular habitat, and besides that a considerable stock of patience to obtain them. The same with plants and land animals, though with perhaps greater facilities for obtaining them. The beautiful

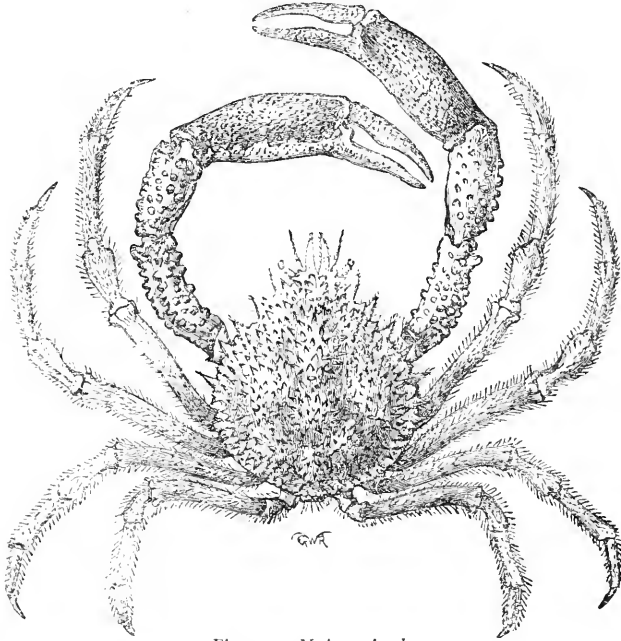

Fig. 129.—*Misi squinado*.

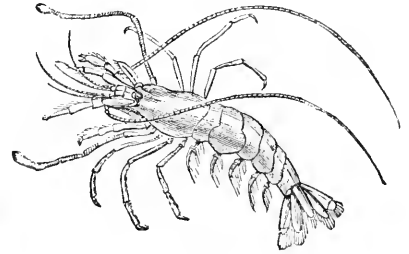

Fig. 131.—*Nika edulis*.

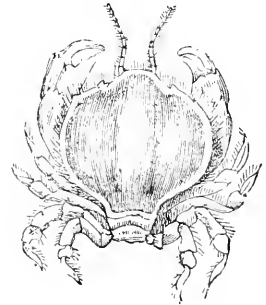

Fig. 132.—*Thia polita*.

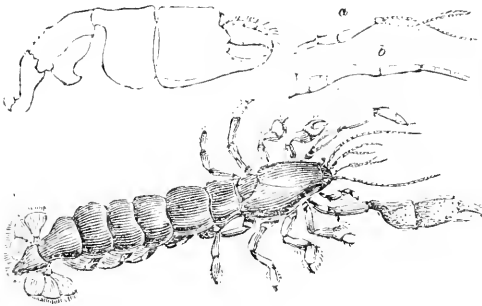

Fig. 130.—*Callianassa subterranea*. a. One of the internal antennæ; b. base of external antennæ; c. right claw.

or are likely to attract the attention of the naturalist, by their relationship to the particular locality in which they occur. A remarkable feature in distribution, is the apparently restricted areas to which

lizard (*Lacerta viridis*), although fairly distributed, affects certain favourable spots, whilst its congener (*Lacerta agilis*) is almost confined to the barely accessible rocks and ledges which form the coast line of Bouley Bay, on the north of the island.

Roughly speaking, Jersey is eleven miles long, by six miles broad, and contains about sixty-three square miles. Its coast line is varied, and broken up into eight or nine fine bays, with numerous smaller indentations and inlets.

On the northern coast, the cliffs are high and abrupt, and consequently there is deep water close in shore, so that no low tide hunting is to be obtained here; on the western shores, St. Ouen's Bay occupying nearly the whole, the coast line is principally formed of hills of blown sand which afford interest to the geologist; the shore being flat and sandy here, the marine fauna is not very rich in consequence, but embraces those species which are to be met with

in such localities, such as the crustacean *Portunus latipes*, &c.

The southern coast is more varied, consisting of the fine sandy bay of St. Aubin's, bounded on either side by the rocky Bays of Portelet and Grève d'Azette. Near St. Aubin's, a large number of "spiders" (*Maia squinado*) are caught in pots, and the bay is a good one for dredging. We obtained a considerable number of species of crustacea and mollusca there, notwithstanding unfavourable weather. On the south-east and eastern shores, the coast is low and shelving, so that at low tides a large quantity of rocky ground is uncovered, and as this is the most interesting part of the island as regards its marine zoology, we shall refer to it more in detail later on. This flat but rocky shore is broken by one marked feature, namely, Green Island, or La Motte. It consists of a mass of sand and clay, and appears to correspond, as a remnant, with the sandhills of the western shores. Further northwards the coast rises, being very lofty at Anne Port and St. Catherine's, and reaching a grand altitude at La Tour. The island thus rises from the south, northwards, and its chief beds dip from north-east to south-west. The geology of Jersey is as yet but little worked; it is, however, of great interest—the syenites of the south-east and south-west parts of the island, the diorite of the St. Clement's district with veins of pink syenite forming a beautiful contrast of colour. The felsites and hornstones of the north-east part of the island, and the lavas and remarkable conglomerates still more to the north-east, all form subjects not only of great interest to the geologist, but also of great scope for their explanation and description. A few words as to localities for certain rocks, together with their chief points of interest, might be of use to some, and we will again refer to this subject; at the same time we may mention that to those who make fossiliferous strata their study, the island offers no attraction; its rocks, even when sedimentary, being much altered; but it is very rich in many of the rocks already alluded to, some of which are of great value from an economic point of view.

(To be continued.)

AN UNUSUAL FORM OF AMŒBA.

WHILE observing the circulation in the Nitella, some of which I had put into a shallow glass cell for that purpose, I found a number of Amœbas of various shapes and forms; some were globular and surrounded with a very transparent envelope, and they gradually continued to change their appearances (of which I have taken a variety of sketches). As they passed from one state to another, they presented forms that I had never before witnessed. Among them were

some of the most extraordinary shapes, and of the largest size I ever saw. The sketch I now send was one of them. This creature travelled in the direction indicated by the arrow; the foremost part of the body was very transparent, up which very few, but rather large granules were moving as it progressed onwards. The processes put forth resembled the arms of a tree. At times the pseudopodia put forth were much more extended than at other times, and were gently waved about bent in all directions. The posterior part of the creature was filled with granular matter of various shapes, while the edge was very hyaline at

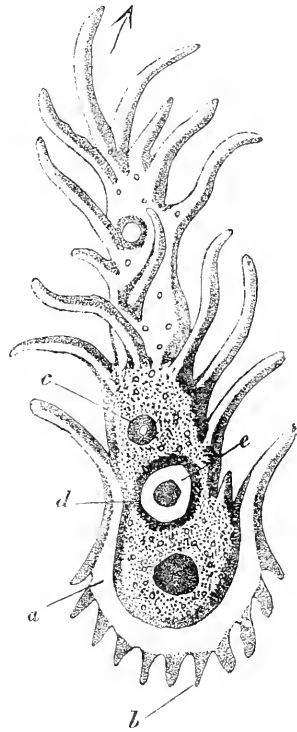

Fig. 133.—An unusual form of Amœba.

(a), from which were given out short and mostly pointed pseudopodia (b). At (c) a pulsating vesicle was seen, which at intervals became enlarged as at (d), showing a dark centre surrounded by a bright ring (e). A second paper was read on these strange organisms, at the meeting of the East Kent Natural History Society, on the 5th of January, 1881, illustrated by a number of sketches (the sketches were taken in October 1880) showing their various changing forms. The one I send to you I think is one of the most singular of them all.

JAMES FULLAGAR.

Canterbury.

HINTS TO LOCAL METEOROLOGICAL OBSERVERS.

I. HAILSTORMS.

AS hailstorms are essentially local phenomena, it is to local observers that we must look for any addition to our knowledge of them.

A reference to any Encyclopædia article will show the sadly confused state of our information on the subject. Flat contradictions will be found on every page. It will be seen that while some authorities assert that hailstorms occur most frequently in summer, others maintain that winter is pre-eminently the hail season. There must be an error somewhere. As a matter of fact, false statements have been so persistently reiterated that by mere repetition they have come to be regarded as truths.

Let me allude to one fertile source of error. I have referred to it before.* It is the confusion of hail proper, or French *grêle*, and winter hail, or *grésil*—two entirely different phenomena. *Grésil* is the small round powdery snow which often falls towards the end of a snowstorm and in the early part of a very frosty night. I suspect that Dalton and other observers did not distinguish between the two kinds of hail, and spoiled their results in consequence.

The following points are of primary importance, and should not be overlooked in taking down an account of a hailstorm :—

1. *Period*.—The date and hour at which a hailstorm occurs, though apparently small matters, are of the utmost importance. I am inclined to think that while each country has distinct maximum and minimum periods of hail-fall, the distribution of the quantity over the year varies materially. For example, in this country the maximum occurs in summer, and is very strongly marked, while in Germany the maximum is in spring and is not so decided. If the periods of maxima and minima all over the world could be determined, a comparison of them would doubtless throw much light upon the nature and cause of hailstones.

2. *Area*.—When a hailstorm is not purely local it usually assumes the form of the tornado and sweeps over the country in one, or sometimes two, narrow bands. In the former case it is sufficient to ascertain the area covered by the storm, but in the latter it is necessary to determine (*a*) the length, (*b*) breadth, (*c*) direction of motion, and (*d*) rate of progression of the storm-band. Such particulars can only be obtained by the co-operation of numerous local observers. Our organized observatories are quite incompetent for such work, being too sparsely distributed over the country.

3. *Physical features of the locality*.—The proximity of mountains seems to induce the fall of hail, while

that of forests has the opposite effect. Progressive storms often diverge from their course on encountering a river or valley, and follow that of the depression. It is therefore useful to note if any of those physical features be in the neighbourhood of the storm, and if so, their effect upon it. It is also of importance, especially in the tropics, to determine the elevation of the country above the sea level. It is frequently asserted, on what authority I know not, that hail never falls in the tropical regions at a less elevation than 2000 feet. It is worth while testing the statement.

4. *Temperature*.—The fluctuations of temperature during a hailstorm are often very remarkable, and should be carefully observed. A reading of the thermometer may be taken shortly before the storm begins and another directly on its cessation.

5. *Barometrical readings* should be taken, if possible.

6. *Wind*.—Its (*a*) direction near the earth's surface, (*b*) direction in the higher regions as indicated by the cloud motion, and (*c*) force, are important points. Some observers have noticed that the clouds move in various directions while a hailstorm is in progress. Kämtz actually went the length of attributing the formation of hail to the conflict of opposing winds; and Beccaria says, "While clouds are agitated with the most rapid motion, rain generally falls in the greatest plenty; and if the agitation be very great, it generally hails." Howard, in 1809, noticed the wind change from E. to S., then to W., back again to E., and finally to W., during a hailstorm.

7. *Rain*.—Rain sometimes falls before hail, sometimes after it. The area of a hailstorm is generally fringed with rain, and in the case of a moving storm, rain falls along both edges of the track. Rain before hail is somewhat rare, and its occurrence should be carefully noted.

8. *Clouds*.—Hail clouds are invariably cumulus. Volta and other theorists have assumed that there are always two strata of clouds at different elevations. Arago pointed out that they are generally of an ashen hue. Their aspect, apparent thickness, and height above the earth may be noted.

9. *Electrical phenomena*.—It is frequently stated that thunder and lightning always accompany the fall of hail, but such is by no means the case. When there is lightning it is important to observe the relation between the discharges and the fall of the hail—whether the lightning precedes the hail, or *vice versa*. If possible, the electricity of the air before and after the storm should be ascertained by means of an electrometer.

10. *Duration*.—The duration of the storm at one spot may be noted.

11. *Preliminary sound*.—Kahn, Tessier, Peltier, and others affirm that they have heard a peculiar rumbling or pattering sound in the air immediately

* "Nature," vol. xxiv. pp. 137-99.

before the descent of hail. This cannot be a common phenomenon, or it would have been more generally remarked.

12. *Structure and size of the hailstones.*—Observations of the structure of hailstones are seldom of any use, as the necessary precautions are generally neglected in conducting the examination. The ice of which they are composed undergoes a rapid change when exposed to a high temperature, so they ought to be collected immediately on descent. Further, as collision with the ground is liable to cause alteration of shape, if not entire fracture, it is well to catch the hailstones destined for examination upon a piece of flannel, which not only preserves the stones in their entirety, but, being a bad conductor of heat, keeps them from dissolving rapidly. The scrutiny may then be conducted in a cool room. Size should be determined by accurate measurements. Such vague terms as the "size of peas," or the "size of eggs," or "like large nuts," are useless for scientific purposes.

The above points may be supplemented by any others that the experience of observers may suggest or that peculiarities in individual storms may require.

J. A. WESTWOOD OLIVER.

Athenæum, Glasgow.

RECREATIONS IN FOSSIL BOTANY.

CALAMITES.

NO. VI.

By JAMES SPENCER.

EVERY student of geology is familiar with the sandstone and ironstone fossils called calamites. They derive their name from *calamus*, a

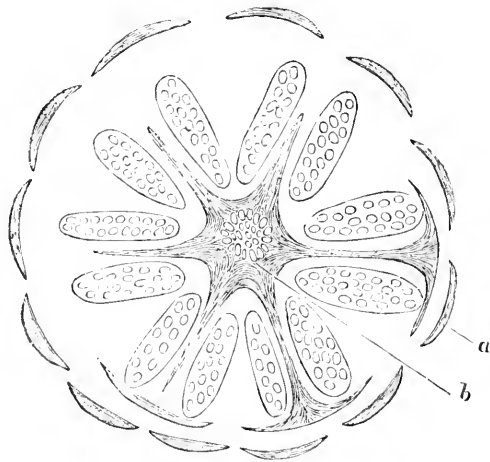

Fig. 134.—Transverse Section of Fruit of Calamite.

"reed," on account of their outward resemblance to the reed plants, such as canes and horsetails.

But it is now well known that these sandstone

and ironstone fossils do not represent the real forms of the plants when growing erect in their native habitat, but are merely the casts of the interior of the original plants, which were plain and smooth externally and not ribbed and jointed.

In our Halifax coal balls we meet with calamites in a perfect state of preservation, and of various sizes, the best preserved specimens being generally small in size, though fragments of larger ones are sometimes met with. A transverse section of a calamite shows that the centre was hollow, except at the nodes, and that the woody cylinder was composed of a number of vascular wedge-shaped bundles of vessels which were arranged in regular radiating laminae.

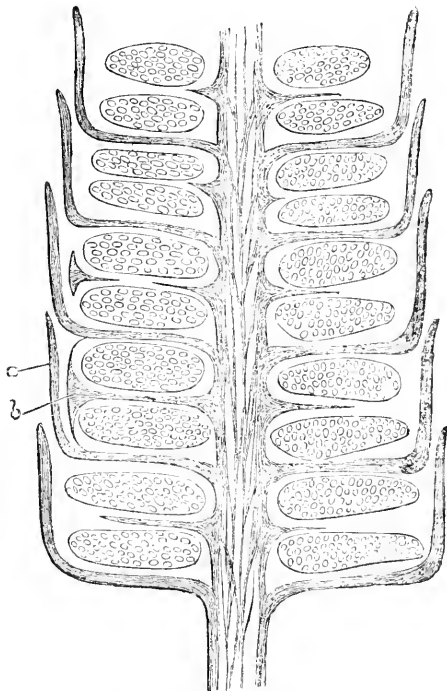

Fig. 135.—Vertical Section of Fruit of Calamite.
(*c*, protective bracts; *b*, peltate scales.)

Each of these wedges terminated at the inner side in a rounded point which was perforated with a hole or canal that extended along each wedge from node to node. This canal is one of the distinguishing features of the calamite. At each node the vessels forming the woody wedges formed a series of arches in such a way that while one portion went to help to form the wedge on the right, the other portion helped to form that on the left. These wedges were generally joined together at their peripheral bases or outside of the woody zone, while the space between each wedge at the inner side was filled with the cellular tissues of the pith, which also formed a thin wall around them, leaving the centre of the plant hollow, except at the nodes where a thin layer ex-

tended across. The stem of a calamite was thus composed of three divisions, viz. bark, woody zone and fistular pith, the most important of these being the woody zone. This zone was formed by a series of woody wedges which varied in number from eleven to sixty or more, according to the size of the plant—the wedges being composed of from fourteen to eighteen laminae or rows of vessels. In transverse and longitudinal sections these vessels closely resemble those of the fossil pines of the coal-strata; the only difference being that in the calamites they are arranged in a different way, and their markings are different, from what obtains in the fossil pines. The nodes were formed by a series of arches which extended across the young plant in a rather complicated manner and gave off the leaves in verticels.

It is generally supposed that the branches were

Sandstone casts of young calamites are very liable to break up into segments at the joints, in digging them out of the matrix. This is owing to the fact that in the young calamites the arches of woody tissue crossing the nodes were thicker and more compact than they appear to have been in the older plants, so that during the process of fossilisation when their interiors became filled with sand or other material and their woody cylinders became converted into coal, a thin layer of coaly smudge was formed between each joint or node, thus preventing that cohesion of the joints which obtains in older plants.

It is very singular that a complete stem of a calamite should be so seldom met with, yet such is the case; not one specimen in a dozen shows any trace of the bark. When it does occur it is seen to consist of a loosely formed parenchyma, and there is

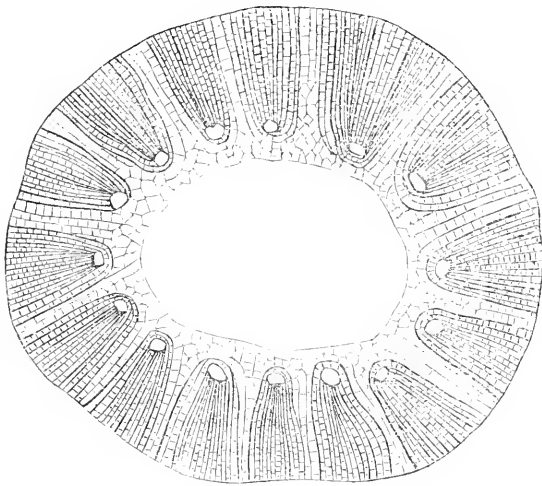

Fig. 136.—Transverse Section of Calamite. $\times 20$ diameters. (From a young specimen in the Author's cabinet.)

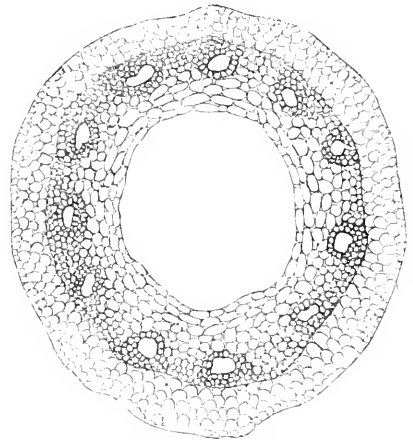

Fig. 137.—Calamite; the young specimen with the bark on. (From the Author's cabinet.)

also arranged in verticels, at each node after the manner which obtains in the horsetails, but recent researches have shown that such was not the case, except in very young plants. The branching took place at the nodes, but probably at irregular intervals, each branch being articulated to the stem, and taking its rise in one of the small orifices at a node, rapidly increased in size in passing through the thick bark, so that upon or shortly after emerging to the surface it was nearly as thick as its parent stem. Some of my sections show this peculiar mode of branching remarkably well. These facts explain the curious appearance of the end of an ordinary calamite, where it begins in a small point and rapidly increases, so that in a few inches it attains its maximum size, while the large number of nodes which are there crowded together in so short a space, show how firmly it was attached to the bark of its parent stem.

no wonder that such a delicate corky structure should be so infrequently preserved in a fossil state. To me it is still more singular, that the smooth hard woody cylinder should have been so rarely preserved as a sandstone or ironstone fossil. It is very probable that the following explanation of this point may be the correct one. "The cast of the interior which in time became harder than the vascular tissues of the stem acted upon as it was by the water that saturated the deposit, resisted more successfully the pressure of the superincumbent deposits, which in compressing the stem produced on its outer surface a counterpart of the furrows and constrictions of the internal cast." ["The Botany of a Coal-mine," by William Carruthers, F.R.S., P.S. Review, July 1876.]

We frequently find sandstone casts of calamites of large diameter—sometimes over six inches. If these merely represented the "casts" of the

interior, then the diameter of the original stem would probably have been from eighteen inches to two feet, and the height from sixty to eighty feet. It is however extremely improbable that the calamite ever attained to these dimensions, and therefore we must seek some such explanation as that afforded by the above theory of Mr. Carruthers. I have a specimen of a sandstone cast, lying before me in my study, which is nearly four inches in diameter. It was about four yards in length when extracted from the quarry, and was incomplete at each end. It did not seem to vary much in thickness in all the four yards of length obtained, and even on the supposition that the specimen represents the original thickness of the woody cylinder, and not merely that of the pith, the plant when living must have attained a height of from forty to fifty feet. But the great majority of calamites found in our coal balls are small plants not much thicker than the stems of our horsetails, though a few are found with stems of from half an inch to an inch in thickness, and occasionally fragments of much larger stems are met with.

As stated above, the real original external form of the calamite was plain and smooth and not ribbed and jointed, as seen in sandstone casts. In beds of shale we sometimes come across them preserved in their original form, but they are generally compressed to a flat ribbon-like form, very difficult to extract, and so uninteresting that few collectors care to have them. I well recollect my first acquaintance with them. Some years ago, during one of my geological excursions to the Yoredale strata of Hebden Bridge, I came across a gang of men engaged in digging a trench for the foundations of a weir across the bed of the stream in Horse-bridge Clough. There was a bed of shale exposed of about nine feet in depth, which was literally one mass of vegetable remains. Ferns in a wonderful variety formed the main bulk of the fossils, but associated with them were a great number of other fossil plants, such as Calamites, Asterophyllites, Lepidodendrons, Sigillaria, Lepidostrobus, &c. This was a great surprise to me, for I had not expected to find such a bed of vegetable remains anywhere outside of the coal-measures, and these Yoredale Strata which have yielded such a large and beautiful group of fossil shells, such as Nautili, Goniatites, Orthocera, Aviculo-pectens, &c., were thus rendered still more interesting on account of the discovery of these vegetable remains. Among the rest of the plants were some very curious objects which took me some time to make out as to what class they belonged; they were long narrow black plant-like fossils which shone like polished ebony, and totally unlike any fossils I had ever before met with. They were of various sizes from a few feet to as many yards in length, and as I stood and watched the men working for some time I saw them lying athwart the bed in all directions looking like, as the men remarked, so many

black fossil snakes. Had they been ribbed and jointed, instead of being plain and smooth, there could have been no doubt of their being calamites, but as it was, they were an enigma that I could not solve. Some time afterwards I came across a similar fossil from the coal-measures, but in this case the black shining coating had been turned into coal, and upon carefully cleaning it off I found underneath the usual ribbed and jointed appearance of a true calamite. I had all along suspected that the curious Hebden Bridge fossils were calamites, and this fresh discovery appeared to confirm that idea.

The calamite in its original state having thus being proved to have been smooth externally, and not ribbed and jointed as seen in ordinary sandstone casts, its supposed affinity to the reeds and horsetails on that ground is valueless. "Yet, it is singular to find," observes Mr. Carruthers, in his lecture on the "Botany of a Coal-mine," "that, after all, the structure of its fruit proves that it really did belong to the family to which at first, though on false observation, it had been referred."

Since the above paper was written, our knowledge of fossil botany has been greatly increased, and the fruit which Mr. Carruthers then so confidently assumed to have belonged to calamites has been shown to have belonged to a different family altogether.

The fruit here referred to was the *Calamostachys Binneyana* of Williamson, who has shown that it is not, and could not have been the fruit of calamites, on account of its solid axis and spirally-arranged leaves. From the triangular form of the axis and other points of agreement, he has further shown that it is the fruit of Asterophyllites or of Sphenophyllum. In his eleventh memoir, "On the Organization of the Fossil-plants of the Coal-measures," quite recently published in the Transactions of the Royal Society, Professor Williamson has described a good specimen of *Calamostachys Binneyana*, found by John Aitken, Esq., in our Halifax material, containing both macro and microspores, the microsporangia occupying the upper, and the macrosporangia the lower part of the strobilus—thus proving most conclusively that this is a true lycopodiaceous fruit. It is well known that the fruit of the modern equisetaceæ has only one kind of spores, and such was also the case with the ancient calamites. Several specimens of the true calamitean strobilus have been found in the Oldham and Halifax coal strata. The structure of this fruit agrees very closely with that of the modern equisetaceæ. It differs from *Calamostachys Binneyana* in having no vascular axis, but has a hollow cylinder, like the stem of a calamite, and has only one set of bracts, which contain the sporangia, and are arranged in verticils.

Many other kinds of fruits besides *Calamostachys Binneyana* have been described as Calamitean, under the names of Volkmania, Huttonia, Aphylostachys, &c., but all these, with the exception of one described

by Professor Williamson, have had solid piths. It is surprising how many of our best palæophytologists have fallen into the mistake of describing fruits with solid axes as calamitean. One would have thought that the knowledge of what obtains in modern equisetaceæ, combined with the well-known fact that there is always a certain correspondence between the structure of the stem of a cone-bearing plant and that of the cone, would have saved them from falling into this error.

Most of our fossil botanists are familiar with the fact, that all cones are only modified forms of the stem and branches. If this be so, then the axis of the cone must be the same in structure as that of the branch of which it is a continuation. If the axis of the stem be solid, such will be the axis of the fruit, and if it be fistular, so will that of the fruit be fistular.

Much controversy has also arisen concerning the leaves of calamites, some authors having described Asterophyllites, Sphenophyllum, Annularia, &c., as such, but we now know that Asterophyllites and Sphenophyllum are quite distinct plants, having a totally different structure to calamites. It is probable that Annularia may have been of calamitean origin, but we have no satisfactory knowledge on that point or of what was the exact form of the leaves.

(To be continued.)

BRITISH ASSOCIATION.

(REFLECTIONS: JUBILEE, 1881.)

BUT fifty years! what wonders rare
Come from the Association chair!
To hear the savants science talk
You'd think the "hub" of earth was York.
Oh, listen to the famed Sir John
The feats of science dwell upon.
Hear how mankind came on the earth,
How bees and flowers had their birth;
Or, how by measure and by rule
We span the tiny molecule.
How through wave trembling atoms light
The optic nerve receives its sight.
And Maxwell's theory that unlocks
The fact that all's atomic shocks;
For not a savant now but raves
From morn to night of heat and waves.
And wondrous nature, what a child!
Has gone mechanically wild.
Ah! men through speculations vain
Can scarce on reason hold the rein,
As oft their instruments they whet,
Most antique knowledge to upset.
For instance, once we held it true
That green was yellow mixed with blue;
But now the "primaries," 'tis said,
Consist of violet, green, and red.

And yellow is—'tis quickly seen—
Composed of—don't laugh—red and green.
The artist that these rules applies
Will really turn out funny skies,
And though the colours may absorb
The rays, he will produce a daub,
Except to those among mankind,
Like Gladstone's Homer—colour-blind.

Nothing is right; we march apace,
Of four dimensions making space.
But if our science is alive,
We need not even stop at five.
"Swallow" is not the word; he "bolts"
Who theorises with Helmholtz.
Can he be wiser than poor poll,
Who calculates the death of Sol?
Or tries to show with figures bold
The shining orb will soon be cold.
Why stop we here? I heave a sigh
At such a simple prophecy.
Why not with figures thus assault
The "bright patines" in heaven's vault?
And calculate—for thus we're taught—
When everything will come to naught.

So fast coal's going! it is dinned
By Thomson we must end in wind.
Oh, surely, he is poking fun,
For have we not in "wind" begun?
Or, is he not himself "a blower"
Of the batteries of Faure?
Though Armstrong thinks them small potatoes
As practical accumulators.

A more exact equivalent
Of heat to find what pains are spent!
How far will have to fall in feet,
One pound for one degree of heat
In water measured? It is true
'Tis seven hundred and seventy-two.
To prove this truth long years were lent
By Joule so much experiment.
We feel as wise as any owl
But wish we could be "check by Joule."

In close relation to the latter
Stands continuity of matter.
We brag that no gas can defy
The chemist's power to liquefy.
E'en atmospheric air they state
Will fluid get by pressure great.
And applications passing cold,
Or other methods quite as old.
Oxygen as oxygen cannot rest
When it's sufficiently compressed;
And hydrogen will follow suit
In storm of pattering hail to boot—
If th'cold reach the "critical point"
At which the gas gets out of joint.

Oh! what improvements can't we boast
 To sum them up—they are a host.
 Why formerly men used to catch it
 From the palæolithic hatchet.
 But now man often proves his right
 By blowing up with dynamite.
 And the acutest form of fun
 Is who shall make the biggest gun ;
 So with cotton, bomb, and ram,
 He still will "lie down with the lamb."
 For in this way he does contrive
 To show who's fittest to survive,
 Exhibiting in full perfection
 Darwin's theory of selection.
 Or Wallace's—not he who led
 The Scotchmen to their gory bed.
 Though sending millions to perdition
 May still be quite a kingly mission.

What is an atom? At a pinch
 'Tis fifty millionths of an inch,
 So small you scarce could ever hope
 To see it with a microscope,
 But is it hard, or soft, or round?
 This is a question too profound!
 Oh! can it like a pea be split,
 Or is it intangible as wit?
 Why of its size make a clatter,
 When none can say "it is matter!"
 For can we even form a notion
 Of anything excepting motion?
 Whatever turn the question takes
 It seemingly must end in "shakes."

Now to geology we turn
 And much from rocks and fossils learn ;
 An animal is served up for us
 Called by Marsh Titanosaurus.
 An awkward customer to meet—
 A centipede—a hundred feet.
 Nor is this all. The missing links
 America has found, methinks,
 In birds with teeth, reptiles with wings,
 And other such cretaceous things.
 The "medals" prove to be no myth,
 You've won the toss, oh William Smith!
 Thus science plays the game of brag,
 Not choosing in the race to lag ;
 But though it oft the "copper" lacks
 It should not stoop to "scratching backs."
 We hold this evident and true,
 So bid the British Ass. adieu. A. CONIFER.

LIST OF ASSISTING NATURALISTS.

[Continued.]

SURREY.

Putney. C. Mills, 4 Stanbridge Road, S.W. *General Natural History*, especially *Microscopy*, *Fossil Life*, and *Aquaria*.

MICROSCOPY.

SPRING CLIP BOARDS.—The accompanying sketch is taken from the spring clip boards I have now had in use for some time, and which for reducing the breakage of thin glass-covers to a minimum, economy of construction, and convenience of moving, far surpass any arrangement that has come under my notice. Mine are made of mahogany, but of course pine or other wood can be used; all, however, should be baked previous to finally planing up. A piece of mahogany 12 in. \times $7\frac{3}{4}$ \times $\frac{3}{4}$; B two strips

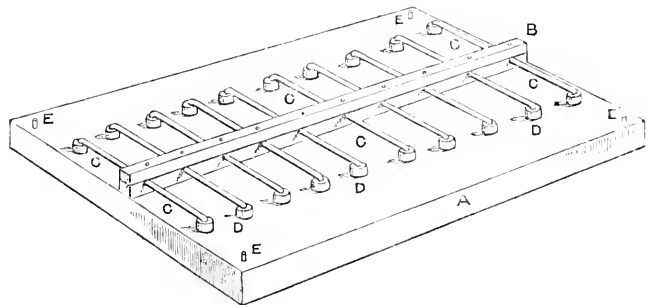

Fig. 138.—New Spring-Clip Board.

\times $\frac{3}{4}$ each securely fastened down centre of base board A by eleven screws; CCC pieces of watch or crinoline steel $3\frac{3}{4}$ long, $\frac{3}{8}$ wide, with hole punched in either end to allow of a small brass pin passing through for securing the pressers: DD small pieces of phial corks; EEEE four screws fitting in corresponding holes drilled in bottom of each board, thus allowing a number to be placed one on the other without injury to the slides, and admitting a free current of air.—*W. Stringfield.*

BUBBLES IN GLYCERINE JELLY.—Your correspondent, Mr. G. H. Bryan, seems to be very unlucky in his mounting with glycerine jelly. I have for some years used this medium, which certainly does require care in use. Regarding the air bubbles, it seems to me that a good deal would depend on the manner of finishing the slides. If a varnish is used which gets soft, acted on by the jelly, air bubbles would appear. I use gold size to finish with, but I am informed that the "brown cement," sold at a shilling a bottle by Edward Ward of Manchester, is a remarkably good finish. If in cleaning the superfluous jelly too much is removed, air will appear. It must be remembered also that glycerine jelly is quickly liquified by an increase in temperature. In every case where "a network of bubbles" has appeared in my glycerine mounts, I have found the gold size has been defective. Slides should now and then be re-coated with gold size.—*Charles F. W. S. Williams, St. John's Coll., Cambridge.*

BUBBLES IN GLYCERINE JELLY.—With regard to Mr. G. H. Bryan's remarks in this month's SCIENCE-GOSSIP, I may say that I have used Deane's gelatine medium for the past two years and always with the best results; in fact, slides made a year ago have not shown any visible change, although they have made several journeys by rail during the time. In mounting, I simply place the bottle containing the medium in a cup of boiling water, and when liquid drop on the object with a pipette, lower the covering-glass carefully, and press out bubbles should they be formed. When cold the superfluous jelly may be scraped off with a penknife under cold water, and the slide finished with a ring of varnish in the usual manner. A short time ago, being unable to obtain Deane's, I tried another maker, with the misfortune of discovering all the objectionable qualities in his preparation which have troubled Mr. Bryan.—*J. D. Butterell.*

MOUNTING IN GLYCERINE JELLY.—A question similar to that of G. H. Bryan, page 208, was asked by one of the members of the "Postal Microscopical Society," in the note-book that accompanies the box of slides of that society. I gave my experience in reply, as follows: "The glycerine jelly (Dean's medium) if overheated during the process of mounting, is very apt indeed to shrink and cause vacuoles; and this shrinking occurs more readily if the object itself be not quite dry. I have had many mounts thus spoilt, but I do not give up the use of the medium, considering that due care is required not to overheat when mounting.—*Henry Basevi, Colonel.*

PARASITE ON HYDRA FUSCA.—I think Mr. F. George has been unfortunate in his selection of a hunting place for *Hydra fusca*, unless he was anxious to find that zoophyte beset with parasites. If the water of the Preston canal resembles that of other canals it cannot be very clean, and the state of the water would at once suggest an impaired state of health of all its inhabitants. The higher forms of life would by analogy suffer most. This would absolutely support the theory of the editors of the Micrographic Dictionary, viz., that the presence of parasites is evidence of impaired or weak health. I think the contaminated state of the water would cause a less robust state of health than is enjoyed by the inhabitants of pure water. It is the same in crowded cities, not directly from the crowding but indirectly from the contamination of the atmosphere. At all events *Hydra fusca* is to be taken here, in ordinary ponds or ditches, more or less entirely free from parasites of any kind. I think also, in answer to the second portion of Mr. F. George's query, that the editors of the Micrographic Dictionary would in all probability be inclined to consider that the absence of the parasites in question would be a fair sign of perfect health in *Hydra fusca*, in proportion as they

believe their produce to be indicative of weak or failing health.—*C. H. Griffith, Stratfield Turgiss, Hunts.*

CLEANING SLIDES.—A number of slides which had been kept in cedar-wood drawers, were rendered useless by a deposit from the wood of resinous matter which thickly coated the exposed surfaces. The edges of the glass covering the object were varnished with asphalt. Failing to find a solvent which would remove the deposit without injuring the asphalt ring, I varnished the latter with a strong aqueous solution of gum arabic. After this had dried, the slides were easily and perfectly cleaned by washing with methylated spirits. The gum arabic was then removed by washing with cold water.—*J. W. Ogilvie.*

MR. THOS. BOLTON'S "PORTFOLIO OF DRAWINGS."—No. 6 of this interesting publication has just appeared. As many of our readers are aware, it consists of a half-yearly collection of the drawings and notes which accompany Mr. Bolton's weekly bottles containing living organisms. As the winter is drawing near, our microscopical readers cannot do better than enrol themselves among Mr. Bolton's subscribers, and thus ensure a fund of intellectual amusement for the long evenings, in the examination of the abundant and interesting material which Mr. Bolton sends out.

"JOURNAL OF THE QUEKETT MICROSCOPICAL CLUB."—No. 47 of the above contains the following papers: "On the Natural History and Histology of Sponges," by B. W. Priest; "On the Periodicity of Filarial Migrations," by P. Manson; "On a Zoophyte Trough, Growing slide, or Live-box," by Rev. H. J. Fase; On "*Cliona ciliata*—does the Sponge make the burrow?" by J. G. Waller.

THE BRITISH BEE-KEEPERS' ASSOCIATION AT SOUTH KENSINGTON.—At the meeting on July 26th, for the best microscopic slides illustrating the natural history of the honey bee, Mr. F. Enock was awarded the silver medal. The slides were four dozen in number, and the preparation of parts *in situ* without pressure gave an opportunity of examining structure that flattened chitine could not afford. The beauty of these objects is very great. On some slides Mr. Enock brings side by side the homologous parts of drone, worker and queen, which gives a ready means of comparison, and on others displays the parts illustrative of the complete anatomy of the insect. Some sections and some specimens of the interesting parasite *Stylops Spencii* were included in the collection.

DEUTZIA SCABIA.—I think "Beginner" will find Liquor Potasse the best to boil these in. It readily mixes with balsam. I have tried it and found it satisfactory.—*John Alex. Ollard.*

ZOOLOGY.

CORMORANTS INLAND.—It may be worthy of recording that, on Wednesday, the 24th of August, a cormorant established itself for some time on a pond in the grounds of Mr. Montague Williams, at Woolland, near Blandford, and, when it moved, appeared to fly still further inland. Woolland itself is, by the ordnance map, sixteen and a half miles from the sea, as the crow flies. The following day, perhaps I need scarcely remind your readers, was one of exceptional rain and storm, even in this ungenial and blustering season. In my long experience I do not know that I ever chanced to see one of these birds so far from its marine haunts.—*C. W. Bingham.*

THE LESSER RORQUAL (*Balaenoptera rostrata*, Fab.).—A young female specimen of this whale was captured near Fraserburgh by some fishermen on the 19th of August, having got entangled in their nets. It was afterwards exhibited for a few days in Edinburgh, where I saw it twice, when the following notes and measurements were taken:—

	ft.	in.
Total length	14	2
Greatest girth	5	5
Length to tip of dorsal fin	10	7
Height of dorsal	0	6
Tip of dorsal to end of tail	3	7
Breadth of tail, tip to tip	3	7
Length to back of gape, along outer curve of mandible	2	9
Length to orbital opening	2	8½
Length of orbital opening	0	2
Length to blow-holes	1	10

The head slopes gradually downwards to the front of the jaws, at the same time narrowing sideways, so that it is of an oblong, somewhat triangular form. The baleen is about half an inch long at the front of the jaw and gradually lengthens to about the inward bend of the mandible, where it is five and a half inches long, after which it quickly shortens. It extends two feet nine inches along each side, and its numerous plates form a beautiful screen, yellowish-white in colour, and split into a hair-like fringe along their under margins. The lower jaw is much larger than the upper, and forms a capacious triangular trough, the sides of which are formed by the jaw-bones, and slope upwards and outwards. Consequently when the animal's jaws are closed, a hollow space, such as is formed between the base of a teacup and the edge of its saucer, extends along each side of the mouth, gradually widening and deepening from the front backwards. The blow-holes are two longitudinal openings in the forehead, with a furrow between them. They are five inches long and have their back ends curved outwards. The flippers are two feet two inches long, measured along their outer margin. A white band extends one foot one inch along each, the rest being black. Their greatest breadth is eight inches. The animal is black above and white beneath, with the throat and belly furrowed. When

I first saw it the fore part of the body was slightly inclined to the left side, so that I was enabled to ascertain its girth by measuring the right one; but I neglected to note the length and number of the furrows, and when next seen there was no opportunity of doing so, as the animal was exhibited resting on its belly. For the same reason the sex is given on the authority of the exhibitor. The white colour on the under parts of the body is nowhere so high as the flippers, except for about one foot behind them. There, beginning at the flippers, it rises and descends with a gentle curve, the highest part of which is four inches above them. I had no difficulty in identifying the species from Mr. Southwell's description, the white band on each flipper, and the yellowish-white baleen, being characteristics about which there could be no mistake.—*David Douglas.*

ALTERNATION OF GENERATION IN INSECTS.—It has been shown that the common cynips, or gallfly is also a case in point. It had long been known that in some genera belonging to this group males are entirely wanting, and it has now been shown by Bassett, and more thoroughly by Adler, that some of these species are double brooded; the two broods having been considered as distinct genera. Thus, an insect known as *Neuroterus lenticularis*, of which females only occur, produces the familiar oak spangles so common on the under sides of oak leaves, from which emerge, not *Neuroterus lenticularis*, but an insect hitherto considered as a distinct species, belonging even to a different genus, *Spathegaster baccharum*. In *Spathegaster* both sexes occur, they produce the currant-like galls found on oaks, and from these galls *Neuroterus* is again developed. So also the King Charles oak-apples produce a species known as *Teras terminalis*, which descends to the ground, and makes small galls on the roots of the oak. From these emerge an insect known as *Biorhiza aptera*, which again gives rise to the common oak-apple.—*Sir John Lubbock's British Association Address.*

COCCUS VITIS VINIFERÆ.—Can any of your numerous readers inform me whether the coccus vitis viniferæ (Linnaeus) so accurately described in White's Selborne (Letter 53 to Mr. Barrington) is of common occurrence in England now? White mentions it as being most uncommon. I observed it a year or two ago on a vine at Blackheath, and some time after came across White's description, from which I recognised this insect at once.—*C. F. Worters.*

SCARCITY OF WASPS.—I do not remember a season when wasps were so scarce as the present, although in May there seemed fully as many queens out as in preceding seasons, and I destroyed a goodly number. About the middle of June I destroyed a nest containing only the queen and eight or ten weakly young ones just emerged from the pupa, and I have not seen a single wasp since. I

have only heard of one other nest in the neighbourhood. I think the heavy rains we have had during spring and summer will have had a deal to do with this scarcity. I am sure, I shall be the last to grumble at the non-appearance of these troublesome pests, for last year they were a perfect nuisance, both amongst the fruit and in the house, for every "meal-time" we had a regular battle with them for our food. Five years ago wasps were unusually abundant with us, and I destroyed over thirty nests within a radius of three hundred yards from the house, without making any very marked diminution in the numbers which came into the house whenever doors or windows were opened. This puzzled me until a lady friend accidentally discovered an enormous nest suspended amongst the topmost branches of a large yew-tree near the house. Little time was lost in fetching out my gun, and a couple of discharges of small shot speedily brought the nest tumbling to the ground—and then we had peace.—*R. Standen, Gosnargh, Preston, Lancashire.*

"THE BUTTERFLIES OF EUROPE."—By H. C. Lang, M.D., F.R.S. London: L. Reeve & Co. We have received Part III. of this beautifully got up work, which we regard as the best of its kind yet brought before the notice of entomologists.

"GARDEN PESTS AND THEIR ERADICATION."—Under this title a shilling *brochure* has just been published by L. Upcott Gill, 170 Strand. We cordially recommend it as dealing ably with all kinds of insects, &c. The numerous illustrations render the identification of garden pests all the easier.

THE WORK OF LOCAL SOCIETIES.—The Norfolk and Norwich Naturalists' Society.—Part II. vol. iii. of the Transactions of this well-known society is published, containing the address of the President (Mr. J. H. Gurney, jun.), and a paper by the same on "The Spring Migration of Birds at St. Leonards;" others on "The Extinction of Species by the indirect acts of Man," by Mr. Thos. Southwell, F.Z.S.; on "The Fungoid Diseases of Cereals," by the Rev. J. M. Du Port; on "Norfolk Names derived from those of Animals, Birds, and Plants," by W. H. Bidwell, &c. The ninth annual report of the Lambeth Field Club has been issued, showing that eighteen papers on subjects connected with botany, geology, &c., were read last year, and giving a list of those to come in during the ensuing winter. The Report and Transactions of the Penzance Natural History and Antiquarian Society for 1880-81 contains a well-written account of the excursions; a valuable paper on "Cornish Antiquities viewed in the light of Modern Research," by W. C. Borlase, M.A.; another on "The Fungi of West Cornwall," by John Ralfs; a careful paper (with lists of species) on "The Thysanura and Coleoptera of the Land's End District," by E. D. Marquand, &c. The Croydon Microscopical and

Natural History Club have also published their Proceedings and Transactions down to January 19th, 1881. The contents are varied, and include papers by Mr. John Flower, E. Lovett, Dr. A. Carpenter, a very ably drawn up "Botanical Report," &c., all of which indicates healthy scientific activity. Part III. vol. iv. of the Proceedings of the Liverpool Geological Society is to hand, containing the address of the President (Mr. William Semmons); papers on "Split and other Boulders," by Dr. C. Ricketts; the "Carboniferous Limestone of Gower compared with that of North Wales," by G. H. Morton, F.G.S.; "Worked Flints of the Raised Beaches on the north-east Coast of Ireland," by F. Archer; "On the Southern Drift of England," by T. M. Reade, F.G.S., &c. The Proceedings of Bristol Naturalists' Society, Vol. III. Part I. includes the following papers: "Some New Optical Illusions," by Professor S. P. Thompson; "Underground Temperature," by E. Wethered; "Life History of a Sponge," by Professor Sollas; "Proliferation in *Cyclamen Persicum*," by Adolph Leipner; "Catalogue of the Lepidoptera of the Bristol District," by A. E. Hudd, &c. &c.

NORWICH NATURALISTS' SCIENCE CLUB.—Under this name a number of young men have banded themselves together for mutual help and encouragement in natural science. We heartily wish them success.

BOTANY.

"RAMBLE ON THE LECKHAMPTON HILL."—In his interesting note of a ramble on Leckhampton Hill, Mr. Harris speaks (Sept. No.) of finding *Gentiana*, &c., with *Campanula rapunculus*. I have myself found the plants he names growing on the hill in company with *Campanula glomerata*. It occurred to me he might have mistaken this for *rapunculus*, but I should be glad to know if he really found the latter there, as I do not know of any locality for it in this district. I quite sympathise, as all botanists must, with his complaint of extermination of rare plants by mercenary collectors. Perhaps the best remedy would be to induce the landed proprietor (if he takes any interest in the matter) to prosecute a few of these spoliators. A wholesome fine or two would do much to stop them.—*A. D. Mevin.*

VARIETIES OF MOUNTAIN ASH.—Can any botanist inform me how many varieties there are of the mountain ash or rowan-tree (*Pyrus* or *Sorbus aucuparia*)? as there are three distinct varieties growing in this locality. Hooker and Arnott's "British Flora" only mentions one.—*Rev. S. A. Brennan.*

THE COLOURS OF SPRING FLOWERS.—Dr. A. W. Bennett, in a paper on this subject read before the British Association, said every one must have noticed

the variations in the predominance of our wild flowers as the season advanced from spring to summer and autumn. In our hedge-banks the pure white of the larger stitchwort and "Jack-by-the-hedge" gave way to the bright blue of the speedwell, and then to the reddish-purple of the black horehound and the various shades of the mallows. In our meadows the golden yellow buttercups were gradually replaced by the pink of the sorrels and ragged robins, and then by the yellow ragwort and purple knapweed. Our river-sides were gay in the early spring with the golden marsh marigold, in the early summer with the yellow flag, in the later summer with the purple loosestrife. The bright scarlet of the poppies and the pimpinell only appeared in the ripening corn. The blue campanulas, the bright yellow St. John's-wort, the purple heather do not brighten the landscape till the summer is in its prime, when the green or inconspicuous flowers of the hazel, the elm, the oak, and nearly all our timber trees have long since passed away. He did not know, however, whether any attempt had ever been made to reduce those facts to a general law. Out of a total of 64 species he found in the list 26 white, 9 green, 13 yellow, 5 red or pink, and 11 blue and violet. He had not been able to prepare a list of our common summer and autumn flowers, but, even without that, there were a few striking points. There was for instance a very great preponderance of white flowers, which was not the case at any other time of the year; yellow was also greatly in excess, compared with other seasons; and the number of red and pink flowers was extremely small. It was obvious, therefore, that if the excluded natural orders were restored, the plants belonging to them being mostly inconspicuous green or brown flowers while some had bright yellow anthers, the proportion of red and blue in particular would be greatly diminished. Comparing those results with the spring flora of Switzerland, although difficulties in the way of any exact enumeration were very great, he found that out of 50 species 18 were white, 1 was green, 10 were red or pink, and 8 blue or violet. In endeavouring to arrive at any general conclusion for these data, it should be borne in mind that the two colours, white and green, stood on a different footing from all the rest, and might be regarded as an indication of the absence of colour. With regard to yellow, he found an exceedingly interesting observation by M. Flahaut, that "a solid insoluble pigment, the Xanthine of Frémy and Cloëz, is in the first place to be distinguished from all the soluble colouring matters—blue, yellow, red, and their mixtures—all of which are acted on very readily by reagents, and which are usually formed only in epidermal cells." The difference between the prevailing spring flowers in England and in Switzerland seemed to him to be due to the same cause. Owing partly to the spring being a month later, partly to the more southern latitude, and consequent greater elevation of the sun, partly to the clearer

air of a high altitude, the light which opens the earliest spring flowers is much stronger in Switzerland than in England.

THE BOTANICAL EXCHANGE CLUB.—The Report for 1880 is of great interest to botanists, in spite of the smallness of the number of specimens sent. Among the Orkney plants is a new variety, *Ruffia rostellata*, var. *nana*, Boswell.

THE FLORA OF MICHIGAN.—Messrs. C. F. Wheeler and E. F. Smith have compiled a most valuable work, entitled "Catalogue of the Phænogamous and Vascular Cryptogamous Plants of Michigan: Indigenous, Naturalised, and Adventive." The paper was originally prepared for the Michigan Horticultural Society.

MRS. E. EDWARDS.—We regret to have to announce the death of this accomplished lady, whose papers on botanical subjects, and "notes" in other parts of our volume, have been familiar to our readers for many years past.

VICIA TETRASPERMA.—It may interest your Scotch and other readers to know of this vetch having been found by me growing last month in the outskirts of Aberdeen, indicating a more northerly range for the plant than mentioned in Hooker's Flora.—*Alexander Somerville, 11 South Park Terrace, Hillhead, Glasgow.*

GEOLOGY.

DISCOVERY OF FOSSIL FISHES IN THE NEW RED SANDSTONE OF NOTTINGHAM.—Mr. E. Wilson, F.G.S., read a paper on the above subject in section C, British Association. The paper stated that the discovery was of great rarity. It was also observed that during the construction of the Leen Valley outfall sewer in 1878, a remarkably interesting section was given by the tunnelling driven through Rough Hill, or Colwick Wood, near Nottingham, showing the lower beds of the Waterstones resting on a denuded surface of "basement beds" of the Keuper. The lowest stratum of the Waterstones was a sandstone about a foot thick, with streaks of red and green marl, and a seam of pebbles at the base. The fishes occurred in this bed, and chiefly in a thin seam of red marl, overlying the pebbly seam at the very bottom of the "Waterstones;" they were present in large numbers, as if in a shoal, for a distance, in the line of section, of about 33 feet. The specimens obtained had been examined by several competent authorities, but unfortunately their state of preservation is so bad that nothing certain can be made out as to their precise zoological affinities. Dr. Traquair, however, believed that they probably belong to some species, new or old, of the genus *Semionotus*.

ABUNDANCE OF MESOZOIC ANIMALS IN THE WESTERN TERRITORIES OF AMERICA.—Professor Huxley, in his address before the British Association at York, stated that Professor Marsh had informed him that, within two years, remains of more than one hundred and sixty distinct individuals of mammals, belonging to twenty species and nine genera had been found in a space not larger than the floor of a good-sized room; while beds of the same age have yielded three hundred reptiles, varying in size from sixty or eighty feet to the dimensions of a rabbit.

JURASSIC BIRDS AND THEIR ALLIES.—Professor O. C. Marsh (Harvard University, U.S.) delivered a lecture on "Jurassic Birds and their Allies" before the Biological section of the British Association. Just twenty years ago, he said, two very important fossils were discovered in the lithograph slates of America, one of which was the *Archæopteryx*, now in the British Museum, and the other the skeleton of *Consummatus*, preserved in the Royal Museum, Munich. He gave an elaborate explanation and description of the different points of interest observable in the two specimens. In the course of his remarks he referred to a work which he had recently published on the teeth-birds of America, and in which he had endeavoured to throw some light on the origin of birds. If, however, asked to state the difference between a bird and a reptile he should be puzzled to explain the difference, for if the bones of each were crushed and scattered together as they found them, it would be extremely difficult to say which was the bird and which the reptile. That he held to be a point of importance, and one which naturalists who had been engaged on *Deinosaurs* would fully appreciate. It appeared to him that feathers might have played a very important part in the transformation of the reptile into the bird. When they came to consider the four oldest known birds, they found them to be as distinct from each other as any of the birds of the present day. That fact of itself, therefore, showed that in order to get at the origin of birds they would have to look further back in the history of the world.

FOSSIL CORALS.—A capital paper by Mr. James Thomson, F.G.S., has just been published, accompanied with very beautiful illustrations, on "the genus *Atricolites*, *Amplexus*, and *Zaphrentis*," from the carboniferous system of Scotland.

PROCEEDINGS OF THE GEOLOGISTS' ASSOCIATION.—No. 2 of vol. vii. is to hand, containing papers by Professor Bonney on a "Proposed Classification of Rocks," and the "Formation of Basalt;" "Notes on the Microscopical Structure of Basalt," by J. Slade; "A Geological Trip in Colorado," by S. R. Pattison; and descriptive of various excursions to places of geological interest.

NOTES AND QUERIES.

AERIAL DISTURBANCES.—About four o'clock on Saturday afternoon, the 23rd of July, a remarkable aerial disturbance passed over this district, sweeping along the ground for the space of a furlong in length, and about thirty yards in width. About a mile S.W. by S. and S.E. of Pomeroy there was a sound like that of the noise of a number of railway trains as it were running in the air! As the disturbance passed over the townland of Gortnagarn, cut turf was lifted out of the bogs and carried in the air. Some large pieces of bog timber were lifted, and thrown with great force against the turf banks, the water was scooped clean out of a flax steeping-hole in the townland of Killeagh, the wooden roof of offices at the farm residence of Mr. Reid, and almost all the roofs of Mr. Noble's houses in the same townland were lifted. In the townland of the Bawn a wooden house was taken clean away from the residence of Mr. Trimble, the timber and boards were hurled in the air, then let down like a shower mostly in pieces. There seemed to be a violent commotion in the air as a smoke went up as from the chimney of a factory. Many people who saw it thought it was the end of the world. Torrents of rain fell on either side, while the sun was shining strangely bright sparks of fire issued from the column of smoke, a man felt so scorched that he had to flee for his life, and a boy was carried off his feet for some distance. No doubt some of your readers will explain this apparent electrical disturbance, and oblige your subscriber from the commencement of SCIENCE-GOSSIP.—S. A. Brennan, Pomeroy, co. Tyrone.

METEORIC DUST.—I notice in a recent number of SCIENCE-GOSSIP, an interesting summary of Professor Jacchini's researches on the meteoric dust of the sirocco. His conclusion that it is transported by a cyclone from the Sahara is certainly novel, and it will be legitimate if it can be shown that metallic iron, oxide of nickel, &c., are constituents of the sand of the African desert. M. von Lasaulx, the eminent mineralogist, has recently examined the Sicilian dust, and also some found in the snow near Kiel. The former was found to consist of argillaceous particles, quartz splinters and granules, calcite, gypsum, metallic iron, plagioclase, augite, olivine, and microcline, the particles of the four last substances being very few. The latter contained quartz, red and yellow argillaceous particles, feldspar, mica, hornblende, magnetite, and some dark particles which were not attracted by the magnet, and which gave a manganese reaction. The only constituent of both these dust-masses which need be referred to a cosmic origin is the metallic iron, and M. von Lasaulx is of opinion that the iron might arise from terrestrial sources. Hence he concludes that atmospheric dust is simply detritus. Dr. Reichenbach, of Vienna, has shown that the dust which covers the tops of mountains contains nickel, cobalt, phosphorus, and magnesia, so this detritus would seem to impregnate the atmosphere throughout its whole mass. But if we adopt the conclusions of M. von Lasaulx, it seems to me that the origin of *ærolites* becomes wrapped in more impenetrable mystery than ever. Are we to revive Playfair's theory, or rather a modification of it, and assume meteoric stones to be masses of atmospheric dust consolidated by some electric action? Or shall we go back still further, and discover in the writings of Aristotle the true explanation of the phenomenon, that the masses are raised by the wind?

Doubt regarding the source of meteoric dust has only arisen since Professor Laurence Smith, and others proved the Orifak iron to be of terrestrial origin, and I venture to say that it is scarcely philosophical to base deductions concerning the origin of dust which is precipitated in all quarters of the globe, upon the evident source of a few isolated masses found in one spot only. The fact of the Greenland iron being telluric does not prove meteoric dust to be telluric also, nor even terrestrial. Indeed, the composition of the former offers direct proof of its dissimilar origin to the latter. Dr. Smith states that all the iron obtained from Greenland contains combined carbon, while meteoric iron has none. I therefore think that, as Jacchini and Von Lasaulx have rested their conclusions upon the assumption that the Orifak iron is of meteoric composition but terrestrial origin, and that assumption is false, the presence of iron particles in atmospheric dust must still be referred to a cosmic source. The argillaceous and other particles may be merely detritus; but the iron particles cannot be so. See "Comptes rendus," lxxxvii. 911, "Annales de Chimie," for April, 1879, "Geographical Magazine," 1871, p. 570, "Quarterly Journal Geological Society," vol. xviii. p. 44, and for Daubrie's Papers, "Comptes rendus," lxxiv. 1541, and lxxv. 240.—*J. A. Westwood Oliver, Athenaeum, Glasgow.*

THE HOLLY-FERN IN HEREFORDSHIRE.—How is it that in no botanical works I have seen, is Hereford or Monmouthshire named as a locality for the holly-fern? When visiting some few years ago at a friend's house about four miles the Herefordshire side of the town of Monmouth, I found it growing pretty plentifully in a lane between Welsh Newton and Llanrothal; also in another lane leading out of Welsh Newton, but there only in one spot. I brought away several plants, one of which I gave to a friend who has a large collection of ferns; my others died. I am not confusing this with *Polystichum aculeatum*, which also grows in abundance in that neighbourhood and which I know well.—*Fanny Bryan, Cambridge.*

THE FERN CAVE AT MATLOCK.—A recent visit to Matlock was singularly corroborative of a correspondent's lamentation as to the extinction of our rare ferns. In the streets were plenty of baskets containing the common species; but in none of these appeared *Cystopteris fragilis*, probably on account of its general eradication in the neighbourhood. The rocks on the High Tor, rent asunder as by a magician's hand, are well suited for fern growth; but we saw at first only a few specimens of *Asplenium Trichomanes*, *Asplenium Ruta-muraria*, and *Polypodium vulgare*. A board pointed to the Fern Cave, and one wondered where the ferns could have existed free from destruction. Entering its narrow, gloomy and fortunately lofty defiles, the mystery was explained. High up, and alike unattainable from above and below, were lovely fronds of *Cystopteris* and other fine ferns, tantalising to the sight; but pleasing to the thought that they would be able to retain their native beauty.—*F. H. Arnold.*

OUR "LIST OF ASSISTING NATURALISTS."—The following statistics of the numbers of assisting naturalists in various branches, in the recent lists in SCIENCE-GOSSIP, are very significant. Botany, total 52; 23 are marked "botany," which probably generally includes phanerogamia; besides this, phanerogams 24; cryptogams 16. Almost all specialists include: ferns 4, mosses 4, hepaticæ 2, fungi 5, algae (freshwater and marine) 4, diatoms 1. Geology 19; mineralogy 3, microscopy 12, general natural history 5.

Zoology, total 35; of which we have mammalia 6, ornithology (principally oology) 14, reptilia 4, amphibia 2, mollusca 9, arachnida 2, entomology 13 (lepidoptera 9, coleoptera 2, diptera 1), infusoria and pond life 2, polyzoa, zoophytes, and foraminifera, each 1. Now, sir, if we take half of those marked "botany" as phanerogamists (and I am sure this is far within the mark), we shall have thirty-five persons all willing to assist beginners in determining the names of wild flowers, a thing easily done by the aid of one of the many (perhaps too many) British Floras, some of which are very easy and cheap. Besides, the list of books published in SCIENCE-GOSSIP in 1879 would enable a beginner to choose his book. On the other hand, we have arachnida and coleoptera each represented by two assisting naturalists, lichens, diatoms, diptera, infusoria, zoophytes, polyzoa, foraminifera, &c., by one; hymenoptera, neuroptera, hemiptera, orthoptera, desmidiaceæ, and many others by none. But these are just the subjects where most help is needed; for the books on them are few and expensive, their language often unintelligible to a beginner, while the most valuable information is contained in various "Proceedings" and "Transactions" where it is often very difficult to find, and too often drops into oblivion. Another example may be found from the fact that of the nine lepidopterists several make "macros," and "butterflies" their speciality, but none the "micros."—*G. H. Bryan.*

SCARCITY OF WASPS.—Up to the present time in this part of Somersetshire and parts of Wiltshire there has been a great scarcity of wasps, as your correspondent has observed in Reading. Last year they were very numerous with us. Large numbers of nests were destroyed; may this not have something to do with their scarcity this year? Gilbert White tells us that though the summers of 1781 and 1783 were unusually hot and dry, yet in the former years they had not any wasps, while in the latter there were "myriads," and from this he points out that though wasps only abound in hot summers yet they do not do so every hot summer. (See White's Selborne, page 309, edited by J. E. Marting, F.Z.S., second ed. 1876.)—*Charles F. W. T. Williams, Bath.*

QUEEN AND WORKER WASPS.—It has been noticed by several in this district that there was an extraordinary abundance of queen wasps in the spring, and until the late rains a great scarcity of workers. Can any of your readers inform me whether this is due to the exceptional dryness of the early summer months or to what other reason they attribute it?—*S. Burlingham, Hitchin.*

SCARCITY OF WASPS.—I have not seen a wasp in this locality up to the present date, although in the early spring the queen wasps were very numerous. I killed a hundred and fifty at that season, and numbers must have escaped. Last summer they were a perfect plague.—*S. A. Brennan, clerk, Allan Rock, co. Tyrone.*

HAIR BELL OR HARE BELL.—Having noticed in "Flora Hertfordiensis" (Flora of Hertfordshire, published about 1850) that the editors spell this name hare bell, and apply it to *Hyacinthus non-scriptus*, and that other authorities spell it hair bell and apply it to *Campanula rotundifolia*, I was interested in the notes which recently appeared in SCIENCE-GOSSIP on this subject. Where authorities thus differ it is scarcely worth while to dogmatise, but under such circumstances something may generally be allowed

for the probabilities of the case. Assuming that the name should be spelt hare bell and applied to *Hyacinthus non-scriptus*, it may be remarked that the latter is not a campanula, or bell-flower at all, though often called "blue-bell." If to this it be replied that our wild-flowers received their popular names first, and their botanical classification afterwards, it should also be borne in mind that to apply the name in question to *Hyacinthus non-scriptus* would leave the genuine little bell-flower (*rotundifolia*) in the anomalous position of having no popular name, excepting perhaps that of heath-bell which is sometimes applied to it. On the other hand if we assume that the name should be spelt hair bell and apply it to *Campanula rotundifolia*, we at once satisfy the demands of botanical accuracy and of the fitness of things, for the application of hair bell to the slender, fragile little flower which adorns our heaths and dry pastures, is as singularly appropriate as it is the reverse if applied to the stout, succulent wild-hyacinth.—*A. Kingston, Royston, Herts.*

FLUKE OR LIVER-PLAICE (*Distoma hepatica* or *Fasciola hepatica*).—Can any of the readers of SCIENCE-GOSSIP tell me the scientific name of the embryo of the fluke? In the spring of 1880, all the water-snails (*Limnaea stagnalis*) which were brought from the river for my aquarium had their heads covered with fluke in a certain stage of development, but those brought me this spring, 1881, and I had several lots, were entirely free. I can only account for this by this spring being particularly dry, whereas that of last year was quite the reverse, for we had water more or less out in the marshes between Canterbury and Grove Ferry as late as the end of June. Any information respecting the fluke will be acceptable to myself and many others.—*Clara Kingsford.*

NOTICES TO CORRESPONDENTS.

TO CORRESPONDENTS AND EXCHANGERS.—As we now publish SCIENCE-GOSSIP earlier than heretofore, we cannot possibly insert in the following number any communications which reach us later than the 8th of the previous month.

TO ANONYMOUS QUERISTS.—We receive so many queries which do not bear the writers' names that we are forced to adhere to our rule of not noticing them.

TO DEALERS AND OTHERS.—We are always glad to treat dealers in natural history objects on the same fair and general ground as amateurs, in so far as the "exchanges" offered are fair exchanges. But it is evident that, when their offers are simply disguised advertisements, for the purpose of evading the cost of advertising, an advantage is taken of our *gratuitous* insertion of "exchanges" which cannot be tolerated.

B. E. DAWSON (Brixton).—The best book is Sowerby's "British Grasses," with coloured plates of every species, published at one guinea. Apply to D. Bogue, 3 St. Martin's Place, Trafalgar Square, London.

A. CORLETT.—The leaves of the oak-trees you mention were no doubt attacked by the larvæ of *Tortrix viridana*.

A. W. PATCHING.—The insects were a species of gnat.

T. MCGANN (Gortaclare).—Many thanks for the slides, which we consider are excellent examples of mounting.

B. W. WARD.—The object you gave us a rough sketch of is very common in fresh water. It is a species of Nais.

G. ROBERTS.—Please send us other specimens of the plants. The former were mislaid.

T. PEARSON.—Landsborough's "British Seaweeds" (with coloured plates) is a capital book for a beginner. A good work on the same subject is published at the "Bazaar" newspaper office, written by Mr. W. H. Grattan. See paper by this latter gentleman in "Collecting and Preserving Natural History Objects," published by D. Bogue, at 35. *Ed.*

A. G. DAVIDSON.—Your box was smashed when it reached us, and not a trace of a shell was visible.

W. RATCLIFFE.—We have no doubt whatever from your sketch that your large moth is the meadow tiger (*Arctia caja*). The eggs on the herring were very probably those of some crustacean parasite.

H. C. BROOK.—Accept our best thanks. Send us the hairs for mounting; also write out a full description of the frog and the glowworm for insertion.

J. TEMPERE.—Apply to Mr. W. Shrubsole, F.G.S., Sheerness-on-Sea.

N. T.—The small fragment of carboniferous lime-stone contained a fossil coral called *Lithostrotion junceum*.

W. B. MASON (Bolton).—The insects enclosed in a small bottle, and which were found in a garden after a heavy shower of rain, belong to order Thysanurida, and are called *Achorutes purpurascens*. See SCIENCE-GOSSIP for January 1873, for figures and description of the same.

W. S.—A description of Faure's battery was given in "Nature," and also, we believe, in the "English Mechanic."

A. WALLER.—We shall be very pleased indeed to have your notes on botanical folk-lore.

D. DOUGLAS.—Accept our best thanks for your beautifully mounted specimens of male Anacharis, which reached us quite safely.

J. WILSON.—Your plant is a *Lycium barbarum*, and it belongs to the Solanaceæ. It is very common in the hedges and about cottages in the eastern counties, and generally goes by the name of the tea-tree. It is a native of Asia Minor, hence its generic name.

EXCHANGES.

SEVERAL slides of diatoms (fresh and salt water) offered for other diatoms, foraminifera, or spicula, or entomological or botanical desiderata.—**G. H. Bryan**, Trumpington Road, Cambridge.

WANTED, 23, 194, 1042, and others, for 1132, 1212, or other rare plants. Lists exchanged.—**C. A. O.**, Lyndhurst Cottage, Lyndhurst Road, Worthing, Sussex.

FOR a second-hand bicycle, 54 or higher, or tricycle, thirty-four volumes on geology, &c., also sixty fossils and characteristic rocks (bloodstone, Iceland spar, &c.), Harting's "Subterranean World," "Popular Recreator," "Transformations of Insects," "Advanced Text Book of Geology," "Geological Terms," &c., to the value of £115 ss. List on application.—**F. S. Atkinson**, Thornbury House, White Cross Road, Hereford.

WILL send six nicely-mounted palates (various) for a bulb of crown-on-crown imperial lily, which bears two tiers of bells. Write first to **J. Turner**, Davenport, Stockport.

EXCHANGE Reade's "Diatom Prism," large stage forceps, do. mineral holder, stage condenser, micrometer 1½ inch in brass cell, 3 English objective, wide angle with collar adjustment, for first-class microscope slides, or offers.—**J. L. Mitchell**, 6 Mansfield Place, Edinburgh.

PRESSED specimens of *Feltia andromedaefolia*, *P. ornithopus*, *Gymnogramme triangularis*, from the Santa Cruz Mountains, in exchange for British ferns, shells, or other curiosities.—**J. E. Reed**, Wrights, Santa Clara Co., California.

STAINED leaves, botanical, anatomical sections, echinodermata, wings exotic lepidoptera, micro fungi, and all classes of microscopic objects.—**Fred. R. Martin**, Clevedon.

WANTED, volumes of "Notes and Queries," "Descent of Man," "Origin of Species," or other of Mr. Darwin's works; also Yarrell's or Macgillivray's "British Birds," Sir John Lubbock's work on "Fertilization," Wilson's "Synopsis of British Plants," and Hudson's "Flora Anglica." Other books, or well-mounted botanical specimens in exchange.—**Jno. Watson**, Institution, Old Trafford, Manchester.

A NUMBER of micro slides, marine algae, principally with parasitic diatoms *in situ*, beautifully mounted in balsam, illustrating many species; also a varied and interesting collection of prepared material, mostly marine, as well as some fine M. algae on paper. Will exchange for photo apparatus, lantern and micro slides, if very good, or cash, &c.—**T. McGann**, Burren, co. Clare.

WANTED in exchange for *Gentiana pneumonanthe*, *Scilla autumnalis* and *Erycastrum polyctii* (a newly-discovered plant at Saffron Walden, Essex), any good offers of British plants or lepidoptera.—**C. E. Stansfield**, 20 Bootham, York.

Zonites alpinus, *Ulinius decollatus*, *Helix candidissima*, *H. vermiculata*, and a few other shells, also some good butterfly flies. Wanted good lepidoptera.—**T. C. Hedley**, 3 Hyde Gardens, Eastbourne.

WANTED, fresh roots of *Polygonum Fistortii*, *Corallorrhiza innata*, *Pelargonium triste* and *Cyclamen Eurocarum* for herbarium. Cash or exchange. **S. B. Axford**, 15 Commercial Road, Bournemouth.

PARASITES prepared ready for mounting. The tick of sheep, horse, and dog, also fluke from sheep, one of each sent for a good mounted slide.—**Alfred Tozer**, Jackson's Row, Manchester.

WANTED specimens (in spirits preferred) of myriapods from any locality.—**T. Carmichael**, Castlecragh, Dolphinton, N.B.

WANTED to exchange SCIENCE-GOSSIP 1876, 1877, 1878, unbound, "The Collectors' Handy-book," by Johann Nave, and "Selection of Eatable Funguses of Great Britain," by Hogg, for "The Variation of Animals and Plants under Domestication," by Darwin.—**Thomas Hebden**, Hainworth, near Keighley.

DIATOMS, *Gomphonema geminatum*. A splendid pure gathering of this large diatom (in spirits). One ounce bottle exchanged for twelve best quality microscopic slides. Sample tube for three good slides. J. Lillie Mitchell, 6 Mansfield Place, Edinburgh.

EGGS, side-blown, of chiffchaff, coot, goldfinch, jackdaw, lapwing, magpie, moorhen, pheasant, mallard, tree pipit, lesser redpole, rook, swift, in exchange for others not in my collection. Offers solicited.—W. Wells Bladen, Stone, Staffordshire.

Will be glad to exchange lists of duplicates and desiderata of rare plants, viz. 235, 236, 242b, 725b, 1056, 1071, 1422, 1430, 1446, 1467b, and many others.—Henry Searle, Rook Street, Ashton-under-Lyne.

"OTT of Doors," by Rev. J. G. Wood, "Midland Naturalist," 1878, "Naturalist," 1879, 1880, and other natural history books in exchange for "Rimmer's Land and Freshwater Shells" or "Gamekeeper 'at Home,'" &c.—Rev. W. W. Fleming, Portlaw, co. Waterford, Ireland.

WANTED, naval and military war medals, coins, tokens, &c. Good exchange offered in fossils, shells, minerals, and natural curiosities.—F. Stanley, Margate.

BRITISH shells for exchange. For lists of duplicates and desiderata, apply to J. W. Cundall, Carrville, Alexandra Park, Redland, Bristol.

DUPPLICATES.—(Coleoptera) *Agalus guttatus*, *Cercus bipustulatus*, *Heterocerus laevigatus*, *Hypera punctata*, *Donacia dentipes*, *sericea* and *lucida*, *Proscocuris marginella* and *phelandrii*, *Sphaeroderma testacea*, and many others. Desiderata British coleoptera.—T. Wood, 5 Selwyn Terrace, Jasper Road, Upper Norwood.

"MIDLAND NATURALIST" for 1881, complete (up to present month—October—inclusive), "Midland Naturalist" for 1879, one number missing—May. What offers in exchange?—G. Hall, 5 Rasen Lane, Lincoln.

STAINED vegetable tissues, marine algae (foreign and British) with diatoms *in situ*, choice plant and animal hairs, foraminifera, &c., all well mounted, for other good slides.—J. Ford, Tettenhall, Wolverhampton.

For exchange, a new and highly-improved camera for drawing in perspective.—Robert Dale, Fell. Soc. Sci., Sherborne, Dorset.

WANTED, first-class mounted preparations of insects and other objects, also all classes of unmounted material. Good exchange in slides, micro sundries, and material offered.—F. R. Martin, Malvern House, Clevedon.

LOUIS FIGUIER'S "World before the Deluge," containing thirty-four full page illustrations of extinct animals and landscapes of the ancient world, 202 figures of animals, plants, and other fossil remains; wanted, English accordion, or "Tom Brown's Schooldays" and "Tom Brown at Oxford," or offers.—Mr. S. Levermore, 8 Foundry Terrace, Maldon, Essex.

WANTED, Gosse's "Naturalist's Sojourn in Jamaica," "Birds of Jamaica," &c., also Bell's "Stalk-eyed Crustacea," Fritchard's "Infusoria," Johnston's "Zoophytes," Westwood's "Sessile-eyed Crustacea," Couch's "Fishes," or other good works on Natural History, in exchange for Gosse's "Devonshire Coast," Burmeister's "Entomology," &c., or cash.—C. Grimes, Dover.

GALVANOMETER (Henley's Telegraph) in perfect order, very delicate for long lines, for 1-inch object glass by good maker, Beck preferred.—H., 1, Tamworth Villas, Hornsey Road.

SCIENCE-GOSSIP for 1872-1878, 1879-1880, and vol. i. of "Great Industries of Britain," all unbound, for offers.—A. Alletsee, 11 Foley Street, Langham Place, W.

L. C. 7th ed. Nos. 10, 80, 126, 218, 265, 305, 343, 357, 405, 475, 565, 581, 672, 674, 650, 1009, 1237b, 1239c, 1241, 1278, exchanged for other rare plants. Lists exchanged.—J. Jackson, Wetherby, Yorkshire.

WANTED, British birds' eggs; will give in exchange Cassell's "Illustrated Family Paper," for 1866, handsomely bound.—R. Darling, Eyke, Woodbridge, Suffolk.

L. C. 7th ed. Offered, 2, 38, 60, 115b, 201, 307, 396, in fruit, 534, 539, 548, 581, 588, 626, 628, 731, 737, 830, 852, 911, 912, 1043, 1109, for other rare plants.—D. J. Powrie, M.A., Dockhead, Dumfries.

WANTED, well-authenticated specimens of *Sphaerium cornutum*, vars. *nucleus* and *fishoides*, and *Fissidium fontinale*, vars. *fallida* and *pulchella*. Other shells or micro slides of odontophores offered in exchange.—J. D. Butterell, 2 St. John Street, Beverley.

WANTED to exchange, microscopical lamp, on sliding stand, with shade, cost £1 1s, for some of the works of Darwin, or what offers?—Rev. W. Johnson, Catherine Street, Hartlepool, Durham.

WANTED, strong fresh plants, *Primula Scotica*, exchange *Primula farinosa*.—Miss Forster, Backworth House, Newcastle-on-Tyne.

LONDON CATALOGUE, 7th ed. Wanted, 325, 676, 1007, 1221, 1228, 1234, 1363, 1369, 1545, 1622. Offered, 218, 731, 739, 944, 1233, and a few examples of *Hernandia*. F. H. Arnold, Hermitage, Emsworth.

WANTED, any small British mammals, especially bats, stoats, weasels, water-moles, and harvest mice; also nest of harvest mouse.—H. C. Brooke, 45 Union Grove, Wandsworth Road, London, S.W.

GOOD anatomical slides wanted (injections preferred), for good geological, approval both sides.—W. H. Harris, Caerleon Villa, Partridge Road, Cardiff.

FOR exchange or sale, a good binocular microscope; two eye-pieces, 1-in., 1½-in., and 1½ objectives, polariscope, spot lens. Frog plate, condenser, &c.—R. W. Watson, 22 Highbury Park, N.

I HAVE several living specimens of the tansy beetle (*Chrysomela fulgida*) exchange for other natural history objects, birds in the flesh, for stuffing, preferred.—Edward J. Gibbins, 20 Bootham, York.

WANTED, in good fruit, any species of *Syzygium*, *Selligeria*, and *Phascum*, except *P. cuspidatum*, also *Pleuridium nitidum* and *Splachnum vasculosum*. Exchange in mosses.—Miss Ridley, Whitehaugh, Alford, N.B.

NINE parts of "The Intellectual Observer," March to November, 1863; vol. i. of the "Student and Intellectual Observer," bound; "Natural History Review," 1861, in parts; for offers.—R. Smith, 30 Great Russell Street, Bedford Square, W.

PARTS 1 to 36 inclusive, of Cassell's "European Butterflies and Moths," with plates, all perfect, including the butterflies *Sphingida*, and greater part of *Noctua*. Will exchange for works on entomology, or cash.—H. B. Pim, Leaside, Kingswood Road, Upper Norwood.

TINE slides (several hundred objects), in exchange for good material. Send list and quantity. A liberal exchange for sponges, especially British Gorgonias.—J. Temper, Storrington, Sussex.

WANTED, minerals, fossils, or microscopic slides in exchange for polished specimens of agates.—J. Campbell Christie, Hamilton, N.B.

WANTED, micro-material in quantity, will exchange slides or purchase.—Joseph Severs, Airedraite, Kendal.

FIRST-CLASS anatomical and pathological micro-slides in exchange for good stereoscopic slides.—Henry Vial, Crediton, Devon.

SAND from the shores of the Shetland Islands, washed up from the bed of the Atlantic, rich in foraminifera. A quantity sufficient to form many good slides for twelve stamps.—H. F. Hunter, The Manse, Goole, Yorks.

SHELLS or British Lepidoptera wanted in exchange for "Doric Picture Gallery."—J. T. Lightwood, Lytham.

WANTED, British fossils, microscopical slides, &c. Offered in exchange, named foreign jurassic and tertiary fossils. Dr. Rudolf Hauesler, F.G.S., &c., Dedham, Essex.

BOOKS, ETC., RECEIVED.

"Deaf-Mutism." By Dr. Arthur Hartmann, translated by J. P. Cassells, M.D. London: Bailliere, Tindal, & Cox.

"Gardens and Woodlands." By the late Frances Jane Hope. London: Macmillan & Co.

"The Fig, Mulberry, and the Quince." By D. T. Fish. London: "Bazaar" Office.

"Northern Microscopist." September.

"Midland Naturalist." September.

"Land and Water." September.

"Journal of Applied Science." September.

"The Antiquary." September.

"Revista." September.

"Feuille des Jeunes Naturalistes." August.

"La Monde de la Science et de l'Industrie." August.

"La Science pour Tous." August.

"Canadian Naturalist." August.

"The American Naturalist." August.

"Good Health." August.

"Ben Brierley's Journal." August.

"American Monthly Microscopical Journal." July and August.

&c. &c. &c.

COMMUNICATIONS RECEIVED UP TO 9TH ULT. FROM:—C. H. G.—C. K.—G. H. B.—F. B.—B. M. O.—G. A. W. O.—C. F. W. T. W.—C. W. B.—S. A. B.—J. F.—D. D.—F. S. A.—J. T.—J. M. M.—G. C. D.—F. M. K.—B. E. D.—G. B. T.—J. L. M.—J. S.—E. T.—J. W.—F. R. M.—S. B.—J. E. R.—A. W. P.—G. C. D.—J. M. M.—F. R. M.—W. S.—H. P. M.—C. D. J.—R. D.—J. F.—Col. H. E.—J. E. F.—A. K.—J. A. O.—G. H.—T. W.—E. L.—C. F. W.—T. S. K.—E. D. M.—J. W. C.—J. R.—A. D. M.—M. J. C.—F. S.—G. H. B.—C. E. S.—W. W. F.—H. S.—W. W. B.—B. H.—C. M.—J. C. H.—S. B. A.—A. T.—W. T. G.—T. H.—J. M. R.—W. W. R.—R. S.—A. B.—G.—G. D.—E. T. D.—A. H.—N. J.—F. W. O.—A. A.—C. J. G.—J. T. P.—R. D.—J. P.—S. A. B.—J. D.—B.—W. J.—W. H. H.—W. R.—F. H. A.—J. A. W. O.—T. C. U.—A. G. D.—J. S. H.—A. H. S.—A. S.—&c.

ERRATUM.—At page 204, second line, transpose * to preceding *brachyphylla*.

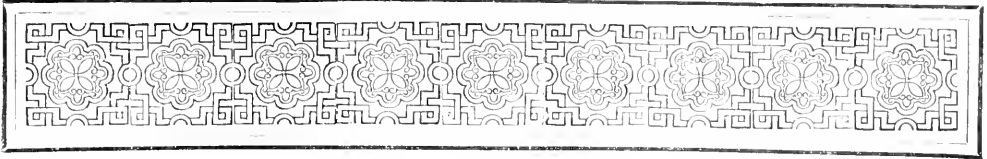

BOTANICAL NOTES FROM THE SWISS HIGHLANDS.

BY DR. DE CRESPIGNY.

[Continued from page 204.]

VII.

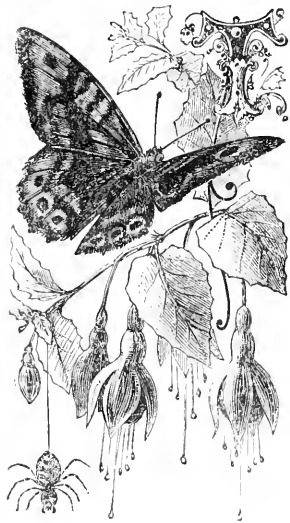

THE Rothhorn, 7900. Upper section, above the pines. In addition to those plants of more ordinary occurrence already mentioned as growing upon Pilatus, the following less common species occur upon this mountain range and upon the adjoining Nesselstock, Schratzen, &c.: *Anthericum scrotinum*; *Androsace villosa*; *Anemone vernalis*; *Athamanta Cretensis*; *Allium Violorialis*; *Arenaria verna, ciliata*; *Arabis pumila*; *Aronicum scorpioides*; *Adenostyles albifrons*; *Aster alpinus*; *Avena versicolor*; *Bupleurum ranunculoides*; *Campanula Scheuchzeri* (= *linifolia*) like *rotundifolia* less the radical leaves, and but for its few-flowered panicle, (var. *b*) *uniflora* (= *Vallensis*); *thyrsoides*, Schratzen mount; *Cherleria sedoides*; *Crepis montana, blattaroides*, Tagweid Alp; *Carex atrata, nigra, ferruginea, sempervirens, firma*. *Draba atroides, tomentosa, pyrenaica*, on the Schratzen; *Erigeron uniflorus*, highest ridge. *Empetrum nigrum*, foot of the ridge, north slope; *Festuca violacea*, north slope, Tagweid, *pulehella*, Staffel Alp; *Globularia cordifolia*, rocky places; *Gentiana acaulis, nivalis, Bavarica; lutea* and *purpurea* on the Nesselstock; *Gaya simplex*, frequent along the ridge which divides the Maisee and Tagweid Alps; *Gnaphalium Leontopodium*, in the same locality as the preceding and as frequent; *supinum*. *Festuca violacea*, foot of the

Horn towards Tagweid, *pumila*, same place; *Heli-anthemum Oelandicum* (= *canum*), *Hedysarum obscurum*; *Hieracium alpinum*, Maisee; *villosum* and *amplexicaule*, Nesselstock; *casium*, Schratzen; *Lilium martagon*, rocky places; *Leucanthemum coronopifolium, alpinum*, stems short, almost leafless; monocephalous, rocky débris; *Lonicera alpigena*; *Meum Mutellina*, this plant differs from *athamanticum* in the leaves not being so finely divided, in its stem two-branched above, and geminate 12-16-rayed umbel, contracted when ripe; *Mæhringia polygonoides*, *Nigritella angustifolia*, *Oxytropis montana, campestris*, highest point of the Nesselstock; *Oxyria digyna*, *Onobrychis montana*, *Pinguicula alpina*, *Phaca astragalina, frigida*, north slope on Maisee and Tagweid; *Phleum Michelii*, same localities; *Poa laxa*, north slope between Staffel Alp and Maisee; *Rumex arifolius, scutatus*; *Ranunculus montanus, Villarsii*, this species is more pubescent than the preceding, and has compressed lenticular achenes, with the beaks strongly recurved. *Scabiosa lucida*, a variety of *colubaria*; *Swertia perennis*, wet places close to the Staffeli, &c.; *Sibbaldia procumbens*; *Saxifraga androsacca, oppositifolia, stellaris, moschata, bryoides*; *Spergula saginoides*; *Senecio Doronicum*, alpine pastures; *Silene quadrifida*, scarce, Nesselstock; *Salix retusa, herbacea, reticulata*; *Thesium alpinum*; *Trifolium alpinum*; *Tozzia alpina*; north side, in wet places at the base of the Nesselstock; *Viola biflora*; *Valeriana montana*; *Veronica aphylla*, &c.

The best localities here, as generally elsewhere on these calcareous mountains, are the débris mixed with masses of fallen and disintegrated rock along the basis of the crags; and in the steep and narrow grassy ravines above the pines, especially on the southern slopes; dry grassy slopes too, high up in places inaccessible to cattle are good for some species; these cattle are close croppers and devour everything. If sleeping quarters can be secured at the inn on the summit it were well worth while to

devote a day to exploring the Nesselstock and Schratten or adjoining Tannhorn. The descent to Brienz can be made by the old road which passed by the Irtschelen Alp and Schwanden, leaving the Eysee lakelet on the left.

In the immediate neighbourhood of Interlaken several interesting plants may be gathered in the course of a matutinal stroll; *Erinus alpinus* and *Globularia cordifolia* on rocks foot of the Harder; *Gentiana asclepiadacea* in the woods about; *cruciata* south shore of the Brienz lake; *Hepatica triloba* and *Cyclamen Europæum*, woods; also *Luzula albida* and *Maianthemum bifolium*, *Pyrolas*, *Spirea Aruncus* *Thalictrum aquilegifolium*, *Salvia glutinosa*, yellow *Digitalis*, &c. In wet meadows, *Tetragonolobus siliquosus*, a plant with yellow lotus-like flowers, but larger and fewer, and a curious four-sided pod; wet meadows, near Bönningen, on the lake, *Hippophae rhamnoides*; Marshy flat, at Neuhans, lake of Thun, *Spiranthes aestivalis*, and in one place *Liparis Loeselii*.

If an excursion to the cave of Saint Beatus on the Beatenberg north shore of lake Thun be undertaken, look for *Lactuca perennis*, *Laserpitium Siler*, and *Helianthemum fumana*, in the crevices of rocks by the footpath leading up to the cave, and for *Physalis Alkekengi* on the débris below before you ascend. On the rocks about the cave itself, *Carex humilis* and *Laserpitium siler*. Farther on and among rocks by the footpath through the wood downwards, *Aemulachier vulgaris*, a pomaceous shrub allied to *Sorbus*; *Rhamnus alpinus*; *Cyclamen Europæum*; *Laserpitium glabrum*; *Saponaria oeymoides*; *Melittis melissophyllum*, scarce; *Geranium sanguineum*; *Peucedanum Cervaria*; and by the stream which issues from the cavern, *Lasiagrostis Calamagrostis*; a large coarse grass densely tufted and with long linear involute leaves. On the Nase, rocky promontory of the Bratenberg, *Rhododendron ferrugineum* grows down to the water's edge. Just before leaving the wood, if a little footpath be followed leading right for a short distance, *Trifolium rubrum* will be met with: a trefoil somewhat like *incarnatum*, but glabrous and with stipules of a different character. Return by steamer from Merlingen. *Liliastrum album* grows in the valley above this place, and several good mosses are to be gathered on the fallen rocks there.

The ascent of the Sigriswyl Rothhorn were superfluous almost from botanical motives; it is about 2500 feet lower than its namesake of Brienz. Nothing therefore out of the common is to be expected. Of more distant excursions, that viâ Lauterbrunnen to the Wengern Alp, and to Mürren with ascent thence of the Schilthorn, 9000: a guide necessary:—or viâ the Suarten Valley to the Sulgg, 8000; Dreispitz, 8300; Schwalmnen, 9000; or lastly to Spiez on the lake, for the ascent of either the Niessen or Stockhorn or of both. Facility of access and good repute with regard to the richness of their flora are reasons for giving these a preference to the others.

There is nothing attractive for botanists in the Wetterhorn, Schreckhorn, and adjoining giants of the Bernese Alps: little can be expected from bare precipices and snow-fields: *Campanula Cenisii* is recorded as growing above the first glacier of the Wetterhorn, and that is undeniably a rarity; below the glacier three gentians, *acaulis*, *terna* and *nivalis* which are not rarities.

Desor reports *Ranunculus glacialis* as growing upon the Schreckhorn at 11,600 feet, *Androsace pennina* at 10,550 feet, and the lichen *Parmelia elegans* on the highest summit at 13,050!

It is not that alpine plants will not grow in greater abundance at these elevations under favourable circumstances of sheltered locality, &c., but simply because there is no soil for them to grow upon.

(To be continued.)

NOTES FROM THE HIGHLANDS.

WHATEVER fortune the majority of your lowland readers may have had this summer in collecting, we in the north have been overwhelmed with rain, and little or nothing of insect life has been seen, excepting in the very brief snatches of sunshine which have burst through the clouds.

On the 10th of June I caught the first Artaxerxes of the season, the specimen being very noticeable for the large size and brilliancy of the row of orange spots along the upper margin of both wings. No more of this fascinating little butterfly was seen until the second week in July, when, at an elevation of 1600 feet above the sea, and on a steep mountain-side, littered with broken rocks and green with ferns and heather, a spot was accidentally discovered, where, in company with the common blue and small heath, Artaxerxes were flitting about in every direction, and I had a lively morning's work amongst them.

Their flight is rapid, and owing to the dark colour of the upper side of their wings it is very difficult to keep the little insects in sight over broken ground. When settled—generally on the dwarf mountain buttercup—they open and shut both pair of wings, and then the rapid contrast of the upper and under sides makes them very noticeable. In the specimens I took in July the marginal row of red dots varied from great distinctness, in the earlier captures, to others in which they were hardly visible. The white dots on the forewings were also sometimes large and clear, and in one or two individuals so minute as to be hardly discernible.

Alexis, of the brilliant Scotch variety, appeared suddenly on the 22nd of June, during a bright sunshine, but two wet weeks following, it entirely disappeared,—in fact, towards the end of July, and all through August, butterflies were very scarce, and the only insect abroad in any numbers were day-flying Noctua. On the 12th of the latter month I was out grouse-

shooting, and noticed two *Davus* and a few *Aglaia*, but much worn and in the tatters of their former gaiety. Since then I have shot nearly every day over a wide range of moor and mountain, but have come across few moths and no other butterflies of consequence.

One proof of the effect of the very heavy rainfall in the Highlands was afforded in the case of *Vanessa urticae*. Early in June there were thousands of the larva of that butterfly on the nettles, but before they were full grown, they were swept from their feeding-places and drowned by hundreds, and now there are very few perfect insects either on the wing or hibernating.

I am glad to see, from several very interesting articles which have recently appeared in SCIENCE-GOSSIP, that the lowland collectors have had better weather and sport than we have had up here.

EDWIN LESTER ARNOLD.

Balmyle, Blairgowrie, N.B.

A VISIT TO A WELSH STONE-QUARRY.

By E. HALSE, A.R.S.M.

THE quarry about to be described is only a few hundred yards from the small village of Pontrhydfendigaid ("Bridge of the Blessed Ford"), situated midway between Lampeter and Aberystwith. The face of the quarry shows a series of beds of clay-slate, of Lower Silurian age, striking at a low angle to the N.N.W., and dipping away from us to the W.S.W. Organic remains are by no means common in this quarry, or in the surrounding formation; indeed, the ordinary observer would soon come to the conclusion that it was entirely destitute of them; but the geologist, after careful search, would doubtless succeed in finding one or two specimens of graptolites, and other apparently insignificant fossils. Without looking for any 'medals' and 'footprints' of former epochs, let us examine the quarry as it has been opened out, collect as many data as we can, and endeavour to form therefrom rational conclusions with regard to its history, and the history of the surrounding strata.

By means of a clinometer we see that the beds dip, on an average, at an angle of 39° . The beds are of variable thickness, 12, 8, and even as little as $1\frac{3}{8}$ inches. Layers of quartz are seen between some of the beds, and we note that little veins of the same mineral run through the beds, generally parallel to the larger layers of quartz between the beds, and therefore parallel to the planes of the beds of clay-slate themselves. But this parallelism is not invariable; some veins are seen to run cross-wise, meeting the more parallel ones at an acute angle (fig. 139). These veins are also of inconstant thickness, one we measure is $1\frac{1}{2}$ inches thick, widening to the N.N.W. to as much as $2\frac{1}{4}$ inches; others measure 1 inch, $1\frac{8}{10}$ inches,

$\frac{1}{2}$, $\frac{3}{10}$, $\frac{3}{8}$ inch, down to mere lines or threads. On examining a large vein or layer of quartz, we find it to be more or less crystalline in appearance, and in parts very tender, rotten, and of almost a cellular structure, and discoloured with black earthy matter. As an indistinct line is seen to run roughly down the centre, and the vein breaks easily into two portions along the central line, it is evidently composed of two layers. Here and there little cavities or "vughs" are conspicuous, lined with rather large crystals of quartz. But there is another mineral in these veins—iron-pyrites—visible to us as clusters of little crystals, and occasionally as rather large isolated ones. In places we observe that there is an accumulation of iron-pyrites, whilst in other parts of the vein there is little or none of that constituent. The iron-pyrites in the rotten portions of the veins is discoloured, and is, in fact, in a more or less oxidised or decomposed condition. The smaller veins, and parts of the larger ones, are composed of milk-white quartz, with here and there very bright and metallic crystals of iron-pyrites. Nothing has affected these smaller veins, and, on close examination, they appear to consist of two or even more layers of quartz, similar to the larger ones. If we examine the crystals of iron-pyrites with a lens we shall find them to be in the form of a cube, more or less developed. In most cases little shoulders, as it were, of the cube peep out, and a series of deeply indented lines or striations are seen running parallel with the edges, and twin crystals are not uncommon. The striæ on two adjacent faces are at right angles to each other (fig. 140). Now it appears that when iron-pyrites is crystallising out, it has a tendency to form, besides the cube or primary, and many other forms, the form known to mineralogists as the pentagonal dodecahedron (fig. 141). The result is, as it were, an oscillation between the two forms, consequently these striæ are produced; but the general form taken is that of the cube, as the tendency to form a cube in this instance, was much greater than that to form a pentagonal dodecahedron.

In fig. 142 we have an interesting case of one little vein connecting two larger ones.

We cannot fail to notice that the beds break up along planes practically at right angles to those of bedding; the quarryman is thus enabled to take away the stones in large blocks. These planes perpendicular to the bedding are the joints.

A careful examination will soon reveal to us another series of lines (fig. 143.x), dipping towards us to the N.E., and making variable angles with the beds of clay-slate. Here the angle is 50° , there 48° , and in one place as high as 75° . We notice, however, that these lines are constant with regard to each other—they are parallel—and, if they deviate at all from this the deviation is only local, and apparently due to local causes. These lines are very indistinct in the dry rock, but they are easily perceptible where the rock is wet. If we test a portion of the rock with a

hammer, we can in time perhaps, succeed in breaking it along these lines—in other words the rock is to a certain extent cleavable along these lines; but in nineteen cases out of twenty, the rock will fail to split along the latter, therefore the cleavage is in a very crude or undeveloped condition. We cannot fail to conclude from this fact that the rock has been subjected to a tremendous mechanical force, which has produced these lines of cleavage, but that this force was not sufficient to obliterate the planes of bedding, and to produce distinct planes of its own.

We notice another remarkable fact. Where the angle which these lines make with the line of bedding is a moderate one, say from 30° to 50° , the rock will not cleave along the former lines, but breaks only along the plane of bedding, and along the joints perpendicular to these planes; but where the lines of cleavage make a high angle with the beds, say 75° , the rock cleaves along the lines of cleavage,* being broken in

of iron-pyrites, we must conclude that their contents were deposited from solution, and that the veins were formed, or at all events filled up subsequently to the consolidation of the clay-slate. The history then of this particular quarry, and of the surrounding strata, resolves itself into the following periods: (1.) The beds were deposited in the first instance horizontally, or nearly so. (2.) After consolidation they were tilted up to the moderately high angle of 40° . During this process of tilting, or subsequently to it, some of the planes of bedding became opened in a greater or less degree, and a series of fissures were formed in the beds, some parallel to the planes of the beds, and others making an acute angle with them. (3.) Heated water from certain depths below the surface of the earth containing silica in solution filled up these veins, and silica was deposited or crystallised therein. Crystals of iron-pyrites were afterwards deposited on the quartz, either in clusters, or in more

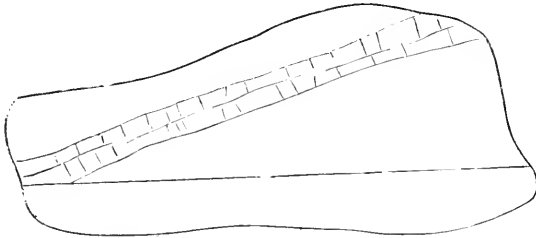

Fig. 139.

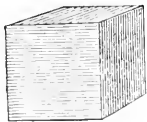

Fig. 140.

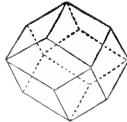

Fig. 141.

this way into rough rhombohedrons. On once more inspecting the veins of quartz we notice that the cleavage lines are distinctly traceable through the veins themselves, especially where they are decomposed, and still so, but in a less degree, where the veins are in their normal state. We infer from this—and it is an important inference—that the cleavage lines were produced subsequently to the formation of the quartz veins. Now these latter show a “comb-structure,” an indistinct one it is admitted, but from this fact, and from the fact of the presence of numerous little vughs of rock-crystal, and of crystals

* This observation is somewhat different from that of Mr. T. McKenny Hughes, who remarks that “where a rough cleavage cuts flagstones at a considerable angle to the planes of stratification, the rock often splits into large slabs, across which the lines of bedding are frequently seen, but when the cleavage planes approach within about 15° of stratification, the rock is apt to split along the lines of bedding.” (Lyell's “Student's El. Geol.” 1871, p. 573.) The latter in our case do not appear across the slabs, but from the upper and lower surfaces of it; the two sides are formed by the vertical joints, and the front and back by the planes of cleavage.

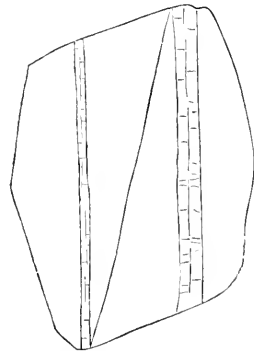

Fig. 142.

or less isolated crystals. (4.) The rocks were next subjected to tremendous lateral pressure, producing undeveloped cleavage. (5.) Very recently atmospheric influences have affected the rock, vertical joints have widened, and have in places become filled with rubbish; water percolating from above through numerous cracks has helped to disintegrate the rock and the veins, and to some extent has decomposed the iron-pyrites in the latter.

About three miles to the east of this quarry there is a quarry which has been worked for slate, but which has lately been abandoned for want of capital. The beds here are not tilted up quite so much as at the former quarry, dipping only at an angle of 35° , but the strike is exactly the same, namely to the N.N.W. The cleavage here is more highly developed, and moreover no quartz veins are visible. Fig. 144 is a sketch of the beds taken from one side of the quarry. Along *a* are seen a series of lines somewhat irregular, dipping at an angle of 76° from the horizon. The lines in *b*, *c*—*m* are flatter, straighter, and more crowded together. Again the lines running through

the bed *n* below are similar to these running through *a*. What is the meaning of the want of parallelism of these planes of cleavage? Now the beds *a* and *n* consist of hard and solid clay-slate, while the other beds are soft in comparison—it is in fact an interesting case of the refraction of planes of cleavage. Just as a ray of light is bent when passing from a denser to a less dense medium, so were these planes bent when passing from the harder rocks *a* and *n* to the less hard ones *b*, *c*—*m*. The cleavage planes in *b*, *c*—*m* make an angle of only 53° with the horizon, in other words the former—the result of the great mechanical pressure on the strata—when passing from *a* to *c* were bent or refracted as much as 23°. There is no doubt about this, for the chief planes of cleavage are easily traceable from *a* through *c*, *e*, &c. Again, in parts of *a* and *n*, coloured bands or

and dip are not the same. The strike of course of the lodes is about at right angles to that of these veins and the dip is much higher, being from about 60° to 75°. Among the analogies we note the general parallelism of the veins—the occasional presence of cross or 'counter' veins—the diversity in richness of the metalliferous portion of the veins, the latter being sometimes absent altogether, while the vein still exists—the crystalline character of the filling, and the general turb-like structure—this latter quality is not nearly so apparent in the lodes, for the nature of the filling in them is often of an extremely complicated character

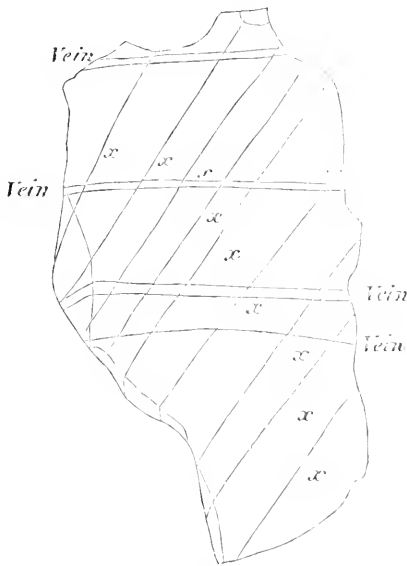

Fig. 143.

“water-lines” are seen, which denote strata of different density to *a* and *n*, and the lines of cleavage are bent by these bands as seen in fig. 145. The rocks *a* and *n*, which are really the “posts” of this quarry are converted into slabs two or three feet thick, while the other beds are made into slates $\frac{2}{3}$ inch thick, or even $\frac{1}{2}$ inch, but these slates are very irregular, often thinning away to a very sharp edge at the sides, and are moreover heavy and discoloured. They are not to be compared to the red and blue slates of North Wales, although they have been used locally to a small extent. They show no traces of iron-pyrites, hence, notwithstanding their clumsiness, they would probably wear well.

Finally let us see what analogies and what discrepancies exist between the small white quartz veins of our quarry, and the lodes of the district. The strike

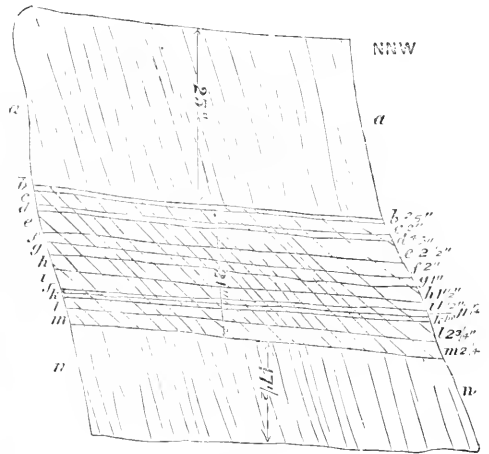

Fig. 144.

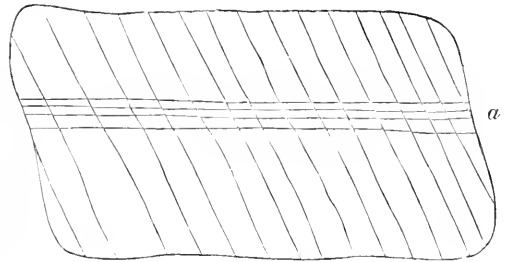

Fig. 145.

—the variability of the thickness, strike, and dip of the veins—the presence of vughs, and the marked absence of veins where the cleavage is highly developed. Miners know well that where the country rock becomes fissile, the lode is not only often faulted but is considerably reduced in size and richness; sometimes it is continued through the fissile bands only as a few insignificant strings, or, should the fissile rock be of very great thickness, the lode even “dies away,” entirely, the fissure becoming in fact untraceable, if not quite obliterated. The decomposition of the larger veins near the surface is also comparable to what takes place in true lodes. Large lodes near the surface usually become disintegrated,

oxidation takes place, and "gossan" is formed, consisting chiefly of peroxide of iron, and oxidised compounds of other metals. But we noticed that the small veins were unchanged; this is the case also with small tight or compact lodes; hence the miner looks upon the presence of gossan as a very favourable sign; it is the harbinger of a good wide lode, containing probably a large store of the useful metals lower down.

Thus have we made our strata tell their own tale, and we see that their career has been a chequered one. Originally the result of slow and calm deposition from water, they have been subjected to mighty forces, which have tilted them up, have produced small fissures in them, and have indelibly stamped them with a series of lines, which are in reality incipient cleavage planes. We have also compared small things with great, and have shown, that from a few hours' study of a quarry we can learn a good many of the commoner characteristics of metalliferous veins.

HYDRA FUSCA VERSUS ACTINOPHYRYS EICHORNII.

NATIONS quarrel and settle their differences by pitched battles, and immense slaughter of their fellow-creatures, whose blood dyes the land, and friends grieve for the loss of those dear to them. Individual men quarrel and frequently descend to the level of the beasts, disfiguring the beautiful image of a Creator's wisdom. The beasts of prey gain their sustenance by living on the weaker creatures of the denizens of the forest. The eagle, vulture, and other ravenous birds of the air, prey on the smaller feathered tribe. In the depths of the mighty ocean, the larger fish prey on the smaller, and every genus in nature exhibits an amount of savage desperation according to the resistance it receives from its victim. Man is no exception. Look at the sturdy butcher who has had some difficulty in bringing the beast to the slaughtering block; what extra amount of strength he puts into the pole-axe as it descends on the head of the unoffending victim. Even in the tiny pond voracity exists as the "struggle for life" goes on; each animalcule preying on something more minute than itself, and indulging in as fierce a fight as ever was fought on a field of battle which would possibly decide the fate of a nation. Yet the victory even in this case is not always to the "mighty," even when the assailant is the most powerful both in size and armament, as I am able to testify, being an eye-witness to a contest between a full-grown *Hydra fusca* and an *Actinophrys Eichornii*. It took place on a Sunday evening—I am afraid my little pets have no day of rest, and if they have not they are to be pardoned, for many of the greatest battles of Europe have been fought on that day. In my large zoophyte-trough, which I keep especially for watching the

reproduction by budding of the *Hydra fusca*, I have had some very magnificent specimens this season. I had two very beautiful *Actinophrys Eichornii*, and their peculiar method of capturing and absorbing their prey, and afterwards throwing off the excreta, afforded me as great a source of observation as the Hydras. Both Hydra and Actinophrys lived very comfortably together for some time, neither molesting the other, but, whether from a spirit of mischief, or a feeling of jealousy—it could not be hunger, for I had kept Mrs. Hydra tolerably well fed with *Daphnia pulex*—on the part of *Hydra fusca* I know not, but it took it into its head to meddle with Actinophrys, and Actinophrys seemed in no way disinclined to make the acquaintance; and only when the Hydra became too loving by embracing Actinophrys with two of its tentacles did the latter begin to exert himself, and gather up his processes for the fray. His spines, at all times prominent, seemed to bristle like the quills on a porcupine's back. A pause ensued; and, whether sharply stung by the spines of Actinophrys, or an act of its own volition, I know not, but Hydra brought all its tentacles to bear on Actinophrys, and, turning them inwards tried to thrust Actinophrys down its throat. But this was evidently no easy task, and Hydra found it had not a dainty young *Daphnia* as a *bonne bouche*, for it dropped Actinophrys to the end of its tentacles and commenced lashing him as if in a furious rage; thrashing him as if it would beat every spine out of his globose form. It now became very interesting to watch the contest. It was evidently a waiting game for Actinophrys. If he could stand this thrashing he could stand anything. Whack-whack, the blows seemed to fall and made you fancy you heard them as you gazed through the instrument. But more was in store for Actinophrys—*Hydra fusca* finding this of no avail had recourse to other means. In spite of spines, it wrapped one of its tentacles round Actinophrys, and, with the aid of the others, alternatively began trying to tear him to pieces; but all to no purpose. Wrench, wrench; pear-shape, lozenge-shape and every conceivable shape, I thought he was quite smashed and torn up, but Actinophrys' protoplasmic substance stood him in good stead, and he seemed to make good use of his spines, for Hydra was glad to keep shifting its tentacles as though it felt the effects of them. And so the fight went on for more than an hour—an age in Hydrozoic and Protozoic existence—when, Hydra finding it could make no end of Actinophrys, uncoiled its tentacles and let him go. And a woeful spectacle it was. His beautiful spines were wrenched and torn, and he sought the solitude of a friendly leaf. The next evening Actinophrys had "repaired damages" and was sailing fearlessly about in his little world, and at no time since have I noticed either of the Hydras molest Actinophrys.

Canterbury.

T. B. ROSSETER.

HOW CAN WE POPULARISE
ENTOMOLOGY?

A RAPID progress has been made of late years in most branches of zoology, a progress which is twofold, the students of each division having been rewarded with discoveries far beyond anticipation, and the public generally having been led to regard Natural History with a keener interest and an interest marked also by more intelligence. Not only the curious and beautiful in structure are beginning to be appreciated, the habits and instincts of animals are now regarded by numbers who are not professed naturalists as worthy of observation and record. In fact, as all editors of scientific or semi-scientific periodicals know to their cost, a great many individuals of both sexes are most eager to communicate to others the real or fancied discoveries they make, and the sifting of these is arduous work, for it is ever true that "the eye sees what the eye brings the means of seeing," and even with the best intentions, the inapt at observing is liable to fall into grave blunders, though sometimes his very inaptness enables him to seize upon some notable facts which the more philosophic man might miss, just because it is against recognised beliefs. Somehow or other, Entomology is still, to an extent thrown into the background, the objects which it contemplates are often regarded with indifference and dislike, and entomologists meet with little favour amongst the educated generally, while the ignorant make no secret of their ridicule. There are several things which account for this, and these have been shrewdly dwelt upon by Kirby and Spence. Some of these things will always continue to be causes of popular prejudice and dislike, since insects will ever inflict annoyance upon men and animals, and commit ravages in the field, the garden, the wood, and the house. Certainly from time to time some misconceptions have been cleared away, and some species proved to be less harmful than was supposed; yet more extensive researches of recent years have brought to view a new host of insect enemies. And really the insect-hunter is confessedly, in some of his manœuvres, exceedingly amusing to those endued with a keen sense of the ludicrous; while those who have any practical experience of the injuries occasioned by insects, cannot but look upon the ordinary collector, pursuing his netting, pinning and breeding operations as either a comparative idler, who fails to destroy the most troublesome insects, or as actually a public enemy, invidiously favouring their multiplication.

It is very desirable, both in the interests of the science itself, and also for the sake of its votaries, that Entomology should be placed on a better footing. If we can but ensure for it some measure of popular estimation, we should have its students rapidly increase, and insect-lore would become as much sought after as bird or fish-lore, which cannot be said to be the case at present, since the numerous books

which have been published of late years, though testifying to an improvement, do not show that Entomology has so largely advanced in public favour as some might imagine. A large proportion of these are comparatively limited in their circulation, and the illustrations attract a great deal more attention than the letterpress does.

We shall never popularise Entomology unless we can largely increase the number of observers. The ordinary "collector" may be, and very often he is, a painstaking and tolerably unselfish individual, but he is too frequently blind to any facts in insect-life which do not tend towards his immediate object—the filling of his boxes or cabinets. Collecting, for the sake of collecting only, is not a despicable thing; but we must endeavour to "step higher" if we wish to assume the title of "entomologists," and prove to the public that we love the science because of the truths it discloses to us, and not only because by its cultivation we are able to accumulate a fine array of specimens, or to write ourselves the authors of elaborate descriptions of species which scarcely any one reads. Those who study insect-life for its own sake, and in order to enrich, not a scientific clique, but the world at large, by the discoveries they make, must increase in numbers considerably ere Entomology can command such a share of public attention as it is entitled to receive, for, when the extensive fields of research which it embraces are considered, it has a right to be placed nearly on an equality with those other branches of zoology which have established themselves in popular favour.

An important movement is commencing with reference to the instruction of the young in Natural History, and, though as yet not much has been done towards instructing juveniles in the alphabet of Entomology, we may ere long see much accomplished by this means, could we but have efficient teachers. Prejudices against insects are so generally imbibed in early life, and they adhere so firmly in spite of the knowledge of after years, that to clear these off at the outset would help greatly towards the opening up of a new era. To produce neutrality is something, to form a liking is more desirable still, and this is possible amongst the bulk of children, who take kindly to Natural History (even technically treated) if it is not presented in the shape of a task. I should gladly see getting into vogue not "lectures," but rather "talks" upon Entomology, of a character suited to the young, and illustrated, not only by diagrams, but by living objects; the instructor himself being heartily interested in the subject. Occasional excursions might be taken by teacher and pupils, as has been done in the case of juvenile botanical classes with much success. Insect-life is a million-paged volume of wonders, and children and youth will not easily weary of it when it is wisely unfolded to them, nor will such impressions be easily effaced.

J. R. S. CLIFFORD.

ADULTERATION OF TEA, AND A NEW PROCESS FOR THE EXTRACTION OF CAFFEINE OR THEINE.

By A. B. GRIFFITHS, MEDALLIST IN CHEMISTRY AND BOTANY, &C.

THE tea-plant (*Thea Chinensis*) belongs to the natural order Ternströmiaceæ. It bears white flowers like the wild rose. The calyx is polysepalous and inferior; the corolla is polypetalous and hypogynous; the stamens or male organs of the plant are indefinite, polyadelphous and hypogynous; and the pistil or female organ of the plant is syncarpous and superior. The tea-plant is an evergreen; the leaves, which are of various sizes, are somewhat similar to those of the rose; they are serrated and arranged on the stem alternately.

The tea-plant is indigenous to China, but has been of late years introduced into India and Japan.



Fig. 146.—*Thea viridis*.

It was first used in this country in the seventeenth century. The chemist has nothing or very little to do with the flower of the plant. It is the leaves to which his attention is drawn, because of their use as an article of diet by a large proportion of the human race.

Tea is sometimes adulterated with leaves of other plants, as for instance sloe, ash, hawthorn, &c.; but by a careful microscopical examination these adulterants can be easily found out. Genuine tea-leaves, when moistened with hot water and opened, and then examined by the microscope, show a very characteristic venation; when once seen, this character will not be easily forgotten.

The midrib passes from the petiole to the end of the leaf; and the veins proceeding from the midrib are parallel to each other, but these veins curve a little towards the edge of the leaf. By this character tea may be recognised from other leaves. The edge of the leaf of the tea-plant is serrated, but this is not an essential character. Tea is adulterated in other ways besides the admixture of foreign leaves. Firstly, the leaves are often "faced" or artificially coloured

with Prussian blue and turmeric, or indigo and talc-powder, to give a green colour. Black tea is often "faced" with plumbago. Secondly, the leaves are sometimes mixed with sand and other mineral substances; all these bodies can be detected by microscopical and chemical analysis in the ordinary way. There is still another method in which this leaf is rendered not genuine; that is, by the practice of selling the tea more or less exhausted.

The principal ingredients in the ash of tea-leaves are potash, protoxide of manganese, and phosphoric acid. The following table will show the percentage of these ingredients of the ash from a sample of genuine tea, and the same sample when completely "spent":—

Genuine "Souchong."	Spent "Souchong."
Potash 38.456	Potash 7.523
Phosphoric Acid 14.621	Phosphoric Acid 24.900
Manganese Protoxide 1.204	Manganese Protoxide 1.809

A pretty fair judgment as to adulteration of a sample of tea can be arrived at by a simple process of my own. This process is based on the extraction of the theine contained in tea; and ascertaining the percentage of theine extracted from a known weight of tea. Tea contains from a half to five per cent. of theine.

The way to proceed in this new process of extraction is to weigh out about 180 grammes of the sample of tea, and boil with 2 litres of distilled water in a glass beaker; allow the infusion to boil for five minutes; then add to the infusion a small quantity of glass (reduced to a fine powder) and magnesian oxide. Keep this mixture in strong ebullition for about twenty or twenty-five minutes; at the same time occasionally stirring with a glass rod. Again, add 250 c.c. of water, and boil for fifteen minutes longer. The aqueous extract is now to be evaporated very carefully to complete dryness. The residue left on evaporation is to be treated three or four times with rectified ethylic ether by means of Payen's percolator.

Three or four treatments with ether generally suffice to remove all the theine. The last portions of the ethereal washings when evaporated should leave no residue. These ethereal solutions are to be gently heated, and then allowed to evaporate in a shallow dish of known weight. The solid remaining is the pure alkaloid theine.

The dish and its contents are now weighed. The weight of the dish and the theine, minus the weight of the dish alone, gives of course the weight of the theine. From this, the percentage of theine in the original weight of tea can be ascertained by means of simple proportion.

If the percentage is less than a half per cent., you

may conclude that the sample has been either adulterated with foreign leaves (which can easily be recognised by their botanical structures under the microscope, as I have alluded to at the commencement of this article), or the leaves have been exhausted.

The author has experimented upon various teas, among which may be mentioned, "Souchong," "Orange-Pekoe," and "Paraguay Tea" (*Ilex Paraguayensis*). The smallest percentage of theine was yielded by a sample of Paraguay tea.

This *Ilex Paraguayensis* is a kind of holly of South America; and the beverage it yields with water is called Maté by the natives.

Besides the crystallisable alkaloid theine or caffeine ($C_8H_{10}N_4O_2$) which belongs to the family of "organic compound containing triad and pentad nitrogen;" the principal ingredients are an essential oil and tannin. The exhilarating effect of tea (which induces such a large proportion of the human race to partake of it in their daily diet) is owing to the



Fig. 147.—*Thea viridis* (z shows flowers on a larger scale than a).

presence of the above three constituents. The essential oil is the ingredient that gives an infusion of tea the aromatic flavour; theine combined with the essential oil stimulates the stomach, and by inducing a slight perspiration, gives a lightness and increased strength to the body of the consumer.

The astringency of tea is due to the tannin present.

The base theine (in ordinary tea) is combined with tannic acid, forming tannate of theine. The author comes to the conclusion that in the process of extraction just described, the mixture of glass and magnesian oxide has the power of liberating tannic acid, which may combine with a portion of the magnesian oxide, forming magnesian tannate, or the tannin may be left in an uncombined state, but being almost insoluble in ethylic ether, is by this means separated from the base theine.

There are three varieties of *Thea Chinensis*, namely, *Thea viridis*, *Thea Bohea*, and *Thea Assamica*; all of them yielding green and black tea.

The difference in colour and quality of teas depends chiefly on the time of the year when gathered, and also the method employed in drying the leaves;—and for this reason, also, the variation in the percentage of theine (that is between a half and five per cent.).

A GOSSIP ABOUT NEW BOOKS.

A FEW months of unusually hard work in other directions have compelled us to defer the notice of various new books of importance until the commencement of the "reading season." It is not too late, however, to draw the attention of our readers to them now, and our high opinion of *Anthropology: an Introduction to the study of Man and Civilisation*, by Dr. E. B. Tylor (London: Macmillan & Co.), is best indicated by our selecting it as the first on which to make a few remarks. It is always a treat to read a book written by the man who best knows his subject, and this is the case with that before us. The subject is treated from the evolution standpoint, but so calmly and dispassionately, and without the slightest offence even in the most sensitive regions, that the author proves himself a philosopher by his tact alone. We have read the book through with much pleasure—a task rendered all the more delightful by the plain but attractive style in which it is written—and we cordially recommend it to the student as by far the best and clearest and fullest manual of Anthropology in the English language. Its cheap price places it within the reach of almost the poorest reader.

Studies in the Theory of Descent, by Dr. Aug. Weismann, Part II. (London: Sampson Low & Co.), deals in the present part with "The Origin of the Markings of Caterpillars," and "Phyletic Parallelism in Metamorphic species." Mr. R. Meldola (vice-president of the Entomological Society of London) has ably translated and edited the work, and enriched the author's remarks and comments by additional ones of his own. This work casts new light on the study of Entomology. It is not many years since this branch of natural science was regarded as inimical rather than helpful to the doctrine of Evolution, and now we find it acting as one of the richest contributors to that theory. Or rather, the theory helps us to understand what before was either completely overlooked, or regarded as hardly worth the trouble of investigating. Here, for instance, is Dr. Weismann devoting himself to the task of carefully observing the various changes which the caterpillars of certain moths undergo after their first extrusion from the egg. He finds that the markings on their skins, after repeated moultings, are always in a certain order of arrangement, and he regards them as presenting a picture, so to speak, of phyletic development (that is, the changes through which the species has passed in its development). Thus, a number of species of

Sphingide, as *Deilephila Galii*, *D. lineata*, *D. vesperilio*, *D. hippophaes*, &c., have caterpillars which go through the same initial changes—the specific and characteristic markings being assumed generally at the last moult, or the last but one. We cannot too strongly recommend this work to entomologists. A number of coloured plates at the end assist the author in rendering his most interesting observations and conclusions all the better understood.

The following volumes are additional contributions to the *International Scientific Series*—a scientific library which may be regarded as the best ever attempted, every author being engaged to write a book on the subject with which he is best acquainted. Authors from every nation have contributed to this series. Thus we have *Illusions*, by James Sully, dealing with a subject on which the author is a well-known authority—a subject rendered as broad in its views as it can well be made, embracing all that can well come under the head of “*Illusions*,” physiological or psychological. The reader will find some very striking and original remarks in this work.

Sight, by Dr. Le Comte, is an exposition of the principles of monocular and binocular vision, and the author's endeavour to render this book intelligible and interesting to the general reader, as well as profitable to even the most advanced specialist, is highly successful.

Muscles and Nerves, by Dr. J. Rosenthal, is a connected account of their general physiology. In it the reader finds a plain and readable summary of all that has been said or written on muscles and nerves, so that to a physiological student, to whom time is precious, this treatise is invaluable.

Volcanoes, by Professor Judd, F.R.S. We call special attention to this volume, for we regard it as one of the most important yet issued. Nobody is better able to speak on this subject than the author—no one will be more attentively listened to. The clearness of the literary style and aptness of the similes render the study of this little treatise almost a recreation. The woodcut illustrations are numerous and well selected. Every student of physical geography ought to procure this volume, and then get somewhere out of the way in order to read it through at once! All the above works are published by C. Kegan Paul & Co., London.

Vegetable Mould and Earthworms, by Charles Darwin, LL.D., F.R.S. (London: John Murray), is only just out, and it is one of the most readable of the many very readable books of this remarkable man. As far back as 1837 Mr. Darwin read a paper on this subject before the Geological Society, and now we have what is quite a manual upon it, in which are many important zoological, botanical, geological, and archæological side-lights. Clearness of expres-

sion is one of Mr. Darwin's literary characteristics, and this is unusually manifested in the volume before us.

On the Indian Hills, by Edwin Lester Arnold, in 2 vols. (London: Sampson Low & Co.). The author of this attractive and most ably written work in an esteemed contributor to our pages, and many of our readers have already made acquaintance with him unknowingly. They will therefore be prepared to expect in such a work as the present a good many original natural history observations over and above the subject matter of the book itself, and they will not be disappointed. Whatever may be the special object of a man in writing a book about another country, the fact that he has open eyes for all the natural objects around him predisposes us to think that his reflections on the main object will be all the more correct on that account. Mr. Arnold really relates his short experience as a coffee-planter in Southern India, but he is a cheerful portrayer for non-voyagers of the different scenes which struck him on the way out. The descriptions of Ceylon and its people, Kandy, and the “*Jungle days*” are quite graphic. “*On the Indian Hills*” is eminently an entertaining book, and one that cannot fail to establish a literary reputation for its young and accomplished author.

Sea Mosses, by A. B. Hervey, M.A. (London: Trübner & Co.), is a work concerning which we have no fault to find except that its name is likely to be misleading. For the book really is a collector's guide and introduction to the study of marine Algæ. The present is an English edition of an American work. It is illustrated by twenty exquisitely coloured plates of sea-weeds (nearly all of which are also British), and it is altogether a most attractively got up work.

Gardens and Woodlands, by Frances Jane Hope (London: Macmillan & Co.), is a memorial volume, consisting chiefly of reprinted papers by the deceased lady from the *Gardeners' Chronicle*, &c. The papers are eminently readable, and display much botanical knowledge and horticultural taste.

A Pocket Guide to British Ferns, by Marian S. Ridley (London: David Bogue), is exactly what its title-page professes it to be—a somewhat rare occurrence. In spite of the numerous popular works on ferns, there was room for a little manual of this kind. The student will find that all the peculiarities of each species of fern are tabulated, so that the mind can perceive them at a glance. It is just the book to take in one's pocket when out fern-collecting.

Rambles of a Naturalist round Folkestone, by Henry Ulyett, B.Sc., F.G.S. (Folkestone: J. English). This handsome little volume (also by an old contributor to our pages) gives a pleasantly written description of

the geology, zoology, botany, entomology, &c., of the country around Folkestone, and also contains lists of plants, lepidoptera, birds, land and fresh-water shells. A few of the papers have been contributed to SCIENCE-GOSSIP, and all form a very bright and attractive book, which does much credit to the author, and supplies the scientific tourist with a most trustworthy guide to a well-known and much frequented locality.

Among the Rocks round Glasgow, by Dugald Bell (Glasgow : James Maclehoze), is another well got up little book, consisting for the most part of already contributed papers. The title-page is preceded by a very capital, useful, coloured geological map of the district round Glasgow, than which we know of few places where so many things geological are packed in so small a compass. Mr. Bell wrote these papers when acting as secretary to the Glasgow Geological Society, and their reprint is a credit both to himself and the society he represented.

The History of Salt, by E. Marlett Boddy (London: Baillière, Tindall, & Co.), is a small book, whose title, although expressive, hardly gives one a fair idea of the amount of valuable matter it contains. The history of salt is treated geologically, chemically, geographically, physiologically, medically, &c., and in each department Mr. Boddy shows himself fully up to his task. We regard this treatise as a both valuable and compendious enough to place by for further reference.

The Book of the Rabbit (London : "Bazaar" Office) has already been noticed in our columns as the different parts were issued. In the completed volume form it is a very handsome book, and one that will for the future be the authority to be consulted on everything relating to Rabbits.

Dramatic Singing, by Dr. W. H. Walshe (London : C. Kegan Paul & Co.) is a study of the subject from a physiological point, so that listeners at the Opera may be helped to analyse their impressions all the more profitably. It is an excellent treatise on the subject, and deals with it in an original and thoughtful manner.

Deaf Mutism, by Dr. A. Hartmann. (London : Baillière & Co.) This is a translation and enlargement of Dr. Hartmann's work by Dr. J. P. Cassells. It deals with the modern education of deaf-mutes by lip-reading and articulation, and it is hoped that its issue in the present form will help forward the education of English deaf-mutes.

Practical Chemistry, by J. Howard, F.C.S. (London : W. Collins & Co.), is a new and revised edition of one of this firm's Elementary Science series. It is abundantly illustrated with experiments which teachers and students are to perform, and which will lay the foundation of practical chemical knowledge.

JUSSIEUA NATANS: A REMARKABLE ROOT.

By GREENWOOD PIM, M.A., F.L.S.

THE genus *Jussiaea* belongs to the natural order Onagraceæ, or evening primrose family; the species being for the most part natives of tropical swamps.

J. natans resembles both in general appearance and in flower some of the garden forms of *Genothera*, and has nothing very striking about it. It is, however, to the structure of the roots that I wish to direct the attention of readers of SCIENCE-GOSSIP.

They are from $\frac{1}{10}$ to $\frac{3}{10}$ in. thick, and woolly-looking, their tips frequently projecting above the water. On breaking one across, a curious concentric rim structure in the wood is visible even to the naked eye surrounding a small central core, but is much more distinctly seen with a pocket lens.

If we make a transverse section, no easy matter, the root is so soft and yielding, we find that the central core consists of two kinds of cellular tissue, the inner resembling pith cells, but with strong thick walls and no chlorophyll; the outer, more woody in its nature, consisting of large and small cells of nearly circular section, and containing some chlorophyll. Of the outer tier of this layer about every fourth or fifth cell, instead of being nearly spherical, is prolonged into a hairlike process. These long slender cells at a given distance anastomose, not only those arising from each layer of cells, but also those arising from the neighbouring layers. They again separate and again anastomose several times, according to age; the last anastomosis being at the surface of the root, so that these elongated cells form a kind of felt cylinder round the normal portion of the root, having their ends all united into a kind of net. It is these rings of anastomosing points that give the annular appearance before alluded to.

Sometimes we find the root giving off fibrils similar to those of other roots; they arise from the woody portion of the core, make their way out through the felt, and are quite distinct from it. I believe the plant is not uncommon in Botanic Gardens, so that it will not be difficult for any one desiring to examine it to obtain specimens. Small cuttings appear to grow freely in a vessel of water in a warm atmosphere.

Monkstown, Dublin.

THE ELECTRIC LIGHT AT NORWICH.—These lamps are the centre of attraction for entomologists, as there have been some good moths caught there lately, amongst which were three *Sphinx conroversi*. These are usually rather rare moths, but there have been a great many taken this year.—*M. N. S. C.*

NOTES ON THE COMMON DIPPER.

THE Dipper needs no description, as doubtless your readers, who are interested in the subject, are well acquainted with it. It is fast disappearing from the banks of many of our streams. There are various causes at work to bring about this result; and one of these proceeds from the mistaken idea, entertained by many, that the dipper feeds almost entirely upon the spawn of the salmon and other fish. I have

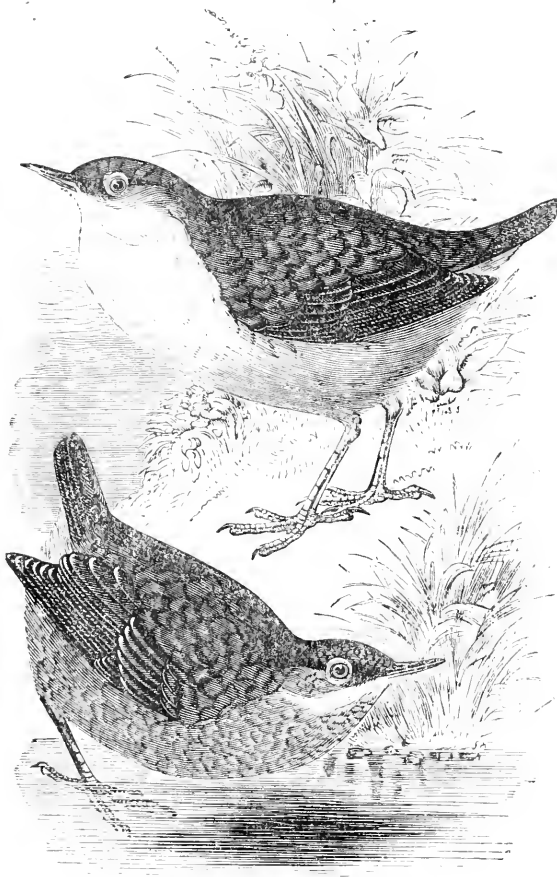

Fig. 143.—The Dipper or Water Ousel (*Cinclus aquaticus*).

found as many as ten nests of this bird along the course of a certain stream, now they have dwindled considerably. I have watched this bird—the water crow of my boyhood—for hours together, in its search for food, have seen it examined after it had had a hearty meal, but never found traces of the spawn or eggs of fish. It may be possible, however, that these tit-bits may quickly be assimilated by this bird, which, like the rest of the bird tribe, has marvellous powers of digestion. The only traces of fish in the crop of one were the remains of a very small minnow. The

crops were generally well supplied with all manner of “creeping,” things taken at the bottom of the stream, mixed with particles of sand. My object in writing is to find from one or more of your numerous correspondents, who may have given this subject their careful attention, what conclusion they have come to concerning this much persecuted bird, and thus be enabled to put forward a strong plea for its preservation. The following quotations will be interesting, as they all bear directly on the subject, and show that naturalists as well as doctors differ.

Montague says:—“The dipper devours a considerable quantity of fishes’ spawn, especially the large ova of the salmon.”

Mudie, in his “Feathered Tribes of the British Isles,” vol. i. p. 281, has the following:—“The food of the dipper is water-flies, water-larvæ, water insects, worms, the dragon flies, water beetles, and, in short, a variety of animals and animal matters found in the waters. The fry of the trout and salmon, while still in their cradle pools, numerous as motes in the sun, and each not an inch long, form a supply for it and its young while these are in the nest.

“This harmless frequenter of our brooks, has of late been accused of devouring salmon spawn, and in some quarters has been doomed to the fate of all ‘vermin.’ A few years ago I examined specimens that were killed, because they were feeding on the spawning ground of the salmon in North Tyne, and found that their crops contained nothing but aquatic insects and their larvæ; no trace whatever of spawn could be detected. In fact, the insects upon which our poor doomed friend had been feeding were much more likely to destroy fish spawn than it was.”—Hancock, in the “Natural History Transactions of Northumberland and Durham,” p. 62.

“The food of the dipper consists of small fishes and insects.”—Bewick, “British Birds,” vol. ii. p. 116.

“Various water insects, small freshwater shell-fish, and beetles, and the larvæ of these, with occasionally, *perhaps*, fry and spawn of fish, are its fare. It also swallows a little gravel, to aid the digestion of its food.”—

Morris’s “British Birds,” vol. iii. p. 33.

The “perhaps” in the above quotation implies doubt.

Thomas Edwards, the Banff naturalist, remarks: “Every means has been put in requisition to destroy this little bird (the dipper). It was abundant thirty years ago; but it is now rarely to be seen. It was supposed to destroy the young salmon, hence it has been shot down wherever found. But I have never as yet found anything appertaining to fish in its stomach, and I have dissected about forty; water-insects and

their larvæ being what I have most frequently observed."

Varrell, in his "British Birds," vol. i. p. 195, says that he never saw the bird alive; but he quotes Mr. Macgillivray, who declares that he examined the contents of the stomach of the dipper on various occasions, and found only beetles and the animals of freshwater shells, belonging to the genera *Lymnea* and *Ancylus*, &c.

R. D. KERR.

HISTORY OF THE PEAR-TREE (*PYRUS COMMUNIS*).

By H. G. GLASSPOOLE.

THE pear as a fruit stands next in popularity to the apple, and has, like it, been known and cultivated from time immemorial. It is mentioned by the earliest writers as a fruit growing abundantly in Syria, Egypt, as well as Greece, and it appears to have been brought into Italy from these places about the time that Sylla made himself master of the latter country (68 B.C.) and from thence it spread over Europe to Britain. Homer mentions the "pendent pear" as one of the fruits of the orchard of Laertes (*Odys.* 24 B. 289 l.). Theophrastus often speaks in praise of them and of the great productiveness of old pear-trees in his works. That learned physician of ancient times, Galen, considered pears as containing in a greater degree more strengthening and astringent virtues than apples. The Greeks and Romans had several kinds of pears whose names included their taste and form. Pliny describes about forty varieties cultivated in Italy. Of all pears, he says, the *Crustumine* is the most delicate and agreeable; this fruit *Columella* places first in his catalogue. Then there was the *Falernian* pear, which was esteemed for its abundant juice, which Pliny compares to wine. The *Tiberian* pears were so named because they were the sort *Tiberius* the emperor preferred, and they grew to a larger size than most pears; others were named after the persons who had introduced or cultivated them. Some, Pliny tells us, are reproached with the name of proud pears, because they ripened early and would not keep. There were also winter pears, pears for baking, etc., as in the present day. Nevertheless, Pliny did not consider this fruit in an uncooked state good for the constitution, for he states all pears whatsoever are but a heavy meat, even to those in good health, unless boiled or baked with honey, when they become extremely wholesome to the stomach. Some pears were used as a counter-poison against venomous mushrooms; the ashes of the pear-tree wood were also used for the same medical purpose. The ancients appear to have had a curious notion respecting the effect of this fruit on beasts of burden, for Pliny tells us a load of apples or pears, however small, is singularly fatiguing to them; the

best way to counteract this they say is to give the animals some to eat, or at least show them the fruit before starting. Virgil speaks of pears which he had from *Cato*.

At what period the cultured pear was first brought into Britain we have no account, but we may believe that the Romans did not neglect the propagation of this fruit when they were masters of the country, and that in after times the monks paid great attention to its varieties. There is a tradition that King John was poisoned with a dish of pears by the monks of *Swinstead Abbey*. The poet *Chaucer* mentions this fruit in the *Marchantes Tale*, v. 1035. In the reign of Edward III. we are told by *Fosbrooke* that *Lord Berkeley* sent a dish of pears from Berkeley to *Ludlow* to his mother-in-law *Lady Mortimer*, "pro novitate fructus" (vide *Fosbrooke's* "Berkeley Family"); perhaps these were some new variety introduced at that period. In an old book of the household account of Henry VIII. there is an item of 2*l.* to an old woman who guff the kyng peres, and another of 3*s.* 4*d.* for warders and medllars. Sir T. Elyott who wrote his "Casket of Health" in this monarch's reign (1541), says peres are moche of the nature of apples, but they are heuyer, taken after meate rosted or beaten they are not unwholsome. The warden, or baking pear, so named it is said from its keeping properties, is one of the oldest known varieties. Mrs. B. Bernard, in "Our Common Fruits," tells us, that it was extensively cultivated by the "monks of old." An ancient medical authority affirms that "the red warden is of great virtue to quench choler," but as this authoress says, it "would be libellous to suppose that cloistered serenity would itself require the fruit on this account. Imagination is free to picture the benevolent recluses sending round a basket of pears to any notedly fiery spirits in the neighbourhood as modern good people might distribute a bundle of tracts."

William Bulleyn, who lived during the reigns of Edward VI. and Mary, in his "Doctor's Book of Simples," writing on pears, says, "There is a kynd of peares growing in the city of *Norwich* called the *Blackfriars* peare, very delicious and pleasant, and no less profitable unto a houte stomache, as I heard it reported by a ryghte worshipful physician of the same city called *Doctour Manfield*." Other pears too are mentioned, such as have names "a peare *Robert*, peare *John Bishops* blessing," with other pretty names.

Gerard enumerates several kinds of "tame peares," and also mentions some called *choke* pears, but he adds, "to write of this fruit and of apples would require a particular volume, every country hath its own peculiar fruit; myself knowe some one curious who hath in one piece of ground, at the point of three-score sundrie sorts of pears, and those exceeding good, not doubting but if his mode had been to seek after multitudes he might have gotten together the like number of these worse kindes. Master *Richard*

Pouter," he says, "has them all growing in his grounds, at a small village called Twickham, neere London, who is a most cunning and curious grafter and planter of all manner of rare fruits, also in the ground of an excellent grafter and painful planter, Master Henry Banbury, of Touthill Street, neere unto Westminster, and likewise in the ground of a diligent and most affectionate lover of plants, Master Warner, neere Hornsey Down, by London, and in divers other grounds about London." The Katherine pear was considered the best in Gerard's time and stood at the head of his list, as *Pyrus superba sive Katherina*. It is a small brilliant-coloured but ill-flavoured fruit which is occasionally met with in the present day in old orchards and also seen in the markets, as it ripens early. The bright colour furnished an illustration to the poet Suckling; in his ballad upon a wedding, he compares the streaks of red on the lady's cheek to those on

A Catherine pear
The side that's next the sun.

And the schoolmistress of Shenstone speaks of the lovely dye of the Catherine pear.

(To be continued.)

ON ACCESSORY BUDS.

By JOHN GIBBS.

ACCESSORY buds have received less attention from botanists than the frequency of their occurrence would lead us to expect, or than their importance in the organic structure of plants makes them deserve. That more than one bud sometimes appears in the axil of a leaf, is a fact with which it is easy to become familiar. In a vigorous young stem of the common bramble we may often find two or three buds in one axil, the uppermost being most vigorous. When they grow into branches, as often comes to pass, before the leaf to which they are axillary ceases to be green, the second and weaker branch comes under the first. In *Galium Aparine*, where two opposite leaves have buds in their axils, neither of them is limited to have only one bud, but a second branch may be frequently seen growing under the first. So it is with the pimpernel and many herbaceous plants, whether annual or perennial. The growth of several buds from the same node of a stem does not often give rise to fasciation of the branches, because of the subordination which prevails among them, one of the buds being always forwarder and stronger than the others, usually, but not always, that which is uppermost. Every plant seems to have a law of its own for these matters. When several buds are on a level they differ in character when developed, as in the pumpkin plant and other sorts of gourd, which have three buds in each axil, one of them commonly opening into a flower, another growing into a leafy branch and the third becoming a tendril. When, as

now and then happens, two of them are flower-buds they tend to cohere by their pedicels, or, it may be, by their ovaries. A gourd plant with no tendrils may have a second leafy branch instead. The stinging-nettle when in flower, has branches growing in the axils of its leaves, and the inflorescence comes on each side of these axillary branches, as if the stipules were bracts, each subtending a flower-stalk. In the black horehound and other labiate plants the inflorescence (an axillary cyme or fascicle) takes precedence of the leafy branch, which may be often found below it as developed from an accessory bud. On plants with indefinite inflorescence it happens now and then that, instead of a solitary flower in the axil of a leaf, there are two or three. The best botanists have been bewildered by such incidents and imagined that they had to deal with a contracted cyme, inasmuch as the flower that was uppermost expanded first, and that below it afterwards. But in a contracted cyme we may observe diminutive bracts, which are seldom wanting from the stalk which bears a solitary flower, but is capable of branching. The stalk that bears a single flower in our wild convolvulus or bindweed represents that which bears three, five, or seven flowers in our cultivated species of *Ipomœa*, and its true character appears in the pair of bracts, which are never missing from below the flower unless they be converted into leaves, when the flower becomes terminal. In the common money-wort or the yellow loosestrife, on the contrary, when a flower appears below another flower in the same axil, there is no bract upon the stalk. When three flowers blossom in the axil of one leaf, as is the case with a sort of *Lysimachia* that I have only seen in cultivation, and which may possibly be a garden variety, the second and third flowers do not grow on opposite sides of the first, but below it, and the third is below the second. Recognising the true character of these accessory buds we perceive the constancy with which plants of the order Primulaceæ adhere to the characters of indefinite inflorescence, not having a central flower in the umbel of a cowslip, nor a contracted cyme in the axil of a leaf of *Lysimachia*.

If it had one of these forms of definite inflorescence we might expect to find the other within the limits of the order.

In the order Onagraceæ the inflorescence is as constantly indefinite as in that which contains the primroses. The great hairy willow-herb bears flowers which may seem to be terminal because the first of them opens before the top of the stem which bears many more has grown above it, but any one who examines the plants later in the season will find the arrangement of their flowers identical in *Epilobium hirsutum*, in which one or two flowers blossom at a time, and *E. angustifolium*, in which a handsome spike of flowers is in bloom at once. The fuchsia, being a plant of the same order, also has axillary flowers, but when an accessory bud appears, as it

will sometimes, it does not go to puzzle botanists by imitating the centrifugal expansion of a cyme, but the accessory bud appears above the principal, the second flower is higher than the first, and commonly smaller, it may be, with three sepals, a like number of petals, and six stamens instead of eight.

In plants with definite inflorescence accessory buds may play a part as prominent and, to the eyes of superficial observers, as misleading. The unilateral flowers of the periwinkles would probably long ago have been recognized as truly terminal, if it were not for a bud in the axil of the leaf opposite a flower; from which it was inferred that a flower-bud occupied the axil of one leaf and a leaf-bud that of its fellow opposite, which seemed a much more equitable arrangement than if the flower were the true summit of the stem with two leaves below it, one of them having nothing in its axil, and the other having, first, a leaf-bud grown into a branch apparently terminal, and a second or accessory leaf-bud not elongated but yet visible. A comparison of different species of periwinkle may satisfy us that such is nevertheless the case. In the lesser periwinkle, *Vinca minor*, it sometimes happens in early spring before the first of April that the true position of the flower is revealed, not only by a stem which bears a flower opposite a solitary leaf, and therefore certainly terminal in the estimation of botanists, but by an occasional instance in which a flower appears on the top of a stem which is forked below it by the growth of a branch in the axil of each of its uppermost leaves, as commonly happens in the chickweed and other species of *Stellaria*. Every cluster of the vine is opposite a leaf, so is every tendril. The peduncle in this case is truly terminal, and the branch which grows beyond it is the development of an axillary bud which the uppermost leaf subtends. Here again a difficulty has arisen from the occasional or frequent presence of a leaf-bud opposite a flowerstalk or tendril. The difficulty disappears when we learn to see in this leaf-bud nothing but what is common to plants which have more than one bud in the axil of a leaf, the first or principal bud growing vigorously, while the second or accessory bud is more weak and backward.

A DAY'S BOTANISING AT HUNSTANTON.

TO the north-east of the little town of Hunstanton, beyond the chalk cliffs, a long ridge of dunes runs along the seashore for some distance, and in an opening in these is enclosed a salt-marsh of no very great extent, but a rich field for botanists.

With the object of exploring this we assembled at the Cambridge station on the morning of the 11th of August, all of course provided with "botanical tins." It was a beautiful morning, but long before we had reached Hunstanton it came on to rain, and all the

rest of the day was wet. And what made it more provoking was that only two of the party had taken umbrellas, all thinking it would be fine.

After dining at an inn just beyond the cliffs (at old Hunstanton) we commenced our tramp in the wet—partly along the top of the dunes, partly behind them. Nothing of any importance was found, although *Cynoglossum officinale*, which was in fruit, happened to be new to one of the party. Had it been fine, our intention was to come down on the marsh at its farthest end and follow it right along, but as it was, we climbed up the sandbank which hid it from our view, and, coming down began to find rare plants at every step. Beside the marsh, on the side farthest from the sea, of course: *Sueda fruticosa*, stem shrubby at base; *S. maritima*; *Armeria vulgaris*, *Atriplex portulacoides*, leaves nearly white, perennial; *Frankenia levis* was found by only one of the party. Going on to, and then crossing the marsh, which, though very wet, is not treacherous, we found *Statice Limonium*, making the marsh purple with its beautiful panicles of purple flowers; *S. auriculifolia*, leaves smaller; *S. reticulata (caspia)* a smaller plant, with many flowerless branches to its inflorescence; *Triglochin maritimum* growing thickly in places, its tall and now brown spikes being very conspicuous, though the other species, *T. palustre*, which is said to occur, was not found. The little *Sedum Anglicum* was growing in places. The rain prevented our devoting so long to the various species as we should have done otherwise, so we merely got our specimens as rapidly as possible, and then returned by the sandbanks nearer the sea, finding on our way such maritime plants as *Eryngium maritimum*, *Salsola Kali*, *Salicornia herbacea*, *Arenaria peploides*, *Carex arenaria*; we did not, however, look up the carices. I found a good "razor shell" (*Solen ensis*).

From the inn, I returned by the foot of the cliff of which the geology is most interesting, a peculiar red chalk forms the lower part of them. But we had no time to devote to this, and the only geologist of the party had given over his hammer to one of the others and spent the rest of his time on the mussel beds, hunting for shells, I believe.

In the hope of finding microscopic objects I had provided half-a-dozen corked tubes, which I hurriedly filled with diatoms from the numerous shallow pools on the marsh. Each tube contained different forms of free Diatomaceæ which I have few opportunities of procuring; some were very beautiful. I filled one from the "sand ripples" on the seashore.

Entomology was, of course, quite out of the question. The frequent excursion trains make Hunstanton easier of access than it would otherwise be. Let us hope that the rarer plants will not be exterminated after the manner, alas! too usual.

GEORGE H. BRYAN.

Cambridge.

MICROSCOPY.

A MANUAL OF THE INFUSORIA.—By W. Saville Kent, F.L.S. (London: David Bogue). Part v. of this work has just been published. Only another part remains to complete what all zoologists and microscopists will agree in saying is perhaps the finest work of its kind ever offered to the public. Mr. Kent treats in detail of the different orders and genera, and describes all those species which are figured. The life histories of many of the species are carefully traced. The interesting genus *Vorticella* is treated upon at great length. The eight plates which accompany this part contain nearly three hundred highly finished illustrations of different species of Infusoria, in all the discovered stages of their development.

THE MICROGRAPHIC DICTIONARY.—Parts ii. and iii. of the fourth edition of this invaluable work have just been issued.

THE "JOURNAL DE MICROGRAPHIE."—This excellent French microscopical journal now appears more regularly than heretofore. The parts for July and August contain some capital articles on "Unicellular Organisms," "Observations on Certain Species of Saprolegniaceæ," &c. The "Revue" is a special feature in this journal, and is written by the editor, Dr. Pelletan.

BUBBLES IN GLYCERINE JELLY.—These are probably due to the elasticity of the object which the pressure upon the cover glass having been removed, has gradually elevated it. The remedy is either to use a cell or to use little or no pressure. If the jelly is kept fluid for a short time the cover will sink down until it touches the elevated part of the object; the slide should be placed in a moderately warm and dry place, and kept there some time before cleaning off the superfluous jelly.—*F. K.*

HOW TO OBTAIN FORAMINIFERA FROM CHALK.—I should be very much obliged for information as to the best method of obtaining foraminifera and diatoms from chalk and clay and limestone.—*Ilickin.*

ZOOLOGY.

EROSION OF SHELLS.—Although much has been written concerning the erosion of shells, I beg to offer the following suggestion. It is well known that one function of the epidermis is probably to protect the limy portion of the shell from chemical action. Now it appears to me that if the epidermis is scratched or ruptured, by mechanical or other causes, the calcareous layers of the shell would be laid bare to the action of any acids occurring in the mud or

water, just as in etching the acid only acts on the copper where the wax has been removed by the etching needle. I have before me some specimens of *Anodonta cygnea* from a brook a few miles from Godalming, which are so deeply eroded, that they appear as if eaten into by a small slug or worm. When first taken out of the water, many of the shells had small dark hemispheres which appear to be organic; I do not know whether they are animal or vegetable, but I believe they help to rupture the epidermis. In some of my specimens the nacre is all laid bare towards the hinges of the shell. Perhaps it is only fair to add that I have seen old window-glass eaten into in a similar manner. In this case a small fungus I believe originates the point of attack. I have remarked in the stagnant pools where small shells are exceedingly abundant, dead, or bleached shells are comparatively speaking of rare occurrence, so I take it the shells are soon dissolved after the death of the mollusca.—*H. W. Kidd, Godalming.*

CORMORANTS.—In reply to J. H. H.'s query at page 210, I quote Thompson's "Natural History of Ireland," vol. iii. page 240: "In the middle of June 1833, some (cormorants) appeared about Lough Neagh, in the vicinity of Ram's Island, and when visiting the lake on another occasion, I was told that a species of cormorant had bred on Scawdy Rock—a low ridge—between Toome and Shane's Castle. This is very improbable, and may have been imagined from the circumstance of the birds being seen there during summer." My own experience is that there are several places in Lough Neagh—the largest freshwater lake in the United Kingdom—where numbers of cormorants are to be found "at home" night and day, all the year round. There are certain shallows where fish abound, and where the stones are exposed in summer. There is a small stony islet covered with brushwood, called Croghan, three-quarters of a mile from the shore at my glebe, where the fishermen tell me their nests have frequently been found. The last I knew of was in 1876, they may have bred since in the same place, as the birds are as numerous as ever, but latterly the operations of egg-stealers have all but obliterated the nesting of the larger birds of our Lough. There is a further reference in same vol. of Thompson to cormorants breeding in freshwater haunts, notwithstanding the belief of the country people that "they would die if they could not get a drink of salt water within the twenty-four hours." At page 244, "Upon an island in a freshwater lake at Castlemartyr, co of Cork, the seat of the Earl of Shannon, the game-keeper reckoned more than eighty nests of the cormorant on Scotch fir-tree's not less than sixty feet in height, about the year 1833." The authority for this is given in a foot-note as "Proceedings of Zoological Society of London, 1847," page 97.—*H. W. Lett, M.A.*

"THE BUTTERFLIES OF EUROPE," by Dr. Lang.—Part IV. of this beautiful work is to hand, containing four exquisitely-coloured plates of the caterpillars and chrysalides.

"MONTHLY NATURAL HISTORY NOTES."—Edited by F. J. Rowbotham. No. 10 of this neatly got up and well-edited periodical has just appeared.

SPHINX CONVULVULI.—A specimen of this fine moth, comparatively rare so far north, was captured at Maulesdan, Forfarshire, on the 29th of August, having made its way into the kitchen of a house—much to the confusion of the Scotch domestics, none of whom dared touch the "dreadfu' looking beast with twa or three stings aneath its wings." There are two of these moths in the possession of the Dundee Naturalists' Society, but the present insect is larger than either, more rounded at the tail, and the brown streaking on the body darker than usual.—*Edwin Lester Arnold.*

SPHINX CONVULVULI.—This moth appears to have put in an unusual appearance in various parts of England this year, but particularly in the eastern counties. I had three specimens, male and female, brought to me in one week at Ipswich.—*J. E. Taylor.*

"THE STATE AND HIGHER EDUCATION."—This is the title of an elaborate address recently given to the Minnesota Academy of Natural Sciences by Professor N. H. Winchell.

SCIENCE IN THE PROVINCES.—The Proceedings of the Nottingham Literary and Philosophical Society for the Session 1880-1881 has just appeared, containing an address by the President (Dr. T. A. Stephens) on "The Disposition of the Dead;" on "Preparation of Rock Sections for the Microscope," by J. H. Jennings; "Notes on the Names of the Natives," by S. D. Walker; "Ancient and Modern Oratory," by J. K. Wright; "Rise and Progress of Philosophy," by J. Glendinning; "The Permian Formation in the North-east of England," by E. Wilson, F.G.S.; "Youlgreave Church," by S. D. Walker; and on "Arbor Low," by A. H. Scott White, B.Sc., F.G.S., &c. The latter paper is illustrated.

THE Haggerston Entomological Society held their Annual Exhibition of Lepidoptera (Life Histories, &c.), Coleoptera, and other orders of natural history, at the schoolrooms of All Saints' Church, Haggerston Road, E., on Friday, October 1, 1881.

A PRELIMINARY meeting of those interested in the formation of the Beverley Field Naturalists' and Scientific Society was lately held at the Assembly Rooms, Norwood, and in spite of the inclement weather, the number of those present, who were subsequently enrolled as members, was very gratifying. The two main objects of the society are, to

acquire a scientific knowledge of the district, and to encourage the study of natural history, for which purpose, sections, embracing zoology, geology, botany, conchology, entomology and microscopical research, are being formed. The society purposes to hold regular fortnightly sances for the reading of papers by members, discussions, and exhibition of specimens, and those who have not yet had the opportunity of signifying their intention of becoming members are requested kindly to send in their names at once, either to the hon. sec., Mr. J. D. Butterill, St. John Street, or to the hon. treasurer, Mr. F. Mills. The first general meeting was held on the 5th of October.

ASSISTING NATURALISTS.—I think, by his remarks in the October number, Mr. G. H. Bryan has rather misunderstood one object at least of "Our List," which was (as mentioned by me when I first suggested it in your columns some two years ago) to compile a sort of directory of local naturalists: that is, persons willing to afford to one another and to others desiring it, information regarding the natural history of their district, and to exchange specimens, &c. This idea was expanded by Mr. Hobson of Sheffield, who asked for the names of specialists willing to assist beginners in their several departments, as well as localists (if I may coin a word to express my meaning). This may have deterred some from sending in their names, who, while quite able and willing to give much valuable local information, did not feel justified in setting up as professors of any special subject. While I quite agree that a list of specialists willing to impart knowledge to learners would be most valuable, I still think a directory of local naturalists quite a desideratum. To prevent confusion I think it would be well to publish a full complete list of the naturalists who have already sent in, and any others that by reading this may be induced to give their names. If it will facilitate this, as your valuable time is much engaged, I shall be glad to receive before the 31st of December a postcard from any local naturalist willing to allow his name to be published, giving (1) full name and address with county; (2) Branch of natural history, it being understood that these naturalists will give information on local topics only to any visitor or correspondent. I hope to be quite inundated with postcards, for surely none but the veriest tyros need be deterred from joining the list. I will then classify the names and send you a tabulated list to be published in February 1882, which might afterwards be republished annually with corrections. If this plan succeeds a list of specialists might be prepared in the same way.—*Arthur D. Melvin, Madresfield, Great Malvern.*

THE EIDER DUCK.—Three specimens of this duck (*Somateria mollissima*), including both sexes, were shot on the river Orwell, near Ipswich, on the 11th of October last.

THE BLACK-HEADED GULL.—I have no doubt Mr. Gurney is correct in his statement in your September number that the common black-headed gull and the American laughing gull are respectively (zoologically) named *L. ridibundus* and *L. atricilla*, but it is, I think, very curious that the word *ridibundus* should be used to denote "black-headed" and *atricilla* "laughing"—their respective meanings being reversed. It looks as though zoological Latin had become somewhat mixed.—*J. D.*

S. CONVULVULI.—On the 8th of September I took a specimen of the convolvulus hawk moth (*Sphinx convolvuli*) evidently just out of the pupa. This is the first time I have heard of this moth being taken in Hull.—*H. Slater.*

BOTANY.

MALE AND FEMALE FLOWERS OF HOP.—Climbing up the front of the station buildings here (Paddock Wood, Kent) is a hop-plant, which bears both male and female flowers. Each branchlet of the panicles is tipped by a female cone, which develops into a more or less perfect hop; the remainder, and by far the majority of the flowers, being male. I find by inquiring among neighbouring growers that such a plant has been seen but rarely, and is not likely to be encouraged, as being valueless from a commercial point of view. I should be glad to know whether it is recognised as a distinct species, and also, whether in the case of the normal female plant, fertilisation of all the cones can possibly occur, seeing that the proportion of male to female plants is very small (many growers planting none), and if fertilisation does not occur, how the great enlargement of the "hop" is to be accounted for.—*M. E. Pope.*

WHITE BARTSIA ODONTITES.—Is *Bartsia O.* with pure white corolla common? Colonies of dozens of plants flourished this year on the roadside north of Lurgan. The ordinary red-flowered plants were abundant close by, but were not mixed with the white variety. A few years ago there were several cuttings of hills through boulder clay at the locality.—*H. W. Lett, M.A.*

PLANT-LORE.—Some two or three years ago, when living at Weston-super-Mare, I happened to need a few roots of the early orchis (*O. mascula*), and knowing that it grew plentifully at some little distance from the town, I asked some of the country people, who were often coming to the house with garden produce, &c., to bring me a few. But they none of them knew what an orchis was. I tried to explain in various ways, but without success, till I procured and showed them a flower. "Oh," said they, "we call them *stannen-gusses*;" and they seemed to know them by no other name. The orthography of course

is my own, but it represents the word used as nearly as I can put it. It would be interesting to know whether the plant goes under this name in other parts of the country, and what may be the origin and meaning of the word. Perhaps some of your correspondents can throw light upon it.—*G. N. Widcombe, Bath.*

GAELIC NAMES OF PLANTS.—Mr. John Cameron is continuing his important papers in the "Scottish Naturalist" on this subject.

THE FLORA OF DERBYSHIRE.—The Rev. W. H. Painter has now concluded his papers in the "Journal of Botany" on this subject. The lists are very complete, and give full references to authorities, &c.

STAMENS WITH DOUBLE FUNCTIONS.—Dr. F. Müller has discovered in a species of Heerin (belonging to the Melastomaceæ) found in the Brazils, that the flowers had two sets of stamens, possessing different functions. One set is distinguished by having short filaments and yellow anthers, and the other by their long filaments and red anthers, the latter being also the colour of the petals. The stamens are so arranged that insects plundering one set of anthers are sure to have their bodies dusted with the pollen of the other set.

HYDROCHARIS.—In June I went to some brick ponds near here and brought back some *Hydrocharis Morsus-rane* for my aquarium. Since that time I have observed that when one leaf is detached from the whole plant, that leaf will soon form roots, &c, and make another plant; which will produce another or more in the same way should one of the leaves become detached. I have never seen this remarkable peculiarity noticed. I should like to know if any other person has observed it. I have also noticed that the *Lemnas* sometimes attach their thread-like roots to the long petiole of the *H. Morsus-rane*.

FLORA EUROPEA.—I shall be much obliged if one of your numerous correspondents will inform me of the meanings of the following abbreviations in Rabenhorst's "Flora Europæa Algarum:"

"v.v."	—Page 33, line 8, vol. i. (Diatoms).
"v.s."	,, 33 ,, 14 ,, ,,
"a.m."	,, 33 ,, 23 ,, ,,
"n.v."	,, 34 ,, 17 ,, ,,
"v.ic."	,, 39 ,, 27 ,, ,,
"v.i."	,, 107 ,, 24 ,, ,,

THE SILVER SWORD PLANT.—In *Scribner's Monthly* for June last there appeared an interesting account of a visit, by Constance F. C. Cumming, to what is probably the largest extinct volcano in the world: Haleakala in the Hawaiian group; the crater being at least 20 miles in circumference and upwards of 2000 feet deep. At certain spots in it is found a beautiful plant known as the silver sword, which has the appearance of being made of finely

wrought silver, and bears a blossom like a purple sunflower. Can any of your readers, either here or in America, give the writer any further information as to the botanical name of this beautiful plant, which would doubtless prove a valuable acquisition to our conservatories, if not already introduced?—*J. F. Cranswick, Leeds.*

“THE FIG, THE MULBERRY, AND THE QUINCE.”—This is the title of a shilling *brochure* written by Mr. D. T. Fish, the well-known horticulturist, and issued at the “Bazaar” office. It deals with the history, varieties, cultivation, and various diseases of these little-cultivated plants.

CONTRAST BETWEEN THE COLOURS OF FLOWERS AND FRUITS.—A brief reply is due to the friendly critique of your correspondent Mr. Hanson, which appeared on page 143, on the article in a previous number, with the above title. It has always been understood by myself that seeds with an indurated testa, do pass through the intestinal canal of animals, with the embryo in most cases uninjured. In confirmation it may be mentioned that as a rule, in proportion as the size of a seed is increased, so is the density of its closely investing covering, by which the embryo is preserved from injury by the masticatory and digestive organs. As an illustrative series may be mentioned the seeds of blackberry, currant, gooseberry, grape, hawthorn, cherry, sloe, damson, and plum. Your correspondent, however, has arrived at a different opinion from his reading of the “Origin of Species,” or at any rate that it “has held true only to a very limited degree.” Reference is particularly directed to the chapter on Geographical distribution, for which my best thanks are due, as it had escaped my attention. From this chapter as it appeared in the latest edition of the work, the following sentences are extracted, “Living birds can hardly fail to be highly effective agents in the transportation of seeds . . . I have never seen an instance of nutritious seeds passing through intestines of a bird, but hard seeds of fruit pass uninjured through even the digestive organs of a turkey.” “But the following fact is more important: the crops of birds do not secrete gastric juice, and do not, as I know by trial, injure in the least the germination of seeds; now after a bird has found and devoured a large supply of food, it is positively asserted that all the grains do not pass into the gizzard for twelve or eighteen hours. A bird in this interval might easily be blown to the distance of 500 miles, and hawks are known to look out for wild birds, and the contents of their crops might get readily scattered.” Surely the above extracts warrant one in assuming that Dr. Darwin believes, both that the hard seeds of succulent fruits pass uninjured through the intestinal canal of birds, and that these are effective agents of the distribution of such seeds. These views are entirely in accordance with the suggestions thrown out in the

article on “Contrasts of Flowers and Fruits” which appeared in the April number of SCIENCE-GOSSIP; but as the paper in question was rather a seeking after truth than the expression of a matured opinion, it no doubt was wanting in perspicacity, hence your correspondent’s failure in arriving at its conclusions. After a careful consideration of all the facts that have come under one’s notice, the following theory seems most in accordance with them. That in the struggle for existence during a long series of generations, those seeds and fruits that had a tendency to succulence and colour, were most attractive to birds, and that these tendencies were intensified by inheritance and natural selection. It is also worthy of notice that in those fruits that are distributed by mechanical agencies there is a suppression both of colour and succulence.—*J. Saunders.*

GEOLOGY.

THE JOURNAL AND PROCEEDINGS OF THE ROYAL SOCIETY OF NEW SOUTH WALES for 1879 forms a stoutish and official-looking volume of 250 pages, and it is crowded with evidence of active scientific work in many directions. Among others we find the following papers:—“On the Geological Formations of New Zealand compared with those of Australia,” by Dr. Hector; “On the Occurrence of Remarkable Boulders in the Hawkesbury Rocks,” by C. S. Wilkinson, F.G.S.; “On the Languages of Australia in connection with those of the Mozambique and the South of Africa,” by Hyde Clark; “On the Anatomy of *Sistichipora* with a Monograph of the Genus,” by the Rev. J. E. Tenison Woods. The address of the President contains a very lengthy and enthusiastic tribute to the well-known geologist, the late Rev. W. B. Clark, F.G.S.—“the first explorer who proclaimed the probable auriferous riches of Australia.”

NOTES AND QUERIES.

BLACKBIRDS.—We have been much interested in a pair of blackbirds, which have been nesting about our garden for some time. The hen is of the usual blackbird colour, but the cock, which is a fine bird, has on its right side a band of feathers $\frac{1}{4}$ inch wide, and an inch and a half long, purely white. It is on the left side spotted with white, and also has a few similar white spots on the right side, together with the white band. Under the throat the feathers are a light grey, in the shape of a crescent moon, presenting somewhat in appearance the throat of the ring-finch, only the feathers in colour are greyish-white, and do not form a ring round the neck, as in the latter-mentioned bird; the rest of this blackbird’s feathers are perfectly black, as is usually the case. We judge from the movements of the male and female birds, that they still have a nest, though we know not exactly where to find it. In referring to Mary Howitt’s interesting book, “Birds and their Nests,” we find she mentions a singular variety of a

white blackbird occasionally occurring, but we should rather speak of this as a pied one. We send a little sketch to show the appearance of the throat, or rather upper part of the breast.—*Elizabeth Edwards.*

AQUARIUM EXPERIENCES.—Perhaps the following may be interesting to aquarium keepers. I lost several of my carp. They darted about and then went up to the top of the water, kept on one side and ultimately died. My attention was one day called to the fact that a small beetle (I forget name, black, $\frac{1}{2}$ long) had settled on a carp's back and was being frantically conveyed about the aquarium (which in this case is a large bell-glass 22 inches in diameter), and, so far as the beetle was concerned, free of charge. Subsequently I found two of the same beetles enjoying themselves in a similar way, having fastened on to the top of the carp's tail and levying blackmail in a way that would do credit to any far-seeing cannibal. They were eating the carp up by inches; on the principle of take a little and come again. The carp has since died. I found that the boat-fly, or water-boatman, has the same interesting habits, with the slight difference of fastening itself underneath the hapless fish. The sticklebacks were left alone—but all newts disappeared. The beetles and boat-flies are now in an abode of their own, and, for aught I know, eating up each other.—*John Alex. Ollard.*

RARE MOTHS.—Can any reader of the SCIENCE-GOSSIP tell me where I should be likely to come across the following two rare moths, *Canna* and *Neurice*, in the east of England?—*E. P. D.*

HOW LEECHES BREATHE.—In the September number of SCIENCE-GOSSIP, Mr. G. Førdén says that in the leeches "respiration is effected partly by the general surface of the body, but principally by means of special organs, termed segmental organs or respiratory pouches, formed by involutions of the integument." The segmental organs are now generally considered to have an excretory function. In Branchellion there are lobe-like extensions of the integument which may be respiratory, but I think the majority of leeches breathe by means of the skin alone. Huxley gives the following account of the nervous system of the Turbellaria: "The nervous system consists of two ganglia placed in the anterior end of the body, from which, in addition to other branches, a longitudinal cord extends backwards on each side of the body. In some cases, these lateral trunks exhibit ganglionic enlargements, from which nerves are given off; and they may become approximated on the ventral side of the body, thereby showing a tendency to the formation of the double ganglionated chain characteristic of higher worms."—*W. J. B.*

THE MILKWORT.—SCIENCE-GOSSIP, pages 152, 189, 214. Will your correspondents, W. Mower and E. Edwards, pardon my asking if they are quite sure that the specimens of milkwort which they found in flower in the middle of April were *Polygala vulgaris*? As H. E. Watney remarks, the "Gang Floure" generally blossoms much later, but I am well aware that sheltered nooks give wild-flower gatherers many pleasant surprises, and I am putting my query in no quibbling spirit. I write chiefly because I want to hear of new localities for a species, or variety called by some botanists *P. calcarea*, and because I want to call attention to it as I know it is often overlooked. This polygala is in its perfection of beauty in April; at any rate I have found it in large quantities in Hampshire during that month. It is very distinct

from *vulgaris* when closely examined. The Rev. C. A. Johns, in his "Flowers of the Field" (a book to which I owe a deep debt of gratitude), says it differs from the ordinary milkwort "in having the lower leaves tufted," and in "blunt calyx wings which are differently veined," also, in "ceasing to flower almost before the common milkwort begins." Are W. Mower and E. Edwards quite sure that the flowers which they gathered in April were not those of *Polygala calcarea*?—*S. A. Bridges.*

THE EXTINCTION OF RARE PLANTS.—Having read the remarks by Mr. T. G. Harris on the above subject, I should like to back him up in any plans for the furtherance of the protection of plants. But while deploring these wholesale depredations, I would also point out that some safety and reliance may be placed in the ignorance of these rapacious vendors of plants, for some few weeks ago an advertisement appeared in the "Bazaar" offering the are man-orchis (*Aceras anthropophora*) at a very low price per dozen. On the arrival of a dozen they were nothing else than the common tway-blade (*Listera ovata*). At the same time, some movement is necessary to prevent extinction of rarities, and I think that if some head botanist will undertake to receive suggestions and advice from others, some satisfactory result may be attained, either by the formation of some society or the individual efforts of every botanist in his own locality.—*T. C. Vize.*

A REMARKABLE TREE.—The following is from a letter sent by Thomas de Hoghton, Lieutenant, R.N., of Woffleton Kirk, Ella, Hull, and published in the "Standard" last August (in reference to his report on the Torres Straits Pearl Shell Fishery). "Whilst writing of Torres Straits I should like to mention a somewhat curious tree I saw on one side of the islands there, which, though probably known to science, would, I think, be new to most of your readers. While lying in H.M.'s schooner *Beagle* off the island in question I was told by a white man resident there, that there was a tree there which took bones up to its upper and all its branches, and walking over one afternoon to see this tree, I certainly saw a large tree, I suppose quite thirty feet or more in height, with the extremities of all its branches and twigs covered with bones, apparently adhering to them. My informant told me that as the tree stood close outside some huts, they noticed that bones thrown under it were taken up (by I believe its leaves) in some way, so they always threw bones there afterwards, and the result was the tree was laden with them when I saw it. It was quite impossible they could be placed there by human agency, I think, as many were on the extremes of too slender branches to bear any weight, and I have no reason to doubt the statements of the white men residing on the island; and should Mr. Moff, of Plymouth, son of a warrant officer, residing there, see this, I am sure he would confirm it." Is the above tree known to science?—*J. A. O.*

ADDERS HISSING.—In SCIENCE-GOSSIP (Sept. no.) Mr. Campbell considers that I am incorrect in two cases. As regards the first I most certainly have noticed that adders do most frequently hiss after a warm shower of rain. Perhaps I was too incautious in saying that the hissing of the adder is due only to the creature's joy of existence; but I have observed adders hissing when I feel perfectly sure they were totally unaware of my presence. On several occasions I have noticed this, and when they did not appear in the least put out, if I may use the expression thus. I trust that if I have been in-

cautious, I have done no harm, and must thank Mr. Campbell for correcting me. I can testify that the weasel is found in the west of Ireland, as I shot one myself near the town of Roscommon, co. Roscommon, in August, 1879. I was informed by the gentleman on whose estate I shot it that they are of great use in exterminating rats.—*G. Dewar.*

COLLECTING ON THE NORFOLK MARSHES.—It was a rather dull morning, the latter end of August, that we started from Norwich for a day's collecting on the marshes. As we walked along the lanes leading from Wroxham to Horning, we captured a splendid specimen of *Phlogophora meticulousa* resting on the edge, also *Gonepteryx rhamni*. We also noticed in a meadow near Horning the *Dianthus deltoides* growing very abundantly. At last we got on the river, about 9.30, and at once set off for some marshes about half a mile down, where machæon are very abundant. On our way we landed once or twice and collected some pupæ of the Io, and Atalanta, also a great many larvæ of the same. The pretty little plant, *Drosera rotundifolia*, was very plentiful on the wet marshes. We reached the favourite haunt of the machæon about mid-day, but it was so dull that we hardly expected to get anything; but as we were collecting some pupæ of the Io, we came across two of the machæon fastened to the stem of the marsh carrot. We found a few more common pupæ, but we were obliged to shorten our ramble and return home soaked to the skin, for the rain was coming down in torrents.—*E. W. G. and E. P. D.*

FROG-SPAWN.—Last February I obtained a lot of frog-spawn and put it in a large bell-glass with a few water-plants, but nothing else. They were so well balanced that I have not had to change the water since, only adding for evaporation. When the eggs were all hatched I found the tadpoles very gradually diminishing, until now I have only about twelve left out of a hundred or more. If they are in the habit of eating each other, one would expect to find a youngster going about minus his tail or part of his body; I certainly have not seen this, though I looked closely for it. Would some reader kindly account for their disappearance?—*P. W. A.*

QUERY AS TO SPIDER.—Could any of your correspondents tell me the name of a spider whose web I found to-day in the corner of a window? It was a light yellow colour itself—slight in body, with long legs. It was surrounded by a very strong web which stretched across the angle of the window-frame, enclosing the spider in a roomy triangular house. Up in the corner of the nest was a round ball-like cotton, about the size of a pill. I put the spider out and then opened this ball, out of which rolled small yellow eggs; I counted ninety-four, and think there must have been quite one hundred. I enclose you the little ball in which these eggs lay. Please to inform me if all spiders propagate in this way, or if this one I found is a distinct and uncommon species. An answer in the next number of SCIENCE-GOSSIP would much oblige.—*A Lover of Insects.*

HAIR-BELL OR HARE-BELL.—In the preceding number of SCIENCE-GOSSIP, Mr. Lynn takes exception to my suggestion that hare was an erroneous spelling of some old form of the word hair, as being beside the question. I am now prepared to admit it. I have searched several old Herbals, but have not been able to find that either of the prefixes were employed. Parkinson calls it the blue bell-flower, but this is only the English equivalent of the Latin campanula. Lobel, in his list of English names, also

calls it bell-flower, nor can I find any mention of it in Chaucer or Piers Plowman, nor in the still earlier Anglo-Saxon Leechdoms. It would be interesting to know when it first appeared by either name. I cannot see that Mr. Skeat's book would be likely to help, although it may merit all the praise Mr. Lynn bestows upon it. We do not want the etymology of hare or hair, but only to know which of them was used in connection with this plant. I should be glad to know where and when the s is found attached (Hare's bell) this would settle the matter, as far as the writer was concerned, but I have never seen or heard it called by that name. Our popular names of plants were given 1st, from some resemblance to other objects; 2nd, from their real or supposed medical virtues; 3rd, from the time they first appeared or flowered, and 4th from the partiality (imaginary or otherwise) animals had for them as food. The what may be termed specific name, I quoted from the Kruidtboeck of Matthias de Lobel (not Christoffel Plantyn, he was only the printer), was given on account of the two small tubers at the bottom of the stem. Lobel's synonymy is as follows: "Vosse Cullehyns, *Terticulus vulpinus*. In Franchois, Mouchereus; in Spanish, Satyrion." In English the name I quoted. The plant meant was the butterfly orchis; indeed most of the orchids had similar names, as the foxes, the goats, &c. I think that if any intelligent country labourer was asked why this plant was called hair-bell he would at once reply, from the likeness of the flower stalk to a hair. Mr. Lynn asks for an instance of hare being used for hair. I can give him one, "Hoshare boght hear," this I remember seeing exhibited in a marine-store dealer's window for many years. Since writing the above I have met with a curious instance of a name being given not for the resemblance, but the reverse. Our "go to bed at noon" (*Tragopogon pratensis*) has or had in Holland the popular name of "Joseph Bloem," and is thus called because Joseph would not go to bed at noon.—*F. A.*

SPIDER ROBBED OF ITS PREY.—In a web there were two spiders—male and female—I suppose, and a fly which they had killed. The whole centre of the web had been torn away, and the fly was on the inner edge of what remained. Standing on the fly was a scorpion fly (*Panorpa communis*), busily sucking all its viscera. Once the larger of the two spiders tried to drive away the unbidden guest, but as panorpa threatened to violate all laws of hospitality by devouring his hostess if she interfered, she prudently retired. Do the scorpion flies gain their living as pirates regularly, or is this exceptional?—*A. Dixon, Wye.*

GRASSHOPPERS IN TURKEY.—Turkey, it appears, is overrun with grasshoppers, and the Government has been compelled to adopt very extraordinary measures to overcome the plague. A particularly voracious species has appeared in the Bodirun District (Smyrna), and the whole population is employed to combat the insects. At Angora all business was suspended for three days by order of the Governor-General, and all the inhabitants were ordered to march out into the fields to destroy the grasshoppers. Every inhabitant was compelled to deliver twenty oka (about fifty-six pounds) of dead grasshoppers to the officials. The swarms are said to emanate principally from Persia.

FLUKES.—I believe Clara Kingsford will find all the information she desires under the heads of "Cercaria" and "Trematode Worms" in any modern Encyclopedia. The fluke is said to lay its eggs in the skin of sheep and other animals, but they

find their way out into the wool and there begin a series of changes. I have heard the young of the Trematode Worm called Cercaria, and I have also been told that this worm is the fluke. There are, according to some writers, 344 species of flukes, and they are divided into five families, the *Æstomidae* being one of the number.—*Helen Watney.*

ALBINO FLOWERS.—I have been somewhat struck by the large quantity of albino flowers that I have seen this year. In the spring a large field at Ewias Harold, Herefordshire, was covered to some extent with perfectly white flowers of *Orcis morio*, and white specimens of *Lychnis flos-cuculi*, and *Malva moschata* were for the first time found. *Geranium Robertianum* was also prevalent in the albino state. During a ramble along the shore from Ventnor towards Blackgang, in the month of August, I found some flowers of *S. Dulcamara* quite white, and although dry, they have not altered in colour. Is it not unusual to find this plant with albino flowers?—*George T. Harris.*

SINGULAR POSITION OF SNAILS.—While in my greenhouse the other evening I noticed what appeared to be a large snail spirally twisted, climbing on the woodwork. On examining it, I found that it was two large common tiger snails twisted round one another. From the right side of each of their heads, just behind the feelers connecting the two was a ligature formed of some substance resembling white of egg when boiled! From the extremity of their tails was a connection, formed of a substance somewhat resembling a leather shoelace, the covering of which was striped like their bodies—thus forming a double connecting link; head and tail. You will understand how it occurred, that they were twisted as the head connection proceeded from the right side of both. I immediately (I regret without thinking) severed the connections, when the white substance soon dissolved; the other did not. The snails both seemed no worse for their liberation, and both prepared to walk off. I regret, however, that I killed them. I wish to know if this is not extraordinary.—*J. Ernest Bancroft.* [No doubt the snails were in *cop.*—ED.]

TREE FROGS.—Whilst at Budapest this past July and August I found some beautiful little tree frogs. I have them here safe in a glass case, and at present they are most flourishing. I feed them on flies, but what I should much wish to know is, what can I feed them on in the winter? If any of your readers have kept these beautiful little green creatures, can they give me hints as to their management?—*J. Fitz-Gerald, Folkestone.*

LAMPREYS.—Can any one give me any information as to the best food for these in captivity; also is the character of the pope such as would admit him into an aquarium containing rudd, gudgeon, tench, carp, minnow and bleak?—*Walter A. Pearce.*

INSECT SWARMS.—The article on "Insect Swarms" in SCIENCE-GOSSIP for October has made me search up the accompanying specimens of swarms of insects which prevailed here from 19th to 28th of April, 1881, and the following notes written at the time. I should like to know the scientific name of the creature. The insect, of which specimens are enclosed, is known to the dwellers on the shore of Lough Neagh as the pollan fly, it being a favourite food of that fish during the summer months. The fishermen say that the pollan is not worth eating till it has fed for a few days on the fly. The first ap-

pearance of the insects—they pass the larva state in the water—takes place about the middle of April; round the margin of the Lough they cover the ground and every stone and blade of grass, and cloud the air in millions. Outside the whitewashed walls and windows of my glebe house are dark grey with the little beings, each of which is $\frac{1}{10}$ of an inch long. The piece of paper which I send I covered with paste and laid it against the wall, but it did not take off half the insects that were beneath it; however, though it measures only 5 by 8 inches it has 160 adhering to it. When the air is calm the noise of those which rise and play in clouds is as if the atmosphere were thronged with swarms of bees. I notice that my bees which are in wooden bar-frame hives are greatly annoyed at the flies alighting in thousands on the hives, as evidenced by the bees soiling the alighting board, and instantly killing with their mandibles such as come near the flight hole. The natives of this parish tell me they never before saw them so numerous. They get into everything, one's tea, or milk, or water, or plate at dinner; they have however, while alive, no unpleasant smell or taste, and do not bite or sting: if I open a book I am sure to crush some dozens that instantly creep in between the leaves—and one's eyes have suffered. Some trout I bought were gorged to the gills with these flies. I am glad to say "the plague of flies" lasted but one week, when they died off as quickly as they appeared, and then the smell from the heaps of the dead was most unpleasant for another week.—*H. W. Lett, M.A., Ardmore Glebe, Lurgan.*

VARIETIES OF MOUNTAIN ASH.—On reading the query about this, I looked into my "Ancient and Modern Botanical Authorities," Smith, Withering, Mackay, Bentham and Hooker, but found no mention of any sub-species of *Pyrus aucuparia*. However, after living for forty years amongst "rowan trees," growing indigenously in glen and bog and mountain, I quite agree with your correspondent that there are "three distinct varieties, big, little and middling sizes."—*H. W. Lett, M.A.*

"RAMBLE ON LECKHAMPTON HILL."—As Mr. Melvin appears to know Leckhampton Hill and its floral treasures far better than I do, and as the notes in question were jotted down hurriedly as I went along, I think that very likely Mr. Melvin is right, and that *C. glomerata* was mistaken for *C. rapunculoides*. Did it occur to Mr. Melvin that were his remedy for the preservation of rare ferns applied, the innocent botanist might be mistaken for the guilty collector, and punished accordingly?—*George T. Harris.*

INTERESTING DISCOVERY.—On cutting below a bog in the townland of Tunnabaron, Pomeroy, co. Tyrone, the stones were discovered with the paved road, well worn, 14 yards long, and 2 feet broad, to what is supposed to have been an altar of Druidical structure. Opposite this altar of whin-stone 2 feet square, there was found a stone 2 feet long dish-shaped with a cover, and a similar one to the one side, both cut out of freestone, which is not found in the vicinity and must have been brought from some distance. One of the dish-shaped stones and cover is in my possession.—*Rev. S. Arthur Brennan, Allan Rock, co. Tyrone.*

SCARCITY OF WASPS.—I, like your correspondent John L. Hawkins, Reading, have noticed the great scarcity of wasps in this district. This time (Sept.) last year the grocer's shops in this city were infested with swarms of them, greatly to the annoyance of the grocers and their customers. This year only an odd one is to be seen, and indeed, one grocer's assistant told

me he had only seen two during this summer. I may remark the weather for the past six weeks is much colder than last year.—*R. I. Hayden, Waterford, Ireland.*

THE DOMESTIC ARRANGEMENTS OF SWALLOWS.—This year a pair of swallows built their nest in the wash and brewhouse at Mr. Ford's farm, Blackmore, Haunts (about four miles from the home of Gilbert White). The nest was only about six feet from the ground, and was built on the plate just over the entrance. Other doors communicated with the dwelling-house and dairy, so that the inmates were continually passing near the nest. When the brewing and washing were going on the birds took no notice of the people, nor were they at all alarmed at the steam. They regarded the dog as a friendly individual, but the appearance of the cat always caused consternation. The young birds would crouch down in the nest, and the old ones set up a chatter of alarm which continued as long as pussy was visible. Mrs. Lemmon, the house-keeper, was on the best of terms with the birds. She used to open a door opposite the nest and the birds would at once perch on the top of it, while she would stand close to the door and talk to them. Two broods were reared, five in the first and three in the second. When the young of the first brood were on the wing they came every night to the nest to sleep until the first egg was laid for the second brood, when they had to find other lodgings. The whole family, however, always assembled at their old home on wet days, or during heavy showers. The nest was kept clean by the old birds, who carried away the dung in their beaks, until the young ones were strong enough to keep the nest clean themselves.—*J. Boggust, jun.*

DO PARROTS REQUIRE WATER?—One would think that there could be no difference of opinion among ornithologists or bird-fanciers on such a question as this. Yet J. R. C. S. in your September number says—"Water they do not require"—a statement which Dr. Greene in October marks with a (!) and then says: "To say that parrots do not drink is an absurdity, and to deprive them of water the height of cruelty; why, parrots are nearly always captured by the professional bird-catchers at their drinking-places, to which it is their nature to resort night and morning." Now I myself know nothing about this question, but beg to submit the following paragraph from the London *Figaro* of November 6th, 1880, which I thought very curious at the time. Perhaps some other correspondent can say whether Mr. Bartlett, of the Zoological Gardens, is right or wrong: "Do parrots require water? Mr. Bartlett, of the Zoological Gardens, ought to be a judge, and he says: 'Having during the last thirty years kept many hundreds of parrots under my charge, I can say most positively that parrots do not require water. The valuable collection of birds in the Zoological Gardens, London, the finest in the world, are kept without water altogether.' Yet, Mr. Cross, the well-known naturalist, of Liverpool, has been summoned by the officials of the Society for the Prevention of Cruelty to Animals for sending six parrots from Liverpool to London without water. The magistrates decided against Mr. Cross, though only inflicting a nominal penalty, and we are glad to learn that the case is to be taken by Mr. Cross to a higher court. Our conviction, which is based upon practical experience, is the same as Mr. Bartlett's. But Mr. Bartlett's testimony is in itself sufficient condemnation of the action of the Society for the Prevention of Cruelty to Animals. The supposition that Mr.

Cross would not (if only in his own interests) have supplied the birds with water had he considered it necessary, is simply absurd; it is strange that any one but a jealous rival of Mr. Cross should have gravely put it forward."—*James Hooper, 3 Claude Villas, Denmark Hill, S.E.*

NOTICES TO CORRESPONDENTS.

TO CORRESPONDENTS AND EXCHANGERS.—As we now publish SCIENCE-GOSSIP earlier than heretofore, we cannot possibly insert in the following number any communications which reach us later than the 6th of the previous month.

TO ANONYMOUS QUERISTS.—We receive so many queries which do not bear the writers' names that we are forced to adhere to our rule of not noticing them.

TO DEALERS AND OTHERS.—We are always glad to treat dealers in natural history objects on the same fair and general ground as amateurs, in so far as the "exchanges" offered are fair exchanges. But it is evident that, when their offers are simply disguised advertisements, for the purpose of evading the cost of advertising, an advantage is taken of our *gratuitous* insertion of "exchanges" which cannot be tolerated.

TO MEMBERS OF THE BOTANICAL EXCHANGE CLUB.—It has been decided to wind up the affairs of this club, as the number of members this year is too small to make the exchange of any value. All members who have paid their subscriptions will have them returned (together with their parcels, &c.) on application to our office.

"MUCKROSS."—The gelatinous substance sent is a fine specimen of *Nostoc commune*.

R. LEIGH.—"The Scientific Roll" is published (price 1s.) by Bradbury, Agnew, & Co., 10 Boulevard Street, London, E.C.

MUCKROSS.—The specimen marked No. 1 is *Athyrium Filix-femina, latifolium*, a variety but seldom found. No. 2, *Lastrea dilatata*, not unlike *L. dilatata, collina*; it would, however, be better to take it as the type, or simply *L. dilatata*, for it is very variable. No. 3 is also *Lastrea dilatata*. No. 4 is *Lastrea fanisecti*, or the hay-scented fern. It is always better to gather a selection of the different forms, as you have done.

A. E. L. (Birkenhead).—Your species is one of the Onagraceæ. Could you send a specimen in flower? It would be unwise to name it solely from the leaves.

D. W. (Bury).—The leaves belong to the service-tree. The one large, ovate, is *Pyrus Aria*, L., the other, lobed and cut, and pinnatifid, is the *P. informis*, Johr. (*P. Scamitica*, Bab.) We did not observe the fruit mentioned.

NEMO (Malvern).—It is probably *Allium Schoenoprasum*, L.; but it is impossible to name any plant with certainty, except in flower or fruit. Have you a perfect specimen? If it is the true plant, it is a good find.

F. M. R. (Charmouth).—The species is *T. hybridum* (Alsike). The other is a very interesting example, from its umbellate inflorescence, of floral proliferation.

A. E. LOMAX.—Your specimens and lists have not reached us.

J. B. MAYOR.—The "Insecta Britannica" would answer your purpose as well as any work we know, otherwise you would have to go to great expense.

W. G. W.—You will find the fine collection of cretaceous fossils in the Brighton Museum very handy in assisting you to name your specimens. The new edition of Dixon's "Geology of Sussex" contains numerous plates of chalk fossils. Dana's "Manual of Mineralogy" is the best for your other purpose.

"WINNIE" neglected to pack up the larva carefully. It was quite unrecognisable when it reached us.

T. S. KING.—No specimen of wasp has yet reached us.

A. WALLER.—Your plant is *Linum angustifolium*.

E. M. H.—Your specimen is the first stage in the construction of the nest of the tree wasp (*Vespa Britannica*).

EXCHANGES.

Scirpus carinatus offered in exchange for 1383, 1391, 1403, 1404, 1407, 1410, 1411, 1415, 1417, 1432, 1435, 1437, 1444, 1453, 1456, 1457, 1471, 1474, 1475, L. C., 7th ed.—H. Jones, 45 Doughty Street, London, W.C.

WANTED, to exchange a vasculum suitable for long excursions (size, 20 X 9 X 5) for a smaller one, or useful botanical article of similar value.—George T. Harris, High Street, Steyning, Su-sex.

BRITISH marine, land, and freshwater shells for exchange. Lists sent.—R. Ley, St. Leonard's Lawn, Exeter.

WANTED, specimens, living preferred, of any of the rarer species of spiders, such as green and water-spiders. For microscopists I have hairs (unmounted) of black rat, squirrel, and silver-backed fox.—H. C. Brooke, Sutton Valence Grammar School, near Staplehurst, Kent.

NEW and secondhand books, Christmas cards, illuminating paints (new), &c., in exchange for curiosities of any kind.—Tunley, Albert Road, Southsea.

A FEW British eggs for exchange. Wader's, gull's, and grouse especially wanted. Locality and date necessary.—Robert Miller Christy, Saffron Walden, Essex.

A SMALL quantity of fine butterflies (in paper), caught this summer in Switzerland, including about twelve *Apollo Parnassius*. Wanted, a good half-crown of George I. or Charles II., or other good English coin.—Rev. H. Housman, Chichester.

I WISH to correspond with collectors of British shells—marine, land, and freshwater—with a view to exchanges.—A. Loydell, 10 Aulay Street, Ossory Road, S.E.

NEST and four eggs of K. W. starling, also nest and three eggs of troopole, for other foreign eggs or good English ones.—Geo. A. Widdas, Bond Street, Leeds.

HUMAN skull wanted, complete, and in good condition; also fully-articulated skeleton of dog or cat.—Send particulars to Fred Page, 4 Queensferry Street, Edinburgh.

WANTED, a few aquatic larvae of dragon-flies, and of the whirligig beetle (*Gyrinus natator*), freshly killed, in spirit; also larvae of the crane-fly (*Tipula olereacea*), of the drone-fly (*Eristalis tonax*), and of the water-beetle (*Hydrophilus piceus*). Good entomological or botanical slides given in exchange, or cash.—Micro, 15 Prior Park Buildings, Bath.

DUPLICATES (Coleoptera). *Adimonia tanacetii*, *Chrysomela hyperici*, *Cassida equestris*, *Dichrotrichus pubescens*, *Pogonus chalcicus*, *Hylastes palliatus*, and others. Desiderata, British coleoptera.—Henry F. Collett, 12 Springfield Road, St. Leonard's-on-Sea, Sussex.

WANTED, *Mya truncata* or *M. arenaria*, alive or recently dead.—C. K. Rudge, Ashgrove House, Redland, Bristol.

BRITISH shells for exchange. Send list of Desiderata to C. K. Rudge, Ashgrove House, Redland, Bristol.

Vertigo edentata and *Helix rapusstri* in exchange for other rare varieties.—Apply to S. Donald, Sedbergh, Yorkshire.

WANTED, to exchange a very full report of "Proceedings of British Association, 1878 (Dublin)," for Odes (Book I.), Satires, and Epistles of Horace (Anthon or White), or "Pitman's Phonographic Phrase Book," reporting pencil-case, and cover. Also, a bicycle, "Celerrima," little used, for any suitable offer of books (hi-tory and law preferred).—John Benner, 9 Bridge Street, Tralee.

A FIRST-CLASS slide of theine from the tea leaf (polariscope) in exchange for any other object of interest. Also a dozen anatomical slides for exchange.—D. Burford, Bowbridge, Stroud, Gloucestershire.

WANTED, animal parasites, ixodes, and acari, either mounted or unmounted. Have for exchange a large number of mounted parasites and other slides.—W. A. Hyslop, 22 Palmerston Place, Edinburgh.

DOUBLE-STAINED sections of elder mounted, in exchange for other mounts.—E. B. L. Brayley, 2 Burlington Buildings, Redland, Bristol.

WANTED, microscopic material and slides; will give books, slides, &c., in exchange.—F. S. Lyddon, 2 Oakland Villas, Redland, Bristol.

For slides showing portions (*a*, honey-glands; *b*, smooth conducting surface; *c*, acid glands of digestive surface) of inner surface of pitcher plant (*Nepenthes distillatoria*). Send other well-mounted slides to John G. Patterson, 2 Dalrymple Crescent, Edinburgh.

THE "Entomologist" for 1878, 79, 80, in exchange for Jukes' and Geikie's "Manna of Geology," Woodward's "Geology of England and Wales," Ramsay's "Physical Geology and Geography of Great Britain," Lyell's "Elements," Campbell's "Frost and Fire," Darwin's or Wallace's works, &c.—J. W. Carr, 28 Emery Street, Cambridge.

WHAT offers in microscopical works or anything useful in microscope for the four complete volumes of "The Sea: its Stirring Story of Adventures, Peril, and Heroism." Contains forty 7d. numbers, unsold and unbound. Also Page's "Advanced Geology."—Edmund Price, 2 Malsam Villas, The Uplands, Stroud, Gloucestershire.

I HAVE a set of Maguire's celebrated engravings of naturalists, 15 x 24 in. Portraits of Gould, Yarrell, Jardine, Bonaparte, Stanley, and others, nine in all. Published at £4 10s.; will take good cabinet fus-ils, or astronomical eye-piece (300 diameters) in exchange.—Science, 105 White Ladies Road, Bristol.

I HAVE some really good British and foreign beetles, moths, &c., to exchange for tertiary or secondary fossils; ammonites from blue lias especially required.—Science, 105 White Ladies Road, Bristol.

FOR slides or good material an assortment of named zoophytes, &c., also lists of slides exchangeable for other slides of interest.—I. E. Read, Puttlegate Street, Norwich.

WANTED, to exchange for a good microscope my collection of Cretaceous and carboniferous fossils, good specimens.—Lists on application to George Ward, 10 Friar Lane, Leicester.

WANTED, tropical butterflies, beetles, leaf insects, and silk-worm moth, atlas, selene, yama-mia, Brazilian butterflies, *Morpho pelides*, *Papilio obalus*, *P. maszenius*, *P. Krishna*. Will exchange Australian butterflies and owl in glass case, a fine specimen.—J. Bates, 10 Orchard Terrace, Wellingborough.

WANTED, first-class mounted preparation of insects—Foraminifera Polycystinae, section of spines of Echini, double-stained botanical section, anatomical and pathological preparation, and other objects—in exchange for beautifully-mounted specimens in all departments of natural history.—Fred Martin, Clevedon.

HOGG, "On the Microscope," Staunton's "Chess-Players' Companion," any two vols. of Orr's "Circle of Science," offered for a good 3 or 4-in. objective, or a fair collection of mounted microscopical slides.—Fairmount, 153 Breakspears Road, Brockley, S.E.

WILL correspondents who can supply specimens of British sponges (correctly named), perfect or fragmentary, kindly send their names to the Editor?

DUPLICATES, *Aphochius porcus*, *A. subterraneus*, *Coccinella ocellata*, and many others. Desiderata, British coleoptera, especially the smaller Brachelytra. Shall be glad to hear from coleopterists with a view to mutual assistance.—T. Wood, 5 Selwyn Terrace, Jasper Road, Upper Norwood.

I WILL send a bottle of my mounting medium to any reader of SCIENCE-GOSSIP for this month only.—A. Smith, The Laboratory, Essex Road, Islington.

SWISS, Pyrenean, and Mediterranean plants, including grasses, sedges, &c., splendidly preserved, and all correctly named. The collection includes thousands of specimens, price 6d. each, a discount made for large numbers.—Address, Dr. B., care of Editor of SCIENCE-GOSSIP.

WANTED, Beesley's "Geology of the Neighbourhood of Banbury." What exchange?—J. Gregory, Holdenby, Northampton.

WANTED, any species of the genus *Mentha*. Will exchange charas and other rare plants.—E. Straker, Hagslesnaw, Kenley, Surrey.

OFFERED, 131, 133, 313, 336, 846, 923, 927 b, 1310, 1467 b, 1516, 1676, and variety for other rare plants.—Joseph S. Rowse, 25 Ashton Street, Dukinfield.

EDUCATIONAL microscope with slides and apparatus, good as new, cost over £3, will exchange for good magic lantern.—F. C. Long, 6 Bartle Street, Burnley, Lancashire.

WANTED, a correspondent in Ireland, with a view to exchanging dried specimens of Phanerogams. Send desiderata list to Rev. H. H. Slater, Sharlow, Ripon, York.

I HAVE a few slides of the tufted hairs of the caterpillar, called the "hop-dog," (pale Tussock-moth). Send list to Rev. A. C. Smith, St. John's, Crowboro', near Tunbridge Wells.

BOOKS, ETC., RECEIVED.

"Vegetable Mould and Earthworms," by C. Darwin, F.R.S. London: John Murray.

"A Pocket Guide to British Ferns," by Marian S. Ridley. London: David Bogue.

"The Herefordshire Pomona." Part IV. London: David Bogue.

"The Student's Handbook of Chemistry," by H. Leicester Greville, F.C.S. London: E. & S. Livingstone.

"European Butterflies," by Dr. Lang. Part IV.

"Micrographic Dictionary," 4th ed. Parts II. and III.

"American Naturalist."

"Canadian Entomologist."

"Good Health."

"American Journal of Microscopy."

"The Antiquary."

"Chemist and Druggist."

"Journal of Applied Science."

"Land and Water."

"Ben Brierley's Journal."

&c. &c.

COMMUNICATIONS RECEIVED UP TO 10TH ULT. FROM:—
Dr. R. H.—J. C.—J. L.—H. V.—A. S.—H. F. H.—J. T. L.—
Dr. De C.—A. M. P.—R. W. W.—E. J. G.—F. E.—J. T.—
A. W.—M. E. P.—J. F. G.—H. B. P.—R. S.—E. W.—D. D.—
J. A. S.—Miss R.—A. A.—R. J. H.—N. C.—J. H.—J. W.—
J. A. O.—W. H. P.—G. A. R.—G. L.—F. F.—A. T. H.—
G. A. W.—E. L. A.—F. C. L.—H. H. S.—F. J. B.—Dr. F. B. W.—
A. C. S.—H. P. M.—J. W. W.—H. S.—V. C.—W. T. G.—
G. E. B.—G. P.—H. H.—H. H. S.—I. W. K.—J. R.—A. D.—
S. R. H.—R. L.—E. M. H.—F. A. B.—W. T. O.—T. B. R.—
G. T. H.—E. W.—W. H. T.—F. P.—H. C. B.—R. M. C.—
H. W.—W. B.—H. L. J.—E. T. D.—Dr. W. T. G.—A. E. L.—
T. P.—J. B. M.—S. A. B.—G. T. H.—J. H. G.—H. F. C.—
C. K. R.—W. A. H.—J. F. R.—S. D.—T. W. G.—C. H. W. L.—
W. G. W.—J. B. Jun.—J. B.—F. J. G.—E. P.—D. B.—E. L.—
E. B. L.—W. B.—W. A. P.—J. A. O.—T. S. K.—J. G.—
T. S. L.—J. G. P.—R. L.—A. M.—E. S.—A. D.—M.—J. S.—
T. E. R.—J. F. G.—G. W.—J. B.—F. R. M.—H. C. C.—
J. S. R.—T. F. C.—D.—J. H.—J. D. B.—A. L.—&c.

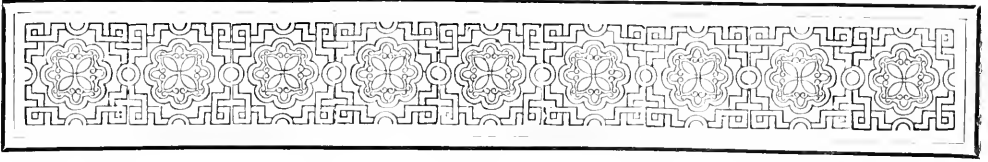

NOTES ON THE HOLLY (*ILEX AQUIFOLIUM*).

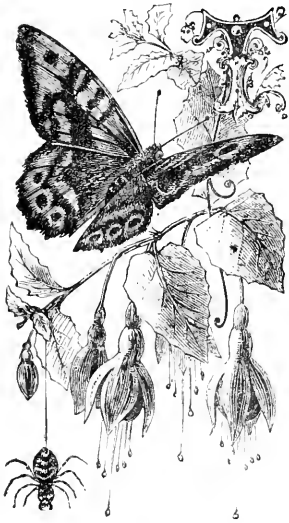

THE common Holly has long been esteemed for its great beauty, glittering, as Evelyn observes, with its armed and varnished leaves, and blushing with its natural coral. This tree is indigenous in most parts of the middle and south of Europe; it is also considered a native of Britain, as the soil and climate of England and Scotland appear particularly

favourable to its growth: standing detached and left to nature in some of our woods and forests, it forms one of the most beautiful evergreen trees that this or any other country produces. The holly was known and admired by the Greeks and Romans. Theophrastus mentions it. Pliny tells us that Tiburtus built the city of Tibur near three holly-trees, and that these trees were standing in his own time, and must therefore have been upwards of 1200 years old. He also mentions one growing in Rome with an inscription engraven in Tuscan letters, and that this tree was older than Rome itself. This ancient author notices the leaves of the holly, and says they are provided with spines lest greedy quadrupeds should browse upon them, the hand wantonly seize or the careless foot tread on them, or the perching birds break them. It has been said by some old writers that the lower leaves of the holly are sharply armed with spurs for defence, while the upper leaves are without them, and on this supposition our poet Southey has introduced the following lines in his poem entitled the Holly Tree,

“Below a curling fence its leaves are seen
Wrinkled and keen;
No grazing cattle through their prickly round
Can reach to wound,

NO. 204.—DECEMBER 1881.

But as they grow where nothing is to fear
Smoother and unarmed the pointless leaves appear.”

This is a pretty poetical idea, but like many others not exactly correct. On looking at a full grown holly a considerable variety will be noticed in the prickly character of its foliage. The spines are formed by the hardened extremities of the veins proceeding from the midrib to the margin, it is only the old and mature leaves that have these spines. The young and tender leaves which are more numerous on the upper branches are destitute of them, or only have them in a rudimentary character. Sometimes a holly growing in a very luxuriant soil has all its leaves in a manner metamorphosed so as entirely to lose the peculiar aspect of the tree. There are also many varieties of holly with more or less spiny leaves. The timber of this tree is as white as ivory, and is readily stained with black, green, blue, or red; it is chiefly used in inlaying and Tunbridge ware, also by turners, and mathematical instrument makers. The straight shoots, five or six feet in length, make excellent coachman's whip handles. Bird lime is made from its bark, by washing and separation of the wood fibre. As an evergreen fence, it is superior to every other plant. The extract and powdered leaves and bark of the holly have been used medicinally as a tonic and febrifuge, but it does not appear to be one of the recognised remedies of the present pharmacopœia. The name holly is probably a corruption of the word Holy. Dr. Turner, our earliest writer on plants, calls it the holy tree, most likely from its being used in churches at Christmas. It was also called Hulver, by which name it is still known in Norfolk; and Holme in the Southern counties, as appears by the name it has given to many places where it grows naturally, as Holmwood, between Horsham and Dorking. Evelyn says that the vale near his house in Surrey was anciently called Holmesdale, from the quantity of holly growing there.

The time when the holly is brought more particularly before our notice is at the approach of the glorious festival of Christmas, when our churches, houses, shops, and markets appear decked with its shiny leaves and vermilion berries. It is evident that the use of flowers and green leaves as a means of decoration is almost instinctive in the human breast,

and we accordingly find scarcely a people civilised or savage with which it has not become more or less familiar. The custom of placing evergreen in places of religious worship prevailed long before the introduction of Christianity. The Jews employed them in their Feast of Tabernacles in the month of September, and we find several texts of Scripture, particularly in chapters xl. xli. li. and lv. of Isaiah and in chapter viii. of Nehemiah, having reference to this custom, but the evergreens originally made use of were branches of pine, fir, cedar, and sprigs of box. When the late Dean Stanley preached in the catacombs of Rome, he mentioned that the decorations of churches with holly was a religious observance which came from the time of the heathen, who suspended green boughs and holly about their houses, that the fairies and spirits of the woods might find shelter under them during the inclement weather.

The ancient Greeks and Romans were accustomed to decorate their temples with garlands of flowers and fruits. It was also customary among the Romans during the feast of Saturn, which took place about the 18th of December, to send boughs of holly as emblematical of good wishes with the gifts they presented to their friends at that season, and thus the holly came to be considered an emblem of peace and good will. Tradition says that the early Christian disciples in Britain used boughs for the construction of their churches, as the heathen of these islands made their temples in the same manner, probably to imitate the temples of Saturn, which were always under the oak. The great feast of Saturn, as I have before observed, was held in December, and as the oaks of this country are then leafless the priests obliged the people to bring in boughs and sprays of evergreens, and the Christians on the 25th of the same month did the like; and from this circumstance arose the custom of placing holly and evergreens in our churches and houses, to show that the feast of Christmas has arrived. In the early age of Christianity its ministers frequently experienced the utmost difficulty in inducing their converts to refrain from indulging in the popular amusements which were so largely participated in by their Pagan countrymen. Among others the revelry and license which took place on the Saturnalia or feast of Saturn called for special condemnation, but at last convinced and partly influenced by the idea that the spread of Christianity might thereby be advanced, the church endeavoured to amalgamate as it were the old and new religions, and sought, by transferring the heathen ceremonies to the solemnities of the Christmas festival, to make them conducive to the cause of religion and piety. Ingrafted thus on the Roman Saturnalia, the Christmas festivities received in Britain further changes and modification by the arrival of the Saxons, who introduced the various ceremonies practised by the ancient Germans and Scandinavians. The result has been the strange medley of Christian

and Pagan rites which contribute to make up the festivities of our modern Christmas.

One of our oldest carols, written in the fifteenth century, contains an account of the victory of the Holly over the Ivy, which may be considered as a worldly emblem. "Stowe informs us in his 'Survey of London,' 1598, that against the feast of Christmas, every man's house, as also their parish churches, were decked with holme, ivy, bays, and whatsoever the season of the year afforded to be green. The conduits and the standards in the streets were likewise so garnished." He goes on to state that, "in the year 1444, by a tempest of thunders and lightnings, towards the morning of Candlemas Day, at the Leadenhall, in Cornhill, a standard tree, being set up in the midst of the pavement, fast in the ground, nailed full of holm and ivy, for the disport of Christmas to the people, was torn up and cast down by the devil, as was thought, and the stones of the pavement all about were cast in the streets and into divers houses, so that the people were much afrighted at the great tempest." Among the ancient disbursements of the Church of St. Mary-at-Hill, in the City of London, there is the following entry: Holme and Ivy at Xmas (4*d.*) In the churchwarden's accounts of St. Martin's, Outwich, 1524: Item for Holly and Ivy at Xmas (2*d.*) In the accounts of the parish St. Margaret's, Westminster, 1647, we read: Item paid for rosemarie, holly, and bays, that was stuck about the church at Christmas, 1*s.* 6*d.* Thus we see holly, ivy, bays, and rosemary were the favourite plants for Christmas decoration even in olden time. Ivy is rather objectionable in churches from its associations, having anciently been sacred to Bacchus, and employed largely in the celebrations in honour of the god of wine. Cypress, we are informed, has been sometimes used, but its funeral relations render it rather out of place at a festive season like Christmas. One plant is specially excluded, the mystic mistletoe, which, for its antecedents, would be regarded as almost as inappropriate to the interior of a church, as the celebration of the old Pagan rites within the walls of the sacred building. A solitary exception to this universal exclusion is mentioned by Dr. Stukely, who says that it was at one time customary to carry a bunch of mistletoe in procession to the high altar of York Cathedral, and thereafter proclaim a general indulgence and pardon of sins at the gate of the city. No doubt this was one of the burlesques on the services of the church which, under the leadership of the Boy-Bishop or the Lord of Misrule, formed so favourite a pastime at Christmas in those bygone days. See Hone's "Every-day Book," in which work it is also mentioned that some mistletoe was put up in the church at Teddington, but the clergyman immediately ordered it to be taken away. The decorations remain in the churches from Christmas till the end of January; but, according with the Ecclesiastical Canon, they must all be cleared away before

the 2nd of February, Candlemas Day. The same holds good as a custom with regard to private dwellings, superstition in both cases rendering it a fatal presage if any of these sylvan ornaments are retained beyond the period just indicated. If every remnant of Christmas decoration is not cleared out of the church before Candlemas Day, the superstitious believe that there will be a death that year in the family occupying the pew where a leaf or a berry is left. And it is told of an old lady who was so persuaded of this superstition, that she would not be contented to leave the clearing of her pew to the constituted authorities, but used to send her servant on Candlemas Eve to see that her own seat at any rate was thoroughly freed from danger. There were many curious customs connected with Christmas and the holly which are now almost obsolete. Southey mentions in his "Common-place Book": on St. Stephen's Day in Wales, everybody is privileged to whip another person's legs with holly, and this is often reciprocally done till the blood streams down.

Festive carols used to be chanted in bygone days at Christmas, in praise of the evergreens so extensively used at this season, and I will conclude this paper with a verse from a Cornish one. In Cornwall, the holly used to be, and perhaps is now, called "Aunt Mary's tree," Aunt being a term of endearment in that locality, therefore they call the Virgin "Aunt Mary."

"Now of all the trees by the king's highway
Which do you love the best?
O, the one that is green upon Christmas Day,
The bush with the bleeding breast.
Now the holly with her drops of blood for me,
For that is our dear Aunt Mary's tree."
—See Notes and Queries.

HAMPDEN G. GLASSPOOLE.

15 Mall Road, Hammersmith.

WHEAT MILDEW AND BARBERRY BUSHES

MR. C. R. PLOWRIGHT, F.L.S., has been experimenting with the fungus of the barberry leaf (said by Professor De Bary to produce wheat mildew), and has given the following result of his experiments:—The experiments, which were thirteen in number, were made during the months of June, July, August, and September of the present year. Some 176 plants of wheat were employed, of which seventy-eight were inoculated with the barberry fungus, and ninety-eight were not inoculated, but were kept for check plants, to see whether they would produce the mildew fungus without artificial inoculation. Of the inoculated plants 76 per cent. developed the disease in an average of 15·1 days. But of the uninoculated plants no less than 70 per cent. developed it also. One experiment, and one only, of the thirteen seemed to support the theory. This was the second, in which three wheat plants were infected, while three

were kept as check plants. One inoculated plant, in the course of twenty-three days, developed the disease, while the check plants remained healthy. In the next experiment, however, in which three plants were inoculated and three kept for check plants, only two of the former, at the end of thirty-one days, had *uredo* upon them, while all the check plants were affected. In the fifth experiment, in which ten plants were inoculated and a similar number kept for check plants, only half the number of the former had the disease upon them at the end of twenty-five days, while all the latter, except one, had it. In the sixth experiment fourteen plants were employed, half of which were inoculated and the other half not. Of the inoculated plants five only, at the end of twenty-four days, had the disease, while all the uninoculated plants had it.

In two of the experiments (Nos. 10 and 11) the sample of seed wheat was divided into two portions—the one I kept in King's Lynn, and inoculated with the barberry fungus spores; while the other half was sent to two gentlemen at a distance, namely, the Rev. Canon Du Port, of Mattishall, near East Dereham, and Mr. W. Phillips, F.L.S., of Shrewsbury, who grew and kept the check plant. But the result was the same. Both inoculated and check plants were affected with *uredo*.

In the thirteenth experiment, two groups of six plants in each were grown from wheat that had been previously poisoned with sulphate of copper, in ground that was disinfected with diluted carbolic acid, and under two perfectly clean bell glasses, which exclude *uredo* spores that might accidentally be floating in the air. In due course one of these groups of wheat plants was inoculated with the barberry fungus, and the bell glass was replaced and kept over the plants for thirty days, at the end of which time no trace of *uredo* was found upon either patch of wheat.

In order to learn how long the spores of the *uredo* took to reproduce themselves, in another experiment six healthy wheat plants were inoculated with the spores of the *uredo*. In eleven days the whole six were simultaneously attacked by the disease.

The true wheat mildew sometimes, but rarely, occurs upon the oat, so in another experiment I inoculated a healthy oat plant with the barberry fungus, on the second of August. On the sixteenth, *uredo* appeared upon it; on the ninth of September the *uredo* was abundant upon the leaves of the oat plant, but upon microscopic examination this *uredo* was found to be not the *uredo* of the wheat mildew, but *uredo* of *Puccinia coronata*, a totally distinct species which is affirmed to originate, not from the barberry fungus, but from a similar though distinct species, which occurs upon the buckthorn (*Rhamnus frangula*).

In the discussion that followed the paper which was read at Hereford, Mr. A. S. Bicknell related his experience of having seen repeatedly the barberry grown as a hedge plant in Switzerland and Northern Italy during his residence in those countries, to such an extent

indeed that were the theory true, the wheat plant would have been extirpated; but upon the contrary, he neither heard complaints made by the farmers of the prevalence of mildew there, nor did he ever hear them suggest any connection between it and the barberry.

It is worthy of note, too, that few districts have suffered more severely from mildew this year than the fen country between Cambridge and Lynn, where the barberry is almost an unknown plant.

These experiments were carried on by me perfectly impartially, as I have no interest either one way or the other in the controversy. Certainly my experiments are distinctly against the theory that the barberry fungus is a state of the wheat mildew; and I must, in common with the majority of my British mycological colleagues, decline to accept the heterocism of *Puccinia graminis* as not proved.

BOTANICAL ETYMOLOGY.

THE other day I came across a work written five-and-thirty years ago by one Talbot, containing etymological truths and speculations, both interesting and instructive. Amongst others were several respecting botanical names, and I have extracted the following as being worthy of note.

Ash tree,—usual derivation Æsc, A.-S. an ash, has relation also to hasta, a spear, as spear handles were generally made of ash wood. Æsc may also mean a spear.

Asparagus,—may have been spear grass, for the plant comes up like a multitude of little spears.

Dove Carnation,—not from its scent is it so called, but from the petals being so remarkably cloven; as clover grass is so called from the division of its leaves into three.

Penny-royal,—a corruption of its old name puliall royall, so that the modernised should really be polyroyal.

Gooseberry,—German plants of this genus are named Johanns beeren, because the fruit is ripe about the feast of St. John. In Low Germany the name is Jans beeren, corrupted into Gans beeren, and then literally translated Gooseberries.

Pansy,—not from pensée, although a beautifully poetical name, but from panacea. Amongst the Greeks it was a most celebrated herb curing all woes, the heartache amongst others—hence its synonym in English, heart's-ease.

Houseleek,—a corruption of houseleaf. Its German name is hauslaub. The plant has no resemblance to a leek.

Fungus,—the usual derivation is from A.-S. faran, to go, as its spores, when concealed about the person, enable one to wander invisible. Our author however prefers the derivation of fer, a northern word for

feather, applied to the plant on account of the shape of its fronds.

Mustard,—from the Spanish mastuerzo, carelessly pronounced mustort. Mastuerzo in its turn is corrupted from nasturtium, a plant nearly allied to mustard, and nasturtium is derived from nasus, the nose, and wort, a plant (an inadmissible hybridism); the word thus means nose plant, a very descriptive name. I believe however the true derivation of the word is nasus and torqueo, tortus, or nose-twister, from its pungent qualities.

Vetch,—from vicium, a Latin word often used in the sense of a weed. It injures and disfigures crops in the same way as vices disfigure and blemish the moral world.

Rue or Herb of Grace,—the latter name from the resemblance of the former to Rood or Holy Cross.

Southern Wood,—has nothing to do with the south, and affords no particular kind of wood, as it is only a low shrub. The old English name is suthewurt or soothing wort, so called from its possessing a soporific quality.

Wagbread,—an old name for plantain. Has nothing to do with bread. The German is wegetritt, i.e. way tread, from the plant being trodden underfoot by the wayside.

Wolfsbane,—the ultimate syllable of course indicates poison; but as this plant would not affect wolves in particular, whence have we the first word of the compound? Our author gets at it thus. All poisonous herbs were called banes in the ancient German; and this was called white bane to distinguish it from aconite or blue bane. Some Greeks who understood a little German (showing how a little learning is a dangerous thing), mistook this word for beans (bohnen), hence the plant was called in Greek the white bean. The error of calling it a bean was perceived by the acute retranslators, who restored the bane; but at the same time they read leukos, white, as though it were lukos, wolf, and so rendered the name wolfsbane, as it remains to this day. Which tale is of course to be received *quantum valet*.

F. H. HABEEN, B.A.

TREE FROGS.—When I was at Cannes two years ago, in company with a pupil of mine, we found scores of tree frogs, and brought a few home with us. They are alive and flourishing still. We find they require no food in the winter, for being provided with sufficient depth of soil they will bury themselves. If however any of the party refuse to go below, we provide him with an occasional meal worm—or common earth worm will do. Care must be taken that only small worms be given. If your correspondent has a greenhouse, he may turn the frogs loose in it in summer and feel no further concern about their food, for they will forage for themselves, and the greenhouse (or rather the plant-) will not regret the experiment.—*Sin R' or.*

ARRENURUS PERFORATUS—A NEW
WATER-MITE.

DURING the past season I found a very beautiful and curious water-mite, and as I have not been able to find a figure or description of it in Müller, Koch, or Walckenaer, I believe it has not before been figured, or described; and therefore send you a camera outline sketch, as seen with a two-thirds object glass, and A eye-piece. The general colour of the body is light dull brick red, insensibly shading off to green at the edges; as in other arrenuri it is chitinous, and covered all over with circular mark-



Fig. 149.—New Species of Water-Mite (*Arrenurus perforatus*).

ings, reminding one of a coat of mail; the eyes when properly illuminated are ruby red, the oval impressed line is somewhat irregular in shape, and very distinct; the tail is green, thick at the sides and thinned in the middle in a wedge-shaped fashion. In the centre near the posterior border is a heart-shaped perforation, very conspicuous, from which circumstance I have given it the name *perforatus*, above this is situated a dark rather spear-shaped projection, under which there is a light-coloured elevation almost of the same shape, but broader and longer. The legs and palpi are green, the two posterior legs are well supplied with long swimming bristles, and six hairs project from the tail as shown in the figure. If any readers of SCIENCE-GOSSIP have seen this mite figured, or described, I shall be glad to be referred to the paper or work containing it.

C. F. GEORGE.

Kirton Lindsey.

NOTES ON THE NATURAL HISTORY OF
JERSEY.

By EDWARD LOVETT.

[Continued from page 226.]

GEOLOGY.

VERY little has yet been done with regard to a systematic investigation of the geology of Jersey, and although the island is of small dimensions, it presents difficulties in connection with the arrangement of its rocks, greater than are met with in wider areas. We have, however, reason to believe that this investigation is being undertaken in an efficient manner by a local geologist.

In this paper we would simply follow the coast-line of the island, enumerating in succession the chief features which present themselves, together with any point of special interest as regards the rocks, &c., as they occur.

Starting at the harbour of St. Helier, and proceeding eastwards, we notice the large mass of pink syenite upon which the fort is built; this hard, close-grained rock stands as a proof of the former existence of a vast area that has been removed by decomposition and weathering. The whole of the coast-line in this locality is low and shelving, leaving at low tide an enormous expanse of rugged rocks, which are barely covered at high water, these, stretching round St. Clement's Bay, La Rocque, and Grouville Bay, are composed principally of diorites and greenstones, with veins of pink syenite, forming a beautiful contrast to the rich dark colour of the diorites. In some spots these veins are extremely abundant, and are accompanied by other veins of a dense basaltic lava.

Near La Rocque, the syenite contains some magnificent crystals of quartz. During some excavations many of these were obtained; they fell free when detached from their matrix, and some presented the curious form of being cone in cone, yet each separate from the other. The majority of these crystals measured over twenty-five inches round the base of the apex. These diorites, &c., terminate, so far as the coast-line is concerned, at Gorey, where the rocks again rise to a considerable elevation; a little beyond this we meet with a purple clayslate-looking rock which forms a small headland; this, upon examination appears however to be part of the remarkable rhyolite which is so well shown on the corresponding portion of the north coast which we shall presently reach.

St. Catherine's Bay, which now follows, is a very characteristic one; the two cusps of the bay are two headlands, being the continuous ridges of high ground running inland and forming a long valley, the wasting of which, by the sea, has formed the bay. Following the sea-margin of this valley, it will be seen that the rocks, which are much torn and bent in the direction of the trend of the valley, are overlaid by a mass of

clay containing quantities of angular rock-fragments : this deposit thins away up each bank of the valley, but is of considerable thickness in the middle. The origin of this valley "till" is perhaps difficult to decide, but as it contains fragments of rocks foreign to the locality, and as the fragments generally are in a most confused state, we think it possible that it, like many others in the island, has been caused by small local glaciers which, without being of sufficient dimensions to striate and groove the rocks over which they passed, were, nevertheless, able to tear and fracture the tilted strata and veins and mingle them with the coarse clay which they gathered in their course, from decomposed surfaces. These valley clays are often covered by another drift deposit which can be traced on almost all parts of the island, but which is not allied to the former; these again being sometimes covered by blown sand, renders the true position of these beds difficult to determine, except in such characteristic examples as the one above referred to.

Leaving this fine bay, the rocks again rise and we suddenly enter upon a remarkable conglomerate, the contact of which with the rhyolitic rocks, is very defined. This conglomerate is of a rich bluish-brown colour and consists of rounded and subangular fragments of felsites, syenites, hornstones, and a somewhat dubious sandstone; near the base of this bed the boulders are of great size, often from six to twelve feet in diameter; this part of the formation is well seen between Fliquet Bay and La Tour, and the conglomerate itself extends round to Bouley Bay, thus occupying the whole of this extreme corner of the island.

At Bouley Bay, where it joins the rhyolites again the latter rocks present a most remarkable and diversified appearance; their general structure merging from a flow, having all the appearance of stratification, to that of a highly spherulitic character. It is this latter structure that has presented such difficulties in determining this rock. In one part, the spherules are of a reddish colour, and of the size of peas imbedded in a greenish matrix; in others, they occur as much as two or three inches in diameter, but not so well defined as in the finer examples; but the most normal form is that in which the natural flow of the lava is preserved. This latter form merges into the spherulitic one and shows how the formation of the concentric nodules occurred; for in a small hand specimen can be observed the lines of flow, often containing quartz, breaking up into long oval bodies, these again gradually becoming spherular. If a fracture be made so as to show the structure of these nodules, it will be seen that they are almost oolitic in their appearance, and are moreover rarely blended together; in most instances a crescent-shaped fragment of quartz forms a half-ring round the nucleus, but it is remarkable that this crescent occupies various positions in even adjoining spherules. It is also highly probable that this quartz contains fluid cavities, but

this we have not yet had an opportunity of ascertaining.

The higher ground of this locality consists of a very decomposed form of this rock, the real structure of which is thereby much obliterated. These rhyolites now merge gradually at Vicart Point into the syenite again, which latter is overlaid by a small bed of conglomerate of a much older appearance than that already referred to, being of a much finer composition and having been apparently subjected to fusion. At Les Rouaux the syenite is overlaid by clayslate, and a fault in the junction of the beds has formed a chasm on the shore varying from eight to twelve feet in its present depth, and extending for a considerable distance; one ledge of this cleft being clayslate and the other syenite. The syenite rocks now predominate, but near Sorel enormous boulders of basalt and diorite, many of which contain thirty or forty cubic yards, occur not only on the shore, but also on the high ground. These appear to owe their origin to the same causes as the clays already referred to, and most decidedly suggest the former existence of glaciers, particularly as there is a fine example of a morainic deposit at this point.

A short distance inland, in the parish of St. John, are the celebrated quarries of Mount Mado, from which are obtained two fine varieties of syenite, highly adaptable for building purposes, the one is a finely grained pinkish variety, whilst the other is a coarser and whiter kind. About a mile from here a "china-stone" is largely worked for export, this aplite or bi-granite is an interesting rock, it is intersected by a large vein of massive quartz, containing traces of molybdenite. Returning to the coast at Sorel we have a large funnel-shaped cavity, known as the *Creux du vis*, this is a fine example of the results of the action of the sea upon the base of a softer vein of rock; the sea having access to the lower portion causes the superincumbent mass to gradually detach and fill up the cavity thus caused, this in turn becomes removed in the same manner, until the whole of the softer mass disappears, forming, as in this instance, a creux, but in others, as seen near Bouley Bay, a tall narrowing gully with vertical sides often a hundred feet in height.

At Grève-de-lecq the syenite contains fine conical crystals of quartz, similar to, but not so fine as those which we mentioned as occurring at La Rocque; some of these are well shown in section on the water-polished boulders and are very beautiful—a deposit of felspar occupying an inch of space between the cones.

All about this part of the coast-line are numerous caves, some of which are of considerable dimensions; these caverns are principally washed by the sea, except at low tides, but there are some far up out of reach of the waves, but bearing evidence of having been once accessible to the ocean. These caves may have been formed in this manner. The syenite in which

they occur has been split and cracked in all directions, so that it sometimes happens that these cracks unite with each other thus forming a *core*; this, from long weathering becomes gradually loose, and the action of the waves soon works out this core in the form of *boulders*, the remains of which on the floors and in front of these caves testify to the manner in which they were formed.

The coast-line from here to Grosnez is very grand, and at L'Etac the syenite is overlaid by clayslate, which on the shore exists in extensive ledges forming a rocky expanse at low water; here galena has been obtained, but in very small quantities; the syenite in many places is intrusive, and it is possible to obtain the two rocks even in a small hand specimen showing the junction.

After leaving L'Etac we came to the long flat sandy bay or St. Ouen, with its weird, dreary fresh-water pond; the recent geology here is well worth careful study, the blown sand is gradually encroaching inland, destroying what once was good pasture. This part of the island contains evidences of more than one change of level, for not only are older sand-hills showing traces of a vegetation, being worn down to supply a new series of sand-hills, but slabs of peat are frequently washed ashore from a lower and sea-covered area. Some distance inland, but still in the parish of St. Ouen, we can trace on the high ground a well-defined raised beach, the triturated pebbles in which are as characteristic of wave action as the beaches of to-day several hundred feet below.

The lower part of this large bay is bounded by cliffs of syenite, which, stretching round by St. Brelade's and Portelet Bay, present one of the best rocks in the island for practical purposes; that of St. Brelade's district being particularly good. At Portelet Bay there is a beautiful form of syenite, the felspar being very massive, and reddened by sea action, containing large fragments of white quartz. Working round to St. Aubin's, we again come upon the clayslate, a fine quarry of which, containing calcite and traces of copper, is worked at St. Peter's. Here may be seen a very fine example of ripple marks. Perhaps no part of the island possesses such fine examples of branching valleys, again supporting the theory of a local glaciation, as does this charming district, those of St. Peter and St. Lawrence being the most characteristic and beautiful.

The particularly noticeable ridge which seems to form the western boundary of the town and which is, or was, known as Gallows Hill, is composed of a claystone porphyry of a most peculiar form. In one part the matrix is a fine greenish-black containing pale coloured, lenticular crystals, the weathered form becoming a dull yellowish-brown; in other parts the crystals are accompanied by amygdaloidal cavities, and others again contain small quartz crystals scattered through the matrix. As may be imagined, it is easy to obtain specimens of this remarkable

rock which exhibit the most beautiful and interesting structures. Traces of carbonate of copper in some places occupy whole surfaces of cleavage fracture, but there is scarcely sufficient evidence of it to suggest its existence in any quantity. This ridge is intersected by a vein of basalt which, although much decomposed, shows some fine examples of concentric structure.

The decomposed syenite which occurs in so many parts of the island, is largely worked and exported for gravel; if well worked it forms excellent paths, and is used for that purpose nearly all over the island.

We have thus taken a rapid and very superficial glance at the various points of geological interest as they occur, in a journey round the coast-line of the island; and we think that there are very few localities that would not well repay a careful investigation, and which would, moreover, be of great interest and instruction to the investigator.

(To be continued.)

RECREATIONS IN FOSSIL BOTANY.

DADOXYLON.

No. VII.

By JAMES SPENCER.

THERE is a very singular fossil, met with in the sandstone rocks of carboniferous age, especially in those of the millstone grit and the coal-measures, which is well known to fossil collectors under the name of Sternbergia. Occasionally it is found in its natural or round state, but more commonly it has been flattened by pressure into an oval form. It is characterised by being marked by a series of transverse bars, somewhat like the rungs of a ladder, or, more correctly, like the transverse bars seen on the woody vessels of scalariform tissues, only they are more irregular in form and consist of a series of grooves and ridges. This curious fossil was named Sternbergia, in honour of Count Sternberge, a celebrated geologist of former days, and at that time and for a long time after, it was thought to have been a distinct plant. In the same quarries, there occurs along with Sternbergia, but much more rarely, another fossil plant of larger and more tree-like aspect. It generally assumes a rounded trunk-like form, and the specimens vary considerably in thickness, from a few inches to two or three feet, and from a few inches to many feet in length. It is recorded by Lyell and other writers that in some places these tree-like forms have been found of great length—from 60 to 70 feet or more. They have no external markings, by which their fragments can be readily distinguished from other fossil plants like Calamites, Lepidodendron, Sigillaria, &c., and in fact, it is chiefly through the absence of these Calamitean and Lepidodendroid markings, combined with their

tree-like forms that the student readily learns to distinguish them from the other fossil plants. In several places they have been found with their original woody structure well preserved, and microscopic sections taken from them have fully demonstrated the fact, that these plants belonged to the pine family, and that their nearest modern representative is the *Araucaria* or Norfolk Island pine. These fossil pines are known by the name of *Dadoxylon*. The great majority of fossil plants appear to have grown on large plains or mud flats, which were but little elevated above the sea level, where they seem to have grown most luxuriantly and formed those extensive vegetable deposits which ultimately became converted into coal. But the *Dadoxylons* appear to have preferred a different habitat, and to

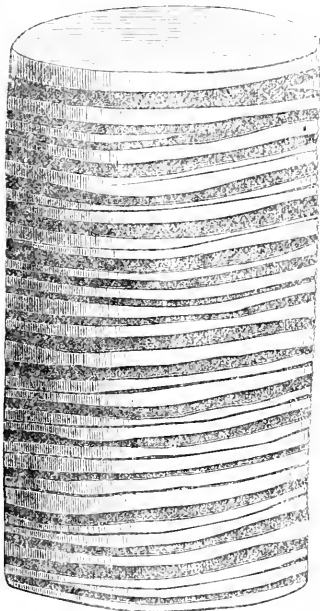

Fig. 150.—*Sternbergia* (natural size), from specimen in Author's collection.

have grown in the more elevated districts of the Carboniferous lands, and this preference for upland districts appears to have characterised the pine tribe, in every succeeding geological age down to the present day. Storms and hurricanes also appear to have occasionally prevailed among the ancient *Dadoxylon* forests, causing death and destruction among them, and scattering their fragments far and wide, and these along with the uprooted stems were sometimes carried by floods into the rivers and deposited in the sandbanks at the mouths of the river, where many of them became fossilised and ultimately, after the lapse of untold ages, are now being exposed to the light of day by quarrying operations. The same sandbanks would also receive the wreck from the lower levels inhabited by the chief coal form-

ing plants, and hence we frequently find the remains of *Dadoxylon* side by side with those of *Lepidodendron*, *Sigillaria*, &c. Although *Dadoxylon* and *Sternbergia* are nearly always found associated together in the same sandstone quarries, yet their relationship was not suspected, until Professor Williamson clearly demonstrated the fact that *Sternbergia* was merely a cast of the pith of *Dadoxylon*. Some years ago he obtained a specimen of a fossil plant from Coalbrookdale which proved to be part of the stem of a *Dadoxylon*. It was a few inches in length by a little over half an inch in diameter, and was enclosed in a calcareous nodule. It was in a wonderfully good state of preservation, showing to perfection the various tissues composing the bark, woody cylinder, and the cellular pith. The structure of the bark and woody cylinder showed that the plant was a fossil pine, while the exposed pith showed the transverse bars of *Sternbergia*. Thus, these two fossils, which had up to that time been regarded as belonging to widely different species, were found to belong to one and the same species. What kind of a plant *Sternbergia* had been, was always a difficult problem to solve, and in fact never had been solved, until its true nature was seen in this unique specimen. Some of the recent pines have a moderately large pith of very delicate cellular tissue, and the ancient *Dadoxylons* had even larger and quite as delicate piths. In some of my specimens of these fossil pines the diameter is nearly equal to half of that of the stem. In smaller specimens the proportion is not so great. Upon the death of the plant, the pith seems to have been the first to decay, and when it became imbedded in sand or other material, its hollow centre became filled by the infiltration of sand or lime, or other surrounding material. In this manner a solid core was formed, which was in many instances an exact model of the original pith, and retaining its external markings. Both the surrounding ligneous zone and bark might afterwards be completely destroyed, as appears to have been the case when we find isolated portions of *Sternbergia* in sandstone rocks, or the woody cylinder and pith might both have been destroyed and the bark alone preserved until a solid core of sandstone had been formed, and then there would remain the tree-like form of an ordinary *Dadoxylon* enveloped in its filmy layer of dark carbonaceous matter, which is the mineralised remains of the original bark. I have found specimens of *Dadoxylon* in all the geological formations in the neighbourhood of Halifax, including the coal-measures, millstone grit and Yoredale rocks. In the beds of shale, in all the three formations, there occur calcareous nodules, which contain the remains of marine shells, such as *Goniatites*, *Nautili*, *Orthoceras*, &c., and fish remains; they also, not unfrequently, contain fragments of *Dadoxylon* which have the structure well preserved. One of the best specimens in my cabinet came from the Yoredale rocks of Hebden Bridge, but I have obtained some

very good ones from the marine strata overlying the Halifax hard bed coal.

Description of the diagrams.

Fig. 150 is a diagram of an ordinary sandstone cast of *Sternbergia*, showing the peculiar transverse markings of the fossil.

Fig. 151 is a transverse section of *Dadoxylon* with the tissues preserved, with the exception of the bark, which is absent, as it is in the great majority of specimens. The transverse section of the ligneous zone shows a regular network arrangement of the vessels

probably a specific difference between them. In many of the transverse sections the annular rings of growth are plainly visible: one of my specimens, which is less than an inch in diameter, shows five or six of them.

The pith, when any is preserved, is seen to be a regularly-formed parenchyma of very delicate structure, and composed of hexagonal cells. Many of my sections show a portion of this structure, but it is generally very much disintegrated, and only detached portions are preserved.

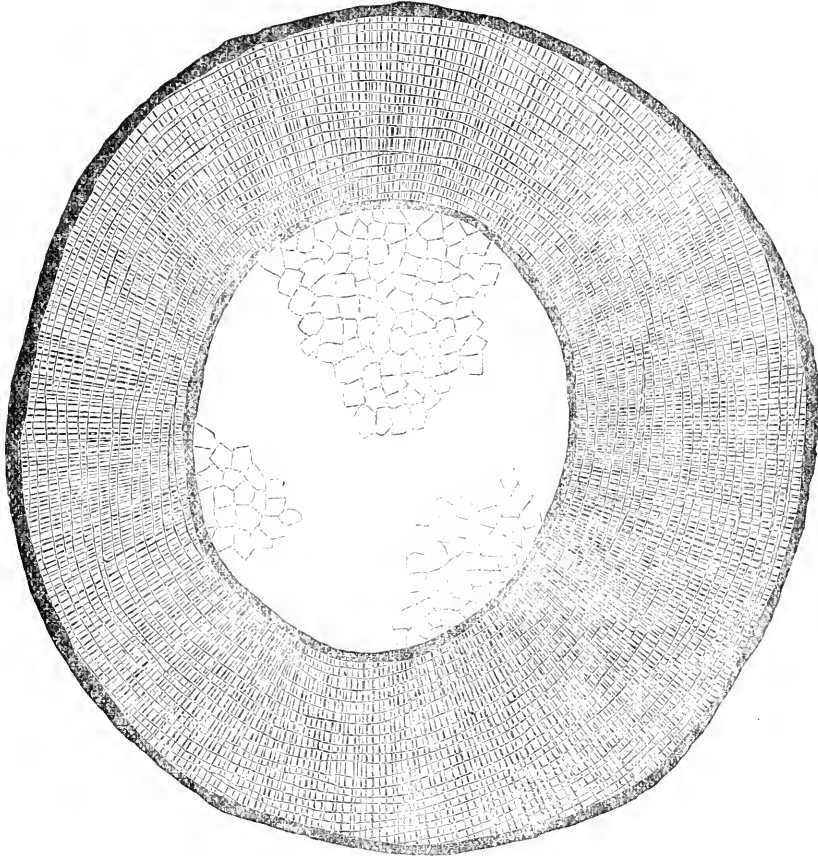

Fig. 151.—*Dadoxylon* (magnified 4 diams.), transverse section. From a specimen in the Author's collection.

which are square and as regular as a woven fabric, and the finest meshes of gossamer silk fabrics are coarse and ugly compared to them. The longitudinal section of these tissues shows a series of long tube-like vessels which are marked with pitted disks, just the same as those which characterise the living pines. The medullary rays may be seen crossing these vessels in a very interrupted manner, also in the same way that they do in recent species. There are many specimens of *Dadoxylon* which do not show the pitted disks, but have the vessels reticulated, this is

In comparing the structure of the fossil pines with that of their modern representatives, we shall not fail to observe the very close affinity which exists between them, and as we know that structure is very much modified by surrounding conditions, we may reasonably infer that the habitats of the ancient carboniferous pines was similar in a general way to those which recent pines seem to prefer, namely upland districts. There are other collateral evidences which also point to the same conclusion, such as the fact that all specimens of this genus bear evidence of

having been drifted some distance away from their original place of growth, no specimens of this tribe have been found *in situ*, or on the very spot where they grew, that I am aware of, such as is very frequently the case with *Sigillaria* and other coal plants. The fossil pines are nearly always decorticated, being devoid of leaves, branches and bark, and occur in a fragmentary condition. Those which show structure are found in calcareous nodules, which also contain marine shells and fish remains, but there can be no doubt of the fact that these plants are land plants, and must have come from some neighbouring land, and many of them have probably been carried a long way from their native soil, down the ancient carboniferous rivers before reaching their final resting-place in the sea. The larger tree-like forms became imbedded in the sandbanks at the mouths of the rivers, while the smaller branches and stems were carried farther out to sea, and ultimately sank to the bottom and became imbedded in the limy ooze and enclosed in nodules along with the remains of the shells and fishes inhabiting that sea. It is also worthy of note, that the *Dadoxylon* has not been found in our coal-balls, which shows that they preferred a different locality to that in which the *Calamites* and *Lepidodendrons* flourished. The small fruit stones which occur so plentifully in some sandstone rocks called *Cardiocarpons* and *Trigonocarpons* are supposed to have belonged to *Dadoxylon*. Our coal-balls yield a great variety of these fruits, but these very probably belong to another fossil pine which was associated with the *Lepidodendroid* plants, and which I shall describe in my next paper.

Halifax.

LIST OF ASSISTING NATURALISTS.

[Continued.]

ESSEX AND MIDDLESEX.

London. Thomas S. Morten, 42 Haverstock Hill, N.W. *Phanerogamic Botany, Exogens, Endogens, and Micro-Fungi.*

MIDDLESEX.

Ealing. George D. Brown, Henley Villa, W. Subjects: *Cryptogamic Botany*, especially *Diatomaceæ* and *Micro-Fungi*; *Polyzoa*, British and foreign, recent and fossil.

VORKSHIRE.

Sheffield. J. W. Williams, Wesley College. *Zoology, Lepidoptera, and Taxidermy.* Correspondents please enclose stamped addressed envelope.

ERRATUM.—SCIENCE-GOSSIP, October 1st, 1881; page 221. For "Extinct Volcano, Isle of Mull," read "Lava Stream or Dyke, Carsaig or Charsaig Bay."

MICROSCOPY.

A HOLLOW GLASS SPHERE AS A CONDENSER FOR MICROSCOPIC ILLUMINATION.—A glass globe filled with water has long been employed by watch-makers and engravers for the purpose of condensing the light upon their work; it was also used by some of the early microscopists. Ledermüller, in his "Mikroskopische Gemüths- und Augen-Ergözung" (Microscopic Mind-and-eye-delights) 1763, gives a representation of his lamp and condenser: the latter is a globe without foot or neck, and is supported on the top of a square brass rod by six claws, the lamp being supported in a similar manner, both of them sliding into square holes at the opposite ends of a brass arm fixed on a stand. In the "Micrographia," Hooke gives a figure of his microscope and accessories, amongst them is a globe condensing the light on the stage of the instrument. This form of condenser was probably used by many of the old microscopists, but it appears soon to have fallen into disuse, as it is not mentioned by Adams in his "Micrographia Illustrata," 1771, or in his "Essays on the Microscope," 1787. Possibly the opticians of the period did not care to introduce so simple and inexpensive a contrivance to their patrons (mine cost one and eightpence). I had looked upon the "globe condenser" as one of the relics of the past, and not worthy of resuscitation; until a short time ago when watching an artist engraving some fine shading on wood, I was struck with the sharpness and definition of the engraved lines (about $\frac{1}{50}$ inch apart). It at once occurred to me that this kind of illumination would suit the microscope. I therefore borrowed it and tried it first with a $\frac{1}{4}$ objective (a Ross 75°) upon *Pleurosigma angulatum*, using oblique light from the mirror; the striae came out very distinctly. I then removed the globe, and the striae vanished and required a more oblique ray to render them again visible. I next tried it on *Synedra robusta* and resolved the striae into beads; this I had not been able to do before with this objective. I next tried it with low powers ($1\frac{1}{2}$ in., 1 in., and $\frac{2}{3}$ objectives). I first used the $\frac{2}{3}$, but forgot to alter the previous position of the mirror, and consequently obtained a "black field," the object I had placed upon the stage was *Halimma Humboldtii*. I was surprised at the beautiful effect upon that form. It appeared as though illuminated by intense moonlight with a slight green tinge and delightfully cool to the eye. I have since purchased a smaller globe (6 inches in diameter) than the one I tried; the liquid with which it is filled is a dilute solution of sulphate of copper (about $\frac{1}{2}$ ounce of saturated solution to 1 pint of water). The mixture must be filtered if ordinary water is used; the intensity of colour is however somewhat a matter of taste. The distance of the globe from the lamp should be about two or three

inches; from the globe to the mirror about eight to twelve inches. As the height of the globe cannot be altered the necessary adjustments must be made with

the lamp, e.g. if the mirror is at $\begin{Bmatrix} C & C \\ B & B \\ A & A \end{Bmatrix}$ A, the lamp flame must be at C; if at C, the flame must be at A.

I have just received a letter from a friend to whom I recommended the illumination, in which he writes, "I am delighted with the black ground illumination, which is certainly softer, and the definition sharper than any I have tried before. Have you tried it with polarised light? I think you would be pleased with it, there is such great softness of tint and such impenetrable blackness of field when the prisms are crossed."—*F. Kitton.*

STAINING VEGETABLE TISSUES NOT A MODERN INVENTION.—Probably the earliest method of staining vegetable tissue is that described by John Hill, in his work on "The Construction of Timber from its early growth, explained by the microscope and proved from experiments in a great variety of kinds. By John Hill, 1774." The following is a condensed description of his *modus operandi*. Dissolve one drachm of sugar of lead in one ounce and a half of water; filter the material. A stem, or piece of a small branch of a tree is to be immersed upright for half its length in this solution, and covered with a glass to prevent evaporation, and allowed to remain two days in it. Cut off the part immersed and throw away. Place the remaining piece in orpiment lixivium (which is thus prepared). Place in a basin two ounces of quicklime and an ounce of orpiment (yellow sulphate of arsenic); pour upon them one pint and a half of boiling water. When it has stood a day and a half, it is fit for use. By this process a deep brown stain is produced.—*F. K.*

FORAMINIFERA IN CHALK.—Mr. Hicken will have no difficulty in obtaining abundance of these organisms if he places a small piece of whiting in a test-tube and pour some boiling water upon it. When cold let it be well shaken, and pour off all that does not subside in one minute. Repeat the process until the water is clear. After the expiration of that time, mount in balsam. Hard chalk or clay sometimes requires the aid of a stiff tooth-brush to break it up. Limestone must be ground thin and mounted in balsam. Hydrochloric acid will dissolve the calcareous matter, leaving any siliceous forms uninjured.—*F. K.*

HABIRSHAW'S CATALOGUE OF DIATOMACEÆ.—I have just received Part I. of this work, edited and published by Mr. Romyn Hitchcock, of 53 Maiden Lane, New York, and to be completed in four parts. The price is 5s. 6d. a part, and only 250 copies are to be printed. To any one who has no acquaintance with the Diatomaceæ, the book will appear to be little more than an alphabetical string of unintelligible

references; but to those who have studied them, or who desire to do so, it is invaluable. Only those who have attempted the compilation of such a catalogue can realise the labour involved in its production; and it is to be hoped the remaining three parts will speedily follow. There are, of course, slight errors; for instance, at p. 17, l. 24, after "M. J." should be inserted "1860," and again, at p. 25, l. 13, "J. M." should be "T. M. S."—not to mention others. A few such errors are, however, inevitable, but the immense utility of the work far outweighs them. Though one may possess the numerous necessary books of reference and may have an intimate acquaintance with the Diatomaceæ, none but those who have tried can realise the time occupied and the uncertainty involved in trying to find the description or figure of any particular species. The want of such a catalogue has long been felt, and the thanks of Diatomists are due to Mr. Habirshaw and his publisher for now supplying the want.—*H. Ramsden.*

SOUTH LONDON MICROSCOPICAL AND NATURAL HISTORY CLUB.—The above society have just removed to new quarters in Brixton Hall. It is an important move, inasmuch as it is approved by nearly every individual in the club. The rooms of the general meetings are now more in unison with the standing of the society, being brighter and larger in respect to the library room. At the last general meeting a very interesting paper was read by Sibert Saunders, Esq., of Whitstable, upon "Barnacles."

ZOOLOGY.

SCIENCE IN THE PROVINCES.—The report of the Proceedings of the Seventh Annual Meeting of the Norwich Science Gossip Club, contains the address of the President (Mr. James Carver), in which he gives a brief résumé of the past session. The subjects reviewed are the following: Astronomy, Heraldry, General Literature, Botany, Geology, Entomology, Physical Science, Social Science, Travel, &c. We commend the structure and management of this spirited club to the attention of those towns where a similar society may be in process of formation.

SCIENCE TEACHING.—We see that Mr. W. J. Harrison, F.G.S., has read a valuable paper on "The Teaching of Science in Public Elementary Schools," before the Birmingham Philosophical Society. The Appendix, containing a scheme of instruction in Elementary Science, as carried out in the Birmingham Board Schools, will be found useful to all engaged in the work of education.

AN UNUSUAL FORM OF AMŒBA.—With respect to the rhizopod described and figured by Mr. J. Fullagar of Canterbury, in the October number of SCIENCE-GOSSIP, p. 226—a form closely resembling

it appears in the June number of the Journal of the Royal Microscopical Society, p. 474, as *Dactyamaba elongata*, described and figured by M. A. Korotoneff; it is quoted from Arch. Exp. et Gén. Zool. viii. (1880), pp. 467-83.—*W. T. Suffolk.*

HONEY BUZZARDS.—Perhaps it might interest some of your readers to know that two spotted crakes and also two honey buzzards have been shot near Woodbridge, Suffolk.—*R. D., Woodbridge.*

HOW WORMS TURN IN THEIR BURROWS.—Dr. Darwin, in his work on Worms, remarks at page 117, "When a worm comes to the surface to eject earth, the tail protrudes, but when it collects leaves its head must protrude. Worms therefore must have the power of turning round in their closely-fitting burrows; and this, as it appears to us, would be a difficult feat." It does seem to be a difficult feat indeed, unless we have put to the test the marvellous attenuating power which the worm possesses. I have put this to the test, with a result which certainly surprised me and helps to explain how the feat is accomplished. In order so to do, I obtained a long narrow glass tube—so narrow in fact that it seemed impossible that a worm of any size could be got into it—and attempted therein to cage a large worm, say in its normal condition, about five inches in length. The tube was too small to get the worm into it, except when drawn out to the utmost attenuated condition of its anterior (head) part when dragging itself along the ground. It was a matter of no little time and difficulty to compel the worm to go into so slender a tube, too small to admit it except in its attenuate condition. It was unearthen in the daytime, so I had plenty of light to watch its movements and direct my own. Laying the glass tube on the ground, I carefully moved the end towards the finely drawn-out head of the worm, so that the next movement forward in the same line must bring part of the creature within the tube. But no, time after time did it withdraw before any length had entered the tube; at length however, after checking its onward movement, time after time, except into the opening of the tube, and by gently and repeatedly tapping the tail, at last drawn out apparently to its utmost length so as to fill the circumference of the tube, I had my unwilling prisoner fairly caught in his narrow cell. One end of the tube was already plugged up, and no sooner was the worm inside than I securely plugged the other, so that at neither end was there a possibility of escape. The inside surface of the tube was soon covered with a kind of slimy secretion, but the tube was more than double the length of the worm, thin drawn as it was, and it soon made its way to the extreme end. Here, however, all egress or progression was barred, and now, thought I, if you want any more locomotion, Mr. Worm, you must go *backwards*, for *turn round* you cannot. What was my surprise, to see it slowly and gradually attenuate its

head even yet more, and double back over itself! I should have said it was impossible, had I not seen it do it, as slowly ring by ring of its length was drawn round and two circumferences of the worm occupied the space in the circumference of the tube, until at last the whole worm had fairly turned round and begun to crawl back to the other end of the tube, where as egress was barred it repeated the operation. After this, I had no difficulty in understanding how a worm turns in its burrow, so as to protrude its head or tail as the necessity of the creature requires; as the worm hole is, I believe, always large enough for the worm to draw itself into its normal or unattenuated condition.—*W. Budden, Ipswich.*

ON THE COCOON OF CIONUS.—In the third vol. of his "Mémoires" (pp. 31-3, pl. 2, fig. 9-12), Réaumur describes among leaf-miners, the larva of a weevil which lives in the leaves of mullein (*bouillon-blanc*), and which is evidently a species of Cionus. Judging by the size and description, p. 33, I suppose it to be *C. thapsus*. It differs from *C. Scrophulariæ* in living, according to Réaumur, in the substance of the leaf and not upon the surface, and also in the duration of the pupa stage—seven to eight days, or less; whilst the same stage in *C. Scrophulariæ* is from thirteen or fourteen to some eighteen days. His account of the cocoon agrees substantially with that which I have given of the cocoon of *C. Scrophulariæ* in SCIENCE-GOSSIP, vol. xvi. p. 209; except that Réaumur was unable to discover the mode in which it was made, but supposed it to be spun by an oval spinneret like that of caterpillars. "Pour se transformer en nymphes, ces vers se filent une jolie coque, presque sphérique, de couleur blancheâtre, et d'un tissu si serré, qu'elle paroît plutôt faite d'une membrane, que de fils appliqués les uns contre les autres. . . . Je ne suis pourtant pas parvenu à les leur voir filer, parce qu'ils ont tous pris la nuit pour le temps de leur travail. Mais j'ai cru voir leur filière placée comme celle des chenilles, et leur tête se donner des mouvemens semblables à ceux des chenilles qui filent. J'ai d'ailleurs été convaincu que leurs coques n'étoient point faites de la peau du ver," &c. &c. The resemblance to the coarctate pupæ of the diptera seems also to have struck your correspondent, W. H. G., in his Note on the Betony Weevil, in SCIENCE-GOSSIP for Jan. 1876, p. 17. As to the way in which the beetle makes its escape from the cocoon, Réaumur says: "Le scarabé qui vient de laisser sa dépouille, rongé circulairement la coque; la pièce qu'il a détachée presque tout autour, est une porte aisée à ouvrir, il la pousse, elle cède et elle lui donne un libre passage."—*J. A. Osborne, M.D., Milford, co. Donegal.*

DOVER FIELD CLUB AND NATURAL HISTORY SOCIETY.—The annual meeting of this society was held recently and was well attended. Thomas Lewis, Esq., was elected president; Sydney Webb,

Esq., was re-elected as hon. secretary; Mr. C. A. Grimes, as hon. treasurer. The Dover Field Club and Natural History Society was formed in May of last year for the purpose of extending a taste for natural history pursuits in the neighbourhood by means of excursions during the summer, and evening meetings in the winter months. It numbers forty-two ladies and gentlemen as honorary or ordinary members. Attention has been given during the year to the botany and etymology of the neighbourhood, which has resulted in the addition of several new species to the fauna of the district. Specimens have also been exhibited at the meetings, and papers read on the structure of plants illustrated by drawings and sections for the microscope. Excursions during the summer months were made to St. Margaret's Bay, Alkham, St. Radigund's Abbey, Fredville Park and grounds, Folkestone Warren, and Whitfield, by the Roman way.

LATE SWALLOWS.—On Saturday last, November the fifth, about half-past four in the afternoon, upon going to my window to look at the sky touched with crimson clouds of much beauty of approaching sunset following heavy rain, I was surprised to see three swallows flying across from side to side, only a short distance off; which, after remaining near for a few minutes, so as to be distinctly recognised against a clear space of sky, gradually flew away towards the south-west. Never before can I remember having seen any in this neighbourhood later than the twentieth of October.—*Horace Pearce, F.L.S., Stourbridge.*

THE ANNUAL SOIREE AND EXHIBITION OF THE LAMBETH FIELD CLUB will take place at St. Philip's schools, Kennington, on Monday, January 2nd, when exhibits of specimens (botanical, entomological, &c.), will be heartily welcomed. Notice of same to be sent to W. G. Masters (at the Old Vestry Hall, Lambeth Road).

BOTANY.

MALFORMATION IN DAISY.—Late in October I collected a daisy (*Bellis perennis*) in which four of the bracts of the involucre were converted into true leaves.—*J. E. Taylor.*

ABBREVIATIONS IN RABENHORST.—In answer to your correspondent's query (p. 258, Nov. 1881)—asking the meaning of certain abbreviations in Rabenhorst's "Flora Europæa Algarum," I beg to explain them as follows:—*v. v.* (= *vidi vivam*) means that the author had seen and examined a living specimen of the diatom he was describing; *v. s.* (= *vidi siccam*) means that he had only seen it in a dry or fossil state; *n. v.* (= *non vidi*) means that he had not seen the diatom either living or dry; *v. ic.*, *v. i.* (= *vidi iconem*) each means that he had seen the

figure of the diatom he referred to in his description; *a. m.* (= *ab mari*) is used by him when referring to the number of feet the locality indicated was "above the sea level."—*H. Ramsden, M.A., F.L.S.*

PLANTS IN EXTINCT VOLCANO.—In SCIENCE-GOSSIP for November, J. F. of Cranswick, Leeds, wishes to know the botanical name of the plant growing in the extinct volcano Haleakala in the Hawaiian group. It is *Argyroxiphium Sandwicensis* of Sir William Hooker, it belongs to the composite family, and was grown at Kew twenty years ago.—*J. Smith, Ex-Curator, Royal Botanic Gardens, Kew.*

PLANT LORE.—In your last number, G. N. Widcombe states that plants of *Orchis mascula* are popularly known about Western-super-Mare as "stannegusses." In the Western Lowlands of Scotland, plants of the same species—and of *O. maculata* and *latifolia* as well—are known as "Baldberries," the accent being put on the second syllable. What the primary meaning or derivation of the word "Baldberry" may be, I do not know; but I have frequently heard it used in Lanarkshire and Ayrshire. Perhaps some of your correspondents may be able to throw light on the etymology of the word.—*R. T.*

BOTANISING ON THE SUSSEX DOWNS.—Has it been the good fortune, I wonder, of any of the numerous readers of SCIENCE-GOSSIP to wander at will over the breezy downs in the neighbourhood of Steyning, plant-hunting? If it has not, the following list may indicate some of the treasures awaiting their first visit; and if it has, let me hope that the perusal of these jottings will call up not unpleasant reminiscences. Ascending the downs from Steyning, we notice an abundance of *Clematis Vitalba*, and find *Rubus cœsius* in the hedgerows. The fields through which we pass yield *Centaurea Scabiosa*, *Silene inflata*, and *Scabiosa Columbaria*. *Eupatorium cannabinum* in the hedgebanks appears very seductive to insects. Having reached the downs we are constantly on the *qui-vive*: a bit of blue, different in shade from what we have been accustomed to, turns out to be *Phyteuma orbiculare*, and growing near *Carduus acutis* and *Carlina vulgaris*. We are too late for perfect specimens of *Anthyllis Vulneraria*, but gather one or two dilapidated heads. *Helianthemum vulgare* has also done flowering, but there is abundant evidence of its having done so profusely a little earlier. On the top of the downs is a thicket composed to a great extent of *Rubus Idæus*, among which *Origanum vulgare* is noticed; another thicket gave us *Epilobium angustifolium*, and *Spiræa Filipendula*. *Gentiana amarella*, though present, was not yet in flower. *Reseda Luteola* and *Echium vulgare* were found, but sparingly. Near to the steep down we gathered *Onobrychis sativa*, but its being indigenous is doubtful. The lanes and fields are not the least attractive surroundings of Steyning,

but we cannot linger in them now, so will be content with naming *Campanula Trachelium*, *Cuscuta Europea*, and *Orobancha major* as among the most noteworthy of their inhabitants.—*F. II. II.*

COLOURS OF FRUITS OF THE NORTHERN UNITED STATES.—In further elucidation of the theory suggested by the contrasts existing between the colours of the British flowers and fruits, in an article in the April number of *SCIENCE-GOSSIP*, may be adduced the facts contained in the following table. This is a compilation from Asa Gray's "Botany of the Northern United States," and is an approximately complete list of the coloured fruits and seeds that occur in that district. It will be observed that, just as in the British flora, there is a great preponderance of red and black, the former being about 45 p.c., the latter about 33 p.c., whilst yellow, blue, and white occur only in very limited numbers. From a rapid survey of the colours of the flowers as mentioned in the same work, it appears that the contrasts between the prevailing tints of flowers and fruits are strongly marked in the temperate regions of the United States, as well as in the British Isles.

	Scarlet and Red.	Crimson and Purple.	Orange and Yellow.	Green.	Blue.	Deep Blue.	Black.	White.
Fruits . .	96	15	9	4	17	2	59	8
Seeds . .	2	0	0	0	0	0	13	0
Receptacles and Ovaries)	10	0	0	0	0	1	0	0
	108	15	9	4	17	3	72	8

Total 236. From the foregoing it will be seen that the percentage of red and black fruits is about the same in the northern portion of the United States as it is in this country, the details of which were given in the April number of *SCIENCE-GOSSIP*. This is certainly interesting, and may be taken as an indication that similar causes have produced like results in both continents.—*J. Saunders.*

LOCAL NAMES OF PLANTS.—*Fingicula vulgaris*, "Sleepweed" or "Sleepwort;" co. Antrim. "Bird's-foot Trefoil," "Claver;" co. Antrim. *Knautia*, "Cardies;" co. Antrim. *Potentilla anserina*, "Mash Corns;" co. Tyrone. *Typha* and *Iris*, "Saggons," Brooklime, "Wellink." "Chicken-pox" is called "Nerls," near Ballymena, co. Antrim.—*S. A. Brennan, Clerk.*

A. SCHENOPRASUM.—Would Nemo (Malvern) kindly inform me if he has met with *Allium Schenoprasum* in the neighbourhood of Malvern, as I am much interested in the flora of the district? I have myself never met with the plant.—*R. F. Forwoodron, 2, Commercial Buildings, Malvern Link.*

GEOLOGY.

A VISIT TO A SLATE QUARRY.—*Errata*:—p. 245-2nd col, line 1, for "of course" read *or course*. Do. do. l. 6, for "counter" read *caunter*. Do. do. l. 10, for "turb-like" read *comb-like*.—*E. II.*

R. ETHERIDGE, F.R.S., who has for many years acted as Palæontologist to the Geographical Survey, has accepted the office of Assistant-Keeper of the Department of Geology in the British Museum.

AN INTERESTING GEOLOGICAL DISCOVERY.—In the recent number of "Nature," Professor Arch. Geikie, gave an interesting and important account of "A recent 'find' in British Palæontology." The "find" is located in a particular zone of shale on the banks of the Esk, and has been brought to light by the Scottish Geological Survey, during their recent investigation of the Carboniferous rocks lying between the Silurian uplands and the English border. The most important fossils are the remains of fishes, crustaceans, and arachnida. The fishes were at once placed in the hands of Dr. Traquair, the first part of whose report on the Ganoidei has been already communicated to the Royal Society of Edinburgh. Dr. Traquair points out the extraordinary interest of the collection, both as opening up an almost entirely new fish-fauna, and as revealing remarkable structural peculiarities in many of the new forms. Out of twenty-eight species of ganoids, no less than twenty at least were new. Of sixteen genera, five are new to science (*Phanerosteon*, *Holurus*, *Canobius*, *Cheirodopsis*, and *Tarrasius*) of which one (*Tarrasius*) is altogether so peculiar that no place can be found for it in any known family. The phyllopod and decapod crustaceans have been worked out by Mr. B. N. Peach, who has described them in a memoir also contributed to the Royal Society of Edinburgh. The phyllopods consist of two new species of *Ceratiocaris*, which differ from the Silurian species in having the body relatively much larger than the carapace. Of macrurous decapods several new species occur which differ in no essential respect from their living representatives. The most important fossils are scorpion remains. The specimens are both numerous and perfect, inasmuch so, that Mr. Peach has been enabled to work out their structures in considerable detail. He finds that they much resemble the scorpions of the present day. The combs are much like those of the modern scorpion, but with a sculpturing characteristic of the Eurypterids. These remains have enabled palæontologists to correct a notable mistake. When the Geological Survey first began its work in Scotland, and was engaged in mapping the east of Berwickshire, a remarkable and unique specimen was found, and was described by Salter under the name of *Cycadites Caledonicus*, as the most ancient cycad known.

Among the specimens collected from the Border Ground are several similar specimens, but so well preserved as to show that they are not plants at all. They are most probably a yet undescribed comb-like organ belonging to *Eurypterus*.

NOTES AND QUERIES.

ATMOSPHERICAL ELECTRICITY.—In a note to the article "On Certain Phenomena connected with Atmospheric Electricity," in the June and July numbers by Mr. Woolcombe, a remark is made on my recent pamphlet "Electric Meteorology," and I did hope that the subject would have gone on so that some distinct objections might have been made to the theory I advance, and not a mere vague allusion. On the phenomenon to which Mr. Woolcombe refers in his note (Ball Lightning), my remarks are these, "I have omitted reference to what are at times described as globuled lightnings or electric fire-balls, simply from the fact that, although an earnest observer of thunder-storms from my childhood, I have never seen anything to which such a description would apply and I can form no opinion on the subject." This is not "denying the existence of ball lightning;" but that a ball of electricity, as described by Mr. Woolcombe, should "strike the earth and rebound," is so opposed to all known laws of electricity in motion, that I do not hesitate in expressing my disbelief in such a phenomenon. The following are my remarks on the subject of the two last paragraphs of Mr. Woolcombe's paper:—"With regard to what is called the return electric stroke, i.e. an upward stroke of lightning from the earth to the clouds, I not only have never seen anything of the kind, but I believe it is an impossibility. That electricity on a great and sudden collapse of vapour should at once pass off from a cloud to the earth, seems strictly in accordance with its powerful tendency to gain an equilibrium, and it has the whole globe to attract it. But as regards the return stroke of electricity, what have we to support the idea of it? We know of no natural cause for a sudden development of electricity on the earth's surface, as in the collapse of vapour. In drawing a spark from any charged body we have evidence of atmospheric resistance to the passage of electricity. How then can it be imagined that a collection of mere mist could thus draw lightning through a long course of resisting medium, and on the instant disturb the electric equilibrium over a considerable portion of the earth's surface? The evidence I have seen in support of the reality of this phenomenon seems insufficient, and I believe it has been accepted from its being in accordance with the bipartite theory of negative and positive electricities, or has been advanced in support of it."—*G. A. Rowell, Oxford.*

HAIR-BELL OR HARE-BELL.—Your correspondent Mr. Kingston, whose letter I have only just seen, seems (so far as I understand him) to propose to remove the ambiguity of calling two very different flowers by the name of hare-bell, and to do so more than effectually, by depriving them both of that name. For he objects to call the *Hyacinthus non-scriptus* (which I think most botanists now call *Scilla nutans*) any kind of bell, because it is not one of the Campanulaceæ, and suggests to spell the popular name of the *Campanula rotundifolia* as hair-bell. As his argument about the wild hyacinth applies as much to calling it blue-bell as hare-bell, he would

apparently deprive it of any popular name at all. But surely when he says that by applying the spelling hair-bell to the *Campanula rotundifolia*, "we at once satisfy the demands of botanical accuracy and of the fitness of things," he forgets how hopeless it was apparent from the first that it would be to seek scientific accuracy in popular names. (I presume by the "fitness of things" he means the hair-like stalk of the little campanula.) As far as my experience goes, I have never heard the wild hyacinth called anything but blue-bell, and it was only in books that I found it, as well as the *Campanula rotundifolia*, was called hare-bell. The analogies pointed out by Professor Skeat, in his "Etymological Dictionary," make it probable that this is the correct spelling; though it is not more easy to see what the hare has to do with it than the fox has with the digitalis or fox-glove. A question of great interest to me is to which of these did Shakespeare refer in the lines I quoted from "Cymbeline" in SCIENCE-GOSSIP for July? Mr. Bowker thinks to the *Hyacinthus* or *Scilla nutans*; and subsequent consideration, from the season of the year, leads me to believe that he is right, although I should never liken the colour of the human veins (unless of a very much older person than Fidele was supposed to be) to that of the blue-bell. I cannot help thinking that heath-bell (which is sometimes used for it) is the most appropriate name for the *Campanula rotundifolia*. Small as it is, it is a conspicuous flower on heaths, from coming at a season when there are so few others,—P.S.—Since writing the above, I have seen F. K.'s note in last month's SCIENCE-GOSSIP. I am afraid, from one expression in it, that he somewhat misunderstood a remark of mine with regard to the hare-bell. I too never saw it spelt hare's-bell with an s, but in the failure of finding any instance of its use by early English writers (I know of none earlier than Shakespeare) it seemed worth while to refer to the analogy of other plant-names, and the frequency of those of animals forming a part of them. The hare in particular often occurs in this connection, and I adduced the fact that it has sometimes, when part of the name of a plant an s after it (e.g. hare's-lettuce, &c.), as decisive of the quadruped being intended. I am quite aware that the non-occurrence of that letter in hare-bell may be used to look upon it as an exception in this respect, but cannot consider this more than merely possible. I should be quite as glad as F. K. to find any early instance of its use, until which the question must be to some extent doubtful. An historical basis, as is so well set forth by example rather than precept, in Professor Skeat's "Etymological Dictionary," is (where it may be had) the only trustworthy one in matters of this kind.—*W. T. Lyun, B.A., Blackheath.*

HARE-BELL, &c.—May not the spelling and structure of the maidenhair fern be taken as an analogy, in deciding the question of the rival spellings between hair-bell and hare-bell?—*J. A. E., Westwick Rectory, Herts.*

FOLK-LORE OF PLANTS.—If your correspondent G. N. Widcombe has not yet found an answer to his interesting question concerning "stannen gusses" he may like to hear that in old Gerarde the "Lady-traces" (*Vicia spiralis*) is called "Stander-grasse," and in Dutch "Standelwelks and Standelcraut," which latter word pretty well explains itself as applied to many of the orchis family. The termination "craut" (herb) is of course the same as "grasse," or its corruption "gasse." May I suggest to your correspondent, and to others interested in plant-lore,

that it is still worth searching in old "Herbals" and medical books for an explanation of the meaning of the "deadly Hebenon" in Hamlet; the "insane root" in Macbeth; Oberon's "Love-in-idleness;" and the "Hemony" in Comus. The exquisite descriptions which accompany these names lead one to think that they are not simply flowers of poetry, but represented some plants of forgotten "temperature and vertues."—*Thomas E. Anyot, Diss.*

IS FOOL'S PARSLEY (ÆTHUSA CYNAPIUM) POISONOUS?—The reason for still asking this question will be explained by the following report taken from the "Scotsman" newspaper of September 30th. "The fatal case of poisoning at Nairnside—Report by the analyst.—A report has just been received by the procurator-fiscal of the county of Inverness from Dr. Littlejohn, of Edinburgh, with regard to the fatal case of poisoning which occurred at the house of Mrs. Johnstone, Nairnside, on August 29th. In consequence of having partaken of rabbit soup, in which were some parsley and some curry powder, ten persons were taken ill, and one of these, Mary Macdonald, the cook, died. The contents of the stomach of the deceased were sent to Edinburgh for analysis by Dr. Littlejohn, and Dr. Littlejohn's report says there can be no doubt that the symptoms point to a poison possessing narcotic properties, and, therefore, not a pure irritant; he has been struck by their similarity to those caused by the Umbellifera, to which common parsley belongs. A plant of this family, which possesses actively poisonous properties (fatal accidents having been recorded from its having been taken instead of domestic parsley) is called 'Fool's parsley,' from its resemblance to ordinary parsley, of which the popular name is lesser hemlock. Had portions of this plant accidentally (in mistake for parsley) been put into the soup and eaten, Dr. Littlejohn is clearly of opinion that the fatal result in the case of the girl Macdonald, and the symptoms of poisoning in the others affected, would be satisfactorily accounted for. He thinks it, therefore, highly probable that all these cases at Nairnside were due to a vegetable poisoning of an accidental character." After the careful and apparently conclusive experiments of Dr. Harley with this plant, noted in SCIENCE-GOSSIP of February (p. 46), and July (p. 164), another question arises, viz., can the same species of plant be poisonous in one locality and innocuous in another? This seems highly improbable, and yet statements to this effect have been made by eminent authorities, with regard to other reputed poisonous plants of the same family, such as the water-hemlock (*Cicuta virosa*), the hemlock-dropwort (*Cenanthe crocata*), &c.—*R. L., Edinburgh.*

PULEX IRRITANS.—Will you, or any of your readers, kindly inform me how to obtain specimens of the larva and pupa of the human flea? I read that the female flea lays a great number of eggs, sticking them together with a glutinous matter; those of fleas infesting the dog or cat are made fast to the roots of the hairs; in four days' time the eggs are hatched, and a small white worm or grub is seen crawling about, and feeding actively. After remaining in this state about nine or ten days, it assumes a pupa form, which it retains for four days; and in nine days more becomes a perfect flea. I have never been successful in finding them in the larva or pupa state, and fancy they would not be uninteresting objects for the microscope.—*F. Farrant, 43, Sydney Street, Brighton.*

BITING POWERS OF THE STAG BEETLE.—As opinions and facts rather diverse from each other

have been published on this question, I may state that I have had several living males, and one or two females in my possession, and did not find them inclined to be pugnacious, even when irritated.—*J. R. S. C.*

FLUKES IN SHEEP.—Sir, kindly allow me to correct two misprints in my little note respecting flukes which appeared in SCIENCE-GOSSIP for November. The eggs of the fluke are produced in the *Liver*, not the "skin" of the sheep, and they find their way out into the *World*, not "wool," to effect their various changes.—*Helen E. Watney.*

TREE FROGS.—Tree frogs pass the winter in their native homes at the bottom of some stagnant pool of water, and they will gladly do the same in confinement, if the means are provided by placing a shallow pan half filled with wet mud in a corner of their glass house. A lady I know kept three of these pretty little creatures for several years in this manner. She fed them in summer with flies, spiders, small earth-worms, tiny white slugs, and they occasionally took a little raw beef minced very fine. But in winter they retired to the mud bath and rested. The pan containing them was kept in a warm greenhouse. All frogs lose their desire for food as winter advances, and the tree frog is no exception to the others of its race. Fitz Gerald should put a small fern or two in the glass case along with his frogs; they thrive better if they have plants to shelter under.—*Helen E. Watney.*

A TAILED FROG.—While camping out on one of our beautiful lakes, Lovesick Lake—so called from the untimely death by drowning in its waters of an Indian maiden, whose unrequited love for a young "brave" had made her life a burden—I captured the other day, a frog with a tail. The reptile is two and a half inches long from tip of nose to tip of tail: the latter abnormal appendage, which, from some cause or other, perhaps from failure to procure sufficient or proper food, had not been eliminated or become absorbed, on the development of the legs, is an inch in length, and a quarter of an inch wide at the butt-end.—*Rev. Vincent Clementi, B.A., Peterboro', Ontario, Canada.*

DO PARROTS REQUIRE WATER?—Most assuredly they do; like all other birds, parrots, in their wild state, are water drinkers; and I have seen thousands of them, of different species, resorting night and morning to the water-holes and creeks, when I lived in Australia, and I have shot numbers of them while they were in the act of drinking. I have also repeatedly seen them sucking the dew from the grass and leaves, a custom which my own domesticated parakeets have not forgotten. The startling statement attributed by "Figaro" (a novel authority by-the-way in such matters) to Mr. Bartlett that the birds under his care are deprived of water, can only be accepted with a considerable amount of reservation, as Mr. James Hooper may ascertain for himself any day by paying a visit to the Parrot House in the "Zoo," where he will find a great many of the parrots with drinking-water in their cages, and the remainder supplied with moist food, such as sops, and soaked corn and seed. That parrots are not large drinkers, I am prepared to admit; and that they can and do exist for a long time without water is certain; but that scarcely affects the question at issue. Wild parrots, at least those in Australia, unquestionably drink, for I have seen them do so; and I have bred numbers of different kinds of these birds in this country, and have closely studied their habits, and they too drink freely. I can therefore only repeat what I have written before, that it is absurd to say

they do not, and the height of cruelty to deprive them of water for any length of time; nevertheless, the worthy magistrates who, at the instance of the excellent Society for the Prevention of Cruelty to Animals, fined Mr. Cross for sending six parrots to London from Liverpool without water, were utterly ignorant of the subject upon which they undertook to adjudicate, as were also the prosecutors in the case, who I understand, at a subsequent hearing had to compensate the dealer they had rashly proceeded against. Finally, even supposing that the parrots at the Zoological Gardens were all, really and truly, kept deprived of water, or its equivalent, and still contrived to exist, that would in no wise alter the case, or my opinion upon it, for I think it is an open question. I don't know if Mr. Bartlett ever saw a wild parrot, or studied their habits in their native woods, many animals will live for a long time without water that, nevertheless, drink freely whenever they have an opportunity of doing so.—*W. T. Greene, M.D., Moira House, Peckham Rye.*

PARROTS.—A friend of mine has a parrot which is about three or four years of age. During the last few months the bird has acquired a lamentable habit of plucking out the breast and back feathers, leaving the long feathers of the wings and tail undisturbed. In all other respects the bird seems healthy. Can any of your correspondents explain the probable cause, and suggest a remedy or means whereby the bird may regain its natural plumage?—*W. E. B.*

HOW CAN WE POPULARISE NATURAL HISTORY?—With reference to the article by Mr. J. S. Clifford in the November number of SCIENCE-GOSSIP, allow me to give the results of my limited experience. The instruction of the young in entomology is the keystone of the movement suggested, and I feel confident that if there was one master at each of our higher-grade schools who would try to interest the boys in its kindred subjects, he would find no lack of eager listeners. When I came here there was no natural history society at all, the one that used to exist having died a natural death, not by any means through the fault of its very energetic president and officers, but from lack of real workers among the boys. I offered to devote two hours a week out of school to give lectures on this subject, and at first eight boys availed themselves of this offer, some of whom wished to take up botany, others entomology. I determined to take the two alternately. Within three days after my second lecture the number of attendants was trebled, and it seems as if the number would continue to increase. I am taking them through the whole of the animal and vegetable kingdom in an elementary way, and they listen most attentively when I tell them of the wonders they have never heard of before. The fact that these boys devote two hours of their playtime a week to be instructed in natural history, and that every one of them regularly attends both series of lectures, proves that this branch of science would be eagerly embraced by many and many a young student, if one willing to teach them were forthcoming. The notes which are taken during the lectures are copied out neatly in a way that only those who love the subject could do. Another great and almost equally efficacious way of exciting latent interest is to disseminate such papers as the SCIENCE-GOSSIP, which treat of a variety of subjects in a clear and very interesting way, and I have often heard regret expressed at not having known of such a periodical before. If only we can get boys to look upon natural history, not in the isolated manner with which it is generally viewed, but

as a science capable of almost infinite extension in all its branches, we shall have no cause to seek for a method of popularising it.—*Walter G. Woolcombe, B.A., F.L.S., &c.*

THE VIRGINIA NIGHTINGALE.—I am somewhat surprised at the want of knowledge respecting the so-called "Virginia Nightingale," expressed by E. C. Morris in your August number, inasmuch as Wilson, a recognised authority in Europe as well as on this Continent, in his chapter on the cardinal grosbeak (*Loxia cardinalis*), says: "This is one of our most common cage birds, and is very generally known, not only in North America, but even in Europe;" and he adds that in England "they are usually called Virginia Nightingales." This is the name by which they are commonly known in Canada also. Wilson then inserts a quotation from Dr. Latham to the following effect: "To this name," Virginia Nightingale, "they are fully entitled, from the clearness and variety of their notes, which, both in a wild and domestic state, are various and musical." Having kept this bird myself for some years, I can fully endorse the opinion entertained by both those gentlemen. At the same time there is no doubt that the mocking bird (*Turdus polyglottus*), a singularly happy epithet, is superior as a songster.—*V. C.*

THE ENGLISH SPARROW.—This bird, alluded to by the same correspondent, is a regular nuisance in Canada, for it not only devours our small fruits, but it bullies and drives away our own prettier and more charming spring birds, e.g. the blue bird (*Sylvia sialis*), the chipping sparrow (*Fringilla socialis*), &c. A short time ago, attracted by a loud and angry twittering, I saw four English sparrows worrying a chipping sparrow on the ground; and they would, I feel sure, have killed that familiar little native, the tamest of our birds, but for my intervention. We cannot but admire their pluck, but we disapprove of "their tricks and their manners."—*V. C.*

CIRCUS SWAINSONII.—In your journal for July, I notice among the "Notes on the Inland Birds of Ceylon," what most evidently be a mistake in F.L.'s description of *Circus Swainsonii*; under his heading "Distribution," he writes of it as "fluttering over one spot, or *stooping* as it is called." Now these characteristics, including the size and colour, are all far more in keeping with the habits of *Elanus melanopterus*, than either *Circus Swainsonii* or *Circus cineraceus*, both of which are nearer seventeen inches in length than twelve inches, which are given as the length of the specimens which he possesses. The upper wing-coverts, too, are specially those of the *Elanus melanopterus*, and the brown colour on the under sides of the wing must result from immature specimens.—*William Robert Laurie.*

ORCHIS MORIO.—One of your contributors mentions that he found *Orchis Morio* with white flowers. I have only seen the fact mentioned once, and that is in Babington's "Manual;" I have never met with it myself. It will be rarely that such a form is met with. Such valuable additions to our "variety flora" will be welcomed by all botanists.

BIFURCATION OF THE FIR.—In No. 186 Mr. G. T. Harris asks if any of the readers of SCIENCE-GOSSIP have noticed the bifurcation of fir. It is quite common in this part. I have seen all kinds of firs bifurcated, some with three and four stems. I should think there are various causes for it, in some the tops get damaged, and some from other causes.—*J. J.*

SCARCITY OF WASPS.—Like a number of correspondents, I have noticed the scarcity of wasps in this district. I do not remember seeing a wasp since the first week in June. I have not heard of nests being seen anywhere near; there were a great number of females in the early part of spring.—*J. J.*

SCARCITY OF SKY-LARKS.—A number of correspondents have given their opinion on the scarcity of sky-larks. I think none of them are satisfactory, nor am I able to give a satisfactory one. I think there is another cause which may help to lessen their numbers, that is the rooks. I believe these are more likely to destroy either the eggs or young bird than the starlings. I saw a rook eating a young lapwing, it flew off with a part of it, but dropped it. I saw some young lapwings running about in the field the day before. I have seen the eggs of lapwings which had been carried from the nest and destroyed after a flock of rooks had been in the fields feeding. I have seen the nests of other ground-building birds turned out of the hole, sometimes an egg or part of one left after a number of rooks had been in the field.—*J. J.*

THE LATE GALE.—An ill wind always blows somebody good. It has done a deal of damage amongst our vegetable kingdom. Trees two or three hundred years old have been up-rooted, branches torn off, and trunks broken clean in halves. It has also done a deal of good; it has opened up many secrets of nature to the young as well as the old naturalist. Ants' nests have been brought to light from the centre of old trees, and also different burrowing larvæ and beetles were met with; numbers of rare insects we found in the rotten wood. Pupæ likewise turned out of their warm beds. Naturalists ought now to be hard at work gathering in their second harvest, before the birds and other enemies have done it for them. I have found some good specimens from one or two trees which were blown down by the wind. Amongst them was a nest of the yellow ant (*Formica flava*) constructed of wood, in the hollow trunk of an ash-tree; a piece of which is now in the collection of the Norwich Natural Science Club. I also found a piece of it made of earth, but it was very brittle and broke before I reached home. Under the bark of another tree I found some very curious larvæ about $\frac{1}{4}$ inch long. They were of a greyish colour, having two tufts of brown hair on each side of the tail (name unknown).—*E. P. Dyball, Norwich.*

HEATHER.—I had sent me lately a quantity of heather (*Calluna vulgaris*), and amongst it was just a little of the white variety. I have seen it mentioned in one or two botanical books that a white variety is to be got, and I should like to know if it is common. What I have seen is the common purple, which, mingled with the gorse, makes our heaths look so beautiful—the one taking the place of the other. I have only got one piece and do not think I shall be able to get any more this year; or I would have forwarded some with pleasure.

FOOD FOR LAMPREYS.—Doubtless small worms or, in default, raw or slightly cooked meat or grubs would suit lampreys. I can testify by long experience to the merits of the pope in an aquarium. No fish bears confinement so well, or becomes tame so soon. He will undoubtedly devour any small fry in his company, but the size of his mouth will barely allow him to swallow fishes more than an inch long, and he will do no further harm to larger fishes than occasionally shoot out his lips and send them out of

his way with considerable force if his dignity is offended. He will eat worms, grubs, bluebottles, but not paste. The one I had in my aquarium was a very large specimen, in a very short time he learned to take food from my fingers, in fact he came up to the surface whenever one came near, and thrust his nose out of the water, blowing bubbles to attract attention (presumably). Large flies were his great delight, which he took down to the bottom and crunched with his teeth, as one could distinctly hear. He lived about four years. Upon the whole, therefore, as an intelligent, interesting, and by no means voracious fish, and one easy to keep in an aquarium, I strongly commend him.—*W. B. R.*

REMARKABLE TREE.—Under the heading of "A Remarkable Tree," I see one of your correspondents gives an account of a certain tree, which is supposed to draw upwards into its branches, by some unseen attraction, any bones that may be placed under it. At the first glance the story seems very strange, but a little thought will convince any one that there must be some other agent at work, besides the tree and the bones. As it is "quite impossible they could be placed there by human agency," is it likely that they could not be conveyed thither by some bird, or climbing animal? It does not appear that any one has seen the bones actually ascending, and we must no doubt look for a solution of the mystery to the prowlings of some nocturnal carnivorous creature.—*J. A. Wheldon.*

TURNSTONE.—Would some of your Ornithological readers kindly inform me whether the account given of the Turnstone in the "Life of a Scotch Naturalist," by S. Smiles, is to be relied on, as I have heard it asserted that this bird could not have moved the cod-fish as stated, p. 246. If this bird is web-footed it could not have scraped away the sand from beneath the fish as stated.—*S. A. Brennan, Clerk.*

FROG-SPAWN, &c.—In reply to query of P. W. A. ("Frog-Spawn") of last month, I may mention that having some young tadpoles of frog in the house, I noticed one night after dark that two or three of them were greedily feeding upon one of their fellows. Next morning "*non est inventus*," there was not a trace of him left. The conclusion is obvious, I have no doubt that those of P. W. A. did likewise. Lots were cast during the darkness, and nothing of the unfortunate one was allowed to see the morning light.—*W. B. R.*

DO TADPOLES EAT EACH OTHER?—I have proved beyond a doubt that they do, for I have caught them in the act, not only once, but many times. They are not pugnacious creatures, and will not molest each other as long as they remain in health, but as soon as one shows signs of ill health or weakness the healthy ones keep a sharp look out, and almost before the poor little thing expires, they will pitch upon it and eat it up. Tadpoles like all other creatures are liable to die, especially when kept artificially, and too many in a small quantity of water. When they put forth their fore-limbs or graspers, as I believe they are called, they appear particularly weak and many die, and those tadpoles which are not so fully developed pick their bones clean. I have rescued many a skeleton from their cannibal grasp; indeed I have pulled the skeletons out of the water with the tadpoles clinging to them. When they are still more advanced, and have become lung-breathing batrachians with yet half of the tadpole's tail, they die and are speedily devoured by their surviving relations. If they were in the habit of biting each other's tails off

the poor wounded creatures would not live long, for I had one which had quite three parts of its tail bitten off (but not by a tadpole); it grew slightly and formed a perfect tail again—much shorter than the original—but it was at the expense of its body, for as the tail enlarged and perfected, the body shrank, and at the end of a fortnight it died. I have had tadpoles two seasons, and have had some hundreds of them, and have kept separate lots of them in different vessels to try the effects of different treatment, &c. A piece of cork should be put on the top of the water for the young batrachians to rest upon.—*Clara Kingsford, Canterbury.*

CORMORANTS.—It may be interesting to note that the older naturalists were aware that cormorants are occasionally found some distance from the sea. Buffon says:—"Le cormoran est d'une telle adresse à pêcher et d'une si grande voracité, que quand il se jette sur un *étang*, il y fait seul plus de dégât qu'une troupe entière d'autres oiseaux pêcheurs; heureusement il se tient *presque toujours* au fond de la mer, et il est rare de le trouver dans les contrées qui en sont éloignées." (The italics are mine.) He also gives in a foot-note the following quotation from a letter of M. Hébert's:—"Le 27 janvier (1779), on m'apporta un cormoran que l'on venoit de voir au bord de la rivière d'Ouche, il étoit perché sur un saule" (willow). (See Buff. Hist. Nat. ed. 1784-91, t. 38, p. 33.) But the French naturalist does not refer to the fact of cormorants building nests on or near freshwater lakes. It is well known that sea-gulls often take long inland excursions. I live near a village about fourteen miles from the sea as the crow flies, and sea-gulls are not uncommon visitors here, although very unwelcome ones, being looked upon by us as the pretty sure harbingers of a storm. Are not cormorants driven inland in like manner by stress of weather? * If so it will account for them being sometimes seen on the borders of lakes and rivers, but it will not account for some broods making lakes their general habitat. "Struggle for existence" is the more probable cause of their breeding in such localities.—*E. Halse.*

* See SCIENCE-GOSSIP, p. 234, above.

NOTICES TO CORRESPONDENTS.

TO CORRESPONDENTS AND EXCHANGERS.—As we now publish SCIENCE-GOSSIP earlier than heretofore, we cannot possibly insert in the following number any communications which reach us later than the 8th of the previous month.

TO ANONYMOUS QUERISTS.—We receive so many queries which do not bear the writers' names that we are forced to adhere to our rule of not noticing them.

TO DEALERS AND OTHERS.—We are always glad to treat dealers in natural history objects on the same fair and general ground as amateurs, in so far as the "exchanges" offered are fair exchanges. But it is evident that, when their offers are simply disguised advertisements, for the purpose of evading the cost of advertising, an advantage is taken of our gratuitous insertion of "exchanges" which cannot be tolerated.

A. B. S. W.—Obtain Dr. Lankester's "Half Hours by the Microscope," edition by F. Kitton, price 2s. 6d., published by D. Bogue.

E. HALSE.—Your MS. is to hand, and shall appear shortly. **J. W. G. (Glasgow)**—We judge from your written description that your shell is a species of *nicula*. It is very abundant off the coast of Eute, where we have dredged it, *Ancula nicula* being especially common there.

M. N. S. C.—Get "Practical Taxidermy," by Montagu Brown, published at the "Bazaar" office, price 3s. 6d. It will give you all the information you seek.

W. JACOBS.—Get "Weather Charts and Storm Warning," by R. H. Scott, F.R.S., published by H. S. King & Co., (now Messrs. C. Kegan Paul & Co.)

J. W. WILLIAMS.—Your paper is in hand; please send us the rest as soon as you have completed them.

"NEPTUNE."—You may purchase "British Shells" of R. Damon, F.G.S., Weymouth. Sowerby's book is of great use to students in enabling them to identify species from the illustrations, but Dr. Gwyn Jeffrey's work (in 4 vols.) is the most scientific in its treatment.

COPTON.—Nearly all the shark family of fishes (including dog-fish, skates, &c.) possess a vertical eyelid, or nictitating membrane, as it is called.

W. J. S. (Calcutta).—We shall be very glad to have your papers, &c., on the centipede.

J. R. ("Muckross").—We shall be pleased to have your note on the flora of your neighbourhood, and especially the folk-lore. The club-moss is *L. selago*. You are right. The reindeer "moss" (*Ceomoyce raniferina*) is not a moss at all, but a lichen. Yours are very fine specimens.

A. E. GIBBS.—Get Stark's "History of British Mosses," with coloured plates, published by Routledge, Warne, & Co.

A. JENKINS.—The first discoverer of gold in Australia was the Rev. W. B. Clark, F.G.S., whose memoir appears in this year's proceedings of the Geological Society. Mr. Clark was led to its discovery quite through geological reasoning.

H. R. A. (Upper Norwood).—The neatly dried plants you forwarded are as follows: *a. Carlamine pratensis*, L.; *b. Epilobium montanum*, L.; *c. Galcepsis Tetrahit*, L.; the latter is var. *l. Benn.* We always use the names in the "Student's Flora."

W. G. W. (Brighton).—It is an American aster, and not the erigeron. Several species were found some few years since on the banks of the Tay; now your discovery in Cornwall is very interesting.

A. W. O. (Windsor).—The indehiscent sporangium is a well-marked character of the *Phascum*; your species are, *Phascum bryoides* and *Typhnum velutinum*, another species is mixed with the first, *Dicranum heteromallum*.

C. J. (Birkenhead).—No distinguishing number or mark was attached to your specimens, we trust you will detect them; *Raphanus Raphanistrum*: *L. Pink Ladies Bedstraw (Galium verum*: *L. yellow)* Bitter *Cress (Caramine hirsuta*: *L. white)* *Coronilla varia*, the latter is not a British species, it is often found on ballast heaps.

W. Martin.—No. 29: *Melica uniflora*: *L. No. 30: Erachyodipnum sylvaticum*: *K. and S. No. 33: Luzula nivea*: *Desv. (a garden escape)* No. 37: *Carex stellulata*: *L. No. 41: Molinia caerulea*. No. 36: a form of *Carex remota*. He merely use the words in "Student's Flora," respecting 33. Would you send a short note for SCIENCE-GOSSIP about the discovery?

EXCHANGES.

BRITISH land, freshwater, and marine shells offered for others, or foreign shells.—Send list of duplicates to William Jordan, Cockfield, Sudbury, Suffolk.

DIATOMS. Remarkably pure gathering of *Gomphonema geminatum*, highly commended by best mounters in England. Sample tube for three microscope slides or 1-oz. bottle for twelve good slides. Exchanged for first-class cleaned micro materials.—**John L. Mitchell**, 6 Mansfield Place, Edinburgh.

WANTED, micro-fungi in exchange for other material, including parasites, parts of insects, or well-mounted slides.—**Thomas S. Morten**, 42 Haver-tock Hill, London, N.W.

NAMED foreign fossils, tertiary and jurassic, comprising foraminifera, sponges, molluscs, &c. Large specimen of *Spongilla fluviatilis* offered in exchange for microscopical slides (foraminifera or diatoms preferred) or British fossils.—**Dr. Rudolf Haensler**, Dedham, Essex.

OFFERED, L. C., 7th ed., 2s. 6d., 79, 99, 115 b, 135, 140, 159, 217, 201a, b, 438c, 448c, 449, 737, 875, 914, 1351, 1014, &c., for other rare plants.—**A. E. Lomax**, 41 Church Road, Transmore, Birkenhead.

THE Secretary of the Sea-Shell Mission having a quantity of fragile and other shells unsuitable for the mission work, will be happy to exchange for others of a stronger kind, or for works on conchology.—Address, 24, Richmond Terrace, Clapham Road, S.W.

WANTED Testacella Stangei and *T. halitoides*; will return a mounted slide of the oodontophore for living specimens. Also a few American land and freshwater shells to exchange for good British species.—**J. D. Futterell**, 2 St. John Street, Beverly.

WANTED to borrow or receive in exchange for other books, Annals and Magazine of Natural History for the year.—**J. D. Futterell**, 2 St. John Street, Beverly.

WANTED, SCIENCE-GOSSIP from 1868, 1876, 1879; clean numbers not bound.—**J. R. Murdoch**, 24 Elenheim Place, Leeds.

JESSIE'S "Gleanings in Natural History," 2 vols. full calf, "Rambles in search of Flowerless Plants," M. Flues, Hugh Miller's "Cruc of the Betsy," Edinburgh and its Neighbourhood, and "Old Red Sandstone," all equal to new. What offers—in micro slide, or Natural History objects?—**W. R. Murdoch**, 24 Elenheim Place, Leeds.

A FEW slides of selected Diatoms, including *Biddulphia pulchella*, *Triceratium fauces*, *Navicula distyma*, *Stauroneis pulchella*, &c. for exchange for other selected Diatoms or

good Diatomaceous material.—T. E. Doeg, Bridge Street, Faversham.

WANTED for dissection, a few living full grown individuals of *Helix fusca*. Other British land-shells given in exchange.—C. Ashford, Christchurch.

A FEW good side-blown specimens of the eggs of Lesser Black back gull, arctic and Sandwich terns in exchange for Lepidoptera (many common species wanted but must be good, well-set specimens). Apply, Jno. D. Walker, 21 Holly Avenue, Newcastle-on-Tyne.

For exchange: the following skins prepared for stuffing:—hooded crow, sparrow hawk (male and female), jay, curlew, magpie, rock dove. What offers?—F. Anderson, Alre Villa, Chichester.

WANTED unbound SCIENCE-GOSSIP for 1855, 1865. Address to Rev. T. S. King, 108 Broomgrove Road, Sheffield.

CABINETS suitable for British and foreign snails, British shells and foreign shells. Will exchange 17 vols. of "Art Journals" (or part) for above. Address, Conchologist, 26 Clapham Road, S.W.

WANTED, Johnston's "Botany of the Eastern Borders," offered Watson's "Compendium to the Cybele Britannica." W. H. Groser, 44 Hillmarton Road, Holloway, N.

INDIAN reptiles, preserved in spirits, in exchange for fossils or natural history objects. Address, T. C. Maggs, Yeovil.

For exchange, emu's eggs for British beetles or lepidoptera. J. R., Stonyhurst College, Lancashire.

WANTED, Sowerby's "Ferns and Fern Allies of Great Britain."—A. Warner, Hodde-don, Herts.

WANTED, Newman's "British Moths," SCIENCE-GOSSIP for 1850, and "Entomologist" for 1850. Two last wanted unbound.—A. S., 624 King's Road, Fulham, S. W.

SCIENCE-GOSSIP, unbound, in good condition, complete for 1875, 1876, 1877, 1878, 1879, 1880, 1881 till present date.—H. Kieckel, Walpole Street, Wolverhampton.

I HAVE 26 parts of Cassell's "Doric Gallery," at 2s. each; will exchange for a microscope.—A. B., care of Mr. Z. Collier, 334 Kennington Park Road, S. E.

WANTED, Rooke Pennington's "Barrows and Bone Caves of Derbyshire." Will exchange Geological Ordnance map of Castleton (Derbyshire) and neighbourhood, or books.—Arnold Linnell, Stretford, Manchester.

WANTED, L. C., Nos. 13b, 14d, 15b, 18c, 18d, 23, 28b, 31b, 32, 36b, 36c, 37, 1415, 1416, 1417, 1421b, &c., for other dried specimens.—J. A. Wheldon, 9 South Street, Scarborough.

NAMED foreign fossils (including foraminifera) offered in exchange for British fossils, foraminifera, radiolaria, or diatoms.—Dr. Rudolf Hauesler, F. G. S., &c., Dedham, Essex.

WANTED, Onycha (see Wood's "Bible Animals"), cedarwood, sabbatum, also anything illustrating Bible rites and customs, &c. Can offer Balm of Gilead, spikenard, sandal, pistachia, frankincense, books &c.—Tonley, Albert Road, Southsea.

WANTED, Dolgelly, Luneberg, Santa Fiore, Cuxhaven, Biergehnl deposit, and others; will give in exchange first-class slides or material.—J. Tempere, Storrington, Sussex.

WANTED, Permian fossils (Schizodus, etc.) Exchange good oolitic, cretaceous, and other fossils, rarer British shells.—B. A., 29 Tavistock Place, Tavistock Square, W. C.

WANTED, good British or Irish specimens of *Loxonema*, *Murchisonia*, *Pachyrhina* (grand), *Megalodon*, *Conocardium*, *Pleuronchelus*, and *Platycrinus*. Exchange good oolitic, cretaceous, and other British fossils, rarer British shells.—B. A., 29 Tavistock Place, Tavistock Square, W. C.

"DAXILE'S INFERNIO" (Cassell's edition, 1866, published at £2 10s.), for good modern work on conchology.—A. Loydell, 10 Aulay Street, Osney Road, S. E.

WANTED, Couch's "Fishes," Bell's "Stalk-eyed Crustacea," Gosse's "Naturalist's Sojourn in Jamaica," &c. Pritchard's "Infusoria," Smith's "Diatomacea," Johnston's "Zoophytes," Ralf's "Desmidiæ," Carpenter's "Foraminifera," or other good works on Natural History, in exchange for other books or a student's microscope with accessories.—C. Gromes, Dover.

Two ounces of dried marine algae from Corsica, rich in diatoms (90 species), sent in exchange for other good diatomaceous material.—J. Tempere, Storrington, Sussex.

STUDENT'S microscope, 1½ and 1-in. objective; about 100 slides; several books; turntable &c.; also case of electron mathematical instruments (French), offers to Rev. W. H. Skam, 49 Mayfield Road, Dalston, E.

For tube of rotiferæ and other infusoria send really good and well-mounted object of interest (botanical preferred) to H. Maccio, 4 B. Igrave Terrace, Bath.

A NUMBER of good species of land and freshwater shells in exchange for desert crata in marine mivalves. No special value attached to British specimens.—C. P. Gayne, 44 Norland Square, Notti g Hill, London, W.

SOME beautiful slides of crystals, such as chlorate of potash, sulphate of copper, &c., for the polariscope, exchange for other slides of interest.—Geo. J. Wightman, 33 Fresco Road, Nunhead, London, S. E.

WANTED, good slides of foraminifera, desmids, diatoms, parasites, for anatomical and pathological slides; approval on both files.—D. H. Barley, Cambridge Street, Newcastle-on-Tyne.

HAVE still many slides and prepared material to part with. See October SCIENCE-GOSSIP.—T. McGann, Burren, Ireland.

"INSECTS AT HOME" and "Insects Abroad," by Rev. J. G. Wood, 1876, unsoiled; for geological or physiological books or micro-slides.—R. McCully, 41 Vandyke Street, Liverpool.

A QUANTITY of unmounted micro-material, algae, zoophytes, soundings, mosses, &c., in exchange for good slides.—R. McCully, 41 Vandyke Street, Liverpool.

WANTED, Waterhouse Hawkins's "Comparative View of the Human and Animal Frame," 1850, by Chapman and Hall, in exchange for British shells, lepidoptera, chalk fossils, or plants. It need not be new if no pages or plates are missing.—H., 82 Abbey Street, Faversham, Kent.

AQUARIUM, strong make, with glass front, fit for outdoor or indoor ornament. Will exchange for microscopic apparatus, or books on botany, biology, or microscope. For particulars as to height, length, &c., apply to V. Wager, Middle Street, Strand, Gloucestershire.

SCIENCE-GOSSIP, two years, 1880-81, unbound, clean, Penning's "Field Geology," 2nd edition, new, and Rev. J. C. Wood's "British Beetles," coloured plates; what offers? Wanted, vols. of "The Antiquary," or Akermans's "Coins of the Romans relating to Britain."—A. G. Wright, Newmarket, Suffolk.

WANTED, two death's head moths. Exchange.—J. McGrouther, 1 Dunkeld Place, Hillhead, Glasgow.

WANTED, an Irish correspondent for exchange of genuine wild plants and mosses.—C. A. O., 76 Trafalgar Road, Old Kent Road, London, S. E.

Good plants offered in exchange for others from south of England, or for fossils. Will send list on application.—J. Hamson, 1 Alexandra Place, Bedford.

FINE oak secretary, cost £25, in exchange for books, scientific art, architecture, or engineering.—H. J., Durham House, Westbourne Park, London, W.

BRITISH birds' eggs. A small but choice collection, including golden eagle, in exchange for books or scientific apparatus; list sent. Offers requested.—Dr. Webb, 12 Brougham Terrace, West Derby Road, Liverpool.

For rare plants, 19, 17, 41, 150c, 242b, 313, 1071, 1259, 1287, 1324, 1358, 1402, 1412, 1497b, 1482, *Carex ornithopoda*, 1510, and many others.—H. Searle, Rock Street, Ashton-under-Lyne.

ANATOMICAL microscopic objects well finished, for good unmounted microscopic material. Fragments of sponge, gorgonias named *Holothuria chirodota*, and synapta most wanted.—W. White, 7 Marden Place, York Street, Nottingham.

BOOKS, ETC., RECEIVED.

"Freaks and Marvels of Plant Life," by Dr. M. C. Cooke. London: Society for Promoting Christian Knowledge.

"Coloured Zoological Plates," Ditto.

"The Brain and its Functions," by J. Luys. London: Kegan Paul & Co.

"Miscellanies of Animal Life," by Elizabeth Spooner. London: Society for Promoting Christian Knowledge.

"The Student's Handbook of Chemistry," by H. Leicester Greville, F. C. S. Edinburgh: E. and S. Livingstone.

"Land and Water." November.

"Journal of Applied Sciences." November.

"Aunt Judy's Magazine." November.

"Ben Brierley's Journal." November.

"The Antiquary." November.

"Chemist and Druggist." November.

"Midland Naturalist." November.

"Northern Microscopist." November.

"American Naturalist." November.

"Canadian Entomologist." November.

"Good Health." November.

"Boston Journal of Chemistry." November.

"Revista" (Oporto). November.

&c. &c. &c.

COMMUNICATIONS RECEIVED UP TO 10TH ULT. FROM:—
E. H.—J. R.—R. T.—W. F. G.—C. A.—P. C. M.—J. D. W.—
J. S.—E. S.—F. A.—W. B. R.—T. S. K.—J. L.—B. W.—
T. E. D.—J. R. M.—J. A. E.—J. T. H.—H. R.—G. H. A.—
J. D. B.—J. A. O.—C. J. D.—C. R.—E. L.—E. H.—H. R. A.—
A. B. S. W.—J. A. W.—G. D. B.—W. E. B.—W. A. L.—
J. R.—R. F. F.—S. A. B.—Z. C.—G. M.—A. W. S.—H. R.—J. T. O.—
F. W. H. G.—F. L. A.—M.—W. H. D.—W. H. T.—J. W. T.—
F. H. S.—H. R.—A.—M.—W. H. H.—A. J.—H. L.—C. A. G.—
H. M.—C. P. G.—A. W.—O.—E. H.—W. T. L.—G. T. W.—
H. H.—J. M.—M.—W. J.—H. P.—G.—O. H.—T. McE.—
R. McC.—W. G. M.—J. S.—J. E.—P. D.—E. M. G.—
E. M. F.—A. W.—A. L.—F. A.—J. S.—J. S.—W. J.—A. F.—
A. B.—S. W.—H. S.—R. E.—S.—E. A.—W.—H. J.—A. F.—
B. M. O.—G. S.—G. H. W.—J. H.—A. W.—P.—F. Z.—S.—J. H.—
J. C. T.—A. E.—G.—J. J.—E.—B. R.—H. H. B.—J. R.—
J. W. B.—T. B. R.—W. J. H.—E. L.—E. P.—W. M.—E. J. T.—
W. G.—C. V. R.—H. M.—F. L.—E. D.—A. H.—W. T. S.—
E. de C.—W. N.—E. W.—H.—R.—L.—E. L.—A. G. L.—
R. D.—J. F. H.—W.—R.—W.—C.—J. A.—E. F. K.—G. F. G.—
F. H. H.—T. S. M.—A. H.—S.—W.—T. L.—Dr. H.—W. J.—
W. J. S.—W. T. G.—J. M.—&c.

INDEX TO VOL. XVII.

- ABNORMAL GEOLOGICAL DEPOSITS IN THE BRISTOL DISTRICT, 21**
 Accessory Buds, 254
Achavis Cranchii, 191
Achelous granulatus, 53
Acmea lineata, 210
 Adders Hissing, 204, 214, 260
 Aerial Disturbances, 237
 "Aerial Spores," 160
Aethusa cynapium, 46
Agabus bipustulatus, 11, 83
Agabus paludosus, 11, 83
Alauda arvensis, 103
 Albino flowers, 262
Alcedo hispida, 28
Alisma plantago, 11
Allium Schanoprasum, 278
 Alpine Botany, 1, 49, 106, 122, 202, 241
 Alternation of Generation in Insects, 234
 Ambiguous Phraseology, 16
 American Water Weeds, 11
 Amœba, an unusual form of, 226, 275
Anacharis a sinistratum, 11, 211
Anagallis carulea, 46, 92
Anchomenus dorsalis, 11
Anchomenus marginalis, 10
Anchomenus pallipes, 10, 11
 Ancient Buildings of Wilmingtion Priory and Church, 69
Andropogon ischaemum, 50
Androsace glaciatis, 50
 Animal Defences, 209
 Animal Teratology, 110
Animal versus Vegetable Life, 212
 Annelids, 159
Anthocharis Cantanines, 17
 Ants, Formic Acid in, 197
 Ants, Notes on, 164
 Aphides and the Potato Disease, 212
 Aquaria (Marine), My Experience of, 128
 Aquarium Experiences, 260
 Arabin, its use in mounting Micro-Objects, 112
Arabis turrita, 50
 Archæm Geology of Anglesea, 66
Arcuaria pepuloides, 255
Armeria albina, 50
Armeria vulgaris, 255
Arviculus perfoliatus, 269
Asellus aquaticus, 86, 181
 Ashy Falcon, or Harrier, 152
 Assisting Naturalists, 39, 64, 87, 134, 183, 232, 238, 257, 274
Asthmatos ci vari, 208
Astur trivirgatus, 151
Athene castanonota, 183
 Atmospheric Electricity, 121, 146
 Atmospheric Electricity, 275
Atriplex portulacoides, 255
Aulostoma gulo, 11
 Australian Parakeets, 75
Baleoptera nostrata, 234
Baxisia Odontites, 258
 Basking Shark, 42
 Bats, 45, 94
 "Bee Keepers' Guide," 210
 Bee Orchis, 115
 Bee Orchis in 1889, 3
 Bee Orchis, Sea city of, 45
 Beetle and Ants, 58
Bembidium littorale, 10
 Bifurcation of the Fir, 281
 Bird of Paradise, a New, 33
 Bird Studies in Chalk, 33
 Birds, a List of European, 114
 Birds and Fruits, 45, 119, 142
 Birds during Winter, 140
 Birds' Eggs, 18
 Birds Feigning Death, 89
 Birds in Isle of Man, 92
 Birds in London, 92
 Birds in North America, 187
 Birds of Ceylon, 104, 151, 183, 185
 Birds of the Isle of Man, 43
 Birds, Scarcity of in Spring, 142
 Birds, the Diminution of Small, 188
 Birds, Tenacity of Life among, 45
 Blackbirds, 259
 Blackbirds and Adders, 190
 Blackcap Warbler, 39
 Blackheaded Bunting, 29, 31
 Blue Robins, 77
 Blue Rocks, 118
 Boar Fish, 138
 Bog-louse, 86
 Bolton's Portfolio of Drawings, 88, 160, 233
Bombyx Pernyi, Rearing, 215
 Books received, 24, 48, 72, 96, 120, 144, 192, 216, 240, 264, 284
Borago officinalis, 11, 90
 Botanical Etymology, 268
 Botanical Exchange Club, Report for 1889, 25
 Botanical Gardens, Sheffield, 65
 Botanical Notes, 3
 Botanical Notes from Kent, 212
 Botanical Notes from the Swiss Highlands, 1, 49, 106, 122, 202, 241
 Botanical Ramble over the Cotswolds, 213
 Botanic Names, The Termination of Ordinal, 19
 Botany at Hunstanton, 255
 Botany on the Sussex Downs, 277
 Botany, 19, 43, 65, 99, 115, 138, 185, 211, 235, 258, 277
 Botany, Rustic, 195
 Botany in the Swiss Highlands, 86
 Bottle, Broad stoppered, 45
 Brain, Cavity of young Alligator, 33
 Brain Cavity of *Colinus torquatus*, 33
 Brain Cavity of *Hesperornis regalis*, 33
 Brain Cavity of *Icthyornis victor*, 33
 "Brass and Glass," 113
Branla cæca—and its relation to the Honey Bee, 168
Branla cæca, 165
 Breeding Foreign Birds in England, 75, 142
 Brimstone Butterfly, Variety of, 215
 British Association, Reflections, Jubilee, 1881, 231
 British Birds, A List of, 89
 British Dragon-flies, 35, 84
 British Flora, The Distribution, 116
Brittle-Star, 51
Bronnus Beuchonii, 25
 Bubbles in Glycerine Jelly, 208, 232, 233, 256
 Budgetiger, The, 75
 Buds, Accessory, 254
 Buds, Terminal and Sub-terminal, 38
 Bullfinch, The, 29
Bupthalmium salicifolium, 50
 Burnet Moth, Transparent, 41, 114
 Buttercup, The, 189
 Butterflies and Moths, 69
 "Butterflies of Europe," 210, 257
 "Butterflies of Europe," Lang., 235
 Buzzard (Rough legged) in Yorkshire, 94
 CABBAGE-WORMS, REMEDY FOR, 18
 Caddis-worm, 11
 Caffeine, or Theine, To extract by a New Method, 248
 Cæja, 189
Campanula cenisii, 50
 Candle-Wicks smouldering, explanation of, 79, 119
Caprella linearis, 150
Capros aper, 138
Cardamine pratensis, 79
Cardamine pratensis, curious growth of, 20
Carex arenaria, 255
Carex tomentosa, 50
 Carlisle Basin, The Permian, Triassic and Liassic Rocks of the, 91
 Carrion Crow Roosts, 166
 Caterpillars, Pugnacity of, 17
 Cats, Habit of, 164, 188
 Centipedes, Phosphorescent, 68
Ceratophyllum, 112, 184
Certhia familiaris, 56
 Cetacea, the Natural History of, 98
 Ceylon, Unclassified Notes on the Inland Birds of, 104
 Chalk, Bird studies in, 33
 Chalk Flints, The Origin and Formation of, 162
 Chalk Flints, the Physical History of, 22
 Chalk, Foraminifera, 275
 Chalk, The Zones of the, 139
 Chara, 26
 Characeæ of America, 20
Chelonia Caja, 127
 Chickens and smallpox, 82
 Chloritic Marl and Upper Greensands of the Isle of Wight, 117
Chrysanthemum maritimum, 26
Clydonus sphaericus, 86
Cyada hematodes in the New Forest, 201
Cinclus cinereus, 252
Circus agorascens, 152
Circus swainsonii, 151, 281
 Clay-Field, Natural History in, 10
 Cleaning Glasses for Micro Work, 40
 Cleaning Slides, 233
 "Cloud Hill," 162
Cnemidites castus, 11
Coccothraustes vulgaris, 137
 Coccus Vitis-Vinifera, 234
 Cocks and Chickens, 22
 Cocoon of *Cionus*, 276
 Colours of Flowers and Fruits, Contrast-between, 73, 143, 259
 Colours of Fruits of the Northern United States, 278
 Colours of Spring Flowers, 235
 Collecting Bottle, a New, 209
 Collecting Crustacea, 41
 Collecting on the Norfolk Marshes, 261
 Collecting Micro-Fungi, 97
 Commensalism, 46
 Conographical Excursion on the Gloucestershire Hills, 205
 Condenser formed by a hollow glass sphere, 274
Consortaria, 201
 Constitution and History of Grits and Sandstones, 44
 Contrasts between the Colours of Flowers and Fruits, 73, 143, 259
Convolvulus majalis, 25
Coriaria, 83
 Cormorants, 210, 256, 283
 Cormorants, English, 69
 Cormorants, Inland, 234
Corophium crassicornis, 150
Corobium crassicornis, abundance of in British Seas, 150
 Cotton, The Natural and Commercial History of, 99
 Cow suckling Lambs, 189
 Crab, Shrimp and Lobster Lore, 166
Crotogeus oxyacantha, 185
 Crater of Vesuvius, 13
 Cretaceous Flints, The Physical History of, 67

- Crustacea, Notes on the Collection of, 41
 Crustacea, Preserving, 46
 Crustacean, The, use-less claws of, 58
 Cuckoo, The, 68, 163
Currucula atricollis, 30
Cyclops vulgaris, 84
Cyananthus ruficollis, 50
Cynoglossum officinale, 255
 Cyprus, 10
Cypripis ornata, 85
Cystopteris montana, 25

Dadoxylon, 271
 Daffodil, 161
 Dagger Moth, The, 212
 Daisy, Malformations, in, 277
 Daniel's Den, 191
Daphnia Bairdii, 209
Daphnia pulex, 84
 Derbyshire Flora, 258
 Desmids, some New to Britain, 112
Deutzia sabra, 233
 Developed Primulas, 43
 Development of Frog Spawn, 50
 Devitrified Rocks, their Microscopic Structure, 138
 Diamond Fields of South Africa, 187.
Diaptemus Castor, 200
 Diatomaceæ, Certain Miniature Forms of, 112
 Diatomaceæ, Habirshaw's Catalogue of, 275
 Diatomaceæ in Coal, 113
 Diatom Mounting, 17
 Diatoms in Oysters, 141
 Diatoms, to Clean, 102
 Dipper or Water Ousel, 252
Distoma hepatica, 239
 Distribution of the British Flora, 110
 Dog-Whisk, 4
 Double Flowers, 167
 Double Staining, 160
 Dragon Flies, 78, 94
 Dragon Flies, British, 35, 46, 54
Drypanornis Albertii, 33
 Dulness in Objectives, 49
 Dumb Animals, 185
 Duncan, The Aberdeenshire Weaver and Botanist, 93
Dytiscus marginalis, 83, 143

 EAGLE, THE BLACK, 105
 Eagle, The Ceylon, 106
 Eagle, The Crested, 105
 Eared Seals, *alias* Sea Lions, 47, 65
 Early-flowering Milkwort, 152
 Early Swallows, 140
 Eel, Freaks of an, 118
 Eels, 140
 Eggs, A Ramble in Search of, 28
 Eggs of Gnat, 55
 Eider Duck, 257
 Electricity, Atmospheric, 121, 146, 279
 Electric Light at Norwich, and its Effect on Moths, &c., 251
 Elephant Hunting in Essex, 67
 Elm Trees, Query about, 211
Emberiza schanickius, 20
 Entomologists and the Electric Light at Norwich, 251
 Entomology, How can we Popularise, 247
 Entomostraca, 10
Eosoin Canadense, 130
Ephemera, Larva of, 84
Ephemera vulgaris, 83
 Epidemics, The Fungoid Origin of, 184
Epilebium roseum, 115
 Erosion of Shells, 256
 Errata, 23, 162, 278
Erycinum maritimum, 255
 Etymology, Botanical, 268
Eugenia viridis, 135
Euphorbia Esula, *g. gemina*, 26
 Evolution Theory, 43
 Exchanges, 24, 48, 71, 95, 119, 143, 192, 216, 249, 263, 283
 Excrescences on Trees, 117
Exterisaria, 201
 Extinction of Rare Plants, 261, 269
 Extinct Reptile, a Remarkable, 117

 FAILURE IN MOUNTING, 112
 Falcon, The Rufous, 151
 Fern Cave at Matlock, 238
 Ferns and Ferneries, 20
 Ferns Propagated by Cuttings, 161, 186

 "Fertility," 187
 Field Mouse (English), 104
 Fig, Mulberry, and the Quince, 259
 Finishing Micro Slides, 65
 Fishes of Great Britain and Ireland, 42
 Fishes that haunt the Shore, 110, 145
 Flea-Banes, 66
 Fleas and Fleabanes, 2
 Floods, their Causes and Cure, 117
 Flora of Deal, 3
 "Flora of Derbyshire," 258
 "Flora Europea," 258
 Flora of Lucerne, 1
 Flora of Michigan, 236
 Flora of Warwickshire, 161
Floscularia, 88
 Flowers and Fruits, Contrast between the
 "Colours of, 73, 143, 259
 Flowers, Colours of, 235
 Flowers, Objects of Sex and Odour in, 186
 Fluid Mounting, 64
 Fluke or Liver-Plaiice, 239, 261, 280
 Folk-lore, A Dictionary of, 138
 Folk-lore, Ursine, 14, 26
 Fool's Parsley, 46
 Fool's Parsley, not Poisonous, 164
 Foraminifera, How to Obtain from Chalk, 256, 275
 Foraminifera, Notes on Jurassic, 206
 Formic Acid in Ants, 197
 Fossil Botany, 53, 79, 99, 123, 179, 228, 271
 Fossil Corals, 237
 Fossil Fishes in the New Red Sandstone of Nottingham, 236
 Fossil Flora of the Halifax Hard-Bed Coal, 52
 Fossiliferous Pebbles in the Drift in Warwickshire, 162
 Fossil Trees in a Marl Pit at James Square, 99
Frankonia lewis, 255
 Freezing of Boiled and Unboiled Water, 189
 Freshwater Deposits, 118
 "Freshwater Rhizopods, A Synopsis of the," 268
Fringilla erythrora, 76
 Frog-spawn, 261, 282
 Frog-spawn and its Development, 59
 Frog-spawn and Tadpoles, 114
 Frog with a Tail, 280
 Frozen Larva returning to Life, 93
 Funerary Plants, 150
 Fungi, Distribution of, 47
 Fungi, Notes on some of our Smaller, 7
 Fungi, Preservation of, 20
 Fungoid Origin of Epidemics, 184
 Fungus-Growths to Destroy Insects, 43

 GAELIC NAMES OF PLANTS, 186
 "Gaelic Names of Plants," 258
 Gale, The Late, 282
Gammurus pulex, 85
 Gapes in Pigeons, 82
 "Garden Pests and their Eradication," 235
Gayia simplicifera, 50
Gentiana Bazarrica, 50
Gentiana pneumonanthe, 50
 Geodephaga, 11
 Geological (abnormal) deposits in the Bristol District, 21
 Geological Discovery, 278
 Geological Distribution of Endemic Gnat, 186
 Geological Lessons among the Sandhills, 195
 Geological Lessons from the Great Snow-storm of 1881, 67
 "Geological Magazine, The," 212
 Geology, 21, 43, 66, 91, 116, 138, 186, 211, 236, 259, 278
 Geology of East Central Africa, 43
 Geology of Jersey, 269
 Geology of York and the Neighbourhood, 169
 Geology, The Newer Pliocene period in England, 4
 Geranium, White, 22, 56, 70
 Germinating Spores of *Spumaria alba*, 8
 Glacial Beds of the Clyde and the Forth, 21
 Glass Sphere (Hollow) used as a Condenser, 274
 Glycerine Jelly, Bubbles in, 268, 232, 233, 259

 Gnats and the Frost, 92, 141
 Gnat's Eggs, 55
 Goitre (E endemic), The Geological Distribution of, 186
 Goldfish, 139
 Goshawk, the Ceylon, 151
 Gossip about New Books, 62, 249
 Grapples for Pond Life or Marine Work, 39
 Grasshoppers in Turkey, 261
 Grasshopper Warbler, 31
 Great Grey Shrike, 65, 116
 "Great Ice Age," The, a Record in Rime, 159
 Great Tit, The, 163
 Grits and Sandstones, 44
 Gros-beaks, 92, 137
 Growing-slide, a simple, 112
 Gull, the Black-headed, 258
 Gutta-Percha Cells, 268
Gyrinus natator, 83

Habenaria albidula ON THE NORTH
 Downs, 214
 Hailstorms, 213, 227
 Hair or Hare Bell? 118, 165, 189, 215, 238, 261, 279
 Harrer, The Pale, 151
 Hawtiches, 142, 190
 Hawfinch, The, 107
 Haws, Holly Berries, &c., 166
 Hawthorn, 185
 Hawthorn Blossom, 69
 Hayling Island, A Ramble in, 207
 Head of Tail? 165
 Heather, 282
 Heliotropism, 43, 66, 115
Helix aspersa in Mauritius, 82
Helix Pomatia, 189, 210, 214
 Hen-Harrier, The, 140
 Hessian-fly in America, 18
Hieracium Flourenianum, 50
 Highlands, Notes from the Scotch, 242
 Holly Berries, 93
 Holly Berries, scarcity of, 49
 Holly-Fern in Herefordshire, 238
 Holly, Notes on, 265
 Honey Buzzards, 276
 Horse-leech, 11
 House-fly, Suction in, 94
 Human Vision and Touch, their limits, 99
Hyalina Draparnaldi, 161
Hyalina Draparnaldi found in England, 89
Hydra fusca and *Actinophrys Eickhornii*, 246
Hydrocharis, 258
 Hydrozoa, 150
 Hymenomyces of Shropshire, 99
Hyoscyamus niger, L., 26
Hypericum coris, 50

 ICE ACTION IN WALES, 163
Ilex Aquifolium, 185, 265
 Incubating by Male Birds, 22, 94
 Incubation by a Capon, 189, 214
 Incubator for Pupæ, 141
 Infusoria, Kent's Manual of, 19, 49, 169, 256
 Injurious Insects, 114
 Insect Swarms, 223, 262
 Insects and Meteorology, 41
 Insects and Primroses, 135
 Insectarium in the Zoological Gardens, 138
 Interesting Discovery, 262
 Iron Ores of Antrim, 185
Isatis tinctoria, 50
 Isle of Man, The Birds of, 43

 JACOB'S LADDER, 117, 213
 Jamaica, English Plants in, 182
 Java Sparrow, Breeding, 69, 76
 Jersey Fern, 66
 Jersey, Natural History of, 224
 Jersey, Notes on the Natural History of, 269
 Jurassic Birds and their Allies, 237
 Jurassic Foraminifera, 206
Jussiaea natans, a remarkable Root, 251

 KENT, BOTANICAL NOTES FROM, 212
 Kestrel, The, 169
 Kingfisher, The, 28, 30

Laminum album, 47
Laminum Galeodolon, 23

- Lampreys, 262
 Lampreys, Food for, 282
 Landslip, The Naina Tal, 45
Lanius excubitor, 95, 119
 Lapwings, 101
Larus atricilla, 90
Larus atricilla v. *Larus ridibundus*, 101, 210
 Larvæ of Beetles, 141, 166
 Larvæ, Rearing Young, 215
Lascepiptium siler, 50
 Laughing Gull, 90, 114
 Lava Stream in Argyleshire, 218
 Leaf-cutting Ant, A New, 90
 Leckhampton Hill, Ramble on, 235, 262
 Leech, The Common, 85
 Leeches, How do they Breathe? 260
 Lepidodendron, The, 99
 Lepidoptera in the New Forest, 201
 Lepidopterous Names, 117, 105
Leucocjum vernum, 50
 Liassic Rocks of the Carlisle Basin, 91
 Liberian Coffee, 115
 Lightning, 68, 69
Linnaea, 103
Linnaea stagnalis, 11, 85
Linnaeus cristatellus, 135
 "Lithology of Gas Coals," 212
 Liverpool Geological Society, 44
 Local Floras of the United Services College, Westward Ho, 115
 Local Names of Plants, 278
Lotus hispidus, 25
 Lucerne, Flora of, 1
Lumbricus terrestris, 86

Maera stultorum, 4
 Maggot Combat, 215
 Magpie Roosts, 166
Malaxis paludosa, L., 26
 Malformation in Daisy, 277
 Marine Aquaria, my Experience of, 128
 Marine Happy Family, 58
 Marine Zoological Harvest, 4
 Marine Zoology and H.M.S. "Hydra," 159
 Marine Zoophytes, A Week among the, 131
 Mauritius and Great Britain, Naturalist's Notes in, 58, 82, 142
 May-flv, 83
Mentha citrata, 25
Mentha rubra, 25
Mentha viridis, 25
Mercurialis perennis, 115
 Mesozoic Animals in the Western Territories of America, 237
 Meteor, a fine, 213
 Meteoric Dust, 237
 Meteoric Dust of the Sirocco, 154
 Meteorological Observers, Hints to Local, 227
 Meteorology and Insects, 41
 Mice, do they Kill Birds? 47
 Micro-Fungi Collecting, 97
 "Micrographic Dictionary," 184, 256
Micromis badius, 151
 "Microscopic Journal," French, 256
 Microscopic Structure of Devitrified Rocks, 138
 Microscopic Test for Poison, 208
 Micro-copy, 16, 49, 64, 87, 111, 135, 184, 208, 232, 256, 274
 Micro-slide, fini-hung, 16
 Migration of Birds at St. Leonards, 235
 Mildew (Wheat) and Barberry Bushes, 267
 Mild Season, 47
 Milkwort Blooming Early, 189
 Milkwort, The, 260
 Mocking Bird, The, 208
 "Moss Flora," Braithwaite, 21, 133
 Mountain Ash, Variety of, 235, 262
 Mounting Diatoms, 17
 Mounting (Dry) for Opaque Objects, 112
 Mounting, Failure in, 112
 Mounting Starches, 83, 135, 160
 Mounting Vessels, &c., 184
 Mounting without Pressure, 64
 Mount Pilatus, 106
 Mouse, A Curious, 46, 94
 Muscivæ, 41
Mus sylvaticus, 104
Mytilus edulis, 150

 Naiadaceæ, 11
 Naina Tal Landslip, 45

 Names of Plants, 29, 211
 Narrow Escape of a Bird, 70
Natica monitifera, 4
 Natural History Clubs of London, 185
 Natural History, How Can we Popularise? 284
 Natural History in a Clay-Field, 10
 Natural History in Winter, 83
 Natural History Journal and School Reporter, 115
 Natural History, Notes, 257
 Natural History of Jersey, 224, 269
 Natural History Transactions, 18
 Naturalist's and Sportsman's Pocket-Book, 42
 Naturalist in Mauritius and Great Britain, 82, 142
Nebria brevicollis, 10, 11
Nepus Malabaricus, 105
Nepa cinerea, 11
Nepeta Glechoma, 26
Nepeta parviflora, 26
 Nesting of Swifts, 77
 Nest of Tree Creeper, 57
 New Books, 62
 New Books, A Gossip about, 249
 New Forest, A Visit to the, 200
 New Guinea, A Naturalist's Exploration of, 31
 New Rotifer, 40
 Newts and Frogs, 11
 Newts, British, 89, 164
 Newts near London, 155, 183, 213
 Nightingale, Virginian, 76, 210
 Nitellæ, 26
 Nomenclature, 136
 Norfolk Marshes, Collecting on, 261
 North-American Plants, 81
 "Northern Microscopist," 64, 169
 Notes and Queries, 21, 45, 68, 92, 117, 149, 187, 212, 237, 259, 279
 Notes by a Naturalist in Mauritius and Great Britain, 58, 82, 142
 Notices to Correspondents, 23, 47, 70, 95, 117, 119, 143, 191, 215, 239, 263, 283
Notiophilus biguttatus, 11
Notonecta glauca, 83

 OBITUARY, 42, 91, 236
 Objectives, Dulness in, 83
Ocistes Janus, 112
Enanthe flavivittæ, 26
Oenothera biennis, 50
 Old Red Sandstone and the Carboniferous Formation, 67
 Olive, The, 58
 Omnivorous Rat, 82
 Ophioderpeton in Scotland, 44
Ophiocoma neglectæ, 51
Ophrys apifera, 45, 93, 115
 Orange, The Structure of, 98
 Orchids, Catalogue of, 186
 Orchids on the North Downs, 153, 186
Orchis Aloria, 281
 Origin and Formation of Chalk Flints, 162
 Origin and Structure of Volcanic Cones, 12
 Ornithological Notes from Bournemouth, 94
 Ornithological Notes, 98
Orbanche Hedera, 25
Orthosiphonis Moltæ, 175
 Owls, A Strange Flight of, 118, 166
 Owl, The Chestnut-winged, 183
 Owl, The "Devil Bird," 183

Paliplus variegatus, 11
 Parakeets, 75
 Parasite of the Cat, 18
 Parasites and their Functions, 59
 Parasites on Flies, 189
 Parasites on Hydra, 114, 135, 160
 Parasites on *Hydra fusca*, 184, 233
Parrotia scapensis, 32
 Parrots, Can they reason? 22
 Parrots, Do they require Water? 263, 280
 Parrots, Food for, 222
 Parrot, Keeping, 212
 Pea-Green Moth, 184
 Pear-Tree in Blossom, 47
 Pear-Tree, History of, 253
Pecten varius, 4
Pelicularis sylvatica, 45
 Pekin Robin, 77
Peridermium Pini, Chev., 162
Peridermium Pini, 186

 Permian Rocks of the Carlisle Basin, 91
 Petals, a degraded Form of Leaves, 161
 Phosphorecent Centipedes, 68
Physanus grandis, 11
 Physical History of the Cretaceous Flints, 67
 Physiological Unity of Plants and Animals, 136
 Pigeons feeding on Turnip-roots, 142
 Pin-eyed double Primrose, &c., 107
Pinnaria, 201
Pleurois cornuus, 85
Pleurois cortex, 85
 Plant Lore, 99, 258, 277, 279
 Plant Names, 20, 211
 Plant Remains at the base of the Denbighshire Grits, 186
 Plants and Animals, the Physiological Unity of, 136
 Plants, English, in Jamaica, 182
 Plants, Gaelic Names of, 185
 Plants, How to obtain Cuticles of, 182
 Plants in Extinct Volcano, 277
 Plants, Local Names, 278
 Plants, North-American, 81
 Plants, The extinction of Rare, 260
 Pliocene (The Newer) period in England, 4
 Poison, a Microscopic Test for, 208
 Poison Glands in Frogs, 214
 Poisonous Herbs, 90, 142
 Polecat, 214
 Polemonium, 190
Polemonium caruleum, 117
 Polemonium, White, 191
Polygala vulgaris, 152
Polygonatum officinale, 25
 Pond and Marine Life, A new Grapple, 39
 Pond-Life, Apparatus for, 164
 Ponds in Winter, 83
 Pond-Snail, 86
 Pond-Snails, 103
 Pond Weeds, 11
 Popularising Natural History, 211
Potamogeton Zizii, 25
 Potato Disease and Aphides, 212
Potentilla frigida, 50
Poterium platylobium, 26
 Pre-Cambrian Rocks in the British Isles, 132
 Pre-historic Hackney, 187
 Pre-historic implements in and around Allendale, 98
 Preserving Crustacea, 46
 Preserving fluid, 88, 118
 Primulas, Developed, 43
Primula Scotica, 20, 60
Primula veris, 138
Procellaria pelagica, 45
 Protective imitation by Colour in a Crustacean, 58
Pulex hircundinis, 39
Purpurea Lapillus, 4
Pyrrhtrum alpinum, 59
Pyrrhula vulgaris, 29
Pyrus communis, History of, 253
 Python, Voracity of a, 149

 QUEEN WASPS, 149, 238

 "RABBIT, THE BOOK OF THE," 209
 Rainborst, Abbreviations in, 277
 Rainbow, Strange appearance of, 149
 Ramble in search of Eggs, 28
Ranatra linearis, 83
Ranunculus acris, 189
Ranunculus glacialis, 59
 Rare Moths, 260
 Rare Plants, The Extinction of, 201
 Rare Visitors, 99
 Rat, the Black, 210
 Rats climbing Trees, 163
 Rat's Nest, 163, 184
 Razor-shell, 4
 Records in Rime of the Great Ice Age, 159
 Recreations in Fossil Botany, 79, 99, 123, 179, 228, 271
 Red Frog, 94
 Remarkable Tree, 260, 282
 Reproductive Organs of Lepidodendroid Plants, 179
 Rhinoceros, Siberian, 67
 Rhizopods, A Synopsis of the Freshwater, 268
Rhododendron ferrugineum, 50

- Rhododendron hirsutum*, 50
 Rorqual, the Lesser, 234
 Roses, A Chapter on, 128
 Rotifer, A New, 40
 Rustic Botany, 195
- ST. GOTHARD TUNNEL, 116
 Saffron Finch, 77
Sagina nivalis, 25
Salicornia herbacea, 255
Salsolea Kali, 265
Sambucus laciniata, 26
 Sandhills, Geological Lessons among the, 198
 Sandpiper, The, 29
 Sandstones and Grits, 44
Saxifraga bryoides, 50
Saxifraga muscoides, 50
 Scent of the Hare, 82
 "SCIENCE-GOSSIP," Botanical Exchange Club Report for 1880, 25
 Science in the Provinces, 93, 257, 275
 Science Teaching, 275
 Scientific Discussion, 44
 "Scientific Roll, The," 186
Scirpus carinatus, 25
 Scotch Primrose, 90
 Sea-beaches on Hill-sides, 139
 Sea Lion, 42, 65
 "Seals and Whales of the British Seas," Southwell, 137
Sedum Anglicum, 255
Selache maxima, 42
Seseli libanotis, 50
 Severe Weather in North Hants, 92
 Sex and Odour, Object of in Flowers, 185
 Sheet Lightning, 46, 118, 167
 Shells, Races of Land, 137
 Shore-haunting Fishes, 110, 145, 172
 Shore Lark, 94
 Shrimp, Freshwater, 85
 Siberian Rhinoceros, 67
Sigillaria, 123
Silene acaulis, 50
 Silver Sword Plant, 258
 Skeleton Wheel-bearer, 112, 160, 184
 Skylarks, Disappearance of, 141
 Skylarks in Scotland, 92
 Skylarks, Scarcity of, 93, 141, 282
 Skylark Singing, 103
 Slow-worm, 94
 Slow-worm Casting its Slough, 165
 Snails, Edible, 214
 Snails, Singular Position of, 262
 Snakes, How they Cast their Slough, 115, 165, 190
 Snow Storm and its Geological Lessons, 67
- SOCIETIES:—Proceedings, &c.
 Beverley Field Naturalists' Society, 235
 Botanical Exchange Club, 236
 Bristol Naturalists' Society, 235
 British Association, 185
 British Bee Keepers' Association, 233
 Cirencester Microscopical and Natural History Society, 185
 Croydon Microscopical and Natural History Club, 215
 Dover Field Club and Natural History Society, 276
 Eastbourne Natural History Society, 99
 Epping Forest and Essex Naturalists' Field Club, 99, 209
 Geologists' Association, 67, 139, 211, 237
 Glasgow Natural History Society, 98
 Haggerstone Entomological Society, 257
 Hertfordshire Natural History Society, 185
 Highbury Microscopical and Scientific Society, 184
 Isle of Man Natural History and Antiquarian Society, 43, 99, 137
 Kent (East) Natural History Society, 112, 135
 Lambeth Field Club, 235, 277
 Liverpool Geological Society, 21, 44, 213
 Liverpool Microscopical Society, 64, 115
 Liverpool Science Students' Association, 115
 London, Geological Society of, 139
- SOCIETIES' PROCEEDINGS, &c.—continued.
 London (South) Microscopical and Natural History Club, 275
 London Natural History Clubs, 185
 Manchester Microscopical Society, 89
 New South Wales, Royal Society of, 259
 Norfolk and Norwich Naturalists' Society, 235
 Northumberland, Durham, and Newcastle Natural History Society, 98
 Norwich Geological Society, 162
 Norwich Naturalists' Science Club, 235
 Norwich Science Gossip Club, 43, 275
 Nottingham Literary and Philosophical Society, 257
 Nottingham Naturalists' Society, 99
 Ontario Entomological Society, 138
 Penzance Natural History and Antiquarian Society, 235
 Postal Microscopical Club, 40, 41
 Quckett Microscopical Club, 40, 112, 233
 Scarborough Scientific Society, 90
 Shropshire Archaeological and Natural History Society, 99
 Staffordshire (North) Naturalists' Field Club, 99
 Tasmania, Royal Society of, 209
 Whitby Field Naturalists' Club, 114
- Solen ensis*, 4, 255
Solitaire, How to Identify the Bones of, 58
 Sound, the Velocity of in the Photophone, 46
 "Southern Drift of England and Wales," Reade, 211
 Sparrow, English, 281
 Sparrow-Hawk, The Indian, 151
Spergularia marginata, 26
Sphinx Convolvuli, 257, 258
 Spider, Query as to, 261
 Spider Robbed of its Prey, 261
Spilornis hacha, 106
 Sponge, The Structure and Life-History of a, 155, 193, 217
 Spring Clip Boards, 232
 Staining Vegetable Tissues not a Modern Invention, 275
 Stamens with Double Functions, 258
 Starches, to Mount, 88, 135
 Starlings and Sky-larks, 21, 70, 92, 141
Statice auriensis-folia, 255
Statice limonium, 255
Statice reticulata (caspia), 255
Sternbergia, 272
 Stoats, 190
 Stone Quarry (Welsh), A Visit to, 243
 Stormy Petrel, 45
 Stray Leaves on Trees, 213
 Structure and Life History of a Sponge, 155, 193, 217
 Structure (Microscopic) of Devitrified Rocks, 138
 Succineae, Notes on the, 152
 Summer of 1879 in the Staffordshire Moorlands and Churnet Basin, 99
Suaeda fruticosa, 255
Suaeda maritima, 255
 Sussex Clay, 117
 Swallows, Early, 140
 Swallows, Late, 277
 Swallow's Nest, an unusual site for, 214
 Swallows, The Domestic arrangements of, 203
 Swift, Nesting of the common, 77
 Swiss Alpine Flora, 185
 Swiss Botany, 1, 49, 122, 202, 241
 Swiss Highlands, Botany in, 80, 241
 Swiss Plants, 90
Synochadia, 98
Syrnium irioance, 183
- TADPOLE, THE, 61
 Tadpoles, Do they Eat each other? 282
 Tameness of a Sparrow, 212
Tapes palustris, 4
 Tea Adulterations and a new Process for the Extraction of Caffeine and Theine, 248
 Teeth, The Crust on, 136, 160
 Tenacity of Life, 118, 191
- Tenacity of Life in Freshwater Molluscs, 23
 Teratological Notes, 138
Thlaspi rotundiflorum, 50
Tinniculus alaudarius, 106
 Terminal and subterminal Buds, 38
Teucrium montanum, 50
Teucrium Scorodonia, 51
Thalictrum Kochii, 26
Tha Chinensis, 248
 Toad, the Climbing powers of, 22, 69
 Tortoiseshell Butterfly, 147, 176
 Trap-door Spiders, 68
 Tree Creeper, 56
 Tree Frogs, 262, 268, 280
 Triassic Rocks of Cheshire, 99
 Triassic Rocks of the Carlisle Basin, 91
 Trichina in Figs, 16
Trichodectes subrostratus, 18
Trifolium montanum, 51
Trifolium rubrum, 51
Triglochin maritimum, 255
Triglochin palustre, 255
Trochus zephyrinus, 4
 Tropical Vegetation, 99
Tryphana pronuba, 210
 Tubes for conveying moist Specimens by post, 17
 Tubularia, 150
 Turbellaria, 101, 213
 Turnstone, The, 252
Turritis glabra, 3, 20
- UPPER GREENSANDS AND CHLORITIC MARL OF THE ISLE OF WIGHT, 117
 Ursine Folk-lore, 14, 26
- Vanessa Urtice*, 147, 176
Vernonia alpina, 50
 Vesuvius, Crater of, 13
Vicia tetrasperma, 236
Viola Curtisii, 26
Viola mirabilis, 51
 Virginian Nightingale, 76, 210
 Vivarium, A New, 88, 112
 Volcanic Cones, The Origin and Structure of, 12
 Volcano (Extinct), Plants in, 277
 Volcano, The Oldest and Most Recent Lava Stream in Argyleshire, 218
- WASP PREYING ON LARVA, 22
 Wasp's Nest, A Curious, 199
 Wasps, Queen, 149
 Wasps, Scarcity of, 214, 234, 233, 262, 282
 Water Boatmen, 11
 Water Bugs, 83
 Water-hen Simulating Death, 47
 Water-mite, A New, 269
 Water-plantain, 11
 Water-scorpion, 11
 Wax Cells, 208
 Weasel or Stoat? 113, 142, 166
 Weather and the Birds, 118
 Weather of 1880, 114
 Welsh Stone Quarry, a Visit to, 243
 West-Kerry, Notes from, 125
 Wheat-Mildew and Barberry Bushes, 267
 White Geranium, 81, 118
 Whitethroat in December, 70
 White Zinc Cement, 209
 Wild Birds Protection Act, 89
 Wilington Priory and Church, 99
 Winter, Natural History in, 83
 Worms, How they Turn in their Burrows, 276
- YELLOW ARCHANGEL, 23
 Yellow and Neighbourhood, the Geology of, 169
 York Museum, 67
- ZEBRA FINCH, 77
 Zoology, 17, 41, 65, 80, 114, 136, 184, 209, 234, 256, 275
 Zoophyte Trough, New, 111, 135, 160
 Zoophytes, A Week among the Marine, 131
 Zoophytes, to Preserve, 139
Zostera marina, 25

WH 1AQS S

