

XH .H79

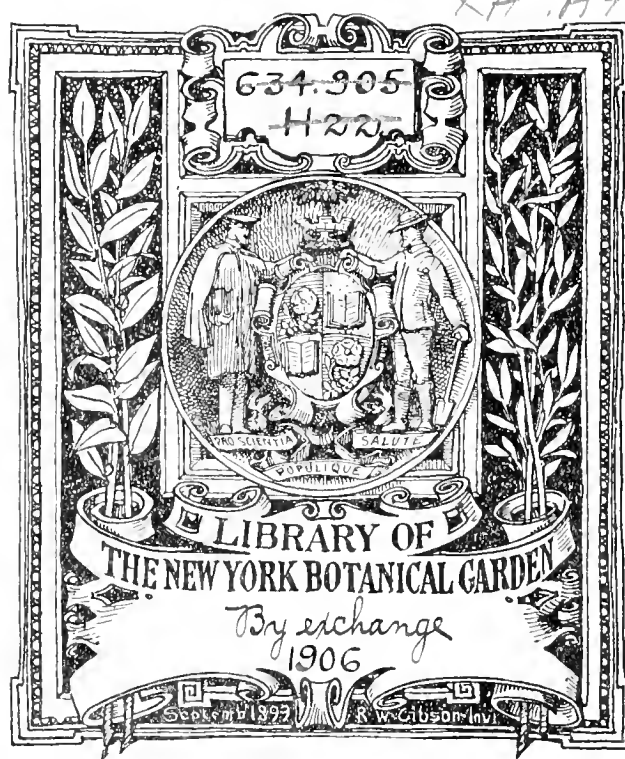

634.905  
H22

LIBRARY OF  
THE NEW YORK BOTANICAL GARDEN

By exchange  
1906

SEP 17 1897 R. W. GILSON, Inv.













# Hardwood Record

Eleventh Year. {  
Semi-monthly. }

CHICAGO, APRIL 25, 1906.

{ Subscription \$2.  
Single Copies, 10 Cents. }

## CHERRY

C. E. LLOYD, JR.  
Manager Sales

## RIVER

## LUMBER

GROWS IN  
WEST VIRGINIA

Sold by  
Cherry River Boom &  
Lumber Co.  
Offices: Philadelphia, Pa.

## RED GUM

We produce and market a carload of Gum Lumber  
: every 45 minutes during the working day. :

Himmelberger-Harrison Lumber Co.  
Morehouse, : : Missouri

## The Lumber Mutual Fire Insurance Company

Boston, Massachusetts

### STRENGTH

Net Assets: January 31, 1906,

All Liabilities Deducted—Sec. 1.—Chap. 118.—Mass. Laws.

**\$743,422.49**

### ECONOMY

Dividends to Policy-Holders,

**33 $\frac{1}{3}$  Per Cent**

Mail Expiring Policy with Your Order.

THE DAVIDSON = BENEDICT CO.  
NASHVILLE, : : : TENNESSEE

EVERYTHING IN

### Southern Hardwoods

POPLAR, CHESTNUT, ASH, OAK

(Plain and Quartered). Straight or mixed cars.  
DRESSED POPLAR ANY WAY YOU WANT IT.

You get what you want when buying from US. Delivered prices any  
—railroad point—

WE WANT TO MOVE

## QUARTERED WHITE OAK

125,000 1 inch No. 1 and No. 2.  
500,000 1 inch No. 1 Common.  
300,000 1 inch No. 2 Common.  
100,000 2 inch No. 1 Common Red Oak.  
400,000 1 inch Sap Cull Poplar.

STOCK TWO YEARS DRY.

## THE ATLANTIC LUMBER CO.

2 Kilby Street, - BOSTON, MASS.

## Lumber Underwriters

Supply the demand for sound insurance at low rates.  
We cater to the wants of lumbermen exclusively.

66 BROADWAY, : : NEW YORK

# LOUISVILLE

MANUFACTURING AND DISTRIBUTING CENTER OF KENTUCKY

## The Norman Lumber Co., Inc.

Manufacturers and Wholesalers of

### Hardwood Lumber

FOR SALE

Seasoned Ash, Oak, Poplar, and Walnut Lumber

WANT TO BUY

Walnut, Oak, Ash, Hickory and Poplar Logs and Lumber

Office and Yards: Third Street, H to K Streets  
LOUISVILLE, KY.

## EDWARD L. DAVIS & CO.

OFFER FOLLOWING STOCKS:

<b>POPLAR.</b>	<b>OAK WAGON TONGUES.</b>
30,000 ft. 4/4 1st & 2d.	12,000 ft. 4x4"x4x2"—12', 1-6 mos. dry.
50,000 ft. 4/4 Common.	800 ft. 3 x4 "—12', 12-18 mos. dry.
15,000 ft. 5/4 Common.	400 ft. 3 1/2 x4 1/2"—12', 12-18 mos. dry.
<b>QUARTERED RED OAK.</b>	300 ft. 3 1/2 x4 1/2"—12', 12-18 mos. dry.
50,000 ft. 4/4 1st & 2d.	250 ft. 3 1/2 x4 1/2"—12', 12-18 mos. dry.
50,000 ft. 4/4 Common.	800 ft. 3 1/2 x4 1/2"—12', 12-18 mos. dry.
<b>QUARTERED WHITE OAK.</b>	180 ft. 3x4" & Lgr.—14', 12-18 mos. dry.
50,000 ft. 4/4 1st & 2d.	<b>REACHES.</b>
10,000 ft. 5/4 1st & 2d.	1 car 2x4" and larger, dry.
20,000 ft. 6/4 1st & 2d.	<b>BOLSTERS.</b>
10,000 ft. 8/4 1st & 2d.	2 cars 3x4" and larger, dry.
50,000 ft. 4/4 Common.	<b>HICKORY AXLES.</b>
5,000 ft. 5/4 Common.	1,500—3 x4 "—6', 1-6 mos. dry.
5,000 ft. 6/4 Common.	1,500—3 1/2 x4 1/2"—6', 1-6 mos. dry.
20,000 ft. 8/4 Common.	2,000—4 x5 "—5', 1-6 mos. dry.
10,000 ft. 2 1/2" Common.	1,000—4 1/2 x5 1/2"—6', 1-6 mos. dry.
40,000 ft. 3" Common.	1,000—5 x6 "—6', 1-6 mos. dry.
1 car Hickory Plank, 1 1/2 to 4"—8' to 16'.	

# STOTZ LUMBER COMPANY

Incorporated

MANUFACTURERS :: WHOLESALERS

Oak, Ash, Poplar, Gum, Cottonwood

KELLAR BUILDING

LOUISVILLE, KENTUCKY

## Ornamental Hardwood Floors

400 STYLES AND PATTERNS

Illustrated Catalog on Application

### WOOD=MOSAIC FLOORING CO.

Rochester, N. Y. New Albany, Ind.

## The Kentucky Lumber & Veneer Co.

HARDWOOD MANUFACTURERS

Post Office and Band Mill, ROBBINS, KY. Shipping Point and Telegraph Office, JACKSON, KY.

Specialties:

PLAIN WHITE OAK OAK PLANKING  
YELLOW POPLAR RAILROAD TIES

We manufacture all the lumber we sell from original forest timber. Therefore the lengths and widths are good. All logs are manufactured in ten to thirty days after being felled, insuring bright, new stock, free of sap worms and rot. WRITE OR WIRE FOR PRICES.

## DRY LUMBER At Our Louisville Yards Prompt Delivery

<b>QUARTERED WHITE OAK.</b>	8,000 ft. 6/4 firsts & seconds.	20,000 ft. 5/4 No. 1 common.	<b>ASH.</b>	42,000 ft. 5/4 firsts & seconds
75,000 ft. 4/4 firsts & seconds.	5,000 ft. 8/4 firsts & seconds.	30,000 ft. 6/4 No. 1 common.	1 car 4/4 firsts & seconds.	17,000 ft. 6/4 firsts & seconds
18,000 ft. 5/4 firsts & seconds.	38,000 ft. 4/4 No. 1 common.	50,000 ft. 8/4 No. 1 common.	3,000 ft. 6/4 firsts & seconds	58,000 ft. 8/4 firsts & seconds
15,000 ft. 6/4 firsts & seconds.	12,000 ft. 5/4 No. 1 common.	18,500 ft. 10/4 No. 1 common.	7,000 ft. 6/4 firsts & seconds	3,000 ft. 10/4 firsts & seconds
19,000 ft. 8/4 firsts & seconds.	7,000 ft. 6/4 No. 1 common.	12,000 ft. 12/4 No. 1 common.	5,000 ft. 8/4 firsts & seconds	17,000 ft. 12/4 firsts & seconds
150,000 ft. 4/4 No. 1 common.	3,000 ft. 8/4 No. 1 common.	<b>PLAIN RED OAK.</b>	3,000 ft. 10/4 firsts & seconds	6,000 ft. 16/4 firsts & seconds
30,000 ft. 5/4 No. 1 common.	<b>PLAIN WHITE OAK.</b>	47,000 ft. 4/4 firsts & seconds.	7,000 ft. 12/4 firsts & seconds	60,000 ft. 4/4 No. 1 common.
40,000 ft. 6/4 No. 1 common.	80,000 ft. 4/4 firsts & seconds.	15,000 ft. 5/4 firsts & seconds.	4,000 ft. 16/4 firsts & seconds	26,000 ft. 5/4 No. 1 common.
22,000 ft. 8/4 No. 1 common.	17,500 ft. 5/4 firsts & seconds.	9,000 ft. 6/4 firsts & seconds.	10,000 ft. 4/4 common.	18,000 ft. 6/4 No. 1 common.
22,000 ft. 4/4 cull.	19,000 ft. 6/4 firsts & seconds.	27,000 ft. 8/4 firsts & seconds.	2,000 ft. 5/4 common.	31,000 ft. 8/4 No. 1 common.
<b>QUARTERED RED OAK.</b>	22,000 ft. 8/4 firsts & seconds.	31,000 ft. 4/4 No. 1 common.	20,000 ft. 6/4 common.	12,000 ft. 10/4 No. 1 common.
14,000 ft. 4/4 firsts & seconds.	18,000 ft. 10/4 firsts & seconds.	24,000 ft. 5/4 No. 1 common.	3,000 ft. 8/4 common.	8,000 ft. 12/4 No. 1 common.
18,000 ft. 5/4 firsts & seconds.	16,000 ft. 12/4 firsts & seconds.	14,000 ft. 6/4 No. 1 common.	<b>POPLAR.</b>	We have all thicknesses in
	127,000 ft. 4/4 No. 1 common.	29,000 ft. 8/4 No. 1 common.	60,000 ft. 4/4 firsts & seconds.	Selects and Saps.

ALL THICKNESSES IN CULL POPLAR, ASH, CHESTNUT.

Your Inquiries Would Be Appreciated.

## W. P. BROWN & SONS LUMBER CO.

WHOLESALE HARDWOODS  
LOUISVILLE, KY.

# CADILLAC

CELEBRATED FOR HIGH STANDARD OF QUALITY AND MILL WORK

Demand for all KINDS of Lumber is very strong. We still have the following list of Southern Michigan Hardwoods which we can offer you at reasonable prices:

- 4 4 Basswood in Clear, Nos. 1 and 2 Common.
- 4 4 Gray Elm in Clear, Nos. 1, 2 and 3 Common.
- 6 4 and 8 4 Gray Elm in 1st and 2nd Clear.
- 4 2, 10-4, 12 4 and 16-4 in 1st and 2nd Maple.
- 4 4, 5 4 and 8 4 Selected End Dried White Maple.
- 5 4 and 8 4 No. 2 Common and Better Beech.

We would also call your attention to our MAPLE FLOORING, the VERY BEST produced. Standard widths and grades in 3-8, 13-16 and 5-4.

If in the market let us hear from you.

## Mitchell Brothers Company

# Cummer, Diggins & Co.

MANUFACTURERS  
 "CUMMER" MAPLE  
 AND BEECH FLOORING

## MICHIGAN HARDWOODS

Good assortment of dry stock on hand ready for immediate shipment in Hard Maple, Beech, Birch, Soft Elm and Cherry.

SEND US A LIST OF YOUR REQUIREMENTS.

## MURPHY & DIGGINS

Offer all grades of the following special dry stock

- MAPLE—5 4, 6 4, 8 4, 10 4, 12 4, 14 4, 16 4
- GRAY ELM—4 4, 12 4
- BASSWOOD—4 4
- BIRCH—5 4, 6 4

Our own manufacture. Perfect Mill Work. Uniform Grades.

LET US FIGURE ON YOUR HARDWOOD WANTS.

## The Cadillac Handle Co.

. . Band Sawn . .  
 Michigan Hardwoods

- 2 cars 8 4 Maple, No. 1 Common and Better.
- 1 car 5x5 Maple, Select Stock.
- 2 cars 4 4 Basswood, No. 2 Common and Better.
- 1 car 4 4 Soft Elm, No. 2 Common and Better.
- 2 cars 8 4 Soft Elm, No. 1 Common and Better.
- 2 cars 4 4 Birch, No. 2 Common and Better.

## Michigan Hardwoods

BASSWOOD  
 SOFT GRAY ELM  
 BIRCH  
 HARD MAPLE

BE FRIENDLY :: WRITE US



**COBBS & MITCHELL**  
 (INCORPORATED)  
 CADILLAC, MICHIGAN







**ST. LOUIS**

LARGEST OF ALL HARDWOOD MARKETS

**LOTHMAN CYPRESS CO.**

AIR DRIED

**Louisiana Red Cypress**

FOOT OF ANGELICA STREET

**SIX MILLION FEET**

Ash, Oak, Cypress, Poplar, Etc.

READY FOR PROMPT SHIPMENT

**STEELE & HIBBARD**

NORTH BROADWAY, DOCK AND HALL STREETS

**Ozark Cooperage Co.**

**WE BUY STOCKS READY CUT OR CONTRACT FUTURE OUTPUT**

Four Inspectors in the South

Direct Shipments from mill stocks of COTTONWOOD, CYPRESS, GUM, OAK. MAIN OFFICE: FRISCO BUILDING

**CHAS. F. LUEHRMANN HARDWOOD LUMBER COMPANY**

Carry a complete stock of Hardwood and are constantly in the market to purchase large blocks of stock for cash. Are also the largest manufacturers of the famous St. Francis Basin Red Gum.

General Offices: 148 Carroll Street

**W. R. CHIVVIS,** Lesperance Street and Iron Mountain Railroad.

WHOLESALE HARDWOODS

BLACK WALNUT LUMBER MY SPECIALTY. Always in the market to buy Walnut and Cherry Lumber. Pay spot cash and take up at shipping point when amounts justify.

**Stoneman-Zearing Lumber Co.**

203 Frisco Building

We have the following Dry Stock for sale piled at our mill:

QTD. WHITE OAK :	COTTONWOOD :
3 Cars 4 4 Common.	3 Cars 1" 1 and 2.
2 Cars 4 4 Common and Better Strips	1 Car 1x13 to 17" Box Boards.
GUM :	ELM :
5 Cars 1" Common Red.	1 Car 6 4 Log Run.
1 Car 1x13 to 17" Box Boards.	4 Cars 4" Log Run.
1 Car 2" 1 and 2 Sap.	
6 Cars 1 1/2 Common and Better Sap.	

This Stock is All Band Sawn and Equalized

**Wanted—Cypress, Ash and Cottonwood**

INSPECTION AT POINT OF SHIPMENT WHEN QUANTITY JUSTIFIES

**Hafner Manufacturing Co.**

CYPRESS, HARDWOODS

Mail orders receive our immediate attention.

YARDS: FOOT OF DOCK STREET

**Thomas & Proetz Lumber Co.**

CASH BUYERS OF OAK, ASH, CYPRESS, POPLAR, CHERRY AND ALL

**HARDWOODS**

SEND INSPECTOR WHEN QUANTITY JUSTIFIES

Office and Yards: Hall and Angelrodt Sts.

**Garetson-Greason Lumber Co.**

MANUFACTURERS OF SOUTHERN HARDWOODS

Carload Shipments Direct from Our Own Mills Located at Fisk, Campbell and Cary, Mo., and Prescott, Ark.

519 Bank of Commerce

**JOHN B. RANSOM & CO.,  
NASHVILLE, TENNESSEE**

We want to move quickly the following old dry stock. All of it has been on sticks 6 to 18 months. Write us for delivered prices. We are prepared to furnish promptly mixed cars of rough and dressed hardwoods of all kinds:

<b>QUARTERED WHITE OAK</b>	<b>QUARTERED RED OAK</b>
90 M 4 4 first and second	100 M 4 4 first and second
15 M 5 4 first and second	58 M 6 4 first and second
80 M 6 4 first and second	15 M 8 4 first and second
10 M 10 4 first and second	95 M 4 4 No. 1 Common
120 M 4 4 No. 1 Common	84 M 6 4 No. 1 Common
65 M 6 4 No. 1 Common	72 M 8 4 No. 1 Common
58 M 8 4 No. 1 Common	
20 M 10 4 No. 1 Common	<b>PLAIN OAK</b>
	50 M 4 4 1st and 2nd White
70 M 5 8 first and second Poplar	100 M 4 4 No. 1 Common White
80 M 5 8 No. 1 Common Poplar	100 M 4 4 first and second Red
15 M 4 4 1st and 2d Quartered Sycamore	100 M 4 4 No. 1 Common Red
10 M 4 4 No. 1 Com. Quart'd Sycamore	

No. 1, No. 2 and No. 3 Common  
Poplar, 4-4, 5-4, 6-4, 8-4. For sale by

**The Loomis & Hart Manufacturing Co.**  
Chattanooga, Tennessee

WRITE FOR PRICES

**SOUTHERN OAK LUMBER CO.**



WE WANT TO BUY  
FOR CASH

**OAK  
CYPRESS  
ASH**

MILL CUTS OR ROUND LOTS

910 CHAMBER OF COMMERCE 1217 TENNESSEE TRUST BLDG.

**CHICAGO MEMPHIS**

YARDS : NORTH MEMPHIS

**Upham & Agler**

Bedford Building  
CHICAGO

Wholesale Northern and Southern  
**Hardwoods**

Quick Service  
Perfect Milling  
Right Prices

DISTRIBUTING YARD: CAIRO, ILLINOIS

**Swann-Day Lumber Company**

MANUFACTURERS OF

**POPLAR AND OAK**

PLANING MILL STOCK, BOX SHOOKS  
AND HARDWOOD DIMENSION

CLAY CITY, KENTUCKY

**T H E E A S T**

BOSTON NEW YORK PHILADELPHIA

ESTABLISHED IN 1798

**J. Gibson McIlvain & Company**

**WHOLESALE HARDWOODS**

PHILADELPHIA, PENNSYLVANIA.

Although we lost by fire on March 27 four acres of lumber sheds, containing 10,000,000 feet of select hardwood lumber piled at our yard at the junction of the Philadelphia Wilmington & Baltimore Railroad and the Baltimore & Ohio Railroad, at Fifty-eighth Street and Woodland Avenue, Philadelphia, our offices and stables were not injured, and we were well insured in first-class companies.

As we have a number of other dry stocks to draw from, we anticipate but little delay in filling our orders and taking care of current trade. We will therefore continue in the hardwood lumber business as heretofore, and respectfully solicit offerings of dry and desirable stocks of all varieties of hardwoods.

**WM. E. LITCHFIELD**

MASON BUILDING, BOSTON, MASS.

**Specialist in Hardwoods**

Manufacturers are requested to supply lists of stock for sale

J. H. SCHOFIELD

R. W. SCHOFIELD

**SCHOFIELD BROTHERS  
WHOLESALE LUMBER**

**Hardwoods a  
Specialty.**

1020-22 Pennsylvania Building  
PHILADELPHIA

**WILLIAM WHITMER & SONS, Inc.**

**Broad and Chestnut  
Streets....**

IN THE MARKET FOR ROUND  
LOTS OF DESIRABLE HARD-  
WOODS. SEND US LIST  
OF YOUR OFFERINGS.

**PHILADELPHIA,  
...PENNA.**

**Jones Hardwood Co.**

(INCORPORATED)

**WANTS**

4-4, 5-4 and 6-4 Chestnut, largely 1s and 2s.

147 MILK STREET, BOSTON, MASS.

**Wistar, Underhill & Co.,**

**WHOLESALE  
HARDWOOD LUMBER**

816 Real Estate Trust Building, PHILADELPHIA.

**Holloway Lumber Company**

**WHOLESALE HARDWOODS**

In the market for all thicknesses of  
OAK, ASH and CHESTNUT.

312 Arcade Building,  
PHILADELPHIA, PA.

**Charles S. Wentworth & Co.**

**WHOLESALE LUMBER MERCHANTS**

147 Milk Street  
**BOSTON**

We are in the Market for POPLAR, PLAIN OAK, CYPRESS and NORTH CAROLINA PINE LUMBER; also OAK, MAPLE and BIRCH FLOORING, and would appreciate correspondence from manufacturers in position to supply any of the stock named.

**STEVENS - EATON CO.**

Buyers of  
ROUND LOTS  
of

**Hardwoods**

No 1 Madison  
Avenue,  
NEW YORK

ESPECIALLY IN MARKET FOR PLAIN RED OAK

**H. D. Wiggin Wholesale Hardwoods**

**Specialties:** Poplar, Chestnut, Canadian  
Hardwoods, and Mahogany Veneers.

FISKE BUILDING

BOSTON, MASSACHUSETTS



# INDIANA



WHERE THE BEST HARDWOODS GROW

THE WOODS FOR  
WHICH INDIANA  
IS FAMOUS.

Quart'r'd White Oak

Plain White Oak

Quartered Red Oak

Plain Red Oak

White Ash

Poplar

Black Walnut

Cherry

Sycamore

Red Gum

Hickory

Beech

Maple

Veneers of

Indiana Hardwoods

## LONG-KNIGHT LUMBER CO.

MANUFACTURERS AND DEALERS  
Quarter Sawed White and Red Oak a Specialty  
INDIANAPOLIS, IND.

## MALEY & WERTZ

Manufacturers, Wholesalers and Exporters of Hardwood Lumber  
EVANSVILLE, IND.

## NO. VERNON PUMP & LBR. CO.

MANUFACTURERS AND DEALERS  
Would Like to Figure on Your Hardwood Requirements  
Send for Stock List  
NORTH VERNON, IND.

## PERRINE-ARMSTRONG CO.

Long Timber up to 60 feet—Hardwood Specialties  
The largest Band Mill in Indiana.  
FORT WAYNE, IND.

## J. V. STIMSON

All Kinds of Hardwood Lumber Manufactured  
HUNTINGBURG, IND.

## YOUNG & CUTSINGER

Manufacturers and Wholesalers  
Our Specialty Fine Figured Quartered Oak  
EVANSVILLE, IND.

## CHARLES H. BARNABY

Manufacturer of Band Sawed Hardwoods  
Quarter Sawed Indiana White Oak a Specialty  
GREENCASTLE, IND.

## D'HEUR & SWAIN LUMBER CO.

Manufacturers and Wholesalers  
Our Specialty Quartered Oak and Sycamore  
SEYMOUR, IND.



# PITTSBURG

HARDWOOD DISTRIBUTING CENTER OF PENNSYLVANIA

## A. M. Turner Lumber Company

Everything in lumber. We buy hardwoods as well as sell them. If you have anything to offer, please submit same to us. : :

## Linehan Lumber Company

PERFECT

## MAPLE FLOORING

SEND US YOUR INQUIRIES

## Willson Bros. Lumber Co.

MANUFACTURERS

## WEST VIRGINIA HARDWOODS

FARMERS BANK BLDG. :: PITTSBURG, PA.

## Hardwoods a Specialty

FOR SALE

POPLAR	CHESTNUT	PLAIN OAK
125,000' 4 4 1s and 2s	200,000' 4 4 Sound Wormy	60,000' 4 4 No. 1 Com.
40,000' 4 4 No. 1 Com.	80,000' 5 4 Sound Wormy	18,000' 4 4 No. 2 Com.
325,000' 4 4 No. 2 Com.	100,000' 6 4 Sound Wormy	<b>QUARTERED OAK</b>
228,000' 4 4 No. 3 Com.	48,000' 8 4 Sound Wormy	2 cars 4 4 No. 1 Com.
150,000' 4 4 Mill Cull		1 car 4 4 No. 2 Com.

OAK TIMBERS SAWED TO ORDER.  
WRITE FOR PRICES.

CHEAT RIVER LUMBER COMPANY, Pittsburg, Penna.

## Babcock Lumber Co.

MANUFACTURERS OF  
PENNSYLVANIA  
HARDWOODS

23,000,000 FEET ANNUALLY

LONG ON MAPLE  
AND CHERRY

MILLS AND OFFICE  
ASHTOLA, PA.

## Dry Stock for Quick Shipment:

12,189 ft 4 4 clear Quartered Oak	66,232 ft 4 4 No. 1 Common Poplar
14,570 ft 4 4 1st & 2ds qtd. Red Oak	10,315 ft 6 4 1st & 2ds Poplar
30,302 ft 4 4 No. 1 Com. Red Oak	56,000 ft 4 4 1st & 2ds Cottonwood
63,204 ft 4 4 No. 1 Com. Pl White Oak	119,000 ft 4 4 No. 1 Com. Cottonwood
4,417 ft 5 4 No. 1 Com. Pl White Oak	150,000 ft No. 2 Common Cottonwood
5,934 ft 6 4 No. 1 Com. Pl White Oak	90,000 ft 4 4 Mill Cull Cottonwood
23,473 ft 4 4 1st & 2ds Plain Red Oak	110,000 ft 5 4 No. 1 Com. Cottonwood
14,168 ft 4 4 1st & 2ds Poplar	40,000 ft 5 4 No. 2 Com. Cottonwood

## American Lumber & Mfg. Co.

PITTSBURG, PA.

## The Nicola Brothers Company

One million feet 4-4 Bay Poplar.  
Can be shipped log run, or sold  
on grade. Bone dry; band  
sawed. Send your inquiries.

## Flint, Erving & Stoner Co.

Wholesale Lumber  
Northern and Southern Hardwoods

Beech and Maple Timbers a Specialty

**"Ideal" Steel Rock Maple Flooring**  
Burnished

is the flooring that is manufactured expressly to supply the demand for the best. It is made by modern machinery from carefully-selected stock and every precaution is taken throughout our entire system to make it fulfill in every particular its name—"IDEAL."

Rough or Finished Lumber—All Kinds

Send us Your Inquiries

**The I. Stephenson Company**  
 WELLS, MICHIGAN

**White and Red Oak**

Secure our special prices on the following dry stock. We need the piling room.

30,000 feet 7-4 and 8-4 Quarter Sawn.  
 150,000 feet 4-4 1st and 2nds Clear Plain Sawn.  
 200,000 feet 4-4 No. 1 Common Plain Sawn.  
 200,000 feet 4-4 No. 2 Common Plain Sawn.

We also manufacture chair and table stock. Let us figure with you. Address all communications to

**Dierks Lumber & Coal Company**  
 MILLS: DE QUEEN, ARK. KANSAS CITY, MISSOURI

INCORPORATED 1902.

**The Michigan Maple Company**

WHOLESALE

**MICHIGAN HARDWOODS**

HENRY W. CAREY, President  
 HENRY N. LOUD, Vice Pres  
 WILLIAM P. PORTER, Vice Pres  
 WILMER T. CULVER, Secretary  
 WILLIAM H. WHITE, Treasurer  
 EDWARD BUCKLEY, Director  
 G. VON PLATEN, Director  
 MARSHALL F. BUTTERS, Director  
 HARRY NICHOLLS, Director

609-611 Mich. Trust Bldg.,  
 GRAND RAPIDS, MICH.

**Timber Bonds**

SECURED BY FIRST MORTGAGE ON TIMBER LANDS

**H. C. Barroll & Co.**  
 BANKERS, First National Bank Building, CHICAGO.

**OAK FLOORING**

Kiln Dried  
 Bored  
 Polished

Hollow Backed and Bundled

**Wolverine Brand Maple Flooring**  
 = "THERE IS NONE BETTER" =

It is the same old story, but we want you to know what WOLVERINE BRAND will do for you, and what it will cost you. We want to do this before you place your next order. If we make you quotations, we expect the quality and prices will get your order. TRY US.

**BLISS & VAN AUKEN**  
 900 S. Niagara St., Saginaw W. S., Mich.

H. B. LEAVITT, Prest.    B. F. RICHARDSON, V. P.    E. H. ADAMS, Secy.

**The Leavitt Lumber Co.**

MANUFACTURERS  
 SOUTHERN AND WISCONSIN HARDWOODS

CHICAGO YARD—DRY STOCK ON HAND

1,000,000 feet 1 inch to 3 inch ..... Birch  
 1,000,000 feet 1 inch to 2 inch ..... Basswood  
 200,000 feet 3 inch ..... Soft Elm  
 300,000 feet ..... Quartered White Oak  
 300,000 feet ..... Quartered Red Oak  
 500,000 feet ..... Plain Red Oak

Besides Gum, Maple, Hickory, Ash and Other Hardwoods.

ALSO 12,000,000 FEET HARDWOOD AND PINE AT FREDERIC, WISCONSIN.

MILLS: FREDERIC, WIS.    Yards and Office: Center Ave., near 35th St. CHICAGO

**THE "FINEST" MAPLE FLOORING**

**W. D. YOUNG & CO.**  
 BAY CITY, MICHIGAN.

Producers from TREE to TRADE of the highest type of Michigan Forest Products. Large stock of Maple Flooring and 15,000,000 feet of Hardwoods—1 to 4 inches thick—on hand.

**Maple, Birch and Beech Lumber**

# Hardwood Record

Published in the Interest of Hardwood Lumber, American Hardwood Forests, Wood Veneer Industry, Hardwood Flooring, Hardwood Interior Finish, Wood Chemicals, Saw Mill and Woodworking Machinery.

Vol. XXII.

CHICAGO, APRIL 25, 1906.

No. 1.

Published on the 10th and 25th of each month by

## THE HARDWOOD COMPANY

HENRY H. GIBSON, President      FRANK W. TUTTLE, Sec.-Treas.

### OFFICES

Sixth Floor Ellsworth Bldg., 355 Dearborn St. Chicago, Ill., U.S.A.  
Telephones: Harrison 4960      Automatic 5659

### TERMS OF ANNUAL SUBSCRIPTION

In the United States, Canada, Philippine Islands and Mexico . . . \$2.00  
In all other countries in Universal Postal Union . . . . . 3.00

Subscriptions are payable in advance, and in default of written orders to the contrary are continued at our option.

The entire contents of this publication are covered by the general copy-right, and articles must not be reprinted without special permission.  
Entered at Chicago Postoffice as Second Class Matter.

Advertising copy must be received five days in advance of publication date. Advertising rates on application.

## ALL ROADS LEAD TO MEMPHIS.

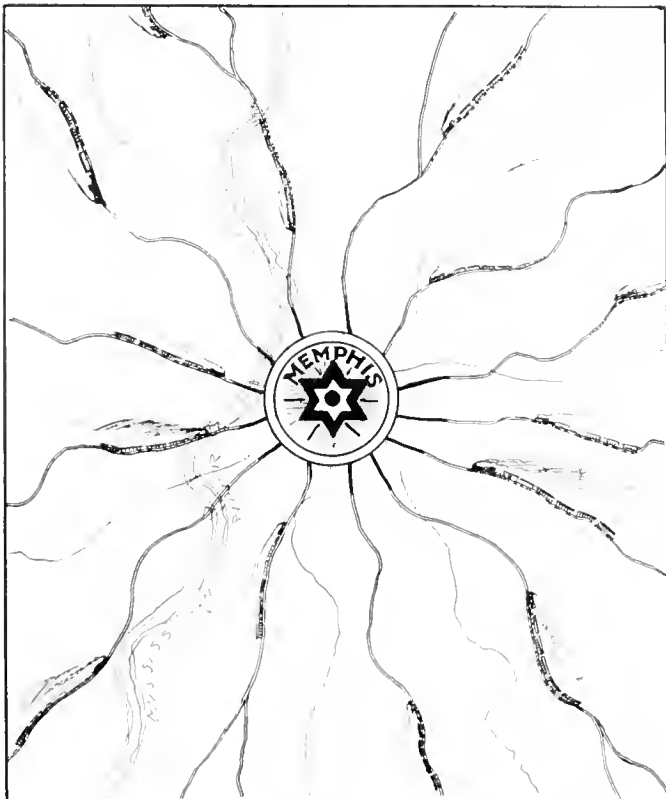

The ninth annual convention of the National Hardwood Lumber Association will be held at the Gayoso Hotel, Memphis, on Thursday and Friday, May 3 and 4.

### General Market Conditions.

The hardwood market conditions throughout the country still remain strong in practically every wood. The good end of poplar, cottonwood and basswood has taken care of itself for many months in admirable shape, and stocks in first hands have been reduced to the minimum. Latterly the demand for the low grades of these woods has been increased to such an extent that generally the producing market is very bare. This demand is directly traceable to the immense call for box shooks. As the low grades of conifers have not been equal to the demand for box shook purposes, box makers have taken on not only the comparatively soft hardwoods noted, but are also augmenting the supply with the coarse end of nearly all the denser hardwoods. While a few years ago nothing but soft woods was employed in box making, today one sees vast quantities of boxes and crating made of gum, elm, birch, beech, etc.

Oak still has the lead in demand, and while some quartered stock has been sold recently at a pretty low value in the middle West, both demand and price are looking better in the eastern sections.

There is no gainsaying the fact that hardwoods of practically every variety are going to be in very short supply before midsummer, and many of them are pretty nearly out of the market at the present time. Apparently there is not a cloud on the hardwood horizon, and every man who has any variety of hardwood for sale will be able to obtain a good price for everything he has. Communications from northern sawmills indicate that they have sold in advance the larger proportion of the stock they will saw during the season to jobbers and wholesale consumers. In the South advance contracts have been taken to nearly as great an extent. It is patent that the majority of jobbers have placed themselves in a very good position in the market for the succeeding few months, as they either own or have under contract the larger proportion of the output for 1906.

### Farm Wagon Woodstock.

The HARDWOOD RECORD is in receipt of the following letter, under date of April 12, from E. W. McCullough of Wilmette, Ill., who is secretary of the National Wagon Manufacturers' Association of the United States:

I have been much interested in your issue of the 10th and greatly admire the enterprise you exhibit in bringing the various matters of interest before your people, but in referring to your article entitled "Farm Wagons and the Hardwood Industry" I rather think that you state some of the conditions a little strongly, and there is a possibility that some of your mill men will take a position that will eventually prove disappointing to them.

I refer to your statement that the present prices of hardwood dimension stuff are satisfactory to the wagon makers. This is true only in the same sense of the boy chasing the woodchuck—he simply had to have it, and while all consumers of hardwood realize that some of the advance is justly due to the growing scarcity of it in some sections, undoubtedly the larger part of the advance is due to the increased demand and the natural tendency to get all we can while we can.

The position of lumber, in a sense, is much the same as that of hard coal—it is a natural product and is just where nature left it, while the facilities of getting it out and manufacturing it have greatly improved and in a manufacturing sense should mean lower rather than higher prices; but when it is suggested that, after some kinds of lumber have advanced over one hundred per cent in the last six or eight

years, that from ten to twenty dollars per thousand feet more advance will not affect its consumption. I think that opinion is a mistake. Every advance has to be handed on to the consumer, and he is carrying about all he can afford to stand at this time, and I venture to suggest that if any such increase as you intimate were made on hardwood materials you would find that wagon manufacturers are not so wedded to the wagon of wood construction that they will accept such advances cheerfully and continue its use. Right at this time one of the largest producers of wagons is putting upon the market an improved metal wagon, and others are experimenting with various important parts, so that some very radical changes along these lines seem imminent. Even now the legitimate trade is being affected by the manufacture of metal wheels, who have gone farther and constructed gears also of metal, with the exception of one or two parts, that they are substituting for the regular wagon in many uses about the farm, and the inroads these cheap trucks have made have been largely due to the increasing cost of the standard wagon.

So I suggest that while it is the rule of trade to get as large a margin on your product as it will possibly stand, the wiser course, it seems to me, is moderation, so that not only may the materials continue in demand but the volume be maintained over a long term of years; whereas, extremely high prices, while temporarily giving large profits, would simply cause the use of a substitute that would certainly affect the demand in this branch of your business.

It would seem to me a wise course for the mill men getting wagon dimension stuff to occasionally consult with a representative committee of their customers, just as we invite suggestions and discuss our mutual interests with the jobbers and dealers selling our line of goods.

I do not write you this as a criticism of your able article, but being closely in touch with the conditions in our own line of business, I feared that your article possibly might incline some of your mill men not thoroughly posted on the situation to believe that there was really no limit to the prices that could be obtained for his products, and if this idea prevailed it certainly would result in disappointment all around.

I observe also your suggestion for a list of manufacturers of wagon stock, and I am sure such a list would prove of mutual benefit.

While the position taken by the writer of this letter is to a considerable extent authoritative, as both by experience in the wagon making industry and in his association work he has the subject well in hand, still it must be considered from the viewpoint of ex parte opinion.

The statement made by the HARDWOOD RECORD that the present prices of hardwood dimension stuff were "satisfactory" to the wagon making trade was based partly on the statement of a number of producers of this material, who advised that they were readily marketing their output to the wagon making trade at the prices established at the dimension meeting at Cincinnati on Feb. 22 and 23, and partly from statements made to the writer by jobbers of wagon material, who reported that they were able to market the material at practically the prices agreed upon. The premises taken by the author of the letter are not well grounded when he concedes no more intrinsic value for standing timber today than he did in years past, or that the cost of production by reason of improved facilities is very much lessened at the present time. The cost of making lumber is in very much the same condition as the cost of producing wagons. The trade is past the period of reducing cost; the maximum of efficiency was reached some years ago, and since that time the cost of lumber, labor and materials entering into lumber production has been largely augmented. The menace to lumber consumption by reason of the wagon making trade using iron instead of wood is not serious, as it is yet to be demonstrated that a wagon of equal utility and at a less cost can be produced from this material. Again the writer of the letter is in error in his assumption that the present prices demanded for wagon stock show an excessive margin of profit to producers. There are scores of lines of lumber production that can be named where the profits are much higher than in making wagon stock, even at the present price standard. Again, it was one of the foremost aims of the gentlemen organizing the dimension branch of the Hardwood Manufacturers' Association to consult with representatives of all the leading industries interested in the use of dimension material before the matter of grades or of

values was decided upon. At this meeting there were present representatives of the chair, furniture, wagon and carriage industries, and everyone had an opportunity to state his position on both subjects.

It was not the intention of the dimension manufacturers of the country to advance prices unreasonably or at any time in the future to plan the making of schedules of prices that would in any wise militate against the volume of consumption. They have attained all they asked for, and that is a fair margin of profit on this material. In years past practically every man who had the temerity to engage in the manufacture of dimension material was a loser in the venture. If he was not forced to commercial failure he simply stopped making it before he reached that unhappy state. The present range of values established for this stock is sufficient to afford a moderate profit to all desiring to engage in the business, and is an especially valuable feature of the trade, as it enables both the small mill man to produce and market a green product, and the large operator to utilize his forest and sawmill refuse to a considerable extent.

### New German Lumber Duties.

There has been considerable fear prevalent on the part of exporters of American woods that the new German autonomous tariff rate would be so high as to seriously militate against exports to that country. The new tariff recently promulgated there provides first, for an autonomous rate; second, for a "favored nation" treaty rate. The United States consul-general at Berlin has supplied the HARDWOOD RECORD with the features of the new tariff that have special application to the lumber trade of this country. The report is especially valuable at this time on account of the recent agreement between the United States and Germany, under which the new treaty schedule promulgated will be protected until June 30, 1907. It is alleged that the introduction into congress of a resolution providing that an extra import duty of twenty-five per cent above the Dingley tariff be placed upon goods reaching this country from any nation discriminating against us in its import duties might have had some effect on the extension of the treaty.

The following table shows the old schedule and the new treaty rates on American timber and lumber products imported into Germany. The autonomous rates are much higher. The rates given are based on the square meter—10.7629 square feet. It will be seen that the new tariff on hardwood logs is twelve cents lower than the old rate; on hewn hardwood timber it is twelve cents higher; on rough hardwood lumber it is twenty-three cents higher; on hardwood ties it is three cents higher; on oak staves it is five cents lower. It will be noted that the changes instituted are not of serious consequence.

	TREATY		FORMER	
	Marks	Dollars	Marks	Dollars
Wood and Timber for Building. <sup>1</sup>				
Round—Hard .....	1 08	25	1 20	28
Soft .....	72	.17	1 20	.28
Hewn—Hard .....	1 92	.46	1 80	.43
Soft .....	1 44	.34	1 80	.43
Wood, sawed but not planed:				
Hard .....	5 76	1 37	4 80	1 14
Soft .....	4 32	1.08	4 80	1 14
Railway Ties, hewn or sawed lengthwise but not planed				
Of hardwood .....	1 92	.46	1 80 <sup>2</sup>	.43
Of soft wood .....	1 44	.34	4 80 <sup>3</sup>	1.14
Impregnated Ties, additional duty:				
Of hardwood .....	1.20	.28	.....	.....
Of soft wood .....	1.20	.28	.....	.....
Staves, not planed:				
Oak .....	1 60	.38	1 80	.43
Other hardwood .....	2 40	.57	1 80	.43
Soft wood .....	1 80	.43	.....	.....

<sup>1</sup> On steamed, impregnated, or otherwise chemically treated wood there is an additional duty of 2.40 marks (57 cents) per square meter on hardwoods, and 2.60 marks (62 cents) on soft woods. <sup>2</sup> Not sawed lengthwise. <sup>3</sup> Sawed one long side.

### Lignum-Vitae.

There seems to be an unusual call for lignum-vitae at the present time. The United States consul at Port de Paix, Haiti, says that foreign offers for lignum-vitae are very numerous, and as high as \$48 a ton has been offered for wood nine inches and over in diameter. Heretofore the making of balls for bowling alleys has consumed a large portion of the lignum-vitae that has been imported into this country.



# Pert, Pertinent and Impertinent.

**Because.**

"He's fast, I'm told," the widow mused.  
 "Yet I'll marry him some day,  
 Because I've got him—well, so fast.  
 He really cannot get away."

**"Tainted Money."**

A curate—somewhat of a saint—  
 Sought funds his small chapel to paint,  
 And with every donation  
 Went this conversation:  
 "I hope it ain't tainted?"  
 "It ain't."

**Troublesome Fruits.**

An apple, you know, caused the sorrow and strife  
 That overtook Adam and Eve, his sweet wife;  
 When I get in trouble, the fates I beseech  
 That it will be just on account of a "peach."

## THE HARDWOOD RECORD'S PUZZLE PICTURE.



**In the above sections of portraits will be found the picture of the next President of the National Hardwood Lumber Association. To the first subscriber of the Hardwood Record who correctly assembles these sections and delivers the picture to this office will be presented copies of the inspection rules of the National Hardwood Lumber Association and of the Hardwood Manufacturers' Association of the United States, handsomely bound in one volume, with asbestos covers. Only one guess goes.**

**A Friend in Need.**

A friend in need is a friend to steer clear of.

**Even That.**

Mules have one characteristic that is admirable; they refuse to be influenced by flattery.

**Tomorrow.**

Wrapped up in the word tomorrow is the cause of a great many failures.

**Time to Borrow.**

In fair weather there's no difficulty in borrowing an umbrella.

**Then.**

The master's back shows the servant's true face.

**Get Busy.**

The busy man is immune from the wiles of his satanic majesty.

**A Definition.**

The ideal existence: Either the way we used to live or the way we are going to live some time.

**How Many!**

How many women's reputation as a good wife hangs upon her husband's buttons!

**Why?**

You can trust a great many more men with your money than with your reputation.

**Never Fails.**

The surest way in the world to make enemies is to hire friends.

**Popular!**

The more a man owes the more he's apt to be sought after.

**They Conflict.**

When truth and honesty are strongly characteristic, diplomacy usually is lacking.

**They Think So.**

All men think they help others more than others help them.

**Nothing.**

Nothing is harder for an ignorant man to say than "I don't know."

**Talk's Cheap.**

Many men are charitable — when it comes to giving advice.

**The Reason.**

Truth is stranger than fiction because there is less of it.

**The Extremes.**

No man is as bad as his enemies paint him, nor as good as his sweetheart knows he is.

**Only There.**

Every little frog is great in his own bog.

**Companion Traits.**

Faultless people are usually forceless.

**Not Last.**

The man who hesitates to be first can be sure that he will not be last in the list of failures.

**Cloaked.**

How much immorality is effectively concealed under the term "broad-mindedness!"

**Helps Some.**

When a man's bound to marry a fool, it helps some to choose a good-looking one.

**Much Better.**

It's all right to say nothing but good about the dead, but how much better to apply this rule to the living.

**Just Criticism.**

More people are criticized for assumed virtues than for any real faults.

**True to His Trust.**

The man that made a million out of a combine.

**Actions Speak Loud.**

The best arguments for a religion are found not in books, but in the lives of its adherents.

**Few Friends.**

A man who is a friend only to himself has few other friends.

**Never Kicks.**

The undertaker is the one man who never complains of being worked to death.

# AMERICAN FOREST TREES.

THIRTY-SECOND PAPER.

Bull Pine—Arizona White Pine—California White Pine.

*Pinus ponderosa*.—Laws.

The range of growth of this tree is through the Pacific Coast states, from British Columbia southeast to Mexico, through Colorado, New Mexico, Arizona, the Black Hills of Dakota, and parts of Texas. In California, Colorado, Montana, Idaho, Utah, Washington and Oregon it is called yellow pine; in California, white pine; in Utah, Washington, Idaho, California and Oregon, bull pine; in Montana, big pine; in Utah and Nevada, long-leaved pine; in England, heavy-wooded pine; while in various other sections of this country it is called red pine, pitch pine, southern yellow pine, western pitch pine, Sierra brownbark pine; and in English literature, "Gambier Parry's pine."

*Pinus ponderosa* forms large forests in northern California, along the slopes of the Sierra Nevadas, frequently growing on dry, open ridges in southern California, through the San Bernardino and San Jacinto ranges, as high as 8,000 feet above the sea level. It is often intermixed with sugar pine. It is planted as an ornamental tree in parts of Europe, and is sometimes successfully grown in the eastern states.

This great tree grows to a height of one, two or even three hundred feet in favorable environment, with a trunk four to six feet in diameter. The bark is bright reddish brown, deeply fissured, and very thick. The leaves are in tufts of three, four to nine inches long, stiff and elastic, remaining on the branchlets from six to nine years. The flowers are yellowish-green. The fruit of this tree is a cone five to twelve inches long, the scales of which are fitted with strong, slim prickles, usually hooked backward. The seeds are often a half inch in length, and winged.

In structural qualities the wood is heavy, hard, strong and brittle; the thin heartwood is light red in color, while the sapwood is nearly white. The pores are coarse, and the structure compact. The weight of a cubic foot of the seasoned wood is approximately thirty pounds.

On the lower levels of New Mexico and Arizona the timber is short bodied and of ordinary quality, but as the higher altitudes are reached the growth improves in quality, until on levels of from 6,000 to 8,000 feet above the sea it attains its maximum size

and excellency. In this part of the country the tree is known as "peno veta." Botanically it is the nearest approach to the white pine of the North that can be found anywhere in the United States, save a scattering growth in parts of Tennessee and North Carolina. In fact, in some characteristics it surpasses *Pinus strobus*. The wood takes

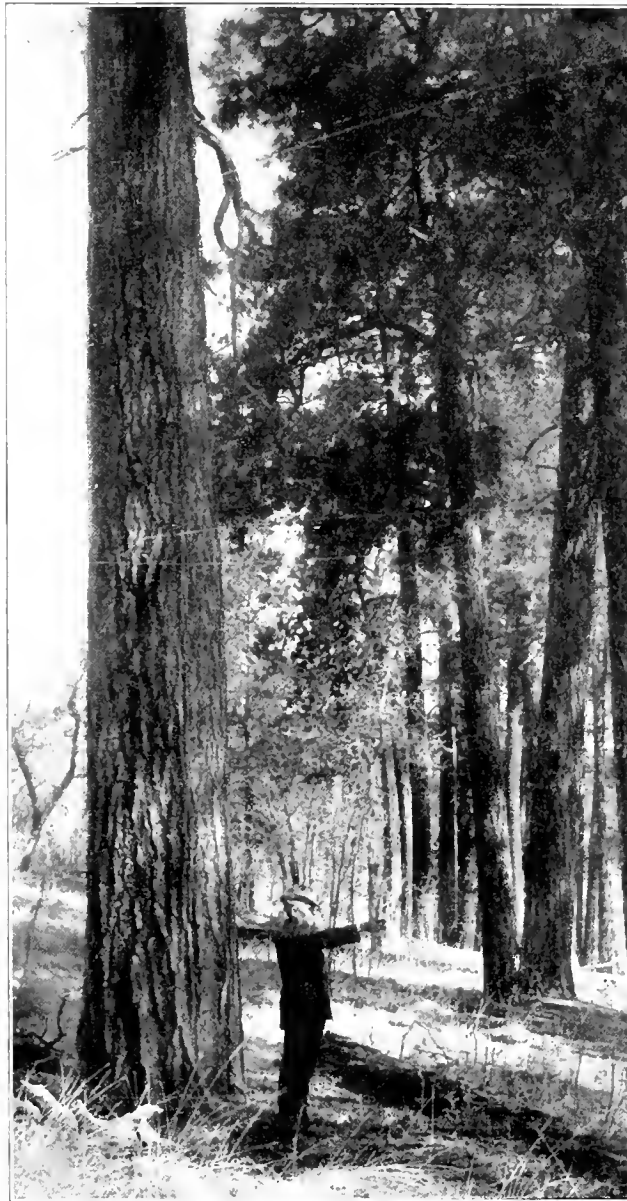

TYPICAL FOREST GROWTH WESTERN WHITE PINE, VALENCIA COUNTY, NEW MEXICO.

easily and holds well a finish possessing a brilliant sheen not excelled by any fancy wood in the United States, and it compares in softness with northern white pine. However, some trees are found which exhibit many characteristics of short-leaved yellow pine in fiber, color and gum.

*Pinus ponderosa* attains its largest growth in the Lewis and Clark reservation of north-

western Montana, in the valleys, at an altitude of about 3,500 feet, where it forms perhaps a fourth of the forest growth. In this region trees from 180 to 200 feet in height, with a trunk three to seven feet in diameter, are common. In parts of Idaho and western Washington the growth is equally prolific. From this outline of the range of growth it

will be noticed that the tree reaches its highest perfection from a comparatively low altitude in the North to a high altitude in the South. This, however, is true of all woods naturally adapted to a temperate zone. The same will be noticed in the white pine growth of eastern Tennessee and western North Carolina—the timber on the lower levels being scrubby and defective, but at altitudes of several thousand feet closely approaching perfection, while in the North the finest specimens are found at no great height above the sea level.

This species of pine is slow growing, trees in the southwestern states ranging in age from 175 to 450 years. The sapwood appears to withstand climatic conditions as well as the heartwood. It does not decay under conditions which would speedily rot the sap of northern white pine. When green the wood has an approximate weight of 4,500 pounds to the thousand feet, but when seasoned only 2,500. In regions where the atmosphere is exceedingly dry and frequent winds prevail, the seasoning of *Pinus ponderosa* is very speedy. Its wood is thoroughly adaptable for the purposes to which good white pine is put—pattern making, sash and doors, ties, beams and general mining uses. In house building it is highly esteemed. As box material it is excellent, as it is for handsome and durable interior finish.

From the botanist's viewpoint *Pinus ponderosa* is yellow pine. It is practically the connecting link between the white pine of the North and the short-leaved pine of the South and Southwest. While in the West and Northwest it forms a part of a mixed forest growth, in

New Mexico and Arizona it grows in a pure stand. The larger operations in *Pinus ponderosa* are at Albuquerque, New Mexico, the source of timber supply being the highest levels of the Zuni mountains in Valencia and McKinley counties; at Flagstaff, Arizona, where a large sawmill and box-making plant is located, and at Williams, Arizona, in the San Francisco mountain district,





THOMAS J. MOFFETT,  
CINCINNATI, OHIO

where large quantities of the lumber are produced. In California and the Northwest it



TRAINLOAD WESTERN WHITE PINE LOGS, FLAGSTAFF, ARIZ.

constitutes only a portion of the general mill product, as it often grows interspersed with white pine and redwood, and farther north, with the fir and cedars.

The good end of the lumber product of *Pinus ponderosa* is being shipped often as far east as Cleveland, Pittsburg, Philadelphia and New York. The doors manufactured in the local plants and in the Middle West are sold as white pine the country over, and a good many even go into export. The box shoo product finds its best market in the fruit growing district of California, and large quantities are also consumed in Colorado and as far east as the Mississippi river dis-

trict. Considerable quantities of the lumber go into export to Mexico, Great Britain and the Continent.

The picture herewith produced illustrating the growth of *Pinus ponderosa* is from a photograph made by the writer on the property of the American Lumber Company in Valencia county, New Mexico; the trainload of logs was photographed at the mill of the



STRAW AND CONE OF PINUS PONDEROSA.

Arizona Timber & Lumber Company, Flagstaff, Arizona.

## Builders of Lumber History.

NUMBER XXV.

(See Portrait Supplement.)

(See Portrait Supplement.)—Nonp. Italic.

While the number of successful hardwood lumbermen who started out in life in other business is comparatively few, among that few may be mentioned prominently Thomas J. Moffett.

Mr. Moffett was born Dec. 3, 1864, at Edinburg, Ind., and was educated in the public schools of that town, from which he was graduated with honors. At fourteen years of age he went to work washing bottles in a drug store at \$1.50 a week, and during the next six years he acquired a general knowledge of the drug business, as clerk in this store. In his twentieth year he went to Philadelphia, where he obtained a position in a drug store and entered the Philadelphia College of Pharmacy, the leading institution in that line in the country.

After graduating with the degree of Ph. G. he returned to Edinburg and engaged in the drug business with his two brothers, Owen and Charles, under the name of Moffett Brothers. Charles died soon after the partnership was formed, but Thomas and Owen continued the business until, feeling the need of a life less confining than the drug trade, Thomas J. Moffett moved to Dayton, O., and bought the Daniels interest in the lumber firm of Maley, Daniels & Thompson. The concern then became Maley, Thompson & Moffett. L. J. Thompson of

this firm is a brother-in-law of Mr. Moffett. At that time the company operated one hand sawmill. This was moved about ten years ago from Dayton to Cincinnati and located at McLean avenue and Eighth street. The firm was incorporated some years later and shortly afterward, on the death of Mr. Thompson, the business was acquired by T. J. Moffett and E. W. Robbins, who still operate under the name of Maley, Thompson & Moffett.

The present officers are: T. J. Moffett, president and treasurer; E. W. Robbins, vice president and general manager, and C. L. Smith, secretary. In ten years the business of the company has developed with astonishing rapidity. Instead of one hand sawmill the company now owns four modern sawmills complete in every particular, and a great veneer plant, perfectly equipped. One sawmill at Havana, Cuba, cuts mahogany exclusively; another mill is located at Rapid Run, O.; and one is also in commission in western Kentucky. These, with the original mill at Cincinnati, make the quartet of sawmills to which is added the veneer plant, which produces from 75,000 to 100,000 feet of veneer a day.

This wonderful growth will not be considered phenomenal when one knows T. J. Moffett. He has that thorough identification with business which is concomitant with success, a lack of which is indicative

of failure. It is probable that when he was a druggist he was one of the best in the trade, just as it goes without saying that the name T. J. Moffett stands today in the hardwood industry for strict integrity and clean methods, as well as business acumen of more than ordinary quality. It also stands for gentility, sociability, civic pride and interest quite as much as for business success.

Thomas J. Moffett is one of Cincinnati's leading citizens. Last year he was president of the Cincinnati Business Men's Club, an organization of a thousand members, and gave to it the most successful administration it had ever known. He was formerly president of the Lumbermen's Club and is a member of the Chamber of Commerce, of the Carriage Club, of the Manufacturers' Club and of the Associated Organizations.

Mr. Moffett was at one time a member of the examining board of Purdue University, Lafayette, Ind., and was recently appointed by the mayor of Cincinnati one of the directors of the University of Cincinnati. He is also director in the University school, chairman of the Erkenberker Memorial Commission, which aims to erect a suitable monument to the founder of the Cincinnati Zoo, and a director of the Third National Bank, one of Cincinnati's foremost financial institutions.

Mr. Moffett is a man of commanding presence, who instantly gives an impression of forcefulness and reserve power, and he exemplifies most thoroughly the honest, earnest, energetic, brainy business man of today. His executive ability is unquestioned. One may admire a man who does things, but one will respect the man who does things in the best possible manner. Thomas J. Moffett is a diplomat as well as a business man, a combination seldom found in the same individual. To honor him is to honor the entire lumber trade.

### N. W. L. D. A. Committees Appointed.

The HARDWOOD RECORD is in receipt from Secretary Perry of the list of committees for 1906 and 1907 appointed by the National Wholesale Lumber Dealers' Association. The make-up of these committees remains essentially the same as last year. The hardwood inspection committee consists of:

M. M. Wall, Buffalo, N. Y., chairman.  
W. L. Sykes, Keating Summit, Pa.  
J. V. Stinson, Huntingburg, Ind.  
J. L. Alcock, Baltimore, Md.  
N. H. Walcott, Providence, R. I.  
M. B. Farrin, Cincinnati, O.  
W. E. Litchfield, Boston, Mass.

The forestry committee is as follows:

G. F. Craig, Philadelphia, Pa., chairman.  
W. H. Gratwick, North Tonawanda, N. Y.  
G. C. Edwards, Ottawa, Ont.  
C. B. Farr, Williamsport, Pa.  
Sam Burkholder, Crawfordville, Ind.  
J. B. Blades, Elizabeth City, N. C.

The new advisory committee to the American Forestry Association is composed of the following:

R. C. Lippincott, Philadelphia, Pa., chairman.  
George F. Craig, Philadelphia, Pa.  
Lewis Dill, Baltimore, Md.

## A Lumberman's Letters to His Son.

CHICAGO, April 20.

MY DEAR SON: I have no wish to preach to you or load you down with advice, for I know that one's own experience is more valuable to him than advice based on the experiences of his elders. This Arkansas timber and sawmill is a mighty good proposition if it is carried out with even a moderate amount of good sense. I propose to make you responsible for the success of the deal. At the same time, I want to suggest to you some features of logical sawmill operation, to be carefully considered by you before you act differently.

This mill we are putting up down there is supposed to have a normal capacity of 45,000 feet of lumber a day on the class of logs we have. I believe that guarantee can be made good and that the mill will actually cut that quantity of lumber in the time named. However, I think it would be a mistake to ever cut over 25,000 feet a day. This strife for "tonnage" may be all right in some lines of trade, but it is not right in the sawmill business. You can make more money sawing 25,000 feet of lumber a day, and doing it well, than you can by making twice that amount of indifferently manufactured stock.

Saving miscellaneous hardwoods is a different proposition from cutting hemlock or small yellow pine logs. In that class of lumber you can pretty nearly take one log as a sample and cut them all alike. In hardwoods every log is an individual problem, and to achieve the best results the sawyer must be given time to carefully analyze them, log by log.

## Hardwoods Used in Organ Building.

Some interesting facts relative to the selection and use of woods for pipe organs may be noted by a visit to the mill of a reliable pipe organ maker. Nearly all of these instruments are made to order, and the customer specifies the kind of wood to be used. Pipe organs usually go into churches, and so most frequently are made to correspond with their interior finishings. Very often a sample of the wood in which the building is finished is sent to the factory to be matched in the organ woodwork.

Occasionally an order is sent in calling for a walnut case, but the price of black walnut is very high, especially in the grades which are required for this work. No grades of any wood except firsts and seconds ever go into a pipe organ. Very rarely, also, are cherry cases made, although they are invariably very handsome. Red birch, which the factories buy in Michigan and Wisconsin, is now very popular, and in its natural state, with only a coat of varnish, is most beautiful. This same wood, with a mahogany stain, is used for the so-called "mahoganyized" cases, and is indeed a fine substitute

for mahogany, scarcely being excelled in appearance by that wood itself. For the general run of orders, however, quarter-sawed oak is the popular finish. A panel of this wood, picked up where an organ case was in process of construction, proved to be a thin poplar board with a veneer of quarter-sawed oak on both sides, although only one of them was to be exposed to view. This is done to prevent cracking or warping. Another case was entirely of poplar, and was made in an unusual design, with Grecian columns and grille work. It was to be filled with shellac filler, and then covered with heavy white enamel, and shipped to a handsome summer residence being built at Lake Geneva.

Again, it won't do to crowd an edger on hardwoods. Even a good edgerman can waste enough stock, if overloaded, to pay the wages of an entire sawmill crew. On the contrary, if he has time to stop and figure out how to get his saw kerf largely out of wane in place of clean stock, he can earn a lot of money. It is the same thing on the trimmer—speed means waste every time. I therefore say to you, don't cut a log a day more than you can have sawed, edged and trimmed to attain the best possible results.

When you get out into the yard work I want to warn you not to spoil lumber after you have made it. See that your foundations for lumber piles are substantial, of sufficient number, and lined up with absolute accuracy. Don't be afraid of pitch in your piles, and don't pile gum with less than a twenty-inch pitch, in a sixteen-foot pile, with dry stickers not more than three feet apart. Build your piles narrow, largely separating widths and entirely separating lengths and thicknesses. Give plenty of air space between boards and between piles. See that the bottoms of your piles are well up from the ground with lots of air space below. Be particular about your piling ground; select the highest, driest place available.

In short, don't take good saw logs and make bad lumber; don't take good lumber and spoil it by bad yarding.

Your affectionate FATHER.

P. S.—No, you can't have a young lady stenographer. An Arkansas sawmill is no place for such sensitive creatures. You will have to get along with a young man.

factory's kilns and kept there two weeks, commencing with a temperature of 125° and gradually increasing the heat. Cases are all put together with tenons, dowels and glue; no nails or screws are ever used.

The wood which enters into the working parts of an organ is even more carefully selected than that for the case. Carrying as it does, the most delicate adjustments, and going into all ranges of climatic conditions, and very often into ignorant and careless hands, the organ proper must be most carefully constructed. The customer sometimes claims the right to select the wood for the inside, as well as for the case, and it may be either pine, basswood or poplar. If the choice be left to the organ builder the latter wood is chosen as the most suitable.

For the mechanism of the instrument the lumber is never kiln dried. After seasoning in the yard one or two years, it is taken into the warm stock room of the factory and kept there six months or more before being used. In this way it is better "acclimated," so to speak, and less likely to be affected by atmospheric conditions. The working parts of the organ are also treated with shellac filler, and then given a coat of varnish.

### Pipe Dreams from Mexico.

William E. Curtis, the prolific writer on the wonders he encounters in all parts of the world, has been recently traveling in Mexico, and has become the victim of the local voracious chronicler. He says that worn out steel rails are used for telegraph poles down in the Tehuantepec country, with a couple of holes drilled at the top so that wooden cross bars can be fastened on. He alleges that it is impractical to use wooden poles because the soil is so rich that they take root and grow, even if the pole be of seasoned wood. Mr. Curtis' informant tells him that the surveyors of railroads down in that country have a great deal of trouble with the wooden stakes which they drive to mark the right of way, because they blossom like the rod of Moses. He alleges that the fences along the railroads, used to support fence wire, are all flowering hedges. Dipping further into the marvels of Mexican forest growth, he tells of the *Arbor diabolii*, the octopus of trees, which has an extraordinary way of coiling up its twigs and seizing birds and animals which are unfortunate enough to select it as a resting place. He alleges that if a stone or piece of wood or other object of bulk or weight be laid upon one of the branches, it will be seized in the same way by this wonderful tree, and the limbs will twine about it and hold it there indefinitely. He claims that no man can climb the tree without becoming fatally entangled in its branches.

The Hardwood Lumber & Mining Company has been organized with \$50,000 capital at Roanoke, Va., to cut timber from a 6,000-acre tract of hardwood timber land in Bland county, Virginia. The officers are: R. H. Angell, president, Roanoke; C. L. Bush, treasurer, Roanoke; B. F. Johnson, Jr., secretary, Narrows.

# Cincinnati's Greatness as a Hardwood Market.

Back in the early thirties two small saw mills practically represented the hardwood industry of Cincinnati. Today the hardwood interests of the Queen City are said to be greater in proportion to general volume of business transacted than in any other city in the United States. Last year Cincinnati houses are credited with manufacturing and handling the grand total of over one billion feet of hardwood lumber.

Few people, unless they have stopped to figure it out, have any idea of the vastness of this industry, of its sources of supply and phenomenal development and expansion, to which Cincinnati is to the manner born. The city is the logical hub of the lumber industry for the northern, southern and eastern trade, located as it is between the pine, hemlock and hardwood forests of Michigan, Wisconsin, Minnesota and Canada, and the great hardwood, yellow pine and cypress regions of the South.

Cincinnati is the terminus of five great railroad systems, tapping on the east the rich forests and heavily wooded mountain slopes of Virginia and West Virginia; on the south, Kentucky, Tennessee, Alabama, Georgia and the two Carolinas; and on the southwest, Mississippi, Arkansas and Louisiana, which pour into her lap rich stores of oak, ash, gum, cypress and other hardwoods.

Many Cincinnati lumber houses have rep-



CLINTON CRANE, DEAN OF CINCINNATI LUMBERMEN.

resentatives engaged in cutting mahogany in Cuba, Mexico, South America, Central America, and also several points in Africa, from whence comes the rich and beautiful

Lagos and Sepeli woods. It is a curious fact that mahogany lumber is cheaper in Cincinnati than it is in New York, Liverpool, Marseilles or Hamburg, notwithstanding that these points are the headquarters of large ocean forwarding companies. Cincinnati exports vast quantities of high-class hardwoods, notably oak, ash, hickory, walnut



SAW AND VENEER MILLS, CYPRESS LUMBER COMPANY, SHEFFIELD, ALA.

and yellow poplar, to many foreign points.

The Ohio river is a tremendous factor in contributing to Cincinnati's success as a lumber market, as over 100,000,000 feet are annually floated down from the timber tracts along the Ohio, Big Sandy, Guyandotte, the two Kanawhas, Licking, Kentucky and Green rivers. Cincinnati owes the largest share of its furniture, carriage, piano and wagon factories to its favorable location with respect to sources of supply.

### C. Crane & Co.

Oftentimes a destiny is decided by even such a trifle as the turning of a straw. So it was with C. Crane & Co. When Clinton Crane, king of Cincinnati lumbermen, becomes reminiscent, which is not infrequent, he delights in telling how he was forced into the lumber manufacturing business, much against his will. This was nearly thirty years ago, and the circumstance that wrought havoc in one quarter brought opportunity in another, as it in proof of the old saying, "It's an ill wind that brings good to no one." To verify this statement, only a view of the great stretch of bottom land which constitutes a goodly portion of Cincinnati's reach along the Ohio river, now occupied by the great sawmill and lumber yards of C. Crane & Co., is necessary. But this is not all; the rest of the company's holdings is reached by crossing the river and going up into West Virginia; and until the 150,000 acres of timber land on each side of the Guyandotte river have been traversed, all of C. Crane & Co.'s possessions have not been seen.

There was located at Xenia, O., some thirty years ago, a small sawmill which sup-

plied lumber to the firm of Cole & Crane, which at that time was doing a very modest jobbing business. Operations were unsteady, and in due course Cole & Crane found themselves with the Xenia sawmill on their hands in lieu of cash. There was nothing to do but to operate the mill themselves, so Clinton Crane loaded the sawmill on a car headed for Cincinnati, and set it up on the banks of the Ohio, the site of the present gigantic plant of C. Crane & Co., and began to saw lumber at the rate of 10,000 feet daily. The firm continued operations under the title of Cole & Crane for five or six years, when it was changed to Crane & Co.

In 1883 Crane & Co. bought the Glenn mill, a little way down the river. Business increased rapidly, and thereafter they knew naught but success. In 1885 a new mill was erected, and in 1893 the concern bought out their neighbors and competitors, Baker & Hauley. Mill after mill was erected, old equipment was thrown out for

new, and everything in milling machinery that reduced operating expenses, time and labor added. In 1894 the firm was incorporated as C. Crane & Co., since which time business has increased phenomenally until at present writing the company operates seven mills with a capacity of 300,000 feet every ten hours. The logging equipment is up-to-date in every particular. C. Crane & Co. float all their logs, and by means of a splendidly organized system manage to



W. A. BENNETT, SOLOON OF THE TRADE.

keep a steady run of timber from the woods to the mill. The company's line of production includes poplar, oak, ash, chestnut, sycamore, elm, spruce and pine.



**Bennett & Witte.**

The firm of Bennett & Witte is one of the oldest hardwood concerns in Cincinnati, having been established in 1884. Its prin-



HARRY P. WIBORG, PRESIDENT WIBORG & HANNA COMPANY.

cipals are W. A. Bennett and George C. Ehemann, the former in charge of the Cincinnati house, and the latter manager of a branch office in Memphis. Their trade is not confined to any particular section of the country, their maxim being "the place to sell lumber is where it is wanted." The purchasing business, as well as the manufacturing department, is governed accordingly. Domestic and foreign affairs are conducted along the line of giving the purchaser exactly what he buys. No mixed grades are sold even when the needs of the customer require them. National Hardwood Lumber Association rules govern their inspection and they are firm believers in the usefulness of this system to the manufacturer as well as to the consumer and dealer. The firm's output consists chiefly of gum, cottonwood, oak, cypress, ash and poplar, and it does a large export business.

**The Wiborg & Hanna Company**

The history of the Wiborg & Hanna Company dates back nearly three score and ten

years. The present concern has in its employ today a German, Henry Fredelake, bent and furrowed with age, who has been continuously in the service of the Wiborg & Hanna Company and its predecessors for fifty-four years. Although a pensioner, "Old Cap" presides over the kindling poles, an autocrat in his realm, with the same

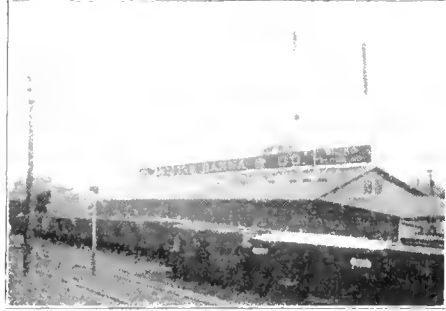

SAWMILL, WIBORG & HANNA COMPANY

constancy which characterized his service when his arm was stronger and his step lighter.

Along about 1839 the firm of Wm. Hanna & Co., composed of the estates of Capt. Wm. Hanna and John P. Hanna, started a sawmill not far from the present plant of the Wiborg & Hanna Company. For fifty years



STORAGE SHEDS, UNLOADING TRACK AND PLANING MILL, WIBORG & HANNA COMPANY

this firm did a flourishing business. A number of years later another concern was organized to mill logs under the name of Lewis & Wiborg. About 1889 Lewis & Wiborg and Wm. Hanna & Co. consolidated, taking the name of Lewis, Wiborg & Hanna.

This concern continued until January, 1890, when the organization was readjusted under the name of Wiborg, Hanna & Co., composed of H. P. Wiborg and John P.



JOHN P. HANNA, VICE-PRESIDENT WIBORG & HANNA COMPANY.

Hanna. Later, in 1905, the new organization was effected, the officers of the present corporation being Harry P. Wiborg, president; John P. Hanna, vice-president; and A. Lloyd, secretary and treasurer.

Until the year 1892 the concern did a strictly wholesale business, at which time a planing mill was established at Junction City, Ky., where everything in the planing mill line was manufactured. In 1900 this mill was destroyed by fire, and the company decided to build a model plant at Cincinnati. The work was completed about two years ago, and lumbermen visiting Cincinnati rarely fail to visit and inspect this great institution. At this mill is manufactured house trimmings of poplar, gum and cypress. The Wiborg & Hanna Company makes a specialty of mixed cars, and handles a wide variety of hardwoods. The mills are equipped with machinery of the latest and most approved type, and shipping facilities are excellent. The yards cover sixteen acres of ground, with 3,500 feet of



A GENERAL VIEW OF THE EXTENSIVE HARDWOOD YARDS AND M.



## HARDWOOD RECORD



SAWMILL, KENTUCKY LUMBER COMPANY, WILLIAMSBERG, KY



PLANING MILL, KENTUCKY LUMBER COMPANY, WILLIAMSBERG, KY.

trackage. They are located between the tracks of the C. H. & D. R. R. and those of the Big Four and B. & O. Southwestern.

### The M. B. Farrin Lumber Company.

Prominent among Cincinnati's great lumber concerns is the M. B. Farrin Lumber Company, a large producer of ash, chestnut, cypress, poplar, oak and gum, and of "Century" oak flooring. The present company, consisting of M. B. Farrin, president; William B. Hay, vice-president; and W. J. Eckman, secretary, was organized in January, 1901, succeeding the M. B. Farrin Company, a concern which had been in the field for more than twenty years.

The company's plant covers about nineteen acres of ground, alongside of which runs a half mile of railroad siding. The equipment is strictly up-to-date in every particular. In fact, it has been the company's aim to maintain a model plant, in which is installed every approved appliance for manufacturing flooring, siding and finish. The grounds are enclosed with neat fences, the buildings are large and admirably arranged and the office building is a substantial structure of pressed brick.

The planing mill is 450x70 feet, with a capacity of 100,000 feet of poplar and 35,000 feet of oak flooring a day. The warehouse, 650x50 feet in dimensions, carries an average stock of 2,000,000 feet of oak flooring, and 1,000,000 feet of poplar for export. The dry kiln is of concrete, with a capacity of 800,000 feet. It is of special design, all lumber being dried by moist air, remain-

ing in the kiln from five to six weeks, and emerging in perfect condition. The company also kiln-dries poplar and hardwood for the trade. The poplar beveled siding sheds, 20x800 feet, carry an average of about 3,000,000 feet of poplar beveled siding at all times. The main part of the yard is paved with brick. The power is supplied by a 600 horsepower Corliss engine. There is a baled shaving factory with a capacity of 1,000 bales per day. Immense electric dynamos furnish light throughout the plant.

The company makes a specialty of expert stock and cabinet lumber, handling poplar, oak, chestnut, ash, walnut and cherry. About 40,000,000 feet of poplar alone is handled. A stock of approximately 15,000,000 feet is carried at all times. The company operates at Valley View, Ky., on the Kentucky river, two modern band mills. The "Century" oak flooring manufactured by this concern is well and favorably known and finds a ready market in all parts of the United States and Europe. Recently a single order from London called for five carloads.

### Mowbray & Robinson.

The firm of Mowbray & Robinson, composed of two thoroughly experienced lumbermen, F. W. Mowbray and E. O. Robinson, is a foremost member of Cincinnati's hardwood fraternity. Mr. Robinson was for fifteen years superintendent for C. Crane & Co. Mr. Mowbray began his lumber career with C. H. Brownell, at Peru, Ind. Later he was employed by the Union Planing Mill

Company, of Chicago, where he remained for two years, leaving to accept an important position with C. Crane & Co., of Cincinnati, where he remained nine years. In April, 1901, the Mowbray, Robinson & Emswiler Company was established, which continued successfully for four years, when it was reorganized and the name changed to Mowbray & Robinson.

Three yards, within a stone's throw of the general offices, along sidings of the Big Four and the B. & O. R. R., are operated by this concern. Mowbray & Robinson deal in all kinds of hardwood lumber, making specialties of oak, poplar and ash, and approximately 30,000,000 feet of hardwood lumber is handled yearly. The three yards contain normally about 3,500,000 feet of hardwoods.

### The Kentucky Lumber Company.

The latest acquisition to Cincinnati's hardwood contingent is the Kentucky Lumber Company, whose general sales offices were until recently located at Burdette, Ky. The offices were moved to the Queen City the first of the year, and now occupy a commodious suite in the First National Bank Building. The Kentucky Lumber Company was incorporated in 1884, and had then been operating for twenty years. It is one of the oldest lumber concerns in the country.

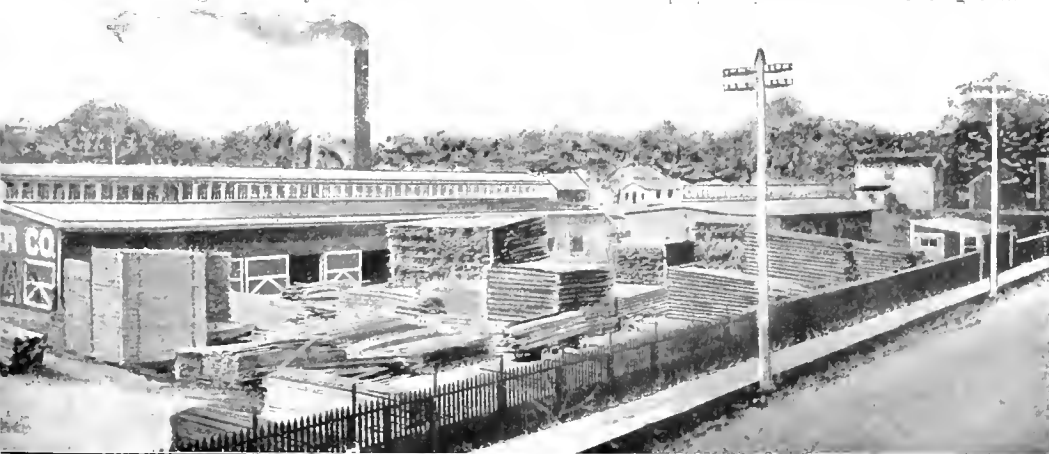

THE FARRIN-KORN LUMBER COMPANY.



CHESTER F. KORN, SECRETARY AND TREASURER, FARRIN-KORN LUMBER COMPANY.



VIEW PART GREAT PLANT, M. B. FARRIN LUMBER COMPANY

The concern operates two mills, one at Burnside, Ky., and one at Williamsburg, Ky. A few years ago the Williamsburg sawmill and planing mill burned. This was a large institution, practically four good-sized mills under one roof. Its capacity was 150,000 feet per day. The mill which replaced it is smaller, but more modern and convenient. It is one of the finest mills in the South. The Burnside mill was destroyed by fire in 1897, but was rebuilt at once. It has a capacity of 90,000 feet daily. The Williamsburg plant is located on the Cumberland river, and the Burnside plant at the junction of the Cumberland and the Big South Fork rivers. Both of these waterways tap the company's main timber holdings. In addition to these mills the concern owns and operates a mill at Haversham, Tenn., a modern bandmill of 30,000 feet daily capacity, cutting poplar and oak exclusively.

The officers of the company are Charles Minshall, president and treasurer; J. H. Keyes, vice-president and general manager. These two gentlemen live at Terre Haute, Ind., and are not active in the management



M. B. FARRIN, PRESIDENT M. B. FARRIN LUMBER COMPANY

of the business. Ralph McCracken is head of the sales department, and although only twenty-six years of age, has remarkable ability along this line. He knows the lum-



UNLOADING DOCK AND DRY KILNS, M. B. FARRIN LUMBER COMPANY.

ber business as a veteran lumberman, and handles the entire selling end of this large institution very creditably. The milling operations are under the able supervision of W. E. Delaney. Secretary George P. Wood lives at Louisville.

The annual output of the company is about 30,000,000 feet. In addition to the general offices at Cincinnati a large plot of ground has been leased at Sixth and Burnside streets, where yards will be established, stocked with a well-assorted line of hardwoods. The Kentucky Lumber Company handles all kinds of hardwood; oak and poplar are its specialties.

#### Duhlmeier Bros.

In 1898 C. E. Duhlmeier and his brother, W. F. Duhlmeier, organized the firm of Duhlmeier Brothers, which is well and favorably known to users of hardwoods practically the world over. These energetic young men have increased the volume of their business year by year, and the story of their progress makes a good-sized chapter in lumber history.

The firm's yards are located on a siding of the C. N. O. & T. P. R. R. fronting on Wade street and extending to McLean avenue. Plan and quartered oak, poplar, ash, hickory, chestnut, birch, mahogany, basswood, walnut, cherry and maple are the woods handled by this concern. The stock averages about 1,500,000 feet. The total sales last year approximated 20,000,000 feet. Besides the yards in Cincinnati, Duhlmeier Brothers operate seven yards in various parts of Ohio, Kentucky and Tennessee, carrying a stock of 5,000,000 feet in Tennessee alone.

#### The Freiberg Lumber Company.

Although but twenty-seven years of age, Harry A. Freiberg carries upon his shoulders the responsibilities of one of the greatest lumber enterprises in Cincinnati. This necessarily means that, although young in years, Mr. Freiberg is a lumberman par excellence, and what he is today is the result of his own thrift, energy and far-sightedness. He has been engaged in the lumber business ever since he left school. His lumber training was acquired with the R. E. Beek Lumber Company, which business has been controlled by the Freiberg Lumber Company since February of this year. When



INTERIOR OAK FLOORING WAREHOUSE, M. B. FARRIN LUMBER COMPANY.

Mr. Freiberg first entered the employ of the Beek Lumber Company he saw the way the wind was blowing and laid his plans carefully to fit himself for the work he proposed to do. Long after the employees had gone home for the night, this young man pored over his Spanish and various works on business methods. Mr. Freiberg now speaks Spanish fluently, which gives him the greatest advantage in dealing with the mahogany timber growers of Mexico. For a number of years he was a heavy stockholder in the R. E. Beek Lumber Company, and he took over the business at the beginning of the year, organizing the Freiberg Lumber Company, with himself president, and William E. Shampton, a lumberman of wide experience, secretary and treasurer. The company operates one of the largest yards in Cincinnati, occupying an entire square on McLean avenue, bounded by Poplar and Dalton streets, on a siding of the C. N. O. & T. P. R. R. The company carries a large stock of fine imported and domestic hardwoods at all times.

Tabasco mahogany, walnut, quartered oak



WILLIAM B. DAY, VICE-PRESIDENT M. B. FARRIN LUMBER COMPANY.

and Indiana white oak are the products of the concern. Mr. Freiberg goes into Mexico himself and buys Tabasco logs direct from the cutters, shipping it from all parts of

Laguna, Frontera, Santa Ana and Tabasco via Mobile, to Cincinnati. The company operates one of the most up-to-date millage mills in the country, sawing only the



O. E. ROBINSON, MOWBRAY & ROBINSON.

highest class Tabasco wood, which is famous for its hard texture, good color and excellent figure.

**The Farrin-Korn Lumber Company.**

The spacious plant of the Farrin-Korn Lumber Company, with its convenience and excellent facilities for handling lumber, is well-nigh perfect. The company prides itself on its model plant and neat, well-kept yard, which is said to be the largest city yard in the United States. The office building is a model structure of pressed brick, and the various departments are especially arranged with regard to their peculiar needs. Every contrivance, both steam and electrically driven, that will facilitate the work, has been added. Trained specialists are employed in every department, and although the office force is like one large happy family, the strictest order and system is maintained.

Some idea of the magnitude of the business may be gained by the knowledge that

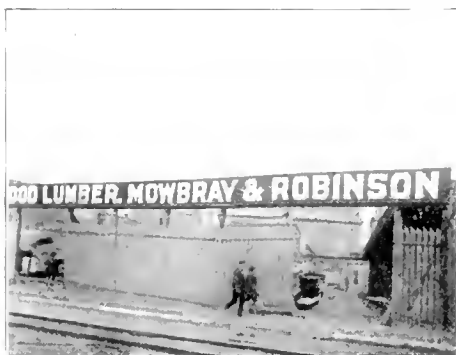

FRONT OF MOWBRAY & ROBINSON'S YARDS

in the neighborhood of thirty cars of lumber a day are handled in and out of this plant. The company operates one of the most modern and best equipped planing and

woodworking plants in the country. Its specialties are eypress, red gum and oak. Various agencies are maintained throughout the South and the buyers and inspectors from these agencies are constantly touring the timber sections of the country. Salesmen cover the trade east of the Mississippi and north of the Ohio rivers, including the eastern and New England states. The policy is to cover the field thoroughly, keep well posted, and so far as possible establish desirable connections of a permanent nature at both the buying and selling ends of the line. A branch purchasing office is located in the Randolph building, Memphis.

Speaking for his company recently, Chester F. Korn, secretary and treasurer, said: "Our location is admirably adapted to receiving, storing and reshipping lumber consigned to us by southern mills. From some localities lumber can only be shipped at certain seasons, owing to weather conditions, bad roads, suspended navigation, car famine, etc., therefore rendering it advisable to forward to some central distributing point from whence orders may be promptly executed any day in the year. Lumber for quick delivery sells at a premium, and when lumber is here on consignment it is always subject to shipper's instructions in case an order is obtained that will fit the stock before we find a customer. We prefer that the consignors place a price limit on their stock, but in the absence of this we will dispose of same to the best advantage, immediately remitting proceeds, less our brokerage, which is uniformly five per cent selling commission on delivered cost of the lumber, and two per cent for cash on amount remaining due after deducting freight, handling charges, etc. We pay the freight, deducting same from proceeds, and by special arrangement we also make liberal cash advances on consignment, charging at the rate of eight per cent interest. Upon receipt of telegram followed by full particulars by mail, accompanied by bill of lading, we will take care of any shipment in dispute wherever located, and adjust or re-sell to the best advantage. In case of necessity we will procure the services of licensed inspectors. We make a specialty of milling in transit for out of town concerns which desire to stop off cars at our place to be re-manufactured. We want our customers to feel that all our facilities, yards, mills, machinery, organization, money, experience and brains are at their service."

**John Dulweber & Co.**

The firm of John Dulweber & Co. succeeded in 1885 the firm of Bungener & Co. The late John Dulweber was interested in the firm of Bungener & Co., which dates back to the sixties. After the death of B. Bungener, the business was continued by John Dulweber under the title of John Dulweber & Co. until 1897, when his son, B. F. Dulweber, took up the active management. The business is still conducted under the style of John Dulweber & Co., although B. F. Dulweber is the sole owner and manager.

The name of Dulweber is known wherever lumber is known. It has seen the development of the lumber business from the crude and unsatisfactory methods of forty years



F. W. MOWBRAY, MOWBRAY & ROBINSON.

ago, through all the various stages, to the high state of efficiency of the present day. It has weathered the storms and famines, and has reaped a harvest. It has seen thousands come and go, some falling by the wayside, others retiring from choice, but it is still in the field and promises to remain. In a financial way it has been successful. Being very conservative, its success has not been spectacular, but has been sure, gaining steadily year by year.

John Dulweber & Co. handle a large variety of hardwoods, giving particular attention to oak, poplar, chestnut and walnut.

**The Cypress Lumber Company.**

The Cypress Lumber Company was organized seven years ago and has become a large factor in Cincinnati's lumber trade. The company maintains yards at Cincinnati with an average stock of 8,000,000 to 10,000,000 feet, besides shipping direct from its mills. Its specialties are oak and cypress. The offi-



VIEW WITHIN ONE OF MOWBRAY & ROBINSON'S YARDS

cers of the company are: S. Tuthill, president; J. Ernest Tuthill, secretary treasurer.

**L. W. Radina & Co.**

One of the substantial, rapidly growing



MILL AND LOG YARD, K & P LUMBER COMPANY

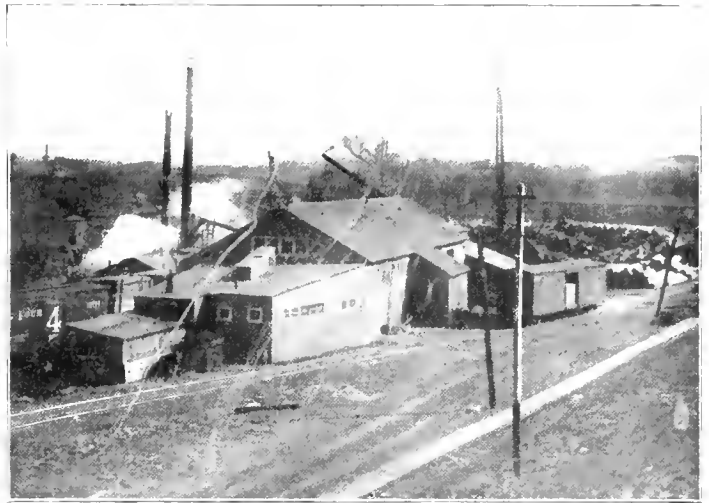

ALLEY IN WALNUT YARD, K & P LUMBER COMPANY.

lumber concerns of Cincinnati is L. W. Radina & Co. The yards, located at Clark and Dalton streets, are 360x120 feet in dimensions, and are constantly supplied with well assorted stocks of hardwoods. The company is composed of L. W. Radina and his brother F. E. Radina, who organized the concern in December, 1898. Both are energetic and persevering men, and have succeeded in increasing the business since that time until at present an average of 10,000,000 feet of hardwoods is handled by the company yearly.

**Cincinnati Hardwood Lumber Company.**

Ferdinand Bosken, with two score years' experience in the lumber business, and Joseph Bosken, his brother, hardly less efficiently equipped in that direction, combined working forces some four years ago and organized the Cincinnati Hardwood Lumber Company. They started in a small way, as business increased enlarging their capacity and adding to their capital, until today the concern has one of the most profitable businesses in Cincinnati. The company operates a veneer plant with a capacity of 50,000 feet daily. Four buildings, with new and modern equipment, comprise this plant. The company's large yards on a C., H. & D.

siding on Summer street, just north of Gest, carry a stock of about 1,000,000 feet of hardwoods at all times. The company ships



T. B. STONE, PRESIDENT T. B. STONE LUMBER COMPANY

approximately thirty cars of lumber a month, besides supplying a large local trade.

**The E. E. Beck Lumber Company.**

The E. E. Beck Lumber Company is not an old concern, but it is one which has forged its way to prominence during the first year of its existence. E. E. Beck, president, is still a young man. He received his training with C. Crane & Co. Secretary W. J. Pugh is a thoroughly experienced lumberman, as is also Vice President Charles B. Stevenson. The E. E. Beck Lumber Company maintains Cincinnati yards, but operates principally direct from the mills, handling all kinds of hardwoods, making specialties of poplar and chestnut.

**The K. & P. Lumber Company.**

The K. & P. Lumber Company derives its name from its two moving spirits, Max Kosse, president, and J. N. Penrod, vice president and treasurer. Its other officers are S. F. Prouty, secretary, and P. D. Shoe, assistant secretary. The company started in business Nov. 1, 1899, at first handling only walnut logs for export, with an occasional carload of walnut lumber. Business gradually increased, and in the summer of 1901 the company opened a yard in St. Bernard, a suburb of Cincinnati, and early in 1902 installed a sawmill on the premises. This was a circular mill, and in the summer of 1902



OFFICE AND CORNER OF YARDS, DUHLMEIER BROTHERS.



PRINCIPALS OF DUHLMEIER BROTHERS IN THEIR GENERAL OFFICE.

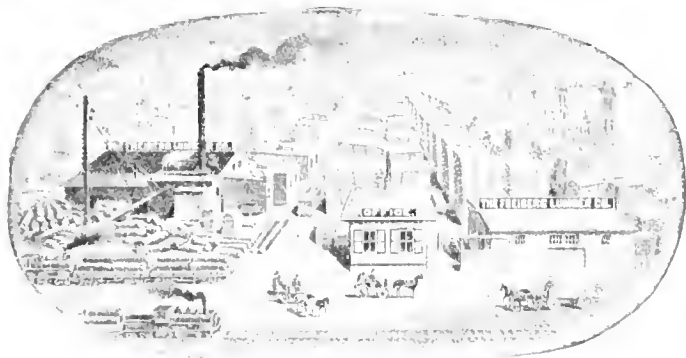

GENERAL VIEW OF PLANT, FREIBERG LUMBER COMPANY.



CARGO MEXICAN TARASCO LOGS AT CINCINNATI MILL, FREIBERG LUMBER COMPANY.

it was replaced by a band mill, and this a year later was replaced by a larger one. Last year the company purchased a large boundary of virgin timber in eastern Kentucky, consisting principally of white oak and yellow poplar, with some very fine ash and hickory. The larger prime logs are brought to the Cincinnati mill to be manufactured. The others are being cut on two circular mills which have been installed on the timber property. The K. & P. Lumber Company makes a specialty of white oak and walnut, in both of which it does a large export as well as considerable domestic business.

**The Pease Company.**

The Pease Company is known to the trade as one of the largest manufacturers of building materials, doors and interior finish in the country. The house was organized in 1893 with C. H. Pease, president, G. M. Paine, vice president, and H. W. Brock, secretary. The company's warehouses cover three and a half acres of ground, comprising 180,000 square feet of floor space. The wood work factory, utilizing fifteen acres, contains 200,000 square feet of floor space. The company has excellent shipping facilities, and makes and jobs all kinds of building materials.

**Leland G. Banning.**

Leland G. Banning is one of Cincinnati's most prominent lumbermen. Mr. Banning has been in the business for more than a score of years, and has in that time gained for himself and his associates an enviable reputation. As a jobber he controls the output of some half dozen mills in the South. In addition to shipping direct from the mills, he maintains a yard in Cincinnati

at Eighth street and McLean avenue, where he carries at all times a large stock of all kinds of hardwoods. He makes specialties of mahogany and quartered oak.

**T. B. Stone Lumber Company.**

The T. B. Stone Lumber Company occupies an enviable position in Cincinnati's hardwood trade. Thomas B. Stone, presi-

dent of southern hardwoods, operating large mills near Knoxville, Tenn. Two yards are maintained in Cincinnati, one at Hopkins and Dalton streets, the other at Liberty and McLean avenue. One yard is for oak and ash exclusively, and the other for poplar, basswood, chestnut and gum. The mill capacity is between 75,000 and 100,000 feet per day.

T. B. Stone has been continuously in the lumber business in Cincinnati for over thirty years. Will Stone has taken an active part in the business since 1898. Four years ago the firm of Stone & Hinekley was organized as a selling agency to handle yellow pine for the T. B. Stone Lumber Company.

**The Maley, Thompson & Moffett Company.**

The house of Maley, Thompson & Moffett was established many years ago in Dayton, O., as a copartnership, and operated a single band mill at that point for some years. About ten years ago it was moved to Cincinnati, and the mill plant reerected at the corner of Eighth street and McLean avenue. A few years afterward the copartnership was changed into a corporation, organized under the laws of Ohio. From time to time the business has been expanded until it now comprises a complete sawmill and dimension mill, and a veneer plant, which is located at the corner of Eighth and Evans streets, Cincinnati. Besides this, the company has a large sawmill and dimension plant near Delhi, O.; a similar institution in western Kentucky, and an extensive plant operating exclusively in mahogany in the city of Havana, Cuba.

This company has in its veneer plants a complete outfit of slicers, rotary machines



W. W. STONE, SECRETARY T. B. STONE LUMBER COMPANY.

dent of the concern, is a veteran lumberman, and he is training his son Will to follow in his footsteps.

The T. B. Stone Lumber Company was organized some ten years ago with T. B. Stone, president, and W. W. Stone, secretary. It manufactures and jobs all kinds

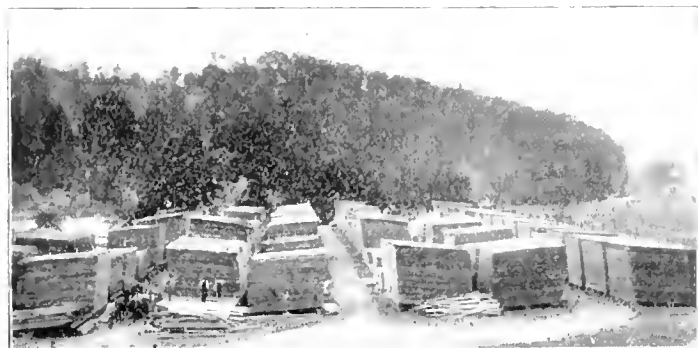

KENTUCKY LUMBER YARD, E. E. BECK LUMBER COMPANY.



KENTUCKY LOG YARD, E. E. BECK LUMBER COMPANY.



and veneer saws, and produces large quantities of high-class quartered oak, mahogany, black walnut and other hardwood veneers. The Havana end of the enterprise is operated by the company under the name of



L. W. RADINA, L. W. RADINA & CO

Moffett, Robbins & Co., but the entire output is sold through the Maley, Thompson & Moffett Company's general offices at Cincinnati.

The enterprises noted are owned entirely by and under the direct management of Thomas J. Moffett, who is president and treasurer, and E. W. Robbins, vice president and general manager, of the parent company. The Maley, Thompson & Moffett Company has a large yard and warehouse at 424 East Thirty first street, New York City, where it carries a complete assortment of veneers, mahogany and American hardwoods. It does a large domestic business in all parts of the United States, and has also been engaged in the export trade for many years. Its goods are sold extensively in Great Britain, continental Europe, Scan-

dinavia, South America, South Africa and New Zealand. The company's specialties comprise a complete line of sawed, sliced and rotary cut veneers of all woods, Cuban mahogany, Indiana quartered white oak, black walnut, ash, hickory and poplar. It goes without saying that the Maley, Thompson & Moffett Company is one of the foremost institutions of its kind, not only in Cincinnati, but in the United States.

**Important Wisconsin Deal.**

The Forster-Whitman Lumber Company is a new concern which has purchased from the F. P. Hiles Lumber Company of Milwaukee the entire village of Hiles, Wis., a large farm and its stock, logging outfits, logging railroad, with 25,000 acres of fine hardwood timber land. About \$500,000 was involved in the transfer. The property includes one of the largest timber tracts in northern Wisconsin. The village of Hiles was founded five years ago by F. P. Hiles. It contains two sawmills, a shingle and lath mill, a planing mill, a stove mill, a hotel, thirty cottages and a store, with a complete stock of general merchandise. On the farm are 100 head of cattle and fifteen horse teams. It is estimated that it will take about fifteen years to clear the timber tract.

**Car Stake Conference at Pittsburg.**

It will be remembered that immediately following the convention on the car stake and equipment matter held in Washington a conference was held between representatives of the railroad companies and of the lumber interests, which resulted in the appointment of a subcommittee of eight, four from each of the parties in interest. This subcommittee of eight was authorized to consider all designs and plans which might be submitted to them for permanently equipping cars and to make and offer any designs which might suggest themselves to the committee. At their meeting in Chicago, March 22, several plans were presented, and after considering the question of permanent stakes in all its bearings they resolved to recommend to the full conference committee of fourteen that a telescopic stake for gondola cars seemed to be both feasible and practicable, and to further recommend that a certain number of cars be equipped with these telescopic stakes for the purpose of demonstrating whether or not such stakes would answer the purpose for which they were intended.

The full committee met at Pittsburg April 12 to receive the subcommittee's report. The re-

commendations above named were unanimously adopted and the subcommittee authorized to have equipped sixty gondola cars with telescopic stakes on the Pennsylvania, New York Central, Illinois Central and such other railroads as might be selected.



LELAND G. BANNING.

The question of permanent equipment of flat cars was discussed at the Pittsburg conference, and the sense of the meeting seemed to be that a certain number of cars should be equipped with movable stakes which could be provided with boxes underneath the cars for holding them. This question, together with one or two other plans, was referred back to the subcommittee with directions to report the result of their further investigations, so that the situation in brief is that the two parties in interest have agreed upon a stake which seems to be worthy of full investigation as far as gondola cars are concerned, and the experiments for the test of this stake will be made forthwith.

L. P. Noble & Co. of Cincinnati are erecting a band sawmill at Pisgah, Ala. The company will also erect a planing mill at Hollywood, Ala., to manufacture window casings, doors and other finishing material. It will draw its timber supply from 5,000 acres of hardwood timber lands. A ferry boat service will be operated on the Tennessee river to effect delivery of lumber and other products to the railroads.



B. F. DULWEBER, JOHN DULWEBER & CO.

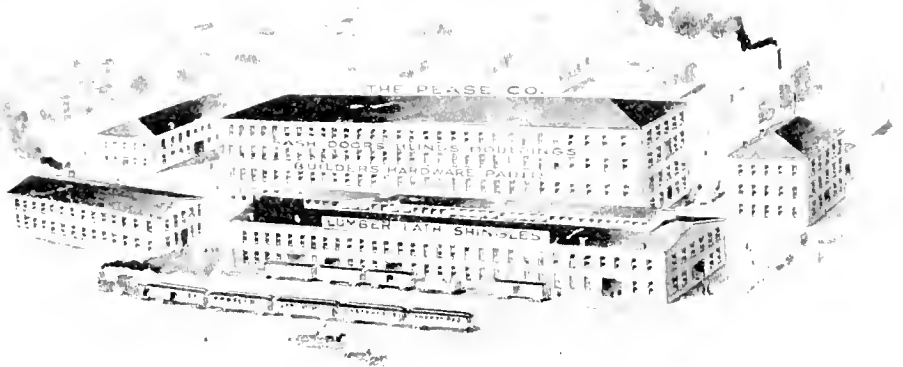

GENERAL VIEW GREAT BUILDING MATERIAL PLANT OF THE PEASE COMPANY.

# Development in Product of a Great Detroit Institution

There is no concern in the United States so well known to users of logging cars, car trucks and railway supplies for lumbermen, as the Russel Wheel & Foundry Company of Detroit, Mich. The Russel log car has become the standard of the country, and all other log-

gies in the state of Michigan. Among its specialties is the building of steel lighthouses for the United States government. Visitors are often amazed to see an immense lighthouse erected in the company's yards. These structures are then taken down and shipped to var-

iously hold the load in place; which by no chance could be misplaced, and which could be tripped only from the opposite side from which the loads would be discharged. There is scarcely a logger in the country who will not appreciate this appliance, as it precludes the possibility of injuring men, effects economy in both loading and unloading, and is absolutely secure. Back of these recommendations is the guarantee of the Russel Wheel & Foundry Company that every device it puts on the market is the best of its kind.

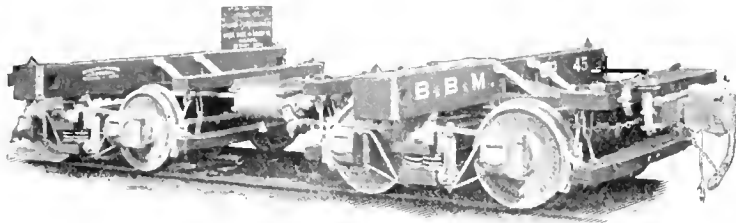

STANDARD LOGGING CAR, MANUFACTURED BY THE RUSSEL WHEEL & FOUNDRY COMPANY

ious railroad equipment is gauged by the high state of efficiency that has been attained by this company. This institution, great as is its plant, has developed business to such an extent that its manufacturing equipment, occupying many acres of ground, became inadequate during the past year and it has been necessary to practically double the size of structures and output. For months past the company has been obliged to refuse hundreds of orders for various products, but it is now rapidly getting in shape to fully care for its augmented business. While in the lumber trade this house is chiefly known for its logging cars, it also produces a vast amount of structural iron work of many descriptions, being the largest manufacturer in this line

of points where Uncle Sam furnishes beacon lights for his sailor men.

For several years past the Russel Wheel & Foundry Company has spent a great deal of money and time in perfecting a holder for car stakes which would facilitate rather than retard the loading of logs; which would sim-

ply hold the load in place; which by no chance could be misplaced, and which could be tripped only from the opposite side from which the loads would be discharged. There is scarcely a logger in the country who will not appreciate this appliance, as it precludes the possibility of injuring men, effects economy in both loading and unloading, and is absolutely secure. Back of these recommendations is the guarantee of the Russel Wheel & Foundry Company that every device it puts on the market is the best of its kind.

Another appliance now being manufactured by this company is a new type of skidding tongs which is made with three prongs for small logs and four prongs for larger logs. Just a glance at the illustrations accompanying this article will convince any practical logger of the utility and superiority of these tools over any others. The harder the pull, the tighter the tongs grip the log. The form in which they fold renders them easily portable on returning for the next log or logs to be pulled.

Besides these minor appliances the Russel

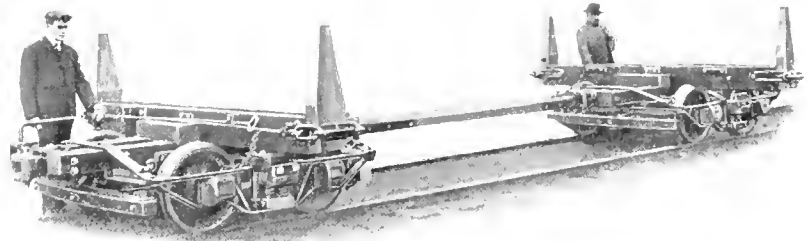

LOGGING CAR FTTED WITH RUSSEL TRIP STAKE HOLDERS

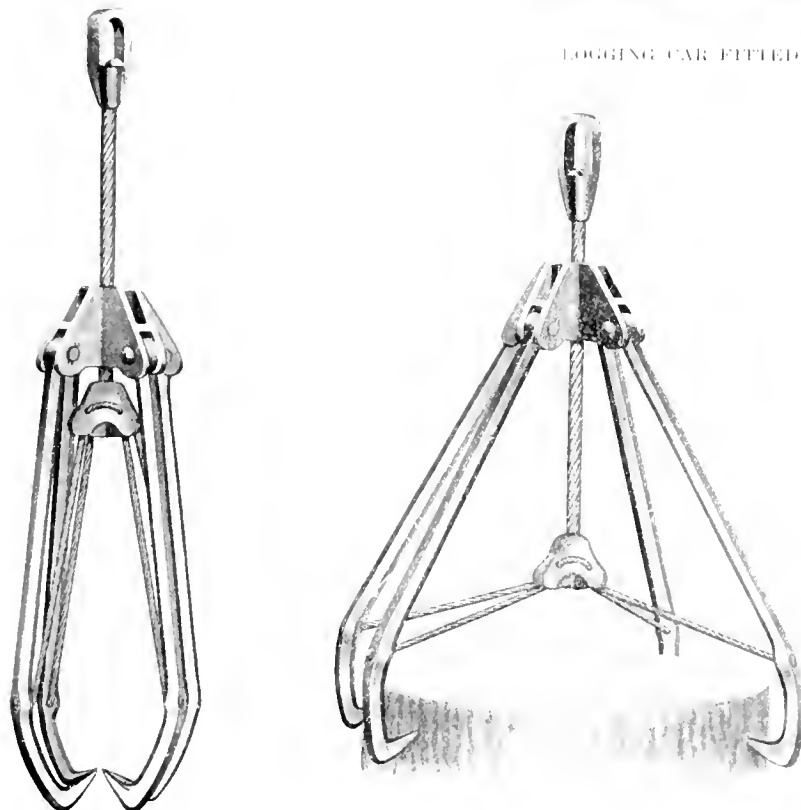

Closed.

Open.

RUSSEL FOUR PRONG SKIDDING TONGS

Wheel & Foundry Company is about ready to put on the market a full equipment of logging machinery, including donkey engines for skidding and loading, as well as high class, self-propelling combined skidders and loaders.

A larger illustration of the new Russel trip stake holder will be found in the company's advertisement in this issue of the *Hardwood Record*. The Russel Wheel & Foundry Company will be glad to supply particulars concerning machines or appliances adapted to any logging or log transportation problem that lumbermen may have presented to them.

### New Credit Rating Book.

The *Hardwood Record* is in receipt of the fifth volume (April, 1906) of the *Credit Rating Book* published by the National Lumber Manufacturers' Credit Corporation of St. Louis. Its contents, consisting of a classified list of capital and pay ratings of manufacturers, wholesalers and retailers of lumber, index of railroads operating in each state, list of factories buying lumber in carload lots, etc., makes it one of the most valuable books of the kind ever issued. No pains have been spared to make it a complete and accurate reference work. The information on which the ratings are based has been obtained from reliable sources, and is as conservative as possible, consistent with each case. The arrangement of the book is excellent, the facts being given in concise form and easily accessible.

## Hardwood Record Mail Bag.

[In this department it is proposed to reply to such inquiries as reach this office from the HARDWOOD RECORD clientele as will be of enough general interest to warrant publication. Every patron of the paper is invited to use this department to the fullest extent, and an attempt will be made to answer queries pertaining to all matters of interest to the hardwood trade, in a succinct and intelligent manner.]

### President Palmer's Position on Westbound Lumber Freight Rates.

LAMOREAU, KY., April 12. Editor HARDWOOD RECORD: In reading the report, contained in your issue of the 10th inst., of the meeting of the Wisconsin Hardwood Lumbermen's Association, held at Marshfield, Wis., on March 27, I note that the president of that organization places me in rather an unfavorable light before the trade with regard to my alleged position upon the question of securing a reduction in the existing rate upon hardwood lumber to the Pacific coast, and quotes certain extracts from a letter written by me in support of the assertion that I have been guilty of indifference toward a matter of much importance to the hardwood trade.

I regret that it is necessary for me to go into print in order to correct a misunderstanding with regard to my position on this question, that may obtain in the minds of those who have read the report of the Marshfield meeting, but I believe in justice to myself that the entire letter from which the extracts were quoted should be made public, that the trade may have an opportunity to judge whether the charge of indifference made by Mr. Arpin is or is not supported by the expressions contained therein.

The letter referred to was addressed to Mr. O. O. Agler, as chairman of the railroad and transportation committee of the Wisconsin Hardwood Lumbermen's Association, written under date of January 2 of the present year, and is submitted below.

"I have your favor of the 29th ult. inclosing letter from Mr. Arpin, president of the Wisconsin Hardwood Lumbermen's Association, extending a tentative invitation to the National association to cooperate in an effort to secure a reduction in the existing rates on lumber to the Pacific coast.

"This is certainly competent matter for our association, and in fact for all lumber associations, to carefully consider.

"While it is not my disposition to be a prophet of ill omen, I very much doubt whether the time is propitious to make such a demand. I am influenced to this opinion by reason of the fact that the western shippers have been recently denied a reduction to eastern points. If this denial has been made to those who are the veritable proteges of the railroads, it is quite likely that the eastern shippers in their present disorganized condition could hardly hope for better things. Then again, a reduction of 10 per cent has lately been made from the entire southeastern territory that is dominated by the Southern Railway system, which was only accomplished after a hard fight, and it is not probable that a further reduction would be considered from that territory at the present time.

"I hardly agree with Mr. Arpin that the railroads are in a conciliatory condition as a result of the recent rate agitation. They are thoroughly organized and I believe are standing pat. If rate regulation by the government is to come, they are going to wait for it, without discounting its effects by voluntary concessions in advance.

"While these are my views on the subject, they should not be construed by you or by Mr. Arpin as evidencing any unwillingness on my part to render all the assistance in my power to forward the movement suggested. Before beginning the movement, however, I should like

to see the ranks of the hardwood lumber trade closed up, so that we can present a solid front to the railroads and to all other industries that are now completely organized. It is sometimes disastrous to start upon a campaign with forces partially organized. Such an enterprise is likely to flash in the pan."

The statement made by Mr. Arpin that the South, having secured what it wanted in the way of a reduction to the Pacific coast, we of the South were now indifferent to the necessities of the Wisconsin lumbermen, carried with it a discordant and sectional note entirely out of spirit with the advanced commercial conditions of the day.

The territory to which I referred did secure a reduction, but it was only a reduction that placed its shippers upon a parity with all other eastern and northern shippers. That territory simply threw off the incubus imposed by the Southern Railway Company several years ago, which practically shut that portion of the South entirely out of the Pacific coast trade.

It would seem that when we are all placed upon an equal basis there is little of which to complain from a sectional standpoint.

EARL PALMER, President.

The editor of the HARDWOOD RECORD was present at the Marshfield meeting referred to, and according to his understanding of the discussion that prevailed concerning Mr. Palmer's attitude on the subject, there was no suggestion on the part of President Arpin that President Palmer was indifferent to the subject, and especially was there no comment of a sectional nature. However, it is a subject worthy of full and complete discussion, as it will only be through agitation of the matter that the transcontinental lines can be made to appreciate justice in the matter of westbound lumber freight rates as compared with its current rates on eastbound traffic.—Editor.

### Has His Nerve with Him.

About the richest piece of literature that has come to the attention of the HARDWOOD RECORD in a long time is a communication that was forwarded through the courtesy of the Swann-Day Lumber Company of Clay City, Ky., with the notation "How is this for a hot one!"

The letterhead is inscribed "John O. McMahon, Attorney and Counselor at Law, 32 Everson Bldg., Syracuse, N. Y. A specialty of corporation law and the promotion of lumber companies. Bargains in timber lands and lumber products. Machinery and enterprises bought and sold." The upper portion of the letterhead is devoted to the following solid chunk of edifying matter:

Dear Sir: Would you like to invest in the safest and most profitable of American enterprises, and in that greatest of American money-making machines, the manufacturing corporation? If so, then come in with us in the organization of a corporation to put together some bargains in machinery and timber lands and manufacture lumber, with ample capital to insure the best success.

I have enclosed a duplicate of our subscription paper which you can sign, with a statement of your address and the amount of your proposed investment and any additional conditions, as well, which you may wish to attach.

This subscription paper will convince you that there is no chance for hidden profits to dishonest promoters, since it is expressly provided that the timber lands and mill equipment are to be selected and acquired by the proposed company after the completion of its organization.

People wishing to sell timber or machinery will be willing to allow a ten per cent commission to the agent or promoter who creates the opportunity to sell. They will be willing to allow this commission when they will not be willing to reduce the price for any other purpose, so that the commission, taken care of for the promoter, will not, in any sense, be an expense to the investors; but will be his well earned compensation, in lieu of the hidden and usually enormous profits secured by the option promoters, at the expense of investors.

Every mill is nearly six months behind its orders, and the prices for lumber have doubled in ten years and are still advancing.

Rents are likewise advancing in all the cities and towns and there is a growing demand for new houses that must be built within the next few years regardless of the prices of lumber.

Numerous great lumber companies are operating in the South and Northwest making millions of every one of their larger investors. Their profits seldom fall below 100 per cent per annum upon their capital actively employed, and in many cases a single year's operation will pay for the plant and thousands of acres of timber as well.

It is a simple business to conduct. It is always easy to find similar successful operations elsewhere that can be imitated to fit every conceivable situation. The sawing of lumber is a simple operation and lumber sells itself at the mill, at the moment of manufacture, so great is its demand. Railroad rates for lumber are exceedingly friendly to distant mills. For instance, the rate from Arkansas to New York City is less than 40 cents per hundred and from Florida to New York about 30 cents per hundred, which is less than the rate on household furniture from Syracuse to New York City.

In my business of hunting up and bringing together the sellers and buyers of bargains in timber lands and second hand saw mill equipments I have found many sawmills in the Middle West and Northern states that have exhausted the timber in their vicinity and that can be bought and removed at great bargains, about one-quarter the cost of a new equipment. While timber lands near the railroads are held at a comparatively high price by speculators and because of the demand for them on the part of small operators, such a corporation as we are organizing, with ample capital, can run a switch back into the forests for a few miles and procure tracts of the most desirable virgin growth timber, hundreds of thousands of acres in extent, in numerous places in the South and Northwest for \$3 or \$4 per acre; lands which when cut off would be valuable for stock ranches; timber which in the state of New York would sell quickly for \$100 per acre.

Kindly investigate the truth of my assertions about the lumber business. Read about it in the magazines and newspapers, and then learn from experience of its profits by making an investment with us. Yours truly,

In the small remaining blank space of the letterhead below this document is the following letter, typewritten, which practically amounts to a confession of faith, and is as monumental a piece of nerve as is often encountered, even in a lawyer—or an imitation of one:

April 5, 1906.

Swann-Day Lumber Co., Clay City, Ky.

Gentlemen: I am entirely without practical experience in the manufacture of lumber, something that I find necessary in order to carry out my plans in "lumber" promoting.



I would like to learn something about the management of a large mill and its logging operations, and would like to gain the prestige of such experience and connections.

Will you make a place for me, for a few months, as an assistant (a sort of aid-de-camp) to one of your managers at one of your mills?

I will make myself useful to him in any way he finds desirable, and am sure that I can be of service in many ways.

I am not particular about the compensation; anything will do. Very truly yours,

J. O. McMAHON.

P. S. Do you want to buy any kind of a machine or engine, new or second hand? If so I can offer you a bargain.

J. O. McMahon must certainly be a peach!

#### Plain Rot.

The secular press is full of foolish literature about lumber affairs, but among the craziest stuff that finds its way to print are the fake records of the wonderful prices obtained for black walnut. It is alleged that black walnut has ceased to be of commercial importance in the United States and cannot be obtained in any quantity. Other would-be forestry experts relate how quickly black walnut timber can be grown into merchantable trees. The RECORD has a note from J. V. Hamilton, the well-known black walnut specialist of Fort Scott, Kas., enclosing a clipping from the "Boy's World," a youth's paper published in Chicago, which is very evidently without truth in any particular.

As a matter of fact, black walnut logs and lumber are produced in the United States to the extent of well toward 40,000,000 feet annually, the average remaining at about this stage for some years. The larger proportion of the wood goes into export, chiefly into Germany and France, although there seems to be a renaissance in its use for wood specialists, electrical work, and some lines of furniture, in this country. The price of walnut is not considerably greater than that commanded by first-class white oak. The item referred to is printed below:

Twenty odd years ago a Texas farmer who had moved south from Michigan planted on his new land the seedling of a black walnut tree. In time he died and the farm came into the possession of his daughter, who married. Her husband worked the farm and with her took good care of the tree, although neither of them thought it of much value.

One day in August, 1905, John F. Alcott, a lumber dealer of Chicago, driving through that part of Texas on a vacation trip, saw the tree and stopping at the house, asked:

"How old is that black walnut?"

"About twenty-six years, I think," was the reply of the woman of the house.

"What will you take for it?"

"We wouldn't think of selling it. It is a sort of family tree."

Some talk followed, and Mr. Alcott finally halted to wait until the man of the house came home. After much discussion with him he finally bought the tree, roots and all, for \$1,500. The next day he had it dug up and shipped just as it was on a flat car to Chicago. There it was taken into a mill and converted into wood for pianos, for veneers on desks and other ornamental purposes.

After all the expense of buying and handling the tree was paid, it yielded a profit of about \$1,500 to the lumber dealer.

The particular point in this story for the boy

who is making investments for the future is that it pays to plant and to keep a tree. It may not always be a black walnut tree, but it always can be a tree worth keeping and usually worth selling. Just invest a little of your boyhood energy and time in planting a young tree and so long as you are at home raising it.

#### To Aid San Francisco Lumbermen.

ST. LOUIS, April 19. Editor HARDWOOD RECORD: While it is too early to receive any detailed information regarding the lumbermen of San Francisco, they all have undoubtedly suffered greater or less loss, and it occurs to us that lumbermen throughout the country would be glad to have the opportunity of doing something for them. A mite from each would be of great moment to those who have and will for some time feel the effect of the great misfortune. If each firm in the lumber business, including retail, wholesale and manufacturing, would contribute \$10 or more as each saw fit, the total sum would be such an amount that it would be of material assistance to San Francisco lumbermen, the amount collected to be placed in the hands of a committee of three, say N. W. McLeod of St. Louis, R. A. Long of Kansas City and J. E. White of Grandin, Mo., to be prorated as loss sustained to amount invested, or on any other equitable basis. The San Francisco people will undoubtedly suffer a loss from earthquake and fire, both at their residences and business, and will also sustain losses of accounts through inability of their customers to pay on account of misfortune of the customers.

If you approve of the above, would suggest that you publish same with a view to ascertaining what others think of it. BONSACK LUMBER COMPANY.

## Suggestions to Small Sawmill Men.

### FIFTH PAPER

In the life of every active sawmill man, whether he operates a little portable mill or a mammoth institution, are incidents from which may be drawn pointers and suggestions of value in the study of ways and means to successfully conduct saw milling enterprises. Thus it is in order to turn from the discussion of mechanical things and glean a thought from the experiences of others.

There is one individual known to the writer whose experience might be of value to those who are working for better commercial returns from lumber manufacture. He operated a number of small mills, and had increased the number and pushed the output steadily for years on the theory that it was quantity and not quality that counted. Most of his product was ear material, railway ties, street car ties, bridge bills and other common stock. But one day he hired a new sawyer at one of his mills who proved to be a thinker as well as a worker, and in the course of events this sawyer gave him a pointer. They were edging up sidings, including one and two-inch boards, of which as many as possible were made of two-inch, because of a better sale for that size, when the sawyer called attention to the fact that some of these two-inch boards were clear stock and would make coupling poles for farm wagons. The operator was not very enthusiastic about the matter, but as he did not put much value on his siding anyway, he told his sawyer to go ahead and do as he

The HARDWOOD RECORD is pleased to give publicity to the above plan, and bespeaks for it the hearty cooperation of lumbermen all over the country. Correspondence on the subject may be addressed to the writer of the foregoing letter, W. A. Bonsack, or to N. W. McLeod, chairman of the above-named committee. Error.

#### Walnut Squares and Shorts.

The HARDWOOD RECORD is in receipt of the following letter, and the writer's address will be cheerfully furnished to prospective purchasers:

FORT WAYNE, IND. Editor HARDWOOD RECORD: We wish we could reach some customer for walnut squares and also walnut shorts, 1X3X20 to 36 inches in length, through your columns. We understand that the principal users of this stock at the present time are the Germans, and should be glad to know of some firm in Germany that is in the market, or better still, some American firm. — LUMBER COMPANY.

#### English House Wants Dimension Stock.

The RECORD is in receipt of a letter from Newcastle-on-Tyne, England, making inquiry for the addresses of reliable shippers of birch planks 2½ inches and upward in thickness; also of satin walnut squares and black walnut squares. Producers interested in this request may have the address of the inquirer by applying to the HARDWOOD RECORD.—EDITOR.

thought best with them. About a month afterward, when he found they had enough for a carload of this coupling pole stock, he undertook to sell it. This was in the earlier days, before common oak was worth much, and clear oak was not as high in price as it is now, but the price realized for this car of clear poles was more than twice what the lumber out of which they were made had been bringing.

This set the sawmill man to thinking that perhaps there were other things besides quantity to be considered, and he determined to keep his eyes open and see what he could find. In his meanderings he came upon a spoke factory one day which was in the market for good butt stock. He soon discovered that he could cut a spoke length or two off a white oak tree, have them split into spoke blanks, and realize more for them than if sawed into ties or other common stock. This proved to be some improvement, but not entirely satisfactory. Mr. Sawmill Man was ambitious and, having a little wanted more. So he cast about again, this time to the wagon factory where his poles had been sold. Here he found they needed other material in good oak stock, among other things bolsters. This stock he had always avoided, because ordinarily it is difficult to manufacture, requiring the best of logs and producing a discouraging quantity of culls even then. But he reasoned somewhat as follows: It would not be prac-

tical to cut this 3x4, 3 $\frac{1}{2}$ x4 $\frac{1}{2}$ , 4x5 and such squares 4 ft. to 4 ft. 8 in. out of the regular run of logs he was milling. His oak was what is called common oak, running rather small in size, but sound. Still, almost any of the trees even among the smallest would furnish a practically clear and extremely tough butt cut for one length of bolster and some of them for two.

To do work of this kind with the mill and its full crew was a problem, especially if the stock were to be handled haphazard just as it came along. The question resolved itself into either piling the short blocks back and waiting until there was enough for a day's run, or providing some independent means of working them up. He finally compromised by piling the blocks aside, not necessarily for a day's run, but perhaps an hour's run, or enough to save too much shifting of the head blocks of the carriage. All that was done with those blocks on the sawmill was to split in the middle all of moderate size, and to quarter the largest ones. Then he added to his sawmill equipment a form of small rip saw, commonly known as a bolter saw, and after the blocks were split they were turned over to one man who did the balance of the work of converting them into bolsters on this saw. It is not necessary to go into the details of the plan, as they would vary under different conditions, but the idea was to have only one man, or one man and a boy, do the work of sawing out the bolsters, and it was found that as much work was done under this plan as could have been done with the mill proper and done better.

The success of this undertaking inspired further undertakings on the part of this alert operator. He found that small pieces accumulated in making bolsters that might be worked into something else, and then he began to see in every scrap of timber about the yard a chance to make something in the form of small dimension stock. This took him back to the wagon factory, where he gathered up specifications for wagon bed cross bars, slide bars, stakes, double-trees and other dimensions. From time to time he added a new line of manufacture until he got a sort of craze for collecting specifications for small dimension stock from all sources, furniture, agricultural implement, wood novelty manufacturers, and from any and all users of hardwoods in small dimensions. It was not long before he had a most complicated line of manufacture; but keeping track of the different sizes was too trying for the average mind, and the man at the bolter saw spent more time studying specifications than he did sawing, and the more he studied and the more he worked, the more confused he became.

Finally they came to the conclusion that enough of a thing is enough and it is possible to get too much, even though it may be a good thing. Matters were simplified by selecting a few sizes at a time that would work fairly well together. All other

sizes were simply ignored until the orders for these few sizes were completed.

Now, there are several points to be gathered from the foregoing statements and the last is by no means the least. Many a man is cutting oak today and putting stock into car timber, ties and into other "sound and merchantable" sizes which might by a little care (that is, clear stock on the butts of the trees) be worked into material that would bring considerably more money, and at the same time not impair the general quality of the regular "common and merchantable" stock. There are different ways to convert the best part of the tree into a

high-class product, and there is a variety of products into which it can be made, all of which requires study and harmonizing with local conditions and the requirements of the accessible markets. There are two things that should not be lost sight of: First, that this class of material is worth more primarily than common stock and it costs more to manufacture, so that it should bring a good price; second, that in the cutting of small dimensions, while it is well enough to get acquainted with the requirements of a large range of trade in this line, it is not desirable to give too many different sizes and kinds at once to be cut by one man on one saw.

## News Miscellany.

### Program of Memphis Convention.

Following is the proposed program of the ninth annual convention of the National Hardwood Lumber Association to be held at the Gayoso Hotel, Memphis, Tenn., May 3 and 4:

#### THURSDAY, MAY 3.

9:30 a. m. Reception of members and guests in Convention Hall.  
10:30 a. m. Opening session.  
11:00 a. m. Reports of officers.  
Address by the president, Earl Palmer.  
Report of secretary, F. F. Fish.  
Report of treasurer, O. E. Yeager.  
Intermission for luncheon.  
2:00 p. m. Report of standing committees. Inspection, W. W. Knight, chairman. Rules, Theo. Fathamer, chairman. Forestry, M. M. Wall, chairman.

#### FRIDAY, MAY 4.

9:30 a. m. Members will reassemble.  
10:00 a. m. Meeting called to order.  
Consideration of reports of officers and committees.  
Introduction of new business.  
Intermission for luncheon.  
2:30 p. m. Members will reassemble in executive session.  
3:30 p. m. Election of officers and five directors to serve three years.  
5:00 p. m. Adjournment.  
5:30 p. m. Meeting of board of managers.

A banquet will be tendered the members of the convention by the Memphis Lumbermen's Club at 7:30 p. m. Friday evening at the Gayoso hotel.

As an impression that Memphis hotels will not be able to accommodate the delegates to the annual meeting seems to exist, the Lumbermen's Club of Memphis has issued an announcement stating that it will take pleasure in securing reservations of rooms for all who will send their requests to the hotel committee, consisting of John W. McClure and E. E. Taeizer. Requests can be forwarded to either member of the committee and will receive prompt attention.

The HARDWOOD RECORD acknowledges receipt of a very handsome engraved invitation to attend the convention, issued through Earl Palmer, president, and F. F. Fish, secretary.

### Charles A. Ward.

At 5:30 o'clock on Easter morning, at his home in Evanston, Ill., occurred the death of Charles Albert Ward, president of the Ward Lumber Company of Chicago, and widely known in lumber circles the country over. Mr. Ward was taken with pleuro-pneumonia but a few days before his death, which was thus a severe shock to his friends and family.

Charles A. Ward was born in Battle Creek, Mich., Oct. 11, 1849. His father was Joseph M. Ward, pioneer miller, merchant and banker, to whose memory the son had just completed a magnificent monument in the form of the new

Ward building at Battle Creek. After attending the public schools Mr. Ward entered the Racine, Wis., College, later joining his father in the conduct of an extensive grain purchasing and milling business in southern Michigan, with offices in their home town. In 1877 he removed to Port Huron, where he engaged in the grain business extensively. He founded the Commercial Bank of that city, of which he was president for twenty years, and a director at the time of his death. In addition to these interests Mr. Ward was secretary and treasurer of the Port Huron Elevator Company, treasurer of the Port Huron & Gratiot Electric railway, and vice president of the Port Huron & Northwestern railway. In 1894 he removed to Chi-



THE LATE CHARLES A. WARD.

ago and broadened his commercial affairs in many ways. At the time of his death he was president of the Ward Lumber Company of Chicago, vice president of the American Lumber Company of Albuquerque, N. Mex., and a director in the Bankers' National Bank of Chicago. In accordance with the wishes of Mr. Ward and others interested, the business of the Chicago concern will be continued along the same lines as heretofore, under the general management of Mr. P. Ford, who has for several years been associated with its president in a confidential capacity.

Although preferring the quiet of home to social life and publicity, Mr. Ward was a valued member of several clubs—the Athelstan of Battle Creek, the Evanston and Country Clubs of Evanston, Ill. In 1875 he was married to Miss Belle Hinman of Battle Creek, who, with one

daughter, Mrs. Laurence De Golyer of Evanston, survive him.

Funeral services were held April 15 at the Ward residence, and the following morning the remains were taken by special car to Battle Creek, where, after services at the old home, they were interred in Oak Hill cemetery.

The passing of Charles A. Ward removes from the community a true gentleman, a public benefactor and a capable financier. The death of the weakest and most insignificant among us is a sad, strange thing. But when a man in the prime of life, successful in business, beneficent toward his fellows, is taken away, the loss is irreparable, and the mystery too deep to fathom.

**Death of Major M. Spalding.**

On April 20, at Cadillac, Mich., occurred the death of Major M. Spalding. Mr. Spalding had been dangerously ill for some time, so that his death was not a surprise to his relatives and close friends. To the city of Cadillac it has brought the deepest sorrow, for he held a high place in the esteem and affection of the entire community.



MAJOR M. SPALDING, DECEASED

Mr. Spalding was born in Ann Arbor, Mich. June 16, 1851, and took up his residence in Cadillac twenty-four years ago, going there from Northville, where he was associated with the Michigan School Furniture Company. Since his removal to the former city, he has occupied an important post with the Mitchell Brothers Company, the great maple flooring concern. He was married August 31, 1881, to Miss Alice L. Jacklin of Detroit, who with three children, survives him. Funeral services were held at the Spalding home Monday afternoon, April 23, after which relatives and friends accompanied the remains to Detroit, for burial at Elmwood cemetery. The ceremony in Detroit was conducted by the Masons, Mr. Spalding having been a devoted Knight Templar and Shriner.

**Asheville Meeting Hardware Manufacturers' Association.**

The consolidation of the hardwood producers of western North Carolina with the Hardwood Manufacturers' Association of the United States is the object of an important meeting to be held at the Battery Park hotel, Asheville, N. C., May 5. At that meeting will also be discussed the various conditions in the lumber regions of this section of the state. Prominent manufacturers from various parts of the country will be present to participate in the convention.

In a recent interview at Asheville, Lewis Doster, secretary of the Hardwood Manufacturers' Association, said: "The Hardwood Manufactur-

ers' Association of the United States has 250 members and operates about 650 sawmills. It embraces the products of twenty-two states, representing an annual output of 1,350,000,000 feet of hardwood lumber. This organization was formed in June, 1902, with the object in view of effecting uniform methods of business dealing between the producer and the consumer, and for the purpose of studying the conditions existing in the different sections of production, and to effect measures which develop themselves by meetings of the various districts. It studies the comparative values of the different kinds of material being sold upon the market to avoid unnatural substitution, and in addition to this gives to all of the members the results of its work, together with statistics which at all times are of benefit for the sawmill man to know while he is developing his product.

"The most important bureau is the department of grades, which is composed of salaried inspectors located in the various consuming points for the purpose of inspecting shipments of lumber which are disputed as to the grade.

"Meetings similar to the one which will be held in Asheville have been held in other sections of the country where production is represented, and great interest is shown by operators for the purpose of protection."

**Ober Manufacturing Company.**

In a conspicuous place in the general offices of the Ober Manufacturing Company at Chagrin Falls, O., there stands a crude model of the first machine ever invented to make axe and other handles automatically. It is not much of a machine, judged from the standard of the new types now being sent broadcast throughout the civilized world by the Ober Manufacturing Company, but it is a sacred legacy from the late G. H. Ober, pioneer of the automatic handle manufacturing business.

It was just about the close of the civil war that Mr. Ober perfected his first model. It was a machine to make axe handles. Mr. Ober sent the model to Washington, where the merits of the invention were quickly seen, and in a remarkably short time letters patent were issued to the inventor. At this time Mr. Ober and his brother were operating a small saw and planing mill. The next invention proved a better one than they ever dreamed of. He and his brother found it impossible to keep pace with the orders they received for axe handles, and then it dawned upon them to manufacture the machines. Today the other machines are known throughout the world.

Two years ago the Ober Manufacturing Company was organized. The president is A. M. Ober, son of the original inventor. The plant

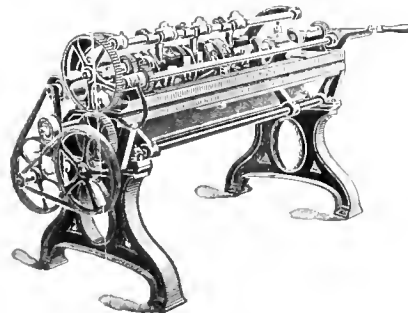

covers a considerable section of the town of Chagrin Falls.

The accompanying cut shows the No. 10 Ober lathe for turning fork, hoe, rake, mop, broom and ice hook handles, pike poles, trolley poles, tent poles, curtain poles, chair bows, dowels, rods and similar work.

**Miscellaneous Notes.**

The Ingersoll Handle Factory at Summit Hill, Pa., was recently destroyed by fire. The loss was about \$2,000.

The Acme Lumber & Manufacturing Company

has been incorporated at Mount Pleasant, Pa., with \$25,000 capital.

A broom factory, at an estimated cost of \$50,000, is to be erected in Louisville, Ky., by the Myers Bridge Company.

It is reported that the Bliss-Cook Oak Company of Blissville, Ark., recently suffered a \$100,000 loss by fire, fully covered by insurance.

The Owen Arnold Casket Company of Allegan, Mich., will soon enlarge its plant, as will also the Baines & Moiser Kitchen Cabinet Company of the same place.

The American Veneer Products Company is erecting a veneer mill in connection with its plant at Mishawaka, Ind. Other improvements are contemplated.

The Louisa Manufacturing Company, Louisa, Va., has been organized by James E. Porter, O. P. Bims, Jr., and John F. Sommers to manufacture lath, shuttles and hardwood novelties.

D. McCarley, Walter Smith, D. H. Shell and Fred Clarke are the principals in the new Alert Handle Company at Okolona, Miss. The factory will turn out cant hook handles and dimension stock.

The C. W. Allen Company of New Albany, Ind., has been incorporated to deal in hardwoods and floors; capital stock, \$4,000. The directors are C. W. Allen, L. O. O'Daniel and W. A. McLean.

The MacEachron Haven Lumber Company of Waterloo, Iowa, has changed its name to the Iowa Lumber Company. Its offices and hardwood yards were recently damaged by fire, but the buildings have been rebuilt and stock replenished.

Veneer panels will be manufactured by the Crandall Panel Company, recently organized at Brocton, N. Y., with a capital stock of \$30,000. Jay L. and Charles L. Crandall and Lester H. Skinner, all of Brocton, are interested in the enterprise.

The new plant of the New York Boat Oar Company, near the Atlantic Coast Line, at Cheraw, S. C., is about completed. James Wilsey of New York is manager. Ash is used in manufacturing the oars, and is supplied from timber along the Pee Dee river.

Charles W. Hagerman is president and general manager and Eugene B. Nettleton secretary-treasurer of the West Florida Hardwood Company, recently incorporated at Marysville, Fla., with \$35,000 capital stock. The officers are both residents of Philadelphia, Pa.

The Demopolis Coffin & Cabinet Company of Demopolis, Ala., will soon have its plant in operation. In addition to their regular line, they will manufacture fine cedar chests. Cedar abounds in that locality and the outlook for this industry is exceedingly good.

A spoke and handle factory is to be established at Bessemer, Ala. Robinson Bros., of Selma, have purchased the property and plant of the Krebs Manufacturing Company at Bessemer, which will be remodeled and equipped with all conveniences for the manufacture of handles.

The Core Hardwood Company of Charlotte, N. C., is purchasing persimmon and hickory timber for export to England. It is stated that, because the supply has been practically exhausted in that country, there is a great demand for this timber, which is used in the manufacture of high-grade golf sticks.

William E. Uptegrove & Bros.' veneer factory at Johnson City, Tenn., which has been idle for some time because of a shortage of logs, has resumed operations and is running full time with a large force of men. The company has on hand a sufficient quantity of logs to keep the mill running well into the summer months.

Harned & Quiggins of Caseyville, Ky., have secured a very convenient site at Dawson Springs, Ky., on which they will establish a plant to manufacture all kinds of wooden handles. The factory will be up to date in every particular. The Illinois Central will build a spur track from the main line to the factory premises.

John S. Owen of Eau Claire, president of the John S. Owen Lumber Company, already one of the largest land owners of Wisconsin, is negotiating a deal with George Earley of Chippewa Falls for an extensive tract of fine hardwood timber lands in Chippewa county. Undoubtedly, as the difference in price offered and asked is slight, the deal will be closed soon.

A hoop factory is to be added to the list of industries at Sycamore, O. William Shedenhelm of Tiffin has purchased the machinery and plant owned by L. Holmes, which has been idle several years but was operated only a few months. After a thorough overhauling the plant will be put in operation. Mr. Shedenhelm is an experienced hoop manufacturer and will undoubtedly meet with success.

Fred Herrick of Lac du Flambeau, Wis., with other Wisconsin capitalists, has purchased for \$600,000 the 50,000-acre tract of hardwood and yellow pine timber lands in the Pearl River valley, bought some months ago by Foley & Larson, the St. Paul capitalists, and formed the Interior Lumber Company, capitalized at \$500,000, with privilege of increasing this to \$1,000,000 at will. The company proposes establishing a large mill at Jackson, Miss., and building a road through the Pearl River valley for the purpose of developing these holdings.

Pittsburg and local capitalists have organized the Pittsburg & Southern Veneer Manufacturing Company and are planning the erection of a large veneer factory at Narrows, Giles county, Virginia. The site has been chosen, and R. H. Enoch of Pittsburg, who will be the general manager of the business, is on the ground arranging

for the immediate erection of the plant. The main building is to be 80 by 500 feet in dimensions and two stories high. The factory will be operated day and night, seventy-five men on the day shift and probably an equal number at night. The output of the plant will be about four carloads of veneer a day.

The Wolverine Manufacturing Company and the Cadillac Cabinet Company, both of Detroit, Mich., will establish a hardwood manufacturing plant at Memphis, Tenn. The companies referred to have purchased about three acres of ground and secured an option on more for the location of the plant, in which it is proposed to invest about \$10,000 at first. It is planned to begin work at once on a dimension mill to have a capacity of two carloads per day, the product to be used by the Wolverine Manufacturing Company and the Cadillac Cabinet Company in the manufacture of tables, cabinets, etc. George A. Blessed, Tennessee Trust building, Memphis, will be in active charge of the plant at Memphis, which is to operate as the Wolverine Manufacturing Company.

The Ferd Brenner Lumber Company has transferred its principal offices and yards from Chattanooga to Norfolk, Va. The company has for several years conducted a branch plant at the latter place, and from this time forth the entire business will be conducted through the Norfolk office, where all correspondence should be addressed. Ferd Brenner and Leland G. Hanning of Cincinnati, stockholders in the concern, will make a European tour together this summer, visiting the principal lumber markets.

## Hardwood News.

(By HARDWOOD RECORD Special Correspondents.)

### Chicago.

This office is in receipt of a communication from a committee consisting of W. A. Bennett, T. B. Stone, C. H. Pease, J. Watt Graham and C. E. Korn, acting on behalf of the Cincinnati Lumbermen's Club, announcing the candidacy of their fellow member, Thomas J. Moffett, for the office of president of the National Hardwood Lumber Association. The Memphis Lumbermen's Club announces the candidacy of William H. Russe for the same office. If the candidates are confined to these two distinguished lumbermen, the association cannot go far wrong in the choice of its next president at the Memphis meeting, May 3 and 4.

J. G. Leavitt of the Leavitt Lumber Company, this city, has just returned from a seven weeks' trip to the Pacific coast. The company reports business as excellent and the demand for oak still particularly strong.

Henry Ballou of Cobbs & Mitchell, Inc., Cadillac, Mich., was a Chicago visitor last week.

The HARDWOOD RECORD acknowledges receipt of the thirty-third annual special issue of the Timber Trades Journal of London, England. This number is exceedingly handsome and large and contains many special articles on a variety of subjects of interest to the lumber trade. Among them may be mentioned one on Canadian lumber camp life with portraits of prominent Quebec and Montreal shippers; on methods of felling, preparing and transporting Benin mahogany logs; another on "Mahogany as a Decorative Aid;" one on Scandinavian forests; the "Teak Trade of Burma;" the developing of woodworking machinery, etc. The number is full of handsome illustrations, and reflects great credit on its publishers.

The Lumbermen's Exchange of Philadelphia courteously acknowledges by a vote of thanks the copies of the HARDWOOD RECORD that are regularly supplied the association's club rooms.

The Southern Oak Lumber Company will be located in its new and handsome quarters, 910

Chamber of Commerce building, next week. The company is getting its new yard at North Memphis stocked with lumber, but it will continue to maintain its downtown office at 1217 Tennessee Trust building. Manager John D. Spaulding is dividing his time between the Memphis plant and Chicago headquarters.

J. L. Lane of the Lane-White Lumber Company, Fort Smith, Ark., was in town on April 13. Mr. Lane will continue his general sales office in the Stock Exchange building, but will spend most of his time at the Fort Worth plant.

Charles Colfin, ex-viceregent of the southern district of Indiana, is planning a floo-floo concatenation to be held at Evansville April 27. This will be the first concatenation that has been held in Evansville for several years. The prospects are good for a large class and a very successful meeting.

N. A. Gladding of E. C. Atkins & Co., Inc., Indianapolis, was in Chicago last week and paid the RECORD office a friendly call. Mr. Gladding has started out on another of his "grand tours" of the West to visit his company's branch offices.

C. H. Pease of the Pease Lumber Company, Cincinnati, O., called at the RECORD office while in Chicago last week.

Lewis Foster, secretary of the Hardwood Manufacturers' Association, is back at the Chicago office after an extended trip over a large portion of the hardwood district of the South.

The Danforth Picture Frame Company, Chicago, has been incorporated with \$20,000 capital. George Danforth, William Rukeberg and Percival Steele are the promoters of the enterprise.

H. E. Bacon of the Bacon-Nolan Hardwood Company, Memphis, paid the RECORD office a call a few days ago.

Charles H. Barnaby, of Greencastle, Ind., was in Chicago a few days last week.

A. C. Fuller, advertising manager of the Hanchett Swage Works of Big Rapids, Mich., paid the RECORD office a call a few days ago and left a copy of his first work for the Hanchett institution. It is a handsome illustrated catalog of

the complete equipment of automatic filing room machinery and saw fitting tools manufactured by the Hanchett Swage Works. As a specimen of catalog work, explaining in minute detail the features of the many appliances manufactured by the company, it is excellent. Copies of the work can be secured by addressing the foremost manufacturers of filing room machinery, the Hanchett Swage Works, Big Rapids, Mich.

The RECORD acknowledges receipt of a booklet from the John Schroeder Lumber Company, Milwaukee, in which are illustrated the various methods pursued in the manufacture of its famous "Steel Polished Perfection" hardwood flooring. This house makes a very high-class product of beech, birch, maple, red and white oak, plain and quarter-sawn flooring, and also on special orders produces walnut and cherry flooring for ornamental borders. The company will be glad to supply copies of the handsome little booklet on application.

The Morton Dry Kiln Company is out with a very handsome illustrated pamphlet entitled "The Morton Dry Kiln." Within its pages are many handsome pictures showing the superior methods of construction of its kilns, methods of piling lumber in the kilns, its roller bearing channel steel car bunks, steam traps, recording thermometers, canvas doors, etc. A list of users of the Morton system is incorporated in the book. Copies can be secured on request from the Morton Dry Kiln Company, 1328 First National Bank building, Chicago.

The Globe Mirror & Frame Works, 230 South Clinton street, this city, reports an increase in its capital stock from \$25,000 to \$50,000.

In addition to the district meeting of the Hardwood Manufacturers' Association, which is being held today at Greenville, Miss., a second meeting in the same interest will be held at New Orleans at the office of the Southern Cypress Manufacturers' Association on April 27, and a third meeting is scheduled for Asheville, N. C., at the Battery Park hotel, on May 5, at which time the hardwood manufacturers of western North Carolina expect to join forces with the Hardwood Manufacturers' Association.

### Boston.

The Massachusetts Wholesale Lumber Association held its regular meeting and banquet at the Parker House Tuesday, April 17. About twenty members were present. Following the dinner, President Litchfield called upon Morris Hall for a report of the committee appointed at the last meeting to consider the advisability of uniting the wholesale and retail trade into one association. Mr. Hall stated that the committee had had only one meeting, but at that meeting it was decided that they preferred to undertake some means to increase their own association rather than to unite with the retail branch of the business. It was voted to extend the power of the committee and give them additional time.

Burrows & Kenyon, Providence, R. I., were visited by fire early in the month. The loss was about \$100,000. Two lumber sheds erected about two years ago were completely destroyed.

The Blair Veneer Manufacturing Company of North Troy, Vt., is planning a large addition to its plant.

Isam Mitchell of I. Mitchell & Co., Brockton, has returned from a trip to California.

William E. Litchfield states that his brother is remodeling their mill at Mt. Vernon, Ind.

Amasa Pratt of the Amasa Pratt Lumber Company, Lowell, Mass., has transferred his interest in that company to his sons.

The Kempton Lumber Company has been organized under the laws of Maine with a capital of \$125,000, all paid in. E. L. Kempton is president and H. H. Furbish treasurer.

The Franklin County Lumber Company, Greenfield, Mass., is planning to build an extensive addition to its plant.

J. S. McMaster & Co., a new wood working firm in Rutland, Vt., is erecting a factory for the

manufacture of various articles from hardwood.

The E. K. Parsons mill, Southampton, Mass., recently destroyed by fire, will be rebuilt.

The Boston & Maine Railroad Company has discontinued its lumber sheds in Boston with the exception of those of the Eastern and Pittsburgh divisions.

Nelson Wallace Wyman of Southampton, Mass., died at his home April 9. For a number of years he conducted a lumber business under the firm name of S. & N. W. Wyman. In 1900 the partnership was dissolved and Mr. Wyman continued the business alone. He is survived by two sons.

Patrick Drummey of the firm of Proctor & Drummey died April 5 at his home in South Boston. With the late George Proctor he formed a partnership several years ago. On the death of Mr. Proctor his son, George Proctor, succeeded to the business and the firm was continued under the old name. Mr. Drummey is survived by one daughter, Mrs. Henry F. Napphen, widow of the late Congressman Napphen of South Boston.

### New York.

On May 1 the Adirondack Fire Insurance Company, with a paid in cash capital of \$300,000, will open its books for business in the lumber and wood working line exclusively, its business being written by the Lumber Insurers' General Agency, 66 Broadway, this city. This new company is owned largely by the same interests which control the Lumber Insurance Company of New York, the Lumber Underwriters of New York and the Toledo Fire & Marine Insurance Company of Sandusky, O., and will be conducted along the same lines as these companies, which have been doing such good work for the trade. With this company these interests will practically control four trade insuring institutions with combined cash assets of over one million dollars, which will place their policies beyond all question of financial stability and will likewise enable the Lumber Insurers' General Agency to place lines on standard risk of as high as \$60,000.

Important changes have been announced in the J. C. Turner Cypress Lumber Company, 1123 Broadway, which company has been succeeded by the J. C. Turner Lumber Company, with a paid-in capital of \$1,000,000. The company has been heretofore a distinctly cypress specialist, but J. C. Turner and his associates have purchased large yellow pine holdings and during the past year acquired a substantial interest in the H. L. Jenkins Lumber Company of Blaine, Wash., of which company Mr. Turner has been elected vice president, and it was because of these diversified interests that it was decided to reorganize the company and drop the word cypress. The new company will handle Pacific coast products extensively this year in addition to its other specialties.

I. N. Stewart of I. N. Stewart & Bro., Buffalo, was a recent visitor to this city and Philadelphia on business. This concern has just purchased 500,000 feet of virgin cherry at a West Virginia operation, half of which is now on sticks.

The semiannual meeting of the New York Lumber Trade Association was held at 18 Broadway April 11, at which time a great deal of routine business was transacted.

The local office of the Lumbermen's Credit Association, George K. Towles, manager, has been removed from 16 Leaver street to Suite 507, 18 Broadway, where commodious quarters have been leased.

Robert W. Higbie returned last week from a three weeks' trip to Bermuda only to leave immediately for a visit to his large hardwood operation in the Adirondacks.

S. L. Eastman of the S. L. Eastman Flooring Company, Saginaw, Mich., accompanied by Mrs. Eastman, spent several days in the city on pleasure during the fortnight.

Another prominent visitor was W. M. Ritter, president of the W. M. Ritter Lumber Company, extensive hardwood manufacturers of Columbus, O., who was on a brief business and pleasure trip.

Stone & Hershey of Newark, N. J., have installed a branch office at 18 Broadway, through which they will cater more to the trade of the district than in the past.

The new freight schedule from Adirondack points to New York by the hundred weight as against the previous rates per thousand feet board measure, which becomes effective May 1, has been announced by the New York Central lines, and is on a basis which will mean a sharp increase in the cost of lumber products in the local market, the percentage of the advance being about twenty-five per cent.

F. T. Nesbit & Co., Inc., has been organized to succeed to the wholesale lumber, sash, door and blind business in this city carried on in the past by F. T. Nesbit & Co. The capital is \$100,000 and the directors are F. T. Nesbit and G. L. Jost of 115 Nassau street, New York, and G. W. Johnson of Brooklyn.

James Cant of Cant & Kemp, lumber brokers, Glasgow, Scotland, and London, England, arrived in New York a few days ago en route to the Canadian markets.

George H. Thomson, representing Singleton, Dunn & Co. of Glasgow, Scotland, after a visit to mill points throughout the country, sailed last week.

### Philadelphia.

Jerome H. Sheip of Sheip & Vandegrift and president of the Philadelphia Veneer & Lumber Company, has just returned from a ten days' trip to Knoxville, Tenn., where he was looking over the plant of a ladder manufacturing concern which has a veneer mill at that point. Mr. Sheip is vicegerent spark of Hoo-Hoo of the eastern district of Pennsylvania and is busy planning the regular spring outing which usually takes the form of a planked shad dinner at one of the Delaware river resorts.

F. O. Worden of the Rumbarger Lumber Company is making a trip to Pittsburg, Cleveland, Cincinnati and other Ohio points. He finds the market holding well and expects a brisk trade in hardwoods.

The regular financial meeting of the Pennsylvania Lumbermen's Mutual Fire Insurance Company was held on Tuesday, April 17, at the company's offices in the Drexel building. The usual business was transacted. The progressive policy of the concern has resulted in making this its banner season, and Justin Peters, the capable manager, announces that the volume of business controlled by the company is now greater than at any other time in its history.

Warren Somers of the Somers Lumber Company, Atlantic City, N. J., paid the trade a short visit last week. He reports business at the resort brisk and a considerable building boom in progress.

J. W. Diferderfer of the J. W. Diferderfer Company returned a few days ago from the company's mills at Damascus, Va., where he hurried out the firm's shipments. The Laurel River Lumber Company, of which Mr. Diferderfer is president, is installing new boilers and engines in its mill.

J. H. Schofield of Schofield Bros. is at their Pennsylvania mills looking after shipments. R. W. Schofield has been spending a week at the Weston, W. Va., office of the firm rushing out orders.

F. A. Kirby of the Cherry River Boom & Lumber Company is making an extensive trip through the West. C. E. Lloyd, Jr., who is now on a business trip to the office of the concern at Scranton, Pa., has arranged to leave Philadelphia about April 30 for the South. He will stop over in Pittsburg.

The Producer's Lumber Company has engaged

G. W. Shank as buyer. Mr. Shank is well and favorably known to the trade and has had thorough lumber experience, having been in business for himself in North Carolina for twenty-five years. Franklin H. Smith, secretary of the company, has almost recovered from his recent illness and expects to be in harness again in about ten days.

John J. Soble of Soble Bros. returned last week from an extensive trip, during which he acquired a considerable quantity of good chestnut.

Hugh McLean of the Hugh McLean Lumber Company, Buffalo, N. Y., was in town this week calling on the trade.

The nineteenth annual meeting of the Lumbermen's Exchange of Philadelphia was held Tuesday afternoon, April 12, with nearly every member present. The election of officers resulted as follows: President, George F. Craig of Geo. F. Craig & Co.; vice president, William L. Rice of T. B. Rice & Sons Lumber Company; treasurer, Charles P. Maule. Directors: J. Danforth Bush, W. L. Shaw and Ralph Souder. Auditors: Henry C. Riley, Samuel B. Vrooman and Franklin Smedley.

It was proposed that the exchange appoint a hardwood inspector, but the committee on inspection recommended that, inasmuch as the National Hardwood Lumber Association had appointed a resident inspector for Philadelphia, and since its rules of inspection were the standard rules, this inspector should act in a similar capacity for the members of the exchange. The meeting declared itself opposed to the introduction of the metric system of measurement, and ordered that their protest should be forwarded to the committee in charge of the bill favoring such an introduction at Washington.

At the conclusion of business a vote of thanks was extended to the HARDWOOD RECORD for its careful treatment of the affairs and policies of the Exchange.

A considerable number of Philadelphia lumbermen are arranging to attend the ninth annual convention of the National Hardwood Lumber Association to be held at Memphis, Tenn., May 3 and 4. Most of them will go by way of Cincinnati, where they have planned to stop off on May 2 to attend a luncheon to be given in their honor at the Lumbermen's Club by the lumbermen of that city. After the function they will join forces with their hosts and proceed to Memphis.

Frank P. Rumbarger, who will attend the annual meeting of the National Hardwood Lumber Association, has arranged to stop off and look after the interests of his company in western North Carolina, where it operates three sawmills and where it owns a tract of some 22,000 acres of hardwood timber. He will also visit eastern Tennessee, where the concern controls the output of several large mills, and from there will proceed to various points in the South to look after hardwood stocks. It is uncertain when he will return.

### Baltimore.

The Iron Mountain Lumber Company, which is composed of two young Baltimoreans, has completed negotiations for the purchase of 3,000 acres of timber land in Smyth county, Virginia, along a branch of the Norfolk & Western. The timber is poplar, oak and chestnut, and, together with other holdings of the company in Grayson county, will give it about 25,000,000 feet. At Trout Dale, Grayson county, the company has had a sawmill in operation since last November. A big plant is to be erected on this tract, logging having already commenced. The character of the mill has not yet been decided on. The company is composed of David T. Carter and Thomas Hughes of the firm of Carter, Hughes & Co. Mr. Carter will superintend active operations at the two mills of the company, making his residence at Trout Dale, while Mr. Hughes will look after the distribution of the output here.



Gustave A. Farber, for ten years connected with Price & Heald of this city, has withdrawn from the partnership and engaged in business on his own account at Memphis, where he has offices at 2257 Gaylord avenue. He will follow the lines with which his previous duties have made him familiar—domestic and export trade in hardwoods. Mr. Farber is now engaged in closing up various matters connected with the old firm and will continue to give them his supervision until his successor has been named.

Richard P. Baer of the hardwood firm of R. P. Baer & Co. of this city returned last week from a ten days' trip in southwestern Virginia and northern North Carolina, where he visited a number of mills and arranged for the delivery of stocks. Everywhere he found manufacturers working under pressure, with plenty of orders to keep them going for some time.

Henry B. Curtin of the Pardee-Curtin Lumber Company of Sutton, W. Va., was in town recently. He found business very brisk wherever he went. Work on the new mill to take the place of the one destroyed by fire several months ago, he says, is progressing rapidly. It will be of the double band variety, and will be operated day and night to meet the heavy demand on the company's product.

The large planing mill of the United States Lumber Company at Green Spring, about fourteen miles east of Cumberland, Md., was destroyed by fire April 11. A quantity of hardwood lumber was also consumed. The company will undoubtedly rebuild.

Joseph Cant of Cant & Kemp of Glasgow, Scotland, was in Baltimore last week and called on a number of firms here. He spoke encouragingly of the conditions abroad.

After a careful reading of the decision handed down by Judge Morris of the United States Court here in the case of John L. Alcock & Co. in the matter of clean through bills of lading, the trade interested has settled down to the conviction that the opinion is a complete victory for the exporters. The only point decided in favor of the transportation companies was that involving the criminal charge, with regard to which the court ruled that the bill of lading did not violate the Harter act. The court distinctly declared, however, that no clause in the bill of lading could be construed as relieving the companies of liability for loss or damage beyond the limitations set down in the bill. The shippers, of course, were not eager to have the transportation companies convicted of a criminal offense, desiring merely to have their rights defined, and this the opinion is believed to accomplish. Hence a feeling of satisfaction prevails in the trade, which will no longer be under the necessity of going into a foreign court and bringing action for loss or damage against the steamship companies, but can institute proceedings here.

### Pittsburg.

The McMillan Lumber Company's sawmill near Oakland, Md., was badly damaged by fire April 13. The big stock of lumber was damaged but little, and most of the loss on the mill was covered by insurance. The offices of the company have been moved from the Keystone building to Bayard, W. Va., which is central to its operations.

Frederick R. Babcock of the Babcock Lumber Company was on April 6 elected president of the Merchants' and Manufacturers' Association. This association is recognized as the most powerful business organization in Pennsylvania, and being its president is no inconsiderable honor.

The Milliken-Bradley Lumber Company of Allegheny has been chartered with a capital of \$10,000 by James E. and W. A. Milliken and S. W. Bradley. The company will carry a large stock of general building lumber.

C. B. Howard & Co. of Williamsport, Pa., have bought 40,000 acres of timber land on Elk river,

near Huttonsville, Randolph county, Pa., for about \$1,000,000. This sum provides for the building of a railroad either from Huttonsville on the Western Maryland or from Cloud Run on the Chesapeake & Ohio.

The Buckeye Lumber Company is a new concern at 712 House building, composed of H. C. Hoffman, C. L. Wickersham and H. O. Burdette. The concern is now a partnership, but expects to incorporate later. It will be a wholesale agency, making a specialty of hardwood lumber. Mr. Hoffman was formerly with the Keystone Company and the Pennsylvania Door & Sash Company, and Mr. Burdette was for years a manufacturer of hemlock and hardwood lumber.

J. N. Woodlett, hardwood manager for the American Lumber & Manufacturing Company, spent a few days in New York last week. Recently he booked a big contract for ties in Ohio. He has added to the hardwood sales department L. A. Bennett, formerly of the Stearns Lumber Company of Cincinnati, who will manage the Chattanooga trade of the American.

Willson Brothers are making fine headway in their new hardwood department and its superintendent, I. F. Balsley, is well satisfied with the outlook. The firm, from its big hardwood connections and splendid prestige in other lines of lumber, bids fair to become a strong competitor in the hardwood market.

Among the hardwood firms which have fine shows in the permanent exhibit of the Builders' Exchange League in the Heeron building is the Pittsburg Floor Company, whose display of hardwood and parquet floors is attracting much attention. The offices of the firm are now in the Farmers' Bank building. Another firm which has a unique exhibit is the Hercules Specialties Company of 506 Fourth avenue. Its show of ladders and scaffolding is probably the most complete ever seen in Pittsburg.

The Nicola Brothers Company has been succeeded by the Nicola Lumber Company, incorporated under the laws of Pennsylvania. The officers are: President, George W. Nicola; vice president, A. D. Knapp; secretary, T. N. Bettinger; treasurer, Herbert L. Seaman. The new company will have the advantage of the splendid lake connections which the Nicolas established in Cleveland several years ago. It will also profit much by the old company's affiliations in the South, especially the 20,000 acres of yellow pine and hardwood timber in Mississippi. All the contracts and the good will of the company are turned over to the Nicola Lumber Company, which retains the old offices in the Farmers' Bank building. The Nicola Brothers Company was the oldest wholesale firm in Pittsburg, having been started by T. E. Nicola in 1885.

Fair & Keator and H. W. Melchers & Co. are now located in the House building.

W. P. Craig, of Wm. Whitmer & Sons, Inc., just returned from a trip through the South, where he says most of the mills are running night and day, and have comparatively small stocks on hand.

Among the recent visitors to Pittsburg wholesalers was Dr. W. Williams of the Pocahontas Lumber Company, Burner, W. Va. His firm has a good trade here in hemlock and hardwood.

The fear that Pittsburg building would be tied up by a carpenters' strike May 1 is rapidly subsiding. The 8,000 carpenters in the Pittsburg district want \$4 a day after May 1, this being an advance of 50 cents over the present union scale. Several of the largest contractors in the city are paying practically this rate now and have expressed their willingness to grant the general advance. The Master Builders' Association is favorable to the advance and the Brotherhood of Carpenters and Joiners has given pretty substantial assurance that they will not attempt to enforce their demands with a strike.

The Red Cliff Lumber Company is a new concern at 239 Fourth avenue. Its principals are L. R. Hawes and W. M. Cox.

### Buffalo.

F. M. Sullivan has the site cleared for his addition to yard storage sheds for Pacific coast lumber, but dropped proceedings lately to make a trip through the eastern markets to keep them in sight.

J. N. Seacherd has at length concluded his term of service on the grand jury, which sat several weeks and caused a great sensation by indicting a number of well-known citizens in the armory graft matter.

A. Miller somehow manages to get hold of some good ash lumber these days when it is so scarce, and he is making elm and basswood go, which is good evidence that the yard is a live one and finds what it needs.

The new oak sawmill of the Hugh McLean Lumber Company at Memphis is in running order and will soon be turning out more lumber to make good the claim of the company to lead the country in quartered oak.

A. J. Elias is in a way to come out best in his negotiation for a sale of the old Hamburg canal strip for a railroad station, as he usually does, for he never lets go. The yard is headquarters as usual for heavy timber.

The Standard Hardwood Lumber Company is getting so much lumber in from the South that piles of it are appearing along the railroad switches into the yard, most of it being oak.

The Buffalo Hardwood Lumber Company is getting its usual big supply of oak in from the South, though late reports from its mill at Benton, Ark., stated that there was so much water about the mill that sawing was stopped.

F. W. Vetter went to St. Louis lately to look after some land sales, a good price being offered for a large tract of out-over territory, after which he will prepare to drop off south and southwest for a longer stay.

J. I. Knox has gone south again after more oak and other hardwood lumber for Beyer, Knox & Co., not stopping short of Arkansas this time. Business at the Buffalo yard has been fine of late and is increasing.

O. E. Yeager has been hustling lately, and the result is a good lot of white ash, though ash is very hard to find now. Sales are so good that it is anything but easy to keep up the general stock.

H. A. Stewart has also gone south again and is picking up a lot of oak, cherry, poplar and the like for the trade of I. N. Stewart & Bro. He has been very successful in these trips and keeps the yard well supplied.

Buffalo lumbermen are planning some of the trips they are noted for. The Hoop-Hoos have made a river date for June 20 and the Lumber Exchange will picnic by automobile possibly sooner than that, as there will be a still later outing during the season.

### Saginaw Valley.

The sawmills are now all in operation with the exception of the Hargreave mill at Bay City, and that has steamed up and goes into commission this week. The mills running are all well taken care of in the matter of logs. Three mill plants, W. D. Young & Co., Bliss & Van Anken and Kneeland Bigelow Company, are operated day and night. Two of these plants will run through the year with two shifts, and Bliss & Van Anken will run double shifts until September. Only one saw mill on the river is cutting pine exclusively, and eight are cutting hardwood with some hemlock on the side.

The S. G. M. Gates sawmill began sawing for the season last week. This plant has about 7,000,000 feet to cut.

Phillips & Seeley of Saginaw will operate the sawmill at Logan which the Yuill Brothers purchased from the Rodgers-Allison Company last fall. It will cut out 4,000,000 feet.

The Gale Lumber Company's mill at West Branch will finish its operations there and will be sold as soon as the cut is exhausted. The plant will probably be dismantled and the machinery taken out.

Frank Buell will run seven logging camps during the season. He is furnishing 20,000,000 feet annually to the Kneeland, Buell & Bigelow Company at Bay City; he furnishes the stock for the Bliss & Van Anken mill; about 2,000,000 feet of basswood for Bousfield & Co.; 2,000,000 feet of elm for Jackson & Wylie and is operating two sawmills up in the woods in Cheboygan county, cutting 30,000 feet a day.

The maple flooring plants are doing good business, there being a brisk demand for that commodity with prices satisfactory. The Kerry & Hanson Flooring Company at Grayling reports the best business last month since the plant went into commission last season, both in sales, ship ments and the quantity manufactured.

The first boat out of Au Sable, owned by the H. M. Loud Sons' Company, the Ketcham, carried a cargo of maple to North Tonawanda, N. Y., for the owners.

J. W. McGraw purchased last week a tract of timber in Oscoda county, estimated to cut 1,500,000 feet of lumber, mostly maple.

James Norn, who operates a hardwood sawmill at Standish, has sold his property there to Thomas Miln and is to retire from business.

James Campbell is cutting 500,000 feet of hardwood at Campbell's Corners, near West Branch.

Charles Bigelow states that he has sold the entire cut of basswood mill culls that the Kneeland, Buell & Bigelow mill will cut this season at \$15 a thousand. The high price asked for pine mill culls for box stuff has forced dealers and manufacturers to buy hardwood culls as a substitute, and basswood, beech and even maple are being utilized.

The Michigan Contract Company of Detroit is to build a small hardwood sawmill near Millersburg, on the line of the Detroit & Mackinac Railway.

Frank E. Preston of Detroit and Malcolm Melroe of Alpena have purchased 18,400 acres of hardwood timber land in Presque Isle county.

W. B. Rouse is cutting up a large quantity of beech, elm and basswood logs into staves and heading at his Bay City factory.

#### Grand Rapids.

Quite a large party of lumbermen will leave this city May 2 at noon to attend the National Hardwood Lumber Association convention at Memphis, going via Chicago. The committee on arrangements is made up of L. L. Skillman, E. K. Pritchett of the Macey Company and C. F. Sweet of the Fuller & Rice Lumber & Manufacturing Company. An active campaign is on in support of Carroll F. Sweet for a place on the directorate of the National body.

Grand Rapids lumbermen and furniture manufacturers responded nobly to the need of quick aid to San Francisco sufferers.

An inventory of the estate of Charles H. Hackley, Muskegon, shows an increase of over \$350,000 in the past year, owing in large part to the sale of Hackley & Hume timber lands in the South. An accounting of the executors shows the value of the property at the present time to be \$3,891,483.96.

The Thomas MacBride Lumber Company has a cut of about 4,500,000 feet of hardwood at Wexford, and is operating its mill day and night.

Lots of dry rock elm lumber have sold for \$12 per thousand in the past. Recently the Hart Cedar & Lumber Company sold its standing rock elm for export at \$25, in the tree. The timber is located in Oceana county, and the company received over \$5,000 for the elm taken from less than 500 acres.

#### Cleveland.

The largest tree cut in Trumbull county, Ohio, at least for the past fifty years, was a white oak on the farm of C. K. Shipman in Gustavus township. When cut the log measured 69 feet in length, the diameter at the stump

being 7 feet, but 7 feet was found defective and the log was cut down to 62 feet. The log as it now stands is 62 feet long and contains 7,365 feet of lumber, board measure. Its weight is fully 38 tons. It was purchased by D. L. Holman of Warren, O., for \$100. This great stick will be dressed down to 30x30 62 and will be used as a dredge spud or anchor. The immensity of this tree will be realized when it is known that the average run of white oak trees in this section yield less than 800 feet board measure.

W. J. Fell, who is largely interested in the manufacture of staves and lumber at Salt Lick, Ky., was here a few days ago. He reports the demand for his products active, with every indication of a good demand for the balance of the year.

J. C. Roane, of the Weston Lumber Company, Weston, W. Va., stopped at Cleveland en route home. He says the demand for all kinds of hardwoods has kept the company's stocks very low.

H. R. Cool, accompanied by Mrs. Cool, is in Cuba. Recent letters from him say they are having an enjoyable time; that they find much of interest to the traveler and are putting in their time to good advantage.

W. A. Cool, of W. A. Cool & Son, returned last week from a trip south and reports their mill running on full time, cutting about 70,000 feet daily, but that cars are scarce. He says this is the complaint made by all the mills in that section.

#### Indianapolis.

Building operations are now on in full blast in Indianapolis. Notwithstanding the advanced prices that are being asked for material, building activity is unusually strong. Although the year may not prove to be as big as 1905, still it is safe to say the building will be very heavy. Lumber of nearly all grades has advanced approximately twenty per cent, but despite this a great deal of building is being done. The year promises to be a most successful one for Indianapolis lumber dealers.

The C. W. Allen Company of New Albany, Ind., has been incorporated with a capital stock of \$1,000 to deal in hardwoods and hardwood flooring. C. W. Allen, L. O. O'Daniel and W. A. McLean comprise the board of directors.

The Indiana Lumber Company of Madison, Ind., has been incorporated with a capital stock of \$30,000. The directors are John F. Hamnell, D. C. Bear and Richard Johnson.

The Capital Lumber Company of Indianapolis has just been sued in the superior court by Manless V. Sligor for \$10,000 damages as compensation for the loss of his right hand while engaged as a rip sawyer in the employ of the company. The complaint alleges that the accident occurred March 10, 1905, after the company had neglected to guard the saw properly according to orders from the state factory inspector.

Stroh & Co., lumber dealers of Crawfordsville, have sold their yard to a syndicate composed of F. L. Mercer of Chicago, Hart Winchell of Windfall, Ind., and J. J. Brannum of Alexandria, Ind. The new company will reorganize under the name of the Crawfordsville Lumber Company. Mr. Winchell will be treasurer and general manager of the company.

#### Milwaukee.

Fire caused \$60,000 damage to the plant of the M. Hilty Lumber Company, St. Paul avenue and Twelfth street, April 20, though Charles G. Forster, president of the company, immediately after the fire estimated the loss at a much higher figure. The company carried about \$75,000 worth of stock, fancy grades of maple and other hardwoods. The plant had been recently improved with machinery, making the value of the factory about \$25,000. The plant will be rebuilt at once and arrangements have been made by which orders will be filled as usual.

Fire fanned by a fierce north wind on April 20 destroyed the sawmill of the Robbins Lumber Company, Rhinelander, Wis., one of the largest mills in the Wisconsin valley, causing a loss of \$30,000. The flames spread to the yards of J. H. Quaal & Co., causing a further estimated loss of \$20,000. The big mill of the Johnson Lumber Company narrowly escaped destruction. Last fall the Robbins mill in the same district was scorched.

Representing the Citizens' Business League, Secretary R. E. Watrous will attend the annual convention of the National Hardwood Lumber Association at Memphis to secure its next convention for Milwaukee.

Market conditions remain unchanged. Heavier movements are expected with the advance of the season and the increased demand in all lines, especially that of furniture. It is expected that the demand for woods suitable for piano stocks will be unprecedented this season.

Milwaukee is to have another large and modern piano manufacturing plant, on which building operations will begin at once. It will represent an investment of \$75,000. The builders and manufacturers are the Charles F. Netow Mann factoring Company, now located on East Water street, this city. The firm has acquired four and one-half acres of land for its plant and the main building will be 60x292 feet, four stories high and of brick. Within five years, the company estimates, it will be so enlarged as to have facilities for manufacturing 10,000 pianos and organs yearly. The plant will be completed and ready for operation within five months.

#### Bristol.

R. E. Wood, president of the R. E. Wood Lumber Company of Baltimore, Md., was here on important business last week. Mr. Wood's company now operates large band mills in Carter county, Tennessee, and in Mitchell county, North Carolina, as well as numerous small country mills, and is shipping a great deal of stock out of this section.

The body of George C. Luppert, lately of the Luppert Lumber Company, who was drowned in the Watauga river near the Luppert operations several months ago, was recovered last week by Mrs. Isaac Estep, after months of search. Mrs. Estep claims that, acting under the impulse of a strange presentiment which she had the night previous, she found the body partially buried in the sand. A tide had washed the sand off the head of the body and it was plainly visible from the bank. The woman will be paid a large reward. The body was taken to the former home of the deceased at Williamsport, Pa., for interment, accompanied by the father, Valentine Luppert, and the grief-stricken widow and children.

Arrangements are being made for a Ho-Hoo concatenation at Mountain City to be held in the near future. It is reported that about twenty-five lumbermen are anxious to affiliate with the order in the Mountain City district and a large and enthusiastic meeting is expected.

M. N. Offett of the Tug River Lumber Company and J. S. Matthews will go to Bluefield, W. Va., on May 6, where they will hold a Ho-Hoo concatenation. A large number of applications have already been received and one of the most successful concatenations ever held in this section is anticipated.

The Norfolk & Western Railway has revised its schedule of rates on lumber in Virginia and rectified the discrepancies and inconsistencies in the rates which have worked hardships on shippers and handicapped buyers in a large measure. The rate from southern mills to Roanoke was formerly higher than the rate to Washington and Lynchburg, thereby enabling stock to be sold cheaper two hundred miles farther distant from the mills than Roanoke and rendering the Roanoke dealers and others in the region affected powerless to compete with the dealers doing business on the line given the low rate. The matter was brought before the Norfolk & Western oh

cials and the Southern, and freight traffic managers of these concerns held a conference and promulgated a new schedule of rates which are equitable to all concerned and remedy the defects in the old tariff.

The John T. Dixon Lumber Company is doing an extensive manufacturing business at Elizabethton, and the record of the company's business shows marked increases in the volume of stock manufactured and handled. The business of this company is very gratifying.

The Bristol Door & Lumber Company, lately reorganized at Boston with W. O. Caine of Bristol as president, is making improvements on the big woodworking plant and band mills in Bristol, with a view of materially augmenting the output. This company manufactures a large amount of doors, mill work, etc., from the log for the New England trade.

The construction of the Laurel River Railroad, connecting Abingdon, Va., and Mountain City, Tenn., has opened up an almost inexhaustible boundary of some of the finest forests in east Tennessee and southwest Virginia, and the work of felling the timber and freighting it to the various big mills at Damascus, Sutherland, Abingdon and elsewhere has begun on a large scale.

#### Cincinnati.

Thos. A. Moffett of the Maley-Thompson & Moffett Company will be a candidate for the presidency of the National Hardwood Lumber Association at the convention in Memphis, May 3 and 4. Mr. Moffett was at first unwilling to make the race, but friends prevailed upon him. The Cincinnati Lumbermen's Club has appointed the following committee to take charge of Mr. Moffett's interests: W. A. Bennett, chairman; T. B. Stone, C. F. Korn, C. H. Pease and Watt Graham. Two special cars with Cincinnati members of the National Association will leave this city a day or two in advance of the convention to boom Mr. Moffett's candidacy. If Mr. Moffett is elected it is a foregone conclusion that he will administer the duties of the office in a highly capable manner. He was president of the Cincinnati Business Men's Club in 1905 and the affairs of the club were never looked after better than during his term. He has also taken a prominent part in all hardwood gatherings.

L. G. Banning will leave for a three months' European trip shortly. A party of friends will accompany him.

James Cant of the Cant-Kemp Company, Glasgow, Scotland, and R. Sondheimer of Memphis were visitors here the middle part of the month.

The Wiborg & Hanna Company has established a branch office in Memphis in the Tennessee Trust building. It will be in charge of F. B. Palmer.

Wallace D. Wolf is in the South buying hardwoods for the W. H. Perry Company, which recently entered the hardwood business. Their plant is located on Gilbert avenue.

The Smenner-Muchmore Company has been incorporated with \$10,000 capital to engage in the hardwood business in this city. The incorporators are: A. W. Smenner, W. J. Muchmore, C. C. Bishop, S. M. Loomis and E. D. Woodward.

H. P. Wiborg of the Wiborg & Hanna Company has recovered from the effects of an operation on his head. He will be at his desk in about a month, it is expected.

#### Nashville.

The Palmetto Manufacturing Company is a concern recently organized in Nashville to manufacture ax, hoe and hatchet handles. It is expected that the plant will be completed in the next sixty to ninety days. A site has been secured on the Southern Railway on First avenue North. The members of the corporation, which is capitalized at \$25,000, are: W. H. Cooper, John S. Woodall, Dr. H. P. Campbell, William Lowndes, W. H. Hicklen and J. H. Samuel. The plant will be managed by I. D. Matthews, an expert in the wood working business.

News has been received in Nashville of the

death of Edwin E. Smith, southeastern representative of the Southern Lumberman. Mr. Smith had been connected with the paper for several years and had a wide acquaintance among the lumbermen of Tennessee.

Serious hindrances to the building boom that has been on in this city for quite a while may be experienced, as the local carpenters' union, a body affiliated with the Structural Building Trades Alliance, has given notice that after May 1 its members will not work with men who do not hold union cards. Many of the nonunion carpenters are said to be joining the union and the trouble may be averted.

The Robertson-McGill Manufacturing Company at Shelbyville, Tenn., will at once begin work on a big carriage factory, where carriages and buggies, also harness, will be made. The firm has been in business in Shelbyville for several years, but recently was reorganized and enlarged. The new plant will employ a large number of skilled workmen.

The Gallatin Spoke Works at Gallatin, Tenn., which has not been running for the past three years, has started up again with H. Orman as manager. The capacity of the factory is about 25,000 spokes a day and both wagon and buggy spokes are being made. Messrs. Powell and Ellis have also broken ground for their new box factory there. The plant will be located convenient to the L. & N. Railroad.

The Nashville Carriage & Wagon Makers' Association gave a delightful but informal banquet as part of the program at the last meeting. The organization of an association among the employes of the carriage and wagon manufacturers was brought up, and it was the sense of the meeting that such an association would be entirely agreeable, and that the two bodies, if run along correct lines, would be of mutual benefit.

A story comes from Union City, Tenn., that will make some of the lumbermen and nurserymen in the country look incredulous. E. H. Badger of that city pruned some fruit trees. He was also growing a vineyard, so he stuck the limbs he had cut off in the ground for the grapes to entwine about and climb upon. To his astonishment the limbs themselves put out fresh leaves and give promise of being healthy trees.

The Interstate Coeprage Company has just purchased from the Hurricane Iron & Mining Company, represented by George Campbell Brown and Johnson Bransford, two of its officers, the timber rights to about 15,000 acres of land in Hickman county, Tennessee, in the Duck River valley. The consideration was \$85,000 cash. This tract is said to be one of the finest pieces of virgin timber land in the state. Trees with a diameter of more than 14 inches passed in the sale, and the purchasers were given ten years in which to get it out. They will at once erect several large sawmills on the property and will get out large quantities of it as fast as possible.

The Nashville Carriage Makers' Union is being organized in this city. Its membership includes blacksmiths, painters, trimmers and wood workers employed in the local wagon and carriage shops. Thomas Whitely is chairman of the organization and S. H. Eason is secretary.

An amendment to the charter of the H. Scott Lumber Company of Shelby county, increasing the capital stock \$10,000, has been filed in the office of the secretary of state at Nashville.

The W. M. Ritter Lumber Company of Columbus, O., capitalized at \$8,000,000 under the laws of West Virginia, has filed an abstract of its charter at Nashville for the purpose of doing business in Tennessee.

Theodore Hutton, a banker and capitalist at Waynesboro, Tenn., has just bought an 800-acre tract of timber land in Wayne and Bedford counties, paying \$24,000 for it. Mr. Hutton will at once begin the work of preparing the timber for market.

The Faust Brothers Lumber Company has been organized at Clifton, Tenn., with capital stock of \$25,000. The incorporators are: Carl and

J. Faust, W. H. Newcomb, S. M. Wakefield and S. K. Hale. The members of the firm are all practical lumbermen and have been in the business in this section for a number of years.

One of the large dry kilns of the American Lead Pencil Company at Shelbyville, Tenn., was destroyed by fire recently, entailing a loss of about \$2,500. The kiln contained about two carloads of cedar slats which were being cured for shipment to pencil factories at the time. The loss was covered by insurance.

The Dickson Stave & Lumber Company is erecting an up-to-date factory on its property in South Dickson, adjoining the plant of the Interstate Coeprage Company. New machinery is being installed for the manufacture of spokes and hubs.

In spite of the fact that red cedar is precious and scarce, much of it is being shipped out of Tennessee to foreign countries. Eleven cars were shipped over the Nashville & Decatur Division of the L. & N. last week for Rotterdam, Holland.

One of the recent visitors to Nashville was Leon F. Miller, who formerly lived in this city, and is now superintendent of the Three-States Lumber Company at Madison, S. C.

A. M. Tippit of Dover, Tenn., has just added an up-to-date planing mill to his wagon manufacturing plant.

The Southern Seating & Cabinet Company of Jackson, Tenn., has been sold for \$100,000. The stock is said to have brought \$250 a share.

#### Memphis.

The candidacy of W. H. Russe for the presidency of the National Hardwood Lumber Association is being actively pushed. J. W. Thompson of the J. W. Thompson Lumber Company is chairman of a committee appointed for this purpose, and this of itself is guarantee enough that if anyone wins over Mr. Russe it will be only after a hard fight.

There is an interesting report current here that the New England delegation to the national convention will be very strong and that it will combine all of its resources to secure the next annual meeting for Atlantic City. It now seems certain that the struggle for the next meeting will precipitate a contest. The delegation will have some strong arguments to bring to bear, including the fact that there will be no business interests in Atlantic City to detract from the convention itself.

F. E. Stonebraker, who April 15 became general southern manager for the Lansing Wheelbarrow Company of Lansing, Mich., in which he recently acquired an interest, has secured offices at 436-438 Seimitar building. Mr. Stonebraker, who is also president and general manager of the Crittenden Railway Company, which is building a line connecting the Rock Island and St. Louis, Iron Mountain & Southern with termini at Earle and Heath, Ark., reports rapid progress in the construction of this road, which will be completed, with favorable weather conditions, within the next eight or ten weeks. A stretch of track one and one-half miles long will be built, thus connecting the plant of the Lansing Wheelbarrow Company with the main line of the Crittenden Railway. A handsome volume of traffic is already assured the new road.

Another addition to the lumber yards of Memphis will be those of the Briggs & Cooper Lumber Company, Ltd., of Saginaw, Mich., which will be established adjacent to those of the Dudley Lumber Company of Grand Rapids, Mich.

The S. C. Major Lumber Company has purchased the yards of Lesh & Matthews in North Memphis and will soon remove its offices from the Randolph building to the yards.

Dispatches received here from Jackson, Miss., are to the effect that the conference committee of the legislature has agreed upon a compromise whereby manufacturing companies of that state, including the big lumber corporations, may hold \$10,000,000 worth of personalty and realty in stead of \$2,000,000 worth, the limit heretofore maintained, as advised by the lower house.



There are two provisions in this connection: One that any company holding more than this amount will forfeit one-half of it to the state, and the other that not more than \$250,000 worth of stumpage lands, based on the purchase price, can be held by any one company. This last provision, it is stated, is for the purpose of forcing these companies to sell their lands as fast as they have been cleared, thus stimulating the agricultural development of the state. This solution is not what the large lumber and timber syndicates desired, but it is so much more liberal than they expected that they are much pleased with the outcome.

The following additions are reported to the Lumbermen's Club of Memphis: J. F. McIntyre of the Memphis Rim & Bow Company, A. C. Lang of the Paepcke-Leicht Lumber Company, Chicka sawha, Ark.; O. Dircks of the Askins Dircks Lumber Company, Union City, Tenn., and H. W. Mosby of the Helena Box Company, Helena, Ark.

Moore & McFeiren report that the work on buildings to replace those destroyed by fire some weeks ago is progressing rapidly and the plant will be in readiness for operation about July 1.

Spar tracks are being run into the tract of land recently acquired by C. L. Willey of Chicago for the establishment of a big sawmill. The E. Sondheimer Company, which has the tract adjoining, will build enough houses to accommodate all the employes of its own plant and yards as well as those of C. L. Willey. These houses will be built on a strip 150 feet wide and 1,200 feet long and will be rented exclusively to employes of the two companies.

The crest of the rise in the Mississippi river has passed Memphis and the water is receding slowly. The levees are all intact and no over flow of land protected by levees is anticipated. There is considerable timber being brought out on this rise and it now seems certain that the beneficial effects of the rise will more than compensate for any loss that may have resulted.

#### Ashland, Ky.

Business is excellent in the Ashland district. The local mills are all running, but the supply of logs is short. The demand for dry lumber exceeds the supply, and firms are turning down orders. Prices firm and strictly list. There is a small run of timber in the Big Sandy and Guyandotte rivers.

O. D. Garred of Huntington, W. Va., has about completed the work of arranging and building his camps on the Clear fork of Coal river, where he has the contract to cut the timber on a tract of land comprising 9,000 acres. A large force of men is at work. It will take between three and four years to clear the land of the timber, which is the finest virgin oak and yellow poplar.

Miss Carrie White of this city and J. B. Lytle of Pittsburg were married in Parkersburg on March 10. Mr. Lytle is located at Bayard, W. Va., as representative of Currell & Lytle Lumber Company of Pittsburg. Miss White has been employed as stenographer for the Carolina Pine Company of Huntington, W. Va.

One of the largest runs of walnut timber that has floated down the Guyandotte river for some time is now drifting down the stream from Wyoming county. Many of the logs will cube several times and will bring the owners a good round sum. They are owned by Jeff Gill and others who are actively engaged in lumbering operations at the head of the river.

Tom Moore, lumber inspector for the Keyes-Famin Lumber Company at Graham, Va., is in the city.

The W. H. Dawkins Lumber Company has sold 3,000 acres of valuable timber land in Logan county, West Virginia, to J. W. Johnson & Co. of Huntington, W. Va.

#### Louisville.

The local river sawmills have received quite a bunch of the spring crop of logs already and

are running their mills at full capacity. There is still quite a large quantity to be received and operators are making ready for a busy time.

W. H. Hoskins is a missing landmark among the Point mills this year, having moved the center of his milling operations to Arkansas, where he is interested with R. M. Cunningham in cutting from quite a tract of hardwood timber.

R. M. Cunningham says of the hardwood market situation that the main worry is to get stock. There is no trouble selling hardwoods, but the rains, scarcity of cars and almost everything else that could happen has kept the output much below normal.

The Southern Lumber Company has something of the same story to tell. The demand is good and everything in the line of merchantable hardwood can be sold at a fair price, but there is not enough stuff to take care of orders as promptly as might be desired.

Ed Rhubeszky, Columbia Building, is building up quite a nice hardwood business. Like the others, he reports that it is generally easier to sell hardwood these days than it is to get it.

#### Minneapolis.

A. S. Bliss of this city, who has represented the R. Connor Company of Marshfield, Wis., in Twin City territory for the past three years, has been advanced to the rank of hardwood sales manager and has left for Marshfield to take charge of his new work. This position is one made necessary by the growth of the business, the veteran sales manager of the company having all he can do handling other stocks. Mr. Bliss is well qualified for the position, being a thoroughly experienced hardwood man. He has been with the R. Connor Company for eleven years past, for eight years traveling almost constantly as inspector and buyer for the company. The company will not abandon this field, Mr. Bliss continuing to give it considerable personal attention. For the present he will not move his family to Marshfield. Later a permanent representative may be located here.

P. R. Hamilton of the Minneapolis Lumber Company reports a steady trade and says the company has been able thus far to keep enough dry stock on hand to supply orders for a while to come. The factories are all enjoying a season of prosperity and using hardwood extensively. A continuance of warm, windy weather such as the northwest has been having for a few days will dry out lumber rapidly, and Mr. Hamilton hopes to be able to move some of the new crop of basswood in two weeks or so.

E. Payson Smith of the Payson Smith Lumber Company returned this week from an extended business trip through the southern states. He says moneyed men from the north are flocking into the south to buy up tracts of timber, both pine and hardwood. The mills in Alabama are shipping heavily, but those along the Mississippi are flooded and compelled to shut down. The labor problem is a serious one also with the southern mills. It is next to impossible now to secure common labor at prices two or three times what they were half a dozen years ago. There is a great deal of railroad building, and the sections Mr. Smith visited are enjoying tremendous prosperity. His company is having a big demand for oak, which is hard to meet. Heavy shipments were made from the mill at Henderson Mounds, Mo., before the flood came, running as high as twenty four cars a day, but the stock shipped has been cleaned up and the plant is now flooded, the offices even being two feet under water. Owing to the wet winter season there is little green lumber now in the south.

L. C. Nolan of the Bacon Nolan Hardwood Company, Memphis, Tenn., is visiting for a few days in the Twin cities.

D. E. Clark of Osborne & Clark has gone to Winnipeg to look after business there. The firm ships considerable hardwood to the Canadian city. C. E. Osborne of the same company reports their trade from the retail yards active as ever,

and it is beginning to be a problem to supply the demands of dealers. Those who want oak cannot always get just what they want, but must take what there is and are glad to.

#### Wausau.

The C. A. Goodyear Lumber Company of Tomah, which had but two more years of sawing, has purchased an immense tract of hardwood lands in northern Michigan, the timber from which will keep the company's mill employed for at least ten years. The company is also negotiating for the purchase of another large tract of timber lands which will cost several hundred thousand dollars. The firm employs 300 men in and about its mill and several hundred more in the woods. The average daily output is 90,000 feet of lumber.

The Roper Lumber Company of Menominee has purchased 1,200,000 feet of lumber from a firm at Selzer Bay. About 90,000 feet of the lot is white pine, the balance mixed hardwoods. Much of it will be retailed from yards at the bay, while the balance will be transferred to yards in Menominee.

The Antigo Building & Supply Company of Antigo is at present doing the largest business in its history. The company has a sufficient supply of logs on hand to keep running throughout the season. They are a choice lot of birch and maple.

The Chippewa Falls Furniture Company, Chippewa Falls, which lately completed the erection of a large plant, has started the same in operation and is running night and day. At present a large order for refrigerators is being filled, shipments made at the rate of a car a day. Later the manufacture of mission furniture will be taken up. The officers are: R. H. Shook, president and general manager; W. B. Castenholz, secretary and treasurer; G. E. Smith, vice president and salesman; Morris Breunig, superintendent. The company also has a plant at Plainfield, Ind., which is worked to its fullest capacity.

Ex-State Senator D. E. Riordan of Eagle River has sold to N. A. Coleman of the same place 1,600 acres of hardwood lands, situated in Vilas and Oneida counties, the price paid being \$10,000. The lands were formerly owned by Mr. Coleman and were sold to Mr. Riordan in 1898 for \$2 per acre, since which time they have more than trebled in value.

Messrs. Emil Maas, Justin Means, Lige Gould and Fred Smith of Merrill have purchased 7,700 acres of timber lands in Houston county, Texas. The timber growth is oak, ash, black jack and other hardwoods, and will cut from 1,000 to 5,000 feet per acre. They will hold it as an investment.

Proposals were opened in the Indian office in Washington, D. C., recently for the sale of logs on the Menominee Indian reservation in Wisconsin. The timber growth on the reservation is largely hardwood, the pine having been sold off years ago.

The Edwards Thrig Company of Oshkosh has filed an amendment to its charter, increasing its capital stock from \$25,000 to \$150,000. The company was organized in the fall of 1902. The firm occupies a huge stone building and manufactures caskets, furniture and other hardwood articles.

One of the largest lumber manufacturing concerns of Oshkosh has refused to accept the decision of the Association of Hardwood and Hemlock Manufacturers to increase the price of all grades of lumber and its manufactured products \$1.50 per 1,000 feet. The result, it is said, will mean a clash between the company and the association. Local contractors, of course, are pleased at the stand taken by the Oshkosh concern and point to the figures taken from the "universal price list," showing that in two years hardwood flooring has advanced from \$27 to \$45 per 1,000 feet, varying slightly according to grade. Other building materials have advanced even greater. The outcome of the situation is being watched by contractors all over the state.

# Hardwood Market.

(By HARDWOOD RECORD Exclusive Market Reporters.)

## Chicago.

There seems to have been a manifest slackening of sales of hardwood in the Chicago market during the past fortnight. Buyers have placed orders all during the year with a good deal of freedom, and nearly every woodworking institution in the city has orders out for stock that when delivered will last them for some time. There is a manifest slowness in getting lumber to destination largely on account of the stock not being dry enough for shipment. There is no diminution in values on any kind of wood, and it is doubtful if a lessened price would increase the volume of sales at the present moment. There simply seems to be a desire on the part of buyers to get stock already bought into their possession before placing additional orders. What activity there is in the market seems to be centered on plain oak.

## Boston.

A steady improvement is reported in the market for hardwoods, although in some instances the demand is checked by the recent advances. Furniture manufacturers, especially those making office furniture, are very busy and are constantly in the market.

The high prices continue to check the call for export. A few dealers report more doing along this line, but the majority still find the demand quiet.

Plain oak is firmer today than it has been for months, and a fair demand is reported. Offerings are small. Quartered oak is also considerably firmer than it was. White and brown ash are in small offering and firm in price. Maple flooring has advanced. Opinions differ somewhat regarding the demand. A few wholesalers state that they have a good volume of orders on their books, while others find that the higher prices have checked the call. Whitewood is in much better demand. This is due in part to the advance in cypress and the unsatisfactory condition of the wood offered in this market. The advance in cypress is said to be due to the fact that there is but little dry stock at mill points and that logs are not as plentiful as usual at this season of the year.

## New York.

A canvass of the district during the past fortnight revealed a marked activity in all branches of the trade. The furniture, interior finish and general manufacturing trades are all running full time and buying is free. While quite a number of the yards are supplied with good stocks, a large proportion of this is sold, but cannot be moved as work is not ready for it, and it is freely admitted that if all the lumber sold by the yards were delivered at once stocks would be by no means normal. The conditions surrounding dry lumber and the output at manufacturing points is such as to preclude the possibility of anything but a prolonged bullish market, unless something unforeseen happens.

The export trade is in fair shape. Maple flooring has gone up 82 for export during the fortnight. Conditions in the foreign markets at the present time do not seem to be conducive to a very large trade.

The local demand for hardwoods is pretty general with the possible exception of quartered oak and maple, although it is admitted that the former has shown some tendency toward revival during the past thirty days. Plain oak, ash, chestnut, birch and poplar are all in good call, with prices firm and stocks only nominal. The call is for the better grades, and offerings of stock in fair shipping condition are rapidly absorbed.

## Philadelphia.

The hardwood market continues good and is improving steadily, and the opinion among the trade is that it will continue to do so. The

demand seems to be heavy enough to take care of all the lumber that is coming into the market. Trade in chestnut is brisk, and good stocks are short. This is particularly true of sound wormy chestnut, for which there is a nice demand. There is a good call for poplar, the quotations in this wood on firsts and seconds being higher than ever and the scarcity of dry stocks is noticeable.

Quartered white oak in firsts and seconds is drawing well, while inch plain oak and two-inch plain oak is a little weak at the present time. Red oak, however, is holding its own, and thick oak, five and six quarter, is scarce, as is also good ash.

The scarcity of dry stocks, and particularly poplar, is general, and buyers returning from the South report the same conditions prevalent there. Some of the heaviest dealers in the local market report their line of seasoned stock fairly good, but not equal to what they would desire.

Some of the largest lumber houses are of the opinion that the market ought to be better than it is and attribute the present conditions to the stringency of money in local circles. The whole trade, however, looks forward to a continuation of good conditions throughout the summer, with a probable increase as the building operations get fairly under way.

## Baltimore.

The hardwood situation here has lost none of its buoyant character. All the woods in general are continuing to be in active demand, and the mills have enough orders on hand to keep them running for months to come. One difficulty which has hindered the trade, the bad roads, has been obviated by good weather, so that a marked increase in the receipts at the various points of distribution may be looked for. Some dealers think that this will cause a sagging off in values, but the preponderance of opinion is that the demand will keep pace and values will remain firm.

Oak leads in point of activity, bringing high prices and finding ready takers where the quality is at all acceptable. Even the common grades have shown much strength of late. The furniture manufacturers and other consumers are buying freely and orders are being placed ahead through six months seems to be about the limit. The foreign business, while in the main quiet shows slight improvement. Stocks abroad seem to have run fairly low. They are having strong competitors in the car builders here, who are taking large quantities of oak and whose requirements as to quality are comparatively low. These concerns have orders for many thousands of cars, and they are buying up all the oak they can get, together with such other woods as they use in the work of construction. The enormous orders for rolling stock placed by American railroads is one of the most important factors in the lumber trade and help to keep the market at a penurial figure. Ash is also in good request at prices that compare favorably with oak. This trade, likewise, gives every promise of continuance. Walnut seems to retain its popularity among domestic buyers, while mahogany and other hardwoods are all doing well both as to value and volume of movement.

## Pittsburg.

From western Pennsylvania, West Virginia, eastern Ohio, Kentucky and Tennessee, where are located the hardwood mills that supply Pittsburg wholesalers, there has come the wail the last six weeks that the roads were practically impassable. Stocks of good hardwood have been hard to get. As a result, the local yards have now more lumber on hand than for five years at this season, and are buying accordingly slow

This has caused a noticeable lull in the local trade, but as soon as the ground is dry things are bound to look brighter, for the volume of building started gives assurance of a brisk call for all kinds of lumber.

Outside of this purely local feature trade has been good in hardwoods. For the last two weeks the inquiry from railroads and street railways has been quite satisfactory. Ties, poles and bridge timbers are in excellent demand and are bringing, in some cases, fancy prices. There is little doubt that the market for heavy hardwood sticks will be better in Pittsburg this year than last.

Prices remain exceptionally firm. The scarcity of good oak keeps that wood at top list. Chestnut is selling well as a substitute for oak and the prices which contractors, especially in the coke regions, are willing to pay are surprising. Maple flooring continues on the same base. No change is noted in the price of minor hardwoods, and a fine string of small orders is being booked by local firms to be delivered to the manufacturers at an early date.

## Buffalo.

It still appears that the hardwood lumber trade is gaining. There is no complaint that the hardwoods are not moving, for even the slowest of them are now doing fairly well. The demand for chestnut and plain oak is very active.

A white pine dealer, lately on a tour of the door mills of the southern-tier cities of the state, found that they were all doing much more in hardwoods than formerly. Not many years ago they were big buyers in this market of a grade of white pine that would work up into doors, but the tendency now is to use a great amount of the various hardwoods instead.

The changes in hardwood lumber of late are a greater scarcity of chestnut, ash and plain oak, the better movement of quartered oak, the activity of maple at better prices, the strength of the poplar market and the slow return to activity of elm and basswood. Reports from the southern oak districts are that logging is slow and much behind because of bad weather. Legs are high and the demand for anything that will make fairly good lumber is great.

There is not much change in the outlook in this district in a personal way. Everybody appears to be prosperous and satisfied. There is no boom in anything, but all is in a satisfactory condition.

## Cincinnati.

The market continues in satisfactory shape. The demand has been good and while dry stocks have increased perceptibly values continue firm. Plain oak maintained its position as the market leader.

## Bristol, Va.-Tenn.

Trade conditions in the Bristol district remain in a satisfactory condition. The tendency of the market seems to be toward higher prices and a still better demand, although the demand has been so great within the past few weeks that the mills are running behind and some of them working overtime, and even with this there is still a considerable scarcity of almost all kinds of stock. Since the roads have dried sufficiently hauling to the railroads has been begun and is progressing. When the stock is all hauled from the country mills to the railroads and placed on the market the supply from this section will be much larger.

Local exporters declare the foreign markets are much improved and values are becoming firmer. They have a great deal of faith in the foreign markets, and are not confining themselves to conservative limits in making contracts for future delivery. Liverpool, London and Glasgow concerns have tied up several prominent local dealers in big contracts for months to come.

## Saginaw Valley.

Hardwood lumber is moving fairly well and prices are firm and well sustained. For No. 2

common and better elm the quotation here is \$22-\$26; basswood is held at \$23, and \$15 for culls; beech is quite firm at \$13 and \$14; birch brings \$20 to \$22.50; maple, \$16 to \$18, and ash, \$27.

There is not a large stock of ash available, but some firms will handle quite a large amount, and the same may be said of basswood, although there are larger stocks of the latter.

No difficulty is experienced in getting cars and there is a free movement. Some maple is going into building timber, one or two firms having large orders for it for that purpose.

### Nashville.

The Nashville market is reported firm in practically every line. The local firms are breaking all records in their shipments to all parts of the United States, as well as to Europe. There seems to be a universal building boom, and as Nashville is in the heart of the hardwood district much wood for interior finishing is shipped from here to all sections of the country.

Stiff prices are quoted on all kinds and grades of lumber. Quartered red oak may be termed a trade slow, and plain red is bringing prices nearly as high as quartered. The local activity in building lines continues and the woodworking plants are buying large quantities of timber. The spring business is holding up better than was anticipated, and lumbermen are more than satisfied with trade conditions.

### Memphis.

There is a continued good hardwood demand in Memphis and vicinity and conditions are regarded by the trade as quite healthy. There is a slight falling off in the call for plain oak reported by a few, but this condition is not having much bearing on the situation for the reason that there is very little for sale. One manufacturer expresses the opinion that there is not 500,000 feet of 2-inch plain oak in the whole Memphis territory and that there is relatively little of any kind of plain oak ready for immediate handling. Quarter-sawn red oak is slow in the higher grades, but there is a fairly good demand for the lower, some manufacturers reporting the sale of practically their entire holdings. Just the reverse obtains in white quarter-sawn, the higher grades selling well and the lower being in very slight request. Prices on all grades of oak are well maintained.

Ash and cypress are growing in strength and there is an excellent call for both woods, which is limited only by the light stocks available. Some of the larger manufacturers report their yards more depleted in these two items than they have been for five or six years. Prices are very firm.

The position occupied by gum is one of growing importance. The demand is strong at prices that would have seemed incredible even three or four months ago. All grades are wanted and not a little of this lumber is being exported. Offerings are not large, though some of the smaller mills are willing to sell their cut ahead, so that considerable quantities can be secured for delivery when the product now being turned out is dry enough for handling.

Cottonwood is scarce and strong, with an upward tendency. There is not much dry material to be had. One big company here is selling considerable cottonwood because prices for the lumber are higher, proportionately, than those for box shooks. Box boards are exceptionally scarce and some extremely fancy prices are obtainable for dry stock.

There is a good demand for all grades of poplar, the scarcity of cottonwood stimulating the inquiry for the lower grades. Prices are firmly held.

Production is on a fairly large scale both here and in the interior, but, even with favorable weather conditions, it is conceded that it will

be some months before there will be a restoration of normal stocks of dry lumber. Export demand shows some further slight increase and prices are very satisfactory on the business put through.

### Minneapolis.

This is naturally a season of light demand from factory trade, especially from sash and door people, but hardwood dealers are doing an excellent run of business just the same. There is steady buying of mixed cars with a goodly proportion of hardwood, and oak stock is being drawn upon to the limit. Maple flooring is very active and advanced another dollar in price a few days ago. The furniture factories are taking oak when offered and are scouring the country for dry rock elm. There is no northern oak for factory consumption and the southern mills that have sold to ship into this territory are nearly all out of by high water.

Dry birch in upper grades promises to be well cleaned up by the time new stock is ready to ship. Basswood is also well cleaned up. There has been some fine drying weather the past week, dry, warm and windy, and green lumber is rapidly rounding into condition for shipping. Farring a long wet spell new basswood will be on the market early in May. Stocks of hardwood are very low, and the mills all report their stocks sold out much closer this year than usual. All are sawing and expect a prosperous year. There is plenty of building going on, and the sash and door factories will be using large quantities of hardwood stock again before long. Box men are preparing to buy basswood culls heavily this year right from the start.

### Louisville.

The Louisville hardwood market would be in excellent shape if manufacturers could catch up with orders and get in position to take new business for attention in the near future. There is a good volume of inquiries and orders all along the line, but there is also a great clamor from those who have made purchases because of delayed shipments. If there is a hardwood man in this territory who is not behind on orders he has not yet been heard from.

There has been among the box factories quite an active demand lately for Nos. 1 and 2 cottonwood. Ordinarily No. 2 is the wood that goes into boxes, but the Louisville trade, which makes lots of high grade whiskey boxes, uses a quantity of No. 1 cottonwood. Cottonwood is the favorite material for whisky boxes, and is now in more active demand even than low-grade poplar, and the latter, as is well known, has been on the active and scarce lists all spring. Cottonwood box boards have been selling well, and of late there has been some inquiries for this material in the Louisville market that the local dealer could not take care of. In oak the demand continues heavy for plain sawed and there is some improvement in quartered, though it has never caught up with plain oak and probably will not this season.

There are some inquiries from abroad, but the prices prevailing across the water do not offer as much inducement this season as those of the local markets. Oak, maple and beech flooring manufacturers have enjoyed a very good run of business lately, and the outlook is for a continued heavy run of business in hardwood flooring in this territory.

### London.

The market is still dull and likely to remain so for the next fortnight, the higher prices asked for all lumber not tempting buyers to contract for stock whilst the demand is so inactive. Most of the lumber recently arrived has been sold on the quays, but not at prices that are likely to tempt shipments.

Prime stocks of one-inch and under dressed whitewood are wanted, there being very little stock left in the docks. Culls are also in fair demand.

Parcels of plain oak in all grades are selling well, immediately on arrival, but there is little demand for quartered.

Black walnut in boards and planks would sell well and at good prices, but there is little offering. Prime logs fit for veneers are wanted.

There is very little stock of satin walnut and what there is does not move quickly.

There is at present a good demand for hickory and ash, in logs and planks.

Mahogany is still the leading wood and commands full prices. This wood seems to be in greater request than ever before among the manufacturers.

Cedar is scarce and good prices are being paid for parcels of rather inferior quality.

### Liverpool.

Trade in this market is undoubtedly better than it has been for some months past, and prices have been advanced. Shippers should, however, have orders before shipping, and on no account should they ship on consignment.

Ash planks and logs are in good request and prime white oak planks, especially 1½-inch and 3-inch, should bring fair prices, which many importers on this side think are now at the top. Plain oak planks are very scarce and prices for prime wood have advanced during the last few months.

Hickory is not quite so good as a fortnight ago; the heavy import of logs has rather filled up the consumers here for the present, and importers have difficulty in disposing of this wood at remunerative prices.

Quartered oak boards find quick sale and all the imports are going into consumption. At the last sales held at the end of last month nearly 2,000,000 feet of mahogany was disposed of and only 700 logs were withdrawn. It is reported that these were all disposed of privately.

American buyers would do well to cover their requirements well ahead, as there is an increasing demand for this wood in Great Britain.

Good board and panel logs are in great request and at the last sales could have been made ten times over. The first shipments of birch are being rapidly snapped up, but shippers seem to be showing a tendency to meet buyers, while maple of good sizes is also in good request.

Shippers should bear in mind that only plain rock maple should be shipped, wood with the hard "bird's eye" is absolutely unsalable. Manufacturers of oak and ash dimension stock could obtain large and profitable orders if they would guarantee prompt delivery.

John H. Burrell & Co.'s wood circular makes the following report regarding American hardwoods in the Liverpool market:

Round ash logs have again come forward in considerable quantities, principally on contract, the demand for ash lumber is not quite so active and values are somewhat easier. Prime parcels of good to large black walnut logs continue to command favorable attention, but small and faulty wood is very much neglected; supplies of the lumber have continued to arrive in excess of the demand and prices have further declined. Arrivals of hickory logs still continue in excess of the requirements and prices are falling; shipments should be curtailed until fall. Oak cabinet planks of prime quality and suitable specifications meet with ready sale at good prices; oak collar planks are still arriving plentifully and values are therefore weak; oak wagon planks have not been coming in as freely as last month, and as the stock is light and demand good the market is still in an encouraging position for prime shipments of good and suitable specifications. The demand for poplar logs is confined to large timber of prime quality; the supply of all descriptions of poplar lumber is still in excess of the demand. Inquiry for good, well-conditioned shipments of prime quality satin walnut lumber is moderate. Arrivals of staves have been moderate, but prices are easy.

# AT COST

✿ IS AN UNCOMMON TERM AS APPLIED TO INSURANCE ✿  
But this is the actual price of Indemnity against Fire Loss furnished by the

## MANUFACTURING LUMBERMEN'S UNDERWRITERS.

### THE STRONGEST INSURANCE ORGANIZATION TODAY IN AMERICA

---

The saving is not  
on a small portion  
of your Insurance  
but on the ✿ ✿  
ENTIRE LINE.  
There are other ad-  
vantages equally  
interesting. ✿ ✿

---



---

Only well built  
plants with ade-  
quate protection  
and at least five  
years timber supply  
are considered eligi-  
ble. ✿ ✿ ✿

---

For List of Members and further information Address

**HARRY RANKIN & COMPANY**  
KANSAS CITY, MO.

# Wanted and For Sale -SECTION-

Advertisements will be inserted in this section at the following rates:

For one insertion ..... 20 cents a line  
For two insertions ..... 35 cents a line  
For three insertions ..... 50 cents a line  
For four insertions ..... 60 cents a line

Eight words of ordinary length make one line. Heading counts as two lines. No display except the headings can be admitted.

Remittances to accompany the order. No extra charges for copies of paper containing the advertisement.

## EMPLOYES WANTED.

### SUPERINTENDENT.

A first class man in handle factory. Address "HANDLES," care HARDWOOD RECORD.

### SALESMAN WANTED.

Experienced hardwood salesman to travel east of Buffalo. State fully, experience, age, etc. BUFFALO HARDWOOD LUMBER CO., 940 Seneca Street, Buffalo, N. Y.

### LATHE OPERATOR.

An experienced man to operate Defiance Lathe. SOUTH BEND WOOD TURNING CO., Attica, Ind.

### INSPECTOR WANTED.

Capable man familiar with National hardwood inspection rules. State experience and wages wanted. GEORGE CRAIG & SONS, Winterburn, W. Va

## LUMBER WANTED

### WANTED—BRIDGE PLANK.

50,000 ft. 3" plank, 10 ft. long. White or Burr Oak. R. G. JESTER, Perrysville, Ind.

### WANTED.

4 4 1st & 2nd Butternut.  
4 4 1st & 2nd Chestnut.  
4 4 1st & 2nd Cherry.

W. R. CHIVVIS, Lesperance & Iron Mt. R. R., St. Louis, Mo.

### WANTED—HICKORY BLANKS.

In car load lots F. O. B. our track, and inspection from pay. SOUTH BEND WOOD TURNING CO., Attica, Ind.

### WANTED.

To contract for the output for this year of a good mill cutting Oak and Poplar lumber. Address "MORGAN," care HARDWOOD RECORD.

### GREEN WHITE AND RED OAK PLANK.

300 M ft., prefer White Oak, 2 1/2", 2 1/4", 2 3/4" and 3" thick, No. 1 Commons and Better. Prompt shipment. SICKLESTEEL LUMBER CO., Detroit, Mich.

### OAK WANTED.

3 and 4 inch White Oak; also Mixed Oak; also 12x12 Timbers and Piling of all kinds. CONTINENTAL LUMBER CO., 1213 Monadnock Bldg., Chicago, Ill.

### WANTED—POPLAR, OAK, CHESTNUT.

Will receive lumber at shipping point and pay cash. D. B. MURPHY & CO., London, Ky.

### CHESTNUT, POPLAR, OAK, ASH.

Wanted all grades and thicknesses. Send description and lowest cash price. Amount justities, will send buyer.

RODE & HORN, Brooklyn, N. Y.  
Southern Office: Johnson City, Tenn.

### WAGON STOCK.

Wagon poles, axles, bolsters, double trees of Oak, Maple, Ash and Hickory. THE WICKS LUMBER COMPANY, Battle Creek, Mich.

### WANTED.

200 M Log Run Plain Sawed White Oak, 1" & up.  
300 M Log Run Red Gum, 1"  
50 M Log Run Walnut, 1" & up.  
100 M No. 1 Com. & Bet. Ash, 1" & up, mostly 3" and up.  
100 M No. 1 Com. & Bet. Cottonwood, 1" & up.  
100 M No. 1 Com. & Bet. Tupelo Gum, 1" & up.  
Mill inspection; prompt cash. Address P. O. BOX 986, New Orleans, La.

### WHITE ASH WANTED.

50 M to 100 M feet of strictly clear, straight grain, second growth white ash, ranging from 3"x4" to 4"x5"—12 and 14 foot lengths, suitable for horse poles. AMERICAN-LA FRANCE FIRE ENGINE CO., Elmira, N. Y.

### WALNUT ONLY.

Wanted, Walnut lumber, green or dry, all grades, all thicknesses, log run or on grades. Highest market price paid. Liberal inspection. C. J. FRANK, 2440 N. New Jersey St., Indianapolis, Ind.

### WANTED—HARDWOOD LOGS.

200 M feet 25-inch and up White Oak logs.  
200 M. feet 12-inch and up Walnut logs.  
50 M. feet 12-inch and up Cherry logs.  
C. L. WILLEY,  
Blue Island Av. and Robey St., Chicago.

### OAK.

We are in the market for plain sawed oak, all grades and thicknesses. P. G. DODGE & CO., 2116 Lumber St., Chicago.

## MACHINERY WANTED

### WANTED.

Small second-hand planer and matcher in good repair. E. E. PORTER, Killmaster, Mich.

### AT ONCE.

If you are in need of machinery—new or second hand—a few lines in this column will place your wants before those who have such goods for sale. For particulars address HARDWOOD RECORD, Chicago, Ill.

## MACHINERY FOR SALE

### FOR SALE.

Having lost our woodenware plant by fire we offer for sale:

A complete machine shop equipment consisting of two iron lathes (one each large and small), one iron planer, one drill press, one forge with blower, one emery wheel stand (two wheel), two vises, tools, some material, counter shafts, line shaft, hangers, pulleys, belts. Two 60"x16" horizontal tubular boilers, rated at last inspection (Oct. 19, 1905) at 110 lbs. pressure. One two horse dump cart, almost new. Also about 500,000 ft. Maple Squares of various sizes and lengths. If interested apply to BELLAIRE WOODEN WARE CO., I. W. Bechtold, Sec'y, Bellaire, Mich.

### FOR SALE.

One six ft. Hoosier left-hand band mill, three block carriage, latest improved dogs, Soule feed, in use only about thirty days. WRIGHT BACHMAN LUMBER CO., Portland, Ark.

## TIMBER LANDS FOR SALE

### FOR SALE.

Two thousand acres Pennsylvania hardwood. Railroad now being graded through property. Low freight rates Pittsburg, Buffalo and Baltimore markets. Can show property any time. Address, "TIMBER," care HARDWOOD RECORD.

### UNUSUAL OPPORTUNITY.

For investment or manufacturing. About 3,836 acres, hardwood timber and lands; large, tall-bodied Oak, Hickory, White Ash, Sweet Gum, Cypress and other varieties, estimated fifty to fifty-five million feet; very rich bottom lands; one and one-half miles to nearest railway station; eighty-five miles by rail or water to Norfolk, Va., and fronting eight miles on Roanoke river, in western part of Bertie County, N. C. One can leave Washington or Baltimore in the evening and be on the property the following forenoon. No agents. Address BOX 488, care HARDWOOD RECORD.

## BUSINESS OPPORTUNITIES

### FOR SALE.

Lumber yard northern Indiana. Town 1,000. Good farming country, thickly settled. A well paying business, no opposition. A clean, big stock. Do not apply unless you have the money and mean business. Address H. 731, care HARDWOOD RECORD.

### SAW MILL AND TIMBER FOR SALE.

Saw Mill. Eight months' use. 20,000 capacity. On Frisco Railroad, at Frisbie, Mo., near Kennett, Mo. Millions of feet of good Oak, Cypress, Hickory and Gum. Price and terms reasonable. Best timber on the market in this country. Do not write unless you have money and mean business. A splendid bargain for a lumber broker. R. H. JONES, Kennett, Mo.

### HARDWOOD TIMBER.

A number of good mill propositions along the Cotton Belt Route. Tracts ranging from five hundred to twenty thousand acres, principally Oak, Hickory, Gum, Cypress, some Ash, Cottonwood and other hardwoods. Can be secured at very reasonable figures now—in some cases at less than \$1 per thousand stumpage. Choice openings for hardwood lumber mills, handle and spoke factories, slack coo-erage plants and other hardwood enterprises.

A number of points on the Cotton Belt offer free sites or will raise cash bonus or take stock in practical propositions. Let us have your wants and see what we can do for you.

E. W. LA BEAUME, G. P. & T. A., COTTON BELT, St. Louis, Mo.

## MISCELLANEOUS

### FACTS FROM PRACTICAL MEN.

The HARDWOOD RECORD is always in the market for articles on any and every feature of the hardwood industry. It wants practical statements of fact from practical men who know how certain things can be done in the best way. Literary quality not essential. Liberal pay for acceptable articles. Address Editor HARDWOOD RECORD.

## RAILWAY EQUIPMENT

### RAILS AND LOCOMOTIVES.

All inquiries for industrial railway equipment listed before "Record" readers will find ready response. HARDWOOD RECORD, Chicago, Ill.

# Advertisers' Directory

**NORTHERN HARDWOODS.**

American Lumber & Mfg. Co. . . . . 9  
 Arpin Hardwood Lumber Co. . . . . 48  
 Babcock Lumber Company . . . . . 9  
 Barnaby, C. H. . . . . 8  
 Beyer, Knox & Co. . . . . 55  
 Bliss & Van Auken . . . . . 10  
 Boyle, Clarence, Lumber Co. . . . . 54  
 Boyne City Lumber Co. . . . . 51  
 Briggs & Cooper Co. . . . . 4  
 Brownlee & Company . . . . . 50  
 Buffalo Hardwood Lumber Co. . . . . 55  
 Cadillac Handle Company . . . . . 3  
 Cheat River Lumber Co. . . . . 9  
 Cherry River Boom & Lbr. Co. . . . . 1  
 Chivvis, W. R. . . . . 5  
 Cincinnati Hardwood Lumber Co. . . . . 53  
 Cobbs & Mitchell, Inc. . . . . 3  
 Crosby & Beckley Co. The . . . . . 48  
 Crosby, C. P. . . . . 48  
 Cummer, Diggins & Co. . . . . 3  
 Darling, Chas. . . . . 54  
 David, A. H. Lumber Co. . . . . 11  
 Davis, John R., Lumber Co. . . . . 48  
 D'Heur & Swain Lumber Co. . . . . 8  
 Dennis Bros. . . . . 51  
 Dennis & Smith Lumber Co. . . . . 50  
 Dixon & Dewey . . . . . 52  
 Duhlmeier Bros. . . . . 52  
 Elias, G., & Bro. . . . . 55  
 Empire Lumber Co., Buffalo . . . . . 55  
 Estabrook Skeele Lumber Co. . . . . 54  
 Fall, E. H. . . . . 52  
 Flint, Erving & Stoner Co. . . . . 9  
 Freiberg Lumber Company . . . . . 53  
 General Lumber Company . . . . . 52  
 Goldie, J. S. . . . . 51  
 Haak Lumber Company . . . . . 51  
 Hackley-Phelps-Bonnell Co. . . . . 51  
 Hayden & Lombard . . . . . 54  
 Heath-Witbeck Company . . . . . 54  
 Holloway Lumber Co. . . . . 7  
 Ingram Lumber Company . . . . . 49  
 Jenks, Robert H., Lumber Co. . . . . 49  
 Jones Hardwood Company . . . . . 7  
 Keith Lumber Company . . . . . 54  
 Kelley Lumber & Shingle Co. . . . . 50  
 King & Bartles Lumber Co. . . . . 49  
 Kitzinger, Gns. . . . . 11  
 Leavitt Lumber Company . . . . . 10  
 Lesh & Matthews Lumber Co. . . . . 54  
 Lueban Lumber Company . . . . . 9  
 Litchfield, William E. . . . . 7  
 Long-Knight Lumber Company . . . . . 8  
 McClure Lumber Company . . . . . 50  
 McHvain, J. Gibson, & Co. . . . . 7  
 McLean, Hugh, Lumber Co. . . . . 55  
 Malley, Thompson & Moffett Co. . . . . 53  
 MacBride, Thos., Lumber Co. . . . . 51  
 Maley & Wertz . . . . . 8  
 Martin-Barriss Company . . . . . 49  
 Michigan Maple Company . . . . . 10  
 Miller, Anthony . . . . . 55  
 Mitchell Bros. Company . . . . . 3  
 Mowbray & Robinson . . . . . 53  
 Murphy & Diggins . . . . . 3  
 Nicola Bros. Company, The . . . . . 9  
 No. Vernon Pump & Lbr. Co. . . . . 8  
 Norman Lumber Company . . . . . 2  
 North Shore Lumber Company . . . . . 51  
 North Western Lumber Co. . . . . 48  
 Page & Landeck Lumber Co. . . . . 48  
 Perrine-Armstrong Company . . . . . 8  
 Peters, R. G., Salt & Lbr. Co. . . . . 51  
 Price, E. E. . . . . 5  
 Radina, L. W., & Co. . . . . 53  
 Rumbarger Lumber Company . . . . . 7  
 Schofield Bros. . . . . 7  
 Simmons Lumber Company . . . . . 51

Soble Bros. . . . . 6  
 Southern Oak Lumber Co. . . . . 6  
 Standard Hardwood Lbr. Co. . . . . 55  
 Stephenson, The I., Company . . . . . 10  
 Stewart, I. N., & Bro. . . . . 55  
 Stinson, J. V. . . . . 8  
 Sullivan, T., & Co. . . . . 55  
 Tegge Lumber Company . . . . . 9  
 Turner, A. M., Lumber Co. . . . . 9  
 Upham & Agler . . . . . 6  
 Van Keulen & Wilkinson Lumber Company . . . . . 51  
 Vollmar & Below . . . . . 48  
 Wegstaff, W. J. . . . . 54  
 Ward Lumber Company . . . . . 54  
 Wentworth, Chas. S., & Co. . . . . 7  
 White, W. H., Company . . . . . 50  
 Whitmer, Wm., & Sons, Inc. . . . . 7  
 Wiborg & Hanna Company . . . . . 53  
 Wiggin, H. D. . . . . 9  
 Willson Bros. Lumber Company . . . . . 9  
 Wistar, Underhill & Co. . . . . 55  
 Yeager, Orson E. . . . . 8  
 Young & Cutsinger . . . . . 10  
 Young, W. D., & Co. . . . . 10

**SOUTHERN HARDWOODS.**

Advance Lumber Company . . . . . 49  
 American Lumber & Mfg. Co. . . . . 9  
 Atlantic Lumber Company . . . . . 1  
 Bacon-Nolan Hardwood Co. . . . . 4  
 Beck, E. E., Lumber Company . . . . . 53  
 Beyer, Knox & Co. . . . . 55  
 Bennett & Witte . . . . . 53  
 Black, F. W., Lumber Co. . . . . 51  
 Bliss-Cook Oak Co. . . . . 41  
 Boyle, Clarence, Lumber Co. . . . . 54  
 Briggs & Cooper Co. . . . . 4  
 Brown, W. P., & Sons Lbr. Co. . . . . 2  
 Buffalo Hardwood Lumber Co. . . . . 55  
 Carrier Lbr. & Mfg. Co. . . . . 10  
 Cherry River Boom & Lbr. Co. . . . . 1  
 Chicago Veneer Company . . . . . 49  
 Chivvis, W. R. . . . . 5  
 Cincinnati Hardwood Lumber Co. . . . . 53  
 Crandall & Brown . . . . . 54  
 Crane, C., & Co. . . . . 53  
 Crittenden Lumber Co. . . . . 4  
 Crosby & Beckley Co. The . . . . . 48  
 Cypress Lumber Company . . . . . 52  
 Darling, Chas. . . . . 54  
 Davis, Edw. L., & Co. . . . . 2  
 Davidson-Benedict Company . . . . . 1  
 D'Heur & Swain Lumber Co. . . . . 8  
 Dennis & Smith Lumber Co. . . . . 50  
 Dierks Lumber & Coal Co. . . . . 10  
 Dixon & Dewey . . . . . 52  
 Duhlmeier Bros. . . . . 52  
 Dullweber, John, & Co. . . . . 53  
 Elias, G., & Bro. . . . . 55  
 Empire Lumber Co., Buffalo . . . . . 55  
 Estabrook-Skeele Lumber Co. . . . . 54  
 Fall, E. H. . . . . 52  
 Farrin-Korn Lumber Company . . . . . 52  
 Flint, Erving & Stoner Co. . . . . 9  
 Freiberg Lumber Company . . . . . 53  
 Garetson-Greason Lumber Co. . . . . 51  
 Hackley-Phelps-Bonnell Co. . . . . 51  
 Hafner Mfg. Co. . . . . 54  
 Heath-Witbeck Company . . . . . 54  
 Himmelberger-Harrison Lumber Company . . . . . 1  
 Jenks, Robert H., Lumber Co. . . . . 49  
 Jones Hardwood Company . . . . . 7  
 Kentucky Lumber Company . . . . . 52  
 Kentucky Lumber & Veneer Co. . . . . 2  
 King & Bartles Lumber Co. . . . . 49  
 Keith Lumber Company . . . . . 54  
 Leavitt Lumber Company . . . . . 10

Lesh & Matthews Lumber Co. . . . . 54  
 Lueban Lumber Company . . . . . 9  
 Litchfield, Wm. E. . . . . 7  
 Loomis & Hart Mfg. Co. . . . . 6  
 Long-Knight Lumber Company . . . . . 8  
 Luehrmann, Chas. F., Hardwood Lumber Company . . . . . 5  
 McClure Lumber Company . . . . . 50  
 McHvain, J. Gibson, & Co. . . . . 7  
 McLean, Hugh, Lumber Co. . . . . 55  
 Malley, Thompson & Moffett Co. . . . . 53  
 Martin-Barriss Company . . . . . 49  
 Miller, Anthony . . . . . 55  
 National Lumber Mfg. Co. . . . . 54  
 Nicola Bros. Company . . . . . 9  
 Norman Lumber Company . . . . . 2  
 Ozark Cooperage Co. . . . . 5  
 Paepcke-Leicht Lumber Co. . . . . 4  
 Page & Landeck Lumber Co. . . . . 48  
 Price, E. E. . . . . 5  
 Radina, L. W., & Co. . . . . 53  
 Ransom, J. B., & Co. . . . . 6  
 Ritter, W. M., Lumber Co. . . . . 56  
 Roy Lumber Company . . . . . 41  
 Rumbarger Lumber Company . . . . . 7  
 Schofield Bros. . . . . 7  
 Smith, W. E., Lumber Co. . . . . 6  
 Southern Oak Lumber Co. . . . . 6  
 Standard Hardwood Lbr. Co. . . . . 55  
 Steele & Hibbard . . . . . 5  
 Stewart, I. N., & Bro. . . . . 55  
 Stevens-Eaton Company . . . . . 7  
 Stinson, J. V. . . . . 8  
 Stoneman-Zearing Lumber Co. . . . . 5  
 Stutz Lumber Company, Inc. . . . . 2  
 Sullivan, T., & Co. . . . . 55  
 Swann-Day Lumber Company . . . . . 6  
 Thomas & Proetz Lumber Co. . . . . 5  
 Three States Lumber Company . . . . . 4  
 Turner, A. M., Lumber Co. . . . . 9  
 Upham & Agler . . . . . 6  
 Ward Lumber Company . . . . . 54  
 Wentworth, Chas. S., & Co. . . . . 7  
 Whitmer, Wm., & Sons, Inc. . . . . 7  
 Wiborg & Hanna Company . . . . . 53  
 Wiggin, H. D. . . . . 9  
 Willson Bros. Lumber Company . . . . . 9  
 Yeager, Orson E. . . . . 55

Luehrmann, C. F., Hardwood Lumber Company . . . . . 5  
 Ozark Cooperage Co. . . . . 5  
 Paepcke-Leicht Lumber Co. . . . . 4  
 Smith, W. E., Lumber Co. . . . . 4  
 Stoneman-Zearing Lumber Co. . . . . 5  
 Stutz Lumber Company, Inc. . . . . 2  
 Three States Lumber Co. . . . . 4

**CYPRESS.**

Crandall & Brown . . . . . 54  
 Cypress Lumber Company . . . . . 52  
 Hafner Mfg. Co. . . . . 5  
 Lothman Cypress Co. . . . . 5  
 Thompson, J. W., Lumber Co. . . . . 4

**HARDWOOD FLOORING.**

Bliss-Cook Oak Company . . . . . 41  
 Bliss & Van Auken . . . . . 10  
 Carrier Lbr. & Mfg. Co. . . . . 10  
 Cobbs & Mitchell, Inc. . . . . 3  
 Cummer, Diggins & Co. . . . . 3  
 Haak Lumber Company . . . . . 51  
 Mitchell Bros. Company . . . . . 3  
 Nashville Hardwood Flooring Company . . . . . 4  
 Pease Company, The . . . . . 52  
 Stephenson, The I., Company . . . . . 10  
 Wood Mosaic Flooring Co. . . . . 2  
 Young, W. D., & Co. . . . . 10

**SAW MILL MACHINERY.**

Mershon Company, The . . . . . 48  
 Phoenix Mfg. Company . . . . . 48

**WOOD WORKING MACHINERY**

American Wood Working Machinery Company . . . . . 43  
 Berlin Machine Works, The . . . . . 54  
 Boland Machine Works . . . . . 42  
 Ober Mfg. Company, The . . . . . 49  
 Smith, H. B., Machine Company . . . . . 47

**VENEER MACHINERY**

Co. Manufacturing Company . . . . . 47

**LOGGING MACHINERY.**

Clyde Iron Works . . . . . 42  
 Overpack, S. C. . . . . 50  
 Russell Wheel & Foundry Co. . . . . 46

**LUMBER INSURANCE.**

Lumber Insurance Company of New York . . . . . 9  
 Lumber Mutual Fire Insurance Company, Boston . . . . . 1  
 Lumber Underwriters . . . . . 1  
 Pennsylvania Lumbermen's Mutual Fire Insurance Company . . . . . 38  
 Rankin, Harry & Co. . . . . 38  
 Toledo Fire & Marine Ins. Co. . . . . 48

**SAWS, KNIVES AND SUPPLIES**

Atkins, E. C., & Co. . . . . 45  
 Hatchett Swage Works . . . . . 50  
 Champion Saw Company . . . . . 42 & 45  
 Shimer, S. J., & Sons . . . . . 45

**MISCELLANEOUS.**

Barroll, H. C., & Co. . . . . 10  
 Lacey, J. D., & Co. . . . . 44  
 Lumbermen's Credit Assn. . . . . 52  
 Pease Company, The . . . . . 52  
 Schenck, C. A., & Co. . . . . 48

**POPLAR.**

Advance Lumber Company . . . . . 49  
 Atlantic Lumber Company . . . . . 1  
 Bennett & Witte . . . . . 53  
 Brown, W. P., & Sons Lbr. Co. . . . . 2  
 Cheat River Lumber Company . . . . . 9  
 Chicago Veneer Company . . . . . 40  
 Crane, C., & Co. . . . . 53  
 Davis, Edw. L., & Co. . . . . 2  
 Davidson-Benedict Company . . . . . 1  
 Dawkins, W. H., Lumber Co. . . . . 52  
 Hayden & Lombard . . . . . 54  
 Kentucky Lumber Company . . . . . 52  
 Kentucky Lbr. & Veneer Co. . . . . 2  
 Loomis & Hart Mfg. Co. . . . . 6  
 National Lumber Mfg. Co. . . . . 54  
 Ritter, W. M., Lumber Co. . . . . 56  
 Roy Lumber Company . . . . . 41  
 Stevens-Eaton Company . . . . . 7  
 Swann-Day Lumber Company . . . . . 6  
 Thomas & Proetz Lumber Co. . . . . 5  
 Vansant, Kitchen & Co. . . . . 56  
 Yellow Poplar Lumber Co. . . . . 56

**COTTONWOOD AND GUM.**

Bacon-Nolan Hardwood Co. . . . . 4  
 Farrin-Korn Lumber Company . . . . . 52  
 Himmelberger-Harrison Lumber Company . . . . . 1

# CHICAGO VENEER COMPANY

(INCORPORATED)

MANUFACTURERS OF

## Veneer and Lumber

### YELLOW POPLAR A SPECIALTY

General Office,  
 Veneer Mills:  
 BURNSIDE,  
 KENTUCKY.

Lumber Mills:  
 TATEVILLE,  
 KENTUCKY.

We make a Specialty of  
**Sound Wormy Chestnut.**  
 If in the market to buy or sell, write us.  
**A. H. DAVID LUMBER COMPANY,**  
 GRAND RAPIDS, MICH.

**GUS. KITZINGER**  
**Michigan Hardwoods**  
 By Car or Cargo. Manistee, Mich.

**BLISS=COOK OAK**  
**COMPANY**  
 BLISSVILLE, ARK.

**MANUFACTURERS**  
 Contemplating establishing plants  
 in the West should take advantage  
 of a location on



**Chicago & North-Western Ry.**  
 which reaches the famous

**WATER POWERS,  
 COAL FIELDS,  
 IRON ORE RANGES,  
 HARD AND SOFT  
 LUMBER DISTRICTS,  
 MINING DISTRICTS**

of the West and Northwest, and  
 affords the best means of transporta-  
 tion to the markets of the world.

FOR FURTHER PARTICULARS APPLY TO  
**MARVIN HUGHITT, Jr., E. D. BRIGHAM,**  
 Freight Traffic Manager, Gen'l Freight Agent,  
**GEO. BONNELL,**  
 Industrial Agent,  
 NW513 CHICAGO.

**Locations for  
 Industries**  
 ON  
**THE ERIE, THE COMMERCIAL RAILROAD**  
 CHICAGO TO NEW YORK

The Erie Railroad System's Industrial Department has all the territory traversed by the railroad districted in relation to resources, markets and advantages for manufacturing, can advise with manufacturers of specific products as to suitable locations, and furnish them with current information of a comprehensive nature dealing with the project in its full relation to manufacture and commerce.

The Erie is one of the greatest of trunk lines. Its own rails connect the two largest cities of America. Every section of the System has its particular merits. Profitable locations exist. It has great general and coal, oil and natural gas resources.

It is important in this age of modern facilities for manufacturers to locate where they can obtain side tracks so as to receive from and ship directly into cars at the factory. Information can be promptly furnished in this connection about every point on the system between New York and Chicago.

Manufacturers' inquiries as to locations are treated in strict confidence and absolutely reliable information, so as to promote permanent traffic, is furnished. Address

**LUIS JACKSON**  
 Industrial Commissioner  
 Erie Railroad Company  
 21 Cortlandt Street, New York

MANUFACTURERS  
**Hardwood  
 Lumber**  
 and  
**Flooring**

We manufacture 15,000,000 feet of Oak Lumber per year for export and domestic markets, from 3/8 to 4 inches thick.

Also Quartered and Plain Polished Oak Flooring, kiln dried, end matched, hollow back

**Mills and Flooring Plants at  
 SHULTS AND BLISSVILLE, ARKANSAS**



**WALNUT,  
 OAK,  
 ASH,  
 POPLAR.**

**WOOD WORKING  
 PLANTS**

Manufacturers seeking locations for Saw Mills, Stave and Heading Factories and other Wood Working Plants in the Central Southern States, can secure full and accurate information as to Sites, Timber Tracts, Fuel, Transportation Facilities, etc., by addressing

**G. A. PARK,**  
 General Immigration and Industrial Agent

**Louisville & Nashville  
 Railroad Company**

Louisville, Kentucky

**INDUSTRIES  
 ARE  
 OFFERED  
 LOCATIONS**

WITH

**Satisfactory Inducements,  
 Favorable Freight Rates,  
 Good Labor Conditions,  
 Healthful Communities,**

ON THE LINES OF  
**THE ILLINOIS CENTRAL R. R.**  
 AND THE  
**YAZOO & MISSISSIPPI VALLEY R. R.**

For full information and descriptive pamphlet address

**J. C. CLAIR,**  
 Industrial Commissioner,  
 1 Park Row, Chicago, Ill.

**HARDWOOD  
 TIMBER**

There is no section with so fine and large a supply of hardwood timbers of various kinds left for the lumbermen as that portion of the South in Alabama, Georgia, Kentucky, Mississippi, North Carolina, South Carolina, Tennessee and Virginia served by the lines of the

**Southern Railway  
 and  
 Mobile & Ohio Railroad**

There are oak, poplar, hickory, gum, cypress, ash, elm, buckeye, balsam, spruce, chestnut, and other varieties. There are also available pine lands. These timber resources and many other important features bearing on the cost of manufacture and marketing give special advantages and opportunities for EVERY KIND OF WOOD USING INDUSTRY. We have information about the best locations in the country at towns in these States and in Southern Indiana and Southern Illinois, which will be given if requested. All correspondence in regard to timber lands or factory locations will be given prompt and confidential attention. Address your nearest agent.

**M. V. RICHARDS,**  
 Land and Industrial Agent,  
 Washington, D. C.

**CHAS. S. CHASE,** Agent,  
 622 Chemical Building,  
 St. Louis, Mo.

**M. A. HAYS,** Agent,  
 225 Dearborn Street,  
 Chicago, Ill.



# "DEFIANCE" WOOD-WORKING MACHINERY

COMPLETE EQUIPMENTS OF  
HIGH GRADE TOOLS

✻ FOR MAKING ✻

Hubs, Spokes, Wheels,  
Wagons, Carriages,  
Rims, Shafts, Poles,  
Neck-Yokes,

Single Trees, Hoops,  
Handles, Bobbins, Spools,  
Insulator Pins and  
Oval Wood Dishes.

INVENTED AND BUILT BY

The DEFIANCE MACHINE WORKS  
DEFIANCE, OHIO.

Send for 500 Page Catalogue

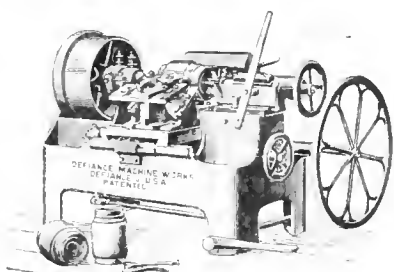

No. 1 AUTOMATIC HUB LATHE.

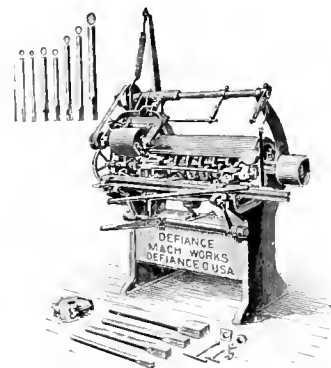

32 IN. AUTOMATIC SPOKE LATHE.

## KNIVES

*Evenness of temper, correct finish, two points  
in the making of good knives that we observe  
to your economy. All the knives you use.*

CHAMPION SAW COMPANY,  
BEAVER FALLS, PA.

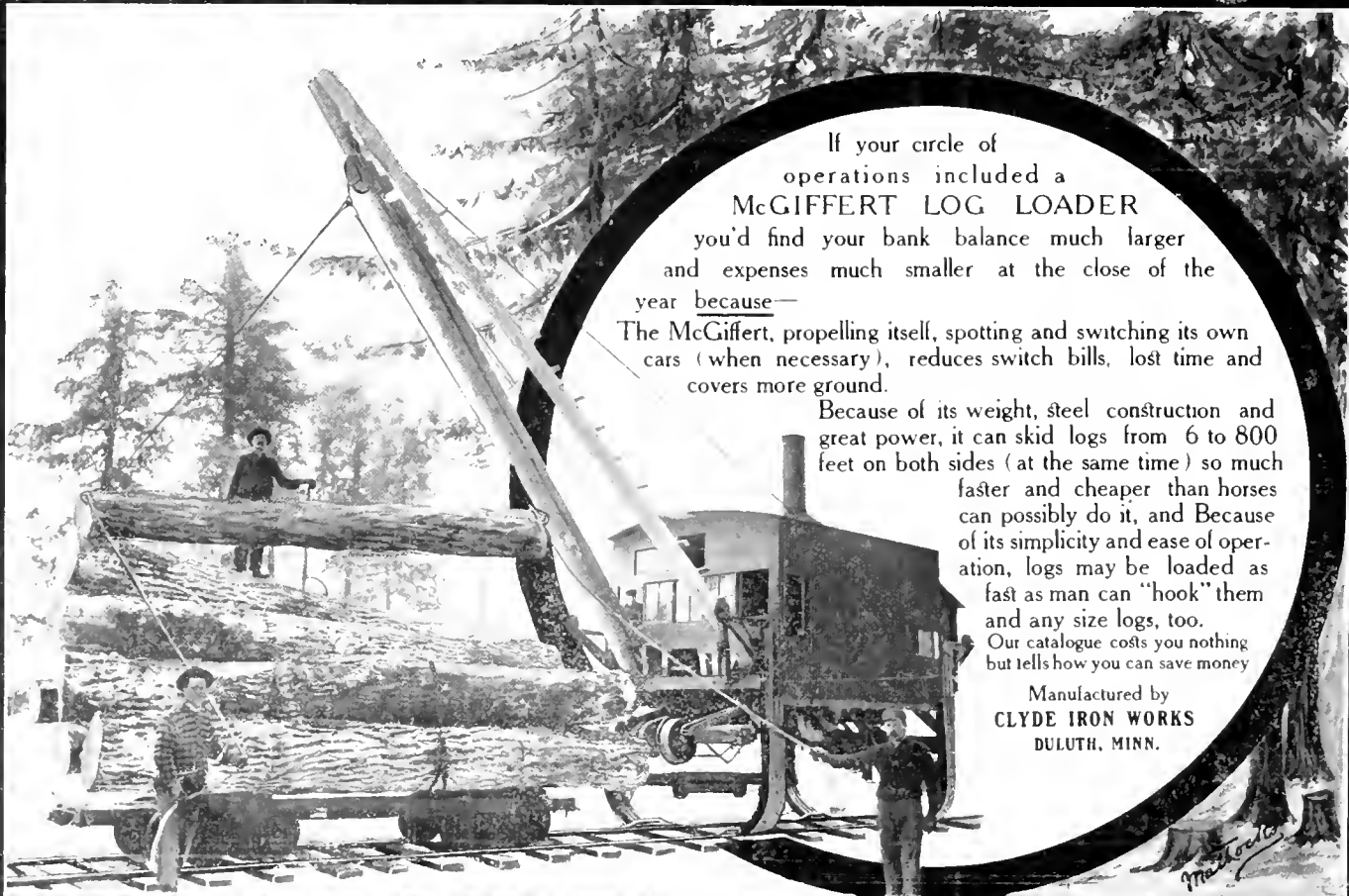

If your circle of  
operations included a  
McGIFFERT LOG LOADER  
you'd find your bank balance much larger  
and expenses much smaller at the close of the  
year because—

The McGiffert, propelling itself, spotting and switching its own  
cars (when necessary), reduces switch bills, lost time and  
covers more ground.

Because of its weight, steel construction and  
great power, it can skid logs from 6 to 800  
feet on both sides (at the same time) so much  
faster and cheaper than horses  
can possibly do it, and Because  
of its simplicity and ease of oper-  
ation, logs may be loaded as  
fast as man can "hook" them  
and any size logs, too.

Our catalogue costs you nothing  
but tells how you can save money

Manufactured by  
CLYDE IRON WORKS  
DULUTH, MINN.



STOP AND CONSIDER THE SAVING TO YOU BY USING OUR

# AMERICAN No. 1 BAND RIP SAW

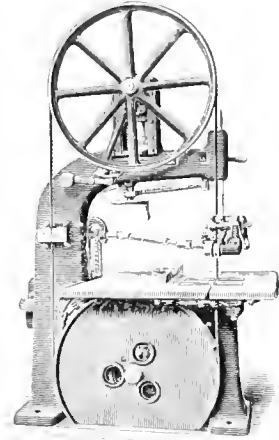
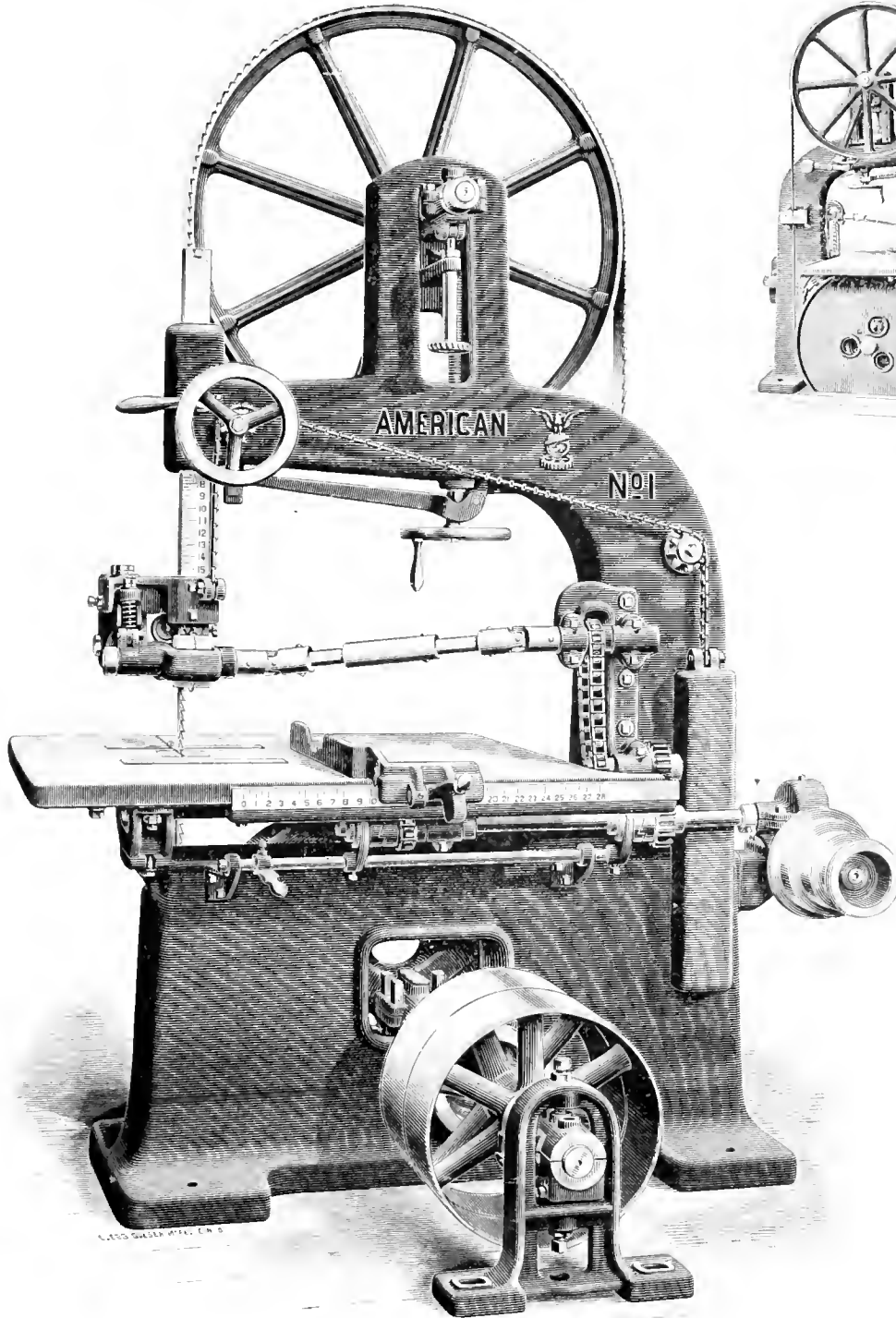

If you want facts, write us.

Are you in need of Machinery? Tell us your wants.

Get our Catalogue and Sander Pamphlet.



## American Wood-Working Machinery Co.

NEW ORLEANS

CHICAGO

NEW YORK

# Timber Lands

OUR SPECIALTY



We have several

## Yellow Pine Tracts

in Alabama, Louisiana and Mississippi  
for sale. Our own estimates on  
every tract. We guarantee  
our representations.

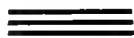

**JAMES D. LACEY & CO.**

608 Hennen Building, NEW ORLEANS. 1200 Old Colony Building, CHICAGO.

507 Lumber Exchange, SEATTLE, WASH.

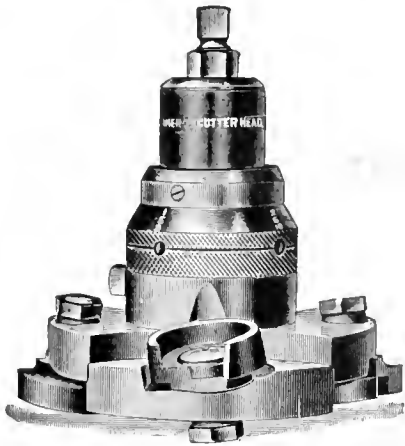

## The Shimer Cutter Heads

**Pay You Big Profits,  
Saving Your Workmen's Time.**

The man who is well up in the mill business understands the important place good tools hold in economizing time. Whatever reduces his time improves his system and enables him to become more useful and proficient in mill management. In actual practice a Straight Cutter, which is the cheapest of all in its first cost, proves a most expensive shift-about in the doing of things. It requires careful fitting and re-fitting to pattern at each sharpening, and haste in this item is often responsible for the ill-shaped work found upon the market in many localities.

**Samuel J. Shimer & Sons, Milton, Penna.**

# SAWS

There is a skill of workmanship and an accuracy of finish in Champion products found in no other saws. ☐ That is one reason why these saws serve you well. :: :: :: :: ::

## CHAMPION SAW CO.

BEAVER FALLS, PA.



## THE SAWS OF QUALITY

'Material, Temper, Workmanship

**PERFECT**

## THE SAWS FOR YOU

WRITE FOR QUOTATIONS

# E. C. Atkins & Co.,

(Incorporated)

HOME OFFICE AND FACTORY,

INDIANAPOLIS, U. S. A.

BRANCHES:

ATLANTA,  
CHICAGO,  
MEMPHIS.

MINNEAPOLIS,  
NEW ORLEANS,  
NEW YORK CITY,  
TORONTO, CANADA.

PORTLAND,  
SAN FRANCISCO,  
SEATTLE.

# RUSSEL TRIP STAKE HOLDER

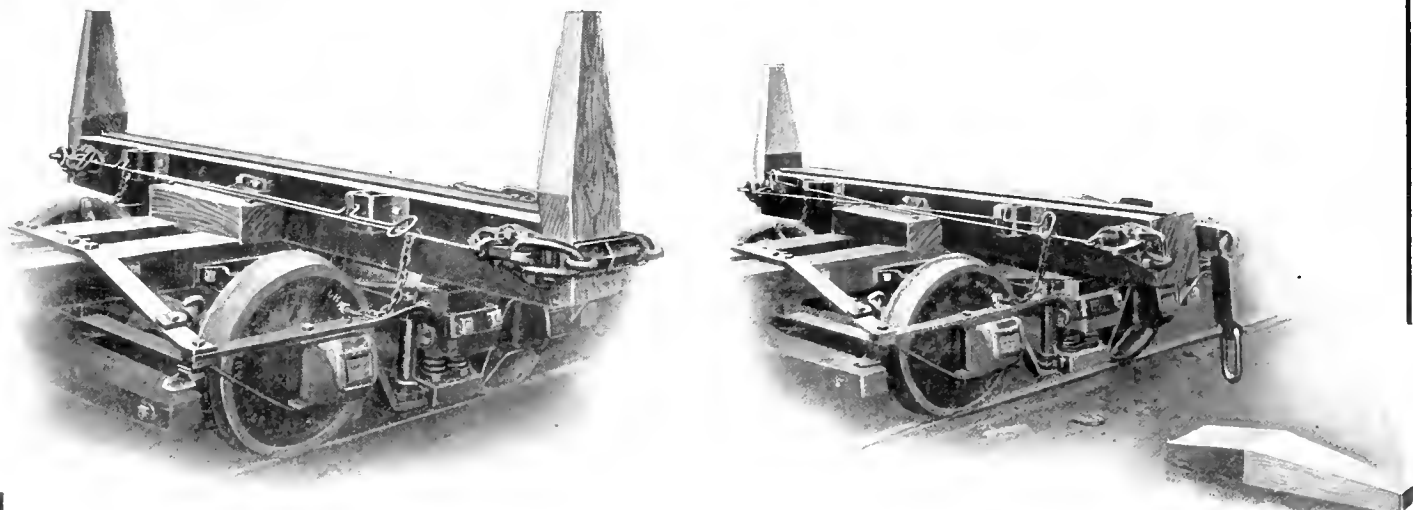

☞ You've all had your troubles with make-shift devices, with wrecks, with injuring or killing men, with cost and cussing.

☞ We offer a practical, strong and simple device that will hold logs firmly on bunk while they are being handled, and which will allow loads to be quickly and easily unloaded without danger to men.

☞ One man can quickly set up holders and stakes for a train. Stakes can *only* be tripped from side *opposite* that on which logs are dumped.

☞ When loading logs, or after cars are loaded, stakes are positively locked. Can be applied to any style of car, wagon or sled that has wood bunks.

☞ The picture tells the story. Equip one car and you'll order a full complement.

☞ Our stake holders are like all our logging machinery and cars—backed by our guaranty of the *best on the market*.

☞ Let us tell you more about them. Write us.

**RUSSEL WHEEL AND FOUNDRY CO.,**  
**DETROIT, MICHIGAN, U. S. A.**

A PAGE OF THE FAMOUS COE VENEER MACHINERY

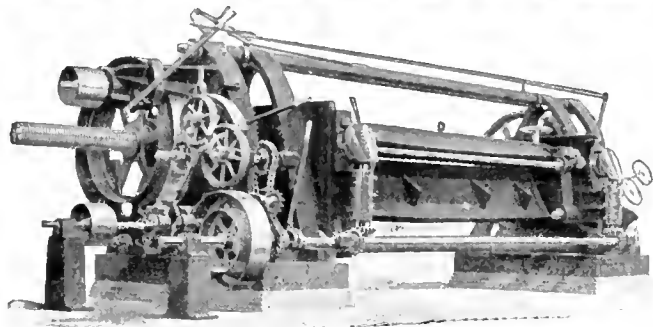

Style A Veneer Cutter

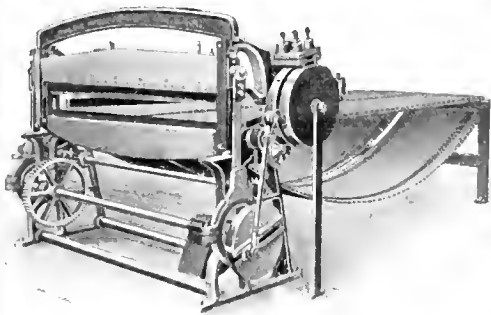

Coe Clipper

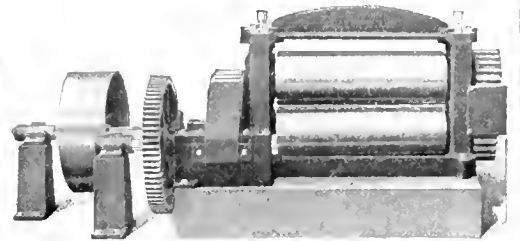

Coe Wringer

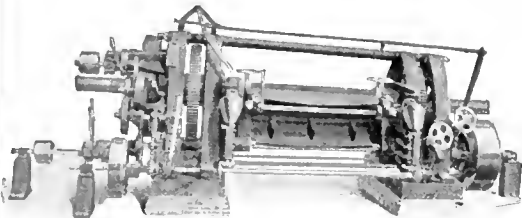

Style D Veneer Cutter

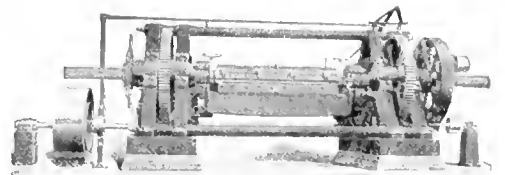

Style B Veneer Cutter

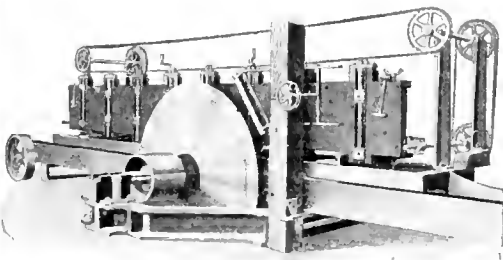

Coe Veneer Saw

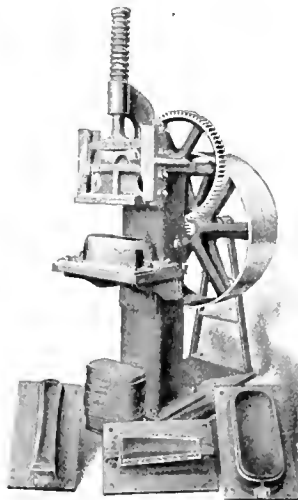

Coe Stamper

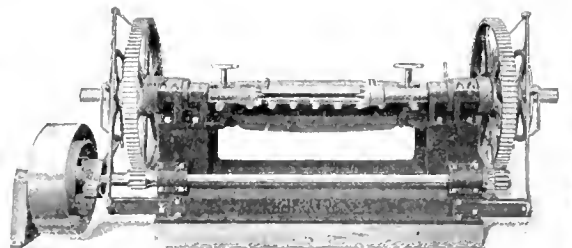

Style H Veneer Cutter

These machines and many others are fully described in our 1906 Catalog No. 5. Write for a copy to-day.

THE COE MFG. CO.

105 BERNARD STREET

PAINESVILLE, OHIO

**WISCONSIN**  
WHERE THE FINEST NORTHERN HARDWOODS GROW

**C. P. CROSBY**  
RHINELANDER : : : : WISCONSIN

**Wholesale Hardwood Lumber**

Hard Maple a Specialty in all thicknesses from 1 inch to 4 inch. Finest Birch in Wisconsin. Black Ash, Rock Elm, Soft Elm, Red and White Oak. : :

DIFFICULT AND MIXED ORDERS A SPECIALTY

**North Western Lumber Co.**  
GENERAL OFFICES: EAU CLAIRE, WIS. MILLS AT STANLEY, WIS.

BAND SAWED

**Wisconsin Hardwoods**  
CAREFUL GRADINGS PROMPT SHIPMENTS

SPECIALTIES:  
Inch No. 2 Common Birch Inch No. 3 Common Birch

MIXED CARS - EVEN GRADES - PROMPT SHIPMENT

**Wisconsin Hardwoods**

SPECIAL OFFERINGS:  
1" No. 1 Common and Better Birch (Red in)  
1" No. 1 Common and Better Basswood  
1" No. 1 Common and Better Hard Maple  
Also Elm, Pine, Cedar Products,  
and "SHAKELESS" Hemlock.

**John R. Davis Lumber Company**  
PHILLIPS, : : : : WISCONSIN

**VOLLMAR & BELOW**  
MARSHFIELD, WISCONSIN

**Basswood, Birch**  
and Other Wisconsin Hardwoods

LET US KNOW WHAT YOU ARE IN THE MARKET FOR

**ARPIN HARDWOOD LUMBER CO.**  
GRAND RAPIDS, - - - WISCONSIN  
Saw and Planing Mill at Atlanta, near Bruce, Wis., on Soo Lines.

Manufacturers

**Wisconsin Hardwoods**  
PINE AND HEMLOCK

WRITE US FOR PRICES ON  
1, 1½, 2 INCH PLAIN AND RED BIRCH. 1½ INCH RED BIRCH.  
1 INCH NO. 1 AND NO. 2 BASSWOOD. RED BIRCH FLOORING.

**Lumbermen, Attention!**

If you own any timber or timber lands.  
If you are contemplating buying or selling any timber or timber lands.  
If you want your stumpage accurately estimated.  
If you want an exact survey or map of your property.  
If you want advice in any logging or lumbering proposition.  
Write to us and find out what we can do for you.  
We send thoroughly reliable and practical engineers to all parts of the country, and guarantee quick and accurate work.

**C. A. Schenck & Co.** DAVIDSON'S RIVER, NORTH CAROLINA  
Consulting Forest Engineers

<p><b>NORTHERN STOCK</b></p> <p>Hemlock Birch Basswood Rock Elm Soft Elm Ash Oak</p>	<p><b>SOUTHERN STOCK</b></p> <p>Quartered White and Red Oak Plain White and Red Oak Sycamore Poplar Cypress Gum</p>
--	---

**PAGE & LANDECK LUMBER CO.**  
Wells Building - - - MILWAUKEE, WIS.



**Ten per cent  
More Profit**

The profits of a saw mill can readily be increased ten per cent by using a band mill instead of a rotary. The price of this mill with six foot wheels for saws eight inches wide is readily within the reach of all. It cuts smooth and perfect lumber and has a capacity of 25,000 feet to 35,000 feet per day. It runs with less expenditure of power than a rotary and puts only half as much of the log into saw dust as does the circular saw.

**PHOENIX MFG. COMPANY,**  
EAU CLAIRE, WIS.

# CLEVELAND

HARDWOOD DISTRIBUTING CENTER OF NORTHERN OHIO

## Do You Want It? What? Money?

What have you in lumber to exchange for it? We want particularly Plain Oak, Chestnut, Poplar, Basswood, Ash.

What Have You?

## The Advance Lumber Co.

13th Floor  
Rockefeller Bldg. CLEVELAND, OHIO

Memphis Office, No. 56 Randolph Building J. E. MEADOWS, Mgr.

## THE ROBERT H. JENKS LUMBER COMPANY

### FOR SALE

60 M feet 1" 1st and 2ds Poplar  
223 M feet 1" No. 1 Common Poplar  
125 M feet 1" No. 2 Common Poplar  
25 M feet 2" 1st and 2nd Poplar, 14" and up  
125 M feet 8 4" Sound Wormy Chestnut  
275 M feet 1" Sound Wormy Chestnut  
153 M feet 1" 1st and 2nd Plain White Oak  
85 M feet 1" 1st and 2nd Plain Red Oak  
125 M feet 1" No. 1 Common Plain Red Oak

**Quartered White and Red Oak.**—We have a good assortment of dry stock,  $\frac{3}{8}$  to  $\frac{1}{2}$  inches thick. Your inquiries solicited.

**Plain White and Red Oak.**—A limited amount of nice stock, ready for shipment.

## The King & Bartles Lumber Company

We have in pile at our Cleveland yard the following

2,000' 16 4" No. 1 Common and Better Birch, unselected.	18,200' 8 4" 1sts and 2nds Plain Birch.
7,520' 12 4" No. 1 Common and Better Birch, unselected.	11,558' 6 4" 1sts and 2nds Red Birch.
4,125' 10 4" No. 1 Common and Better Birch, unselected.	18,464' 5 4" 1sts and 2nds Red Birch.
15,051' 8 1" 1st and 2nds Red Birch	40,950' 4 4" 1sts and seconds Basswood, 7" and wider, 14 and 16".
	48,250' 4 4" No. 1 Common Basswood, 7" and wider, largely 14 and 16".

Yard and Office: No. 1955-2025 Scranton Road, N. W.,

CLEVELAND : : : : OHIO

## MARTIN-BARRISS COMPANY

Importers and Manufacturers  
**MAHOGANY**

—AND FINE—  
**HARDWOODS**

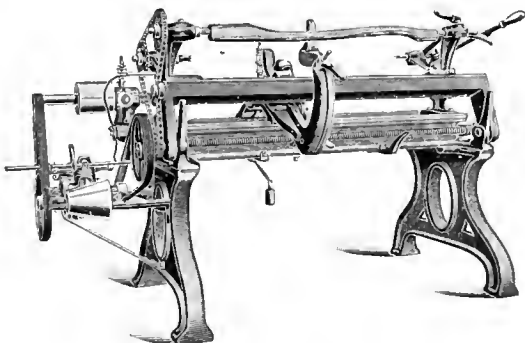

This cut shows the **No. 1 OBER LATHE** for turning Axe, Adze, Pick, Sledge, Hammer and Hatchet Handles, Spokes, Whiffletrees, Gun Stocks, Lasts and other irregular work.

## Simple, Strong, Durable, Economical

We also manufacture other lathes for making handles, spokes and variety work, sanders, shapers, boring and chucking machines, rip saws, etc., etc. Complete catalogue and price list free.

## THE OBER MFG. CO.

28 Belt St., Chagrin Falls, O., U. S. A.



# MICHIGAN

FAMOUS FOR HARD MAPLE AND GREY ELM

## APRIL STOCK LIST

MAPLE		BIRCH		BASSWOOD	
1 in.	2,000,000 ft.	1 in.	500,000 ft.	1 in.	300,000 ft.
1 1/4 "	100,000 "	1 1/2 "	100,000 "	1 1/4 "	30,000 "
1 1/2 "	400,000 "	2 "	100,000 "	1 1/2 "	50,000 "
2 "	1,000,000 "	2 1/2 "	50,000 "	2 "	75,000 "
2 1/4 "	200,000 "	3 "	75,000 "	3 "	4,000 "
2 1/2 "	500,000 "	<b>ROCK ELM</b> 2 in. 25,000 ft. 2 1/4 " 50,000 "			
3 "	500,000 "				
4 "	400,000 "	<b>GRAY ELM</b> 1 in. 300,000 ft. 1 1/2 " 200,000 " 3 " 200,000 "			
BEECH		WHITE MAPLE		ASH	
1 in.	500,000 ft.	End Piled		1 in.	500,000 ft.
1 1/4 "	250,000 "	1 in.	100,000 ft.		
1 1/2 "	400,000 "	1 1/2 "	20,000 "		
2 "	100,000 "	2 "	50,000 "		
2 1/2 "	200,000 "				

KELLEY LUMBER & SHINGLE CO., Traverse City, Mich.

## DENNIS & SMITH LUMBER CO.

Wholesale Hardwood Lumber

Office and Yards, FOURTH AND HOLDEN AVENUES,  
DETROIT, MICH.

MILLS AT: Heaters, W. Va. Valley Bend, W. Va. Diana, W. Va. Parkersburg, W. Va. McNutt Siding, W. Va.

"THE THICK MAPLE FOLKS"

# BROWNLEE & COMPANY

DETROIT MICHIGAN

MANUFACTURERS OF

Michigan Hardwoods

DOCKS AND PLANING MILL, RIVER ROUGE, SOUTH DETROIT  
CITY OFFICE, 303 TELEGRAPH BLDG.

## McCLURE LUMBER COMPANY

MANUFACTURERS OF  
**Hardwoods**

Main Offices, DETROIT, MICH.  
Mills, EUTAW, ALA.

SPECIAL OFFERINGS:

3 cars 3 and 4" Nos. 1 & 2 White Ash. 1 car 2" Nos. 1 & 2 Red Ash.  
2 cars 4" Common White Ash. 2 cars 1 to 2" Nos. 1 & 2 White Ash.  
1 car 2" Nos. 1 & 2 White Ash. 10 cars 2 to 4" Dry Hard Maple.  
5 cars 1" Dry Log Run Birch.

## SWAGE YOUR SAWS

WITH THE

Hanchett Adjustable Swage

Made for either Band or Circular Saws. Every Swage thoroughly tested and fully guaranteed. For full information write for Catalog No. 10.

Manufactured by

**Hanchett Swage Works**

BIG RAPIDS, MICH., U. S. A.



Hanchett Circular Saw Swage

## Michigan Logging Wheels

Have Made More Than 1,000 and Know How.

Standard for a Quarter Century



Cheap and easy logging. S. C. OVERPACK

MANISTEE, MICH.

W. H. WHITE, Pres.  
JAS. A. WHITE, Vice-Pres.

W. L. MARTIN, Secy.  
THOS. WHITE, Treas.

# W. H. WHITE COMPANY

BOYNE CITY, MICHIGAN

Manufacturers of Hardwood and Hemlock Lumber, Cedar Shingles,  
White Rock Maple Flooring.



**M I C H I G A N**  
FAMOUS FOR RED BIRCH AND BASSWOOD

**OUR MAPLE FLOORING**

is as near perfection, in every particular, as it is possible to make it, for we personally supervise every step in its manufacture, from the stump to the shipping of the finished product. Our prices will interest and a trial convince you.

**HAAK LUMBER COMPANY**  
HAAKWOOD, MICHIGAN

**Hackley-Phelps-Bonnell Co.**  
MANUFACTURERS OF  
**Northern and Southern Hardwood Lumber**  
Main Office, Michigan Trust Company Building  
GRAND RAPIDS : : : MICHIGAN

**DENNIS BROS.**  
GRAND RAPIDS, : : : MICHIGAN  
MANUFACTURERS OF  
**Hardwood Lumber, Perfect Birch and Maple Flooring**

**DRY STOCK AT BARGAIN PRICES:**  
2 cars 8 4 Basswood, No. 1 Common and Better.  
3 cars 5 4 Basswood, No. 2 Common and Better.  
15 cars 4 4 Birch, No. 1 and 2 Common  
1 car 1x4 Clear Birch Strips  
2 cars 4 4 No. 3 Common Cherry.  
60M feet 12 4 Hard Maple.  
245M feet 8 4 Hard Maple.  
40M feet 8 4 Hard Maple, No. 3 Common.

Main Office :  
205-209 Michigan  
Trust  
Company  
Building

**Thos. MacBride Lumber Company**  
HEADQUARTERS FOR  
**HARDWOODS**  
I N M I C H I G A N  
Michigan Trust Building, Grand Rapids, Mich.

**BIRCH**

This is our specialty. We are in the heart of the best Birch section. Have good stock, Common and better, 4-4, 5-4, 6-4, 8-4, 10-4, 12-4, and 16-4. Let us figure with you.

**Simmons Lumber Company**  
SIMMONS, MICHIGAN

We have the following dry stock piled on our docks which we offer for Spring delivery:

160 M 4-4 Birch	55 M 8-4 Grey Elm
55 M 8-4 Birch	95 M 5-4 Basswood
158 M 4-4 Beech	250 M 5-4 Maple
75 M 4-4 Grey Elm	Write for particulars

**The North Shore Lumber Co.**  
Thompson, Michigan

**SOFT ELM AND ROCK ELM**  
FOR SALE BY  
**The R. G. Peters Salt & Lumber Co.**  
EASTLAKE, MICHIGAN

**VAN KEULEN & WILKINSON LUMBER COMPANY**  
Manufacturers and Wholesalers of  
**HARDWOOD LUMBER and CRATING STOCK**  
Complete Stocks of Michigan Hardwoods—Maple, Beech, Birch, Elm, Ash and Basswood for sale.  
Grand Rapids, : : : Michigan

**BOYNE CITY LUMBER COMPANY**  
BOYNE CITY  
**MICHIGAN ROCK MAPLE and other HARDWOODS**  
LARGE CAPACITY PROMPT SHIPMENTS RAIL OR CARGO

 **J. S. GOLDIE**  
Cadillac, : : Michigan.  
SPECIAL PRICES on 5 in. Maple Squares, Maple and Basswood Lumber, 1 in. and 3 in. Northern Michigan Soft Elm.  
INQUIRIES SOLICITED ON ALL HARDWOODS.

# CINCINNATI

THE GATEWAY OF THE SOUTH

## WANTED

Oak  
Walnut  
Gum  
Cottonwood  
Poplar  
White Pine  
Hemlock  
Yellow Pine

Will inspect at shipping point when quantity justifies and pay cash. Can use entire mill cuts. Write us before selling elsewhere. We can also handle mixed cars of dressed stock send us your list with prices

**Kentucky Lumber Co.**

Suite 508 First National Bank Bldg  
Cincinnati, Ohio.  
Formerly of Burnside, Ky

## "BUY GUM"

We are in the market to buy Dry Gum Lumber in any quantity, from a single car load to a million feet. Will take all grades and thicknesses. We receive lumber at shipping point, pay cash and are liberal in inspection.



**THE FARRIN-KORN LUMBER COMPANY**

General Office, Yards,  
Planing Mills, Dry Kilns,  
Cincinnati, Ohio  
Purchasing Office,  
Randolph Building,  
Memphis, Tenn.  
Cypress Red Gum Oak

FRAMES,  
SASH, DOORS,  
BLINDS, MOULDINGS,  
COLUMNS, GLASS,  
STAIRWORK,  
INTERIOR TRIM.



PAINTS,  
BUILDERS' HARDWARE,  
MANTELS, ETC.  
LARGE CINCINNATI FAC-  
TORIES MAKE PROMPT  
SHIPMENTS POSSIBLE.

## LOCATIONS FOR NEW INDUSTRIES

can be secured on the lines of the

**Chicago, Milwaukee &  
St. Paul Railway**

in the great middle west. It reaches the Copper Country and the pine and hardwood areas of Northern Michigan, the lead, zinc and iron regions of Wisconsin, the coal fields of Illinois, Iowa and Missouri.

Traverses the great agricultural and manufacturing states of Iowa, Minnesota, North and South Dakota. Operates 7,000 miles of thoroughly equipped railroad.

Correspondence is solicited with eastern manufacturers who desire to move their factories to, or establish branches in the West. Co-operation with Business Men's Associations on the lines of this railway in all matters affecting mutual interests is assured.

Inquiries should be as definite as possible

Address

**Industrial Department**

**Chicago, Milwaukee & St. Paul Railway,  
Room 1327, Railway Exchange  
Chicago**

## PLAIN OAK—BASSWOOD

Are what we want. All thicknesses and grades. Spot cash. Send us list of your offerings with prices.

**DUHLMEIER BROS., CINCINNATI, O.**

## CYPRESS LUMBER CO.

Manufacturer of Hardwoods and Cypress

Plain and Quartered White and Red Oak, Yellow Poplar, Yellow Pine, Walnut, etc. Mills in Tenn., Ala. and Va

OFFICE AND YARDS, GEST AND DALTON AVE., CINCINNATI, OHIO.

## THE GENERAL LUMBER COMPANY

**HARDWOODS  
HEMLOCK, YELLOW PINE.**

**COLUMBUS**

**OHIO**

The only trade paper reaching all classes of hardwood consumers

**HARDWOOD RECORD  
355 Dearborn St., Chicago**

# W. H. Dawkins Lumber Co.

Manufacturers of Band Sawed

## Yellow Poplar

ASHLAND, KY.

# CINCINNATI

THE GATEWAY OF THE SOUTH

## THE MALEY, THOMPSON & MOFFETT CO.

Always in the Market for  
**BLACK WALNUT LOGS,  
 SELECTED WHITE OAK LOGS,  
 LUMBER OF ALL KINDS.**

CINCINNATI, : : : OHIO

WHAT HAVE YOU FOR SALE IN

Red and White **OAK** Qtd. and Plain

ALSO POPLAR, CHESTNUT, WALNUT, ETC.

JOHN DULWEBER & CO., CINCINNATI, OHIO

THE E. E. BECK LUMBER COMPANY  
 Cash Buyers

**Poplar, Oak, Chestnut**

And Other Southern Hardwoods

ALL GRADES AND THICKNESSES. WE BUY MILL CUTS.

# THE WIBORG & HANNA COMPANY

CINCINNATI, OHIO

PLAIN  
 AND  
 QUARTER  
 SAWED

## White and Red Oak

CHESTNUT  
 POPLAR  
 GUM AND  
 CYPRESS

Flooring, Siding, Ceiling, Base, Case and Molding. Rough, Dressed and Re-sawed. Mixed Carloads.

IN THE MARKET FOR

## OAK—ASH—POPLAR

ALL GRADES AND THICKNESSES

## MOWBRAY & ROBINSON

Office:  
 1219 West Sixth Street

Yards:  
 Sixth Street, below Harriet



THE FREIBERG LUMBER CO.

Manufacturers of

**Tabasco Mahogany  
 Walnut, Oak**

Poplar, McLean and Findlay Aves.  
 CINCINNATI, O.

Poplar, Oak,  
 Ash, Chestnut,  
 Sycamore,

## C. Crane & Co.

We would like to buy

W. Va. Spruce.  
 Pine and Elm

**2,000,000 feet Dry Oak  
 2,000,000 feet Dry Poplar**

Mostly heavy stock. Quotations Solicited.

MILLS AND YARDS  
 CINCINNATI, O.

YEARLY CAPACITY  
 100,000,000 FT.

LONG BILL STUFF  
 A SPECIALTY

## BENNETT & WITTE

MANUFACTURERS OF SOUTHERN HARDWOODS

THAT ARE SOLD  
 ON NATIONAL HARDWOOD LUMBER ASSOCIATION  
 INSPECTION ONLY.

Plain and Quartered . . . } White and Red Oak  
 Red and Sap Gum  
 Cottonwood, Ash, Cypress, Poplar, Soft Maple, Tnpelo  
 Gum and Chestnut. . . We cut Gum and Oak in Thick-  
 nesses of 3/8 to 4 inches. EXPORT AND DOMESTIC.

224 W. 4th Street, CINCINNATI, OHIO

Branch: 1301-2 Tenn. Trust, Memphis, Tenn.

## L. W. RADINA & COMPANY

Correspondence Solicited with Buyers and Sellers of All Kinds of

### HARDWOODS

Wanted for cash—desirable blocks of 1 inch to 4 inch Poplar, all grades,  
 Especially 1 1/4-inch stock, for immediate shipment.

CLARK STREET AND DALTON AVENUE

Cash buyers for stock in our line.

## Cincinnati Hardwood Lumber Co.

GEST AND SUMMER STREETS

Wholesalers Mahogany, Thin Lumber, Veneers

Finely figured quarter sawed oak veneers a specialty.

# CHICAGO

THE GREATEST HARDWOOD MARKET IN THE WORLD

**W**E solicit your inquiries and would be pleased to quote you on the following stock, which is in our Chicago yards:

1,000,000 ft 1 to 4 in Louisiana Red Cypress.	5,000 ft 3 in 1st and 2nd Maple.
300,000 ft 1 to 2 in Plain Oak.	20,000 ft 2 in 1st and 2nd Maple.
40,000 ft 3 in Quartered Sawed White Oak.	40,000 ft 1 1/2 in Yellow Pine Finish.
80,000 ft 1 1/2 and 2 in Birch.	20,000 ft 2 in Yellow Pine Finish.
30,000 ft 1 in Common Red Birch.	50,000 ft 1 in Yellow Pine Finish.
	20,000 ft 2x1s in and wider Yellow Poplar.

Also a good assortment of Yellow Pine Flooring, Ceiling, Maple Steps, Poplar Squares, 4x4 lath Spruce Squares, etc.

## CRANDALL & BROWN

Yards and Office, 3300 Center Avenue, CHICAGO

## NATIONAL LUMBER MFG. CO.

1019 Ashland Block

Manufacturers of Southern Hardwoods, Oak, Poplar, Hickory, Ash, Cottonwood, Gum, etc.

Band Mills: Smithfield, W. Va., Jackson, Ala.

Circular Mills: Kentucky, Tennessee

I am in the market to buy

## Hardwood Lumber

Can handle the cut of one or two good mills on a cash basis. Send me your stock list.

**Charles Darling** ROOM 1001, MERCHANTS' LOAN AND TRUST BUILDING

## HAYDEN & LOMBARD

WANTED—GREEN OR DRY, FOR PROMPT SHIPMENT:

50 M feet 1/2 x 10" and wider 12 to 16' 1s and 2s Poplar.  
50 M feet 3/4 x 8" and wider; 10 to 16' Com. and Bet. Birch.  
50 M feet 1/2 x 6" and wider No. 1 Common and Bet. A-h.

Will pay good price for Car Oak material.  
Specifications furnished on application

511 RAILWAY EXCHANGE

CHICAGO

## Estabrook-Skeele Lumber Co.

203 FISHER BUILDING, CHICAGO

We are in the market for

## Wagon Stock

REACHES, BOLSTERS, TONGUES, AXLES, ETC., AND

Hardwood Lumber

PARTICULARLY WANT WHITE ASH AND HICKORY

TELL US WHAT YOU HAVE TO OFFER

## The Keith Lumber Company

HARDWOOD, POPLAR & SOUTHERN PINE LUMBER,

MAHOCANY,

REDWOOD,

RED CEDAR,



CYPRESS,

CHESTNUT,

SPRUCE,

MAPLE FLOORING, OAK TIMBERS & WAGON STOCK.

Office and Yards: Fourteenth and Wood Streets.

## THE WARD LUMBER COMPANY

MANUFACTURERS OF

**HARDWOODS**

CHAMBER OF COMMERCE BUILDING :: CHICAGO

## CLARENCE BOYLE LUMBER CO.

Wholesale Dealers in

**Hardwoods** Yellow Pine and Cypress

319 WEST TWENTY-SECOND STREET :: CHICAGO

## Heath-Witbeck Company

### Hardwood Lumber

We have for quick shipment 170,000 feet DRY BIRCH, First and Seconds and Common 2, 2 1/2, 3 and 4 inch.

Main Office and Yards: Loomis and 22nd Streets, CHICAGO

FRED W. BLACK, President

HORACE W. BLACK, Secretary

## FRED W. BLACK LUMBER COMPANY

MANUFACTURERS OF

**HARDWOOD LUMBER**

305 Old Colony Building

## Lesh & Matthews Lumber Co.

1649-50 MARQUETTE BUILDING

Are now offering bone dry BIRCH, ROCK ELM, BLACK ASH, etc., Wisconsin stock. Also PLAIN AND QUARTERED OAK, POPLAR, etc., from our Memphis yard. We are constant buyers.

# BUFFALO

THE GREAT WHOLESALE LUMBER CENTER OF THE EAST



Manufacturers and  
Dealers in

Ash

White and Brown

Basswood

Birch

Red and White

Butternut

Cherry

Chestnut

Cottonwood

Cypress

Elm

Soft and Rock

Gum

Red and Tupelo

Hickory

Maple

Hard and Soft

Red Oak

Plain and Quartered

White Oak

Plain and Quartered

Black Walnut

White Wood

Poplar



## HUGH McLEAN LUMBER COMPANY

Specialty: INDIANA WHITE OAK

940 ELK STREET

## ANTHONY MILLER

HARDWOODS OF ALL KINDS

893 EAGLE STREET

## SCATCHERD & SON

HARDWOODS ONLY

Yard, 1555 SENECA STREET

Office, 886 ELLICOTT SQUARE

## STANDARD HARDWOOD LUMBER CO.

OAK, ASH AND CHESTNUT

1075 CLINTON STREET

## I. N. STEWART & BROTHER

Specialties: CHERRY AND OAK

892 ELK STREET

## T. SULLIVAN & COMPANY

Specialties: BROWN ASH, BIRCH, PACIFIC COAST FIR AND SPRUCE

50 ARTHUR STREET

## ORSON E. YEAGER

Specialties: OAK, ASH AND POPLAR

932 ELK STREET

## BEYER, KNOX & COMPANY

ALL KINDS OF HARDWOODS

Office and Yards, 69 LEROY AVENUE

## BUFFALO HARDWOOD LUMBER CO.

We want to buy for cash:

Oak, Ash and other Hardwoods, all grades and thicknesses.

Will receive and inspect stock at shipping point.

518 RANDOLPH BLDG., MEMPHIS, TENN.

940 SENECA STREET.

## EMPIRE LUMBER COMPANY

Our specialties are PLAIN and QUARTERED OAK and ASH.

1142 SENECA STREET.

## G. ELIAS & BROTHER

BUY AND CARRY LARGE QUANTITIES OF ALL KINDS OF HARDWOODS

955 TO 1015 ELK STREET

# YELLOW POPLAR

Manufacturers  
BAND SAWED  
POPLAR LUMBER

ALL GRADES

**DRY** 5-8, 4-4, 5-4, 6-4, 8-4, 10-4, 12-4, 16-4  
Bevel Siding, Lath and Squares  
Specialty, Wide Stock.

# LUMBER CO.

COAL GROVE, OHIO, U. S. A.

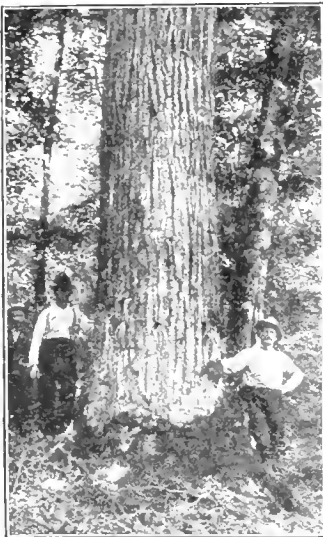

Specimen of Our Poplar Timber

W. M. Ritter Lumber Co.

MAIN OFFICE: COLUMBUS, OHIO

## YELLOW POPLAR

White Oak, Basswood, Chestnut,  
Ash, White Pine and Hemlock

We Want Your Business

Stock all band sawed, square edged, equalized. Dry Kilns,  
Planing Mills, Dressed Stock, Bevel Siding, Drop Siding

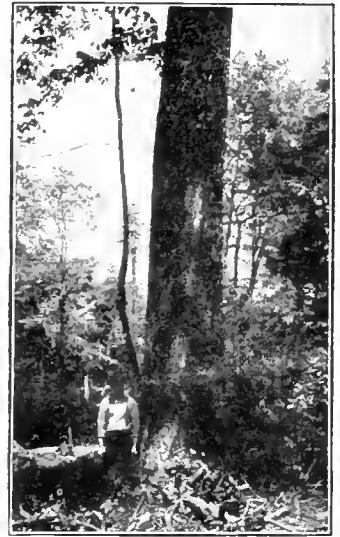

Specimen of Our Oak Timber

# Vansant, Kitchen & Co.

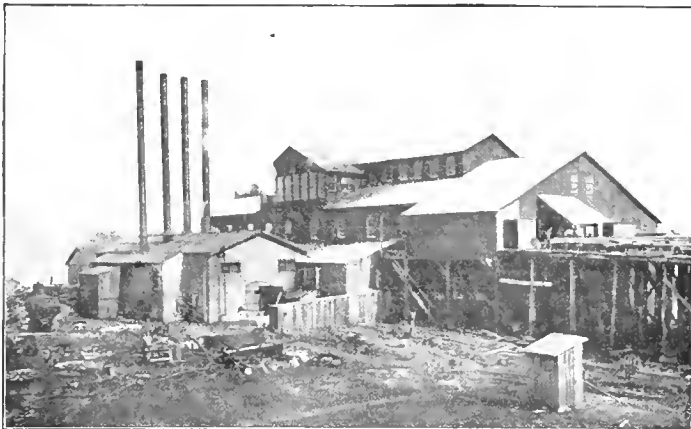

NEW ASHLAND MILL

Old-Fashioned

## YELLOW POPLAR

Ashland, Kentucky

5/8 AND WIDE STOCK SPECIALTIES

# Hardwood Record

Eleventh Year. Semi-monthly.

CHICAGO, MAY 10, 1906.

Subscription \$2.50  
Single Copies, 10 Cents.

## CHERRY

C. E. LLOYD, JR.  
Manager Sales

## RIVER

## LUMBER

GROWS IN  
WEST VIRGINIA

Sold by  
Cherry River Boom &  
Lumber Co.  
Offices: Philadelphia, Pa.

## RED GUM

We produce and market a carload of Gum Lumber  
: every 45 minutes during the working day. :

Himmelberger-Harrison Lumber Co.

Morehouse, : : Missouri

# YOUR FIRST DUTY

TO SECURE GOOD INDEMNITY

## PENNSYLVANIA LUMBERMEN'S MUTUAL FIRE INSURANCE COMPANY

923 DREXEL BUILDING

PHILADELPHIA, PENNA.

# RUMBARGER LUMBER COMPANY

<p><b>Ash.</b> 5 cars 1 in., log run. 3 cars 1½ in., log run. 6 cars 2 in., log run. 2 cars 2½ in. to 3 in. Com. &amp; Better.</p> <p><b>Basswood.</b> 30 cars 1 in., log run.</p> <p><b>Beech.</b> 25 cars 1 in., log run. 2 cars 2 in., log run.</p> <p><b>Birch.</b> 20 cars 1 in., log run. 2 cars 1½ in., log run. 1 car 2 in., log run.</p> <p><b>Red Oak.</b> 10 cars 1 in., log run.</p>	<p><b>Cherry.</b> 500,000 ft. 1 in., log run. 1 car 1½ in., Nos. 1 &amp; 2 &amp; No. 1 Com. 1 car 2 in., Nos. 1 &amp; 2 &amp; No. 1 Com. Choice old growth stock, good lengths and fine widths. Will sell on grades.</p> <p><b>Chestnut.</b> 10 cars 1 in., sound wormy. 1 car 3 in., sound wormy. 3 cars 2 in., log run. 5 cars 1 in., Nos. 1 &amp; 2 &amp; No. 1 Com. 2 cars 1½ in., Nos. 1 &amp; 2 &amp; No. 1 Com.</p> <p><b>Cucumber.</b> 7 cars 1 in., log run.</p> <p><b>Maple.</b> 20 cars 1 in., log run. 10 cars 2 in., log run.</p>	<p><b>Mountain Oak.</b> 4 cars 2 in., Nos. 1 &amp; 2. 2 cars 2 in., No. 1 Common. 10 cars 1 in., Nos. 1 &amp; 2 &amp; No. 1 Com.</p> <p><b>White Oak.</b> 1 car 1½ in., Nos. 1 &amp; 2. <b>Quartered White Oak.</b> 3 cars 1 in., Nos. 1 &amp; 2. 5 cars 1 in., No. 1 Common. 5 cars 1 in., No. 2 Common. 1 car 1 in., Clear Strips. This stock shows an exceptionally fine figure.</p> <p><b>Quartered Red Oak.</b> 1 car 1 in., Nos. 1 &amp; 2. 2 cars 1 in., No. 1 Common. 1 car 1 in., No. 2 Common.</p>	<p><b>Hardwood, No. 3 Common.</b> ½ car 1 in., rough. 5 cars 1 in., surfaced 1 side. 4 cars 2 in., either rough or surfaced. Clear Spruce. 3 cars 1 in., Nos. 1 &amp; 2. 5 cars 2 in., Nos. 1 &amp; 2.</p> <p><b>Poplar.</b> Have a fair stock of 1 in., 1½ in., 1½ in. &amp; 2 in.</p> <p><b>White Pine.</b> 12,000,000 feet No. 3 Barn &amp; Better. 500,000 feet Box. 1 in., 1½ in., 1½ in. &amp; 2 in., either rough or worked.</p>
--	--	--	---

MAIN OFFICE: 808 HARRISON BUILDING, 15TH AND MARKET STREETS, PHILADELPHIA, PA.

NEW YORK OFFICE: 8018 METROPOLITAN BLDG., 1 MADISON AVENUE.

PITTSBURG OFFICE: 701 KEYSTONE BUILDING.

# ADIRONDACK FIRE INSURANCE COMPANY

CAPITAL AND SURPLUS, \$300,000.

LUMBER AND WOODWORKING RISKS EXCLUSIVELY.

A new company organized to further serve the patrons of the Lumber Insurance Company of New York, 66 Broadway, New York, and allied organizations.

Home Office: 66 Broadway, NEW YORK



# LOUISVILLE

MANUFACTURING AND DISTRIBUTING CENTER OF KENTUCKY

## DRY LUMBER At Our Louisville Yards Prompt Delivery

<p><b>QUARTERED WHITE OAK.</b>                  75,000 ft. 4/4 firsts &amp; seconds.                  18,000 ft. 5/4 firsts &amp; seconds.                  15,000 ft. 6/4 firsts &amp; seconds.                  19,000 ft. 8/4 firsts &amp; seconds.                  150,000 ft. 4/4 No. 1 common.                  30,000 ft. 5/4 No. 1 common.                  40,000 ft. 6/4 No. 1 common.                  22,000 ft. 8/4 No. 1 common.                  22,000 ft. 4 4 cull.</p> <p><b>QUARTERED RED OAK.</b>                  14,000 ft. 4/4 firsts &amp; seconds.                  18,000 ft. 5/4 firsts &amp; seconds.</p>	<p>8,000 ft. 6/4 firsts &amp; seconds.                  5,000 ft. 8/4 firsts &amp; seconds.                  28,000 ft. 4/4 No. 1 common.                  12,000 ft. 5/4 No. 1 common.                  7,000 ft. 6/4 No. 1 common.                  3,000 ft. 8/4 No. 1 common.</p> <p><b>PLAIN WHITE OAK.</b>                  80,000 ft. 4/4 firsts &amp; seconds.                  17,500 ft. 5/4 firsts &amp; seconds.                  19,000 ft. 6/4 firsts &amp; seconds.                  22,000 ft. 8/4 firsts &amp; seconds.                  18,000 ft. 10/4 firsts &amp; seconds.                  16,000 ft. 12/4 firsts &amp; seconds.                  127,000 ft. 4/4 No. 1 common.</p>	<p>20,000 ft. 5/4 No. 1 common.                  30,000 ft. 6/4 No. 1 common.                  50,000 ft. 8/4 No. 1 common.                  18,500 ft. 10/4 No. 1 common.                  12,000 ft. 12/4 No. 1 common.</p> <p><b>PLAIN RED OAK.</b>                  47,000 ft. 4/4 firsts &amp; seconds.                  15,000 ft. 5/4 firsts &amp; seconds.                  9,000 ft. 6/4 firsts &amp; seconds.                  27,000 ft. 8/4 firsts &amp; seconds.                  31,000 ft. 4/4 No. 1 common.                  24,000 ft. 5/4 No. 1 common.                  14,000 ft. 6/4 No. 1 common.                  29,000 ft. 8/4 No. 1 common.</p>	<p><b>ASH.</b>                  1 car 4/4 firsts &amp; seconds.                  3,000 ft. 5/4 firsts &amp; seconds.                  7,000 ft. 6/4 firsts &amp; seconds.                  5,000 ft. 8/4 firsts &amp; seconds.                  3,000 ft. 10/4 firsts &amp; seconds.                  7,000 ft. 12/4 firsts &amp; seconds.                  4,000 ft. 16/4 firsts &amp; seconds.                  10,000 ft. 4/4 common.                  2,000 ft. 5/4 common.                  20,000 ft. 6/4 common.                  3,000 ft. 8/4 common.</p> <p><b>POPLAR.</b>                  60,000 ft. 4/4 firsts &amp; seconds. Selects and Saps.</p>	<p>42,000 ft. 5/4 firsts &amp; seconds                  17,000 ft. 6/4 firsts &amp; seconds                  3,000 ft. 10/4 firsts &amp; seconds                  17,000 ft. 12/4 firsts &amp; seconds                  6,000 ft. 16/4 firsts &amp; seconds                  90,000 ft. 4/4 No. 1 common.                  26,000 ft. 5/4 No. 1 common.                  18,000 ft. 6/4 No. 1 common.                  31,000 ft. 8/4 No. 1 common.                  12,000 ft. 10/4 No. 1 common.                  8,000 ft. 12/4 No. 1 common.</p> <p>We have all thicknesses in</p>
--	---	---	--	--

ALL THICKNESSES IN CULL POPLAR, ASH, CHESTNUT.

Your Inquiries Would Be Appreciated.

**W. P. BROWN & SONS LUMBER CO.**

**WHOLESALE HARDWOODS**  
 LOUISVILLE, KY.

### The Norman Lumber Co., Inc.

Manufacturers and Wholesalers of

## Hardwood Lumber

FOR SALE

Seasoned Ash, Oak, Poplar, and Walnut Lumber

WANT TO BUY

Walnut, Oak, Ash, Hickory and Poplar Logs and Lumber

Office and Yards: Third Street, H to K Streets  
 LOUISVILLE, KY.

### EDWARD L. DAVIS & CO.

OFFER FOLLOWING STOCKS:

<p><b>POPLAR.</b>                  30,000 ft. 4/4 1st &amp; 2d.                  50,000 ft. 4/4 Common.                  15,000 ft. 5/4 Common.</p> <p><b>QUARTERED RED OAK.</b>                  50,000 ft. 4/4 1st &amp; 2d.                  50,000 ft. 4/4 Common.</p> <p><b>QUARTERED WHITE OAK.</b>                  50,000 ft. 4/4 1st &amp; 2d.                  10,000 ft. 5/4 1st &amp; 2d.                  20,000 ft. 6/4 1st &amp; 2d.                  10,000 ft. 8/4 1st &amp; 2d.                  50,000 ft. 4/4 Common.                  5,000 ft. 5/4 Common.                  5,000 ft. 6/4 Common.                  20,000 ft. 8/4 Common.                  10,000 ft. 2 1/2" Common.                  40,000 ft. 3" Common.                  1 car Hickory Plank, 1 1/2 to 4"—8' to 16'.</p>	<p><b>OAK WAGON TONGUES.</b>                  12,000 ft. 4x4"x4x2"—12', 1-6 mos. dry.                  800 ft. 3 x4"—12', 12-18 mos. dry.                  400 ft. 3 1/2 x4 1/4"—12', 12-18 mos. dry.                  300 ft. 3 1/2 x4 1/4"—12', 12-18 mos. dry.                  250 ft. 3 1/2 x4 1/4"—12', 12-18 mos. dry.                  800 ft. 3 1/2 x4 1/4"—12', 12-18 mos. dry.                  180 ft. 3x4" &amp; Lgr.—14', 12-18 mos. dry.</p> <p><b>REACHES.</b>                  1 car 2x4" and larger, dry.</p> <p><b>BOLSTERS.</b>                  2 cars 3x4" and larger, dry.</p> <p><b>HICKORY AXLES.</b>                  1,500—3 x4"—6', 1-6 mos. dry.                  1,500—3 1/2 x4 1/2"—6', 1-6 mos. dry.                  2,000—4 x5"—5', 1-6 mos. dry.                  1,000—1 1/2 x5 1/2"—6', 1-6 mos. dry.                  1,000—5 x6"—6', 1-6 mos. dry.</p>
--	---

# STOTZ LUMBER COMPANY

Incorporated

MANUFACTURERS :: WHOLESALERS

Oak, Ash, Poplar, Gum, Cottonwood

KELLAR BUILDING

LOUISVILLE, KENTUCKY

## Ornamental Hardwood Floors

400 STYLES AND PATTERNS

Illustrated Catalog on Application

**WOOD=MOSAIC FLOORING CO.**

Rochester, N. Y. New Albany, Ind.

### E. W. Rhubesky

Wholesale  
 Poplar, Rough and Dressed.  
 Oak, Chestnut and Other  
 Hardwoods

### Southern Lumber Co.

Oak, Poplar and  
 Chestnut.  
 Louisville Ky.

### Albert R. Kampf

Oak, Hickory, Poplar and  
 Walnut.  
 Louisville, Ky.

### North Vernon Pump & Lumber Co.

Band Sawed Plain and Quartered  
 Oak and Poplar.  
 North Vernon, Ind., and  
 Louisville, Ky.

# CADILLAC

CELEBRATED FOR HIGH STANDARD OF QUALITY AND MILL WORK

Send us your inquiries when desiring prices  
on the following

## Southern Michigan Hardwoods

4-4 Basswood in Clear, No. 1 and No. 2 Common.  
4-4 Gray Elm in Clear and No. 1 Common.  
6-4, 8-4 and 12-4 Gray Elm in 1st and 2nd Clear.  
4-4, 10-4, 12-4 and 16-4 in 1st and 2nd Maple.  
5-4 and 8-4 Selected End Dried White Maple.  
5-4 and 8-4 No. 2 Common and Better Beech.

For HIGH-GRADE Maple Flooring in  
standard widths and grades, WRITE US.

## Mitchell Brothers Company

CADILLAC, MICHIGAN

## Cummer, Diggins & Co.

—MANUFACTURERS—  
"CUMMER" MAPLE  
AND BEECH FLOORING

## MICHIGAN HARDWOODS

Good assortment of dry stock on hand ready  
for immediate shipment in Hard Maple, Beech,  
Birch, Soft Elm and Cherry.

SEND US A LIST OF YOUR REQUIREMENTS.

## MURPHY & DIGGINS

Offer all grades of the following special dry stock

MAPLE—5 4, 6 4, 8 4, 10 4, 12 4, 14 4, 16 4  
GRAY ELM—4 4, 12 4  
BASSWOOD—4 4  
BIRCH—5 4, 6 4

Our own manufacture. Perfect Mill Work. Uniform Grades.

LET US FIGURE ON YOUR HARDWOOD WANTS.

## The Cadillac Handle Co.

. . . Band Sawn . . .  
Michigan Hardwoods

We offer for Rail Shipment from Cadillac.  
2 cars 8 4 Maple, No. 1 Com. & Better  
1 car 5x5 Maple, Select Stock  
2 cars 4 4 Basswood, No 2 Com & Bet.  
2 cars 4 4 Birch, No. 2 Com. & Bet.

Also the following for Water Shipment:  
100,000 feet of 4 4 Basswood  
100,000 feet of 4 4, 8 4 and 12 4 Soft  
Elm  
150,000 feet of 4 4, 5 4 and 6 1 Birch

## Michigan Hardwoods

### DRY STOCK

<b>HARD MAPLE</b>	}	360 M feet 5 4 Nos. 1 and 2 Common
		185 M feet 6 4 1s and 2s
		340 M feet 6 4 Nos. 1 and 2 Common
		38 M feet 12 4 1s and 2s
		1 1/2 M feet 16 4 1s and 2s
	2 M feet 16 4 Common	
<b>SOFT GRAY ELM</b>	}	145 M feet 1 4 Nos. 1 and 2 Common
		50 M feet 4 1 No. 3 Common
		18 M feet 6 4 1s and 2s
		27 M feet 6 4 Nos. 1 and 2 Common
		47 M feet 6 4 No. 2 Common and Better
		180 M feet 8 4 1s and 2s
		24 M feet 8 4 Nos. 1 and 2 Common
		20 M feet 8 1 No. 2 Common and Better.
		10 M feet 10 4 1s and 2s
		39 M feet 12 4 1s and 2s
	3 1/2 M feet 1x4 Clear Face and Better	
	8 M feet 4 4 No. 1 Com. & Bet. Saw Culls	

Our lumber is graded according to the rules of the National Hardwood Lumber Association.



**COBBS & MITCHELL**  
(INCORPORATED)  
**CADILLAC, MICHIGAN**



# MEMPHIS

THE HUB OF THE HARDWOOD WORLD

F. W. GILCHRIST, President  
W. A. GILCHRIST, Vice President  
W. E. SMITH, Sec'y and Treasurer

## W. E. SMITH LUMBER CO.

Manufacturers of  
**HARDWOOD LUMBER**

Mills, Tennessee, Arkansas, Mississippi  
Distributing Yards, Cairo, Illinois  
General Office, Tennessee Trust Bldg.

MISSISSIPPI VALLEY COTTONWOOD

Nelson H. Walcott, Pres't. Frank E. Stonebraker, Vice-Pres't.  
Chas. C. Gardiner, Sec'y and Treas.

## THE CRITTENDEN LUMBER CO.

MANUFACTURERS

MILLS AT

EARLE, ARK.

## Briggs & Cooper Company, Ltd.

MANUFACTURERS

### NORTHERN SOUTHERN HARDWOODS

GET OUR PRICES ON THESE ITEMS:

1,000,000 feet Soft Grey Elm, 1 to 3".  
500,000 feet Unselected Birch, 1 to 3".  
3,000,000 feet Michigan Hard Maple, 1 to 6".  
350,000 feet End Dried White Maple, 1 to 1½".  
625,000 feet No. 1 Common and Better Winter Sawn Basswood, 1 to 3".  
150,000 feet Selected White Basswood, 1", 1¼" and 1½".  
210,000 feet Plain and Quartered White and Red Oak, 1 to 2".

YARDS AT

SAGINAW, CHICAGO AND MEMPHIS

## BACON-NOLAN HARDWOOD CO.

Manufacturers of

### Band Sawn Oak, Ash Gum, Cypress, Etc.

Office,  
Memphis, Tenn.

Mills,  
Chancy, Miss.

Address all correspondence to Memphis office.

**W**E have in all thicknesses the following kinds and amounts of lumber at places designated. Kindly send us your inquiries.

MEMPHIS YARD

Ash..... 680,000 feet  
Quartered White Oak.. 75,000 feet  
Plain White Oak..... 140,000 feet  
Quartered Red Oak.... 225,000 feet  
Plain Red Oak..... 410,000 feet  
Cypress..... 225,000 feet  
Cottonwood..... 200,000 feet  
Poplar..... 308,000 feet

SELMA YARD

Poplar..... 409,000 feet  
Bay Poplar..... 857,000 feet  
Red Gum..... 55,000 feet  
Cypress..... 787,000 feet

BERCLAIR YARD

Bay Poplar..... 100,000 feet  
Cypress..... 800,000 feet

OTHER YARDS

Plain Red Oak..... 350,000 feet

## J. W. THOMPSON LUMBER COMPANY

Office and Yards: Randolph Road and I. C. R. R. : : MEMPHIS, TENN

F. W. GILCHRIST, Pres. W. A. GILCHRIST, Vice-Pres.  
W. E. SMITH, Sec'y and Treas.

## Three States Lumber Co.

MANUFACTURERS OF

Mills:  
Missouri  
Arkansas  
Tennessee

**Hardwood Lumber  
Cottonwood and Gum**

Office  
Tennessee  
Trust  
Building

GET OUR PRICES, TRY OUR LUMBER  
WE SHIP ROUGH, DRESSED, RESAWED

**COTTONWOOD GUM**

# PAEPCKE-LEICHT LUMBER COMPANY

MANUFACTURERS OF

## COTTONWOOD GUM AND OTHER HARDWOODS

Large stocks of well seasoned Lumber always carried at our yards and mills.

General Offices: Tribune Building, CHICAGO. Mills: Cairo, Ill., Marked Tree, Ark., Greenville, Miss., Arkansas City, Ark., Blytheville, Ark.

**ST. LOUIS**

LARGEST OF ALL HARDWOOD MARKETS

**Thomas & Proetz Lumber Co.**

CASH BUYERS OF OAK, ASH, CYPRESS, POPLAR, CHERRY AND ALL

**HARDWOODS**

SEND INSPECTOR WHEN QUANTITY JUSTIFIES

Office and Yards: Hall and Angelrodt Sts.

**Garetson-Greason Lumber Co.**

MANUFACTURERS OF SOUTHERN HARDWOODS

**GUM LUMBER  
OUR SPECIALTY**

Carload Shipments Direct  
from Our Own Mills

519 Bank of Commerce

**LOTHMAN CYPRESS CO.**

AIR DRIED

**Louisiana Red Cypress**

FOOT OF ANGELICA STREET

**SIX MILLION FEET**

Ash, Oak, Cypress, Poplar, Etc.

READY FOR PROMPT SHIPMENT

**STEELE & HIBBARD**

NORTH BROADWAY, DOCK AND HALL STREETS

Roland F. Krebs, Manager **Ozark Cooperage Co.** Hardwood Department

**WE BUY STOCKS READY CUT OR CONTRACT FUTURE OUTPUT**

Four Inspectors in the South

Direct Shipments from mill stocks } COTTONWOOD, CYPRESS, GUM, OAK. MAIN OFFICE, FRISCO BUILDING

**CHAS. F. LUEHRMANN HARDWOOD LUMBER COMPANY**

Carry a complete stock of Hardwood and are constantly in the market to purchase large blocks of stock for cash. Are also the largest manufacturers of the famous St. Francis Basin Red Gum.

General Offices: 148 Carroll Street

**W. R. CHIVVIS,** Lesperance Street and Iron Mountain Railroad.

**WHOLESALE HARDWOODS**

**BLACK WALNUT LUMBER MY SPECIALTY.** Always in the market to buy Walnut and Cherry Lumber. Pay spot cash and take up at shipping point when amounts justify.

**Stoneman-Zearing Lumber Co.**

203 Frisco Building

We have the following Dry Stock for sale piled at our mill:

<b>QTD. WHITE OAK :</b>	<b>COTTONWOOD :</b>
3 Cars 4 4 Common.	3 Cars 1" 1 and 2.
2 Cars 4 4 Common and Better Strips.	1 Car 1x13 to 17" Box Boards.
<b>GUM :</b>	<b>ELM :</b>
5 Cars 1" Common Red.	1 Car 6 4 Log Run.
1 Car 1x13 to 17" Box Boards.	4 Cars 4' Log Ruu.
1 Car 2" 1 and 2 Sap.	
6 Cars 1 1/4 Common and Better Sap.	

This Stock is All Band Sawed and Equalized

**Wanted—Cypress, Ash and Cottonwood**

INSPECTION AT POINT OF SHIPMENT WHEN QUANTITY JUSTIFIES

**Hafner Manufacturing Co.**

CYPRESS, HARDWOODS

Mail orders receive our immediate attention.

YARDS: FOOT OF DOCK STREET

# Swann-Day Lumber Company

MANUFACTURERS OF

## POPLAR AND OAK

PLANING MILL STOCK, BOX SHOOKS  
AND HARDWOOD DIMENSION

CLAY CITY, KENTUCKY

# Upham & Agler

Bedford Building  
CHICAGO

Wholesale Northern and Southern  
**Hardwoods**

Quick Service  
Perfect Milling  
Right Prices

DISTRIBUTING YARD: CAIRO, ILLINOIS

JOHN T. DIXON HARRY S. DEWEY



There are numerous reasons why you should permit us to make prices for your requirements. If you will be kind enough to favor us with your inquiries in the future, we will tell you all about it.

Hardwoods and Maple  
and Oak Flooring

OUR SPECIALTIES

## DIXON & DEWEY

716 and 716 A, Flatiron Building,

NEW YORK

# WILLIAM WHITMER & SONS, Inc.

We are buyers of desirable hardwoods in round lots.  
What have you? Send us list of your offerings.

Girard Trust Building,

PHILADELPHIA, Pa.

# THE EAST

BOSTON NEW YORK PHILADELPHIA

## Charles S. Wentworth & Co.

WHOLESALE LUMBER MERCHANTS

147 Milk Street  
BOSTON

We are in the Market for POPLAR, PLAIN OAK, CYPRESS and NORTH CAROLINA PINE LUMBER; also OAK, MAPLE and BIRCH FLOORING, and would appreciate correspondence from manufacturers in position to supply any of the stock named.

## STEVENS - EATON CO.

Buyers of  
ROUND LOTS  
of **Hardwoods** No. 1 Madison  
Avenue,  
NEW YORK

ESPECIALLY IN MARKET FOR PLAIN RED OAK

## WM. E. LITCHFIELD

MASON BUILDING, BOSTON, MASS

**Specialist in Hardwoods**

Manufacturers are requested to supply lists of stock for sale

## The Crosby & Beckley Company

### HARDWOODS

We are  
In the Market for Choice Stock  
WRITE US

No. 1 Madison Ave.,  
New York, N. Y.

New Haven,  
Connecticut.

J. J. SOBLE

H. I. SOBLE

## SOBLE BROTHERS

Wholesale Hardwoods

911-912 Land Title Bldg. PHILADELPHIA

WANTED: 20 cars Common and Better Chestnut, all thicknesses

J. H. SCHOFIELD

R. W. SCHOFIELD

## SCHOFIELD BROTHERS WHOLESALE LUMBER

**Hardwoods a  
Specialty.**

1020-22 Pennsylvania Building  
PHILADELPHIA

1798

FROM 1798 TO 1906

1906

ALWAYS BUYING AND SELLING

## The Choicest Hardwoods

We want to buy large stocks of choice, dry Hardwoods to replace our late loss by fire. What have you to offer? We are filling all orders promptly and satisfactorily from our reserve stocks at outside points. What do you want? We will buy or sell. Ask for McIlvain's May "Lumber News."

## J. Gibson McIlvain & Co.

Philadelphia, Penn.

58th St. and Woodland Ave.

## Wistar, Underhill & Co.,

WHOLESALE

### HARDWOOD LUMBER

816 Real Estate Trust Building, PHILADELPHIA.

## Holloway Lumber Company

### WHOLESALE HARDWOODS

In the market for all thicknesses of  
OAK, ASH and CHESTNUT.

312 Arcade Building,  
PHILADELPHIA, PA.

## Jones Hardwood Co.

(INCORPORATED)

### WANTS

Poplar, Plain Oak, Quartered Oak and Cypress

Manufacturers please send stock lists and prices

147 MILK STREET, BOSTON, MASS.

## H. D. Wiggin Wholesale Hardwoods

**Specialties:** Poplar, Chestnut, Canadian  
Hardwoods, and Mahogany Veneers.

FISKE BUILDING

BOSTON, MASSACHUSETTS

BALTIMORE, MARYLAND **E. E. PRICE** BUYER AND EXPORTER OF

### HARDWOODS POPLAR and LOGS

I am always in the market for nice lots of dry and well manufactured lumber. I inspect at point of shipment. Correspondence solicited.

# NASHVILLE

HEADQUARTERS FOR ALL SOUTHERN HARDWOODS

## The Davidson-Benedict Company

NASHVILLE, TENNESSEE

Everything in

### Southern Hardwoods

POPLAR, CHESTNUT, ASH, OAK

(Plain and Quartered.) Straight or Mixed Cars.

DRESSED POPLAR ANY WAY YOU WANT IT. YOU GET WHAT YOU BUY FROM US. ASK FOR OUR DELIVERED PRICES, ANY RAILROAD POINT.

## LOVE, BOYD & CO.

Offer:

- 5,000,000 ft. Quartered White Oak.
- 2,000,000 ft. Quartered Red Oak.
- 1,000,000 ft. Plain White Oak.
- 1,000,000 ft. Plain Red Oak.
- 1,000,000 ft. Poplar.
- 2,000,000 ft. Chestnut, Ash, Hickory, Red Cedar, Etc.

Our Own Manufacture.  
Prompt Service.  
Dry Stock.

MAIN OFFICE,  
NASHVILLE, TENNESSEE

## JOHN B. RANSOM & CO.,

NASHVILLE, TENNESSEE

We want to move quickly the following old dry stock. All of it has been on sticks 6 to 18 months. Write us for delivered prices. We are prepared to furnish promptly mixed cars of rough and dressed hardwoods of all kinds:

QUARTERED WHITE OAK	QUARTERED RED OAK
90 M 4 4 first and second	100 M 4 4 first and second
15 M 5 4 first and second	58 M 6 4 first and second
80 M 6 4 first and second	15 M 8 4 first and second
10 M 10 4 first and second	95 M 4 4 No. 1 Common
120 M 4 4 No. 1 Common	84 M 6 4 No. 1 Common
65 M 6 4 No. 1 Common	72 M 8 4 No. 1 Common
58 M 8 4 No. 1 Common	
20 M 10 4 No. 1 Common	PLAIN OAK
70 M 5 8 first and second Poplar	50 M 4 4 1st and 2nd White
80 M 5 8 No. 1 Common Poplar	100 M 4 4 No. 1 Common White
15 M 4 4 1st and 2d Quartered Sycamore	100 M 4 4 first and second Red
10 M 4 4 No. 1 Com Quarter'd Sycamore	100 M 4 4 No. 1 Common Red

## Nashville Hardwood Flooring Co.

Manufacturers of

### "Acorn Brand"

THE FAMOUS FAULTLESS FLOORING  
IN OAK AND BEECH.

Car Lots and Less Than Car Lot  
Orders Solicited. Write for Prices.

Nashville, Tennessee

## PREWITT-SPURR MFG. CO.

OLDEST LUMBER CONCERN IN NASHVILLE

Large Dealers in

### Hardwood Lumber

CEDAR AND WOODENWARE

Only Manufacturers of Cedar Buckets in the World

## INDIANA LUMBER CO.

Manufacturers Lumber

DIMENSION STOCK A SPECIALTY.

Office and Mills: Corner Oldham  
Street and Cumberland River

NASHVILLE, TENN.

## GEO. C. BROWN & CO.

SHIPPERS

### Southern Hardwoods

MILLS:  
McMINNVILLE.

Specialty: Tennessee Red Cedar.

YARDS:  
NASHVILLE.

## McLean Lumber Company

MANUFACTURERS OF THE CHOICEST

### HARDWOODS

LET US FIGURE WITH YOU

Nashville, Welch Station, Sparta and Slayden, Tenn.

## What Do You Want?

WRITE US FOR ANYTHING IN

### Native Hardwoods

LUMBER, DIMENSION STOCK, BOXES

## STANDARD LUMBER & BOX CO.

NASHVILLE



# PITTSBURG

HARDWOOD DISTRIBUTING CENTER OF PENNSYLVANIA

## The Nicola Brothers Company

One million feet 4-4 Bay Poplar.  
Can be shipped log run, or sold  
on grade. Bone dry; band  
sawed. Send your inquiries.

## Flint, Erving & Stoner Co.

Wholesale Lumber  
Northern and Southern Hardwoods

Beech and Maple Timbers a Specialty

## A. M. Turner Lumber Company

Everything in lumber. We buy hardwoods  
as well as sell them. If you have anything  
to offer, please submit same to us. : :

## Linehan Lumber Company

PERFECT

## MAPLE FLOORING

SEND US YOUR INQUIRIES

## Willson Bros. Lumber Co.

MANUFACTURERS

## WEST VIRGINIA HARDWOODS

FARMERS BANK BLDG. :: PITTSBURG, PA.

## Hardwoods a Specialty

FOR SALE

POPLAR	CHESTNUT	PLAIN OAK
125,000' 4 4 1s and 2s	200,000' 4 4 Sound Wormy	60,000' 4 4 No. 1 Com.
40,000' 4 4 No. 1 Com.	80,000' 5 4 Sound Wormy	18,000' 4 4 No. 2 Com.
325,000' 4 4 No. 2 Com.	100,000' 6 4 Sound Wormy	QUARTERED OAK
228,000' 4 4 No. 3 Com.	48,000' 8 4 Sound Wormy	2 cars 4 4 No. 1 Com.
150,000' 4 4 Mill Cull		1 car 4 4 No. 2 Com.

OAK TIMBERS SAWED TO ORDER.  
WRITE FOR PRICES.

CHEAT RIVER LUMBER COMPANY, Pittsburg, Penna.

## Babcock Lumber Co.

MANUFACTURERS OF  
PENNSYLVANIA  
HARDWOODS

23,000,000 FEET ANNUALLY

LONG ON MAPLE  
AND CHERRY

MILLS AND OFFICE  
ASHTOLA, PA.

## Dry Stock for Quick Shipment:

12,189 ft 4 4 clear Quartered Oak	66,232 ft 4 4 No. 1 Common Poplar
14,570 ft 4 4 1st & 2ds qtd. Red Oak	10,315 ft 6 4 1st & 2ds Poplar
30,302 ft 4 4 No. 1 Com. Red Oak	6,000 ft 4 4 1st & 2ds Cottonwood
63,204 ft 4 4 No. 1 Com. Pl White Oak	119,000 ft 4 4 No. 1 Com. Cottonwood
4,417 ft 5 4 No. 1 Com. Pl White Oak	150,000 ft No. 2 Common Cottonwood
5,934 ft 6 4 No. 1 Com. Pl White Oak	90,000 ft 4 4 Mill Cull Cottonwood
23,473 ft 4 4 1st & 2ds Plain Red Oak	110,000 ft 5 4 No. 1 Com. Cottonwood
14,168 ft 4 4 1st & 2ds Poplar	40,000 ft 5 4 No. 2 Com. Cottonwood

American Lumber & Mfg. Co.  
PITTSBURG, PA.

H. B. LEAVITT, PREST.  
E. H. ADAMS, SECY

B. F. RICHARDSON, VICE-PREST.  
J. G. LEAVITT, TREAS.

## THE LEAVITT LUMBER CO.

MOST COMPLETE STOCK OF HARDWOODS IN  
**CHICAGO**

MAKE KNOWN YOUR WANTS AND GET  
**IMMEDIATE RESULTS**

Mills  
WISCONSIN  
TENNESSEE  
ARKANSAS  
LOUISIANA  
MISSISSIPPI

General Office and Yard  
CENTER AVE. NEAR 35TH ST.  
Southern Office:  
115 TENNESSEE TRUST BLDG.  
MEMPHIS, TENN.

## THE "FINEST" MAPLE FLOORING

### W. D. YOUNG & CO.

BAY CITY, MICHIGAN.

Producers from TREE to TRADE of the highest type of Michigan Forest Products. Large stock of Maple Flooring and 15,000,000 feet of Hardwoods—1 to 4 inches thick—on hand.

## Maple, Birch and Beech Lumber

## "Ideal" Steel Rock Maple Flooring

is the flooring that is manufactured expressly to supply the demand for the best. It is made by modern machinery from carefully-selected stock and every precaution is taken throughout our entire system to make it fulfill in every particular its name—"IDEAL."

Rough or Finished Lumber—All Kinds

Send us Your Inquiries

## The I. Stephenson Company

WELLS, MICHIGAN

## White and Red Oak

Secure our special prices on the following dry stock We need the piling room.

30,000 feet 7-4 and 8-4 Quarter Sawn.  
150,000 feet 4-4 1st and 2nds Clear Plain Sawn.  
200,000 feet 4-4 No. 1 Common Plain Sawn.  
200,000 feet 4-4 No. 2 Common Plain Sawn.

We also manufacture chair and table stock. Let us figure with you. Address all communications to

## Dierks Lumber & Coal Company

Mills: DE QUEEN, ARK. KANSAS CITY, MISSOURI

INCORPORATED 1902.

## The Michigan Maple Company

WHOLESALE

### MICHIGAN HARDWOODS

HENRY W. CAREY, President  
HENRY N. LOUD, Vice Pres  
WILLIAM P. PORTER, Vice Pres  
WILMER T. CULVER, Secretary  
WILLIAM H. WHITE, Treasurer  
EDWARD BUCKLEY, Director  
G. VON PLATEN, Director  
MARSHALL E. BUTTERS, Director  
HARRY NICHOLLS, Director

609-611 Mich. Trust Bldg.,  
GRAND RAPIDS, MICH.

## Timber Bonds

SECURED BY FIRST MORTGAGE ON TIMBER LANDS

## H. C. Barroll & Co.

BANKERS, First National Bank Building, CHICAGO.

## OAK FLOORING

Kiln Dried  
Bored  
Polished

Hollow Backed and Bundled

## Wolverine Brand Maple Flooring

"THERE IS NONE BETTER"

It is the same old story, but we want you to know what WOLVERINE BRAND will do for you, and what it will cost you. We want to do this before you place your next order. If we make you quotations, we expect the quality and prices will get your order. TRY US.

## BLISS & VAN AUKEN

900 S. Niagara St., Saginaw W. S., Mich.

# Hardwood Record

Published in the Interest of Hardwood Lumber, American Hardwood Forests, Wood Veneer Industry, Hardwood Flooring, Hardwood Interior Finish, Wood Chemicals, Saw Mill and Woodworking Machinery.

Vol. XXII.

CHICAGO, MAY 10, 1906.

No. 2.

Published on the 10th and 25th of each month by

## THE HARDWOOD COMPANY

HENRY H. GIBSON, President FRANK W. TUTTLE, Sec.-Treas.

### OFFICES

Sixth Floor Ellsworth Bldg., 355 Dearborn St. Chicago, Ill., U.S.A.  
Telephones: Harrison 4960 Automatic 5659

### TERMS OF ANNUAL SUBSCRIPTION

In the United States, Canada, Philippine Islands and Mexico . . . \$2.00  
In all other countries in Universal Postal Union . . . . . 3.00

Subscriptions are payable in advance, and in default of written orders to the contrary are continued at our option.

The entire contents of this publication are covered by the general copyright, and articles must not be reprinted without special permission.

Entered at Chicago Postoffice as Second Class Matter.

Advertising copy must be received five days in advance of publication date. Advertising rates on application.

### General Market Conditions.

The particular feature of the last fortnight was an increase in the demand for nearly every variety of hardwood. Buyers have come to realize that hardwood stocks are very short in all sections, and that to carry on manufacturing enterprises in house finish, furniture, car building and other lines requiring large quantities of wood, immediate buying is essential. Prices are not standing in the way of many purchases—it is simply a question of the delivery of stock.

There is much trading going on between both manufacturers and jobbers to eke out stock enough to take care of current business.

Plain oak is still in the highest demand of any of the woods, although poplar, chestnut, ash, the box end of cottonwood and many other varieties of both southern and northern hardwoods are in almost equal request.

Substitutions are going on in every channel where it is possible to utilize a new wood for those which have been standard in the past. Thus there has become active buying in a much neglected wood, hackberry, as a substitute for ash; pecan is taking the place of hickory in many instances, and both red and tupelo gum are increasing in demand and in breadth of distribution, as substitutes for poplar and even for oak.

Foreign buyers have commenced to awaken to the fact that the shortage of hardwood stocks is not a "Yankee bugbear," but actually exists. One London trade paper of the last week says that the buyers of Great Britain must awaken to the fact that American hardwoods are actually in very short supply and that prices will range higher. The same paper is fearful that the necessity of immediately rebuilding San Francisco will make such tremendous inroads on the yellow pine of the South as to preclude the possibility of normal receipts on the other side. Of course this is all nonsense, as the Pacific coast has ample wood supplies to take care of the rebuilding of the devastated city.

The veneer and panel business is growing apace, and although producers of this class of stock do not yet seem to realize its value, and are surely selling the product for much less than it is worth, it is hoped that the tentative efforts toward organization will eventually

stimulate values to a point approximately relative to prices being received for hardwood lumber. Prices asked for veneer and panel stock today make it impractical for manufacturers of lumber to compete with the product. Comparatively few veneer makers have a reputation of making any considerable profit on their investments, and the sooner they awake to the fact that they are selling their output for less than they need the better.

The hardwood flooring people manufacturing oak, maple, birch and beech are all extremely busy. Prospective demand for this class of material in rebuilding San Francisco is excellent, and undeniably prices will range higher.

Owing to the scarcity and high price of oak and other high-class American woods, the mahogany market is showing considerable strength and the volume of sales is increasing. This is as it should be, because in relative value mahogany still remains the lowest-priced wood on the market today.

Black walnut and cherry are still pursuing the even tenor of their way. Prices are comparatively low, and the demand is only moderate.

### Falling Out Among the Foresters.

Apropos of nothing, there is a legend that when certain people fall out the devil gets his due. There is war in the camp of the foresters of the country. The head of the Forest Service of the United States Department of Agriculture is having the phials of the wrath of certain factions in the forestry game poured out upon his devoted head. This Forest Service, which was originally supposed to be a division of forestry pure and simple, of the Department of Agriculture, has, during the last few years, branched out into a great many enterprises that are considered by many to be entirely removed from its original sphere.

The administration department of this service includes a forester and assistant forester; an assistant forester in charge of forest management; an assistant forester in charge of dendrology; an assistant forester in charge of forest products; an assistant forester in charge of forest extension; a special fiscal agent; a representative in charge of records; one in charge of the section of publication and education; one in charge of section of law; one in charge of section of grazing; one in charge of section of silvics; one in charge of section of reserve boundaries; a forest inspector detailed as district forester in the eastern district; another in the southern district; and still another in the northern district. In field work in connection with the office of forester there is a corps of ten; in forest management there is a corps of twelve; in forest products a corps of two; and in forest extension one.

This is but the beginning of the long list of representatives of the Forest Service to whom certain lines of work in connection with a great many things other than the rebuilding of the forests of the country are entrusted.

It is alleged that the Forest Service of the country cost Uncle Sam last year approximately \$900,000, and the sum is so great that many people interested in legitimate forest problems of an inquiring turn of mind are beginning to ask if this money is being well expended. They are also asking pertinent questions about practical measures toward rehabilitating our forests, and generally they are making matters decidedly interesting for the chief of the Forest Service.

Thos. P. Ivy of Dunlinne, Centre Conway, N. H., is out with a pamphlet on "Forestry Problems in the United States," of which the following is his preface:

Express yourself.  
Whatever you are, out with it!  
We do not want a world of masqueraders.  
Make yourself felt, make your real self felt.  
Put your private stamp upon the future.

The writing of this pamphlet was undertaken to present in a short space and in uncensored language the forest situation as it appears to be today in the United States. It is the opinion of the writer that much of what the National Government is doing in the name of forestry is based on a mistaken forest policy, and if continued the nation as a whole will be in a worse forest condition an hundred years hence than if our present forest problems had been left to individuals and to the states to work out. If this contention is true, it is most important that the error be corrected now. Whether there are errors or not can only be ascertained by a free discussion of forestry in Congress, on the rostrum, and in the public prints. Certainly it is supreme folly to leave a subject so vital to every citizen, state and territory to be dealt with by the exclusive judgment of one person, the United States forester.

In his pamphlet Mr. Ivy scores the Forest Service and its chief unmercifully.

The editor of *Arboriculture* for May also has an article under the head of "The United States Government Opposed to Forest Planting." *Arboriculture* is the official organ of the International Society of Arboriculture and is edited by John P. Brown, its secretary and treasurer, and is published at Connersville, Ind. Excerpts from Mr. Brown's criticism of the Forest Service are as follows:

The people in the United States have the disgraceful spectacle of an important branch of the government, organized for the special purpose of encouraging the perpetuation of our forests, subverting their purposes, and actually engaged in discouraging corporations and individuals from planting trees.

During the past six years the International Society of Arboriculture has been obliged to expend forty thousand dollars in efforts to overcome the evil influences caused by the publications and personal attacks by the United States Forestry Bureau officials in their antagonism to the work of this society, mostly caused by the gross ignorance of employees of the bureau.

Moneys appropriated by Congress for the sole purpose of protecting our forests and extending them by planting trees are misappropriated, the officials of the Forestry Bureau advancing arguments against the planting of *Catalpa speciosa* trees, of which they are as totally ignorant as they are of many other practical matters pertaining to forest growth and management. This has now been going on so long, and with such disastrous results, that forbearance ceases to be a virtue, and we are compelled to make this expose of the United States Forestry Bureau methods.

The American Congress has been very liberal in providing the Forestry Bureau with unlimited funds to carry out the work of forest perpetuation. An army of clerks, apprentices, professionals and scribes are employed by the bureau in various ways and at very high salaries. Large numbers of young men, just out of college, are maintained in the field as professional foresters, with hotel bills and traveling expenses without limit.

But, strange to say, this army neither plants trees nor encourages others to do so, but has played the role of obstructionists, advising individuals and corporations not to plant trees, and has in many ways antagonized the work of the International Society of Arboriculture, which society has planted many millions of forest trees.

The Forestry Bureau is one of absorption, reaching out with its tentacles to grasp everything in sight and gain control of every organization, state or independent, which undertakes to promote the planting, care, management and perpetuation of American forests. It is well known how the bureau attempted to secure control of finances of the state of New York, and to displace the most excellent forestry service of that state, in order that it might give employment to its own army of employees, and secure the handling of the money appropriated by the legislature.

But we have to deal with the many dishonorable acts of the Bureau of Forestry toward the International Society of Arboriculture, and the work of this society among the railway systems.

Officials of the Forestry Bureau have undertaken to persuade railway companies which had employed the International Society of Arboriculture to plant trees not to follow the advice of this society, but to turn the work over to the United States Forestry Bureau. These officials have advised the railway companies that the trees recommended by the society would not grow in their territory, and by such misrepresentations have endeavored to prevent the planting of trees, and in some cases have succeeded in prejudicing some railway officials, so that the plans for forest planting have been entirely abandoned.

The Department of Agriculture has sent out men to make alleged

soil analyses, to determine whether trees could be grown in certain sandy lands, and these experts, with a work on chemistry in one hand and a vast amount of inexperience in the other, have certified to land owners and railways that such trees could not grow in these soils. Yet ten thousand instances are known where the *Catalpa speciosa* trees are growing thriftily in exactly identical locations.

The bureau called into session the American Forestry Congress and selected only such speakers as were known to be opposed to the *Catalpa speciosa*. Some of these speakers had been coached by Forestry Bureau officials, and much misinformation given them in order to be sure of destroying the influence of the International Society of Arboriculture at one blow. No member of this society—numbering three thousand members—was permitted to say a word in behalf of the *Catalpa speciosa*, but the secretary was invited to send delegates who might listen to abuse without the privilege of reply or correcting wrong statements. \* \* \*

It is the well known ambition of the head of the Forestry Bureau to control every organization and individual who is engaged in the work of forest restoration and thus claim the honor of everything done in this line. Also to increase the army under his directions and provide them with work at high salaries, by crowding out and absorbing independent foresters and organizations and thus secure control of all government, state and private forestry work.

The Forestry Bureau maintains a "Press Bureau" through which it secures the publication of press items in the country papers of America, lauding the acts and policies of the bureau with the view to creating public opinion in its favor. Some of these newspapers may be surprised to learn of the inside workings of the authorities in their efforts to prevent forest tree planting.

The bureau employs several inexperienced youths, just out of college, with an overflowing surplus of theory and a corresponding paucity of experience, who are sent out to instruct mature men, born and brought up in the forest and familiar with every tree and shrub, if not acquainted with their Latin nomenclature, how to manipulate forest operations so as to provide paying jobs for the greatest number of government employees for the largest period of time at the joint expense of the government and the timber owners.

In explanation of the foregoing it may be stated that it is possible that Mr. Brown is somewhat of a *Catalpa speciosa* crank, as he seems to regard the planting of that tree as a panacea for all forest denudation evils.

### Hardwood Freight Rate to the Pacific Coast.

The agitation started by the Wisconsin Hardwood Lumbermen's Association and promptly taken up by the *HARDWOOD RECORD*, protesting against the unjust freight rate charged from Mississippi valley points to the Pacific coast, is now receiving the support of all leading interests in the hardwood production of the country. At the Memphis meeting of the National Hardwood Lumber Association last week the subject came up for discussion, and a committee on railroad affairs was appointed to take up this and other freight matters that would naturally come before the association. The Hardwood Manufacturers' Association of the United States has also taken steps to interest its members in a protest to the transcontinental freight committee against the eighty-five cent rate. Even the Pacific coast associations are thoroughly in sympathy with the hardwood producers in their demand for a lower rate on hardwoods to the coast. As the matter now stands, the general rate on building woods from the coast to Mississippi valley points is sixty cents, with a special rate of fifty cents on fir, and forty cents on fir to Minneapolis.

The argument may be presented by the transcontinental freight alliance that hardwoods shipped west have a higher value than building woods going east, and therefore should stand a higher freight rate. This is scarcely a tenable position, because hardwoods are of such weight that even refrigerator cars now going west empty can be loaded to their capacity with hardwoods, and the business should be a very desirable one at a rate twenty-five cents less than is now charged.

Again the people of San Francisco will need about a billion feet of lumber in rebuilding that city. It seems certain that at least ten per cent of this quantity will naturally be hardwoods in the form of finish and flooring. If these woods could be obtained on a reasonable freight rate it would be of great assistance to that section, and would also give an outlet for some hardwoods that can be spared from the Mississippi valley. As the matter stands today quite a portion of the hardwood demand of the Pacific coast is being supplied from Australia, the Philippines and Japan, simply because woods of corresponding value to our own can be obtained from these countries at a less cost, attributable solely to the high freight rate.

## Pert, Pertinent and Impertinent.

### Beauty Culture.

Nor does the mode in which your days  
Are spent, dear ladies, cause offense;  
To thoughtful minds your latest phase  
Betrays the hand of Providence;  
For though this beauty-culture fad  
Has gone, perhaps, a bit too far,  
'Twould make the brightest of us sad  
To see you as you really are. —PUNCH.

### Paradoxical.

Phlebotomy is out of date,  
For doctors long since have decreed  
That ailments now they can abate  
By other modes; they never bleed.  
Yet strange it seems, for though they call  
Its substitute by other name,  
It is not different at all—  
They always bleed us just the same.

### Money.

Money may not bring us honor,  
Money may not lift us high;  
Money may not keep us youthful  
As the fleeting years go by.  
Money may not make us happy  
When we've wronged our fellow men,  
Money may be filthy, but it  
Comes in handy now and then.

### Sufficient.

Beauty is only skin deep, but that's deep enough to satisfy any reasonable man.

### To Win a Woman.

If she is pretty, make love to her; if she is plain, make love to some one else.

### Missing.

A lumberman may drink to forget, but where is there one who forgets to drink!

### Has Limitations.

Money makes the mare go, but it won't always start the automobile.

### Slander.

They say Love is blind, but he gets his eyes open after marriage.

### Resourceful.

Some men have more money than they know what to do with—women never!

### Lonesome.

He who never does wrong must lead a dull existence.

### One Way.

Fools who can attract attention by no other means, usually buy red ties or green vests.

### Apt Pupils.

Pessimists are the understudies of cynics.

## SWAPPING HORSES WHILE CROSSING A STREAM SUCCESSFULLY ACCOMPLISHED.



And They Never Even Got Wet!

### Elastic.

A man's heart is like a trolley car—always room for one more!

### Plentiful.

The girl with money to burn never lacks for matches.

### Watch Out!

Many a man is chaperoned by a detective if he only knew it!

### Unscrupulous.

Many a good dishwasher has been spoiled by encountering a piano teacher who needed the money.

### Think.

If you and she are failures don't blame it on marriage!

### Superstition.

There is no such thing as an omen; destiny does not send us heralds; she is too wise—or too cruel—for that.

### A Bad Habit.

Give most men a sympathizer and most women enough note paper—and they'll tell all they know.

### Policy.

When you're in the right you can afford to keep your temper, and when you're in the wrong you can't afford to lose it.

### Procrastination.

Postpone the doing of an easy thing and it becomes hard; postpone a hard one and it becomes impossible.

### Politeness.

Politeness costs nothing, whether one is paid or not, and it always marks the gentleman.

### Don't Wait.

You can't gain time by putting the clock ahead, nor business by prospective advertising.

### Strange!

Why is it that a man will often submit like a lamb to Misrule, but Mrs. Rule he won't stand for a minute?

### Logical.

The business woman makes a good wife, for she runs the house on business principles—not hit or miss.

### Persevere.

Don't be daunted if she cries for help when you try to kiss her—perhaps she means help yourself!

# AMERICAN FOREST TREES.

THIRTY-THIRD PAPER.

## Hackberry.

*Celtis occidentalis*—Linn.

Hackberry is found from the St. Lawrence river southward through Ontario; from Massachusetts Bay westward to Nebraska, North Dakota, Idaho, eastern Washington and the valley of the Snake river in Oregon; through Nevada and New Mexico to parts of Florida, and in middle Tennessee, Missouri, Mississippi, Arkansas, Kansas, Indian Territory and eastern Texas.

The tree is called hackberry in New Hampshire, Vermont, Rhode Island, New York, New Jersey, Delaware, Pennsylvania, West Virginia, North Carolina, South Carolina, Alabama, Florida, Mississippi, Louisiana, Texas, Arizona, Arkansas, Kentucky, Missouri, Illinois, Indiana, Wisconsin, Iowa, Kansas, Nebraska, Michigan, Minnesota, South Dakota, Ohio and Ontario; sugarberry in New York, Pennsylvania, Delaware, North Carolina, South Carolina and Minnesota; nettletree in Rhode Island, Massachusetts, Delaware and Michigan; American nettletree in Tennessee; hoop ash in Vermont; one-berry in Rhode Island; hack-tree in Minnesota; juniper-tree and bastard elm in New Jersey.

This tree is of the elm family. In shape it is round-topped, with spreading or pendulous branches. It sometimes reaches a height of 130 feet in the South, particularly in the Ohio river basin, though it is usually much smaller. The trunk is straight and slender, though sometimes two to three feet in diameter in the larger specimens. The branches are slender and glabrous when first appearing, containing a thick, pale pith; they are light green, becoming tinged with red.

The bark of hackberry bears a very close resemblance to that of beech, being greenish-grey in color, smooth and thin. The tree without its foliage is often mistaken for beech, although in general contour hackberry does not resemble it.

The leaves of hackberry are broad, gradually sloping to a narrow pointed apex; rounded at the base; sharply serrate. In color they are bright green, glabrous and lustrous on the upper surface, lighter below and sometimes pubescent along the ribs. The petioles are short and grooved. The flowers are greenish and axillary. The staminate ones are in clusters, while the pistillate are solitary. The calyx is divided into five lobes, is tinged with red and sometimes furnished with a tuft of hair. The fruit of hackberry grows on

a slender stem; it is about a quarter of an inch in length; has a dark purple skin and deep yellow flesh and brown nut. It ripens in September or October, and is sweet and edible.

Hackberry is a rapidly growing tree. It is admirable for transplanting, and fine specimens are very effective in landscape garden-

purposes. Its fruit, remaining on the tree through the winter, is a favorite food of robins. The chief insect enemy of the tree, the hackberry-gall, does no great harm to it.

The wood of hackberry resembles ash to a considerable extent, although it is somewhat softer, and not as strong. It is coarse-grained, with light yellowish heartwood and lighter sapwood. While up to this time the commercial use of the wood has been confined to building purposes and cheap furniture, it has qualities that will bring it into active commercial demand, owing to the great scarcity of ash, as a substitute for that wood. For purposes where the elasticity and strength of white ash are not extremely essential, hackberry makes an excellent substitute. In fact, such of the lumber as comes into the market at this time is sold as ash.

Unfortunately the quantity of hackberry growth in the average hardwood forest is not sufficient to insure a very large output of the wood. The operator in the middle South who manufactures five to ten million feet of hardwoods annually is likely not to secure more than two or three hundred thousand feet of hackberry in that time. However, such quantity of the wood as may be developed has commercial possibilities of rather a high order and will command a price approximating that of white ash in the near future. Unlike southern ash, it is not afflicted with "calico" discoloration, and will therefore be highly appreciated for many uses.

### Black Walnut Gun Stocks.

A minor but important use to which black walnut is placed is for the making of gun stocks. Eastern gun manufacturers consume many thousands of "blanks" in the manufacture of rifles for government use, as well as for fancy rifles and shotguns for sportsmen. The blank for a regulation army rifle contains eight inches of lumber and sells for from ten to twelve cents at the gun factories.

The beautifully figured walnut blanks to be used for fancy shotguns contain twelve inches of lumber and command a price of from seventy-five cents to two dollars and a half, the highest price being paid for a full figured blank of crested walnut. Two hundred and fifty dollars a thousand is quite a handsome price for even the highest type of either foreign or domestic woods.



TYPICAL FOREST GROWTH HACKBERRY, WASHINGTON COUNTY, MISSISSIPPI.

ing. The tree displays wonderful tolerance of long spells of dry weather. W. H. Freeman, secretary of the Indiana State Board of Forestry, says that hackberry has been but little planted as a shade tree, altogether too little to his notion. He says that while it is not as graceful in figure or as rich in foliage as some other trees, it grows rapidly and its good appearance at all stages of development makes it specially valuable for ornamental





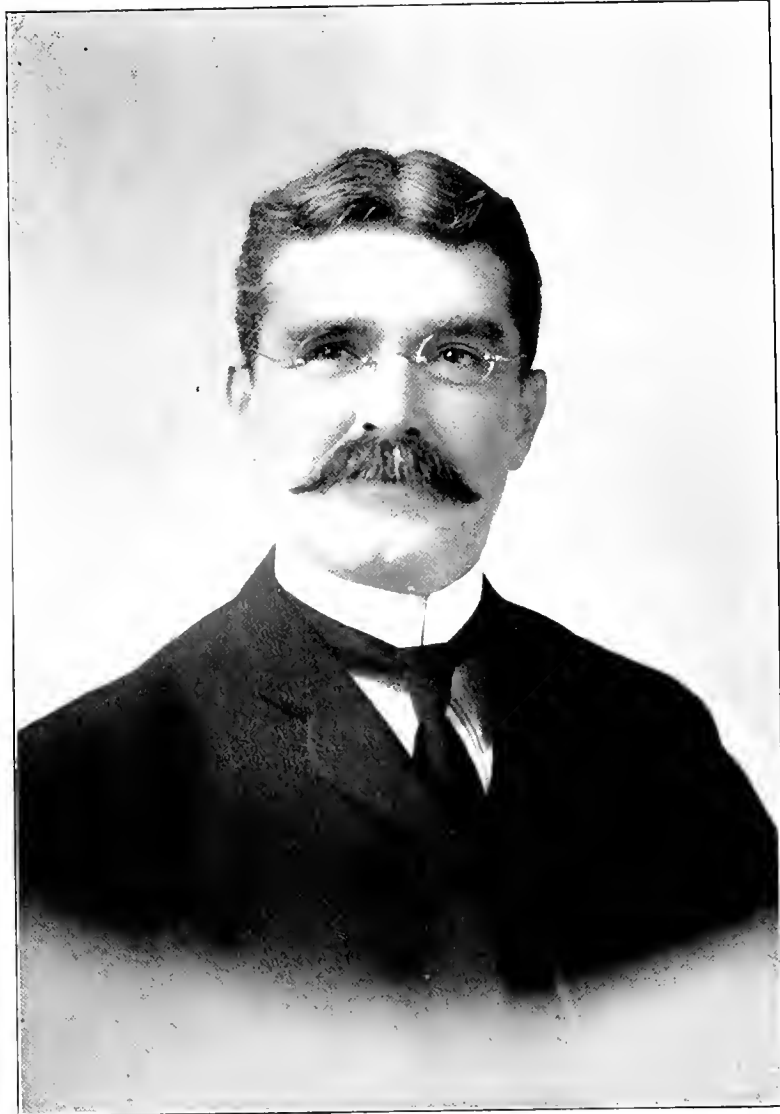

WILLIAM H. RUSSE,  
MEMPHIS, TENN.

## Builders of Lumber History.

NUMBER XXVI.

William H. Russe.

(See Portrait Supplement.)

Carlyle truly says: "The race of life has become intense; the runners are treading upon each other's heels; woe be to him who stops to tie his shoestrings." The men who force their way to the front in the hardwood industry have to be quite as strenuous in their endeavor as in any other walk of life. Some, however, have had the advantage of being born in Indiana, the heart of the greatest hardwood belt this world has ever known. One of these fortunate men is so well known that merely mentioning his name to the majority of the hardwood lumbermen in the United States brings forth an enthusiastic, "Oh, yes, we know Bill Russe."

Mr. Russe was born in Indianapolis Dec. 17, 1855. He attended the public schools at that place and North Western Christian University until he was fifteen years old. Then, like most of the successful men of today, he decided to learn a business, and went to work for an Indianapolis hardware firm. His enthusiasm and energy early brought returns, and in eighteen months he graduated from the store and became a full-fledged drummer. Until he was twenty-two he sold hardware on the road, and then Cupid took a hand in his affairs. In 1877 Mr. Russe married Miss Clara Northway of Indianapolis. He realized that a traveling man would make a rather indifferent husband, and decided to learn the lumber business. He entered the employ of N. C. Long, remaining in this position ten years. At the age of thirty-three he formed a partnership with Henry Latham and George D. Burgess, under the firm name of Russe, Latham & Burgess. Three years later Messrs. Russe and Burgess bought out Mr. Latham's interest, and the firm of Russe & Burgess has continued ever since. Soon after purchasing Mr. Latham's interest, Russe & Burgess opened a branch yard in Cairo, Ill., and in 1881 moved the main office to that point. About six years later a branch yard was opened in Memphis, and in 1888 the main office was moved to that great hardwood lumber town.

Mr. Russe has four children and to arouse his greatest enthusiasm one need only mention to him his grandchild. One son, George C. Russe, is with the E. Sondheimer Company, Memphis; another, F. W. Russe, Ph. D., is with the Mallinckrodt Chemical Works of St. Louis. His daughters, Miss Lillian and Miss Evelyn, are still at home.

Mr. Russe is always cheerful and optimistic, making his acquaintances glad they know him. His enthusiasm is contagious, and he doubtless impresses the foreigners with whom he mingles for about four months in the year while closing his sales abroad, as a typical American—always ready to talk busi-

ness, always overflowing with energy. Mr. Russe is one of the largest hardwood exporters in this country. His friends are legion and he always has a good story or an entertaining speech at hand, which makes him in

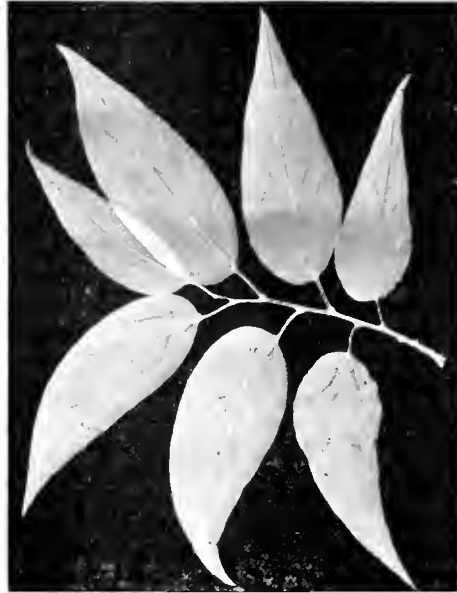

PRINT OF HACKBERRY FOLIAGE—HALF SIZE.

demand wherever hardwood lumbermen meet.

Mr. Russe has always taken a great interest in lumber associations and is a thorough

believer in the work done by them. He was a charter member and secretary of the Cairo Lumber Exchange. He has served as president of the Lumbermen's Club of Memphis, and is a member of the board of managers of the National Wholesale Lumber Dealers' Association.

Honors are crowding thick and fast on W. H. Russe. In January of this year he was re-elected president of the National Lumber Exporters' Association, and last week at Memphis by a very large majority he was made president of the largest hardwood organization in the world—the National Hardwood Lumber Association. As is known, he was originally nominated for this distinction by the Hardwood Lumber Exchange of Chicago at its annual meeting a month ago. One by one other great hardwood centers of the country endorsed his candidacy, and the result of the election at the Memphis meeting demonstrated most thoroughly his popularity and the belief of his constituents that he was the right man for the right place. Mr. Russe's abilities as a presiding officer, as a logician, and as a diplomat surely will secure for him much added distinction in the office that has come to him with so much enthusiasm. He well knows the work that is marked out for him, and that it means a great personal sacrifice to do it well. He is no shirker of responsibility and it goes without saying that he will do his best.

It is with pleasure that the HARDWOOD RECORD prints as the supplement of this issue the portrait of the most popular lumberman not only of the Memphis district, but of the hardwood industry of the United States—the new president of the National Hardwood Lumber Association, William H. Russe.

## A Lumberman's Letters to His Son.

CHICAGO, May 8.

My dear Son: I am just back from the Memphis meeting, and I am going to say to you right here that your old dad is going to resign all lumber conventions to you after this. I'm all to the bad, and your mother thinks I have been hitting them up again, though I explained matters carefully. It was a fierce proposition. Hot doesn't express it! The weather was hot; the election was hotter; and the Memphis bunch the hottest that ever happened! We were packed in the hotel like sardines in a box, and if it hadn't been for Max Sondheimer's lunch house we'd have gone hungry. They tell me this food factory he's running is costing him a lot of money, but he's a charitable cuss and can stand it. But no more conventions for the old man—the simple life for mine.

I don't know what will happen at Atlantic City next year. There were enough temptations at Memphis to lead even the best of us astray—but Atlantic City! Whew!!!

Am glad to know you are getting on so well with the work of building the mill. Hope to see you running it very soon. We certainly need the stock. Lumber is actually higher in Memphis than it is in Chicago today. That bunch has got too wise for me, and I've given up hopes of making any more money off that spot on the map.

Where in the name of common sense did you pick up your stenographer? For Heaven's sake teach him to distinguish between firsts and seconds and one and two inch, and give him a few kindergarten lessons in spelling. Tell him he's working too hard—one "1" is enough to put in elm—the price won't stand for any more.

Let me hear from you often. Keep busy.  
Your affectionate FATHER.

P. S.—Wish you would write a letter to your mother inquiring after my health, and tell her you understand I was threatened with pneumonia while at Memphis.

## A Question Still Unanswered.

In the HARDWOOD RECORD of April 10, under the title "Is It a Legitimate Lumber Enterprise or a Get-Rich-Quick Proposition?" was published a copy of an advertisement of the International Lumber & Development Company of Philadelphia, which stated that it had paid dividends of twelve per cent from the sale of mahogany lumber between April 1, 1905, and Jan. 31, 1906. The article also covered the general conditions of the mahogany lumber business in the United States and abroad, and quoted letters from the majority of the mahogany producers of this country, in which it was incontrovertibly proven that the statements made of the earnings of the Philadelphia concern should be taken with a good many grains of salt. Repeated inquiries by letter made to the International Lumber & Development Company by the editor of the HARDWOOD RECORD and by well-known business men throughout the country, asking for definite figures concerning the imports of this wood by the company named and a statement of cost, expense and net results from its shipments, have failed in every instance to elicit a reply.

### What the Vice President Says.

Col. A. K. McClure, vice-president of the concern, ex-editor of the Philadelphia Times and now occupying the position of prothonotary of the Supreme Court of Pennsylvania, to whom a Baltimore gentleman, interested in lands and other investments, forwarded the article from the RECORD, was asked by him for some specific information about the International Lumber & Development Company. The following is Col. McClure's reply:

PHILADELPHIA, April 23.—Dear Sir: I have your favor with its enclosure. If you will look with any reasonable care at the article in the HARDWOOD RECORD you will see that it is simply one of the many blackmailing devices which have attempted to prey upon us without success and which do prey upon all organizations which are not on a sound basis. Of all the letters given, there is not a single responsible name presented, and the publication would likely never have been made if we had sought the favor of the RECORD by liberal advertising and big pay for notices. If you will call or send any competent person to the office of the company you can readily ascertain that the statement made by the RECORD that we are paying dividends from stock sales is absolutely false. We not only have never paid a dollar out in dividends that was not earned and applicable for that purpose, but we have today legitimately earned not only the dividend we are paying this month but the additional four per cent that will be paid in October.

Some months ago when there was quite a flurry about the failure of several speculative rubber companies in Mexico, the government was appealed to to investigate them. We voluntarily asked the government to extend their inspection to our company, and they sent two inspectors, neither of whom was known to any of our company. Everything was presented to them, every book was open, the title given up to examination, and they found not a thing to report against either the management or the prospects of the company. Of course, they could not make a report in favor of any company, but they could make formal report where they found the company was either violating the law or manifesting a fraud upon the public. I would be very glad indeed if you would come in person and make the examination, or if you cannot, any person who comes here with a letter from you will be given every opportunity to ascertain that the business of this company is conducted on the soundest business basis and that its earnings today are far in excess of its promised dividends.

Yours truly,

A. K. McCLURE.

The HARDWOOD RECORD would say that it has not attempted to blackmail either Col. A. K. McClure or his company. It would be a matter of sincere regret for this publication to be obliged to call that gentleman a hoary-headed old liar, but the alternative is too sad a one to contemplate. Col. McClure states to his correspondent that if he will call or send any competent person to the office of the company he can readily ascertain that the statement made in this paper that his company is paying dividends from stock sales, is absolutely false. The article merely said it was "dollars to doughnuts" that the company was not paying the dividends named from the sale of mahogany lumber, and in the light of the evidence published, this statement may be reiterated. Again, repeated efforts by mail and by personal calls at the office in Philadelphia have failed to establish any evidence that the company is *not* paying dividends from stock sales.

The HARDWOOD RECORD will be just as frank in this matter as Col. A. K. McClure, and a good deal franker. If he or an authorized representative of his company will call at this office he will be supplied with indubitable evidence that the greater number of legitimate mahogany importing and manufacturing houses in this country having a thorough equipment of capital, brains and *experience*, are unable to show earnings that approximate half the sum named in his company's advertisement; and he will be further given evidence that will constitute proof that the letters published are bona fide and the authors are entirely responsible.

### Interview with Secretary McMahon.

A representative of the HARDWOOD RECORD called at the offices of the International Lumber & Development Company, 701-715 Drexel building, Philadelphia, to secure information concerning the mahogany operations of the concern. The headquarters of the company are located in one of the most spacious suites in the building, and the office force, consisting of about fifteen girls, was busily employed in sending out advertising matter, which appeared to be the chief business done there. The assistant secretary, who sat at an imposing desk with pigeon-holes labeled "lists of agents," "instructions to agents" and "agents' contracts," etc., declined to talk in the absence of C. M. McMahon, secretary and treasurer of the company.

When Mr. McMahon returned from lunch he received the caller affably. He is a man of good appearance, about forty years old, and expresses confidence in the ultimate success of the project. He was asked if the company had experienced any difficulty in getting its lumber to market.

"No," he replied, "we have had no difficulty in getting our stock to the United States. Our land is situated in the State of Campeche, Mexico, and lies along the coast. We have an ocean frontage of over twenty-four miles, in the middle of which is situated the port of Chenkau, where we have our wharf. We own a railroad, which traverses our territory, and ship the mahogany to the port by our own cars."

"Have you any mills on the land?" he was asked.

"Yes," he replied, "we have two small saw-mills, but when we fell the logs they are hewn on the ground in a form almost square for easier shipment and then dragged to the cars and forwarded to the port."

"By what line do you ship?"

"We own our own boat, the Vneltabajo, a steamer of 1,260 tons. Each cargo consists of about 400 tons of wood."

"How does that total up in feet?"

"Well, roughly speaking, there are about 480 feet in each ton, or 192,000 feet."

"And how many carloads have you shipped?"

"Altogether we have sent to the United States

seven boatloads, the first one, shipped about fourteen months ago, was sent to New York, where the wood was sawed up by the Astoria Mills there. The other six have been unloaded at Mobile, Ala., and discharged into a large boom which we own at that point. The last cargo arrived April 11."

"By whom was this lumber cut up?"

"By the Underwood Veneer Company of Mobile, but we are now building a mill down there. I can't tell you the exact dimensions of the building, but we are going to employ seventy-five men there. The machinery was shipped about thirty days ago and is now being installed. We hope to have the plant in running order in about a month."

"How much do you calculate that it costs your company to ship mahogany from the woods to Mobile?"

"Roughly speaking, we can cut the timber and land it in Mobile for \$9 to \$10 a thousand, and right here we have the advantage over our competitors. I know of no one who is bringing mahogany from the section of the country where our land is located who can do it as cheaply as we do. This is because we own all our shipping facilities, the railroad, the wharf and the boat."

"Who handles your mahogany?"

"We do it ourselves. We employ no brokers, but sell direct to the trade."

"Then you have shipped altogether about 1,300,000 feet of mahogany since you have been in business?"

"Yes."

"At what price do you sell it?"

"At the market price. We have been able to dispose of it to good advantage because of the superior quality of the wood."

"But do you know the exact price at which the various consignments were sold?"

"No; that is not my end of the business, but I do know that we secured good prices for it."

"You claim to have 288,000 acres in Mexico; how much of this is covered with trees?"

"About three-fourths of the land is timbered."

"How is the wood found—is it scattered or in lots?"

"The mahogany is scattered all over the land. We find it growing among the other trees, but the mahogany growth is scattered."

"Have you yet brought away any of the other woods, such as rosewood, etc.?"

"No; the only lumber we have shipped besides mahogany has been some cedar. We have about ten different kinds of woods that are marketable, but we haven't come to them yet."

"How many shares of stock have you sold, Mr. McMahon?"

"I can't say."

"Can't you say approximately?"

"No."

It was learned in the office, however, that there have been about 3,000 shares disposed of.

"Is the money coming in from stock subscriptions being used to develop your resources?"

"Yes. As fast as the money comes in, it is applied in that way. We are already cultivating 20,000 acres of ground or one acre for each share of stock. We are building up a big business in heniquen, which is used for making fibre, and only needs combing out to make good rope. We have in the ground now 1,200,000 plants, some over two years old when planted. We expect to place 5,000,000 of these plants in the ground. The value of this feature alone can be seen when it is considered that \$187,000,000 worth of heniquen has been shipped from the port of Progreso, a short distance from our land, during the past twenty-three years, and that \$2,000,000 worth was sent out last May. We have, besides, about 2,000 head of cattle, and they are turned loose on 30,000 acres of grazing land, covered with the finest grass. Another source of revenue is that our steamer carries freight on her return trips, and thus adds to the profits of the company."

"Then all these improvements have been made with the money subscribed for stock, and you have been able to declare a dividend of twelve per cent on your sale of mahogany alone?"

"Yes, we have been able to do this because we have sent our cargoes to Mobile and had the wood sawed at the mills of the Underwood Veneer Company, and then sold to the trade. Of course, our profits come largely from the fact that our initial expenses are much lighter than those of our competitors, since the wood is easy of access and is shipped via our own cars and our own boats."

Mr. McMahon did not discuss the amount of stock sold, nor the money paid into the treasury. The company advertises, however, that its shares sell for \$300 each, and that the amount can be paid in installments.

It is apparent to the mere tyro in the lumber business that C. M. McMahon's statement that his company can cut mahogany in

Mexico and land it in Mobile for \$9 to \$10 a thousand feet is absolutely and unqualifiedly ridiculous. Many other statements he

has made exhibit his want of knowledge of any detail of the business. He may be a glibly-promoted promoter, but he has been wise in not telling what he doesn't know about the mahogany business over his signature.

#### Interview with an Expert.

One of the heaviest buyers of mahogany and veneers in Philadelphia was seen by a Record representative regarding the statements of the International Lumber & Development Company. He was asked if he had ever received price lists or quotations from them.

"No," he replied: "the only dealings I ever had with that company was when one of their agents came to me and wanted to sell me some stock. When I talked to him about the mahogany end of the business, and tried to get a line on how they manufactured and sold it, he was all at sea and appeared completely ignorant of that end of the business. I told him I would be glad to have him come around when he had some lumber to sell, but that I didn't want any stock. They have never come near me since."

"Have you ever seen any of their lumber?" he was asked.

"No, I never saw any of their mahogany," he replied, "but I bought some veneer that was cut up at the Astoria Mills in New York when they shipped a cargo there about a year ago. I got the goods at a fair price, and was well satisfied with them. It was reported around at the time, and so I understood it, that the Astoria people practically owned the stock in payment for their work. I don't know who bought the lumber, but it was put on the market somewhere. If they are selling mahogany, the sales are being made in the West, for I have heard of none of their lumber being offered in this market."

"Do you know anything of the Underwood Veneer Company?"

"Not personally. I have heard that they are interested in the National Lumber & Development Company, but I do not know to what extent. I have also heard that their work is not of the finest quality, but as I have never seen it, I am not in a position to speak positively on that point."

"Do you think that the International Lumber & Development Company can pay a dividend of twelve per cent the first year from their sales of mahogany?"

"I don't know what they can do, but I know that if that is the fact they are doing more than any of the rest of us can do, and I, for one, would like to see how they do it. They claim to have developed the land, bought or built

a railroad, come into possession of a wharf, and bought a good sized steamship, and in spite of all these expenditures to have paid a dividend of twelve per cent on their stock for the first year. I don't believe it can be done, and it will probably be found that the whole affair has more in common with a stock jobbing operation than with a legitimate lumber enterprise."

#### From Other Mahogany Producers.

PHILADELPHIA, April 15. Editor HARDWOOD RECORD: I have given the matter of the International Lumber & Development Company considerable thought and believe it is impossible for the dividends they name to have been paid from profits on the sale of mahogany. I have personal knowledge of two cargoes which were brought into New York, which were sold at a very low price. I should say only enough to pay freight and actual cost of getting the stock out. Without having the actual figures before me, my recollection is that the wood sold at \$40 to \$65. The freight would be \$10, and the cost of getting the wood to the coast, based on the average cost of mahogany produced in Mexico, is from \$50 to \$60 a thousand. I believe they brought in three other shipments. One of these I myself saw at Mobile, and it consisted of logs put from their property at all, but which they had purchased on the outside market at Laguna. This particular lot of logs amounted to about 125,000 feet. Allowing for the best results, should say that \$1,500 profit from such a lot of wood would be about all that could be obtained. I do not think that this company will ever bring in enough mahogany to have any effect upon the mahogany market, but for the protection of any innocent investors, I think your ventilation of this concern is very commendable.

#### Letter from Prominent Mahogany Concern.

BOSTON, April 14. Editor HARDWOOD RECORD: Your edition of April 10 has come to hand, and we have noted with much interest the article on the International Lumber & Development Company. You certainly have put this in very good shape, and it ought to be conclusive as to the character of that concern.

#### Letter from Pioneer Mahogany Operator.

CINCINNATI, April 23. Editor HARDWOOD RECORD: We have received your valuable paper and have read your article on the International Mahogany & Development Company with much interest. I endorse all you are doing to enlighten investors concerning this scheme. We have been in the mahogany business for forty years, from the ground up, and I say it is impossible for any company to pay such dividends as stated. Keep up the good work.

## What Does it Look Like to You?

It is really unfortunate that the HARDWOOD RECORD should be obliged to devote so much of its space to the gratuitous advertising of the more or less notorious Imel-Spiro-Harris bunch, which has headquarters at Pittsburg, Pa., and has acquired so unsavory a reputation in lumber circles for several years past.

Advice from Pittsburg announce that the Pittsburg Fuel Company disappeared from the Bijou building about April 5. The agent of the building sold out the fixtures of the two offices occupied by the concern last week, and has no knowledge of the whereabouts of either J. C. Harris or Louis N. Sturman, the only people connected with the enterprise with whom he was acquainted. It is reported they have "done" everybody they could, and skipped to parts unknown.

Simultaneous with this report comes word from Wilmington, Del., announcing the incorporation on April 12, under the laws of that state, of the Delaware Hardwood Lumber Company, with a capital stock of \$20,000, of which \$10,000 is said to have been paid in. Its officers are as follows: James C. Harris, Wilmington, Del., president; Edward J. Emery, Philadelphia, Pa., vice-president; J. L. Greenwald, Indianapolis, Ind., secretary and treasurer. The office of the concern is

located at 306 Ford building, Wilmington, and it announces its intention to do a wholesale business in hardwoods in the eastern markets.

Of the incorporators, who are also officers, James C. Harris claims to be the moneyed man of the concern and to own about 80 per cent of the stock. The remainder is said to be divided between the other two officers, J. L. Greenwald and Edward J. Emery are the practical lumbermen of the company and are to transact the business. James C. Harris, the president, does not claim to have any knowledge of the lumber business, but to have been formerly connected with the Pittsburg & West Moreland Coal Company of Pittsburg.

Inquiry among the trade and among residents of Wilmington fails to reveal any knowledge of James C. Harris, but the register of the Clayton House shows that he was registered there with his wife and son March 26 to March 31. From the hotel he removed to 914 West street in the same city. When interviewed, Mr. Harris said that the company had selected Wilmington as headquarters for its operations on account of its railroad facilities, and stated that he had come from Pittsburg and intended to re-

side permanently in Wilmington. He gave his former residence in Pittsburg as 217 Vine street., Edgewood Park, where formerly resided the James C. Harris, who was connected with the Pittsburg Fuel Company, a concern which has been frequently referred to in these columns, who at one time posed as the moneyed man in the notorious house of S. S. Spiro & Co., which made a disastrous failure in Columbus, O., a few years ago. Mr. Harris is brother-in-law to C. J. Imel, of unsavory reputation, and has been associated with him in several deals.

Diligent inquiry among the trade in Philadelphia reveals that no one knows anything about Edward J. Emery, and no one of that name has recently been recorded in the city directory save a machinist who lives in a suburb. Mr. Harris was asked where Edward J. Emery lived in Philadelphia, and replied that he was a lumber salesman who had no fixed abode, but that he lived in hotels. When pressed to tell the name of any particular hotel at which Mr. Emery had stopped, Mr. Harris said he lived wherever he pleased. On further interrogation he said he did not know for whom Emery worked before he became vice president of the Delaware Hardwood Lumber Company, but that he was a lumber salesman of Pittsburg. Later Mr. Harris said he had known Emery several years. Who Edward J. Emery really is is uncertain, but it is suspected that he is none other than Walter Imel, a brother of C. J. Imel, another of the free-booting gang which has preyed on the lumber interests for some time. Walter Imel was in Philadelphia previous to the filing of the papers of the Delaware Hardwood Lumber Company.

Various reference looks fail to show any lumber and coal dealer in Indianapolis, Ind., by the name of J. L. Greenwald. This gentleman is secretary and treasurer of the Delaware Hardwood Lumber Company. His headquarters are said to be in that city, and he is supposed to buy and sell lumber for the corporation.

S. S. Spiro registered at the Bellevue-Stratford Hotel at Philadelphia April 7, and remained there several days and was continually in the company of Walter Imel. It is thought that possibly Spiro is playing the part of J. L. Greenwald of Indianapolis, Ind.

Dun's Agency in Wilmington states that it has not yet given the Delaware Hardwood Lumber Company a rating, but it is very favorably impressed with Harris. One of the particularly dangerous features of the Imel crowd is the fact that it has always succeeded in making such a showing before commercial agencies as to secure a good rating at the start.

From the foregoing facts concerning the Delaware Hardwood Lumber Company it would seem wise on the part of the lumber trade to exercise at least reasonable caution before entering into business alliances with it.

## Hardwood Record Mail Bag.

[In this department it is proposed to reply to such inquiries as reach this office from the HARDWOOD RECORD clientele as will be of enough general interest to warrant publication. Every patron of the paper is invited to use this department to the fullest extent, and an attempt will be made to answer queries pertaining to all matters of interest to the hardwood trade, in a succinct and intelligent manner.]

### Birch in Nova Scotia.

The following letter from M. W. Teufel, manager of the Davison Lumber Company, of Bridgewater, Nova Scotia, is self-explanatory, and imparts considerable information concerning the timber resources of Nova Scotia. Mr. Teufel is carrying on a great spruce operation at Bridgewater, and the lumber product is going extensively into export to Great Britain. The many Chicago friends of Mr. Teufel will recall him as having been with the John O'Brien Land & Lumber Company and subsequently as Pittsburg manager for the John M. Hastings Lumber Company:

BRIDGEWATER, NOVA SCOTIA, April 16.—Editor HARDWOOD RECORD: Noting your article on the value of birch in your issue of the 10th, desire to state we fully concur in your opinion, and while no doubt the timber is getting quite scarce in Pennsylvania and the Adirondacks, desire to state that there is a large quantity of valuable birch timber in Nova Scotia and that a large portion of same runs to the red variety.

There is an abundance of birch, beech and maple and a small amount of red oak in Nova Scotia; in fact, the hardwoods and hemlock here are still in their virgin state, very little ever having been cut by reason of the fact that heretofore all operators were obliged to drive their logs to the mills, but with modern methods of operation, namely logging railroads, which our company now have adopted, we can handle hardwoods and hemlock to good advantage.

The manufactured product naturally would find its way readily to the Atlantic coast states of the United States; furthermore the English market takes a large quantity of log run birch deals, but in our opinion our hardwood stock should be manufactured and shipped to the United States.

Large bodies of hardwood lands can be secured in the province at very favorable rates in the interests of buyers for either operation or investment.

We take the liberty of mentioning these facts for the reason that the province of Nova Scotia has been standing in the background, hence its wonderful advantages in the way of supplying spruce, pine, hemlock and hardwoods is generally unknown in the United States.—DAVISON LUMBER COMPANY, LTD., M. W. Teufel, Manager.

### McMahon of Syracuse.

In the last issue of the HARDWOOD RECORD was printed the letterhead of John O. McMahon, "attorney and counselor at law," 32 Eversou Bldg., Syracuse, N. Y., which was extremely rich reading for lumbermen, coming from a man who confessed in the letter below it that he was entirely without practical experience in the lumber business.

Love, Boyd & Co. of Nashville, Tenn., have sent the HARDWOOD RECORD another communication from this versatile lawyer-lumberman as follows:

SYRACUSE, N. Y., April 25, 1906.

DEAR SIRS:—I have calls for the lumber products described in your ad. Some of them

are from wholesale dealers and some from consumers, as designated. Can you respond to any of them; if so, how fully, and at what price f. o. b. city of consumer—New York City? What else have you got in lumber products that would be bargains to my customers? State prices f. o. b. New York. Do you offer these bargains to wholesale or retail dealers or to builders and consumers? I can sell to either as you direct. Also please state whether my charge of five per cent commission against the seller on lumber sold by or ordered through me will be satisfactory to you. Very truly yours,

J. O. McMAHON.

P. S.—I buy and sell lumber products both between wholesaler and dealer and between retailer and builder; wholesale prices will not be divulged to builders, therefore state whether your prices are for dealers or builders.

There is one good thing about McMahon—he doesn't have to spend any money buying nerve tonic.—EDITOR.

### A Trip of Business and Pleasure.

On invitation of R. E. Wood, president of the R. E. Wood Lumber Company, Baltimore, Md., a party of his business associates and friends joined him at Washington, D. C., on the evening of Friday, April 20. They were ushered into a private car attached to the special Southwestern Limited of the Southern Railway and started for the Sapphire country. In this section of South Carolina, North Carolina and east Tennessee, the R. E. Wood Lumber Company has timber holdings aggregating 125,000 acres.

The trip was planned to give Mr. Wood's associates in his timber and lumber enterprises an opportunity to see something of the magnificent timber owned by the corporation in the southern Appalachian country, as well as to give the ladies in the party an opportunity to revel in the sunshine and natural beauties of Asheville and the Toxaway country.

The party reached Asheville on Saturday afternoon, and after dining at the Battery Park Hotel were given a carriage drive about Asheville, and through the magnificent Biltmore estate of George W. Vanderbilt. Mr. Wood and his guests returned to the hotel in time for dinner, and Sunday was spent in driving and church-going. On Sunday evening the party left for the Sapphire country to make its headquarters at Toxaway Inn, Lake Toxaway, N. C. Several days were spent in sightseeing in the beautiful Sapphire country and in viewing the timber of that section. A half-tone illustration printed in this issue of the HARDWOOD RECORD shows Mr. Wood and his guests during the drive through the Biltmore estate.

The party consisted of: R. E. Wood and sister, Baltimore, Md.; A. P. Perley and wife, Williamsport, Pa.; P. B. Shaw and daughter, Williamsport, Pa.; H. S. Mosser and daughter, Williamsport, Pa.; A. T. Page and wife, Williamsport, Pa.; O. F. Hershey and wife, Baltimore, Md.; W. L. Taylor, Welch, West Va.; G. L. Wood and wife, Asheville, N. C.; Henry H. Gibson, Editor HARDWOOD RECORD, Chicago.

### Hoo-Hoo's Well Doing.

Occasionally a member of the Black Cat Order is proud of being identified with that organization. On hearing of the terrible disaster in San Francisco the order promptly wired \$2,000 from its imminent distress fund to Vicegerent Trover of that city, to assist members who are in trouble.

This sum wipes out the distress fund of the order and more, and every loyal Hoo-Hoo should see that his mite is sent to Scrivenoter Baird at once, so that the organization may be in a position to assist in the next emergency. In place of having on hand \$2,000 the order should have \$10,000 in its distress fund. It is hoped that

every Hoo-Hoo will get to the front promptly, even though it be only for the regulation ninety-nine cents.

### Big West Virginia Deal.

The Flint, Erving & Stoner Company has bought from E. V. Dunlevie of Dunlevie, W. Va., a tract of 10,000 acres of timber in Pocahontas county, West Virginia, for a price approximating \$1,000,000. The deal is the largest West Virginia purchase made for months, and gives to the company the finest tract of spruce and hardwood in the mountain state. It is estimated that the tract will cut 200,000,000 feet of lumber, spruce and hardwood. The tract is compact and is well located, its seven miles of railroad and the seven miles more which will be built, controlling a large amount of adjoining timber land.

The property is on the Chesapeake & Ohio railroad and the Green Briar river. Included in the purchase are seven miles of railroad and the entire town of Dunlevie, containing two large boarding houses, 26 houses, a store, offices, post-office, two mills, blacksmith and repair shops, oil, boiler and machine shops and an up-to-date electric light plant, which supplies light to the entire town. The best machinery is found in the plant, including a band mill and a Stearns resaw with a total capacity of 100,000 feet of lumber a day, boilers with a capacity of 450 horsepower, gang edger, trimmers, slashers and dozens of live rolls. The company has already taken possession and will shortly operate the mills day and night.

The operation will be carried on by a new West Virginia corporation, to be called the Flint, Erving & Stoner Lumber Company. This concern already has 60,000 cords of round pulp wood sold to the West Virginia Pulp & Paper Company, and 60,000 cords of slab pulp wood, which is taken from the refuse as it is on the way from the carrier to the burner, contracted with the same company. It will market most of the lumber in the East, but a large part of it, especially the hardwood, will be sold in the Pittsburg district, where the Flint, Erving & Stoner interests are among the largest distributors of staple lumber. This operation, which will last ten years, will give the company 20,000,000 feet of lumber annually, which, with its other operations in the South, and in northern Pennsylvania will give it a total of 50,000,000 feet of lumber a year.

The officers of the Flint, Erving & Stoner Lumber Company are: President, J. B. Flint, who negotiated this purchase; vice-president and general manager, A. W. Eckhart, who was for many years manager of the enormous operations of the Weyerhaeuser lumber interests in Wisconsin; secretary, E. H. Stoner; treasurer, R. H. Erving.

### The General Lumber Company.

The General Lumber Company is the name of a new Memphis hardwood house at 380 Randolph building, whose officers are W. J. Richardson, president; E. E. Bookmiller, vice president and manager, and P. H. Ravesties, secretary and treasurer. The concern is capitalized at \$10,000 to do a general wholesale hardwood lumber business, which capital is all paid in and will be increased as the growth of the enterprise warrants.

Mr. Ravesties was formerly connected with the Sullivan Lumber Company of Memphis, while Mr. Bookmiller has also had considerable experience in the lumber business in that market.

William H. Lloyd and other local capitalists have organized the Pine Apple Spoke & Handle Company, which will erect a factory at Pine Apple, Ala., to manufacture spokes, handles and other articles of hardwood. The concern is capitalized at \$1,500. The seat of operations is only a short distance from the Alabama river, and the output will be shipped via Mobile to market. The interests controlling this enterprise are planning the establishment of other institutions of the same kind.

Complete Official Report of the Proceedings of the Ninth Annual Convention of the

# National Hardwood Lumber Association

Held at Memphis, Tenn., May 3 and 4, 1906

## OFFICERS AND NEW DIRECTORS FOR 1906-7

### OFFICERS

President, W. H. Russe, Memphis, Tenn.  
 First Vice President, O. O. Agler, Chicago, Ill.  
 Second Vice President, C. E. Lloyd, Jr., Philadelphia, Pa.  
 Third Vice President, H. C. Humphrey, Appleton, Wis.  
 Treasurer, J. Watt Graham, Cincinnati, O.  
 Secretary, Frank F. Fish, Chicago, Ill.

### DIRECTORS

Earl Palmer, Paducah, Ky.  
 C. H. Barnaby, Greencastle, Ind.  
 C. F. Sweet, Grand Rapids, Mich.  
 George E. Hibbard, St. Louis, Mo.  
 O. E. Yeager, Buffalo, N. Y.  
 G. J. Landeck, Milwaukee, Wis.

The ninth annual meeting of the National Hardwood Lumber Association has gone into history as the largest gathering of hardwood men ever assembled in this country. The roster of attendance had the signatures of 430 people, and a number of persons failed to have their names recorded. It is safe to say that there were nearly 500 people present at one or more of the sessions.

Although the weather was very hot and the hotel accommodations inadequate for such a large crowd, the Memphis lumbermen did everything in their power to make the stay of the visitors agreeable. They proved to be hosts par excellence, and were lavish in their attentions attempting to see that every individual was made comfortable and happy. Both the banquet and the social entertainments given the visitors were delightfully planned and executed.

Each session of the convention was characterized by spirited debates, and while the prevailing interest was centered in the election of a president, other important business coming before the convention was dispatched with vim and vigor. Among the notable features of the convention was the taking of an entirely new attitude on the subject of forestry, the association recognizing at once the valuable suggestions on the subject brought out in the report of Chairman Wall of the Forestry Committee and fully endorsing his ideas on the right way to get after reforestry problems.

The convention demonstrated its charity in a marked way by raising a substantial sum for the benefit of the San Francisco sufferers. It elected to hold its next annual meeting at Atlantic City, N. J.

Furthermore, it was decided to remove the association's headquarters from Indianapolis to Chicago.

The full official stenographic report of the proceedings herewith follows:

### THURSDAY MORNING SESSION.

The convention was called to order by President Earl Palmer, in the assembly room of the Gayoso Hotel, at eleven o'clock.

Mr. Barksdale: As president of the Lumbermen's Club of Memphis I want to welcome you, each and all, as guests of this club and as guests, also, of the citizens of Memphis. It is my pleasure and privilege to introduce to you our mayor, the Hon. James H. Malone, who will now deliver an address of welcome.

#### Address of Welcome.

Mr. Malone: There is no gavel here, but I gave your honorable president a dollar to use in calling the meeting to order. I have asked him to return the dollar before I get through with my speech.

Mr. Chairman, and gentlemen of the National Hardwood Lumber Association, on behalf of the city of Memphis and all its citizens, I extend to you a most hearty and sincere welcome to our midst. We are glad to have you with us today. We are always glad to have with us visitors from a distance. We are more than pleased when the great commercial interests, not only of the surrounding states, but throughout the United States of America, see fit to turn their eyes from their homes and to look, it may be, to the far South, and to have a meeting among us and honor us with their presence. We are glad to have you here today. I had been a very common man until last November. It was the first time in my life that I was ever elected to a public office. Since then I have been mayor of Memphis, and I have been called upon to look into the faces of a great many gentlemen in conventions which have met in the city of Memphis. I asked my honorable predecessor not long ago about welcoming these different conventions, and he said: "Malone, cut it out." [Laughter.] But I have not. I think it is an honor to myself and an honor to the city of Memphis, to look into the faces of these distinguished gentlemen here today in this audience. It almost nonplusses me. [Applause.] I don't see any log run here today.

[Applause and laughter.] It looks to me like all firsts and seconds, all along the line. [Applause.] And we are glad to have you among us.

Now, gentlemen, I am going to be very frank with you. While we feel honored by your presence, we think it not inappropriate that the lumbermen and timbermen throughout the United States should come to Memphis, inasmuch as it is one of the first hardwood markets upon the continent of America. [Applause.] When I was a boy—and I am not old yet, although my hair is a little gray—when we looked in our old geographies, we saw something about timber and lumber interests. We either saw the woodman cutting the tree or drawing the drag over the snow or the felled trees being taken down to the stream, and the geography spoke about the magnificent timber forests which beautified this country. Since then a stream of wealth flowed in and the trees were felled and used to make beautiful residences and public buildings; not only upon the continent of America, but also upon the continent of Europe our beautiful woods have adorned residences and buildings; so much that I cannot but think of my boyhood days when I looked at the rude cuts of the forests of America. There were great wealth and great duty and great possibilities in them, but they have been almost denuded, except in the Southern States, where we have a great wealth of forests. I trust the members of this association, while they look to profit, will improve the opportunity, so far as they can to preserve the forests, and the United States itself, and the several states have instituted such proceedings as will, as far as possible, renew the forests of this great country. I therefore trust you will lend your endeavors to this end and to the preservation of the forests in our western states, and especially in the mountain ranges where reserves have been made.

Now allow me to say one thing, dropping out of the formal and going into the informal. As I said, I am only a common lawyer and they elected me, unhappily, mayor of the city of Memphis. I was called over to my office a few

days ago—now this comes down to you boys personally—to look after some details with respect to a certain lawsuit, and when I went, there was a negro man named Florida, whom I had known many years; as I passed he seemed to be dejected and melancholy; whereupon I recalled the fact that he had been a client of mine, and this great city of Memphis, in extending its streets and boulevards, had determined that it would extend and widen the boulevard in front of his humble shanty, and I was his lawyer. Seeing him so dejected I said, "What is the trouble, Florida? I am mayor of the city of Memphis, and I am your lawyer no longer. I understand the city of Memphis has not only agreed to compensate you in money and to give you a fair equivalent for taking part of the frontage of your lot, but they have also agreed to build a sidewalk in front of your property." He said, "Yes, yes, boss." I said, "Florida, that being so, I want to be fair with you while I am mayor. Let us look at it from the city's standpoint. You, being a carpenter, can buy some material, fix up your shanty, add to it and adorn it so that it may be respectable upon this grand boulevard." He said, "That's all right, boss, but that ain't the p'int—that ain't the p'int—" I tried to be dignified, and said, "Florida, what is the 'p'int'?" He said, "Why, the high price of lumber—the high price of lumber, boss." [Laughter and applause.] "Well," I said, "that is true, Florida, but within one month now, they tell me at the city hall, according to their agreement with you, you will have your money." "Oh, my God, boss," he said, "those timbermen from all over the United States is going to meet at the Gayoso Hotel, and they is going to have a banquet, and every time they have a banquet they raise the price of lumber." [Laughter and applause.]

Now come, boys, do the best you can for Florida. You are going to have a great banquet here; a great meeting. I do hope and trust that this meeting of this association may be the greatest and grandest in its history. Now, one other word. This is a damp, humid at-



mosphere. We know it in the South. We are observing men, and I know that this association is composed of respectable gentlemen, but it may be that you may get up on the sticks somewhere; some of the boys may wander off and come in contact with the guardians of the



O. O. AGLER, CHICAGO, FIRST VICE PRESIDENT.

peace. [Laughter.] If you do, and if you are not dry all along the line, and you get a little wet and they put you on the sticks, and you get in the hands of the guardians of the peace, remember one thing: I have already said to the chief of the police department [applause] that if any such there be, deal gently with the young men for my sake, as was said by one of old. [Laughter and applause.]

I will say one other thing and then I will be done. This city is named Memphis. I had the distinguished honor of being introduced to a few of the wives of some of the association members. Now, gentlemen, I am a married man and in domestic servitude, and I know what that means, and you know it. I explained to the ladies why this hotel was named Gayoso, and they will explain further, but there is scarcely a man in Memphis who knows why it is so named. There is no woman in the world who, if she knew why it was named Gayoso, would not be proud of the fact. I won't tell you that. But this city is named Memphis after another city that flourished five thousand years ago upon the banks of the Nile in Egypt, the great inland sea of the continent of Africa. Memphis of today, Memphis, Tenn., sits upon the banks of the Mississippi river, the grandest river in the world, the inland sea of the continent of America. [Applause.] And if, in future years, when you and I have passed away, if our successors have any doubt in their minds as to where they wish to meet, they will turn their eyes to the Mississippi river and to the city of Memphis and find, as you do now, a hearty welcome in our midst. I thank you for your attention. [Applause.]

President Palmer: I want to tell you about it. [Laughter.] The mayor said to me a second ago: "Shall I go now, or shall I wait until you are through speaking?" I think, in common justice, if I can stand to hear his speech he ought to listen to mine. [Applause.] Mayor Malone: I will do that.

President Palmer: I wish to say that one of the most trying features of the office which I have held has been the duty to respond to addresses made by orators such as the mayor of Memphis. When you put a lumberman beside a trained orator, a trained lawyer, he doesn't appear very well in competition.

Mayor Malone: I am only a common lawyer.

President Palmer: Mr. Mayor, someone has said that to paint the lily or to gild the finest gold were a wasteful and ridiculous excess, and I believe that any attempt on my part to add to that which has already been said with regard to the quality of Memphis' hospitality may well be placed in the same wasteful category. I should, however, be false to the trust reposed in me as presiding officer of this meeting did I fail to thank the mayor for the kindly words of welcome to which we have just listened. We fully appreciate the warmth and the sincerity of the welcome that has been extended to us by the city of Memphis, through her executive, the mayor, who in his address alluded to a Memphis away back five thousand years ago. To my mind, Memphis rather corresponds to a city of later date, a city thrown upon her seven hills and stretching her scepter over the entire civilized world. That city was Rome. Memphis might well be compared to the Rome of the past. Rome became great by conquest and Memphis is becoming great by conquest; but the conquest of Rome was over empires and that of Memphis is over human hearts. I leave it to you, gentlemen, as to which will be the more enduring. But Memphis, in imitation of her ancient prototype, still binds her willing captives to the wheels of her chariot, with a golden chain. The greatness of Rome is of the past. Her sun has set, while the sun of Memphis has scarcely



C. E. LLOYD, JR., PHILADELPHIA, SECOND VICE PRESIDENT.

risen, and no one can foretell what its glory will be at noonday. The greatest reason, to my mind, for the downfall of Rome, was the fact that there was lacking an essential element in her citizenship. In all the cosmopolitan population of Rome, history has failed to disclose the presence of a single hardwood lumberman. [Laughter and applause.] Now, while I may be wrong in assuming that the downfall of Rome was due to the absence of the lumbermen, there is none that can gainsay the statement that the upbuilding of Memphis is largely due to the lumbermen. [Applause.] The Memphis lumberman—a topic worthy of a better speaker than your humble servant—the Memphis lumberman is not a local product. He comes from Wisconsin, from Michigan, from Indiana, and from everywhere; from the northern and eastern states, in stubborn pursuit of the gradually receding hardwood timber belt, until he has made his final stand here in this city, and has converted Memphis into the largest hardwood producing market the world has ever known. [Applause.] Memphis was an old town when the lumberman discovered it. [Laughter.] Memphis was a cotton town; it was a town in the true meaning of the word. But since the

lumbermen have come here and gone out and advertised it in all the marts of the world, Memphis has become a city—a city of destiny—and the people of the United States, through the active efforts of the lumbermen, have been caused to sit up and take notice of the destiny of Memphis. As I say, these Memphis lumbermen are big people. They are, I believe, in a class by themselves, and as such they are viewed with pride and hailed with joy by the remaining portion of the lumber trade. I would like to discontinue this response right here. I believe I have said enough.

Mayor Malone: Go on, Mr. President.

President Palmer: I am going to, sir. I believe that I have an accounting with the mayor. I noticed a wave of surprise and sadness settle over the faces of this distinguished audience during a portion of the remarks of the mayor. It may not be seemly for me to find fault with an address of welcome, but I am here to do my duty, and I am going to object to that portion of the address in which the mayor referred to the fact that special instructions had been issued to the police force on account of the attendance at this meeting. Mr. Mayor, we are your guests today, but we are asking for nothing but the liberty to enjoy every rational and lawful entertainment that may be extended by our hosts. We will have none of your license. [Laughter.] I would, therefore, suggest that those special instructions to the blue-coated guardians of the peace and guardians of law and order be recalled, and in place thereof, that they be directed to be exceedingly vigilant during the next two days. [Laughter and applause.] Let them throw out a drag-net for evil doers of every description, and, sir, I pledge you, upon the honor of every guest here, that when that net is pulled in not a single member of the National Hardwood Lumber Association will be found entangled in its meshes, unless he also be a member of the Memphis Lumbermen's Club. [Great laughter and applause.] Perhaps you would desire to know why I speak with such cocksure authority on that question.

Mayor Malone: I would.

President Palmer: I want to tell you we are traveling under the guardianship of our hostesses who are sitting on the seats in the rear. [Applause.] Now, going back to Rome again when Rome ruled the world the coun-



H. C. HUMPHREY, APPLETON, WIS., THIRD VICE PRESIDENT.

sans occupied the throne, and that is why Rome fell. Today, in our own country there is a throne at every fireside, and that throne is occupied by a wife and a mother.

Mayor Malone: That is right, sir, that is



right. [Applause.] With the permission of your distinguished chairman, and in accord with the beautiful sentiments which he has just expressed with respect to the home and the fireside, I am going to say to you now why this hotel is named Gayoso. There are not many men in Memphis, probably, who know the reason, but on account of the beautiful tribute which your president has paid to womanhood, to the ladies who have come with this distinguished association, I think it not inappropriate to make that statement. This hotel is named after Don Gayoso, the last governor-general of the Louisiana Purchase, which, as you will remember, embraced the state of Louisiana, but also included the territory up to the western bank of the Mississippi river, embracing Arkansas, and all across the line, and extending to the Pacific ocean, the purchase of which was made by President Jefferson from Napoleon III. The last governor-general of this great territory was the great Don Gayoso, who died at the age of forty-one years. As one of the last acts of his life, in the year 1784, having his encampment and headquarters in what is now called Hopefield, opposite us, this being the third Chickasaw blood upon the Mississippi river—he came across the river in 1784 to celebrate, as he said, the birthday of his master, the king of Spain. After he had celebrated that day he wrote a letter to his dear wife in Spain. He said he came across upon a flotilla with cannon and with music and on dress parade, and celebrated the occasion; that it was a beautiful day, as this day is, and, to quote Lord Byron, "So clearly beautiful that God alone was to be seen in the heavens." He wrote further: "There is but one thing lacking to make it a perfect day, and that is your dear presence. But I hope to see you soon, and until that time I count the months, the weeks, the days, nay, the hours, till I can be in your dear presence." The God of the universe struck him down before he could see his beloved wife, and now I think it is not unfit and not inappropriate that his memory should be remembered today, and that this great hotel should be named after Gayoso, the man who loved his wife and loved his home, and who paid a tribute to womankind that is imperishable, and that can never fade away. I thank you. [Applause.]

**For San Francisco Sufferers.**

President Palmer: Gentlemen, before enter-



EARL PALMER, PADUCAH, KY., DIRECTOR.

ing upon the regular program prepared for this session, I desire to call your attention to a matter that, in my opinion, is of paramount importance. A great calamity has recently befallen a large number of our fellow citizens.

The beautiful city of San Francisco has been practically wiped out of existence by the destructive forces of nature imprisoned within the earth. When the news first reached us of that catastrophe, our minds could hardly grasp the full import of the devastation that had been wrought, and as the details have come to us from day to day our hearts have throbbed in sympathy and bled in pity; but pity, unaccompanied by action toward relieving the distress of those upon whom that pity is bestowed, is of little avail. I therefore believe it to be fit and appropriate, that before we enter upon any part of the regular business of this meeting some action be taken toward raising a substantial relief fund to be wired in the name of the National Hardwood Lumber Association, to the chairman of the finance committee at San Francisco. I realize that many of us have already contributed to funds of this description, either through our lodge work or through local relief organizations, or in some other manner, but I do not believe that there is a man present who has as yet satisfied the demand that has been made upon his sympathy by the sufferings of those people. They are the largest hearted and the most generous race of men and women that the world has ever produced. In bringing this matter to your attention, I do not urge it upon you as a duty, but I simply present it to you as an opportunity to compare your generosity with theirs if you were

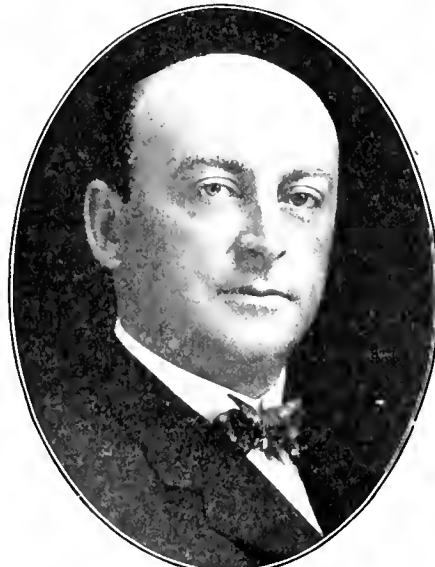

FRANK F. FISH, INDIANAPOLIS, SECRETARY.

the sufferers and they held the purse string. I do not expect any large contributions, but I believe we should all do something, and by doing that, we will put this association on record as following out the principles and the spirit that has always prevailed in our deliberations, the spirit of fellowship and of brotherly love. I will be pleased to entertain a motion that this matter be now immediately considered by this assembly, sitting as a committee of the whole.

Alex. Lendrum: Inasmuch as we all have numbers, I think in order to facilitate this matter, it would be well to appoint a secretary to call off the numbers of those who subscribe. You may put down No. 26 for \$25.

President Palmer: Before doing that I would like to hear a motion, in order to carry this along upon parliamentary lines.

W. A. Bennett: I make that motion, Mr. Chairman.

Motion seconded by W. A. Bonsack, and carried.

President Palmer: Mr. Sondheimer, will you tell us about San Francisco?

Mr. Sondheimer: Mr. Chairman, and gentlemen of the convention, everything that can be

said in reference to this proposition has already been said much better than I could say it or would attempt to tell you. The only thing to do now is to "dig" quick and plenty, and I move you that a committee of five be appointed to gather subscriptions and return them to the



J. WATT GRAHAM, CINCINNATI, TREASURER.

secretary or to the treasurer of our association for disposition

Mr. Bonsack: I would suggest, Mr. Chairman, that if any one is not prepared to make a cash subscription, we make a note of the subscription on a card, and that it be paid later.

President Palmer: The committee is to proceed up and down the aisles and take the names and amounts, and the payments will be made to the treasurer of the association or to the secretary. The treasurer will hold the money until the time to send it on. I will appoint upon that committee Max Sondheimer, Alex. Lendrum, W. A. Bonsack, W. A. Bennett, J. W. Thompson. The committee is going to see every member of the association before it submits its report. Every member is going to see the committee and the results will be reported at one of the sessions of this convention. Not one wicked man is going to escape.

With the permission of the membership the roll call will be omitted, but cards will be circulated among those present in order to get a full roster of those in attendance.

Mr. Sondheimer: You will have to send out to the racetrack to get the full attendance.

President Palmer: Mr. Sondheimer is out of order. The next business is the reports of officers. The president is now ready to submit his report, but before doing so, the president of the Lumbermen's Club desires to make an announcement.

W. R. Barksdale: Gentlemen, the committee in charge of entertainment desires each and every member present to register in the hotel at the private booth of the club, where he will get his number and tickets for an excursion tonight. We want every gentleman of this association, with the ladies in attendance and friends, to be with us. The boat leaves the wharf between half past seven and eight. Tomorrow night there will be a banquet, to which you are all invited, but we want your name on the register in order that you may get your ticket for the banquet.

President Palmer: The first business coming before the meeting is the officers' reports, and the president heads the list, so I will now read my annual address:

**President's Address.**

To the members of the National Hardwood Lumber Association, assembled in annual meet-

ing at Memphis, Tenn., May 3, 1906.—It is an exceedingly pleasant duty that I find imposed upon me as presiding officer to welcome this notable gathering of lumbermen to this, the ninth annual meeting of the National Hardwood Lumber Association. The increased attendance



GEORGE E. HERRARD, ST. LOUIS, MO., DIRECTOR.

from year to year at the meetings of this association affords eloquent testimony to the interest that has been developed in the work being prosecuted by this organization, as well as to the good that results from the intermingling in a spirit of good fellowship of many engaged in the same line of trade, which concourse is rendered possible by meetings of this nature. I am therefore able to greet you with the complete assurance that, notwithstanding the sacrifices of time and money which all have been called upon to make in order to be present upon this occasion, each will return to his home entirely satisfied that he has been repaid many times for these sacrifices in the profit derived from participating in the deliberations of the various business sessions of this meeting and in the pleasure resulting from the generous hospitality that will be dispensed while we are guests of the Memphis lumbermen. I am glad that so many are here today, and I believe that each one shares in my pleasure. Under this condition it requires no Delphic oracle to forecast that this will be one of the best meetings ever held by the National Hardwood Lumber Association.

In accordance with a custom observed at former annual meetings of this association, the president is expected to prepare and submit, as a preface to the work of the meeting, an address in manuscript. In making such preparation I endeavored to produce an address that would be worthy of this occasion, but after a final revision of the manuscript, I realize that I have fallen far short of the mark at which I aimed. In offering my apologies for the deficiencies contained herein, which will be only too evident as I proceed, I can but urge, in extenuation, that I did my best, and remind my friendly critics that "angels could do no more."

From a personal viewpoint, this meeting has meant much to me, for here I expect to realize the climax as well as the finality of my official career in this association. This address, while primarily one of welcome, must also be accepted as a message of farewell from the honorable office to which I was called two years ago. It is my purpose in its contents to touch only upon the mountain tops of events, leaving to the officers and chairmen of the several standing committees who are to follow me the privilege of exploring, in their carefully prepared reports, the valleys of details that lie between.

A proper understanding and conception of results is not possible at all times without taking into consideration, in the same connection, the causes to which they are due. Therefore, it is impossible to separate entirely the events of the year just ended from those belonging to the preceding twelve months, because the work of the first year of my administration was largely devoted to paving the way for the accomplishments of the year now ending.

It is my belief that these two years, taken as a whole, have been epochal in the history of this association. Within that period volunteer effort has been replaced by regular service; abstract conceptions have crystallized into concrete realities; provincial measures have yielded to definite methods.

It is not my purpose to speak slightly of the volunteers who devoted so much time, thought and effort to the work of establishing this association and but for whom no such organization would be in existence today. But, while it is the province of volunteer effort to achieve, it inevitably remains for regular service to maintain. So today the best guarantee that this association offers for its permanence rests in the fact that it now has established a complete regular service, represented by its secretary installed in a well-equipped office and supplied with competent help, to properly care for the details of the work; a surveyor general and a corps of salaried inspectors, widely distributed among the leading producing and consuming hardwood markets of the United States.

In the genesis of the National Hardwood Lumber Association the cherished dream of its founders was that a uniform system of hardwood inspection be established throughout the entire country. Today I am able to make the statement that that dream has been realized; that national inspection is no longer a dream, but an accomplished fact; that in the term national inspection a definite standard finds expression a standard common to and thoroughly understood in every market in this country where hardwood lumber is bought or sold.

Today the National Hardwood Lumber Association stands for a square deal. Its position is well defined. It obligates to absolutely protect the buyer and seller of hardwood lumber who relies upon the efficacy of its bonded certificates to accomplish that end. If, upon investigation, the fact is developed that an error exists in any of the certificates issued by a regularly authorized inspector of the association, this association, without delay or circumlocution, renders payment in full for the difference existing between what is right and what was wrong to the party suffering from the error. No individual, no corporation, no association can do



CARROLL F. SWEET, GRAND RAPIDS, MICH., DIRECTOR.

more. To do less is to invite disgrace and to welcome ultimate disintegration. This association keeps the faith and discharges its obligations, thereby deserving and compelling the respect and confidence of the entire hardwood trade.

In the accomplishment of this work there was no precedent for guidance, and to obtain the end desired it was necessary to blaze a new trail. But, with the foundations of this organization firmly planted upon the bedrock of truth, honesty and square dealing, the only problem that now confronts this membership is that of administration. The wise and proper solution of that problem, however, is surrounded by a sufficient amount of difficulty to demand the exercise of much wisdom on the part of those to whom the destiny of the association is committed. But few appreciate to the fullest extent what is implied by the responsibility for the proper administration of the hardwood inspection of this country. To accomplish this work in a creditable manner and to the satisfaction of all concerned demands that the executive positions in the association be filled by men possessing a comprehensive grasp of the importance and immensity of the task before them, as well as a due regard for the details by which their efforts become effective. Therefore, great care should be exercised in filling positions of trust

in this association, to the end that men peculiarly fitted to the discharge of the duties pertaining thereto are secured.

The results obtained from the inspection department during the past year have been extremely gratifying to me, as I am certain they will be to this membership, when the details are submitted by the chairman of the Inspection Committee, to whom great credit is due for the manner in which the affairs of that important department have been administered.

It is also proper for me to commend the efficient services rendered by the surveyor general. His industry, faithfulness and absolute honesty of purpose, coupled with his unquestioned ability as a thorough judge of lumber, have enabled him to discharge the trying duties imposed upon him in a manner that has given general satisfaction to those with whom he has come in contact, and won for him the thanks and congratulations of every member of this association.

Now, in this connection, should the men behind the guns be overlooked? I refer to those upon whom the association relies for the proper application of its rules of inspection—the bonded inspectors of the association. With few exceptions these inspectors have absolutely justified the trust imposed in them, and by the conscientious discharge of their duties have accomplished much in inspiring confidence in the methods and satisfaction with the results derived from the use of National inspection. It is, therefore, my belief that to them, in as great a degree as to any other agency of this association, is due the gratitude of this membership for the high repute in which National inspection is now held by the trade at large.

The success that has attended the system adopted two years ago of maintaining salaried inspectors has been such as to encourage me to urge the expediency of increasing that particular branch of the service as rapidly as men of the proper qualifications can be obtained. There are urgent demands from various sections of the country yet unsupplied by that class of inspectors. The board of managers has recognized the necessities of the situation and has directed the inspection department to take prompt action in the premises. I trust that these pressing requirements for an addition to the number of salaried inspectors will receive the attention that its importance merits. The most gratifying feature of the situation is that the greatest pressure for National inspection now comes from localities where, but a few years ago, that system of inspection was either unknown or totally ignored.

On account of the fact that the functions performed by National inspectors partake largely of a judicial nature, it is absolutely necessary that these positions be filled by men in whom the judicial faculty is developed in a high degree, and who possess a thorough understanding of the process of properly grading hardwood lumber. In order to obtain men of the proper caliber for the work in hand, it may be necessary to pay a higher rate for the services required than is usually accorded to inspectors



ORSON E. YEAGER, BUFFALO, DIRECTOR.

employed by private concerns. But in this connection the truth comes with redoubled force that good men will be cheap at any reasonable price, while the services of poor men would be exceedingly expensive even though they were donated.

The only complaints that have reached me regarding National Inspection during the past year have come from members who have failed to follow the course of procedure outlined by the inspection department for obtaining the benefits that are derived from the application of that system of inspection. The hand book published by this association last October contains complete and concise information as to the manner in which the inspection department is conducted, and I would commend to this membership a careful consideration of the provisions contained therein in order that any confusion or misunderstanding arising from a lack of knowledge regarding the methods by which National Inspection is administered may be obviated in the future.

The rules for the inspection of hardwood lumber, as amended at the Buffalo meeting, became effective December 1, 1905, and while some objections have been urged as to the wisdom of some of those amendments, it is not my belief that these adverse criticisms are sustained by sufficient grounds to warrant any action in opening up the question of a change in the rules at this meeting. While I do not believe that the members in attendance upon this meeting are lawfully bound by the action taken at any previous meeting, in view of the fact that at the Buffalo meeting a resolution was adopted to the effect that no further changes should be made in the inspection rules for a period of three years from the date of that meeting, I do believe that the pledge then given should be respected at each subsequent meeting until that period of time is completed, unless we are called upon to face conditions in the trade radically different from those prevailing at the present time. It would be well, however, owing to the fact that the hardwood lumber trade is constantly undergoing a process of transition or evolution, for the Inspection Rules Committee to keep in close and constant touch with the trade for the purpose of collecting such information and data as may be afforded, to the end that when the proper time approaches for further consideration of changes in the inspection rules of this association, that a sufficient amount of authoritative information upon the subject be at hand to enable this membership to enact amendments that shall intelligently and comprehensively cover the situation as it may then exist.

The address delivered by me at the annual meeting held in Buffalo last May contained the following paragraph:

"It has been the belief of the president that the entire energy of the association be devoted to the work of increasing the efficiency of associated effort in rendering the offices of the association indispensable to the hardwood trade, under the further belief that when this is accomplished it will not be necessary to urge lumbermen to join our organization, as the benefits to be derived from such a connection will be plainly apparent to all."

The soundness of this view, as to the proper method of propagating an extended membership, has been strikingly demonstrated by the results

good item of news nor of an interesting chapter of the year's work that is yet to be related by an officer to whom is largely due the credit for the growth that has occurred in the ranks of this association within the year ending with this meeting. I may properly state, however, that, while a large addition to the membership has been effected since the Buffalo meeting, the doors of the association have not been opened to all who have desired admittance. Every application for membership has been submitted to a rigid investigation by the Executive Committee, and if any doubt was entertained as to the desirability of adding a name to the membership roll such application was rejected.

While the steadfast adherence and consistent support of a large majority of the older members to the cause of the National Hardwood Lumber Association during the period of its existence has ever been a source of congratulation to those who have had the interests of the association at heart, there is today a special reason for rejoicing on the part of this membership.

"How think ye? If a man had an hundred sheep and one of them be gone astray, doth he not leave the ninety and nine and goeth into the mountains and seeketh that which is gone astray? And if so be that he find it, verily, I say unto you, he rejoiceth more of that sheep than of the ninety and nine which went not astray."

It is my belief that the crowning achievement in the work of the past year was the location and restoration to membership of more than one way-worn member who had strayed from the fold of this association. Hence I repeat, there exists a special reason for rejoicing today on the part of this membership.

At a meeting of the board of managers, convened directly after the adjournment of the last annual meeting, it was decided to employ a secretary, who should devote his entire time and attention to the effects of this association. In accordance with this arrangement the board of managers met in July for the purpose of considering a number of applications for the posi-

our association met with a hospitable reception in the Hoosier capital, the location possesses some objectionable features: it is not as easy of access as some other cities, and as a result the secretary does not come in contact with as large a percentage of the members of the asso-



CHARLES H. BARNABY, GREENCASTLE, IND., DIRECTOR.

tion as would be the case if the office were located in some of the larger hardwood markets. I would, therefore, recommend that at the meeting of the board of managers to follow this general meeting the expediency of changing the location of the office of the secretary and surveyor general be considered.

It gives me pleasure to be able to report that the finances of this association have stood the test of every strain to which they have been submitted during the year, which condition amply confirms the opinion expressed by me at the Buffalo meeting that "So long as this association continues to earn valuable returns upon the investments of its members, no apprehension need ever be entertained as to any difficulty arising from a scarcity of money with which to carry forward any practical undertaking that may be proposed in the interests of its membership."

At the last annual meeting it was decided that the importance of the widely discussed subject of forestry justified the appointment of a standing committee, the duties of which should be to keep in touch with the effort that is being made to convert a nation of tree slayers into a nation of tree planters, and by thus recognizing the necessity for concerted action in the premises, this association should appear upon record as being ready and willing to uphold those who were earnestly striving to establish in this country a system of practical forestry.

I do not consider that any obligation rests upon lumbermen to maintain or restore the forests that is not equally as binding upon every other inhabitant of the country without regard to occupation, for, while lumbermen have been in a large measure the actual instruments of the denudation that is occasioning such widespread discussion and alarm at the present time, what they have done was at the behest of the entire people who demanded from the forests material wherewith to construct houses, barns and stores, to build boats and railroads, to fence their lands and supply their homes with furniture. Hence, I insist that, according to the well-defined principle of jurisprudence which holds the receiver of stolen goods equally guilty with him who committed the theft, lumbermen are no more responsible for the condition in which the country finds itself placed with regard to its timber supply than are the remainder of the inhabitants.

But while I deny any special responsibility on the part of the lumbermen for existing conditions, I believe that, as lumbermen come in closer touch with the situation and possess a keener appreciation of the emergency by which this country is confronted than do those not connected with that trade, it is eminently proper that they be found in the front with the workers who propose in a measure to prevent the distressing condition by which this country is threatened. The practical knowledge gained by lumbermen in years of experience in the forests will be of incalculable assistance to the government and to the several states when a comprehensive system of practical forestry is finally inaugurated, and to such a system I can safely pledge the unqualified support of the National Hardwood Lumber Association.

This membership will recall the action taken



GEORGE J. LANDECK, MILWAUKEE, DIRECTOR.

tion. After careful investigation of each applicant the unanimous choice of the board resulted in the election of the incumbent, Frank F. Fish, who took charge August 1. Since entering upon the discharge of the duties assigned to him Mr. Fish has contributed much to the success of the administration now ending, and has proven himself entirely competent to conduct the affairs of an office the importance of which is vital to the interests of this organization.

I believe it is entirely proper for me to take this opportunity to congratulate the board of managers upon its happy choice in filling this important office, to congratulate Mr. Fish upon the success that has attended his administration and the association membership upon its good fortune in obtaining the services of so competent an officer. I trust that the connection may be continued indefinitely, because I know of no one who can accomplish more for the association than can Mr. Fish, and neither do I know of another organization that will appreciate his exceptional abilities to a greater extent or support his office in a greater degree than will the National Hardwood Lumber Association.

At the July meeting of the board of managers it was decided to establish the office of the secretary in the city of Indianapolis in connection with that of the surveyor general. While



B. F. SWAIN, SHELBYVILLE, IND., DIRECTOR.

obtained during the past year, with a comparison of our membership list today with that of one year ago will conclusively prove. The story of this increase and how it was accomplished I shall leave to the secretary, as it is not my purpose to discount the effect of any particularly

at the Buffalo meeting with regard to the support to be extended to the National Wholesale Lumber Dealers' Association by our association, in the effort being made by the former organization to secure an equitable adjustment of the car stake question at the hands of the various railroad companies. At a meeting of the National Wholesale Lumber Dealers' Association, held in Ottawa last August, an executive committee was selected to take charge of the prosecution of the work. The president of this association was included in that committee, which held its first meeting in Chicago in October. At that meeting the president, who had already been empowered by the board of managers to act according to his best judgment in the premises, subscribed, in the name of the National Hardwood Lumber Association, the sum of \$400 to assist in defraying the expense connected



B. R. THOMPSON, GRAND RAPIDS, MICH.,  
DIRECTOR.

with properly bringing the question at issue before the Interstate Commerce Commission.

An attorney was employed for that purpose and proceedings against the railroads were instituted and prosecuted with so much vigor that the railroad companies in suit acquiesced to the demand for the 500 pounds allowance in weight on account of temporary equipment, and suggested the possibility of a compromise with regard to permanent equipment of flat and gondola cars. In order to exhaust every means for a peaceable settlement of the vexed question this proposition was accepted by the executive committee, and the proceedings before the Interstate Commerce Commission were held in abeyance pending the result of the efforts at compromise. Since that time there have been two conferences between the executive committee and the representatives of the railroads, at each of which this association was capably represented. Sub-committees were appointed to continue the investigation with regard to the practicability of equipping flat and gondola cars with permanent stakes, but nothing definite as yet has been accomplished. While I am not disposed to criticize the action that has already been taken in the matter, I believe that, unless some substantial assurances of good faith are submitted by the railroad companies as to their actual intention, the compromise conferences should be discontinued and the case be resumed before the Interstate Commerce Commission. If relief is to be obtained, the sooner it is secured the greater the saving to the lumber interests, and if it transpires that the compromise conferences are but a dilatory measure to postpone the day when that relief is to come, then the shorter the period of procrastination the better for the lumbermen.

If the issue of this car stake and equipment case results in a complete victory for the lumbermen, as I believe it eventually will, a valuable precedent will have been established as to what can be accomplished by the lumbermen of the country when they act in unison upon a given proposition, and this precedent should not be forgotten when the necessity arises for similar action in seeking to improve other conditions in the trade.

In October I attended the rate regulation meeting held in Chicago as a self-appointed delegate of this association. For reasons that appeared good and sufficient to me at the time—and the soundness of which I have not had occasion to doubt since—I allied myself with the gathering held in the Studebaker theater. I

have never been able to determine with any degree of accuracy just what portion of this membership I represented, as I am aware that some of our members attended or have since supported the action of the meeting held in Steinway Hall. Neither am I disposed at this time to argue the merits of the cause espoused at either meeting. I have never regarded the split that occurred upon the occasion referred to as an unadvised evil. If in this country we were all to take one side of a question the ship of state might list violently, either to port or starboard. But when divergent views are held by nearly an equal number of the people on each side, the final decision generally results in a middle course, in which each may find some part of his belief expressed, and such I believe will be the final result of the rate regulation harvest which is now being threshed out on the floors of congress.

It was my pleasure to represent this association at the annual meeting of the Wisconsin Hardwood Lumbermen's Association, held in Milwaukee, and of the Indiana Hardwood Lumbermen's Association, held in Indianapolis. The National association was honored at each of these meetings by the courtesy extended to its president by these state organizations, and by the adoption of resolutions commending the work now being performed by this association, each pledging its support in carrying forward that work to a successful issue. The local hardwood lumber associations, exchanges and clubs the country over may be properly regarded as constituting efficient buttresses to the National Hardwood Lumber Association, and as such they deserve the gratitude of this entire membership.

At the risk of becoming tedious, I have gone into details regarding the affairs of this association for the purpose of affording to the members a comprehensive understanding of what is being done within the ranks of the organization to the support of which they are called on to contribute. I doubt if any other association is covering a wider field of effort with more satisfactory results. I believe that this membership fully appreciates what is being accomplished, and so long as it shall be apparent that this association is conducted in the interest of its members and so long as each member is able



E. F. DODGE, CHICAGO, DIRECTOR.

to trace tangible results from his connection therewith, just so long will this association continue in the course of prosperity upon which it is now so successfully launched.

Whatever degree of success if any may have attended my work during the past two years has been largely due to the enthusiastic and consistent support which I have received from the membership, the directors and officers of this association, and any attempt on my part to publicly express my thanks for the quality of that support would appear perfunctory in nature and would fall far short of conveying a proper idea of my full appreciation of the generous treatment accorded to me by all.

In conclusion I desire to recall the following metaphor used by me in my brief inaugural address at Cincinnati two years ago: "The presidential pathway looks rosy enough from my present point of view, yet I doubt not but there be now and then a thorn among those roses."

The thorns were there according to prediction, but the scars made by them have long since dis-

appeared while the fragrance of the flowers that bloomed by the wayside, the flowers of trust, loyalty and friendship, will remain with me until the shadows have grown long in the evening of my life, and the day will not come when I shall cease to be proud of the fact that for two years I was permitted to wear the badge of honor of the National Hardwood Lumber Association.

EARL PALMER, President.

W. A. Bennett: Mr. President, I move that a committee of three be appointed to consider the suggestions and recommendations contained in the president's report.

J. W. Thompson: With the consent of the original mover, I suggest that we put Tom Moffett, W. H. Russe and Maurice M. Wall on this committee.

President Palmer: I would suggest that we include the secretary's report and the report of the treasurer in that motion.

Mr. Bennett: I accept the amendment.

Motion seconded and carried.

President Palmer: We will now hear the secretary's report.

#### Secretary's Report.

Mr. President and Gentlemen—In the preparation of this report for the consideration of the membership of the National Hardwood Lumber Association at this, the ninth annual meeting, I have been handicapped in a degree by a lack of knowledge of the history of the association which I have the honor to represent as secretary, as well as by ignorance of the precedents that have been heretofore established as to the proper subjects for discussion in the secretary's report.

However, I am encouraged to believe that the profitable results following the efforts put forth by the officers and directors during the past year will compare favorably with those of any preceding year in the history of the association. That the ground covered by this report may not transgress the limits accorded to the office which I occupy, owing to the fact that I was not installed in the secretary's office until August 1, any credit that may be due that office for what has been accomplished within the year should be shared in a large degree by my esteemed predecessor, A. R. Vinnege, to whom I owe a debt of gratitude for many courtesies extended and much assistance rendered during the first months of my official career.

I have also found in the president a wise counselor upon all matters pertaining to the work of the association, and there is perhaps no one who understands as fully as I the amount of time and attention devoted by him to the interests of this organization. I have been greatly inspired in my new field of labor by the absolute sincerity of purpose and the perfect confidence in ultimate results entertained by



J. WISTAR EVANS, PHILADELPHIA, DI-  
RECTOR.

all the officers, directors and members of this association with whom I have come in contact in the discharge of my duties. While I possess no practical experience in the lumber trade, it is not difficult for me to understand and appreciate the benefits that will assuredly accrue



to that trade as a result of a complete and harmonious combination of the units of which it is constituted, and while I hope at some time to understand all that is implied by the term National inspection, I have thus far exerted myself largely along the line of increasing the membership of this association under the belief that the greater the number that join in the work, the earlier the harvest of effort will ripen.

As a result of this special effort to add to the number of members I am pleased to report that during the year ending with this meeting 204 new firms have been placed upon the membership roll. While this addition in members is certainly gratifying, the fact should not be overlooked that this increase is not made up of the doubtful and questionable elements of the trade but rather includes the names of many of the best hardwood lumber firms in this country. A detailed statement of the membership for the year is as follows:

Membership May 18, 1905.....	332
Applications received since.....	211
Applications rejected.....	7
<b>Total accepted.....</b>	<b>204</b>
Resignations and withdrawals by reason of going out of business, etc....	536
Association membership May 3, 1906..	503

The finances of the association have also received my careful attention and while at times the funds in hand have been reduced to a small figure, the association has not been without a cash balance in the treasury at any time where-with to prosecute any work outlined in the interest of its membership. I trust that the Auditing Committee will be able to reconcile the following statement of receipts and disbursements with the books of the treasurer and the voucher files with him:

RECEIPTS.

From membership dues.....	\$11,819.94
From inspection fees.....	11,831.55
From sale of inspection rules.....	526.86
From cash deposits.....	769.00
From reinspection fees.....	321.89
	<hr/>
	\$25,190.34

DISBURSEMENTS.

Remitted treasurer.....	\$24,420.88
Checks and cash on hand.....	769.46
	<hr/>
	\$25,190.34

While, as indicated above, I am not able to speak as one having authority upon matters pertaining to inspection, it affords me pleasure to be able to offer my testimony as to the efficient manner in which the affairs of the surveyor general's office have been conducted. Owing to the fact that that officer shares the office of the association with the secretary, an ample opportunity has been offered me to arrive at an

The larger part of the time since I have been your secretary has been spent at the association headquarters in Indianapolis. I have, however, made several trips to the large hardwood centers and have been asked frequently by our members why Indianapolis was selected as headquarters for the association. There were doubtless good reasons for making this change and while the association has prospered since its removal to the present location I believe it would now be advantageous to locate the executive offices in a larger hardwood center. This action would result in placing the membership in much closer touch with the executive offices, and I also believe the convenience of the members of the various committees, whose duties necessitate attending several meetings during the year, would be best suited were the offices located in some city where they have other business interests.

In conformity with the by-laws the Executive Committee have held five meetings during the year: at Indianapolis, July 18 and September 21; at St. Louis, November 6; at Indianapolis, January 18, and at Grand Rapids, March 16. The Board of Managers have also held two meetings, the first at Indianapolis, September 21, and the second at Grand Rapids, March 16. These meetings were well attended and the chairman and other members of the Inspection Bureau Committee were also present.

The popularity of the inspection rules of this association is shown by the increase in the demand from all sources for the pamphlets containing these rules. In former years 5,000 to 10,000 copies have been printed, but in November last 25,000 copies of the rules were printed and at the present rate of distribution the edition will be exhausted at an early date and it will be necessary to issue another edition.

Good reasons exist for the belief that all

pregnant with opportunity. You will all agree that the executive committee acted wisely in their instructions to the secretary to emphasize quality and to investigate all names thoroughly before inviting them to membership and submitting their applications for approval.

In accordance with the decision of the Board



W. A. BENNETT, CINCINNATI, DIRECTOR

of Managers at our last annual meeting the proceedings of that convention were published in pamphlet form and distributed among the membership. A large number of these pamphlets were also sent to nonmembers and on request have been supplied to the trade throughout the country. Frequent letters requesting information regarding the association's objects and methods resulted in publishing the present hand book. In addition to supplying the membership with this booklet we have distributed many thousand copies among manufacturers, dealers and consumers, in each instance accompanying same with a special letter. It is therefore reasonable to claim that the National Hardwood Lumber Association is today better known throughout the United States than at any time previous in its history. It has occurred to me that if the members of this association were to adopt a uniform and distinctive emblem to be imprinted upon the letter heads used by them in conducting their business correspondence, some advantage would result to the association from the practice if it could be made general among the members. It is my belief that the emblem appearing upon the letter heads of the officers of this association for the past nine months as well as upon all printed matter coming from the secretary's office might serve. I should be pleased to have this suggestion considered at this meeting, and if it meets the approval of the members present I shall take pleasure in supplying cuts of the design referred to at cost for distribution. I desire to thank the members of the National Hardwood Lumber Association for the many courtesies extended during the year and for your attention to this report.

FRANK F. FISU, Secretary.

President Palmer: The committee on officers' reports can report at their convenience. The report of the committee, however, should be in before the order of new business tomorrow, so that anything they recommend can be taken up.

O. O. Agler: It occurs to me that it might be well at this time to have a resolution adopted, authorizing the president to appoint a committee of three on rules and credentials, and I make the motion that the president be so empowered.

J. W. Thompson: I would amend the motion to read a committee of five.

President Palmer: That, as I understand it, does not refer to inspection rules, but parliamentary rules to govern this meeting.

Mr. Agler: Yes, I accept the amendment. The motion as amended was carried, and the president appointed the following committee on rules and credentials: O. O. Agler, O. E. Yeager, T. R. Stone, G. J. Landeck, R. J. Darnell.

President Palmer: We are ready for the treasurer's report.



JOHN N. SCATTHERD, BUFFALO, DIRECTOR.

branches of the lumber industry are becoming cognizant of the necessity and importance of organized effort under present trade conditions. The interest evinced by our own membership in the work of this association and the material increase in that membership affords abundant proof of this condition. Since our last annual meeting at Buffalo we have admitted many important, long established manufacturing and wholesale firms who have never until now been identified with association work. The secretary is now in correspondence with many others who are quite certain to connect themselves with this association at an early date. While many requirements are necessary to carry to a successful issue the work of organizing the hardwood interests, I believe all agree that harmony is of vital importance. It is my belief that a condition of absolute harmony prevails today in the ranks of the National Hardwood Lumber Association, and to this condition is due in a greater degree than to any other the rate of progress and the position which it now occupies in the hardwood trade. I do not claim that the National association has the strangle hold on prosperity and that our battle is ended, but I do believe that it is possible to build on our present foundation an organization that will embrace all the best firms in the hardwood industry of the United States. A membership of 500 aggressive firms is a great nucleus, and while it is perhaps true that many of our own members do not fully realize the present possibilities, the situation is



EDWARD BUCKLEY, MANISTEE, MICH., DIRECTOR.

authentic judgment as to the manner in which Mr. Smith has discharged his duties, and I am certain that no organization ever had a more diligent, faithful and conscientious employee than this association possesses in the person of the present surveyor general.

Statement of Treasurer for Year Ending  
May 3, 1906.

GENERAL FUND.  
RECEIPTS.

From W. S. Darnell, treas-  
urer ..... \$ 2,624.84



GARDNER I. JONES, BOSTON, DIRECTOR.

Membership dues  
from secretary..\$11,412.09  
Inspection fees  
from secretary. 11,485.04  
Inspection rules  
from secretary. 526.86  
Reinspection fees  
from secretary. 321.89 23,745.88

Total receipts.....\$26,370.72

DISBURSEMENTS.

Paid 175 vouchers.....\$25,850.25

Cash on hand (per bank cer-  
tificate) ..... \$ 520.47

CASH DEPOSIT FUND.

RECEIPTS.

From W. S. Dar-  
nell, treasurer. \$ 1,399.86  
Amount from sec-  
retary ..... 675.00  
Interest accrued  
to April 1,  
1906 ..... 50.55

Total ..... \$ 2,125.41

REFUNDS.

Paid thirteen vouchers....\$ 325.00

Cash on hand (per bank  
certificate) ..... 1,800.41

Total cash on hand.....\$2,320.88

O. E. YEAGER, Treasurer.

Mr. Thompson: I move that an auditing com-  
mittee be appointed to audit the report.

President Palmer: I will state that no com-  
mittee of that kind was appointed at the Buf-  
falo meeting. Inasmuch as there is to be a  
change of administration I requested Mr. Thomp-  
son to make that motion.

The motion was duly seconded and carried  
and the president appointed the following audit-  
ing committee: J. W. Thompson, A. R. Vin-  
nedge, Walter S. Darnell.

President Palmer: It occurs to me that A. R.  
Vinnedge is a good man to check up the sec-  
retary and Mr. Darnell is a good man to check  
up the treasurer.

On motion, duly seconded, recess was taken  
for luncheon.

THURSDAY AFTERNOON SESSION.

The afternoon session was called to order by  
President Palmer at 2:15 o'clock.

B. F. McMillan: Mr. President, they tell

me that Memphis furnishes the best whisky in  
the world. Now, I would like to know about  
what kind of water they furnish.

J. W. Thompson: We never thought of that,  
Colonel.

W. H. Russe: Does the gentleman from  
Wisconsin wish to take a bath? That is all we  
use it for.

President Palmer: I would like to announce  
that there is a standing committee on the San  
Francisco relief fund. Possibly there are a  
number of gentlemen in the room who did not  
get their subscriptions down this morning, and  
to those gentlemen I wish to say that the chair-  
man of the committee is Alex. Lendrum. If you  
will go to him and make your donations they  
will be taken up later. We raised a considerable  
amount this morning that we have not yet  
counted. We will not act on it until we get  
enough to be worthy of this association. I also  
wish to announce that the executive committee  
will meet in this room directly after the ad-  
journalment of this meeting. It is necessary to  
have the meeting of the executive committee  
to pass upon the applications which we have  
here, in order to install all the new members  
that have applied.

The first business this afternoon on the regu-



W. A. BONSAK, ST. LOUIS, DIRECTOR.

lar program is the report of standing commit-  
tees. W. W. Knight is chairman of the inspec-  
tion bureau committee, and he will now read his  
report.

Report of Inspection Bureau Committee.

At the seventh annual convention of this asso-  
ciation, held in Cincinnati, May, 1904, your  
inspection bureau passed a resolution to the  
effect that the surveyor general and the in-  
spectors in the large hardwood markets be  
placed on a salary basis.

During the years 1904 and 1905 there were  
four inspectors appointed on a salary basis,  
viz., New York City, Buffalo, Cincinnati and  
Memphis. During the past year, dating from  
June 1, 1905, we have not only maintained the  
four inspectors above mentioned, but have ap-  
pointed salaried men for Chicago, Philadelphia,  
Milwaukee, Grand Rapids, St. Louis and New  
Orleans, making at present a total of ten.

During the time that these salaried inspec-  
tors have been working for the association they  
have inspected 21,258,184 feet of lumber, and  
the records in the surveyor general's office show  
that the fee inspectors have inspected 89,498,609  
feet of lumber for a period of eleven months.  
Adding to this the average amount for one  
month gives a grand total of 97,634,848 feet,  
a material increase over the work of last year.  
This does not by any means cover the amount  
inspected under the association rules, but simply  
the total shown by records of the office for  
which certificates have been issued.

The expense of the inspection department of  
this association for the past eleven months,  
dating from June 1, 1905, to May 1, 1906, has  
been as follows:

Salary and expense of salaried inspec- tors .....	\$12,001.12	
Fees received and due from salaried inspectors.....	\$10,449.58	
Fees received and due from fee inspectors.....	2,948.13	
		\$13,397.71
Salary and expense of sur- veyor general, including rent, telephone, travel- ing expense, stationery, etc. ....	4,294.36	
Less traveling expenses paid by members.....	423.20	3,871.16
Total cost of inspection de- partment .....	\$15,872.28	
Less fees .....	13,397.71	
Cost to association....		\$ 2,474.57

At present there is a demand for a second  
deputy inspector in St. Louis. New England has  
been asking for a salaried inspector, and like-  
wise Baltimore, Norfolk and St. Paul. Expe-  
rience has taught us that wherever we have  
placed a salaried inspector that as soon as he  
has become known to the trade the demand for  
his services has materially increased.

In order to illustrate to you the difficulty  
in securing the right man for a position of this  
kind I wish to quote to you the language used  
by the former chairman of the Inspection Bureau  
Committee regarding this matter: "A man who  
can be hired on a salary as inspector, who is  
capable of going out and practically arbitrating  
between buyer and seller—as the surveyor gen-  
eral proposes to do—I say such men are scarce  
and hard to get. Men who are capable of taking  
care of a position of this kind are well em-  
ployed and do not care to make a change, nor  
are their employers willing to give them up."

I believe that the success of this association  
depends greatly upon the salaried inspectors.  
They are supposed to be men of good judgment  
and even temper, and at all times to take into  
consideration that they are arbitrating between  
the two or more parties concerned in the trans-  
action; therefore, it is necessary that these  
men show no favoritism. I am confident that  
as far as we have gone in securing salaried in-  
spectors the present corps is as good as any  
similar number of inspectors that could be em-  
ployed.

Referring to the certificates issued by the  
inspectors of this association there are some  
things that this committee would like to im-  
press upon you. First, that the certificate of  
inspection and measurement issued by the in-  
spector shall be *joint between buyer and seller*.  
That is to say, if A sells a carload of lumber to  
B, and the invoice is accompanied by a certifi-  
cate of inspection, B should pay that invoice  
according to the certificate attached. Then,  
upon examination of the car by B, if he finds  
that the lumber is not up to grade, he is entitled  
to a reinspection, whether he is a member of



M. M. WALL, BUFFALO, CHAIRMAN FOR  
ENTRY COMMITTEE.

this association or not. Before calling upon the  
surveyor general for a reinspection, it is the  
duty of B to accept the result of the original  
inspections as a basis of settlement with A, and  
then upon reinspection of the shipment if it is  
found that the deputy inspector made an error.

the National Hardwood Lumber Association is responsible to B for the amount of difference, provided the inspector making the original inspection is in error in excess of the 1 per cent leeway.

Some objection has been urged by members to the allowance of 4 per cent leeway, and it may not be generally understood by the membership that the Board of Managers has ordered that where the amount exceeds 4 per cent the whole difference is charged to the inspector making the original inspection. This rule is now effective and observed by the inspection department. The surveyor general has ruled that where the lumber, the grade of which is in dispute, is obviously of a lower grade than that certified to by the original inspection the 4 per cent clause shall not apply, as the intent of that clause is only to cover line board upon which a difference of opinion might reasonably exist between the two inspectors.

There have been a few cases where certificates have been issued, and without notifying the surveyor general the parties receiving the lumber have asked other deputy inspectors to inspect the lumber, keeping the fact that there had already been a certificate issued on the lumber well concealed. In cases of this kind the surveyor general has declared such certificates void, and would not recognize such certificates as a reinspection.

A great many consumers of lumber make their contracts based upon the rules of inspection and measurement of this association, and I am fully convinced that if this association continues the policy it has adopted, of placing salaried inspectors in the different markets where the amount of prospective work will justify such appointments, there is no doubt that the membership will increase materially, and the trade be benefited accordingly.

W. W. KNIGHT, Chairman.

The report was adopted, on motion.

President Palmer: Theodore Fathauer, chairman of the Inspection Rules Committee, will now please read their report.

**Report of Inspection Rules Committee.**

It is safe to assert that no action taken by this association has ever given greater satisfaction than that of a year ago which is expressed in our inspection rules as follows: "These rules shall not be changed for a period of three years." This action has given our inspection rules the much needed quality, stability, and has placed them for a stipulated period above annual revision. We have established a firm standard which is highly appreciated in this country and abroad. We are glad and proud of the fact that, after a number of years of hard, earnest and conscientious work, inspection rules have been adopted that are satisfactory to all concerned, which is a great achievement when we consider the vast territory in which hardwood lumber is produced and the still larger territory in which the product is marketed, for each producing territory has wood of an identity peculiar

practice; therefore the problem in the beginning was a very complex one.

Your Inspection Rules Committee worked patiently and earnestly year after year to discharge the task assigned and entrusted to them, and I feel that I should publicly speak of my colleagues in this work in terms of highest praise. Much as we differed at times, our arguments pro and con were always sincere, and our views were not prejudiced nor prompted by selfish motives, but each was willing to study the issue in question earnestly at all times and look at it from both sides. The result was that either one or the other was convinced, and that finally the decision was accepted in the most harmonious and unanimous manner, the result of broad views and close study.

We are also indebted to the members at large for the patience they have shown us, and for the unflinching support they have given us at all times. It is nothing short of remarkable that a large body of practical lumbermen should, and did at all times, adopt the report of its rules committee, and we can assure you, gentlemen, that the committee has appreciated the high compliment you paid it in this matter.

Anyone who has studied the inspection rules of the National Hardwood Lumber Association, whether a member or not, must agree with us that they have been expressed in the plainest terms possible and arranged in the most concise form so that any inspector can understand them. There are no contradictions, or even seeming contradictions, in our rules today. We have not too many rules, nor too much phraseology, but yet enough. You will also find that

forest conditions within the United States; something of the details of the efforts being made toward reforestation, and some suggestions from the viewpoint of practical lumbermen on the subject of the necessities and possibilities of regrowing and maintaining a forest area to an extent that shall provide a perpetual source of timber supply for the nation's needs.



T. J. MOFFETT, CINCINNATI, WHO RAN A GOOD RACE FOR THE PRESIDENCY.

Primarily, if we take an account of the standing timber possessed by this country, we will find of the soft woods that the north-eastern states possess approximately 25,000,000,000 feet; the lake states, 70,000,000,000 feet; the Rocky Mountain states, 80,000,000,000 feet; the southern and southwestern states 250,000,000,000 feet, and the Pacific states 800,000,000,000 feet, or a total stand of soft woods of 1,220,000,000,000 feet.

Of the hardwoods remaining in this country, an estimate of approximate accuracy places them at only 250,000,000,000 feet. Thus we have remaining in the United States today a total stock of 1,475,000,000,000 feet of timber of all kinds.

This woodland area is estimated to cover 700,000,000 acres. The government still owns about thirty-six per cent of it; thirty per cent is attached to farms, and the remaining thirty-four per cent is in the hands of individual timber owners, lumbermen, railroads and other corporations.

It is more than probable that not more than one-half of this woodland is in a productive state. Much of it is in a stationary stage where the death rate equals the new growth, and much of it is cut-over lands. It is estimated that the lumber consumption of the United States is 15,000,000,000 feet annually.

With reasonable accuracy it is estimated that the average acre of timber will show an annual growth of only ninety feet. If this be true we can depend upon a total annual increment from the existing forests of only 63,000,000 feet per annum, as an offset against the 45,000,000,000 feet of annual consumption.

Not taking into account the constantly increasing demands for lumber, we have a timber supply that will be exhausted in less than thirty-five years. Reforestation from a national point of view would necessitate measures being taken to insure an annual growth of timber which should provide for the needs of the nation for all time to come.

The question arises—can this result be accomplished, and how? The chief of the Forest Service of the United States Department of Agriculture, Gifford Pinchot, who has devoted the greater portion of his life to a study of forest problems, in a speech delivered before the National Wholesale Lumber Dealers' Association last March, confessed that reforestation for the individual was not a practical proposition.

Today in this country there are no adequate state or national laws that make it worth while for the individual to engage in forestry pursuits. If a man should have the tenacity to plant 10,000 acres of seedlings suitable to soil, he has little or no protection to his property from fire or other devastation, and beyond that, before the trees of his infant forest gained a merchantable size, the taxes on the property would have rolled up and compounded to an extent that would mean ruin to the adventurer from a financial standpoint.

Thus, without exception, so far as this committee can see, in the present default of legislation favorable to forest pursuits, the individual



WILLIAM R. BARKSDALE, PRESIDENT LUMBERMEN'S CLUB OF MEMPHIS.

there is great uniformity in the rules themselves. That has always been strictly adhered to, and as nearly carried out as it could be, consistent with the different woods, and so it should be, for one wood is always a competitor of another. Therefore the standard of one wood should always be the standard of another wood as nearly as possible. The standard as already stated has been firmly established and no vacillating policy in these rules can change it for the next two years. Consequently the only change in the value of the different woods is in the prices, which are governed by the universal law of supply and demand. The rule of making no change in the rules for a stated period gives the inspectors who apply these rules in a practical sense an excellent opportunity to become more conversant with them and to perfect themselves in their application. That these rules are better understood than heretofore by the lumbermen at large is evidenced by the fact that your chairman had fewer letters in the past year asking for interpretation of these rules than ever before in the same period of time.

THEODORE FATHAUER, Chairman.

On motion duly seconded and carried, the report was adopted.

President Palmer: The next thing is the report of the chairman of the Forestry Committee, Maurice M. Wall.

**Report of Committee on Forestry.**

To the president and members of the National Hardwood Lumber Association: Your committee, to whom was referred the subject of forestry, has deemed it wise to submit an analysis of



J. W. THOMPSON, MEMPHIS, CHAIRMAN ENTERTAINMENT COMMITTEE.

to itself, and the same wood in another territory also bears its stamp of location. We must also bear in mind that the different markets in this vast land of ours have customs of their own strongly entrenched by virtue of long years of



can accomplish little toward assisting in the maintenance of American forest growth.

Theoretical foresters have materially changed their views on the subject of forestry within the past year. They tell us today that conservative lumbering constitutes true forestry. What they mean by conservative lumbering is cutting timber by selection, choosing from a forest only trees of a large, or mature growth, and so felling this timber and removing it that the younger trees shall have an opportunity to continue their growth and finally become valuable timber. From the viewpoint of practical lumbering, this method is very largely theoretical and could not be successfully employed. In coniferous growth every lumberman knows that these trees are what the woodman calls "flat-footed." They have no tap-root. A virgin pine forest will withstand tremendous winds, but remove from this forest only the larger growth and the first wind storm of even moderate velocity would level the remainder and make a ruin of it. There would be more possibility of success in lumbering by selection in a hardwood growth, because the tap-root of every hardwood tree would, to a great measure, protect it from devastation by wind. Another serious argument against lumbering on the basis of selection of mature growth is the fact that it is a very expensive proposition. It contemplates the felling of trees with great care, the removal of tops and debris to avoid fires and the continual paying of taxes on timber land which will have no productive value for many years. This method of lumbering would impose a cost on manufacturers indulging in it that would utterly preclude the possibility of competition with their neighbors who did not pursue the system. Say what you will, from a practical standpoint, under our present laws, there is little in sight for financial results in individual forestry or in lumbering on the basis of selection.

To our minds, if we provide for a perpetual timber supply for this country, or even provide for a moderate source of timber supply fifty years hence, it is a matter for national and state legislation and effort.

Today we are certainly at the beginning of the end of our forests, great as they apparently are, because of the immense inroads we are making on them annually. It is more than probable that to provide for the ever-increasing wood consumption in this country we must needs have recourse to the experience and practice of France and many of the German states; i. e., compulsory reforestation. In these countries when a lumberman cuts down a tree he is required to plant another, and thus the European countries have to a moderate extent provided for their future forest needs.

These arguments and suggestions we know are not in line with the prevailing forestry sentiment of this country, but from a practical viewpoint we see no other solution of our forest problem. Undeniably there are other steps which might be taken to contribute to the lengthening of the life of our existing forests and primarily we believe that, like the Dominion of Canada, laws should be enacted to absolutely prohibit the exportation of logs. For more than two hundred years the United States has supplied Great Britain, Continental Europe and a large portion of the rest of the civilized world with its hardwoods, and altogether too much of it is supplied in the form of round logs, which have contributed very little to the wealth of the nation, but a modicum of the amount that would be contributed if the material was sold in the form of lumber. The average theoretical forester is not a forester at all. Forestry is justly defined as the treatment of land and tree growth for the maintenance of woodlands to be utilized for forest products or for a protective covering for the source of streams and for the protection of game. The average theoretical forester is simply a silviculturist.

The planting of trees along the village road or for the beautifying of a park or even the adornment of national playgrounds is not forestry from a commercial viewpoint. To get at the matter of practical commercial forestry the silviculturist must be eliminated from the practical element who would see something done and done at once to assist in the perpetuation of commercial American forests. The work of the silviculturist is thoroughly commendable in its way, but it is not and never can become forestry.

In presenting this analysis of conditions surrounding American forests, we believe that it will be just for this association to go on record as advocating practical things in connection therewith, rather than theoretical ones, and we would especially urge that state and national legislative bodies be petitioned for the enactment of laws:

First, to relieve from taxation for a long period of years lands owned by individuals, that shall be devoted to forest growth, under practical supervision.

Second, to provide legislation that shall insure individual timber owners protection from fire and depredation.

Third, to demand that states take up in a comprehensive and practical way the replanting

of lands undesirable for agriculture to timber.

Fourth, to prohibit the exportation of logs.

M. M. WALL, Chairman.

B. F. McMILLAN.

T. J. MOFFETT.

W. A. Bonsack: I move that the report be adopted.

D. F. Clark: I think the motion should be that the report be adopted and the committee be continued to act along the lines suggested by them.

President Palmer: I don't believe Mr. Clark's suggestion would apply, because the committees are appointed and the next administration has that in hand. It seems to me, though, that some special mention is due Mr. Wall for the work he has performed, and also the committee in the preparation of that report. It certainly is a fine exposition of the subject of forestry, and I think the thanks of this association are due Mr. Wall for the able manner in which he has handled the subject.

The report of the Committee on Forestry was adopted.

President Palmer: That concludes the program for this session, but it seems to me that there must be some pretty good suggestions loose in the audience, and if it is agreeable to this gathering, an informal discussion of the inspection or forestry question might not be out of order. If anybody has anything to say on any of these subjects, we will be glad to hear from him in an informal way.

B. F. McMillan: Mr. Chairman, I have been waiting for that chance. You are aware that there are two great improvements, both of which are necessities, which this country is in need of. One of them is forestry; the other is its brother, the good road movement. Under our form of government, without an amendment to our constitution we can do nothing in the way of forestry. I can remember in the state of Wisconsin when they took 150,000 to 200,000 acres of pine land out of the market and put it into what they called the water reserve to protect the headwaters of our streams, and they held it there until the lumbermen wanted it for their supply. Then the lumbermen put it in the market and bought it up, and now they slaughter that. If we had a law permitting the cutting of only a certain percentage we would have some protection, but under our present constitution our congress could at any time put the whole thing on the market, provided there were enough big grafters to get them to do it. I think the first thing we want to do is to amend our constitution, so as to allow the government to reforest and restrict them to the percent that they shall cut, and force them to do as they do in Germany—to replant one tree for every tree they cut. Take it in the Black Forest of Germany, the villages own tracts, the individuals own tracts, the government owns tracts, but they are all under the supervision of the general government which will permit them to cut just so much and no more. We should have something in our constitution that will protect the forests perpetually, not today and tomorrow, but forever, as long as this government shall last—and, gentlemen, you know it is going to last forever. [Applause.]

There is another thing which our government could do, and that is one of the main things in forestry—the policing of forest reserves. And how can we do it? We can do it on the same lines along which we are today policing Yellowstone Park. Instead of having our soldiers at Fort McPherson, at Fort Snelling, and at Jefferson Barracks and other places, let us put them to work to police our forest reserves. And I would say to you, gentlemen, that I am in favor of a law that will permit any of our territory where it is suitable for reforesting, to be sold to individuals in one thousand, five thousand, or ten thousand acre lots, and get trees to growing in ten years upon as many acres as any individual can reforest, and can

grow in ten years; but always that must be exempt from taxes and under the control of the government. No individual ever should have the right to cut more than a certain percent, and the government ought to be prohibited by the constitution from allowing them to cut a bigger percent. I think forestry is one of the things that we are coming to. I can see it. In my short life I have seen fine timber—as fine pine as ever stood on the face of God's earth—not worth more than 10, 15 or 20 cents a thousand, slaughtered and wasted, and today the white pine of the North is practically wiped off the earth. We can never reforest a great part of the state of Wisconsin or Minnesota or Michigan. We have got to come to the mountainous sections of the South. To show you the little effort that it costs to reforest in a mountainous country, go to the state of Vermont. The state of Vermont has today more saw timber than she had one hundred years ago. Why? Because this land is inaccessible, barren. Now what are they doing? They have gone in there with little portable mills and are slaughtering it and selling it at prices at which it is impossible for the box manufacturers of Green Bay and Warsaw to furnish the Diamond Match Company boxes at Oshkosh. The Diamond Match Company is shipping the box shooks from New Hampshire to Oshkosh. Can you realize this, Mr. President? It is a fact. We should put a stop to this. Our eminent president, Theodore Roosevelt, has gone to Idaho and taken out a vast tract of timber and called it his forest preserve. I think he will keep it out until Weyerhaeuser and a few of those fellows get there, and then they will have it put back into the market and gobble it up. It does not take much to do it. All they have to do is to play a little game of politics, as some of you Memphis fellows do, and they will have it all right. This forestry business is along the right lines, and I would like to see this forestry committee continued and composed of as able men as we have in our association. I thank you, gentlemen. [Applause.]

President Palmer: Are there any other gentlemen that will favor us with a few remarks? The range is a wide one—inspection, forestry, or anything you would like to tell about.

G. V. Nash: I would like to offer a suggestion on the matter of reforestation. The lumbermen are to blame, themselves. Take Michigan and Wisconsin. There they have cut all that they could cut, and have cut all the good trees, leaving the debris on the ground. If the lumbermen had only as many acres as they can put into cultivation and individually followed that line, the whole question would be solved—only cutting as many acres as they need for cultivation of crops.

C. E. Lloyd: We have had from Mr. Wall a very interesting report, and it deserves not only our consideration, but our thanks. In addition to that, we ought to go on record. I think Mr. Wall is right about that. This national association is large enough to have its words given some attention. I would move you that a committee of five be appointed to consider Mr. Wall's report, and I believe Mr. Wall should be on the committee.

J. M. Pritchard: I think that should be done by all means, and I second the motion.

The motion was carried, and the president appointed the following committee on report of forestry committee: C. E. Lloyd, J. M. Pritchard, S. B. Anderson, E. C. Colcord, A. B. Klise.

President Palmer: Are there any other gentlemen who would like to make remarks on any question? This is a democratic body. If anyone has any kick let us have it now.

Mr. McMillan: With the consent of Mr. Russe I would like to take a drink.

Mr. McMillan then took a drink of ice water.

President Palmer: I would like to ask the committees to have their reports prepared and ready to be submitted at the opening session tomorrow morning. The meeting of the ex-

executive committee occurs in this room directly after the adjournment of this session, and any member of the board of managers not on the executive committee is cordially requested to meet with us.

M. M. Wall: Mr. Chairman and gentlemen, that paper of mine on forestry seemed to read pretty well, and I was not sat upon very hard. I have another paper here, along about the same line. I am almost afraid to read it, because somebody may think it is a little out of place. It is very dear to my mind, and if I have made any mistake, I hope the members of the association will forgive me. It is not done with malice or intent to trample on the toes of any member of the association, but it goes almost hand in hand with the forestry question. That I may not be misunderstood or incorrectly quoted, I have jotted down a little memorandum of this, which I will read.

#### Address of M. M. Wall on Lumber Tariff.

Mr. Chairman and Gentlemen: I would like to say a word about the lumber tariff.

The National Hardwood Lumber Association has never figured in political measures, being entirely non-partisan in its character. Individually we are made up of protectionists and free traders, and it is with hesitancy that I even mention the subject of the prevailing lumber tariff, as you may accuse me of trying to drag you into politics.

At the time of the enactment of the law imposing a duty of \$2 a thousand feet on lumber imported into the United States, there was an excuse for the excitement. It was in a dull period of commercial history and the majority of manufacturers of lumber were pretty well loaded up with the coarse end of their product and were having strong competition from the Dominion of Canada. It was felt that the imposition of this duty would contribute to the bettering of values for at least the coarse end of the United States wood product. Perhaps to a considerable extent it did at that time, but today the country is in very short supply of lumber of all kinds.

There possibly is some excuse for a manufacturer of northern white pine and hemlock, of southern yellow pine and of Pacific coast fir, cedar, pine and redwood being an advocate of the continuance of an import duty of \$2 a thousand feet on lumber, but I can scarcely believe any hardwood producer or dealer, if he has thoroughly analyzed the subject, can be a believer in the justice of the law.

In short, this is the proposition: This protecting government of ours presumes to protect the manufacturer of oak, of hickory, of cypress, of poplar and of cottonwood with a duty of \$2 a thousand feet against competition in these woods (which grow nowhere, in commercial quantities, on God's green earth, save in the United States) from the possibility of having our market encroached upon by foreigners.

In exchange for this munificent alleged protection, we are allowed to participate in a scheme of tariff enactment, whereby we are cheerfully permitted to pay \$10 a ton more for the steel rails we use in our railroad operations, and perhaps twenty-five per cent more for the machinery with which we manufacture lumber, and possibly a like sum for many of our food products, all items increasing the cost of our hardwood lumber product.

As a matter of fact, I believe that we hardwood manufacturers and dealers of this country are being used to pull the chestnuts out of the fire, for the benefit of the manufacturers of iron, steel and food products.

I believe this is an important question and one well worthy the consideration of this association. I don't believe we want any protection on woods that don't grow anywhere else on the face of the earth. I can't figure out how we are being benefited. I am of the opinion that possibly we will find that the hardwood trade of this country is not remarkably astute, and it would be proper for this association to go on record as being in sympathy with an absolute readjustment of existing tariff laws and to say to our law makers that we don't want protection of lumber, we want lumber.

I therefore offer the following:

Resolved: That this association favors the readjustment of our tariff laws in as far as hardwoods at least are concerned, and that we recommend to our law makers that they enter into negotiations with Canada and other countries interested, with a view to reciprocal relations to the end that hardwood lumber may be admitted free of duty, and for this concession they take off the export duty on logs and make our country such other concessions as may be considered fair and equitable.

President Palmer: Mr. Wall, do you move the adoption of that resolution?

Mr. Wall: I move the adoption of the resolution.

Mr. McMillan: I second the motion. I think Mr. Wall has lost sight of the fact that we are trying to get to the Pacific coast with our hardwood lumber. I think he has lost sight of the fact that we have been unable to do it, for one principal reason, that the Australian cherry is taking the place of our hardwood, coming to the East from the Pacific coast. I do not think it is wise for this association to deviate one iota from its former position of keeping out of politics. It is enough to have Memphis forever dabbling in politics, and I do not think it is desirable to have this association go on record when there are only about two hundred in the house out of a membership of five hundred. I think we ought to consider those who are away before we go to mixing in politics. I think it is a mistake, and I am opposed to the resolution.

Mr. Clark: The location where I am, Minneapolis, is such that I am not familiar with the effect the duty has in the East and West, between Canada and the United States. I would like to ask Mr. Wall the conditions of the birch market, and also any of the eastern members whether the birch from Canada and Ontario at this time is shipped into the United States under the two dollar duty he speaks of.

H. C. Humphrey: There is no duty on hardwood. It is on sawed wood—\$2 on all lumber.

Mr. Clark: The position that we are in in the Northwest is such that I agree that while it might be far better if the duty was taken off of pine and all other lumber for the states of North and South Dakota, Minnesota and Wisconsin, yet they have a duty of twenty-five per cent on all maple flooring that goes into the Northwest territory. When Canada made the proposition to take off the tariff the United States did not respond promptly or make any advancement along that line. I was in Canada week before last and had a talk with a great many dealers in that section of the country, and they tell me today that Canada is in better position to take care of its own trade without asking odds of the United States than ever before. With the scarcity of all commodities in the shape of lumber and the demand in the Northwest, it seems to me it would be better for the United States to take the duty off of all lumber coming into the United States from Canada, except, possibly, birch. The scarcity of birch is appalling. Thirty years ago, under the same conditions that exist today, and with the increased population of the United States and no increase in the production of timber, it seems to me the increase in the consumption of the wood will decrease the pine materially. Canada has not any lumber to speak of that enters much into competition with the United States. The pine lumbermen have a big trust and they raised the prices, so that they would be better off with competition in Canada.

Theo. Fathauer: I fully agree with the sentiments and opinions voiced by Mr. McMillan, that this association should not dabble in politics, and that is what you mean by the resolutions. It is a dangerous one. If we recommend any tariff reduction, or \$2 per thousand feet on lumber from Canada to this market, it simply means an increased value on stumpage in this country, and when you touch the pocketbook of the stumpage holders in the states of Wisconsin, Minnesota and Michigan, especially considering that we are trying to increase the membership of the association, I feel that we are in danger of reducing the membership in the future.

Mr. Thompson: You can touch a man's favorite black horse or say his automobile is second hand, but when you touch his pocketbook he begins to squirm. This is a political question, and it seems to me if there is anything we ought to protect it is the forests. As Mr. Clark has said, the figures are simply appalling. It is amazing to conceive that within one generation, at the present rate of consumption of our forests, we shall actually be deprived of any great ones in the United States. Canada

doesn't allow us to get a log. We cannot import any logs. If we knew today the amount of timber, in the way of logs, that we export from the United States, we would be astounded at the figures, and would be surprised at the destruction of our forests. I think this is one of the most important questions that has ever come before us. I am a free trade crank, but I am not talking from that standpoint alone. We are paying \$15 a ton on our steel. We stand here and allow a tariff on our own commodity and we are afraid to stand up and speak our honest sentiments, just because we voted the Republican ticket or some other ticket, and are in favor of a high-protection tariff. It seems to me that we ought to act on this question and that we ought to spread this report of Mr. Wall's on the records of our association.

Mr. McMillan: Gentlemen, don't bring politics in here. This is a political question, and the freer we keep from this the better off we will be. I was never more in earnest in my life than I am about this question of meddling with politics. I admire this association because it has always kept out of politics. I have worked with it and I am going to continue to work with it just as long as it will keep within its sphere and do the good work it has undertaken. We all have different ideas about rates and tariffs and duty. This is a commercial organization. I want to say that you are treading on very dangerous ice. I have the greatest admiration for my friend Wall. He is the noblest Roman of them all. I have admired his work, but because he has always been right before is no reason why he cannot be wrong now.

Mr. Pritchard: I move that we lay the report on the table.

The motion was seconded and carried.

President Palmer: Mr. Humphrey, have you anything to offer on the San Francisco rate question?

Mr. Humphrey: At a meeting of the Wisconsin Hardwood Lumbermen's Association at Marshfield in March, a committee was appointed to bring up the matter of the rates on lumber from our section to Pacific coast points. As you all know, the present rate is 85 cents, which, in our opinion, is excessive. Prior to the meeting last March we appointed a committee to meet with the Transcontinental Freight Bureau. Mr. Agler of Chicago was chairman of that committee. He is here and can speak for himself, but as I understood it the rate committee refused to allow him to appear before them, but they would accept a written petition from him. Our association is weak and we thought the proper thing to do was to come before the National association to see if we could bring pressure on the Transcontinental Freight Bureau to give the lumbermen of this country some consideration. The rate to the Pacific coast is 85 cents per hundred. The rate on Pacific coast lumber to this section of the country is 50 to 60 cents. There is a vast amount of business waiting for the lumbermen of Wisconsin and Michigan, and I think southern lumbermen also, on the Pacific coast, provided we can get a rate so as to put our products in there in competition with foreign wood. Last freight bureau meets in Chicago the 21st of this month, and we would like to see this association take some action on this matter, either appointing a transportation committee or bringing it up in some other way whereby we can go before the traffic bureau with the National Hardwood Lumber Association back of us, so that we can tell them where we stand, giving them an idea of how much lumber we can put out in that section of the country if they can make a rate. There is more lumber going east than there is going west, and I do not understand why it is that a railroad company should prefer to haul empty cars west in order to haul that produce east on a 50-cent rate, instead of hauling loads both ways. I do not see why it should cost more to haul lumber west

## FRIDAY MORNING SESSION

than east. I want to submit this to the association for action, and I would make a motion that a transportation committee of three be appointed to handle this matter.

Mr. McMillan: I would like to ask Mr. Humphrey if he knows anybody who, in the last six months or year, has shipped a carload of hardwood on that rate west.

Several members: Yes.

Mr. Humphrey: Yes, we have shipped several cars; I think between three and four million feet of hardwood lumber and maple flooring has gone west out of Wisconsin, Michigan and Minnesota within the last twelve months on this \$5-cent rate. We could increase that five hundred per cent if we had an opportunity.

Mr. Clark: I want to express my sentiments in line with Mr. Humphrey. We are in exactly the same position as the Wisconsin lumbermen. We ought to work together. He gave the exact conditions that exist in our territory.

President Palmer: Is the committee to be a regular standing committee?

Mr. Humphrey: Yes, a standing committee to which any of these problems can be referred.

Mr. Pritchard: I think the first step is to appoint a committee to report on the advisability of appointing a regular standing committee.

Mr. Humphrey: If you make that as an amendment I will accept it.

President Palmer: The motion by Mr. Humphrey has been amended by Mr. Pritchard, in substance that a committee be appointed to report on the advisability of the appointment of a standing transportation committee. We will vote on the amendment.

A vote on the amendment was taken, and the amendment was carried.

The president then appointed J. M. Pritchard, A. B. Klise and W. A. Bonsack as such committee.

President Palmer: I believe there is a little explanation due the association owing to certain misrepresentations that have gotten into the papers regarding the position of the president of this association on the Pacific coast rate question. The report was circulated that at the Marshfield meeting of the Wisconsin Hardwood Lumbermen's Association the president of that association, Mr. Arpin, made the statement that the president of the National Association was very indifferent to this matter, and in proof thereof he read one or two extracts from a letter that I had written in regard to the rate question. I believe that it is due to the president of this association that Mr. Humphrey make a statement of just about what occurred at the Marshfield meeting.

Mr. Humphrey: Well, the thing has already appeared, I believe, Mr. President. Mr. Arpin, in reading your letter, did not read all of the letter, but simply extracts from it, and I think the members of that association got the wrong impression of what your ideas were, and I tried, in my own weak way, to straighten the matter out. That is about all I can tell you.

Mr. McMillan: Mr. Chairman, I was there and really I did not get that impression. I think we should consider the advisability of whether it would be good policy for this association to take up some of these excessive rates to the Pacific coast and sue the railroad companies in behalf of the association and see if we can come to an understanding in some way that will make them believe that we amount to something, that we are bigger than one individual. I believe that we are today suing the railroads on over-charge rates in Wisconsin. We have all the law necessary to prosecute any railroad for over-charge.

President Palmer: If there is nothing further to come before the meeting a motion to adjourn will be in order.

Upon motion, duly seconded, adjournment was taken until Friday morning.

The meeting was called to order by President Palmer at 10:50 a. m.

The first business was the reports of committees.

Thos. J. Moffett, chairman of the Committee on Officers' Reports, read a report, as follows:

## Report of Committee on Officers' Reports.

To the president and members of the National Hardwood Lumber Association: Your committee on officers' reports has carefully considered the president's address and the report of your secretary in detail. These papers are well worthy of the most particular attention and your committee recommends them to every member for careful consideration. In an association of this character such reports are practically the only means of giving to the members a statement of the work accomplished and of the developments contemplated. For this reason, and in view of the fact that the officers have given their time and labored hard for the welfare of the organization, it is certainly incumbent upon every member of this association to give these reports the consideration that is due.

We recommend that the association endorse the design now being used upon the stationery of the association and adopt it as the official emblem, and that every member be urged to use it upon stationery and in such other ways as to popularize it and make of it a trade mark of the National Hardwood Lumber Association.

As to the question of the removal of the headquarters of the association, we feel that this is a matter for the board of managers to consider, as has always been done in the past.

Thos. J. MOFFETT, Chairman.

It was moved and seconded that the report be accepted, printed and circulated among the members, and the motion carried.

O. O. Agler, chairman, read the report of the Committee on Rules and Credentials, which, upon motion duly seconded, was adopted. The report follows:

## Report of Committee on Credentials and Rules.

We, your committee, recommend that the election of officers be held in the following manner:

Two tellers for each candidate to be appointed by the president, who shall receive the ballots and certify to the vote. The secretary shall call the roll of complete list of members, and as each is called one member of such firm or corporation or duly authorized representative connected with said firm or corporation, who shall identify himself to this committee, shall deposit his ballot, announcing to tellers name of firm or corporation and voter's connection with same. Should any question arise as to the eligibility of anyone offering a ballot, same to be decided by this committee.

O. O. AGLER, Chairman.  
T. B. SPONE.  
O. E. YEAGER.  
G. J. LANDECK.  
R. J. BARNELL.

M. M. Wall: I would like to ask if it is the intention to vote on every office at one time. There are five hundred names here to be called off, and it will take a good deal of time to do that.

Mr. Agler: The idea was to vote separately on each candidate, unless otherwise ordered.

Mr. Wall: It would take us two days, with five hundred names, to vote on each office to be filled.

President Palmer: The chairman recognizes that this remark is entirely pertinent to the subject, but I think the gentlemen present recognize the fact that there will be but one contested office, and the chair is of the belief that the report of the Rules and Credentials Committee was intended to cover that. The chair has no authority for the statement, and it is merely his assumption. The question is on the adoption of the report.

Upon vote, the report was adopted.

President Palmer: The next business is the report of the Auditing Committee, but I am informed the committee has not had time to prepare its report. We will pass this.

The hearing of the report of the Committee on Forestry was also temporarily postponed.

President Palmer: We have also a committee on the San Francisco relief fund. That committee is not ready to report. There have been

a great many pledges made that have not yet been redeemed, and until those pledges are paid it will be impossible for the committee to report. We have been unable to get enough money pledged to do justice to the association, and I would like to see every gentleman come forward a little more liberally. There are probably forty or fifty who were not here yesterday morning, but before this session adjourns there will be opportunity given them to subscribe to this fund. It is important that the National association should be properly represented in this matter. I am not asking you to do God's work in this matter, but I am asking you to do man's work. That is all there is to it. There is nothing doing. We must have some more money. New business will be in order while we are waiting on the reports.

Secretary Fish then read the following letters from E. F. Perry, secretary of the National Wholesale Lumber Dealers' Association:

## Letters from National Wholesale Lumber Dealers' Association.

NEW YORK, April 30, 1906.  
E. F. FISH, Sec'y, National Hardwood Lumber Association, Memphis, Tenn.: Stress of circumstances has just compelled me to cancel my hotel reservation and forego the pleasure of meeting with you at your annual meeting in Memphis. I had expected to go right up to the present moment, but matters have come up this afternoon which keep me from being away from New York on Friday of this week. I desire to thank you for your kind invitation and regret my inability to be with you. I wish for you, however, a very successful and pleasant meeting, and hope for a visit from you in New York. Yours very truly,  
E. F. PERRY, Sec'y.

NEW YORK, April 30, 1906.  
E. F. FISH, Sec'y, National Hardwood Lumber Association, Memphis, Tenn.: I am sending you under separate cover a few copies of the joint report of the railroad and transportation and legislation committees, which was given at our annual meeting in Washington. A glimpse at this will show you that it is largely in connection with car stake equipment matters, and on page 23 is a little report of the conference at Pittsburg on April 12. Possibly your officers and directors will be interested in this letter. Later we hope to send copies to each of your members.

I am also sending you a few copies of the complaint that has been filed before the Interstate Commerce Commission against the western roads. Yours very truly,  
E. F. PERRY, Sec'y.

Secretary Fish: Mr. Perry further calls attention to some literature which the National Wholesale Lumber Dealers' Association, in the joint report of the transportation and legislation committees is getting out. He says that all our members will receive a copy. He has a limited supply of these booklets, which the members can get by calling for them after the meeting.

Mr. Pritchard was then called upon to read the report of the committee on interstate commerce transportation, which, upon motion duly seconded, was adopted. The report was as follows:

## Report of Committee on Transportation Matters.

Gentlemen of the National Hardwood Lumber Association: We, your committee, appointed to consider the advisability of this association creating a standing committee on interstate commerce transportation of lumber, beg to report as follows:

We believe that there are many questions on interstate transportation of lumber of vital importance to all members of our association which should have the attention of the regular standing committee, and further that such a committee duly authorized by this association could secure much better results than individual members; therefore,

Resolved, That this association authorize a permanent standing committee of three to be known as the "Interstate Commerce Transportation Committee" and that the president be directed to appoint the members of same annually.  
J. M. PRITCHARD, Chairman.  
A. B. KLISE.  
W. A. BONSAK.

President Palmer: If any member has any business to be introduced while we are waiting we would like to hear from him.

W. A. Bennett: I think we should take some action in regard to the recommendation of the inspection bureau regarding the location of a man abroad to take care of our business. I think it is a very important matter that this be attended to. We need an inspector abroad as much as we need them in the United States. There is a world of lumber going over there, and every once in a while there is some trouble about it. We have no one there to inspect the lumber, consequently we have no protection. I would like to hear from our brothers here on this subject.

President Palmer: Will you make a motion to that effect?

Mr. Bennett: Yes, sir. I move that we recommend to the bureau of inspection the appointment of a salaried inspector abroad. I will not say at what port, but that can be agreed upon by the people interested. The people who ship abroad are as much entitled to protection there as we in this country. The fact of the business is that if a shipment goes over there it cannot be inspected; consequently we have no protection. We are spending our money for inspection and protection here, and what might be done over there is absolutely necessary.

The motion was seconded.

President Palmer: Are there any further remarks?

Mr. Bennett's motion was amended by referring the matter of the appointment of a licensed inspector abroad to the Executive Committee.

C. E. Lloyd, Jr., then read the report of the Committee on Forestry, with the accompanying resolution, as follows:

#### Report of Committee on Forestry Report.

Members of the National Hardwood Lumber Association: Your committee has carefully considered the report of Mr. Wall of the Forestry Committee, and heartily congratulates him on the able and thorough work shown in the preparation of his paper.

We would recommend that this paper be printed in a special bulletin to be issued by our secretary and so brought before every member of the association; and we also recommend that the resolution herewith be printed with said bulletin, and we ask our members to write to their national and state representatives urging proper legislation on this subject.

We further recommend that our standing forestry committee be empowered to represent this association on forestry subjects when necessary.

C. E. LLOYD, JR., Chairman

Upon motion, duly seconded, the report and resolution were adopted.

T. J. Moffett: Mr. Chairman, this question of forestry is so important that I feel we should not leave it as it is. As you no doubt know, some states have taken the initiatory steps looking toward the ideal that Mr. Lloyd has presented to us, notably New York. New York has probably made greater progress than any other state. Next comes the grand old state of Indiana. If Dr. C. A. Schenck is in the audience I would like to ask that we give him the privilege of the floor. He, as you know, represents Mr. Vanderbilt at Biltmore, and no doubt he can give us some information.

Dr. Schenck: Mr. President and gentlemen, I thank you for this opportunity of relieving my brains, if I have any. Eleven years ago I came over to America on a pleasure tour, so to speak, invited by Mr. Vanderbilt to take charge of his forestry undertaking at Biltmore, N. C. I did not know much of the language, and I knew less of the American lumber business; and consequently Mr. Vanderbilt and I made a mess of the lumber business. [Laughter.] It has not broken Mr. Vanderbilt and has not broken me, but it has given me a chance, I dare say, to gather an unusual experience while I was getting Americanized. Gentlemen, it is a much greater task, I think, for a young fellow to discard ideas with which he was impressed from his boyhood days on than to gather new ideas, and I had to get rid of my European impressions. I happened to be chairman of a forestry school which is entitled Grossherzoglich Hes-

sische Oberfürsterei (and any stenographer who can put that in print will get from me ten gold dollars). I dare say I had to undo a lot of my primary teachings in German forestry. We have no more room in this country for German forestry than for Chinese forestry, because our local conditions, our economic conditions are so much at variance with those which prevail in my dear Fatherland. I set out to develop American forestry, very much aided by prior experience in the lumber business. I believe the report which has been submitted here is more than excellent. It is brilliant. It strikes me exactly. The keynotes of the forestry problem are two, one of them safety of your investment, and the second, remunerative investment. Forestry is merely an investment in timberland, and there will be no investment unless it is remunerative and safe. You are all good business men, the best upon whom the American sun ever shone, and you should be practitioners of conservative forestry today. Here these conditions have not prevailed and these conditions are particularly absent in my beloved state of North Carolina, where the tarheels grow and the moonshine springs. [Laughter.] The main problem for us hardwood men is safety from forest fires, and my experience with forest fires has been a disheartening one. It is expensive to fight them; it is disheartening; and it is a hard job. I would rather pile lumber twenty feet high than to fight forest fires. What sense, I ask, is there to leave on a certain tract the smaller oaks and poplar, if I am pretty cock-damn sure that the next forest fire will devour my small yellow poplar and will eat up or checkmate and jeopardize in their growth my dear little white oaks, until they are changed into absolutely nothing; that is the condition confronting us. It is nonsense to leave any assets in young timber in the woods until these assets are absolutely safe from fire. Mr. Moffett has alluded to the fire laws of New York, Wisconsin and Indiana. There is not a state that does not have fire laws, but including New York, Minnesota, Wisconsin, Indiana, these fire laws do not give the owner of second growths, or a young growth, a seedling growth, that degree of protection which I demand for my investment. What farmer would plant what if he thought on the 15th of every June his wheat would be destroyed by fire? It is just as nonsensical to invest in second growth if that second growth is to be destroyed by fire. I am absolutely sure, in spite of the fact that we spend thousands of dollars to keep fires out, that my young regenerations of poplar regeneration means young growth will not prove to be valuable in the future, valuable to Mr. Vanderbilt and valuable to the nation, unless I am cocksure they will be allowed to develop into trees. This is particularly so where you do not only foster a second growth, where you do not only leave something for a second growth, but where you drop something in young growth by way of planting. We do not do that at all at Biltmore, in the backwoods, because it would be an unsafe investment to plant trees at about 1,500 to the acre. I have planted about 1,000 acres at this time, and we have at Biltmore about 2,000 acres of planted forests and I know what I am talking about. But this investment was made only in the settled part of the state, where we controlled absolutely every tenant, every hand, and where consequently we had continuously a fire guard ready to move at a second's notice. There alone I can make these investments on 5,000 acres; I can plant and invest in second growth. On the balance, all I can do is to give Nature a little chance, because I would not dare to spend more money on it. It would be an unsafe investment. I might add that, as a matter of fact, what we want above all, is safety from fires. Whatever you do, however heavy you log in hardwoods - I emphasize the word hardwoods, if you keep fires out there will be a second growth sure. There must be a second growth. Nature will

furnish it, unless you bar Nature by allowing the grounds to be fired. The primeval trees which we now cut were second growth trees once. They had been able to come up because there were no fires. But at present, with forest fires, second growth is impossible. Keep the fires out and the second growth must follow. It might not be a second growth on which yellow poplars grow at the rate of 500 to the acre, but it is good enough for me, under the present conditions, to have a second growth of fifteen good yellow poplars to the acre. Nature will cause that second growth as sure as the sun shines, because trees are nothing but air and rainfall solidified by sunshine. You cannot stop the sun from shining nor the rain from falling nor the wind from blowing, and you cannot stop second growth coming up in hardwoods except by forest fires; and I want to emphasize that, in order to prove that our forestry problem on private estates is practically identical with the forest fire problem. Keep forest fires out and you can keep any American forest, and you can keep in prospect a second growth, which your children and your grandchildren will have running through their midst. [Applause.]

The second important financial problem is taxation. So far, in the South, taxes have not been very heavy on us; but these miserable county commissioners [laughter] I hope I do not insult any one of you, because I myself was a county commissioner once. I have to deal with in four counties, and they don't care a snap for the future of the county. They want as high a revenue for the county as they can get, and they say, "Mr. Schenck," catching me by my ears, which is an easy task [laughter] - they say, "Mr. Schenck, you are practicing conservative forestry. You leave something on your land. You improve your land, and consequently we charge you a higher tax than anybody else." [Laughter.] They say, "Here is the constitution of the state of North Carolina which states, 'the more value land has, the higher shall be the taxes on that land.' You don't cut your timber and you don't spoil your forests by fires and you don't need every bit of vegetation on your land. Consequently it is more valuable, and we assess you three times as high as anybody else." [Laughter.] Now, what can I do? What I should like to do is - very much I should like to buy the county, so as to elect my own county commissioners. [Laughter.] If all our lands were situated in one county the task would not be so difficult, but because we are split up into four counties, I am simply powerless. These fellows these gentlemen representing the welfare of their counties, represent above all their own welfare. They want to get high taxes in order to improve the county? No. In order to improve the value of their own farms; want to build a new schoolhouse; want to build a new courthouse, which is no advantage to me, because I always lose my suit in the courthouse. [Laughter and applause.] And they make me pay the bill. You see it is not quite easy to practice forestry in the United States, and particularly not in western North Carolina or in the Appalachian mountains, or where we have a backwoods population, and there, according to the American standpoint of the forestry business, is all that is necessary - there lie the headwaters of our streams. There lies unlimited water power, hidden, protected to a certain extent by the forest. I would not advocate for a minute conservative forestry on land which will pay better with the plow. When we have any land that is fit for farming I do what everybody else does that has common sense. I cut the trees down as quick as I can, and convert the lands into farms and especially in the mountains, at five or six thousand feet elevation, where the wind sweeps, and where, consequently, the trees cannot attain any greater height than this room, when they are tipped over. There you have fine pastures, and there I have pastures. There my

problem is. Every acre of land is to be devoted to forests or pastures or farms, whichever I think best, and here, in the neighborhood of Memphis, where the trees develop very quickly on fine agricultural land, it is not so difficult; but there the chances are that second growth will not be profitable. In my Appalachian range, it seems to me, the national government should take steps to make forestry financially profitable, and above all, to protect it and save it from fire, and protect it against the county commissioners. [Applause.]

Mr. Sondheimer: Mr. Chairman, I got in late. I wish the gentleman would repeat his remarks.

Dr. Schenck: Complying with your request, I beg to say— [Laughter and applause.]

Mr. Sondheimer: I withdraw my motion.

President Palmer: I think we are all very grateful to Dr. Schenck for his remarks on forestry, and the only thing I regret is he has not told us what to do yet, except, possibly to kill off the county commissioners. [Laughter.] Is there any further new business before the meeting?

J. V. Stimson: I have a resolution I wish to offer, as follows:

Resolved, That it shall be unlawful and without authority for any licensed National Hardwood Lumber Association inspector, while in the employ of any firm or member of the association, to receive and inspect lumber for such employer, and issue certificate therefor, and any certificate issued in violation of this resolution shall be void.

Mr. Sondheimer: If you had waited a moment I would have cut that out. I was going to say nobody seconded that motion, from the fact that it is absolutely impracticable. If the gentleman lived in Memphis or smaller centers he would find that it is absolutely necessary for the employer of the National inspector to ask his services from the fact that he is the only man there. It makes very little difference whether that man does the inspection or a man whom he may deputize, from the fact that they are under bond and supposed to be competent men, appointed by the surveyor-general, and I think that is a reflection on the surveyor-general's integrity, and certainly a reflection on the National inspectors. I consider this entirely out of order.

President Palmer: No motion was made and this is out of order.

Mr. Stimson: I move its adoption.

A second reading of the resolution was called for.

Mr. Stimson: I would like to make a statement before I read the resolution. There is one thing we desire above everything else, and that is harmony and unity of action, and that the administration of the inspection rules be placed on a plane above reproach and criticism, and that we avoid all places of stumbling as nearly as we can, and that we avoid all opportunities for criticism as nearly as we can. It seems there are or have been instances where lumber was sold on National inspection, and a licensed inspector in the regular employ of the purchaser of the lumber, who received and inspected the lumber at the assembling point for the purchaser and for his employer, has left opportunity for criticism. It seems to me that that can be avoided in a degree by placing that matter absolutely in the hands of the surveyor-general, and that the surveyor-general may be called upon to place an inspector who cannot be considered as partial to his employer, to inspect this lumber, and thereby protect both parties, and avoid criticism. It has occurred where lumber was inspected by the regular inspector in the regular employ of the purchaser and the lumber taken right on and mixed, losing its identity, that the seller of the lumber criticised the action, finding the surveyor-general had no opportunity to get on this lumber and verify the final inspection.

Mr. Stimson again read the resolution.

Mr. Sondheimer: Mr. Stimson doesn't understand the rule. He doesn't know what he is talking about. He says the lumber was received and its identity lost before the seller had an opportunity to have it reinspected and the matter placed before the surveyor-general. You have a rule governing that. The licensed inspector's inspection is not final. You understand that if you know anything about the proposition. You have a perfect right, if you are a seller, to have the car reinspected, and if the lumber was not inspected properly, originally, the man is responsible under his bond, and if the man makes it impossible to have a reinspection, you have a remedy against him.

Mr. McMillan: I feel a good deal like my friend Sondheimer.

Mr. Sondheimer: That is the first time you ever agreed with me in your life.

Mr. McMillan: That is the first time you ever were right. [Laughter.]

Mr. Sondheimer: I request a privilege.

Mr. McMillan: I have the floor, Mr. Chairman, and I claim protection.

President Palmer: Mr. McMillan.

Mr. McMillan: There is danger in employing any of our personal or firm inspectors to inspect lumber for anybody. I know of cases in Minneapolis where the inspector was employed by an entirely different corporation from the two corporations interested and that man went on the pile and ripped the seller up the back, for the simple reason that his firm always shipped better grades, and he demonstrated it at the shipper's expense. Am I right, Minneapolis? Certainly, I am. As Mr. Sondheimer says, we have protection and that is the protection we all have, and therefore I move that we lay the motion on the table.

Motion seconded.

D. F. Clark: I move that it be referred to the Executive Committee.

President Palmer: The motion to lay on the table takes precedence.

The motion was not carried.

Mr. Pritchard: Now I second the motion to refer to the Executive Committee.

The motion to refer to the Executive Committee was carried.

Gardner I. Jones: Inasmuch as we must give this hall up at three o'clock, I move that we proceed to the election of officers.

Mr. McMillan: I do not think it is wise to proceed at the present time to elect officers, when the election was set for a later hour.

President Palmer: You gentlemen have a right to say when you want to vote, but if there are some men out at the mills or somewhere else, you have no right to deprive them of their vote by changing the time of the election. The chair is going on record as saying that this thing is going off on the square.

The motion, not receiving a second, was unanimously voted down.

President Palmer: Mr. Barksdale will tell you where this election is going to take place.

Mr. Barksdale: In order that the hotel proprietors can use this room for the accommodation of their patrons, while arranging the dining hall for the banquet, we will meet in the billiard hall, across the alley, this afternoon.

President Palmer: If there is nothing further, a motion to adjourn will be in order.

On motion the meeting adjourned, until two p. m.

#### FRIDAY AFTERNOON SESSION.

Call to order.

President Palmer: The Conference Committee appointed to confer with the Exporters' Association that was authorized by the meeting this morning will consist of the following: W. A. Bennett, Alex. Lendrum, R. J. Darnell.

The Auditing Committee that we were waiting on this morning is unable to submit a report. The books of the treasurer are in Buffalo and the books of the secretary are in Indianapolis. For that reason the committee was

unable to do any auditing. The committee delayed, hoping they might be able to bring in a suitable report, but their idea was that a plain statement of facts would suit the association better than anything else. Without doubt the Executive Committee will use its judgment in having these accounts audited. There has never been any expensive grafting on the part of the officers of this association, and for that reason there is no great apprehension felt over the condition of the treasury. It is only fair to state that the amount shown in the treasurer's report is short by \$500, but not on account of the fact that anybody has misappropriated the money. That money was sent to Mr. Knight, chairman of the Inspection Bureau Committee, at Indianapolis, and it has been held there by him to pay any contingent expenses that might come up. The fund is at Indianapolis intact, and should properly be added to the balance shown by the treasurer as funds now in the possession of the association.

I desire to call your attention to that relief question. We have a great many pledges that were made yesterday morning at the opening meeting that have not yet been redeemed. We can only send the amount that we have in hand. We do not intend to make a book on the relief question, and therefore we trust every gentleman who has signed for any amount will meet the secretary and discharge his obligation. In addition to that, any liberal gentlemen in the crowd who have \$10, \$15 or \$20 to give to the San Francisco sufferers in order to swell the donation to a sum that is creditable to an association of this kind will kindly do so, and it will be cheerfully received.

Now, have we any new business to come up before this meeting before we proceed to election?

No new business being submitted for the attention of the meeting, the election of officers was next in order.

President Palmer: According to the rule submitted by the Committee on Credentials and Rules and approved by the association, it is necessary for the secretary to call a complete roll of the membership of this association. Since the meeting of the Executive Committee yesterday to approve applications for membership in the association, the secretary has received six other applications. He will read the names of the applicants in order that they may enjoy the privilege of participating in this election, if there is no objection on the part of the members. If there is no objection to the applicants, it will be understood that they be accepted as members and will be placed upon the roll and included in the roll call.

The secretary then read the following applications: J. B. Ferguson, Memphis, Tenn.; International Harvester Company, Chicago, Ill.; J. W. Wheeler & Co., Madison, Ark.; G. H. Palmer, Sheridan, Ind.; E. W. Leech, Detroit, Mich.; George H. Sivan, Bobo, Miss.

Upon motion, duly seconded and carried, the applications of the foregoing applicants for membership were favorably received and said applicants were declared duly elected to membership in the association.

#### Election of President.

President Palmer: The office of president is the first one to be filled. Nominations for president of the association are now in order.

S. B. Anderson: Mr. President and Gentlemen, allow me to present the name of a candidate for president of this association. I think we are offering the best man in the association for this position. You all know Mr. Russe. We especially know him. He is known throughout the trade of the country, but not as we know him here. We know him for his courage, his perseverance, his tact, his all-around qualities and his good fellowship. He is an ideal candidate for this position. Not only has he the personal qualities of the other applicants for this position, but we refer to his experi-



ence and business. He has been on the board two years. There has been no meeting that he has not attended, whether in Chicago, Boston or elsewhere. Mr. Russe would not take a position of this kind for the honor that is in it, but he takes it for the work, and he will do it well. We want you to know him as well as we know him. The better you know him the better you will appreciate him, and if he is elected president of this association (as I hope he will be) you will come to know him better than you know him now. Aside from the personal qualities of the candidate we offer, we think Memphis is entitled to the presidency. Memphis is something of a lumber center itself. For two years the presidency was in Chicago; one year in Indiana, two years in Paducah, and four years in Cincinnati, which we think is a fair proportion of the nine years. I hope you will all vote for W. H. Russe.

S. L. Dodds: As a lumber producer of Mississippi I would like to second the nomination of Mr. Russe.

Mr. Bennett: Mr. President, I have had a sick man on my hands and I have not had time to memorize my short speech, but if Mr. Sondheimer will keep quiet I will tell you something about Mr. Moffett.

Nine years ago the presidency of this association seemed to go begging, and for several years thereafter, and in order to interest you Mr. Vinnedge and others were at a loss what to say or do to secure the desired attendance. Often we had to manufacture some plausible reason to secure attendance. The press was kind to us then and helped our cause along, and we have gradually grown, slowly but surely, until now we are the largest hardwood lumber organization in the world. In the beginning there was no competitive organization and we had a clear field, but after a while some of our friends thought we were getting along well enough and that we were noticing some things and were being noticed by other organizations in other lines of trade, and thinking probably our success might mean their downfall in their business they organized a competitive association. The results of this you all know. We have increased in members until the 500 mark has been reached, and, so far as I know, we are at peace with all men and with only harmony existing among ourselves and with the best of feeling toward all organizations in our line. I want to nominate a man for our leader who will carry out this same policy. Mr. Thomas J. Moffett of Ohio, for president of this organization. Mr. Moffett is a charter member, having attended our first meeting in Chicago and all other meetings since. He is up at Cincinnati one of our best citizens, a man who stands well at home, a worker among the busy people, one who never neglects a trust and who has ability born of experience and trained in the school of activity in the executive line; a man who was asked to be mayor of our city six months ago and refused the nomination. I do not know whether he is a Democrat or a Republican. I do know he is a manufacturer of lumber in this country as well as in Havana, Cuba, and a wholesale dealer as well; a man among men, who knows both sides of our membership and will respect them. This problem is not new to him, and while he may not have had experience on the Board of Directors, we have not always gone there for a candidate, nor is this essential. We didn't get Palmer there.

Mr. Sondheimer: Palmer was discovered. I found him. [Laughter.]

Mr. Bennett: The men who discovered Palmer were Jess Thompson and myself, in Chicago. We are more than pleased to have such a candidate as Mr. Moffett—a man who has made no promises and has no affiliations with anybody, and whose sole purpose will be the building up of our association along the lines of National inspection of hardwood lumber, and the application of the same as legislated by

this body. I sincerely trust you will give him your unanimous support.

J. J. Rumbarger: Mr. Chairman and Gentlemen, Pennsylvania has no candidate for the presidency, but I rise to second the nomination of Mr. Moffett. You all know him. He is not an unknown quantity. He has been tried and not found wanting. He is a good presiding officer, a large manufacturer and a large dealer. I hope you will pass your votes for him.

I. F. Balsley: I have not attended every meeting of the association. I have never heard a member from Pittsburg ask anything of the association. They have delegated me to come to this convention and have asked me to use my influence and do all I can to support Mr. Moffett for the presidency of the association, and I take pleasure in endorsing his nomination.

Mr. McMillan: Gentlemen, I rise to second the nomination of a man, and, when you can say that of a fellow citizen, all other praise is superficial. I think that this association has its duty to perform in selecting from their midst men for the places for which they are best fitted. I care not for city or for individual. I say, keep every man where he is best fitted to promote the welfare of this association. As I told a man coming down from Chicago, I thought Chicago made an awful mistake when it proposed the name of Mr. Russe. You, gentlemen, are taking away from the floor the most able debater you have and you are placing him in the chair, where he is tied.

Mr. Sondheimer: Do you mean that?

Mr. McMillan: No; if it were you, sir, I would stand here and nominate to get you off the floor. [Laughter and applause.] Mr. Moffett is a manufacturer of lumber, is eligible for the office, and, gentlemen, all I have got to say to you is to look him in the face and you will see that my first application of "man" is there. I want to say to you, gentlemen, that if I had my way I would never allow a good member to be placed where he could not do his work. Now if you will place Mr. Moffett in the chair and he survives the year and any of you would survive him, after he has passed to the great unknown—if any of you should pass by his grave you could stop and quote Bobby Burns and say:

"An honest man lies here at rest,  
As here God with his image blest;  
A friend of man, a friend of truth,  
The friend of age, the guide of youth.

"Few hearts like his with virtue warm,  
Few heads with knowledge go to harm;  
If there's another world he lives in bliss,  
If there's none other he made the best of this."  
[Applause.]

E. C. Colcord: As a member representing a state adjoining the great State of Ohio, I beg leave to second the nomination of Mr. Moffett for president of this association.

Mr. Stinson: Mr. President and Gentlemen of the Convention, We all recognize the merits of Mr. Moffett. We know that he is a clean-cut man. We know that he is capable of administering the office of president of this association, and, gentlemen, there are hundreds of others in this body of 500 who could administer the office of president of the National Hardwood Lumber Association and do it ably. I second the nomination of a "man," and we don't want this president in the future that Mr. McMillan referred to. We want him now; we want him here, and I second the nomination of W. H. Russe.

J. N. Scatcherd: Mr. President, it is with some embarrassment that I stand up here before this membership today, because only just a year ago today you complimented us in Buffalo by coming there as our guest. There you had a man that you wanted to succeed himself, and Buffalo helped you. Mr. Moffett is all that you say about him. Mr. Russe always makes good,

and there is no better average quality of credit before the banking world of this country today than a lumberman's word, and you told us in Buffalo that the next time you had an election you would make Mr. Wall the president of this association. And we have come here demanding our rights. I never want to break faith. I never want to be mistaken by a lot of men as honest as you men. You made us the promise, and we come here and ask you to make M. M. Wall the president of this association. Mr. Bennett always gets back of the winner, but I want this to be done fairly and honestly, and I hope Mr. Wall will receive the honor at your hands.

Hugh McLean: I desire to second the nomination of Mr. Wall.

Mr. Sondheimer: Mr. President and Gentlemen of the Convention, After having listened to the apologies of the gentleman who had not prepared his speech in advance, after having listened to the eulogies on the dead one [laughter and applause], I desire to make a few remarks in the way of seconding the nomination of Mr. Russe. There is no occasion, taking into consideration the heat of this room and the bun cigars that are being smoked [laughter], to spend much time eulogizing the gentleman. It is not particularly a question whether a man is a man of family or not; whether or not he refused the nomination for mayor of a city almost unknown, neither is it necessary to fly into an ensemble allegory, bringing tears to your eyes. [Laughter and applause.] I simply want to ask you what kind of a man we desire to have as president of this association? [A number of voices—Moffett.]

J. W. Thompson: Don't get nervous, Max.

Mr. Sondheimer: When I get nervous I will not call for water. We desire a man who is not only a good business man but one who is in touch with all the interests and conditions of this association. We desire a man who is used to association work. Every member of this organization knows that there is no man in the organization who has more closely followed it from its very incipency up to the present day than the gentleman we advocate. He knows all the inside workings of the association; he has fought against adverse criticism and almost impossible conditions. He has never wavered; nor has he been on the fence one moment. He has been a National Association man, and the question has never come up as to whether it was possible for him to go to the Manufacturers' Association. If you desire to continue the prosperity of this association you will make no mistake by choosing Russe as your representative. Gentlemen, I thank you very kindly for the vociferous applause, and I say to you, in spite of the fact of my not having had time to prepare my speech—I say to you it is not necessary when you have such a subject as Russe to talk on. You have nothing to prove. Our case is already proven. Gentlemen of the convention, I submit this man to your recognition, and I am perfectly satisfied that when the result is made known you will be able to address him as "Mr. President." [Applause.]

Theodore Fathauer: Gentlemen, on March 17 last the Chicago Hardwood Lumber Exchange held its annual meeting. At that time Chicago had a candidate in the field, the first vice president, Mr. Agler. He was tendered the nomination, but for private reasons declined it. Inasmuch as Chicago is no inconsiderable market for hardwood lumber, nor a small factor in the National Hardwood Lumber Association, we proposed that we should have a candidate. We nominated Mr. Bill Russe of Memphis. In doing so we looked over the field, and it was our earnest and sincere intention to select the best man for the office. Mr. Russe, as you all know, has fought in the front ranks of the association. He has attended its meetings. He has served on the Executive Committee, and he possesses the vigor and enthusiasm of youth.

At the same time his mature years have taught him tact and diplomacy, a combination of qualities that are rarely found in one and the same man. I also wish to present to you a common sense business proposition. If, in your own business, a vacancy occurs, and you have employees in your employ who have been with you a great many years and who, by diligence and efficiency, have proved worthy, it is your duty to promote those men as a reward for efficiency and diligence. I appeal to you as common sense men, and the Chicago Hardwood Lumber Exchange, knowing you to be fair, through me respectfully requests you to reward an honest, efficient, diligent employee of the National Hardwood Lumber Association by giving him the highest reward within your gift.

D. F. Clark: I also wish to second the nomination of Mr. Russe for president. I have known Mr. Russe a good many years and have never known him to be wrong. I represent nine out of ten of the northwestern lumbermen, and I am sure the sentiment of those here from my section of the country favor Mr. Russe for president.

O. O. Agler: Gentlemen, since this matter has come up I cannot refrain from saying a word in favor of my friend Russe. I have served with him two years on the Executive Committee, and there has not been a time when we did not know where Mr. Russe stood. He has been always right, fair and square. It is the least we can do to elect him president. The state of Illinois seconds his nomination.

F. H. Smith: I am well acquainted with the early days of this association. I want to say a few words in behalf of Mr. Russe not only for myself but for the St. Louis delegation. Every one of them wants Mr. Russe. We all know how long and how hard he has worked. This association is working along the lines and precedence established by former officers and committees, and a man like Mr. Russe, who is entirely familiar with the early history of the association, should be honored by you with this office.

W. W. Knight: Mr. President and gentlemen, in behalf of some of the Indiana members, a majority of them, I want to second the nomination of Mr. Russe. I have known him a good many years and I have never known him to falter in any action he has taken. You cannot make any mistake in electing him president.

W. R. Barksdale: As president of the local association of hardwood lumbermen of Memphis I desire to second the nomination of W. H. Russe. I have been associated with him closely for many years and I can appreciate his work as thoroughly as any one. We feel a pride in W. H. Russe and we feel the association will do credit to itself and credit to Memphis if you elect him as your president.

G. J. Landeck: The Wisconsin members of this association, with the exception of a small majority, endorse the candidacy of William H. Russe.

M. M. Wall: I do not desire to have this business closed without having an opportunity to say something at my own expense. My good friend and fellow townsman, Mr. Scatterd, saw fit to make some remarks to you about some alleged promise made at Buffalo, which he seems to think ought to be carried out. I guess all you gentlemen know that I am not a candidate and have not been a candidate, and I am not running for the office of president of the association. I do not desire to come in here and be considered a candidate for this office, but I want to thank the gentleman who nominated me. [Applause.]

G. V. Nash: On the part of Arkansas I move that the rules be suspended and that the convention vote as a unit for W. H. Russe.

W. A. Bennett: Mr. President, we did not come down here for that purpose. If Cincinnati had not put up a man and gotten up this interest and if we had not carried this fight

on, half of you would not be here.

Mr. Sondheimer: Joke?

Mr. Bennett: No. We ask for a ballot and we insist on it.

Mr. Sondheimer: Mr. Chairman, I am opposed to gag rule, and in spite of the fact we are absolutely sure our candidate will win, I propose giving every man a square deal. Let us go to a vote on this.

It was moved and seconded that nominations for president be closed.

President Palmer: The motion before the house is that the nominations for president be closed.

Voted upon and carried.

President Palmer: According to the rule brought in by the Credentials Committee, the chair will appoint tellers for each candidate. For Mr. Russe I will appoint A. L. Foster and John W. McClure. For Mr. Moffett, W. A. Bennett and J. Watt Graham. For Mr. Wall, Hugh McLean and A. Miller. The vote will be by cards to be passed around. These cards were gotten up by a trade journal, the name of which I will not mention, for the purpose of securing the names of those in attendance. You will disregard the typewriting on the face of the card and use the back of the card. The roll of members will be called by the secretary, and as your names or your firms are called you will step forward and deposit your vote in the box provided by the tellers in the presence of the tellers.

Voting was then proceeded with, the secretary calling the name of every member of the association. The voting consumed nearly one hour's time, after which F. H. Smith moved that the ballots be closed and the vote counted. The motion was seconded and carried, whereupon a recess of ten minutes was taken to enable the tellers to count the vote.

The meeting reconvened in regular session after the recess.

The first order of business was the announcement of votes as reported by the tellers. President Palmer announced the result as follows: W. H. Russe, 114; T. J. Moffett, 54; M. M. Wall, 6. [Great applause.]

President Palmer: Gentlemen, I will appoint W. A. Bennett and J. W. Thompson as a committee of two to escort Mr. Russe to the chair.

Mr. Bennett: Mr. President, on behalf of the Cincinnati delegation we want to thank you for the support you gave us. We brought about this fight for the good of the association. We sent out over 6,000 pieces of mail. You would not have had anybody here compared with the number you have if we had not brought about the fight and had created some sentiment and stirred things up in this association. Memphis would never have sent out more than two or three letters. [Laughter.] Now I move you, gentlemen, that we make the election of Mr. Russe unanimous.

The motion was seconded and carried unanimously.

President Palmer: Gentlemen, it is my great pleasure to introduce to you your new president, Mr. W. H. Russe.

#### President's Speech of Acceptance.

Mr. Russe: Gentlemen, I wish to thank you for your confidence and for the implicit trust you seem to have placed in me, and the only thing I can say now is that I hope, at the end of the next year, you will be able to say, "He made good." We have a great deal of business yet to transact. This is a very warm hole we have been obliged to bring you to, and you will hear from me probably later on in the evening; but I believe the best policy now will be to get through with our business and get out of this place, and a little fresh air and a clean collar on for tonight. I realize, of course, that I have a very difficult road to travel, because I am following a man that has, more than any other one man, made this association what it is today. [Applause.] There

was no carrying water on two shoulders. When any question came up and he decided it was right he traveled along that line, and the policy of the association was followed along that line. That is the only thing that I fear of the coming administration that the past record has been so good that it will take every effort that the new administration can bring about to make any creditable showing whatever as compared with the past year. But we cannot make this a success unless we have the support of every member of the association. This we must have. Your committees, your Board of Managers, cannot do much unless the members themselves take interest in the work and help push it along.

Again thanking you, I think we had better proceed to business and get out of this place. [Applause.]

#### Nominations for Vice Presidents.

D. F. Clark: I move you that the nominations for first vice president be in order.

Mr. Palmer: Mr. President, some of the old members of this association will call to mind that at one time I chanced to be president of this association. [Laughter.] When I was president a gentleman served with me upon the Executive Committee, upon the Board of Managers, and upon his judgment I relied greatly whenever anything was up before me for decision, a gentleman that has never missed any meeting of the Board of Managers, nor of the Executive Committee, a gentleman who contains presidential timber of first class quality, and one who, in time, is to be recognized for the highest office of this association. It is my pleasure to nominate Mr. Agler for the office of first vice president. [Applause.] I am also going to move that this nomination be made by acclamation and unanimously.

Motion seconded.

Mr. Sondheimer: I move that nominations be closed.

Motion seconded and carried.

President Russe: Gentlemen, Mr. Agler has been duly elected as first vice president of this association. [Applause.]

Mr. Bennett: Mr. President, we have some pretty good timber down East for second vice president and I would put in nomination C. E. Lloyd of Philadelphia, a young man who has been a good man in association work, and we need strength in the East, and I think he will give it to us. He comes from Philadelphia, where we have had quite an addition to our membership since Mr. Lloyd became third vice president, and I think we ought to move him up one notch. I move that we close the nominations and make the election of Mr. Lloyd unanimous.

Motion seconded and carried.

President Russe: Gentlemen of the association, C. E. Lloyd has been duly elected to the office of second vice president.

Gardner J. Jones: Gentlemen, it gives me great pleasure to present the name of a man from the northern part of this country for third vice president. For many years I have traveled from Boston to these meetings, and I have gotten a great deal out of them. We want the association to go East next summer. I nominate H. C. Humphrey of Appleton, Wis., for the office of third vice president.

Mr. McMillan: I think this association can cover itself all over with glory by making this election, and I second the nomination.

Mr. Pritchard: I move that the nominations be closed and that Mr. Humphrey be elected by acclamation.

Motion seconded and carried.

President Russe: Mr. H. C. Humphrey is duly elected to the office of third vice president.

Mr. Sondheimer: I move you that they be not asked to make any speeches. [Laughter.]

#### Election of Treasurer.

Mr. Palmer: If I may be permitted, I move



that the present incumbent of the office of treasurer, O. E. Yeager, be re-elected by acclamation.

Mr. Bennett: Hold on. We people in Cincinnati have been after something and we haven't got it. We are with you gentlemen on everything. Mr. Yeager has made us a good, honest treasurer. There is no question of that; but we have a man at Cincinnati, and we want something there. We have asked for it and we ought to get it. I nominate Mr. J. Watt Graham, of Cincinnati for the office of treasurer, and I move you that the nominations be closed and that Mr. Graham be elected by acclamation.

Mr. Palmer: With the consent of my second I wish to withdraw my nomination.

President Russe: I have great pleasure in announcing the election of J. Watt Graham to the office of treasurer, and I would further announce that the money will be in Cincinnati the next year.

#### Election of Directors.

Mr. Palmer: In order to expedite this business I move that a committee be appointed by the chair to bring in the names of six persons to act as directors, five of them for three years and one to succeed Mr. Russe for one year.

Motion seconded and carried.

President Russe: I will appoint on that committee the following: J. W. Thompson, Allen R. Vinneedge, Gardner I. Jones, A. H. Barnard, B. R. Thompson. We have another question that has to be settled and we want some suggestions regarding the place at which the next meeting is to be held.

#### Place of Next Meeting Selected.

G. J. Landeck: Mr. President and Gentlemen, Wisconsin is in the field. Wisconsin has a city that has a product which made it famous. You all have heard of that city Milwaukee. Milwaukee invites you to hold your next annual convention in that city. I have with me letters and a telegram from the mayor of Milwaukee, who invites you and herewith extends to you Milwaukee's invitation.

Mr. McMillan: Mr. President, when we were at Buffalo we invited you then. We did not succeed on account of our friend and president of the association, who sits in the chair now, but I am glad that we did not get you last year, for if we had I would not have had a chance to come to Memphis and see this glorious city and accept your hospitality and drink your good water. [Laughter and applause.] We have the greatest number of hotels of any city of its size in the United States, and every one of these hotels are homes, where you will think you are right at home and under mother's wing. There is no more hospitable people on the face of the earth than in that good old solid German town. She is the convention town of the United States. She has them from one end of the country to the other and from Canada. Come to Milwaukee. We will extend to you the open hand and we will take good care of you, and the minute you drop your grip you will be assigned to a room and will not have to sleep double.

Mr. Lloyd: Mr. President and Gentlemen: Next year will be the tenth annual meeting of this association. Ten years is a decade and means something. This association has much to be proud of and still has much before it, and I want to ask the members to consider the advisability of entering a new field. We have never had a meeting east of Buffalo. I have here a little button, which you have all seen, which states that New York, Boston, Baltimore and Philadelphia extend an invitation to you. This is not an invitation from any one city; it is an invitation from all four of those cities. We want you to go to a place where you will be able to keep cool; where you can have greater accommodations than in any other place in the world; a place where you can take your wives. They will enjoy it, and so will you. Within the last year the membership in the East has

increased very largely, but it was only a beginning. We have a field there that has barely been touched. I know many of you do not ship much lumber East, but millions of feet are shipped in the East, and they get it somewhere. There are many sawmills there not represented in this association. The influence of your going East will reach not only the wholesale dealers in the East, many of whom have money invested in sawmills and factories, but will reach to the southeastern part of the country, where we buy much of our lumber. This is a national organization. We want the North, the East, the South and the West, and we want you to give the East a chance. In May, 1907, opposite Fortress Monroe, in Chesapeake Bay, will be held an exhibition, and to that exhibition are coming the navies of the world. The United States Government has invited them and they are coming. If you go East you will have an opportunity of witnessing some of the finest naval maneuvers the world has ever seen, and this will all take place a few days after our next annual meeting. I want to name a point for the meeting that has been agreed upon by our members in New England, Boston, the Central states, New York, Philadelphia, Pittsburg, Baltimore—a point that is within an hour's ride of Philadelphia, two hours of New York, three hours of Baltimore, where you can have plenty of room, and you will not have a lot of noise to bother you in the convention hall. I notice a number of friends here wearing buttons on which there is something about a bright spot. [Meaning the Milwaukee button.] I want you to come to a brighter spot, on the Atlantic ocean. I know that our generous friends from Wisconsin will not feel very badly if you change your minds and vote to go east. Our friends from Wisconsin are the most generous we have and we ask them to pardon us for trampling on their toes in this way. We are now opening up in the East with new members and our inspectors are busy all the time. Every carload of lumber that is inspected in the East by a national inspector adds to the importance of this association. I do not know that I can add anything more.

Edward J. Young: Wisconsin produces more hardwood than any state in this country. At our convention a year ago we modestly suggested our willingness to honor this association by permitting it to hold a meeting within our borders. Hardwood was not the thing that made Milwaukee famous, but had it not been for hardwood we realize we would not have had the other product which is sold by the bottle. Milwaukee is famed as a convention city, and is able to afford ample entertainment.

Mr. Palmer: We owe it to Milwaukee. Milwaukee went to Buffalo and tried to get it, and she came awfully near doing it, and we told them we would go there next year. Gentlemen, if you are going to keep the faith, go to Milwaukee.

T. J. Moffett: If you will let a lamb that has been brought to slaughter speak a few minutes I would like to be heard. I think this association owes it to the East to go there this year. We are strong in the West and in the South, and if we would fulfil the destiny of this association we must get more members in the East than we have. As I understand it the National Association is to work toward the ideal of universal inspection. You can never bring this about in the United States unless every section of the United States is properly represented in our association. The East is not properly represented, and has not received proper recognition. Personally I much prefer that the meeting go to New York City, but inasmuch as the four cities on the Atlantic coast have agreed on Atlantic City I do not think there is anything else for this association to do but to go there, and I sincerely hope that we go there.

Now, gentlemen, there is not a sore spot

anywhere in Memphis. We came down here to lick Bill Russe, but we didn't. We are just as much in favor of the National Association as we ever were, and Mr. Russe will find no section of the country that will hold up his hands any stronger than the people of Cincinnati will do. The Cincinnati delegation made this association. In the early days the greatest interest was manifested in this association in Cincinnati, and when Chicago, with its timid-ity, sent out its invitation, the boys were afraid there would not be a corporal's guard there, but when Cincinnati with a full carload went up to Chicago they said, 'Boys, you saved the day,' and Cincinnati is the originator of this association, and will not desert it. I cannot think that any one in the association would believe that we would weaken because of our unsuccessful fight in this election. And right here I want to thank the gentlemen who supported me, but, in addition to that, I want to pay a tribute to the loyalty of Cincinnati. It is an honor to me to have had the support of the Cincinnati delegation. Those boys never wavered, and it compares well with the election. Next to the presidency itself, this loyal support is better than anything else. [Applause.]

President Russe: I wish to say that Mr. Moffett not only has the good will of those gentlemen but he has the good will of the entire association. He had me very badly scared. I do not believe that any two candidates we could select who would run a race of this kind would feel sore over the result. I believe the only thing that we all look to is the good of the association, and the interest that has been brought about by this contest has been the saving of the Memphis meeting. It has saved us a lot of money in booze. I am not referring to Mr. McMillan but I appreciate Mr. Moffett's remarks, and I was satisfied that, if I could secure the honor of being president for the coming year, I would have his support, and not only his but the entire Cincinnati delegation, including our own dear Billy. [Applause.]

Mr. Curry: I do not think I need tell you what I am here for. The chief thing that Milwaukee has advanced in support of having the convention there is the fact that it has a local product which made it famous. The reason that we want you to come to Atlantic City is not for the liquid refreshments dispensed there but the fact that we think the East should have some favor shown it. You were compelled until a short time ago to sell your lumber on Philadelphia rules of inspection; in New York they had standard New York inspection rules, and it has only been by the combined efforts of the eastern members that it has been possible to sell our product on the rules of the National Hardwood Lumber Association.

Theo. Patherer: On behalf of the Chicago contingency, believing that it is very important that our next annual meeting should be held at some central point, which can be reached by the greatest number in the shortest possible time, I move you that we accept the invitation of Milwaukee.

Motion seconded.

President Russe put the motion to a vote, but in the noise and confusion it was impossible to determine the result.

Mr. Bennett: Mr. President, I think it would be very nice to go to Atlantic City, if Atlantic City was to entertain us. If the association, so as not to be an expense on the city it goes to, would cut out the banquet I would be in favor of Atlantic City. The lumbermen there cannot take care of us. If the people in the East desire to entertain us and will permit us to pay for the banquet tickets, as if we cut out the banquet, I say go to Atlantic City. I think the best thing to do is to cut out the banquets.

President Russe: There is a motion before the house.

Mr. McMillan: Mr. Chairman, we ask you to go to Milwaukee because we want to entertain

you. We don't want you to pay one cent for your banquet, and if we cannot set you up a banquet that will make your hair stand up I lose my guess. Wisconsin is no sluggard. She is full of vim. The people there live in a northern climate, where you find men, and the lumbermen of Wisconsin have helped to make every lumber district in the United States.

Mr. Agler: Gentlemen, it is not a question of where we want to go but where we can go to do this association the most good. Milwaukee was promised the convention last year.

Mr. Rumbarger: My concern is a member of the New York Lumber Trade Association; also a member of the Philadelphia Exchange and the Philadelphia Lumber Dealers' Association. On behalf of those associations I ask you to go to Atlantic City, and they will give you a banquet. You will not need to pay for your banquet. In New York and Philadelphia we have many new members who have never attended an association meeting, and if you should go there you would have an opportunity to visit your customers.

S. E. Barr: As a member from New York I, too, ask you to go to Atlantic City, but I want you to cut out all question of banquet. That is not what we came here for. We do need some representation in the East, regardless of any promise made at Buffalo last year, which does not bind us. I am the only one from New York City, but Baltimore has spoken and Philadelphia has spoken, and now I want Boston to speak. I would ask Mr. Woods to come up now and say the rest.

John M. Woods: Mr. President and Gentlemen: I would not give a cent to come to a convention and represent only one state. I come representing Maine, New Hampshire, Rhode Island and Connecticut. [Applause and laughter.] Every one of you gentlemen has got rich out of us in the past. You can see the representation from Massachusetts. On behalf of the Lumbermen's Club of New England, I invite you to go to Atlantic City, and if you go as far as Atlantic City you are pretty near the best and biggest place in this world, the old commonwealth of Massachusetts.

Mr. Rumbarger: I now offer an amendment to the pending motion, to strike out the word "Milwaukee" and substitute the words "Atlantic City."

Mr. McMillan: I offer an amendment to the amendment, that we strike out the words "Atlantic City" and substitute the word "Milwaukee."

It was moved that the amendment to the amendment be laid on the table. This motion was seconded and carried.

President Russe: I will now put the amendment to the original motion to vote; that is, to change the wording of the original motion, substituting "Atlantic City" for "Milwaukee."

A vive voce vote was then taken, but it was impossible to determine the result.

President Russe: I object to members coming to the chair and saying, "Milwaukee got it," or "Atlantic City got it." I am frank to say I cannot tell who got it. It is a question of noise. I have been informed by both sides of the question that we have visitors here, which is all right, and we are glad to have them, but they are not entitled to vote, and I sincerely hope that no man will vote unless he is entitled to do so. We will now take a standing vote.

A standing vote was then taken, the members being divided in different parts of the room. The president appointed the secretary and W. W. Knight to go out among the members and make an individual count of both sides. This showed the result to be as follows: Atlantic City, 70 votes; Milwaukee, 45 votes.

President Russe: The two tellers appointed have reported that Atlantic City has the greatest number of votes. The next meeting will be held at Atlantic City.

It was then moved and seconded that the selection of Atlantic City as the place at which the next annual convention is to be held be made unanimous.

Motion seconded and carried.

#### Permanent Committee on Transportation.

President Russe: The retiring president says he failed to announce the committee on transportation. The members of that committee are O. O. Agler, G. J. Landeck, and J. M. Pritchard.

A motion was then made by B. F. McMillan and seconded that the association extend to Earl Palmer, the retiring president, the thanks of the association for the able manner in which he has administered the affairs of the association during the last two years.

Motion unanimously carried, followed by the Hoo-Hoo yell.

#### Report of Committee to Name Directors.

Mr. Thompson: Your committee begs to report the following names for directors for a three-year term:

Earl Palmer, Paducah, Ky.; George E. Hibbard, St. Louis, Mo.; C. F. Sweet, Grand Rapids, Mich.; O. E. Yeager, Buffalo, C. H. Barnaby, Greencastle, Ind.

One-year term (to succeed W. H. Russe): G. J. Landeck, Milwaukee, Wis.

Mr. Bennett: I do not think this is divided up right, and I would suggest the name of J. M. Card, Chattanooga, Tenn., and also the name of I. F. Baisley of Pittsburg, Pa.

Mr. Moffett: I second the motion.

Mr. Palmer: I wish to withdraw in favor of Mr. Card.

Many voices: No.

Mr. Thompson: If the gentleman will examine the book containing all the directors (fifteen) he will find that the directors are scattered all over the country. It was the aim of the committee to appoint good men from the locality least represented, and if any place is represented by too many we will be glad to strike it from the list, or if there is any section not represented we would be glad to make a change to include all. I therefore move that the six gentlemen we have named be elected by acclamation.

Motion seconded and carried.

Mr. Rumbarger: I think it is in order to offer a motion thanking the citizens of Memphis for the courtesy extended us and the hospitable manner in which they have entertained us.

Motion seconded and carried unanimously.

President Russe: I wish to say in behalf of the Memphis Lumbermen's Club that your being here is thanks enough for us. You have showed that you like us or you would not have come, and it was only a little delicacy, being a Memphis man, that caused me to refrain from putting the motion myself.

#### Meeting of Board of Directors.

Immediately following the adjournment of the convention a meeting of the Board of Directors was held and a working organization for the ensuing year was promulgated. Frank F. Fish was reappointed secretary, and George L. Smith, inspector general.

It was resolved to move the offices of the secretary and inspector general and the general headquarters of the association to Chicago, forthwith.

The Executive Committee was organized as follows: W. H. Russe, Memphis, Tenn., chairman; Earl Palmer, Paducah, Ky.; O. O. Agler, Chicago, Ill.; C. H. Barnaby, Greencastle, Ind.; G. J. Landeck, Milwaukee, Wis.

To the Inspection Rules Committee, with terms expiring in 1909, were added D. F. Clark, Minneapolis, reappointed; T. B. Stone, Cincinnati, O.; A. B. Klise, Sturgeon Bay, Mich.; and E. J. Young, Madison, Wis., appointed to succeed G. J. Landeck, resigned, whose term would have expired in 1908.

To the Inspection Bureau Committee, with terms expiring in 1909, were added the names of Harry S. Dewey, New York City; John J. Rumbarger, Philadelphia, and F. H. Smith, St. Louis.

The Committee on Forestry of last year was reappointed. This committee consists of M. M. Wall, Buffalo; B. F. McMillan, McMillan, Wis.; T. J. Moffett, Cincinnati.

#### The Excursion.

The excursion on the Mississippi, tendered by the Memphis Lumbermen's Club to the members of the association and the lady visitors on Wednesday evening, was a most charming affair. A spacious steamer was provided and the party, to the number of more than 500, made the trip on the Father of Waters, returning to the levee at 11 o'clock. A band discoursed sweet strains and many indulged in dancing. A collation was served between decks and the affair was voted one of the most enjoyable held in connection with the convention.

#### The Banquet.

The visitors were entertained at an elaborate dinner in the great dining hall of the Gayoso hotel at 8 o'clock on the evening of May 4, the Lumbermen's Club of Memphis acting as hosts. Of this club Wm. R. Barksdale of Barksdale, Denton & Co. is president; W. S. Darnell of I. M. Darnell & Sons Company is vice president; E. E. Gary of the Baker Lumber Company is second vice president, and George C. Ehemann of Bennett & Witte is secretary and treasurer. J. W. Thompson of the J. W. Thompson Lumber Company was chairman of the Entertainment Committee. Covers were laid for 350 and every table in the great dining hall was beautifully decorated with flowers and flags. The music was excellent. Wm. R. Barksdale acted as toastmaster, and both the dinner and the speeches were brilliant successes. The menu follows.

Manhattan Cocktail.  
Caviar Canape.  
Bouillon, Frappe.  
Sauterne.  
Celery, Salted Almonds, Olives.  
Soft-shell Crabs, Tartare Sauce.  
Shoestring Potatoes.  
Pommery Sec.  
Broiled Spring Chicken.  
New Potatoes in Cream, Asparagus Tips.  
Tomato and Lettuce, Mayonnaise.  
Cheese Straws.  
Strawberries, Whipped Cream.  
Coffee.  
Cigars and Cigarettes.  
Apollinaris Water.

#### Attendance.

Agler, O. O., Fpham & Agler, Chicago.  
Alcott, C. A., Clarksdale, Miss.  
Allen, Stuart A., C. B. & D. Ry., Cincinnati.  
Allen, J. R., Indianapolis.  
Archer, W. A., Hackley-Phelps-Bonnell Co., Grand Rapids.  
Anderson, James T., Hurricane, Tenn.  
Andrews, J. R., the Pine Lumber Co., Milwaukee.  
Arthur, L. P., Arthur Hardwood Flooring Co., Memphis.  
Armstrong, W. W., the Trowbridge Co., Detroit.  
Anderson, W. R., Southern Lumberman, Memphis.  
Anderson, S. R., Anderson-Tully Co., Memphis.  
Alexander, H. H., Belzoni, Miss.  
Asher, J. M., Nicola, Stone & Meyers Co., Cincinnati.  
Ammons, W. E., W. E. Ammons Lumber Co., Sumner, Miss.  
Brown, G. A., Erie Despatch, Memphis.  
Blair, James R., L. H. Gage Lumber Co., Memphis.  
Blackwell, F. J., Brownsville, Tenn.  
Barnaby, C. H., Greencastle, Ind.  
Bennett, W. A., Bennett & Witte, Cincinnati.  
Banks, George, Banks & Co., Hernando, Miss.  
Farr, Sam E., New York City.  
Barrett, W. E., W. E. Barrett & Co., Chicago.  
Bomer, J. O., Homer Bros., Brownsville, Tenn.  
Faird, J. H., Southern Lumberman, Nashville.  
Barnard, A. H., Minneapolis.  
Baker, F. M., Hardwood Mills Lumber Co., Chicago.  
Baird, D. W., Dudley Lumber Co., Memphis.  
Bulkley, L. C., the Bulkley-James Co., Benton, La.  
Bigelow, W. H., Boston, Mass.  
Brooks, P. H., Douglass & Walkley Co., Drew, Miss.

Earns, W. E., St. Louis Lumberman, St. Louis, Mo.  
 Balsley, I. F., Willson Bros. Lumber Co., Pittsburg.  
 Burgoyne, George W., Official Reporter, Chicago.  
 Boyd, James, Lumber Trade Journal, New Orleans.  
 Bonner, W. C., J. H. Bonner & Son, Heth, Ark.  
 Bailey, George E., Taylor & Crate, Chattanooga.  
 Blanton, R., Blanton-Thurman Lumber Co., Memphis.  
 Bourne, C., Michigan Central railway, Memphis.  
 Barksdale, W. R., Jr., Barksdale-Kellogg Lumber Co., Memphis.  
 Barksdale, W. R., Barksdale, Denton & Co., Memphis.  
 Barr, C. L., G. Wilkinson Lumber Co., Cairo, Ill.  
 Bramlage, B. E., Bennett & Witte, Cincinnati.  
 Blessed, George A., Wolverine Manufacturing Co., Detroit.  
 Burgess, George D., Russe & Burgess, Memphis.  
 Bader, H. O., Stover Lumber Co., Memphis.  
 Blakely, W. W., B. & O. S. W. R. R., Memphis.  
 Beck, E. E., E. E. Beck Lumber Co., Cincinnati.  
 Buckley, James, Brookville, Ind.  
 Bruner, J. J., E. Sondheimer Co., Memphis.  
 Beyer, Frank A., Beyer, Knox & Co., Buffalo.  
 Burgess, S. M., S. M. Burgess & Co., Rockport, Ky.  
 Bonsack, W. A., Bonsack Lumber Co., St. Louis.  
 Bell, E. B., Southern Oak Lumber Co., Macon, Miss.  
 Bacon, C. I., C. I. Bacon Cypress Lumber Co., Cincinnati.  
 Cabell, Joseph B., Mexican-American S. S. Co., New Orleans.  
 Cathey, F. M., Crenshaw & Cathey, Memphis.  
 Claypool, E. H., Missouri Pacific railroad, Memphis.  
 Cooper, Robert, Hughart & Kendal, Memphis.  
 Conutess, J. M., J. M. Conutess Lumber Co., Doran, Ark.  
 Cansy, John W., Union City Lumber Co., Grand Rapids, Mich.  
 Cline, L. C., Thompson & McClure, Memphis.  
 Coppeck, S. P., S. P. Coppeck & Co., Fort Wayne, Ind.  
 Coge, H. H., Erie Despatch, Memphis.  
 Cooper, R. S., Briggs & Cooper Co., Ltd., Saginaw, Mich.  
 Clark, D. F., Osborne & Clark, Minneapolis.  
 Crenshaw, W. L., Crenshaw & Cathey, Memphis.  
 Curry, E. C., Jr., R. M. Smith & Co., Philadelphia.  
 Cowen, James C., Schultz Bros. & Benedict, Chicago.  
 Callon, W. T., W. A. Powell Co., Ltd., New Orleans.  
 Carrier, C. M., Carrier Lbr. & Mfg. Co., Sardis, Miss.  
 Coles, Howard, Bliss-Cook Oak Co., Blissville, Ark.  
 Cobb, B. E., Lumber Review, Kansas City.  
 Christian, T. J., Fullerton-Powell Hardwood Lumber Co., South Bend, Ind.  
 Card, J. M., J. M. Card Lumber Co., Chattanooga, Tenn.  
 Cone, Albert, American Lumberman, Chicago.  
 Chandler, Kelly R., St. Louis.  
 Conn, J. C., Funnagusha Lumber Co., Howard, Miss.  
 Colcord, E. C., Bowman Lumber Co., St. Albans, W. Va.  
 Conkling, F. A., Farrin-Korn Lumber Co., Memphis.  
 Cool, W. A., W. A. Cool & Son, Cleveland.  
 Cotter, R. B., Metal Bound Package, Mound City, Ill.  
 Crossfield, W. M., Crossfield & Co., Nashville.  
 Dennis, A. S., Dennis & Smith Lumber Co., Detroit.  
 Direks, O., Askin & Direks Lumber Co., Union City, Tenn.  
 Dilks, George R., Richmond, Ind.  
 Duggan, C. R., Tindle & Jackson, Pellston, Mich.  
 Dudley, H. J., Dudley Lumber Co., Grand Rapids, Mich.  
 Defebaugh, J. E., American Lumberman, Chicago.  
 Davis, C. E., C. E. Davis & Co., Grand Rapids, Mich.  
 Douglass, W. E., Douglass & Walkley Co., Columbus, O.  
 Dabolt, F. P., Eureka Hardwood Lumber Co., Beeton, Ark.  
 Dudley, C. B., Memphis.  
 Dney, Charles, American Lumberman, Chicago.  
 Dolph, W. A., I. M. Darnell & Sons Co., Memphis.  
 Davidson, J. R., Cincinnati Northern R. R., Cincinnati.  
 Debays, H. E., C. H. & D. R. R., Cincinnati.  
 Darnell, R. J., R. J. Darnell, Inc., Memphis.  
 Dudley, Ben H., C. H. & D. and Interstate D.  
 Dewey, W. C., Chapman Dewey Lumber Co., Memphis, spatch, Nashville.  
 Dulweber, B. F., John Dulweber & Co., Cincinnati.  
 Dickson, J. W., J. W. Dickson Co., Memphis.  
 Davis, W. A., Chicago.  
 Dickinson, Charles C., E. Sondheimer Co., Memphis.  
 Darnell, W. S., I. M. Darnell & Sons Co., Memphis.

Dickson, J. S., Green River Lumber Co., Memphis.  
 Dodds, S. L., Sunflower Lumber Co., Clarksdale, Miss.  
 Dickinson, C. M., Dickinson Lumber Co., Paragould, Ark.  
 Emery, F. B., Lake Shore-Lacka. Line, Chicago.  
 Euler, F. P., The Crosby-Beckley Co., Evansville, Ind.  
 Ehrhus, Alexander, Long Knight Lumber Co., Clarksdale, Miss.  
 Engel, George, Engel Land & Lumber Co., Grand Rapids, Mich.  
 Ehemann, George C., Bennett & Witte, Memphis.  
 Elms, Charles S., New Orleans.  
 Erb, M. M., Case Lumber Co., Chattanooga.  
 Evans, J. M., Philadelphia Veneer Lumber Co., Knoxville, Tenn.  
 Elliott, C. M., Lackawanna Line, Louisville.  
 Evans, T. L., Lackawanna Line, Cincinnati.  
 Felger, Jesse L., Hackley-Phelps-Bonnell Co., Grand Rapids, Mich.  
 Findley, J. H., Helena Box Co., Memphis.  
 Ferguson, John, Ferguson & Palmer Co., Paducah, Ky.  
 Ferrell, C. H., Humboldt Hoop & Hdg. Co., Humboldt, Tenn.  
 Fuler, G. H., Star Union Line, St. Louis.  
 Fitzgibbons, P. F., McLean Lumber Co., Chattanooga.  
 Foster, G. E., Foster-Latimer Lumber Co., Mellen, Wis.  
 Fontaine, Lamar, Clarksdale Lumber Co., Lyon, Miss.  
 Fish, F. S., Guirl-Stover Lumber Co., Memphis.  
 Flynn, G. M., Southern Oak Lumber Co., Macon, Miss.  
 Fish, F. F., secretary N. H. L. A., Indianapolis, Ind.  
 Ford, E. M., Memphis.  
 Felger, Otis A., Hackley-Phelps-Bonnell Co., Grand Rapids, Mich.  
 Fair, W. A., Edwards-Fair Lumber Co., Lansing, Ark.  
 Fair, A. N., S. S. Fair & Co., Ludwig, La.  
 Fair, Robert, Edwards-Fair Lumber Co., Lansing, Ark.  
 Farber, G. A., Memphis.  
 Fathauer, Theo., Theo. Fathauer Co., Chicago.  
 Fathauer, Fred, Banks & Co., Hernando, Miss.  
 Foote, H. L., Dennis Bros., Grand Rapids, Mich.  
 Fish, Charles W., Hackley-Phelps-Bonnell Co., Grand Rapids, Mich.  
 Fuller, F. A., Edwards Lumber Co., Oshkosh, Wis.  
 Ferguson, John K., Ferguson & Palmer Co., Paducah, Ky.  
 Fooshe, George W., Lumber Press Correspondent, Memphis.  
 Fowler, William, Case Lumber Co., Chattanooga, Tenn.  
 Fowler, H. C., Fowler-Personett Lumber Co., Birmingham, Ala.  
 Freeland, V. L., Cincinnati, O.  
 Foster, A. L., J. W. Thompson Lumber Co., Memphis.  
 Gracie, Frank N., J. W. Darling Lumber Co., Cincinnati.  
 Garrison, J. H., W. O. Hughart, Jr., Grand Rapids, Mich.  
 Graham, J. Watt, Graham Lumber Co., Cincinnati.  
 Grissam, Clyde, Lumber Press Correspondent, Memphis.  
 Gilbert, P. E., W. A. Davis, Chicago.  
 Gibson, W. G., National Inspector, Memphis.  
 Goodlander, E. E., Goodlander-Robertson Lumber Co., Memphis.  
 Gary, F. E., Baker Lumber Co., Memphis.  
 Greble, W. H., Three States Lumber Co., Memphis.  
 Grant, J. B., Buffalo Hardwood Lumber Co., Memphis.  
 Gladding, G. W., E. C. Atkins & Co., Inc., Memphis.  
 Gladden, C. L., Memphis.  
 Gibson, Henry H., HARDWOOD RECORD, Chicago.  
 Gage, L. H., Gage-Possell Lumber Co., Cincinnati.  
 Goodman, Charles A., Sawyer-Goodman Co., Marinette, Wis.  
 Glauber, M., E. Sondheimer Co., Memphis.  
 Gray, H. J., The Macey Co., Grand Rapids, Mich.  
 Hughart, W. O., Hughart & Kendal, Memphis.  
 Hascall, C. G., East St. Louis Walnut Co., East St. Louis, Ill.  
 Hitchcock, J. D., Douglass & Walkley Co., Drew, Miss.  
 Heald, J. M. D., Price & Heald, Baltimore, Md.  
 Humphrey, H. C., G. W. Jones Lumber Co., Appleton, Wis.  
 Horn, T. William, G. W. Jones Lumber Co., Appleton, Wis.  
 Hodges, R. F., Milwaukee.  
 Helder, F. J., Fink-Helder Co., Chicago.  
 Holmes, C. W., J. A. Holmes Lumber Co., Memphis.  
 Hibbard, George E., Steele & Hibbard, St. Louis.  
 Hill, I. D., Pine Bluff, Ark.  
 Hafner, J. A., Hafner Mfg. Co., St. Louis.  
 Harris, S. C., Southern Hardwood Lumber Co., Memphis.  
 Haas, Weaver, T. B. Stone Lumber Co., Cincinnati.

Hanner, W. E., James I. M. Wilson & Co., Pittsburg.  
 Hancock, W. H., W. J. Hancock Lumber Co., Mississippi.  
 Hoshall, W. E., Hoshall & McDonald Bros., Eola, La.  
 Hayden, Harvey S., Chicago.  
 Hull, H. S., Oval Wood Dish Co., Traverse City, Mich.  
 Hull, W. C., Oval Wood Dish Co., Traverse City, Mich.  
 Hanna, John P., Wiborg & Hanna Co., Cincinnati.  
 Hurst, N. A., Arthur Hardwood Flooring Co., Memphis.  
 Hatfield, C. B., Jr., Florence Pump & Lumber Co., Memphis.  
 Horne, James A., New York.  
 Holloway, J. T., Holloway Lumber Co., Philadelphia.  
 Hurd, O. P., Jr., O. P. Hurd, Jr. & Co., Cairo, Ill.  
 Harwood, J. J., Robert H. Jenks Lumber Co., Cincinnati.  
 Huffstutter, P., Charles Thueuer Planing Mill Co., St. Louis.  
 Hyde, C. E., Hyde Lumber Co., Memphis.  
 Edison, A. B., Paine Lumber Co., Oshkosh, Wis.  
 Jones, Gardner I., Jones Hardwood Co., Boston.  
 Jayne, J. M., Jr., R. J. Darnell, Inc., Memphis.  
 Jones, Ted T., Appleton, Miss.  
 Janovich, P., Floria Janovich, New Orleans.  
 James, V. L., Empire Lumber Co., Buffalo.  
 James, J. W., Jr., Goodlander-Robertson Lumber Co., Memphis.  
 Jardon, R. L., K. & P. Lumber Co., Cincinnati.  
 Jenks, John H., Robt. H. Jenks Lumber Co., Cleveland.  
 Jones, W. J., Jones, Coates & Bailey, Chicago.  
 Joy, Levi, Arthur Hardwood Flooring Co., Memphis.  
 Johnson, B. A., American Lumberman, Chicago.  
 Knight, W. W., Long-Knight Lumber Co., Indianapolis.  
 Kellogg, C. M., Barksdale-Kellogg Lumber Co., Memphis.  
 Kwies, L. B., Goodland Cypress Co., New Orleans.  
 Krebs, Roland F., Ozark Cooperage Co., St. Louis.  
 Klise, A. B., A. B. Klise Lumber Co., Sturgeon Bay, Mich.  
 King, W. O., W. O. King & Co., Chicago.  
 Kramer, C. H., C. & W. Kramer Co., Richmond, Ind.  
 Korn, C. E., Farrin-Korn Lumber Co., Cincinnati.  
 Kipp, B. A., B. A. Kipp & Co., Cincinnati.  
 Kramer, H. M., C. & W. Kramer Co., Richmond, Ind.  
 Kerns, George, Kerns Lumber Co., Freeport, Ill.  
 Lewis, H. Z., Memphis.  
 Laskey, J. D., May, Thompson & Thayer, Evansville, Ind.  
 Love, A. M., Darnell-Love Lumber Co., Memphis.  
 Lendrum, Alex., Penrod Walnut Corporation, Kansas City.  
 Le Crone, E. B., W. E. Kelley & Co., Chicago.  
 La Crone, C. E., Memphis.  
 Long, J. W., New York Lumber Trade Journal, New York.  
 Lesh, L. B., Lesh & Matthews Lumber Co., Chicago.  
 Lloyd, C. E., Jr., Cherry River Boom & Lumber Co., Philadelphia.  
 Lawrence, E. W., Lawrence & Wiggin, Boston.  
 Leiding, J. H., Standard Mill Work Co., Cincinnati.  
 Landeck, G. J., Page & Landeck Lumber Co., Milwaukee.  
 Littleford, George, Littleford Lumber Co., Cincinnati.  
 Lang, Elliott, R. J. Darnell, Inc., Memphis.  
 Leech, E. W., Detroit.  
 Lewis, J. A., Chicago-Mississippi Land & Lumber Co., Chicago.  
 Lane, J. L., J. L. Lane & Co., Chicago.  
 Lambert, U. S., Green River Lumber Co., Memphis.  
 McCary, Earl, C. A., C. H. D. R. R., Nashville.  
 Miller, E. C., Guirl-Stover Lumber Co., Memphis.  
 Miller, F. E., W. E. Kelley & Co., Chicago.  
 Miller, A., Buffalo, N. Y.  
 McClure, J. W., Thompson & McClure, Memphis.  
 Morse, Fred S., Fred S. Morse Lumber Co., Springfield, Mass.  
 McSwayne, James F., Grand Rapids.  
 McFarland, Thomas, Thos. McFarland Lumber Co., Cairo, Ill.  
 Major, S. C., S. C. Major Lumber Co., Memphis.  
 Mayer-Dinkel, Leo, Dreyfus & Mayer-Dinkel, Mannheim, Germany.  
 Martin, W. L., W. H. White Co., Roynce City, Mich.  
 Moore, John H., National Inspector, Muskegon.  
 Miller, Charles, Miller Bros., Chicago.  
 Miller, Milton, Miller Bros., Chicago.  
 Moore, Tom, The Moore Co., St. Louis.  
 Merritt, J. S., Bennett Hardwood Lumber Co., Memphis.  
 Mallory, J. H., Illinois Central railway, Memphis.  
 Miller, A. B., Southern Oak Lumber Co., Memphis.  
 McCree, T. J., Lackawanna Line, Memphis.  
 Meadows, J. E., Advance Lumber Co., Cleveland.  
 Montano, John, Bennett & Witte, Cincinnati.  
 May, Ralph, May, Thompson & Thayer, Evansville, Ind.

- McLean, Hugh, Hugh McLean Lumber Co., Buffalo.
- McMillan, B. E., B. E. McMillan & Bro., McMinn, Wis.
- Moffett, T. J., Maley, Thompson & Moffett Co., Cincinnati.
- Morgan, W. B., Anderson-Tully Co., Memphis.
- McCool, O. T., Arthur Hardwood Flooring Co., Memphis.
- McIntyre, J. E., Memphis Rim & Bow Co., Memphis.
- Morgan, E. J., St. Francis River Lumber Co., Madison, Ark.
- McDonough, M. J., Seaboard Air Line, Birmingham, Ala.
- McDonald, John, McDonald Bros., Helena, Ark.
- McIntosh, W., Stoneman Lumber Co., Clarksdale, Miss.
- Nash, G. V., Forest City Mfg. Co., Forest City, Ark.
- Newman, R. H., Simonds Manufacturing Co., Chicago.
- Neely, M., McDonald Bros., Helena, Ark.
- Newborn, G. W., Star Union Line, Memphis.
- Neible, W. H., New Albany Furniture Co., New Albany, Miss.
- Plummer, Theo. M., Plummer Lumber Co., St. Louis.
- Perrine, Van B., Perrine-Armstrong Co., Ft. Wayne, Ind.
- Palmer, Earl, Ferguson & Palmer Co., Paducah, Ky.
- Palmer, C. R., L. H. Gage Lumber Co., Providence, R. I.
- Powell, C. G., Fullerton-Powell Hardwood Lumber Co., South Bend, Ind.
- Pomeroy, L. J., L. J. Pomeroy & Co., Chicago.
- Pritchett, E. K., the Macey Co., Grand Rapids, Mich.
- Prange, C. F., Crockett Bluff Lumber Co., Crockett Bluff, Ark.
- Palmer, G. H., Shendandig, Ark.
- Palmer, O. K., Guilt-Stover Lumber Co., Memphis.
- Pritchard, J. M., Long-Knight Lumber Co., Indianapolis.
- Palmer, W. C., Wiborg & Hanna Co., Cincinnati.
- Pease, C. H., Standard Millwork Co., Cincinnati.
- Powell, William P., W. B. Mershon & Co., Saginaw, Mich.
- Pinney, D. R., Penned Land Co., Caruthersville, Mo.
- Palmer, F. B., Wiborg & Hanna Co., Cincinnati.
- Pritchard, W. R., Norfolk & Western R. R., Memphis.
- Pescia, Lee, Wabash railway, Memphis.
- Perkins, M. R., Memphis.
- Pennington, W. M., Big Four Route, Memphis.
- Roach, C. J., D'Heur & Swain Lumber Co., Seymour, Ind.
- Roberts, G. G., Robt. H. Jenks Lumber Co., Cleveland.
- Ravesties, P. H., General Lumber Co., Memphis.
- Robinson, E. O., Mowbray & Robinson, Cincinnati.
- Ramshaw, W. G., Chicago.
- Ryan, Philip A., Ryan & McParland, Chicago.
- Richardson, W. J., the General Lumber Co., Memphis.
- Reeves, W. D., W. D. Reeves Lumber Co., Helena, Ark.
- Reeves, Horace A., Jr., R. E. Wheeler & Co., Philadelphia.
- Russe, George C., E. Sondheimer Co., Memphis.
- Robertson, F. B., Goodlander-Robertson Lumber Co., Memphis.
- Russe, W. H., Russe & Burgess, Memphis.
- Richardson, B. F., Leavitt Lumber Co., Chicago.
- Rumbarger, John J., Rumbarger Lumber Co., Philadelphia.
- Richey, S. W., Richey, Halsted & Quick, Cincinnati.
- Richards, H. A., Grand Trunk Ry., St. Louis.
- Rumbarger, Frank T., Rumbarger Lumber Co., Philadelphia.
- Radina, Fred E., L. W. Radina & Co., Cincinnati.
- Reed, C. C., Reed & Dnecker, Memphis.
- Rhodes, E. D., Stimpston Land Co., Lula, Miss.
- Ranson, W. A., Gayoso Lumber Co., Memphis.
- Reichman, J. A., Reichman-Crosby Co., Memphis.
- Schneider, H., Indley Lumber Co., Grand Rapids.
- Stimson, J. V., Huntingburg, Ind.
- Stone, T. B., T. B. Stone Lumber Co., Cincinnati.
- Stoneman, G. W., Stoneman-Zearing Lumber Co., St. Louis.
- Strickland, J. L., Planters Lumber Co., Greenville, Miss.
- Smith, John A., Smith Sash & Door Co., Rochester, N. Y.
- Scobee, John E., John P. Scobee Lumber Co., St. Louis.
- Swain, B. F., D'Heur & Swain Lumber Co., Shelbyville, Ind.
- Smith, George L., National Hardwood Lumber Association, Indianapolis.
- Schmuhl, William P., J. S. Ford-Johnson Co., Michigan City, Ind.
- Stevens, F. J., Forest City Land & Lumber Co., Woodruff, Miss.
- Sweet, C. F., Fuller & Rice Lumber & Mfg. Co., Grand Rapids, Mich.
- Spalding, John D., Southern Oak Lumber Co., Chicago.
- Smith, F. H., F. H. Smith Co., St. Louis.
- Sullivan, J. P., J. P. Sullivan Lumber Co., Memphis.
- Stimson, H., J. V. Stimson, Huntingburg, Ind.
- Stoneman, E. C., Stoneman Lumber Co., Clarksdale, Miss.
- Schulte, E. M., Hoyt & Woodin Mfg. Co., Memphis.
- Stewart, Alcee, Alcee Stewart & Co., St. Louis.
- Swain, E. A., D'Heur & Swain Lumber Co., Seymour, Ind.
- Sullivan, F. R., Michigan Central railway, St. Louis.
- Scott, Leo E., A. M. Stevens Lumber Co., Dyersburg, Tenn.
- Schneider, Theo. A., Brunswick-Balke-Cobbender Co., Chicago.
- Soble, H. I., Soble Bros., Philadelphia, Pa.
- Smith, W. E., W. E. Smith Lumber Co., Memphis.
- Schwartz, G. W., Vandallia railroad, St. Louis.
- Shoemaker, H. O., Southern Oak Lumber Co., Memphis.
- Stark, James E., James E. Stark & Co., Memphis.
- Sondheimer, Max, E. Sondheimer Co., Memphis.
- Stimson, D. C., J. V. Stimson, Owensboro, Ky.
- Stahlman, G. W., Star Union Line, Memphis.
- Sterritt, Will S., Sterritt Lumber Co., Cincinnati.
- Scatcherd, J. N., Scatcherd & Son, Buffalo.
- Sondheimer, Rudolph, E. Sondheimer Co., Memphis.
- Scott, T. P., T. P. Scott & Co., Cincinnati.
- Stonebraker, F. E., Lansing Wheelbarrow Co., Memphis.
- Streeter, W. L., Chicago-Mississippi Land & Lumber Co., Chicago.
- Schatzman, C. H., Green Line, Penn. R. R., Cincinnati.
- Smith, A. P., Mt. Vernon Pump & Lumber Co., Mount Vernon, Ala.
- Storrs, C. L., Wisarkana Lumber Co., Nettleton, Ark.
- Stetson, C. B., C. B. Stetson Lumber Co., Memphis.
- Schlesinger, A. L., Bennett Hardwood Lumber Co., Memphis.
- Stark, William A., James E. Stark & Co., Memphis.
- Sweet, E. E., Bacon-Nolan Hardwood Co., Memphis.
- Smith, Lewis C., Traders' Dispatch, Memphis.
- Stimpston, C. F., Stimpston Land Co., Lula, Miss.
- Scott, D. A., Sunflower Lumber Co., Clarksdale, Miss.
- Smith, E. B., E. B. Smith & Co., Earle, Ark.
- Schenck, C. A., Biltmore Estate, Biltmore, N. C.
- Styman, George H., J. H. Long, Sumner, Miss.
- Tate, John F., E. C. Atkins & Co., Inc., Indianapolis.
- Talbert, W. E., Talbert Lumber Co., Cincinnati.
- Thompson, J. M., James Thompson & Co., Memphis.
- Thompson, B. R., Thompson Lumber Co., Grand Rapids.
- Terry, Edward M., N. L. E. A., Memphis.
- Thomas, Charles E., Thomas & Proetz Lumber Co., St. Louis.
- Thurman, J. R., Blanton-Thurman Lumber Co., Memphis.
- Taylor, H. F., Taylor & Crate, Buffalo.
- Teckemeyer, H. W., Teckemeyer & Wehinger Lumber Co., St. Louis.
- Tillison, Walter, National Inspector, Grand Rapids.
- Taenzer, E. E., E. E. Taenzer & Co., Inc., Memphis.
- Thurman, B. R., Blanton-Thurman Lumber Co., Memphis.
- Tausig, L. J., St. Louis.
- Thompson, J. E., Sondheimer Co., Memphis.
- Todd, Miles J., Lake Shore-Lehigh Valley Route, Cincinnati.
- Turner, John W., N. C. & St. L. Ry., Memphis.
- Thamer, George R., Empire Lumber Co., Chicago.
- Thompson, A. N., Thompson & McTure, Memphis.
- Thompson, J. W., J. W. Thompson, Lumber Co., Memphis.
- Epedgraf, P. D., Helena Hoop & Lumber Co., Helena, Ark.
- Van Keulen, N. J. G., Van Keulen & Wilkenson Lumber Co., Grand Rapids.
- Van Tros, J. E., Big Four Route, Memphis.
- Vaughn, J. S., E. Sondheimer Co., Memphis.
- Vinnedge, A. R., A. R. Vinnedge Lumber Co., Chicago.
- Victor, Warder C., Bennett & Witte, Memphis.
- Worrall, F. M., Lumber Trade Journal, New Orleans.
- Whiteside, J. R., I. M. Darnell & Sons Co., Memphis.
- Walkley, R. L., Douglass & Walkley Co., Columbus, O.
- Wilson, J. Milton, Warnell-Wilson Co., Leland, Miss.
- Wheldon, W. W., Eureka Hardwood Lumber Co., Becton, Ark.
- Williams, S. A., Williams & Voris Lumber Co., Chattanooga.
- Watrons, R. B., secretary Citizens' Business League, Milwaukee.
- Wright, Isaac, Scatcherd & Son, Memphis.
- Wilkinson, William, I. C. R. R., Chicago.
- Walsh, John, Buffalo Hardwood Lumber Co., Memphis.
- Welsh, G. H., Buffalo Hardwood Lumber Co., Buffalo.
- Wallace, W. H., N. Y. C. & St. L., Cincinnati.
- Wall, M. M., Buffalo Hardwood Lumber Co., Buffalo.
- Williams, T., Stoneman Lumber Co., Clarksdale, Miss.
- Wallace, J. W., E. Sondheimer Co., Memphis.
- Waynesburg, M. W., C. H. & D. Ry., Memphis.
- Westcott, Charles, International Harvester Co., Chicago.
- Ward, L. A., Obion, Tenn.
- Whitaker, J. D. S., Bennett Hardwood Lumber Co., Memphis.
- Wigges, R. J., R. J. Darnell, Inc., Memphis.
- Willingham, J. T., Memphis Coffin Co., Memphis.
- Wedding, J. W., C. L. Willey, Chicago.
- Wheeler, C. L., J. W. Wheeler & Co., Madison, Ark.
- Willmann, R. K., Willmann Lumber Co., Hartford City, Ind.
- Wade, G. G., Sunflower Lumber Co., Memphis.
- Wonger, A. W., I. C. R. R., Cairo, Ill.
- White, A. P., Lane-White Lumber Co., Ft. Smith, Ark.
- Woods, John M., John M. Woods & Co., Boston.
- Walsh, James H., Empire Lumber Co., Buffalo, N. Y.
- Wagner, J. W., Robert H. Jenks Lumber Co., Cleveland.
- West, A. C., Wilmington, O.
- Witmore, A. G., Southern Hardwood Lumber Co., Memphis.
- Yeager, Orson E., Buffalo.
- Young, Edward J., Brittingham & Young Co., Madison, Wis.
- Young, B., Young & Cutsinger, Evansville, Ind.
- Young, C. W., New Albany Furniture Co., New Albany, Miss.
- York, S. J., Michigan Central, Memphis.
- Yancey, H. T., Lake Shore-Lehigh Valley Route, Buffalo.
- Zupke, F. E., E. Taenzer & Co., Inc., Memphis.
- Zearing, George B., Stoneman-Zearing Lumber Co., Devall Bluff, Ark.

### New Racine Hardwood House.

The Racine Lumber & Manufacturing Company has recently been incorporated under the laws of Wisconsin to engage in a general wholesale lumber business at Racine, with a capital of \$20,000. The company's specialties are northern and southern hardwoods and agricultural implement and wagon stock. E. W. Bartley, formerly buyer for the Racine-Sattley Company, is president and treasurer, and will assume active charge of the business. The offices are at 507 Robinson building. A large and varied stock will be carried.

### The Growth of Black Walnut.

The daily newspapers and even some of the lumber press and publications devoted to forestry matters have for a long time indulged in a lot of literary "rot" concerning the marvelous rapidity of growth of black walnut. Some of these articles, a few of which have been reproduced in the HARDWOOD RECORD, allege that fortunes can be made in a very few years in growing walnut.

Alexander Lendrum, the well-known walnut expert of the American Walnut Company of Kansas City, has taken the trouble to establish the age of walnut growing in Missouri by counting the rings of growth on ten logs of every size, from twelve to thirty inches. The result of his investigation shows that the average age of black walnut trees of each diameter named is as follows:

12 inches in diameter,	37 years old
13 inches in diameter,	43 years old
14 inches in diameter,	48 years old
15 inches in diameter,	55 years old
16 inches in diameter,	63 years old
17 inches in diameter,	69 years old
18 inches in diameter,	75 years old
19 inches in diameter,	80 years old
20 inches in diameter,	86 years old
21 inches in diameter,	91 years old
22 inches in diameter,	94 years old
23 inches in diameter,	97 years old
24 inches in diameter,	101 years old
25 inches in diameter,	107 years old
26 inches in diameter,	113 years old
27 inches in diameter,	119 years old
28 inches in diameter,	129 years old
29 inches in diameter,	141 years old
30 inches in diameter,	163 years old

While this table of walnut sizes and ages will apply with a good deal of accuracy to the walnut growing in western Missouri on account of its much slower growing qualities there, in Indiana, for example, the age of corresponding sizes would be much greater. The figures and deductions made by Mr. Lendrum as supplied to the HARDWOOD RECORD are extremely interesting.

# District Meetings Hardwood Manufacturers' Ass'n.

The Hardwood Manufacturers' Association of the United States is pursuing a very energetic course in organizing the local hardwood manufacturers of various sections into subordinate associations in general harmony with the tenets of the national organization. The members of these local orders are very generally joining the parent organization.

The idea involved in these district meetings contemplates frequent gatherings of hardwood manufacturers interested in the development of a particular section, where the local conditions will be fully discussed and recommendations made to the Hardwood Manufacturers' Association of the legislative needs of the various sections. Thus far there has been a good deal of enthusiasm manifested over these meetings, and the outcome for the general good of the hardwood manufacturing trade is a foregone conclusion. Of recent date the first of these meetings was held at Memphis on March 31, as recounted in the *Hardwood Record* of April 10.

## Greenville Meeting.

At Greenville, Miss., on Wednesday, April 25, a number of hardwood manufacturers of that section of the state, pursuant to call, held a general conference on the subject of forming a Mississippi hardwood district association and becoming affiliated with the Hardwood Manufacturers' Association. The meeting was held in the beautiful little club house of the Elysian Club in that city. J. L. Strickland, vice-president and manager of the Planters' Lumber Company of Greenville, Miss., was introduced by James Boyd, and selected as chairman. The choice was logically made, as Mr. Strickland has been greatly interested in the movement to organize the hardwood manufacturers of Mississippi, and played host to the visitors to perfection. Upon assuming the chair he expressed his gratification at the large attendance, and announced that, although there were but four manufacturers of hardwood in Greenville, they had arranged to give a banquet to those present at the Cowan Hotel in the evening.

The mayor of Greenville, William Yerger, was introduced, and welcomed the guests to the beautiful little city, of which both himself and all residents are justly proud. He said that the lumber manufacturers of that section, though not pioneers, have done more to develop the resources of Washington county than any other class of citizens. He stated that the city of Greenville was not founded until 1865, although the hardwood territory surrounding it was as fine as any in the country.

Lewis Doster, secretary of the Hardwood Manufacturers' Association of the United States, was asked to address the meeting and explain the system of district meetings being held by that organization. He said that the hardwood interests of Mississippi were rapidly being developed, and it was the object of the association to organize the manufacturers for their own benefit. The sole object of the movement was to further the welfare of the manufacturers. He stated that before the Hardwood Manufacturers' Association was organized, grading rules were made by buyers, who failed to recognize the varying conditions in the several sections of the country, or changes in the state of the market. He stated that the bureau of grades is maintained at heavy expense, and its object is to protect the manufacturer and consumer and to teach the manufacturer correct and logical systems of grading, and to make grades suitable to the wants of the trade. He further stated that the association maintained inspectors either in or nearby all the large consuming markets, whose duty it is to take up all complaints regarding shipments and to reinspect and settle disputes when necessary. He detailed the system of sending inspectors directly

to the mills of manufacturers, who are either above or below grade in their inspection, to educate local inspectors on correct grading. He closed by stating that the Hardwood Manufacturers' Association membership is now about 700, comprising the largest manufacturers of hardwoods in the United States, with an annual output of approximately 2,000,000,000 feet.

Mr. Doster explained that his association



LEWIS DOSTER, SECRETARY H. M. A. OF U. S., CHICAGO

maintains a bureau of information which has collated a list of about 6,000 wholesale consumers of hardwoods, and that information is complete concerning the kinds of lumber bought and the quantity purchased each year. From this list local manufacturers can select localities where their lumber may be sold to the best advantage on the basis of freight rates. The information bureau also has a list of unde-



J. L. STRICKLAND, GREENVILLE, MISS.

sirable buyers who make unreasonable complaints. Another feature of association work noted by the secretary is the semi-monthly and monthly stock sheets, which show lumber both in long and short supply. This information assists the manufacturer in turning out stock that will balance the market. A study of these stock lists enables manufacturers to cut their logs into thicknesses that will at all times be

salable. Mr. Doster stated that it is particularly important that Mississippi be well represented in the parent organization, as undoubtedly this state will soon be the center of the hardwood production of the country.

The meeting was next addressed by R. M. Carrier, president of the Carrier Lumber & Manufacturing Company of Sardis, Miss., who stated he was an old member of the Hardwood Manufacturers' Association and that it meant dollars and cents to its members, and that the price lists issued by the association were not arbitrary ones, but represented suggestions from the members showing the current value of stock actually received by the foremost manufacturers of the association.

The meeting was further addressed by William I. Barr of the Barr-Holiday Lumber Company of Isola, Miss., who told of his experience in having unjust claims satisfactorily adjusted by association inspectors; by W. J. Cude of Cude, Miss., who also operates a mill at Kimmings, Tenn., stating that the association had been of great benefit to him; by G. L. Haley of Itta Bena, Miss., who stated that he had been in the lumber business only a short time, but had had considerable experience in being "bogged up," and would be glad to affiliate himself with any movement looking toward lessening his troubles in lumber production; by L. C. Nolan of the Bacon-Nolan Hardwood Company, Chaney, Miss., and Memphis, Tenn., speaking a good word for his experience with the work of the association; by Henry H. Gibson, editor of the *Hardwood Record*, on the general good that has been accomplished by the association movement; by F. J. Stevens of the Forest City Land & Lumber Company of Woodruff, Miss., on his lumber manufacturing experience; by J. Milton Wilson of the Darnell-Wilson Lumber Company, Greenville, Miss., making sundry inquiries concerning association work, which were answered by Secretary Doster; by George E. Watson, secretary of the Southern Cypress Manufacturers' Association, on the success attained by his organization; by B. A. Johnson of the American Lumberman, Chicago; by W. R. Anderson of the Southern Lumberman, Memphis; concluding with an address of welcome to Greenville by J. H. Leavenworth, the pioneer hardwood manufacturer of that section.

Letters were read expressing interest in the movement from Frank E. Wright, Hollandale, Miss.; Hagadorn & Louks, Columbus, Miss.; Edgar Mysterfeldt, Plains, Miss.; A. B. Learned, of R. F. Learned & Sons, Natchez, Miss.; A. M. Love, Darnell-Love Lumber Company, Leland, Miss.; R. B. Hall of Hall Bros. and Hall Cady Lumber Company, Vicksburg, Miss.; W. R. Gibbs, Funnagusha Lumber Company, Howard, Miss.; W. J. Davis, Terry Manufacturing Company, Jackson, Miss.; C. M. Stratton, D. L. Moore Land & Lumber Company, Booth, Miss.; T. A. Burford, K. E. Burford Manufacturing Company, Choctaw, Miss.

Quite a number of those present immediately authorized Secretary Doster to enroll their names as members of the Hardwood Manufacturers' Association, and a good many others promised to join at an early date. At the meeting there were present:

F. W. Lanzo, Paepcke-Leicht Lumber Company, Greenville, Miss.

John E. Spaulding, Southern Oak Lumber Company, Chicago.

A. B. Miller, Southern Oak Lumber Company, Memphis, Tenn.

L. C. Nolan, Bacon-Nolan Hardwood Company, Chaney, Miss., and Memphis, Tenn.

W. J. Cude, Cude, Miss., and Kimmings, Tenn.

R. M. Carrier, Carrier Lumber & Manufacturing Company, Sardis, Miss.

A. P. Steele, Carrier Lumber & Manufacturing Company, Sardis, Miss.



W. H. Neal, Planters' Lumber Company, Greenville, Miss.

J. L. Strickland, Planters' Lumber Company, Greenville, Miss.

F. J. Stevens, Forest City Land & Lumber Company, Woodruff, Miss.

J. Milton Wilson, Jarnell-Wilson Lumber Company, Greenville, Miss.

W. G. Ramshaw, Chicago.

Con. Werlich, Chicago-Mississippi Land & Lumber Company, Napanee, Miss.

W. S. Streeter, Chicago-Mississippi Land & Lumber Company, Napanee, Miss.

J. A. Lewis, Chicago-Mississippi Land & Lumber Company, Chicago.

George F. Riel, Paepcke-Leicht Lumber Company, Memphis.

F. B. LeCrone, W. E. Kelley & Co., Memphis.

G. L. Haley, Itta Bena, Miss.

A. S. Winford, A. G. Wineman & Son, Greenville, Miss.

J. H. Leavenworth, Greenville, Miss.

William I. Barr, Barr-Holaday Lumber Company, Isola, Miss., and Greenville, O.

Thomas Shackleton, T. N. Adair, Doddsville, Miss.

J. W. Denison, J. W. Denison & Co., Friarpoint, Miss.

Geo. E. Watson, secretary Southern Cypress Manufacturers' Association, New Orleans.

those in attendance at a reunion of Confederate veterans.

Samuel Hopper of Samuel Hopper & Sons, Baton Rouge, La., was selected as chairman of the meeting, and James Boyd of the Lumber Trade Journal secretary. Mr. Hopper said he thought that it was a matter of great importance to the hardwood manufacturers of Louisiana to get together and get acquainted, as there are many questions affecting their interests which could be discussed with profit.

F. H. Ruger of the Duluth Lumber Company of Dunn, La., thought the organization was of the greatest importance, and favored the calling of another meeting in May, the call to be signed by all represented at the meeting either in person or by letter.

Lewis Doster, secretary of the Hardwood Manufacturers' Association of the United States, addressed the meeting on the subject of the aims and achievements of his association. He stated that it was more economical for the manufacturers of the various sections to hold district meetings from time to time, and forward their requests for legislation to the Manufacturers' Association than to attend the annual meetings of the parent organization. They would thus have the full value of the big association's inspection corps, bureau of information, stock list system, trade conditions

William E. Barns, St. Louis Lumberman, St. Louis.

David M. Walker, American Hardwood Lumber Company, New Orleans.

George E. Watson, secretary Southern Cypress Manufacturers' Association, New Orleans.

H. H. Gibson, editor HARDWOOD RECORD, Chicago.

Others reporting as interested in the movement were the East Melville Lumber & Shingle Company, Melville, La.; Minden Hardwood Manufacturing Company, Minden, La.; Jefferson Sawmill Company, Ltd., New Orleans, La.; Hoshall & McDonald Brothers, Eola, La.; McDonald Brothers, MacLand, La.; International Lumber Company, Alexandria, La., and the Otis Manufacturing Company, New Orleans.

#### Bristol Meetings.

On Saturday, April 21, at Bristol, Va.-Tenn., a preliminary meeting of manufacturers of hardwoods in that vicinity was held, and an organization was established known as the Lumber Exchange of Southwestern Virginia and Eastern Tennessee. On Friday, May 4, at the rooms of the Holston Club at Bristol, an adjourned meeting was held at which were present:

W. O. Came, Bristol, Tenn.

B. B. Burns, Bristol, Tenn.

M. N. Offett, Bristol, Tenn.

G. E. Davis, Bristol, Tenn.



VISITORS ON STEPS OF ELYSIAN CLUB AT GREENVILLE MEETING. R. E. WOOD AND PARTY DRIVING IN PARK AT BILTMORE, N. C.

William Yerger, mayor of Greenville, Miss.

B. A. Johnson, American Lumberman, Chicago.

W. R. Anderson, Southern Lumberman, Memphis.

Henry H. Gibson, HARDWOOD RECORD, Chicago.

James Boyd, Lumber Trade Journal, New Orleans.

Lewis Doster, secretary Hardwood Manufacturers' Association of the United States, Chicago.

In the evening the hardwood manufacturers of Greenville entertained the visitors at dinner at the Hotel Cowan, where a very delicious banquet was served to them. The occasion was an exceedingly enjoyable one, and the Greenville lumbermen established an enviable reputation as hosts.

#### New Orleans Meeting.

A preliminary meeting of the hardwood manufacturers of Louisiana was called at the offices of the Southern Cypress Manufacturers' Association at New Orleans on Friday, April 27, but owing to the small attendance was adjourned to May 17. The reason of the paucity of attendance was apparent to all owing very largely to insufficient notice, the extreme and unseasonable heat, and the fact that New Orleans was packed to its utmost capacity by

reports, and of all the machinery of the various departments of the association.

Henry H. Gibson, editor of the HARDWOOD RECORD, addressed the meeting on the commercial value of association work.

On motion it was decided that the most favorable time to hold an adjourned meeting would be Thursday, May 17, as the annual meeting of the Cypress Association would be held on May 16, and a good many individuals would be interested in both meetings. Chairman Hopper was authorized to issue such call and to subscribe thereto the names of all hardwood manufacturers present, and others who had expressed approval of the movement.

There were present:

Samuel Hopper, Samuel Hopper & Sons, Baton Rouge, La.

G. S. Bishop, Duluth Lumber Company, Dunn, La.

F. H. Ruger, Duluth Lumber Company, Dunn, La.

J. N. Day, St. Louis Lumberman, St. Louis.

George F. Riel, Paepcke-Leicht Lumber Company, Memphis.

James Boyd, New Orleans Lumber Trade Journal, New Orleans.

Lewis Doster, secretary Hardwood Manufacturers' Association, Chicago.

G. W. Peter, Bristol, Tenn.

F. R. Bradshaw, Marion, Va.

J. C. Campbell, Marion, Va.

C. C. Lincoln, Marion, Va.

F. E. Highley, Atkins, Va.

R. H. Vansant, Asbland, Ky.

W. S. Whiting, Abingdon, Va.

H. Fugate, Abingdon, Va.

J. Van R. Gardner, Hampton, Tenn.

F. C. Fischer, Coal Grove, Ohio.

G. L. Wood, Coleville, Tenn.

Lewis Doster, Chicago.

In the absence of the president of the exchange, E. D. Galloway of the Galloway-Pease Company of Johnson City, Vice President B. B. Burns of the Tug River Lumber Company of Bristol presided. The minutes of the last meeting were read and approved.

W. O. Came, chairman of the committee on constitution and by-laws, submitted a report and a form for a constitution and by-laws which was adopted. The same committee was continued to make suggestions on any needed revision before the documents were published.

Addresses were made by R. H. Vansant, F. C. Fischer and Secretary Lewis Doster of the Hardwood Manufacturers' Association on the value of association work. An election of directors then took place, which resulted in the

selection of W. O. Came and J. C. Campbell for two years, and Mr. Archer and W. S. Whiting for one year.

Practically all present made brief addresses endorsing the idea of cooperation and outlining the benefits to be derived therefrom, and suggested matters necessary to be taken up by the Exchange at future meetings. A membership committee was appointed, composed of the officers and board of directors, to work for the enrollment of new members.

The following resolution was then adopted:

At this meeting today it is agreed that the manufacturers here are in perfect sympathy with the plan of adopting the grading rules of the Hardwood Manufacturers' Association of the United States, and have appointed a committee to present their views to the meeting of the manufacturers of hardwood at Asheville, N. C., May 5.

Be it also resolved, that G. Leidy Wood be appointed to carry and present such resolutions to the Asheville meeting. Signed by those present.

A vote of thanks was extended to the Holston Club for the use of its rooms. The meeting then adjourned.

**Asheville Meeting.**

A meeting of the hardwood manufacturers

- William Stephens, Stephens & Co., Asheville, N. C.
- F. L. Winchester, Asheville, N. C.
- William Pratt, Asheville, N. C.
- J. M. Burns, Monger Lumber Co., Asheville, N. C.
- A. Buchanan, Bone & Buchanan, Asheville, N. C.
- J. W. Buchanan, Bone & Buchanan, Asheville, N. C.
- C. A. Schenck, Biltmore, N. C.
- F. C. Fischer, Yellow Poplar Lumber Company, Coal Grove, O.
- H. W. Frye, Frye Lumber Company, Asheville, N. C.
- C. J. Harris, Whittier Lumber Company, Bryson City, N. C.
- W. H. Woodbury, Whittier Lumber Company, Bryson City, N. C.
- Harvey Berne, W. M. Ritter Lumber Company, Panther, W. Va.
- J. Mortimer, Jr., W. M. Ritter Lumber Company, Mortimer, N. C.
- G. G. Thompson, Southern Railway Company, Asheville, N. C.
- H. E. Hudson, Southern Railway Company, Asheville, N. C.
- A. K. Orr, Southern Railway Company, Asheville, N. C.

a successful end, and which resulted in this call for a larger and more representative meeting, to be composed of hardwood stumpage owners and manufacturers in the district of western North Carolina.

"It was decided that such a meeting should be held at Asheville, N. C., Saturday, May 5, 1906, at the Swannanoa Country Club.

"You will no doubt realize the necessity of not only joining such a movement, but of attending the above meeting and to take a part in the work to be considered.

"The following points have already been presented for discussion:

- "1. The Car Service Situation.
- "2. The Appalachian Park for Government Control.
- "3. The Grading and Measurement of Lumber.
- "4. The Comparative Basis of Rates and Weights of Our Product.

"There may be other subjects brought before this body, when in convention, but one of the most vital subjects to be considered is the grading of hardwood lumber. Owing to the position, and the grading rules as provided for by the buying element, it is impossible to market our products with such existing conditions.

"The manufacturers today have every oppor-



R. H. VANSANT, ASHEVILLE, N. C.



ALBERT F. HALL, ASHEVILLE, N. C.



R. E. WOOD, BALTIMORE, MD.

of western North Carolina was held at the Swannanoa Country Club, Asheville, N. C., on Saturday, May 5. There were present:

- T. J. Littleford, Littleford Lumber Company, Asheville, N. C.
- W. A. Rexford, Asheville, N. C.
- A. J. Coumbe, Coumbe & Hall, Asheville, N. C.
- W. T. Mason, W. T. Mason Lumber Company, Whittier, N. C.
- E. H. Hall, W. T. Mason Lumber Company, Whittier, N. C.
- Bert Mason, W. T. Mason Lumber Company, Whittier, N. C.
- George A. Murray, George A. Murray & Co., Asheville, N. C.
- R. H. Vansant, Vansant, Kitchen & Co., Ashland, Ky.
- J. M. English, J. M. English & Co., New York City and Asheville, N. C.
- R. E. Wood, R. E. Wood Lumber Company, Baltimore, Md.
- G. Leidy Wood, R. E. Wood Lumber Company, Asheville, N. C.
- F. C. Harley, Thresherman, Detroit, Mich.
- W. G. Chandler, Thresherman, Detroit, Mich.
- R. H. Johnson, Asheville Veneer Company, Asheville, N. C.
- D. W. DeLoss, DeLoss Lumber Company, Asheville, N. C.

- D. F. Gard, Asheville, N. C.
- J. Ford, Asheville, N. C.
- J. J. Coombes, Asheville, N. C.
- J. B. A. Bennett, Unagusta Manufacturing Company, Asheville, N. C.
- S. L. Taylor, Asheville, N. C.
- W. K. Merriek, J. M. English & Co., Asheville, N. C.
- G. N. Hutton, Hutton & Bourbonnais, Hickory, N. C.
- A. H. Winchester, Asheville, N. C.
- Lewis Doster, secretary Hardwood Manufacturers' Association, Chicago.
- James Cain, Asheville Gazette, Asheville, N. C.
- J. H. Whaley, Southern Lumberman, Nashville, Tenn.
- J. M. Schloenbach, Hardwood Record, Chicago.

W. T. Mason was appointed chairman and Lewis Doster secretary. The chairman instructed the secretary to read the call for the meeting, outlining its purposes, which was as follows:

"ASHEVILLE, N. C., April 9.

"To the Hardwood Producers of Western North Carolina.

"Gentlemen:—At an informal meeting held here, the need of an organization became plain to us to assist us in developing our interests to

tunity in their favor to head off unjust legislation, to put into effect impartial but practical rules and to make them permanent.

"Success can only come by holding a large representative meeting, and you should see that your neighbors come with you.

"Write a few letters on this line and we can effect the strongest organization possible.

"Very truly,

- "R. E. WOOD,
- "W. T. MASON,
- "C. J. HARRIS,
- "J. RANDALL WILLIAMS, JR.,
- "W. A. REXFORD,
- "E. H. HALL,
- "J. M. BURNS,
- "A. J. COUMBE,
- "A. F. HALL."

Letters and telegrams were read from various manufacturers who were unable to attend the meeting, but who expressed sympathy with the movement. Addresses were made by Messrs. Fischer and Vansant, giving terse explanations of organization work and its benefits, especially to manufacturers of lumber. A talk was also made by Lewis Doster, secretary of the Hardwood Manufacturers' Association, illustrating its methods of organization, its aims and achievements. Addresses were also made by C. J.



Harris, R. L. Wood, William Stephens, F. T. Winchester, G. N. Hutton and others, and the benefits to be derived from organization by lumber manufacturers of the Asheville district discussed.

A report of the work done at the Bristol meeting of the Lumber Exchange of Eastern Tennessee and Southwestern Virginia was made by G. Leidy Wood, after which a committee of three, consisting of R. E. Wood, J. M. Burns and Lewis Foster, was appointed to draw up a plan of organization. The meeting then adjourned for luncheon, which was tendered at the club rooms by Asheville lumbermen. The session reconvened immediately afterward, and a resolution of sympathy was extended Albert E. Hall, who was unable to be present, owing to a severe accident. Mr. Hall is vice president and general manager of the W. T. Mason Lumber Company and a partner in the firm of Cumble & Hall, and has been particularly vigilant in attempting to secure a large attendance for this meeting.

The committee on organization then presented the following report:

"Be it resolved that the Asheville Lumber Exchange be organized for the purpose of securing a full understanding of the conditions surrounding the lumber market in the territory covered by the exchange, the establishment of uniform grades for the inspection of lumber as the only legitimate basis for uniform prices, the establishment of uniform customs and usage among the lumber fraternity; to prepare and furnish members such information as will tend to protect them against unbusinesslike methods of those with whom they deal, and help to further the interests of the manufac-

turing industry in uplifting the value of the product to be prepared for the market; to provide a committee of three to prepare a constitution, such committee be composed of W. T. Mason, C. J. Harris and A. H. Winchester."

G. G. Thompson of the Southern Railway then spoke to the meeting, explaining the car situation, rates of different commodities to the consuming markets and other important matters. He stated that he would be willing to meet a committee to take up all questions vital to the members of this exchange.

Immediately thereafter the following committee was appointed to meet with Mr. Thompson for the discussion of questions as he proposed: C. A. Schenck, W. A. Rextord and W. H. Woodbury (W. T. Mason, alternate).

This committee was instructed to make a report at the next meeting of the exchange regarding its deliberations.

A resolution was also adopted to place before the executive board of the Hardwood Manufacturers' Association and its board of directors the desirability of having the next annual meeting of that association held at Asheville, owing to its advantages in the way of climate in the winter season.

A unanimous vote of thanks was extended to Mr. McCluskey and the Swannanoa Country Club for the use of their club house.

A hearty vote of thanks was also tendered to the Asheville lumbermen for their hospitality, to the visiting lumbermen for their assistance in developing the organization, and to the chair for his work in connection with the meeting.

Whereupon the meeting adjourned, to convene again at the same place, Saturday, May 26.

## Suggestions to Small Sawmill Men.

### SIXTH PAPER

The main point of a recent article in this series, in which a leaf was taken from the experience of a certain mill man, was that from the ordinary run of oak timber, even though it may not be what is classed as fine virgin growth, may be cut a short length or two of good stock from the butt of most logs that can be profitably worked into wagon and agricultural implement stock. Bearing this point in mind it appears worth while to turn for a moment to the present prospects and tendencies in the wagon manufacturing trade.

Spokes were among the articles mentioned incidentally in the paper referred to above. Going back into the history of the spoke industry, it will be found that in the early days it was very seldom that the idea of sawing out a spoke billet was entertained. The idea prevailed that there was only one way to get a straight-grained spoke, and that was to split it out. There was, however, more than one way to split them, but only one right way—to split them quartering, as shown in diagram 1 in the accompanying illustration. This plan of quartering is still adhered to in the making of spokes, no matter whether they are split bolts or sawed billets.

Through new men bringing new ideas into the industry and the growing scarcity and increasing cost of timber, the thought has gradually taken form that blanks for spokes can be sawed as well as split. A skillful man at the bolting saw can take a

spoke length block of timber and follow the grain with the saw closely enough for all practical purposes, and produce a smoother blank from less timber than is possible by splitting. It has taken time and the overcoming of prejudice, but today there is an extensive business in sawed spoke billets, which, besides wagon bolsters and other stock of that class, is made from the butt ends of oak timber that is ordinarily considered good enough only for ties, car timber and other similar stock. In fact, the smaller oak timber, especially where it is of rapid growth so that it may come within the class of second growth, demands the highest price when made into spoke bolts. Of course, there are no great lengths from any tree, but the object here is to point out that a short cut or two can be taken from the butt of most trees and made into spoke billets at a profit. Where the trees are small enough, so that the man at the bolting saw can handle the block whole it can go direct to the bolting saw. Where they are larger, they may be piled up and held until there are enough to make a little run in the mill and then put through the main saw of the mill and split into halves or quarters, as their size may suggest, for convenience in handling at the bolting saw.

By way of instructions for flitching and working stock of this kind into spoke bolts perhaps the best plan would be to quote from the specifications and instructions at-

tached to a recent order. The sizes mentioned are as follows:

1½ in. x 1¾ in. x 30 in.  
1½ in. x 1½ in. x 30 in.  
1¾ in. x 2 in. x 30 in.  
1¾ in. x 2¼ in. x 30 in.  
2¼ in. x 2½ in. x 30 in.  
2¼ in. x 2¾ in. x 30 in.  
2½ in. x 3 in. x 30 in.  
2½ in. x 3¼ in. x 30 in.  
2½ in. x 3½ in. x 30 in.

This order was for second growth white oak, free from all defects, and the following caution in the way of specifications was attached thereto:

"In reference to the above small sizes, the first three, 1¾ in., 1½ in. and 2 in.

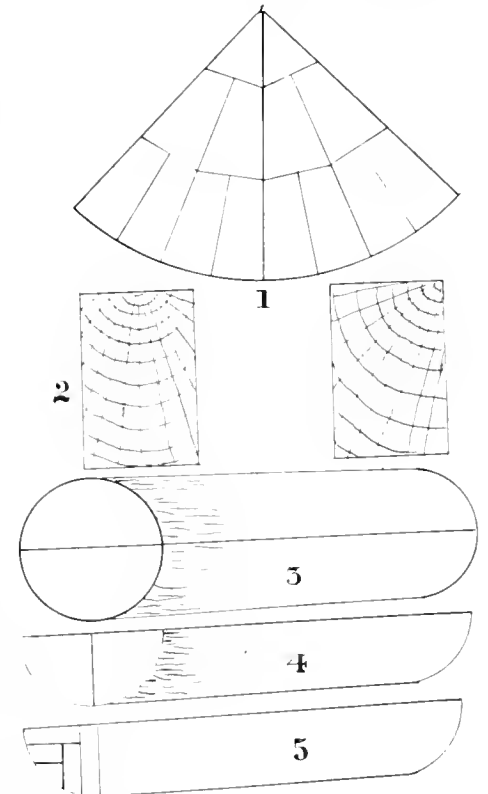

Note: Figure 1 of the above illustration demonstrates the correct way to split a quarter block into spoke bolts. The left-hand cross section of Figure 2 shows the results attained. The right-hand cross section of Figure 2 shows spoke bolts split incorrectly. Figure 3 shows the method of sawing bolts into halves. Figure 4 illustrates method of sawing halves into quarters. Figure 5 shows the correct way the quarters should be flitched. It will be seen that the block should be reversed for each cut. The flitches are then sawed on a table to get proper widths. By this method sawn flitches can be produced which will make almost every spoke straight-grained. All flitches should be cut one eighth inch full to allow for shrinkage.

billets, we want to caution and advise that these must be cut from the very choicest stock. They must be in first class especially, clear of sap, and sawed with the grain. The small spokes must always be better than the large ones. Make a very careful selection of stock cut into the remaining sizes. All to be sawed full to allow for shrinkage."

Accompanying these instructions was a diagram showing how all blocks, which should first be cut to 30 inches in length, should in the process of flitching be split in half, the halves into quarters and the

quarters into ditches, as illustrated in the accompanying cut, the block being reversed for every ditch, and then the stock taken to the table to reduce it to the proper width.

While these instructions are all right, it is not necessary to do the ditching on the big saw if the man at the bolter saw knows his business, and it will generally be found more profitable and will facilitate matters in every way to simply halve or quarter the blocks on the mill and let the man at the bolter saw do the rest.

Where there appears to be enough spoke timber available in a community where a man may gather butt cuts from his own

volves considerable expensive machinery and a crew of skilled help. It requires so much, in fact, that it is seldom advisable for a mill man to tackle a job of this kind unless he is permanently located at a good concentrating point for hardwood, which has also facilities for shipping out the finished product.

The club turned spoke, while, of course, it does not bring as much money as the finished product, is greatly in demand by the big wagon factories, which prefer to buy them this way so that when they are thoroughly dry they can be finished as may be desired and the tenons cut so they will fit the hub mortise without any reworking.

and out through this opening. The metal clamp A is secured over the opening.

The common claw garnet block is exhibited in Fig. 2. A rope passes completely around the block as shown, supporting the eye above.

The body of the long tackle style of block in Fig. 3 is composed of two sheaves carrying two ropes. Following the successful use of this design, multiple pulley blocks were introduced, made on the shoulder block fashion, and arranged to carry two or more wheels in each block, side by side. The style of sheave employed in these blocks is illustrated by Fig. 4, which is bored so as to revolve the wheel on a pin. The wheel may also be constructed as shown in Fig. 5, in which case the shaft and the wheel are in one piece. Sometimes the pin is made separately, driven into the bore of the wheel and secured. In this case the axle carrying the wheel has to revolve in the bearings of the block. More often the reverse method is used and the wheels are free on the pins and revolve without turning them.

The common type of shoulder block, which can be designed for one or more sheaves, is shown in Fig. 6. Sometimes the blocks are chambered out to receive a wheel for each of its separate compartments. In other designs, two or more wheels are placed side by side in the one section.

Fig. 7 is the form of hardwood pin usually employed in the single block for carrying one wheel. In the event that metal wheels are used, metal pins are required. Fig. 8 is the most common pattern. The pin is placed in position and either headed at both ends to hold it securely, or provided at each end with washers fastened on by means of set-screws fitted and turned into threads tapped into each end of the pin.

The machinery used in making blocks has been greatly improved in recent years, and in efficiency and capacity is now very satisfactory. The old-time block maker, who did much of the work by hand has been supplanted by machines which handle the work in much less time and with greater accuracy. The straight cutting saw cuts the stock into strips the width of the blocks. The circular cutting saw next comes into play and the lengths are cut off, bringing the blocks a little further along in the process. The reciprocating rip-saw cuts the blocks in the direction of the grain, roughly outlining the shape of the blocks. Holes are then bored as a guide for mortising the slots. The blocks are drilled and then passed on to be mortised. The slots for the wheels are neatly and quickly cut out and the blocks are ready for the sheaves.

Whether the wheels are turned from metal or hardwood, the cutting tool adjustment is an essential factor and therefore worthy of considerable attention. Suppose the wheel is to be turned from lignum vitae. After the blocks are cut to convenient form for turning, the turning lathe and the cutting tool are made ready. Fig. 9 illustrates the proper conditions under which turning

GREEN SIZES FOR TURNED WAGON SPOKES.											
LARGE POINTS.	BUTTS.				POINTS.		THROATS.			LENGTH.	
	Size of Spoke.	Distance from Butt to Measure Size.	Distance from Corners where Turning should commence. See cut above.	See distance from Butt to Measure Size.		Width of Point.	Thickness at Point.	See distance from Butt to Measure Size.			
				Width.	Thickness.			Width Front.	Width Hind.		Thickness.
2 1/2	2 1/4	3 1/2 from Butt	2 3/8	1 1/8	1 1/2	1 1/4	6 1/2	2 3/8	2 3/8	1 3/8	Front, 22 1/2 in. Hind, 27 in.
2 1/4	2 3/4	3 1/2 on corners	2 1/8	1 3/8	1 1/8	1 3/8	7	2 1/2	2 1/4	1 1/2	
2 3/8	3	3 3/4 on corners	2 1/4	1 1/4	1 7/8	1 1/2	7	2 3/8	2 1/4	1 3/8	Front, 24 in. Hind, 28 in.
2 1/2	3	3 3/4 on corners	2 1/8	1 1/4	1 1/2	1 1/2	7	2 1/2	2 1/4	1 1/2	
2 3/8	3	3 3/4 on corners	2 1/8	1 1/4	2 1/8	1 3/8	7 1/2	2 1/4	2 3/8	1 3/8	Front, 24 in. Hind, 28 in.
2 1/4	3 1/4	4 1/4 on corners	3 1/8	1 1/2	2 3/8	1 5/8	7 1/2	2 3/8	2 1/4	1 3/4	
3	3 1/2	4 1/4 on corners	3 3/8	1 1/2	2 3/4	1 3/2	8 1/2	2 3/8	2 3/4	1 1/2	Front, 24 in. Hind, 28 in.
3 1/4	4	4 1/2 on corners	3 3/8	2 1/8	2 3/2	1 3/2	8 1/2	3 1/8	3 3/8	1 3/2	
3 1/2	4	4 1/2 on corners	3 7/8	2 1/8	2 1/2	2	8 3/4	3 3/8	3 1/4	2 3/8	Hind, 28 1/2 in.

SPOKE SPECIFICATIONS OF THE KENTUCKY WAGON MANUFACTURING COMPANY

timber and from a number of neighboring mills to make it worth while, there is a chance to carry spoke making a little nearer the finished product, and make club turned spokes, which are extensively used by the larger wagon manufacturers. In the spoke business there are three branches of the trade: the spoke blanks and billets, club turned spokes—roughly cut and without tenon or finish—and the finished spoke. The finished spokes go largely into blacksmiths' shops and the smaller wagon manufacturers, and are handled extensively through the iron stores that carry blacksmiths' and wagon makers' supplies. To properly manufacture finished spokes in-

whereas if they used so-called finished spokes they would have to rework them anyway. In fact, some big wagon factories will not buy anything but club turned spokes, or spoke billets, which they turn themselves. A club turned spoke is simply a spoke bolt put into a lathe and roughly turned to form; in other words, it is a spoke billet handled through one machine. The size and specifications differ somewhat with different concerns, but a very good idea of how specifications run may be had from the list of sizes and specifications used by a wagon manufacturing concern, which operates one of the largest wagon factories in the world, reproduced in connection with this article.

## Hardwood Pulley Blocks.

The hardwood pulley block, from the great variety and large number used, should be of interest to manufacturers of hardwood articles. The very hardest of wood is selected for this purpose. Lignum vitae is a very satisfactory material for this purpose, and is commonly used. The sheave is often made of metal, and some block makers have the necessary machinery for making brass, iron, steel, and other cast metal wheels for the block. The body of the block is constructed of elm, ash, or woods of similar

character. The pin on which the sheave turns is made of either metal or wood, according to the design of the block.

Various types of blocks are required on vessels, in mines, in building, by sign painters, masons, carpenters, etc., and for an infinity of other purposes. The snatch block shown in Fig. 1 is a common and convenient pattern. The object of this form is to permit of adjusting the rope without drawing it through the block. A section is cut out as at B, and the rope may be lifted

## Manufacture of Clothes Pins.

should be done. Too great care cannot be exercised in getting the point of the cutting tool correctly adjusted. The clearance and the rake should be taken into consideration. Only the cutting edge should come in contact with the work, and yet many instances are found where the front of the tool, at the base, touches the work and interferes with the cutting. The point of the tool should be just above the center of the work as in the cut. The tangent line is from the cutting point to F and the radial from the same point to C. This gives the right angle. The angle of clearance is in front of the tool between it and the work, which in this case is liberal and gives plenty of freedom for the cutting operation. The angle of rake is along the incline of the tool on top, designated by lines D-G, and C-G. An angle of about 20 degrees on the line G-D is suitable for pulley cutting. If the tool comes too far below the center of the work, as in Fig. 10, where the cutting point is much below the center, the cutting

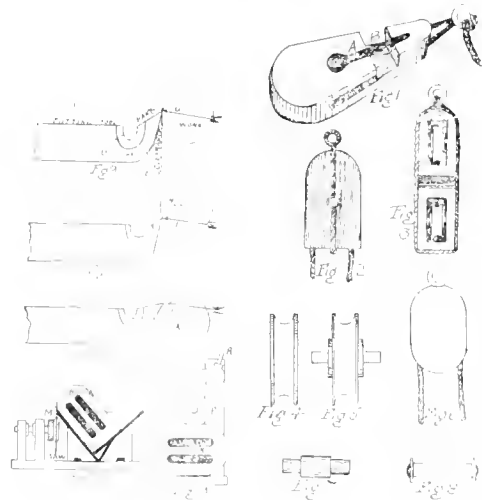

will be harsh and uneven. Too far above the center line, as in Fig. 11, with the cutting point at J and center line K, is equally disastrous.

Next the corners of the block are sawed off or turned to rounding form. Fig. 12 shows a form of corner saw set often employed. A mandrel is mounted on a frame carrying a circular saw as at M. This saw is revolved by a belt running on a pulley keyed to the saw shaft, and is operated by a hand lever which raises the saw up to the block. The blocks then pass to the shaping machine which gives the finishing touches, smoothing the surface and perfecting the shape. Then comes the scoring, Fig. 13 showing an outline of one of the machines used for this process. This operation puts in the groove for the rope. The circular plane or cutter P, is revolved by a belt running in a grooved wheel and the scoring edges are brought into contact with the block by working the lever R. The usual processes of varnishing, oiling, etc., follow the insertion of the sheaves, and the blocks are ready for the market.

While beech is the wood usually used in the manufacture of clothes-pins, a variety of stock may be used for this purpose. Some manufacturers purchase waste stock from woodworking factories, taking whatever is offered and using it indiscriminately. This is very unsatisfactory, as the greater proportion of it is wood of very inferior physics, although, of course, some is superior stock. Beech possesses certain qualities which meet the essential requirements of the clothes-pin, but it should be carefully selected and seasoned. The varying conditions of growth influence the character of the timber to a great extent. In poor rocky soil on mountain sides, the wood is white in color, hard and less elastic than that growing in the soil of the plains, where it is somewhat reddish in color, strong and resilient, and is indeed the ideal wood for pin making. Beech is often irregularly grained, which fact is a source of annoyance to manufacturers, but its close texture, strength and elasticity make up for the deficiency in this respect.

Elm, oak and walnut, though not in very large quantities, are used in the manufacture of special grades of pins, and ash, hard pine, cedar and locust are also employed. Most large manufacturers of clothes-pins carry a line of pins for exhibition, made from especially selected stock and beautifully finished. One manufacturer known to the writer displayed a show-case of artistically manufactured clothes-pins at an industrial fair recently which contained pins made from hazel, hickory, black ebony, cherry, willow and alder. Some of the pins were made from a spongy fiber, while others were as hard as flint. Artistically designed pins are now used in fastening draperies and hangings in homes, and some special pins are made in similitude of the human figure for toys for children. But the common every-day clothes-pin of the laundry is not featured in any way. It is simply cut from beech or kindred wood, and is entirely without ornamentation.

The logs are first sawed into six-foot lengths, unless special dimensions are required, when a shorter or a longer section is cut off. The six-foot piece is then sawed into boards, as shown in Fig. 1. These boards are sawed into strips of the right width which are then squared as represented in Fig. 2. Now comes the seasoning process. If the stock is rushed through at this point, the pins will warp and crack even before they are put on the market. Seasoning is done both by modern mechanical processes, and by exposure to the sun.

The next operation involves the sawing up of the strips into three to five inch lengths, according to the size of the pin. Four inches is the popular length. This gives the pieces as shown in Fig. 3, which may be turned to shape or put through additional seasoning. The high-grade pins are not worked until the

wood is thoroughly treated, but the cheaper grades are usually hastened through with little seasoning or preparing. If there is plenty of time, a second seasoning of the stock is preferable. The stages of turning the pin to shape are represented in Figs. 4 and 5. Slotting next follows, and then comes the tumbling operation in the cylindrical device exhibited in Fig. 6. The easiest way to scour and polish the pins is to put them through the tumbler. Several baskets of pins are dumped into the cylinder, which is keyed to a shaft as shown, and the shaft bears upon journals fitted to wood uprights. At the right end of the shaft is keyed a tight and a loose pulley, and a belt runs from these wheels to the wheel of the driving shaft of the mill. Hence by means of the tight and the loose pulley the belt may be shifted and the tumbler operated at will. The rubbing of the pins against each other in the speedily revolving tumbler smooths and finishes them very nicely in a few hours.

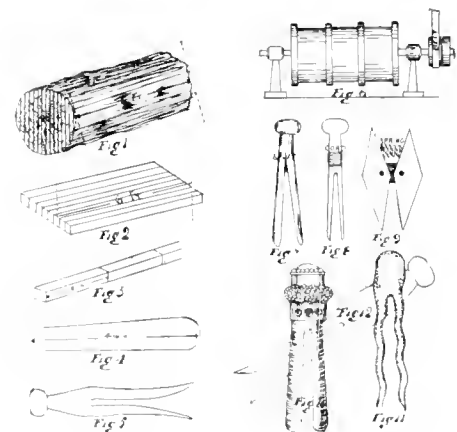

The pins as they come from the tumbler are ready for packing. The cheap pins are packed in rough boxes and sent to the markets, where they are retailed at exceedingly low prices. The better grades of pins are carefully assorted into firsts, seconds, thirds, and sometimes even fourths. The cheaper grades of pins often split when in use as shown in Fig. 7, and in some instances may be protected by winding tarred cord around them, as in Fig. 8.

In every clothes-pin factory are seen specially designed pins, made to order for special purposes, a popular design of which is exhibited in Fig. 9. In this pin the diamond-shaped pieces are expanded by a steel spring. Compressing the ends of the spring opens the opposite ends, and when the spring is released the jaws close upon the line. Figs. 10 and 11 portray some fancy pins suitable for exhibition purposes. The common pin shown in Fig. 12, however, is the real commercial article which is produced in enormous quantities and millions of which are used annually.

# In the Heart of Tennessee's Great Hardwood Belt.



UNLOADING TRACK AND MILL, JOHN B. RANSOM & CO.



VIEW IN YARD, JOHN B. RANSOM & CO.

Not so very many years ago, practically all the farms about Nashville were surrounded by rail fences of walnut or cedar logs, and not infrequently were negro cabins and sheds of various kinds constructed of these woods. The value of the magnificent hardwoods which grew in abundance on the hills of Tennessee was not appreciated, and men hacked and hewed the precious timber with reckless abandon. Then came the awakening. The markets of the world were calling for hardwoods and Nashville was one of the first to rise to the occasion.

About the close of the Civil War the hardwood industry of Nashville was fairly on its feet, although there were only a handful of sawmills in operation. The population of Tennessee's capital was at that time in the neighborhood of 25,000. As the lumber industry increased the population grew, and the two have kept pace ever since. It is true that no factor has had more to do with this growth than the development of the lumber industry. Nashville's population at this writing is about 135,000 and bids fair to reach the 200,000 mark in a few years. The business men of the city are wearing little red buttons in

their coat lapels, bearing the words "Nashville 200,000 club." And it is significant

that the lumbermen are first and foremost in this fight for population. In the early seventies Nashville's hardwood industry included probably a half dozen concerns of importance: the E & N Furniture Company, Hartwell & McClay, the Southern Pump Company, William Southerland, the Prewitt-Spurr Manufacturing Company and Goldberg & Co. were the largest. Some of these existed but a few years and long since passed into oblivion; the others have advanced with the times and are today among the great industries of the land. The hardwood interests of the city today are of great proportions and represent a diversified line of manufacture. Nashville is one of the greatest hardwood producing centers in the country. It is in the heart of the red cedar district of Tennessee, and most of the concerns there handle large quantities of this wood. The Cumberland river is an important adjunct in the carrying on of these great enterprises; it taps the splendid forests of Tennessee and Kentucky, and most of the timber is floated down in the log to the mills at Nashville. The city has splendid railroad connections, which enable it to handle the finished product to all parts of the country with dispatch.



JOHN B. RANSOM.

that the lumbermen are first and foremost in this fight for population.

In the early seventies Nashville's hard-

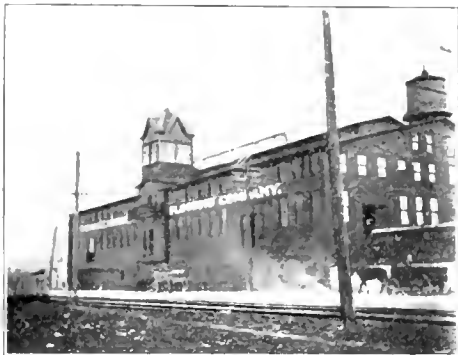

MAIN FACTORY, NASHVILLE HARDWOOD FLOORING COMPANY.

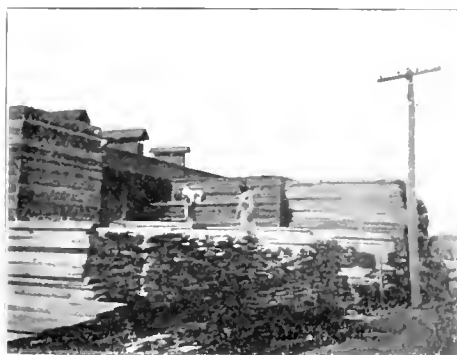

PILING HARDWOOD, NASHVILLE HARDWOOD FLOORING COMPANY



EXECUTIVE STAFF, NASHVILLE HARDWOOD FLOORING COMPANY



PANORAMIC VIEW PLANT, DAVIDSON BENEDICT COMPANY.

**John B. Ransom & Co.**

This institution, one of the largest in Nashville, was established by John B. Ransom in 1881. John B. Ransom is head of the concern and his brother, A. B. Ransom, is the other prominent factor. The Nashville plant of this concern covers about twenty-five acres of ground; the West Nashville plant about forty acres. A stock

red cedar flooring are their specialties. John B. Ransom & Co. enjoy a heavy export trade in addition to their extensive domestic business.

Besides the Nashville business the Ransom interests control a large operation at Memphis under the name of the Gayoso Lumber Company, of which John B. Ransom is president and A. B. Ransom vice president.

**Nashville Hardwood Flooring Company.**

About ten years ago the manufacture of hardwood flooring was taken up by John B.

detail and reflects great credit upon those responsible for its existence. It is provided with every device for handling the product and is supplied with band saws, surfacers, and matchers and cut-offs. The company's entire output is taken by the trade and its shipments now cover the whole of the United States, parts of Canada and various foreign ports. The company turns out enor-



W. V. DAVIDSON



OFFICE, DAVIDSON BENEDICT COMPANY.



J. W. LOVE.

of from 15,000,000 to 25,000,000 feet of well assorted hardwoods is carried at these plants continually. Three band sawmills, a modern planing mill and a box factory are operated by John B. Ransom & Co. Red cedar, yellow poplar, walnut, ash and oak are the woods manufactured, and oak flooring, red cedar telegraph poles, vineyard stakes and

Ransom & Co. Having an up-to-date planing mill this product was incorporated with their other lines, and so successful was the venture and so rapidly did trade increase that in a short time they could not supply the demand. In 1903 Mr. Ransom, seeing the great possibilities in this line, organized the Nashville Hardwood Flooring Company and erected a handsome and commodious plant, consisting of a mill, dry kiln and warehouses. This plant is complete in every

mous quantities of oak and beech flooring end matched, bored and hollow backed square edge strips, squares and wood carpet, its "Acorn Brand" standing on its merits the country over. The concern is now exploiting satin walnut as the ideal flooring for all ordinary uses.

The management of the company is in



LOG RAFT, LOVE, BOYD & CO.



SCENE IN YARD, LOVE, BOYD & CO.



LOADING CEDAR, LOVE, BOYD & CO.

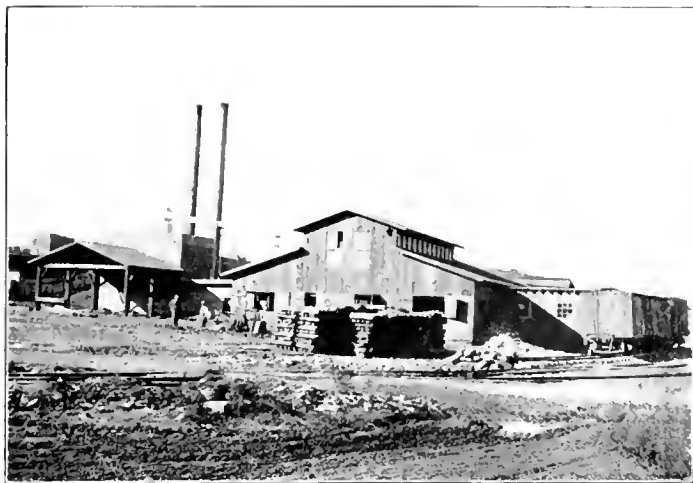

GENERAL VIEW STAVE PLANT, McLEAN LUMBER COMPANY.

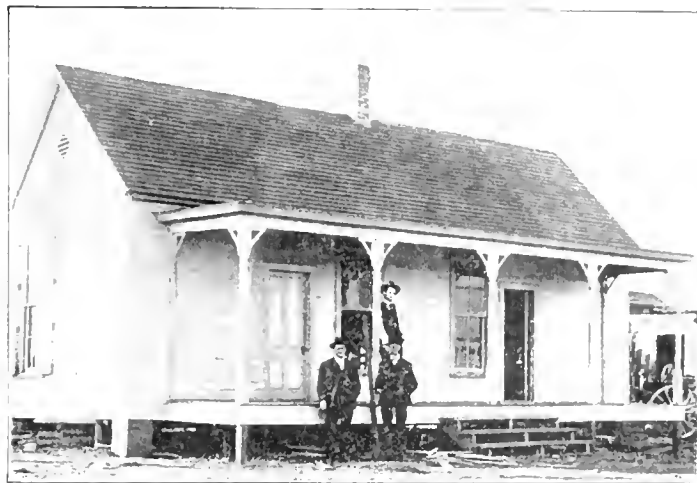

OFFICE, McLEAN LUMBER COMPANY

most competent hands: J. B. Ransom is president; A. B. Ransom, vice president; R. T. Wilson, treasurer, and D. S. Hutchinson, general manager.

**The Davidson-Benedict Company.**

This concern was organized in 1900, the firms of Benedict Brothers and the W. V. Davidson Lumber Company consolidating their interests. Two or three years previous to this time, M. F. Green had severed his connection with the Nashville Lumber Company and joined the W. V. Davidson Lumber Company. The organization continued as a firm until two years ago, when it was incorporated.

The Davidson-Benedict Company does a general manufacturing and wholesale business and its operations are distinct from many of the large concerns in this section in that it manufactures fully ninety per cent of all the lumber it handles, taking the timber from its own lands and cutting it at its own mills, thus insuring a constant supply and making the grades more nearly uniform. The business of this concern has grown steadily since its organization until at present it is one of the largest in the state.

Besides its most complete plant for the manufacture of hardwoods, the company operates a well equipped factory, turning out interior finish. It carries on a large retail business under the name of the Union Lumber Company and the Standard Furniture Company, with a large and up-to-date

plant, manufacturing high class furniture, is another of this concern's enterprises. This branch of the business has grown rapidly and employs constantly about 200 men. The advantage of having an abundant supply of lumber is a great benefit in this particular line. W. V. Davidson is president of the Davidson-Benedict Company, as well as of the various allied concerns; C. B.



TRAINLOAD OF LOGS, GENERAL LUMBER COMPANY.

Benedict is vice president, M. F. Greene, secretary, and J. N. Hicks, general manager.

**Love, Boyd & Co.**

The plant of Love, Boyd & Co. occupies a long stretch of land on the Cumberland river in South Nashville, and this represents only a small part of the company's holdings. Love, Boyd & Co. own vast tracts of valuable timber lands in Tennessee and

Kentucky, operating in all ten mills in different sections of these states. These mills cut 100,000 feet of lumber a day—poplar, red and white oak, chestnut, ash, sycamore, hickory and red cedar. The concern makes a specialty of quartered oak. The principal yards and offices are located at Scottsville, Ky., where five million feet of lumber is always carried in stock. Another five million feet is distributed among the other yards, making a total stock of ten million feet always on hand.

The firm of Love, Boyd & Co. is a sort of family organization. J. W. Love, J. W. Boyd, Hamilton Love and J. D. Read are all related. J. W. Love is general manager, J. W. Boyd is the timber man, J. D. Read the saw mill man, and Hamilton Love sales manager.

**Indiana Lumber Company.**

When, thirty years ago, F. M. Hamilton cast about for a place in which to embark in the lumber business he selected Nashville as an ideal location because of its being available to a rich growth of hardwood and conveniently situated on the Cumberland. He organized the Indiana Lumber Company in the summer of 1876, and the next year built a saw mill on the banks of the Cumberland. This was not modern in every respect, but it did good work and cut a lot of lumber every day, and when orders overstepped its limit and made a larger mill necessary Mr. Hamilton had no difficulty in selling it. A modern band mill has re-



PANORAMIC VIEW OF PLANT, LIEBERMAN, LOVELAN & O'BRIEN



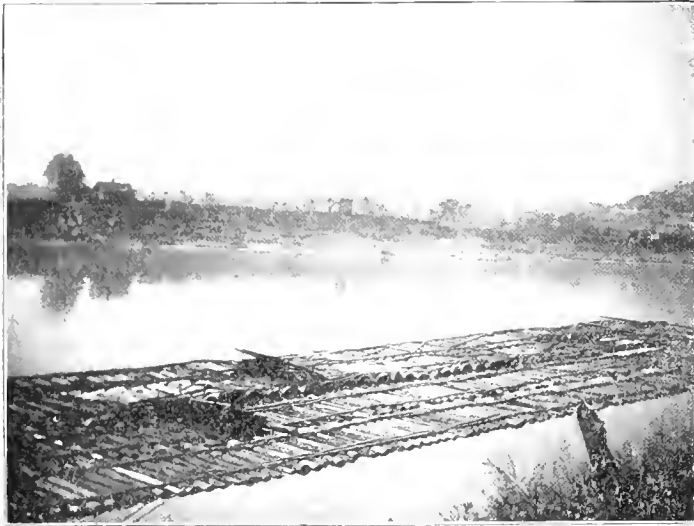

LOG RAFT, INDIANA LUMBER COMPANY.

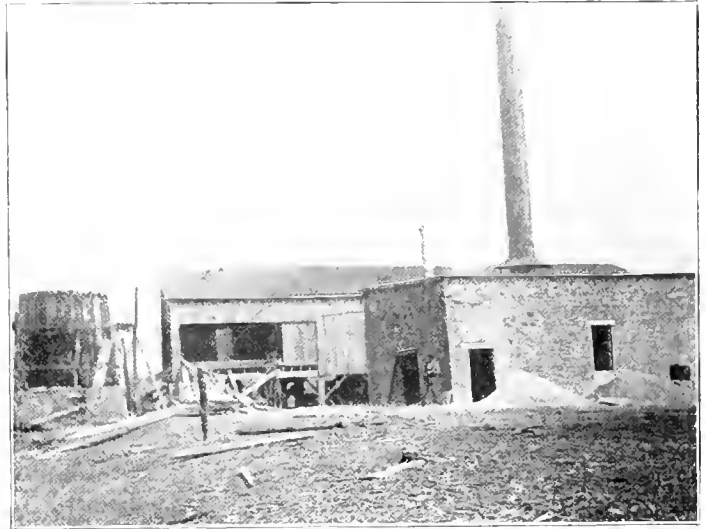

SAWMILL, INDIANA LUMBER COMPANY.

placed the old circular mill and a large planing mill has been added. Today the plant covers a large area, where a stock of approximately 4,000,000 feet of hardwood lumber is carried at all times.

The Indiana Lumber Company does an extensive wholesale business. It owns valuable timber lands in Tennessee and also contracts for large cuts. The logs are floated down the Cumberland and stored at a point about three miles above the city and then floated down to the mill as required. F. M. Hamilton is president of the company and A. L. Read is secretary and treasurer.

**Lieberman, Loveman & O'Brien.**

By standing on Reservoir Hill and looking down into the valley below a panoramic view of the great Lieberman, Loveman & O'Brien plant may be had, but a closer and more detailed study of this great hardwood operation is necessary to appreciate its enormity. The concern considers its stock meager indeed if it falls below 20,000,000 feet. In fact, it is usually kept up to 25,000,000 feet. At its Nashville plant three modern band mills and two circular mills, besides a planing mill and dry kiln, are in commission. Several circular mills are operated on the concern's holdings in the woods. The firm also operates a large

box factory and cuts considerable dimension stock.

The present organization was effected in 1878 by S. Lieberman, A. Loveman and J. H. O'Brien. Prior to that time it was known

reached the pinnacle of success. Its plant is the largest in Nashville.

**George C. Brown & Co.**

Four months ago the general offices of George C. Brown & Co. were removed from McMinnville, Tenn., to Nashville. The milling operations are still conducted at McMinnville. The dominant figure in the concern is L. E. Brown, son of the founder, George C., who has retired from active participation in the conduct of the business. The institution was organized about six years ago. It controls the output of several mills in Tennessee, and just now has also under contract a large cutting in Louisiana, and another in Alabama. George C. Brown & Co. deal in all kinds of hardwoods, principally red cedar, poplar, oak, ash, chestnut and walnut. Those who compose the concern are George C. Brown, D. D. Drake, Butler Brown and L. E. Brown.



W. H. GLEAVES.

as Lieberman & Goldberg. The concern is today as progressive and alive as any in the city in spite of the fact that it is one of the wealthiest; in fact, has almost

**McLean Lumber Company.**

The lumber interests of I. F. McLean, president of this company, are very extensive. Three separate and distinct branches, each a great institution in itself, are controlled by him and his associates—the McLean Manufacturing Company, manufacturing tight barrel circular heading; I. F. McLean, manufacturing staves of all kinds, and



PLANT, STANDARD BOX & LUMBER COMPANY.

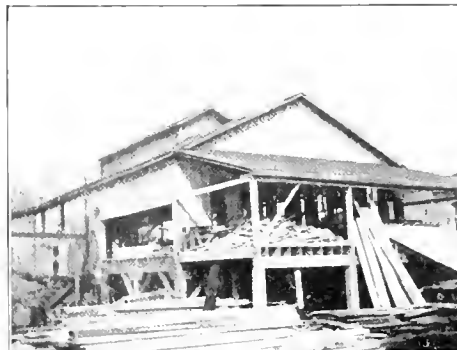

SAWMILL, STANDARD BOX & LUMBER COMPANY.



LUMBER SHEDS, STANDARD BOX & LUMBER COMPANY.

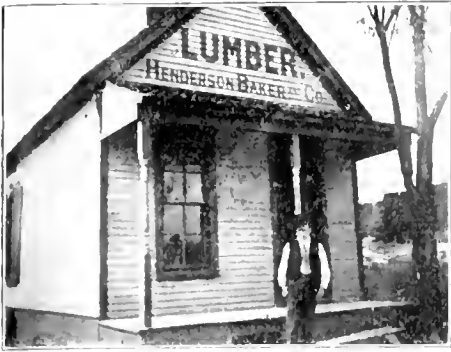

OFFICE, HENDERSON BAKER & CO

the McLean Lumber Company, manufacturer and dealer in hardwood lumber.

The heading factory is the only one of the kind in that section of Tennessee. This part of the business is conducted by I. F. McLean and W. B. Leach. Mr. McLean is probably the oldest and most widely known stave manufacturer in Tennessee.

The lumber end of the business is under the supervision of J. H. McFall, assisted by J. H. and L. D. Johnson, in charge of the milling operations. The company owns large boundaries of timber lands, also contracts for lumber. Besides the Nashville plant the company maintains branches at Welch Station, Sparta, White Bluff, Sylvia and Slayden, Tenn.

**Henderson Baker & Co.**

Henderson Baker, although young in years, is old in lumber experience. This firm, organized only five years ago, now occupies a ten-acre piece of ground at Monroe and First avenue, constantly supplied with a well assorted stock of about 2,000,000 feet of hardwoods. Red cedar, yellow poplar, walnut, oak and ash are its specialties. One band mill with a daily capacity of 30,000 feet is operated by this concern. This mill was recently damaged by fire and has been rebuilt, a modern and perfectly equipped structure. The company owns tim-

ber lands in Tennessee and operates one circular mill in the woods.

Mr. Baker has just formed a new planing mill concern, which is erecting a modern planing mill to turn out dressed stock. This organization is known as the Scheffer Lumber Company.

**Central Lumber Company.**

G. W. Gilliland, M. C. Ewing and M. E. Ferriss, composing the Central Lumber Com-



WITHIN YARD, HENDERSON BAKER & CO.

under contract in middle Tennessee and Kentucky.

**Standard Lumber & Box Company.**

W. H. Gleaves and his brother, J. A. Gleaves, enjoy the distinction of being the pioneer box men of Nashville. These two gentlemen built the first box factory in this city in 1878. Prior to that time they had been engaged in the lumber business, having organized a company for this purpose immediately after the close of the Civil War. The present company was organized two years ago with W. H. Gleaves, general manager, J. H. Wiles, Jr., president; R. H. Dudley, secretary, and J. A. Gleaves, vice president. The company has a fine plant on the river bank and operates a first-class saw mill, planing mill and carpenter shop. Prior to the organization of this company Messrs. Gleaves owned and operated the Southern Lumber Company.

**Prewitt-Spurr Manufacturing Company.**

This is one of the oldest lumber concerns in Nashville. The original company was organized by Col. William Prewitt and Major M. A. Spurr in 1866 to manufacture red cedar buckets. This wood was then very abundant and red cedar buckets very commonly used. The company was incorporated in 1872 and reincorporated in 1899. Its present officers are: George P. Thruston,



SCENE IN YARD, PREWITT-SPURR MANUFACTURING COMPANY.

pany, are manufacturers, wholesalers and retailers of rough and dressed hardwood lumber of all kinds. The present company was organized two years ago, succeeding the G. W. Gilliland Lumber Company. The concern operates a band mill and planing mills, and maintains a large yard on the banks of the Cumberland river at Nashville. The company also has large cuttings



PLANT, PREWITT-SPURR MANUFACTURING COMPANY

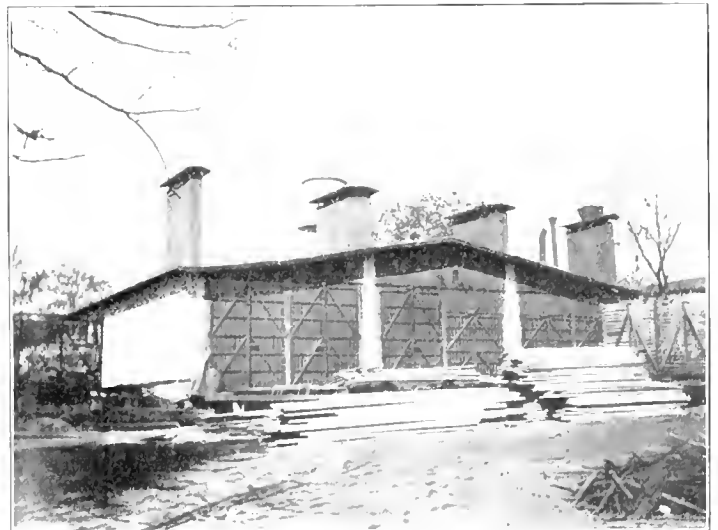

DRY KILN, PREWITT-SPURR MANUFACTURING COMPANY.

president; Robert Orr, vice president; J. H. Baskette, secretary and treasurer. Colonel Brewitt died twenty years ago; Major Sparr still retains an interest in the company.

The plant occupies about thirty acres of ground and comprises yards, saw mill, planing mill, carpenter shop and bucket factory. Poplar, oak and ash lumber, red cedar ware, ash churns, white oak well buckets and packing puns of every description constitute the diversified line of products turned out by this concern. The Brewitt-Sparr Manufacturing Company operates the only cedar bucket factory in the world.

#### Felling of a Noted Oak.

The famous big tree of Lafayette, Ind., under whose branches Gen. William Henry Harrison slept while on his way to the battle of Tippecanoe, has been cut down because the top boughs were constantly falling away, menacing life and property. The tree which is over 200 years old, stood directly in the middle of a highway which was built in 1872, and which was divided around the tree to save it on account of its history and great size. In years past a dense forest surrounded the tree, but civilization has made such inroads on the native woods that but few trees remain near it. For years the great tree was celebrated as a trysting place; hundreds of travelers have stopped to rest in its shade, and visitors have been taken to see it, as one of the points of interest about the city. It stood 115 feet high, and on its old trunk could be seen traces of high water, the Wabash flowing but a few feet from it. For years the children of Lafayette have used the big oak to denote direction. It is supposed to have marked the site of an Indian village, for many arrow heads and other weapons have been unearthed near it. It is said that Tecumseh held many a council fire beside it. Its mammoth trunk was covered with signs and posters and carving, and it is probable that the mutilation to which it was subjected was responsible for its decay.

#### Cypress Mine on the Sabine.

Here is one of the weird stories that comes from the daily press, alleged to have been related by the recruiting sergeant of a Louisiana sawmill:

"The strangest thing I know of in the business is a cypress mine in the Sabine river. Straight goods; you needn't laugh! There is an old fellow over on that stream who has a regular mine and who manages to make a very fair living out of it. I do not know how much ore he has in sight, or rather out of sight; probably he does not know fully himself, but he has been working the mine for a number of years and apparently the supply is as good as ever. He splits shingles by hand and makes about three dollars a day, year in and year out. I have been at his mint and have seen sticks of cypress of a diameter which at the

present time cannot be secured along any of the southern rivers. I have heard rumors that he had something to do with the sinking of a number of express rafts which mysteriously disappeared from the Sabine river a great many years ago, but such stories are very vague and no credit can be placed in them on account of the length of time which has elapsed."

#### Poisoning from Wood.

So strange an effect on persons has a certain rare wood, brought from the Philippines to a Cambridge, Mass., furniture factory, that twenty-six employees have been made ill by it, says the Washington Post. A special order of 15,000 feet of the wood was imported, to be made into furniture for a New York firm, to use in a handsome home in Buffalo. The workmen who had inhaled the dust, or whose hands had come in contact with the wood, were affected by a sort of asthma, and a very irritating rash broke out on the arms, or wherever perspiration had formed. The strange wood is known as tonquin, is dark in color, and resembles English oak, having nearly the same grain and beautiful figures, and sparkling like silver when placed under a strong light. Employees were so annoyed and the wood caused so much trouble generally, that the firm has refused to have any more in the factory, although when finished, nothing disagreeable can be detected in the material.

#### Mining Oaks in England.

At Yaxley, Petersborough, has been discovered what is supposed to be a buried forest. At a depth of seven feet have been found a number of oaks which have lain hidden for perhaps 2,000 years. Most of them are almost perfect in condition, and are being sold to veneer and furniture manufacturers. Eighty trees have been raised and hundreds more are still untouched. In nearly all cases, the roots are attached. The trees are in clusters of three or four, pointing in different directions, and in some instances they lie across each other. The wood is exceedingly hard, and can only be worked by machinery, as it turns the edge of an axe. William Waldorf Astor is having some of them employed in the construction of his new mansion.

#### The Oldest Tree in the World.

The dragon trees of the Canary islands are said to be among the oldest specimens of tree life in the world. The famous dragon tree of Tenerife is credited with being from 4,000 to 6,000 years old, or as ancient as are the Pyramids of Egypt. It survived intact until 1819, when a terrific hurricane broke off one of the great branches. In 1867 the remaining branches were stripped from the trunk, leaving it naked and alone. The name dragon tree is derived from a reddish exudation known as dragon's blood, supposed to have been used centuries ago in embalming the dead.

At one time this product was an important article of export from the Canaries.

#### Passing of Historic Philadelphia Tree.

Another of the famous old elms in Independence Square, Philadelphia, has been felled because of the ravages of old age. It is thought to have been one of the hundred elms brought there from New York in 1785. Death, the dry rot of age, and fierce storms have greatly reduced the number of large trees in the Square of late years. The last one to go was a magnificent specimen of its kind, being about three feet in diameter and between sixty and seventy feet high. It will require many years for the younger elms in the park, among which is the young tree planted by General Grant, to reach this great size.

#### Object to Forest Reserve.

The proposed creation of the Cabinet forest reservation, embracing about half the area of Sanders county, a large portion of Flathead county, and quite a slice of Kootenai county, is meeting with strenuous objections on the part of Idaho citizens of the districts named. It is alleged that the proposed forest reservation comes within six miles of the town of Plains, and within a mile of the town of Thompson, and it is said to contain a large quantity of good agricultural lands. Idaho citizens contend that setting apart such a large timber reservation will materially interfere with the settling and development of the country.

#### Two Big Ohio Trees.

A local paper states that a white oak tree, the largest felled in Trumbull county, Ohio, for the past fifteen years, was recently brought to the Holman timber mill at Warren, O. The trunk measured sixty-two feet in length, seven feet in diameter, and contained 7,365 feet of lumber. The farmer on whose land it grew received \$100 for the tree. It was over 1,000 years old.

The delivery of an elm log at Findlay, O., is recently recorded, which was thirteen feet in length, and scaled 1,573 feet. It grew in what remains of the old black swamp country along the Hancock-Wood county line. It was consigned to the Buckeye Stave Factory.

#### Scarcity of Brierwood.

It is said that the supply of French brier root is practically exhausted. Formerly large quantities were obtained from the Department of the Landes and from the Pyrenees mountains. The current supply of imported brier now comes largely from Scotland, but the pipes are manufactured at St. Claude in the Department of Jura, near the Swiss border. During the past few years large quantities of the burly roots of ivy, laurel and rhododendron have been harvested in the mountains of eastern Tennessee and western North Carolina and exported to France as a substitute for French brier in the manufacture of wooden pipes.

### Autographed Oaks.

Many English queens have chosen oak trees in the forest of Windsor castle on which to inscribe their names. Their choice and the dates have been commemorated by means of brass plates. In different parts of the forest, with seats surrounding the trees, are oaks bearing the names of Queen Elizabeth, Queen Caroline, Queen Charlotte and Queen Victoria. "Herne's oak," mentioned in the Merry Wives of Windsor, as being in Windsor Park, was destroyed by a gale on August 31, 1863.

### Elephant Tree.

In Bristol, Pa., is a peculiar remnant of a grand old catalpa tree—a great stump more than twenty-five feet high, which viewed from a certain position looks like an elephant standing on his hind feet. It attracts the attention of travelers from far and wide and has a history that runs back at least as far as the days when English Tories owned the ground upon which it stands. It is said to have been planted in 1793. Today it measures twenty-one and a half feet in circumference.

### The Hangman's Tree.

The little village of Aldworth, close to Streatley-on-Thames, boasts one of the largest yew trees in England, and one which has a grewsome history. It is twenty-seven feet in circumference, and depending from one of the low branches is an old rusty chain, which in olden times was used to suspend lifeless bodies of daring robbers as a warning to their kind.

### Alleged Defective Cant-hooks.

Oscar F. Holmes, administrator of the estate of John W. Brown, who came to his death by reason of a log falling on him while unloading cars for the Talge Mahogany Company of Indianapolis, on Dec. 27, 1905, has sued the company for \$10,000 damages. The allegation recites that the company did not provide good and substantial cant-hooks.

### Miscellaneous Notes.

H. P. Kidney, of Delphos, O., will soon open up a handle factory at Sycamore.

The Beebe Handle Company has been incorporated at Beebe, Ark., by O. A. H. Loy, R. J. Haley and W. R. Owens.

The Dahlonega (Georgia) Spoke & Handle Company has been organized by M. J. Williams, J. F. Moore, H. D. Gurley and W. A. Charter. Buildings will soon be erected.

Petrie & Leak is a partnership formed at Norwood, La., to manufacture and deal in lumber, logs and staves, poplar, oak, ash, hickory and yellow pine being their specialties.

The Chippewa Hardwood & Hemlock Company of Chippewa Falls, Wis., has been incorporated with a capital stock of \$150,000, by G. W. Charter, D. A. Kennedy and J. D. Kennedy.

The Danaher Hardwood Lumber Company recently closed a deal for hardwood timber near Eckerman, which will keep its mill at Dollarville, Mich., in operation for the next six years.

Work has been commenced on the big addition to the Ward & Hanson Veneer Company's plant in Bay City, Mich., which will be of brick 112x

52 feet in dimensions. It will be ready for use in July.

The Globe Wernicke Company, one of the largest manufacturers of filing cabinets, sectional bookcases and office supplies in the world, will add two stories to its great factory in Norwood, a Cincinnati suburb, and erect an additional building five stories in height.

The Bliss Cook Oak Company, Blissville, Ark., whose sawmill was destroyed by fire on April 12 will rebuild at once. The new mill will consist of a single band and a resaw. Although the sawmill was burned to the ground, the flooring plant and lumber yard were not damaged.

Schedules in bankruptcy of the W. H. Furniss Company, dealer in mahogany logs at 391 Avenue A, New York, show liabilities to the amount of \$18,112 and assets \$794, consisting of cash, \$33; accounts, \$221; claims, \$510. Most of the creditors are Liverpool concerns.

John M. Bender, Bernard Brown and George N. Torrey have incorporated with a capital stock of \$10,000 to manufacture show cases at Houston, Tex. Details of the organization have not been announced, although it is known that the new plant will be in operation within a short time.

The Palmetto Manufacturing Company is the name of a new Nashville, Tenn., handle company, which has been organized with a capital stock of \$25,000 by W. H. Cooper, John S. Woodall, Dr. H. P. Campbell, William Lowndes and others, to manufacture ax, hoe and hatchet handles.

The Ahnapee Veneer & Seating Company, Algoma, Wis., whose veneer mill at Brechwood, Wis., was recently destroyed by fire will rebuild at once. The company has already placed an order for one rotary cutter 55 inch and one

100 inch machine. In addition to the veneer equipment a small band mill will be erected.

The death of N. C. Washburn, which occurred at Monroe, La., on March 20 is announced. Mr. Washburn was a native of North Carolina, but went to Louisiana a number of years ago, and moved to Monroe in 1901, where he operated a sawmill. He was most highly esteemed by all who knew him. He is survived by a wife and five children.

The National Sewing Machine Company, is making arrangements for an addition to its factory at Belvidere, Ill., which will be operated for the making of woodwork for the company's machines. A building has been secured, and machinery will be installed immediately. It will be operated on a moderate scale at first, but will eventually employ 200 men.

The Virginia Hardwood Manufacturing Company of Albemarle, Va., is arranging for the erection of a plant at Dunn, Ky., to manufacture showcases, store fixtures, bank fixtures and various kinds of hardwood furniture. M. T. Young is in charge. Rembert & Tyler of Timpson, Tex., are installing a plant to manufacture all kinds of handles, wagon timbers, etc.

The Alexandria, La., plant of the H. E. Cady Lumber Company of Omaha, Neb., consisting of a cypress tank factory, planing mill, six acres of land with excellent railroad connections and numerous buildings and sheds, has been purchased by the International Lumber Company, manufacturers of cypress, yellow pine and hardwoods at Alexandria. The International Company will operate the planing mill, turning out its own dressed stock, and also the cypress tank factory. New and strictly up-to-date machinery will be installed and extensive improvements made in the recently acquired plant.

## Hardwood News.

(By HARDWOOD RECORD Special Correspondents.)

### Chicago.

The Record is in receipt of a note from Justin Peters, manager of the Pennsylvania Lumber Mutual Fire Insurance Company of Philadelphia, in which he says that his company is not involved in the terrible catastrophe that has come to our fellow countrymen on the Pacific coast, as the company had no insurance or reinsurance on property in California. The Pennsylvania Lumber Mutual Fire Insurance Company, after providing for all losses and expenses, has at the present time net cash assets of about \$204,000.

The firm of Hayden & Lombard, manufacturer and wholesale pine and hardwood dealer of the Railway Exchange, this city, was dissolved by mutual consent on April 26. The house is succeeded by Harvey S. Hayden, long and favorably known in connection with the hardwood trade of this city. Mr. Hayden is to be congratulated both on the success of his old firm and on the fact that he will continue in the same line of trade under the most favorable auspices.

The Record is in receipt, in handsome pamphlet form, of the report of the annual meeting of the National Wholesale Lumber Dealers' Association, which was held at Washington, March 7 and 8 last. The work is illustrated with a handsome copper plate of the majestic structure at 66 Broadway, New York City, in which are located the general offices of the association.

The Forestry Committee of the National Wholesale Lumber Dealers' Association has published in pamphlet form for general distribution, an essay on forestry as related to the future prosperity of the country and its bearing on the lumber industry, by Hon. S. B. Elliott, a member of the Forestry Commission of Pennsylvania. The Record is indebted to the committee for a copy of the interesting document.

The fourth annual meeting of the National Lumber Manufacturers' Association was held at

the Jefferson Hotel, St. Louis, May 8 and 9. It is presumed that this meeting was one of the most important that has ever been held by the association. The proceedings perforce cannot be handled in this issue of the Record, and the details thereof will be presented in the next number of this publication.

While the "puzzle picture" presented on the cartoon page of the last issue of the HARDWOOD RECORD was printed entirely as a bit of pleasantry, hundreds of subscribers have taken the matter seriously, and have flooded this office with the pictures correctly assembled. The first correct grouping to reach the editor's desk was from the F. H. Smith Company of St. Louis, Mo., to which was attached the following notation: "It takes just thirteen pieces to make Mr. Russe's picture; therefore, he will be the next president." Our book binder is at work on binding the rules in asbestos covers, as promised in our issue of April 25, and when his work is completed, it will be a pleasure to forward the twin volume to the F. H. Smith Company.

Miller Brothers, hardwood dealers, announce that they are now located in their new office at Room 208 Woughloughly building, 6 East Madison street, this city. Their yard is south of Twenty-second street, on Loomis.

F. H. Pardoe of the Fenwood Lumber Company, Wausau, Wis., was a welcome visitor at the Record office the early part of the week. Mr. Pardoe was en route to the fourth annual meeting of the National Lumber Manufacturers' Association held at St. Louis May 8 and 9, as delegate from the Wisconsin Hardwood Lumbermen's Association.

E. P. Arpin of the Arpin Hardwood Lumber Company, Grand Rapids, Wis., paid the Record office a pleasant call on May 7.

The well-known banking firm of H. C. Barrall & Co., First National Bank building, Chicago, is

out with an announcement of a new issue of \$400,000 first mortgage, 6 percent serial gold bonds of the Ozan Lumber Company, Prescott, Ariz. It is understood that a large portion has Ark. It is understood that a large portion has

The HARDWOOD RECORD was favored a few days ago with a call from Benjamin F. Cobb, editor of the Lumber Review, formerly of this city but now located at Kansas City, Mo. Mr. Cobb has fully recovered from his recent illness which incapacitated him for work for more than a month.

Sam E. Barr, the well-known hardwood wholesaler of the Flatiron building, New York, accompanied by his genial smile, was a welcome caller at the RECORD office on Tuesday. Mr. Barr was en route home from the Memphis meeting, where he distinguished himself by devoting his energies to convincing the western members of the National Association that Atlantic City was the proper place for the next convention, in which laudable effort he succeeded.

Charles Darling, formerly doing business from offices in the Merchants' Loan & Trust building, has taken over the office and yard at Centre avenue and Twenty-second street lately used by Miller Brothers. As previously stated, Miller Brothers have removed to the Willoughby building.

The Rittenhouse & Embree Company, the big hardwood flooring manufacturer of this city, is about to erect a handsome office building at its factory and yard at the corner of Thirty-fifth street and Centre avenue. The building will be 40x64 feet, two stories high with a basement, and will be built of brick and handsomely finished.

The Heath-Witbeck Company has removed its general offices from Loomis street to the Willoughby building, No. 6 Madison street. The company will still continue the yard on Loomis street, immediately opposite its old location.

J. D. Lacey & Co., the foremost timber land operators in the country, have returned from New Orleans to their summer headquarters in the Old Colony building, this city.

The HARDWOOD RECORD is indebted to the Himmelberger-Harrison Lumber Company, the big red gum operator of Morehouse, Mo., for a handsome desk paper weight embellished with the card of the company.

The Paepcke-Leicht Lumber Company has removed its general offices from the Tribune building to its new office building erected specially for that purpose at the corner of Chicago avenue and Sangamon street. The new offices are models of convenience and are most beautifully fitted up.

Upham & Agler are now nicely located in their new offices in the American Trust building. This company has recently added to its Cairo yard facilities by the purchase of the plant of George T. Houston & Co. of that city.

W. E. Kelley & Co., as previously announced in the RECORD, have removed their offices from the Chamber of Commerce to 201 Railway Exchange.

The Southern Oak Lumber Company is now nicely located in its new and enlarged quarters, Suite 910 Chamber of Commerce building, having removed thereto from the seventh floor of the same building.

The John O'Brien Land & Lumber Company has taken flight from the Chamber of Commerce to offices at its yards on Lathin street, south of Twenty-second.

The National Lumber Manufacturing Company of this city has been forced into involuntary bankruptcy. The misfortune of this company is said to have been caused by the trail of disasters that has overtaken many other concerns in whose affairs F. E. Creelman was mixed.

At a meeting of the Board of Directors of the Ward Lumber Company, held at its offices in the Chamber of Commerce building on May 8, P. Ford was elected president and L. N. DeGolyer

treasurer, to succeed Charles A. Ward, president and treasurer, deceased. As previously announced, the business of the Ward Lumber Company will be conducted on the same lines as in the past.

#### Boston.

The business of Proctor & Drummey of this city was discontinued on May 1. This firm had been in business for thirty-five years. Following the death of George Proctor several years ago his son entered the firm and continued with Mr. Drummey. Mr. Drummey died early in April.

Albert Hammett, Newport, R. I., died at his home April 24. Mr. Hammett conducted a large and successful lumber business for many years, for the past few years his son, Harry G. Hammett, being associated with him under the firm name of A. & H. G. Hammett. Mr. Hammett is survived by a widow, three sons and two daughters.

Thomas Angell Millett of Providence, R. I., died April 24. Mr. Millett had been a lumberman all his life, first in the employ of Bailey Bros. and later in partnership with Henry K. Potter, under the name of Millett & Potter. Still later he was a member of the firm of Ezra D. Fogg & Co., and also of Talbot & Co. For a few years past he has been engaged in a commission lumber business.

A license has been issued to the National Lumber Insurance Company of Buffalo, N. Y., to do business in Connecticut.

Parker & Page Company of Boston has been incorporated with a capital of \$60,000. The incorporators are Galen A. Parker, Francis E. Page and Frank W. Page.

The C. W. Leatherbee Lumber Company was visited by fire Friday evening, May 4, causing a loss estimated at about \$30,000. This company had a bad fire only a few months ago on their old wharf. The recent fire was on the new wharf and destroyed a large shed used for the storage of finished lumber. Fortunately the large lumber piles outside the shed were nearly all saved. The loss was covered by insurance.

William E. Litchfield has been in Memphis, Tenn., attending the convention of the National Hardwood Lumber Association. Before returning he will visit his mill in Indiana.

The Chappell-Ely Company of New London, Conn., has been incorporated with a capital stock of \$50,000. The incorporators are A. C. Ely, E. C. Ely, Grosvenor Ely and Arthur H. Brewer.

#### New York.

The New York lumber trade were very generous contributors to the San Francisco sufferers, and the fund of the New York Lumber Trade Association totals at this date almost \$7,000.

F. L. Gilbert of the Red Cliff Lumber Company, Duluth, Minn., arrived at this port last week after a three months' Mediterranean trip.

C. W. Manning, 66 Broadway, this city, has just returned from an extended trip to western and southern hardwood mill points. He reports conditions at manufacturing points very favorable, with manufacturers securing such prices at shipping points as to make purchases for eastern shipments impossible of profit after paying the freight.

W. K. Knox of the local office of Lucas E. Moore & Co., 11 Broadway, has just returned from a trip to the New Orleans headquarters of the company, where he has been spending several weeks in the interest of business.

Frank R. Whiting of the Whiting Manufacturing Company, Abingdon, Va., was here last week on business and stated that the two mills of the company at Abingdon and Judson are running in good shape and the company will shortly have a choice line of hardwood to market.

J. N. Woollett, manager of the hardwood department of the American Lumber & Manufacturing Company, Pittsburg, Pa., was another

New York visitor. He is optimistic over current and prospective hardwood conditions.

F. H. Loud, sales manager of the Buffalo Maple Flooring Company, Buffalo, N. Y., was here last week subsequent to the announcement issued by the company that it has been reorganized on a strong financial basis by the well-known White and Loud interests of Michigan and will make a stronger bid than ever for eastern business. The mill is conveniently located and well equipped and the company is well backed financially and expects to be an important factor in the eastern maple flooring business.

The Iroquois Door Company, manufacturer of veneer doors and general woodwork material, is about to open a sales and exhibition room in the local market under the management of B. P. Salmon. A. J. Phinney, manager of the company, has been here arranging for this new department.

M. B. Eutsler of the Clinch Valley Lumber Company, Bluefields, W. Va., was in town last week conferring with Doyle, Thomson & Co., 16 Beaver street, the company's local sales representatives. The Clinch Valley Company is erecting a fine new mill on a choice body of timber in Kentucky to be in operation within a short time, the product of which will also be distributed in this section by Doyle, Thomson & Co.

The Stevens-Eaton Company, 1 Madison avenue, has recently completed office changes which improve its equipment very materially. Each of the principals is located in a private office and an attractive reception room provides them with one of the best equipped headquarters in the district.

W. M. Ritter, the distinguished Ohio lumberman, head of the W. M. Ritter Lumber Company, Columbus, O., was in town for several days during the fortnight. In this connection it is of interest to note that Mr. Ritter's hardwood interests have recently been capitalized in the state of West Virginia under the same style with a capital of \$8,000,000, which gives an appreciation of his extensive holdings.

L. G. Banning of Cincinnati, O., has been here in connection with some export orders.

Nelson H. Walcott of the L. H. Gage Lumber Company, Providence, R. I., called upon his several customers in the local trade during the fortnight.

As an appreciation of the excellent prospects for business in the lumber trade for the ensuing year, we note that the plans for building filed for the first quarter this year in the borough of Manhattan alone represent a total cost of \$34,358,000. The corresponding quarter of last year represented only a cost of a little over \$25,000,000.

#### Philadelphia.

The Thos. Forman Company of Detroit, Mich., through Wistar, Underhill & Co., its Philadelphia representatives, has secured several desirable contracts for oak flooring in this market. The choicest flooring contract of the year, that of the capitol at Harrisburg, was recently awarded to this company. Quartered oak is to be used and about 160,000 feet required.

R. W. Wistar of Wistar, Underhill & Co. is making an extensive trip through North Carolina and Tennessee in search of stock.

I. D. Miller of I. D. Miller & Co. left for the South May 3 to help along the shipments which the firm has under contract at the mills, and to look over the lumber field in that section generally. He will not return for some weeks.

Wm. L. Patterson of the Philadelphia Hardwood Lumber Company reports a busy season for that concern. H. N. Patterson, another member of the company, is visiting the mills in Maryland, Virginia and West Virginia, and the South, buying lumber.

William B. Allen of the Colonial Lumber Company is at the company's mills at Amelia, Va. After leaving there, he will travel through Virginia and the South to secure stock.



The Cherry River Boom & Lumber Company has removed a part of its clerical force to the main office at Scranton, but still keeps a considerable establishment at its old offices in Philadelphia, which will be used as a branch sales office. C. E. Lloyd, Jr., attended the convention of the National Hardwood Lumber Association at Memphis. On his way home he will stop off at various points of the South to look up the lumber interests of his house. In his absence F. A. Kirby is sitting on the lid.

Owen M. Bruner has increased his sales force by the addition of B. I. Patterson of Westville, N. J., formerly of the Coles & Son Company. The new salesman is well known among the local trade and is a son of Z. Patterson of the firm of Z. Patterson & Sons, lumber merchants at Westville. The Owen M. Bruner Company has lately received fifteen carloads of thick ash and is in the market to buy still further. It is handling more hardwood now than for some time.

Visitors to the trade during the last fortnight included J. R. Whiteside of I. M. Darnell & Sons Co., Memphis, Tenn.; L. M. White, president Henderson-White Mfg. Co., Coburn, Va., who was on his way to the Pacific Coast; E. D. Flynn of the Scotch Lumber Co., Fulton, Ala.; H. Fugate of H. Fugate & Co., Richmond, Va.; E. A. Beckley of Crosby & Beckley, New Haven, Conn.; and Arthur C. Woods, president Mutual Lumber Co. of New York.

Three hundred men went on strike May 1 at the factory of Geo. W. Smith & Co., manufacturers of artistic furniture at Thirty-ninth street and Powelton avenue. During the past month the union demanded that the firm should adopt a scale of wages and an eight-hour day. The company has been paying from thirty-five to forty cents an hour, according to the worth of the man, and refused to fix the scale of wages according to the union's demands.

The Pennsylvania Lumbermen's Mutual Fire Insurance Company has been besieged with inquiries regarding the effect of the recent catastrophe in San Francisco had on it, and Manager Justin Peters has announced that the corporation has sustained no loss whatever.

R. W. Schofield of Schofield Bros. returned recently from their mills in West Virginia, where he superintended the filling of orders. The concern has just contracted for the output of a mill in Pennsylvania and of several mills in Virginia, taking all their output of poplar and red and white oak. The firm reports that April was the busiest month in its history.

The Philadelphia Veneer & Lumber Company is installing a new 12-foot dryer and new veneer saws in its mill at Knoxville, Tenn. These improvements will double the capacity of the plant and necessitate the taking on of new hands. The company has already secured the services of several high-grade men, and expects to obtain in a short time the full complement needed.

Henry B. Sheip & Co. have installed a new boiler in their sawmill and otherwise increased the facilities of their plant. The business of this company is rapidly increasing and it has made its distributing yard on north Fifth street one of the best stocked in the city.

The engagement of J. Wistar Evans, vice president of the Philadelphia Veneer & Lumber Co., to Miss Elizabeth Barlow of Boston, Mass., has been announced, and the marriage will take place in June. Mr. Evans is located at Knoxville, Tenn., where he is superintending the mills of the company, and, after the marriage, will make his home in that city.

The threatened strike of the carpenters was averted on May 1 by the master carpenters, who advanced the wages of the men to forty-five cents an hour. The plasterers, who demanded an increase of \$1 a day, entered into an agreement to work until July 1 and in the meantime to hold conferences with the employers regarding an advance in wages. The settlement of the labor question dispels the fear that the building boom would be checked. The building

operations of the month just closed exceed those of April of last year by \$2,180,750.

On April 23 a special meeting of the Lumbermen's Exchange of Philadelphia was called for the purpose of joining in the work of relieving the San Francisco sufferers. A committee was appointed to raise contributions, consisting of J. C. Gillingham, chairman; W. L. Rice and E. B. Malone. Funds were solicited at the meeting, and \$875 was raised. Circular letters were afterwards sent to the trade and \$4,165 was collected and turned over to Drexel & Co. by the Exchange. Besides this respectable sum, over \$2,500 was contributed to other relief organizations by the lumbermen of this city.

On April 24 the directors and newly elected officers of the Lumbermen's Exchange met for organization. Herbert P. Robinson was elected a director to fill the vacancy caused by the election of William L. Rice to the office of the vice president. John Lank was unanimously reelected secretary. The courteous and affable manner of Mr. Lank deserves special mention, as do his thoroughness and competency for his work. His reelection gave satisfaction to the entire association. At this meeting the Board of Arbitrators was also elected by the directors, and the committee on credit system was appointed by the president.

On Thursday, May 3, occurred the first regular meeting of the Exchange since the annual election took place. The standing committees on Finance, Membership, Railroads and Transportation, Legislation, Office and Entertainment, By-laws and Rules, and Protection to Trade were appointed. It was also resolved that "owing to numerous changes having been made in the inspection of lumber in the past few years that the rules of inspection of lumber adopted by this Exchange, July, 1899, are hereby repealed."

E. B. Nettleton, formerly of Philadelphia but now of Marysville, Fla., where he is superintendent of the mills of the West Florida Hardwood Company, is in town conferring with Horace G. Hazard & Co., sales agents for his firm, and visiting the trade generally. The West Florida Hardwood Company has recently started in business and controls extensive timber lands in Calhoun and Liberty counties, Fla., lying along the Apalachicola creek, and consisting of red gum, cottonwood, ash, hickory and oak. A band mill and circular mill are now in operation and the company contemplates further construction of mills as soon as possible.

#### Baltimore.

The lumbermen of this city have done nobly in contributing to the relief of the San Francisco sufferers. The Lumber Exchange took up the matter, appointing a special committee to see all the members and solicit subscriptions. This committee consisted of Theodore Mottu, Edward P. Gill, John T. Galvin, Ridgeway Marryman, George F. Sloan, George Poehmann and L. H. Gwaltney. About \$1,600 was raised. To this sum must be added the amounts previously contributed, which bring the total considerably above \$2,000.

The Dry Fork railroad, running from Hendricks on the Western Maryland railroad to Horton, and then down into the Pocomontas country, has been completely tied up this week, many of the bridges having been washed away by a cloud burst which flooded the valley drained by the Dry Fork river. The road, which is owned by the Whitmer lumber interests of Philadelphia, also operates a passenger service, and druggers were held up all along the line, some of them having to take long drives in carriages over the mountains in order to get out of the region.

George Spindler, furniture manufacturer at 608 and 610 West Pratt street, will erect a four-story warehouse in the rear of the factory. On the completion of this building the present structure will be used as a warehouse and the new one as the factory.

W. L. Rowe & Co., hardwood dealers, have

removed from the southeast corner of President street and Canton avenue to the corresponding corner of Canton and East Falls avenues, where Mr. Rowe recently purchased a yard. The place is being extensively renovated and improved. The old location has been added to the plant of the Philippe A. Broadbent Mantel Company.

R. E. Wood, president of the R. E. Wood Lumber Company, Continental Trust building, returned last Monday from a trip to the company's property in North Carolina, where he looked after business and piloted a pleasure party. Yesterday he left again, this time for Tennessee and other places to look after business matters. The company is developing timber tracts in Tennessee and North Carolina, and also has holdings at other points. In Swain county, North Carolina, much of the preliminary work yet remains to be done, and constant supervision is needed.

Norris S. Tremaine, president of the National Lumber Insurance Company, was in town the early part of this week and called on a number of lumber firms on business connected with insurance.

R. S. Reynolds, a son of Major A. D. Reynolds of Bristol, Va., has organized a furniture manufacturing company with a capital of \$50,000, and the company will establish a plant at Bristol. Mr. Reynolds has associated with him practical furniture manufacturers from North Carolina.

#### Pittsburg.

An important development in lumber affairs in Pittsburg is the formation of the Fort Pitt Lumber Company, under a Delaware charter, with an authorized capital of \$500,000, which plans to operate a modern hardwood mill in South Carolina, having a capacity of 100,000 feet a day. The properties secured are 20,000 acres of timber on the Great Pee Dee river, estimated to contain 150,000,000 feet of cypress, 100,000,000 feet of pine and 100,000,000 feet of elm, oak, ash, hickory and gum. The project is unusual for it is based on a royalty payment for all timber cut. This avoids payment of interest and taxes. J. W. K. Snider, president of the Avalon bank, is president of the company, and the directors are: J. O. Johnston, A. H. King, W. S. Mathews and J. W. Fowler. The lumber cut can be shipped to the eastern market at a low cost, while the Atlantic Coast line railroad offers direct routes for the Central West markets and to Pittsburg. The logging will be done entirely by water and thus avoid the cost of building a logging railroad and will give the lowest freight rates. Considerable of the capital stock has been subscribed by Pittsburg men, and the general offices will be located in the People's bank building.

The relief committee for the San Francisco sufferers had no trouble in touching the purse strings of Pittsburg lumbermen. They were among the first givers and total amount contributed, \$1,786.40, shows their interest in the ruined city on the Pacific coast.

Forest fires have commenced the work of destruction near Du Bois, in Ballton, Elk county, where there are extensive lumber interests. A force of 700 men are engaged in fighting them. At Rathmel the flames threatened to destroy much property and they were gotten under control only after a hard fight. Fires burned at numerous points along the railroads near Du Bois.

The Paine Lumber Company, Ltd. under its new manager, J. W. Anderson, is making rapid strides in the door trade in this vicinity. In addition to the line of birch veneered doors which the company placed here with the Breitjeser Lumber Company on the south side two years ago, it is now introducing oak veneered doors, which are proving very popular. The birch doors are in four varieties, the red, white, unselected, and unselected stained mahogany. The firm is now making a specialty of six-crossed paneled doors of unselected birch and



of red birch festooned doors for front entrances.

The Nicola Lumber Company regards the hardwood market as in first-class shape. George W. Nicola, president of the company, which took over the business of the old Nicola Brothers Company, announces that they are receiving excellent reports from their salesmen on the road and that prices have every appearance of remaining stiff all summer.

The Bentah Lumber Company is a new wholesale concern which will deal largely in spruce and hardwoods. It is located in the Ferguson building and its manager is W. E. Powynall, who was formerly in the lumber business in Homestead, Pa. The company is said to be strongly backed financially.

Plint, Erving & Stoner are getting along nicely with the subsidiary operation in northwestern Pennsylvania, where they are cutting a fine lot of hardwood. Mr. Stoner reports trade steady in all lines.

The Babcock Lumber Company has its big office force working hard to keep business well lined up. E. V. Babcock is a bull on the lumber situation and sees no reason for fearing a decline in prices. Reports from all the company's mills and outside connections indicate short stocks and a very self-reliant spirit among the mill owners.

J. L. T. Penney of J. E. Melvain & Co. was down at New Martinsville, W. Va., a few days last week to size up hardwood conditions. His firm is doing a fine business in oak timbers and piling and could handle nearly double the amount of dry stock if it were obtainable.

The Buckeye Lumber Company, which was organized recently by H. C. Hoffman, H. O. Burdette and C. L. Wickersham, is now located in a fine suite of offices at 712 House building. The company has bought a small tract of very fine oak timber on the B. & O. railroad in Washington county and will put in a portable mill at once to cut it off.

The Cheat River Lumber Company reports that lumber is being offered a little more freely and that shipments in general are easier to make. The company is buying all the chestnut it can get, its market for that wood in Chicago and Indiana, as well as the eastern cities, is strictly O. K. The company is just beginning to cut off a tract of 700 acres of hardwood at Blackstone, Va., on the Norfolk & Western railroad. It has put in two portable mills, which have a capacity of 30,000 feet a day. Its various plants are now turning out five and six cars of lumber a day, most of which is hardwood.

The W. M. Gillespie Company is a new wholesale lumber firm incorporated by William M. Gillespie, a well known lumberman, Albert J. Loeffler and John R. Shanghnessy. The company will handle all kinds of lumber and will make a specialty of hardwoods.

I. F. Balsley, hardwood manager of the Willson Brothers Lumber Company, looks upon the hardwood outlook as very bright in the Pittsburgh territory. The company is having less trouble in getting stocks shipped than a few weeks ago and finds that many customers who were then afraid to buy are now buying freely.

The American Lumber & Manufacturing Company has an order for 50,000 railroad ties, to be delivered in Ohio. J. N. Woollett, manager of the hardwood department, has gone down to Tennessee to look up new stocks of hardwoods, and he has recently put a new man in the Tennessee field regularly for the same purpose.

The C. P. Coughly Lumber Company says that since there are at least 100 miles of street car lines to be built around Pittsburgh this summer, it expects a big market for ties. The company has lately bought a nice tract of oak timber in Washington county, on the Pennsylvania R. R.

#### Buffalo.

T. Sullivan & Co. are a trifle anxious over the possibility of Pacific coast lumber going higher on account of the San Francisco dis-

aster, but have no notice of an advance yet. They have a large stock of fir and spruce.

Scateherd & Son are turning out oak lumber in good quantity at their Memphis mills, but find the demand greater than the supply, either as producers or jobbers, which means a better price if it also means harder work.

In his trip to North Carolina F. W. Vetter hopes to get hold of some good lots of chestnut still in that direction. He will not give up the Seneca street yard yet, as he still finds use for it.

O. E. Yeager finds a better movement of maple, with stocks running low, due to the fact that it is now used so much for ash. He is getting a good lot of birch and oak by lake this season.

G. Elias & Bro. will soon be adding to their stock of southern pine lumber and timber from seaboard way by canal. They are covering the South very thoroughly for lumber of all sorts and are keeping stocks up well.

J. F. Knox is still spending a great part of his time looking up oak and other hardwood lumber for Peyer, Knox & Co. at various points south, and he keeps the home yard well filled with it right along.

The Buffalo Hardwood Lumber Company has had some delay at the Arkansas mill all spring from high water, but business has gone on notwithstanding. The home yard has sold a big lot of all sorts of hardwood this year, oak leading.

A. Miller is showing that the worst is over with elm and basswood, for he is getting in new supplies of them right along now, besides running strong on other hardwoods.

The Hugh McLean Lumber Company is still one of the big leaders in the quartered oak trade, selling so much of it that even with its numerous mills it is not always able to keep stocks complete in all sizes and grades.

Oak is gaining on cherry in the list of specialties with E. N. Stewart & Bro., especially as H. A. Stewart, when he goes into West Virginia after cherry, finds oak of very fine quality, also some poplar and chestnut.

The Standard Hardwood Lumber Company still runs a badly overcrowded yard, on account of the amount of oak that comes up from its mills in Tennessee and Kentucky. The company recently acquired a tract of timber land in Kentucky, on which will be erected a band mill this summer.

Arthur W. Kreinheder, vicegerent of the western district of New York, expects to hold a concatenation at Buffalo, N. Y., Wednesday, June 21. On the day following he has arranged a river trip down the Niagara river and around Grand Island, stopping at several pleasure points. This will be Vicegerent Kreinheder's first concatenation and he expects every member of the order in good standing in his district to be present at this meeting, and he will accept no excuse from resident members.

#### Detroit.

The Dennis & Smith Lumber Company has been receiving a large amount of poplar and oak, and its yard is heavily stocked.

The season of navigation is now in full swing, and while the bulk of stock being received at this port is building woods, a few cargoes of hardwood are coming in. Brownlee & Company received this week by barge 536,000 feet of basswood, from 1 inch to 2 inches in thickness. They still have another half million feet of the same stock to come down. They have taken a large suite of offices on the third floor in the Telegraph building, corner of Griswold and Congress streets.

#### Saginaw.

Bliss & Van Auker are hustling their plant day and night and will have stock enough to run nights until fall. Their flooring plant is also crowded and the firm readily disposes of its product. Flooring is in much better demand than it was a year ago at this time.

W. D. Young & Co. are running as usual day and night and report a satisfactory business in hardwood lumber and in flooring. They are stocking the Flood sawmill at Bay City also. They have operated a number of camps during the winter and the logs are coming down the Mackinaw division by rail.

The steamer Tecumseh came in here during the week and loaded 89,000 cubic feet of hardwood timber for McArthur Brothers. It goes to Quebec.

The Salling, Hanson people of Grayling are about closing a deal for the purchase of the sawmill plant of the Gale Lumber Company at West Branch, seventy miles north of Bay City. The Gale company has nearly finished operations there. A crew of experts from Bay City is raising about 700,000 feet of sunken logs at the mill pond which will be converted into lumber and then the company will be through. If the mill goes into the hands of the parties named it will be operated cutting hardwood five years, the logs being taken to the mill from Roseomon and Crawford counties by rail.

Salling, Hanson & Co. are among the heaviest hardwood operators in the state. They operate a mill at Johannesburg, thirty miles from Grayling, two mills at Grayling and stock a big flooring plant at Grayling operated under the name of the Kerry-Hanson Flooring Company, and also stock the Thomas Forman flooring plant at Detroit, shipping about 12,000,000 feet of maple lumber there annually.

The Ottawa Hardwood Company started its mill at Tawas last week and will cut out a number of million feet of maple and other hardwood stock.

The Michigan Central is to extend the Haakwood branch six miles, and three other logging branches about twelve miles in all, to reach hardwood logs, mostly belonging to the Kneeland, Buell & Bigelow concerns.

Frank Inell went to Virginia last Friday to look over a large body of timber.

Holmes & Nicholson of Alpena lost a skidway of 90,000 feet of hardwood logs in Montmorency by fire last week. Thus far this season there has been very little destruction of timber by reason of forest fires.

The H. M. Loud's Sons Company of An Sable shipped a full cargo of maple to Tonawanda last week. The company is running its mills steadily and gets three trains of logs from its camps every twenty-four hours.

Last fall the Rodgers-Alison sawmill at Logan was purchased by Yuill Brothers of Vanderbilt. C. O. Rodgers has recently purchased a mill in the upper peninsula and has begun operating the same, cutting hardwood mostly.

A. P. Bradley and Charles Lindell of Millersburg have moved a hardwood mill over to Long Lake, north Wisconsin, and will engage in the manufacture of lumber as soon as the mill can be set up.

#### Grand Rapids.

A bill of complaint has been filed with the local district attorney against the American School Furniture Company, under the federal antitrust laws, and the case will be investigated at the present term of the grand jury in Chicago. It is charged that the company is a trust, pure and simple, operating factories in this city, Buffalo, Piqua, O., Manitowoc and Racine, Wis., and bound by agreements with other school furniture concerns, the purpose being to create a monopoly for its products and stifle competition. Eugene Carpenter, a local attorney, is complainant. The Grand Rapids branch of the American School Furniture Company is one of the largest factories in the city.

The Ranney Refrigerator Company of Greenville, Mich., is having 800,000 feet of elm logs cut on lands north of St. Louis, in Gratiot county, Mich.

The St. Johns Table Company of Cadillac, which is now operating its new factory, elected the following board of directors at its annual

meeting held recently: Fred A. Diggins, E. J. Haynes, S. H. Kramer, F. J. Cobbs, T. C. Beach, G. M. Petrie, Henry Knowlton, D. B. Kelly and A. H. Webber. It was reported at this meeting that orders ahead amounted to more than \$30,000, and business prospects are very bright. The company will show a line in this market in June and July.

The Excelsior Wrapper Company of Sheloygan, Wis., is beginning work on its new factory in this city. The site of five and a half acres is located at the intersection of Hall street and Godfrey avenue. It is expected that the local plant will consume 7,000 cords annually of three foot basswood and poplar bolts, running from 2 to 10 inches in diameter.

John H. Bonnell of the Hackley-Phelps Bonnell Company has returned from San Francisco, where he was stopping with a sister on Van Ness avenue when the earthquake occurred. He says that there are signs up all over the ruins reading, "Stop talking and get busy," and this was the slogan of the people. He came east with Dr. Hartland Law, owner of the Fremont hotel and the Monadnock building, who was worth \$8,000,000 before the fire and now has only the real estate left. Dr. Law's mission east is to raise funds for immediately restoring his buildings.

The power-house of the Brunswick-Balke Colender Company at Muskegon is practically completed, and work on the three other buildings is being pushed.

Fire destroyed the sawmill, which was operated in connection with the furniture manufacturing plant of Spencer & Barnes at Benton Harbor. It is doubtful if the mill will be replaced, since timber has grown scarce in that section. The ratio of native woods to foreign used by the Spencer-Barnes people is one to twenty.

S. A. Wellman & Co. have replaced their burned handle factory at South Boardman with a two-story building, with granite roof and steel sides, equipped with new machines, and the manufacture of broom handles has been resumed. Bolts are being cut at the Springfield camp and hauled to the mill.

The desk and table manufacturers are already beginning to feel the influence of the San Francisco calamity. A Los Angeles furniture man was in the city last week, coming here from Kentucky chair factories where he placed large orders. Some of the large Frisco homes have written the trade here that they will be doing business again within thirty days.

The Grand Rapids Hand Screw Company, of which Walter C. Winchester is president, has purchased a site for a new factory in the south end, near the Macey plant. This is one of the most prosperous concerns in the city, using large quantities of maple and other hardwoods.

The American School Furniture Company, of which the Grand Rapids School Furniture Company is a part, has been reorganized and is now known as the American Seating Company, with \$4,000,000 capital. The old company was capitalized at \$10,000,000.

The Turtle Lake Lumber Company of this city has increased its capital from \$150,000 to \$300,000, the additional stock being taken by the old stockholders. The company owns 17,000 acres of hardwood, pine and hemlock lands in Vilas county, Wisconsin. A railroad has been built into the tract and active manufacturing operations will begin this year. W. S. Winegar of the Winegar Furniture Company is president of the company, Henry Idema is vice president, and Walter C. Winchester is secretary and treasurer. John J. Foster and Charles W. Johnson of Greenville, J. R. Wylie, Fred C. Miller, F. B. Winegar and George A. Rumsey of this city are stockholders.

**Milwaukee.**

George J. Landeck of the Page & Landeck Lumber Company is just home from Memphis, where he attended the convention of the Na-

tional Hardwood Lumber Association. He assisted R. B. Watrous of the Citizens' Business League in trying to secure the next convention for Milwaukee, but failed. Mr. Landeck's many friends are glad to know that he was elected a director and a member of the executive board of the big association.

On indictments charging conspiracy to defraud the government by means of alleged land frauds in the state of Oregon, Leander Choate, James Matt Bray, Benjamin Doughty, James Doughty and Thomas Daly of Oshkosh, and August Anderson and Joseph Black of Shewana were arrested and placed under \$2,000 bonds each. They will be given a preliminary hearing Friday, May 11. It is charged that these men, who are prominently identified as officers and stockholders with the Bray & Choate Lumber Company of Oshkosh furnished money to Oregon parties to make entries and buy homesteads in that state in 1900-1903. The defendants protest their innocence, and declare they never owned any land within a radius of forty miles of that described in the indictment. In their land transactions they have dealt through third parties, and their friends believe that they have been made the victims of Oregon land sharks.

**Asheville.**

R. E. Wood, president of the R. E. Wood Lumber Company of Baltimore, Md., was in this section recently in company with a party of friends. They arrived here Saturday afternoon, April 21, spending Saturday and Sunday at the Battery Park Hotel, then proceeding to Lake Toxaway in the Sapphire country for a week's stay of pleasure and business combined. Mr. Wood's company owns in that section 125,000 acres of timber land. The company is represented in Asheville by G. L. Wood, brother of R. E. Wood. The party was composed of R. E. Wood, Miss Allie Wood, Mr. Wood's sister; A. P. Perley of Williamsport, Pa., president of the West Branch National Bank of that city; P. B. Shaw, president of the street railway and electric light company of Williamsport, and daughter; H. S. Mosser, a prominent manufacturer and tanner of Williamsport, and daughter; A. T. Page, president of the Williamsport Furniture Company and also interested in the Wood enterprises, and wife; O. E. Hershey of Baltimore, attorney for and interested in the Wood enterprises, and wife; W. L. Taylor, general counsel for the Wood interests; G. L. Wood and wife, who have recently removed to this city, and Henry H. Gibson, editor of the *Harwood Record* of Chicago.

E. C. Fischer of Tryon, N. C., was here a few days ago on his way home from New York. Mr. Fischer is president of the Yellow Poplar Lumber Company of Coal Grove, O.

The lumbermen in Asheville and western North Carolina are experiencing some inconvenience on account of car shortage. They say that the Southern railway claims that it has a sufficient supply of cars, but that it is short of engines and that delays are due to this fact.

A number of North Carolina hardwood men met here Saturday afternoon, May 5, to discuss plans for organizing the trade into local organizations subordinate to the Hardwood Manufacturers' Association of the United States. There were forty-six hardwood men in attendance, all having interests in this section of the country. A number of short interesting talks were made on the purpose of these district meetings and the value of membership in the Hardwood Manufacturers' Association. It was decided to establish an association here to be known as the Asheville Lumber Exchange, and a meeting was called for May 26 when permanent organization will be effected and officers elected.

**Bristol, Va.-Tenn.**

At Knoxville, Tenn., in the parlors of Hotel Imperial, on Friday morning, April 27, Ellis Hale Wilkinson, a prominent young lumberman, son of J. A. Wilkinson of this city, with whom he

is associated in business, was married to Miss Virginia Jones, one of the most beautiful and accomplished young women in this section. The couple had eloped from a german which was danced at the Elks' home on Shelby street, Thursday evening, April 26. Mr. Wilkinson and Miss Jones had been engaged for some time, but for reasons best known to themselves decided to elope to Knoxville. The decision was reached only a very short time before the departure of the train for Knoxville, which pulled out with Mr. Wilkinson and his bride to be aboard. They reached Knoxville early the next morning and were married at 4:30. After a bridal tour of two weeks Mr. and Mrs. Wilkinson will be at home in Bristol.

H. W. Nealy, of the Rumbarger Lumber Company of Philadelphia, is in Bristol looking over the company's operations here. This company owns three mills in western North Carolina and a 24,000-acre tract of timber land, and is shipping a large amount of stock out of this section.

The McMillan Lumber Company of Pittsburgh, Pa., has moved its offices from Wilson to Baynard, W. Va., where it has extensive lumber operations.

The lumbermen and business people generally through this section have responded liberally to the call for aid to the thousands on the Pacific coast bereft of home and property by the terrible earthquake, and a considerable amount of money has been sent from Bristol by Mayor W. L. Rice to the mayor of San Francisco, to be used in furnishing food for the homeless.

R. S. Reynolds, son of Maj. A. D. Reynolds, the latter one of the wealthiest men in this section, is heading a company which will manufacture furniture and establish a large furniture factory in Bristol. Mr. Reynolds and associates have their plans outlined, and will at once secure a charter for the company.

The large plant of the Ordway Manufacturing Company, in South Bristol, erected by the Ordway interests of South Framingham, Mass., in 1902, at a cost of over \$100,000, has been sold at public auction to Homer E. Jones, president of the Dominion National Bank of Bristol for \$17,500. The purchase was made by Mr. Jones in behalf of himself, the Dominion National Bank and other bondholders of the defunct Ordway Manufacturing Company, which is being wound up. A pro rata distribution of the assets of the company will be made in a short time by Trustees St. John and Anderson. The judgment creditors will secure priority over the other creditors and bondholders. The purchasers expect to start the plant within a short time. It is one of the best equipped chair factories in Tennessee, and has a large daily capacity. E. L. Webster of Chicago now has charge of the plant.

A big extra-plant, using bark in large quantities, will be started in Carter County, Tennessee, near Elizabethton, within a few months. The site has already been purchased, and it is said work will soon begin on the new operation.

The Coretta Lumber Company, which is allied with the Virginia Pocahontas Coal Company, and one of the operations of the George L. Carter syndicate of Bristol, has over 15,000,000 feet of sawn oak, poplar and other stock on its yards at Coretta, McDowell county, W. Va. George L. Carter purchased a large tract of mineral land in McDowell county some time ago and decided to manufacture the timber thereon. He established a band mill and a circular mill, and began cutting the stock. Not a stick has been sold since the mill was started. The Kingsport Lumber Company is being organized by Mr. Carter's syndicate and will arrange to put the stock on the market and act as sales agent for the Coretta Lumber Company. The latter company will continue to operate the mills. Mr. Carter's syndicate has a vast amount of virgin timber forests in West Virginia, Kentucky, Virginia, Tennessee, North Carolina and South Carolina.

J. W. Diefenderfer, of J. W. Diefenderfer Company of Philadelphia, and president of the

Laurel River Lumber Company of Damascus, about twenty miles from Bristol, was recently in this section, inspecting the latter company's plant and mills at Damascus. The Laurel River Lumber Company is installing three large new band mills at its mill at Damascus.

Jerome H. Shelp of Shelp & Vandegrift of Philadelphia was recently in this section looking over numerous operations, ostensibly with a view of investing in lumber and veneering operations.

The Tidewater Lumber Company, operating at Glamorgan and Dewey, Va., near Pomod's Gap, has just installed six large band mills. The company has just completed a logging road, which has been christened the Indian Creek & Pound River Railway, and shipments are now going over same. The company will locate three other mills at once in the Cumberland Mountains, and the railroad will be further extended.

H. O. Spanger and associates are about to begin cutting timber on their timber lands purchased in Lee county, Virginia, near Jonesville, some time ago, and have established three portable mills. It is estimated the land will 25,000,000 feet of timber.

The Hugh McLean Lumber Company of Buffalo, N. Y., has representatives in this section of Virginia and in western Kentucky with a view to investing in lumber manufacturing enterprises.

The railroad struggle in North Carolina is apparently settled and the Southern has either temporarily or permanently abandoned work on the extension which was started with a view of paralleling George L. Carter's railroad, which is being built from Ohio to the South Atlantic seaboard and known as the South & Western. The work on Carter's road is progressing rapidly and thousands of laborers are at work on it. This road will open up a large area of virgin forests which will produce some of the finest hardwoods in the country. The land has been purchased almost entirely by the George L. Carter syndicate.

Judge T. H. Harvey of Huntingdon, W. Va., has purchased a valuable tract of timber land near the Kentucky-Virginia boundary which he will develop.

Vicegerent D. E. Matthews of Charleston, W. Va., and Vicegerent T. W. Fugate of Richlands, Va., will hold a joint concatenation at Bluefields, W. Va., May 11. They have an excellent class of initiates in sight, and will undoubtedly have a most successful and enjoyable meeting.

#### Cincinnati.

Cincinnati's delegates to the convention of the National Hardwood Lumber Association at Memphis have returned and settled down to business. They have no kick coming at the way they were treated in general, but all were disappointed over T. J. Moffett's defeat for the presidency. Delegates from a number of eastern cities returned with the local party.

R. E. McCracken of the Kentucky Lumber Company is ill at his home with typhoid fever. His condition is not regarded as serious.

The Cincinnati Lumbermen's Club gave \$100 to the fund being collected in this city for the sufferers from the San Francisco earthquake. Nearly every hardwood firm contributed through the Chamber of Commerce or Business Men's Club.

According to the compilations of the Chamber of Commerce statisticians the movement of lumber during April was as follows: Receipts, 6,875 cars; shipments, 5,398 cars. In April, 1905, the receipts amounted to 6,261 cars, while shipments were 5,036 cars.

The Maley, Thompson & Moffett Company is adding new machinery to its mammoth plant at Eighth street and McLean avenue. Several new buildings are also in course of construction.

The H. Leet Company has been incorporated with \$45,000 capital by Horace Leet, E. M. Frank and others. They will conduct a general hardwood business at Portsmouth.

The Cincinnati Cooperage Company, which has a number of stave mills in Tennessee, has begun operating them again, after eight months' idleness.

Building Inspector Tooker reported that 406 permits for improvements, estimated at \$1,006,020, were issued last month. For the same period last year there were 372 permits, valued at \$1,004,285.

J. P. Hanna, of the Wiborg & Hanna Company, is home from a flying trip to New York.

B. F. Dulweber, of John Dulweber & Co., is in Louisiana on business.

Two Cincinnatians, James and Thos. Gassler, who believe there will be a great opportunity to make money in the lumber business in San Francisco, left for that city the early part of the month to engage in business. Both have had experience with local firms.

Leland G. Banning and a number of friends left last week for a trip to Europe. They will be gone about four months and will take a look at Mt. Vesuvius while abroad.

S. Tutill, of the Cypress Lumber Company, has recovered from a severe attack of pneumonia.

Harry J. Freiberg, of the Freiberg Lumber Company, Poplar street and McLean avenue, is in Mexico, buying mahogany logs. He will not return until next month.

The W. E. Talbert Lumber Company, with main office at Greensburg, Ind., and mills at Morris, Ind., is erecting a band sawmill at Winton Place, a Cincinnati suburb. The company hopes to have the mill in operation in about three weeks, and expects to do an extensive business in hardwood and poplar.

#### Chattanooga.

A number of Chattanooga lumbermen attended the annual meeting of the National Hardwood Lumber Association in Memphis, May 3 and 4. In speaking of the meeting M. M. Erb, vice-president of the Case Lumber Company, said: "Memphis lumbermen proved themselves most hospitable hosts, and the manner in which they entertained the visiting lumbermen cannot be too highly complimented. The excursion given on the Mississippi river was a thoroughly enjoyable occasion."

J. C. Morrison of Menlo, Ga., who bought an interest in the planing mill establishment of C. C. Arnold at East End some time ago has sold his interest to Brown Bros. of Sequachee City, Tenn.

The Zack Taylor Lumber Company, which recently purchased the buildings, etc., of the Chattanooga Boat Oar Company, which abandoned its business here, has installed a new system of blow pipes in its large lumber plant. James Long, a lumberman of wide experience, has become foreman for the Zack Taylor Lumber Company.

Robert Morrison of the Consumers' Lumber Company and the Acme Kitchen Furniture Company has returned from a two weeks' vacation, which was spent at St. Simon's Island, Ga. Mr. Morrison always takes his vacation early in the spring.

Hugh McLean of Buffalo, N. Y., president of the Hugh McLean Lumber Company, recently inspected the branch plant in this city.

J. D. Case of Rushville, Ind., leading stockholder in the Case Lumber Company of this city, arrived here Saturday.

James Buckley of Brookville, Ind., was a visitor here recently.

Ferd Brenner of the Ferd Brenner Lumber Company is in Norfolk, Va.

#### St. Louis.

The plant of the St. Louis Basket & Box Company was badly damaged by fire April 29. The loss, as stated by the company, is \$1,000 on building and \$2,000 on stock and machinery.

The Hafner Manufacturing Company has opened up a sample room to display its various

designs of planing mill work, sash, doors and blinds and fancy mantels. It is located at First and Dock streets.

The Garetson-Greaser Lumber Company has erected a new box factory at Fisk, Mo., to manufacture box shooks. The company reports business very active, with all the orders it can handle with stocks as low as they are at present.

The Ozark Cooperage Company reports business very good, but finds some trouble in getting out orders on account of the bad weather at its southern mills.

One of the prominent visitors of the past fortnight was W. H. Sill of the Minneapolis Lumber Company, Minneapolis, Minn. He was booking orders for car material.

The Chas. F. Liebbe Hardwood Lumber Company has plenty of logs on hand and is cutting a great deal of oak, ash and cottonwood. This concern reports a brisk demand extending to practically all hardwoods.

The annual convention of the National Lumber Manufacturers' Association will be held in St. Louis, May 8 and 9, at the Jefferson Hotel.

A meeting of the Lumberman's Exchange of St. Louis was held on Saturday afternoon, April 21, for the purpose of raising money for the relief of San Francisco sufferers. A committee composed of E. H. Warner, C. E. Thomas and John F. Scofield was appointed to solicit subscriptions. The total subscriptions thus far received amount to \$1,350.

F. C. Moore, president of the F. C. Moore Lumber Company, left Tuesday evening on an extended trip through Arkansas and Louisiana, looking after their interests in that section of the country.

The R. N. Collins Vehicle Woodwork Company is now occupying the Huttig Sash & Door Company's plant.

The St. Louis Car Company has increased its capital stock from \$2,000,000 to \$2,500,000. It is erecting a new plant up in Baden, the extreme northern section of St. Louis, for the specific purpose of manufacturing steel cars and auto-

#### Nashville.

Local lumbermen have been visited by quite a number of out of town lumber dealers during the past week. J. W. Smith, of the Smith Sash & Door Company of Rochester, N. Y., spent several days in this section. He bought a large amount of chestnut, probably close to 300,000 feet, and he paid from \$30 to \$40 a thousand. Ralph E. Sumner, manager of Hamilton H. Salmon & Co. of New York, spent several days in Nashville recently, visiting the trade and conferring with his local representative, John J. Miller. Oscar Gartner, an exporter from New Orleans, was a recent visitor. He was here meeting the dealers and looking into trade conditions.

John E. Ransom of John B. Ransom & Co. has gone to St. Louis to attend the convention of the National Lumber Manufacturers' Association. The Hardwood Manufacturers' Association is affiliated with this organization, and Mr. Ransom went as the delegate of that body.

J. W. Warren, general manager of the Edgefield & Nashville Manufacturing Company, has returned from a visit to a mill owned by his company at Crawford, Tenn.

Arthur B. Ransom of John B. Ransom & Co. leaves shortly for an extended visit to the East.

A charter has been granted to the Cumberland Plateau Coal & Timber Land Company, with a capital stock of \$350,000. The incorporators are: William Cooper, of Cumberland county; Joseph Huffaker of Louisville, Ky.; J. E. Jones of Monterey, Tenn.; L. D. Smith of Knoxville; and J. T. Odum of Lebanon, Tenn. The company owns about 75,000 acres of undeveloped timber and ore lands in Cumberland, Fentress and Morgan counties. Several big sawmills are to be installed at an early date to prepare the timber for market.

The Russell Manufacturing Company has been organized at Nashville with a capital stock of \$10,000. The incorporators are: R. S. Russell,

G. C. Porter, Frank P. Bond, R. D. Goodlett, and C. A. Russell. The company will manufacture wooden pins of locust to be used on the arms of telephone and telegraph poles, and will be located at Nolensville, Tenn., a short distance from Nashville.

The Cincinnati Coeprage Company, which has a number of plants in the state, will begin the operation of a new one at Waynesboro, Tenn., this week. A large tract of timber adjacent to the mill has recently been purchased, and there is enough of the wood to run the plant for some time.

An institution in West Nashville that was using considerable hardwood in making handles, the Dixie Lawn Mower Manufactory, has been destroyed by fire. The entire plant was burned, entailing a loss of several thousand dollars, with but little insurance. The origin of the fire is unknown.

The DeFord Buggy Company has recently been reorganized, and will greatly increase its present capital stock of \$30,000. The incorporators are: R. A. Coleman, Eugene Shannon, J. M. DeFord, J. A. Neihans, and M. P. Martin. New officers are to be announced in the near future, and well-known Cincinnati capitalists are said to have taken some stock in the concern. The plant will be moved to a site near the railroad and a big factory will be built to be ready for occupancy by January 1, 1907.

T. P. Ayres, a well-known Nashville lumber dealer, has returned from a several months' trip in Alabama. During his absence he negotiated several big timber deals in that state. Mr. Ayres reports great activity in southern timber lands. He says practically all the good timbered tracts, however, have passed into the hands of men who either contemplate immediate operation or who are strong enough financially to hold them indefinitely for a further advance.

A special from Harriman announces that the Little Lumber Company, composed of Kentucky capitalists, has bought about 4,000 acres of timber lands on the Southern Railway near Goline, and will at once begin to develop it. If the railroads grant satisfactory rates on rough logs, sawmills and finishing plants will be erected.

The Sullivan-Blanks Lumber Company of Shelby county has been granted a charter. The capital stock is \$25,000 and the incorporators are: J. P. Sullivan, H. B. Blanks, A. H. Murray, C. M. Collier, and J. H. Phillips. The Trenton Lumber Company of Gibson county is another concern to which a charter has recently been granted. The capital stock is \$10,000 and the incorporators are: W. T. Ingram, T. Harlan, Mack Morris, D. Weiss, and Paul Harlan.

R. P. Tucker and R. L. Montague of Charleston, S. C., have secured options on about 15,000 acres of timber land near Spencer, Tenn. The property will be developed in the near future.

The Tellico River Lumber Company near Madisonville, Tenn., is running a new line of railroad through a 30,000 acre timber tract extending from Tellico Plains to the North Carolina line. The company is building a big sawmill on the Plains.

### Memphis.

The ninth annual convention of the National Hardwood Lumber Association has passed into history. It was a magnificent occasion, and thoroughly enjoyed by every delegate in attendance, as well as by the local contingent, which, under the name of the Lumbermen's Club of Memphis, gracefully performed the role of host. Memphis lumbermen made a strong fight for the convention, pledging their utmost to make the occasion both a pleasant and profitable one, and the universal comment is that the Lumbermen's Club of Memphis has done far more than it promised. Everything went off splendidly and Memphis has, in the opinion of many of the delegates, set a new standard for the

entertainment of the delegates who will gather at Atlantic City next year. Aside from the pleasures of the occasion, Memphis made only one fight and that was for the presidency and this bore fruit.

Gustave A. Farber, who has been for some years connected with Price & Heald, Baltimore, and who has been here for that firm for the past year, has withdrawn and gone into business on his own account. His headquarters are for the present at the office of the J. W. Dickson Lumber Company in East End. It is understood that he will devote his time largely to the export trade, making a specialty of southern hardwoods most wanted.

The Southern Oak Lumber Company, a branch of a Chicago firm with S. S. Ford in charge, is establishing yards in extreme North Memphis on a tract of about five and one-half acres. It has secured option on other land in the same section and can enlarge its facilities on short notice.

The Southern Seating & Cabinet Company of Jackson, Tenn., has changed hands, and the new owners have secured an amended charter providing for an increase from \$35,000 to \$100,000 in capital stock. It is their intention to enlarge their facilities. The company is engaged in the manufacture of school desks and other hardwood specialties. A new directory has been formed and the following officers chosen: Thomas Polk, president; J. H. Duke, vice-president; F. L. Ingersoll, general manager, and N. S. White, secretary-treasurer.

Application has been filed for a charter for the Sullivan-Blanks Lumber Company, capitalized at \$25,000, and formed for the purpose of establishing a hardwood sawmill, planing mill and general lumber plant in Memphis, and probably another in Mississippi. J. P. Sullivan, formerly connected with J. P. Sullivan & Co., is the principal spirit in the enterprise and will give his entire time thereto. A. H. Murray is attorney for the company and one of the incorporators. Offices are in the Tennessee Trust Building.

The Illinois Central is actively engaged in constructing its new road from Corinth, Miss., in the direction of Birmingham, Ala., and officials of the system say that trains will be running between the two points within eight months. The road, traversing northeastern Mississippi and northwestern Alabama, will offer splendid facilities for the development of the timber resources of that section where there are large quantities of hardwoods to be found.

The Meridian & Tombigbee River Railway Company has made application for a charter for the purpose of building a line from Meridian, Miss., to the Tombigbee River in Choctaw county, Ala., thus making connection through this stream with Mobile, Ala. This road will form an important link in the railroad facilities of eastern Mississippi and western Alabama.

Weather conditions have been more favorable in the Memphis district during the past month and good progress has been made in getting out both timber and lumber. There have been heavy rains within the past few days and these may cause a temporary setback, but production has been on a relatively larger scale than for some time. Several of the large Memphis mills have had trouble getting logs, and have had to run on partial time on this account, but most local plants are pretty fully engaged.

The Interstate Coeprage Company has bought from the Hurricane Iron & Mining Company 13,500 acres of timber lands near Dickson, Tenn., for \$85,000, and will enlarge its plant at that point to facilitate development.

Local lumbermen have made a liberal response to the appeals for help for the sufferers from the San Francisco disaster. The total amount contributed by local lumbermen will exceed \$1,200.

George C. Ehemann of Bennett & Witte reports a good demand for hardwood lumber and states that business conditions are in the main satisfactory.

Russe & Burgess have had some trouble in the operation of their big hardwood mill in North Memphis owing to inability to bring out an adequate supply of timber, but they are now putting a switch into their timber lands, and hope to be able to run without further interruption on this score.

### Louisville.

The Stotz Lumber Company has done a large volume of business in maple flooring this spring. The revival in the demand for No. 1 common poplar has cleaned up all the company's stock that is dry and ready to ship, and there are still many orders ahead. Business with this concern is very satisfactory in all lines.

Kirwan Brothers have received a bunch of exceptionally fine logs from Floyd county on Johns creek, a tributary of the Big Sandy. There are 300 in the lot, averaging 32 inches in diameter, none under 20 inches and many 40 inches and over. Martin Kirwan says that poplar logs this year cost millmen about 40 per cent more on even grades than last year. Oak logs are also higher, so much so, in fact, that Kirwan Brothers have not bought much oak this spring, the first drive consisting mostly of poplar.

Mark Monday is preparing to move a veneer mill which he owns down on Green river to Louisville. He secured the site some time ago, and as soon as he can get materials and erect buildings will set up the mill here. It is his intention at first to cut quarter-sawn oak veneer exclusively. He will put in a band saw for flitching logs and operate veneer saws for working them up. Later he may add a rotary machine.

The Berry-Davis Saw Mill Company of this city bought quite a tract of stumpage on the L. & N. recently, and is now well fixed for a summer log supply. Mr. Davis says business is good, and while country roads are still muddy they are improving right along and hauling can be done with more satisfaction than a month ago.

Ed Shippen of the Louisville Point Lumber Company is bringing a lot of walnut logs down the Kentucky river. Just exactly how many there are and how large is not known, but it is said that it is the finest bunch of walnut ever brought to this market. The drive at this writing is somewhere near Frankfort.

### Ashland, Ky.

R. H. Vansant of Vansant, Kitchen & Co. is in Bristol, Tenn., attending a big lumbermen's meeting. He will also look in upon the interstate convention of the Good Roads Association.

George Clark and J. A. Salmon have gone to Peebles, O., to inspect the timber on the old Peebles estate, a tract of 7,500 acres, more than half of which is virgin growth.

The sawmill department of the Yellow Poplar Lumber Company at Coal Grove, O., is closed for repairs, after a run of several months.

O. D. Garred, of Huntington, W. Va., has about completed the work at his camp on the Clear Fork of Coal river, where he has contracted to cut timber on a 9,000-acre tract. The timber is the finest virgin oak and poplar, and there is probably four years' cutting.

The Chesapeake & Ohio railroad will probably build a new planing mill at Huntington, W. Va., this summer, its present one not being large enough. The proposed mill will be 300x81 feet in dimensions. It will be fitted with the latest improved electrical machinery.

Proceedings were held here last week in the case of the Cranor-Smith Lumber Company against the Winton Lumber Company of More-

head, Ky., which was forced into bankruptcy several months ago. The Cranor-Smith Company holds the largest claim, \$22,000, and will probably gain possession of all of the Winton Company's holdings.

### Minneapolis.

F. M. Bartelme, who for some years has represented Upham & Agler of Chicago, has located in Minneapolis and opened an office on his own account. He will do a wholesale business in hardwood lumber, with headquarters at 430 Andrus building. Mr. Bartelme has made frequent visits to Minneapolis and is well known to the trade in the Northwest.

O. O. Agler of Upham & Agler was up from Chicago a few days ago, getting a line on conditions in the Northwest.

E. Payson Smith of the Payson Smith Lumber Company is out on a short trip to Mississippi river towns. A. S. Bliss of the same company reports an excellent demand for hardwoods. Birch uppers are being sold for finish in remote sections, paying as high as a forty cent rate from Wisconsin, and cull birch is meeting with an active demand. Oak is scarce and the southern mills are so flooded that it is hard to get any shipments through. From all accounts the stocks of dry oak in the south are light, as the winter has been unfavorable for logging.

## Hardwood Market.

(By HARDWOOD RECORD Exclusive Market Reporters.)

### Chicago.

There are no startling features to report in market conditions during the last two weeks. While new sales are not crowding dealers there is an insistent demand from buyers to have old orders filled. Oak and poplar are the strongest items in southern woods and there seems to be an increased call for birch, maple and basswood. The local situation is entirely healthy and a good season's business may be safely predicted.

### Boston.

Hardwoods have continued to show strength during the past two weeks. Furniture manufacturers are busy. A representative of one of the leading eastern desk concerns stated recently that his company had orders enough on hand to keep its plant busy well into the fall. Manufacturers of interior finish are all busy, and new business is coming in freely. Fair stocks of hardwoods are found in the local yards in most instances. Dealers state that advices from mill centers show that dry lumber of almost every kind is in small offering.

Plain oak is very firmly held and offerings are not large. Quartered oak is moving much better than it did, and higher prices are being paid. Brown ash moves in a fair way and prices are strongly maintained. White ash is also very firm. Maple flooring is in good demand, many buyers have fair stocks now and prices tend upwards. Native chestnut is in small offering.

The high prices demanded for cypress have checked the demand to a large extent. White-wood sells fairly well. Many are buying this to be used as a substitute for cypress.

The export demand has ruled rather quiet of late. Exporters do not look for a material increase, as foreign buyers consider prices here too high.

### New York.

Conditions in the local hardwood market are very satisfactory. The demand is brisk for a majority of the list, the only weak items being low-grade poplar and maple. The prospects for a very satisfactory trade throughout the year, with good prices, are generally bright. Reports from producing points indicate that the better grades in all the principal hardwoods are going to be limited this year and will consequently be

C. F. Osborne of Osborne & Clark says the trade with retail yards is beginning to drop off seasonably, but as dry stocks are very light it is a good thing. There is no sixteen-foot oak left. The factory trade seems fairly well stocked and is only taking hardwood in small quantities to tide over till the new cut is dry. Mill cull birch seems to be out of the market, a test having failed to locate any. There is still some shipping cull stock, but it is being taken for flooring. Basswood culls are being sold ahead to box manufacturers at advanced prices.

J. T. Wyman of Smith & Wyman, the local sash and door manufacturers, is back from an extended pleasure trip, extending over part of the south and as far west as Denver.

The record of building permits shows a falling off in activity in this city. In April there were 644 permits issued with an estimated total cost of \$893,090. The same month last year there were 670 permits, with a total cost of \$1,572,625. The total value of permits issued in four months this year is \$2,629,275. The total for the same months last year was \$3,075,260.

The John C. Hill Lumber Company of St. Paul has been made northwestern agent for the Fullerton-Powell Hardwood Lumber Company of South Bend, Ind.

held strongly on a high price level. One large buyer who recently returned from Memphis and the Southwest reviews the manufacturing end as very independent with manufacturers getting prices f. o. b. mill points for plain oak and other desirable stock for shipment to Mexico, the Pacific Coast and Middle West, at such a high level as to make it impossible for eastern buyers to purchase stock and pay freight east and be able to realize an adequate profit. Under these conditions it is hard picking for eastern buyers at mill points and they are realizing that it is necessary to not only buy at the market, but pay what is asked, if they are going to have their usual quota of stock for the summer trade.

Stocks in the local market in the hands of both buyers and manufacturers are only nominal. The high grades of poplar are scarce in the face of a good call; birch is also very active and all offerings of dry stock are quickly absorbed. There is practically no birch veneer to be had in the district. Ash is also in big demand, with all offerings of stock quickly absorbed. In chestnut it is very hard to get anything in the better grades, although there is plenty of sound wormy and the lower grades. Maple is only fair and there seems to be ample stock for current wants. Quartered oak has improved considerably of late, but there is no scarcity of available stocks. Dimension oak and particularly car and ship stock, is exceedingly active in demand and orders hard to fill. Beech and red gum are being utilized more and more and beech flooring seems to be taking on a leanness of life and to be entering increasingly into factory work. Basswood is holding its own and prices are on a level today which should attract buyers.

### Philadelphia.

The local market is excellent and all woods are holding up well, although there has been no decided advance in price. The trade is a unit in declaring that there is no weakness manifest in any direction, and that it is much easier to sell than to get lumber. The mills are demanding higher prices for their stocks, and this, together with the shortage in local yards, and the demands of the retailers, has succeeded in keeping the market up to the high level of recent weeks. Manufacturers of furni-

ture still continue to send in large orders, and some wholesalers are inclined to believe that there will be a further advance in the price of the popular woods.

Considerable quantities of maple were handled during the last fortnight and quite a number of cars of basswood sold, the sales in this latter wood aggregating a higher average than for some weeks past. Red and white oak is also in good condition and there has been, as usual, a big demand for sound wormy chestnut, but no advance in price. The demand for oak generally has been greater than for some time, and there has been a slight advance in the price of this wood. Some dealers report that they are handling more ash than ever before, there having been an especially good demand for this lumber in high grades, common or better, and especially thick ash. The active trading has slightly increased its price. Poplar is holding well in high grades, the scarcity of stock being still felt. The demand for oak and maple flooring is good, the dealers being able to get the full list price without difficulty.

### Baltimore.

All the hardwoods continue to be in excellent shape, with consumers eager after stocks and dealers competing actively at the mills for supplies. Quotations rule high for all the hardwoods in general use. Good dry oak is, of course, in the lead. The demand from car builders is most urgent, and as they pay high prices and are liberal in their requirements, their business is eagerly sought. Ash is also moving freely, with walnut, chestnut and other woods in excellent request.

The poplar situation has lost none of its strength, stocks being in brisk demand and manufacturers having plenty of orders on hand. Values continue to be remunerative, though they do not reach the high figures at first decreed by manufacturers.

The export business is hardly less active than the domestic trade, large quantities of lumber being shipped abroad. Persistent reports are in circulation, however, that lumbermen are emulating the example of other manufacturers and sending their surplus out of the country to keep up high prices here. It can be said, however, that foreign consumers are becoming persuaded by degrees that the prices here are not arbitrary, and they are beginning to meet the terms of shippers. There is some hesitancy, as is always the case on a rising market, about placing contracts for future delivery, but the business shows marked improvement.

### Detroit.

Market conditions show no great change during the fortnight, except that crating lumber of all kinds is in very strong demand and at considerably better prices than formerly. No. 3 common basswood is an especially good seller, and the price runs as high as \$18, in some cases.

Most of the mills tributary to Detroit have stopped cutting thick maple. They claim that the depreciation in this material, because of season checks, much more than offsets the extra price received on account of the thickness. Practically all the mills on the Mackinac Division of the Michigan Central are sawing 1-inch and 1½-inch exclusively. The product goes to the maple flooring factories. It certainly looks as if thick maple would be scarce and higher in the near future.

Local factories claim that southern shippers are crowding the grade of their oak very hard, and complaints on shipments are keeping association inspectors busy.

### Pittsburg.

The demand for hardwoods in all grades and of all kinds is extremely active. The only difficulty is to get stock to fill orders. Prospects for a continuance of this activity are bright and 1906 bids fair to be a banner year for Pittsburg lumbermen.



Oak is decidedly in the lead. There is practically no dry oak on the market and the little that is available is chased hard, resulting in prices above list being paid. For heavy oak timbers there is going to be a splendid demand all summer, as well as for ties, planking and interior finish. Ohio and western Pennsylvania are being scoured by local firms for small tracts of oak where portable mills can be put in to advantage.

Chestnut continues to be an active seller. It is being substituted by many contractors for hemlock at slightly lower prices. There is no surplus of stock and prices are very firm at quotations. Maple is selling well, and beech is coming into market in larger quantities than for many months. The manufactories of Ohio and the East are taking considerable quantities of the minor hardwoods, ash, birch, cherry and hickory, at good prices.

The danger of any serious disturbance in the labor market has passed. About 500 carpenters are out, but the majority of the contractors will pay the \$4 a day asked. With the coming of good weather a great deal of house building has been projected, and this with the large number of business structures going up will insure a splendid market for the best grades of hardwood all summer.

#### Buffalo.

The hardwood trade is quite satisfactory as to sales, but dealers are troubled over the lowness of stocks. This means that while sales have increased steadily all the year, it has not been possible to get enough new lumber to replace shipments. If the present drain continues, there will not be even a fair assortment of stock in most local yards in two months. The plan of shipping to customers from buying points direct is adopted wherever possible, the idea being to keep a good all-around lot in yard to meet hurry orders and save freight by the direct plan.

The Southwest has turned out less lumber this year than usual, so that the special shortage of oak, poplar and ash is to some extent accounted for, but there seems to be no hope of much recovery in chestnut, and some dealers appear to have about given up searching for it, saying it cannot be found except in chance lots. This makes plain oak scarce and is drawing on quartered more and more.

Maple has been used for ash till it is running short, in spite of the big overstock of it last year. Birch keeps up fairly well and is a good seller always. White ash continues short of the demand, and poplar is going out of sight in price, at least so far as this market is concerned. If basswood does not pick up soon it will be strange, for it has been neglected so long that the excessive price that spoiled the trade no longer holds.

Dealers are making an extra effort to keep up stocks, and are covering a much wider territory than ever before to do so. It is likely that during the midsummer lull the effort will produce good results, especially if the Southwest dries up and logging is easy again.

#### Saginaw.

Lumber is moving fairly well, the active season in manufacturing and selling now being on. The market is firm with no special features of interest. Some local dealers handle a lot of southern oak and chestnut from the point of manufacture direct to the customer without bringing it here. A considerable quantity of hardwood stuff is also bought by Saginaw valley dealers from hardwood manufacturers along the lines of railroad in the northern part of the state and while a portion is brought to the yards here much of it is sold and shipped direct to the consumer from the mill. It is estimated that over 100,000,000 feet of hardwood stocks is handled by dealers here every year, only about one-half of which is manufactured in this district.

About 500,000 feet of beech was recently sold to concerns for screen doors, flooring and pulleys. No. 2 common and better is held here at \$13 and \$14. Elm is doing better than it did last year and No. 2 common and better is quoted at \$22 to \$26. Basswood is firm at \$23 and \$15 for snils, birch is doing nicely at \$20 to \$25.50, ash is scarce and firm at \$27, and maple is in good demand at \$16 and \$18.

#### Grand Rapids.

Most of the hardwood dealers in this city report business good. Maple is moving better and thick stock is looking up. Elm is showing improvement, with prices holding well. Ash, black and white, are in good demand. The basswood situation is improving. Birch continues a little slow.

#### Milwaukee.

Market conditions remain unchanged. In a few instances carpenters have gone out on strike because contractors refused to recognize the union, which has caused a cessation of building, but it is thought this will be of short duration and building will be resumed with renewed vigor, so that the market will not be affected by it to any great extent. As an indication of obtaining prosperity, the contract to furnish lumber to the city of Milwaukee recently made by the John Schroeder Lumber Company will serve as an example. That company this year will receive an advance of \$2 a thousand on all kinds of lumber except white oak, which shows a reduction of \$1. The demand for all hardwoods is active, and the situation generally is satisfactory.

#### Bristol, Va.-Tenn.

Hardwood conditions in this section are excellent. Mills are going up everywhere. Eastern lumbermen are starting sawmills and lumber manufacturing industries, evidently having great faith in this section. The increase in volume of business in the Bristol district this year has been phenomenal. Prices are quite satisfactory, though lumbermen are looking for even better prices within a few weeks. The demand is heavy, and the majority of the mills are unable to supply their trade.

Stocks in the yards are low, nor is there much chance of replenishing, as lumber is being shipped out as rapidly as it is unloaded.

#### Cincinnati.

The scarcity of dry lumber is more acute in this market at present than perhaps at any time this year. The belief is also general that it will be some time before this condition is alleviated and for that reason consumers have been buying available lots with great rapidity. So far as prices are concerned the market is in fine shape. Plain oak has sold freely and advanced prices are being obtained. Quarter-sawn white and red oak have moved into consumption at a steady pace and at satisfactory figures. Ash is particularly scarce and rules strong under an urgent call. Cypress, hickory and chestnut have been in good request. Cottonwood firsts and seconds and red gum are active and selling high. Poplar has met with a spirited demand and with low stocks quotations are stiffening gradually.

The labor situation is all right. Several hundred planing mill hands struck on May 1 for increased wages, but this controversy was quickly settled. Weather conditions are favorable and many new buildings have been started.

#### Chatanooga.

The universal cry among local lumbermen is for dry stocks. The situation is a little easier than it was a month ago, however, which is probably due to the favorable weather of the past few weeks.

Plain oak and chestnut are still the leaders. Quartered oak in Nos. 1, 2 and 3 is not moving as freely as might be desired. In poplar there are on the market only the lower grades, the

higher grades being almost entirely sold out.

The mills of this city will not have the log supply this year that they had last. Since December 1 about twelve million feet of timber, about half of which has come by river, has been received. Prices hold their own; in fact, are on the increase. There is a great demand here for railroad ties, and this timber is becoming scarce and prices are steadily advancing. Chestnut is being used almost exclusively in the manufacture of collins and caskets, and the supply is not equal to the demand as Chattanooga is now becoming a collin and casket manufacturing center of importance. Poplar is much used in the manufacture of buggies, carriages, pianos, etc. Walnut is about out of the market and the little that can be had is readily taken by sewing machine manufacturers.

#### St. Louis.

Trade in hardwood in St. Louis is brisk. Stocks of dry lumber are probably lower than for years and receipts are considerably below average. The upper grades of poplar and plain oak are exceptionally short. For the past two months two of the large shipping yards here have refused to sell inch plain oak in straight carload lots. The upper grades of poplar have advanced in this market during the past two weeks. There is no indication of anything but a continuance of firm prices all along the line. The reports from the South are that stocks are very low in the hands of millmen, and weather conditions are still against a normal output.

#### Nashville.

Nashville lumbermen report an exceptional run of business for the months of March and April, 1906. Many of them report that they did 100 per cent more business during these months than for the corresponding months of last year. Prices are steady with an upward tendency. The interior finishing plants in this section are rushed, and as a result the dry stock in both plain and quartered white oak is being cleaned up. There have been heavy purchases of chestnut recently for eastern concerns, and the market is practically bare of that wood. Ash of all grades is in big demand. Hickory is very scarce and poplar dry stock is almost out of the market. There is none of the higher grades to be found. Orders and inquiries continue lively, and the Nashville lumbermen are certainly getting their share in the business that is doing.

#### Memphis.

There is a continued good demand for hardwood lumber and conditions are quite healthy. There is no appreciable increase in the offerings; in fact, if there is any change at all it is in the direction of decrease. The domestic demand is exceptionally good, while there is not a little export business doing here owing to the excellent prices offered from the other side of the water for southern hardwoods. Prices are quite firm, with every assurance of remaining so for some time.

Ash and cypress are both in limited supply, with an exceptional call for both. The mills are doing all they can to meet requirements, but the most acute scarcity is in lumber for immediate shipment, with the result that lumber now being put on sticks has very little bearing on the situation. It is easy to book future-delivery orders for either ash or cypress, but in view of their scarcity manufacturers are somewhat slow about so doing.

Cottonwood is working into still stronger position and the cost of getting out timber, of manufacture, and the scarcity of both raw material and the sawn product, is responsible for the advancing tendency displayed by prices. Box boards are very scarce, as are also wide and narrow firsts and seconds and box common. Most manufacturers are in the market for these grades instead of having anything to offer.

There is a growing demand for gum and a nice volume of business therein. Firsts and



seconds red are now commanding the best price in the history of this lumber and offerings are not large. There is also a good demand for lower grades, as well as for clear saps. The small mills which usually glut the gum market have accomplished comparatively little during the past few months, with the result that there is no gum on the bargain counter. Some thin stock is going into export and several firms are making a specialty of this material with profit.

Plan oak is holding its own. There is enough demand to take everything offered at full prices. Quarter-sawed oak is in moderate request, the demand being rather better than heretofore. Prices are not advancing much, but there is a healthy undertone because there is no surplus stock available.

All grades of poplar are selling well. The lower grades are firm, in sympathy with the scarcity and strength noted in cottonwood, while the upper occupy about the same position as other high grade lumber.

#### Louisville.

The Louisville hardwood market is probably in better shape now than it has been for many months. There is not an item on the list that is not in good demand and bringing fair prices. Some items are in more active demand than others, among them ash, chestnut and plain-sawed red and white oak. Probably the most pleasing feature in the market is the active demand for No. 1 common poplar. Last summer and fall everybody was loaded with this grade of poplar and endeavoring to sell it. Everything else in poplar was selling well. Some became discouraged, sorted over the piles of No. 1 common and made it into bevel siding, worked it off into saps and one thing or another to reduce their stocks a little. Now things are different; No. 1 common is in excellent demand, with available dry stock pretty well cleaned up. The best demand for this stock seems to be coming from the planing mills, and evidently it is taking the place of a higher grade of yellow pine.

For car stock generally the demand is good, in many instances even urgent. The car people have been paying premiums for prompt delivery, and seem to be well supplied with orders to place for future delivery. The furniture trade is in the market for all grades of stock and taking a good volume of it. The local trade in hardwood flooring is active. The skating rink craze has helped it along, increasing the demand for maple flooring considerably. Hardwood manufacturers are all busy, free from worry about sales, only concerning themselves with the problem of getting out and shipping stock.

#### Ashland, Ky.

The hardwood market in Ashland and vicinity is in excellent condition. Hardwoods are selling freely at list prices. Mills are all running full time in an effort to keep up with orders. Stocks are uniformly short, and orders for immediate delivery are being turned down. Throughout the Ohio river mills lumbermen were more prosperous and the trade this spring will largely eclipse that of 1905.

#### Minneapolis.

This is rather off season for the factory trade in the Northwest to buy. The heavy buyers have laid in their stock or placed orders to practically supply their needs until some of the new stock is ready for shipment. They are not stocked with oak, and will buy freely any stock that is offered with a prospect of early delivery. There is very little to be had, however. Reports from southern mills supplying this territory indicate that there is very little oak on hand. Because the winter season was so wet there was little logging done and they have shipped out about all of their stock. The general overflow has prevented shipment from most of the mills, and orders placed here some time ago in many cases remain unfilled. As for northern oak, there is

some heavy plank and wagon stock unsold, but the supply is light and broken.

Trade is not heavy in other hardwood lines. The factories have on hand good stocks of birch uppers and elm, and business in those woods is rather light here. Some shipments are being made east and south. Low-grade birch was in surplus, but is well cleaned out, and what shipping culls are left sell readily for flooring. Maple flooring is having a steady run, and is bought more in smaller towns than a year or so ago. Basswood is stronger than before. Uppers are running rather low, and are in better demand than usual, while culls are cleaned out, and box manufacturers are contracting ahead for the new cut at prices a dollar or two ahead of last year.

The furniture factories have some good business ahead and will be excellent customers. Big orders have been placed by local factories in San Francisco.

#### Asheville.

Trade continues active and lumbermen are enjoying a season of prosperity. The available supply of hardwoods is limited, and in many cases orders for immediate delivery are turned down. Chestnut leads in demand and there is also a good call for poplar. Prices are satisfactory in most instances. Prospects for a continuance of activity seem very favorable.

#### Liverpool.

Trade generally has settled down very quickly after the Easter holidays, and everyone seems to be looking forward to a good run of business during the next few months.

Three mahogany sales took place last week and a large representative list of buyers were present. The wood offered found a ready sale, and as the stocks everywhere are extremely light buyers at last sale prices have made excellent purchases. A large quantity was purchased on behalf of American buyers, several fine figured logs were sold, one with a particularly rich broken roe and mottle realized \$1.85 per superficial foot.

Prices of all classes of hardwood are strong. Ash is in good request, and shipments arriving are all going into consumption.

Several quotations from American shippers came to notice within the past few days for goods to arrive, and without exception prices were much higher than have been paid here during the last six months. Consumers here are holding off on account of these high prices and buying from hand to mouth. In view of the low stocks and increased cost of logs, shippers should stick to their prices, and not ship unless they have a definite order.

Oak has been coming in rather freely during the last fortnight, but it is all wanted and buyers are undoubtedly paying higher prices than they were last year. However, it seems that top prices for this wood have been seen, and shippers would do well to dispose of stock at present prices.

Hickory has gone to pieces, and numerous parcels of logs have been hawked round the market and have been sold at prices which must be far from profitable to the shipper. This wood will undoubtedly right itself in due course, however.

Birch has also eased, though slightly, in price. This may always be expected at this time of year, as buyers here do not care to stock same in the hot weather.

Little or no walnut has been arriving at this port during the last few weeks, but there are large stocks on hand and we do not think this wood has been affected by the general rise in the price of lumber here.

It seems that the "Mariana" has arrived with ten to twelve cars of walnut lumber, but after inspection this proves to be principally medium and common quality which no doubt will take a great deal of "hard pushing" on the part of the brokers here to sell at remunerative prices.

## Saw Mill and Standing Timber For Sale....

Hardwood Mill, now sawing 4000 feet daily, on Illinois Central and Southern Railways in Mississippi.

5000 acres good Gum, Oak, Ash, Cypress and Elm Timber.

Business in going condition, Electric Light Plant; McGiffert Log Loader and Full Logging Equipment; Live Stock, etc.

Good opportunity for practical hardwood lumberman. For full particulars, address

**"CHESTER"**

Care Hardwood Record.



WALNUT.  
OAK,  
ASH,  
POPLAR.

## BLISS-COOK OAK COMPANY

BLISSVILLE, ARK.

MANUFACTURERS

**Hardwood  
Lumber  
and  
Flooring**

We manufacture 15,000,000 feet of Oak Lumber per year for export and domestic markets, from 3/4 to 4 inches thick.

Also Quartered and Plain Polished Oak Flooring, kiln dried, end matched, hollow back.

Mills and Flooring Plants at  
**SHULTS AND BLISSVILLE, ARKANSAS**

**GUS. KITZINGER**  
**Michigan Hardwoods**  
By Car or Cargo. Manistee, Mich.

# AT COST

✿ IS AN UNCOMMON TERM AS APPLIED TO INSURANCE ✿  
But this is the actual price of Indemnity against Fire Loss furnished by the

## MANUFACTURING LUMBERMEN'S UNDERWRITERS.

### THE STRONGEST INSURANCE ORGANIZATION TODAY IN AMERICA

---

The saving is not  
on a small portion  
of your Insurance  
but on the ✿ ✿  
ENTIRE LINE.  
There are other ad-  
vantages equally  
interesting. ✿ ✿

---



---

Only well built  
plants with ade-  
quate protection  
and at least five  
years timber supply  
are considered eligi-  
ble. ✿ ✿ ✿

---

For List of Members and further information Address

## HARRY RANKIN & COMPANY

KANSAS CITY, MO.

# Wanted and For Sale -SECTION-

Advertisements will be inserted in this section at the following rates:

For one insertion ..... 20 cents a line  
For two insertions ..... 35 cents a line  
For three insertions ..... 50 cents a line  
For four insertions ..... 60 cents a line

Eight words of ordinary length make one line. Headings counts as two lines. No display except the headings can be admitted.

Remittances to accompany the order. No extra charges for copies of paper containing the advertisement.

## EMPLOYES WANTED.

### WANTED.

Competent sawmill man owning a small 5 or 6 ft. band mill to cut hardwoods in North Carolina by the thousand; ample log supply. Would consider buying a band mill for responsible party. Address

"A. L. V.," care HARDWOOD RECORD.

### ASSISTANT SALES MANAGER

Wanted in our Hardwood Department. Must be a young man of good habits and address, energetic and a good all round office man and correspondent, capable of buying and selling by letter. He should also be familiar with both the buying and selling end of the business, and capable of taking entire charge of our Hardwood Department in the absence of the manager. Address, giving experience, age, reference and salary desired, to "HARDWOOD JOBBER," care HARDWOOD RECORD.

## LUMBER WANTED

### WANTED.

4/4 1st & 2nd Butternut.  
4/4 1st & 2nd Chestnut.  
4/4 to 8/4 1st & 2nd Cherry.

W. R. CHIVVIS,

Lesperance & Iron Mt. R. R., St. Louis, Mo.

### WANTED.

To contract for the output for this year of a good mill cutting Oak and Poplar lumber. Address

"MORGAN," care HARDWOOD RECORD.

### GREEN WHITE AND RED OAK PLANK.

300 M ft., prefer White Oak, 2 1/4", 2 1/2", 2 3/4" and 3" thick, No. 1 Commons and Better. Prompt shipment.

SICKLESTEEL LUMBER CO.,  
Detroit, Mich.

### OAK WANTED.

3 and 4 inch White Oak; also Mixed Oak; also 12x12 Timbers and Piling of all kinds. CONTINENTAL LUMBER CO.,  
1213 Monadnock Bldg., Chicago, Ill.

### WANTED—POPLAR, OAK, CHESTNUT.

Will receive lumber at shipping point and pay cash. D. B. MURPHY & CO., London, Ky.

### CHESTNUT, POPLAR, OAK, ASH.

Wanted all grades and thicknesses. Send description and lowest cash price. Amount justifies, will send buyer.

RODE & HORN, Brooklyn, N. Y.  
Southern Office: Johnson City, Tenn.

### OAK.

We are in the market for plain sawed oak, all grades and thicknesses.  
P. G. DODGE & CO., 2116 Lumber St., Chicago.

### WHITE ASH WANTED.

50 M to 100 M feet of strictly clear, straight grain, second growth white ash, ranging from 3"x4" to 4"x5"—12 and 14 foot lengths, suitable for horse poles.  
AMERICAN-LA FRANCE FIRE ENGINE CO.,  
Elmira, N. Y.

### WALNUT ONLY.

Wanted, Walnut lumber, green or dry, all grades, all thicknesses, log run or on grades. Highest market price paid. Liberal inspection.  
C. J. FRANK,  
2440 N. New Jersey St., Indianapolis, Ind.

### WANTED—HARDWOOD LOGS.

200 M feet 28-inch and up White Oak logs.  
200 M feet 12-inch and up Walnut logs.  
50 M feet 12-inch and up Cherry logs.  
C. L. WILLEY,  
Blue Island Av. and Robey St., Chicago.

## LUMBER FOR SALE.

### FOR SALE.

Common and better Hickory, 5,277 feet of 2 1/2", 1,082 feet of 3" and 1,024 feet of 4", dry, good quality.

LOVE, BOYD & CO., Nashville, Tenn.

### GOOD HICKORY FOR SALE.

Half carload sawn 1"x1" square x 66" long.  
Half carload sawn 1 1/4"x1 1/4" square x 60" long.  
E. DENNSTAN, Winona, Miss.

## MACHINERY WANTED

### GANG EDGER WANTED.

Small second-hand machine; belt pulley on left for horizontal running. Address

H. S. McAFEOOS, Gastown, Pa.

### AT ONCE.

If you are in need of machinery—new or second hand—a few lines in this column will place your wants before those who have such goods for sale. For particulars address  
HARDWOOD RECORD, Chicago, Ill.

## MACHINERY FOR SALE

### FOR SALE.

One six ft. Hoosier left-hand band mill, three block carriage, latest improved dogs, Soule feed, in use only about thirty days.

WRIGHT-BACHMAN LUMBER CO.,  
Portland, Ark.

## BUSINESS OPPORTUNITIES

### WANTED.

Competent sawmill man owning a small 5 or 6 ft. band mill to cut hardwoods in North Carolina by the thousand; ample log supply. Would consider buying a band mill for responsible party. Address

"A. L. V.," care HARDWOOD RECORD.

### HARDWOOD TIMBER.

A number of good mill propositions along the Cotton Belt Route. Tracts ranging from five hundred to twenty thousand acres, principally Oak, Hickory, Gum, Cypress, some Ash, Cottonwood and other hardwoods. Can be secured at very reasonable figures now—in some cases at less than \$1 per thousand stumpage. Choice openings for hardwood lumber mills, handle and spoke factories, slack cooperage plants and other hardwood enterprises.

A number of points on the Cotton Belt offer free sites or will raise cash bonus or take stock in practical propositions. Let us have your wants and see what we can do for you.

E. W. LA BEAUME, G. P. & T. A.,  
COTTON BELT, St. Louis, Mo.

## TIMBER LANDS FOR SALE

### FOR SALE.

Two thousand acres Pennsylvania hardwood. Railroad now being graded through property. Low freight rates Pittsburg, Buffalo and Baltimore markets. Can show property any time. Address,  
"TIMBER," care HARDWOOD RECORD.

## MISCELLANEOUS

### FACTS FROM PRACTICAL MEN.

The HARDWOOD RECORD is always in the market for articles on any and every feature of the hardwood industry. It wants practical statements of fact from practical men who know how certain things can be done in the best way. Literary quality not essential. Liberal pay for acceptable articles. Address  
Editor HARDWOOD RECORD.

## RAILWAY EQUIPMENT

### RAILS AND LOCOMOTIVES.

All inquiries for industrial railway equipment listed before "Record" readers will find ready response.

HARDWOOD RECORD, Chicago, Ill.

## MANUFACTURERS

Contemplating establishing plants in the West should take advantage of a location on



Chicago & North-Western Ry.

which reaches the famous

WATER POWERS,  
COAL FIELDS,  
IRON ORE RANGES,  
HARD AND SOFT  
LUMBER DISTRICTS,  
MINING DISTRICTS

of the West and Northwest, and affords the best means of transportation to the markets of the world.

FOR FURTHER PARTICULARS APPLY TO

MARVIN HUGHITT, Jr., E. D. BRIGHAM,

Freight Traffic Manager, Gen'l Freight Agent,

GEO. BONNELL,

Industrial Agent,

NW513

CHICAGO.

You want to reach Buyers of

FURNITURE LUMBER

The HARDWOOD RECORD

will do it for you.

# Advertisers' Directory

## NORTHERN HARDWOODS.

American Lumber & Mfg. Co.	9
Arpin Hardwood Lumber Co.	76
Babeck Lumber Company	9
Barnaby, C. H.	75
Beyer, Knox & Co.	83
Bliss & Van Auken	10
Boyle, Clarence, Lumber Co.	82
Boyer City Lumber Co.	79
Briggs & Cooper Co.	4
Brownlee & Company	78
Buffalo Hardwood Lumber Co.	83
Cadillac Handle Company	3
Cheat River Lumber Co.	9
Cherry River Boom & Lbr. Co.	1
Chivvis, W. R.	5
Cincinnati Hardwood Lumber Co.	81
Cobbs & Mitchell, Inc.	3
Crosby & Beckley Co., The	7
Crosby, C. P.	76
Cummer, Digging & Co.	3
Davis, John R., Lumber Co.	76
D'Hour & Swain Lumber Co.	75
Dennis Bros.	79
Dennis & Smith Lumber Co.	78
Dixon & Dewey	6
Dulmeier Bros.	80
Dulweber, John, & Co.	81
Elias, G., & Bro.	83
Empire Lumber Co., Buffalo	83
Estabrook-Skeele Lumber Co.	82
Fall, E. H.	80
Flint, Erving & Stoner Co.	9
Freiberg Lumber Co.	81
Fullerton-Powell Hardwood Lumber Co.	75
General Lumber Company	80
Goldie, J. S.	79
Haak Lumber Company	79
Hackley-Phelps-Bonnell Co.	79
Hayden, Harvey S.	74
Heath-Witbeck Company	82
Holloway Lumber Co.	7
Ingram Lumber Company	76
Jenks, Robert H., Lumber Co.	77
Jones Hardwood Company	7
Kampf, Albert R.	2
Keith Lumber Company	82
Kelley Lumber & Shingle Co.	78
King & Bartles Lumber Co.	77
Kitzinger, Gus.	60
Leavitt Lumber Company	10
Lesh & Matthews Lumber Co.	82
Linehan Lumber Company	9
Litchfield, William E.	7
Long-Knight Lumber Company	75
McClure Lumber Company	78
McLain, J. Gibson, & Co.	7
McLean, Hugh, Lumber Co.	83
MacBride, Thos., Lumber Co.	79
Maley, Thompson & Moffett Co.	81
Maley & Wertz.	75
Martin-Barriss Company	77
Michigan Maple Company	10
Miller, Anthony	83
Mitchell Bros. Company	3
Mowbray & Robinson	81
Murphy & Digging	3
Nicola Bros. Company, The	9
No. Vernon Pump & Lbr. Co.	2
Norman Lumber Company	2
North Shore Lumber Company	79
North Western Lumber Co.	76
Page & Landeck Lumber Co.	76
Perrine-Armstrong Company	75
Peters, R. G., Salt & Lbr. Co.	79
Price, E. E.	7
Radina, L. W., & Co.	81
Rumbarger Lumber Co.	1
Scatcherd & Son	83
Schofield Bros.	7

Simmons Lumber Company	79
Soble Bros.	7
Southern Oak Lumber Co.	82
Standard Hardwood Lbr. Co.	83
Stephenson, The I., Company	10
Stewart, I. N., & Bro.	83
Stimson, J. V.	75
Sullivan, T., & Co.	83
Tegge Lumber Company	74
Turner, A. M., Lumber Co.	9
Upham & Agler	6
Van Keulen & Wilkinson Lumber Company	79
Vollmar & Below	76
Wagstaff, W. J.	7
Ward Lumber Company	82
Wentworth, Chas. S., & Co.	7
White, W. H., Company	78
Whitmer, Wm., & Sons, Inc.	6
Wilberg & Hanna Company	81
Wiggin, H. D.	7
Willson Bros. Lumber Company	9
Wistar, Underhill & Co.	7
Yeager, Orson E.	83
Young & Cutsinger	75
Young, W. D., & Co.	10

## SOUTHERN HARDWOODS.

Advance Lumber Company	77
American Lumber & Mfg. Co.	9
Atlantic Lumber Company	82
Bacon-Nolan Hardwood Co.	4
Beck, E. E., Lumber Company	81
Beyer, Knox & Co.	83
Bennett & Witte	81
Black, P. W., Lumber Co.	82
Bliss-Cook Oak Co.	60
Boyle, Clarence, Lumber Co.	82
Briggs & Cooper Co.	4
Brown, Geo. C., & Co.	8
Brown, W. P., & Sons Lbr. Co.	2
Buffalo Hardwood Lumber Co.	83
Carrier Lbr. & Mfg. Co.	10
Cherry River Boom & Lbr. Co.	1
Chicago Veneer Company	63
Chivvis, W. R.	5
Cincinnati Hardwood Lumber Co.	81
Crandall & Brown	82
Crane, C., & Co.	81
Crittenden Lumber Co.	4
Crosby & Beckley Co., The	7
Cypress Lumber Company	80
Davis, Edw. L., & Co.	2
Davidson-Benedict Company	8
Dennis & Smith Lumber Co.	78
D'Hour & Swain Lumber Co.	75
Dierks Lumber & Coal Co.	10
Dixon & Dewey	6
Dulmeier Bros.	80
Dulweber, John, & Co.	81
Elias, G., & Bro.	83
Empire Lumber Co., Buffalo	83
Estabrook-Skeele Lumber Co.	82
Fall, E. H.	80
Farrin-Korn Lumber Company	80
Flint, Erving & Stoner Co.	9
Freiberg Lumber Company	81
Fullerton-Powell Hardwood Lumber Co.	75
Garetson-Greason Lumber Co.	5
Hackley-Phelps-Bonnell Co.	79
Hafner Mfg. Co.	5
Heath-Witbeck Company	82
Himmelberger - Harrison Lumber Company	1
Indiana Lumber Company	8
Jenks, Robert H., Lumber Co.	77
Jones Hardwood Company	7
Kampf, Albert R.	2
Keith Lumber Company	82
Kentucky Lumber Company	80

Kentucky Lumber & Veneer Co.	80
King & Bartles Lumber Co.	77
Leavitt Lumber Company	10
Lesh & Matthews Lumber Co.	82
Linehan Lumber Company	9
Litchfield, Wm. E.	7
Long-Knight Lumber Company	75
Loomis & Hart Mfg. Co.	8
Love, Boyd & Co.	8
Luehrmann, Chas. F., Hardwood Lumber Company	5
McClure Lumber Company	78
Mellvain, J. Gibson, & Co.	7
McLean, Hugh, Lumber Co.	83
McLean Lumber Company	8
Maley, Thompson & Moffett Co.	81
Martin-Barriss Company	77
Miller, Anthony	83
Nicola Bros. Company	9
Norman Lumber Company	2
Ozark Cooperaage Co.	5
Papecke-Leicht Lumber Co.	4
Page & Landeck Lumber Co.	76
Price, E. E.	7
Prewitt-Spurr Mfg. Co.	8
Rhubesky, E. W.	2
Radina, L. W., & Co.	81
Ranson, J. B., & Co.	8
Ritter, W. M., Lumber Co.	84
Roy Lumber Company	60
Rumbarger Lumber Company	1
Scatcherd & Son	83
Schofield Bros.	7
Smith, W. E., Lumber Co.	4
Southern Lumber Company	2
Southern Oak Lumber Co.	82
Standard Hardwood Lbr. Co.	83
Standard Lumber & Box Co.	8
Steele & Hibbard	5
Stewart, I. N., & Bro.	83
Stevens-Eaton Company	7
Stimson, J. V.	75
Stoneman-Zearing Lumber Co.	5
Stutz Lumber Company, Inc.	2
Sullivan, T., & Co.	83
Swann-Day Lumber Company	6
Thomas & Proetz Lumber Co.	5
Three States Lumber Company	4
Turner, A. M., Lumber Co.	9
Upham & Agler	6
Ward Lumber Company	82
Wentworth, Chas. S., & Co.	7
Whitmer, Wm., & Sons, Inc.	6
Wilberg & Hanna Company	81
Wiggin, H. D.	7
Willson Bros. Lumber Company	9
Yeager, Orson E.	83

## POPLAR.

Advance Lumber Company	77
Atlantic Lumber Company	81
Bennett & Witte	81
Brown, W. P., & Sons Lbr. Co.	2
Cheat River Lumber Company	9
Chicago Veneer Company	63
Crane, C., & Co.	81
Davis, Edw. L., & Co.	2
Davidson-Benedict Company	8
Dawkins, W. H., Lumber Co.	80
Hayden, Harvey S.	74
Kentucky Lumber Company	80
Kentucky Lbr. & Veneer Co.	80
Loomis & Hart Mfg. Co.	5
Ritter, W. M., Lumber Co.	84
Roy Lumber Company	60
Rhubesky, E. W.	2
Southern Lumber Company	2
Stevens-Eaton Company	7
Swann-Day Lumber Company	6
Thomas & Proetz Lumber Co.	5
Vansant, Kitchen & Co.	84
Yellow Poplar Lumber Co.	84

## COTTONWOOD AND GUM.

Bacon-Nolan Hardwood Co.	4
Farrin Korn Lumber Company	80
Himmelberger - Harrison Lumber Company	1
Luehrmann, C. F., Hardwood Lumber Company	5
Ozark Cooperaage Co.	5
Papecke-Leicht Lumber Co.	4
Smith, W. E., Lumber Co.	4
Stoneman-Zearing Lumber Co.	5
Stutz Lumber Company, Inc.	2
Three States Lumber Co.	4

## CYPRESS.

Crandall & Brown	82
Cypress Lumber Company	80
Hafner Mfg. Co.	5
Lothman Cypress Co.	5
Thompson, J. W., Lumber Co.	4

## HARDWOOD FLOORING.

Bliss-Cook Oak Company	60
Bliss & Van Auken	10
Carrier Lbr. & Mfg. Co.	10
Cobbs & Mitchell, Inc.	3
Cummer, Digging & Co.	3
Haak Lumber Company	79
Mitchell Bros. Company	3
Nashville Hardwood Flooring Company	8
Pease Company, The	80
Stephenson, The I., Company	10
Wood Mosaic Flooring Co.	2
Young, W. D., & Co.	10

## SAW MILL MACHINERY.

Mershon Company, The	74
Phoenix Mfg. Company	76

## WOOD WORKING MACHINERY

American Wood Working Machinery Company	69
Berlin Machine Works, The	67
Defiance Machine Works	67
Ober Mfg. Company, The	64
Smith, H. B., Machine Company	68

## VENEER MACHINERY.

Coe Manufacturing Company	71
---------------------------	----

## LOGGING MACHINERY.

Clyde Iron Works	66
Lidgerwood Mfg. Co.	65
Overpack, S. C.	67
Russell Wheel & Foundry Co.	78

## LUMBER INSURANCE.

Adirondack Fire Insurance Co.	1
Lumber Insurance Company of New York	1
Lumber Mutual Fire Insurance Company, Boston	1
Lumber Underwriters	63
Pennsylvania Lumbermen's Mutual Fire Insurance Company	1
Rankin, Harry, & Co.	61
Toledo Fire & Marine Ins. Co.	1

## SAWS, KNIVES AND SUPPLIES

Atkins, E. C., & Co.	73
Hanchett Swage Works	66
Champion Saw Company	66 & 74
Shimer, S. J., & Sons	70

## MISCELLANEOUS.

Barroll, H. C., & Co.	10
Lacey, J. P., & Co.	72
Lumbermen's Credit Assn.	64
Pease Company, The	80
Schenck, C. A., & Co.	66

# CHICAGO VENEER COMPANY

(INCORPORATED)

MANUFACTURERS OF

## Rotary Cut Poplar Veneer

We have over four million feet of selected veneer logs on hand. Our plant is especially adapted for making extra large sizes and we cater only to the high grade trade.

BURNSIDE,

KENTUCKY

# "DEFIANCE" WOOD-WORKING MACHINERY

COMPLETE EQUIPMENTS OF

## HIGH GRADE TOOLS

FOR MAKING

Hubs, Spokes, Wheels,  
Wagons, Carriages,  
Rims, Shafts, Poles,  
Neck-Yokes,

Single Trees, Hoops,  
Handles, Bobbins, Spools,  
Insulator Pins and  
Oval Wood Dishes.

INVENTED AND BUILT BY

The **DEFIANCE MACHINE WORKS**

DEFIANCE, OHIO.

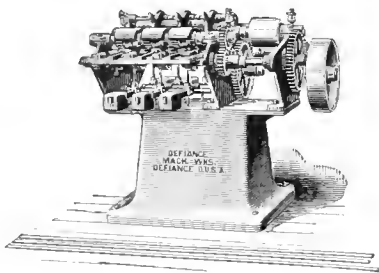

TRIPLE HOOP AND TRUNK SLAT PLANER.

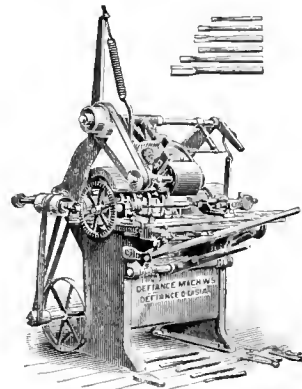

HAMMER AND HATCHET HANDLE LATHE

Send for 500 Page Catalogue

## Save Your Money

By Using the

# RED BOOK

Published Semi-Annually  
in January and July

WRITE FOR TERMS.

Lumbermen's Credit Association

ESTABLISHED 1878

1405 Great Northern Building. : CHICAGO  
16 Beaver Street. : NEW YORK CITY

MENTION THIS PAPER

It contains a carefully prepared list of the buyers of lumber in car lots, both among the dealers and manufacturers.

The book indicates their financial standing and manner of meeting obligations. Covers the UNITED STATES and MANTOBA.

The trade recognizes this book as the authority on the lines it covers.

A well organized Collection Department is also operated, and the same is open to you.

## Industries are Offered Locations

WITH SATISFACTORY INDUCEMENTS, FAVORABLE  
FREIGHT RATES, GOOD LABOR CONDITIONS,  
HEALTHFUL COMMUNITIES, on the lines of

The Illinois Central R. R. and the  
Yazoo & Mississippi Valley R. R.

For full information and descriptive pamphlet address

J. C. CLAIR, Industrial Commissioner, 1 Park Row, Chicago, Ill.

## WOOD WORKING PLANTS

Manufacturers seeking locations for Saw Mills, Stave and Heading Factories and other Wood Working Plants in the Central Southern States, can secure full and accurate information as to Sites, Timber Tracts, Fuel, Transportation Facilities, etc., by addressing

G. A. PARK,

General Immigration and Industrial Agent

Louisville & Nashville  
Railroad Company

Louisville, Kentucky

## HARDWOOD TIMBER

There is no section with so fine and large a supply of hardwood timbers of various kinds left for the lumbermen as that portion of the South in Alabama, Georgia, Kentucky, Mississippi, North Carolina, South Carolina, Tennessee and Virginia served by the lines of the

Southern Railway  
and  
Mobile & Ohio Railroad

There are oak, poplar, hickory, gum, cypress, ash, elm, buckeye, balsam, spruce, chestnut, and other varieties. There are also available pine lands.

These timber resources and many other important features bearing on the cost of manufacture and marketing give special advantages and opportunities for EVERY KIND OF WOOD USING INDUSTRY. We have information about the best locations in the country at towns in these States and in Southern Indiana and Southern Illinois, which will be given if requested. All correspondence in regard to timber lands or factory locations will be given prompt and confidential attention. Address your nearest agent.

M. V. RICHARDS,  
Land and Industrial Agent,  
Washington, D. C.

CHAS. S. CHASE, Agent,  
622 Chemical Building,  
St. Louis, Mo.

M. A. HAYS, Agent,  
225 Dearborn Street,  
Chicago, Ill.

## Locations for Industries

ON  
THE ERIE, THE COMMERCIAL RAILROAD  
CHICAGO TO NEW YORK

The Erie Railroad System's Industrial Department has all the territory traversed by the railroad districted in relation to resources, markets and advantages for manufacturing, can advise with manufacturers of specific products as to suitable locations, and furnish them with current information of a comprehensive nature dealing with the project in its full relation to manufacture and commerce.

The Erie is one of the greatest of trunk lines. Its own rails connect the two largest cities of America. Every section of the System has its particular merits. Profitable locations exist. It has great general and coal, oil and natural gas resources.

It is important in this age of modern facilities for manufacturers to locate where they can obtain side tracks so as to receive from and ship directly into cars at the factory. Information can be promptly furnished in this connection about every point on the system between New York and Chicago.

Manufacturers' inquiries as to locations are treated in strict confidence and absolutely reliable information, so as to promote permanent traffic, is furnished. Address

LUIS JACKSON

Industrial Commissioner  
Erie Railroad Company

21 Cortlandt Street, New York

**Skidders**

**Snakers**

**Lidgerwood Machines  
Will Stock Your Mill**

**Lidgerwood Skidders  
Lidgerwood Snakers  
Lidgerwood Yarders  
Lidgerwood Roaders  
Lidgerwood Pull Boats  
Lidgerwood Cableways**

**LIDGERWOOD MFG. CO.**

**NEW YORK  
ATLANTA  
SEATTLE  
NEW ORLEANS**

**Loaders**

**Cableways**



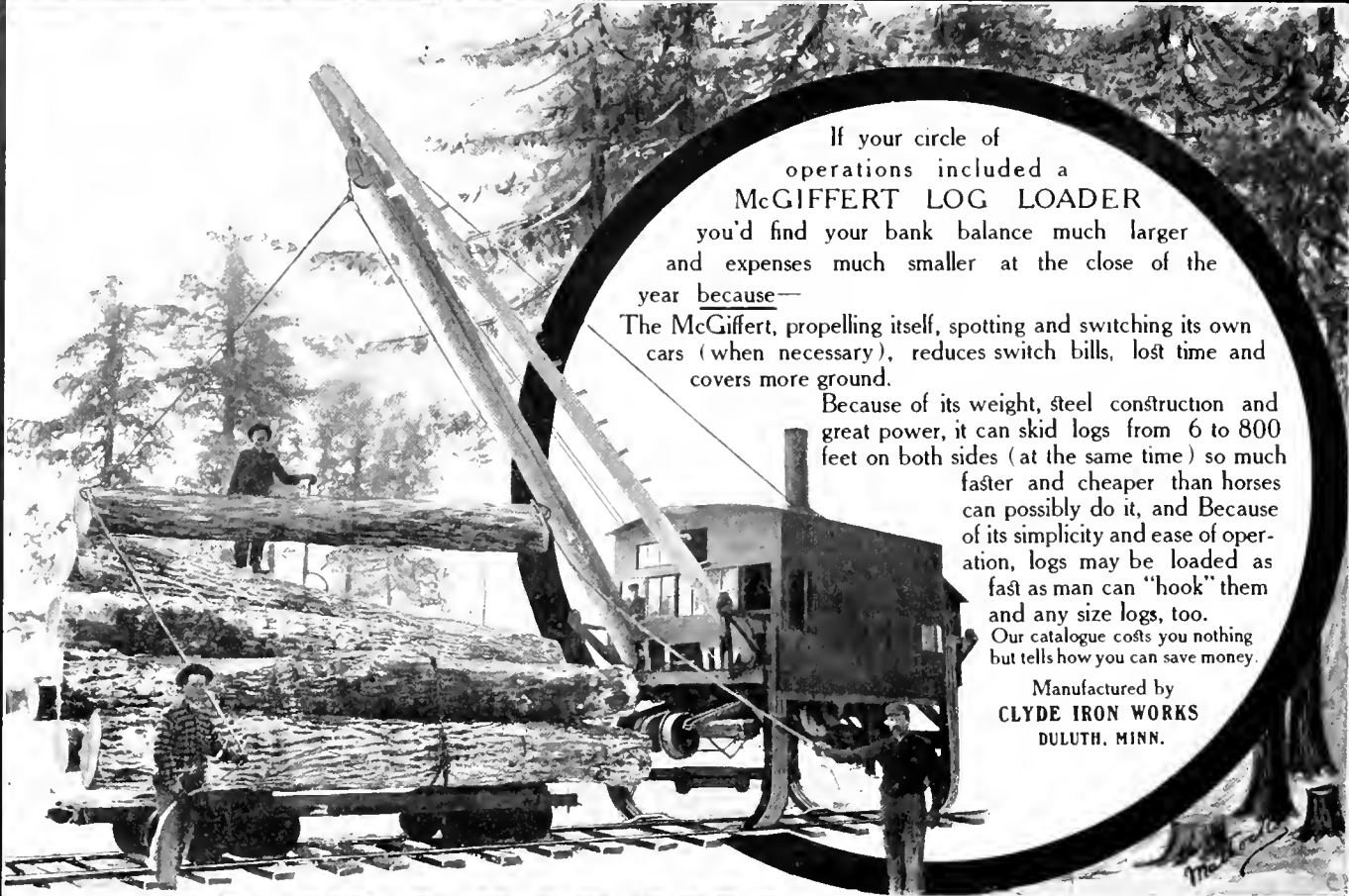

If your circle of operations included a **McGIFFERT LOG LOADER** you'd find your bank balance much larger and expenses much smaller at the close of the year because—

The McGiffert, propelling itself, spotting and switching its own cars (when necessary), reduces switch bills, lost time and covers more ground.

Because of its weight, steel construction and great power, it can skid logs from 6 to 800 feet on both sides (at the same time) so much faster and cheaper than horses can possibly do it, and Because of its simplicity and ease of operation, logs may be loaded as fast as man can "hook" them and any size logs, too.

Our catalogue costs you nothing but tells how you can save money.

Manufactured by  
**CLYDE IRON WORKS**  
DULUTH, MINN.

C-64.

## SWAGE YOUR SAWS

WITH THE

### Hanchett Adjustable Swage

Made for either Band or Circular Saws. Every Swage thoroughly tested and fully guaranteed. For full information write for Catalog No. 10.

Manufactured by

### Hanchett Swage Works

**Hanchett Circular Saw Swage** **BIG RAPIDS, MICH., U. S. A.**

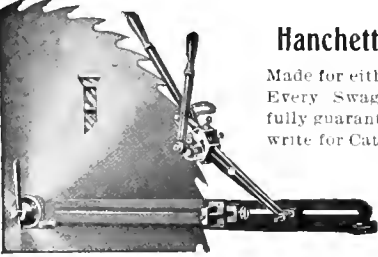

## Lumbermen, Attention!

If you own any timber or timber lands.  
If you are contemplating buying or selling any timber or timber lands.  
If you want your stumpage accurately estimated.  
If you want an exact survey or map of your property.  
If you want advice in any logging or lumbering proposition.  
Write to us and find out what we can do for you.  
We send thoroughly reliable and practical engineers to all parts of the country, and guarantee quick and accurate work.

**C. A. Schenck & Co.** DAVIDSON'S RIVER, NORTH CAROLINA  
Consulting Forest Engineers

# SAWS

United with knowledge of its manufacture is best crucible saw steel. Knowledge plus material is a reason for good saws.

## CHAMPION SAW CO.

BEAVER FALLS, PA.

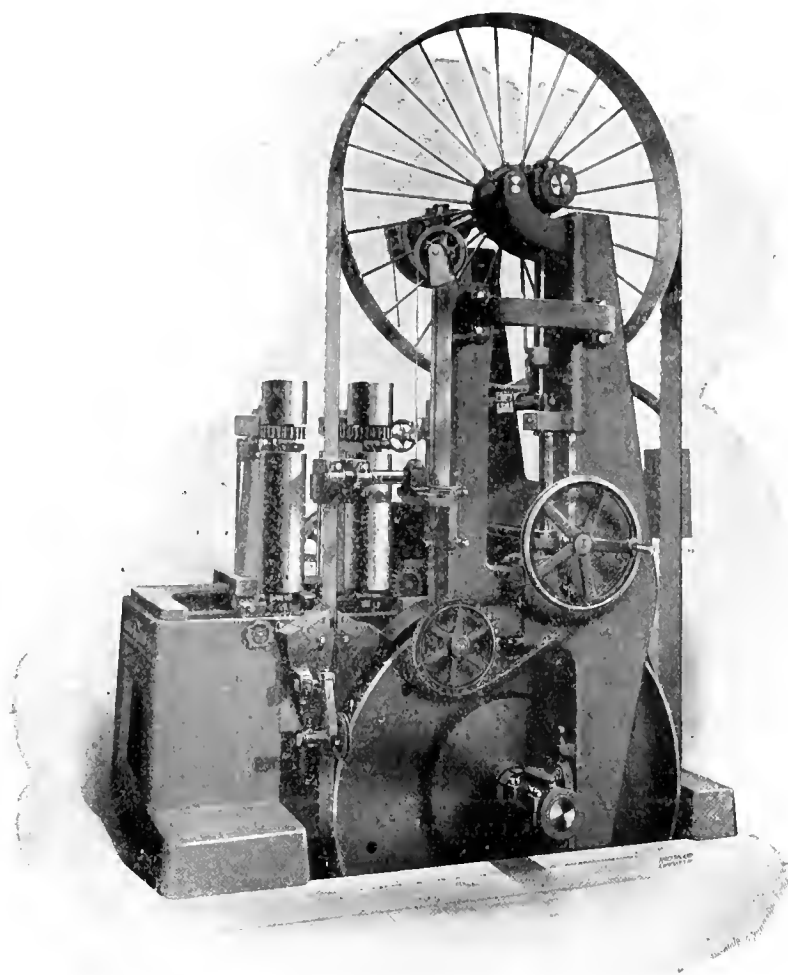

## Berlin No. 284 Band Resaw

Buying a Band Resaw without seeing the rear of it is like buying a horse when you can see nothing but its head sticking out of the stable door.

Have you ever noticed that the rear view of a resaw is seldom shown?

Why?

Simply because the rear view of most of them shows bad features, or, at the best, no good ones. It's different with this machine.

Look at that base extending beyond the lower wheel at both sides.

No chance for vibration there!

No special foundation necessary. See those outside bearings, supported at both ends of a column cast in one piece.

Hot bearings not known by users of this machine. Our Band Saw Book illustrates and describes our complete line of Band Resaws and Rip Saws.

It also contains an illustrated treatise on "Fitting and Operating" and we'll gladly send it to you *postpaid* if you are interested.

What is your address?

### THE BERLIN MACHINE WORKS, Builders

Beloit, Wisconsin, U. S. A.

BRANCHES: NEW YORK, CHICAGO, BOSTON, SAN FRANCISCO, SEATTLE, NEW ORLEANS and MACON, GA.

**SMITH of  
SMITHVILLE**

**The Profit Builder**

**SMITH of  
SMITHVILLE**

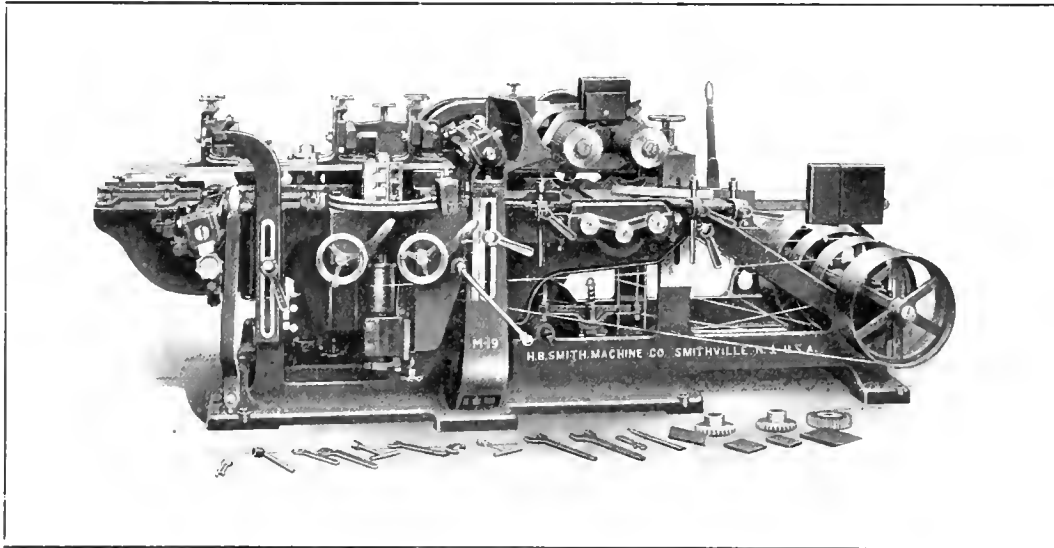

NO. 105-A, EXTRA HEAVY 12-INCH MOULDER



IT HAS been our purpose during the last half century to develop a line of wood working machines containing the best workmanship and material that American skill and wisdom can afford. This fact we are proud to say is well established in the minds of our many patrons. We have, however, now exceeded ourselves by the development of a remarkable Moulder, the excellence of which is due to our obtaining written suggestions from more than a thousand operators throughout America. This machine stands alone as being the composite idea of the thinking operators of this country. One year's test of its work has convinced us that it is impossible for you to compete successfully against the Smith Moulder with any other machine. Can't we send you prices and literature?

**Branches:**  
New York, Chicago,  
Boston

**H. B. SMITH MACHINE CO.**  
SMITHVILLE, N. J., U. S. A.

**Branches:**  
New York, Chicago,  
Boston

# The American No. 112 Single and Double Surfacers

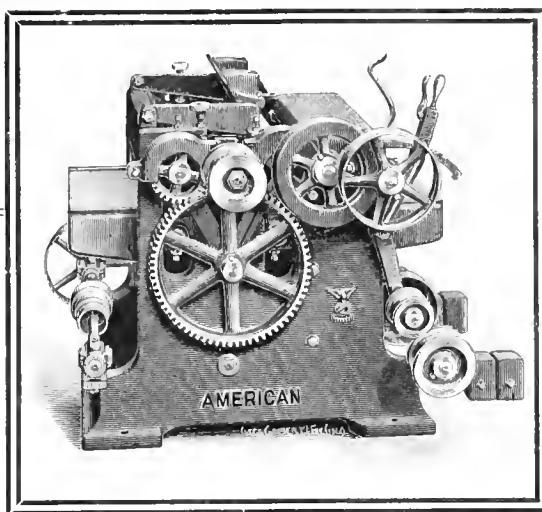

Built to work 24 in. or 30 in. wide by 8 in. thick. Four power driven rolls. Infeed roll solid or divided as ordered. Top cylinder is double belted, has patent side clamping cylinder boxes.

**Investigation is the Spirit of the Age.  
The Opportunity is Yours.  
Improve It.**

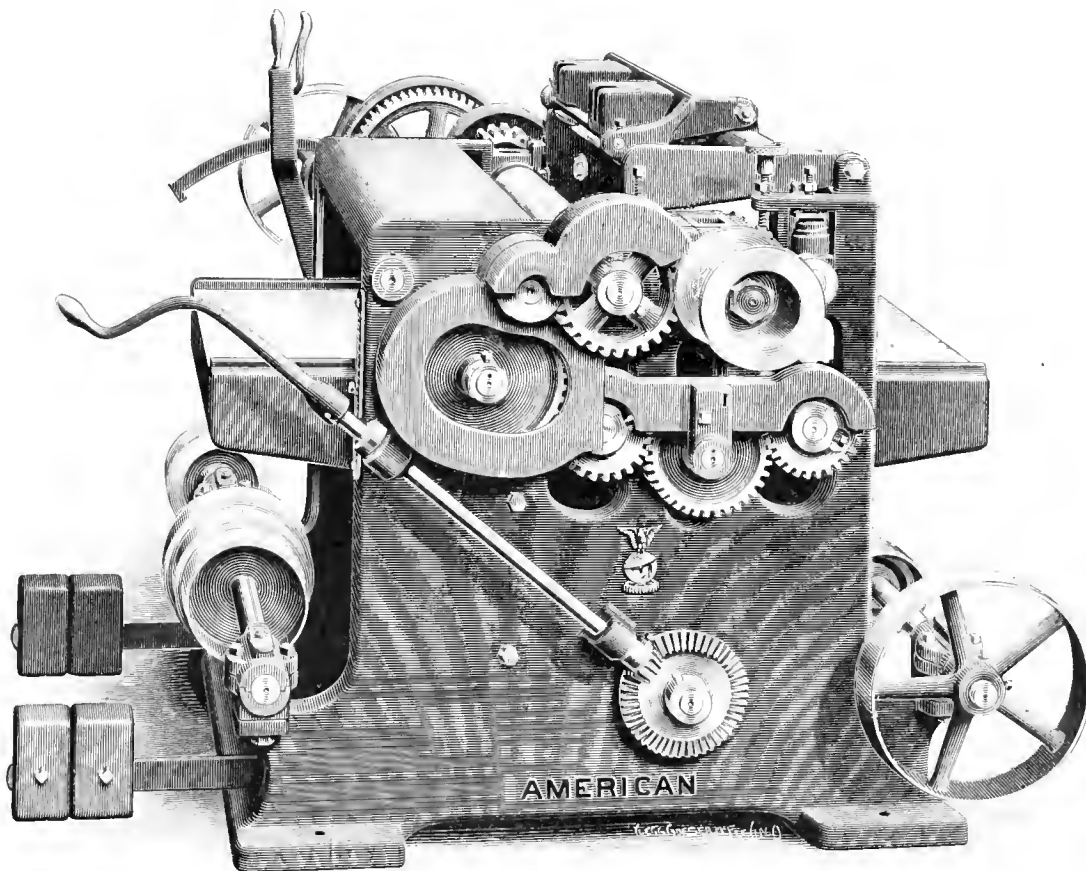

Address nearest salesroom for desired Information, Catalogue and Prices.

## AMERICAN WOOD WORKING MACHINERY COMPANY

SALESROOMS:

NEW ORLEANS  
Hennen Building

CHICAGO  
43 South Canal Street

NEW YORK  
136 Liberty Street

# Be Choice About Your Cutter Heads

FOR THEY ARE THE MEASURE OF RESULTS

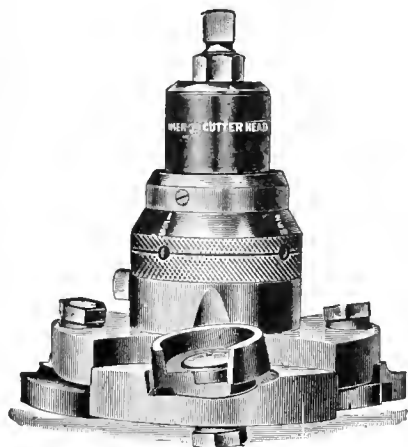

THE MAN WHO  
DOES NOT CARE  
FOR RESULTS  
DOES NOT CARE  
FOR TIME.

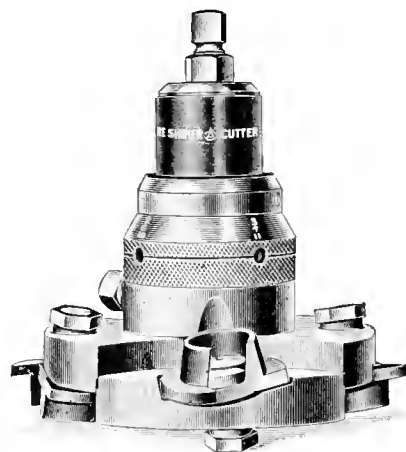

## THE SHIMER CUTTER HEADS

PRODUCE GOOD RESULTS

☞ They match Flooring, Ceiling, Siding, Rabbet Ship Lap, Joint Square Edges, Mould Doors, Sashes, Blinds, and do the Coping to match. They are also made for many kinds of special work.

☞ It has been demonstrated many times that monies invested in a small outfit of The Shimer Cutter Heads will save their cost within a few weeks use. They are, therefore, GOOD TOOLS TO DEPEND ON year in and year out. They are built for business, having within their make-up the principles required to reduce to a system the routine of keeping the knives in perfect order.

☞ The arranging of the Cutters in pairs, and in upper and lower series, is distinctively the plan of The Shimer Cutter Head. It provides for the perfect clearance to all leading points, and permits a ready expansibility of the tongue and groove for tight or loose fitting, or for thicker or thinner stock.

☞ Bear in mind the exact counterpart of your work is found in the Cutters we furnish, saving you all hand fitting. It is this "little item" of fitting (oft repeated) that makes straight bits expensive—that brings about delays to your machine—that curtails your capacity.

☞ Insist upon having The Shimer Cutter Heads and you will receive from your machinery the maximum of capacity, and with this condition, results will be all you can wish for.

☞ We make a number of Heads for special purposes. Upon any design of material you get out in quantity let us give estimate on the Head to do the work. Our prices are all uniformly low—our goods of best quality.

### SAMUEL J. SHIMER & SONS, Inc.,

MILTON,

:

:

:

:

PENNSYLVANIA.

# A PAGE OF THE FAMOUS COE VENEER MACHINERY

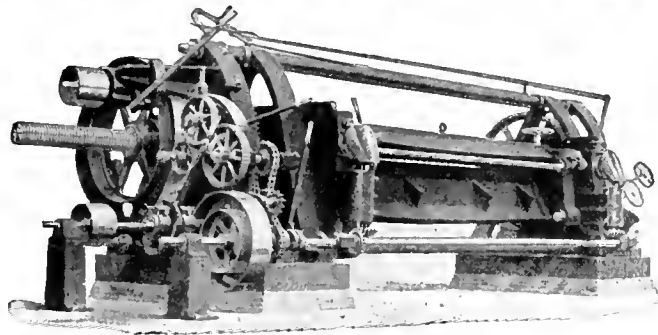

Style A Veneer Cutter

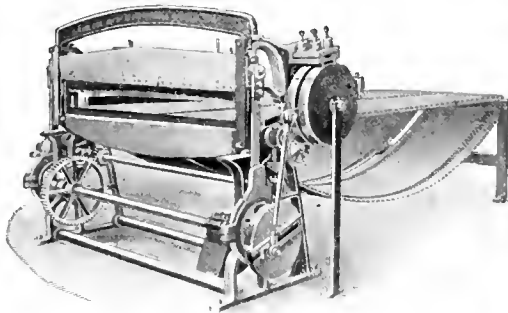

Coe Clipper

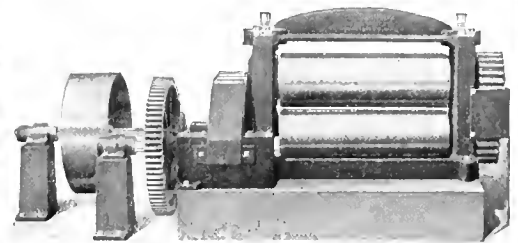

Coe Wringer

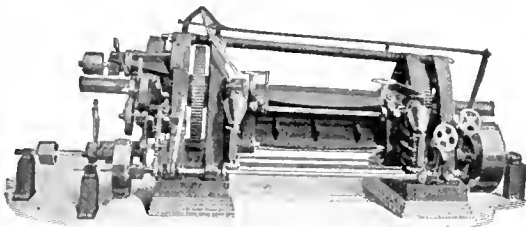

Style D Veneer Cutter

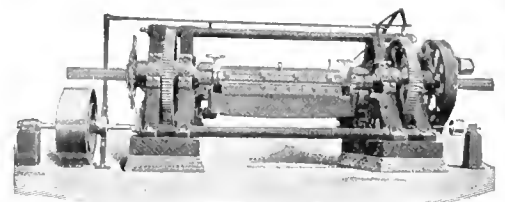

Style B Veneer Cutter

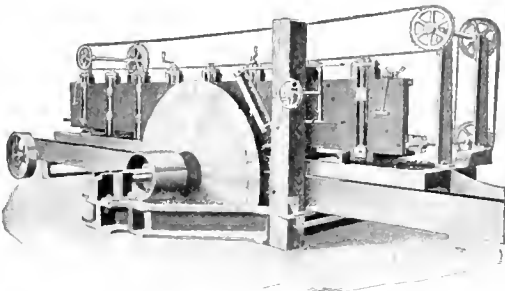

Coe Veneer Saw

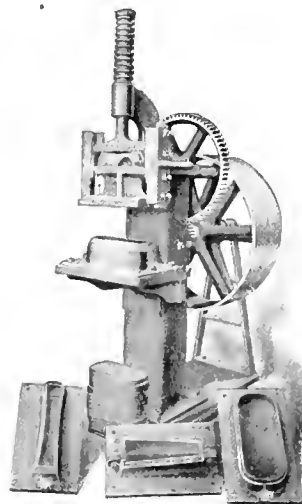

Coe Stamper

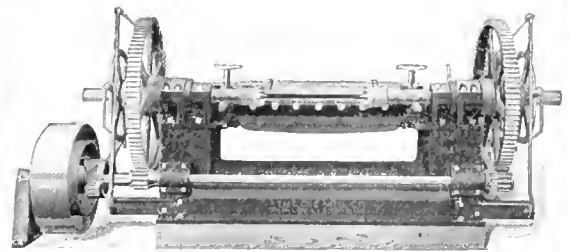

Style H Veneer Cutter

*These machines and many others are fully described in our 1906 Catalog No. 5. Write for a copy to-day.*

**THE COE MFG. CO.**

105 BERNARD STREET

**PAINESVILLE, OHIO**



# WE BOUGHT

—AND—

# SOLD

for our clients nearly

# \$10,000,000

Worth of Timber Lands During Year of

# ...1905...

## REASONS:

WE estimated every tract.

WE employ reliable and expert cruisers.

WE never offer any property without our own estimates on every 40-acre sub-division.

WE deal with buyers and owners direct.

WE guarantee reliable information.

WE solicit correspondence.

# JAMES D. LACEY & CO.

608 Hennen Building,  
NEW ORLEANS

507 Lumber Exchange Building,  
SEATTLE, WASH.

1200 Old Colony Bldg.,  
CHICAGO

**E. C. ATKINS & CO.,**

INCORPORATED

THE

**SILVER STEEL SAW**

PEOPLE

Circular, Band, Crosscut and all other kinds of Saws.

Factory and  
Home Office:

INDIANAPOLIS, IND.

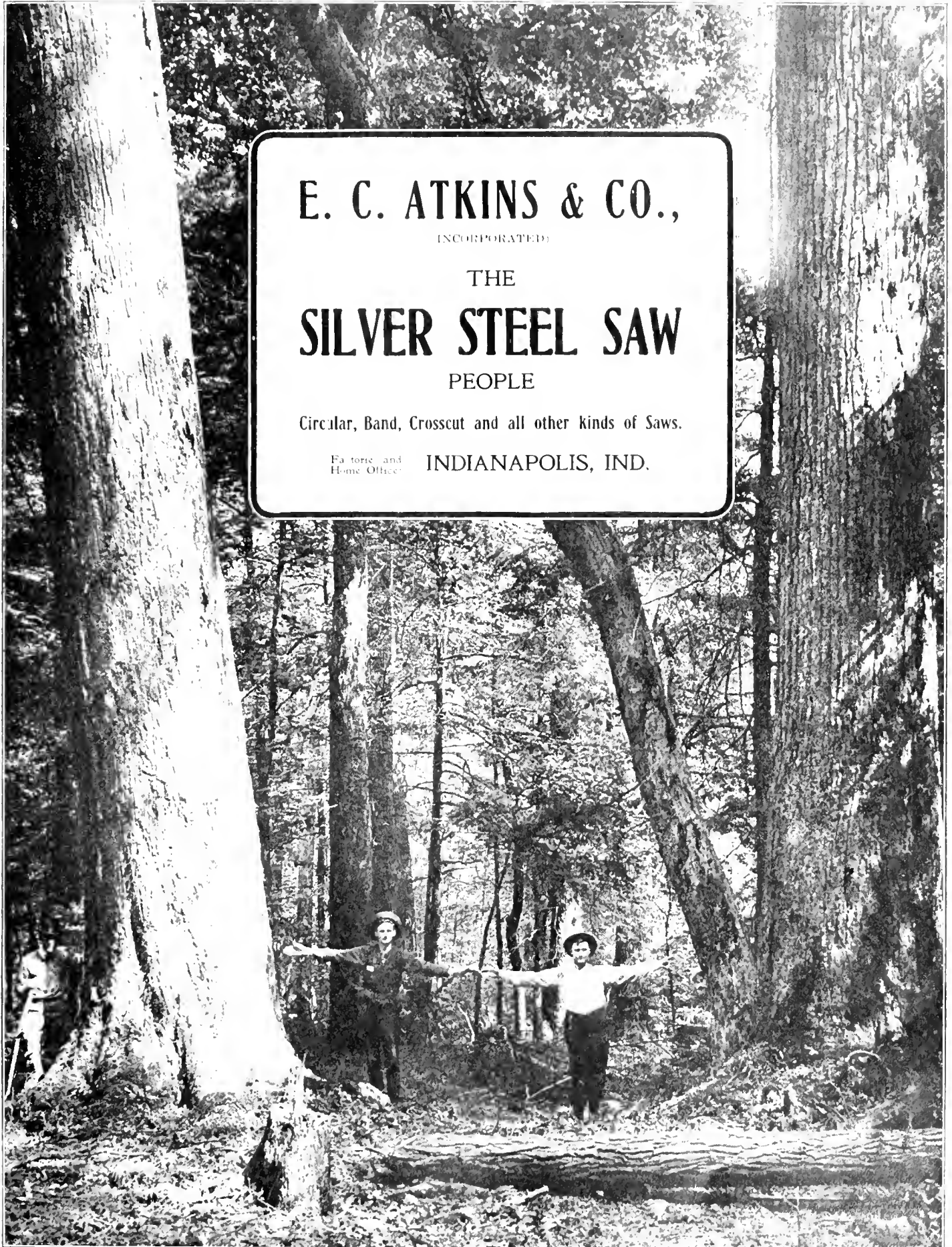

Branches:

Memphis  
Minneapolis

Atlanta  
Portland

New Orleans  
Seattle

Chicago  
San Francisco

New York  
Toronto, Canada

## The Tegge Lumber Co.

MILWAUKEE  
WISCONSIN

BUYERS OF  
ALL KINDS OF

### HARDWOOD LUMBER

### TO WHOM IT MAY CONCERN:

You are hereby notified that the co-partnership heretofore existing between ERNEST B. LOMBARD and HARVEY S. HAYDEN, under the name and style of HAYDEN & LOMBARD, is this day dissolved by mutual consent. Mr. Lombard retires from said business. Mr. Hayden is now the sole and absolute owner of all the firm's business and property, and has assumed and will pay the firm's liabilities. The business will hereafter be conducted under the name of HARVEY S. HAYDEN.

Chicago, Ill., April 25, 1906.

## KNIVES

*All the finishing machines we use in the manufacture of your planer or other knives fulfill their purpose accurately.*

*Well designed machinery, plus special knowledge of manufacture, means good knives.*

CHAMPION SAW COMPANY,  
BEAVER FALLS, PA.

# M E R S H O N

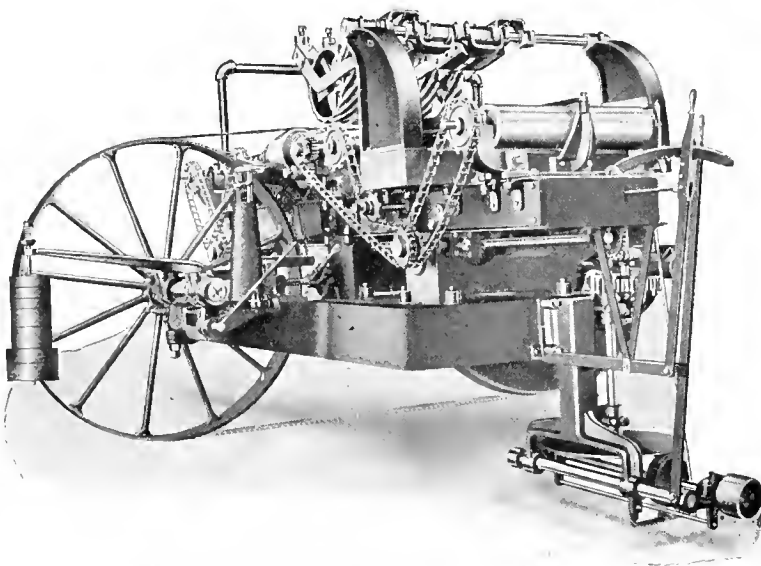

MERSON NEW HORIZONTAL BAND RESAW FOR SAW MILLS

Band Resawing  
Machinery  
for all requirements

WM. B. MERSON  
& CO.,

Saginaw, = Michigan



# INDIANA



WHERE THE BEST HARDWOODS GROW

THE WOODS FOR WHICH INDIANA IS FAMOUS.

- Quart'r'd White Oak
- Plain White Oak
- Quartered Red Oak
- Plain Red Oak
- White Ash
- Poplar
- Black Walnut
- Cherry
- Sycamore
- Red Gum
- Hickory
- Beech
- Maple
- Veneers of
- Indiana Hardwoods

## D'HEUR & SWAIN LUMBER CO.

Manufacturers and Wholesalers

Our Specialty Quartered Oak and Sycamore

SEYMOUR, IND.

## LONG-KNIGHT LUMBER CO.

MANUFACTURERS AND DEALERS

Quarter Sawed White and Red Oak a Specialty

INDIANAPOLIS, IND.

## MALEY & WERTZ

Manufacturers, Wholesalers and Exporters of Hardwood Lumber

EVANSVILLE, IND.

## FULLERTON-POWELL HARDWOOD LUMBER CO.

SOUTH BEND, IND.

## PERRINE-ARMSTRONG CO.

Long Timber up to 60 feet—Hardwood Specialties

The largest Band Mill in Indiana.

FORT WAYNE, IND.

## J. V. STIMSON

All Kinds of Hardwood Lumber Manufactured

HUNTINGBURG, IND.

## YOUNG & CUTSINGER

Manufacturers and Wholesalers

Our Specialty Fine Figured Quartered Oak

EVANSVILLE, IND.

## CHARLES H. BARNABY

Manufacturer of Band Sawed Hardwoods

Quarter Sawed Indiana White Oak a Specialty

GREENCASTLE, IND.

**WISCONSIN**  
WHERE THE FINEST NORTHERN HARDWOODS GROW

<p><b>NORTHERN STOCK</b></p> <p>Hemlock Birch Basswood Rock Elm Soft Elm Ash Oak</p>	<p><b>SOUTHERN STOCK</b></p> <p>Quartered White and Red Oak Plain White and Red Oak Sycamore Poplar Cypress Gum</p>
--	---

**PAGE & LANDECK LUMBER CO.**  
Wells Building - - - MILWAUKEE, WIS.

*Ingram Lumber Co.*  
WAUSAU, WIS.

**BASSWOOD, BIRCH**  
*We cut four million feet of each annually  
Your inquiries and orders solicited*

MILL AND YARDS AT INGRAM, WISCONSIN

**C. P. CROSBY**  
RHINELANDER : : : WISCONSIN

**Wholesale Hardwood Lumber**

Hard Maple a Specialty in all thicknesses from 1 inch to 4 inch. Finest Birch in Wisconsin. Black Ash, Rock Elm, Soft Elm, Red and White Oak. : :

DIFFICULT AND MIXED ORDERS A SPECIALTY

**North Western Lumber Co.**  
GENERAL OFFICES: EAU CLAIRE, WIS. MILLS AT STANLEY, WIS.

BAND SAWED

**Wisconsin Hardwoods**  
CAREFUL GRADINGS PROMPT SHIPMENTS

SPECIALTIES:  
Inch No. 2 Common Birch Inch No. 3 Common Birch

MIXED CARS - EVEN GRADES - PROMPT SHIPMENT

**Wisconsin Hardwoods**

SPECIAL OFFERINGS:  
1" No. 1 Common and Better Birch (Red in)  
1" No. 1 Common and Better Basswood  
1" No. 1 Common and Better Hard Maple  
Also Elm, Pine, Cedar Products,  
and "SHAKELESS" Hemlock.

**John R. Davis Lumber Company**  
PHILLIPS, : : : : WISCONSIN

**VOLLMAR & BELOW**  
MARSHFIELD, WISCONSIN

**Basswood, Birch**  
and Other Wisconsin Hardwoods

LET US KNOW WHAT YOU ARE IN THE MARKET FOR

**ARPIN HARDWOOD LUMBER CO.**  
GRAND RAPIDS, - - - WISCONSIN  
Saw and Planing Mill at Atlanta, near Bruce, Wis., on Soo Lines.

Manufacturers

**Wisconsin Hardwoods**  
PINE AND HEMLOCK

WRITE US FOR PRICES ON

1, 1½, 1¾ AND 2 INCH PLAIN AND RED BIRCH.	1¾ INCH RED BIRCH.
1 INCH NO. 1 AND NO. 2 BASSWOOD.	RED BIRCH FLOORING.

**Ten per cent  
More Profit**

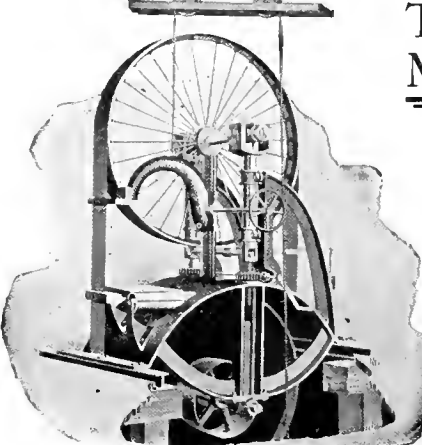

The profits of a saw mill can readily be increased ten per cent by using a band mill instead of a rotary. The price of this mill with six foot wheels for saws eight inches wide is readily within the reach of all. It cuts smooth and perfect lumber and has a capacity of 25,000 feet to 35,000 feet per day. It runs with less expenditure of power than a rotary and puts only half as much of the log into saw dust as does the circular saw.

**PHOENIX MFG. COMPANY,**  
EAU CLAIRE, WIS.

# CLEVELAND

HARDWOOD DISTRIBUTING CENTER OF NORTHERN OHIO

## The King & Bartles Lumber Company

We want to move some 5 4" to 16 4" Wisconsin Birch in pile in our Cleveland yard. We also have a few cars of 1" No. 1 Common and 1sts and 2nds Northern Winter-sawn Basswood, bone dry. We have in pile in Wisconsin for immediate shipment the following:

- 2 cars 4 1" 1sts and 2nds Birch, unselected
- 3 cars 4 4" No. 1 Common Birch, unselected
- 1 car 4 4" 1sts and 2nds Curly Birch, unselected

Send us your inquiries and we will quote you delivered prices.

Yard and Office: No. 1955-2025 Scranton Road, N. W.,

CLEVELAND : : : : OHIO

## MARTIN-BARRISS COMPANY

Importers and Manufacturers

### MAHOGANY

AND FINE

### HARDWOODS

## Do You Want It? What? Money?

What have you in lumber to exchange for it? We want particularly Plain Oak, Chestnut, Poplar, Basswood, Ash.

What Have You?

## The Advance Lumber Co.

13th Floor  
Rockefeller Bldg. CLEVELAND, OHIO

Memphis Office, No. 56 Randolph Building.

J. E. MEADOWS, Mgr.

## THE ROBERT H. JENKS LUMBER COMPANY

### FOR SALE

- 60 M feet 1" 1st and 2ds Poplar
- 223 M feet 1" No. 1 Common Poplar
- 125 M feet 1" No. 2 Common Poplar
- 25 M feet 2" 1st and 2nd Poplar, 14" and up
- 125 M feet 8 4" Sound Wormy Chestnut
- 275 M feet 1" Sound Wormy Chestnut
- 153 M feet 1" 1st and 2nd Plain White Oak
- 85 M feet 1" 1st and 2nd Plain Red Oak
- 125 M feet 1" No. 1 Common Plain Red Oak

**Quartered White and Red Oak.**—We have a good assortment of dry stock, 3/8 to 4 inches thick. Your inquiries solicited.

**Plain White and Red Oak.**—A limited amount of nice stock, ready for shipment.

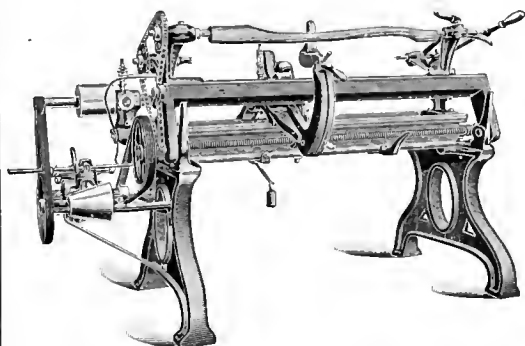

This cut shows the **No. 1 OBER LATHE** for turning Axe, Adze, Pick, Sledge, Hammer and Hatchet Handles, Spokes, Whiffletrees, Gun Stocks, Lasts and other irregular work.

## Simple, Strong, Durable, Economical

We also manufacture other lathes for making handles, spokes and variety work, sanders, shapers, boring and chucking machines, rip saws, etc., etc. Complete catalogue and price list free.

## THE OBER MFG. CO.

28 Bell St., Chagrin Falls, O., U. S. A.



# MICHIGAN

FAMOUS FOR HARD MAPLE AND GREY ELM

W. H. WHITE, Pres.  
JAS. A. WHITE, Vice-Pres.

W. L. MARTIN, Secy.  
THOS. WHITE, Treas.

## W. H. WHITE COMPANY

BOYNE CITY, MICHIGAN

Manufacturers of Hardwood and Hemlock Lumber, Cedar Shingles,  
White Rock Maple Flooring.

### MAY STOCK LIST

MAPLE		BIRCH		BASSWOOD	
1 in.	2,000,000 ft.	1 in.	500,000 ft.	1 in.	300,000 ft.
1 1/4 "	100,000 "	1 1/2 "	100,000 "	1 1/4 "	30,000 "
1 1/2 "	400,000 "	2 "	100,000 "	1 1/2 "	50,000 "
2 "	1,000,000 "	2 1/2 "	50,000 "	2 "	75,000 "
2 1/4 "	200,000 "	3 "	75,000 "	3 "	4,000 "
2 1/2 "	500,000 "	<b>ROCK ELM</b>		<b>GRAY ELM</b>	
3 "	500,000 "	2 in.	25,000 ft.	1 in.	300,000 ft.
4 "	400,000 "	2 1/4 "	50,000 "	1 1/2 "	200,000 "
<b>BEECH</b>		<b>WHITE MAPLE</b>		<b>ASH</b>	
1 in.	500,000 ft.	End Piled		3 "	200,000 "
1 1/4 "	250,000 "	1 in.	100,000 ft.	1 in. 500,000 ft.	
1 1/2 "	400,000 "	1 1/2 "	20,000 "		
2 "	100,000 "	2 "	50,000 "		
2 1/2 "	200,000 "				

KELLEY LUMBER & SHINGLE CO., Traverse City, Mich.

### DENNIS & SMITH LUMBER CO.

Wholesale Hardwood Lumber

Office and Yards, FOURTH AND HOLDEN AVENUES,  
DETROIT, MICH.

MILLS AT • Heaters, W. Va. Valley Bend, W. Va. Diana, W. Va. Parkersburg,  
W. Va. McNutt Siding, W. Va.

"THE THICK MAPLE FOLKS"

## BROWNLEE & COMPANY

DETROIT MICHIGAN

MANUFACTURERS OF

Michigan Hardwoods

DOCKS AND PLANING MILL, RIVER ROUGE, SOUTH DETROIT  
CITY OFFICE, 303 TELEGRAPH BLDG.

### McCLURE LUMBER COMPANY

MANUFACTURERS OF  
Hardwoods

Main Offices, DETROIT, MICH.  
Mills, : EUTAW, ALA.

SPECIAL OFFERINGS:

3 cars 2" Red and White Oak  
3 cars 2", 2 1/2", 3" and 4" White Ash  
2 cars 1" 6 4 White Ash  
2 cars 2" Black Ash  
10 cars 1" to 4" Dry Hard Maple  
5 cars 1" Log Run Birch  
1 car 6 4 and 8 4 Hickory

## RUSSEL WHEEL & FOUNDRY COMPANY

Builders of  
**Logging Cars**  
And **Logging Machinery**

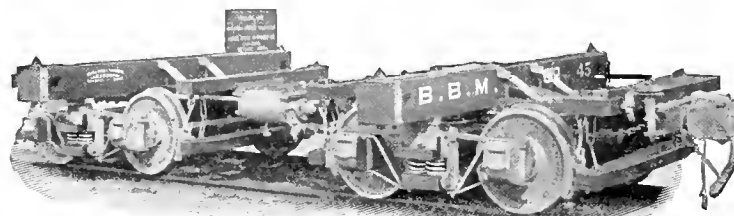

ARE ALWAYS PLEASED TO  
HAVE OPPORTUNITY OF  
POINTING OUT ADVAN-  
TAGES OF THEIR  
EQUIPMENT.

**Detroit, Mich.**

# MICHIGAN

FAMOUS FOR RED BIRCH AND BASSWOOD

## BOYNE CITY LUMBER COMPANY

BOYNE CITY

MICHIGAN ROCK MAPLE and other HARDWOODS

LARGE CAPACITY PROMPT SHIPMENTS RAIL OR CARGO



## J. S. GOLDIE

Cadillac, :: Michigan.

SPECIAL PRICES on 5 in. Maple Squares, Maple and Basswood Lumber.

1 in. and 3 in. Northern Michigan Soft Elm.

INQUIRIES SOLICITED ON ALL HARDWOODS.

## SOFT ELM AND ROCK ELM

FOR SALE BY

### The R. G. Peters Salt & Lumber Co.

EASTLAKE, MICHIGAN

## VAN KEULEN & WILKINSON LUMBER COMPANY

Manufacturers and Wholesalers of

### HARDWOOD LUMBER and CRATING STOCK

Complete Stocks of Michigan Hardwoods—Maple, Beech, Birch, Elm, Ash and Basswood for sale.

Grand Rapids, : : : Michigan

## OUR MAPLE FLOORING

is as near perfection, in every particular, as it is possible to make it, for we personally supervise every step in its manufacture, from the stump to the shipping of the finished product. Our prices will interest and a trial convince you : : :

## HAAK LUMBER COMPANY

HAAKWOOD, MICHIGAN

## Hackley-Phelps-Bonnell Co.

MANUFACTURERS OF

### Northern and Southern Hardwood Lumber

Main Office, Michigan Trust Company Building

GRAND RAPIDS : : : MICHIGAN

## DENNIS BROS.

GRAND RAPIDS, : : : MICHIGAN

MANUFACTURERS OF

### Hardwood Lumber, Perfect Birch and Maple Flooring

#### DRY STOCK AT BARGAIN PRICES:

2 cars 8 4 Basswood, No. 1 Common and Better.  
3 cars 5 4 Basswood, No. 2 Common and Better  
15 cars 4 4 Birch, No. 1 and 2 Common  
1 car 1x4 Clear Birch Strips.  
2 cars 4 4 No. 3 Common Cherry.  
60M feet 12 4 Hard Maple.  
245M feet 8 4 Hard Maple.  
40M feet 8 4 Hard Maple, No. 3 Common.

Main Office :  
205-209 Michigan  
Trust  
Company  
Building

## Thos. MacBride Lumber Company

HEADQUARTERS FOR

### HARDWOODS

IN MICHIGAN

Michigan Trust Building, Grand Rapids, Mich.

## BIRCH

This is our specialty. We are in the heart of the best Birch section. Have good stock, Common and better, 4-4, 5-4, 6-4, 8-4, 10-4, 12-4, and 16-4. Let us figure with you.

## Simmons Lumber Company

SIMMONS, MICHIGAN

## The North Shore Lumber Co.

MANUFACTURERS

### Hardwood and Hemlock Lumber, Cedar Products

Rail and water shipments

THOMPSON :: : MICHIGAN

# CINCINNATI

THE GATEWAY OF THE SOUTH

## WANTED

Oak  
Walnut  
Gum  
Cottonwood  
Poplar  
White Pine  
Hemlock  
Yellow Pine

Will inspect at shipping point when quantity justifies and pay cash. Can use entire mill cuts. Write us before selling elsewhere. We can also handle mixed cars of dressed stock. Send us your list with prices.

**Kentucky Lumber Co.**

Suite 508 First National Bank Bldg  
Cincinnati, Ohio.  
Formerly of Brnside, Ky

## CYPRESS LUMBER CO.

Manufacturer of Hardwoods and Cypress

Plain and Quartered White and Red Oak, Yellow Poplar, Yellow Pine, Walnut, etc. Mills in Tenn., Ala. and Va.

OFFICE AND YARDS, GEST AND DALTON AVE., CINCINNATI, OHIO.

## "BUY GUM"

We are in the market to buy Dry Gum Lumber in any quantity, from a single car load to a million feet. Will take all grades and thicknesses. We receive lumber at shipping point, pay cash and are liberal in inspection.



**THE FARRIN-KORN LUMBER COMPANY**

General Office, Yards,  
Planing Mills, Dry Kilns,  
Cincinnati, Ohio  
Purchasing Office,  
Randolph Building,  
Memphis, Tenn.  
Cypress Red Gum Oak

## E. H. FALL

EXPORTER  
OF

WALNUT, POPLAR  
AND  
BIRDSEYE MAPLE LOGS

Cash paid for Black Walnut Logs at point of shipment. If you have any walnut logs to offer, write me. I have some Sycamore, Red Oak, Ash and other hardwood logs which I am prepared to saw to order. Correspondence solicited. Can also supply Black Walnut lumber, sawed to any specification required.

PORT CLINTON : OHIO

FRAMES,  
SASH, DOORS,  
BLINDS, MOULDINGS,  
COLUMNS, GLASS,  
STAIRWORK,  
INTERIOR TRIM.



PAINTS,  
BUILDERS' HARDWARE,  
MANTELS, ETC.  
LARGE CINCINNATI FAC-  
TORIES MAKE PROMPT  
SHIPMENTS POSSIBLE.

## PLAIN OAK—BASSWOOD

Are what we want. All thicknesses and grades. Spot cash. Send us list of your offerings with prices.

DUHLMEIER BROS., CINCINNATI, O.

## The Kentucky Lumber & Veneer Co.

HARDWOOD MANUFACTURERS

Post Office and Band Mill,  
ROEBINS, KY.

Shipping Point and Telegraph Office,  
JACKSON, KY.

Specialties:

PLAIN WHITE OAK OAK PLANKING  
YELLOW POPLAR RAILROAD TIES

We manufacture all the lumber we sell from original forest timber. Therefore the lengths and widths are good. All logs are manufactured in ten to thirty days after being felled, insuring bright, new stock, free of sap worms and rot.

WRITE OR WIRE FOR PRICES.

## THE GENERAL LUMBER COMPANY

**HARDWOODS**  
HEMLOCK, YELLOW PINE.

COLUMBUS OHIO

The only trade paper reaching all classes of hardwood consumers

HARDWOOD RECORD  
355 Dearborn St., Chicago

# W. H. Dawkins Lumber Co.

Manufacturers of Band Sawed

## Yellow Poplar

ASHLAND, KY.

# CINCINNATI

THE GATEWAY OF THE SOUTH

## BENNETT & WITTE

MANUFACTURERS OF SOUTHERN HARDWOODS

THAT ARE SOLD  
ON NATIONAL HARDWOOD LUMBER ASSOCIATION  
INSPECTION ONLY.

Plain and Quartered . . . } White and Red Oak  
Red and Sap Gum

Cottonwood, Ash, Cypress, Poplar, Soft Maple, Tmpelo  
Gum and Chestnut. We cut Gum and Oak in Thick-  
nesses of 3/8 to 4 inches. EXPORT AND DOMESTIC.

224 W. 4th Street, CINCINNATI, OHIO

Branch: 1301-2 Tenn. Trust, Memphis, Tenn.

## Cincinnati Hardwood Lumber Co.

Cash buyers for stock in our line.  
BEST AND SUMMER STRIETS  
Wholesalers Mahogany, Thin Lumber, Veneers  
Finely figured quarter sawed oak veneers a specialty.

## Red and White OAK Qtd. and Plain

ALSO POPLAR, CHESTNUT, WALNUT, ETC.  
JOHN DULWEBER & CO., CINCINNATI, OHIO

IN THE MARKET FOR

## OAK-ASH-POPLAR

ALL GRADES AND THICKNESSES

## MOWBRAY & ROBINSON

Office:  
1219 West Sixth Street

Yards:  
Sixth Street, below Harriet

## THE E. E. BECK LUMBER COMPANY

Cash Buyers  
Poplar, Oak, Chestnut

And Other Southern Hardwoods  
ALL GRADES AND THICKNESSES. WE BUY MILL CUTS.



## THE FREIBERG LUMBER CO.

Manufacturers of  
Tabasco Mahogany  
Walnut, Oak  
Poplar, McLean and Findlay Aves.  
CINCINNATI, O.

# THE WIBORG & HANNA COMPANY

CINCINNATI, OHIO

PLAIN  
AND  
QUARTER  
SAWED

## White and Red Oak

CHESTNUT  
POPLAR  
GUM AND  
CYPRESS

Flooring, Siding, Ceiling, Base, Case and Molding. Rough, Dressed and Re-sawed. Mixed Carloads.

## THE MALEY, THOMPSON & MOFFETT CO.

Always in the Market for  
BLACK WALNUT LOGS,  
SELECTED WHITE OAK LOGS,  
LUMBER OF ALL KINDS.

CINCINNATI, : : : OHIO

## C. Crane & Co.

Poplar, Oak,  
Ash, Chestnut,  
Sycamore,  
We would like to buy  
2,000,000 feet Dry Oak  
2,000,000 feet Dry Poplar  
W. Va. Spruce.  
Pine and Elm Mostly heavy stock. Quotations Solicited.

MILLS AND YARDS  
CINCINNATI, O.  
YEARLY CAPACITY  
100,000,000 FT.  
LONG BILL STUFF  
A SPECIALTY

## L. W. RADINA & COMPANY

Correspondence Solicited with Buyers and Sellers of All Kinds of  
HARDWOODS  
Wanted for cash—desirable blocks of 1 inch to 4 inch Poplar, all grades,  
Especially 1 1/4-inch stock, for immediate shipment.  
CLARK STREET AND DALTON AVENUE

# CHICAGO

THE GREATEST HARDWOOD MARKET IN THE WORLD

## Heath-Witbeck Company

### Hardwood Lumber

We have for quick shipment 170,000 feet DRY BIRCH, First and Seconds and Common 2, 2½, 3 and 4 inch.

Main Office and Yards: Loomis and 22nd Streets,  
CHICAGO

## Lesh & Matthews Lumber Co.

1649-50 MARQUETTE BUILDING

Are now offering bone dry BIRCH, ROCK ELM, BLACK ASH, etc., Wisconsin stock. Also PLAIN AND QUARTERED OAK, POPLAR, etc., from our Memphis yard. We are constant buyers.

## THE WARD LUMBER COMPANY

MANUFACTURERS OF  
HARDWOODS

CHAMBER OF COMMERCE BUILDING :: CHICAGO

WE solicit your inquiries and would be pleased to quote you on the following stock, which is in our Chicago yards:

1,000,000 ft 1 to 4 in Louisiana Red Cypress.	5,000 ft 3 in 1st and 2nd Maple.
300,000 ft 1 to 2 in Plain Oak.	20,000 ft 2 in 1st and 2nd Maple.
40,000 ft 3 in Quartered Sawed White Oak.	40,000 ft 1½ in Yellow Pine Finish.
80,000 ft 1½ and 2 in Birch.	20,000 ft 2 in Yellow Pine Finish.
30,000 ft 1 in Common Red Birch.	50,000 ft 1 in Yellow Pine Finish.
	20,000 ft 2x18 in and wider Yellow Poplar.

Also a good assortment of Yellow Pine Flooring, Ceiling, Maple Steps, Poplar Squares, 4x4 inch Spruce Squares, etc.

## CRANDALL & BROWN

Yards and Office, 3300 Center Avenue, CHICAGO

## CLARENCE BOYLE LUMBER CO.

Wholesale Dealers in **Hardwoods** Yellow Pine and Cypress

319 WEST TWENTY-SECOND STREET :: CHICAGO

FRED W. BLACK, President

HORACE W. BLACK, Secretary

## FRED W. BLACK LUMBER COMPANY

MANUFACTURERS OF

HARDWOOD LUMBER

305 Old Colony Building

## Estabrook-Skeele Lumber Co.

203 FISHER BUILDING, CHICAGO

We are in the market for

### Wagon Stock

REACHES, BOLSTERS, TONGUES, AXLES, ETC., AND

Hardwood Lumber

PARTICULARLY WANT WHITE ASH AND HICKORY

TELL US WHAT YOU HAVE TO OFFER

## The Keith Lumber Company

HARDWOOD, POPLAR & SOUTHERN PINE LUMBER,

MAHOGANY,

REDWOOD,

RED CEDAR,



CYPRESS,

CHESTNUT,

SPRUCE,

MAPLE FLOORING, OAK TIMBERS & WAGON STOCK.

Office and Yards: Fourteenth and Wood Streets.

## SOUTHERN OAK LUMBER CO.

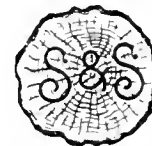

WE WANT TO BUY FOR CASH

OAK  
CYPRESS  
ASH

MILL CUTS OR ROUND LOTS

910 CHAMBER OF COMMERCE 1217 TENNESSEE TRUST BLDG.

CHICAGO

MEMPHIS

YARDS: NORTH MEMPHIS

# BUFFALO

THE GREAT WHOLESALE LUMBER CENTER OF THE EAST



Manufacturers and Dealers in

Ash

White and Brown

Basswood

Birch

Red and White

Butternut

Cherry

Chestnut

Cottonwood

Cypress

Elm

Soft and Rock

Gum

Red and Tupelo

Hickory

Maple

Hard and Soft

Red Oak

Plain and Quartered

White Oak

Plain and Quartered

Black Walnut

White Wood

Poplar



## G. ELIAS & BROTHER

BUY AND CARRY LARGE QUANTITIES OF ALL KINDS OF HARDWOODS

955 TO 1015 ELK STREET

## HUGH McLEAN LUMBER COMPANY

Specialty: INDIANA WHITE OAK

940 ELK STREET

## ANTHONY MILLER

HARDWOODS OF ALL KINDS

893 EAGLE STREET

## SCATCHERD & SON

HARDWOODS ONLY

Yard, 1555 SENECA STREET

Office, 886 ELLICOTT SQUARE

## STANDARD HARDWOOD LUMBER CO.

OAK, ASH AND CHESTNUT

1075 CLINTON STREET

## I. N. STEWART & BROTHER

Specialties: CHERRY AND OAK

892 ELK STREET

## T. SULLIVAN & COMPANY

Specialties: BROWN ASH, BIRCH, PACIFIC COAST FIR AND SPRUCE

50 ARTHUR STREET

## ORSON E. YEAGER

Specialties: OAK, ASH AND POPLAR

932 ELK STREET

## BEYER, KNOX & COMPANY

ALL KINDS OF HARDWOODS

Office and Yards, 69 LEROY AVENUE

## BUFFALO HARDWOOD LUMBER CO.

We want to buy for cash:

Oak, Ash and other Hardwoods, all grades and thicknesses.  
Will receive and inspect stock at shipping point.

518 RANDOLPH BLDG., MEMPHIS, TENN.

940 SENECA STREET.

## EMPIRE LUMBER COMPANY

Our specialties are PLAIN and QUARTERED OAK and ASH.

1142 SENECA STREET.



# Vansant, Kitchen & Co.

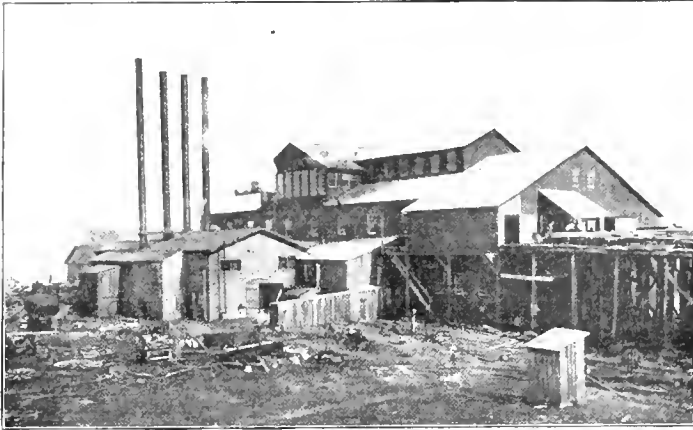

NEW ASHLAND MILL

Old-Fashioned

## YELLOW POPLAR

Ashland, Kentucky

5/8 AND WIDE STOCK SPECIALTIES

# YELLOW POPLAR

Manufacturers  
BAND SAWED  
POPLAR LUMBER

ALL GRADES

**DRY** 5-8, 4-4, 5-4, 6-4, 8-4, 10-4, 12-4, 16-4  
Bevel Siding, Lath and Squares  
Specialty, Wide Stock.

# LUMBER CO.

COAL GROVE, OHIO, U. S. A.

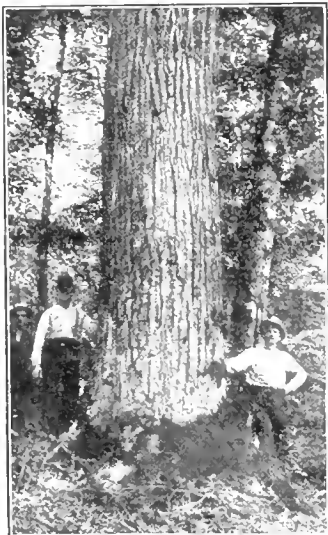

Specimen of Our Poplar Timber

W. M. Ritter Lumber Co.

MAIN OFFICE: COLUMBUS, OHIO

## YELLOW POPLAR

White Oak, Basswood, Chestnut,  
Ash, White Pine and Hemlock

We Want Your Business

Stock all band sawed, square edged, equalized. Dry Kilns,  
Planing Mills, Dressed Stock, Bevel Siding, Drop Siding



Specimen of Our Oak Timber

# Hardwood Record

Eleventh Year. Semi-monthly.

CHICAGO, MAY 25, 1906.

Subscription \$2. Single Copies, 10 Cents.

## CHERRY

C. E. LLOYD, JR.  
Manager Sales

## RIVER

GROWS IN  
WEST VIRGINIA

Sold by  
Cherry River Boom &  
Lumber Co.  
Offices: Philadelphia, Pa.

## LUMBER

## RED GUM

We produce and market a carload of Gum Lumber  
: every 45 minutes during the working day. :

Himmelberger-Harrison Lumber Co.  
Morehouse, : : Missouri

# Conflagration Proof Insurance

This is a correct description of the indemnity furnished by this Company, owing to the special class of business written. The money saving feature combines to make the contract offered a most desirable one for lumber dealers and wood workers. Correspondence solicited.

PRESENT RATE OF DIVIDEND TO POLICY HOLDERS 33 1/3%

## THE LUMBER MUTUAL FIRE INSURANCE COMPANY, OF BOSTON

The Davidson-Benedict Company

NASHVILLE, TENNESSEE

Everything in

## Southern Hardwoods

POPLAR, CHESTNUT, ASH, OAK  
(Plain and Quartered.) Straight or Mixed Cuts.

DRESSED POPLAR ANY WAY YOU WANT IT. YOU GET WHAT YOU BUY FROM US. ASK FOR OUR DELIVERED PRICES, ANY RAILROAD POINT.

WE WANT TO MOVE

## QUARTERED WHITE OAK

125,000 1 inch No. 1 and No. 2.  
500,000 1 inch No. 1 Common  
300,000 1 inch No. 2 Common  
100,000 2 inch No. 1 Common Red Oak.  
400,000 1 inch Sap Cull Poplar.  
STOCK TWO YEARS DRY

## THE ATLANTIC LUMBER CO.

2 Kilby Street. BOSTON, MASS.

# ADIRONDACK FIRE INSURANCE COMPANY

CAPITAL AND SURPLUS, \$300,000.

LUMBER AND WOODWORKING RISKS EXCLUSIVELY.

A new company organized to further serve the patrons of the Lumber Insurance Company of New York, 66 Broadway, New York, and allied organizations.

Home Office: 66 Broadway, NEW YORK



# CADILLAC

CELEBRATED FOR HIGH STANDARD OF QUALITY AND MILL WORK

## Thick Hard Maple

Cut during the winter of 1904-5.

10-4 1's and 2's . 51,000 ft.

12-4 1's and 2's . 55,000 ft.

16-4 1's and 2's . 10,000 ft.

This stock was sawed in our own mill and has been seasoned in a first-class manner. It is largely 12 inch and wider and very choice.

We also have end-dried in shed:

4-4 Birdseye Maple, 8,000 ft.

5-4 White Maple . 21,000 ft.

PLEASE SEND US YOUR INQUIRIES.

## Mitchell Brothers Company

CADILLAC, MICHIGAN

## Cummer, Diggins & Co.

MANUFACTURERS  
"CUMMER" MAPLE  
AND BEECH FLOORING

## MICHIGAN HARDWOODS

Good assortment of dry stock on hand ready for immediate shipment in Hard Maple, Beech, Birch, Soft Elm and Cherry.

SEND US A LIST OF YOUR REQUIREMENTS.

## MURPHY & DIGGINS

Offer all grades of the following special dry stock

MAPLE—5/4, 6/4, 8/4, 10/4, 12/4, 14/4, 16/4  
GRAY ELM—4/4, 12/4  
BASSWOOD—4/4  
BIRCH—5/4, 6/4

Our own manufacture. Perfect Mill Work. Uniform Grades.

LET US FIGURE ON YOUR HARDWOOD WANTS.

## Michigan Hardwoods

### DRY STOCK

<b>HARD MAPLE</b>	}	360 M feet 5/4 Nos. 1 and 2 Common
		185 M feet 6/4 1s and 2s
		340 M feet 6/4 Nos. 1 and 2 Common
		38 M feet 12/4 1s and 2s
		1 1/2 M feet 16/4 1s and 2s
	2 M feet 16/4 Common	
<b>SOFT GRAY ELM</b>	}	145 M feet 4/4 Nos. 1 and 2 Common
		50 M feet 4/4 No. 3 Common
		18 M feet 6/4 1s and 2s
		27 M feet 6/4 Nos. 1 and 2 Common
		47 M feet 6/4 No. 2 Common and Better
		180 M feet 8/4 1s and 2s
		24 M feet 8/4 Nos. 1 and 2 Common
		20 M feet 8/4 No. 2 Common and Better.
		10 M feet 10/4 1s and 2s
		39 M feet 12/4 1s and 2s
	3 1/2 M feet 1x4 Clear Face and Better	
	8 M feet 4/4 No. 1 Com. & Bet. Saw Culls	

Our lumber is graded according to the rules of the National Hardwood Lumber Association.

## The Cadillac Handle Co.

. . . Band Sawn . . .  
Michigan Hardwoods

We offer for Rail Shipment from Cadillac:  
2 cars 8/4 Maple, No. 1 Com. & Better  
1 car 5x5 Maple, Select Stock  
2 cars 4/4 Basswood, No. 2 Com & Bet.  
2 cars 4/4 Birch, No. 2 Com. & Bet.

Also the following for Water Shipment:  
100,000 feet of 4/4 Basswood  
100,000 feet of 4/4, 8/4 and 12/4 Soft Elm  
150,000 feet of 4/4, 5/4 and 6/4 Birch



**COBBS & MITCHELL**  
(INCORPORATED)  
**CADILLAC, MICHIGAN**



# MEMPHIS

THE HUB OF THE HARDWOOD WORLD

## ANDERSON-TULLY COMPANY

STOCK LIST, MAY 15, 1906

<b>COTTONWOOD.</b>		<b>ASH.</b>	
20 M ft. 7 8" 1st & 2nd, 8" up	15,000 ft. 4 4" 1st & 2nd Strips, 2 1/2" to 5 1/2"		
200 M ft. 4 4" 1st & 2nd, 6" up	5,000 ft. 4 4" Common.		
14 M ft. 4 4" 1st & 2nd, 7"-10"	12,000 ft. 5 4" & 6 4" No. 3 Common.		
25 M ft. 4 4" 1st & 2nd, 11"-12"	<b>GUM.</b>		
40 M ft. 4 4" 1st & 2nd, 18" up	60,000 ft. 4 4" 1st & 2nd Saps, 13" to 16"		
15 M ft. 5 4" 1st & 2nd, 6" up	60,000 ft. 4 4" 1st & 2nd Saps, 16" and up.		
20 M ft. 5 4" 1st & 2nd, 12"	50,000 ft. 4 4" No. 1 Common Red.		
35 M ft. 5 4" 1st & 2nd, 11" & 12"	100,000 ft. 4 4" No. 1 Common Sap.		
45 M ft. 6 4" 1st & 2nd, 6" up	60,000 ft. 4 4" 1 & 2 Red Strips, 2 1/2" to 5 1/2"		
50 M ft. Wagon Box Boards, 3" to 12"	<b>POPLAR.</b>		
	20,000 ft. 4 4" Common & Better.		
<b>CYPRESS.</b>	<b>RED OAK.</b>		
20,000 ft. 4 4" Clear Strips, 2 1/2" to 5 1/2"	1,750 ft. 4 4" Quartered 1 & 2.		
<b>WHITE OAK.</b>	2,930 ft. 4 4" Quartered Common.		
4,000 ft. 4 4" 1 & 2 Quartered	14,440 ft. 4 4" Plain 1 & 2, 12" and up.		
6,500 ft. 4 4" Com. Quartered	50,000 ft. 4 4" Nos. 2 & 3 Com. Red & White.		

J. B. Ransom, Pres't. A. B. Ransom, V.-Pres't. W. A. Ransom, Sec. C. R. Ransom, Treas.

## GAYOSO LUMBER CO., Inc.

MANUFACTURERS AND DEALERS IN

## SOUTHERN HARDWOODS

Also make a specialty of Wagon Stock in rough, such as Tongues, Axles, Reaches, Bolsters, and 6-4 to 16-4 Hickory.

F. W. GILCHRIST, President  
W. A. GILCHRIST, Vice President  
W. E. SMITH, Sec'y and Treasurer

## W. E. SMITH LUMBER CO.

Manufacturers of  
**HARDWOOD LUMBER**

Mills, Tennessee, Arkansas, Mississippi  
Distributing Yards, Cairo, Illinois  
General Office, Tennessee Trust Bldg.

MISSISSIPPI VALLEY COTTONWOOD

F. W. GILCHRIST, Pres. W. A. GILCHRIST, Vice-Pres.  
W. E. SMITH, Sec'y and Treas.

## Three States Lumber Co.

MANUFACTURERS OF

Mills: Hardwood Lumber Office  
Missouri Arkansas Tennessee Trust  
Tennessee Cottonwood and Gum Building

GET OUR PRICES. TRY OUR LUMBER  
WE SHIP ROUGH, DRESSED, RESAWED

COTTONWOOD GUM

## Briggs & Cooper Company, Ltd.

MANUFACTURERS

NORTHERN SOUTHERN **HARDWOODS**

GET OUR PRICES ON THESE ITEMS

1,000,000 feet Soft Grey Elm, 1 to 3".	
500,000 feet Unselected Birch, 1 to 3".	
3,000,000 feet Michigan Hard Maple, 1 to 6".	
350,000 feet End Dried White Maple, 1 to 1 1/2".	
625,000 feet No. 1 Common and Better Winter Sawn Basswood, 1 to 3".	
150,000 feet Selected White Basswood, 1", 1 1/4" and 1 1/2".	
210,000 feet Plain and Quartered White and Red Oak 1 to 2".	

YARDS AT

SAGINAW, CHICAGO AND MEMPHIS

## BACON-NOLAN HARDWOOD CO.

Manufacturers of

Band Sawn Oak, Ash  
Gum, Cypress, Etc.

Office, Memphis, Tenn. Mills, Chancy, Miss.

Address all correspondence to Memphis office.

**WE** have in all thicknesses the following kinds and amounts of lumber at places designated. Kindly send us your inquiries.

<b>MEMPHIS YARD:</b>		<b>SELMA YARD</b>	
Ash.....	680,000 feet	Poplar.....	409,000 feet
Quartered White Oak.....	75,000 feet	Bay Poplar.....	857,000 feet
Plain White Oak.....	140,000 feet	Red Gum.....	55,000 feet
Quartered Red Oak.....	225,000 feet	Cypress.....	787,000 feet
Plain Red Oak.....	410,000 feet	<b>BERCLAIR YARD</b>	
Cypress.....	225,000 feet	Bay Poplar.....	100,000 feet
Cottonwood.....	200,000 feet	Cypress.....	800,000 feet
Poplar.....	308,000 feet	<b>OTHER YARDS</b>	
		Plain Red Oak.....	350,000 feet

## J. W. THOMPSON LUMBER COMPANY

Office and Yards: Randolph Road and I. C. R. R. : : MEMPHIS, TENN.

Nelson H. Walcott, Pres't. Frank E. Stonebraker, Vice-Pres't.  
Chas. C. Gardiner, Sec'y and Treas.

## THE CRITTENDEN LUMBER CO.

MANUFACTURERS

MILLS AT EARLE, ARK.

**ST. LOUIS**

LARGEST OF ALL HARDWOOD MARKETS

**Wanted—Cypress, Ash and Cottonwood**

INSPECTION AT POINT OF SHIPMENT WHEN QUANTITY JUSTIFIES

**Hafner Manufacturing Co.**

CYPRESS, HARDWOODS

Mail orders receive our immediate attention.

YARDS: FOOT OF DOCK STREET

**Stoneman-Zearing Lumber Co.**

203 Frisco Building

We have the following Dry Stock for sale piled at our mill:

QTD. WHITE OAK :	COTTONWOOD :
3 Cars 4 4 Common.	3 Cars 1" 1 and 2.
2 Cars 4 4 Common and Better Strips	1 Car 1x13 to 17" Box Boards.
GUM :	ELM :
5 Cars 1" Common Red.	1 Car 6 4 Log Run.
1 Car 1x13 to 17" Box Boards.	4 Cars 4" Log Run.
1 Car 2" 1 and 2 Sap.	
6 Cars 1 3/4 Common and Better Sap.	

This Stock is All Band Sawed and Equalized

**Thomas & Proetz Lumber Co.**

CASH BUYERS OF OAK, ASH, CYPRESS, POPLAR, CHERRY AND ALL

**HARDWOODS**

SEND INSPECTOR WHEN QUANTITY JUSTIFIES

Office and Yards: Hall and Angelrodt Sts.

**Garetson-Greaseon Lumber Co.**

MANUFACTURERS OF SOUTHERN HARDWOODS

**GUM LUMBER  
OUR SPECIALTY**

Carload Shipments Direct from Our Own Mills

519 Bank of Commerce

**LOTHMAN CYPRESS CO.**

AIR DRIED

**Louisiana Red Cypress**

FOOT OF ANGELICA STREET

**SIX MILLION FEET**

Ash, Oak, Cypress, Poplar, Etc.

READY FOR PROMPT SHIPMENT

**STEELE & HIBBARD**

NORTH BROADWAY, DOCK AND HALL STREETS

**Ozark Cooperage Co.**

Roland F. Krebs, Manager Hardwood Department

WE BUY STOCKS READY CUT OR CONTRACT FUTURE OUTPUT

Four Inspectors in the South

Direct Shipments from mill stocks COTTONWOOD, CYPRESS, GUM, OAK. MAIN OFFICE, FRISCO BUILDING

**W. R. CHIVVIS,** Lesperance Street and Iron Mountain Railroad.

WHOLESALE HARDWOODS

BLACK WALNUT LUMBER MY SPECIALTY. Always in the market to buy Walnut and Cherry Lumber. Pay spot cash and take up at shipping point when amounts justify.

**CHAS. F. LUEHRMANN HARDWOOD LUMBER COMPANY**

Carry a complete stock of Hardwood and are constantly in the market to purchase large blocks of stock for cash. Are also the largest manufacturers of the famous St. Francis Basin Red Gum.

General Offices: 148 Carroll Street



# Schultz Brothers & Benedict

WE ARE IN THE MARKET TO BUY

POPLAR—OAK—ASH—CHESTNUT

AND OTHER HARDWOODS—ALL GRADES AND THICKNESSES

1225 to 1240 OLD COLONY BUILDING,

CHICAGO

## “MICHIGAN” MAPLE FLOORING

- ☞ Our model factory is equipped with the highest class tools and appliances made for flooring production, and is operated by experts.
- ☞ We produce our lumber from the best Rock Maple area in Michigan, and have twenty years' supply.
- ☞ The brand “Michigan,” our Trade Mark, is a guaranty of quality. Will be glad to quote prices on large or small orders.

WARD BROTHERS,

∴

∴

BIG RAPIDS, MICH.

## Swann-Day Lumber Company

MANUFACTURERS OF

**POPLAR AND OAK**

PLANING MILL STOCK, BOX SHOOKS  
AND HARDWOOD DIMENSION

CLAY CITY, KENTUCKY

## PAEPCKE-LEICHT LUMBER COMPANY

MANUFACTURERS OF

**COTTONWOOD**  
**GUM AND OTHER HARDWOODS**

Large stocks of well seasoned Lumber always carried at our yards and mills.

General Offices: 140 W. Chicago Ave., CHICAGO. Mills: Cairo, Ill., Marked Tree, Ark., Greenville, Miss., Arkansas City, Ark., Blytheville, Ark.

**THE EAST**  
 BOSTON NEW YORK PHILADELPHIA

**WILLIAM WHITMER & SONS, Inc.**

MANUFACTURERS OF

**HARDWOODS**

We are always in the market for round lots of well manufactured stock, and shall be pleased to enter into correspondence with manufacturers with a view to purchase.

Girard Trust Building  
 PHILADELPHIA, Pa.

**Jones Hardwood Co.**

(INCORPORATED)

**WANTS**

Poplar, Plain Oak, Quartered Oak and Cypress

Manufacturers please send stock lists and prices

147 MILK STREET, BOSTON, MASS.

**STEVENS-EATON CO.**

Buyers of  
 ROUND LOTS  
 of

**Hardwoods**

No 1 Madison  
 Avenue,  
 NEW YORK

ESPECIALLY IN MARKET FOR PLAIN RED OAK

**WM. E. LITCHFIELD**

MASON BUILDING, BOSTON, MASS.

**Specialist in Hardwoods**

Manufacturers are requested to supply lists of stock for sale

**Charles S. Wentworth & Co.**

WHOLESALE LUMBER MERCHANTS

147 Milk Street  
**BOSTON**

We are in the Market for POPLAR, PLAIN OAK, CYPRESS and NORTH CAROLINA PINE LUMBER; also OAK, MAPLE and BIRCH FLOORING, and would appreciate correspondence from manufacturers in position to supply any of the stock named.

J. J. SOBLE

H. I. SOBLE

**SOBLE BROTHERS**

Wholesale Hardwoods

911-912 Land Title Bldg. PHILADELPHIA

WANTED: 20 cars Common and Better Chestnut, all thicknesses.

J. H. SCHOFIELD

R. W. SCHOFIELD

**SCHOFIELD BROTHERS**

WHOLESALE LUMBER

Hardwoods a  
 Specialty.

1020-22 Pennsylvania Building  
 PHILADELPHIA

**HEADQUARTERS FOR HARDWOODS  
 WE BUY AND SELL--WHOLESALE--**

The McIlvain's have been lumber merchants continuously for over one hundred years.

We have 20,000,000 feet of all kinds of lumber from which to fill your orders satisfactorily, if you are a buyer.

We want large lots of choice, dry Hardwoods to round up our stocks again after the late fire. What have you for sale? Get McIlvain's "Lumber News" and "Stock List" for June.

**J. Gibson McIlvain & Co.**

58th and Woodland Ave.,

PHILADELPHIA, PA.

**Wistar, Underhill & Co.,**

WHOLESALE

**HARDWOOD LUMBER**

816 Real Estate Trust Building, PHILADELPHIA.

**Holloway Lumber Company**

WHOLESALE HARDWOODS

In the market for all thicknesses of  
 OAK, ASH and CHESTNUT.

312 Arcade Building,  
 PHILADELPHIA, PA.

# NASHVILLE

HEADQUARTERS FOR ALL SOUTHERN HARDWOODS

## JOHN B. RANSOM & CO.,

NASHVILLE, TENNESSEE

We want to move quickly the following old dry stock. All of it has been on sticks 6 to 18 months. Write us for delivered prices. We are prepared to furnish promptly mixed cars of rough and dressed hardwoods of all kinds:

QUARTERED WHITE OAK		QUARTERED RED OAK	
90 M	4 4 first and second	100 M	4 4 first and second
15 M	5 4 first and second	58 M	6 4 first and second
80 M	6 4 first and second	15 M	8 4 first and second
10 M	10 4 first and second	95 M	4 4 No. 1 Common
120 M	4 4 No. 1 Common	84 M	6 4 No. 1 Common
65 M	6 4 No. 1 Common	72 M	8 4 No. 1 Common
58 M	8 4 No. 1 Common		
20 M	10 4 No. 1 Common	PLAIN OAK	
70 M	5 8 first and second Poplar	50 M	4 4 1st and 2nd White
80 M	5 8 No. 1 Common Poplar	100 M	4 4 No. 1 Common White
15 M	4 4 1st and 2d Quartered Sycamore	100 M	4 4 first and second Red
10 M	4 4 No. 1 Com. Quart'd Sycamore	100 M	4 4 No. 1 Common Red

## Nashville Hardwood Flooring Co.

Manufacturers of

### "Acorn Brand"

THE FAMOUS FAULTLESS FLOORING  
IN OAK AND BEECH.

Car Lots and Less Than Car Lot  
Orders Solicited. Write for Prices.

Nashville, Tennessee

## GEO. C. BROWN & CO.

MANUFACTURERS AND WHOLESALE DEALERS IN

### Hardwood Lumber

Tennessee Red Cedar Lumber a Specialty

NASHVILLE, TENNESSEE

## LOVE, BOYD & CO.

Offer:

5,000,000 ft. Quartered White Oak.  
2,000,000 ft. Quartered Red Oak.  
1,000,000 ft. Plain White Oak.  
1,000,000 ft. Plain Red Oak.  
1,000,000 ft. Poplar.  
2,000,000 ft. Chestnut, Ash, Hickory, Red Cedar, Etc.

Our Own Manufacture.  
Prompt Service.  
Dry Stock.

MAIN OFFICE,  
NASHVILLE, TENNESSEE

## INDIANA LUMBER CO.

Manufacturers Lumber

DIMENSION STOCK A SPECIALTY.

Office and Mills: Corner Oldham  
Street and Cumberland River

NASHVILLE, TENN.

No. 1, No. 2 and No. 3 Common  
Poplar, 4-4, 5-4, 6-4, 8-4. For sale by

## The Loomis & Hart Manufacturing Co.

Chattanooga, Tennessee

WRITE FOR PRICES

## Vestal Lumber & Mfg. Co.

Manufacturers and Wholesalers  
of all kinds of

### HARDWOODS

BEVELED SIDING A SPECIALTY.  
UNSURPASSED FACILITIES  
FOR DELIVERING.

Knoxville  
Tennessee

## Upham & Agler

American Trust Building  
CHICAGO

Wholesale Northern and Southern  
**Hardwoods**

Quick Service  
Perfect Milling  
Right Prices

DISTRIBUTING YARD: CAIRO, ILLINOIS

# PITTSBURG

HARDWOOD DISTRIBUTING CENTER OF PENNSYLVANIA

## Babcock Lumber Co.

MANUFACTURERS OF  
**PENNSYLVANIA  
HARDWOODS**  
23,000,000 FEET ANNUALLY

LONG ON MAPLE  
AND CHERRY

MILLS AND OFFICE  
ASHTOLA, PA.

## Dry Stock for Quick Shipment:

12,189 ft 4 4 clear Quartered Oak	66,232 ft 4 4 No. 1 Common Poplar
14,570 ft 4 4 1st & 2ds qtd. Red Oak	10,315 ft 6 4 1st & 2ds Poplar
30,302 ft 4 4 No. 1 Com. Red Oak	56,000 ft 4 4 1st & 2ds Cottonwood
63,204 ft 4 4 No. 1 Com. Pl White Oak	119,000 ft 4 4 No. 1 Com. Cottonwood
4,417 ft 5 4 No. 1 Com. Pl White Oak	159,000 ft No. 2 Common Cottonwood
5,934 ft 6 4 No. 1 Com. Pl White Oak	90,000 ft 1 4 Mill Cull Cottonwood
23,473 ft 4 4 1st & 2ds Plain Red Oak	110,000 ft 5 4 No. 1 Com. Cottonwood
14,168 ft 4 4 1st & 2ds Poplar	40,000 ft 5 4 No. 2 Com. Cottonwood

## American Lumber & Mfg. Co.

PITTSBURG, PA.

## The Nicola Brothers Company

One million feet 4-4 Bay Poplar.  
Can be shipped log run, or sold  
on grade. Bone dry; band  
sawed. Send your inquiries.

## Flint, Erving & Stoner Co.

Wholesale Lumber  
Northern and Southern Hardwoods

Beech and Maple Timbers a Specialty

## A. M. Turner Lumber Company

Everything in lumber. We buy hardwoods  
as well as sell them. If you have anything  
to offer, please submit same to us.

## Linehan Lumber Company

PERFECT

## MAPLE FLOORING

SEND US YOUR INQUIRIES

## Willson Bros. Lumber Co.

MANUFACTURERS

**WEST VIRGINIA  
HARDWOODS**

FARMERS BANK BLDG. :: PITTSBURG, PA.

## Hardwoods a Specialty

FOR SALE

POPLAR	CHESTNUT	PLAIN OAK
125,000' 4 4 1s and 2s	200,000' 4 4 Sound Wormy	60,000' 4 4 No. 1 Com.
40,000' 4 4 No. 1 Com.	80,000' 5 1 Sound Wormy	18,000' 4 4 No. 2 Com.
325,000' 4 4 No. 2 Com.	100,000' 6 4 Sound Wormy	<b>QUARTERED OAK</b>
228,000' 4 4 No. 3 Com.	48,000' 8 4 Sound Wormy	2 cars 4 4 No. 1 Com.
150,000' 4 4 Mill Cull		1 car 4 4 No. 2 Com.

OAK TIMBERS SAWED TO ORDER.  
WRITE FOR PRICES.

CHEAT RIVER LUMBER COMPANY, Pittsburg, Penna.

## OAK FLOORING

Kiln Dried  
Bored  
Polished



Hollow  
Backed  
and  
Bundled

## Timber Bonds

SECURED BY FIRST MORTGAGE ON TIMBER LANDS

### H. C. Barroll & Co.

BANKERS, First National Bank Building, CHICAGO.

H. B. LEAVITT, PREST.  
E. H. ADAMS, SECY.

B. F. RICHARDSON, VICE-PREST.  
J. G. LEAVITT, TREAS.

## THE LEAVITT LUMBER CO.

MOST COMPLETE STOCK OF HARDWOODS IN  
CHICAGO

MAKE KNOWN YOUR WANTS AND GET  
IMMEDIATE RESULTS

Mills:  
WISCONSIN  
TENNESSEE  
ARKANSAS  
LOUISIANA  
MISSISSIPPI

General Office and Yard  
CENTER AVE. NEAR 35TH ST.  
Southern Office:  
715 TENNESSEE TRUST BLDG.  
MEMPHIS, TENN.

## THE "FINEST" MAPLE FLOORING

### W. D. YOUNG & CO.

BAY CITY, MICHIGAN.

Producers from TREE to TRADE of the highest type of Michigan Forest Products. Large stock of Maple Flooring and 15,000,000 feet of Hardwoods—1 to 4 inches thick—on hand.

### Maple, Birch and Beech Lumber

## "Ideal" Steel Burnished Rock Maple Flooring

is the flooring that is manufactured expressly to supply the demand for the best. It is made by modern machinery from carefully-selected stock and every precaution is taken throughout our entire system to make it fulfill in every particular its name—"IDEAL."

Rough or Finished Lumber—All Kinds

Send us Your Inquiries

### The I. Stephenson Company

WELLS, MICHIGAN

## White and Red Oak

Secure our special prices on the following dry stock We need the piling room.

30,000 feet 7-4 and 8-4 Quarter Sawn.  
150,000 feet 4-4 1st and 2nds Clear Plain Sawn.  
200,000 feet 4-4 No. 1 Common Plain Sawn.  
200,000 feet 4-4 No. 2 Common Plain Sawn.

We also manufacture chair and table stock. Let us figure with you. Address all communications to

### Dierks Lumber & Coal Company

Mills: DE QUEEN, ARK. KANSAS CITY, MISSOURI

INCORPORATED 1902.

## The Michigan Maple Company

WHOLESALE

### MICHIGAN HARDWOODS

HENRY W. CAREY, President  
HENRY N. LOUD, Vice Pres  
WILLIAM P. PORTER, Vice Pres  
WILMER T. CULVER, Secretary  
WILLIAM H. WHITE, Treasurer  
EDWARD BUCKLEY, Director  
G. VON PLATEN, Director  
MARSHALL F. BUTTERS, Director  
HARRY NICHOLLS, Director

609-611 Mich. Trust Bldg.,

GRAND RAPIDS, MICH.

## Wolverine Brand Maple Flooring

="THERE IS NONE BETTER" =



It is the same old story, but we want you to know what WOLVERINE BRAND will do for you, and what it will cost you. We want to do this before you place your next order. If we make you quotations, we expect the quality and prices will get your order. TRY US.

### BLISS & VAN AUKEN

900 S. Niagara St., Saginaw W. S., Mich.

# Hardwood Record

Published in the Interest of Hardwood Lumber, American Hardwood Forests, Wood Veneer Industry, Hardwood Flooring, Hardwood Interior Finish, Wood Chemicals, Saw Mill and Woodworking Machinery.

Vol. XXII.

CHICAGO, MAY 25, 1906.

No. 3.

Published on the 10th and 25th of each month by

## THE HARDWOOD COMPANY

HENRY H. GIBSON, President      FRANK W. TUTTLE, Sec.-Treas.

### OFFICES

Sixth Floor Ellsworth Bldg., 355 Dearborn St. Chicago, Ill., U.S.A.  
Telephones: Harrison 4960      Automatic 5659

### TERMS OF ANNUAL SUBSCRIPTION

In the United States, Canada, Philippine Islands and Mexico . . . \$2.00  
In all other countries in Universal Postal Union . . . . . 3.00

Subscriptions are payable in advance, and in default of written orders to the contrary are continued at our option.

The entire contents of this publication are covered by the general copyright, and articles must not be reprinted without special permission.

Entered at Chicago Postoffice as Second Class Matter.

Advertising copy must be received five days in advance of publication date. Advertising rates on application.

### General Market Conditions.

From a review of the market reports from practically every hardwood trade center in the United States, found in this issue of the HARDWOOD RECORD, a very encouraging view may be taken of the situation. The demand seems to be strong all along the line, with a general strengthening of values. However, there is apparently a disposition on the part of some large consuming buyers to make their purchases with a good deal of caution, refusing to place new orders until shippers fulfil old contracts. The markets throughout the East manifest even more strength than in the middle West. In this great consuming center, Chicago, trade seems to lack vim. A good deal of lumber is being placed, but apparently the trade is being forced.

In times of general commercial prosperity, with advancing values, it often happens that all woods do not receive their just proportion of accretion in price. Just now it is particularly noticeable that the standard northern hardwoods—maple, gray elm, birch, basswood and beech—are not commanding nearly the proportionate price that has been obtained for oak, chestnut, white ash, hickory, poplar and even cottonwood. During the last three or four years the advance in the price of northern woods has been very moderate as compared with the high values achieved by the southern woods. Apparently these woods have been overlooked, as certainly the intrinsic value of maple, birch and gray elm particularly for a multitude of purposes, is not exceeded by any other woods growing in the United States. Beyond question, in relativity of value, either northern hardwoods are too low or southern hardwoods are too high.

There are some encouraging signs of a betterment in prices of northern woods given in the several reports from northern sections, but still the increase in demand and value is not sufficient to warrant the opinion that these hardwoods are reaching a just scale of value.

Plain oak, chestnut, white ash, poplar and cottonwood still remain exceedingly scarce, at high values. The output of northern woods has been pretty well absorbed for the season by jobbers and wholesale consumers, but the price is far from being satisfactory. What stock remains in the hands of manufacturers is dragging.

### Money.

Students of monetary affairs profess to see some clouds on the horizon. Undeniably the banks of New York and Chicago and of some of the other chief commercial centers are short of money. The interest rates are increasing and a good many loans are being called in.

Some explanation of the condition of the New York money market may be found in the figures of the banks themselves, as disclosed in comparative statements of the Clearing House Association. The figures of last Saturday showed that compared with one year ago there has been a decrease in deposits of over \$138,000,000. A year ago the figures stood at \$1,165,151,700; Saturday's figures were \$1,026,832,900. Such a shrinkage in deposits has necessarily caused a curtailment in loans, and that item on Saturday showed a contraction of \$94,000,000 as compared with a year ago. The money that naturally should have grown in volume with the New York banks in the last two years has steadily declined. The country has grown wealthier and prosperity has been unabated, but demands have gradually increased from commercial borrowers, and the money to satisfy such needs is now being distributed by the country banks themselves.

Western country banks are being besieged by metropolitan institutions today for rediscounts. High finance as practiced in the conduct of New York insurance companies and certain railroads as well and the relations of a good many bank officials to these institutions has brought its punishment to the financial center of the United States in the way of a withdrawal of confidence. Chicago banks gained a good deal by this situation until within the last few months, when they have had some untoward events of their own, and are now suffering in a milder way, but still suffering. The money which naturally would have come back from the country for deposit in New York and Chicago has remained with the country institutions, and they are now large buyers of commercial paper.

There is nothing of a serious, menacing nature in the financial situation, but at the same time it would seem wise for lumbermen, who notoriously depend very largely on banks for money, to keep a little nearer shore, and exercise a good deal of conservatism in the conduct of enterprises, which, however promising, may fail of fulfillment owing to a handicap for easy money.

### American Agricultural Implements Abroad.

One of the American consuls in South Africa says that if all American exporters showed the same energy in selling their wares abroad that is shown by the agricultural machinery man, the United States would soon become the leading nation in foreign commerce. The Cape Town Journal states that the energetic American drummer selling agricultural machinery is not satisfied with keeping his stock in central store-rooms or with being a regular exhibitor at the shows. He endeavors to bring his machinery to the gate of every farm. Wherever he can sufficiently engage the attention of the farmer he gives an experimental demonstration of his machines. The result of a tour of this character is a large number of orders, which more than repays the heavy outlay incurred. Thus it will be seen that American agricultural implement producers are pursuing exactly the same business methods abroad that they did at home for years. During 1904 more than half the farm implements and agricultural machinery imported into South Africa came from the United States.



### Necessary and Unnecessary Legislation.

Congress is at present occupied in going through its usual practice of playing politics rather than determining just legislation. The country is promised a much-needed railroad rate bill. The country may get it and may not. At least this bill is out of the way until the Conference Committee shall make its report. This nation ought to have the rate bill, but if Congress promptly enters upon its appropriation campaign and makes a rash to adjourn, as is customary, the people will have to get along without the rate bill for a while. There are other bills that should be passed, notably the one for reduction of duties on sugar and tobacco coming from the Philippines. But apparently it is not good politics and will not be passed.

There is a Senate bill in the House which is a just and righteous one and which calls for prompt action. It is the pure food bill. Legislation is surely needed, and there is a popular demand for it. However, certain congressmen have discovered that it will not be good politics to pass a pure food bill, and therefore it will probably die.

The most foolish measure and the one which seems more likely to pass than any mentioned is the bill to take the tax off alcohol used for industrial purposes. An exploitation campaign has been made for months in rural districts to instruct farmers that with the tax off alcohol all the waste farm products can be made into this liquid, which would mean a great deal to them. There is probably but a medium of truth in this statement, but it has been received with popular acclaim, and members of Congress are urged to adopt the measure.

A few years ago there fell to the lot of northern lumbermen a large area of hardwood timber land, which, previous to the exhaustion of white pine timber, was regarded so nearly valueless as to be scarcely worth owning and paying taxes on. Lumber manufacturers who had plants in northern Michigan, Wisconsin and extreme north-eastern Minnesota, to which hardwood timber was contiguous, were anxious to maintain their residence and means of livelihood in the sections with which they were familiar. Serious study, comprehensive experimentation and the highest approved methods combined, showed conclusively that the lumber business *per se*, as previously practiced in soft woods would not show a reasonable profit in the manufacture of northern hardwoods. These lands showed from four to ten thousand feet of hardwood timber per acre, interspersed with hemlock. Unlike the old pine proposition, where the lands were stripped comparatively clean, less than fifty per cent of the forest was merchantable timber. For years this contingent of the lumber trade exercised all the talent and ingenuity of which they were possessed to invent plans whereby the offal of the forests might be utilized to place the business on a paying basis. Eventually they struck upon the production of charcoal, wood alcohol and acetate of lime. Today when the foremost manufacturers of Michigan and Wisconsin produce a million feet of lumber they make at the same time about five hundred cords of wood—almost an equivalent quantity—whilst they charcoal, and from the gases and fluids produce wood alcohol and acetate of lime. With this extension of the hardwood lumber industry of the North it has been placed upon a reasonably profitable basis, and many millions of dollars have been expended in plants for the production of these by-products. These institutions employ thousands of workmen. With a tax being continued on grain alcohol a fair profit remains to manufacturers of northern hardwoods. With free grain alcohol and the consequent lowering of the value of both the grain and wood alcohol product it is more than likely that the business would again be placed on an unprofitable basis. The general contention that it is not wisdom to legislate so that one industry is made possible only by the disruption of another is true, and thus it would seem that there is no result of any value to be obtained from the enactment of a free alcohol bill.

If there is any measure this country needs it is legislation to promote forest economy to the complete utilization of forest products. In a general way it may be stated that old methods of lumbering have not insured in the form of merchantable commodities more than thirty per cent of the standing timber. There can be but very little value in the free alcohol bill to the farmer, and it is a serious menace

to the hardwood industry of this country as a whole. It is sincerely to be hoped that the bill will fail.

### West Bound Hardwood Freight Rate.

Even without a rate bill to enforce their just demands the hardwood lumbermen of the country should have no great difficulty in demonstrating to the transcontinental freight lines that the rate of eighty-five cents on hardwood lumber from Mississippi valley points to the Pacific coast is not only out of proportion but is unjust. With the passage of the pending rate bill doubtless there would not be the least contention on the part of railroads against reducing this rate, and with it pending it is quite likely that at the forthcoming meeting of the Transcontinental Freight Association Committee at Chicago on June 4 they will deem it wise to seriously consider the claims of hardwood manufacturers and make some concession in the current rate.

The hardwood growth of the Pacific coast is so meager as to amount to almost nothing, and with the popular tendency to finish commercial and home buildings in hardwoods and to use hardwood floors it would seem logical that the railroads should try to encourage the shipment of hardwood lumber from the middle West and South to the Pacific coast, rather than permit these commodities to be imported from Australia and the Orient.

Committees from the National Lumber Manufacturers' Association, the Wisconsin Hardwood Lumbermen's Association, the Hardwood Manufacturers' Association of the United States, and the National Hardwood Lumber Association will all attempt to get a hearing before this freight committee and present their claims for reduction of the eighty-five cent rate.

### Ethics of Trade Journalism.

Tell the truth when saying nothing is not kindlier. "It is the wise newspaper man who knows what to leave out of his paper." Warn the trade against impending evil, either in men or conditions, but don't tramp on a man after he's down.

Stick to your line, and what you do, do well. If a contemporary develops a new field of work and handles it justly, don't try to steal his business from him. Don't be a hog.

Don't distribute half the papers you print to "prospective" advertisers free of charge. They're a boomerang. Make a newspaper worth while and the advertiser will chase you.

Be as careful in admitting concerns to your advertising columns as the conservative man is in his line of credits. A trade newspaper cannot afford to accept business from advertisers of questionable repute.

Be original. Start something—but don't start anything you can't finish. Be enterprising; be forceful; be just; be plain; and your paper will be successful.

Above all things, be honest—not because "honesty is the best policy," but because it is the essence of common sense.

### Sawmilling in Japan.

The Japanese are excellent carpenters, but have never undertaken lumber operations on a very extensive scale. Representatives of the United States government in Japan allege that it would be possible for Americans to establish sawmills on the Yalu to advantage, as timber can be purchased from the authorities. The Japanese government exercises a timber monopoly on that river.

The demand for lumber in China is constantly increasing. The imports of softwood into Shanghai and Tientsin alone amount to about \$350,000 gold annually. Native woods are never properly seasoned, for they are generally transported in the log and sawed as needed for immediate use by primitive whip-saw methods. Large mills operating at Yongampo or Antuny would be able to take advantage of low labor cost and of cheap transportation by junks, which make the voyage to Tientsin or Chefoo in from five to ten days. The consular agent furnishing the above information is of the opinion that such an enterprise would not only supply a long-felt want in China, but would be of undoubted profit to its owners.

# Pert, Pertinent and Impertinent.

## The Shine.

If his work won't stand inspection,  
He's a shine;  
If he whines at each reflection,  
He's a shine;  
If he puts a strong inflection  
On his I's, there's some defection  
In his cerebral collection—  
He's a shine.

If he always makes objection,  
He's a shine;  
If he cannot stand correction,  
He's a shine;  
If, through spirituous affection,  
He removes his recollection  
After every big election,  
He's a shine.

If his life won't stand dissection,  
He's a shine;  
If his wit is past detection,  
He's a shine;  
If he shows a predilection  
Toward abusive interjection  
When he misses his connection,  
He's a shine.  
—STRICKLAND W. GILLILAN.

## The Same.

To bear defeat with dignity is to win a victory.

## Whiners.

Those who complain of life being a burden are always a burden to others.

## And Rightly.

Invariably he who borrows trouble gets the worst of the transaction.

## Poor Bait.

There are men who make a specialty of manufacturing promises on which they hope to make money.

## A Comparison.

Man may be likened to a razor in that he must be thoroughly strapped occasionally in order to demonstrate how sharp he is.

## How True.

Money can be lost in more ways than won.

## Some Consolation.

The faint heart that fails to win fair lady may have reason for self-congratulation later in the game.

## The Last the Best.

If you have great talents be thankful; if you have small talents be satisfied; if you have only capacity for work, work for all there is in it, and the results will not be disappointing.

## One and the Same.

Show us a man who can be trusted and we will show you one who has a lot of debts.

## Good Advice.

Have enough arguments on hand to overcome objections, but don't talk so much that your customer is unable to think.

## Stepping Stones.

If nothing succeeds like success, it is because success begets self-confidence, and self-confidence begets the confidence of others.

## The Difference.

A man loves a woman for the qualities which she possesses which he admires in women; a woman admires the characteristics which a man possesses because she loves him.

## A Pessimist.

"A pessimist is a man who, being offered the choice of two evils, immediately and eagerly seizes them both."

# FIRE AND TAXES



The Enemies of Practical Forestry.

## A Fact.

It is easier to induce two hearts to beat as one than it is to induce two mouths to eat that way.

## Push.

Pull often gets the job, but it is usually push that keeps it.

## To Be Avoided.

Being under obligations to a bad man is about the same as being obliged to be bad.

## A Russian Proverb.

A debt is adorned by payment.

## Versatile.

It is only an auctioneer who can admire equally and impartially all schools of art.

## Why Worry?

Few can recall an anticipated calamity that actually came to pass.

## Wise Plan.

The great disregard trifles.

## True.

Too much publicity has spoiled many a good deed.

## Bad Sign.

Signing your name to a friend's note is a bad sign.

# AMERICAN FOREST TREES.

THIRTY-FOURTH PAPER.

## Water Elm.

*Planera aquatica.*—Gmel.

The range of growth of water elm is from the valley of the Cape Fear river, North Carolina, to western Florida; westward through the southern sections of Alabama and Mississippi to the Trinity river in Texas; north through western Louisiana and Arkansas to the southern districts of Missouri, western Tennessee, central Kentucky and the valley of the Wabash river.

In Alabama it is known as the American planetree; in North Carolina, South Carolina, Florida, Louisiana, Texas, Arkansas and Tennessee as the planer tree; as plene in Louisiana; as sycamore in North Carolina; and most commonly as water elm, this being the name applied to it in many localities. The generic name, *Planera*, is given to the tree in memory of a German botanist and physician of the eighteenth century.

The planer tree or water elm should not be confused with the larger plane tree, often known as buttonwood. The tree is confined in its growth to wet banks along rivers, or to the immediate vicinity of lakes and ponds. It thrives particularly well in swamps covered with water during a large part of the year, and reaches its greatest development and abundance in southern Arkansas and western Louisiana. Water elm rarely attains a height of more than seventy feet; the trunk is comparatively short, and rarely exceeds thirty inches in diameter. Its slim, spreading branches form a low, broad head, giving it a rather graceful appearance.

The leaves are two to two and a half inches long, on short petioles; dark green in color, resembling those of the white elm; they are paler on the under side, with yellowish midrib and veins; serrate, sometimes doubly. The branchlets are tinged with brownish-red when young, becoming dark red during their first winter, and eventually turning ashy gray.

The flowers of water elm appear simultaneously with the leaves, and the fruit ripens in September. It is a rough, tough-skinned nut, about a quarter of an inch through, but quite different from the fruit of elm, which is winged.

The bark is perhaps a quarter of an inch thick, separating into large scales, disclosing the reddish inner bark in falling, as

does that of buttonwood. The wood is light, not strong, and soft. It is close-grained and light brown, with thick, white sapwood showing plainly the layers of annual growth.

In the earlier days of lumber production in the South, water elm was not regarded as a commercial wood of any importance, but

piano men prefer the northern gray elm.

The HARDWOOD RECORD must confess that it is not entirely certain that it has correctly analyzed the botany of this wood. Herewith is shown a specimen of forest growth which was photographed by the editor in Washington county, Mississippi, and accompanying it is a print of the foliage as it appears in May.

## Forest Fires.

Michigan has had another costly lesson in mismanagement of forest affairs. Dispatches from Escanaba of May 19 state that an ocean of flame has swept over the timber regions of a large portion of the northern peninsula of Michigan and across the line into Wisconsin. The counties suffering the greatest damage are Menominee, Dickinson, Delta, Marquette and Alger. It is said that a number of persons are dead and more than a hundred missing. Scores of families are homeless and a dozen lumber towns have been wiped out of existence, or badly burned.

A stretch of timber land over two hundred and fifty miles in length, running from Newberry in Luce county on the east to Bessemer in Gogebie county on the west, and north and south between Lakes Superior and Michigan, has been dotted with fires for the past ten days. The flames spread over into Wisconsin and swept as far south as Peshtigo, covering a large part of Marinette county. The lumber towns reported partially or entirely destroyed are Alfred, Antoine, Birch, Cornell, Daggett, Foster, Hermansville, Loomis, Metropolitan, Niagara, Northland, Pentoga, Powers, Quinnesee, Ralph, Salva, Saunders, Spalding, Spring Valley, Talbot and Woodland. All the foregoing towns were located in Michigan. The I. Stephenson Company of Wells is reputed to be a heavy loser by the fire. Beyond the loss of life, sawmills, homes and lumber the damage to the forest must be stupendous.

The range of this fire was so far-reaching that it will be weeks before an accurate estimate of the loss can be made. It is sincerely to be hoped that the newspaper accounts of the conflagration are over-estimated, but certainly the calamity is serious enough to awaken the legislature of the state of Michigan to the need of providing adequate means for a system of fire rangers, and thus safeguard the remaining standing timber of that state.



TYPICAL FOREST GROWTH WATER ELM, WASHINGTON COUNTY, MISSISSIPPI.

with the growing scarcity of hardwoods it is now coming into the market in a considerable aggregate quantity. The lumber is not of as high a type as the gray elm of the North, but compares favorably with northern water elm. Its chief use is in the making of medium and low grade furniture, and for some portions of pianos manufacturers find it valuable, although generally speaking the

## Suggestions to Small Sawmill Men.

### SEVENTH PAPER.

To the sawmill man who makes a specialty of wagon and agricultural implement material, this season of the year is a problem. Practically all institutions using stock of this kind specify that it shall be cut after the sap goes down in the fall and before it rises in the spring; in other words, during the summer season, from May 1 to September 1, oak and hickory for wagon and implement purposes should not be cut. There is reason for this and some logic in the requirement, of course, but unfortunately the logic and the millman's conditions do not always harmonize. It is invariably true that during the summer months millmen can get more and better help and the roads are always in more favorable condition for hauling than in the winter; consequently, there is a strong tendency to cut such stock in the summer. Moreover, quite a number of millmen do this right along.

There is no question but that it is best to cut stock during the winter months, considering only the matter of quality of the stock and the problem of seasoning. Summer cut timber checks badly as well as stains and is much more inviting for insects than winter-cut, and the trade should seek to do more cutting in the winter, even when the roads are bad, and have the stock ready to haul when they are good. A few may do this, but generally when the small sawmill man cuts timber he wants to get the logs into the mill promptly and get them worked up. He does not, as a rule, figure on cutting them in the winter and sawing in the summer.

However, notwithstanding the fact that cutting timber during the winter has certain elementary advantages, there is something to be said favorable to summer cutting. Hickory axle stock, for example; while specifications always call for winter-cut stock, there are not only large quantities of it cut after the sap begins to rise, but the cutting of it at that time offers certain advantages, chief among which is that it facilitates taking the bark off the log. Hickory bark is very difficult to remove, and to keep saws sharp and do good work the best thing to do before starting in to saw a log is to chop off the bark with an axe. In the early summer when the sap has risen hickory timber can be cut and the bark opened up and peeled off with comparative ease. Many have undoubtedly seen hickory trees girdled and a section of the bark peeled off in clearing for a new farm, and have noted how the bark shelled off in great sections. Stories about the Indians making canoes of these hickory bark shells are familiar to all. Thus it will be seen that the early summer is a good time to cut hickory, notwithstanding all that has been and may be said to the contrary. The

writer has seen it done many times and has known of numerous instances of such stock being sold to people, who are sticklers for winter-cut material, and being accepted without question.

However, there is one thing that should not be overlooked in cutting hickory and oak at this time of year—they must be protected from the sun. The best plan is to keep them in a log pond, for as long as they are in water they will be all right, and it does not make a bit of difference when they are cut. In this connection it may be well to state that while practically all hickory logs will sink with the bark on, many will float if peeled. In the absence of a log pond



PRINT OF WATER ELM FOLIAGE, HALF SIZE.

for storing stock cut at this season, the best thing to do is to work it up immediately after it is cut. Recently one of the government foresters showed the writer a picture of a pile of fine oak logs which had laid in the sun until the ends cracked so badly that they were reduced in value about one-half. This was a good illustration of how timber is wasted through lack of consideration in handling.

Lumber from trees cut at this time of the year requires more careful handling than if cut and piled in the winter. In fact, checking is so bad in some instances that the cull loss is very heavy, and it seems almost necessary to shut down the mill until fall. This trouble can be remedied somewhat by painting the ends of the logs and dipping them in some of the various mixtures to prevent the sap from drying out. Another safeguard against checking is to pile stock

in the shade, where it is cool and comparatively damp. In a two-story mill, for example, axles may be piled in the basement, where they will be protected from the sun and hot winds. By putting them up carefully on dry sticks they will check but very little. If the same pile were put out in the sun, no matter how carefully arranged, much good material would be ruined as the ends of the logs would crack open. This is especially true in the South, where the summers are long and hot.

A very important thing to guard against in piling hickory stock is to be sure that it is entirely free from bark. If there is just the smallest piece of bark on an axle it may be assumed as a foregone conclusion that by the time the axle is dry the sap part of it will be full of worm holes. Old inspectors of axles make it a point to look for bark the first thing, and when they see a piece of bark on the corner of an axle they throw it out. When the bark is removed the outside dries out and becomes hard and shell-like and is practically proof against worms, which will bore their way in wherever there is bark. In parts of the South there are certain insects that get into hickory timber in spite of every effort, but that is a different problem, and the first thing to do under any circumstances as a preventive is to strip the logs absolutely clean of bark. In working oak, while there is not so much trouble from insects, practically the same logic holds good with regard to taking off the bark, piling in a shed or protecting in some way from the hot winds and sun, the idea being to retard the process of drying. Care should be taken, of course, not to pile stock so close as to shut out the air so that it is liable to mildew.

Logs which are kept in water are thus water-seasoned, so-called, and stock cut from them does not check as badly or require as much attention in handling as air-seasoned stock. The water absorbs certain elements of sap and the logs are practically the same as winter-sawed. Thus it will be seen that by exercising a little care it is not only possible but practicable to make wagon and agricultural implement material throughout the summer, and for all practical purposes it is as good and will sell as well as winter-cut stock. A little experimenting along this line is good training, even for the man who cuts wagon stock only in the winter and spring, because it is in a direction that needs more attention from lumbermen. Better care of the lumber on hand should replace the present continual effort to increase output. It is not the amount of timber cut, but what is gotten out of it, that counts. Experiment, study and attention in seasoning timber is worthy of consideration on general principles, and it is especially important to the man who desires to cut wagon and implement stock during the summer months.

By  
Idah McGlone Gibson

## 'SHORTY'

WHEN THE CROSS-CUT MAN QUIT HIS CUSSIN'.

Supplement Illustration

by Robt. L. Stearns.

Night was shutting down in the mountains.

The cook-shanty of the logging camp on the Big Laurel reverberated with the cheerful clatter of tin cups set noisily on the table, and the racket of knives and forks against the heavy stoneware plates. There was much good-natured raillery, which was as rough as the hearty slap on the back with which the brawny woodsmen punctuated a sentence or pointed a joke. The long day's work was over and the men were eating the coarse fare with the gusto that hunger brings to appetite. The day's cut had been a big one, and each man secretly rejoiced that his strength had made possible an aggregate accomplishment that would make the "bunch" on the next job over on Hell-Fer-Sartin creek "hump" itself to surpass.

Bill Anderson, whom the boys called "Shorty," and proudly proclaimed that "no lumber hick could beat him and Long Tom when it came to fellin' a tree," was unusually quiet, and consequently came in for more than his share of the rough horse-play and questionable jokes.

"Shorty's gettin' mealy-mouthed," said Big Pete. "The gray mare stepped on his foot this mornin', and he never let out a cuss-word."

"Have you got religion, Shorty?" asked Jim, the teamster.

Shorty persisted in a good-humored silence, although Long Tom looked at him a little anxiously, as though rather expecting an explosion. Just then the door was pushed open and the tote-boy came in laden with bundles and mail from town. Quite a number of the men were soon engrossed with letters from home, and an occasional exclamation told of sadness or joy brought by the missives. One by one, however, they finished their letters and again began their noisy eating and rough joking. All at once someone noticed that Shorty was gazing with rapt expression at a piece of cardboard of the size and shape of a photograph. One of the men reached over with a laugh and grabbed it from Shorty's hand.

"Did she send yer her picture, Shorty? And does her hair look as red in the photo as it does in the dinin'-room down at the Mansion House?" chuckled Larry, the woods boss.

Instantly Shorty's eyes flashed, and he snatched the picture back. "You go to hell, d—n you!" he shouted with concentrated rage. Then he looked at Long Tom with absolute terror as he murmured to himself, "There, I've broke my promise—I've gone back on my word!"

Long Tom leaned over and said, as he took the card from Shorty's trembling hand, "Boys, you've made a mistake! This is Shorty's kid." And he passed the smiling child-face about the table. It was taken reverently and one or two were seen to brush away a tear as they passed it on, for Shorty's baby was known to be Shorty's all. Her mother died in giving her birth, and last year when she was six Shorty had brought her up to camp. Every lumber jack on the job became her adoring slave at once.

"How she's growed!" "Ain't she pretty, though?" "Bless her little face!" and other admiring remarks failed to have any effect on Shorty, who sat, the picture



SHORTY'S KID.

of despair, only opening his mouth to hopelessly ejaculate. "He kept His word like a gentleman, and I broke mine like a black-guard!"

"Never mind, Shorty," whispered Long Tom, "He'll know you didn't mean it."

"That don't make no difference," answered Shorty doggedly, "I give my word and I've gone back on't."

"What's the matter, Shorty? What're you belly-achin' about?" asked the man who had joked him about the waitress.

"Shut up, you son of a sea-cock," said Long Tom, with an anxious look at Shorty.

"No," said Shorty, answering the look, "I won't do it agin, but if that pie-faced galoot across the table don't stop buttin' in, I'll smash his face for him."

The other man looked more startled than angry and said, "I was only jekin', Shorty; what's the matter with you lately, anyway? From the cussinest gazaboo aroun' the camp you've got to be the dumbest.

Why, I ain't heard you swear in months till you ripped 'em out at me tonight!"

"That's just it, boys," answered Shorty. "I've broke my word and I'm goin' to tell you about it, and I want you to tell me on the square if you think He will overlook it. He was straight goods all through, and I guess I'm a yaller dog." He ended with a sigh.

"Tell 'em about it, Shorty," said Long Tom, as he picked up the photograph and looked at it with a tender smile.

"You know, boys, when I brought the kid up to camp last winter"—there were nods of assent all about the table—"well, ever since she could speak, that visit was the one thing she talked about. You see to the kiddie her dad is the biggest man in the world, and to see him cut down a tree was the dream of her life. She had been promised the trip on her sixth birthday, and I fixed it up with the boss to let me cut the big poplar on the North Fork. You remember the tree—it was eight foot six at the stump, and didn't have a limb for a hundred feet. Boys, I wanted to make a big play for the little gal, and so Long Tom and me, we planned to fell it so it would land in a smooth-bark hickory and make regular fireworks for the kid. I don't think she was any more fussed than I was that mornin'. I toted her to a safe place and told her to stay there 'till I came for her, and then Tom and me, after we ent the kerf true, put the Rex cross-cut into her.

"For a few minits I forgot the baby, but at the first crackle I glanced over to where I'd left her. She was not there! But lookin' round I saw her standin' plumb under the hickory with a big bunch of pink laurel in her arms."

Shorty stopped to wipe the cold drops that had sprung out on his forehead, and there was a strange stillness as with bated breath the men waited until he went on somewhat haltingly: "You know, boys, I've swore all my life. Till lately to hear me talk without cussin' would a' been a surprise to you all. I knew in a minit that nothin' I could do could save my baby, and when the next rippin', tearin' sound came, and the big tree begun to lean, it seemed to pull my heart out. Jes then I heard a little laugh and the kid called, 'Is it goin' to fall now, daddy?' I tell you, boys, thoughts come quick at times like that, and I found myself sayin', 'God, I'm 'shamed to say it—I don't know you very well, but you know me all right enough—won't you save the kid fer me? She's all I've got, and you must have a lot of other



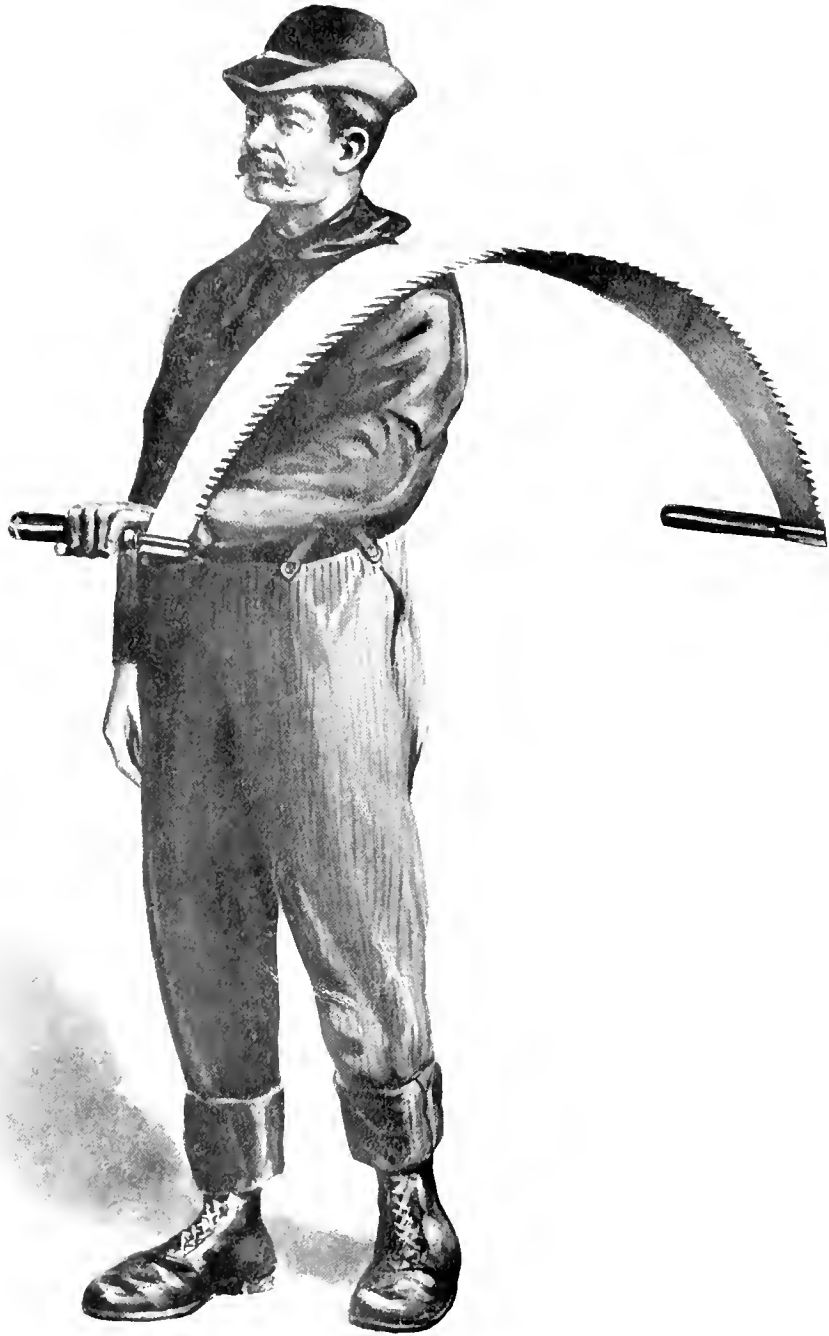

**THE CROSS-CUT MAN**

Redrawn from the original of Robert L. Stearns.



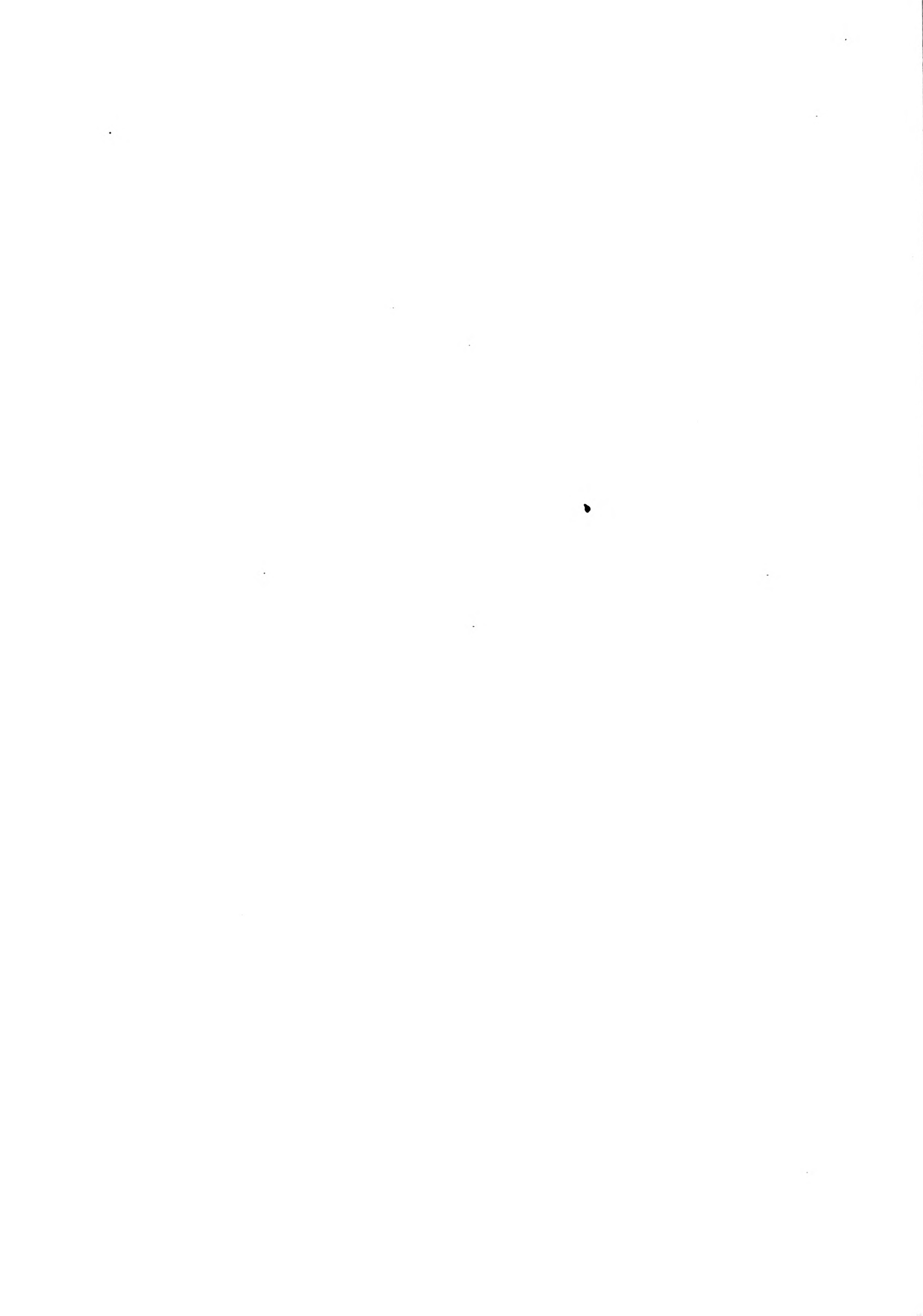

little angels up there.' The tree leaned still farther and I jes' went wild."

Shorty gave a gasp and his head went down on his arms on the table.

Long Tom placed his hands as tenderly as a woman on his comrade's head, and took up the story. "I knew somethin' was wrong, but couldn't make up my mind what it was, for I was on t'other side of the tree liftin' out the saw. I saw Shorty throw up his arms and shout—'Save her, God, and I'll never swear again!'—and I looked where the tree would drop and there square under the hickory was that blessed kid!

"And then, boys, the most wonderful thing happened! That second the poplar dropped straight into the hickory—cuz you know that when me and Shorty can't drop a tree within a foot of where we line her we'll pack our turkeys and take a trip down the hay-road. That hickory bent like an ox-bow with the poplar a'top o' her and the kid under both trees, hidin' her from sight! That hickory weren't more'n twelve inches through, but with that load a'top o' her she straightened back and threwed the big tree a good twenty feet to the right! The kid wasn't even touched

by a leaf, and jes' stood there a-crowin' and a-laughin' at the game her daddy and Long Tom was playin' with her.

"Quicker'n I can tell it Shorty had her in his arms and I thought he never would get through a-huggin' and a-kissin' of her and he made me promise not to say a word about it for fear the baby would get on to the thing and be 'fraid."

Shorty raised his head solemnly as Long Tom paused: "'Twere God that done it—nobody else—and of course He expected me to keep my word, but when I was a-lookin' at the kiddie's picture and thinkin' all about that time, to have that galoot say I was bug-house about a red-headed female lobby-hog was too much.

"I've always 'lowed that there wasn't a hick worth while in the Great Smokies what could get down a tree, drive a yoke of critters or play a decent game of seven-up without cussin', but on the level, boys, I haven't cussed but this once since, and then, *by God, I couldn't help it!*"

Neither Shorty nor his friends noticed that he had made another lapse, "and the Recording Angel, as he wrote it down, dropped a tear upon the word and blotted it out forever."

## Hardwood Record Mail Bag.

[In this department it is proposed to reply to such inquiries as reach this office from the HARDWOOD RECORD clientele as will be of enough general interest to warrant publication. Every patron of the paper is invited to use this department to the fullest extent, and an attempt will be made to answer queries pertaining to all matters of interest to the hardwood trade, in a succinct and intelligent manner.]

### In Market for Gum Flooring.

MEMPHIS, TENN., May 18.—Editor HARDWOOD RECORD: We are in the market for about 250,000 feet of first-class, well-made gum flooring, 1x4 or 1x3—12, 14 and 16 foot lengths. Can you give us the addresses of various manufacturers of this class of stock?—COMPANY.

Manufacturers of the above stock who will send their addresses to this office will be put in communication with the writer of the foregoing letter.—EDITOR.

### Rapid Growth of Wild Cherry.

YOSMITE, KY., May 15.—Editor HARDWOOD RECORD: Apropos of the subject of the rapidity of timber growth discussed in your columns, permit me to state that in the yard of Thomas Carter, three miles west of Moreland, Ky., there is a wild cherry tree planted by Mr. Carter in 1864, at that time the size of a man's little finger. The trunk today measures twenty-eight inches in diameter four feet from the ground. The tree branches at about eight feet from the ground, and the branches are proportionally large.—B. F. MCKINLEY.

### International Lumber & Development Co.

NIAGARA FALLS, N. Y., May 9.—Editor HARDWOOD RECORD: I am somewhat interested in the affairs of the International Lumber & Development Company, which is located at 701 Drexel building, Philadelphia. If you are in a position to give the information, I would like to know what standing this company and its officials have. William H. Armstrong is president; Col. A. K. McClure is vice president, and C. M. McMahon is secretary and treasurer. Are the offi-

cial good honest business men of Philadelphia, and is the company supposed to be a straightforward business proposition? Anything you may be able to give me will be greatly appreciated.

CINCINNATI, O., May 15.—Editor HARDWOOD RECORD: Your paper of May 10 at hand, and the letter contained in the article on page 16, from Col. A. K. McClure, is indeed amusing to say the least, as the writer has just returned from the vicinity in which this company claims to be operating. We believe we could furnish you with some very interesting facts in regard to this, and if at any time you are looking for further information shall be glad to volunteer same. There are any amount of fake companies operating in Laguna and the state of Campeche, and we certainly believe your movement to protect the innocent public from being taken in by schemes is a very good one and deserves assistance, so that those schemers cannot interfere with legitimate business.—LUMBER COMPANY.

### N. L. M. A. Committee on Western Freight Rates.

GRAND RAPIDS, WIS., May 15.—Editor HARDWOOD RECORD: I am in receipt of a letter from Secretary George K. Smith of the National Lumber Manufacturers' Association, stating that the following committee was appointed to take up the western freight rate matter in accordance with the resolution presented by our Wisconsin Association, and passed through the aid of R. H. Vansant, ex-president of the Hardwood Manufacturers' Association of the United States, at the St. Louis meeting: E. P. Arpin, Grand Rapids, Wis., chairman; John B. Ranson, Nashville, Tenn.; Eugene Shaw, Eau Claire, Wis.

We hope to be able to secure a hearing before the next meeting of the Trans-Continental Freight Bureau, which will be held in Chicago on June 4. Also received a good letter from Mr. Doster, secretary of the Hardwood Manufacturers' Association, offering the further co-operation of himself and his association in this matter.

Thanking you for your kind interest in aiding

us in this important question, I remain, yours truly, E. P. ARPIN, President Wisconsin Hardwood Lumbermen's Association.

### The Meaning of "Comb-Grained."

PHILADELPHIA, May 10.—Editor HARDWOOD RECORD: What is the meaning of "comb-grained" as applied to longleaf yellow pine? N. A. PERRY.

Comb-grained is a term early employed in the East, meaning rift or quarter-sawed. It doubtless came about from the surface of the quarter sawed lumber or flooring strips showing the edge or teeth of the winter growth of the wood. The term is rarely employed now, as rift or quarter-sawed has entirely taken its place.—EDITOR.

### Pipe Material Offered.

MICA, N. C., May 23.—Editor HARDWOOD RECORD: Can you put us in touch with some pipe manufacturers who use ivy, laurel and rhododendron roots?—COMPANY.

Any manufacturer in need of this material will, on application to this office, be furnished the address of the above inquirer, who wishes to market the roots named.—EDITOR.

### Looking for Information.

ASHEVILLE, N. C., May 19.—Editor HARDWOOD RECORD: Can you give us any information concerning the Consumers' Lumber Company, whose address is said to be 113 West Twenty-third street, New York City? This company is deluging the small mill operators throughout this section with very alluring literature telling of the fancy prices they can get for lumber in New York, and soliciting consignments. Who is back of this concern, and is it a straightforward business house, or is it trying to rob the small mill men? Yours truly, —COMPANY.

The HARDWOOD RECORD has considerable information concerning the Consumers' Lumber Company which it wishes to verify in detail before telling what the trade generally thinks of it.—EDITOR.

### Coming Meeting of the Southern Cypress Manufacturers' Association.

Secretary George E. Watson of the Southern Cypress Manufacturers' Association is sending out a circular letter to all manufacturers of cypress lumber, urging them to attend the next meeting of the association, which promises to be a large and interesting one. The text of the letter is as follows:

"At a meeting of the members of this association, held at New Orleans May 16, it was decided to hold a meeting at Atlanta, Ga., June 11 and 12, and to invite the attendance of as many manufacturers of cypress as it is possible to assemble together. This action was the result of the earnest request of Georgia and North Carolina manufacturers, who urge the necessity of a general discussion of trade conditions, methods and evils with the idea in view of bringing about greater harmony of action between the Louisiana manufacturers and those in the states named. The importance of such a meeting is very apparent when the limited area of cypress production and the fact that all are competitors in the same field are considered. Differences in freight rates, statistical matters, grading rules, and many other things can be discussed to mutual benefit. It is hoped that each manufacturer of cypress will be present. A large delegation of Louisiana manufacturers will attend, and they hope to impart and receive much information. Further particulars as to meeting place, hour, etc., will be given later."

# Annual National Lumber Manufacturers' Association.

The National Lumber Manufacturers' Association, which is composed of eleven organizations of lumber manufacturers in various parts of the country, representing in all 1,269 concerns, held its fourth annual meeting at the Jefferson Hotel, St. Louis, May 8 and 9. A large number of delegates were present and also many visitors.

At 10 a. m. President N. W. McLeod called the meeting to order and read the annual message as follows:

## President's Address.

During the year we have increased our membership from 919 to 1,269, and the annual output from 11,850,000,000 to 12,000,000,000 feet. This showing fairly represents the interest of lumber manufacturers in association work.

The lumber business has been referred to recently in the public prints as the "Lumber Trust." Candidates for public office in some states have made the "Lumber Trust" the issue in their campaign. These misrepresentations were probably the result of ignorance. There are very few people, other than lumbermen, who realize that the lumber business is a natural, limited monopoly. Stumpage is the raw material for this great industry. It is unlike other great manufacturing industries in that the quantity of raw material available for commercial lumber, present and future, is an absolutely known factor. The supply of raw material cannot be increased as in coal, iron, or other building materials by the opening up of new deposits. With a known, limited quantity of raw material and a rapidly developing consuming market—through the increase in population as well as increase in the per capita purchasing power—the price of stumpage must conform to the law of supply and demand and be determined only by a value that will not retard consumption.

In the earlier years of our industry the large investment of the producer was in plant, stocks of lumber that were carried, and in accounts. The cost of raw material—on account of the supposedly inexhaustible supply—was nominal. Manufacturers were not obliged to invest their capital in large bodies of timbered lands, as they could secure the raw material required as it was needed. The evolution of supply and demand has changed this condition so that the greatest investment of a manufacturer at this time is in standing timber. Manufacturers have been forced to abandon the old method of taking into their cost of production their timber at its original cost without carrying charges or taxes, and, as they have been forced to acquire fresh supply of timber for their plants, they begin to realize that the manufacturer of lumber must occupy a dual capacity, that of a timber merchant as well as a manufacturer and distributor of lumber. Recognition of the value of raw material, from which we are making our lumber, has been a potential factor in the higher values obtained for the manufactured product. In analyzing the results from a lumber operation if the actual value of stumpage, considering the quantity available and the demand for its use, was taken into the cost statements, it would be found that the manufacturer of lumber is not receiving the margin that the investment of large sums in plants and equipment—that must be written off during the life of the plant—that he is justly entitled to.

The question of timber supply for commercial use is one that has been given serious consideration by the older nations. Our own government has realized for a number of years that unless reforms were inaugurated in the present methods of converting the forests into lumber, removing only the matured growths, preserving the young timber for future use, that the supply of lumber would—in a comparatively few years—be exhausted. The Forest Service of the United States government is maintained on broader lines than the reproduction of trees for commercial use, but commercial forestry is recognized by President Roosevelt and those in charge of the Forest Service, as one of the most important works of the department. The Forest Service has met with considerable co-operation and assistance from lumber manufacturers, but when the manufacturers recognize the real value of their stumpage based on the supply and demand considered for a period covering the life of their operations, the Forest Department will enjoy the co-operation and assistance of lumbermen to a degree that has been denied them in

the past. It is believed by students of this question that the actual value of stumpage today, considered as above, would justify manufacturers—who are timber owners—incurring the additional expense in operating that would be necessary in removing only the matured timber, preserving the younger timber for future use. The Forest Service is equipped to cruise timber lands and give estimates of costs and values in a practical way and demonstrate under what method of operation the timber of a given tract can be operated to the best advantage. The secretary's report will give a brief outline of our department work. In statistical work the government Forest Service and our association are co-operating in obtaining reliable statistical information. Complete information as to the production, consumption and stocks of lumber on hand will be compiled and published annually.

The work of the Credit Rating Department has been successful. We have a department fully organized and equipped to furnish our members with first-class service as to credits and collections. The department is now self-sustaining, but provision must be made to finance the amount invested in the plan. The bonds provided for this purpose have not been taken by our members. Therefore, some plan of financing must be provided, or, if it is decided that our members do not want to maintain a Credit Rating Department, the assets of the department should be disposed of, relieving the association of obligation. There is no question that if it is decided to discontinue the department, the assets can be readily sold so as to relieve the association of obligation and leave a balance in the treasury. I recommend that a committee of eleven, one member from each association here present, be appointed to thoroughly investigate the department and arrange either to finance the department or to sell the assets to the best advantage. All delegates to this meeting are invited to call at the general offices of the association on the seventh floor of the Equitable building to make a personal investigation of the Credit Rating Department work.

During the year various associations have taken advanced positions in exploiting their respective products by showing the finished product artistically treated. Results in interior finish and furniture have surprised the lumbermen themselves and the work along this line, it is believed, will materially increase the demand for upper grades of lumber.

At our last meeting the question of odd lengths and odd widths was discussed. Owing to the limited time for discussion, the matter coming up late in the session, it did not receive the consideration that, in my opinion, it deserves. I would, therefore, recommend that a standing committee on economy of mill product be appointed to handle questions of this character.

Under date of March 12, last, President Roosevelt appointed me as representing this association, a member of an Advisory Board of Fuels and Structural Materials. The Advisory Board is to be organized by the Director of the Geological Survey and the Chief of Forest Service of the Government to report to the President suggestions and recommendations as to the best methods and use of the building materials and fuels of the United States. The appointment, under the terms thereof, is to the president of this association and to follow to his successor in office.

During the year great confusion has existed as to terms of sale. This is a subject of great importance and should have our careful consideration. Uniformity of terms would not only simplify the work of accounting, but would eliminate very materially a large number of petty claims and deductions that are made on shipments.

At our last meeting in Chicago a movement was undertaken to provide a fund to endow a chair of practical lumbering at Yale. Committees were appointed to secure the necessary funds. As the value of stumpage increases, the necessity of utilizing the best methods of converting the forests into a marketable product is manifest. Graduates of Forest Schools are equipped by their engineering skill, technical training and field work to undertake and economically administer lumbering operations.

The reports of the following standing committees will treat the subjects referred to them, viz: Transportation, Credit Indemnity, Insurance, Uniform Export Contract, Endowment of Chair of Practical Lumbering.

The president then called upon Secretary George K. Smith for his report, which was given, as follows:

## Secretary's Report.

The year 1905 passed into history as one of the most prosperous ever experienced by the lumber industry. This condition was reflected in all associations affiliating and our present membership is as follows:

Members.	Approximate Annual Output, Ft.
292 Yellow Pine Mfrs. Assn. . . . .	4,000,000,000
163 Pacific Coast Lbr. Mfrs. Assn. . . . .	2,000,000,000
83 Northern Pine Mfrs. Assn. . . . .	2,000,000,000
156 North Carolina Pine Mfrs. Assn. . . . .	1,000,000,000
210 Hardwood Mfrs. Assn. of the U. S. . . . .	1,000,000,000
131 Georgia Interstate Sawmill Assn. . . . .	800,000,000
41 So. Cypress Mfrs. Assn. and	
14 So. Cypress Selling Co. . . . .	600,000,000
85 Northwest'n Hemlock Mfrs. Assn. . . . .	200,000,000
60 Wis. Hardwood Mfrs. Assn. . . . .	200,000,000
32 Southwestern Washington Lbr. Mfrs. Assn. . . . .	200,000,000
1,269	12,000,000,000

Comparing this with the record one year ago, we note several changes in names and two associations merged with their stronger neighbors.

The Wisconsin Valley Association joined with the Mississippi Valley Lumbermen's Association to form the Northern Pine Association. The South Carolina Lumber Association ceased to exist and all its members joined the North Carolina Pine Association. The Southern Lumber Manufacturers' Association changed its name to the Yellow Pine Manufacturers' Association, thus making all the association names descriptive of the particular kind of wood they represent.

There are two active associations—representing large annual outputs, which have not yet affiliated with us, viz.: The Western Pine Manufacturers' Association, of Spokane, Wash., and the Oregon Lumber Manufacturers' Association, of Portland, Ore. We trust they will see it to their interest to join us soon and thus add to the strength and usefulness of this association.

There has been an increase in the membership of practically all the associations named, the total now being 1,269, as against 919 a year ago.

Each association has been doing efficient work along statistical lines, both monthly and annually, and the interchange of this information has become a feature of association work, which is the direct result of the influence of this association and the opportunities offered for personal exchange of views and methods at these annual gatherings of the delegates and secretaries of the affiliated associations.

One year ago we referred to the plan for gathering complete figures, covering output, consumption and stocks of lumber, and are pleased to report that the Forest Service has not only co-operated with us, but has taken the lead in this most important work, and since January 1 has been making an active canvass of the entire United States, and has sent Mr. R. S. Kellogg, of the Department of Forest Products, to address us at this meeting.

This plan has passed the experimental stage and from now on there will be prepared authentic figures annually, covering the three important items of cut, shipments and stocks of lumber. This again proves the wisdom and profit of organization and co-operation.

During the year the work of covering the entire United States in our Credit Rating Book was completed, and the issue of April, 1906, has brought the department to a point where it is securing the patronage of a sufficient number of members of affiliated associations to warrant the statement that it is now on a self-sustaining basis. A detailed report has been prepared for the use of the committee on Credit Rating Department, with definite plans for the permanent financing of this most important department.

It is hoped every delegate will visit the offices and work rooms of this department while in St. Louis, and thus gain a personal knowledge of its methods and carry back to your various associations a report which will create enthusiasm and largely increase the support. If the 1,269 members of the eleven associations now affiliating will give this department unanimous patronage we can cancel our indebtedness in three years and after that time furnish credit rating information at a cost much less than the present schedule. This was the original intention and it rests with those you represent to say when this intention shall be carried out.

Some months ago a request was made for a copy of the terms of sale and discount in use by the members of the various associations, and on receipt they were reproduced on a single sheet, so that easy comparison could be made. The lack of uniformity emphasizes the necessity of keeping this subject before us, in the hope that some progress may be made.

Copies of the printed terms of twelve associations will be handed to the committee appointed to give this question consideration.

Had this report been written a month ago it would have been possible to say that trade

was moving along in well established channels in practically all localities, but the recent appalling disaster in California has brought about abnormal conditions on the coast, which will turn large quantities of lumber from its customary course, and cause a readjustment which will have an effect on the entire territory west of the Mississippi river.

On the Gulf Coast the export and coastwise demand is very active and the outlook for a continuation of present conditions is favorable.

If the present prospects for crops of grain and fruit are not materially changed the purchasing power of the consumers of lumber will be such that the demand during the remainder of 1906 will equal, if not exceed, that of 1905.

The program for this meeting gives notice to the reports of standing committees and two addresses, which will be of interest and profit to all.

Thanking officers and members for their support during the past year and hoping for a continued interest in all departments of our work, this report is respectfully submitted.

The report of Treasurer J. A. Freeman was then submitted, as follows:

<b>Treasurer's Report.</b>	
Assessments, 1905.....	\$ 5,309.24
Assessments, 1906.....	2,031.50
	<hr/>
	\$ 7,340.74
Credit Rating Book.....	813,851.70
	1,175.91
	779.69
	<hr/>
	15,897.30
	<hr/>
	\$23,148.04
Loan .....	5,000.00
	<hr/>
	\$28,148.04
Salaries, printing and postage paid out .....	27,338.01
Cash on hand May 1.....	\$810.03

The chair then appointed a Committee on Credentials, consisting of the following: H. H. Foster, chairman; George E. Watson and Victor H. Beckman.

**Reports of Standing Committees.**

Reports of standing committees being next in order, Chairman C. I. Millard of the Transportation Committee delivered an exhaustive report in which he touched upon freight matters in general, the suit now pending before the Interstate Commerce Commission in particular, and upon national terms of sale—cash discounts, credit ratings, etc.

Mr. Millard's valuable address was followed by the report of F. E. Weyerhaeuser, chairman of the Committee on Endowment of a Chair of Practical Lumbering at Yale. Mr. Weyerhaeuser reported that the result of the committee's work in soliciting subscriptions for this cause had not been as satisfactory as he had hoped, and that the total subscriptions from various organizations and individuals amounted to but \$54,601.20 up to date, while it had been previously decided that the amount must reach \$150,000 in order to adequately endow the proposed chair. The chairman then made an earnest plea for increased subscriptions, pointing out the advantage and necessity of practical forestry and conservative lumbering in future, and concluding with an urgent request for co-operation and financial aid from every direction.

R. S. Kellogg of the United States Forest Service delivered an address, taking for his subject "The Lumber Cut of the United States." He reviewed the splendid results that had been attained through the aid of the association in compiling statistics showing the amount of stumpage in the country, the reproduction and growth of new timber and the aggregate cut of the mills of this country. The address was illustrated by

three large wall charts showing production and stocks, products by states, etc., and was exceedingly interesting and instructive.

**Appointment of Special Committees.**

After some discussion by C. I. Millard, R. A. Long, W. B. Stillwell and J. A. Freeman relative to the importance and use of such statistics, and the desirability of lumbermen knowing the value of their stumpage and conserving it by every possible means, a motion was made and carried to the effect that the president appoint the special committees recommended by him in his message. The following were selected by the chair:

Committee on Resolutions: John L. Kaul, chairman, Birmingham, Ala.; R. A. Long, Kansas City, Mo.; E. C. Fosburgh, Norfolk, Va.; R. H. Vansant, Ashland, Ky.; F. E. Weyerhaeuser, St. Paul, Minn.

Committee on Credit Rating Department: Wm. Irvine, chairman, Chippewa Falls, Wis.; R. H. Vansant, Ashland, Ky.; H. H. Tift, Tifton, Ga.; E. C. Fosburgh, Norfolk, Va.; H. C. Foster, Tacoma, Wash.; W. A. Holt, Oconto, Wis.; Geo. W. Dodge, Napoleonville, La.; Geo. E. Foster, Mellen, Wis.; H. H. Foster, Malvern, Ark.

Committee on Economy of Mill Product: J. E. White, chairman, Kansas City, Mo.; R. H. Downham, New Orleans, La.; Chas. S. Keith, Kansas City, Mo.; F. H. Pardoe, Wausau, Wis.; Wm. B. Stillwell, Savannah, Ga.

The afternoon of May 8 was consumed by committee work, and no regular session of the association was held, but at 8 p. m. a number of members particularly interested in export trade held a session and discussed cargo shipping conditions. Impromptu speeches were made and many important matters talked over.

**WEDNESDAY'S SESSION.**

Immediately after the call to order, at 10 a. m., the Committee on Credentials reported on the attendance and apportioned votes as follows:

N. C. Pine Association.....	5
Yellow Pine Manufacturers' Assn.....	18
Wisconsin Hardwood Lumbermen's Assn.....	3
Southern Cypress Manufacturers' Association.....	5
Northwestern Hemlock Association.....	3
Pacific Coast Lumber Manufacturing Association.....	10
Georgia Interstate Sawmill Association.....	5
Northern Pine Manufacturers' Association.....	14
Hardwood Manufacturers' Assn. of the U. S.....	6

**Report of Credit Rating Department.**

The Credit Rating Department made the following recommendations:

We recommend that an effort be made at this meeting today to secure subscriptions to \$300,000 worth of 6 per cent 5 year bonds, to permanently finance the Credit Rating Department.

That branch offices for the purpose of distributing special reports to members of affiliated associations be opened in the offices of the secretaries of the Pacific Coast Lumber Manufacturers' Association, at Seattle, Wash.; Northern Pine Manufacturers' Association and Northwestern Hemlock Manufacturers' Association at Minneapolis, and the North Carolina Pine Association, at Norfolk, Va.

That the president and secretary of each affiliated association use their best efforts at an early date to induce their members to subscribe for the Credit Rating Book and use the special report service.

Your committee has made a personal investigation of the offices and work of the Credit Rating Department and heartily endorses the plans on which the department is operated. It is well equipped to give first class service and deserves the unanimous support of all association members.

- WM. IRVINE, Chairman,
- R. H. VANSANT,
- W. A. HOLT,
- H. H. FOSTER,
- E. C. FOSBURGH,
- GEO. E. FOSTER,
- GEO. W. DODGE,
- H. G. FOSTER,
- H. H. TIFT.

At this point the association went into executive session, the report was accepted and the delegates present pledged themselves to

see that the various associations raised the required amount.

**Other Committee Reports.**

The Committee on Credit Indemnity, consisting of D. Musser, chairman; L. K. Baker, I. C. Enochs and W. B. Stillwell, then presented an exhaustive report and analysis of the question, recommending that a committee consisting of a member from each association be appointed to complete the required work. A motion prevailed instructing the president to appoint a committee which should duly consider the establishment of a Credit Indemnity Department.

Chairman Millard presented verbally the report of the Committee on Terms of Sale, covering the ground fully and recommending that some set form be adopted to succeed the great variety now in use among sellers, thus securing uniformity, which he pointed out as greatly to be desired. No definite action was taken in the matter.

The Committee on Mill Products reported that the diversified interests represented precluded their reaching conclusions that applied to all woods, and therefore recommended that the matter be referred to each individual association, with request that each appoint a similar committee.

Richard Alexander of Vancouver presented a resolution on behalf of the cargo conference, held the previous evening, asking that the association create a standing committee consisting of one member from each association interested in cargo business to take up matters of interest appertaining to that branch of the lumber trade by correspondence through the secretaries of their respective associations, and that at future conventions matter appertaining to the cargo trade form part of the program.

The resolution was adopted.

After considerable discussion on various subjects, including next meeting place, the transportation question, freight tariffs, etc., the Committee on Resolutions presented the following:

In recognition of the benefits derived from complete and accurate statistical information, covering the timber resources of this country, the rate of consumption, and the distribution of the manufactured lumber, especially as said information pertains to and affects valuation; and, in appreciation of the able service rendered the association by the National Forest Service, as shown in the report of Forester R. S. Kellogg; be it

Resolved, That this association extend its thanks to Mr. Kellogg and to the members of the Forest Service for their efficient assistance; and, be it further

Resolved, That the officers and members of this association do everything in their power to assist the Forest Service in gathering necessary and valuable information, and especially in completing the compilation of figures shown in Mr. Kellogg's report.

Whereas, Congressman Pearre of Maryland recently introduced a bill in congress, known as House Bill No. 18171, which is commonly known as the anti-injunction bill; said bill being introduced at the instigation and in the interests of the American Federation of Labor, and in opposition to the best interests of all manufacturers; therefore, be it

Resolved, That the president of this association appoint a committee of one from each of the associations affiliated with this association, of which he shall be chairman, to go to Washington at the proper time to protest against this anti-injunction bill and use every honorable means to see that it is not enacted into a law.

- JOHN L. KAUL,
- R. A. LONG,
- E. C. FOSBURGH,
- R. H. VANSANT,
- F. E. WEYERHAEUSER.

### Pacific Coast Freight Rate.

R. H. Vansant then offered a resolution protesting against the unjust rate to the Pacific coast, which was adopted as herewith given:

Whereas, The transcontinental lines are now charging and receiving 85 cents per cwt. on lumber from Chicago and common points to Pacific coast points; and

Whereas, This excessive and unjust rate allows the importation of hardwoods from Japan, Australia, Russia and other Asiatic countries, to the exclusion of the hardwoods native to the central districts of the United States, and has never been justified in any manner whatsoever; and

Whereas, The average rate on forest products in hardwoods from the east being carried by the railroads to the Pacific coast market is 70 per cent higher than the rate on forest products carried by the same railroads from the same territory west to the same territory east; therefore, be it

Resolved, By the National Lumber Manufacturers' Association, in convention assembled, that we protest against this excessive and unfair west bound rate, which prohibits the sale of native hardwoods on the Pacific coast (excepting in limited quantities); and be it further

Resolved, That a committee of three be appointed by the president of this association to take this matter up at once with the transcontinental freight bureau (and its allied lines individually) and secure justice for this important branch of the lumber industry, which will enable the hardwood manufacturers of the Mississippi valley and Lake Michigan districts to sell their products in competition with imported hardwoods on the Pacific coast.

### Election of Officers.

Election of officers followed the reports of the various committees and resulted as follows:

## District Meetings Hardwood Manufacturers' Association.

Lewis Doster of the Hardwood Manufacturers' Association is campaigning the country very generally, organizing local hardwood manufacturers into district organizations affiliated with the big association of which he is secretary.

### New Orleans Meeting.

A meeting of the hardwood producers of Louisiana was held at the St. Charles Hotel, New Orleans, on Thursday, May 17, for the purpose of discussing matters of sectional interest, and taking action to improve conditions that are now inimical to the success of the hardwood industry in the state.

President—Wm. Irvine, Chippewa Falls, Wis.  
Vice-President—R. A. Long, Kansas City, Mo.  
Treasurer—J. A. Freeman, St. Louis, Mo.  
Secretary—Geo. K. Smith, St. Louis, Mo.

### Board of Directors Appointed.

Roll call of the affiliated associations for the purpose of receiving nominations to the Board of Directors resulted in the following selections:

Wm. P. Stillwell, Savannah, Ga., representing Georgia Interstate Sawmill Association.  
E. C. Foshburgh, Norfolk, Va., representing North Carolina Pine Association.  
J. B. White, Kansas City, Mo., representing Yellow Pine Manufacturers' Association.  
Edward Hines, Chicago, Ill., representing Northern Pine Manufacturers' Association.  
Wm. Wilms, Chicago, Ill., representing Hardwood Manufacturers' Association of the United States.  
E. G. Griggs, Tacoma, Wash., representing Pacific Coast Lumber Manufacturers' Association.  
A. R. Week, Stevens Point, Wis., representing Northwestern Hemlock Manufacturers' Association.  
J. A. Vaness, Winlock, Wash., representing Southwestern Washington Lumber Manufacturers' Association.  
Geo. E. Foster, Mellen, Wis., representing Wisconsin Hardwood Lumbermen's Association.  
R. H. Downman, New Orleans, La., representing Southern Cypress Manufacturers' Association.

After eloquent addresses on the subject of endowing the proposed chair of forestry by J. B. White, R. A. Long, Edward Hines and others, the meeting adjourned.

The next annual will be held at Norfolk, Va.

There were present Samuel Hopper, Samuel Hopper & Son, Baton Rouge; W. E. Hoshall, Hoshall & McDonald Bros., Eola; E. T. Miller, McDonald Bros., Macland; H. A. Joyner, Boyce Realty Company, Boyce; Jas. H. Baird, Southern Lumberman, Nashville, Tenn.; James Boyd, Lumber Trade Journal, New Orleans; W. E. Barnes, St. Louis Lumberman, St. Louis, Mo.; W. C. Wright, Lumber Trade Journal, New Orleans; Lewis Doster, secretary Hardwood Manufacturers' Association, Chicago.

Samuel Hopper acted as chairman of the meeting and James Boyd secretary in accordance with

the action taken at the meeting held on April 27.

The session was called to order by the chairman, who stated that the purpose of the meeting was to consider the conditions surrounding hardwood production in Louisiana, and to take steps toward forming a state organization for the betterment of the industry.

Lewis Doster, secretary of the Hardwood Manufacturers' Association, outlined the plan of procedure entered into by other state organizations recently formed.

Other topics were discussed by those present, covering the subjects of grading and manufacture, and all were very much interested in the matter of forming a state organization. One topic which was given especial attention, outside of the organization plan, was that portion of the governor's message in which he recom-



G. LEIBY WOOD, ASHEVILLE, N. C.

mented that laws passed which would prohibit the removal of logs in the rough from the state, on the grounds that the best interests of Louisiana required that all lumber cut in the state should be manufactured within its limits.

It was decided at this gathering that a future meeting should be arranged for, either at Alexandria or Monroe, to which all manufacturers of hardwood should be invited. It was not definitely determined at which place this meeting will be held, but this will be decided later. The date for such meeting was suggested as June 27.

At this future meeting plans will be outlined more definitely for the formation of a state organization of Louisiana hardwood manufacturers, with the idea of developing the interests of the state in the matter of hardwood production, manufacture, etc.

### Coming Meetings.

The very successful meeting held a few weeks ago at Asheville is to be followed by another gathering of hardwood operators of that district on Saturday, May 26. G. Leiby Wood, manager of the R. E. Wood Lumber Company's hardwood manufacturing enterprises in eastern Tennessee and western North Carolina, is very prominent in this movement.

On Saturday, June 2, a district meeting of hardwood manufacturers doing business at Charleston, W. Va., and vicinity, will be held in that city.

On Saturday, June 9, the hardwood manufacturers of Arkansas will hold a similar meeting under the auspices of the Hardwood Manufacturers' Association at Hot Springs.

Another meeting is planned for Missouri hardwood manufacturers at some point, to be determined upon later, which will be held about the middle of June.



LUMBERMEN ASHEVILLE DISTRICT MEETING AT SWANNANOA COUNTRY CLUB.

## The Chicago Veneer Company.



VIEW PART GREAT VENEER MILL, CHICAGO VENEER COMPANY.



DRYING BUILDINGS, CHICAGO VENEER COMPANY.

Early in the year 1901 B. W. Lord packed his grip and took a night train out of Chicago, telling his business associates that he would not be back until he had found "the best spot in the country" for the Chicago Veneer Company's plant. He returned at the end of a year, called a directors' meeting, and reported that his mission had been successful. From that time the company has been making veneer history.

During the year of absence Mr. Lord traveled all over the timber districts of the North and South. He knew just the location he was looking for, and when one day he came upon the little village of Burnside, in Kentucky, lying in a beautiful valley where the South Fork river empties into the Cumberland, he at once decided that he had found the ideal spot.

The main plant of the Chicago Veneer Company was established at this point shortly afterward, and the little village of Burnside grew to the proportions of a good-sized town in a surprisingly short time in consequence. The Chicago Veneer Company's business has increased steadily, until today

Mr. Lord and his associates number among their customers some of the greatest consumers of veneer in the world. This growth is attributable both to the excellence of the plant, with regard to equipment and location, and to the great perseverance, close application and unceasing energy of the members of the company. The Cumberland and South Fork rivers, with their numerous tributaries tapping the magnificent forests of upper Tennessee and Kentucky, deposit logs at Burnside practically the year round. Besides this the company operates two barges which bring logs from points sixty miles down the river. The Q. & C. railroad is also of importance, both in bringing in the logs and shipping out the finished product.

Burnside is on the main line of the C., N. O. & T. P. railway, and the plant of the Chicago Veneer Company covers about thirty acres between the railroad and the river. It is devoted exclusively to the manufacture of veneer. The company has in commission a large mill at Tateville, a few miles above Burnside, where it engages

on an extensive scale in lumber manufacture, making a specialty of yellow poplar.

The great success attained by this concern is due to the fact that the most modern and approved business methods have always been employed. All the odds and ends of stock are used, and the work is so arranged as to eliminate the element of waste almost entirely. The handling of the material from the log to the finished product is done by skilled mechanics and the most modern machinery.

The great veneer plant at Burnside is complete in every detail. It is equipped with a log-haul, conveying logs from the river to the mill, ample railway trackage, a large derrick with a 125-foot sweep, six large steaming vats, excellent drying buildings, an immense cutting room, three large dry kilns, shipping rooms and warehouses. Most of the veneer is dried by the hot air circulation process. At present the company has 12,000 logs in the booms at Tateville, which is a very moderate sized stock, as there is room to store 27,000 logs.

The equable climate of Kentucky enables



CORNER OF LOG YARD, CHICAGO VENEER COMPANY.

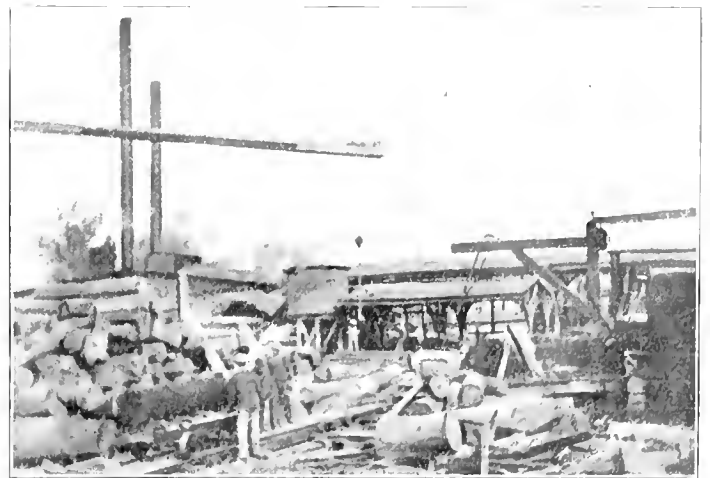

GIANT DERRICK HANDLING LOGS, CHICAGO VENEER COMPANY.



the company to carry on operations practically the year round. The logs are conveyed from the river by means of the log-baul into the spacious yards, where they are arranged in piles within easy reach of the giant derrick. As desired they are stored in the large steaming vats where they are thoroughly cured and made ready for the knife. They are then sent to the cutting machine and reduced to veneer. The Chicago Veneer Company enjoys the reputation of putting out veneer of the highest class. It is used for the finest

grades of work into which veneer enters, expensive cabinet work, furniture, pianos, cars, etc., and is practically world-wide in its distribution.

The company was originally organized in 1888. Some years later Mr. Lord, then of the Sterling Bicycle Company, became identified with the business. The active ones in the company are: B. W. Lord, president and treasurer; S. J. Glanton, manager; H. Wade Beavers, who has charge of the timber and log department, and Leroy Kessler, mechanical superintendent.

## Picker-Sticks and Sweep-Sticks for Looms.

With the increased demand for hardwood bobbins, shuttles, spools and cops for textile, cotton and woolen mills, there comes an active call for hardwood picker-sticks. I remember when I was a lad that the mill in which I worked furnished handmade picker-sticks for the cotton mills in the vicinity. The "boss" used to send me to the woods to get the proper timber. For a number of years locust was most used. This is not a good wood for this purpose, even when properly seasoned and worked, and the way it was seasoned in this particular shop did not, as may be imagined, even bring out its few good qualities. However, it was the best that could be done under the circumstances. The timber was cut, hauled to the mill and sawed. It was not supposed to be used until the next year, giving it a chance to season before the sticks were made from it, but there was never time for this, and green lumber was very often employed. A log was split with wedges as in Fig. 1 and the sticks were then cut to shape with hatchets. They were crude and very irregular, as may well be supposed from the primitive method of manufacture. Fully twenty per cent could not be used at all. Some were knotty and some crooked; many were only fit to be cut up for sweep-sticks.

Today the process and the resultant product are much different. Many of these same mills have undergone a complete transformation; new and improved machinery has been introduced, effective methods of manufacture are in vogue and the work is well systematized. At these mills the wood is especially selected for the purpose from the standpoint of elasticity, toughness, durability and general suitability for the making of picker-sticks. The incessant hammering of the stick against the bunters of the loom make it necessary that the pickers be of wood that is firm and close-grained. Defects, such as knots or parts of knots, are disastrous, as the sticks will break off at such weak points almost immediately.

Picker-sticks are made from many varieties of hardwoods. Crab-tree wood is sometimes used; but the best and most common woods employed are ash, hickory, elm, oak and birch. Poplar, beech, cherry and walnut are also used with good results. Whatever wood

is chosen, precautions are taken at the beginning to get from it the best possible service by cutting it properly. The cross lines in Fig. 2 illustrate the method of cutting the logs lengthwise. The slabs are then marked off with lines and the tapering sticks cut in pairs or triplets, as the width of the slab permits. Usually but two sticks can be obtained from one slab, as represented in Fig. 3. Fig. 4 shows the crude stick of the old days, roughly shaped with a hatchet. Many country textile mills even now use almost as crudely shaped sticks as this, local carpenters making them with but few more tools and facilities than we had in that little

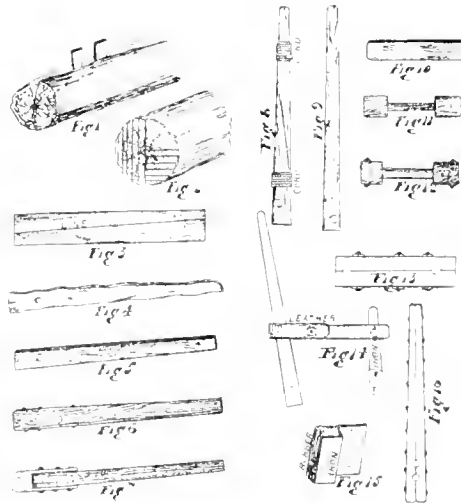

old mill of my early experience. But the city mills, which use thousands of picker sticks annually, contract with large manufacturers for their supplies and these sticks are almost invariably sawed out to pattern and then smoothed by planing. Owing to the tapering form of the stick, they are usually planed by hand, although a few of the larger manufacturers have machines to perform this work. Fig. 5 shows the stick after it has been planed. A hole is then bored for the picker-stick stud, about six inches from the foot of the stick, usually one inch in diameter. Some makers put metal sleeves into the bores, but as a rule the wood bears direct upon the stud. Next comes the boring for the wiring of the sticks. Small holes are

bored through the sides of the stick just above and below the stud hole, and wire rivets are inserted and headed up as shown in Fig. 6. Some manufacturers use bolts and nuts for this purpose, but this is not a good plan, as nuts work loose and come off. The rivet is headed and it cannot get free. Iron foot pieces are sometimes added, as represented in Fig. 7, but as this metal increases the weight of the stick, it has never been entirely satisfactory. Yet some patterns of looms require sticks of this form, and consequently the manufacturer must produce them. Occasionally a stick which is found to be weak is bound up with rawhide, tarred cords or wires as represented in Fig. 8. Sticks are often curved near the upper end as in Fig. 9, so that this curve may come in contact with the back of the picker, thus providing an even sliding motion.

Let us look at the sweep-sticks, for manufacturers usually carry a line of sweep-sticks as well as picker-sticks. In many mills no sweep-sticks are furnished and the loom operator is expected to saw sweep-sticks from broken picker-sticks. There is no economy in this, because in his desperation, when in a hurry, the loom operator often saws up a really good picker-stick to get the necessary sweep-stick, and it is always cheaper to buy regularly made sweep-sticks. Fig. 10 is a good pattern. It is made like the picker-stick and of the same wood, but it is not tapered. It is usually about 20 inches long. In order to have it as light as possible the middle of the stick is frequently sawed out, as in the pattern shown in Fig. 11. It is not absolutely necessary that the ends be bored and riveted, but it is a very good plan, and many manufacturers have adopted it. The same method of riveting the bottoms of the picker-sticks is used to rivet the ends of the sweep-stick. Fig. 12 illustrates a sweep-stick which is riveted.

A rather awkward form of sweep-stick is shown in Fig. 13. The idea in this case was to get two pieces of wood combined, making both the sweep and picker sticks, claiming certain advantages. In most mills the merits of sticks as advertised count for little. They are simply put into service and tested. If the stick works well, that is sufficient recommendation. Hence it is that we see sticks of many different patterns under experimentation in various weaving rooms. This two-piece sweep-stick was being tested in a mill I visited. I was told that the stick was giving fairly good service, but that it was too weighty and bulky for the loom.

Fig. 14 shows the combination of picker-stick and sweep-stick as run in the loom. The iron picking shaft arm carries a stud which fits into the hole in the sweep-stick. The leather strap is bolted around the picker-stick and to the sweep-stick. As the stick is brought up with a hard thump against the bunters, about ninety times per minute in the broad woolen loom, and about two hundred times per minute in the speedy little cotton loom, it may be realized what a

picker-stick combination must be in these days of high speed. The life of the stick depends a great deal upon the bunter. Some stiek makers furnish a hard rubber bunter to fit into the metal bunters of the loom, just ahead of the sweep of the stick, as in

Fig. 15. This makes a cushion to receive the blows of the stick, protecting it and prolonging its term of usefulness considerably. Fig. 16 is a form of picker-stick made on the same plan as the two-piece sweep-stick in Fig. 3. "OBSERVER."

## News Miscellany.

### Veneer Manufacturers Meet at Asheville.

In response to a call lately issued by the National Veneer & Panel Manufacturers' Association a number of concerns operating in the southeastern states sent representatives to a meeting held April 16, at the Battery Park Hotel, Asheville, N. C. The convention was called for the purpose of securing the cooperation of manufacturers in that district in the work which the association is attempting to accomplish for the betterment of the industry.

President D. E. Kline of the Louisville Veneer Mills called the meeting to order and presented a report of what has been accomplished up to date by the association. He gave in brief the objects of the association, and pointed out the value of a complete understanding among manufacturers and hearty cooperation, instead of the antagonistic feeling which has hitherto prevailed. Mr. Kline expressed it as his opinion that if a majority of the establishments engaged in the veneer and panel business would become affiliated with the national association, they would soon find themselves upon a footing which would enable them to stand firm against any difficulties which might arise in the conduct of business.

A sort of experience meeting was called for, which brought out some interesting and valuable discussion.

J. W. Clinard of the High Point Veneer Company, High Point, N. C., presented the following resolution, which was unanimously adopted:

"Resolved, That the Southeastern Branch of the National Veneer & Panel Manufacturers' Association recommend that the grades and specifications on poplar veneers be changed to read as follows: There shall be three grades, clear, No. 1 and No. 2.

"Clear shall be perfect, allowing only such defects as are agreed at the time the order is accepted and in every case this shall be considered as special stock.

"No. 1 shall consist of stock closely and evenly cut and permitting of slight defects such as sound, smooth knots, discoloration, or short closed splits.

"No. 2 shall allow knots (knot-holes not over 3/8 inch diameter) slight shakes, checks, and worm-holes.

"In filler stock enough two and three-piece fractions shall be taken to work up all waste in cutting."

It was decided wise to apply for membership in the national body, and accordingly the following petition was drawn up and signed by every representative of the veneer and panel industry present at the meeting:

"To The National Veneer and Panel Manufacturers' Association: The undersigned manufacturers of veneers in the southeastern states petition your honorable body for admission as members individually with the request that your association designate us as constituting a recognized and accepted Southeastern Branch of the National Veneer & Panel Manufacturers' Association. We agree to be governed by and to cooperate with your rules and regulations and so constituted we claim such recognition for our southeastern branch association as well as our individual concerns."

It was the sense of the convention that the National Veneer & Panel Manufacturers' Association should arrange some plan for the proper inspection of stock in case of rejection of the

goods upon arrival at destination, but no definite action was taken in the matter, and it will be fully considered at the next meeting of that body.

It was recommended that the next session of the National Association be held at Cincinnati, as the most convenient place for all interested.

Those present were: D. E. Kline, Louisville Veneer Mills, Louisville, Ky.; W. K. M. Gilkey, Gilkey Veneer Company, Marion, N. C.; J. J. Kincaid, Kincaid Veneer & Lumber Company, Salisbury, N. C.; D. S. Thomas, North State Veneer Company, Statesville, N. C.; T. O. Teague, Comoly & Teague Veneer Company, Taylorsville, N. C.; J. W. Clinard, High Point Veneer Company, High Point, N. C.; L. V. Phillips, Lynwood Manufacturing Company, Lynwood, N. C.; W. F. Thompson, Cleveland Manufacturing Company, Cleveland, N. C.; Kent



D. E. KLINE, LOUISVILLE, KY., PRESIDENT NATIONAL VENEER & PANEL MANUFACTURERS' ASSOCIATION.

Sheppard, Globe Veneer Company, Winston-Salem, N. C.; M. C. McDonald, West End Veneering Company, West End, N. C.; R. L. Hubbard, Elkin Veneer & Manufacturing Company, Elkin, N. C.; E. M. Henoyer, Philadelphia Veneer & Lumber Company, Knoxville, Tenn.; M. C. Dow, Jr., Goshen Veneer Company, Goshen, Ind.; H. M. McCracken, Kentucky Veneer Works, Louisville, Ky.; W. H. Craddock, Lenoir Veneer Company, Lenoir, N. C.

The following concerns were represented by proxy: Gwyn Veneer & Panel Company, Lenoir, N. C.; Bill Veneer Company, High Point, N. C.; Rural Hall Veneer Company, Rural Hall, N. C.

### Annual Southern Cypress Manufacturers' Association.

The annual meeting of the Southern Cypress Manufacturers' Association was held at New Orleans, May 16, a large number of representative manufacturers being present.

President Wilbert, in his annual address, reviewed the work of the association during the

year of its existence, commenting favorably on what has been accomplished by the various committees and on the cooperative spirit which prevails among members.

Secretary Watson submitted a report setting forth the details of the association's business affairs, and telling of the exploitation of bay poplar, stating that the production of this wood during the last six months has been heavier than ever before in the same length of time. He reported that the association now has thirty-five members.

George W. Dodge, treasurer, presented a statement which showed that after all debts were liquidated, the association had a substantial fund remaining.

After considerable discussion on the matter of grading, which was brought forth by the fact that the rules seemed to have been misinterpreted in many instances, it was decided to appoint a traveling inspector to visit the various mills and explain to employees how to properly construe them.

Election of officers resulted in the following choice: President, Frederic Wilbert; first vice president, R. H. Downman; second vice president, H. M. Bloss; treasurer, George W. Dodge; secretary, George E. Watson; directors, F. B. Williams, Patterson; E. G. Swartz, Burton; J. A. Peterman, Franklin; John A. Bruce, Strader; L. H. Price, Ramos; J. P. Wiggington, Bowie; John Dibert, New Orleans; L. H. Baker, Plattenville; H. B. Hewes, Jeanerette; A. T. Gerrans, Houma; H. M. Cotton, Morgan City; R. S. Ross, Pretoria, Ga.

In the afternoon and evening executive sessions were held, at which some changes in the by-laws were discussed, and reported adopted. At a late hour the convention adjourned, to meet at Atlanta, Ga., June 11 and 12, when it is expected that cypress manufacturers of Georgia, North Carolina, South Carolina, Alabama and Florida will be present; it is Secretary Watson's desire to interest them in association work, and secure their cooperation.

### American Colonization Company.

The American Colonization Company has been organized at Chippewa Falls, Wis., with a capitalization of \$500,000, and the following officers: President, J. T. Barber, Eau Claire; first vice president, Frederick Von Pils, Bremen, Germany; second vice president, F. S. Bell, Winona; secretary, William Irvine, Chippewa Falls; treasurer and assistant secretary, F. E. Weyerhaeuser, St. Paul; manager, Albert C. Uecke, Cumberland; directors, J. T. Barber, Frederick Von Pils, F. S. Bell, William Irvine, A. E. Walrath, G. W. Clausenius.

The object of the company is the sale, development and settlement of northern Wisconsin lands, including more than 2,000,000 acres, the estimated value of which is \$20,000,000. These lands are cut-over timber areas held out of the market for several years by the owners, and the tract comprises holdings of F. E. Weyerhaeuser, John S. Owen Lumber Company, Northwestern Lumber Company, Laird & Norton, Musser-Sauntry Company, Mississippi River Logging Company, Chippewa Lumber & Boom Company, Chippewa Farm Land Company, North Wisconsin Lumber Company, Lake Nebagamon Lumber Company, Superior Timber Company and Uecke Land Company. The throwing open for settlement of the largest tract of land ever put on the market in the northwest means that a large number of colonists will make homes there and open up what promises to be a resourceful agricultural region. A German commission recently visited this country and decided upon northern Wisconsin as the most desirable region in which to start German colonies, and particular attention will therefore be given to diverting foreign immigration from the great cities, particularly of the East, to this section.

**San Francisco Branch E. C. Atkins & Co.**

The branch house of E. C. Atkins & Co., Inc., located at 21 and 23 Main street, San Francisco, was destroyed by the fire following the great earthquake of April 18, together with a complete line of Atkins circular, band, cross cut, hand and other saws, mill specialties, etc., kept in stock there at all times. N. A. Gladding of Indianapolis, vice president and secretary of the company, arrived at Oakland the morning of April 24, and fortunately secured from Gov. Fardee a pass which enabled him to enter San Francisco and visit the devastated districts. He found that R. W. Neighbor, the enterprising San Francisco manager for E. C. Atkins & Co., Inc., had already located a temporary office at 1055 Broadway, Oakland, Cal., and was ready for business. After reviewing the situation further it was decided to lease a large, well-lighted warehouse at 862 Market Street, Oakland, splendidly suited for carrying an extensive stock, and it is at this address that the office will be maintained until further notice.

**Bliss-Cook Oak Company Rebuilding.**

Work has been commenced on the erection of a new mill for the Bliss-Cook Oak Company at Blissville, Ark., to replace the one recently destroyed by fire. A large force of men is employed on the buildings and installing an Allis-Chalmers outfit consisting of a 12-inch single band and a 10-inch resaw, with steam sawworks, a 20x36 Corliss engine, steam feed, niggers, log loaders, trips, etc. When the mill is finished it will be one of the most up-to-date and complete in the South. The yards of the Bliss-Cook Oak Company contain about 5,000,000 feet of lumber not touched by the fire, and also a well-assorted stock of flooring. The flooring plant remained intact and is running full time, turning out exceedingly fine stock. Superintendent Howard Coles has the new work in charge.

**New Orleans Merger.**

The Otis-Alcus Lumber Company is the name of a new corporation at New Orleans, capitalized at \$100,000. Samuel T. Alcus is president, Henry Alcus is vice president, Henry A. Alcus is secretary and Rowland Otis is treasurer. The company will take over the business of S. T. Alcus & Co. and of the Otis Manufacturing Company, storing the lumber at the latter plant, where the sawmill will engage in cutting cottonwood when not busy with mahogany. Boxes of low-grade cottonwood will be made at the Alcus operation, the upper grades being sold as lumber.

**Knoxville and a Great Knoxville Concern.**

Some of the richest timber in Tennessee comes from the section which might be designated as the Knoxville district. Knoxville has splendid railroad connections besides the Tennessee river to furnish supplies, which serve also in distributing the finished material.

The city is in the heart of a great producing territory and is the home of several large concerns cutting and working hardwoods of all kinds. There are also several jobbers who operate from local offices. This section is noted not only for the profusion of its timber but the high class of the lumber produced by the various concerns there.

The largest lumber concern in Knoxville is the Vestal Lumber & Manufacturing Company, controlled by the three Vestal brothers, men young in years but veterans in lumber experience. The company has about twenty-five acres of yards on two railway systems, and a large plant up-to-date in every respect.

**Miscellaneous Notes.**

The Northwestern Cabinet Company of Burlington, Ia., is building an addition to its plant. The Krueger Manufacturing Company of Bell-

ville, Tex., has begun the manufacture of axe handles.

The Mount Olive Stave Company of Mount Olive, Ark., has increased its capital stock from \$25,000 to \$50,000.

The Pine Bluff Lumber & Veneer Company of Little Rock, Ark., has decreased its capital stock from \$100,000 to \$50,000.

The Warren Vehicle Company of Warren, Ark., is building a tramway six miles long to facilitate the hauling of its timber.

J. H. Jewett is installing the machinery in his new kitchen cabinet and hardwood novelty factory at Menominee, Mich.

The Broadway Hardwood Manufacturing Company of Harrisonburg, Va., has recently been organized and a plant will soon be erected.

The Judson Manufacturing Company has been incorporated at Boston to manufacture saw frames and handles; capital stock, \$10,000.

Alex. Rose, a farmer near Lee City, Ky., recently sold the timber on his farm, with the exception of the locust and chestnut, for \$10,000.

The Alluvial & Hardwood Company of Lumberton, N. C., has been incorporated to do a general land, lumber and sawmill business; capital, \$25,000.

The Vicksburg Veneer Lumber Company has been incorporated at Milwaukee, Wis., with a capital stock of \$50,000, by J. F. Conant, R. W. Grace and T. W. Spence.

The Little Lumber Company of Harriman, Tenn., contemplates erecting a sawmill and box factory in that place. The company has recently purchased 4,000 acres of timber land near Isolene.

The Illinois Hardwood Lumber Company has been organized at Alton, with mills in Arkansas and Indian Territory. The capital stock is \$20,000 and the incorporators are all residents of Alton, Ill.

The Ferd Brenner Lumber Company has increased its capital stock from \$10,000 to \$200,000. As reported in these columns before the company's headquarters are now located at Norfolk, Va., having been recently transferred from Chattanooga, Tenn.

The plant of the Hoosier Manufacturing Company of New Castle, Ind., will soon be enlarged, and when completed it will be the largest kitchen cabinet factory in the world. Five additional buildings will be erected, representing an outlay of nearly \$30,000.

The Prescott Company of Menominee, Mich., will this summer turn out five complete sawmills for the imperial government of Japan. The orders for the machinery were booked a few weeks ago and the goods will be ready for delivery before fall.

The Illinois Central has established a forest reserve in southern Illinois and has planted 1,000,000 cottonwood trees. When large enough these trees will be used for ties, and it is said that when treated with a creosote preparation

the wood is as good as any other for this purpose.

Fay Cusick of Milwaukee, a hardwood lumber dealer, has recently purchased a third interest in a large tract of red oak timber in the Northwest. He values the tract at \$100,000. He is making preparations for manufacturing lumber through the Port Wing sawmill, which has a daily capacity of 500,000 feet.

The sawmill of the Santee Cypress Lumber Company at Ferguson, S. C., was recently destroyed by fire. The mill sawed about 50,000 feet of lumber a day, and was valued at about \$75,000. This is an enterprise in which Francis Beidler of Chicago is largely interested. A large portion of the loss was covered by insurance.

Palmyra, Mich., contains a stonecutters' mallet factory, where mallets are turned out made of the best hickory obtainable. They weigh about eight pounds each, and the finishing department can turn out four dozen completed mallets a day. Orders are so steady that the concern runs constantly and never is able to keep a stock on hand.

The Southern Seating & Cabinet Company of Jackson, Tenn., has increased its capital from \$35,000 to \$100,000. Reorganization has resulted in the election of the following officers: Thomas Polk, president; J. H. Duke, vice president; F. L. Ingersoll, general manager; N. S. White, secretary and treasurer, and R. E. Spragins, attorney. The company manufactures school desks and other hardwood specialties.

The Tennessee Stave & Box Factory is a concern recently incorporated to do business in Memphis. It is capitalized at \$200,000, and the incorporators are A. H. Kersting, E. J. Hastings, D. A. Robinson, R. P. Cary and R. B. Goodwin. Under its charter the company may buy, sell and deal in lumber, land and forest products, and manufacture staves, boxes, barrels, etc. The company will acquire timber lands near Memphis and erect a large box factory in that city.

The Sandford Sullivan Lumber Company of Dallas, Tex., is making preparations to establish a hardwood mill plant at Naples, and extend a railroad fourteen miles northwest through the unsettled timber sections of White Oak and Sulphur. The corporation is capitalized at \$500,000 and has bought real estate to the amount of \$61,000 to start with, most of it between the two streams. Three hundred hands will be put to work on the road and plant within a couple of weeks.

Central Lumber Company has been incorporated at Jackson, Miss., by Fred Herrick, C. E. Latimer, R. R. Hogue and A. C. Hogue and others to engage in general timber and lumber development enterprises. The capital stock is \$500,000. The company has 60,000 acres of land, covered with a rich growth of hardwoods and other timber, situated in the Pearl river valley, between Jackson and Carthage, Miss. It bids fair to be one of the biggest lumber concerns of the section.

## Hardwood News.

(By HARDWOOD RECORD Special Correspondents.)

**Chicago.**

James Cooper of the Briggs & Cooper Company, Ltd., Saginaw, Mich., was a Chicago visitor last week.

Chas. S. Bacon of the Pacon Lumber Company, Grand Rapids, Mich., was a caller at the RECORD office on May 15.

The general offices of the National Hardwood Lumber Association have been removed from Indianapolis to Chicago, and Secretary Frank F. Fish and Inspector General Smith are now located in a handsome suite, No. 1012 Rector building, corner of Monroe and Clark streets. It is a matter of a good deal of congratulation to the local members of the association that the offices of the organization should be returned to this city, where they logically belong. Of

course, the many friends of Secretary Fish will be glad to have him again in town.

Vicegerent E. G. Shorrey is making big preparations for a concatenation of Hoo-Hoo at Grand Rapids, Mich., June 1. He now has seven applications for initiation and expects several more before the event takes place. From present indications this will be one of the largest concatenations held in Michigan in a long time.

A concatenation and general gathering of the Hoo-Hoo of the seventh jurisdiction, comprising Arkansas, Louisiana, Texas, Indian and Oklahoma territories and New Mexico, will be held at Little Rock, Ark., June 23. Pledges to be present have been received from several hundred persons, including members of the Supreme Nine, House of Ancients, and others

prominent in the order. The Osirian Cloister will hold a special session to receive initiates, at 9:00 a. m., regular at 1:30 p. m., and at 9:00 p. m. a banquet will be served.

The program is in receipt of the new special catalog of the Browning Engineering Company of Cleveland, O., which is a very well planned and finely executed piece of work. This concern presented an interesting exhibit at the National Lumber Manufacturers' Association meeting, held May 8 and 9, at the Jefferson Hotel, St. Louis, Mo.

The mail of the Hardwood Record is flooded with communications from J. O. McMahon of Syracuse, N. Y., reaching us through the courtesy of lumbermen throughout the entire East. Mr. McMahon announces that he has opened an office in New York city and tells very attractive stories of a prospective lumber yard which he would like to install in the metropolis. He also says he wants hardwood flooring. If any hardwood flooring manufacturer wants Mr. McMahon's trade, it probably will be very easy to secure it. His new address is 112 West One Hundred and Twenty-eighth street.

The offices of the Paepcke-Leicht Lumber Company, the Chicago Mill & Lumber Company and the Marked Tree Lumber Company have been removed to a handsome new office building at 110 West Chicago avenue, corner of Sangamon street, this city.

C. M. Carrier, well known lumberman of Buffalo, N. Y., was in Chicago on Thursday on his way home from a visit to his son Robert M. Carrier of the Carrier Lumber & Manufacturing Company at Sardis, Miss.

#### Boston.

Warren C. Norton of Albany, N. Y., has purchased the woodworking plant of T. R. Glantz at Pittsfield, Mass.

George D. Emery of George D. Emery & Co., Chelsea, Mass., large importers of mahogany, has returned from a trip to the West.

E. B. Estes & Son of Hancock, Mass., are planning to enlarge their plant by the erection of three new buildings.

William E. Litchfield has been visiting his mill in Mount Vernon, Ind. Mr. Litchfield left Boston some weeks ago, fully intending to be present at the convention in Memphis, but was unable to do so owing to a railroad wreck.

W. M. Weston of the W. M. Weston Lumber Company, hardwood dealers, is making a trip through the West.

Frank Lawrence of Lawrence & Wiggin, the well known tobacco mahogany dealers, has returned from a western trip.

J. M. Woods of John M. Woods & Co., dealers in mahogany and manufacturers of veneers in East Cambridge, Mass., has returned from a trip through the Southwest.

#### New York.

The Iroquois Door Company of Buffalo, manufacturer of sash, doors, blinds and general mill work, which makes a specialty of hardwood veneer doors, has opened a local exhibition and salesroom at 18 Broadway, this city, under the management of B. P. Salmon. A full line of samples will be shown here, and with the excellent facilities of the company at Buffalo orders can be filled immediately.

Sam E. Barr, Flatiron building, has just returned from the convention of the National Hardwood Lumber Association at Memphis.

E. J. Marsh of the Sea Coast Lumber Company has just returned from a seven weeks' trip to the cypress belt. He states that he found stocks much depleted with little dry lumber on hand. The new cypress association, he says, is in absolute control of the gulf situation and there is practically no stock available outside of the selling agency. The Sea Coast Lumber Company is doing a large business, and Mr. Marsh is very enthusiastic over the situation.

The new Adirondack Fire Insurance Company, 66 Broadway, is rapidly writing a large line of business, and has been so successful since it

started the first of the month as to leave no doubt that it has an important place to fill in the insurance field.

The hardwood yard of Willson, Adams & Co., which has for many years been located at 138th street and Gerard avenue, has been removed to a new site recently acquired at 150th street and Gerard avenue, comprising forty lots. The company is building an up to date shed and will be in better shape than ever in that department with their new facilities.

W. W. Dempsey, hardwood operator of Johnstown, Pa., has opened a local selling office at 18 Broadway and will make his headquarters here in future and cater more closely to the New York trade.

Harry S. Dewey of Dixon & Dewey, Flatiron building, reports the hardwood trade very fair and says that his firm is in possession of a very choice assortment of stock for the summer trade. Their Pacific coast business is also active. The schooner J. W. Briggs is about due here with a big cargo of fir timber, and another vessel will sail from the coast consigned to them early in June.

O. Quitmann of E. & O. Quitmann, American lumber brokers of London, England, arrived here last week in the interest of business. He will visit the leading hardwood supply sources before returning.

Fire recently destroyed stock in the yards of the S. E. Kellar Lumber Company, Fifty seventh street and Eleventh avenue, valued at \$5,000, and another fire on May 13 entailed an additional loss of \$12,000.

J. H. Dickinson, head of the logging department of the Lidgerwood Manufacturing Company, 96 Liberty street, recently left for an extended southern trip, which will include the cypress belt.

On May 15 the extensive piano case manufacturing plant of Jacob Doll, First avenue and Thirtieth street, was completely gutted by fire, which consumed a large amount of hardwood lumber. The total property loss was \$250,000, of which amount Doll's loss of \$50,000 is covered by insurance.

E. L. Thomas of E. L. Thomas & Son, Yonkers, sailed for Europe May 23, accompanied by his daughter.

The H. M. Bickford Company, hardwood wholesaler of Boston, Mass., has opened branch selling offices at 1 Madison avenue, this city, under the management of A. Shoaf, who has been representing the company in this territory.

#### Philadelphia.

Franklin H. Smith, Jr., secretary of the Producers' Lumber Company, is now completely recovered from his late illness and is back in harness again. The hardwood department of the firm, which was established the first of the year under G. J. Johnson, is now of considerable importance. In the last thirty days the firm has contracted for the output of three mills, taking all their oak and poplar.

Samuel H. Shearer & Son have just completed arrangements to take the entire output of poplar and oak of several mills near Franklin, Va. The purchasing agent of the firm, William Shearer, has just returned from the South, where he inspected several large tracts of timber with a view to purchase.

The Boynton-Chalmers Company announce that they have recently added a planing mill to their works at Sewaren, N. J., besides doubling their yard room and stocks and increasing their working force.

The Neal Morse Lumber Company of Waltham, N. C., passed into the hands of a receiver May 16, owing to the failure of Johnson & Radcliffe, Mr. Radcliffe being quite heavily interested in this company.

W. H. Lear is arranging for the reception of over 1,000,000 feet of cypress, now in transit from Florida by the schooner Collins W. Walton and by steamer. He has lately contracted for the output of cypress of a Florida mill averaging

about 1,000,000 feet a year, and for the output of chestnut of a West Virginia mill.

F. G. Rumbarger of the Rumbarger Lumber Company left last week for Pittsburg, where he will conclude deals which his company has had pending for some time.

George F. Craig is down at the mills of his company at Winterburn, W. Va., overseeing shipments. Isaac H. Rhodes, who has just returned from a sojourn of eight months at Winterburn, is in charge of the firm's Philadelphia office.

George Warner has left for the South to visit the mills in which he is interested and to inspect stocks in general. He will not return for two weeks.

Horace G. Hazard & Co. are preparing to handle considerable ash, the product of mills which the firm has lately acquired. Mr. Hazard is now making a brief visit to the southern properties and expects to be back in a fortnight.

Joseph Dunwoody has left for a ten days' trip to Bristol, Va., East Tennessee and western North Carolina to look over some stocks recently bought at those points by his company.

Thomas W. Raine was a recent visitor to the trade from Edenwood, W. Va., where he has lately bought 18,000 acres of hardwood timber, the stock being principally white oak, with some poplar and chestnut.

E. E. Brillhart and V. Tonkin, vice president of the First National Bank of Cherrytree, Pa., have lately acquired a tract of oak timber in West Virginia containing approximately six million feet. Mills are in course of erection and the stock will be marketed as soon as possible.

Chas. R. Smith & Co. have leased the yard at the northwest corner of Peach and Brown streets, formerly occupied by W. H. Lear, and will transact a general business in North Carolina pine and hardwoods. The company was recently formed by Charles R. Smith, who was for five years a salesman for Geo. W. Kugler & Son and formerly manager for the C. B. Coles & Son Company of Camden, N. J. Clarence L. Spencer has been engaged as salesman for the new concern.

Richard P. Baer of R. P. Baer & Co., Baltimore, Md., paid the trade a visit last week.

F. F. Gummer has lately been engaged by Lukens Bros. as salesman. He will cover eastern Pennsylvania, Philadelphia and vicinity.

The Philadelphia Veneer & Lumber Company has lately received at its mills at Knoxville, Tenn., the raft of logs contracted for last winter. Enough timber is contained in it to last a year's cut.

Sheip & Vandegrift are making an addition to their plant of four more dry kilns, making in all ten. The concern has lately put on a new salesman, Emil Kolb, who will sell in New York city, the firm having discontinued its agency with the Vosnack Lumber Company of that city. Some months ago, Sheip & Vandegrift acquired adjoining property which gave them an outlet on into a yard, 130 feet deep and 51 feet wide, well stocked with plain and quartered oak, poplar and basswood.

C. H. Holden, in charge of the West Virginia territory for the Cherry River Boom & Lumber Company, is making a visit to the Philadelphia offices of the firm. F. A. Kirby left last week for an extended trip through Virginia and Ohio. C. E. Lloyd, Jr., who has been absent for some time in the South and at the main office of the concern in Scranton, is again in active charge of the Philadelphia office.

Frank B. Codling, who recently severed his connection with Charles Este, has opened an office at 2129 Bellevue street, and will do a general wholesale business in hardwoods. He has lately returned from a southern trip. While away he contracted for the output of several mills in western North Carolina and eastern Tennessee.

A forest fire in Seaford, Sussex county, Del., last week destroyed timber valued at \$10,000, besides lumber valued at \$3,000. The fire

started from brush being burned by woodmen.

W. M. McCormick has returned from the company's mills at Townsend, Tenn., where he inspected the rebuilding of the mills recently destroyed by fire. The operations are in such state that the concern will be able to start about June 1.

J. R. Leshner, the well-known salesman of Soble Bros., who was confined for some time in Providence Hospital at Washington, D. C., has now recovered, although he is still nervous and considerably reduced in weight.

### Baltimore.

Maryland has joined the States that are endeavoring to increase their timber wealth by a system of encouraging arboriculture, and in pursuance of this aim the legislature at its last session passed a law creating a forest commission. This commission includes in its membership two practical lumbermen, former Governor E. E. Jackson of the E. E. Jackson Company and Norman James of N. W. James & Co. The other members are Governor Warfield, State Comptroller Atkinson, President Ira Ramsen of the Johns Hopkins University, President R. W. Sylvester of the Maryland Agricultural College, and Prof. William Bullock Clark of the Maryland Geological Survey. Provision was made for the appointment by the board of a state forester, whose salary shall not exceed \$2,000 a year and traveling and field expenses. The board is authorized to purchase lands favorable for forest culture and reserves. Upon the recommendation of the state forester the governor is to appoint such forest wardens as are necessary to serve for two years without salary, but who shall receive such compensation as the forester shall allow for services actually rendered. An appropriation of \$3,500 annually is made to carry out the provisions of the law. One of the objects aimed at by the statute is to prevent the spread of forest fires.

The big sawmill at the Mount Clare shops of the Baltimore & Ohio which was destroyed by fire is to be rebuilt on the same extensive scale. The building is to be of brick and concrete and will cover a lot 247x70 feet. It will be equipped with every improvement, including an elevator.

L. Methudy, a well-known lumberman of St. Louis, Mo., is recovering at the Johns Hopkins Hospital from an operation for some internal trouble. He came here especially to get the benefit of the skill possessed by the staff of the Hopkins Hospital.

Charles Bruening, a representative of Henry Bruening, a lumber and timber dealer of Rotterdam and Bremen, stopped here last week in the course of a trip through the lumber centers and the milling sections of the United States.

The J. J. Kidd Lumber Company has moved from the National Marine Bank building to its new yard on South Sharp street, where it is doing a retail as well as a wholesale business.

The only representative from Baltimore at the annual meeting of the National Hardwood Lumber Association in Memphis was John Heald of Price & Heald. Mr. Heald gave some attention to business while in Memphis, but found prices so high that he felt little disposed to place orders.

### Pittsburg.

J. J. Linchan of the Linchan Lumber Company is at Willhurst, Ky., this week, seeing that everybody is doing double turn at the mills. From this company comes the encouraging assurance that the hardwood market is in excellent shape and that the prices of oak are steadily creeping up.

The Nicola Lumber Company has its forces fully organized and is taking on business with the same zest and energy which characterized its predecessor, the Nicola Brothers Company. F. F. Nicola is devoting his entire time to his real estate interests, chief of which in point of

attention is the development of the Schenley farm in the Bellefield district. O. P. Nicola will confine his attention chiefly to building projects this year, although he is also largely interested in the Schenley Farm.

The American Lumber & Manufacturing Company has made changes in its line-up since the resignation of its secretary and treasurer, G. W. Gates, who has gone to Portland to engage in the pine and fir business. J. N. Woollett, manager of the hardwood department, now has charge of the hardwood and pine departments. His assistant in the former will be A. W. Smeener of the Blackburn & Smeener Company of Cincinnati. E. P. Mackie of the J. J. Newman Lumber Company of Hattiesburg, Miss., will be assistant manager of the pine department. The company is strengthening its forces along all lines, and W. D. Johnston, its president, has gone south to look up new stocks.

The Babcock Lumber Company cut 6,300,000 feet of lumber during April at its Ashtola mills. It is keeping the wheels buzzing at all of its plants and is satisfied that this will be a banner year in the Pittsburg lumber trade.

William H. Schmette & Co., who are now located in a fine suite of offices in the new Machesney skyscraper on Fourth avenue, were unfortunate in being dependent to some extent on the mills at Belhaven, N. C., which burned recently. The fire caused a shifting of some of the Schmette orders pending the erection of new mills.

D. L. Gillespie & Co. will ship 4,000,000 feet of lumber this month to Havana, Cuba, for use in government improvements. They are troubled considerably by shortage of cars in North Carolina and report that in some parts of the state lumber firms are threatening suits against the railroads.

Ambridge, Pa., the hustling industrial town 20 miles below Pittsburg on the Ohio river, has a very thrifty lumber concern, the American Lumber & Building Company, which makes a specialty of mill work. The company has not only furnished a big proportion of the lumber used in the hundreds of houses and store buildings which have grown up there since the erection of the immense plants of the American Bridge Company three years ago, but has done much building on its account.

The Liberty Lumber & Planing Mill Company has succeeded the J. W. Gallagher Lumber & Planing Mill Company. Charles N. Burt, who was for 35 years associated with the Murphy Mill & Lumber Company, is manager of the new concern. It has a capital of \$50,000 and has taken over the big yard and planing mill of the Gallagher Company in Braddock avenue, East End.

According to James I. M. Wilson & Co. there is a big increase in activity this month among the small hardwood mills throughout the country districts. They are getting out a good lot of oak, birch, maple, cherry and hickory, much of which is coming to the Pittsburg market. The Wilson company notes a much better demand for oak and a tendency to "make good" in all lines.

The A. M. Turner Lumber Company is having a very busy season and notes but a slight lull in the general demand for lumber. Its southern projects are progressing finely and its sales will reach a record breaking point for the first half of 1906.

F. X. Diebold, of the Forest Lumber Company, is spending the week in West Virginia hurrying up operations at the mills and looking up some new stocks. The company is sold up to the saw for new woods and is having a fine trade in oak and chestnut.

William T. Munroe, who makes a specialty of figuring mill work for manufacturing plants, has been taking estimates on the immense planing mill, car repair shops and storage house which the Pennsylvania Railroad will build at Euola near Harrisburg, Pa. Mr. Munroe says that the

strike of the structural steel erectors is delaying some projects which he has to figure and which will require a large amount of hardwood to fill.

Willson Bros. have so much confidence in the general situation that they are taking all the lumber they can get. They see no slump in the demand for hardwoods and are steadily pushing out that department of their business which was made more of a specialty this year. I. F. Balsley, hardwood manager for the company, is at Atlantic City and the East this week.

The Kendall Lumber Company has bought from the Mackie Lumber Company of Piedmont, Va., the timber rights on 800 acres of land in Garrett county, Maryland, for about \$10,000. The purchase will give the Kendalls a nice addition to their hardwood supply in this vicinity.

### Buffalo.

F. C. Beyer's visit to the Memphis convention lasted till the 19th, his trip through the South after the meeting being made with a determined effort to locate some good lumber, in which he succeeded very well.

Hugh McLean paid a visit to the Louisville mill of the company before coming home from Memphis, as he is anxious to see all the oak going through it that can be cut. Everybody says the company's new Memphis mill is fine.

The West Virginia cherry supply is lighter than it used to be since H. A. Stewart made his late long trip down there.

The new Kentucky venture of the Standard Hardwood Lumber Company is a very promising one and it looks as though it would continue to be a great source of supply for some years. A mill is to be set up later on.

F. W. Vetter is looking carefully after his purchases of oak and ash at Hallett, N. C., and will be occupied with that end of the trade some time, while H. S. James is occupied with the developments of the Empire Lumber Company in Arkansas.

A. Miller returned from his southern trip following the Memphis convention on the 21st, well pleased with the progress he made in locating oak and other hardwoods.

The Memphis convention was made a strictly business matter by a number of Buffalo hardwood dealers, who scattered through the various parts of the South in search of stock.

### Detroit.

The Whitney Furniture Manufacturing Company at Baker and the Michigan Central Railroad has filed a trust mortgage, naming the Detroit Trust Company as trustee. The mortgage covers the company's plant. The schedule of the company's liabilities names seventy creditors, the various amounts aggregating \$10,000.

The Russel Wheel & Foundry Company has received several rush orders for logging machinery from the northern Michigan district devastated by fire. An area of some 400 square miles in the vicinity of Menominee was ruined by the flames. The Russel people are also sending large shipments of machinery into North and South Carolina this week.

Clayton Gibson of the Wolverine Box Company has gone to Connecticut on business. He will also visit Maine and go up into Canada to investigate large tracts of unclaimed timber.

The C. W. Kotcher Lumber Company will enlarge its mills and increase its capital stock to a large degree.

### Saginaw Valley.

The Kneeland, Buell & Bigelow Company is experimenting in the manufacture of maple lath, the first time in the state, so far as is known. Maple makes very fine lath, having a smooth appearance, compared with pine and hemlock, and has greater strength. Mr. Bigelow, manager of the concern, says that, while it is an experiment as to the reception this commodity will receive from the trade, he is confident the lath will speak for itself, and the extraordinary demand for lath ought to assist it in gaining a foothold at the price at which it will be placed



on the market. The company is building a lath mill, to be operated in connection with the sawmill, equipped with three machines, having a capacity of 25,000 hardwood lath a day. The Kneeland, Buell & Bigelow Company is just now cutting a large quantity of maple special bill timber, some twenty-two feet long, for break-water purposes at Lake Erie ports.

The W. D. Young & Co. sawmill is running day and night and business is reported as very satisfactory. A considerable portion of the flooring output is exported.

The Bonan Lumber Company, operating a sawmill at Bonanville, has now over 1,000,000 feet of logs in the yard and carries on operations the year through.

The H. M. Loud's Sons Company, Au Sable, has shipped three carloads of hardwood to Tonawanda this season.

Charles Lindell of Millersburg has recently purchased 15,000,000 feet of timber, nearly all hardwood, in the vicinity of Forence, Wis. He removed to the site last week, taking a portable mill along. Mr. Lindell has purchased a new mill of 30,000 feet daily capacity, but when he gets fully established will put in a band mill.

The Batchelor Timber Company of Saginaw has filed articles of incorporation, with a capitalization of \$200,000, all paid in, to operate in lands and manufacture hardwood products. It owns large boundaries of timber in Charlevoix, Otsego, Grand Traverse and Cheboygan counties.

The big furniture plant of the Estey Manufacturing Company at Owosso, was destroyed by fire May 18. The L-shaped brick building, five stories high, was completely destroyed. It was packed to the roof with finished stock, the selling season being dull just now. The loss will exceed \$250,000, with an insurance of \$125,000. The concern made only high-grade quartered oak and mahogany furniture.

The Ottawa Hardwood Lumber Company has started its mill at Tawas, and it is expected about 4,000,000 feet of lumber will be manufactured.

### Grand Rapids.

Harry C. Angell has purchased the interest of his partner in the firm of Wagner & Angell, and the new firm dealing in lumber and shingles is H. C. Angell & Co. Mr. Wagner, the retiring member, has been in poor health for some time. Mr. Angell returned May 22 from an extended eastern trip.

Geo. S. Wilkinson of the VanKeulen & Wilkinson Lumber Company is in northern Michigan on a business trip.

A. Gibbs of Traverse City, senior member of the Gibbs, Hall & Allen Company of this city, has been spending the past week at the Grand Rapids office.

A. L. Dennis of Dennis Bros. reports an excellent spring business in all hardwoods. He states that business at their Tonawanda yards during the first four months of the year has run 25 to 30 per cent ahead of the record for the corresponding period of last year.

The mill of the Thomas MacBride Lumber Company at New Wexford was shut down for a few days for the purpose of putting in a steam tugger and loader.

Grand Rapids lumbermen who are familiar with maple are skeptical as to the success of the experiment of the Kneeland, Buell & Bigelow Company of Bay City in manufacturing maple lath. Some of the reasons they offer are as follows: Maple is heavy and freight rates would be high; maple is hard and would necessitate boring; it would split and twist. Tamarack lath was tried in a house at Cadillac and twisted so badly that the plaster fell off and new lath and walls were necessary.

The mill of E. C. Atkins & Co. of Indianapolis, which was removed this spring from Allegan to Hartford, Mich., will be brought back to Allegan next season. This mill turns out

handles for the enormous output of saws manufactured by this company. The timber chiefly used is old apple, with a little cherry, walnut and other special woods. Ten men were employed in the mill last winter and lumber for 165,000 handles was cut.

Arthur Hill of Saginaw, a prominent candidate to succeed Russell A. Alger of Detroit as United States senator, comes over to Grand Rapids frequently and is putting up a warm campaign, even in William Alden Smith's own hailiwick, and it looks as if Mr. Hill would win out.

Secretary O. A. Felger of the Hackley-Phelps-Bonnell Company, while on a business trip in the South, was summoned home by wire on account of the serious illness of his son. The little fellow was badly pinched about the body in a capstan while at play, and peritonitis resulted.

The steam barge Three Brothers of the W. H. White Company, Boyne City, made a quick run to Chicago and return last week. She left Boyne City late Thursday afternoon with a big load of cedar ties, unloaded at Chicago, took on a hundred head of cattle and was back at the company's docks early Monday morning. The cattle will be pastured on the White company's large farm.

Oliver Bros., furniture manufacturers of Allegan, have bought 320 acres of timber land on Nebish island, St. Mary's river.

### Indianapolis.

Although there is considerable building being done here just at this time, it cannot be denied that the higher prices asked for lumber and other building material is having a depressing effect upon building activities. According to statements of Indianapolis contractors, many thousands of dollars' worth of improvements have been temporarily abandoned, because of advanced prices.

W. H. Freeman, secretary of the Indiana State Board of Forestry, who has just returned from a visit in Clark county, is preparing recommendations for the Pennsylvania Railroad Company on the proper care of a tract of land which the company owns in that county, adjoining the state forest reservation. Mr. Freeman will submit plans which will enable the company to save the valuable hardwood trees on the tract. It is the intention to make it a private reserve, similar to that now owned by the state.

On the evening of May 9 the planing mill of the F. M. Bachman Company on Lincoln lane in Indianapolis was damaged by fire of unknown origin, the loss being about \$20,000, only partially insured. At the time of the fire the mill was filled with dressed lumber in anticipation of a heavy building season, but Mr. Bachman had failed to increase his insurance accordingly, so the insurance covered only about one-third of the loss.

The Dynes Lumber & Coal Company of Indianapolis has been granted permission by the secretary of state to change its name to the Dynes Lumber Company.

Articles of incorporation have been filed by the Graham & Davis Manufacturing Company of Windfall, Ind., for the manufacture of kitchen cabinets. The company starts with \$7,000 capital stock. The directors are James Graham, Isaac Graham, W. J. Davis and Malvin Redington.

The Evansville Broom Company of Evansville, Ind., has been incorporated with a capital stock of \$25,000 to engage in the manufacture of brooms.

### Asheville.

The Asheville Veneer Company, a \$40,000 corporation recently organized here with George A. Murray, a prominent lumberman of western North Carolina, as president, has begun building and will have its plant ready for operation some

time in August. The company will manufacture veneer on an extensive scale from the hardwoods of this section, and its products will be sold exclusively in the North and East.

The J. S. Bailey Company, which several years ago purchased the Craggy Mountain boundary, announces that it will shortly begin the erection of a veneer plant at Shope, five miles from Asheville. The J. S. Bailey Company now has a railroad running six miles into the Craggy Mountains, where it is engaged in getting out chestnut for the United States Leather Company of Old Fort. The hardwood used at the new veneer works will be taken from Craggy Mountain boundary.

George A. Murray of this city made a shipment of curly poplar from Asheville last week that has taken nearly two years to collect. The poplar filled a car and measured 13,000 feet. The curly poplar was selected by Mr. Murray in his lumber purchasing operations and stored until a sufficient quantity was secured for shipment.

C. E. Lloyd, Jr., of Philadelphia, representing the Cherry River Boom & Lumber Company, was here for several days' stay recently.

Frank Rumbarger of the Rumbarger Lumber Company of Philadelphia was in Asheville on May 9.

J. B. Hart of Clarksville, W. Va., who owns 65,000 acres of timber lands in western North Carolina and eastern Tennessee, is now in this city for a short stay. Mr. Hart is well known in lumber circles. He built and now operates the road from Newport, Tenn., to Waterville, traversing his timber interests.

A charter has been granted to the Olympia Furniture & Caring Company of Wilkesboro, N. C., with a capital stock of \$3,400.

The Robbins Lumber Company, capital stock \$12,500, has been organized to do business at Elm City, N. C.

The lumber yards and woodworking plant of George W. Vanderbilt, on the Biltmore estate, were damaged by fire May 19. The loss was \$2,500.

Lumbermen report trade a little quiet during the past fortnight, although good prices obtain. Poplar leads. A more active market is expected in June.

### Bristol, Va.-Tenn.

In the case of Bristol Door & Lumber Company vs. J. J. Alley & Co., which has been pending in the courts of Virginia for over a year, involving a log contract to the extent of about \$8,000, Judge John W. Price has handed down a decision on a hitherto undecided point of law. Alley & Co. contracted to supply the Bristol Door & Lumber Company with a large cut of logs, and would have done so, having felled the logs in the woods, but for the failure of a tide. They delivered the logs eight months after the time stipulated and the Bristol Door & Lumber Company refused to accept them and sued Alley & Co. for the advance money on same. Alley & Co. brought suit against the Bristol Door & Lumber Company seeking to compel it to a specific performance of contract. Alley & Co. relied on a plea of "providential hindrance" for their failure to comply with the letter of the contract. After considerable litigation Judge Price held that "providential hindrance" is not of itself sufficient grounds for the breach of a contract, and a decree has been entered in favor of the plaintiffs, Bristol Door & Lumber Company, and judgment awarded for the sums advanced on the logs.

The Furnace Run Saw Mill & Lumber Company of Pittsburg, Pa., has entered the lumber business in this section and established a branch office at Johnson City, Tenn. This company will manufacture and ship stock from this section to its eastern trade.

Fred Brenner of the Fred Brenner Lumber Company, formerly located at Chattanooga, was in Bristol a few days ago, en route to Asheville,



N. C. to inspect timber and timber lands. Mr. Breuner is now running mills at Norfolk and has headquarters in that city.

R. B. Burns of the Tug River Lumber Company has returned from an important trip in Virginia in the interest of his company.

Paul W. Flock of the Paul W. Flock Lumber Company, who is manager of the company's eastern office in the Real Estate and Trust building, Philadelphia, is in Bristol this week looking over the company's business and hurrying out orders.

Joseph P. Dunwoody of Joseph P. Dunwoody & Co., Philadelphia, was buying lumber and making delivery contracts with the lumber dealers in this section last week. Mr. Dunwoody buys considerable hardwood stock in this section.

C. W. Decker, traveling representative of J. Gibson McIlvane & Co. of Philadelphia visited Bristol this week on business. Mr. Decker is making heavy purchases of hardwoods for the domestic and export trade in this section.

The large band mill of the Tug River Lumber Company, located at Mabe, Scott county, Va., was destroyed by fire May 15, and a considerable loss entailed thereby. The mill was fully insured. Considerable lumber was also burned.

John W. Cowles, a Philadelphia lumberman, was in Bristol last week making purchases of oak and other hardwoods.

A Hoo-Hoo concatenation was held at Mountain City May 16 and was well attended by lumbermen from all over this section. A number of "kittens" were initiated, and the banquet which followed was very enjoyable.

Frank L. Rumbarger of the Rumbarger Lumber Company, Philadelphia, was a visitor in Bristol a few days ago, in company with H. W. Nelly, the company's southern manager. Mr. Nelly went from Bristol to Madison, N. C., to inspect a large amount of hardwood lumber which the company is shipping from that place, while Mr. Rumbarger returned to Philadelphia.

John T. Dixon of the John T. Dixon Lumber Company was in Bristol last week en route to Ron Cervere, W. Va., where he resides. Mr. Dixon reports business excellent.

It is rumored that the Virginia Iron, Coal & Coke Company and Virginia & Southwestern Railway Company, which own jointly in the name of the latter considerable timber properties in eastern Tennessee, will soon sell their holdings and apply the proceeds on the construction of the Holston River Railroad, now being built.

### Cincinnati.

The Cincinnati Lumbermen's Club held its annual meeting at the Business Men's Club on May 16. The election resulted in the unanimous selection of T. J. Moffett as president; S. W. Richey and James Buckley, vice presidents; Ben Bramlage, treasurer, and E. J. Thoman, secretary. Mr. Thoman was re-elected. The secretary's report showed the club to be in prosperous condition. There are now forty-four members, the latest acquisition being W. E. Talbert & Co.

Ralph McCracken of the Kentucky Lumber Company has recovered from an attack of typhoid fever.

B. F. Dulweber of John Dulweber & Co. is back from a buying trip through several southern states.

W. A. Bennett of Bennett & Witte spent several days last week in Memphis looking after the firm's office in that city.

"T. J. Moffett for president in 1907," is the cry of Cincinnati members of the National Hardwood Lumber Association. C. F. Korn and W. A. Bennett have taken charge of Mr. Moffett's interests and the campaign has already been started. "Mr. Moffett's election as president of the Cincinnati Lumbermen's Club will add prestige to his cause," said Mr. Korn.

H. W. Salvage, who has large timber interests in the South, has decided to make Cincinnati his home.

The Cincinnati Veneer Company, 1285 West Sixth street, is enlarging its plant to accommodate increased business.

A. M. Lewin & Co., located on West Eighth street, are erecting a number of sheds in Evans-ton to benefit suburban customers.

The Dexter Lumber Company is making considerable improvements to its plant in Norwood, a suburb. Additional storage yards have also been acquired.

The Cincinnati Hardwood Lumber Company is now operating its new veneer mill on Colerain avenue. It has a capacity of 50,000 feet a day.

H. P. Wiborg, president of the Wiborg & Hanna Company, is out again after long confinement in a private hospital. He will assume active work in a short time.

George S. Littleford, who was brought home from the convention of the National Hardwood Lumber Association at Memphis in a serious condition, is gradually improving. He had an attack of appendicitis, but unless his condition changes an operation will not have to be performed.

N. H. Trimble has secured 2,600 acres of timber land in Menifee county, Kentucky. Development will begin immediately.

The Cincinnati Mill & Dry Kiln Company has increased its capital from \$25,000 to \$35,000.

The J. A. Fay & Egan Company has purchased a tract of ground at Augusta street and Central avenue, adjoining its present buildings. President Thos. P. Egan says the company's business is excellent.

A recent visitor was George Kennedy of Buffalo. He closed contracts for several large lots of hardwoods.

M. B. Farrin of the M. B. Farrin Lumber Company was installed as president of the Cincinnati Manufacturers' Club May 21. The club will use all its endeavors to secure a belt line, and T. J. Moffett of the Mabey, Thompson & Moffett Company was made chairman of a committee to outline a plan for such an improvement. Lumbermen particularly are in favor of a belt line and are gratified that Mr. Moffett will have charge of efforts to secure it.

### Chattanooga.

The Loomis & Hart Manufacturing Company has recently erected a large addition to its plant on Montgomery avenue.

The Case Lumber Company has decided to dispense with its local yards and ship direct from the four mills of the company located at Boligee, Scottsboro, Birmingham and Whitney, Ala. The company also takes practically the entire output of the Bridgeport Woodware Company of Bridgeport, Ala., and the F. W. Blait mill of this city. It was deemed wise to ship direct from the mills and thus save the expense of maintaining yards in this city. The offices will be retained here and quarters will be secured at some central downtown point at once.

M. M. Erb, vice president of the Case Lumber Company, has just returned from an extended southern trip.

H. O. Harber of the J. M. Card Lumber Company is on a southern trip this week.

Messrs. Ault and Jackson of Ault & Jackson, Cincinnati, were here recently buying stock.

W. G. Morrison, who held stock in the Arnold Lumber & Manufacturing Company, whose plant is located at East Lake, has sold his interest to R. J. and W. S. Brown of Jasper, Tenn. The company is making extensive improvements, erecting several new sheds, etc., in the plant. It is probable a modern band mill will be installed in the near future. C. C. Arnold, a leading officer and stockholder, says that the band mill will be put in if a sufficient supply of logs can be obtained.

S. A. Williams of the Williams-Voris Lumber Company is on a southern trip.

F. W. Mowbray of Mowbray & Robinson, Cincinnati, bought considerable stock here recently.

### Nashville.

Quite a feature of the big parade given in Nashville May 21, the opening day of the May Festival, was the showing made by the Nashville lumber and furniture concerns. The exhibits of the Nashville Association of Wagon Manufacturers was particularly creditable. The association was represented officially by a handsomely decorated wagon, in which rode a number of its officers. Then came a number of fine wagons manufactured here by the Waller & Porter Wagon Manufacturing Company. The Mitchell-Hunt Wagon Company had a number of vehicles mounted on floats. The National Casket Company had an attractive exhibit, representing old Charon crossing the Styx. A banner bore this inscription: "Charon will row you over right if you go in a National casket." The J. J. Anderson Company, wagon manufacturers, was represented by a most unique exhibit in the shape of a wagon-cage, big enough to contain a pack of foxhounds, and attached to an automobile. Prof. J. F. Draughan, a local auto enthusiast and hunter, takes the animals out with him frequently. Other exhibits which attracted much attention were those of Vogeley & Scharf, George Greer and the Morton-Scott-Robertson Furniture Company.

The Clairfield Lumber Company of Winchester, Ky., has filed an abstract for the purpose of engaging in business in Tennessee. The company is capitalized at \$80,000.

The Fred W. Black Lumber Company of Chicago has purchased a tract of hardwood timber at Dickson, Tenn., from Myatt Bros., for \$7,000.

Several hundred dollars were raised recently by the Nashville lumber firms for the benefit of the sufferers at San Francisco. Among the contributors to the fund were Love, Boyd & Co., Davidson-Benedict Company, Nashville Hardwood Flooring Company, John B. Ransom & Co., Union Lumber Company, Standard Furniture Company, Southern Lumber & Box Company, W. R. Earthman & Co., T. P. Hayes Stave Company, and the employees of the Nashville Hardwood Flooring Company. John B. Ransom & Co., the Nashville Hardwood Flooring Company and W. B. Earthman & Co. did an extensive business with San Francisco firms, as did also Love, Boyd & Co.

During the recent high water in the Cumberland a sycamore tree played havoc with rafts coming down from the up-river country. The big tree lodged at a point a short distance above Carthage, remaining under the water out of sight and snagging floating objects. Levi Spear and Bedford Hill of Monroe county lost a raft of 100 logs and several other rafts were torn to pieces by the big tree. Three men were drowned in one of the collisions with it.

The Nashville Hardwood Flooring Company recently shipped a valuable carload of flooring to London, England. This company has built up quite an extensive foreign trade and is successfully competing with foreign concerns and is selling right in the heart of London. It is believed that more than twenty-five cars will be shipped to London this year. When it is remembered that a car of hardwood flooring such as this company turns out will bring as much as \$3,000 some idea of the extent of this trade can be gathered.

What came near being a building tie-up in Nashville has been averted by prompt action on the part of the contractors. They have acceded to the demand of the union carpenters for the "closed shop" rule.

The charter of the Dixie Match Company of New Jersey has been filed for registration at the state capital. This company will engage in business in Tennessee. Its capital stock is placed at half a million.

Dr. L. G. Glenn, professor of geology at Vanderbilt University, which institution is located at Nashville, was recently appointed by Governor Cox a delegate to appear before the house committee on agriculture and forestry in behalf of the bill to create an Appa-

lachian forest reserve in east Tennessee. The measure calls for an appropriation of \$3,000,000 to inaugurate the work. The entire Tennessee delegation went to Washington to appear before the house committee, and while there called on President Roosevelt, who is heartily in favor of the reserve. Dr. Glenn says that the need of this reserve is apparent and he is confident that congress will make the necessary appropriation at the December session.

### Memphis.

S. Willner, vice president and general manager of the American Art Wood Manufacturing Company, has gone to Europe for a business trip of about four or five weeks to look after the interests of the corporation. The company's plant, which was erected here for the manufacture of lumber, colored in the log, for use in the making of picture frames, cabinets and specialties where fancy material is required, is now in operation and is turning out a product which is satisfactory to stockholders.

The C. B. Kelly Lumber Company of Texarkana, Ark., has been placed in the hands of H. G. McBriney of Texarkana and Judge Leon Lippman of Newport, Ark., as receivers, and will be operated by these gentlemen for the benefit of creditors until July 7, when it will be sold. The company was the largest creditor of the Bank of Newport, Newport, Ark., which failed some time ago, the failure being directly due to the inability of the company to take up its maturing paper. The management attributes this condition to the inability to operate the plant at Homan, Ark., because of the excessive rains for the past eighteen months. The president of the company asserts that it would be able to pay out with favorable weather, estimating the assets at \$180,000 and the liabilities at only \$140,000. Its holdings consist of the mill at Homan, a 6-mile standard gauge railroad, valuable timber land holdings and leases on timber property in that section.

The cottonwood interests in this city estimate that the recent rise in the Mississippi, the most pronounced in two years, brought out only about 5,000,000 feet of cottonwood timber, the bulk of which went to two manufacturers on Wolf river, North Memphis. This is only a very small proportion of what should have come out, and this condition is attributed to the scarcity of labor, the decreasing supply of cottonwood timber and the unfavorable weather which has prevailed for a number of months in the cottonwood section of the Mississippi valley. The amount of other woods floated out on this rise was also exceptionally limited.

An interurban electric line will be built from Memphis to Clarksdale, Miss., paralleling the Yazoo & Mississippi Valley portion of the Illinois Central system the greater part of the distance. The company is capitalized at \$100,000 and is headed by Thomas Taggart of Indianapolis, Ind., as president. The company proposes to operate cars for both passenger and freight traffic, and it is felt by lumber interests here, owning property in the delta, that the road will prove an important factor in the development of the timber resources of this section.

The Pine Bluff Lumber & Veneer Company, Pine Bluff, Ark., has filed a certificate with the secretary of state showing a decrease from \$100,000 to \$50,000 in its capital stock.

The Wolverine Manufacturing Company, a Michigan corporation, is constructing a dimension mill in South Memphis for the manufacture of stock to be shipped to Michigan for the manufacture of center tables, cabinets, furniture and numerous hardwood specialties.

Sparks from a passing locomotive a few days ago caused a fire in the yards of the Sheffield (Ala.) Furniture Company, which destroyed a considerable quantity of lumber and entailed a loss of about \$7,000, uninsured. The main plant was saved by heroic work on the part of the fire department.

The Plummer Lumber Company of St. Louis has been awarded damages in the sum of \$1,500 against W. K. Canaday in the federal court at Jackson, Miss. The suit was brought to enforce a contract for hardwood timber to be furnished by Mr. Canaday, who, it is alleged, failed to comply with the terms agreed upon. The suit was for between \$35,000 and \$40,000.

The Corner Stone Lumber Company has been incorporated with a capital stock of \$350,000, one of the largest companies that has been launched in Tennessee for a number of months. The incorporators are: W. M. Pretorius of Pine Bluff, Ark., a member of the Mann & Giranflo Land & Lumber Company at New Madrid, Mo.; C. D. Coddington of Pittsburg, formerly manager of the Montana Lumber Manufacturing Company at Butte, Mont.; N. N. Thompson of Memphis; C. W. Stover, president of the Stover Lumber Company and a director and stockholder in the Gulf-Stover Lumber Company, Memphis; T. S. Estabrook of the Estabrook Skeele Lumber Company, Chicago, and Edgar G. Stover of the Stover Lumber Company, Memphis. The company is preparing to make a large bond issue, consisting of twenty year five per cent gold bonds, which will be placed on the market soon. It owns 15,000 acres of hardwood timber lands on the Rob Roy (Ark.) branch of the St. Louis Southwestern (Cotton Belt) railroad and will put in a large band saw mill for the development of these resources. The headquarters of the company will be at Memphis.

Plans are under way looking to a reorganization of the Gulf-Stover Lumber Company, but details are not yet obtainable.

The Hugh McLean Lumber Company has completed one of the handsomest mills in this city, with a daily capacity of about 50,000 feet. It is a band mill with resaw, and is now in operation with E. R. McKnight and O. M. Krebs in charge. The plant is located in New South Memphis.

E. R. McKnight and O. M. Krebs, managers of the Hugh McLean Lumber Company's plant here, have joined the Lumbermen's Club of Memphis. J. M. Fritchard of the Long-Knight Lumber Company of Indianapolis, Ind., has also become a member of this organization, thus carrying the total around eighty, the highest in the history of the club.

Secretary George C. Ehemann of the Lumbermen's Club is authority for the statement that the club has secured, through subscriptions from its membership, about \$1,000 for the benefit of San Francisco sufferers.

R. J. Darnell for the past few days has been looking after his interests in Mississippi and Arkansas.

W. A. Bennett of Bennett & Witte, who remained here after the convention of the National Hardwood Lumber Association, has returned to Cincinnati.

### Ashland, Ky.

The J. R. Droney Lumber Company of Island Lick has been incorporated under the laws of West Virginia. The incorporators are J. R. Droney of Olean, N. Y., L. M. McClinty, H. H. Claves, J. W. Sullivan and C. A. Yeager of Marlinton, W. Va. The capital stock is \$200,000.

The R. G. Puge Lumber Company of South Bend, Ind., has leased land in this city from the C. & O., on which will be established a large wholesale lumber yard. It is said negotiations are on for one of the local planing mills, but for the present the business will be confined to buying lumber from the country mills and reshipping in mixed carload lots.

James W. Burns of Catlettsburg and King Burchett of Zella, Ky., have formed a partnership under the firm name of Burchett & Burns to carry on a lumber business at Boone's Camp, Johnson County, and are putting up several big saw mills with a commissary in connection.

R. H. Vansant is at Hot Springs, Ark., for a month's stay.

What is said to be the largest log ever floated down the Big Sandy has recently been sold to The General Lumber Company of Columbus, O. The log is a sycamore and was cut high up in the mountains of West Virginia. It is 54 feet long and 59 inches in diameter at the smaller end, and it is estimated will cut 10,000 feet of lumber. The log will be quarter sawed.

H. J. Millies, a prominent lumber dealer of Fronton, O., died recently after a long illness of cancer of the stomach. Mr. Millies was born in Chicago 57 years ago, and came to this section in 1889 with the Chicago Lumber Company, now the Yellow Poplar Lumber Company of Coal Grove, O. Of late years he has been in business for himself and was identified with all leading movements.

F. C. Fischer of Tryon, N. C., is here looking after the interests of the Yellow Poplar Company of Coal Grove, O.

Clarence Crowell has gone to Tunica, Miss., to engage in the lumber business with his father, S. N. Crowell.

W. G. Ward of Fronton, O., has formed a company to operate a large planing mill, which he expects will be in operation within ninety days. The building will be 100x75 feet and from 40 to 50 men will be employed.

### Louisville.

Considering the general scarcity of timber there is a remarkable amount of walnut lumber being made in Louisville this spring. Nearly all the mills are cutting more or less. The Barry-Davis Saw Mill Company has some, the Platter-Powell Company has several stacks of nice black walnut lumber recently cut, and the Louisville Point Lumber Company has already cut 100,000 feet and expects to cut between 100,000 and 200,000 feet more. The logs are now coming down the river to make this amount. The Louisville Point Lumber Company has in its stock about forty fine big logs, which will probably be exported in the log.

Edward L. Davis says of the hardwood situation that practically the only noticeable change in conditions is the stronger demand for poplar. Other hardwoods continue about as they were, with plenty of demand to take care of all the dry stocks.

W. H. Gillette, manufacturer of hickory exclusively, is in Mississippi looking after the moving of one of his mills, which turns out hickory stock for the factory here. The whole Gillette family seems to be wagon wood stock people. A cousin of W. H. Gillette is in this business at Boston, another Gillette in the same business at Memphis and there are still others.

R. McCracken of the Kentucky Veneer Works has a yard full of nice poplar, oak, maple and gum, and is figuring on buying a tract of gum timber. He is turning out more gum right along on the rotary side of the plant, but still continues to make a specialty of quarter-sawed oak in the sawing department.

J. E. Buscher of the Louisville Spoke & Bending Company says the demand for vehicle wood stock is in good shape. The only thing to complain about is the scarcity and high prices of raw material.

### Minneapolis.

E. Payson Smith of the Payson Smith Lumber Company is away on a business trip to Chicago, Milwaukee and neighboring points. A. S. Bliss of the same company reports that they are getting freer shipments of oak, and are now able to supply their customers with a fair degree of promptness. They find a good run of trade from the northwestern factories, and indeed in every direction.

The Industrial Lumber Company is the name of a new concern which has just opened offices in this city. Its incorporators were formerly with the Waterloo Wholesale Lumber Company of Waterloo, Ia., and are also interested in the Wisawa Lumber Company, a line yard concern which has moved here from Waterloo. The Industrial Lumber Company has two yellow pine

mills, at Village, Tex., and Holly, Ia., and also does a wholesale business in hardwood, redwood and hemlock. E. W. Eastman of Minneapolis is president, L. D. Eastman of Lauerster, Wis., vice president, and C. H. Dietrich, Minneapolis, secretary.

The Wisconsin Land & Lumber Company of Hermansville, Mich., has issued a new edition of its I. X. L. flooring booklet, which is being distributed broadcast to the trade.

Chauncey R. Lamb of this city, who is largely interested in the Bacon-Nolan Hardwood Company of Memphis, has returned from a business trip to that city. He says that the company is about to build another mill, and has others in contemplation, which will make it the largest hardwood producing concern in the world. The company owns large bodies of timber in the Mississippi river bottoms that will keep it going for a number of years. It now operates a mill at Clancy, Miss. The new mill to be built will have two hand saws, a resaw and other all modern equipment.

Halsted & Booream, the new hardwood firm located at St. Anthony Park, Minn., has opened offices in the Northwestern Furniture Exposition building in that suburb, and is therefore well located to supply the factory trade. They will carry a complete line of both northern and southern hardwoods, and in addition will handle west coast lumber. The members of the firm, H. M. Halsted and H. Booream, were formerly with the Abbott Manufacturing Company of St. Paul.

#### Wausau, Wis.

J. G. Kandy, manager of and principal stockholder in the Colby Novelty Company, Colby, Wis., has moved the plant to Grand Rapids and organized the Kandy Manufacturing Company; capital stock, \$25,000. A sash, door and blind factory has been purchased, which will be converted into a home for the institution. To get the company to locate in Grand Rapids the citizens of that town had to subscribe \$4,500 worth of stock. The company will manufacture hotel, church and saloon fixtures and hardwood finishings and novelties.

E. P. Holmes has withdrawn from the Wheeler, Holmes & Timlin Company of Wausau, and the concern has been reincorporated under the name of the Wheeler-Timlin Lumber Company.

The Stolle-Parndt Lumber Company, with plant at Tripoli, has been hiring additional crews with the object of rushing summer logging operations. The company has a hardwood mill with a cutting capacity of 45,000 feet daily. A lumber yard is maintained in Minneapolis.

The North Western Lumber Company, of which the head is Col. J. T. Barber of Eau Claire, has given orders to George H. Chapman of the Stanley plant to advance the wages of all men in the company's employ at that plant. The raise is very liberal and amounts to more than ten per cent of the old scale. The change was voluntary on the part of the company, which has made a number of such raises in the past few years.

The most valuable timber shipped out of Wisconsin the present year was a quantity of rock elm ship timber, cut in Marathon county by a Canadian concern. Only tall, straight rock elm trees were selected and after they were cut down were hewed into square timbers. About fifteen carloads were recently shipped to Green Bay, where they were reloaded on vessels and carried down through the great lakes and St. Lawrence river, and will finally land in the great shipyards of Liverpool, where they will bring \$125 per thousand feet.

Lenke & Nickel, Wausau, have sold their cut of 3,000,000 feet of mixed hardwoods to the Wausau Lumber Company.

C. A. Bentley of Milwaukee, an old lumber dealer, has been appointed by the treasury department to collect of Marinette dealers the \$2

duty on the lumber being shipped in there from their Canadian mills.

A crew of 125 men employed in the mill of the Davis & Starr Lumber Company in the village of Weston, Dunn county, have struck for a ten-hour day. They were working eleven hours. The people of the village refuse to allow outsiders to be brought in to take the strikers' places.

Nearly all the lumber in the Marathon Lumber Company's yards at Marathon City was recently destroyed by fire. The blaze started near the mill, but fortunately the wind carried the fire away from the plant and it was saved. The yards contained about 3,000,000 feet of white oak, maple, birch and basswood, all choice stock. The owner, Philip Menzner, was partially protected by insurance. He still has quite a stock of logs in the pond to saw.

The Quaw Lumber Company, Edgar, has finished a cut of 5,500,000 feet of hardwood. The company secured a better grade of logs the past winter than usual.

## Hardwood Market.

(By HARDWOOD RECORD Exclusive Market Reporters.)

### Chicago.

The local trade is featureless. A fair demand obtains for oak, poplar and cottonwood. Handlers of maple seem to have renewed confidence in the possibilities of this wood, and during the last month a good many orders have been placed with Michigan and Wisconsin operators by local jobbers, for increased supplies. There is one feature of northern hardwoods that has not prevailed until recently, and that is that the coarse end of all woods is being closely picked up for box and crating purposes. Generally the local jobbers feel optimistic over the situation and believe that they will have an excellent business year.

### Boston.

Values in the hardwood market are very firm and in most instances the demand is of a satisfactory character. Manufacturers of interior finish, sash and doors, furniture and desks are busy and in the market for hardwoods. The export trade is fair, but is not as active as it would be if prices were lower. Letters received from abroad indicate that buyers are holding out of the market as far as possible owing to high prices.

Many of the local yards are very well supplied with hardwoods, having bought in anticipation of higher prices. Good quality dry stock is reported as scarce. The call for plain oak is fairly active. The supply of inch stock is small and prices are firm at \$53 to \$55. Quartered oak is in fair demand. Values are firmer. One inch firsts and seconds are quoted at \$78 to \$80, and in some instances dealers will not sell at less than \$81 to \$82. Brown ash is very firmly held, but the demand has been checked somewhat by high prices. The market for maple flooring is firm and the demand fair. Cypress is a little better off than it was. Whitewood is firmly held, with the demand fair.

### New York.

The conditions in the local hardwood market are quite satisfactory. The demand for good, well manufactured hardwood in the better grades is very fair, and the supplies of dry stock are short, although there is the usual accumulation of low grade lumber. Prospects are favorable for a continuance of present prices and market conditions throughout the summer. Buyers returning from manufacturing points all bring the same tale of short stocks in the better grades of the most desirable hardwoods, such as plain oak, birch, ash, poplar, etc., and everyone in the wholesale trade who has any amount of

William Brehmer has purchased the interest held by his former partner, the late Louis Salzman, in a mill and yards west of Wausau. The mill was built four years ago, and a well timbered hardwood country surrounds it.

C. H. Donaldson of Mason & Donaldson, Rhinelander, is to be married to Miss Leona Cordell Cole in Denver, Col., on Tuesday, June 12.

Theodore S. Wilkin, of the Wilkin-Challoner Company, Oshkosh, has won an important suit involving opposing claims to the invention of an improvement in gang sawmills. The defendant was Charles E. Cleveland, of the Giddings & Lewis Manufacturing Company, Fond du Lac. The complainant alleged that Cleveland used a sketch of an invention made by Wilkin as the basis of an improvement, and manufactured two machines. In a suit in the patent office and an appeal to the board of patent examiners Wilkin was successful in establishing his claims. Cleveland appealed to the court of last resort and was defeated.

such stock at this time considers himself in possession of a good asset. Current activities in building circles and general lumber consuming lines are good; the amount of building planned for this year is thus far in excess of last year, notwithstanding that 1905 was a record breaker.

In the various hardwoods, poplar, ash, birch and chestnut in the better grades are still in first call, with dry stocks scarce and prices very firm. Low-grade lumber is easy, but prices are fairly well maintained. Beech is improving in call, particularly heavy stuff for temporary structural work. In quartered oak and maple there is ample stock for current wants and the market is not overactive. The flooring situation is in fair shape; in oak flooring the demand is such as to make it somewhat difficult to secure prompt service in the matter of special orders.

### Philadelphia.

The local market remains firm, and dealers report plenty of inquiries. Hardwoods have for a long time been doing well in this market, with the result that the present year has been so far the best in the history of many firms. At least three big dealers have reported that their business has doubled. Quite a number of other concerns, which heretofore have been doing little in hardwoods, have awakened to the fact that the demand is exceeding the supply, and have entered into contracts with mills that will enable them to get into the market extensively. Several other firms have established departments for hardwoods and find them paying well.

Sales in cherry have not been as heavy during the last fortnight as previously, this wood being hard to get. Stocks of poplar also continue short. Oak and chestnut are still the leaders, prices in the latter seeming to be on the increase. Quartered oak and ash are brisk and basswood rather high. Large quantities of cypress are coming into the market, frequent inquiries justifying the heavy shipments. Hickory still continues good; stocks in local yards are low. The dominant feeling in the local market is that the summer and fall trade will be equal to any ever had here. This condition will be well taken care of as the total of the mill contracts held by local wholesalers has scarcely ever been surpassed.

### Baltimore.

There is no change to note in the hardwood situation, except that the inquiry seems to be somewhat halted. The opinion prevails widely that prices are too high and buyers as a consequence show some hesitancy about placing orders. They are compelled to satisfy current needs, but are holding back on providing for

future requirements, which has imparted a somewhat uncertain tone to the market. The necessities of the trade, of course, continue to be large. Builders and other consumers must draw on the available supplies to a much greater extent than has been the case for some seasons, and the mills are having as many calls as they can well fill, though favorable weather conditions have served to augment their productivity. Competition at manufacturing points is comparatively active, and the producers insist upon getting full list prices, but there appear to be indications that the upward tendency in the quotations has been arrested and that a further advance is not likely to be made. As yet, however, there has been no diminution in the movement, and the entire list of hardwoods is active, with oak in the lead, and ash, chestnut, birch, cherry and other woods following. Walnut is still an important factor in the domestic trade, and mahogany is being used in relatively large quantities. Poplar retains its hold on the trade, and brings prices that stimulate the mill men to do their utmost in getting out stocks.

The export business is quiet, with the movement quite up to the average. There is no especial snap in the demand, though lumber and logs appear to be bringing better prices than was the case some months ago.

#### Pittsburg.

Pittsburg firms which make a specialty of hardwoods have reason to feel jubilant over the present conditions. At no time in the past two years has the market for hardwoods been better than now. This is the more noticeable because the lumber market in general is slightly in the dumps, due partly to the fact that "tighter money" has undoubtedly called off some projects, building and industrial, and partly to the carpenters' and structural steel erectors' strikes.

Oak is selling better today than any other wood in the Pittsburg market. Prices are creeping up slowly on all grades, including bill stuff, which has remained stationary for a long time. It is a question of getting stocks of oak, not customers.

The other hardwoods are showing up well. Maple is selling in good quantities and at satisfactory prices. Chestnut is not quite so active as two months ago, but sound wormy is finding a good market in the East. The hub factories are taking a considerable amount of elm, and the spoke and handle factories throughout Ohio are making good demands on the Pittsburg trade for hickory and ash.

Prices of hardwoods remain very firm, and there is no reason to expect a drop in quotations along any line. From present indications dealers have reason to believe that the market for heavy timbers, ties and poles will be very active as the summer advances, as many projects which will involve a large expenditure of money are just being shaped up for contractors.

#### Buffalo.

The former activity in hardwood lumber continues and the trade is very busy getting stock to make up for the drain on their yards. As a rule most woods command a better price than last year, as they should, if only to meet the increased price of logs and the generally larger expense of business caused by the difficulty of getting new stock. One reason that hardwood lumber is now taking the lead in activity is that pine, both white and yellow, is often as much as \$15 higher in the upper grades than it was two years ago and hardwoods have not gone up anything like that amount. The East is not paying the fancy prices asked for lumber as readily as the West is said to be, and it was reported a few days ago that one reason that hawswood is not yet doing much in this market, after being laid aside some years, is that dealers are still afraid of the mill prices. Elm is also rather slow, largely on account of the mill prices

being too high for this market, but the demand for chestnut and all sorts of ash is much greater than the supply. Oak is doing well, but is very hard to get. Quartered is selling better than formerly, though its substitute, birch, seems to be coming in fairly well. There is a good movement of maple, with prospect of a better profit in it than formerly. Some dealers are making quite a specialty of it again, and where sorting is made an expert business, with reference to special customers, the trade is a good one by itself, despite the old idea that maple is always a cheap wood, selling at small profit. It is no longer plentiful.

There has been much uneasiness on the part of hardwood dealers on account of the reports from yards showing a steady reduction of stocks, so that it was feared that midsummer would see the assortments badly broken, but the search for new lumber has been carried on with so much vigor of late that the drain is not so great as was feared.

#### Saginaw Valley.

The local market for hardwood material is in good form, both in the matter of stock, prices and volume of business. No difficulty is experienced in disposing of any kind of lumber, cull being particularly active by reason of the high prices of pine. Box men are thus using substitutes and basswood and maple culls are bringing a good price. Some manufacturing firms have contracted all their culls for the season. They are to be converted into box shooks.

The maple flooring trade is much better than last year. In this market elm is doing much better than last year. Ash is a quick seller. There will be quite a bunch of ash handled in this market this season. Not a great deal of birch finds its way to the mills in this section.

#### Grand Rapids.

The hardwood situation has improved here and most dealers are reporting a reasonably active market. Some dealers are asking for an advanced price for birch, which is the dullest wood in the market at the present time, and they believe that birch will move. The mills are cutting lots of maple, but dry four-quarter stock at this time is picked up clean. Plain oak continues to bring better prices relatively than quartered oak. Furniture lumber continues in good demand at firm prices.

#### Bristol, Va.-Tenn.

Conditions in the hardwood trade in this section are eminently satisfactory. The increase in business within the past few months has been phenomenal. The great activity displayed in the manufacture of lumber in this region is unprecedented; during the past few weeks numerous new mills have been erected and others are starting up almost daily. It is estimated that at least 30 per cent more lumber is being shipped from this section this year than last and the lumbermen believe 1906 will be a record breaker for heavy sales. The car supply is not entirely satisfactory. There is still some complaint heard that cars cannot be secured promptly enough.

#### Cincinnati.

The demand for hardwoods is slowing up. That seems to be the general opinion of local dealers and manufacturers, although here and there reports are given that the demand is still as good as it was a month ago. However, those firms which have not yet experienced a let-up in their business acknowledge that there is almost bound to be a curtailment in business due to the approach of summer.

There is a universal cry among lumbermen for dry stocks. Receipts are increasing and it is likely that in a short time suitable supplies will be in the yards, providing the receipts continue on the same scale as during the past fortnight

and the demand does not take on a sudden spurt.

Prices are quite firm but it is a question how long they will remain so. Well posted men in the trade believe that the next move in prices will be downward, but they do not care to opine when such a movement will begin. It is a certainty, though, that plain oak will hold its own for a long time. Offerings are being taken with avidity and full prices are being paid without hesitation. Quartered oak is quieting down, although some highly satisfactory orders are still being placed. Ash and cypress continue in limited supply and relatively fair request with the result that the market, so far as prices are concerned, may be said to be taking care of itself nicely. The volume of business in chestnut has grown smaller, but stocks have not increased to such an extent that a decline in quotations is likely. Cottonwood supplies are adequate to the occasion and no change in prices has been made. Box boards are rather scarce. Red gum firsts and seconds rule steady with a fair call and not excessive stocks. All grades of poplar are firm, with the lower grades having a better sale than the upper.

#### Chattanooga.

The lumber market continues active in this section, with the possible exception of middle grade poplar and quartered oak. The demand for these grades of stock has been a little easy in the last two or three weeks. Prices continue firm, with prospects of advance rather than otherwise. There are now more inquiries with a smaller supply of stocks to meet them than has been known in several years.

The cut of the local mills will run far short of that of last year. This is due to the fact that the tides in the river have been low and probably only about three-fourths of the usual amount of logs have come down the Tennessee river. The river mills have received about 1,000,000 feet of logs within the past two weeks, but another tide can hardly be expected before the fall rains. The indications are that the river mills will be compelled to shut down early in the summer, on account of the scarcity of logs.

#### Nashville.

Conditions in the local market remain unchanged. Good prices are being received for all kinds of hardwoods and business is brisk. Foreign orders are lively, and building operations which seem ever on the increase in Nashville keep mill men and woodworking plants busy. The Nashville wagon makers are scooping up all the ash they can find and dry stock is hard to get at any price. Plain oak, always a leader, remains firm. The price, in fact, is high, but there are always plenty of takers for dry stock on the market. There is also a better demand for quartered oak. Dry poplar is reported scarce, and there is a good demand even for the inferior grades. Black locust, extensively used for interior finish, continues in active demand. Beech is now forging to the front locally, as flooring material, and is proving most satisfactory for this purpose. There is some cedar coming in, but it is always in great demand and is bringing fancy prices.

#### Memphis.

There is a very good demand for hardwood lumber of all kinds, with the exception of quarter sawed red oak, and those who have dry stock to offer are having little or no difficulty in disposing of it. Prices are admittedly rather high and there is apparent disposition in some quarters to buy only for immediate requirements. Lumbermen here, however, are confident that trade conditions will continue healthy and that prices will recede little if any until there has been some restoration of more normal relations between supply and demand. Stocks are still much broken and the process of replenishment is slow because shipments are practically as large as local arrivals.

Conditions affecting production now show some improvement. There has been very little rain in lumber producing territory lately, and the weather has been fine, so that reports from the interior suggest that there is a decided increase in the amount of stock going on sticks. However, this will not tend to relieve the situation materially because of the long period required for drying.

Ash is still in active request, in fact, as good as it has been at any time this season, there is a decided shortage in the supply of dry stock. All grades are wanted.

The demand for cypress shows no let-up and prices are firmly held. Cypress mills are producing more lumber now than for some time, but the shipments are on so large a scale as to prevent much recuperation in holdings. High grades sell rather better than low, but there is no lagging anywhere.

The demand for cottonwood in all grades is splendid, while stocks are considerably below the average for this time of year. The amount of timber cut this season is decidedly short, and this points toward a tight supply. The receipts of cottonwood timber here as a result of the recent rise in the Mississippi show a marked falling off compared with the average and this of itself is accepted as a strengthening factor. No. 1 and No. 2 box common are in exceptionally good request.

Gum is steady at prevailing quotations. There is no surplus of well-handled stock. There is a particularly good call for 3/4 to 1-inch red firsts and seconds and clear saps for export trade, while the domestic market is taking care of all the low grade stock.

There is still a pronounced demand for plain sawed white oak, which is selling at good prices, but there is a falling off in some directions on plain sawed red, with prices possibly a shade easier than heretofore. Quartersawed white is moving fairly well, but there is not much demand for quartersawed red, but as there is no great amount of the latter available manufacturers are asking pretty full prices therefor.

The poplar situation appears to be without special change during the past fortnight. The amount of this available in this market is somewhat limited and prices are firmly held.

#### Ashland, Ky.

Conditions are good, prices firm and stocks selling as fast as they are dry enough to ship.

The biggest run of the season is on in the Big Sandy, Levina and Tug rivers, and all the creeks except Shelby have strong tides. Three hundred fine rafts have been brought out of the mouth of the Sandy. The Guyandotte river has also sent out large quantities of timber in the recent rise, twenty-five or thirty rafts, and loose logs enough to give the Guyandotte valley timber men work for several weeks. This output of timber has been a rich harvest for the timber men who brought it out for the market, as they were able to secure higher prices for poplar than have been paid for some seasons, some timber selling as high as 55 cents per cubic foot, which would mean about \$25.50 per thousand feet board measure in the log.

At the present market price of timber, mill men must have a fair price for their poplar lumber or they would not come out even. There is no difficulty in finding a ready market for all poplar lumber. The river mill men are expecting the usual June rise, and are looking for another log tide that will enable them to keep their mills running.

#### Louisville.

The poplar situation still continues to be the feature of the Louisville market. The demand for that wood is exceptionally active, with the supply of dry stock very scarce. Other hardwoods are also in strong demand, prices are satisfactory generally and on the whole conditions are favorable. Level siding finds a particularly brisk demand, with the supply in sight

rather limited. The recent awakening in the call for No. 1 Common still keeps up. In fact, everything made of poplar is in good demand, with prices going up until veneer men and some others who have been using it in what is termed cheaper work are turning from it to gum.

The demand for plain oak, ash and chestnut continues good, with nothing in sight to mar the outlook. In the wagon and implement lines there is an excellent demand for finished wood work. The only thing that worries manufacturers is to get the raw material. Hickory is especially scarce and in strong demand. The factories have cleaned up their yards pretty close on both hickory and oak. As the country roads are better now there are hopes of increasing supplies soon.

#### Toledo.

The tone of the hardwood market is healthy. Local dealers claim there is plenty of trade at firm prices. Some dealers complain of a scarcity of stocks, others seem to have ample supplies to meet the demand, which is strong at the present time. This varying opinion in all probability is due to the fact that those who now have pretty good stocks put in good supplies last fall, while the others did not.

Maple flooring is in brisk demand. Prices on maple lumber are strong. Oak and poplar are rather scarce, and prices are disposed to advance.

The present activity in building is an important factor in the hardwood trade. The records at the office of the city building inspector show that since the first of the year over 500 permits, with a valuation of about \$2,000,000, have been issued.

F. S. Belcher, of the Belcher-Stine Lumber Company, will leave next week to look after his interests in Oregon, having a mill at Fall City. G. R. Stine has removed to Little Rock to remain there until the first of next year.

#### Minneapolis.

Stocks of hardwood in the Northwest are about cleaned up. With the exception of birch and basswood, dry hardwood is nearly out of the market. Local dealers are practically out of elm, ash and northern oak, and prices have taken a decided jump upward, especially on rock elm and ash. There is no stock to be had in any quantity, and the new cut will not be ready for some time. A little new basswood is coming on the market, and is meeting with a good sale. Box manufacturers have their eyes on basswood ends and will buy as soon as they find the stock. Birch ends are well sold out and at good prices. There are some good-sized stocks of birch left in the upper grades, but they are moving rapidly. The factory trade is not taking much but birch, which is used for doors, mill work and finish.

Southern oak is moving more freely as the factories have emerged from the spring floods, but the mills are drawing on light stocks, and prices have advanced. Plain oak uppers are selling readily at good prices. There is no northern stock left in inch lumber, and the timbers and planking are disappearing fast. Maple lumber and flooring are enjoying a ready sale. The country yards, however, are not now in the market to any extent.

Everything indicates a good out of northern hardwood this year, but the prospect is good for a still demand and continued strong prices. Considerable hardwood is being sold by the mills in advance of production.

#### Rhineland, Wis.

The hardwood trade is showing improvement, and shipments this month will be larger than they were in April, when the winter rush was about over. A great many contracts were placed at that time, and as new stock is now getting into shipping condition, it is going forward on these contracts. The best selling items are probably Nos. 1 and 2 Common basswood, and

No. 3 Common birch. Last year, at this time, these items were slow sellers, especially No. 1 Common basswood. Mixed Nos. 2 and 3 basswood and No. 3 Common birch, sell to the box factories, and the demand will take all the available supply. The grain door trade is also good, and takes No. 3 birch, many mills shipping all their 6 and 12 foot stock to the railroad supply departments for grain doors, cutting the 12 foot in two. Other mills make the doors up complete and claim they are getting about \$12 per thousand feet out of the lumber. Trade this year emphasized the statement often made that one-third of our lumber goes into boxes and crating.

The upper grades of birch and basswood are selling fairly well, the planing mills and sash and door factories calling for them to a considerable extent. San Francisco is taking some birch and hard maple. Hard maple is improving in demand, and dry stocks are low, so that customers will have to take a good deal of wintersawed stock, which is now dry enough to go into the kilns. Soft elm has also been selling better this year than last, and at better prices. The amount of soft elm on hand is not large and it will all be needed during the year.

#### Liverpool.

Trade during the last fortnight seems to have dropped off considerably. High prices have undoubtedly frightened off buyers, who seem to think that the proper game to play is "buy from hand to month"; prices cannot go any higher and may go lower. However, prevailing opinion seems to be that it is highly probable that they will advance. Recently in trying to sell a carload of ash planks to a buyer who was known to be out of the stock and would be wanting some within the next few weeks, although he was asked only a slight advance over last year's price and acknowledged that he could not buy lower, he said he would not buy at present prices, but would wait until they were lower. It is more than probable that he will have to buy when prices are higher.

All mahogany bought at the last sales has been rapidly cleared away and yards are very empty. Undoubtedly at the next sales to be held at the end of the month a sharp advance will be made on this wood.

Ash and oak continue firm and good parcels are quickly snapped up. This apparently will continue, but shippers should beware of sending consignments which will only have one result—wakening of prices. Hickory is better, the result of a smaller import being that brokers here can easily place all desirable stock. Birch is still weak.

#### London.

The hardwood market does not yet show any great signs of activity, demand for stock principally being met by parcels that have been stored in the docks for some months past. The arrivals are light, but strange to say, although the general demand and the prices for lumber in the States are so strong, some shippers are still sending consignments which are difficult to dispose of, in many cases, at the f. o. b. value. While parcels which happen to be wanted realize full prices. Several large shipments of lumber are expected in June and considering that dock stocks are not heavy, will be needed, but buyers are in no humor to buy what they do not want, as they say there will be plenty of consignment parcels later on. Oak planks, 3 and 4 inch, are in good demand at full prices; boards are not plentiful, but there is sufficient to meet the demand.

Whitewood boards are in steady request; planks, which have been inactive for some time past, are in slightly better demand. Ash and hickory planks are doing well; arrivals are light.

Mahogany is still eagerly sought after at high prices, and arrivals are not too heavy for the demand.

# AT COST

✿ IS AN UNCOMMON TERM AS APPLIED TO INSURANCE ✿  
But this is the actual price of Indemnity against Fire Loss furnished by the

## MANUFACTURING LUMBERMEN'S UNDERWRITERS.

### THE STRONGEST INSURANCE ORGANIZATION TODAY IN AMERICA

---

The saving is not  
on a small portion  
of your Insurance  
but on the ✿ ✿  
ENTIRE LINE.  
There are other ad-  
vantages equally  
interesting. ✿ ✿

---



---

Only well built  
plants with ade-  
quate protection  
and at least five  
years timber supply  
are considered eligi-  
ble. ✿ ✿ ✿

---

For List of Members and further information Address

**HARRY RANKIN & COMPANY**  
KANSAS CITY, MO.



# Wanted and For Sale -SECTION-

Advertisements will be inserted in this section at the following rates:

For one insertion ..... 20 cents a line  
For two insertions ..... 35 cents a line  
For three insertions ..... 50 cents a line  
For four insertions ..... 60 cents a line

Eight words of ordinary length make one line. Heading counts as two lines. No display except the headings can be admitted.

Remittances to accompany the order. No extra charges for copies of paper containing the advertisement.

## EMPLOYES WANTED.

### WANTED.

Buyer and inspector for export trade, one experienced in wagon oak plank trade. Apply "WAGON OAK," care HARDWOOD RECORD.

### WANTED.

A young man to keep books and inspect hard and soft woods. Write, marking envelope "Personal." H. D. BILLMEYER, Cumberland, Md

### WANTED.

Competent sawmill man owning a small 5 or 6 ft. band mill to cut hardwoods in North Carolina by the thousand; ample log supply. Would consider buying a band mill for responsible party. Address

"A. L. V.," care HARDWOOD RECORD.

## ASSISTANT SALES MANAGER

Wanted in our Hardwood Department. Must be a young man of good habits and address, energetic and a good all round office man and correspondent, capable of buying and selling by letter. He should also be familiar with both the buying and selling end of the business, and capable of taking entire charge of our Hardwood Department in the absence of the manager. Address, giving experience, age, reference and salary desired, to "HARDWOOD JOBBER," care HARDWOOD RECORD.

## LUMBER WANTED

### PERSIMMON WOOD WANTED.

Sawn to sizes for shuttle blocks, 18" 2x2 1/2, 20" 2 1/4 x 3, 18" 2x2 1/4. Address "WOOD," care HARDWOOD RECORD.

### WANTED.

4 4 1st & 2nd Butternut.  
4 4 1st & 2nd Chestnut.  
4 4 to S, 4 1st & 2nd Cherry.  
W. R. CHIVVIS,  
Lesperance & Iron Mt. R. R., St. Louis, Mo.

### WANTED.

To contract for the output for this year of a good mill cutting oak and poplar lumber. Address "MORGAN," care HARDWOOD RECORD.

## GREEN WHITE AND RED OAK PLANK.

300 M ft., prefer White Oak, 2 1/4", 2 1/2", 2 3/4" and 3" thick, No. 1 Commons and Better. Prompt shipment.

SICKLESTEEL LUMBER CO.,  
Detroit, Mich.

## OAK WANTED.

3 and 4 inch White Oak; also Mixed Oak; also 12x12 Timbers and Piling of all kinds. CONTINENTAL LUMBER CO.,  
1213 Monadnock Bldg., Chicago, Ill.

## WANTED—POPLAR, OAK, CHESTNUT.

Will receive lumber at shipping point and pay cash. D. B. MURPHY & CO., London, Ky.

## CHESTNUT, POPLAR, OAK, ASH.

Wanted all grades and thicknesses. Send description and lowest cash price. Amount justified, will send buyer.

RODE & HORN, Brooklyn, N. Y.  
Southern Office: Johnson City, Tenn.

## OAK.

We are in the market for plain sawed oak, all grades and thicknesses.  
P. G. DODGE & CO., 2118 Lumber St., Chicago.

## WHITE ASH WANTED.

50 M to 100 M feet of strictly clear, straight grain, second growth white ash, ranging from 3"x4" to 4"x5"—12 and 14 foot lengths, suitable for horse poles.  
AMERICAN-LA FRANCE FIRE ENGINE CO.,  
Elmira, N. Y.

## WALNUT ONLY.

Wanted, Walnut lumber, green or dry, all grades, all thicknesses, log run or on grades. Highest market price paid. Liberal inspection.  
C. J. FRANK,  
2440 N. New Jersey St., Indianapolis, Ind.

## WANTED—HARDWOOD LOGS.

200 M feet 28-inch and up White Oak logs.  
200 M. feet 12-inch and up Walnut logs.  
50 M. feet 12-inch and up Cherry logs.  
C. L. WILLEY,  
Blue Island Av. and Robey St., Chicago.

## LUMBER FOR SALE.

### WHITE OAK FOR SALE.

100,000' 4 1/4 quartered 1 & 2 and No. 1 Common. Good dry stock, good widths and lengths. THE YOUNG-GREENE LUMBER CO.,  
Goshen, Ind.

### WAGON STOCK FOR SALE.

We are in position to furnish wagon manufacturers with wagon tongues, axles, reaches and bolsters.  
GAYOSO LUMBER CO., Memphis, Tenn.

### DRY STOCK FOR QUICK SHIPMENT.

HARD MAPLE.  
10,000 ft. 1-1 No. 2 Com & Better.  
124,000 ft. 5-4 No. 1 Com. & Better.  
250,000 ft. 8-4 1sts & 2nds.  
25,000 ft. 10-4 1sts & 2nds.  
19,000 ft. 12-4 1sts & 2nds.  
7,000 ft. 4-4 One White Face.  
7,500 ft. 6-4 One White Face.  
11,000 ft. 8-4 One White Face.  
215,000 ft. 4-4 No. 2 Com. & Bet. Bass'wd.  
60,000 ft. 4-4 No. 2 Com. & Bet. Elm.  
5 cars 4 4 1st & 2nd Quartered White Oak.  
5 cars 4 4 No. 1 Com. Quartered White Oak.  
5 cars 4 4 No. 2 Com. & Bet. Plain Red Oak.  
2 cars 4 4 1st & 2nd Plain White Oak.  
5 cars 4 4 No. 1 Com. Plain White Oak.  
Also Poplar, Basswood and Gum. Prices quoted on application.  
THE BECHTER-STINE LUMBER CO.,  
323 Spitzer Bldg., Toledo, Ohio.

### FOR SALE.

Common and better Hickory, 5,277 feet of 2 1/2", 1,092 feet of 3" and 1,024 feet of 4", dry, good quality.  
LOVE, BOYD & CO., Nashville, Tenn.

### GOOD HICKORY FOR SALE.

Half carload sawn 1"x1" square x 66" long.  
Half carload sawn 1 1/2" to 1 3/4" square x 60" long.  
E. DUNSTAN, Winona, Miss.

## MACHINERY FOR SALE

### FOR SALE.

One six ft. Hoosier left-hand band mill, three block carriage, latest improved dogs, Soule feed, in use only about thirty days.  
WRIGHT-BACHMAN LUMBER CO.,  
Portland, Ark.

## MACHINERY WANTED

### GANG EDGER WANTED.

Small second-hand machine; belt pulley on left for horizontal running. Address  
H. S. McAFOS, Gastown, Pa.

### AT ONCE.

If you are in need of machinery—new or second hand—a few lines in this column will place your wants before those who have such goods for sale. For particulars address  
HARDWOOD RECORD, Chicago, Ill.

## BUSINESS OPPORTUNITIES

### WANTED.

Competent sawmill man owning a small 5 or 6 ft. band mill to cut hardwoods in North Carolina by the thousand; ample log supply. Would consider buying a band mill for responsible party. Address

"A. L. V.," care HARDWOOD RECORD.

### HARDWOOD TIMBER.

A number of good mill propositions along the Cotton Belt Route. Tracts ranging from five hundred to twenty thousand acres, principally Oak, Hickory, Gum, Cypress, some Ash, Cottonwood and other hardwoods. Can be secured at very reasonable figures now—in some cases at less than \$1 per thousand stumpage. Choice openings for hardwood lumber mills, handle and spoke factories, slack coarage plants and other hardwood enterprises.

A number of points on the Cotton Belt offer free sites or will raise cash bonus or take stock in practical propositions. Let us have your wants and see what we can do for you.

E. W. LA BEAUME, G. P. & T. A.,  
COTTON BELT, St. Louis, Mo.

## TIMBER LANDS FOR SALE

### FOR SALE.

Two thousand acres Pennsylvania hardwood. Railroad now being graded through property. Low freight rates Pittsburg, Buffalo and Baltimore markets. Can show property any time. Address,

"TIMBER," care HARDWOOD RECORD.

## MISCELLANEOUS

### FACTS FROM PRACTICAL MEN.

The HARDWOOD RECORD is always in the market for articles on any and every feature of the hardwood industry. It wants practical statements of fact from practical men who know how certain things can be done in the best way. Literary quality not essential. Liberal pay for acceptable articles. Address  
Editor HARDWOOD RECORD.

## RAILWAY EQUIPMENT

### RAILS AND LOCOMOTIVES.

All inquiries for industrial railway equipment listed before "Record" readers will find ready response.

HARDWOOD RECORD, Chicago, Ill.

Advertisers' Directory

NORTHERN HARDWOODS.

American Lumber & Mfg. Co. 9  
 Arpin Hardwood Lumber Co. 41  
 Babcock Lumber Company. 9  
 Barnaby, C. H. 43  
 Beyer, Knox & Co. 51  
 Bliss & Van Auken. 10  
 Boyle, Clarence, Lumber Company 50  
 Boyne City Lumber Company. 47  
 Briggs & Cooper Company. 4  
 Brownlee & Company. 46  
 Buffalo Hardwood Lumber Co. 51  
 Cadillac Handle Company. 3  
 Cheat River Lumber Company. 9  
 Cherry River Boom & Lbr. Co. 1  
 Chivvis, W. R. 5  
 Cincinnati Hardwood Lumber Co. 49  
 Cobbs & Mitchell, Inc. 3  
 Crosby & Beckley Company, The. 44  
 Crossby, C. P. 44  
 Cummer, Diglins & Co. 3  
 Davis, John R., Lumber Company 44  
 D'Heur & Swain Lumber Co. 43  
 Dennis Bros. 47  
 Dennis & Smith Lumber Company 46  
 Dixon & Dewey. 48  
 Dulmeier Bros. 48  
 Dulweber, John, & Co. 49  
 Elias, G., & Bro. 51  
 Empire Lumber Company, Buffalo 51  
 Estabrook-Skeele Lumber Co. 50  
 Fall, E. H. 50  
 Flint, Erving & Stoner Company. 9  
 Freiburg Lumber Company, The. 49  
 Fullerton-Powell Hardwood Lumber Company. 43  
 General Lumber Company. 48  
 Goldie, J. S. 47  
 Haak Lumber Company. 47  
 Hackley-Phelps-Bonnell Company. 47  
 Hayden, Harvey S. 48  
 Heath-Witbeck Company. 50  
 Holloway Lumber Company. 7  
 Ingram Lumber Company. 44  
 Jenks, Robert H., Lumber Co. 45  
 Jones Hardwood Company. 7  
 Kampf, Albert R. 7  
 Keith Lumber Company. 50  
 Kelley Lumber & Shingle Co. 46  
 King & Bartles Lumber Company 45  
 Kitzinger, Gus. 36  
 Leavitt Lumber Company. 10  
 Lesh & Matthews Lumber Co. 50  
 Linehan Lumber Company. 9  
 Litchfield, William E. 7  
 Long-Knight Lumber Company. 43  
 McClure Lumber Company. 47  
 McLevain, J. Gibson, & Co. 7  
 McLean, Hugh, Lumber Company 51  
 MacBride, Thos., Lumber Co. 47  
 Maley, Thompson & Moffett Co. 49  
 Maley & Wertz. 43  
 Martin-Barriss Company. 45  
 Michigan Maple Company. 10  
 Miller, Anthony. 51  
 Mitchell Bros. Company. 3  
 Mowbray & Robinson. 49  
 Murphy & Diglins. 3  
 Nicola Bros. Company, The. 9  
 No. Vernon Pump & Lbr. Co. 2  
 Norman Lumber Company. 2  
 North Shore Lumber Company. 44  
 North Western Lumber Company 44  
 Page & Landeck Lumber Co. 44  
 Perrine-Armstrong Company. 43  
 Pefers, R. G., Salt & Lumber Co. 47  
 Price, E. E. 7  
 Radina, L. W., & Co. 49  
 Rumbarger Lumber Company. 48  
 Scatfield & Son. 51  
 Schofield Bros. 7

Schultz Brothers & Benedict. 6  
 Simmons Lumber Company. 47  
 Soble Brothers. 7  
 Southern Oak Lumber Company. 50  
 Standard Hardwood Lumber Co. 51  
 Stephenson, The L. Company. 10  
 Stewart, I. N., & Bro. 51  
 Sullivan, J. V. 43  
 Sullivan, T., & Co. 51  
 Tegge Lumber Company. 47  
 Turner, A. M., Lumber Company 9  
 Upham & Agler. 8  
 Van Keulen & Wilkinson Lumber Company. 47  
 Vollmar & Below. 44  
 Wetzstaff, W. J. 50  
 Ward Lumber Company. 50  
 Wentworth, Chas. S., & Co. 7  
 White, W. H., Company. 46  
 Whitmer, Wm., & Sons, Inc. 7  
 Wiborg & Hanna Company. 49  
 Wiggin, H. D. 49  
 Wilson Bros. Lumber Company. 9  
 Wistar, Underhill & Co. 7  
 Yeager, Orson E. 51  
 Young & Cutsinger. 43  
 Young, W. D., & Co. 10

SOUTHERN HARDWOODS.

Advance Lumber Company. 45  
 Anderson-Tully Company. 44  
 American Lumber & Mfg. Co. 9  
 Atlantic Lumber Company. 1  
 Bacon-Nolan Hardwood Company 4  
 Beck, E. E., Lumber Company. 49  
 Beyer, Knox & Co. 51  
 Bennett & Witte. 49  
 Black, F. W., Lumber Company. 50  
 Bliss-Cook Oak Company. 36  
 Boyle, Clarence Lumber Co. 50  
 Briggs & Cooper Company. 4  
 Brown, Geo. C., & Co. 8  
 Brown, W. P., & Sons Lbr. Co. 2  
 Buffalo Hardwood Lumber Co. 51  
 Carrier Lbr. & Mfg. Company. 10  
 Cheat River Boom & Lbr. Co. 1  
 Chicago Veneer Company. 35  
 Chivvis, W. R. 49  
 Cincinnati Hardwood Lumber Co. 49  
 Crandall & Brown. 50  
 Crane, C., & Co. 49  
 Crittenden Lumber Company. 4  
 Crosby & Beckley Company, The. 44  
 Cypress Lumber Company. 18  
 Davis, Edw. L., & Co. 2  
 Davidson-Benedict Company. 1  
 Dennis & Smith Lumber Company 46  
 D'Heur & Swain Lumber Co. 43  
 Dierks Lumber & Coal Company. 10  
 Dixon & Dewey. 48  
 Dulmeier Bros. 48  
 Dulweber, John, & Co. 49  
 Elias, G., & Bro. 51  
 Empire Lumber Co., Buffalo. 51  
 Estabrook-Skeele Lumber Co. 50  
 Fall, E. H. 50  
 Farrin-Korn Lumber Company. 48  
 Flint, Erving & Stoner Company 9  
 Freiburg Lumber Company. 49  
 Fullerton-Powell Hardwood Lumber Company. 43  
 Gayero Lumber Company. 4  
 Garetson-Greaser Lumber Co. 5  
 Hackley-Phelps-Bonnell Company. 47  
 Hainer Mfg. Company. 5  
 Heath-Witbeck Company. 50  
 Himmelberger - Harrison Lumber Company. 1  
 Indiana Lumber Company. 8  
 Jenks, Robert H., Lumber Co. 45  
 Jones Hardwood Company. 7  
 Kampf, Albert R. 7

Keith Lumber Company. 50  
 Kentucky Lumber Company. 48  
 Kentucky Lumber & Veneer Co. 48  
 King & Bartles Lumber Company 45  
 Leavitt Lumber Company. 10  
 Lesh & Matthews Lumber Co. 50  
 Linehan Lumber Company. 9  
 Litchfield, Wm. E. 7  
 Long-Knight Lumber Company. 43  
 Loomis & Hart Mfg. Company. 8  
 Love, Boyd & Co. 8  
 Luehrmann, Chas. F., Hardwood Lumber Company. 5  
 McClure Lumber Company. 47  
 McLevain, J. Gibson, & Co. 7  
 McLean, Hugh, Lumber Company 51  
 Maley, Thompson & Moffett Co. 49  
 Martin-Barriss Company. 45  
 Miller, Anthony. 51  
 Nicola Bros. Company. 9  
 Norman Lumber Company. 2  
 Ozark Coopage Company. 4  
 Paepcke-Leicht Lumber Company 44  
 Page & Landeck Lumber Company 44  
 Price, E. E. 7  
 Rbubsky, E. W. 36  
 Radina, L. W., & Co. 49  
 Ransom, J. B., & Co. 52  
 Ritter, W. M., Lumber Company 36  
 Roy Lumber Company. 36  
 Rumbarger Lumber Company. 4  
 Scatfield & Son. 51  
 Schofield Brothers. 7  
 Smith, W. E., Lumber Company. 4  
 Southern Lumber Company. 2  
 Southern Oak Lumber Company. 50  
 Standard Hardwood Lumber Co. 51  
 Steele & Hibbard. 5  
 Stewart, I. N., & Bro. 51  
 Stevens-Eaton Company. 7  
 Stimson, J. V. 43  
 Stoneman-Zearing Lumber Co. 5  
 Stotz Lumber Company, Inc. 2  
 Sullivan, T., & Co. 51  
 Swann-Day Lumber Company. 6  
 Thomas & Proetz Lumber Co. 5  
 Three States Lumber Company. 4  
 Turner, A. M., Lumber Company. 9  
 Upham & Agler. 8  
 Vestal Lumber & Mfg. Company. 8  
 Ward Lumber Company. 50  
 Wentworth, Chas. S., & Co. 7  
 Whitmer, Wm., & Sons, Inc. 7  
 Wiborg & Hanna Company. 49  
 Wiggin, H. D. 49  
 Wilson Bros. Lumber Company. 9  
 Yeager, Orson E. 51

COTTONWOOD AND GUM.

Anderson-Tully Company. 4  
 Bacon-Nolan Hardwood Company 4  
 Farrin-Korn Lumber Company. 48  
 Himmelberger - Harrison Lumber Company. 1  
 Luehrmann, C. F., Hardwood Lumber Company. 5  
 Ozark Coopage Company. 5  
 Paepcke-Leicht Lumber Company 6  
 Smith, W. E., Lumber Company 4  
 Stoneman-Zearing Lumber Co. 5  
 Stotz Lumber Company, Inc. 2  
 Three States Lumber Company. 4

CYPRESS.

Crandall & Brown. 50  
 Cypress Lumber Company. 48  
 Haflner Mfg. Company. 5  
 Lottman Cypress Company. 5  
 Thompson, J. W., Lumber Co. 4

HARDWOOD FLOORING.

Bliss-Cook Oak Company. 36  
 Bliss & Van Auken. 10  
 Carrier Lbr. & Mfg. Company. 10  
 Cobbs & Mitchell, Inc. 3  
 Cummer, Diglins & Co. 3  
 Haak Lumber Company. 47  
 Mitchell Bros. Company. 3  
 Nashville Hardwood Flooring Company. 48  
 Pease Company, The. 8  
 Schultz Brothers & Benedict. 6  
 Stephenson, The L. Company. 10  
 Ward Brothers. 6  
 Wood Mosaic Flooring Company 2  
 Young, W. D., & Co. 10

SAW MILL MACHINERY.

Mershon Company, The. 44  
 Phoenix Mfg. Company. 44

WOOD WORKING MACHINERY

American Wood Working Machinery Company. 38  
 Berlin Machine Works, The. 37  
 Duffane Machine Works. 37  
 Ober Mfg. Company, The. 37  
 Smith, H. B., Machine Company 39

VENEER MACHINERY.

Coe Manufacturing Company. 39

LOGGING MACHINERY.

Clyde Iron Works. 42  
 Lidgerock Mfg. Company. 42  
 Overpack, S. C. 46  
 Russell Wheel & Foundry Co. 41

LUMBER INSURANCE.

Adirondack Fire Insurance Co. 1  
 Lumber Insurance Company of New York. 1  
 Lumber Mutual Fire Insurance Company, Boston. 1  
 Lumber Underwriters. 1  
 Pennsylvania Lumbermen's Mutual Fire Insurance Company. 33  
 Raikin, Harry, & Co. 33  
 Toledo Fire & Marine Ins. Co. 33

SAWS, KNIVES AND SUPPLIES

Atkins, E. C., & Co. 40  
 Hanchett Swage Works. 46  
 Champion Saw Company. 40 & 42  
 Shimer, S. J., & Sons. 40

MISCELLANEOUS.

Barroll, H. C., & Co. 10  
 Lacey, J. D., & Co. 36  
 Lumbermen's Credit Association. 48  
 Pease Company, The. 48  
 Schenck, C. A., & Co. 48

CHICAGO VENEER COMPANY

(INCORPORATED) MANUFACTURERS OF

Rotary Cut Poplar Veneer

We have over four million feet of selected veneer logs on hand. Our plant is especially adapted for making extra large sizes and we cater only to the high grade trade.

BURNSIDE,

KENTUCKY

## Saw Mill and Standing Timber For Sale....

Hardwood Mill, now sawing 40000 feet daily, on Illinois Central and Southern Railways in Mississippi.

5000 acres good Gum, Oak, Ash, Cypress and Elm Timber.

Business in going condition, Electric Light Plant; McGiffert Log Loader and Full Logging Equipment; Live Stock, etc.

Good opportunity for practical hardwood lumberman. For full particulars, address

**"CHESTER"**

Care Hardwood Record.

## Save Your Money

By Using the

## RED BOOK

Published Semi-Annually  
in January and July

It contains a carefully prepared list of the buyers of lumber in car lots, both among the dealers and manufacturers.

The book indicates their financial standing and manner of meeting obligations. Covers the UNITED STATES and MANTOBA.

The trade recognizes this book as the authority on the lines it covers.

A well organized Collection Department is also operated and the same is open to you

WRITE FOR TERMS.

### Lumbermen's Credit Association

ESTABLISHED 1878

1405 Great Northern Building, : CHICAGO  
16 Beaver Street, : NEW YORK CITY

MENTION THIS PAPER

You want to reach Buyers of

**FURNITURE LUMBER**

**The HARDWOOD RECORD**

will do it for you.



WALNUT.  
OAK,  
ASH,  
POPLAR.

## BLISS=COOK OAK COMPANY

BLISSVILLE, ARK.

MANUFACTURERS

## Hardwood Lumber and Flooring

We manufacture 15,000,000 feet of Oak Lumber per year for export and domestic markets, from 3/8 to 4 inches thick.

Also Quartered and Plain Polished Oak Flooring, kiln dried, end matched, hollow back.

Mills and Flooring Plants at  
SHULTS AND BLISSVILLE, ARKANSAS

## GUS. KITZINGER Michigan Hardwoods

By Car or Cargo. Manistee, Mich.

## MANUFACTURERS

Contemplating establishing plants  
in the West should take advantage  
of a location on



## Chicago & North-Western Ry.

which reaches the famous

WATER POWERS,  
COAL FIELDS,  
IRON ORE RANGES,  
HARD AND SOFT  
LUMBER DISTRICTS,  
MINING DISTRICTS

of the West and Northwest, and  
affords the best means of transportation  
to the markets of the world.

FOR FURTHER PARTICULARS APPLY TO

MARVIN HUGHITT, Jr., E. D. BRIGHAM,  
Freight Traffic Manager, Gen'l Freight Agent,

GEO. BONNELL,  
Industrial Agent,

NW513

CHICAGO.

## WOOD WORKING PLANTS

Manufacturers seeking locations for Saw Mills, Stave and Heading Factories and other Wood Working Plants in the Central Southern States, can secure full and accurate information as to Sites, Timber Tracts, Fuel, Transportation Facilities, etc., by addressing

G. A. PARK,

General Immigration and Industrial Agent

## Louisville & Nashville Railroad Company

Louisville, Kentucky

## Locations for Industries

ON  
THE ERIE, THE COMMERCIAL RAILROAD  
CHICAGO TO NEW YORK

The Erie Railroad System's Industrial Department has all the territory traversed by the railroad districted in relation to resources, markets and advantages for manufacturing, can advise with manufacturers of specific products as to suitable locations, and furnish them with current information of a comprehensive nature dealing with the project in its full relation to manufacture and commerce.

The Erie is one of the greatest of trunk lines. Its own rails connect the two largest cities of America. Every section of the System has its particular merits. Profitable locations exist. It has great general and coal, oil and natural gas resources.

It is important in this age of modern facilities for manufacturers to locate where they can obtain side tracks so as to receive from and ship directly into cars at the factory. Information can be promptly furnished in this connection about every point on the system between New York and Chicago.

Manufacturers' inquiries as to locations are treated in strict confidence and absolutely reliable information, so as to promote permanent traffic, is furnished. Address

LUIS JACKSON

Industrial Commissioner  
Erie Railroad Company

21 Cortlandt Street, New York

# "DEFIANCE" WOOD-WORKING MACHINERY

COMPLETE EQUIPMENTS OF

## HIGH GRADE TOOLS

✽ FOR MAKING ✽

Hubs, Spokes, Wheels,  
Wagons, Carriages,  
Rims, Shalts, Poles,  
Neck-Yokes,

Single Trees, Hoops,  
Handles, Bobbins, Spools,  
Insulator Pins and  
Oval Wood Dishes.

INVENTED AND BUILT BY

The **DEFIANCE MACHINE WORKS**

DEFIANCE, OHIO.

— Send for 500 Page Catalogue —

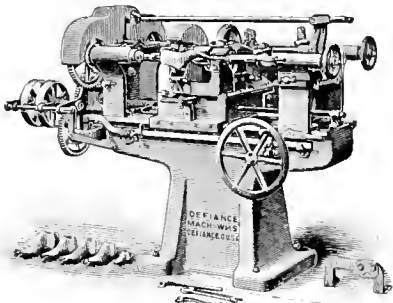

AUTOMATIC LAST TURNING LATHE

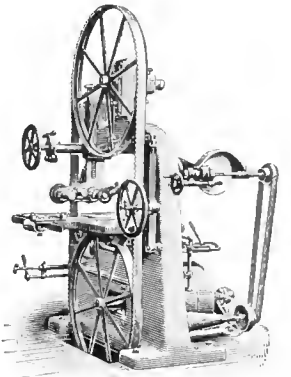

No. 4 POWER-FEED BAND RIP SAW

## Industries are Offered Locations

WITH SATISFACTORY INDUCEMENTS, FAVORABLE  
FREIGHT RATES, GOOD LABOR CONDITIONS,  
HEALTHFUL COMMUNITIES, on the lines of

The Illinois Central R. R. and the  
Yazoo & Mississippi Valley R. R.

For full information and descriptive pamphlet address

J. C. CLAIR, Industrial Commissioner, 1 Park Row, Chicago, Ill.

## FRAMES FOR HARDWOOD RECORD SUPPLEMENTS

Complete with backing, but without the glass, made from Flemish Oak, are to be had delivered by express, charges prepaid to any point east of the Missouri river, at 50 cents each; or at the HARDWOOD RECORD office, at 30 cents each. Prepay orders with two-cent stamps or postal notes, addressed

Hardwood Record, 355 Dearborn Street, Chicago

## The Farmer in the Southwest Prospers

Because he pays from \$8 to \$15 an acre for land that produces as good crops as land in Illinois and Indiana which sells for \$75 to \$100 an acre. The mild climate gives him earlier crops and the short winter makes stock-raising less expensive.

**You** have the same chance to prosper that is being taken by hundreds of the northern and eastern farmers.

Write for free copies of our illustrated books on Texas and Oklahoma.

Low rates to all points in the Southwest on the first and third Tuesdays of each month via



CHICAGO @ EASTERN ILLINOIS R. R.  
W. H. RICHARDSON, G. P. A., Chicago, Ill.

## LOCATIONS FOR NEW INDUSTRIES

can be secured on the lines of the

### Chicago, Milwaukee & St. Paul Railway

in the great middle west. It reaches the Copper Country and the pine and hardwood areas of Northern Michigan, the lead, zinc and iron regions of Wisconsin, the coal fields of Illinois, Iowa and Missouri.

Traverses the great agricultural and manufacturing states of Iowa, Minnesota, North and South Dakota. Operates 7,000 miles of thoroughly equipped railroad.

Correspondence is solicited with eastern manufacturers who desire to move their factories to, or establish branches in the West. Co-operation with Business Men's Associations on the lines of this railway in all matters affecting mutual interests is assured.

Inquiries should be as definite as possible.

Address

Industrial Department  
Chicago, Milwaukee & St. Paul Railway,  
Room 1327, Railway Exchange  
Chicago

# No. 1 $\frac{1}{2}$ American Automatic Back Knife Lathe

Contains every late improvement. Four sizes. Works 28 in., 36 in., 45 in. and 52 in. long, and from 3-16 in. to 2 $\frac{3}{4}$  in. in diameter. For full particulars regarding this or our heavier Lathes, address nearest salesroom.

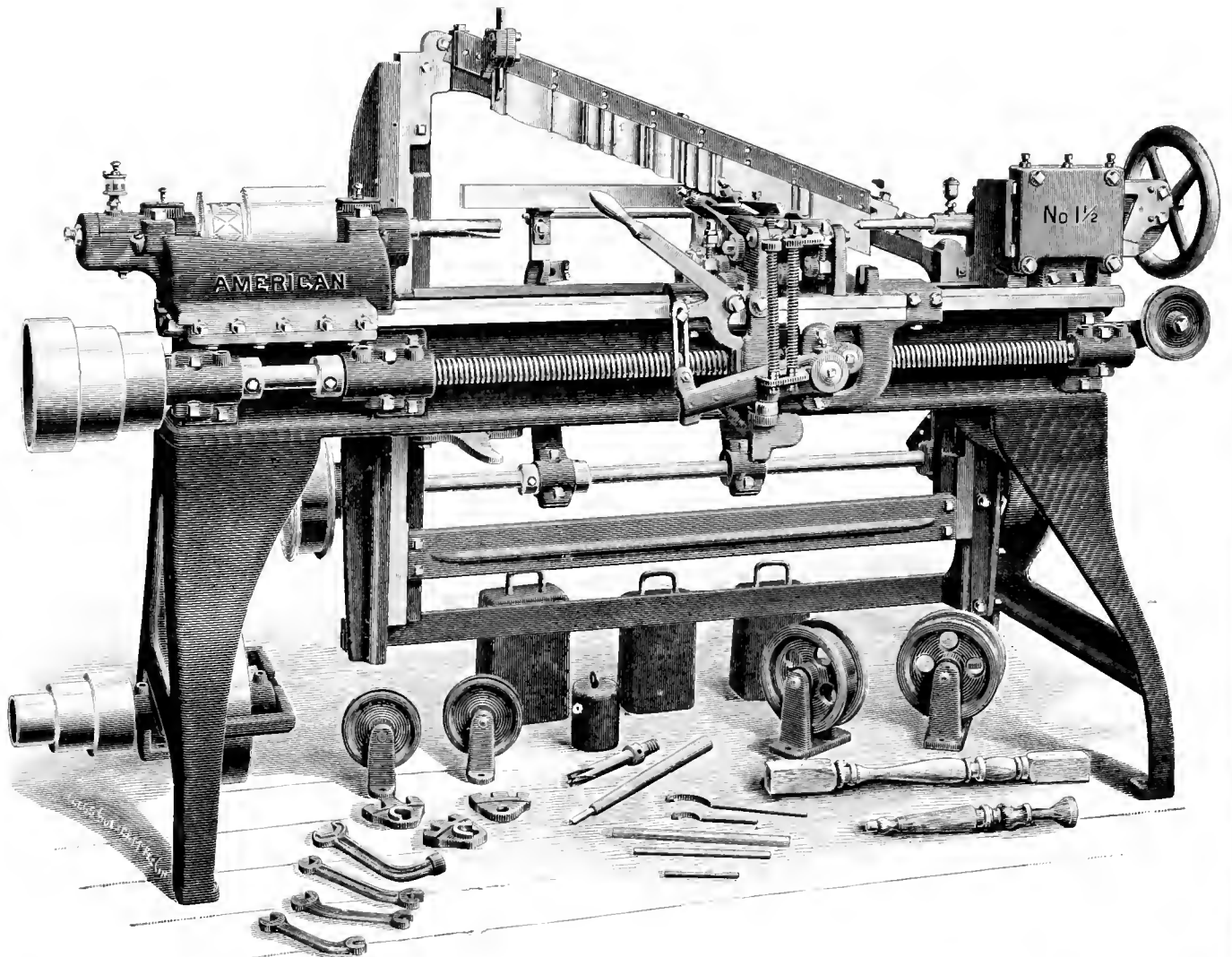

**AMERICAN  
WOOD WORKING MACHINERY CO.**

NEW ORLEANS

CHICAGO

NEW YORK





A PAGE OF THE FAMOUS COE VENEER MACHINERY

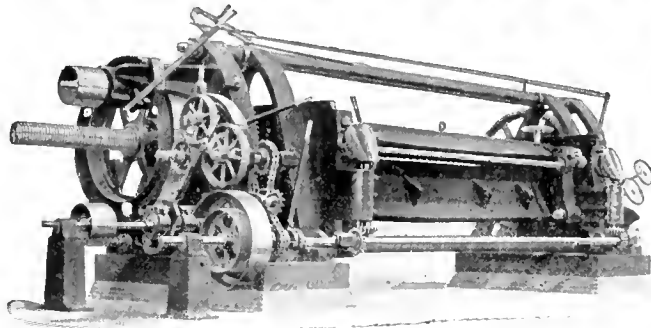

Style A Veneer Cutter

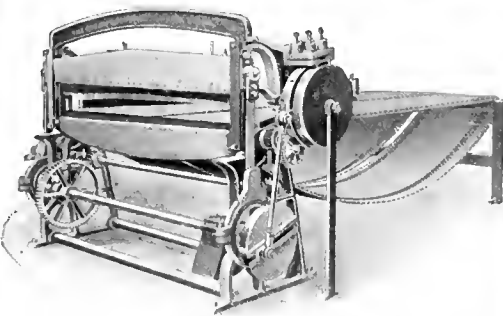

Coe Clipper

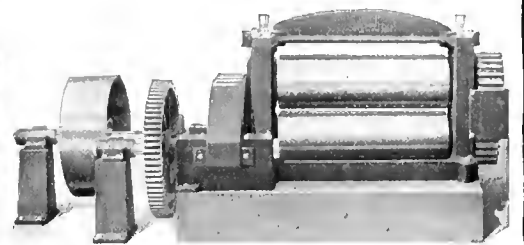

Coe Wringer

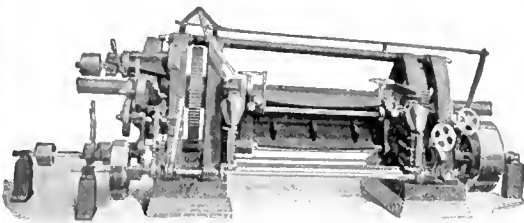

Style D Veneer Cutter

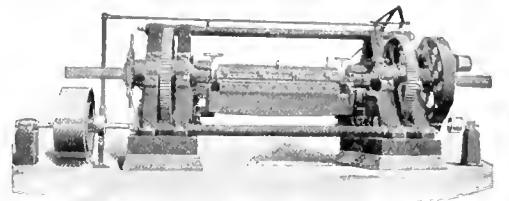

Style B Veneer Cutter

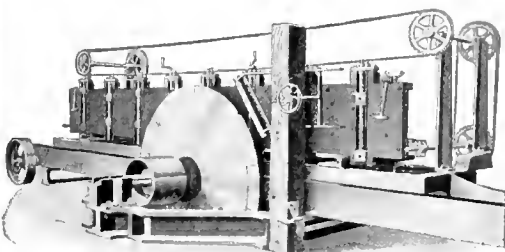

Coe Veneer Saw

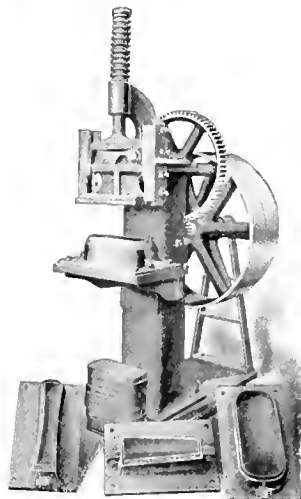

Coe Stamper

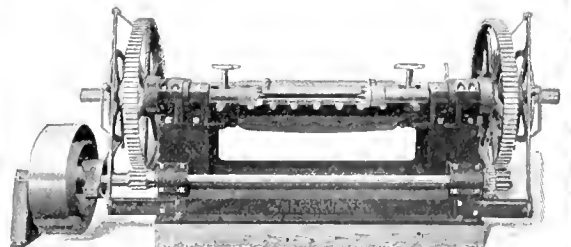

Style H Veneer Cutter

These machines and many others are fully described in our 1906 Catalog No. 5. Write for a copy to-day.



# SAWS

Detail work of filing saws takes time. ¶ You will know the advantage when you buy a saw that will stand to its work with the least repair. These saws are so.

## CHAMPION SAW CO.

BEAVER FALLS, PA.

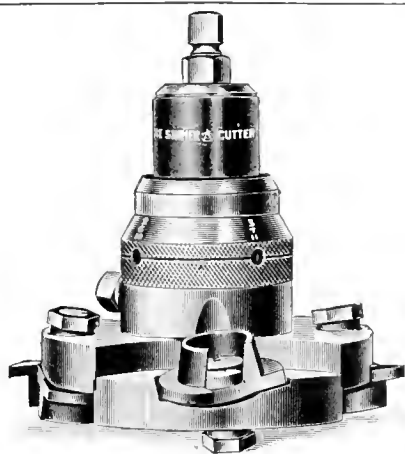

For Matching Hard, Cross Grained and Knotty Lumber

## The Shimer Cutter Head

Is the Only Tool You Can Rely Upon.

It has strength, Durability and correct working principles. It feeds faster, works smoother, cuts true to pattern. No fitting, no trying—no filing to shape. You sharpen the Cutters with a file and set them with a gauge—plain as day.

Everybody profits by their use. For Flooring, Ceiling, Siding. For Ship Lap, Jointing, Double Ceiling. For Doors, Sash and Special designs. Coping Heads to match.

Your Capacity Increased—Your Labor and Expense Reduced.

Samuel J. Shimer & Sons, Milton, Penna.



## THE SAWS OF QUALITY

Material, Temper, Workmanship

**PERFECT**

## THE SAWS FOR YOU

WRITE FOR QUOTATIONS

# E. C. Atkins & Co.,

(Incorporated)

HOME OFFICE AND FACTORY,

INDIANAPOLIS, U. S. A.

BRANCHES

ATLANTA,  
CHICAGO,  
MEMPHIS.

MINNEAPOLIS,  
NEW ORLEANS,  
NEW YORK CITY,  
TORONTO, CANADA.

PORTLAND,  
SAN FRANCISCO,  
SEATTLE.

# RUSSEL TRIP STAKE HOLDER

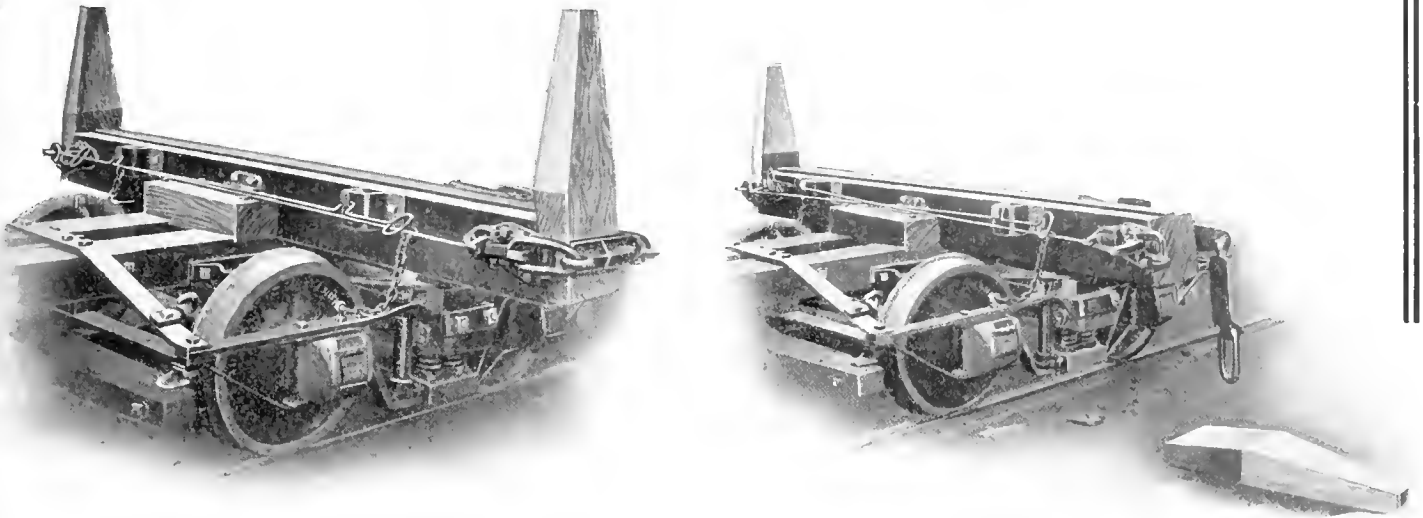

☐ You've all had your troubles with make-shift devices, with wrecks, with injuring or killing men, with cost and cussing.

☐ We offer a practical, strong and simple device that will hold logs firmly on bunk while they are being handled, and which will allow loads to be quickly and easily unloaded without danger to men.

☐ One man can quickly set up holders and stakes for a train. Stakes can *only* be tripped from side *opposite* that on which logs are dumped.

☐ When loading logs, or after cars are loaded, stakes are positively locked. Can be applied to any style of car, wagon or sled that has wood bunks.

☐ The picture tells the story. Equip one car and you'll order a full complement.

☐ Our stake holders are like all our logging machinery and cars—backed by our guaranty of the *best on the market*.

☐ Let us tell you more about them. Write us.

**RUSSEL WHEEL AND FOUNDRY CO.,**  
DETROIT, MICHIGAN, U. S. A.

# KNIVES

☞ How often do you lose good working hours fretting and swearing about poor knives.

☞ Steel plus workmanship will overcome that. Learn now.

CHAMPION SAW COMPANY,  
BEAVER FALLS, PA.

## LIDGERWOOD MACHINES

WILL STOCK YOUR MILL

SKIDDERS  
SNAKERS  
YARDERS

LOADERS  
PULL BOATS  
CABLEWAYS

LIDGERWOOD MFG. CO.

96 Liberty St., New York.

NEW ORLEANS

ATLANTA

SEATTLE



### THE McGIFFERT LOG LOADER

has loaded as high as a quarter of a million feet of logs in eight hours, and here are a few reasons why it was possible: Being self propelling it can move itself, its loaded cars, and spit its own empties, all on the same track. (*saves switching*) Constructed entirely of steel, very powerful, it stands "crowding" and handles the large logs as rapidly as the small. *It saves money and repairs.* Being simple in operation and of few levers the engineer has absolute control at all times without changing his position, and can handle the logs as rapidly as the men can hook them. *saves time*

Our catalogue clearly illustrates and explains many other good points.

Manufactured by  
CLYDE IRON  
WORKS,  
Duluth,  
Minn.

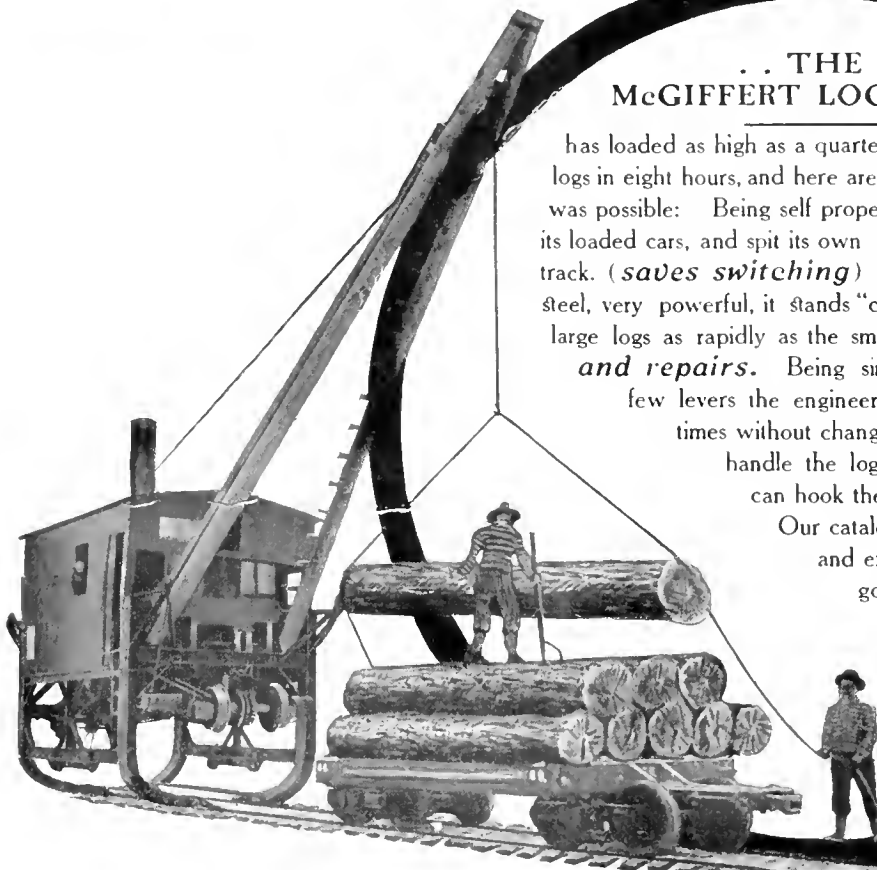



# INDIANA



WHERE THE BEST HARDWOODS GROW

THE WOODS FOR WHICH INDIANA IS FAMOUS.

- Quart'r'd White Oak
- Plain White Oak
- Quartered Red Oak
- Plain Red Oak
- White Ash
- Poplar
- Black Walnut
- Cherry
- Sycamore
- Red Gum
- Hickory
- Beech
- Maple
- Veneers of
- Indiana Hardwoods

## CHARLES H. BARNABY

Manufacturer of Band Sawed Hardwoods

Quarter Sawed Indiana White Oak a Specialty

GREENCASTLE, IND.

## D'HEUR & SWAIN LUMBER CO.

Manufacturers and Wholesalers

Our Specialty Quartered Oak and Sycamore

SEYMOUR, IND.

## LONG-KNIGHT LUMBER CO.

MANUFACTURERS AND DEALERS

Quarter Sawed White and Red Oak a Specialty

INDIANAPOLIS, IND.

## MALEY & WERTZ

Manufacturers, Wholesalers and Exporters of Hardwood Lumber

EVANSVILLE, IND.

## FULLERTON-POWELL HARDWOOD LUMBER CO.

SOUTH BEND, IND.

## PERRINE-ARMSTRONG CO.

Long Timber up to 60 feet—Hardwood Specialties

The largest Band Mill in Indiana.

FORT WAYNE, IND.

## J. V. STIMSON

All Kinds of Hardwood Lumber Manufactured

HUNTINGBURG, IND.

## YOUNG & CUTSINGER

Manufacturers and Wholesalers

Our Specialty Fine Figured Quartered Oak

EVANSVILLE, IND.

**WISCONSIN**  
WHERE THE FINEST NORTHERN HARDWOODS GROW

**ARPIN HARDWOOD LUMBER CO.**  
GRAND RAPIDS, WISCONSIN  
Saw and Planing Mill at Atlanta, near Bruce, Wis., on Soo Lines.

---

Manufacturers

---

**Wisconsin Hardwoods**  
PINE AND HEMLOCK

---

WRITE US FOR PRICES ON  
1", 1 1/4", 1 1/2", 1 3/4" and 2" Plain and Red Birch: Red Birch Flooring and 1" to 2"  
Quarter Sawed Red Oak: Basswood Ceiling and Siding: 1" Birdseye  
Maple: Birch, Maple and Hardwood Flooring.

**VOLLMAR & BELOW**  
MARSHFIELD, WISCONSIN

**Basswood, Birch**  
and Other Wisconsin Hardwoods

LET US KNOW WHAT YOU ARE IN THE MARKET FOR

<p><b>NORTHERN STOCK</b></p> <p>Hemlock Birch Basswood Rock Elm Soft Elm Ash Oak</p>	<p><b>SOUTHERN STOCK</b></p> <p>Quartered White and Red Oak Plain White and Red Oak Sycamore Poplar Cypress Gum</p>
--	---

**PAGE & LANDECK LUMBER CO.**  
Wells Building - - - MILWAUKEE, WIS.

*Ingram Lumber Co.*  
WAUSAU, WIS.

---

**BASSWOOD, BIRCH**  
*We cut four million feet of each annually  
Your inquiries and orders solicited*

---

MILL AND YARDS AT INGRAM, WISCONSIN

**C. P. CROSBY**  
RHINELANDER : : WISCONSIN

**Wholesale Hardwood Lumber**

Hard Maple a Specialty in all thicknesses from 1 inch to 4 inch. Finest Birch in Wisconsin. Black Ash, Rock Elm, Soft Elm, Red and White Oak. : :

DIFFICULT AND MIXED ORDERS A SPECIALTY

**North Western Lumber Co.**  
General Offices EAU CLAIRE, WIS. Mills at STANLEY, WIS.

BAND SAWED

**Wisconsin Hardwoods**  
CAREFUL GRADINGS, PROMPT SHIPMENTS

SPECIAL OFFERINGS:

3 cars 1 1/4" to 2" Scoot Hardwood.	1/2 car 2" 1st and 2d Clear Basswood.
1 car 1 1/2" No. 1 Common Basswood	Large stock No. 2 Common Birch.
1 car 1 3/4" 1st and 2d Clear Basswood	Large stock No. 3 Common Birch.

MIXED CARS - EVEN GRADES - PROMPT SHIPMENT

**Wisconsin Hardwoods**

SPECIAL OFFERINGS:

1" No. 1 Common and Better Birch (Red in)  
1" No. 1 Common and Better Basswood  
1" No. 1 Common and Better Hard Maple  
Also Elm, Pine, Cedar Products,  
and "SHAKELESS" Hemlock.

**John R. Davis Lumber Company**  
PHILLIPS, : : : : WISCONSIN

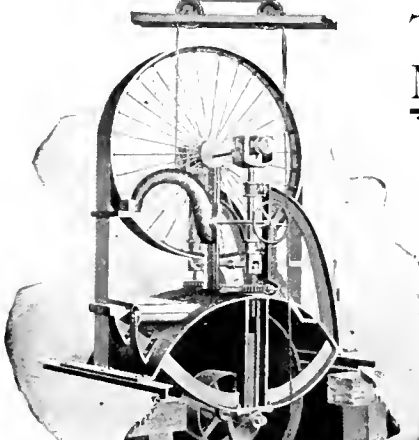

**Ten per cent  
More Profit**

The profits of a saw mill can readily be increased ten per cent by using a band mill instead of a rotary. The price of this mill with six foot wheels for saws eight inches wide is readily within the reach of all. It cuts smooth and perfect lumber and has a capacity of 25,000 feet to 35,000 feet per day. It runs with less expenditure of power than a rotary and puts only half as much of the log into saw dust as does the circular saw.

**PHOENIX MFG. COMPANY,**  
EAU CLAIRE, WIS.

**CLEVELAND**

HARDWOOD DISTRIBUTING CENTER OF NORTHERN OHIO

**THE  
ROBERT H. JENKS LUMBER  
COMPANY**

**FOR SALE**

60 M feet 1" 1st and 2ds Poplar  
223 M feet 1" No. 1 Common Poplar  
125 M feet 1" No. 2 Common Poplar  
25 M feet 2" 1st and 2nd Poplar, 14" and up  
125 M feet 8 4" Sound Wormy Chestnut  
275 M feet 1" Sound Wormy Chestnut  
153 M feet 1" 1st and 2nd Plain White Oak  
85 M feet 1" 1st and 2nd Plain Red Oak  
125 M feet 1" No. 1 Common Plain Red Oak

**Quartered White and Red Oak.**—We have a good assortment of dry stock,  $\frac{3}{8}$  to  $\frac{1}{4}$  inches thick. Your inquiries solicited.

**Plain White and Red Oak.**—A limited amount of nice stock, ready for shipment.

**Do You Want It?  
What?  
Money?**

What have you in lumber to exchange for it? We want particularly Plain Oak, Chestnut, Poplar, Basswood, Ash.

**What Have You?**

**The Advance Lumber Co.**

13th Floor  
Rockefeller Bldg. CLEVELAND, OHIO

Memphis Office, No. 56 Randolph Building. J. E. MEADOWS, Mgr.

**Cooperage Plant for Sale**

Well equipped plant having rail and water facilities, and in location affording an abundance of heading timber, is offered for sale at a bargain, by owners, who are not practical mill men. Refer to St. Louis File 566, or Chicago File 19059.

**M. V. RICHARDS**  
Land and Industrial Agent  
WASHINGTON, D. C.

**CHAS. S. CHASE, Agent**  
622 Chemical Building  
ST. LOUIS, MO.

**M. A. HAYS, Agent**  
225 Dearborn Street  
CHICAGO, ILL.

**The King & Bartles Lumber Company**

We want to move some 5 4" to 16 4" Wisconsin Birch in pile in our Cleveland yard. We also have a few cars of 1" No. 1 Common and 1sts and 2nds Northern Winter-sawn Basswood, bone dry. We have in pile in Wisconsin for immediate shipment the following:

2 cars 4 1" 1sts and 2nds Birch, unselected  
3 cars 4 4" No. 1 Common Birch, unselected  
1 car 4 4" 1sts and 2nds Curly Birch, unselected

Send us your inquiries and we will quote you delivered prices.

Yard and Office: No. 1955-2025 Scranton Road, N. W.,  
**CLEVELAND : : : OHIO**

**Hardwood Board Rules  
FOR HARDWOOD LUMBERMEN**



**Best Goods, Prompt Shipment**

Send your orders to the HARDWOOD RECORD, 355 Dearborn Street

**MARTIN-BARRISS  
COMPANY**

Importers and Manufacturers

**MAHOGANY**

—AND FINE—

**HARDWOODS**



# MICHIGAN

FAMOUS FOR HARD MAPLE AND GREY ELM

"THE THICK MAPLE FOLKS"

**BROWNLEE & COMPANY**  
 DETROIT MICHIGAN

TWO-INCH SOFT MAPLE  
 TWO-INCH BASSWOOD  
 THREE-INCH HARD MAPLE

## MAY STOCK LIST

MAPLE		BIRCH		BASSWOOD	
1 1/4 in.	2,000,000 ft.	1 in.	500,000 ft.	1 in.	300,000 ft.
1 1/2 "	100,000 "	1 1/2 "	100,000 "	1 1/4 "	30,000 "
2 "	400,000 "	2 "	100,000 "	1 1/2 "	50,000 "
2 1/4 "	1,000,000 "	2 1/2 "	50,000 "	2 "	75,000 "
2 1/2 "	200,000 "	3 "	75,000 "	3 "	4,000 "
3 "	500,000 "	ROCK ELM		GRAY ELM	
4 "	400,000 "	2 in.	25,000 ft.	1 in.	300,000 ft.
		2 1/4 "	50,000 "	1 1/2 "	200,000 "
BEECH		WHITE MAPLE		3 "	200,000 "
1 in.	500,000 ft.	End Piled		ASH	
1 1/4 "	250,000 "	1 in.	100,000 ft.	1 in.	500,000 ft.
1 1/2 "	400,000 "	1 1/2 "	20,000 "		
2 "	100,000 "	2 "	50,000 "		
2 1/2 "	200,000 "				

**KELLEY LUMBER & SHINGLE CO.,** Traverse City, Mich.

W. H. WHITE, Pres.  
 JAS. A. WHITE, Vice-Pres.

W. L. MARTIN, Secy.  
 THOS. WHITE, Treas.

## W. H. WHITE COMPANY

BOYNE CITY, MICHIGAN

Manufacturers of Hardwood and Hemlock Lumber, Cedar Shingles,  
 White Rock Maple Flooring.

## UP=TO=DATE

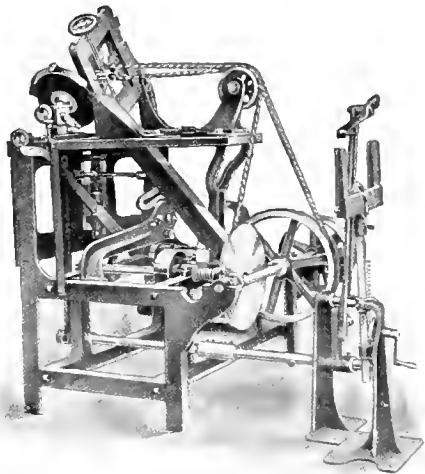

Hanchett Automatic Band Saw Sharpener

This is one of our full line of modern filing room machinery. Let us send you our new Catalogue No. 10.

**HANCHETT SWAGE WORKS**

BIG RAPIDS, MICH.

## DENNIS & SMITH LUMBER CO.

Wholesale Hardwood Lumber

Office and Yards, FOURTH AND HOLDEN AVENUES,  
**DETROIT, MICH.**

MILLS AT: Heaters, W. Va. Valley Bend, W. Va. Diana, W. Va. Parkersburg,  
 W. Va. McNutt Siding, W. Va.

## Michigan Logging Wheels



Have made them 25 years and know how. Easy and cheap way of logging. **S. C. OVERPACK** MANISTEE, MICHIGAN

**MICHIGAN**  
FAMOUS FOR RED BIRCH AND BASSWOOD

**BIRCH**

This is our specialty. We are in the heart of the best Birch section. Have good stock, Common and better, 4-4, 5-4, 6-4, 8-4, 10-4, 12-4, and 16-4. Let us figure with you.

**Simmons Lumber Company**  
SIMMONS, MICHIGAN

**McCLURE LUMBER COMPANY**

MANUFACTURERS OF  
**Hardwoods**

Main Offices, DETROIT, MICH.  
Mills, : EUTAW, ALA.

SPECIAL OFFERINGS:

3 cars 2" Red and White Oak      2 cars 2" Black Ash  
3 cars 2", 2½", 3" and 4" White Ash      10 cars 1" to 4" Dry Hard Maple  
2 cars 1" 6/4 White Ash      5 cars 1" Log Run Birch  
1 car 6/4 and 8/4 Hickory

**BOYNE CITY LUMBER COMPANY**

BOYNE CITY

**MICHIGAN ROCK MAPLE and other HARDWOODS**  
LARGE CAPACITY      PROMPT SHIPMENTS      RAIL OR CARGO



**J. S. GOLDIE**

Cadillac, :: Michigan.

SPECIAL PRICES on 500M pieces  
1" to 3" Maple Squares 16" to 27" long.  
1" to 3" Soft Elm.

INQUIRIES SOLICITED FOR MICHIGAN LUMBER.

**SOFT ELM AND ROCK ELM**

FOR SALE BY

**The R. G. Peters Salt & Lumber Co.**  
EASTLAKE, MICHIGAN

**VAN KEULEN & WILKINSON LUMBER COMPANY**

Manufacturers and Wholesalers of

**HARDWOOD LUMBER and CRATING STOCK**

Complete Stocks of Michigan Hardwoods—Maple, Beech, Birch, Elm, Ash and Basswood for sale.

Grand Rapids, : : : Michigan

**OUR MAPLE FLOORING**

is as near perfection, in every particular, as it is possible to make it, for we personally supervise every step in its manufacture, from the stump to the shipping of the finished product. Our prices will interest and a trial convince you. : : :

**HAAK LUMBER COMPANY**  
HAAKWOOD, MICHIGAN

**Hackley-Phelps-Bonnell Co.**

MANUFACTURERS OF

**Northern and Southern  
Hardwood Lumber**

Main Office, Michigan Trust Company Building

GRAND RAPIDS : : : MICHIGAN

**DENNIS BROS.**

GRAND RAPIDS, : : : MICHIGAN

MANUFACTURERS OF

**Hardwood Lumber, Perfect  
Birch and Maple Flooring**

DRY STOCK AT BARGAIN PRICES:

2 cars 8/4 Basswood, No. 1 Common and Better.  
3 cars 5/4 Basswood, No. 2 Common and Better.  
15 cars 4/4 Birch, No. 1 and 2 Common  
1 car 1x4 Clear Birch Strips.  
2 cars 4/4 No. 3 Common Cherry.  
60M feet 12/4 Hard Maple.  
245M feet 8/4 Hard Maple.  
40M feet 8/4 Hard Maple, No. 3 Common.

Main Office :  
205-209 Michigan  
Trust  
Company  
Building

**Thos. MacBride Lumber Company**

HEADQUARTERS FOR

**HARDWOODS**

IN MICHIGAN

Michigan Trust Building, Grand Rapids, Mich.

# CINCINNATI

THE GATEWAY OF THE SOUTH

## WANTED

Oak  
Walnut  
Gum  
Cottonwood  
Poplar  
White Pine  
Hemlock  
Yellow Pine

Will inspect at shipping point when quantity justifies and pay cash. Can use entire mill cuts. Write us before selling elsewhere. We can also handle mixed cars of dressed stock. Send us your list with prices.

**Kentucky Lumber Co.**

Suite 508 First National Bank Bldg  
Cincinnati, Ohio.  
Formerly of Burnside, Ky.

## PLAIN OAK—BASSWOOD

Are what we want. All thicknesses and grades. Spot cash. Send us list of your offerings with prices.

**DUHLMEIER BROS., CINCINNATI, O.**

## CYPRESS LUMBER CO.

Manufacturer of Hardwoods and Cypress

Plain and Quartered White and Red Oak, Yellow Poplar, Yellow Pine, Walnut, etc. Mills in Tenn., Ala. and Va.

OFFICE AND YARDS, GEST AND DALTON AVE., CINCINNATI, OHIO.

## Lumbermen, Attention!

If you own any timber or timber lands.  
If you are contemplating buying or selling any timber or timber lands.

If you want your stumpage accurately estimated.  
If you want an exact survey or map of your property.  
If you want advice in any logging or lumbering proposition.  
Write to us and find out what we can do for you.  
We send thoroughly reliable and practical engineers to all parts of the country, and guarantee quick and accurate work.

**C. A. Schenck & Co.** DAVIDSON'S RIVER, NORTH CAROLINA  
Consulting Forest Engineers

## "BUY GUM"

We are in the market to buy Dry Gum Lumber in any quantity, from a single car load to a million feet. Will take all grades and thicknesses. We receive lumber at shipping point, pay cash and are liberal in inspection.



**THE FARRIN-KORN LUMBER COMPANY**  
General Office, Yards, Planing Mills, Dry Kilns, Cincinnati, Ohio  
Purchasing Office, Randolph Building, Memphis, Tenn.  
Cypress Red Gum Oak

FRAMES,  
SASH, DOORS,  
BLINDS, MOULDINGS,  
COLUMNS, GLASS,  
STAIRWORK,  
INTERIOR TRIM.



PAINTS,  
BUILDERS' HARDWARE,  
MANTELS, ETC.  
LARGE CINCINNATI FACTORIES MAKE PROMPT SHIPMENTS POSSIBLE.

## The Kentucky Lumber & Veneer Co.

HARDWOOD MANUFACTURERS

Post Office and Band Mill, Shipping Point and Telegraph Office,  
ROBBINS, KY. JACKSON, KY.

Specialties:

PLAIN WHITE OAK OAK PLANKING  
YELLOW POPLAR RAILROAD TIES

We manufacture all the lumber we sell from original forest timber. Therefore the lengths and widths are good. All logs are manufactured in ten to thirty days after being felled, insuring bright, new stock, free of sap worms and rot.  
WRITE OR WIRE FOR PRICES.

## THE GENERAL LUMBER COMPANY

**HARDWOODS**  
HEMLOCK, YELLOW PINE.

COLUMBUS OHIO

The only trade paper reaching all classes of hardwood consumers

HARDWOOD RECORD  
355 Dearborn St., Chicago

# W. H. Dawkins Lumber Co.

Manufacturers of Band Sawed

## Yellow Poplar

ASHLAND, KY.

# CINCINNATI

THE GATEWAY OF THE SOUTH

## THE MALEY, THOMPSON & MOFFETT CO.

Always in the Market for  
**BLACK WALNUT LOGS,  
 SELECTED WHITE OAK LOGS,  
 LUMBER OF ALL KINDS.**

CINCINNATI, : : : OHIO

## L. W. RADINA & COMPANY

Correspondence Solicited with Buyers and Sellers of All Kinds of  
**HARDWOODS**  
 Wanted for cash—desirable blocks of 1 inch to 4 inch Poplar, all grades,  
 Especially 1½-inch stock, for immediate shipment.

CLARK STREET AND DALTON AVENUE

## Cincinnati Hardwood Lumber Co.

CENT AND SUMMER STREETS  
 Wholesalers Mahogany, Thin Lumber, Veneers  
 Finely figured quarter sawed oak veneers a specialty.

## BENNETT & WITTE

MANUFACTURERS OF SOUTHERN HARDWOODS  
 THAT ARE SOLD  
 ON NATIONAL HARDWOOD LUMBER ASSOCIATION  
 INSPECTION ONLY.

Plain and Quartered . . . } White and Red Oak  
 Red and Sap Gum  
 Cottonwood, Ash, Cypress, Poplar, Soft Maple, Tangelo  
 Gum and Chestnut. . . . We cut Gum and Oak in Thick-  
 nesses of ⅜ to 4 inches. EXPORT AND DOMESTIC.

224 W. 4th Street, CINCINNATI, OHIO  
 Branch: 1301-2 Tenn. Trust, Memphis, Tenn.

## WHAT HAVE YOU FOR SALE IN Red and White OAK Qtd. and Plain

ALSO POPLAR, CHESTNUT, WALNUT, ETC.  
 JOHN DULWEBER & CO., CINCINNATI, OHIO

## THE E. E. BECK LUMBER COMPANY

Cash Buyers  
**Poplar, Oak, Chestnut**  
 And Other Southern Hardwoods  
 ALL GRADES AND THICKNESSES. WE BUY MILL CUTS.

IN THE MARKET FOR

## OAK—ASH—POPLAR

ALL GRADES AND THICKNESSES

## MOWBRAY & ROBINSON

Offices: 1219 West Sixth Street Yards: Sixth Street, below Harriet



## THE FREIBERG LUMBER CO.

Manufacturers of  
**Tabasco Mahogany  
 Walnut, Oak**  
 Poplar, McLean and Findlay Aves.  
 CINCINNATI, O.

Poplar, Oak,  
 Ash, Chestnut,  
 Sycamore.

## C. Crane & Co.

We would like to buy  
 2,000,000 feet Dry Oak  
 2,000,000 feet Dry Poplar  
 Mostly heavy stock. Quotations Solicited.

W. Va. Spruce.  
 Pine and Elm

MILLS AND YARDS  
 CINCINNATI, O.  
 YEARLY CAPACITY  
 100,000,000 FT.  
 LONG BILL STUFF  
 A SPECIALTY

# THE WIBORG & HANNA COMPANY

CINCINNATI, OHIO

PLAIN  
 AND  
 QUARTER  
 SAWED

## White and Red Oak

CHESTNUT  
 POPLAR  
 GUM AND  
 CYPRESS

Flooring, Siding, Ceiling, Base, Case and Molding. Rough, Dressed and Re-sawed. Mixed Carloads.

# CHICAGO

THE GREATEST HARDWOOD MARKET IN THE WORLD

## The Keith Lumber Company

HARDWOOD, POPLAR & SOUTHERN PINE LUMBER.

MAHOGANY,



CYPRESS,

REDWOOD,

CHESTNUT,

RED CEDAR,

SPRUCE,

MAPLE FLOORING, OAK TIMBERS & WAGON STOCK.

Office and Yards: Fourteenth and Wood Streets.

## SOUTHERN OAK LUMBER CO.

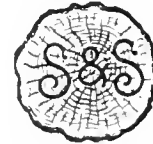

WE WANT TO BUY FOR CASH

OAK  
CYPRESS  
ASH

MILL CUTS OR ROUND LOTS

910 CHAMBER OF COMMERCE 1217 TENNESSEE TRUST BLDG.

CHICAGO MEMPHIS

YARDS: NORTH MEMPHIS

## Heath-Witbeck Company

### Hardwood Lumber

We have for quick shipment 170,000 feet DRY BIRCH, First and Seconds and Common 2, 2½, 3 and 4 inch.

Main Office, 6 Madison St. Yards, Loomis and 22nd St.  
CHICAGO

## Crandall & Brown

LOUISIANA RED CYPRESS,  
YELLOW PINE FINISH,  
FLOORING, CEILING, PARTITION,  
OAK, POPLAR, BIRCH,  
BASSWOOD, MAPLE.

Office and Yards: 3300 Center Avenue, CHICAGO.

## Lesh & Matthews Lumber Co.

1649-50 MARQUETTE BUILDING

Are now offering bone dry BIRCH, ROCK ELM, BLACK ASH, etc., Wisconsin stock. Also PLAIN AND QUARTERED OAK, POPLAR, etc., from our Memphis yard. We are constant buyers.

## THE WARD LUMBER COMPANY

MANUFACTURERS OF  
HARDWOODS

CHAMBER OF COMMERCE BUILDING :: CHICAGO

## Estabrook-Skeele Lumber Co.

203 FISHER BUILDING, CHICAGO

We are in the market for

### Wagon Stock

REACHES, BOLSTERS, TONGUES, AXLES, ETC., AND

Hardwood Lumber

PARTICULARLY WANT WHITE ASH  
AND HICKORY

TELL US WHAT YOU HAVE  
TO OFFER

## CLARENCE BOYLE LUMBER CO.

Wholesale Dealers in **Hardwoods** Yellow Pine and Cypress

319 WEST TWENTY-SECOND STREET :: CHICAGO

FRED W. BLACK, President

HORACE W. BLACK, Secretary

## FRED W. BLACK LUMBER COMPANY

MANUFACTURERS OF

HARDWOOD LUMBER

305 Old Colony Building

# BUFFALO

THE GREAT WHOLESALE LUMBER CENTER OF THE EAST



Manufacturers and Dealers in

Ash

White and Brown

Basswood

Birch

Red and White

Butternut

Cherry

Chestnut

Cottonwood

Cypress

Elm

Soft and Rock

Gum

Red and Tupelo

Hickory

Maple

Hard and Soft

Red Oak

Plain and Quartered

White Oak

Plain and Quartered

Black Walnut

White Wood

Poplar



## EMPIRE LUMBER COMPANY

Our specialties are PLAIN and QUARTERED OAK and ASH.

1142 SENECA STREET.

## G. ELIAS & BROTHER

BUY AND CARRY LARGE QUANTITIES OF ALL KINDS OF HARDWOODS

955 TO 1015 ELK STREET

## HUGH McLEAN LUMBER COMPANY

Specialty: INDIANA WHITE OAK

940 ELK STREET

## ANTHONY MILLER

HARDWOODS OF ALL KINDS

893 EAGLE STREET

## SCATCHERD & SON

HARDWOODS ONLY

Yard, 1555 SENECA STREET

Office, 886 ELLICOTT SQUARE

## STANDARD HARDWOOD LUMBER CO.

OAK, ASH AND CHESTNUT

1075 CLINTON STREET

## I. N. STEWART & BROTHER

Specialties: CHERRY AND OAK

892 ELK STREET

## T. SULLIVAN & COMPANY

Specialties: BROWN ASH, BIRCH, PACIFIC COAST FIR AND SPRUCE

50 ARTHUR STREET

## ORSON E. YEAGER

Specialties: OAK, ASH AND POPLAR

932 ELK STREET

## BEYER, KNOX & COMPANY

ALL KINDS OF HARDWOODS

Office and Yards, 69 LEROY AVENUE

## BUFFALO HARDWOOD LUMBER CO.

We want to buy for cash:

Oak, Ash and other Hardwoods, all grades and thicknesses.  
Will receive and inspect stock at shipping point.

518 RANDOLPH BLDG., MEMPHIS, TENN.

940 SENECA STREET.





Specimen of Our Poplar Timber

W. M. Ritter Lumber Co.

MAIN OFFICE: COLUMBUS, OHIO

# YELLOW POPLAR

White Oak, Basswood, Chestnut,  
Ash, White Pine and Hemlock

We Want Your Business

Stock all band sawed, square edged, equalized. Dry Kilns,  
Planing Mills, Dressed Stock, Bevel Siding, Drop Siding



Specimen of Our Oak Timber

# Vansant, Kitchen & Co.

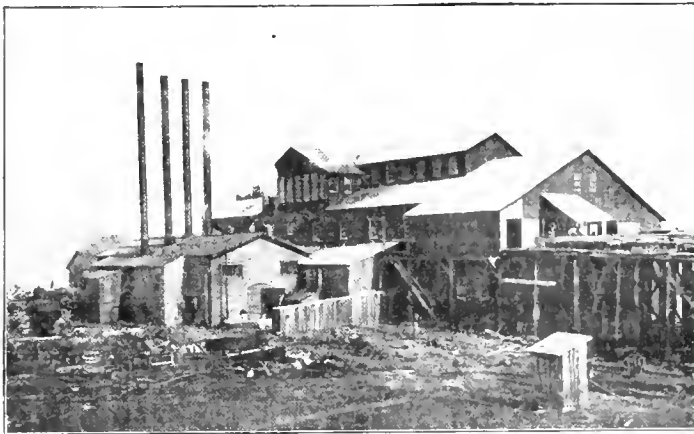

NEW ASHLAND MILL

Old-Fashioned

# SOFT YELLOW POPLAR

Ashland, Ky.

5-8 AND 4-4 IN WIDE STOCK, SPECIALTY

# YELLOW POPLAR

Manufacturers  
BAND SAWED  
POPLAR LUMBER

ALL GRADES

**DRY** 5-8, 4-4, 5-4, 6-4, 8-4, 10-4, 12-4, 16-4  
Bevel Siding, Lath and Squares  
Specialty, Wide Stock.

# LUMBER CO.

COAL GROVE, OHIO, U. S. A.

# Hardwood Record

Eleventh Year.  
Semi-monthly.

CHICAGO, JUNE 10, 1906.

Subscription \$2.  
Single Copies, 10 Cents.

## CHERRY

C. E. LLOYD, JR.  
Manager Sales

## RIVER

## LUMBER

GROWS IN  
WEST VIRGINIA

Sold by  
Cherry River Boom &  
Lumber Co.  
Offices: Philadelphia, Pa.

## RED GUM

We produce and market a carload of Gum Lumber  
: every 45 minutes during the working day. :

Himmelberger-Harrison Lumber Co.  
Morehouse, : : Missouri

## WHAT'S THE USE

of paying more than is necessary for  
your fire insurance?

### Pennsylvania Lumbermen's Mutual Fire Insurance Company

923 DREXEL BUILDING, PHILADELPHIA, PENNSYLVANIA.

## RUMBARGER LUMBER COMPANY

<p><b>Ash.</b> 5 cars 1 in., log run. 3 cars 1½ in., log run. 6 cars 2 in., log run. 2 cars 2½ in. to 5 in., Com. &amp; Better.</p> <p><b>Basswood.</b> 30 cars 1 in., log run.</p> <p><b>Beech.</b> 25 cars 1 in., log run. 2 cars 2 in., log run.</p> <p><b>Birch.</b> 20 cars 1 in., log run. 2 cars 1½ in., log run. 1 car 2 in., log run.</p> <p><b>Red Oak.</b> 10 cars 1 in., log run.</p>	<p><b>Cherry.</b> 500,000 ft. 1 in., log run. 1 car 1½ in., Nos. 1 &amp; 2 &amp; No. 1 Com. 1 car 2 in., Nos. 1 &amp; 2 &amp; No. 1 Com. Choice old growth stock, good lengths and fine widths. Will sell on grades.</p> <p><b>Chestnut.</b> 10 cars 1 in., sound wormy. 1 car 3 in., sound wormy. 3 cars 2 in., log run. 5 cars 1 in., Nos. 1 &amp; 2 &amp; No. 1 Com. 2 cars 1½ in., Nos. 1 &amp; 2 &amp; No. 1 Com.</p> <p><b>Cucumber.</b> 7 cars 1 in., log run.</p> <p><b>Maple.</b> 20 cars 1 in., log run. 10 cars 2 in., log run.</p>	<p><b>Mountain Oak.</b> 4 cars 2 in., Nos. 1 &amp; 2. 2 cars 2 in., No. 1 Common. 10 cars 1 in., Nos. 1 &amp; 2 &amp; No. 1 Com.</p> <p><b>White Oak.</b> 1 car 1¾ in., Nos. 1 &amp; 2. <b>Quartered White Oak.</b> 3 cars 1 in., Nos. 1 &amp; 2. 5 cars 1 in., No. 1 Common. 5 cars 1 in., No. 2 Common. 1 car 1 in., Clear Strips. This stock shows an exceptionally fine figure.</p> <p><b>Quartered Red Oak.</b> 1 car 1 in., Nos. 1 &amp; 2. 2 cars 1 in., No. 1 Common. 1 car 1 in., No. 2 Common.</p>	<p><b>Hardwood, No. 3 Common.</b> ¼ car 1 in., rough. 3 cars 1 in., surfaced 1 side. 4 cars 2 in., either rough or surfaced.</p> <p><b>Clear Spruce.</b> 3 cars 1 in., Nos. 1 &amp; 2. 5 cars 2 in., Nos. 1 &amp; 2.</p> <p><b>Poplar.</b> Have a fair stock of 1 in., 1½ in., 1½ in. &amp; 2 in.</p> <p><b>White Pine.</b> 12,000,000 feet No. 3 Barn &amp; Better. 500,000 feet Box. 1 in., 1½ in., 1¾ in. &amp; 2 in., either rough or worked.</p>
---	--	--	---

MAIN OFFICE: 808 HARRISON BUILDING, 15TH AND MARKET STREETS, PHILADELPHIA, PA.

NEW YORK OFFICE: 8018 METROPOLITAN BLDG., 1 MADISON AVENUE.

PITTSBURG OFFICE: 701 KEYSTONE BUILDING.

## ADIRONDACK FIRE INSURANCE COMPANY

CAPITAL AND SURPLUS, \$300,000.

LUMBER AND WOODWORKING RISKS EXCLUSIVELY.

A new company organized to further serve the patrons of the Lumber Insur-  
ance Company of New York, 66 Broadway, New York, and allied organizations.

Home Office: 66 Broadway, NEW YORK

# LOUISVILLE

MANUFACTURING AND DISTRIBUTING CENTER OF KENTUCKY

## The Norman Lumber Co., Inc.

Manufacturers and Wholesalers of

### Hardwood Lumber

FOR SALE

Seasoned Ash, Oak, Poplar, and Walnut Lumber

WANT TO BUY

Walnut, Oak, Ash, Hickory and Poplar Logs and Lumber

Office and Yards 1 Third Street, H to K Streets  
LOUISVILLE, KY.

## EDWARD L. DAVIS & CO.

OFFER FOLLOWING STOCKS:

<b>POPLAR.</b> 30,000 ft. 4/4 1st & 2d. 50,000 ft. 4/4 Common. 15,000 ft. 5/4 Common.	<b>QUARTERED RED OAK.</b> 50,000 ft. 4/4 1st & 2d. 50,000 ft. 4/4 Common.	<b>QUARTERED WHITE OAK.</b> 50,000 ft. 4/4 1st & 2d. 10,000 ft. 5/4 1st & 2d. 20,000 ft. 6/4 1st & 2d. 10,000 ft. 8/4 1st & 2d. 50,000 ft. 4/4 Common. 5,000 ft. 5/4 Common. 5,000 ft. 6/4 Common. 20,000 ft. 8/4 Common. 10,000 ft. 2 1/2" Common. 40,000 ft. 3" Common.	<b>OAK WAGON TONGUES.</b> 12,000 ft. 4x4"x12"-12", 1-6 mos. dry. 500 ft. 3 x4 "12", 12-18 mos. dry. 400 ft. 3 1/2 x4 1/2 "12", 12-18 mos. dry. 300 ft. 3 1/2 x4 1/2 "12", 12-18 mos. dry. 250 ft. 3 1/2 x4 1/2 "12", 12-18 mos. dry. 800 ft. 3 1/2 x4 1/2 "12", 12-18 mos. dry. 180 ft. 3x4" & Lgr.—14", 12-18 mos. dry.
			<b>REACHES.</b> 1 car 2x4" and larger, dry.
			<b>BOLSTERS.</b> 2 cars 3x4" and larger, dry.
			<b>HICKORY AXLES.</b> 1,500—3 x4 "—8", 1-6 mos. dry. 1,500—3 1/2 x4 1/2 "—8", 1-6 mos. dry. 2,000—4 x5 "—8", 1-6 mos. dry. 1,000—4 1/2 x5 1/2 "—8", 1-6 mos. dry. 1,000—6 x6 "—8", 1-6 mos. dry.

# STOTZ LUMBER COMPANY

Incorporated

MANUFACTURERS :: WHOLESALE

Oak, Ash, Poplar, Gum, Cottonwood

KELLAR BUILDING

LOUISVILLE, KENTUCKY

## Ornamental Hardwood Floors

400 STYLES AND PATTERNS

Illustrated Catalog on Application

### WOOD=MOSAIC FLOORING CO.

Rochester, N. Y. New Albany, Ind.

### Albert R. Kampf

Manufacturer  
Hardwood Lumber and Timber  
Dimension Stock  
Board of Trade Bldg., Louisville, Ky.

### E. W. Rhubesky

Wholesale  
Poplar, Rough and Dressed,  
Oak Chestnut and Other  
Hardwoods

### North Vernon Pump & Lumber Co.

Band Sawn Plain and Quartered  
Oak and Poplar.  
North Vernon, Ind., and  
Louisville, Ky.

### Southern Lumber Co.

Oak, Poplar and  
Chestnut.  
Louisville, Ky.

## DRY LUMBER At Our Louisville Yards Prompt Delivery

<b>QUARTERED WHITE OAK.</b> 75,000 ft. 4/4 firsts & seconds. 18,000 ft. 5/4 firsts & seconds. 15,000 ft. 6/4 firsts & seconds. 19,000 ft. 8/4 firsts & seconds. 150,000 ft. 4/4 No. 1 common. 30,000 ft. 5/4 No. 1 common. 40,000 ft. 6/4 No. 1 common. 22,000 ft. 8/4 No. 1 common. 22,000 ft. 4/4 cull.	<b>PLAIN WHITE OAK.</b> 80,000 ft. 4/4 firsts & seconds. 17,500 ft. 5/4 firsts & seconds. 19,000 ft. 6/4 firsts & seconds. 22,000 ft. 8/4 firsts & seconds. 18,000 ft. 10/4 firsts & seconds. 16,000 ft. 12/4 firsts & seconds. 127,000 ft. 4/4 No. 1 common.	<b>PLAIN RED OAK.</b> 47,000 ft. 4/4 firsts & seconds. 15,000 ft. 5/4 firsts & seconds. 9,000 ft. 6/4 firsts & seconds. 27,000 ft. 8/4 firsts & seconds. 31,000 ft. 4/4 No. 1 common. 24,000 ft. 5/4 No. 1 common. 14,000 ft. 6/4 No. 1 common. 29,000 ft. 8/4 No. 1 common.	<b>ASH.</b> 1 car 4/4 firsts & seconds. 3,000 ft. 5/4 firsts & seconds. 7,000 ft. 6/4 firsts & seconds. 5,000 ft. 8/4 firsts & seconds. 3,000 ft. 10/4 firsts & seconds. 7,000 ft. 12/4 firsts & seconds. 4,000 ft. 16/4 firsts & seconds. 10,000 ft. 4/4 common. 2,000 ft. 5/4 common. 20,000 ft. 6/4 common. 3,000 ft. 8/4 common.	<b>POPLAR.</b> 60,000 ft. 4/4 firsts & seconds. Selects and Saps.	<b>WE HAVE ALL THICKNESSES IN</b> 42,000 ft. 5/4 firsts & seconds 17,000 ft. 6/4 firsts & seconds 58,000 ft. 8/4 firsts & seconds 3,000 ft. 10/4 firsts & seconds 17,000 ft. 12/4 firsts & seconds 6,000 ft. 16/4 firsts & seconds 90,000 ft. 4/4 No. 1 common. 26,000 ft. 5/4 No. 1 common. 18,000 ft. 6/4 No. 1 common. 31,000 ft. 8/4 No. 1 common. 12,000 ft. 10/4 No. 1 common. 8,000 ft. 12/4 No. 1 common.
--	--	--	---	--	---

ALL THICKNESSES IN CULL POPLAR, ASH, CHESTNUT.

Your Inquiries Would Be Appreciated.

**W. P. BROWN & SONS LUMBER CO. WHOLESALE HARDWOODS**  
LOUISVILLE, KY.

# CADILLAC

CELEBRATED FOR HIGH STANDARD OF QUALITY AND MILL WORK

## Thick Hard Maple

Cut during the winter of 1904-5  
 10-4 1's and 2's . 51,000 ft.  
 12-4 1's and 2's . 55,000 ft.  
 16-4 1's and 2's . 10,000 ft.

This stock was sawed in our own mill and has been seasoned in a first-class manner. It is largely 12 inch and wider and very choice.

We also have end-dried in shed:  
 4-4 Birdseye Maple, 8,000 ft.  
 5-4 White Maple . 21,000 ft.

PLEASE SEND US YOUR INQUIRIES.

## Mitchell Brothers Company

CADILLAC, MICHIGAN

## Cummer, Diggins & Co.

—MANUFACTURERS—  
 "CUMMER" MAPLE  
 AND BEECH FLOORING

## MICHIGAN HARDWOODS

Good assortment of dry stock on hand ready for immediate shipment in Hard Maple, Beech, Birch, Soft Elm and Cherry.

SEND US A LIST OF YOUR REQUIREMENTS.

## MURPHY & DIGGINS

Offer all grades of the following special dry stock

MAPLE—5/4, 6/4, 8/4, 10/4, 12/4, 14/4, 16/4  
 GRAY ELM—4/4, 12/4  
 BASSWOOD—4/4  
 BIRCH—4/4, 6/4

Our own manufacture. Perfect Mill Work. Uniform Grades.

LET US FIGURE ON YOUR HARDWOOD WANTS.

## The Cadillac Handle Co.

. . . Band Sawn . . .  
 Michigan Hardwoods

We offer for Rail Shipment from Cadillac. Also the following for Water Shipment:  
 2 cars 8/4 Maple, No 1 Com. & Better 100,000 feet of 4/4 Basswood  
 1 car 5x5 Maple, Select Stock 100,000 feet of 4/4, 8/4 and 12/4 Soft Elm  
 2 cars 4/4 Basswood, No 2 Com & Bet. 150,000 feet of 4/4, 5/4 and 6/4 Birch  
 2 cars 4/4 Birch, No. 2 Com. & Bet.

## Michigan Hardwoods

### DRY STOCK

<b>HARD MAPLE</b>	}	360 M feet 5/4 Nos. 1 and 2 Common
		185 M feet 6/4 1s and 2s
		340 M feet 6/4 Nos. 1 and 2 Common
		38 M feet 12/4 1s and 2s
		2 M feet 16/4 1s and 2s 2 M feet 16/4 Common
<b>SOFT GRAY ELM</b>	}	145 M feet 4/4 Nos. 1 and 2 Common
		50 M feet 4/4 No. 3 Common
		18 M feet 6/4 1s and 2s
		27 M feet 6/4 Nos. 1 and 2 Common
		47 M feet 6/4 No. 2 Common and Better
		180 M feet 8/4 1s and 2s
		24 M feet 8/4 Nos. 1 and 2 Common
		20 M feet 8/4 No. 2 Common and Better.
		10 M feet 10/4 1s and 2s
		39 M feet 12/4 1s and 2s
3 M feet 1x4 Clear Face and Better		
8 M feet 4/4 No. 1 Com. & Bet. Saw Culls		

Our lumber is graded according to the rules of the National Hardwood Lumber Association.



**COBBS & MITCHELL**  
 (INCORPORATED)  
**CADILLAC, MICHIGAN**



# MEMPHIS

THE HUB OF THE HARDWOOD WORLD

**WE** have in all thicknesses the following kinds and amounts of lumber at places designated. Kindly send us your inquiries.

<b>MEMPHIS YARD</b>		<b>SELMA YARD</b>	
Ash.....	680,000 feet	Poplar.....	409,000 feet
Quartered White Oak..	75,000 feet	Bay Poplar.....	857,000 feet
Plain White Oak.....	140,000 feet	Red Gum.....	55,000 feet
Quartered Red Oak....	225,000 feet	Cypress.....	787,000 feet
Plain Red Oak.....	410,000 feet	<b>BERCLAIR YARD</b>	
Cypress.....	225,000 feet	Bay Poplar.....	100,000 feet
Cottonwood.....	200,000 feet	Cypress.....	800,000 feet
Poplar.....	308,000 feet	<b>OTHER YARDS</b>	
		Plain Red Oak.....	350,000 feet

## J. W. THOMPSON LUMBER COMPANY

Office and Yards: Randolph Road and I. C. R. R. : : MEMPHIS, TENN.

Nelson H. Walcott, Pres't. Frank E. Stonebraker, Vice-Pres't.  
Chas. C. Gardiner, Sec'y and Treas.

## THE CRITTENDEN LUMBER CO.

MANUFACTURERS

MILLS AT

EARLE, ARK.

## ANDERSON-TULLY COMPANY

### STOCK LIST

<b>COTTONWOOD.</b>		<b>ASH.</b>	
20 M ft. 7/8" 1st & 2nd, 8" up	15,000 ft. 4/4" 1st & 2nd Strips, 2 1/2" to 5 1/2"	5,000 ft. 4/4" Common.	
200 M ft. 4 1/2" 1st & 2nd, 6" up		12,000 ft. 5/4" & 6/4" No. 3 Common.	
14 M ft. 4 1/2" 1st & 2nd, 7"-10"		<b>GUM.</b>	
25 M ft. 4 1/2" 1st & 2nd, 11"-12"		60,000 ft. 4/4" 1st & 2nd Saps, 13" to 16".	
40 M ft. 4 1/2" 1st & 2nd, 18" up		60,000 ft. 4/4" 1st & 2nd Saps, 16" and up.	
15 M ft. 5 1/4" 1st & 2nd, 6" up		50,000 ft. 4/4" No. 1 Common Red.	
20 M ft. 5 1/4" 1st & 2nd, 12"		100,000 ft. 4/4" No. 1 Common Sap.	
35 M ft. 5 1/4" 1st & 2nd, 11" & 12"		60,000 ft. 4/4" 1 & 2 Red Strips, 2 1/2" to 5 1/2".	
45 M ft. 6 1/4" 1st & 2nd, 6" up		<b>POPLAR.</b>	
50 M ft. Wagon Box Boards, 9" to 12"		20,000 ft. 4/4" Common & Better.	
<b>CYPRESS.</b>		<b>RED OAK.</b>	
20,000 ft. 4/4" Clear Strips, 2 1/2" to 5 1/2"		1,750 ft. 4/4" Quartered 1 & 2.	
<b>WHITE OAK.</b>		2,920 ft. 4/4" Quartered Common.	
4,000 ft. 4/4" 1 & 2 Quartered		14,440 ft. 4/4" Plain 1 & 2, 12" and up.	
0,800 ft. 4/4" Com. Quartered		80,000 ft. 4/4" Nos. 2 & 3 Com. Red & White.	

J. B. Ransom, Pres't A. B. Ransom, V.-Pres. W. A. Ransom, Sec. C. R. Ransom, Treas.

## GAYOSO LUMBER CO., Inc.

MANUFACTURERS AND DEALERS IN

## SOUTHERN HARDWOODS

Also make a specialty of Wagon Stock in rough, such as Tongues, Axles, Reaches, Bolsters, and 6-4 to 16-4 Hickory.

F. W. GILCHRIST, President  
W. A. GILCHRIST, Vice President  
W. E. SMITH, Sec'y and Treasurer

## W. E. SMITH LUMBER CO.

Manufacturers of  
**HARDWOOD LUMBER**

Mills, Tennessee, Arkansas, Mississippi  
Distributing Yards, Cairo, Illinois  
General Office Tennessee Trust Bldg.

MISSISSIPPI VALLEY COTTONWOOD

F. W. GILCHRIST, Pres. W. A. GILCHRIST, Vice-Pres.  
W. E. SMITH, Sec'y and Treas.

## Three States Lumber Co.

MANUFACTURERS OF

Mills: Hardwood Lumber Office  
Missouri Arkansas Tennessee Trust Building

GET OUR PRICES, TRY OUR LUMBER  
WE SHIP ROUGH, DRESSED, RESAWED

COTTONWOOD GUM

## Briggs & Cooper Company, Ltd.

MANUFACTURERS

## NORTHERN SOUTHERN HARDWOODS

GET OUR PRICES ON THESE ITEMS:

1,000,000 feet Soft Grey Elm, 1 to 3".
500,000 feet Unselected Birch, 1 to 3".
3,000,000 feet Michigan Hard Maple, 1 to 6".
350,000 feet Erd Dried White Maple, 1 to 1 1/2".
625,000 feet No. 1 Common and Better Winter Sawn Basswood, 1 to 3".
150,000 feet Selected White Basswood, 1", 1 1/4" and 1 1/2".
210,000 feet Plain and Quartered White and Red Oak, 1 to 2".

YARDS AT

SAGINAW, CHICAGO AND MEMPHIS

## BACON-NOLAN HARDWOOD CO.

Manufacturers of

## Band Sawn Oak, Ash Gum, Cypress, Etc.

Office,  
Memphis, Tenn.

Mills,  
Chancy, Miss.

Address all correspondence to Memphis office.

**ST. LOUIS**

LARGEST OF ALL HARDWOOD MARKETS

Roland F. Krebs **Ozark Cooperage Co.** Hardwood Department  
Manager

**WE BUY STOCKS READY CUT OR CONTRACT FUTURE OUTPUT**

Four Inspectors in the South

Direct Shipments from mill stocks of COTTONWOOD, CYPRESS, GUM, OAK. MAIN OFFICE, FRISCO BUILDING

**CHAS. F. LUEHRMANN HARDWOOD LUMBER COMPANY**

Carry a complete stock of Hardwood and are constantly in the market to purchase large blocks of stock for cash. Are also the largest manufacturers of the famous St. Francis Basin Red Gum.

General Offices: 148 Carroll Street

**W. R. CHIVVIS,** Lesperance Street and Iron Mountain Railroad.  
WHOLESALE HARDWOODS

**BLACK WALNUT LUMBER MY SPECIALTY.** Always in the market to buy Walnut and Cherry Lumber. Pay spot cash and take up at shipping point when amounts justify.

**Stoneman-Zearing Lumber Co.**

203 Frisco Building

We have the following Dry Stock for sale piled at our mill:

<b>QTD. WHITE OAK:</b>	<b>COTTONWOOD:</b>
3 Cars 4/4 Common.	3 Cars 1" 1 and 2.
2 Cars 4 4 Common and Better Strips.	1 Car 1x13 to 17" Box Boards.
<b>GUM:</b>	<b>ELM:</b>
5 Cars 1" Common Red.	1 Car 6 4 Log Run.
1 Car 1x13 to 17" Box Boards.	4 Cars 4" Log Run.
1 Car 2" 1 and 2 Sap.	
6 Cars 1 3/4 Common and Better Sap.	

This Stock is All Band Sawed and Equalized

**Wanted—Cypress, Ash and Cottonwood**

INSPECTION AT POINT OF SHIPMENT WHEN QUANTITY JUSTIFIES

**Hafner Manufacturing Co.**

CYPRESS, HARDWOODS

Mail orders receive our immediate attention.

YARDS: FOOT OF DOCK STREET

**Thomas & Proetz Lumber Co.**

CASH BUYERS OF OAK, ASH, CYPRESS, POPLAR, CHERRY AND ALL

**HARDWOODS**

SEND INSPECTOR WHEN QUANTITY JUSTIFIES

Office and Yards: Hall and Angelrodt Sts.

**Garetson-Greaseon Lumber Co.**

MANUFACTURERS OF SOUTHERN HARDWOODS

**GUM LUMBER  
OUR SPECIALTY**

Carload Shipments Direct from Our Own Mills

519 Bank of Commerce

**LOTHMAN CYPRESS CO.**

AIR DRIED

**Louisiana Red Cypress**

FOOT OF ANGELICA STREET

**SIX MILLION FEET**

Ash, Oak, Cypress, Poplar, Etc.

READY FOR PROMPT SHIPMENT

**STEELE & HIBBARD**

NORTH BROADWAY, DOCK AND HALL STREETS



# PAEPCKE-LEICHT LUMBER COMPANY

MANUFACTURERS OF

## COTTONWOOD GUM AND OTHER HARDWOODS

Large stocks of well seasoned Lumber always carried at our yards and mills.

General Offices: 140 W. Chicago Ave., CHICAGO. Mills: Cairo, Ill., Marked Tree, Ark., Greenville, Miss., Arkansas City, Ark., Blytheville, Ark.

### Are You in the Market?

Send us your inquiries for prices on  
the following

## HARDWOODS

100M ft. 1" Com. and Better Quartered Red Oak.  
100M ft. 1" Com. and Better Quartered White Oak.  
75M ft. 1½" Com. and Better Quartered Red Oak.  
25M ft. 1½" Com. Quartered White Oak.  
25M ft. 1½" 1st and 2nds Quartered Red Oak.  
50M ft. 3" Com. and Better Quartered White Oak.  
50M ft. 3" Com. and Better Plain White Oak.  
100M ft. 1" Com. Plain Birch.  
50M ft. 1" Com. Red Birch.  
50M ft. 1½" Com. and Better Plain Birch.  
100M ft. 1" Com. and Better Hard Maple.  
100M ft. 1½" Com. and Better Hard Maple.  
100M ft. 1" Com. and Better Soft Elm.

## UPHAM & AGLER

Distributing Yards: CAIRO, ILL.

Main Offices :: American Trust Building, CHICAGO

JOHN T. DIXON

HARRY S. DEWEY



We are not **Wizards** in making new grades to fit a price.  
No tricks in our methods of making shipments. The  
straight grades are good enough for us.

If you will give us a trial order for **POPLAR, OAK,  
ASH, CHESTNUT or OAK, MAPLE and YELLOW  
PINE FLOORING**, we believe we can demonstrate our  
ability to please you.

## DIXON & DEWEY

716 and 716 A, Flatiron Building,

NEW YORK

# WILLIAM WHITMER & SONS, Inc.

MANUFACTURERS OF

## HARDWOODS

We are always in the market for round lots of well man-  
ufactured stock, and shall be pleased to enter into corre-  
spondence with manufacturers with a view to purchase.

PHILADELPHIA  
New York, Boston, Pittsburg

**THE EAST**

BOSTON NEW YORK PHILADELPHIA

**HEADQUARTERS FOR HARDWOODS  
WE BUY AND SELL--WHOLESALE--**

The McIlvain's have been lumber merchants continuously for over one hundred years. We have 20,000,000 feet of all kinds of lumber from which to fill your orders satisfactorily, if you are a buyer. We want large lots of choice, dry Hardwoods to round up our stocks again after the late fire. What have you for sale? Get McIlvain's "Lumber News" and "Stock List" for June.

**J. Gibson McIlvain & Co.**

58th and Woodland Ave., PHILADELPHIA, PA.

**Holloway Lumber Company  
WHOLESALE HARDWOODS**

In the market for all thicknesses of OAK, ASH and CHESTNUT. 312 Arcade Building, PHILADELPHIA, PA.

**H. D. Wiggin Wholesale Hardwoods**

**Specialties:** Poplar, Chestnut, Canadian Hardwoods, and Mahogany Veneers.

FISKE BUILDING BOSTON, MASSACHUSETTS

**The Crosby & Beckley Company**

**HARDWOODS**

We are  
In the Market for Choice Stock  
WRITE US

No. 1 Madison Ave.,  
New York, N. Y.

New Haven,  
Connecticut.

BALTIMORE MARYLAND E. E. PRICE BUYER AND EXPORTER OF

**Hardwoods, Poplar and Logs**

I am always in the market for nice lots of dry and well manufactured lumber. I inspect at point of shipment. Correspondence solicited

**STEVENS-EATON CO.**

Buyers of ROUND LOTS of Hardwoods No. 1 Madison Avenue, NEW YORK

ESPECIALLY IN MARKET FOR PLAIN RED OAK

**Jones Hardwood Co.**

(INCORPORATED)

**WANTS**

Poplar, Plain Oak, Quartered Oak and Cypress

Manufacturers please send stock lists and prices

147 MILK STREET, BOSTON, MASS.

**WM. E. LITCHFIELD**

MASON BUILDING, BOSTON, MASS.

**Specialist in Hardwoods**

Manufacturers are requested to supply lists of stock for sale

J. J. SOBLE

H. I. SOBLE

**SOBLE BROTHERS**

Wholesale Hardwoods

911-912 Land Title Bldg. PHILADELPHIA

WANTED: 20 cars Common and Better Chestnut, all thicknesses.

**Charles S. Wentworth & Co.**

**WHOLESALE LUMBER MERCHANTS**

147 Milk Street  
**BOSTON**

We are in the Market for POPLAR, PLAIN OAK, CYPRESS and NORTH CAROLINA PINE LUMBER; also OAK, MAPLE and BIRCH FLOORING, and would appreciate correspondence from manufacturers in position to supply any of the stock named.

J. H. SCHOFIELD

R. W. SCHOFIELD

**SCHOFIELD BROTHERS  
WHOLESALE LUMBER**

Hardwoods a  
Specialty.

1020-22 Pennsylvania Building  
PHILADELPHIA

**Wistar, Underhill & Co.,**

**WHOLESALE  
HARDWOOD LUMBER**

816 Real Estate Trust Building, PHILADELPHIA.

# NASHVILLE

HEADQUARTERS FOR ALL SOUTHERN HARDWOODS

## INDIANA LUMBER CO.

Manufacturers Lumber  
DIMENSION STOCK A SPECIALTY.

Office and Mills: Corner Oldham  
Street and Cumberland River

NASHVILLE, TENN.

## GEO. C. BROWN & CO.

MANUFACTURERS AND WHOLESALE DEALERS IN

Hardwood Lumber

Tennessee Red Cedar Lumber a Specialty

NASHVILLE, TENNESSEE

## JOHN B. RANSOM & CO.,

NASHVILLE, TENNESSEE

We want to move quickly the following old dry stock. All of it has been on sticks 6 to 18 months. Write us for delivered prices. We are prepared to furnish promptly mixed cars of rough and dressed hardwoods of all kinds:

QUARTERED WHITE OAK	QUARTERED RED OAK
90 M 4 4 first and second	100 M 4 4 first and second
15 M 5 4 first and second	58 M 6 4 first and second
80 M 6 4 first and second	15 M 8 4 first and second
10 M 10 4 first and second	95 M 4 4 No. 1 Common
120 M 4 4 No. 1 Common	84 M 6 4 No. 1 Common
65 M 6 4 No. 1 Common	72 M 8 4 No. 1 Common
58 M 8 4 No. 1 Common	
20 M 10 4 No. 1 Common	
	PLAIN OAK
70 M 5 8 first and second Poplar	50 M 4 4 1st and 2nd White
80 M 5 8 No. 1 Common Poplar	100 M 4 4 No. 1 Common White
15 M 4 4 1st and 2d Quartered Sycamore	100 M 4 4 first and second Red
10 M 4 4 No. 1 Com. Quart'd Sycamore	100 M 4 4 No. 1 Common Red

## LOVE, BOYD & CO.

Offer:

5,000,000 ft. Quartered White Oak.  
2,000,000 ft. Quartered Red Oak.  
1,000,000 ft. Plain White Oak.  
1,000,000 ft. Plain Red Oak.  
1,000,000 ft. Poplar.  
2,000,000 ft. Chestnut, Ash, Hickory, Red Cedar, Etc.

Our Own Manufacture.  
Prompt Service.  
Dry Stock.

MAIN OFFICE,  
NASHVILLE, TENNESSEE

## Nashville Hardwood Flooring Co.

Manufacturers of

"Acorn Brand"

THE FAMOUS FAULTLESS FLOORING  
IN OAK AND BEECH.

Car Lots and Less Than Car Lot  
Orders Solicited. Write for Prices.

Nashville, Tennessee

## The Tegge Lumber Co.

MILWAUKEE  
WISCONSIN

BUYERS OF  
ALL KINDS OF

HARDWOOD LUMBER

## LANE=WHITE LUMBER CO.

MANUFACTURERS AND WHOLESALE DEALERS OF

HARDWOOD LUMBER

Our Specialty:

OAK, ASH AND WALNUT

ALWAYS IN THE MARKET FOR WALNUT LOGS

MAIN OFFICE AND  
BAND MILL AT FORT SMITH, ARK.

# Swann-Day Lumber Company

MANUFACTURERS OF

POPLAR AND OAK

PLANING MILL STOCK, BOX SHOOKS  
AND HARDWOOD DIMENSION

CLAY CITY, KENTUCKY

# PITTSBURG

HARDWOOD DISTRIBUTING CENTER OF PENNSYLVANIA

## Willson Bros. Lumber Co.

MANUFACTURERS

### WEST VIRGINIA HARDWOODS

FARMERS BANK BLDG. :: PITTSBURG, PA.

## Hardwoods a Specialty

FOR SALE

POPLAR	CHESTNUT	PLAIN OAK
125,000' 4 4 1s and 2s	200,000' 4 4 Sound Wormy	60,000' 4 4 No. 1 Com.
40,000' 4 4 No. 1 Com.	80,000' 5 4 Sound Wormy	18,000' 4 4 No. 2 Com.
325,000' 4 4 No. 2 Com.	100,000' 6 1 Sound Wormy	<b>QUARTERED OAK</b>
228,000' 4 4 No. 3 Com.	48,000' 8 4 Sound Wormy	2 cars 4 4 No. 1 Com.
150,000' 4 4 Mill Cull		1 car 4 4 No. 2 Com.

OAK TIMBERS SAWED TO ORDER.  
WRITE FOR PRICES.

CHEAT RIVER LUMBER COMPANY, Pittsburg, Penna.

## Babcock Lumber Co.

MANUFACTURERS OF  
PENNSYLVANIA  
HARDWOODS

23,000,000 FEET ANNUALLY

LONG ON MAPLE  
AND CHERRY

MILLS AND OFFICE  
ASHTOLA, PA.

## Dry Stock for Quick Shipment:

12,189 ft 4 4 clear Quartered Oak	66,232 ft 4 4 No. 1 Common Poplar
14,570 ft 4 4 1st & 2ds qtd. Red Oak	10,315 ft 6 4 1st & 2ds Poplar
30,302 ft 4 4 No. 1 Com. Red Oak	76,000 ft 4 4 1st & 2ds Cottonwood
63,204 ft 4 4 No. 1 Com. Pl White Oak	119,000 ft 4 4 No. 1 Com. Cottonwood
4,417 ft 5 4 No. 1 Com. Pl White Oak	150,000 ft No. 2 Common Cottonwood
5,934 ft 6 4 No. 1 Com. Pl White Oak	90,000 ft 4 4 Mill Cull Cottonwood
23,473 ft 4 4 1st & 2ds Plain Red Oak	110,000 ft 5 4 No. 1 Com. Cottonwood
14,168 ft 4 4 1st & 2ds Poplar	40,000 ft 5 4 No. 2 Com. Cottonwood

## American Lumber & Mfg. Co.

PITTSBURG, PA.

## The Nicola Brothers Company

One million feet 4-4 Bay Poplar.  
Can be shipped log run, or sold  
on grade. Bone dry; band  
sawed. Send your inquiries.

## Flint, Erving & Stoner Co.

### Wholesale Lumber

Northern and Southern Hardwoods

Beech and Maple Timbers a Specialty

## A. M. Turner Lumber Company

Everything in lumber. We buy hardwoods  
as well as sell them. If you have anything  
to offer, please submit same to us.

## Linehan Lumber Company

PERFECT

### MAPLE FLOORING

SEND US YOUR INQUIRIES

## "Michigan" Maple Flooring

Our model factory is equipped with the highest class tools and appliances made for Flooring production.

We produce our lumber from the best rock Maple area in Michigan and have 20 years' supply.

Our brand "Michigan" is a guaranty of quality. Perfect mill work and excellent grades distinguish our Flooring and our prices are reasonable.

**WARD BROS., Big Rapids, Mich.**

## Wolverine Brand Maple Flooring

== "THERE IS NONE BETTER" ==



It is the same old story, but we want you to know what WOLVERINE BRAND will do for you, and what it will cost you. We want to do this before you place your next order. If we make you quotations, we expect the quality and prices will get your order. TRY US.

**BLISS & VAN AUKEN**

900 S. Niagara St., Saginaw W. S., Mich.

## OAK FLOORING

Kiln Dried

Bored

Polished



Hollow

Backed

and

Bundled

## Timber Bonds

SECURED BY FIRST MORTGAGE ON TIMBER LANDS

**H. C. Barroll & Co.**

BANKERS, First National Bank Building, CHICAGO

H. B. LEAVITT, PREST.  
E. H. ADAMS, SECY.

B. F. RICHARDSON, VICE-PREST.  
J. G. LEAVITT, TREAS.

## THE LEAVITT LUMBER CO.

MOST COMPLETE STOCK OF HARDWOODS IN  
CHICAGO

MAKE KNOWN YOUR WANTS AND GET  
**IMMEDIATE RESULTS**

Mills:

WISCONSIN  
TENNESSEE  
ARKANSAS  
LOUISIANA  
MISSISSIPPI

General Office and Yard  
CENTER AVE. NEAR 35TH ST.  
Southern Office  
715 TENNESSEE TRUST BLDG  
MEMPHIS, TENN.

## THE "FINEST" MAPLE FLOORING

**W. D. YOUNG & CO.**

BAY CITY, MICHIGAN.

Producers from TREE to TRADE of the highest type of Michigan Forest Products. Large stock of Maple Flooring and 15,000,000 feet of Hardwoods—1 to 4 inches thick—on hand.

**Maple, Birch and Beech Lumber**

## "Ideal" Steel Burnished Rock Maple Flooring

is the flooring that is manufactured expressly to supply the demand for the best. It is made by modern machinery from carefully-selected stock and every precaution is taken throughout our entire system to make it fulfill in every particular its name—"IDEAL."

Rough or Finished Lumber—All Kinds

Send us Your Inquiries

**The I. Stephenson Company**

WELLS, MICHIGAN

## White and Red Oak

Secure our special prices on the following dry stock. We need the piling room.

30,000 feet 7-4 and 8-4 Quarter Sawn.  
150,000 feet 4-4 1st and 2nds Clear Plain Sawn.  
200,000 feet 4-4 No. 1 Common Plain Sawn.  
200,000 feet 4-4 No. 2 Common Plain Sawn.

We also manufacture chair and table stock. Let us figure with you. Address all communications to

**Dierks Lumber & Coal Company**

MILLS: DE QUEEN, ARK. KANSAS CITY, MISSOURI

# Hardwood Record

Published in the Interest of Hardwood Lumber, American Hardwood Forests, Wood Veneer Industry, Hardwood Flooring, Hardwood Interior Finish, Wood Chemicals, Saw Mill and Woodworking Machinery.

Vol. XXII.

CHICAGO, JUNE 10, 1906.

No. 4.

Published on the 10th and 25th of each month by

## THE HARDWOOD COMPANY

HENRY H. GIBSON, President

FRANK W. TUTTLE, Sec-Treas.

### OFFICES

Sixth Floor Ellsworth Bldg., 355 Dearborn St. Chicago, Ill., U.S.A.

Telephones: Harrison 4960 Automatic 5659

### TERMS OF ANNUAL SUBSCRIPTION

In the United States, Canada, Philippine Islands and Mexico . . . \$2.00  
In all other countries in Universal Postal Union . . . . . 3.00

Subscriptions are payable in advance, and in default of written orders to the contrary are continued at our option.

The entire contents of this publication are covered by the general copyright, and articles must not be reprinted without special permission.

Entered at Chicago Postoffice as Second Class Matter.

Advertising copy must be received five days in advance of publication date. Advertising rates on application.

### General Market Conditions.

While there seems to be a slight slackening in hardwood demand in some parts of the country, trade generally remains very good and prices are remarkably firm on the majority of woods. The last few weeks have witnessed very good weather conditions in the South, with the result that logs are coming out of the woods more freely and mills are generally running on full time. Thus green stock is accumulating, while dry stock, notably oak, still remains scarce, as for months past. As a consequence prices are holding firm.

The breadth of consumption and increased demand for red gum and tupelo is going forward with increasing momentum, and the gums are fast becoming a prominent feature of nearly every hardwood market. Until recently the East has not taken hold of gum to any extent, but lately is becoming interested in both varieties of the wood, with every prospect that it will cut as much figure in the East in the next few years as it does now in the middle West.

Values of poplar are ranging high and cottonwood seems to be in increased request. There is not enough of the coarse end of either of these woods to cover the demand for box-making. The general lines of minor southern hardwoods—ash, hickory, and elm, are closely picked up and comparatively light stocks of green lumber are in sight. Chestnut still has a strong call in the East, with the price approximating that of oak.

There is nothing particularly alluring about the situation in northern hardwoods, and in relative value as compared with southern output the prices are well toward twenty-five per cent below normal, and even at these values the majority of these woods are dragging. There seems to be an increased demand just now for the coarse end of basswood, which is being absorbed by the box trade. Birch, gray elm and the general run of basswood are in only moderate request. Inch maple is in excellent demand, but the price is still ranging low. The call for thick maple is extremely moderate, with no particular encouragement for an increased demand for some time to come.

Veneer and panel people are still doing a lot of business, but it is a question whether the majority of them are making any money.

Prices both on veneers and on made-up panels are much lower than the value of the products warrants.

Hardwood flooring makers, both of maple and oak, are being kept busy. Prices are fairly satisfactory, although not unreasonably high.

The foreign trade is only good in spots, as will be noted by letters from RECORD correspondents abroad.

The mahogany trade is showing some improvement, but still the wood remains the lowest priced high-class commodity on the market to-day, value considered. Unquestionably the market in mahogany is being overcrowded. This fact is manifest even with the largely increased demand that has been achieved for the wood during the last twelve months.

### Ironwood.

Northern forests generally have a considerable sprinkling of a tree growth known as ironwood. Scientifically this wood is designated *Ostrya Virginica*. Generally the tree is small, running from four to ten inches in diameter, but occasionally reaching a growth of thirteen to twenty inches. The growth was pictured and fully described in the HARDWOOD RECORD of November 25. It has never come into great commercial prominence and its utility for general use is problematic. For local and domestic use it has been known for years to the lumbermen of the North and to the farmer as the best material for making wagon or sleigh tongues, a skid or a lever, that grows in the northern woods. It is a remarkably tough wood and has a great many of the characteristics of hickory. The complete analysis of this material for wagon and carriage making is well worth the attention of the Forest Service, as well as the wagon and carriage trade. With the prevailing and growing scarcity of hickory ironwood may prove an excellent substitute to a considerable extent in this trade.

### Muck Raking.

It is distinctly an unpleasant task for a newspaper of character and reputation to be obliged to carry on a department exposing irregular practices in any line of trade. At best such criticism reflects on the character of the entire trade. Particularly unpleasant is the duty to its clients which the HARDWOOD RECORD recognizes of taking issue with concerns supposedly allied with the lumber industry, whose practices in no wise accord with what has hitherto been regarded as legitimate.

In an article by Merrill A. Teague on the subject of "Bucket Shop Sharks," contained in Everybody's Magazine for June, he says:

The proprietor, manager or operator of a horseracing pool-room is under the ban of the law in nearly every state in the Union. The professional gambler sets up his outfit for poker, faro, roulette, monte and craps behind barred doors and drawn screens. The expert manipulator of three English walnut half shells and a pea is chased from every county fair ground in the republic. Postoffice inspectors and secret service officers pursue into penitentiary cells the backers and managers of discretionary pool swindles. The promoter of fake mining, oil or "development" stock swindles sooner or later brings up in the dock of a police court. Polley has been outlawed and practically banished.



Under the title "The Price of Success" the following is a specimen of the literature with which an alleged lumber company in Philadelphia is circularizing the country, seeking to induce investments in its enterprise. This particularly alluring article is said to be a quotation from the Journal of Commerce of Philadelphia:

It is little wonder, in view of the unprecedented success which has been merited to the International Lumber & Development Company, with home offices in this city, that there should be awakened, in competitive circles, more or less adverse criticism of the corporation. At this time when lumber is higher than it has ever been it is but natural that an individual company which, through its business enterprise, can profit by marketing lumber at lower than market rates, should thereby invite the disapproval of its rivals.

It is undeniably true that the immense wealth lying undeveloped, or partially so, in the hemp and lumber districts of southern Mexico and Yucatan has brought into the field many unscrupulous development concerns. The government of Mexico, one of the most conservative in the world and the most enterprising in protecting its people against fraud of all kinds, recently inaugurated a thorough investigation into those companies (many of which were capitalized in this country) which were conducting or pretending to conduct their business within the nation below the Rio Grande. The action of the International Lumber & Development Company during this crisis in Mexican financial history at once marks it as a thoroughly trustworthy concern. Despite the fact that its holdings were in Yucatan, beyond the Mexican borders, it courted governmental investigation, and the result of the inquiry into its affairs by the Mexican experts by far exceeded the most sanguine hopes of all concerned. It was shown that the company rather than overestimating its resources had placed an undervalue upon them. It was shown that the company was operating upon a perfected system; that its 283,000 acres were divided into departments each under a competent head; that it is dealing in lumber, cattle, horses, mules and goats, rubber, coffee, cocoa, bananas and other tropical fruits and vegetables; that its charter is constructed upon the safest and broadest lines.

One of the most interesting commodities which the company raises and markets is a plant of the cactus family, known as Henequin (Mex. Jenquen) or Sisal hemp, from which rope and matting is made. This is one of the most important products of Mexico and Central America. The total export of this product from the town of Progreso between the years 1880 and 1892 amounted in money value to \$187,937,955. In Merida, the capital of Yucatan, there are forty-two millonales to a population of 85,000. Sisal hemp has produced this wealth. The International Lumber & Development Company has just planted 1,200,000 plants of this millionaire maker, and are about to plant seven million more.

The income from this source alone will be far more than is necessary to pay the guaranteed eight per cent to every stockholder of the company. Meanwhile other sources of income are being developed with careful haste.

The company is capitalized at six million dollars, which is divided into twenty thousand shares, limited and non-assessable, with par at three hundred dollars.

Mr. C. M. McMahon, upon whom much of the executive work has developed, has proved himself a man of exceptional capabilities. During his incumbency of the secretary-treasurership he has won a host of friends in this city, meriting a greater measure of their confidence with each new move he has made tending toward the advancement of the company.

Mr. John R. Markley, active manager, and Mr. I. B. Miller, his associate, have each had an extended experience in the work which they have undertaken to carry into successful issue for the International Company. They have won new laurels for themselves since this concern was incorporated. They have set about their work with a determination that would not be daunted by obstacles, and in consequence the stockholders of the company are reaping rich rewards.

The president of the company, Mr. William H. Armstrong, is known throughout the entire country as one of the most capable railroad commissioners the United States has yet produced. Vice president Col. Alexander K. McClure is so universally recognized as one of the greatest journalists of the present century as to need no further comment in these columns.

Associated with these gentlemen upon the board of directors of the company may be found the names of such well-known merchants, financiers and professional men as Mr.

H. A. Merrill, president of the City National Bank of Mason City, Iowa; Judge John B. Barnes of the supreme court of Nebraska; Mr. Victor du Pont of the du Pont Powder Works of Wilmington, Del., and Mr. McMahon, of whom reference has been made in a previous paragraph.

Under date of May 25 last the International Lumber & Development Company issued the following circular letter, addressed to its representatives:

This will notify you that on July 31, 1906, our books will be closed for receipt of money on which an extra two per cent dividend will be paid to the stockholders of this company.

This dividend is independent of the regular guarantee of eight per cent per annum, payable April 1 and October 1 of each year.

This dividend will be paid from our rapidly increasing profits realized from the sale of our mahogany, Spanish cedar lumber and veneers; profits from our four merchandising stores on our land; sale of tropical products, etc.

We are pleased to announce the rapidly increasing sale of our shares. At the close of business tonight we have 3,957 individual stockholders upon our books, who have purchased from one to 310 shares each, and the number is increasing rapidly.

We earnestly recommend that you push the sale of our stock rapidly, so that you will be able to get your share of the business before our books are closed for the sale of our capital stock. Every day is valuable to an active and successful representative of this company. Yours very truly,

INTERNATIONAL LUMBER & DEVELOPMENT COMPANY,  
Per C. M. McMahon, Treasurer.

Evidence constituting proof has been presented in recent numbers of the HARDWOOD RECORD showing that the representation made by the International Lumber & Development Company that it earned twelve per cent dividends between April 1, 1905, and Jan. 31, 1906, from the sale of mahogany lumber, was a commercial impossibility. What the company may have earned from its dealings in "cattle, horses, mules, goats . . . and other tropical fruits and vegetables" is unknown to the HARDWOOD RECORD and none of its business. It simply wishes to reiterate the statement that the publicly promulgated representations made by this company, in regard to its profits on mahogany lumber, by means of which it attempts to induce investments in its enterprise, lack not only probability but possibility.

Apropos of the foregoing, it will be pertinent to quote a paragraph from a letter printed a few days ago in the New Orleans Times-Democrat, addressed to Col. Thos. T. Wright of Nashville, and written by Col. A. K. McClure, vice president of the International Lumber & Development Company. The letter is a glittering panegyric on the south country, and is of such character as to warrant a eulogistic editorial by the New Orleans newspaper. However, the paragraph of the letter which is pertinent to this article is the following:

We are now living in a floodtide of conflicting currents reaching into all speculative channels, and the temptation is great on the one hand to be engulfed in speculative schemes and on the other hand fall into the slimy embrace of socialism, that is simply the vestibule of anarchy. You have hundreds of thousands of brave, earnest and energetic young men who are to meet these new conditions, and the natural tendency will be to make a hasty escape from the exactions of poverty to the delusive promises of speedy wealth. Let them avoid both, as they would avoid the pestilence, for only by legitimate industrial and commercial progress can substantial wealth be obtained.

Look on this picture and then on that! What can be thought of a man, or of an institution for which he acts as figure-head, that will make the representations vouchsafed by the International Lumber & Development Company, and then utter the platitude that is involved in the paragraph last quoted? It is up to the public to decide!

# Pert, Pertinent and Impertinent.

*Since She Is Mine*

I did not know how fair the days could be  
Before she came, with her sweet smile, to me;  
I did not know how sweet the wind could blow  
Before she came to me, but now I know.

Before she sweetly came to make me glad  
I could not guess why all men were not sad;  
Why ceaseless joy should be for any man  
I could not guess before, but now I can.

Her figure's fine, her features none excel,  
She's my stenographer, and she can spell!  
Her voice is sweet, her eyes are soft and deep,  
She runs the office—and I get her cheap.  
—S. E. Kiser.

## RIVAL SWIMMING POOLS.



Secretary Fish: Come on in, boys, the water's fine!  
Secretary Doster: Hurry up, boys, the swimmin's bully!

**Very Different.**  
There may be a mite of similarity but there is a world of difference between thrift and stinginess.

**Much Harder.**  
Endeavoring to dodge work tires a great many men more than hard labor.

**A Hint.**  
No man is interested in another man's troubles unless he is a lawyer.

**Without Effort.**  
Some folks act the fool intentionally; others who have no histrionic ability whatever attain the same results.

**Where She Excels.**  
Maybe a woman can't throw a ball, but she can throw a hint pretty skillfully.

**Tut, Tut!**  
If confronted by two evils pass up the first and turn the other down.

**Not Related.**  
The milk of human kindness has little in common with the cream of society.

**A Bit of Advice.**  
Wear your knowledge as your watch, in a private pocket, only bringing it out when called for.

**Changed Conditions.**  
Fifty years ago the measure of a lumberman's success laid in his ability to sell his product; today it lies in his ability to manage men.

**Of Course!**  
Almost any man is willing to patch up a quarrel—providing he is allowed to select the patch.

**Keep Your Temper.**  
When you're in the right you can afford to keep your temper, and when you're in the wrong you can't afford to lose it.

**Food for Thought.**  
There is room in this world for more respect for the old on the part of the young, and more toleration for the young on the part of the old.

**A Preachment.**  
It's unnecessary worry, unwholesome food and unceasing dissipation that send us to early graves.

**Easy.**  
Trouble is the easiest thing in the world to stir up—the careless handling of the truth will do it every time.

**Quite True.**  
The man who has frequent occasions to offer apologies will soon find that his friends have good reasons for declining to accept them.

**The Miser.**  
Time is money, and the only thing in the way of money that the miser is willing to spend.

**Much Better.**  
Most women do not expect their husbands to save money, but to earn a sufficient amount thereof.

**Good Sermon.**  
Everyone likes the sermon that goes over his head and hits the other fellow.

**Another Thing.**  
Of course you earn a princely salary—but do you get it?

**Waiting.**  
As sure as fate if you wait long enough all things will come—to the other fellow.

**The Test.**  
How often is the matchmaker's match worthless when it comes to lighting a fire on a cold morning.

**Impossible.**  
It is impossible to forget most of the things that should be forgotten.

**Foxy.**  
When the average man expresses his gratitude it is merely an off-hand way he has of asking for more.

**Do It First.**  
Do so well today that you need have no fear of being done tomorrow.

**The Trouble.**  
There would be more wisdom in many a head if it didn't leak so badly at the mouth.

# AMERICAN FOREST TREES.

THIRTY-FIFTH PAPER.

## Black or Yellow-bark Oak.

*Quercus velutina*—Lam.  
*Quercus tinctoria*—Bart.

The range of growth of this species of the oak family is from the southern coast of Maine through Vermont, southward to the northern parts of Florida, westward into Ontario and parts of Minnesota, through eastern Kansas, Indian Territory and eastern Texas.

It is known as black oak in Vermont, Massachusetts, Rhode Island, New York, New Jersey, Pennsylvania, Delaware, Virginia, West Virginia, North Carolina, South Carolina, Georgia, Alabama, Florida, Mississippi, Louisiana, Texas, Ohio, Illinois, Iowa, Kansas, Nebraska, Michigan, Wisconsin, Minnesota and Ontario; quercitron oak in Delaware, South Carolina, Louisiana, Kansas and Minnesota; yellow oak in Rhode Island, New York, Illinois, Texas, Kansas and Minnesota; tanbark oak in Illinois; yellow-bark oak in Minnesota and Rhode Island; spotted oak in Missouri; dyer's oak in Texas; and yellow butt oak in Mississippi.

The variety of oak of which this article treats is the most common species of the red or black oak group which is found along the south Atlantic and Gulf coasts. It is often found scattered along dry ridges, among maritime pine growth, but also grows luxuriantly on the bottom lands and swamp country of the entire lower Mississippi valley. Again, it is found in the foothills of the southern Appalachian range in considerable profusion. It reaches its maximum development throughout the lower Ohio valley and Mississippi basin.

Black oak grows to a height varying from seventy to one hundred and fifty feet, with a trunk 3 to 4 feet in diameter; having a narrow, open head, the slender branches spreading out gradually. The leaf is somewhat thin, and is very dark green when mature, with a yellowish tinge on the lower surface, and becoming a dull, rich red in autumn; it drops from the tree during the winter. The leaf is usually seven-lobed, and the lobes serrate, armed with bristles.

The staminate flowers grow on pubescent stems four to six inches long; the calyx is coated with light hairs; the pistillate ones grow on short peduncles; the stigmas are bright red. The fruit of black oak is an acorn, contained in a deep cup, very rough

and having a jagged rim. The kernel is bright yellow and bitter. The acorns grow in pairs or clusters of three, on short stems.

The inner bark of this tree is bright yellow and is saturated with tannin, from which is produced a well-known dye called quercitron. A valuable medicinal agent is also made from the bark. The outer cover-

better qualities growing on ridges often approximate in quality the red oak (*Quercus rubra*), of the North. On the other hand, in sections where it abounds in low, rich, swamp country, it is not of nearly so high a type. Instead of being soft and easily worked, it shows but a small percentage of clear lumber, sometimes dries out hard and flinty, checks badly in seasoning, and often dries out thinner in some places than in others.

Generally speaking, the wood of black oak is heavy, hard and strong. The medullary rays are thin and the annual layers of growth strongly marked. The heart-wood is a light, reddish brown; the sapwood much lighter. The grain is usually coarse. A cubic foot of the seasoned wood weighs approximately forty-five pounds.

Black oak is used extensively in both cooperage and construction work and affords a substitute for the red oak of the North in a large number of furniture manufacturing institutions, but often its physical characteristics are such that it is not nearly so valuable.

The photograph from which the illustration of black oak accompanying this article was made, is of a typical specimen in the Yazoo delta country of Mississippi. It will be noted that the general appearance of the tree is very fine, but on its being felled, it was found that owing to the richness and wetness of the soil, the tree had grown very fast and that heart seams prevailed to an extent that precluded its showing more than fifteen per cent of firsts and seconds when sawed into lumber. Generally speaking, low, wet, rich, heavy soil is not the natural habitat of the oak. Oak of the finest type grows on high ground of not unusual richness, and its quality is due to the very fact of its necessarily slow growth.

Apropos of the great variation in the quality of timber of the same botany growing under different conditions of soil, rainfall, latitude or compensating altitude, there is

perhaps no genus that exhibits the marked differences in this particular as does the oak. Ohio is a state which for a century has been noted for its high class oak growth, yet in some sections of that state an apparently slight variation in soil produces a character of oak growth that does not equal in value the oak in other sections by from \$10 to \$15 a thousand.



TYPICAL FOREST GROWTH BLACK OR YELLOW-BARK OAK, YAZOO DELTA, MISSISSIPPI.

ing is dark brown or nearly black, broken up into close scales.

This type of oak, which in general commercial classification is a variety of red oak, constitutes the larger portion of red oak growth of the Mississippi valley. However, in its different environments and varying soil conditions it shows a wonderful diversity of physical characteristics. The





JAMES D. LACEY  
CHICAGO

# Builders of Lumber History.

NUMBER XXVII.

James D. Lacey.

(See Portrait Supplement.)

What is the secret of commercial success?

This question is perhaps the most important asked by the young man just starting out in life with hopes of wealth and honor to lure, and the examples of "captains of industry" to simulate.

The analytical biographer and writer of business history often thinks he has solved the problem when he comes upon certain facts and formulae in the life of a successful business man, but his theories are often overturned by the discovery that some other man has reached the goal by an entirely different route. There are, of course, certain attributes which must always be emphasized. It goes without saying that honesty, energy and good judgment must be present in the make-up of the commercially successful.

One will be said to succeed because his exquisite tact has enabled him to bring the best of talent to his aid; another will, in the language of the street, "get there" because he smashes through all diplomatic hypocrisy with sledge hammer blows. Each man does his work in his own way, but there must be brains to direct not only his own individual effort but that of others, if he would succeed in the great affairs of business.

The man who can run the machine, whether it is of men or metal, is the man whose day's work counts most in the long run. Such a man is James D. Lacey, of Chicago, the foremost timberman of this country.

Born on a northern Pennsylvania farm some fifty odd years ago, Mr. Lacey received some ideas of lumber and timber business when, as a growing lad, he worked about the old-fashioned sash sawmill and handle factory which his father ran as a side issue to farming. His independence and self-confidence were clearly shown when at twelve years of age he secured employment in a drug store in a nearby town and learned the profession of pharmacy. Mr. Lacey was only seventeen when he went to Grand Rapids, Mich., where for three years he worked in a drug store. In 1871 he went into business for himself, and in 1879 went south to introduce some chemical preparations manufactured by his firm of Mills & Lacey. Almost immediately the vast regions covered with virgin yellow pine forests attracted his attention. At that time southern timber lands had been practically untouched by the woodsman. Mr. Lacey's mind quickly compassed their possibilities, and he determined to put his judgment to the test and immediately commenced their acquisition and handling. At first he was associated with William M. Rob-

inson; later he carried on the business alone for a time; but in 1898 he organized the firm of James D. Lacey & Co., with Wood Beal, who had been for years in his employ, and Victor Thrane, his son-in-law, as partners. These young men have aided Mr. Lacey materially. Both are energetic and perspicacious business men of clean methods and up-to-date ideas. Mr. Lacey first confined his operations to southern Missouri, but later he branched out to all parts of the South. Since his entrance into the timber business he has cruised, grouped, and resold in blocks to investors and operators approximately 6,000,000 acres, and has estimated fully double that amount of timber lands in the various southern states alone, besides vast areas in other parts of the



PRINT OF LEAF OF BLACK OR YELLOW-BARK OAK, ONE-FOURTH SIZE.

country. The history of his enterprise is phenomenal from the fact that with such diligent care and integrity has his business been handled that not a single transaction can be cited in which the purchaser has not had handsome returns from his investment, sometimes reaching into millions of dollars. While Mr. Lacey has made a large fortune for himself, he has made many more for his clients.

Certain it is that the reputation achieved by this firm as purveyors of timber properties is such that its estimates go on record before the large financial institutions of the country as prima facie evidence of the quantity and quality of the timber in question, and as such become negotiable securities almost to the full value placed upon them.

Such is the worthy record of a man who has always played fair and intelligently. During the last year James D. Lacey & Co. have extended their operations beyond yellow pine and cypress properties, to the Pacific coast on the one hand, and to the rich hardwood area of eastern Tennessee and western North Carolina on the other, with every prospect of duplicating in these far-separated sections the history the house has made in yellow pine and cypress.

The personal interests of J. D. Lacey, outside of land and timber properties, have become too well known and numerous to require specific recounting in this brief article; suffice it to say that he is largely interested in lumber operations in yellow pine, cypress and hardwoods; is an important factor in iron and coal production in the South; and has various other interests in manufacturing enterprises.

In epitome, Mr. Lacey's life work may be characterized as the consistent, indefatigable, honest evolution of an idea. He was one of the very first to recognize the immense forthcoming values of yellow pine and cypress timber growth. He practically mapped every section of the United States in which these woods grew in commercial quantities and, by dint of his careful and painstaking effort, through his hands have passed from the original holders to the greatest operators in the country the largest portion of these great properties.

In the south country, they write the name James D. Lacey first among builders of lumber history.

## Atkins Employees' Banquet.

Three months ago the men who have been employed at the great Indianapolis saw manufacturing plant of E. C. Atkins & Co., Inc., for twenty or more years, perfected an organization called the "Atkins Pioneers." On the evening of May 26 the new fraternity was given a banquet by the company, at which John H. Wilde, president of the pioneers, was toastmaster. Many anecdotes and reminiscences of lives spent in the service of the concern were exchanged, and tributes paid to the founder of the great saw works, E. C. Atkins, deceased.

Not the least interesting among the faithful is William Miller, who, though seventy years old, still has muscles as strong as many a man half his age. Mr. Miller is proud of the fact that he has served the Atkins interests for forty-one years, and that it was he who originated the polishing system used by the company today.

H. C. Atkins, son of the founder and now president of the company, made the interesting statement that twenty years ago the payroll showed seventy-five men, and that present at the banquet were sixty-two of them. He said that in addition to this large percentage of twenty-year men, the books contain the names of many in active service, who have been employed by the concern for seventeen, eighteen and nineteen years. Mr. Atkins gives it as his opinion that this record is an evidence of the fair, square manner in which employees of the institution have always been treated, as well as one of the reasons for the unusual success attained by his house. The spirit of good will which prevails cannot but produce unity of action on the part of workers, which assists greatly in the production of a line of goods of uniformly high standard.



## The Mahogany and Cedar Trade.

The mahogany, cedar and foreign hardwood trade, that is, the importation of woods not native to the United States, although directly associated with and really a part of the lumber industry, is nevertheless a business by itself, and it is one that is fraught with many difficulties not met with in the conduct of lumber operations in general. It requires a knowledge of the state of the markets of destination in order that the producer in the foreign fields may be guided in production and shipment by the actual conditions which will confront his shipment on arrival at consuming points. It has been the lack of such information, as well as the crude methods of handling and shipping, which has perhaps done more than anything else to retard the development of this industry along lines commensurate with the growing demand for mahogany and

cedar. As an evidence of the foregoing, the New York market has for a considerable period been short of Cuban cedar, with a brisk demand current, due in the main to the enormous overproduction during the period immediately following the Spanish-American war, when, because of the glittering possibilities told of, there was so great an influx of new and inexperienced interests in the Cuban timber fields that the United States and foreign markets were glutted with receipts, the business was demoralized, and any possible profits eaten by heavy storage charges. On the other hand, with an understanding of the situation, production would have been curtailed and shipments withheld, awaiting revival of demand, thereby effecting a considerable saving, as the expense of storing at supply sources is practically nil compared with that at des-

tinuation. As in all such cases, the reaction which followed was felt to the utter extreme in both Cuban and Mexican cedar, and from the high-water mark of receipts in 1903 the arrivals of 1904 and 1905 were successively less, notwithstanding a steadily increasing demand in the United States and foreign markets during those two years. Thus it will be seen that, had the activity succeeding the late war been governed by a proper knowledge of actual consuming conditions, the New York market on January 1, 1906, would not have been absolutely bare of Cuban cedar in first hands, (meaning receipts unsold) as was the case, and in fact is still the case. The following statistics for Cuba and nearly competitors are given in this connection, the figures readily supporting contentions noted above:

### Summary of Arrivals for Past Fourteen Years at New York.

(Given in number of logs—not feet.)													
MEXICAN MAHOGANY.													
1892. 15,742	1893. 21,882	1894. 7,818	1895. 11,635	1896. 13,587	1897. 12,404	1898. 18,792	1899. 22,953	1900. 19,113	1901. 15,754	1902. 13,880	1903. 18,290	1904. 14,986	1905. 6,389
MEXICAN CEDAR.													
1892. 5,460	1893. 4,921	1894. 4,099	1895. 4,644	1896. 14,717	1897. 28,039	1898. 20,690	1899. 16,183	1900. 16,708	1901. 10,195	1902. 8,098	1903. 8,759	1904. 6,563	1905. 1,623
CUBAN MAHOGANY.													
1892. 31,075	1893. 47,681	1894. 12,051	1895. 20,388	1896. 3,607	1897. 757	1898. 738	1899. 5,510	1900. 28,918	1901. 30,574	1902. 48,347	1903. 37,935	1904. 12,509	1905. 14,629
CUBAN CEDAR.													
1892. 76,828	1893. 80,078	1894. 106,545	1895. 61,888	1896. 28,130	1897. 4,055	1898. 2,040	1899. 8,817	1900. 45,652	1901. 81,468	1902. 75,837	1903. 116,450	1904. 95,768	1905. 88,350

Happily, however, this overproduction and the consequent low ebb of trade has been of value in that it awakened the substantial interests engaged in the business to the necessity of a more careful observation of market conditions which, coupled with closer communication between seller and buyer, has tended to thwart any recurrence of such a state of affairs, and with a proper arrangement for intelligent market advices from the various consuming centers the producing end of this business can be carried on today with fewer difficulties and far more opportunities of profit than ever before.

Now, as to the general needs of the American and foreign markets, present and prospective, as regards an increased supply of mahogany, cedar, etc., it need only be cited that there is a constantly expanding market for these woods as native hardwoods, through enormous consumption, are so steadily advancing in price that mahogany and cedar are available at no great increase in cost, and are therefore entering rapidly into lines of manufacture where a few years ago the wide difference in price in comparison with other woods made their use prohibitive. And not only this, but indications point to advancing values as the demand increases. Hence, the time seems propitious for increased production conducted in the right way, and as Cuban products in mahogany

and cedar are in favor both here and abroad, the close relations and rapidly improving methods of transportation from the island make the future possibilities of profit in Cuban timber development seem bright.

It may be said, by way of comparison with the Mexican product, that Cuban mahogany runs somewhat smaller than Mexican but is much harder, and while the latter is adaptable for such use as furniture, etc., the Cuban wood is in demand for car finish and similar lines where strength and beauty combined are essential. The Cuban production of both woods is much greater than that of Mexico or any other field, but in consuming markets competition of other species has but little effect upon its sale.

Another important feature of the general mahogany traffic is the fact that the New York market is the best in the world for fancy, or more correctly, figured wood, and yet, under the present methods of conducting the business, practically all the finest figured wood reaches New York via Liverpool and the English markets, being sent there in the log and resold for New York. Recently a fancy log sold as high as \$3.50 per foot in Liverpool for shipment to New York. Certainly such roundabout methods seem to call for new blood in the producing trade, which will encourage the shipment of figured wood direct to our home markets.

It is true that finely figured logs are rather scarce, but the fact just mentioned is but one of many which might be cited as explaining the future possibilities of the Cuban field if intelligently handled. The African product is all handled through the English markets as a natural sequence of their geographical location, but the direct shipment to this country of the most desirable logs should receive more attention, and, in fact, has of late, there being at present two cargoes of African wood now unloading at New York which came direct.

Reverting again to cedar, the foregoing table of figures shows a steady falling off in the receipt of Mexican cedar, which is but another argument in favor of the possibility of profit in the further development of Cuba's resources. Then again, the figures given below show that the total receipts of Cuban mahogany for the past year exceeded 1904 by 2,000 logs, and yet on January 1, 1906, the stock in first hands was the smallest for some time.

Viewed from the standpoint of consumption the products of Cuba, while greatly exceeding all others in volume, are active sellers and seldom a drug on the market.

The following is a comparative table of total receipts from all sources for the past five years, to May 1, 1906:

Comparative Table of Mahogany and Cedar Log Receipts at New York.

	Total Arrivals 1901.	Total Arrivals 1902.	Total Arrivals 1903.	Total Arrivals 1904.	Total Arrivals 1905.	Arrivals to May 1, 1906.	Arrivals 1906.
Cuban mahogany logs.....	30,574	48,347	37,935	12,509	14,629	9,272	3,897
Cuban cedar logs.....	81,468	75,837	116,450	95,768	88,350	29,054	8,599
Mexican mahogany logs.....	15,754	13,880	18,290	14,086	6,389	3,160	683
Mexican cedar logs.....	19,195	8,098	8,759	6,563	1,623	1,284	.....
Central and South American mahogany.....	6,603	6,814	7,159	5,683	5,229	722	.....
Central and South American cedar.....	437	33	2,151	101	1,362	60	.....
African mahogany logs.....	4,523	6,321	6,302	4,680	4,294	3,423	1,365
	1901.	1902.	1903.	1904.	1905.	To May 1, 1906.	To April, 1906.
Total number of mahogany and cedar logs received.....	149,576	159,330	197,046	139,393	121,786	46,948	14,454

Much could be said here on the purely technical side of the comparative qualities of the various species of mahogany, but which, after all, would have but little bearing on its future sale. It is all marketable and valuable. The most important point to those who are interested in the possibilities of the foreign hardwood trade is the opportunity for production at the different sources of supply, and in that direction Cuba, under present conditions, seems the most promising.

An outline of existing conditions in the mahogany and cedar market are of interest in this connection. The local market in mahogany and cedar at this time is brisk, the salient features being the lack of sufficient receipts in cedar, particularly, and in some grades of mahogany. In mahogany there was a larger number of logs received in April than in March, but all the receipts have been sold and the market is entirely bare of this wood, while the inquiry is very active. There was only one lot of Mexican mahogany received, part of which has been sold, and the larger portion of the small stock previously on hand has also passed out

of the market. The demand is good and with the small supply in hand dealers should take advantage of the situation and make early shipments. There were no arrivals of Panama or Honduras mahogany in April, with a very fair demand prevalent, and shipments of good logs should meet with ready sale. The situation in the mahogany market is in favor of the shipper, as the natural volume of trade is greatly handicapped, owing to the small receipts of good wood.

In cedar, there were no receipts of Mexican stock during March and April, and there has been no stock on hand for many months. This is significant when it is considered that the present demand for cedar is almost unprecedented and all arrivals are quickly absorbed at the highest range of prices that has yet obtained.

In Cuban cedar, arrivals are being consumed as fast as received and the market is practically bare at present. Shipments are not only urged, but will meet with prompt sale and be received under very satisfactory conditions.

frame of the main building. This gives better support than to hang it to the joist, and is generally easier and less expensive to put up. For the small mill the shafting and equipment throughout should be made as light as consistent with the work to be done so as to save power in running and expense in moving from place to place. If, for example, the equipment is to consist of only a self-feed rip saw and a swing cross cut, the line shaft may be made as light as 1 11/16, and if necessary still be able to carry another light machine; for driving a heavy bolting saw the line shaft should be 1 15/16 to start on. As a rule it will be found best in getting the shaft to have it smooth turned, entirely without key sets, and use wood split pulleys. This gives free range in placing the journals, and it is also a much easier task in the average sawmill to put on, take off or reset a wood split pulley than an iron pulley with keys, because the only tool required is a wrench. A wood split pulley is better than the iron pulley with set screws in this instance, because when it is to be moved it will not be necessary to take down the shaft to get it by the journal—simply take off the pulley and put it wherever desired. As a matter of fact, the average iron pulley with a set screw is an abomination from a mechanical standpoint. It has poor holding power in the first place, and when it is screwed down on the shaft it mars the face of the shaft and causes considerable trouble when taking off the pulley and putting on a new one.

In the selection of machines to equip a department of this kind, after making a study of catalogues and prices and finding out how many different machines there are and the promises the manufacturers hold out for returns on their products, the disposition to buy too many machines at the outset must be guarded against. There are special machines for every conceivable purpose of great capacity and also of good earning power where they are required, but these special machines are not often needed in small sawmills where there is variety of work to do and the speed with which stock can be put through a machine is not so much an item as the matter of power and getting stock to and from the work. This does not mean that it is not important to study the different machines; in fact, the sawmill man should familiarize himself with every kind of machine for doing the work in view, and then select machines to suit his particular needs. For dimension stock work, such as making wagon implement material of oak and hickory, ordinarily the best equipment to start with is a self-feed rip saw and a swing cross cut. Even this outlay may be reduced by making the rip saw a plain table or hand feed saw, but if there is any great quantity of work to do it would be money saved in the end to have a power feed rip saw. Even the cross cut can, where the work is light, be changed to a cord wood

## Suggestions to Small Sawmill Men.

### EIGHTH PAPER

With the increased demand for stock cut to exact dimensions, it may be of interest to the small sawmill man cutting hardwood to discuss the question of where and how to add to his sawmill equipment the machinery necessary for economically manufacturing this stock. If he has a two-story mill the problem is comparatively simple, as it involves merely the matter of what machines to add, the place for location being already provided—the basement at the tail end of the mill. With a little groundhog mill, however, that is moved from place to place, the volume of work at any one point hardly justifying framing up off the ground, to say nothing of the trouble and expense of getting in logs, it is different, for, as a rule, there is no space left in such a mill for the addition of machinery of any kind. The mill shed is built just long enough for the carriage track and just wide enough to take in the carriage and set works on one side of the saw and the saw cab and main belt on the other. The space in front of the saw cab is given over to the log deck, and back

of it the off-bearer needs all the room available outside the rolls, and sometimes more. In other words, there is no room in the main building for such equipment, and the question is where should the addition be made to accommodate it?

The logical place, if the location will permit, is back of the boiler and engine. There are some instances where the boiler is set on the bank of a stream so that there is not much room and no way to get in with teams to load out stock and things of that kind that may make it advisable to cross the main shed and put it on the other side in the back. Where it can be done, however, this addition should be put on the boiler and engine side, because it saves power and line shafting. Being directly back of the engine with the machinery equipment, getting to the line shaft from the engine and from the line shaft to the machines is a very simple problem. The line shaft as a rule, will have to go overhead; a good plan is to mount it on a row of posts passing through the center at right angles to the

or bench type of saw, but for heavy service the swing saw is better. All this must be decided by each mill man for himself, being guided by the amount and kind of work to be handled more than the amount of money the equipment will cost him. Struggling along with a patched-up homemade outfit is not economy and will cost enough extra in operation by reducing capacity, etc., during the year to more than pay for new equipment. There are some instances, however, where an old side edger rig can be overhauled, the table shortened, for practically all the wagon stock work will run 7 feet and less in length, and give excellent results in working up flitches into axles, bolsters, slide bars, bottom cleats, etc. It will relieve the mill of a great deal of detail, and a man at a saw of this kind can be more deliberate about the work than a sawyer with the mill and several men who are temporarily idle every time he pauses to consider how and what is best to be done.

But, to return to the manner of planning the plant, the first thing to settle is where to put the cross cut. The simplest, easiest and cheapest place is to swing it right under the line shaft, which would put the cross cut bench right in the center of the dimension stock department. This is a case where cheapness is not best, however, and there are two other places where the cross cut can be located and give better service. One is along the wall

of the addition, and the other across the line of rolls that pass through the main mill. The latter place, across the rolls of the main mill, is probably the best, for the bulk of the trimming, or at least the heavy trimming, can be done while the stock from the mill is still on the rolls, thus saving one handling. The only objectionable feature about swinging the cross cut over the rolls in the main mill is the fact that it will necessitate the use of either a pair of gear wheels to give a right angle turn to the shafting or a mule stand and a corner turn with a belt. Eventually it may be found that in addition to the swing cross cut over the main rolls for cutting flitches and the general run of stock from the mill it will also be advisable to add some kind of a light cross cutting rig for retrimming small stock from the rip saw. This can be driven from the same line shaft as the rip saw, and may be a light, inexpensive machine of the cord wood kind, or of the regular equalizer type.

For the majority of wagon and agricultural implement stock a single rip saw is all right, but should it be desired to take up the manufacture of chair rungs and other light dimension stock of this class a gang rip saw becomes a necessity. This may also be used to make lath, and it is a good thing to have provided timber and work justifies its use. However, the best advice is to start in modestly, with two machines, and then enlarge as time and experience assure of just what additional machines are needed.

will not handle mahogany lumber or engage in the manufacture of boxes, expecting to devote its main attention at first to the handling of cottonwood lumber and a little later to other domestic lumber. The Otis-Alcus Lumber Company, Ltd., has only a small amount of invested capital, and the combined assets of the Otis Manufacturing Company and S. T. Alcus & Co., Ltd., are at least twenty times the amount so far invested in the Otis-Alcus Lumber Company, Ltd.—OTIS MANUFACTURING COMPANY.

The HARDWOOD RECORD regrets exceedingly this error in regard to two such well and favorably known concerns as the Otis Manufacturing Company and S. T. Alcus & Co., Ltd., and is glad of this opportunity to set its readers right.—EDITOR.

## A LUMBERMAN'S LETTER TO HIS SON

Chicago, June 6, 1906.

My Dear Son: I am surprised that you find it necessary every time you want a fourteen-foot length of four-inch pipe to make a trip to Memphis in order to make the purchase. Buying a chunk of two and thirteen-sixteenths shafting, an iron pulley or a few set-screws really does not necessitate a personal visit to that wicked city on the banks of the Mississippi. There are several good machinery supply houses in that town which will execute your order on a mail requisition without taking up your time or involving so much expense. In doing as you did, you probably had in mind the advice I have given you concerning buying hardwoods in cross-pile. This is another proposition, and it does not require the care which apparently you have been exercising.

I note by your last month's expense account that your trips to Memphis have cost considerable more money than the sum total of the sawmill supply purchases you made. Of course I know it's a little dull for you down in the swamp, and that there is a good deal of the real works around Memphis, but I think the boys will be just as glad to see you up there if you don't go quite so often. I know your bunch of friends at Memphis. They are hot off the griddle all right, and most of them look like certified checks. At the same time I think you will earn more money for the Rattlesnake Lumber Company by sending orders for minor mill supplies by mail and staying around the job. You must get to making lumber pretty soon if we are going to have any dry stock for the fall trade.

Affairs here are not very lively, and a good many buyers are really serious about National inspection. They seem to want National grades when they buy under that agreement. We jobbers in this town are getting wedged in between the devil and the deep sea; manufacturers are soaking us on one side and our customers on the other, with the result that our margins are getting altogether too thin for comfort.

Keep busy and get the mill to going just as soon as possible. Your affectionate  
Father.

P. S.—Your mother wants to go down with me to see you soon. Eighteen and car fare for you if things are not right in the boarding house when she gets there.

## Hardwood Record Mail Bag.

[In this department it is proposed to reply to such inquiries as reach this office from the HARDWOOD RECORD clientele as will be of enough general interest to warrant publication. Every patron of the paper is invited to use this department to the fullest extent, and an attempt will be made to answer queries pertaining to all matters of interest to the hardwood trade, in a succinct and intelligent manner.]

### Wants Table-Tops.

NEW YORK, May 25.—Editor HARDWOOD RECORD: Can you give us the names and addresses of any firms engaged in the manufacture of dimension, kiln-dried, glued-up table tops? We would appreciate any information you can give us.—..... & Co.

This concern has already been furnished with a list of manufacturers known to furnish this stock, but if there are others interested in communicating with the writer of the above letter, the HARDWOOD RECORD will be glad to supplement the list with their names.—EDITOR.

### Slaughter of Hickory in Indiana.

CONNERSVILLE, IND., June 5.—Editor HARDWOOD RECORD: I visited Clark county, Indiana, recently and saw great cords of hickory poles piled up at the railway station for shipment. Upon investigation it was found that 500,000 hickory trees are annually destroyed by the farmers of that one county for hoop poles. These poles bring the land owners but 50 to 60 cents per thousand, out of which must be paid the cost of cutting and hauling to station. The receipts are barely enough to pay common labor prices for the work, the landowners realizing scarcely anything for the trees.

This is a terrible waste. In a few years our

vehicle timber will be gone. These half a million trees destroyed each year in one county alone would bring a handsome revenue for far more important uses. Only one or two men now receive any benefit from this trade as dealers.

Carriage makers should show some interest in the perpetuation of the woods of which they are such heavy consumers. The carriage trade journals are requested to copy this item.—JOHN P. BROWN.

The foregoing letter from John P. Brown, editor of *Arboriculture*, is a very timely communication on the subject of the way in which the small remaining growth of hickory in this country is being destroyed. If the timber were felled and put to uses that would show its owners a reasonable profit there could be but little fault found, but when farmers slaughter hickory for the making of hoop poles, the practice is little short of criminal. The writer of this letter is very much interested in forestry matters, and is doing good work from a practical viewpoint along this line.—EDITOR.

### Otis-Alcus Lumber Company Not a Merger.

NEW ORLEANS, LA., May 29.—Editor HARDWOOD RECORD: Referring to the notice on page 24 of your issue of May 25, this notice is not correct. The Otis-Alcus Lumber Company, Ltd., will not take over the business either of the Otis Manufacturing Company or of S. T. Alcus & Co., Ltd. Both of these firms will remain entirely distinct, the Otis Manufacturing Company making a specialty of mahogany lumber, and S. T. Alcus & Co., Ltd., being engaged in the manufacture of boxes and box shooks. While the Otis-Alcus Lumber Company, Ltd., is owned by some of the stockholders who have an interest in the Otis Manufacturing Company and in S. T. Alcus & Co., Ltd., and expects to have business relations with both of these firms, it

## News Miscellany.

### The Proper Drying of Lumber.

The proper method of drying lumber by artificial means is a question that has been under discussion and experimentation in recent years by some of the most prominent users and manufacturers of lumber in the country. Many expensive experiments have been carried on by lumber manufacturers, the railroads and others, and the problem has even been taken up by the government. When it is taken into consideration that the moisture in green lumber amounts to from one-third to one-half of its total weight and that all this moisture must be expelled before the lumber is in condition for commercial use, the task of accomplishing in a few days by the use of a dry kiln the same results which nature takes as many months to perform, will be seen to be of vast importance. It has taken much time, thought and money to analyze this question and devise a system to meet all the varying conditions of nature.

A few years ago, when hardwood was plentiful, and all the yard stock was air dried, the question of removing the moisture left in the lumber was a different proposition from that to be contended with today. Oak and other

adopted the Morton kiln in preference to all others.

The Pullman Car Company, Pullman, Ill., about three years ago, tore out the various dry kiln systems it was using, almost every conceivable style, and put in a battery of 20 Morton kilns, ranging from 18 to 26 feet in width and 72 feet in length. The kilns are fire-proof, and constitute one of the finest and largest batteries of hardwood kilns in existence, having a capacity of nearly 1,000,000 feet of lumber. This is a good illustration of the range of the Morton kiln, as the Pullman company uses everything, from heavy yellow pine car beam timbers to the finest cabinet woods, and the larger portion of the material passes through the kilns before being used in the manufactured product.

Other users of the Morton dry kiln are: Allis-Chalmers Company, Milwaukee, Wis.; the Western Electric Company, Chicago; the Pennsylvania Railroad Company, Altoona, Pa.; the Lake Shore & Michigan Southern Railroad, Cleveland, Ohio; the C., B. & Q. R. R., Aurora, Ill., and Hannibal, Mo.; and the Canadian Pacific Railroad Company, Montreal and Winnipeg, Canada. The Mitchell Bros. Company, Cadillac, Mich., and the Arthur Hard-

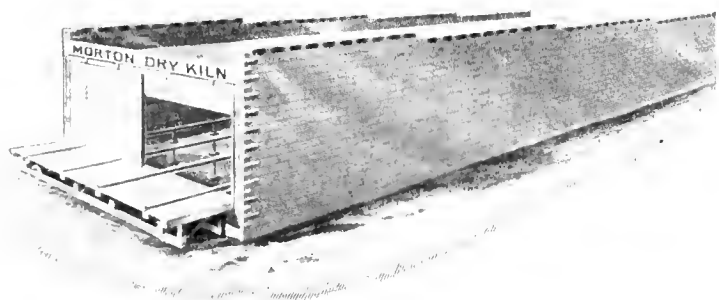

TYPE OF MORTON KILN OF FIREPROOF CONSTRUCTION.

hardwoods have been consumed at an enormous rate, and a manufacturer at the present time is considered very lucky if he obtains from the mill lumber that has been piled on the yard more than three or four months. The progressive and up-to-date manufacturer of dry kilns has endeavored to meet these changes, and has been continually improving his product so as to offer to lumber manufacturers a dry kiln as nearly perfect in its results as money and ingenuity can produce. Without doubt no other concern has been more aggressive or invested more in experiments to reach the highest point of success in drying lumber than the manufacturers of the well-known Morton moist air down draft dry kiln—the Morton Dry Kiln Company. Thirty years' experience has given this concern knowledge that could have been obtained in no other way.

The Morton kiln is based on the moist air method, which has long been conceded the only means of successfully and quickly drying all kinds of lumber. H. J. Morton was the first to exploit this system of drying. When this method was first suggested as the proper means for seasoning lumber, it was declared to be an impossibility to dry anything in moist air. However, Mr. Morton's faith in this new departure was only made stronger by the skepticism with which it was received. Since the Morton moist air dry kiln was placed on the market, the idea has grown until at the present time nearly all the dry kilns manufactured are based on the moist air system.

Perhaps the most convincing argument that can be offered in favor of the Morton kiln is a reference to some of the large woodworking concerns in the United States that have

wood Flooring Company, Memphis, Tenn., may be mentioned as among the users of Morton kilns for seasoning hardwood flooring. There are 35 Morton kilns in operation in furniture factories at Rockford, Ill., 15 at Grand Rapids, Mich., and numerous others throughout the United States and Canada.

Prior to the first of the year the Morton dry kiln was manufactured and sold by another Chicago house, but early in 1906 the Morton Dry Kiln Company was incorporated to take over the entire business and it now has complete control of the patents. H. J. Morton is president of the company, and B. D. Curtis, for many years connected with the manufacture of Morton kilns, is secretary. The company solicits correspondence from all interested in dry kilns, and will take pleasure in giving further information and mailing its catalog D, upon request to the office, 912, 218 La Salle street, Chicago, Ill.

### A Letter from "Mizzouri."

There are lots of lumbermen who are wits, and many others, alas, who are satirists, but it is rare indeed that you find a genuine humorist engaged in this great commercial pursuit. The wit laughs at you, while the humorist laughs with you. You may admire the wit; you love the humorist.

Apropos of the foregoing and incident to the following is quoted a recent letter from C. D. Boynton, the well known head of the Boynton Lumber Company at Cape Girardeau, Mo., addressed to Lyon & Healy, music dealers of Chicago. For pure, unadulterated humor it is one of the cleverest bits of literature that has fallen into the hands of the HARDWOOD RECORD for

many and many a day, and it is with unqualified satisfaction that it is herewith reproduced—  
CAPE GIRARDEAU, MO.

Lyon & Healy, Chicago, Ill.

Gentlemen: Enclosed herewith find check in payment of your invoice of talking machine and phonograph records. I found this canned music perfectly fresh and sweet in every way with one exception, which I will briefly note.

I ordered, among others, a vaudeville record called "Fishing," said to be a faithful reproduction of the dulcet tones and synchronous beel-clicks of that popular favorite, Miss Ada Jones, and her sparring partner, Mr. Len Spencer. Judge of my surprise to find that you had substituted a dirgelike gospel hymn entitled, "Pass Me Not, O Do Not Pass Me By," the copyright of which expired 217 years ago.

Possibly the erudite young person who boxes up things for you in your shipping department figured it out from the address that I belonged to that species of vertebrates called "Mizzourians,"—described in your local papers as consisting principally of a broad-brimmed felt hat and a stogie.

This creature—the creation of your diseased intellects—is represented as passing his entire existence upon the banks of the Chicago Drainage Canal (formerly known as the Mississippi River). And thus the logical conclusion was that, being a democrat, it was more essential for my welfare to send me something calculated to draw me nearer to the throne than to the footlights.

It is true that formerly the literati of Cape Girardeau and the budding young intellects of its State Normal School sought the banks of the Father of Waters for inspiration and soft drinks. This was before we were brought into such close touch with Chicago through the completion of your drainage canal. Now the entire population throngs the levee daily to view the mighty flood bearing upon its bosom tomato cans, Milwaukee pop bottles, and, ever and anon, a defunct pussy cat.

A scientific cuss from your town with a long aquiline nose having a large intake said that we did not seem to be more than a few minutes removed from dear old Chicago.

Alas! The city of Chicago may pollute the water supply of Cape Girardeau with impunity, but when you attempt to interfere with our amusements we must draw the line.

Then again, it might have been a mistake on your part. Mistakes are always liable to happen, as a Chicago young man found out while on a shooting trip down at Seldom Seen, Mo., this winter. He came to the eating tent late one morning and upon the wife of the guide asking him what he would have for breakfast, said he would take some pate-de-fois-gras. She called for help and it took the united efforts of his companions and the neighboring inhabitants to keep the guide from killing him for using such language to a lady.

Another thing, the people of Missouri are suffering from too much substitution at the present time. We have alum in baking powder, preachers in politics and a four-flush reformer as governor. The whole state is run for the benefit of the writers of fire-alarm articles in the 10c monthlies published in New York.

I can see how a druggist could give out morphine for quinine, or how a cross-eyed man could vote the populist ticket by using the Australian ballot system, but for the life of me I cannot see how you could mistake the lugubriousness of "Pass Me Not, O Do Not Pass Me By" for the capers of Miss Ada Jones and the Hon. Len Spencer.

I invited a friend to hear my new records. He had been a river steamboat captain, that is to say, he was opposed to complicated rhetorical flourishes, Dutch Trilogies and Pago operatic music of all kinds. He yearned for the merry quip of the blythesome vaudeville sketch. I said: "We will now have a laughable skit called

'Fishing.' He closed his eyes to recall the rising curtain, the blare of the band and the burst of applause as the head-liner soubrette with the wicked wink, the passionate hosiery and the abbreviated skirts, emerged from the wings and tripped to the footlights in the most approved ten-twenty-third style. Then came the stentorian tones of Mr. Edison's robust announcer, "Pass Me Not, O Do Not Pass Me By," and then—but Mr. Roosevelt is so particular lately about what goes through the mails that I will not go into details.

The captain left without ceremony and while I have a record as good as new, I have lost a friend. He passes me on the streets without speaking, but he looks at me as if I had sold him one hundred shares at par in the Private Snap Gold Mining & Development Company.

Furthermore, the record in question grates on my feelings and is still more inappropriate for constant use, as the Frisco Railroad has not renewed my pass for 1906 and the hymn seems to give them scriptural authority for withholding the same.

Regretting to be obliged to call your attention to this preserved prayer, I am, yours truly,

C. D. BOYNTON.

#### Mershon Resaws in China.

The fame of the Mershon band resaws is not confined to the United States. For years Great Britain and the continent have been large purchasers of these tools. Recently Wm. B. Mershon & Co. received an order for one of their combined band resaws and band log mills from China. The request for this outfit was received by cable, and the message contained three words; beyond the order for the mill it called for five head-blocks, a carriage, full filing room equipment and all accessories.

This type of machine has been advocated by the makers for a long time, and it speaks well for the enterprise of modern China, which is the first Oriental country to make use of a thoroughly practical and reliable method of transforming saw logs into the very thinnest material.

A peculiar feature of this resaw is that when the mill is used as a resaw the saw blade travels in one direction, and when used as a log mill the band wheels and the band saw travels in the opposite direction. This result is accomplished by a mere change in the twist of a belt.

There is doubtless a large field in this country where this kind of machine could be used to great advantage. Those interested in this particular type of mill, by addressing Wm. B. Mershon & Co. at Saginaw, Mich. will be given full particulars and illustrations of the equipment.

#### Important Change in Local House.

An important change has taken place in one of the foremost wholesale lumber houses of Chicago—Schultz Brothers & Benedict, in the Old Colony building. C. D. Benedict has withdrawn from the firm and entered business on his own account, while Schultz Brothers (William W., James M. and Alexander J.) will continue their extensive yellow pine operations, with offices at 1225 to 1240 Old Colony building, under that name.

Incident to the change and of particular interest to the readers of the *HARDWOOD RECORD* is the fact that the Schultz brothers, with James C. Cowen, have embarked in a distinct and extensive hardwood operation under the firm name of Schultz Brothers & Cowen, with headquarters in the same suite of offices. This firm will do an exclusive hardwood business, making a specialty of poplar. The history of the Messrs. Schultz in connection with yellow pine, piling and hardwoods is too well known to need specific mention. Mr. Cowen, who has been associated with Schultz Brothers & Benedict, is a man of wide experience in

hardwood affairs, having been associated for the past twenty years with some of the largest poplar and other hardwood concerns in the Ohio valley. He is particularly well known in Illinois, Indiana and Ohio, where for many years he represented the Yellow



WILLIAM W. SCHULTZ OF SCHULTZ BROTHERS AND SCHULTZ BROTHERS & COWEN, CHICAGO.

Poplar Lumber Company of Coal Grove, O. His work in building up a splendid hardwood trade for Schultz Brothers & Benedict has been justly recognized by Schultz brothers, in directly associating themselves with him in a business way.

The new firm of Schultz Brothers & Cowen, while already enjoying a large trade, has also made a strong organization in both the buying and selling ends of the trade. Mark S. McCullam, well known to Chicago lumbermen, is now stationed at Roanoke, Va., where he has in charge the purchase of lumber, and also supervises manufacturing for the firm at its mills in that locality. W. H. Hines, who for many years has been with C. Crane &



JAMES C. COWEN OF SCHULTZ BROTHERS & COWEN, CHICAGO.

Co. of Cincinnati and is known as one of the best poplar men in the country, will act as general salesman for the firm, and will cover Ohio, Indiana, lower Michigan and Illinois. L. P. Williams will act as buyer for the firm,

with headquarters at Vanceburg, Ky. It will thus be seen that Schultz Brothers & Cowen are well equipped in all the essentials of ability, experience and organization, to do a large and prosperous wholesale trade in poplar and other hardwoods.

Schultz Brothers will continue to operate in their old line specialty of northern and southern pine, piling, railroad ties, and other material, as in the past.

#### Asheville Hardwood Interests.

Through the dealers of Asheville and the immediate vicinity are distributed the famous hardwoods of western North Carolina, reputed to be the highest grade lumber in the world. Asheville, famous as a health resort and tourist point, is just as celebrated for its hardwood interests, which to a large degree have made the city what it is today.

The hardwood concerns of Asheville are principally manufacturers, although there are some large houses there which do a strictly jobbing business. The producers do not make much of an attempt at maintaining yards in Asheville, but operate from there shipping direct from the woods. Most of the producers have extensive timber tracts, besides controlling large leaseholds.

The Asheville district manufactures all kinds of hardwoods, especially oak, ash, poplar, chestnut and basswood. It is one of the most productive districts in the whole hardwood belt of the South, and the output is eagerly sought the country over, but especially in the eastern market.

By organizing as they have just done the dealers will undoubtedly be greatly benefited. There are many ways in which the recently organized Asheville Lumber Exchange can be of service to Asheville dealers, among others the consideration of the treatment of the railroads, and it is expected that these troubles will shortly be taken up by this association. The dealers are particularly grateful to Secretary Lewis Doster of the Hardwood Manufacturers' Association of the United States for showing them the ways and means of pulling together.

One of the progressive concerns in Asheville is the Fry-Buchanan Lumber Company, recently known as the H. W. Fry Lumber Company, organized five years ago by H. W. Fry. Mr. Fry was schooled in the lumber business under the tutelage of his father, J. C. Fry, one of the oldest and best known lumbermen in the state. The new company, besides President H. W. Fry, consists of Andrew Buchanan, an expert timberman, H. C. Johnson and G. C. Brumfield.

#### Asheville Lumber Exchange.

Agreeable to the announcement made in the last issue of the *HARDWOOD RECORD*, a second meeting of the hardwood men of western North Carolina was held at Asheville, May 26, at which the permanent organization of the Asheville Lumber Exchange was effected, and the following officers installed: W. T. Mason, president; J. M. Burns, vice president; A. F. Hall, secretary and treasurer, all of Asheville. The directors chosen were G. N. Hutton, Hickory; W. N. Woodbury, Murphy; E. E. Quinlan, Waynesville; G. L. Wood, Asheville. A constitution and by-laws were adopted.

C. A. Schenck, chairman of the committee on transportation, made a report, which was received and adopted, after thorough discussion. The report contained a recommendation that a committee of seven be appointed to meet with the Southern Railroad officials, which was approved, and C. A. Schenck, G. N. Hutton, E. H. Hall, J. M. English, C. H. Hobbs, F. L. Winchester and R. E. Wood were delegated for this work. They will report at the next meeting of the exchange.

The meeting was a large and enthusiastic one, and the thirty-four lumbermen present have taken up the new work vigorously and harmoniously.



**District Meetings Hardwood Manufacturers' Association.**

There was a meeting of hardwood manufacturers producing lumber in the vicinity of Hot Springs, Ark., held in that city yesterday, under the auspices of Lewis Doster, secretary of the Hardwood Manufacturers' Association.

Another meeting of the same character will be held by the hardwood producers of Missouri at Morehouse in that state, on Tuesday, June 12. This meeting will be held at the Forest Hotel and will convene at 10 o'clock in the morning.

The Hardwood Manufacturers' Association will also hold a district meeting at the Galt House, Louisville, Ky., on Saturday, June 16, in which lumbermen of the Louisville district will participate.

Secretary Doster is arranging other district meetings the dates of which will be announced later, at Nashville, Tenn.; Meridian, Miss.; Evansville, Ind., and at some central point in northern Louisiana.

**Death of Pependennis White.**

No shock has come to the lumber trade in a long time of so sad a nature as the violent death of Pependennis White of Buffalo, who was killed by the collision of an automobile with a street car, in Buffalo on Thursday evening, May 31. The details of this terrible accident are recounted elsewhere in this issue of the HARDWOOD RECORD.

Mr. White has been prominently identified with the lumber interests of the Northwest, the Niagara frontier and New York City for many years. He has been among the leaders in association work, giving special attention to the question of reciprocal trade relations between manufacturer, jobber and retailer. He has been foremost in the formation and carrying on of lumber insurance companies, and was interested financially in many other commercial enterprises. He was a leader in social and club life. Everyone who ever came in contact with Pependennis White was his friend, and this friendship he most thoroughly deserved. He was kindly, he was honest, he was just. The loss to the community and to the trade, occasioned by his death, cannot be estimated.

**Coming Meeting Southern Cypress Manufacturers' Association.**

The coming meeting of the Southern Cypress Manufacturers' Association, to be held at Atlanta, Ga., Monday and Tuesday, June 11 and 12, promises to be the largest cypress gathering ever assembled. The new Kimball Hotel will be headquarters, and the first session will be held there at 2 p. m. Monday. Favorable replies to the call have been received from a very large number of the strongest concerns engaged in the manufacture of cypress lumber, many of whom are in other states than Louisiana, the headquarters of the association. Considerable enthusiasm has been aroused, and much good will doubtless result from this extension of the movement.

**A Foremost Chicago Hardwood House.**

With two such men as Edward Heath and C. H. Wolfe at its head, there was only one road in which it was possible for the Heath-Witbeck Company of Chicago to travel, and that was the road to success. It is not surprising that the business of the company has flourished almost phenomenally, making the concern's products standard in the hardwood lumber trade, when one knows these two men. Such a combination of business foresight, energy, determination and reserve force as they possess could spell no such word as fall. Under their able management the onward march of the Heath-Witbeck Company has been uninterrupted.

The firm was organized in 1891 as a copartnership, composed of Edward Heath, Richard T.

Witbeck and C. H. Wolfe. Business grew steadily and almost from the start presaged the success which later days brought to pass. About three years after the partnership was formed Mr. Witbeck died. A stock company was formed, composed of Edward Heath, president and treasurer,



EDWARD HEATH, PRESIDENT AND TREASURER HEATH-WITBECK COMPANY, CHICAGO.

and C. H. Wolfe, secretary. The company does a general wholesale and retail business, handling all kinds of hardwood lumber and flooring. The Heath-Witbeck Company is well and favorably known wherever hardwood lumber is produced or consumed. It is one of the solid institutions of the trade and a credit to the lumber industry.

The general offices of the company are in the Willoughby building, 6 East Madison street, Chicago. The office work is in charge of C. F. Holle, a man who was brought up in the lumber trade and who knows the inside of this business in the minutest detail. In Chicago the company maintains a large distributing yard, with a modern dry kiln which has a shed capacity of



C. H. WOLFE, SECRETARY HEATH-WITBECK COMPANY, CHICAGO.

2,000,000 feet. The main distributing yards are located at Thebes, Ill. Here the company is erecting a new kiln with a capacity of 170,000 feet. There are also large distributing yards at McEwen, Tenn., and at Holly, Ark. At the

latter place the company operates a modern band and resaw mill, cutting 25,000 feet of quarter-sawed oak daily.

Speaking of the company's business, Mr. Wolfe said to the representative of the HARDWOOD RECORD: "In hardwood lumber manufacture we claim to be expert. It is upon the real merit and worth of our product that we ask the trade to pass judgment. Our drying facilities are unequaled in the West. We have shed capacity for over 2,500,000 feet of kiln-dried stock, and are the only people in Chicago that always carry a complete line of kiln-dried lumber on hand ready for shipment. All the latest machinery of special design required in manufacturing flooring and ceiling is operated at our mills. Indeed, the work performed by these machines in producing a hardwood flooring with smooth, even surface, tongued and grooved, hollow backed, with matched ends and holes bored for blind nailing, is so remarkable for exactness that but little more skill or labor is required in laying it than would be necessary in laying pine."

**Politics in Michigan.**

The political campaign is on in Michigan, and of particular interest to the lumber fraternity is the candidacy of Hon. Arthur Hill of Saginaw for United States senator to succeed Hon. Russell A. Alger, and of J. W. Wells of the I. Stephenson Company, Wells, Mich., and several other large lumber enterprises of the Northwest, for United States representative from his district. Both these gentlemen are Republicans, and nomination is practically equivalent to election. It is to be hoped that both will achieve success in their ambitions. Each is a lumberman of sagacity and with an intimate knowledge of forest conditions in Michigan. With these men, one in the Senate and the other in the House, the country would have two prime advocates of a logical forest policy in this country. Both are clean-cut, upright and honorable. In their respective sections they stand foremost, and the state of Michigan can do itself and the country honor by bestowing congressional honors upon them.

**Liberty Hardwood Lumber Company.**

A new company composed of local capitalists has been incorporated at Galveston, Tex., to be known as the Liberty Hardwood Lumber Company. It is capitalized at \$150,000. The officers are Moritz O. Kopperl, president; C. H. Moore, vice president; Julian Ranger, secretary and treasurer. The board of directors is composed of the above named and I. H. Kempner and John Neethe.

The company's holdings consist of 10,000 acres of timber land, comprising the various kinds of hardwoods, near Big Creek, Liberty county, Texas. These holdings were formerly in possession of the Ranger Hardwood Export Company of Houston, in which the E. Sondheimer Company of Memphis was interested, but which recently met with financial difficulty. On the property is one of the best hardwood mills in Texas.

**Building Operations for May.**

Reports from some fifty of the leading cities of the country, received by The American Contractor, Chicago, tabulated and compared with those of the corresponding month of last year, show that the building operations of May, 1906, fully justified the predictions made in the last report. Two-thirds of the cities show an increase over the operations of 1905. In Greater New York the gain is small, only 1 per cent, but this is a remarkable showing when the enormous, record-breaking business of last year, with which the comparison is made, is taken into account. Chicago breaks all its records with \$6,494,220, a gain of 60 per cent over May, 1905. The percentage of gain in other leading cities is



as follows: Atlanta, 34; Bridgeport, 167; Buffalo, 60; Cleveland, 17; Duluth, 110; Harrisburg, 112; Louisville, 50; Nashville, 130; Newark, 26; New Orleans, 48; Omaha, 75; Philadelphia, 11; Portland, 307; St. Louis, 14; St. Paul, 49; Seattle, 30; Syracuse, 34; Toledo, 93; Tacoma, 111; Wilkesbarre, 271. The following figures show the losses reported in leading cities: Cincinnati, 44; Denver, 26; Indianapolis, 35; Kansas City, 17; Milwaukee, 23; Minneapolis, 25; Mobile, 67; New Haven, 34. Some of the cities showing a loss have enjoyed a building boom for some years past and diminished building was almost a matter of necessity. Taken altogether, the report is of a most satisfactory and encouraging character and leaves no reason to doubt but what the building operations of the season now fairly under way will break all records. This seems all the more remarkable when it is understood that both wages and building materials are now ruling very high.

City—	May, 1906, cost.	May, 1905, cost.	Per cent gain.	Per cent loss.
Atlanta	\$ 549,197	\$ 498,739	34	..
Birmingham	236,752	..	..	..
Bridgeport	281,806	195,459	167	..
Buffalo	1,289,590	891,400	60	..
Baltimore	752,000	735,000	2	..
Chicago	6,494,230	4,653,280	69	..
Cleveland	1,248,593	1,064,940	17	..
Chattanooga	128,302	111,525	15	..
Cincinnati	758,525	1,391,550	..	44
Columbus	546,150	510,130	7	..
Davenport	59,625	74,800	..	59
Denver	445,750	62,235	..	26
Detroit	1,237,400	1,008,900	21	..
Duluth	555,533	169,112	110	..
Evansville	55,092	32,127	72	..
Grand Rapids	238,332	243,649	2	..
Harrisburg	289,775	136,675	112	..
Hartford	327,310	249,851	31	..
Indianapolis	489,724	788,902	..	35
Kansas City	919,570	1,108,417	..	17
Knoxville	128,745	64,040	101	..
Louisville	495,473	330,210	50	..
Los Angeles	1,031,832	1,244,154	..	15
Los Angeles	751,121	382,959	..	23
Milwaukee	846,599	1,134,780	..	25
Minneapolis	343,200	323,373	6	..
*Mobile	92,220	293,170	..	67
Nashville	475,058	296,085	139	..
New Haven	249,895	377,237	..	34
Newark	1,008,852	796,156	26	..
New Orleans	586,718	396,242	48	..
New York	26,616,003	26,309,074	1	..
Manhattan	14,176,680	13,006,800	9	..
Alterations	1,769,750	1,839,698	..	..
Brooklyn	7,336,723	7,295,081	4	..
Bronx	3,473,629	4,116,125	..	22
Alterations	159,230	121,370	..	..
Omaha	706,175	492,599	75	..
Philadelphia	4,886,655	390,980	11	..
Portland	1,087,769	267,106	307	..
St. Louis	2,163,255	1,886,447	14	..
St. Paul	971,250	651,689	49	..
Scranton	248,725	181,065	36	..
Seattle	726,673	555,386	30	..
Spokane	369,436	352,305	3	..
South Bend	61,555	151,747	..	58
Syracuse	192,350	143,443	34	..
Topeka	69,288	101,395	..	49
Toledo	467,922	219,270	93	..
Terre Haute	117,228	141,869	..	17
Tacoma	273,130	129,387	111	..
Washington	1,341,766	2,300,569	..	43
Wilkesbarre	520,445	140,028	271	..
Winnipeg	1,987,800	2,306,500	..	13

\*In May, 1906, Mobile issued a permit for a \$235,000 hotel.

Miscellaneous Notes.

The handle factory at Litchfield, Me., belonging to F. E. Baker was destroyed by fire recently; loss \$1,800.

It is reported that Thomas Scanlon of Nashville, Tenn., will establish a handle factory at Quinton, I. T.

Umbrella and cane handles will be manufactured by Groveman, Kahn & Murnich of New York City, recently organized with \$6,000 capital.

A company has been organized at South Marion, Ind., to manufacture handles, and active steps toward the erection of a plant are being made.

The Montgomery Land & Lumber Company has been formed at Christiansburg, Va., for the development of several million feet of oak, yellow pine, poplar and other timbers.

H. T. Phillips, L. V. Phillips, J. W. Noell, J. G. Walser and others are the incorporators

of the recently organized Lee Veneer Company of Lexington, N. C. It is capitalized at \$10,000.

The band sawmill at Borden, Ky., the property of the Borden Hardwood Company, has been sold to an Arkansas concern, and will be shipped in the course of a few days. The consideration was \$3,000.

The Cache Valley Lumber Company of Walnut Ridge, Ark., has been incorporated with a capital stock of \$40,000, of which \$25,000 has been subscribed. C. H. Wood, Charles Ferguson and others are the incorporators.

The sawmill and hoop and stave factory belonging to the Atlas Cooperage Company of Lindsay, O., was recently burned to the ground. The loss entailed will probably aggregate \$8,000, partly covered by insurance.

The Metropolitan Parquet Floor Company, with \$10,000 capital, is one of the latest concerns to enter the New York field. A. J. Road, Spring Valley, N. Y.; C. A. Wallmenich, and R. V. Wallmenich, Bayonne, N. J., are the promoters of the enterprise.

The new clothespin factory at West Paris, Me., being erected by L. M. Mann & Sons to take the place of the one recently destroyed by fire, will soon be in operation with an increased number of workmen. It is much larger and better equipped than the old building.

The Rogers Hardwood Lumber Company recently organized at Merrill, Miss., has purchased the sawmill and equipment of the J. G. Taylor Lumber Company of that place. Extensive repairs being made in the plant are almost completed, and operations will begin shortly.

The Thistlethwaite Lumber Company, Washington, La., will next fall erect a band mill to cut timber from a 4,500-acre tract of hardwoods. The principals in the company are Edward Thistlethwaite and his sons, John R. and Lote, all three men of wide experience in the lumber business.

The contract to furnish 125,000 feet of white oak timber to the government has just been filled by the Nicolette Lumber Company of Parkersburg, W. Va. It was one of the largest shipments of white oak timber ever taken out of the state, and was sent to San Francisco to be used in ship building.

Extensive repairs have been made in the Union Handle Company's factory at Marion, O., and operations are now proceeding at a lively rate. An average of 10,000 feet of lumber is sawed daily, and 5,000 finished handles shipped out. A railroad siding which the company is constructing to its factory is almost completed.

It is announced that the Oak Lumber Company of Monroe, La., has purchased a tract of land in West Monroe on which it will erect a large plant to manufacture hardwood lumber. The company recently purchased all the hardwoods on the Monroe Lumber Company's holdings. A flooring plant will be added in the course of a few months. Between \$700,000 and \$800,000 will be invested in the enterprise.

The Tioga Lumber Company of Tioga, Mich., lately purchased 4,000 acres of timber lands contiguous to its holdings in Alger county. It is estimated that there are about 60,000 feet of hemlock, pine and hardwoods

on the property which will be sufficient to give the company several years' cut for its mill at its present capacity. The Tioga Lumber Company now has holdings amounting to over 7,000 acres, most of which is virgin timber.

The Woodstock Hardwood & Spool Manufacturing Company, manufacturer of wooden spools and bobbins for textile mills, will remove its plant from Woodstock, 15 miles from Charleston, S. C., to that city some time during the summer. A two-story frame building has been secured, 80x120 feet in dimensions, and \$15,000 will be expended in improvements and equipment. The company will increase its capital stock from \$15,000 to \$50,000.

The Acme Lumber Company, recently incorporated at Toledo, O., has the following officers: President, J. L. Hosler; vice president, Robert C. Bowlus; secretary and treasurer, James W. Hosler; directors, the above, H. T. Lawton and Mrs. C. M. Bowlus. The new concern has taken over the business of J. L. Hosler & Co., dealers in hardwood lumber. Offices will be maintained at Toledo, and the concern will do a wholesale and retail business in hardwood lumber.

The Montgomery Cooperage & Hardwood Company, Montgomery, Ala., declared insolvent some months ago, was purchased at public auction recently by Richard Tillis for \$51,500. The appraised value was \$112,000, and the value placed by the company was \$120,000. The purchase includes besides the plant at North Montgomery, hardwood timberlands, so that it would seem that the purchaser got quite a bargain. Operations will be resumed at the factory at an early date.

In a petition filed in the United States District Court by C. W. Lanar, Pensacola, Fla., on two notes aggregating \$3,050; A. S. Hopkins of Chicago on two notes aggregating \$4,750 and the Hibernia Bank & Trust Company of New Orleans on two notes aggregating \$2,109, the South Arm Lumber Company of Milwaukee, Wis., is declared an involuntary bankrupt. It is claimed that the South Arm Lumber Company owes \$1,000 more than it is able to pay, and that while insolvent it has disposed of lands in Chippewa county, Mich.

The Schramm Wooden Toy Company, manufacturer of wooden horses and other similar toys, recently organized at Trenton, N. J., is the only concern of the kind in the United States. F. Schramm, a native of Germany who has had years of experience in toy making there, is president, and William H. Baker, proprietor of the East Trenton Machine Works, Trenton, N. J., is secretary and treasurer of the company. The factory will be located for the present in the second story of the East Trenton Machine Works. Thirty hands will be employed at first, and large and small wooden horses, platform rocking and swinging horses, carved deer heads and similar articles, all of which were heretofore imported, will be turned out. Two large wholesale concerns have already contracted to take \$100,000 worth of the toys before Christmas. Some idea of the field the new company has will be gained when it is known that last year the importations of this class of products into the United States aggregated \$17,000,000.

Hardwood News.

(By HARDWOOD RECORD Special Correspondents.)

Chicago.

The big hardwood flooring house, the T. Wilce Company, has just issued a very handsome flooring catalog, in which is incorporated a mass of information for the benefit of dealers and users of hardwood flooring.

E. B. Lombard, recently of the firm of Hayden & Lombard, has entered the lumber business on his own account, and is fitting up a handsome suite of offices at 213 Railway Exchange. Associated with Mr. Lombard will be John T. Hughes, who is well known to the local trade.

Perley Lowe and Jacob Mortenson, two well known and wealthy Chicago lumbermen, have purchased the L. Van Winkle sawmill and standing timber at Van's Harbor, Delta county, Michigan. There are upwards of 20,000,000 feet of timber on the property, which will be under the management of Reuben Knox, a well known Chicago lumberman, who was formerly manager of the Ford River Lumber Company of Ford River, Mich. With other timber available to the plant, it is expected that a long-time lumber operation will be continued at Van's Harbor.

The Record acknowledges a call on June 4 from H. E. Bacon, of the Bacon-Nolan Hardwood Company of Memphis, Tenn. Mr. Bacon was en route north, arranging for a summer outing for his family.

Fred Bruening of the hardwood house of Henry Bruening, Bremen, Germany, was a caller at the Record office several days ago. He is visiting the United States on a buying trip.

John B. Ransom of Nashville, Tenn., was in the city the early part of last week.

O. O. Agler of Upham & Agler, spent several days in the Wisconsin hardwood timber country last week.

There will be a meeting of the executive committee of the National Hardwood Lumber Association held at the organization's offices in the Rector building on Thursday, June 11. This will be the first meeting of the executives of this association since the May 4 election.

It is announced that the Edward Hines Lumber Company of this city is having plans drawn with a view to erecting a hardwood flooring plant here.

E. P. Arpin, president of the Wisconsin Hardwood Lumbermen's Association, was a Chicago visitor a few days ago.

W. D. Young, Bay City, Mich., of maple flooring fame, was in town last week.

Those interested in the development of the veneer and panel industry should not fail to remember that the next meeting of the National Veneer & Panel Manufacturers' Association will be held at the Grand Hotel, Cincinnati, Wednesday, June 20. This meeting should call out every manufacturer of veneers and panels in the country, as many matters of particular interest and profit to the trade will be handled.

Excellent opportunities for woodworking establishments are found at a number of points on the North-Western Line in the timber country of Wisconsin and Michigan. Parties dealing in coöperage will be furnished with reference to sections where this business may be conducted favorably. Address the Industrial Department, Chicago & North-Western Railroad, Chicago.

A welcome caller at the RECORD offices last week was L. T. Davidson, the well known manufacturer and wholesaler of hardwoods at Glasgow, Ky., who was in Chicago on a hasty business trip.

The HARDWOOD RECORD has received, with the compliments of Nelson A. Gladding of E. C. Atkins & Co., Inc., Indianapolis, Ind., a very handsome volume entitled "Indiana at the Louisiana Purchase Exposition." The book comprises a brief outline of the work and personnel of the commission which so ably conducted the Indiana state exhibition at St. Louis. It is profusely illustrated, giving beautiful half-tone reproductions of the fifteen members of the commission, a bird's-eye view of the Louisiana Purchase Exposition, various views of the exterior and interior of the Indiana state building, and of the many fine exhibits shown by Indiana interests. It is withal a very creditable publication, its pages giving a very graphic picture of an exhibition of which the Hoosier State may be justly proud.

Secretary Lewis Doster of the H. M. A. of U. S. is back in his office after an extended southern trip.

J. L. Strickland of the Planters' Lumber Company, Greenville, Miss., was a caller at the RECORD office on Wednesday of this week.

The local trade thought it had quite a joke on Lewis Doster, secretary of the Hardwood Manufacturers' Association of the United States, when either by accident or design he located his offices adjoining those of the Anti-Saloon League of America in the First National Bank building. When Frank F. Fish, secretary of the National Hardwood Lumber Association, recently located the executive offices of his organization on the tenth floor of the Rector building, he took particular pains to see who his neighbors were on that floor. Unfortunately the owners of the building were unable to refit Mr. Fish's suite immediately and temporarily located him on the ninth floor. Much to his chagrin he finds that these quarters adjoin the Chicago offices of the Dwight Keeley Cure. It is really quite a sight to see Secretary Fish side-step when he passes this door. He has a force working nights to get his permanent quarters in shape for occupancy, and expects to move in next week.

The firm of Reginald J. Davis & Co., hardwood dealers, filed a petition in involuntary bankruptcy May 25, showing that the firm was interested in building construction in San Francisco and that the great disaster was responsible for its financial trouble. The liabilities are \$60,000 and assets \$30,000.

The Southern Oak Lumber Company of Chicago has filed a certificate in the state of Arkansas showing that \$10,000 of its capital stock is to be used there, and naming James R. Bush of Helena as agent. An anti-trust affidavit was filed simultaneously.

The HARDWOOD RECORD is in receipt of a catalogue of the Biltmore Forest School, Biltmore, N. C., of which C. A. Schenck, Ph. D., is director. The school is now in its eighth year, and is perhaps the most practical and best equipped institution of its kind in the country. It not only has for its director the best practical forester in the United States, but its field work is conducted in the great Pisgah mountain forest belonging to the Biltmore estate of Geo. K. Vanderbilt, than which no other woodlands offer such diversified opportunities for study along this line.

#### Boston.

Several of the local manufacturers of furniture have been having labor trouble at their plants for the past few weeks. Irving & Casson, the A. B. & E. S. Shaw Company and Eastman & Co. have brought a bill in the superior court against the Amalgamated Woodworkers of America, Local 24, and other unions, seeking an injunction to prevent members of the union from interfering in any way with their business.

The Hotchkiss Brothers Company of Torrington, Conn., will erect a building in Hartford, Conn., to be used for the storage of lumber.

Henry S. Locke, a member of the lumber firm of H. S. Locke & Co., Needham and Dedham, Mass., on May 22 was run over by a train at Dedham and instantly killed. He was 63 years of age. Mr. Locke is survived by a widow, three sons and three daughters.

The Boston Lumber Company has removed from 27 Kilby street to 79 Milk street, where it has spacious offices on the sixth floor.

Horace Shepard of the Shepard & Morse Lumber Company has returned from a three months' European trip.

The firm of W. L. Lockhart & Co. of Boston has been dissolved. George H. Howard of the old firm is settling up the affairs of the company.

Charles S. Wentworth & Co. of Boston have

leased a new and much larger office in the Mason building and will remove from their present location at 147 Milk street before August 1.

The Davenport, Peters Company has been incorporated to succeed the firm of Davenport, Peters & Co. The incorporators are George H. Davenport, William Bacon and Lewis M. Pratt.

The H. M. Bickford Company, 147 Milk street, Boston, moved June 1 to larger quarters in the Mason building.

Charles S. Wentworth of Charles S. Wentworth & Co., Boston, has just returned from a trip to New Brunswick.

William E. Litchfield of Boston has returned from a trip to New York. Mr. Litchfield reports that the extensive improvements at his mill in North Vernon, Ind., are about completed.

#### New York.

There will be a big time at the golf course of the Nassau Country Club, Nassau, Long Island, on June 12 and 13, when a large number of lumbermen from all over the East and Canada will contest for valuable cups and prizes, given by representative New York lumbermen.

The H. M. Bickford Company of Boston has opened a local selling office at 1 Madison avenue, under the management of Mr. A. Shoaf.

La Bau & Baker of Jersey City, N. J., well-known cypress specialists, have secured the sales agency north of Norfolk and east of Pittsburg for the Louisiana Cypress Lumber Company of Harvey, La., which have withdrawn from the Cypress Selling Company combine.

Numerous attempts have been made during the past two months to burn out the yards of the S. E. Kellar Lumber Company, some of which have been sufficiently successful to have entailed total losses to date of about \$15,000. The company is hard at work endeavoring to apprehend the culprit.

The many friends of Pendennis White of Buffalo in the local district were shocked to learn of his sudden death in an automobile accident at Buffalo on May 31. Mr. White was president of the Lumber Insurance Company and the Adirondack Fire Insurance Company of this city and a heavy stockholder in the Stevens-Eaton Company of this city, and, in fact, really began his lumber career here with L. P. Rider years ago, which partnership later became White, Rider & Frost. A few years ago Mr. White withdrew and organized White, Gratwick & Mitchell at North Tonawanda, and soon after became associated with the Stevens-Eaton Company. For years he has been a prominent figure in the National Wholesale Lumber Dealers' Association and was its president for one term. One of the strongest supporters of the trade fire insuring movement from its inception, he was at the time of his death the heaviest individual investor in that line in the lumber trade. He was a man of much business ability and energy and a host of friends will miss his wise counsel and warm friendship.

The trustees of the National Wholesale Lumber Dealers' Association held a regular meeting at headquarters, 66 Broadway, May 25, at which time a large amount of routine business was transacted.

W. E. Uptegrove, Jr., son of W. E. Uptegrove, head of the firm of W. E. Uptegrove & Bro., Brooklyn, who has been associated with his father in business for some years, died at the family residence, in Brooklyn on May 25 in his twenty-fifth year. The sympathy of the trade is Mr. Uptegrove's in his bereavement.

English & Co. of 1 Broadway is the latest wholesale house to join the uptown colony at 1 Madison avenue.

Henry Cape, 1 Madison avenue, has been appointed exclusive sales agent for this district for the maple flooring product of W. D. Young & Co., Bay City, Mich.

T. S. Miller, manager of the hardwood department of the Stevens-Eaton Company, accompanied by George M. Stevens, spent several days during the fortnight in the West Virginia hardwood belt on business.

J. C. Turner of the J. C. Turner Lumber Company is off on a tour of inspection of his various southern enterprises.

W. W. Knight, of the Long-Knight Lumber Company, Indianapolis, Ind., was a visitor last week on National Hardwood Lumber Association affairs.

Nelson H. Walcott, of the L. H. Gage Lumber Company, Providence, R. I., was also here during the fortnight.

C. H. Stanton of Buffalo spent several days in the district on business.

W. H. Martz, of the Goodland Cypress Company, New Orleans, was here last week renewing acquaintances in the trade and pushing their "good cypress."

E. D. Galloway, Galloway-Pease Company, Johnson City, Tenn.; C. R. Krimm, Williamsport Hardwood Lumber Company, Williamsport, Pa.; R. B. Currier, Springfield, Mass., and R. E. Wood, R. E. Wood Lumber Company, Baltimore, were also recent visitors.

Allen W. Adams of the Willson & Adams Company of Mount Vernon, N. Y., and a former partner in Willson, Adams & Co., Manhattan, died at Greenwich, Conn., May 18. He was for years a prominent figure in the local fraternity and the entire trade, as well as his business associates, keenly feel his loss.

The new hardwood flooring plant of the Emporium Lumber Company at Galeton, Pa., has begun operations, and Manager C. O. Shepherd of the local office is about ready to entertain orders. The plant is a fine one and will produce about 6,000,000 feet annually.

At a special meeting of the creditors of the International Mahogany Company, held here May 23, a proposition, submitted by George F. Montgomery, a former officer of the company, to take over the assets for \$25,000 cash and make further payments to the creditors by notes, was accepted. This cash payment will immediately give the creditors a 10 per cent dividend, and they will then receive notes at one, two, three and four years of a new company, to be known as the Cuba Commercial Corporation, each for 10 per cent, making a total dividend of 50 per cent to all creditors.

#### Philadelphia.

A special meeting of the inspectors and officers of the lumbermen's mutual insurance companies was held on June 4 in the offices of the Pennsylvania Lumbermen's Mutual Fire Insurance Company in the Drexel building and was attended by representatives of the Lumber Mutual of Boston, Lumbermen's Mutual of Mansfield, O., Indiana Lumbermen's Mutual of Indianapolis, Central Manufacturers' Mutual of Van Wert, O., and the Pennsylvania Lumbermen's Mutual. Mr. Stone of Boston was elected secretary. It was agreed to have a general and systematic inspection and there was also a discussion of matters and methods pertaining to lumber insurance in general.

Geo. F. Craig, president of the Lumber Exchange, attended the meeting of the Pennsylvania State Forestry Association held at Harrisburg June 5 and 6.

A. J. Cadwallader of Geo. F. Craig & Co. left for Savannah last week, where he will superintend matters at the shipping points and offices of the concern at that place.

The mills of W. M. McCormick at Townsend, Tenn., are again in running order. The property was destroyed by fire on February 21. On March 1 rebuilding was started and

the energy displayed in putting affairs in running order was the subject of much favorable comment.

Chas. K. Parry of the Righter-Parry Lumber Company is in the South buying lumber and inspecting the interests of the concern at various points. This company has lately been going into hardwoods extensively.

The Blades Lumber Company of Elizabeth City and Newbern, N. C., announce that they have consolidated with the Elizabeth City Lumber Company and will hereafter be known under that name.

Norman A. Perry of the Robt. C. Lippincott concern is spending some time in the South at various mill points looking over shipments and attending to other matters for the firm.

Wm. H. Fritz of Wm. H. Fritz & Co. is in New York, where he controls considerable trade.

J. J. Rumbarger of the Rumbarger Lumber Company has been ill for a week or more. F. T. Rumbarger, who has been spending some time in New York and Pittsburg, has again taken charge of his work in the home office.

A meeting of the Lumbermen's Exchange of Philadelphia was held on June 7. Besides the transaction of regular business new members were voted upon. Action on the following resolution, which has been mooted in local lumber circles for a long time, was taken: "Resolved, that this exchange approves and adopts the rules for inspection of hardwood lumber known as the National Hardwood Lumber Association Rules, and recommends to its members that all disputes arising under these rules be referred to the resident authorized inspector of the National Hardwood Lumber Association."

A number of local lumbermen who are interested in golf will attend the Lumbermen's Golf Tournament to be held June 12 and 13 at Nassau Country Club, Nassau Station, L. I. Those who attend will go under the auspices of the Philadelphia Lumbermen's Exchange.

H. N. Pattison of the Philadelphia Hardwood Lumber Company is visiting various mill points through Virginia and the South generally. The firm is making a specialty of plain red and white oak, which it finds in great demand among furniture dealers.

R. W. Wistar of Wistar, Underhill & Co. has just returned from a trip through Virginia and North Carolina.

J. W. Diffenderfer has started a new sawmill on poplar a short distance from Bristol, Tenn. He has just returned from Damascus, Va., where the operation is going on double time.

W. H. Howard of Emporium, Pa., has just acquired a tract of about 40,000 acres near Goshen, Va., consisting mostly of oak, chestnut and poplar. The tract extends through four counties, although most of it lies in Bath. Mr. Howard is undecided at present whether to operate or sell.

R. W. Schofield of Schofield Brothers has just returned from their mills where he was looking over shipments and other matters.

Visitors to the trade lately included Wendell M. Weston of W. M. Weston Company, Boston; Myron J. Kimball of Kimball & Prince Lumber Company, Vineland, N. J.; Samuel M. Bickford, Lock Haven, Pa., and C. J. Gibson of West Shore Lumber Yard, Utica, N. Y.

#### Baltimore.

The marriage of David T. Carter of Carter, Hughes & Co. of this city, and the Iron Mountain Lumber Company of Virginia, to Miss Mary Hopkins, daughter of a well-known business man of Port Deposit, Md., took place there on June 7. Mr. Carter is a very popular young man and has the felicitations of a large number of friends. He and his bride will go to Troutdale, Va., after an extended wedding

trip, where the groom is giving personal supervision to the mill operated by his company.

Three mahogany logs, said to be among the most perfect specimens of this wood ever brought into the United States, were received here two weeks ago and taken to the plant of the Williamson Veneer Company at Highlandtown, a suburb, where they are to be cut up into veneers. The logs measured 14 feet in length and 3 to 5 feet in thickness. They were brought from British Honduras and are valued at not less than \$10,000. The work of slicing is being done for a Louisville firm, which imported the logs by way of New Orleans.

Among the visiting lumbermen here within the past two weeks were Norman G. and Boyd Wright, representing the Glasgow hardwood importing firm of Wright, Graham & Co. The Messrs. Wright had been on an extended tour through the United States and were on their way to New York, preparatory to sailing for Europe. Their travels extended as far as Seattle and Tacoma, and they came back full of admiration for the Pacific coast and its opportunities. They sailed from New York June 2.

The saw and planing mill on the farm of Burton H. Bowden, near Seaford, Del., was destroyed by fire May 26, together with several thousand feet of lumber. The plant was sold to John Collins five weeks before, and during the interval had been on fire twice before it burned to the ground. It was valued at \$5,000. There was no insurance.

#### Pittsburg.

O. H. Rectanus of the A. M. Turner Lumber Company has been making quite an extended trip through the Northwest in search of white pine stocks. The company's mills in the South are all very busy and a big season's cut is already assured.

The James I. M. Wilson Company, the Nicola Lumber Company, the C. P. Caughey Lumber Company and the M. B. Farrin Lumber Company report business as excellent, and predict a busy summer.

The last week in May forest fires did much damage in the hardwood districts of West Virginia. Most of them were in the vicinity of Davis and Parsons and on the Otter Creek Boom & Lumber Company's tract. Over 3,000 cords of bark were burned and also the sawmill and a large amount of dressed lumber belonging to Kenny & Rains at Harman.

F. A. Opperman and W. W. Collin are two new wholesalers who have lately located in the Machesney building. The former will make a specialty of mill work and the latter intends to do a general wholesale business.

The Pittsburg Wholesale Lumber Dealers' Association is flourishing, and several new firms have been admitted since April 1. The association will hold its regular annual picnic about the middle of this month at Ross Grove.

Manager J. G. Chre e of the Interior Lumber Company says that his company's mills at Oneida, Tenn., are running full and that they will probably keep going all summer.

The William H. Schuette Company is rebuilding its mill at Bellhaven, N. C., which was burned recently. The new plant will be run under the name of the Bellhaven Lumber Company and will have a capacity of 30,000 feet of worked lumber in addition to a sawmill which will cut 75,000 feet a day.

The Lillo Brothers Company has the contract for 450,000 feet of timber which the Bruening Cork Company will use in the building of its big cork factory at Oakdale.

The Liberty Lumber & Planing Mill Company has been chartered with a capital of \$50,000 to succeed to the business of the J. W. Gallagher Lumber Company which has gone out of existence. The Liberty company has the Gallagher yard in the East End, one of the largest in the city, and is rapidly

stocking it with a full line of hardwoods.

The W. M. Gillespie Lumber Company now has its Pennsylvania charter and has secured a suite of offices in the Farmers Bank building. William M. Gillespie, head of the company, has severed his connection of many years' standing with the Murphy Mill & Lumber Company, and has as his active assistant in the new firm Fontaine McCollum, who was for years with the J. E. North Lumber Company.

The Kendall Lumber Company has added to its force of salesmen William A. Smith of the Buswell Lumber Company of Minneapolis, who will work the Pittsburg trade. The Kendalls are getting their Maryland operations in shape to make some record breaking cuts.

Fred R. Babcock is spending this week at the head of the big Merchants' & Manufacturers' Association of Pittsburg, which is touring northeastern Ohio.

The West Virginia Lumber Company reports stiffer prices on hardwoods. Its connections in West Virginia and Tennessee enable it to be a very active competitor in the hardwood market this year.

The J. M. Hastings Lumber Company has nearly completed its new plant at Jacksonburg, W. Va., where it will cut 20,000 feet a day of hemlock and hardwoods. It has built three miles of steel railroad into its tract and has equipped this with Climax engines, logging cars, loaders and skidders. The manager of the new operation will be J. B. Patterson, who is now directing the work of a large force of millwrights and bridge builders.

J. N. Woollett has been buying much hardwood timber and stock along the Tennessee Central Railroad to keep up with the rapidly growing trade of the American Lumber & Manufacturing Company in hardwoods. Its sales in this department this year bid fair to eclipse all previous records.

The Flint, Erving & Stoner Company is getting its big deal at Dunlevie, W. Va., closed up in good shape and is formulating plans for a big increase in the output of the plants in the fall. J. B. Flint, president of the newly formed Flint, Erving & Stoner Lumber Company, under which name the new operation will be conducted, is delighted with the purchase and says that the company will have an abundance of hardwood of all kinds as soon as it gets its plants in full operation. The feature of the town of Dunlevie, which was included in the \$1,000,000 purchase, is that every house is quite as modern as ordinary city dwellings—something unusual in lumber towns and which draws the best class of workmen.

Willson Brothers Lumber Company is getting its hardwood connections bulwarked in a way that will make them safe against a fierce onslaught of orders. I. F. Balsley, their hardwood manager, reports that the firm has about 7,000,000 feet of dry poplar lumber in its West Virginia stocks.

The Linehan Lumber Company sees the best year in 1906 that it has ever had. J. J. Linehan recently spent a week to good advantage in Boston, New York and other eastern cities and is now on his way to the mills in Kentucky.

### Buffalo.

The Buffalo Hardwood Lumber Company has a barge of birch in from the upper lakes and is also getting it from other sources.

Both F. W. Vetter and H. S. Janes of the Empire Lumber Company are home now, something unusual, as one covers the eastern part of the South and the other the western.

J. F. Knox is home most of the time of late, after his long stay south in oak timber districts.

The Standard Hardwood Lumber Company finds its Buffalo yard too small and has to pile its stock up very high. New yards are

scarce, but efforts to find one are being made. A. W. Krehnheder is south.

A. J. Elias appears to be coming out best in the Buffalo river improvement fight. It has been a long one, but he never gives up and is now able to see preparations for the work under way; and more lumber yards next.

Angus McLean is giving most of his time to the St. Lawrence river mills of the McLean interest.

A. Miller bought considerable chestnut on his late southern trip and is trying to keep a stock of it, but finds it one of the scarcest of woods.

The oak specialty of Scatterd & Son is hard to keep up in these days of poor logging weather and car shortage. A big sale of low-grade oak is reported of late.

### Saginaw Valley.

The present week marks the end and the beginning of a lumber industry. The Batchelor Timber Company of Saginaw, organized a few weeks ago with a capital stock of \$200,000 for the purpose of consolidating the interests of the members of the company, J. T. Wylie, H. A. Batchelor and H. A. Batchelor, jr., has purchased the saw mill property of the Gale Lumber Company at West Branch, on the Mackinaw division of the Michigan Central, seventy-three miles north of Bay City. The Gale company bought several thousand acres of timber land in Ogemaw county, near West Branch, twelve years ago. The timber was mostly hardwood, the pine having been taken off years ago. The Gale people have manufactured the entire timber and the mill quit this week. It has been on the market for some time, as it was known the company was about winding up its affairs. The purchasers will make some repairs in the mill and put it into condition for sawing at the earliest moment. The Batchelor company will bring to the mill about 80,000,000 feet of hardwood timber from lands it owns in northern counties in the lower peninsula. The logs will be carried to the mill by rail and will give the Michigan Central a vast quantity of freight, since the logs must be railed to the mill and the manufactured product shipped to market by rail. The mill is a single band with a capacity of 9,000,000 feet annually. The owners will also erect a modern maple flooring plant to be operated in connection with the mill with a capacity of at least 10,000,000 feet annually. Mr. Wylie is son-in-law of H. A. Batchelor, and in addition to interests in the Wylie & Buell Lumber Company, which owns a large body of timber in Cheboygan and Otsego counties, is also interested in four large cooperative plants, one at Saginaw, one at Gaylord, one at Boyne City and one at Interlochen. The industry just opening at West Branch has a lease of life as long as the one just finished.

The S. L. Eastman Flooring Company at Saginaw is to build two cement dry kilns. The company purchased its entire stock of lumber early in the year, contracting with the Kneeland, Buell & Bigelow Company for 10,000,000 feet of maple lumber, and also bought of other parties.

There will be manufactured this season in the valley a much larger quantity of ash than usual in recent years. This commodity has been rather scarce in this portion of Michigan. A lot of basswood is being manufactured here and at interior Northern Michigan mills. It is held to be good property this year and the culls are quickly sold for box stuff. The entire output of two Bay City mills for the season has been contracted for by local box manufacturers.

Basswood is also used for excelsior. The Alpena Excelsior Company received a cargo of 180 cords yesterday from Cecil Bay, on the Lake Michigan shore.

M. P. Gale of the Gale Lumber Company, whose residence is at Saginaw; J. T. Phillips and A. W. Seeley of Saginaw, and John Toll-free of West Branch recently purchased a tract of timber land of the Sage Land & Improvement Company of Bay City estimated to contain 100,000,000 feet of timber, nearly all hardwood, and located in the upper peninsula. They will either erect a sawmill or arrange to have the timber manufactured at Ontonagon. They have the logging railroad which has been operated by the Gale Lumber Company near West Branch and which was not included in the purchase by the Batchelor Timber Company as the latter has no use for it, and this may be taken to the upper peninsula.

W. D. Young & Co. are running steadily day and night and the J. J. Flood mill is also cutting for Young & Co. The business of the firm is in healthy condition.

The Sherman Saw Mill Company has erected a small hardwood sawmill near Gladwin with a capacity of 15,000 feet a day.

The Kneeland, Buell & Bigelow Company is cutting out a lot of fine maple timber as well as boards. Some of the timber is 22 feet long. The manager says the trade is good and they have all they can comfortably attend to and at that their orders keep ahead of them. The company carries about 4,500,000 feet in the yard.

The Kneeland-Bigelow Company mill is running day and night and is carrying in the yard over 4,000,000 feet of lumber.

Bliss & Van Auken always have a business that is satisfactory and one that keeps their plant in operation day and night. They also operate a flooring plant. The maple flooring business is very good this season.

Holmes & Nicholson shipped from Rogers City a few days ago a cargo of hardwood lumber that had lain on the dock eighteen months and was dry as a bone. It went to Detroit.

The H. M. Loud's Sons Company at Au Sable is manufacturing some fine hardwood lumber and has shipped several cargoes to Lake Erie ports.

### Grand Rapids.

The Hackley-Phelps-Bonnell Company recently opened new yards at Helena, Ark. Chas. A. Phelps is in Hackley, Wis., looking after the cutting and manufacturing operations. Large quantities of basswood and birch are being cut at the double band mill plant.

The Lumbermen's Association of Grand Rapids held an enjoyable meeting at the LaFeside Club May 29 and President Carroll F. Sweet was heartily congratulated on his election to the directorate of the National Hardwood Lumber Association. It was decided by the association to hold monthly meetings.

Imports of mahogany logs by local furniture manufacturers for the past 12 months reached a total of 684,000 feet, as compared with 488,000 feet for the year preceding. The 15 per cent duty on mahogany lumber has shut off the receipts of lumber almost entirely.

The Cobbs & Mitchell mill at Cadillac is making an average cut of 30,000 feet during the night shift.

The mill of the Wisconsin Land & Lumber Company at Hermansville, Menominee county, will cut about sixteen million feet of logs this season, or two million feet in excess of last year's cut. New machinery has been placed in the flooring department.

Harry Kneeland of Traverse City is trying the experiment of raising black locust trees on an eighty-acre tract of cutover land near Mayfield. He proposes to set out the entire tract and it is estimated that in 10 years the trees will be big enough for ties or posts.

John J. Foster of Greenville, president of

the Foster-Winchester Lumber Co. of this city, was in Grand Rapids June 5 on a short business trip.

Fire has destroyed the sawmill of the Gorham Bros. Co. at Mt. Pleasant, with loss of about \$12,000. The water supply pumps were put out of commission, which necessitates a shutdown of the entire woodworking plant, employing nearly 200 hands.

The 15th wedding anniversary of Mr. and Mrs. John F. Ott, the well known lumber manufacturer of Traverse City, was observed in that city June 2 and proved to be the prettiest social function of the season.

The Grand Rapids committee of the Michigan Forestry Association held an enthusiastic meeting in Chas. W. Garfield's office June 4 and discussed the importance of securing effective legislation for preventing and controlling forest fires in the state. Prof. Roth, state forest warden, will spend most of his summer vacation in the state reserve lands, looking after the establishing of fire lines. Three fires started in the reserve during May and two of them were put out before any damage was done, while the third burned over about 100 acres, but happened to be in a section where there were few young trees to be injured.

Most of the refrigerator plants of the state are working to their full capacity. The Alaska Co. of Muskegon Heights will turn out 50,000 refrigerators at the close of the fiscal year, July 31. During May 66 carloads of lumber were unloaded at the plant. The company has just received the first shipment of 1,000,000 feet of ash bought at Manistee last winter.

The Brunswick-Balke-Collender Company expects to start the manufacture of billiard and pool tables and balls at its Muskegon factory in September. The new factory buildings require a million and a half feet of lumber and the builders state that the market price of this lumber has advanced \$5,000 since the contracts were placed less than a year ago.

L. L. King, for many years with the J. E. Greulich Co. of Traverse City as estimator, has accepted a position with the W. H. White Co. at Boyne City.

The Cartier-Chapman Co., manufacturers of sleighs, cutters, etc., at Ludington, after being in operation less than two years has found it necessary to erect larger buildings and the capacity of the plant will be doubled. The main addition is 60x160 feet, and there is a new machine room and blacksmith shop 50x50 feet.

Hardwood logs loaded on barges are being brought down from Drummond island this summer by the Ludington Woodenware Co.

George A. Hume of Muskegon has returned from a trip to the Hume-Bennett Lumber Company's properties in Fresno county, Cal. The company has rebuilt the smaller mill and it is in operation, cutting 75,000 feet daily, while the new mill, with cutting capacity of 100,000 feet, will start up about June 10.

### Indianapolis.

There is no change in the carpenters' strike, which has been on here since May 1. The carpenters demand an increase of wages from 37½ to 42½ cents per hour, which the contractors refuse to grant. As a result over 250 carpenters are on strike, while painters and machinists, to the number of 150 each, are also out. The strike is having little effect on building operations, as many non-union workmen have been put at work in place of the strikers.

In discussing the high prices prevalent on all kinds of lumber, Sam Burkholder, the well-known lumber dealer of Crawfordsville, Ind., says that people are too much inclined to blame the lumbermen for high prices. "As a

matter of fact," says Mr. Burkholder, "the lumber dealer can not help the high prices. While he is now getting from 80 to 100 per cent more for lumber than he did five years ago, he is also paying from 200 to 300 per cent more for stumpage. So it is in reality the farmer or timber owner who has trees to sell who gets the real benefit of the high prices."

The sawmill of Jacob Raab at Raab's Corner, Ind., was recently destroyed by fire, with a loss of \$1,500, and only \$500 insurance.

The plant of the Star Carriage Company of Rushville, Ind., has been removed to Huntington, where the owners were offered a building and a bonus.

On the night of May 29 fire of unknown origin damaged the lumber yard of Henry Maley of Evansville, Ind., to the extent of \$75,000. There was but \$15,000 insurance carried by the firm.

The sawmill belonging to James Everson of Crawfordsville, Ind., has been purchased by Hill & Robinson of Flat Rock, Ind., for \$2,350. Mr. Hill will remove to Crawfordsville to assume active management of the mill. Hill & Robinson own several sawmills in Indiana.

### Asheville.

At an adjourned meeting of hardwood manufacturers of western North Carolina, held at the Battery Park hotel here Saturday afternoon, May 26, the Asheville Lumber Exchange was permanently organized, officers elected, and other business of importance transacted. Although the Asheville Lumber Exchange is an independent association it will co-operate with the Hardwood Manufacturers' Association of the United States and may eventually be consolidated with that organization. The meeting was called to order by W. T. Mason; Louis Doster, secretary of the Hardwood Manufacturers' Association, was made temporary secretary. The minutes of the previous meeting held at the Swannanoa Country Club when the organization of the Asheville Lumber Exchange was determined upon, were read by Dr. C. A. Schenck of Biltmore. Dr. Schenck outlined his conference with the Southern Railway officials relative to freight rates and said that the Southern was willing to make reasonable concessions if certain shipping regulations were complied with. A motion was made that a committee from the Lumber Exchange be appointed to attend the meeting of the Freight Agents' Association at Lake Toxaway June 10. The motion prevailed and a committee composed of Dr. Schenck, chairman, and Messrs. English, Fisher, Hutton, Hobbs, Hall and Wood was appointed.

Mr. Winchester of the Committee on Permanent Organization, made a report recommending that the name of the association be the Asheville Lumber Exchange. A constitution and by-laws were submitted, approved and adopted.

Officers for the exchange were elected as follows: W. T. Mason of Asheville, president; John M. Burns of Asheville, vice-president; A. F. Hall of Asheville, secretary and treasurer; directors for two years, G. N. Hutton of Hickory and W. N. Woodbury of Murphy; directors for one year, E. E. Quinlan of Waynesville and G. L. Wood of Asheville. Honorary members were elected as follows: Judge J. C. Pritchard of Asheville, M. V. Richards of Washington, D. C.; J. F. Hayes and J. H. Caine of Asheville.

A resolution was adopted inviting the Hardwood Manufacturers' Association to hold its next meeting in Asheville.

Among those attending the meeting were: J. O. Foering, H. W. Fry, F. C. Fisher, J. M. Burns, R. H. Johnson, W. T. Mason, A. F. Hall, A. H. Winchester, C. E. Gordon, J. E. Dickerson, A. J. Combe, G. H. Hutton, E. H.

Hall, C. A. Schenck, Wm. Stevens, F. L. Winchester, L. M. Ewbank, J. A. Murray, J. M. English, W. H. Wilcox, C. H. Hobbs, Burt Mason, A. Buchanan, J. L. Clute, L. C. Williams, F. A. Fuller, J. E. Hawthorne, A. R. Stimson, W. K. Merrick, J. C. Tarkington, W. J. K. Osborne, Lewis Doster, W. G. Chandler and J. H. Caine.

The Asheville Lumber Exchange will hold two meetings annually and other meetings upon the call of the president. The principal object for which the association was formed was to further the cause of uniform grading.

### Nashville.

The Jamison Manufacturing Company has been organized here with a capital stock of \$50,000. The incorporators are: H. D. Jamison, Robert Dyas, R. Houston Dudley, E. J. Shepherd, E. M. Shepherd and T. S. Sims. Mr. Dudley has been elected president of the concern, Mr. Dyas is vice-president, Mr. Jamison is secretary and general manager, and E. J. Shepherd is treasurer. A full line of up-to-date furniture will be manufactured. The company has a large warehouse and factory in North Nashville convenient to the Illinois Central and the N. C. & St. L. Railway.

The Palmetto Manufacturing Company, a concern recently organized in Nashville to manufacture axe, hoe and broom handles, brackets, etc., has the following officers: W. H. Cooper, president; William Lowndes, vice-president; W. H. Hicklin, secretary and general manager. The directors are: L. D. Matthews of Arkansas City, Ark.; William Lowndes, Birmingham, Ala., and Dr. H. T. Campbell, W. H. Hicklin, John S. Woodall, John H. Samuel and W. H. Cooper. The company has secured a brick structure in North Nashville on the L. & N. and the Illinois Central tracks. Machinery is now being installed and the concern proposes to begin operations in the near future.

The Nashville Association of Carriage and Wagon Makers met this week at the rooms of the Board of Trade in regular session. An invitation was read setting forth a request from the National Association of Vehicle Makers urging an attendance at the next annual convention to be held in Atlanta, Ga., during October, 1906. The Atlanta Vehicle Club also requested that the Nashville manufacturers take in their exhibit. The Nashville carriage and wagon manufacturers will arrange to send delegates to both.

R. J. Darnell of Memphis was in the city recently purchasing hardwoods, poplar being the principal item sought.

The American Hardwood Lumber Company of St. Louis is establishing a large lumber yard at Dickson, Tenn. The plant will be in charge of John M. Smith, the well-known lumberman who recently had such a disastrous experience with the Creelman interests of Chicago. The company proposes to buy and ship all classes of marketable lumber.

Farmers in this section are making complaints about the unusual number of bugs and insects that are infesting the trees this summer. They declare that the seventeen-year locust, which is the most dreaded of all pests, is on hand in large numbers. The Tennessee Department of Agriculture has been appealed to for information as to how to get rid of the bugs.

A special from Mount Sterling, Ky., states that the boiler in the plant of the Lyons Company near Frenchburg blew up, killing three men and fatally injuring three others. The financial loss to this sawmill is also reported heavy.

A recent visitor to Nashville was G. H. Gross, superintendent of telegraph for the Illinois Central Railroad. Mr. Gross came to Nashville in company with his assistant, B.



Weeks, and their mission was that of looking into the supply of red cedar and chestnut poles left in Tennessee.

The secretary of state has granted a charter to the People's Lumber Company of Hamilton county, with a capital stock of \$4,000 and incorporators as follows: J. F. Nipper, W. R. Sullivan, W. M. Settlers, A. G. Gouss, J. A. Varner and Frank Jones.

The E. & N. Manufacturing Company, one of the largest woodworking plants in the South, has just been awarded the contract to supply the interior fixtures of the new Castner-Knott building in course of construction on Church street. The contract is worth about \$50,000. This concern also secured the contract to furnish the interior finishings for the department store of C. A. Kaufman of New Orleans.

One of the most spectacular fires seen for many a day in Nashville was the burning of a big wooden water tank on top of the E. & N. Manufacturing Company's building, supplying the sprinkler system with water and holding some 15,000 gallons. The flames could be seen in all directions as the tank was on top of a high building and mounted on trestlework at that. The fire caught from sparks from a smokestack of the plant. The loss was only a few hundred dollars.

The big furniture plant of the Greenfield-Tolbert-Finney-Battle Company on Third avenue, North, burned out a few days ago. The company carried about \$50,000 worth of stock and all of it was either burned or seriously damaged. It was fully insured.

Lewis & Vick are erecting a large planing mill at Camden, Tenn.

Dealers at Munsey, Ill., have recently placed an order for 75,000 hickory spokes with the Alexander-Coffee Company at Yokelet, Tenn., near Lynnville. This is a new plant and has a capacity of 10,000 spokes a day. Hickory is reported to be plentiful in that region.

Manchester, Tenn., suffered quite a serious loss by fire on May 31. The big Manchester Manufacturing Company's factory went up in flames, entailing a loss of \$18,000. The buildings caught from a pile of shavings. J. R. Tubb of Sparta, Tenn., and T. B. Clark of Manchester are the principal losers.

Hamilton Love of the firm of Love, Boyd & Co. is at Mount Clemens, Mich., for his health.

### Memphis.

Negotiations are under way here for the consolidation of two prominent lumber companies operating from Memphis headquarters. Those directly interested say that plans have not yet been completed and that for this reason they are not yet in position to give out any details thereon. It may be stated, however, that the corporation resulting from this consolidation will be a very strong one, that it will control a large area of timber lands and will have several mills, one of which is located in Memphis and the others in Mississippi.

Interests identified with the Bacon-Nolan Hardwood Company are preparing for the erection of a large hardwood mill at Charleston, Miss. The Illinois Central is now building a railroad from Phillips, Miss., to Charleston, and this will run directly through the body of timber lands owned by the interests in question, thus materially facilitating their development. In fact, the statement is authorized that the road, which is a branch line, is being built principally to aid in the development of this immense tract of timber lands.

The Corner Stone Lumber Company, organized here a short time ago with capital stock of \$350,000, will erect its mill at Corner Stone, Ark., a station on the St. Louis Southwestern railroad, from which it takes its name. The company controls about 15,000 acres of hardwood timber lands and, as soon as the papers

have been prepared and the bonds, which are to run twenty years and bear five per cent interest, issued, steps will be taken looking to the development of these holdings. C. W. Stover of the Stover Lumber Company is the principal local stockholder.

The sawmill and warehouse of W. S. Mayes, Mt. Carmel, Tenn., about five miles from Covington, were destroyed by fire a short time ago, entailing a loss of about \$5,000, with no insurance. The warehouse was filled with dressed lumber, doors, sash, blinds and other material.

Fred Herriek and associates of Lac du Flambeau, Wis., who recently acquired the 50,000 acres of timber lands owned by Foley & Larson of St. Paul in the Pearl river valley in Mississippi, are acquiring other tracts of both hardwood and yellow pine lands. Tennessee and Louisiana capitalists are also reported to be operating with freedom in the purchase of timber lands in Leake, Winston and Neosho counties, further up in the valley, their purchases being estimated in excess of \$1,000,000. It is believed that these purchases insure the building of a railroad through the valley to facilitate the development of the land.

The Illinois Central is making a preliminary survey for a railroad running from Aberdeen, Miss., to Sheffield, Ala., with the purpose of establishing direct connection between the Illinois Central and the Tennessee river. The Aberdeen Business League is behind the project and regards the new line as assured. The road will run through a magnificent section of hardwood timber lands in northeastern Mississippi and northwestern Alabama.

An assessment of 50 cents on the dollar has been ordered levied on all the stockholders of the recently failed Bank of Newport, Newport, Ark., which closed its doors because of its inability to realize on its claims against the C. B. Kelly Lumber Company of Texarkana, Ark. The latter company is now in the hands of receivers and its plant is being operated for the benefit of creditors. The mill and other holdings will be sold July 7 under orders of the Federal Court.

L. C. and E. H. Nolan, who were stockholders in the Bacon-Nolan Hardwood Company, have withdrawn therefrom, and are now erecting a large tight heading factory in New South Memphis which will soon be in operation. Hardwood timber will be used exclusively in the manufacture of this product.

Russe & Burgess have suffered a slight delay recently in the operation of their re-saw occasioned by the bursting of the fly or drive wheel on the engine running the re-saw. The accident damaged the building and foundation of the engine considerably, but no serious injury or loss of life occurred. They have found the same engine in stock here and are now running again on full time.

The Royal Cafe, operated by the Max Koppel Catering Company, in which a number of prominent hardwood lumbermen here were interested, has been sold to L. D. Block and will be reopened by him about June 15. Max Sondheimer was one of the principal promoters of the company.

J. W. Thompson of the J. W. Thompson Lumber Company has been spending considerable time at Selma, Ala., recently where some changes are being made in the Schuh-Miller Lumber Company in which he is interested.

Mr. Kile of the Kile & Morgan Co., Providence, R. I., who is one of the larger stockholders in the Tyrone Lumber Company at Earle, Ark., was a recent visitor here, enroute to Earle to look after the interests of his firm.

W. E. Smith of the W. E. Smith Lumber Company and the Three States Lumber Company has gone to his old home at Eau Claire, Wis., where he will spend some time in the

hope of regaining his health. Mr. Smith has been in poor health for some time. Mr. Greble is looking after the affairs of the two companies during Mr. Smith's absence.

George Banks of the Banks Lumber Company, Hernando, Miss., was in the city this week.

A railroad has been projected from Marianna to Brinkley, Ark., a distance of 30 miles. A company, known as the Marianna, Brinkley & Western, has been formally chartered.

George C. Ehemann of Bennett & Witte and secretary of the Lumbermen's Club of Memphis, is out of the city on business connected with his firm.

### New Orleans.

A deal whereby the Pensacola Lumber Company and the William S. Keyser Lumber Company, both of Pensacola, Fla., were merged into a half million dollar concern was consummated June 1 in Pensacola. These two companies have for many years been ranked with the largest exporters of lumber and timber in the South. A name for the big concern has not yet been decided upon. The Keyser company was composed of Mr. Keyser and James M. Muldon of Pensacola and William Rudolph of Biloxi. It had offices at Biloxi, Gulfport, Mobile and Pensacola. The Pensacola Lumber Company was composed of F. C. and D. G. Brent, W. H. Knowles and F. R. Meade of Pensacola and foreign capitalists. It had offices at Pensacola and London, Eng.

Between \$700,000 and \$800,000 will be invested by Michigan capitalists in a large hardwood plant which they purpose to build in Ouachita parish, Louisiana. The land on which this plant will be built was secured recently by an act of sale transferring from Capt. L. D. McEain, of Ouachita, to the Oak Lumber Co., of Michigan, a large tract of land south of West Monroe and just across the river from the Monroe Lumber Company's plant. All the hardwood on the Monroe Lumber Company's lands has also been secured by the Oak Lumber Company. The site for the big mill is now being surveyed and it is expected it will be completed and in operation in less than a year.

Stockholders of the Otis Manufacturing Company, of mahogany fame, and of S. T. Alcus & Co., box manufacturers, recently formed the Otis-Alcus Lumber Company, Ltd., with a capitalization of \$100,000. The officers are S. T. Alcus, president; Henry Alcus, vice-president; Henry A. Otis, secretary, and Rowland Otis, treasurer.

Advices from Gulfport, Miss., state that for the month ending May 31, Gulfport exported 84 per cent of the lumber handled in the district between New Orleans and Mobile. The total exports for the district, it is stated, were 36,983,000 feet board measure, and of this amount Gulfport is credited with 30,557,000 feet. This was lumber actually loaded on vessels at the wharf at Gulfport, and does not include a foot brought by vessels from other points to Gulfport, where the remainder of the cargo was loaded.

The Eoice Realty Company, Boice, La., will build a sawmill of 30,000 feet daily capacity about two miles from Boice on the Texas-Pacific Railway. The company owns 12,000 acres of cottonwood, oak, ash and cypress timberlands. It is expected that the plant will be in operation in about two months. A. A. Joiner is president of the company; interested with him are W. R. Borron, J. Dawson Johnson and E. L. Joyner.

### Minneapolis.

Thomas E. Powe, vice president of the Pummer Lumber Company of St. Louis, was in Minneapolis this week interviewing customers. He makes this territory about twice a year and reports an increasing use of cypress



by the sash and door trade on the upper Mississippi. He also finds good sale for it as yard stock, in mixed cars with poplar, to the retailers of the Northwest.

Pert Trump, representing Thomas & Proetz of St. Louis, was also here this week calling on the trade, and at the same time came Ted Jones of the G. W. Jones Lumber Company, Appleton, Wis. L. K. Miller of Chicago and Otto Meyer of the Donsack Lumber Company, St. Louis, have also been here recently.

The building movement is lighter at most northwestern points, including Minneapolis, than it was last year.

E. Payson Smith, Jr., has returned from a trip to down river points. George S. Agnew, associated in the Payson Smith Lumber Company, is back from an extended stay in Mississippi, where he was looking after shipments of stock contracted by the company. A. S. Bliss says the company has been enjoying a good business; sales for the five months of 1906 are equal to the entire year's business in 1905.

F. M. Bartelme, formerly with Upham & Agler, but who since March 1 has been in the wholesale hardwood business here on his own account, returned this week from an extended business trip among the Wisconsin mills. He is handling a good line of northern hardwood, and expects to take on some southern stock a little later.

W. H. Sill of the Minneapolis Lumber Company says his company is about cleaned out of dry northern stock in oak and elm, except a small stock left at the Ruby Lumber Company's mill at Ruby, but it is shipping new basswood at good prices, and soon will have some new birch on the market. The company has already contracted for the sale of about two-thirds of its new stock.

D. F. Clark of Osborne & Clark is back from a business trip to Chicago and Milwaukee. This firm reports a rather light demand for yard stock, but general conditions in the trade satisfactory.

White birch blocks for paving will be given a test in Minneapolis, with the various soft woods. The Forest Service is conducting the test on a Minneapolis city block, with the aid of the city engineer. The other woods being tested here are fir, larch and spruce from the west coast, Norway pine, jack pine, tamarack and hemlock. Southern woods are to be given a similar test at Washington.

#### Louisville.

A new company has been organized in Louisville for the purpose of manufacturing hardwood flooring—the Louisville Hardwood Flooring Company. The company is capitalized at \$100,000, and the officers are: Chas. H. Stotz of the Stotz Lumber Company, president; W. R. Willett, vice president, and T. E. Blood, secretary. Both Mr. Willett and Mr. Blood are already associated with Mr. Stotz in the lumber business. A tract of ground in south Louisville, two or three blocks from the Stotz Lumber Company's present yard, has been purchased on which the new flooring plant will be established, and to which the Louisville lumber yards of the Stotz Lumber Company will be moved. The Stotz Lumber Company, in addition to its heavy volume of business in hardwood lumber in the North and East, has an excellent local trade in hardwood flooring, which it thinks will probably take care of 60 per cent of the product of the new flooring plant. The Louisville Hardwood Flooring Company will make a specialty of oak and beech flooring. The machinery equipment has not yet been purchased, but it is to be the best and most up-to-date from dry kiln to piling shed.

The Platter-Powell Company, which is a branch of the North Vernon Pump & Lumber Company, North Vernon, Ind., operating a mill in southwest Louisville, will add a hardwood

flooring factory and planing mill to its plant in the near future. The company is holding back now until the city puts through a street bordering the plot of seven acres of ground, on which the factory will be located.

The mills on the Point are running steadily, the only complaint being that labor is scarce and they can't get enough hands to keep things moving as they would like.

Mr. Overstreet of the Southern Lumber Company says what has worried him most this year has been the inability to get lumber hauled to the railroads from country mills. He says he has grown tired of making excuses

to customers for delayed shipments when he has had the stock at the mills ready to ship, but has been handicapped by lack of teams to move it. Conditions are improving, however, and from this time on there will not be much trouble in getting teams enough to do all the hauling wanted. Mr. Overstreet says this experience is enough, however, to cure him of selling stock and promising shipment at a specified time without first getting the stock piled on the railroad. He says the demand is good for both poplar and oak, and he finds no trouble at all in disposing of all he can get to market.

## Hardwood Market.

(By HARDWOOD RECORD Exclusive Market Reporters.)

### Chicago.

Inquiries among the local jobbing trade reveal some peculiar features. Holders of dry stocks of oak, gum, poplar and other southern woods are having an excellent trade. In fact, some dealers report having made the best business record of their history during the last month. Other dealers who have not been thus fortunate in owning good stocks of the classes of woods named complain that trade is dull with them.

Inquiry among the furniture, house finish, flooring and other manufacturers consuming a large quantity of hardwoods demonstrates that generally they have taken pretty good care of themselves and are in possession of fair stocks. There has been a little spurt in the demand for basswood during the past fortnight, but generally speaking the trade in other northern woods, such as maple, birch and gray elm, has been only moderate. Black ash and rock elm are in extraordinary request and approximate in demand even the best of the southern woods. The trade feels optimistic over the situation, and thinks there is prospect of an excellent business all through the season.

### Boston.

Strength prevails in the demand for hardwoods, but taking the market as a whole it is not active. In some branches, however, there is a fair demand. Furniture manufacturers have a fair amount of orders ahead and are nearly all in the market for small lots. Some of the local manufacturers are having labor troubles, but it does not keep them from placing orders for lumber. Desk manufacturers continue busy. Nearly all have a fair stock of lumber on hand and bought to arrive, but wholesalers report new orders. The export demand has not ruled active of late, although there is a little more inquiry than there was. Exporters state that if prices were lower a much larger business could be done.

The yards are very well stocked. A very good inquiry continues for plain oak. No weakness is found in quartered oak, although the demand is not active at present. Elm has not been attracting a great deal of attention of late. Black walnut moves in a fair way without any change in prices. Offerings are not large. The usual call for mahogany is reported.

The demand for maple flooring is moderately active and prices hold steady. Whitewood is firmer and the demand fair. Dry stock is in small offering, but larger blocks are expected in about a month.

Cypress is in larger offering, with prices unchanged.

### New York.

At this writing there is no question but that the buying activity in the hardwood trade of New York and vicinity is considerably less than at this season last year, but after a care-

ful consideration of conditions it may be said that there is not the slightest warrant for any foreboding. There is not a lumber yard or a woodworking establishment, except perhaps piano manufacturers and a few others with whom this is always a dull season, which is not running actively, with prospects excellent for the balance of the year. And they are not buying freely simply because so many were caught short of lumber last spring and summer that this year they did their buying early and supplied their wants in January, February and March, instead of waiting until later in the season. It is generally conceded that within thirty to sixty days, or just as soon as the dealers unload sufficiently, buying will be resumed along normal lines.

In the meantime there is nothing for the manufacturer and wholesaler to do but wait. Lumber has moved so freely in the hands of manufacturers and wholesalers during the past few years that they are apt to jump at conclusions relative to market conditions too quickly and endeavor to make concessions here and there to keep up the pace of recent years, but if they properly judge conditions at buying end of line, they will wisely wait.

In plain oak, ash, chestnut and birch there is no surplus stock in the better grades. Purchases are sufficiently free to absorb the offerings and maintain prices, but any increase in demand would immediately force a shortage and put up prices. Every buyer who orders "wants it quick," which indicates actual conditions of supply and also the futility of concession as a means to trade. Quartered oak and maple are slow, and basswood only fair. The hardwood flooring trade is enjoying very fair activity. Poplar is easily holding its own, both in price and demand.

### Philadelphia.

The local market continues good with fair trade, although the demand experienced lately has not been unusual. In fact, at this season of the year, local dealers expect a slight falling off, preparatory to the increasing volume of summer business. The past Spring has been a good one in lumber circles hereabouts, furniture trade and building activity having been sufficient to keep the dealers busy. Yard sales are good. Shipments to local points have been rather heavy during the last fortnight. One of the big local concerns found that every storage yard on the B. & O. was filled, with a practically similar condition prevailing on the Reading line.

The better grades of poplar have stiffened lately and this is the case with all woods. The consensus of opinion among the trade is that if any change at all is impending it will be advance. Several firms declare now that prices are better today than for a long time heretofore. Cypress is steady, with a considerable quantity still coming into the market. Quartered white oak is strong and chestnut is very good. Basswood is doing

well, cars of this wood being very easy to dispose of in this market. Generally speaking, yards are very well supplied owing to recent shipments, while buyers report stocks at mills short, nearly all the local wholesalers making advances to the millmen while cutting.

#### Baltimore.

The hardwood situation has undergone no important changes during the last two weeks. Demand is active, and prices are ruling high. Most consumers have enough orders in hand to keep them going for an indefinite period, and all calls for lumber are urgent. Oak is eagerly sought, at satisfactory prices. Railroads and car builders are buying large quantities of lumber. Now that all the mills are running to the limit of their capacity and the roads are in better state, the receipts at points of distribution are expected to attain exceptional volume.

Poplar is strong. It needed only moderate prices for poplar to get back to its former position, and at the present time it is being used as extensively as ever. Large quantities of it are being shipped abroad, and dealers continue to assert that manufacturers must be making lower prices on this foreign business than they get at home. Ash is moving freely at firm prices. So far, however, the mills have been unable to make any gains on the consumption, and stocks are not in excess of current requirements. Car builders are also taking large quantities of this wood, which stands second to oak in point of popularity. Walnut continues to be demanded for home consumption as well as for export. The domestic revival in the use of the wood is still in evidence, and lumber and logs of marketable quality find ready takers at acceptable figures. Mahogany and all other hardwoods are holding their own, and the entire trade is reported in a prosperous state.

#### Pittsburg.

Of all wholesalers in Pittsburg the men who deal in hardwood lumber have the best reason to feel good these days. In the face of severe complaints about a surplus of stock in the local yards and an oversupply of yellow pine the hardwood men are reporting a busy condition of affairs all along the line. It is true that local demand is curtailed somewhat by the carpenters' strike, but the falling off is not at all serious and is more than counterbalanced by the extra orders which hardwood men are getting from outside. Practically every firm in the city reports a brisk outside trade and building statistics show that in the outlying towns the general call for lumber is much better proportionately than in the city proper. Besides, the demand for heavy stock for railroads and manufacturing is increasing steadily and is at present making up a good part of the trade.

For the better grades of hardwood Pittsburg has never seen a more active market. Most of this stock goes east and to the big furniture towns in the middle west. The concerns are reported to be working overtime and the trouble they have had the last two years in getting sufficient dry stock to run them has taught them to order heavily at the start. Locally the demand is for railroad stuff, ties, poles, timbers, and for house building lumber.

Hardwood men see by far the best season ever experienced in Pittsburg and prices are all shading a little above list. No official changes have been announced for some time in the lists, but if the present demand continues long, a readjustment, especially in the prices of oak, will be necessary. Collections are reported excellent and less difficulty is reported in getting large sums to finance lumber operations than in April and the early part of May, two conditions which are decidedly favorable to hardwood interests.

#### Buffalo.

The hardwood lumber trade is still gaining slowly on pine and is in condition to hold its own against everything else, the only real difficulty being the scantiness of stock. Of course, prices are stronger on that account, though dealers would be glad to see prices much lower if it would mean an easy supply of lumber. Present prices are obtained only because all sorts are hard to get and the demand for it all is good. The only way of keeping in the trade at all is by keeping hard after new stock all over the country.

There is still some report of chestnut coming in from one direction or another, but it is selling strong on account of its not being in full supply and not being likely to be again. Plain oak is selling strong, for there is nothing to take its place now. Birch, as a substitute for quartered oak, is a little more plenty, but it is not a wood that is likely to last as oak does, either in supply or in use, so oak must still be the stand-by.

Some ash is again coming down the lakes, but it is not plentiful enough to depend upon for anything. Dealers are using maple and Washington fir in place of it. The demand for basswood and elm is light, as the consumer does not care to pay the prices. Poplar is about as scarce and high as any wood and it will command its price unless there is a summer freshet to bring in the left-over logs.

A hardwood dealer, complaining of the hard work he is having to get oak, says that there is but one thing for the consumer to do and that is to accept lower-grade lumber after this. They think nothing of a knot in the lumber used in England, he says, and we are coming to the same state of things. The story of no supplies in this or that sort of wood cannot last always without meaning something.

Most of the Buffalo hardwood dealers have been saying all season that they are not keeping up stocks, though they seem to manage to keep a good assortment. In fact, the problem of the trade has been for some time how to keep everything in one's line and still carry a steadily lighter stock. One point is to be neighborly, so that when anything is wanted it goes if anybody has it. The handling of the entire stock here more and more as one is quite necessary.

#### Saginaw Valley.

The hardwood market is in good condition, and shipments are free. The stock goes out in car lots and some grades are not in sufficient supply to meet the requirements of the trade. Ash lumber is particularly firm and active at \$27 for No. 2 common and better. Basswood has also been sold up closely, some manufacturers having disposed of their entire output for the season at \$23, culls bringing \$15. Birch is in more restricted supply and is firm at \$20 to \$22.50. Maple is held at \$16 to \$18, and some maple timber has been sold at \$20. Beech is held at \$13 to \$14, and there is quite a call for it for the manufacture of pulleys, for screens, and considerable quantities of it go into flooring, while the culls are taken by the box makers as a substitute for higher priced pine.

#### Grand Rapids.

There will be no special activity in furniture stock until after the furniture sales, which will open June 18 in this market. The outlook for business the coming season from the manufacturers' standpoint is first-class. Cull lumber and crating stock of all kinds is in active demand. Plain oak is firm as ever and there are indications that the quartered stock will be strong at advanced prices before the close of the year.

#### Indianapolis.

According to hardwood dealers of Indianapolis, all grades of hardwoods are holding steady at satisfactory prices. The present outlook seems to indicate a continuance of present conditions.

On account of the high prices prevailing on building materials, building in Indianapolis has somewhat slackened this spring. Builders, it seems, have been waiting for a decrease in price, and lumber dealers say they will wait in vain. Indeed, it is the opinion of some dealers here that prices are not yet as high as they will be, many predicting a rise within the next few weeks. Time was when Indiana produced considerable hardwood lumber and ranked well as a producer in this line. Now practically all the hardwood sold here comes from the South. However, according to figures obtained by the forest service on the lumber cut of 1905, only four states—Michigan, Kentucky, Arkansas and Tennessee—exceeded Indiana in the production of hardwood timber and Wisconsin and Indiana were tied.

#### Milwaukee.

Business is exceptionally dull, due in large measure to the high prices obtaining. Buyers are not very anxious to close contracts, but offers at reasonable figures are snapped up by astute firms. Local traders do not expect any change for some weeks and possibly not until Fall. On the whole the volume of sales today is no larger than last February. Lumber is very scarce and exceptionally fine lots are held at high prices. A scarcity has made itself felt in choice oak. At the same time building conditions are not on a par with last year's record at the corresponding period. It is generally believed, however, that an improvement in this line will make itself felt shortly, bringing about better conditions in all lines. The John Schroeder Lumber Company reports a growing demand for hardwood flooring. Prices on this commodity are kept at a very low figure in spite of the demand and architects are specifying such floors almost exclusively in all new buildings.

#### Asheville.

Trade continues good. There is an increasing demand, while the supply remains short. Chestnut and poplar are the leading woods, with prices for poplar still on the increase.

#### Nashville.

Scarcity of dry stock in hardwoods, good trade, and brisk prices are the characteristics of the Nashville market at this time. What is termed by local lumbermen as an "old time spurt" is noticeable in the poplar trade at present. Two reasons for this are given. To begin with those who have been using substitutes for this wood have found the practice does not pay, and, secondly, it is stated that the prices of the substitutes vary so little from those of poplar itself that the difference is not worth while as poplar is more desirable in the long run.

The local demand for chestnut and plain oak and ash is most noticeable, and they are selling in the order named. Lumbermen are entirely satisfied with conditions and all are out looking for more timber.

#### Memphis.

It is generally conceded that inquiry for hardwood lumber here is not so active as a short time ago, but the trade is optimistic as to the future. Large bookings have been made during the past few months and these will furnish activity for some time, while a steady flow of orders for early shipment will supplement the former bookings. There is a general shortage of dry lumber. The mills are now making better progress in getting out stock than for some months, but this output

will not be ready for use for some months, with the result that, while it may cause some checking of the demand, it will have little bearing on prices during the period before it is available. The smallest demand appears to be from the New England States and from the East generally. The northern and western buyers are still operating on a fairly liberal scale. Prices range firm on the general list, with one or two items particularly strong.

The demand for ash continues good, the available supply limited. The call for thick stock is particularly strong.

Cypress is moving readily at full quotations. Dry stocks are still much broken, and buyers are not losing time in securing their requirements.

Cottonwood is in good request, and the indications are that it will continue so as the box manufacturers are doing a good business and making large demands. There is not a great deal of dry stock on hand and prices are well maintained on all grades. Taken as a whole, there is less progress in cutting cottonwood in the interior than is noted in connection with any other item of the list.

The call for gum is moderately steady with prices fair. The fear is expressed that the disposition of interior manufacturers to sell their output ahead will have the effect of weakening the market during the summer. There are some manufacturers, however, who assert that, if gum is properly manufactured and carefully handled, there is no reason why it should not find excellent sale at prices now current.

Plain oak continues in good demand in all grades and dimensions, but there is not much business in quarter-sawed stock. There is relatively better call for white than red, in both plain and quartered stock. Prices on plain oak are pretty well maintained while those on quarter-sawed are steady.

Poplar is in moderate request, with the volume of offerings in this market and throughout this territory decidedly light. Prices show no material change.

#### New Orleans.

Conditions which prevailed throughout this section up to sixty or ninety days ago, and which seriously affected the cut of hardwoods, are now beginning to affect the market. Stocks are low and the demand exceeds the supply. This prevails despite the fact that the usual summer conditions have obtained, and notwithstanding that buyers have to a large extent ceased operations. Prices have, of course, been materially affected by the short stocks and good demand.

In the last sixty days favorable weather for logging has prevailed and there are reasons to believe that when the buyers do become active again in the fall there will be plenty of hardwood to supply the demand. At present the export demand is good and considerable lumber is being shipped from here.

#### Minneapolis.

Twin city dealers in hardwood are all optimistic over the prospect for the season's business. They have found a healthy disposition on the part of some large consumers to contract for hardwood supplies in large quantities, and at prices that are quite consistent with the market. There is not a great amount of stock moving now, as the yard trade is quiet and many of the factories are still working on stocks purchased in the winter. There is a good volume of car orders reported. Birch is the leading seller and there is plenty of it. If the demand for birch should weaken there would be a scaling down of prices, since there are some large stocks of last season's cut left over, and the new stock will be ready to ship from a good many mills in a couple of weeks. Basswood culls are strong in price. Consumers are slow to

buy, but will have to come to the higher prices soon. New basswood stock is moving rather freely.

Oak is in steady demand, some dealers reporting a slight reaction and weakening in the price of red oak. Ash, soft elm and rock elm are very scarce, the last especially so. There is a good demand for maple, and the call for flooring is quite equal to last year. The retail yards are not taking much wagon stock now.

Leading factory buyers report that they have stocks of nearly all hardwoods used heavy enough to last for some weeks. They will not do much buying, except to provide for immediate needs, until after the first of August, when the result of the crop season is pretty definitely known. There is a generally prosperous condition among the factories, and they are consuming hardwood at a record-breaking rate.

#### Toledo.

The general condition of the hardwood trade in this city and section is good. Prices are firm on all hardwoods, and the demand active. All grades of ash are in very strong call. Some of the local dealers report that white and brown ash is the scarcest of hardwoods; others that red and white oak is the hardest to get. Maple finds ready buyers and poplar is becoming scarcer with prices strengthening.

Toledo has enjoyed a wonderful building activity this year; 579 permits, with a total valuation of \$1,912,932, were issued by the city building inspector for the first five months of the year. Prospects are bright for a continuance of the building activity.

#### Rhineland, Wis.

While trade is not as heavy as it was in February and March, yet it still keeps up in very satisfactory volume. Traveling men report a great many of the factories well stocked up, as would be natural to suppose after the heavy winter and spring shipments, but they are all cutting at a rapid rate, which is certain to make replenishing of certain stocks necessary before long. The business coming in just now is usually to fill out depleted lines, and this kind of buying is likely to continue till fall. The demand is widespread, no particular locality more than another furnishing the business.

Basswood, especially No. 1 common and the lower grades, is probably the leader, followed closely by birch. Birch is an immediate seller, depending only on the ability of the wholesaler to fill orders for any thickness or grade. A good deal of thick birch is being shipped; the same applies to basswood, though not to as great an extent.

Hard maple is very dull, largely because consumers stocked up several months ago, and will not be in the market again for some time. There is very little dry maple on hand.

Ash is called for frequently by eastern dealers, but there is none to be had dry enough to ship on such a heavy freight rate.

All other woods are in only moderate request. The trade situation as a whole is good, and prospects are that the demand for the balance of the year will average about the same as the past five months.

#### Louisville.

The demand for hardwood continues to exceed the supply in practically everything on the list, except possibly gum. While this wood has been manifesting a tendency toward higher prices this spring it is still an uncertain quantity. While those who have been able to hold to it have been asking about \$17 for mill run, reports from the box factories indicate that Kentucky stock has been contracted for at least \$2 below that figure. Kentucky gum does not run to reds much, but that does not depreciate its value for use in

box factories. In fact, it makes it more desirable, for the whiter the wood the better the appearance when it comes to printing. Poplar bevel siding is still in excellent demand, and while some can not see that the demand for No. 1 common is as good as it has been painted, poplar generally speaking is in excellent shape and probably about the strongest thing in the hardwood market.

The situation among the manufacturers is practically as it was at the last writing; they are handicapped more by inability to move stock than anything else. The trouble is not lack of cars, but want of hauling facilities in the woods. They are all making fairly good time, however, and expect to soon be moving stock out in a satisfactory manner. Meantime they have plenty of orders and are not fretting on that score.

#### Liverpool.

Further mahogany sales have taken place since the last report, but the amount of wood offered was only a handful, and as was to be expected, having regard to the low stock in both first and second hands, sharp competition took place to secure even the poorest of logs. When any figured veneer logs and prime panel wood was offered, quite a scramble took place to secure them. The result of this is obvious and higher prices were paid all along the line. Doubtless prices will remain at this high level, at any rate until the end of this year, though not going higher.

The only thing to bring prices down would be that shippers from the west coast of Africa should be tempted to flood the market. This maxim should also be taken to heart by American shippers who have been obtaining high prices for American hardwoods. It often happens when a broker obtains a good price for a shipper that in reply to a query by a shipper as to whether he can repeat the price, the broker replies "send it along." This may be giving the brokers a very bad name, but of course "sheep and goats" exist among them as doubtless among other classes of commercial men.

It is, however, the over-zealous anxiety of some brokers to earn an increased number of commissions that leads them at times to advise their clients in the United States to ship goods on which they have no chance of realizing a profit for the shipper. Of course there are exceptions to every rule and there are occasions when extremely good prices are obtained for goods shipped on consignment, but shippers would be better off if they never shipped goods without a definite order.

A note in one of the Liverpool trade papers says "now is a good time to buy birch," which of course means that it is a bad time to sell. Very little can be reported about other goods which remain very much as previously. The arrivals being small keeps prices firm.

#### London.

While there has been some slight improvement in trade, it has not had a great effect on lumber. Mahogany being in most active demand, stocks are being cleared from sheds at docks, and arrivals are light, being mostly goods contracted for, very few parcels arriving on consignment. Oak planks are in very good demand, and even "on contract," are slow in coming forward; for boards the supply is more than equal to the demand.

There is a fair demand for cull and medium walnut at good prices. Prime logs for veneers are wanted and would realize high prices; other logs are not wanted. There is a steady inquiry for dressed whitewood of all grades.

Ash logs, planks and boards are wanted and are fetching very good prices at the moment, but the demand bids fair to be filled by several parcels coming on consignment.

# AT COST

✿ IS AN UNCOMMON TERM AS APPLIED TO INSURANCE ✿  
But this is the actual price of Indemnity against Fire Loss furnished by the

## MANUFACTURING LUMBERMEN'S UNDERWRITERS.

### THE STRONGEST INSURANCE ORGANIZATION TODAY IN AMERICA

---

The saving is not  
on a small portion  
of your Insurance  
but on the ✿ ✿  
ENTIRE LINE.  
There are other ad-  
vantages equally  
interesting. ✿ ✿

---



---

Only well built  
plants with ade-  
quate protection  
and at least five  
years timber supply  
are considered eligi-  
ble. ✿ ✿ ✿

---

For List of Members and further information Address

**HARRY RANKIN & COMPANY**  
KANSAS CITY, MO.

# Wanted and For Sale -SECTION-

Advertisements will be inserted in this section at the following rates:

For one insertion ..... 20 cents a line  
For two insertions ..... 35 cents a line  
For three insertions ..... 50 cents a line  
For four insertions ..... 60 cents a line

Eight words of ordinary length make one line. Heading counts as two lines. No display except the headings can be admitted.

Remittances to accompany the order. No extra charges for copies of paper containing the advertisement.

## EMPLOYES WANTED.

### HARDWOOD SAWYER WANTED.

Experienced sawyer for circular mill cutting 15 to 20 M per day. One accustomed to Southern Hardwoods preferred. State experience and wages and how soon you can come in first letter. Permanent position for the right man.

THE WEST FLORIDA HARDWOOD CO.,  
Marysville, Fla.

### WANTED.

A young man to keep books and inspect hard and soft woods. Write, marking envelope "Personal," H. D. BILLMEYER, Cumberland, Md.

### WANTED.

Competent sawmill man owning a small 5 or 6 ft. band mill to cut hardwoods in North Carolina by the thousand; ample log supply. Would consider buying a band mill for responsible party. Address  
"A. L. V.," care HARDWOOD RECORD.

## LUMBER WANTED

### WE DESIRE TO PURCHASE

On contract carloads of Oak Boxes assembled, round corners, made of 1" stock, with cover made of 1 1/4" stock. Also other Oak woodwork machined and sanded ready to varnish. K. D., crated in bulk. Address  
"CASH," care HARDWOOD RECORD.

### WANTED.

Locust, Bois D'Arc or Osage Orange and Mulberry, log run. Write for specifications and prices.  
THE PILLIOD LUMBER CO., Swanton, O.

### WANTED—DIMENSION HICKORY.

Send for our specifications.  
MUNCIE WHEEL & JOBBING CO.,  
Muncie, Ind.

### SMALL HICKORY DIMENSION.

First-class material from waste of wagon stock. Sizes wanted furnished upon application. L. T. La BAR, Hackettstown, N. J.

### WANTED.

To contract for the output for this year of a good mill cutting Oak and Poplar lumber. Address  
"MORGAN," care HARDWOOD RECORD.

### OAK WANTED.

3 and 4 inch White Oak; also Mixed Oak; also 12x12 Timbers and Piling of all kinds.  
CONTINENTAL LUMBER CO.,  
1213 Monadnock Bldg., Chicago, Ill.

### OAK.

We are in the market for plain sawed oak, all grades and thicknesses.  
P. G. DODGE & CO., 2116 Lumber St., Chicago.

### WALNUT ONLY.

Wanted, Walnut lumber, green or dry, all grades, all thicknesses, log run or on grade. Highest market price paid. Liberal inspection.  
C. J. FRANK,  
2440 N. New Jersey St., Indianapolis, Ind.

### WANTED—HARDWOOD LOGS.

200 M feet 23-inch and up White Oak logs.  
200 M. feet 12-inch and up Walnut logs.  
50 M. feet 12-inch and up Cherry logs.  
C. L. WILLEY,  
Blue Island Av. and Robey St., Chicago.

## LUMBER FOR SALE.

### 6/4" NO. 1 COMMON RED OAK.

30,000 feet. Good widths and lengths. Thoroughly dry. Bang up grade.  
THE M. B. FARRIN LUMBER CO.,  
Cincinnati, O.

### FOR SALE—BLACK ASH AND MAPLE.

1 car 4/4 log run, good stock.  
1 car 8/4 No. 1 Common and 1sts and 2nds.  
THE WICKS LBR. CO., Battle Creek, Mich.

### WHITE OAK FOR SALE.

100,000' 4/4 Quartered 1 & 2 and No. 1 Common. Good dry stock, good widths and lengths. THE YOUNG GREENE LUMBER CO.,  
Goshen, Ind.

### WAGON STOCK FOR SALE.

We are in position to furnish wagon manufacturers with wagon tongues, axles, reaches and bolsters.  
GAYOSO LUMBER CO., Memphis, Tenn.

### DRY STOCK FOR QUICK SHIPMENT.

HARD MAPLE.  
40,000 ft. 4-4 No. 2 Com. & Better.  
124,000 ft. 5-4 No. 1 Com. & Better.  
256,000 ft. 8-4 1sts & 2nds.  
25,000 ft. 10-4 1sts & 2nds.  
19,000 ft. 12-4 1sts & 2nds.  
7,000 ft. 4-4 One White Face.  
7,500 ft. 6-4 One White Face.  
11,000 ft. 8-4 One White Face.  
215,000 ft. 4-4 No. 2 Com. & Bet. Bassw'd.  
60,000 ft. 4-4 No. 2 Com. & Bet. Elm.  
5 cars 4/4 1st & 2nd Quartered White Oak.  
5 cars 4/4 No. 1 Com. Quartered White Oak.  
5 cars 4/4 No. 2 Com. & Bet. Plain Red Oak.  
2 cars 4/4 1st & 2nd Plain White Oak.  
5 cars 4/4 No. 1 Com. Plain White Oak.  
Also Poplar, Basswood and Gum. Prices quoted on application.  
THE BELCHER-STINE LUMBER CO.,  
323 Spitzer Bldg., Toledo, Ohio.

### FOR SALE.

Common and better Hickory, 5,277 feet of 2 1/2", 1,092 feet of 3" and 1,024 feet of 4", dry, good quality.  
LOVE, BOYD & CO., Nashville, Tenn.

## BUSINESS OPPORTUNITIES

### HARDWOOD TIMBER.

A number of good mill propositions along the Cotton Belt Route. Tracts ranging from five hundred to twenty thousand acres, principally Oak, Hickory, Gum, Cypress, some Ash, Cottonwood and other hardwoods. Can be secured at very reasonable figures now—in some cases at less than \$1 per thousand stumpage. Choice openings for hardwood lumber mills, handle and spoke factories, slack coope-ge plants and other hardwood enterprises.

A number of points on the Cotton Belt offer free sites or will raise cash bonus or take stock in practical propositions. Let us have your wants and see what we can do for you.

E. W. LA BEAUME, G. P. & T. A.,  
COTTON BELT, St. Louis, Mo.

## MISCELLANEOUS

### FACTS FROM PRACTICAL MEN.

The HARDWOOD RECORD is always in the market for articles on any and every feature of the hardwood industry. It wants practical statements of fact from practical men who know how certain things can be done in the best way. Literary quality not essential. Liberal pay for acceptable articles. Address  
Editor HARDWOOD RECORD.

# INDUSTRIES ARE OFFERED LOCATIONS

WITH

Satisfactory Inducements,  
Favorable Freight Rates,  
Good Labor Conditions,  
Healthful Communities,

ON THE LINES OF

THE ILLINOIS CENTRAL R. R.

AND THE

YAZOO & MISSISSIPPI VALLEY R. R.

For full information and descriptive pamphlet address

J. C. CLAIR,

Industrial Commissioner,

1 Park Row,

Chicago, Ill.

# WOOD WORKING PLANTS

Manufacturers seeking locations for Saw Mills, Stave and Heading Factories and other Wood Working Plants in the Central Southern States, can secure full and accurate information as to Sites, Timber Tracts, Fuel, Transportation Facilities, etc., by addressing

G. A. PARK,

General Immigration and Industrial Agent

Louisville & Nashville  
Railroad Company

Louisville, Kentucky



Advertisers' Directory

NORTHERN HARDWOODS.

American Lumber & Mfg. Co. 9  
 Arpin Hardwood Lumber Co. 44  
 Babcock Lumber Company. 9  
 Barnaby, C. H. 43  
 Beyer, Knox & Co. 10  
 Bliss & Van Auken. 51  
 Boyle, Clarence, Lumber Company 50  
 Boyne City Lumber Company. 47  
 Briggs & Cooper Company. 4  
 Brittingham & Young Company. 44  
 Brownlee & Company. 46  
 Buffalo Hardwood Lumber Co. 51  
 Cadillac Handle Company. 3  
 Cheat River Lumber Company. 9  
 Cherry River Boom & Lbr. Co. 1  
 Chivvis, W. R. 33  
 Cincinnati Hardwood Lumber Co. 49  
 Cobbs & Mitchell, Inc. 3  
 Crosby & Beckley Company, The. 44  
 Crosby, C. P. 44  
 Cummer, Diggins & Co. 3  
 Davis, John R., Lumber Company 44  
 D'Heur & Swain Lumber Co. 43  
 Dennis Bros. 47  
 Dennis & Smith Lumber Company 46  
 Dixon & Dewey. 6  
 Duhmeler Bros. 48  
 Dulweber, John, & Co. 49  
 Elias, G., & Bro. 51  
 Empire Lumber Company, Buffalo 50  
 Estabrook-Skeele Lumber Co. 51  
 Fall, E. H. 48  
 Flint, Erving & Stoner Company. 9  
 Freiburg Lumber Company, The. 49  
 Fullerton-Powell Hardwood Lumber Company. 43  
 General Lumber Company. 48  
 Goldie, J. S. 47  
 Haak Lumber Company. 47  
 Hackley-Phelps-Bonnell Company. 47  
 Hayden, Harvey S. 49  
 Heath-Witbeck Company. 50  
 Holloway Lumber Company. 7  
 Ingram Lumber Company. 44  
 Jenks, Robert H., Lumber Co. 45  
 Jones, G. W., Lumber Co. 38  
 Jones Hardwood Company. 7  
 Kampf, Albert R. 2  
 Keith Lumber Company. 50  
 Kelley Lumber & Shingle Co. 46  
 King & Bartles Lumber Company 45  
 Kitzinger, Gus. 34  
 Leavitt Lumber Company. 10  
 Lesh & Matthews Lumber Co. 50  
 Linehan Lumber Company. 9  
 Litchfield, William E. 7  
 Long-Knight Lumber Company. 43  
 McClure Lumber Company. 47  
 McIlvain, J. Gibson, & Co. 51  
 McLean, Hugh, Lumber Company 51  
 MacBride, Thos., Lumber Co. 47  
 Maley, Thompson & Moffett Co. 49  
 Maley & Wertz. 43  
 Martin-Barriss Company. 45  
 Miller, Anthony. 51  
 Mitchell Bros. Company. 3  
 Mowbray & Robinson. 49  
 Murphy & Diggins. 3  
 Nicola Bros. Company, The. 9  
 No. Vernon Pump & Lbr. Co. 2  
 Norman Lumber Company. 2  
 North Shore Lumber Company. 46  
 North Western Lumber Company 44  
 Page & Landeck Lumber Co. 44  
 Perrine-Armstrong Company. 43  
 Peters, R. G., Salt & Lumber Co. 47  
 Price, E. E. 7  
 Radina, L. W., & Co. 49  
 Rumbarger Lumber Company. 1  
 Scatcherd & Son. 51  
 Schofield Bros. 7  
 Schultz Brothers & Cowen. 42

Simmons Lumber Company. 47  
 Sobie Brothers. 7  
 Southern Oak Lumber Company. 50  
 Standard Hardwood Lumber Co. 51  
 Stephenson, The I., Company. 10  
 Stewart, I. N., & Bro. 51  
 Stimson, J. V. 43  
 Sullivan, T., & Co. 51  
 Tegge Lumber Company. 8  
 Turner, A. M., Lumber Company 9  
 Upham & Agler. 6  
 Van Keulen & Wilkinson Lumber Company. 47  
 Vollmar & Below. 44  
 Wegstaff, W. J. 50  
 Ward Lumber Company. 50  
 Wentworth, Chas. S., & Co. 7  
 White, W. H., Company. 46  
 Whitmer, Wm., & Sons, Inc. 6  
 Wiborg & Hanna Company. 49  
 Wiggin, H. D. 7  
 Willson Bros. Lumber Company. 9  
 Wistar, Underhill & Co. 7  
 Yeager, Orson E. 51  
 Young & Cutsinger. 43  
 Young, W. D., & Co. 10

SOUTHERN HARDWOODS.

Advance Lumber Company. 45  
 American Lumber Company. 42  
 American Lumber & Mfg. Co. 9  
 Anderson-Tully Company. 4  
 Atlantic Lumber Company. 4  
 Bacon-Nolan Hardwood Company 4  
 Beck, E. E., Lumber Company. 49  
 Beyer, Knox & Co. 51  
 Bennett & Witte. 49  
 Black, F. W., Lumber Company. 50  
 Boyle, Clarence Lumber Co. 50  
 Briggs & Cooper Company. 4  
 Brown, Geo. C., & Co. 8  
 Brown, W. P., & Sons Lbr. Co. 2  
 Buffalo Hardwood Lumber Co. 51  
 Carrier Lbr. & Mfg. Company. 10  
 Cherry River Boom & Lbr. Co. 1  
 Chicago Veneer Company. 33  
 Chivvis, W. R. 33  
 Cincinnati Hardwood Lumber Co. 49  
 Coleman, J. S., Lumber Co. 42  
 Crandall & Brown. 50  
 Crane, C., & Co. 49  
 Crittenden Lumber Company. 4  
 Crosby & Beckley Company, The. 47  
 Cypress Lumber Company. 48  
 Davis, Edw. L., & Co. 2  
 Davidson-Benedict Company. 46  
 Dennis & Smith Lumber Company 46  
 D'Heur & Swain Lumber Co. 43  
 Dierks Lumber & Coal Company. 10  
 Dixon & Dewey. 6  
 Duhmeler Bros. 48  
 Dulweber, John, & Co. 49  
 Elias, G., & Bro. 51  
 Empire Lumber Co., Buffalo. 51  
 Estabrook-Skeele Lumber Co. 50  
 Fall, E. H. 48  
 Farrin-Korn Lumber Company. 48  
 Flint, Erving & Stoner Company 9  
 Freiburg Lumber Company. 49  
 Fry-Euchanan Lumber Company. 42  
 Fullerton-Powell Hardwood Lumber Company. 43  
 Gayoso Lumber Company. 4  
 Garetson-Greason Lumber Co. 5  
 Hackley-Phelps-Bonnell Company. 47  
 Hafner Mfg. Company. 5  
 Hamilton, J. V. 34  
 Heath-Witbeck Company. 50  
 Himmelberger - Harrison Lumber Company. 1  
 Indiana Lumber Company. 8  
 Jenks, Robert H., Lumber Co. 45  
 Jones, G. W., Lumber Company. 38  
 Jones Hardwood Company. 7

Kampf, Albert R. 2  
 Keith Lumber Company. 50  
 Kentucky Lumber Company. 48  
 Kentucky Lumber & Veneer Co. 48  
 King & Bartles Lumber Company 45  
 Lane-White Lumber Company. 8  
 Leavitt Lumber Company. 10  
 Lesh & Matthews Lumber Co. 50  
 Linehan Lumber Company. 9  
 Litchfield, Wm. E. 7  
 Long-Knight Lumber Company. 43  
 Loomis & Hart Mfg. Company. 10  
 Love, Boyd & Co. 8  
 Luehrmann, Chas. F., Hardwood Lumber Company. 5  
 McClure Lumber Company. 47  
 McIlvain, J. Gibson, & Co. 51  
 McLean, Hugh, Lumber Company 51  
 Maley, Thompson & Moffett Co. 49  
 Martin-Barriss Company. 45  
 Miller, Anthony. 51  
 Nicola Bros. Company. 9  
 Norman Lumber Company. 2  
 Ozark Cooperaage Company. 5  
 Paepcke-Leicht Lumber Company 6  
 Page & Landeck Lumber Company 44  
 Price, E. E. 7  
 Rhubesky, E. W. 34  
 Radina, L. W., & Co. 49  
 Ransom, J. B., & Co. 52  
 Ritter, W. M., Lumber Company 52  
 Roy Lumber Company. 34  
 Rumbarger Lumber Company. 1  
 Scatcherd & Son. 51  
 Schofield Brothers. 7  
 Smith, W. E., Lumber Company. 4  
 Southern Lumber Company. 2  
 Southern Oak Lumber Company. 50  
 Standard Hardwood Lumber Co. 51  
 Steele & Hibbard. 5  
 Stewart, I. N., & Bro. 51  
 Stevens-Eaton Company. 7  
 Stimson, J. V. 43  
 Stoneman-Zearing Lumber Co. 2  
 Stutz Lumber Company, Inc. 2  
 Sullivan, T., & Co. 51  
 Swann-Day Lumber Company. 8  
 Thomas & Proetz Lumber Co. 5  
 Three States Lumber Company. 4  
 Turner, A. M., Lumber Company. 9  
 Upham & Agler. 6  
 Vestal Lumber & Mfg. Company. 42  
 Ward Lumber Company. 50  
 Wentworth, Chas. S., & Co. 7  
 Whitmer, Wm., & Sons, Inc. 6  
 Wiborg & Hanna Company. 49  
 Wiggin, H. D. 7  
 Willson Bros. Lumber Company. 9  
 Yeager, Orson E. 51

POPLAR.

Advance Lumber Company. 45  
 Atlantic Lumber Company. 49  
 Bennett & Witte. 49  
 Brown, W. P., & Sons Lbr. Co. 2  
 Cheat River Lumber Company. 33  
 Chicago Veneer Company. 49  
 Crane, C., & Co. 49  
 Davis, Edw. L., & Co. 2  
 Davidson-Benedict Company. 46  
 Dawkins, W. H., Lumber Co. 48  
 Hayden, Harvey S. 49  
 Kentucky Lumber Company. 48  
 Kentucky Lumber & Veneer Co. 48  
 Loomis & Hart Mfg. Company. 10  
 Ritter, W. M., Lumber Company 52  
 Roy Lumber Company. 34  
 Rhubesky, E. W. 34  
 Southern Lumber Company. 2  
 Stevens-Eaton Company. 7  
 Swann-Day Lumber Company. 8  
 Thomas & Proetz Lumber Co. 5  
 Vansant, Kitchen & Co. 52  
 Yellow Poplar Lumber Company. 52

COTTONWOOD AND GUM.

Anderson-Tully Company. 4  
 Bacon-Nolan Hardwood Company 4  
 Farrin-Korn Lumber Company. 48  
 Himmelberger - Harrison Lumber Company. 1  
 Luehrmann, C. F., Hardwood Lumber Company. 5  
 Ozark Cooperaage Company. 5  
 Paepcke-Leicht Lumber Company 6  
 Smith, W. E., Lumber Company 4  
 Stoneman-Zearing Lumber Co. 5  
 Stutz Lumber Company, Inc. 2  
 Three States Lumber Company. 4

CYPRESS.

Crandall & Brown. 50  
 Cypress Lumber Company. 48  
 Hafner Mfg. Company. 5  
 Lotliam Cypress Company. 5  
 Thompson, J. W., Lumber Co. 4

HARDWOOD FLOORING.

Bliss & Van Auken. 10  
 Carrier Lbr. & Mfg. Company. 10  
 Cobbs & Mitchell, Inc. 3  
 Cummer, Diggins & Co. 3  
 Haak Lumber Company. 47  
 Mitchell Bros. Company. 3  
 Nashville Hardwood Flooring Company. 8  
 Pease Company, The. 48  
 Schultz Brothers & Cowen. 42  
 Stephenson, The I., Company. 10  
 Ward Brothers. 10  
 Wood Mosaic Flooring Company 2  
 Young, W. D., & Co. 10

SAW MILL MACHINERY.

Mershon Company, The. 38  
 Phoenix Mfg. Company. 34

WOOD WORKING MACHINERY

American Wood Working Machinery Company. 41  
 Berlin Machine Works, The. 34  
 DeFrance Machine Works. 34  
 Ober Mfg. Company, The. 40  
 Smith, H. B., Machine Company. 37

VENEER MACHINERY.

Coe Manufacturing Company. 39

LOGGING MACHINERY.

Clyde Iron Works. 35  
 Lidgerwood Mfg. Company. 36  
 Overpack, S. C. 36  
 Russell Wheel & Foundry Co. 36

DRY KILNS AND BLOWERS

Morton Dry Kiln Company. 42

LUMBER INSURANCE.

Adirondack Fire Insurance Co. 1  
 Lumber Insurance Company of New York. 2  
 Lumber Mutual Fire Insurance Company, Boston. 3  
 Lumber Underwriters. 39  
 Pennsylvania Lumbermen's Mutual Fire Insurance Company. 1  
 Rankin, Harry, & Co. 31  
 Toledo Fire & Marine Ins. Co. 31

SAWS, KNIVES AND SUPPLIES

Atkins, E. C., & Co. 40  
 Hanchett Swage Works. 46  
 Champion Saw Company. 34 & 38  
 Shlmer, S. J., & Sons. 40

MISCELLANEOUS.

Barroll, H. C., & Co. 10  
 Lacey, J. D., & Co. 35  
 Lumbermen's Credit Association. 30  
 Pease Company, The. 48  
 Schenck, C. A., & Co. 42

CHICAGO VENEER COMPANY

(INCORPORATED)

MANUFACTURERS OF

Rotary Cut Poplar Veneer

We have over four million feet of selected veneer logs on hand. Our plant is especially adapted for making extra large sizes and we cater only to the high grade trade.

BURNSIDE,

KENTUCKY



# "DEFIANCE" WOOD-WORKING MACHINERY

COMPLETE EQUIPMENTS OF  
HIGH GRADE TOOLS

FOR MAKING

Hubs, Spokes, Wheels, Single Trees, Hoops,  
Wagons, Carriages, Handles, Bobbins, Spools,  
Rims, Shafts, Poles, Insulator Pins and  
Neck-Yokes, Oval Wood Dishes.

INVENTED AND BUILT BY

The **DEFIANCE MACHINE WORKS**  
DEFIANCE, OHIO.

—Send for 500 Page Catalogue—

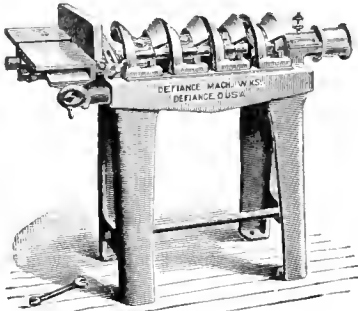

No. 1 Planing and Rounding Machine.

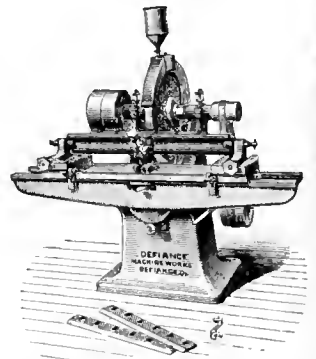

Automatic Knife Grinder.

**Want**  
J.V. Hamilton  
Fort Scott, Kas.  
**Walnut**

*I Want to buy Walnut logs, 10 inches and up in diameter at top end, any length. Will pay cash at stump, or delivered to the railroad. Write me*

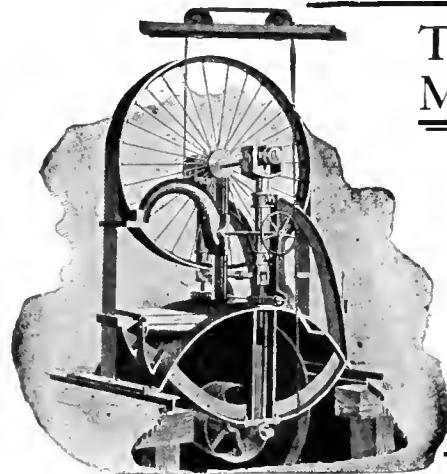

## Ten per cent More Profit

The profits of a saw mill can readily be increased ten per cent by using a hand mill instead of a rotary. The price of this mill with six foot wheels for saws eight inches wide is readily within the reach of all. It cuts smooth and perfect lumber and has a capacity of 25,000 feet to 35,000 feet per day. It runs with less expenditure of power than a rotary and puts only half as much of the log into saw dust as does the circular saw.

PHOENIX MFG. COMPANY,  
EAU CLAIRE, WIS.

## KNIVES

You can know something of these knives by asking. There will be a clue in the answer to your letter. Good machine knives.

**CHAMPION SAW COMPANY,**  
BEAVER FALLS, PA.



WALNUT,  
OAK,  
ASH,  
POPLAR.

**GUS. KITZINGER**  
**Michigan Hardwoods**  
By Car or Cargo. Manistee, Mich.

### Locations for Industries

Erie Railroad System  
Chicago to New York

The Erie Railroad System's Industrial Department has all the territory traversed by the railroad districted in relation to resources, markets and advantages for manufacturing, and can advise with manufacturers in relation to the most suitable locations. For full information address

**LUIS JACKSON**  
Industrial Commissioner, Erie Railroad Company  
21 Cortlandt Street, New York

You want to reach Buyers of  
**FURNITURE LUMBER**  
**The HARDWOOD RECORD**  
will do it for you.

# History Repeats Itself

☐ From nominal values, White Pine timber property has achieved monumental figures.

☐ From cheap Yellow Pine stumpage, the advance in price has made fortunes.

☐ The same history is about to be repeated in Pacific Coast Timber and in the Hardwoods of the Middle South.

☐ We have made fortunes for others. We offer you our expert services. Let us know your timber wants.

## JAMES D. LACEY & CO.

608 Hennen Building,  
NEW ORLEANS

507 Lumber Exchange Building,  
SEATTLE, WASH.

1200 Old Colony Bldg.,  
CHICAGO

### ... THE ... McGIFFERT LOG LOADER

has loaded as high as a quarter of a million feet of logs in eight hours, and here are a few reasons why it was possible: Being self propelling it can move itself, its loaded cars, and spit its own empties, all on the same track. (*saves switching*) Constructed entirely of steel, very powerful, it stands "crowding" and handles the large logs as rapidly as the small. *It saves money and repairs.* Being simple in operation and of few levers the engineer has absolute control at all times without changing his position, and can handle the logs as rapidly as the men can hook them. *saves time*

Our catalogue clearly illustrates and explains many other good points.

Manufactured by  
CLYDE IRON  
WORKS,  
Duluth,  
Minn.

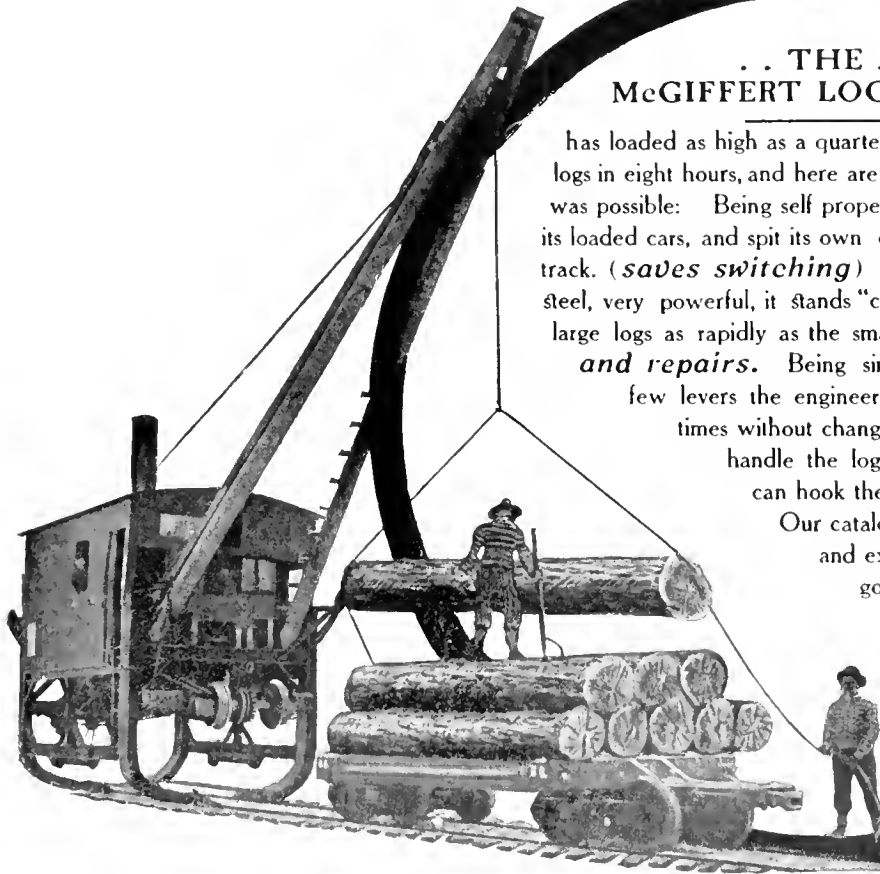

**Skidders**

**Snakers**

**Lidgerwood Machines  
Will Stock Your Mill**

**Lidgerwood Skidders**

**Lidgerwood Snakers**

**Lidgerwood Yarders**

**Lidgerwood Roaders**

**Lidgerwood Pull Boats**

**Lidgerwood Cableways**

**LIDGERWOOD MFG. CO.**

**NEW YORK**

**ATLANTA**

**SEATTLE**

**NEW ORLEANS**

**Loaders**

**Cableways**

**SMITH of  
SMITHVILLE**

**The Profit Builder**

**SMITH of  
SMITHVILLE**

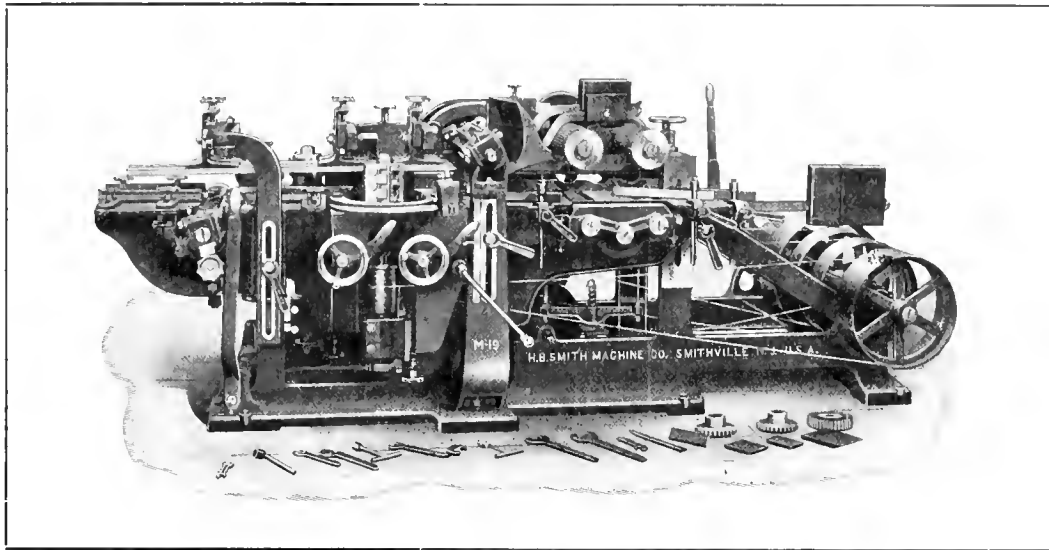

NO. 105-A, EXTRA HEAVY 12-INCH MOULDER



IT HAS been our purpose during the last half century to develop a line of wood working machines containing the best workmanship and material that American skill and wisdom can afford. This fact we are proud to say is well established in the minds of our many patrons. We have, however, now exceeded ourselves by the development of a remarkable Moulder, the excellence of which is due to our obtaining written suggestions from more than a thousand operators throughout America. This machine stands alone as being the composite idea of the thinking operators of this country. One year's test of its work has convinced us that it is impossible for you to compete successfully against the Smith Moulder with any other machine. Can't we send you prices and literature?

**Branches:**  
New York, Chicago,  
Boston

**H. B. SMITH MACHINE CO.**  
SMITHVILLE, N. J., U. S. A.

**Branches:**  
New York, Chicago,  
Boston

# SAWS

☛The skill of the master saw maker means nothing to you unless we can prove out our line of saws.

☛Have you given us that opportunity?

## CHAMPION SAW CO.

BEAVER FALLS, PA.

## Special Attention

Is called to the following, and to the close prices made on same upon receipt of your inquiries:

50M feet 2" Common and Better Plain Birch  
80M feet 2½" Common and Better Plain Birch  
100M feet 1" 1sts and 2nds Plain Birch  
150M feet 1" No. 1 Common Plain Birch  
12M feet 2" 1sts and 2nds Red Birch  
200M feet 2" Common and Better Hard Maple

Above is all cut from choice Wisconsin timber, is bore dry and well manufactured.

50M feet 2" Bridge Plank  
30M feet 1½" No. 2 Common and Better Hickory  
30M feet 1½" No. 2 Common and Better Hickory  
100M feet 1" Common and Better Plain Red Oak  
150M feet 1" Common and Better Qtd. Red Oak  
10M feet 1" No. 3 Common and Better Walnut  
75M feet 1½" No. 2 Common and Better Elm  
150M feet 1" No. 1 Common Red Gum

Above is choice Southern stock.

In addition to the foregoing, we have full stocks of Basswood, Birch and Soft Elm and a full selection of Red and Sap Gum. We guarantee our grades to be made strictly in accordance with National Hardwood Association rules of inspection.

G. W. Jones Lumber Co.

Appleton, Wis.

# MERSHON

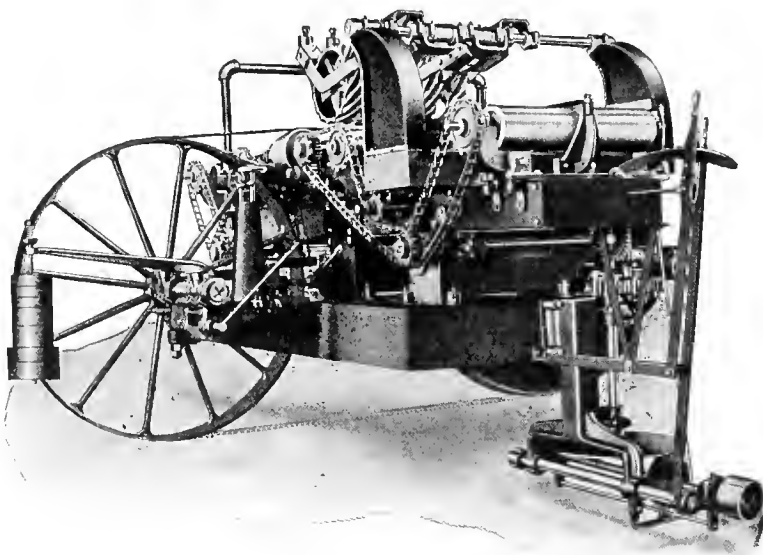

MERSHON NEW HORIZONTAL BAND RESAW FOR SAW MILLS

Band Resawing  
Machinery  
for all requirements

WM. B. MERSHON  
& CO.,

Saginaw, = Michigan

A PAGE OF THE FAMOUS COE VENEER MACHINERY

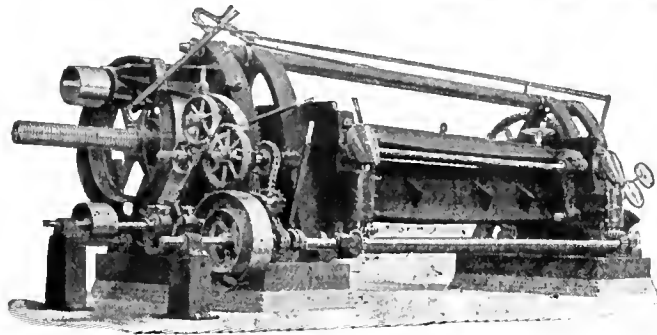

Style A Veneer Cutter

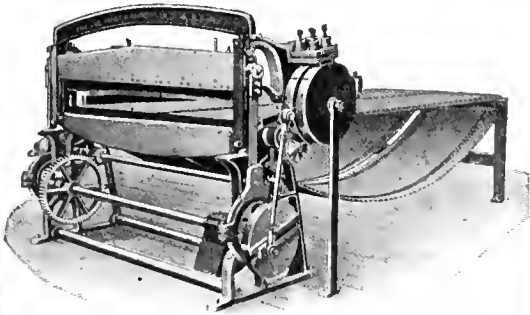

Coe Clipper

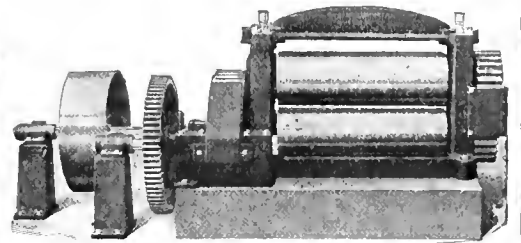

Coe Wringer

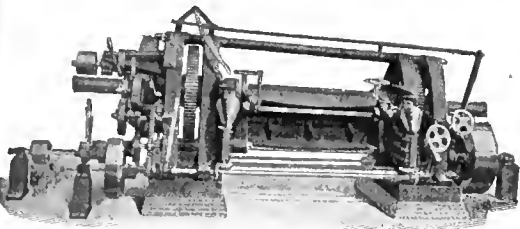

Style D Veneer Cutter

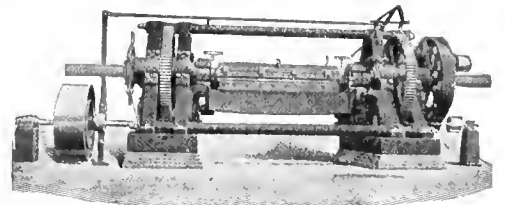

Style B Veneer Cutter

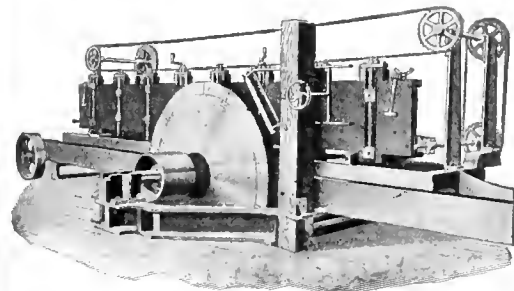

Coe Veneer Saw

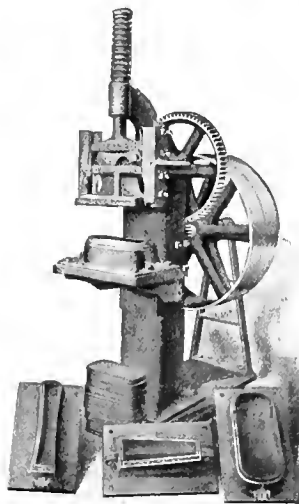

Coe Stamper

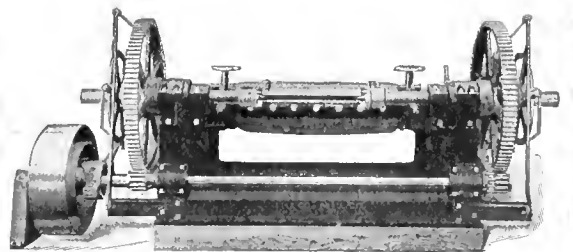

Style H Veneer Cutter

*These machines and many others are fully described in our 1906 Catalog No. 5. Write for a copy to-day.*

THE COE MFG. CO.

105 BERNARD STREET

PAINESVILLE, OHIO



**THE  
HAPPY  
WOODSMAN**



# ATKINS

TRADE  
MARK  
**SILVER-STEEL**

# SAWS

are happy saws all the way round. They run easier, cut faster, and go longer without sharpening than any other

A PERFECT SAW FOR EVERY PURPOSE.  
YOUR JOBBER HAS THEM OR WRITE US.

## E. C. ATKINS & CO., Inc.

THE SILVER STEEL SAW PEOPLE

HOME OFFICE AND FACTORY, INDIANAPOLIS, U. S. A.

Branches: Atlanta, Chicago, Memphis, Minneapolis, New York City, New Orleans, Portland, San Francisco, Seattle, Toronto.

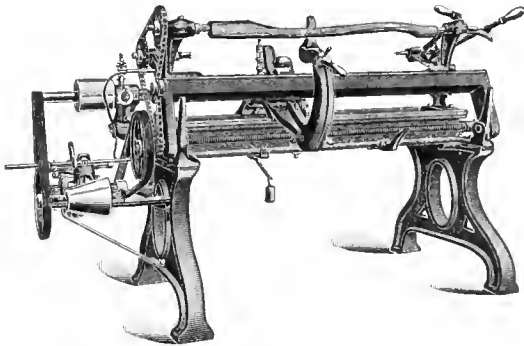

This cut shows the **No. 1 OBER LATHE** for turning Axe, Adze, Pick, Sledge, Hammer and Hatchet Handles, Spokes, Whiffletrees, Gun Stocks, Lasts and other irregular work.

### Simple, Strong, Durable, Economical

We also manufacture other lathes for making handles, spokes and variety work, sanders, shapers, boring and chucking machines, rip saws, etc., etc. Complete catalogue and price list free.

## THE OBER MFG. CO.

28 Bell St., Chagrin Falls, O., U. S. A.

# The Shimer Cutter Head

Best of All, Fig. 202 and Fig. 203.

For Flooring, Ceiling, Siding, Ship Lap, Jointing, Double Ceiling, Doors, Sashes, Blinds, Etc. ∴ Special Tools for Special Service.

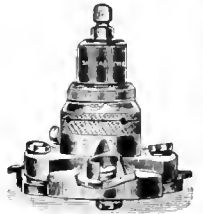
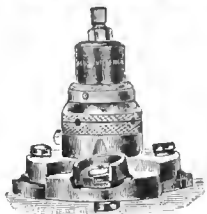

Should appeal to every user of a matching, moulding or tenoning machine because it does more and better work than any others and requires less labor and expense to keep it in order. ¶ We make it of every size and style to fit any machine and send on trial thirty days to responsible lumbermen. ¶ Send for our Catalogue and Pattern Book. It gives illustrations and complete description of a number of these tools, some of which will be of advantage to you.

## SAMUEL J. SHIMER & SONS, - - Milton, Penn.

# American "High-Grade" Machinery

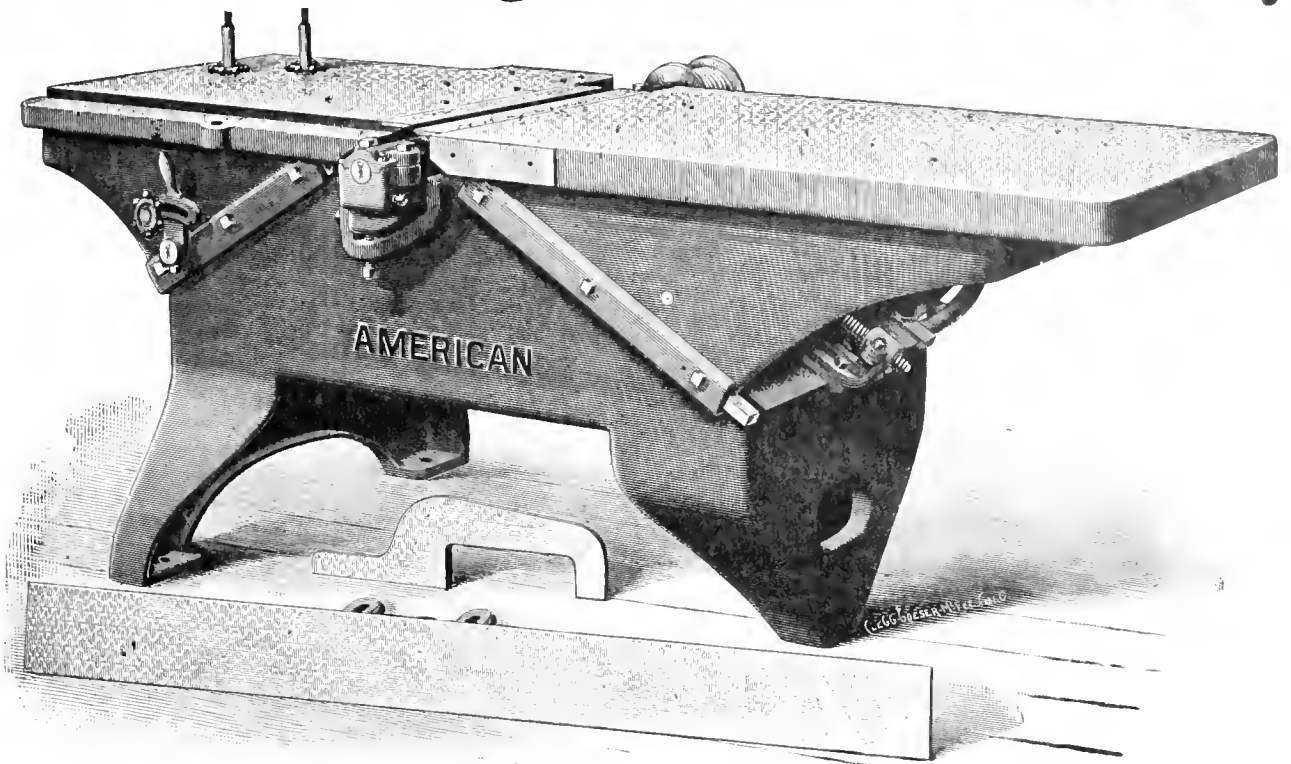

Fig. 800—8", 12", 16", 20", 24", 30" and 36" Clement Buzz Planers and Jointers.

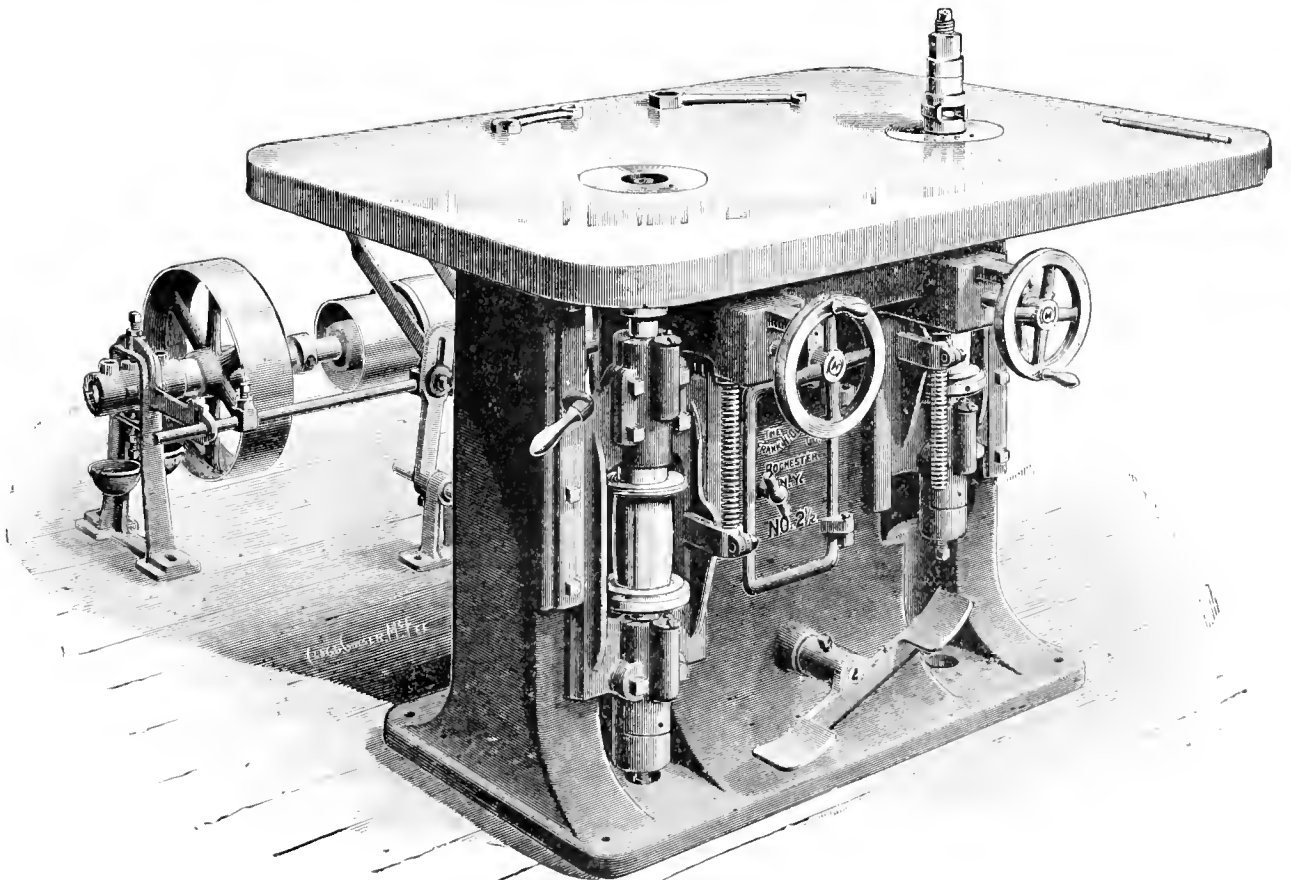

Fig. 929—Clement No. 2½ Two-Spindle Shaper.

## American Wood Working Machinery Co.

NEW ORLEANS  
CHICAGO  
NEW YORK

# EASTERN TENNESSEE—WESTERN NO. CAROLINA

ASHEVILLE KNOXVILLE BRISTOL

## Fry-Buchanan Lumber Co.

INCORPORATED.

Manufacturers and Wholesalers

### Hardwood Lumber

Choicest Varieties. . . Full Grades.

POPLAR SQUARES  
A Specialty.

Asheville, N. C.

## On the Spot

We are located right in the heart of this mountain country producing the best hardwoods in existence.

We are headquarters with ample stock, and can interest you both as to assortment and price. Write us.

## American Lumber Company

ASHEVILLE, N. C.

## HARDWOODS

From the famous Asheville district. Superior in quality, manufacture and gradings. For stock list and prices, address

## J. S. COLEMAN LUMBER CO.

ASHEVILLE, N. C.

## Lumbermen, Attention!

If you own any timber or timber lands. If you are contemplating buying or selling any timber or timber lands.

If you want your stumpage accurately estimated. If you want an exact survey or map of your property. If you want advice in any logging or lumbering proposition. Write to us and find out what we can do for you.

We send thoroughly reliable and practical engineers to all parts of the country, and guarantee quick and accurate work.

## C. A. Schenck & Co.

DAVIDSON'S RIVER, NORTH CAROLINA  
Consulting Forest Engineers

## Vestal Lumber & Mfg. Co.

Manufacturers and Wholesalers  
of all kinds of

### HARDWOODS

BEVELED SIDING A SPECIALTY.  
UNSURPASSED FACILITIES  
FOR DELIVERING.

Knoxville  
Tennessee

## The Morton Dry Kiln

MOIST AIR SYSTEM

Recording  
Ther-  
mometers.  
Transfer  
Cars.

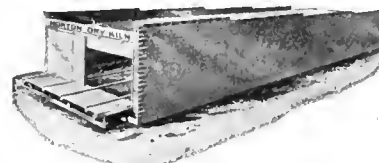

Trucks.  
Canvas  
Doors.

### HOW TO DRY LUMBER

As exemplified in our Catalog D. Free on application.

MORTON DRY KILN CO., Chicago, Ills.

# Schultz Brothers & Cowen

WE ARE IN THE MARKET TO BUY

## POPLAR—OAK—ASH—CHESTNUT

AND OTHER HARDWOODS—ALL GRADES AND THICKNESSES

1225 to 1240 OLD COLONY BUILDING,

CHICAGO



# INDIANA



WHERE THE BEST HARDWOODS GROW

THE WOODS FOR WHICH INDIANA IS FAMOUS.

Quart'r'd White Oak

Plain White Oak

Quartered Red Oak

Plain Red Oak

White Ash

Poplar

Black Walnut

Cherry

Sycamore

Red Gum

Hickory

Beech

Maple

Veneers of

Indiana Hardwoods

## YOUNG & CUTSINGER

Manufacturers and Wholesalers

Our Specialty Fine Figured Quartered Oak

EVANSVILLE, IND.

## CHARLES H. BARNABY

Manufacturer of Band Sawed Hardwoods

Quarter Sawed Indiana White Oak a Specialty

GREENCASTLE, IND.

## D'HEUR & SWAIN LUMBER CO.

Manufacturers and Wholesalers

Our Specialty Quartered Oak and Sycamore

SEYMOUR, IND.

## LONG-KNIGHT LUMBER CO.

MANUFACTURERS AND DEALERS

Quarter Sawed White and Red Oak a Specialty

INDIANAPOLIS, IND.

## MALEY & WERTZ

Manufacturers, Wholesalers and Exporters of Hardwood Lumber

EVANSVILLE, IND.

## FULLERTON-POWELL HARDWOOD LUMBER CO.

SOUTH BEND, IND.

## PERRINE-ARMSTRONG CO.

Long Timber up to 60 feet—Hardwood Specialties

The largest Band Mill in Indiana.

FORT WAYNE, IND.

## J. V. STIMSON

All Kinds of Hardwood Lumber Manufactured

HUNTINGBURG, IND.

# WISCONSIN

WHERE THE FINEST NORTHERN HARDWOODS GROW

MIXED CARS - EVEN GRADES - PROMPT SHIPMENT

## Wisconsin Hardwoods

SPECIAL OFFERINGS:  
 1" No. 1 Common and Better Birch (Red in)  
 1" No. 1 Common and Better Basswood  
 1" No. 1 Common and Better Hard Maple  
 Also Elm, Pine, Cedar Products,  
 and "SHAKELESS" Hemlock.

**John R. Davis Lumber Company**  
 PHILLIPS, : : : : WISCONSIN

**BRITTINGHAM & YOUNG CO.**

## Hardwood Lumber

Manufacturers and Wholesalers

MADISON, . . . . WISCONSIN

Send us a list of your wants,  
 No trouble to answer correspondence.

**ARPIN HARDWOOD LUMBER CO.**  
 GRAND RAPIDS, - - - WISCONSIN  
 Saw and Planing Mill at Atlanta, near Bruce, Wis., on Soo Lines.

---

Manufacturers

---

## Wisconsin Hardwoods

PINE AND HEMLOCK

---

WRITE US FOR PRICES ON  
 1", 1 1/4", 1 1/2", 1 3/4" and 2" Plain and Red Birch; Red Birch Flooring and 1" to 2"  
 Quarter Sawn Red Oak; Basswood Ceiling and Siding; 1" Birdseye  
 Maple; Birch, Maple and Hardwood Flooring.

**VOLLMAR & BELOW**  
 MARSHFIELD, WISCONSIN

## Basswood, Birch

and Other Wisconsin Hardwoods

LET US KNOW WHAT YOU ARE IN THE MARKET FOR

NORTHERN STOCK	SOUTHERN STOCK
Hemlock	Quartered White and Red
Birch	Oak
Basswood	Plain White and Red Oak
Rock Elm	Sycamore
Soft Elm	Poplar
Ash	Cypress
Oak	Gum

**PAGE & LANDECK LUMBER CO.**  
 Wells Building . . . . MILWAUKEE, WIS.

*Ingram Lumber Co.*  
 WAUSAU, WIS.

---

## BASSWOOD, BIRCH

We cut four million feet of each annually  
 Your inquiries and orders solicited

---

MILL AND YARDS AT INGRAM, WISCONSIN

**C. P. CROSBY**

RHINELANDER : : WISCONSIN

## Wholesale Hardwood Lumber

---

Hard Maple a Specialty in all thicknesses from 1 inch  
 to 4 inch. Finest Birch in Wisconsin. Black Ash,  
 Rock Elm, Soft Elm, Red and White Oak. : :

DIFFICULT AND MIXED ORDERS A SPECIALTY

**North Western Lumber Co.**  
 General Offices - EAU CLAIRE, WIS. Mills at STANLEY, WIS.

BAND SAWED

## Wisconsin Hardwoods

CAREFUL GRADINGS, PROMPT SHIPMENTS

SPECIAL OFFERINGS:

3 cars 1 1/4" to 2" Scoot Hardwood. 1/2 car 2" 1st and 2d Clear Basswood.  
 1 car 1 1/2" No. 1 Common Basswood. Large stock No. 2 Common Birch.  
 1 car 1 1/2" 1st and 2d Clear Basswood. Large stock No. 3 Common Birch.

**CLEVELAND**

HARDWOOD DISTRIBUTING CENTER OF NORTHERN OHIO

**MARTIN-BARRISS  
COMPANY**

Importers and Manufacturers

**MAHOGANY**

AND FINE

**HARDWOODS**

**We Solicit Inquiries**

FOR THE FOLLOWING:

- 2 cars 1x4" Clear Birch Strips
- 2 cars 1x5" and 6" Clear Birch Strips
- 1 car 3" No. 1 Com. and Better Birch, unselected
- 1 car 1" 1sts and 2nds Curly Red and White Birch
- 2 cars 1x4" Clear Basswood Siding Strips
- 2 cars 1x5" and 6" Clear Basswood Siding Strips

**The King & Bartles Lumber Company**

1955-2025 Scranton Road N. W., Cleveland, Ohio

**Do You Want It?  
What?  
Money?**

What have you in lumber to exchange for it? We want particularly Plain Oak, Chestnut, Poplar, Basswood, Ash.

**What Have You?**

**The Advance Lumber Co.**

13th Floor  
Rockefeller Bldg. CLEVELAND, OHIO

Memphis Office, No. 56 Randolph Building.

J. E. MEADOWS, Mgr.

**The Farmer in the  
Southwest Prospers**

Because he pays from \$8 to \$15 an acre for land that produces as good crops as land in Illinois and Indiana which sells for \$75 to \$100 an acre. The mild climate gives him earlier crops and the short winter makes stock-raising less expensive.

**You** have the same chance to prosper that is being taken by hundreds of the northern and eastern farmers.

Write for free copies of our illustrated books on Texas and Oklahoma.

Low rates to all points in the Southwest on the first and third Tuesdays of each month via



**CHICAGO @ EASTERN ILLINOIS R. R.**

W. H. RICHARDSON, G. P. A., Chicago, Ill.

**THE  
ROBERT H. JENKS LUMBER  
COMPANY**

**FOR SALE**

- 60 M feet 1" 1st and 2ds Poplar
- 223 M feet 1" No. 1 Common Poplar
- 125 M feet 1" No. 2 Common Poplar
- 25 M feet 2" 1st and 2nd Poplar, 14" and up
- 125 M feet 8 4" Sound Wormy Chestnut
- 275 M feet 1" Sound Wormy Chestnut
- 153 M feet 1" 1st and 2nd Plain White Oak
- 85 M feet 1" 1st and 2nd Plain Red Oak
- 125 M feet 1" No. 1 Common Plain Red Oak

**Quartered White and Red Oak.**—We have a good assortment of dry stock,  $\frac{3}{8}$  to 4 inches thick. Your inquiries solicited.

**Plain White and Red Oak.**—A limited amount of nice stock, ready for shipment.



# MICHIGAN

FAMOUS FOR HARD MAPLE AND GREY ELM

W. H. WHITE, Pres.  
JAS. A. WHITE, Vice-Pres.

W. L. MARTIN, Secy.  
THOS. WHITE, Treas.

## W. H. WHITE COMPANY

BOYNE CITY, MICHIGAN

Manufacturers of Hardwood and Hemlock Lumber, Cedar Shingles,  
White Rock Maple Flooring.

"THE THICK MAPLE FOLKS"

### BROWNLEE & COMPANY

DETROIT MICHIGAN

TWO-INCH SOFT MAPLE  
TWO-INCH BASSWOOD  
THREE-INCH HARD MAPLE

### The North Shore Lumber Co.

MANUFACTURERS

Hardwood and Hemlock  
Lumber, Cedar Products

Rail and water shipments

THOMPSON :: :: MICHIGAN

## UP=TO=DATE

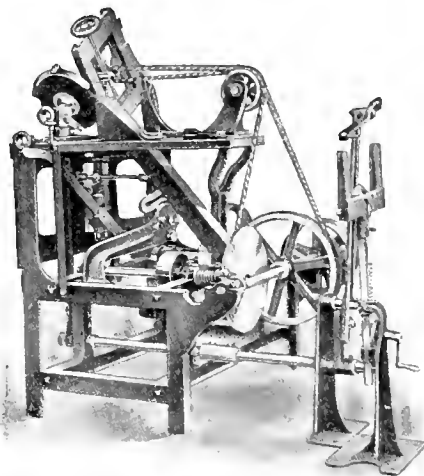

Hanchett Automatic Band Saw Sharpener

This is one of our full line of modern filing room machinery. Let us send you our new Catalogue No. 10.

### HANCHETT SWAGE WORKS

BIG RAPIDS, MICH.

### JUNE STOCK LIST

MAPLE		BIRCH		BASSWOOD	
1 in.	2,000,000 ft.	1 in.	500,000 ft.	1 in.	300,000 ft.
1 1/4 "	100,000 "	1 1/2 "	100,000 "	1 1/4 "	30,000 "
1 1/2 "	400,000 "	2 "	100,000 "	1 1/2 "	50,000 "
2 "	1,000,000 "	2 1/2 "	50,000 "	2 "	75,000 "
2 1/4 "	200,000 "	3 "	75,000 "	3 "	4,000 "
2 1/2 "	500,000 "	<b>ROCK ELM</b>			
3 "	500,000 "	2 in.	25,000 ft.	<b>GRAY ELM</b>	
4 "	400,000 "	2 1/4 "	50,000 "	1 in.	300,000 ft
<b>BEECH</b>		<b>WHITE MAPLE</b>		1 1/2 "	200,000 "
1 in.	500,000 ft.	End Piled		3 "	200,000 "
1 1/4 "	250,000 "	1 in.	100,000 ft.	<b>ASH</b>	
1 1/2 "	400,000 "	1 1/2 "	20,000 "	1 in.	500,000 ft.
2 "	100,000 "	2 "	50,000 "		
2 1/2 "	200,000 "				

KELLEY LUMBER & SHINGLE CO., Traverse City, Mich.

### DENNIS & SMITH LUMBER CO.

Wholesale Hardwood Lumber

Office and Yards, FOURTH AND HOLDEN AVENUES,  
DETROIT, MICH.

MILLS AT: Heaters, W. Va. Valley Bend, W. Va. Diana, W. Va. Parkersburg,  
W. Va. McNutt Siding, W. Va.

# MICHIGAN

FAMOUS FOR RED BIRCH AND BASSWOOD

## DENNIS BROS.

GRAND RAPIDS, : : MICHIGAN

MANUFACTURERS OF

**Hardwood Lumber, Perfect  
Birch and Maple Flooring**

**DRY STOCK AT BARGAIN PRICES:**

2 cars 8 4 Basswood, No. 1 Common and Better.  
3 cars 5 4 Basswood, No. 2 Common and Better.  
15 cars 4 4 Birch, No. 1 and 2 Common.  
1 car 1x4 Clear Birch Strips.  
2 cars 4 4 No. 3 Common Cherry.  
60M feet 12 4 Hard Maple.  
245M feet 8 4 Hard Maple.  
40M feet 8 4 Hard Maple, No. 3 Common.

Main Office :  
205-209 Michigan  
Trust  
Company  
Building

## Thos. MacBride Lumber Company

HEADQUARTERS FOR

## HARDWOODS

IN MICHIGAN

Michigan Trust Building, Grand Rapids, Mich.

## BIRCH

This is our specialty. We are in the heart of the best Birch section. Have good stock, Common and better, 4-4, 5-4, 6-4, 8-4, 10-4, 12-4, and 16-4. Let us figure with you.

**Simmons Lumber Company**  
SIMMONS, MICHIGAN

## McCLURE LUMBER COMPANY

MANUFACTURERS OF

## Hardwoods

Main Offices, DETROIT, MICH.  
Mills, : EUTAW, ALA.

SPECIAL OFFERINGS:

3 cars 2" Red and White Oak	2 cars 2" Black Ash
3 cars 2", 2 1/2", 3" and 1" White Ash	10 cars 1" to 4" Dry Hard Maple
2 cars 1" 6 4 White Ash	5 cars 1" Log Run Birch
1 car 6 4 and 8 4 Hickory	

## BOYNE CITY LUMBER COMPANY

BOYNE CITY

MICHIGAN ROCK MAPLE and other HARDWOODS

LARGE CAPACITY PROMPT SHIPMENTS RAIL OR CARGO



## J. S. GOLDIE

Cadillac, : : Michigan.

SPECIAL PRICES on 500M pieces  
1" to 3" Maple Squares 16" to 27" long.  
1" to 3" Soft Elm Lumber.

INQUIRIES SOLICITED FOR MICHIGAN LUMBER.

## SOFT ELM AND ROCK ELM

FOR SALE BY

**The R. G. Peters Salt & Lumber Co.**

EASTLAKE, MICHIGAN

## VAN KEULEN & WILKINSON LUMBER COMPANY

Manufacturers and Wholesalers of

**HARDWOOD LUMBER and CRATING STOCK**

Complete Stocks of Michigan Hardwoods — Maple, Beech, Birch, Elm, Ash and Basswood for sale.

Grand Rapids, : : Michigan

## OUR MAPLE FLOORING

is as near perfection, in every particular, as it is possible to make it, for we personally supervise every step in its manufacture, from the stump to the shipping of the finished product. Our prices will interest and a trial convince you. : :

## HAAK LUMBER COMPANY

HAAKWOOD, MICHIGAN

## Hackley-Phelps-Bonnell Co.

MANUFACTURERS OF

**Northern and Southern  
Hardwood Lumber**

Main Office, Michigan Trust Company Building

GRAND RAPIDS : : MICHIGAN

# CINCINNATI

THE GATEWAY OF THE SOUTH

## WANTED

Oak  
Walnut  
Gum  
Cottonwood  
Poplar  
White Pine  
Hemlock  
Yellow Pine

Will inspect at shipping point when quantity justifies and pay cash. Can use entire mill cuts. Write us before selling elsewhere. We can also handle mixed cars of dressed stock. Send us your list with prices.

### Kentucky Lumber Co.

Suite 508 First National Bank Bldg.  
Cincinnati, Ohio.  
Formerly of Burnside, Ky.

FRAMES,  
SASH, DOORS,  
BLINDS, MOULDINGS,  
COLUMNS, GLASS,  
STAIRWORK,  
INTERIOR TRIM.



PAINTS,  
BUILDERS' HARDWARE,  
MANTELS, ETC.  
LARGO CINCINNATI FAC-  
TORIES MAKE PROMPT  
SHIPMENTS POSSIBLE.

## PLAIN OAK—BASSWOOD

Are what we want. All thicknesses and grades. Spot cash. Send us list of your offerings with prices.

DUHLMEIER BROS., CINCINNATI, O.

## E. H. FALL

EXPORTER  
OF

WALNUT, POPLAR  
AND  
BIRDSEYE MAPLE LOGS

Cash paid for Black Walnut Logs at point of shipment. If you have any walnut logs to offer, write me. I have some Sycamore, Red Oak, Ash and other hardwood logs which I am prepared to saw to order. Correspondence solicited. Can also supply Black Walnut lumber, sawed to any specification required.

PORT CLINTON : OHIO

## CYPRESS LUMBER CO.

Manufacturer of Hardwoods and Cypress

Plain and Quartered White and Red Oak, Yellow Poplar, Yellow Pine, Walnut, etc. Mills in Tenn., Ala. and Va.

OFFICE AND YARDS, GEST AND DALTON AVE., CINCINNATI, OHIO.

## "BUY GUM"

We are in the market to buy Dry Gum Lumber in any quantity, from a single car load to a million feet. Will take all grades and thicknesses. We receive lumber at shipping point, pay cash and are liberal in inspection.



### THE FARRIN-KORN LUMBER COMPANY

General Office, Yards,  
Planing Mills, Dry Kilns,  
Cincinnati, Ohio  
Purchasing Office,  
Randolph Building,  
Memphis, Tenn.  
Cypress Red Gum Oak

## The Kentucky Lumber & Veneer Co.

HARDWOOD MANUFACTURERS

Post Office and Band Mill, Shipping Point and Telegraph Office,  
ROBBINS, KY. JACKSON, KY.

Specialties:

PLAIN WHITE OAK OAK PLANKING  
YELLOW POPLAR RAILROAD TIES

We manufacture all the lumber we sell from original forest timber. Therefore the lengths and widths are good. All logs are manufactured in ten to thirty days after being felled, insuring bright, new stock, free of sap worms and rot. WRITE OR WIRE FOR PRICES.

## THE GENERAL LUMBER COMPANY

HARDWOODS

HEMLOCK, YELLOW PINE.

COLUMBUS

OHIO

The only trade paper reaching all classes of hardwood consumers

HARDWOOD RECORD

355 Dearborn St., Chicago

# W. H. Dawkins Lumber Co.

Manufacturers of Band Sawed

## Yellow Poplar

ASHLAND, KY.

**CINCINNATI**

THE GATEWAY OF THE SOUTH

**THE WIBORG & HANNA COMPANY**

CINCINNATI, OHIO

PLAIN  
AND  
QUARTER  
SAWED

**White and Red Oak**

CHESTNUT  
POPLAR  
GUM AND  
CYPRESS

Flooring, Siding, Ceiling, Base, Case and Molding. Rough, Dressed and Re-sawed. Mixed Carloads.

**THE  
MALEY, THOMPSON & MOFFETT CO.**

Always in the Market for  
**BLACK WALNUT LOGS,  
SELECTED WHITE OAK LOGS,  
LUMBER OF ALL KINDS.**

CINCINNATI, : : : OHIO

**L. W. RADINA & COMPANY**

Correspondence Solicited with Buyers and Sellers of All Kinds of

**HARDWOODS**

Wanted for cash - desirable blocks of 1 inch to 4 inch Poplar, all grades, Especially 1 1/2-inch stock, for immediate shipment.

CLARK STREET AND DALTON AVENUE

**Cincinnati Hardwood Lumber Co.**

GEST AND SUMMER STREETS

Wholesalers Mahogany, Thin Lumber, Veneers

Finely figured quarter sawed oak veneers a specialty.

**BENNETT & WITTE**  
MANUFACTURERS OF SOUTHERN HARDWOODS

THAT ARE SOLD  
ON NATIONAL HARDWOOD LUMBER ASSOCIATION  
INSPECTION ONLY.

Plain and Quartered . . } White and Red Oak  
Red and Sap Gum  
Cottonwood, Ash, Cypress, Poplar, Soft Maple, Tnpelo  
Gum and Chestnut. We cut Gum and Oak in Thick-  
nesses of 3/8 to 4 inches. EXPORT AND DOMESTIC.

224 W. 4th Street, CINCINNATI, OHIO

Branch: 1301-2 Tenn. Trust, Memphis, Tenn.

WHAT HAVE YOU FOR SALE IN  
**Red and White OAK Qtd. and Plain**

ALSO POPLAR, CHESTNUT, WALNUT, ETC.

JOHN DULWEBER & CO., CINCINNATI, OHIO

**THE E. E. BECK LUMBER COMPANY**

Cash Buyers

**Poplar, Oak, Chestnut**

And Other Southern Hardwoods

ALL GRADES AND THICKNESSES. WE BUY MILL CUTS.

IN THE MARKET FOR

**OAK-ASH-POPLAR**

ALL GRADES AND THICKNESSES

**MOWBRAY & ROBINSON**

Office:  
1219 West Sixth Street

Yards:  
Sixth Street, below Harriet



**THE FREIBERG LUMBER CO.**

Manufacturers of

**Tabasco Mahogany**

Walnut, Oak

Poplar, McLean and Findlay Aves.  
CINCINNATI, O.

Poplar, Oak,  
Ash, Chestnut,  
Sycamore,

W. Va Spruce,  
Pine and Elm

**C. Crane & Co.**

We would like to buy

2,000,000 feet Dry Oak  
2,000,000 feet Dry Poplar

Mostly heavy stock. Quotations Solicited.

MILLS AND YARDS  
CINCINNATI, O.

YEARLY CAPACITY  
100,000,000 FT.

LONG BILL STUFF  
A SPECIALTY

**CHICAGO**

THE GREATEST HARDWOOD MARKET IN THE WORLD

**Estabrook-Skeele Lumber Co.**

203 FISHER BUILDING, CHICAGO

We are in the market for

**Wagon Stock**

REACHES, BOLSTERS, TONGUES, AXLES, ETC., AND

**Hardwood Lumber**

PARTICULARLY WANT WHITE ASH  
AND HICKORY

TELL US WHAT YOU HAVE  
TO OFFER

FRED W. BLACK, President      HORACE W. BLACK, Secretary  
**FRED W. BLACK LUMBER COMPANY**  
MANUFACTURERS OF  
**HARDWOOD LUMBER**  
305 Old Colony Building

**Lesh & Matthews Lumber Co.**

1649-50 MARQUETTE BUILDING

Are now offering bone dry BIRCH, ROCK ELM, BLACK ASH, etc., Wisconsin stock. Also PLAIN AND QUARTERED OAK, POPLAR, etc., from our Memphis yard. We are constant buyers.

**The Keith Lumber Company**  
HARDWOOD, POPLAR & SOUTHERN PINE LUMBER,

MAHOGANY,



CYPRESS,

REDWOOD,

CHESTNUT,

RED CEDAR,

SPRUCE,

MAPLE FLOORING, OAK TIMBERS & WAGON STOCK.

Office and Yards: Fourteenth and Wood Streets.

**THE WARD LUMBER COMPANY**  
MANUFACTURERS OF  
**HARDWOODS**

CHAMBER OF COMMERCE BUILDING :: CHICAGO

**CLARENCE BOYLE LUMBER CO.**

Wholesale Dealers in **Hardwoods** Yellow Pine and Cypress

319 WEST TWENTY-SECOND STREET :: CHICAGO

**Heath-Witbeck Company**

**Hardwood Lumber**

We have for quick shipment 170,000 feet DRY BIRCH, First and Seconds and Common 2, 2½, 3 and 4 inch.

Main Office, 6 Madison St. Yards, Loomis and 22nd St.  
**CHICAGO**

**Crandall & Brown**

LOUISIANA RED CYPRESS,  
YELLOW PINE FINISH,  
FLOORING, CEILING, PARTITION,  
OAK, POPLAR, BIRCH,  
BASSWOOD, MAPLE.

Office and Yards: 3300 Center Avenue, CHICAGO.

**SOUTHERN OAK LUMBER CO.**



WE WANT TO BUY FOR CASH

**OAK**  
**CYPRESS**  
**ASH**

MILL CUTS OR ROUND LOTS

910 CHAMBER OF COMMERCE 1217 TENNESSEE TRUST BLDG.

**CHICAGO**      **MEMPHIS**

YARDS: NORTH MEMPHIS

# BUFFALO

THE GREAT WHOLESALE LUMBER CENTER OF THE EAST



Manufacturers and  
Dealers in

Ash

White and Brown

Basswood

Birch

Red and White

Butternut

Cherry

Chestnut

Cottonwood

Cypress

Elm

Soft and Rock

Gum

Red and Tupelo

Hickory

Maple

Hard and Soft

Red Oak

Plain and Quartered

White Oak

Plain and Quartered

Black Walnut

White Wood

Poplar



## BUFFALO HARDWOOD LUMBER CO.

We want to buy for cash:  
Oak, Ash and other Hardwoods, all grades and thicknesses.  
Will receive and inspect stock at shipping point.

518 RANDOLPH BLDG., MEMPHIS, TENN.

940 SENECA STREET.

## EMPIRE LUMBER COMPANY

Our specialties are PLAIN and QUARTERED OAK and ASH.

1142 SENECA STREET.

## G. ELIAS & BROTHER

BUY AND CARRY LARGE QUANTITIES OF ALL KINDS OF HARDWOODS

955 TO 1015 ELK STREET

## HUGH McLEAN LUMBER COMPANY

Specialty: INDIANA WHITE OAK

940 ELK STREET

## ANTHONY MILLER

HARDWOODS OF ALL KINDS

893 EAGLE STREET

## SCATCHERD & SON

HARDWOODS ONLY

Yard, 1555 SENECA STREET

Office, 886 ELLICOTT SQUARE

## STANDARD HARDWOOD LUMBER CO.

OAK, ASH AND CHESTNUT

1075 CLINTON STREET

## I. N. STEWART & BROTHER

Specialties: CHERRY AND OAK

892 ELK STREET

## T. SULLIVAN & COMPANY

Specialties: BROWN ASH, BIRCH, PACIFIC COAST FIR AND SPRUCE

50 ARTHUR STREET

## ORSON E. YEAGER

Specialties: OAK, ASH AND POPLAR

932 ELK STREET

## BEYER, KNOX & COMPANY

ALL KINDS OF HARDWOODS

Office and Yards, 69 LEROY AVENUE



# YELLOW POPLAR

Manufacturers  
BAND SAWED  
POPLAR LUMBER

ALL GRADES

**DRY** 5-8, 4-4, 5-4, 6-4, 8-4, 10-4, 12-4, 16-4  
Bevel Siding, Lath and Squares  
Specialty, Wide Stock.

# LUMBER CO.

COAL GROVE, OHIO, U. S. A.

## W. M. Ritter Lumber Company

COLUMBUS, OHIO

### 6,000 Car Loads

Sawed and shipped yearly of band-sawed Yellow Poplar, White Pine, White Oak, Basswood, Chestnut, Hemlock and Ash. Planing Mill and Dry Kiln. ☛ If you are in a hurry to get your order placed, call our nearest salesman.

Salesman	Headquarters	Telephone
Fred A. Wilson.....	Portsmouth, Ohio.....	Bell 4392
E. E. Eaton.....	New York City, 158 W. 81st St.....	Riverside 7390
James B. Patton.....	Buffalo, N. Y., Rockford Hotel.....	Bryant 1335-R
A. Wallace Irwin.....	Baltimore, Md., Eutaw Hotel.....	
Frank B. Pryor.....	Pittsburgh, Pa., 7th Avenue Hotel.....	
E. E. Ginn.....	Jamestown, Ohio.....	Bell Phone
A. J. Williams.....	Cleveland, Ohio, Eastman, Detroit St.....	Ridge 593-R
L. G. Anderson.....	Franklin, Ohio.....	Bell 482
James H. Lang.....	Detroit, Mich., Hotel Ste. Claire.....	
W. H. Matthias.....	Chicago, Ill., 1448 Addison St.....	Lakeview 1493
Geo. H. Haganir.....	Philadelphia, Pa., 901 N. 50th St.....	
F. H. Browning.....	Columbus, Ohio.....	Main 7874
W. T. Baker.....	Graham, Va.....	

## Vansant, Kitchen & Co.



NEW ASHLAND MILL

Old-Fashioned

### SOFT YELLOW POPLAR

Ashland, Ky.

5-8 AND 4.4 IN WIDE STOCK, SPECIALTY

# Hardwood Record

Eleventh Year. {  
Semi-monthly. }

CHICAGO, JUNE 25, 1906.

{ Subscription \$2.  
Single Copies, 10 Cents. }

## CHERRY

C. E. LLOYD, JR.  
Manager Sales

## RIVER

GROWS IN  
WEST VIRGINIA

Sold by  
Cherry River Boom &  
Lumber Co.  
Offices: Philadelphia, Pa.

## LUMBER

## RED GUM

We produce and market a carload of Gum Lumber  
: every 45 minutes during the working day. :

Himmelberger-Harrison Lumber Co.  
Morehouse, : : Missouri

For relief from increased rates  
which are now imminent, apply to

## The Lumber Mutual Fire Insurance Company

141 Milk Street, Boston, Mass.

PRESENT CASH DIVIDEND TO POLICY HOLDERS, 33 $\frac{1}{3}$  PER CENT.

## The Davidson-Benedict Company

NASHVILLE, TENNESSEE

Everything in

## Southern Hardwoods

POPLAR, CHESTNUT, ASH, OAK  
(Plain and Quartered.) Straight or Mixed Cars.

DRESSED POPLAR ANY WAY YOU WANT IT. YOU GET WHAT YOU BUY FROM US. ASK FOR OUR DELIVERED PRICES, ANY RAILROAD POINT.

— WE WANT TO MOVE —

## QUARTERED WHITE OAK

125,000 1 inch No. 1 and No. 2.  
500,000 1 inch No. 1 Common.  
300,000 1 inch No. 2 Common.  
100,000 2 inch No. 1 Common Red Oak.  
400,000 1 inch Sap Cull Poplar.

STOCK TWO YEARS DRY.

## THE ATLANTIC LUMBER CO.

2 Kilby Street, BOSTON, MASS.

## ADIRONDACK FIRE INSURANCE COMPANY

CAPITAL AND SURPLUS, \$300,000.

LUMBER AND WOODWORKING RISKS EXCLUSIVELY.

A new company organized to further serve the patrons of the Lumber Insurance Company of New York, 66 Broadway, New York, and allied organizations.

Home Office: 66 Broadway, NEW YORK

# LOUISVILLE

MANUFACTURING AND DISTRIBUTING CENTER OF KENTUCKY

## W. P. Brown & Sons Lumber Co.

WHOLESALE HARDWOODS

Louisville, Ky.

### The Norman Lumber Co., Inc.

Manufacturers and Wholesalers of

## Hardwood Lumber

FOR SALE

Seasoned Ash, Oak, Poplar, and Walnut Lumber

WANT TO BUY

Walnut, Oak, Ash, Hickory and Poplar Logs and Lumber

Office and Yards: Third Street, H to K Streets  
LOUISVILLE, KY.

### EDWARD L. DAVIS & CO.

OFFER FOLLOWING STOCKS:

POPLAR.	OAK WAGON TONGUES.
30,000 ft. 4/4 1st & 2d.	12,000 ft. 4x4"x12"—12', 1-6 mos. dry.
50,000 ft. 4/4 Common.	800 ft. 3 x4 "—12', 12-18 mos. dry.
15,000 ft. 5/4 Common.	400 ft. 3 1/2 x4 1/4 "—12', 12-18 mos. dry.
QUARTERED RED OAK.	300 ft. 3 1/2 x4 1/4 "—12', 12-18 mos. dry.
50,000 ft. 4/4 1st & 2d.	250 ft. 3 1/2 x4 1/4 "—12', 12-18 mos. dry.
60,000 ft. 4/4 Common.	800 ft. 3 1/2 x4 1/4 "—12', 12-18 mos. dry.
QUARTERED WHITE OAK.	180 ft. 3x4" & Lgr.—14', 12-18 mos. dry.
50,000 ft. 4/4 1st & 2d.	
10,000 ft. 5/4 1st & 2d.	
20,000 ft. 6/4 1st & 2d.	
10,000 ft. 8/4 1st & 2d.	
50,000 ft. 4/4 Common.	
5,000 ft. 5/4 Common.	
5,000 ft. 6/4 Common.	
20,000 ft. 8/4 Common.	
10,000 ft. 2 1/2" Common.	
40,000 ft. 3" Common.	
1 car Hickory Plank, 1 1/2 to 4"—8' to 16'.	

REACHES.

1 car 2x4" and larger, dry.

BOLSTERS.

2 cars 3x4" and larger, dry.

HICKORY AXLES.

1,500—3 x4 "—8', 1-6 mos. dry.

1,500—3 1/2 x4 1/2 "—8', 1-6 mos. dry.

2,000—4 x5 "—5', 1-6 mos. dry.

1,000—4 1/2 x5 1/2 "—6', 1-6 mos. dry.

1,000—5 x6 "—6', 1-6 mos. dry.

## We wish to move and will quote low prices on the following:

1 Car 6 4 1st and 2nd Qtd. White Oak, Wide in  
1 Car 8 4 1st and 2nd Qtd. White Oak, Wide in  
1 Car 4 4 No. 1 Com. Qtd. White Oak  
1 Car 6 4 No. 1 Com. Qtd. White Oak  
2 Cars 8 4 No. 1 Com. Qtd. White Oak  
1 Car 12 4 No. 1 Com. Qtd. White Oak  
1 Car 4 4 1st and 2nd Qtd. Red Oak, Wide in  
1 Car 4 4 No. 1 Com. Qtd. Red Oak, Wide in  
1/2 Car 6 4 Com. and Bet. Qtd. Red Oak, 50' each  
1/2 Car 8 4 Com. and Bet. Qtd. Red Oak, 50' each  
1 Car 12 4 Com. and Bet. Qtd. Red Oak, 50' each  
1 Car 6 4 Com. and Bet. Plain Red Oak, 50' each  
2 Cars 12 4 Com. and Bet. Plain Red Oak, 50' each

1 Car 4 4 2" to 5 1/2" 1st & 2nd Qtd. White Oak Strips  
1/2 Car 4 4 2" to 5 1/2" No. 1 Com. Qtd. White Oak Strips  
1 Car 4 4 No. 2 Com. Qtd. White and Red Oak  
1/2 Car 5 4, 6 4 and 8 4 No. 2 Com. Qtd. White and Red Oak  
1 Car 4 4 No. 2 Com. Plain Red Oak  
1 Car 5 4, 6 4, and 8 4 No. 2 Com. Plain Red Oak  
2 Cars 4 4 No. 3 Com. Plain Red and White Oak  
1 Car 6 4 1st and 2nd Poplar, 7 to 15'  
5 Cars 4 4 No. 1 Com. Poplar (Selects in)  
1 Car 4 4 No. 1 Com. and Bet. Bay Poplar  
1 Car 4 4 to 8 1 Com. and Bet. White Ash  
1 Car 4 4 No. 2 Com. and Sound Wormy Chestnut

We have in pile at mills 3,000,000 ft. Plain and Quartered Red and White Oak, Poplar, Chestnut and some Ash, in thickness 1 1/2" to 16 1/4". This will be ready for market in 60 to 90 days. We also handle all kinds of Yellow Pine, Cypress, White Pine, Red and White Cedar, Lumber, Lath and Shingles and all kinds of Hardwood Flooring. Write us for prices.

### STOTZ LUMBER COMPANY

KELLER BUILDING :: :: LOUISVILLE, KY.

## Ornamental Hardwood Floors

400 STYLES AND PATTERNS

Illustrated Catalog on Application

### WOOD=MOSAIC FLOORING CO.

Rochester, N. Y. New Albany, Ind.

#### Albert R. Kampf

Manufacturer  
Hardwood Lumber and Timber  
Dimension Stock  
Board of Trade Bldg., Louisville, Ky.

#### E. W. Rhubesky

Wholesale  
Poplar, Rough and Dressed.  
Oak, Chestnut and Other  
Hardwoods

#### North Vernon Pump & Lumber Co.

Band Sawn Plain and Quartered  
Oak and Poplar  
North Vernon, Ind. and  
Louisville, Ky.

#### Southern Lumber Co.

Oak, Poplar and  
Chestnut.  
Louisville, Ky.

**CADILLAC**

CELEBRATED FOR HIGH STANDARD OF QUALITY AND MILL WORK

**Thick Hard Maple**

Cut during the winter of 1904-5.

- 10-4 1's and 2's . 51,000 ft.
- 12-4 1's and 2's . 55,000 ft.
- 16-4 1's and 2's . 10,000 ft.

This stock was sawed in our own mill and has been seasoned in a first-class manner. It is largely 12 inch and wider and very choice.

We also have end-dried in shed:

- 4-4 Birdseye Maple, 8,000 ft.
- 5-4 White Maple . 21,000 ft.

PLEASE SEND US YOUR INQUIRIES.

**Mitchell Brothers Company**

CADILLAC, MICHIGAN

**Cummer, Diggins & Co.**

MANUFACTURERS  
"CUMMER" MAPLE  
AND BEECH FLOORING

**MICHIGAN HARDWOODS**

Good assortment of dry stock on hand ready for immediate shipment in Hard Maple, Beech, Birch, Soft Elm and Cherry.

SEND US A LIST OF YOUR REQUIREMENTS.

**MURPHY & DIGGINS**

Offer all grades of the following special dry stock

- MAPLE—5/4, 6/4, 8/4, 10/4, 12/4, 14/4, 16/4
- GRAY ELM—4/4, 12/4
- BASSWOOD—4/4
- BIRCH—5/4, 6/4

Our own manufacture. Perfect Mill Work. Uniform Grades.

LET US FIGURE ON YOUR HARDWOOD WANTS.

**The Cadillac Handle Co.**

. . . Band Sawn . . .  
**Michigan Hardwoods**

We offer for Rail Shipment from Cadillac:  
2 cars 8/4 Maple, No. 1 Com. & Better  
1 car 5x5 Maple, Select Stock  
2 cars 4/4 Basswood, No. 2 Com. & Bet.  
2 cars 4/4 Birch, No. 2 Com. & Bet.

Also the following for Water Shipment:  
100,000 feet of 4/4 Basswood  
100,000 feet of 4/4, 8/4 and 12/4 Soft Elm  
150,000 feet of 4/4, 5/4 and 6/4 Birch

**DRY STOCK**

We have a choice line of

**Michigan Hard Maple**  
and  
**Soft Gray Elm**

In placing your orders, remember also our famous "ELECTRIC" BRAND MAPLE FLOORING.

Be Friendly.

Write Us.



**COBBS & MITCHELL**  
(INCORPORATED)  
**CADILLAC, MICHIGAN**



# MEMPHIS

THE HUB OF THE HARDWOOD WORLD

## Briggs & Cooper Company, Ltd.

MANUFACTURERS

### NORTHERN SOUTHERN HARDWOODS

GET OUR PRICES ON THESE ITEMS:

- 1,000,000 feet Soft Grey Elm, 1 to 3".
- 500,000 feet Unselected Birch, 1 to 3".
- 3,000,000 feet Michigan Hard Maple, 1 to 6".
- 350,000 feet End Dried White Maple, 1 to 1½".
- 625,000 feet No. 1 Common and Better Winter Sawed Basswood, 1 to 3".
- 150,000 feet Selected White Basswood, 1", 1¼" and 1½".
- 210,000 feet Plain and Quartered White and Red Oak, 1 to 2".

YARDS AT

SAGINAW, CHICAGO AND MEMPHIS

## BACON-NOLAN HARDWOOD CO.

Manufacturers of

### Band Sawn Oak, Ash Gum, Cypress, Etc.

Office,  
Memphis, Tenn.

Mills,  
Chancy, Miss.

Address all correspondence to Memphis office.

**WE** have in all thicknesses the following kinds and amounts of lumber at places designated. Kindly send us your inquiries.

**MEMPHIS YARD:**

- Ash..... 680,000 feet
- Quartered White Oak... 75,000 feet
- Plain White Oak..... 140,000 feet
- Quartered Red Oak..... 225,000 feet
- Plain Red Oak..... 410,000 feet
- Cypress..... 225,000 feet
- Cottonwood..... 300,000 feet
- Poplar..... 308,000 feet

**SELMA YARD**

- Poplar..... 409,000 feet
- Bay Poplar..... 857,000 feet
- Red Gum..... 55,000 feet
- Cypress..... 787,000 feet

**BERCLAIR YARD**

- Bay Poplar..... 100,000 feet
- Cypress..... 800,000 feet

**OTHER YARDS**

- Plain Red Oak..... 350,000 feet

## J. W. THOMPSON LUMBER COMPANY

Office and Yards: Randolph Road and I. C. R. R. : : MEMPHIS, TENN.

J. B. Ransom, Pres. A. B. Ransom, V.-Pres. W. A. Ransom, Sec. C. R. Ransom, Treas.

## GAYOSO LUMBER CO., Inc.

MANUFACTURERS AND DEALERS IN

### SOUTHERN HARDWOODS

Also make a specialty of Wagon Stock in rough, such as Tongues, Axles, Reaches, Bolsters, and 6-4 to 16-4 Hickory.

## ANDERSON-TULLY COMPANY

STOCK LIST

<b>COTTONWOOD.</b>		<b>ASH.</b>	
20 M ft. 7/8" 1st & 2nd, 8" up	15,000 ft. 4/4" 1st & 2nd Strips, 2½" to 5½"	5,000 ft. 4/4" Common.	
14 M ft. 4/4" 1st & 2nd, 6" up		12,000 ft. 5/4" & 6/4" No. 3 Common.	
14 M ft. 4/4" 1st & 2nd, 7"-10"		<b>GUM.</b>	
25 M ft. 4/4" 1st & 2nd, 11"-12"		60,000 ft. 4/4" 1st & 2nd Saps, 13" to 16".	
40 M ft. 4/4" 1st & 2nd, 18" up		60,000 ft. 4/4" 1st & 2nd Saps, 16" and up.	
15 M ft. 5/4" 1st & 2nd, 6" up		50,000 ft. 4/4" No. 1 Common Red.	
20 M ft. 5/4" 1st & 2nd, 12"		100,000 ft. 4/4" No. 1 Common Sap.	
35 M ft. 5/4" 1st & 2nd, 11" & 12"		60,000 ft. 4/4" 1 & 2 Red Strips, 2½" to 5½".	
45 M ft. 6/4" 1st & 2nd, 6" up		<b>POPLAR.</b>	
50 M ft. Wagon Box Boards, 9" to 12"		20,000 ft. 4/4" Common & Better.	
<b>CYPRESS.</b>		<b>RED OAK.</b>	
20,000 ft. 4/4" Clear Strips, 2½" to 5½"		1,750 ft. 4/4" Quartered 1 & 2.	
<b>WHITE OAK.</b>		2,930 ft. 4/4" Quartered Common.	
4,000 ft. 4/4" 1 & 2 Quartered		14,440 ft. 4/4" Plain 1 & 2, 12" and up.	
6,500 ft. 4/4" Com. Quartered		80,000 ft. 4/4" Nos. 2 & 3 Com. Red & White.	

F. W. GILCHRIST, Pres. W. A. GILCHRIST, Vice-Pres.  
W. E. SMITH, Sec'y and Treas.

## Three States Lumber Co.

MANUFACTURERS OF

Mills:  
Missouri  
Arkansas  
Tennessee

### Hardwood Lumber Cottonwood and Gum

Office  
Tennessee  
Trust  
Building

GET OUR PRICES, TRY OUR LUMBER  
WE SHIP ROUGH, DRESSED, RESAWED

**COTTONWOOD GUM**

F. W. GILCHRIST, President  
W. A. GILCHRIST, Vice President  
W. E. SMITH, Sec'y and Treasurer

## W. E. SMITH LUMBER CO.

Manufacturers of  
**HARDWOOD LUMBER**

Mills, Tennessee, Arkansas, Mississippi  
Distributing Yards, Cairo, Illinois  
General Office, Tennessee Trust Bldg.

MISSISSIPPI VALLEY COTTONWOOD

## Hardwood Board Rules FOR HARDWOOD LUMBERMEN



### Best Goods, Prompt Shipment

Send your orders to the HARDWOOD RECORD, 355 Dearborn Street

**ST. LOUIS**

LARGEST OF ALL HARDWOOD MARKETS

**LOTHMAN CYPRESS CO.**

AIR DRIED

**Louisiana Red Cypress**

FOOT OF ANGELICA STREET

**Garetson-Greaseon Lumber Co.**

MANUFACTURERS OF SOUTHERN HARDWOODS

**GUM LUMBER  
OUR SPECIALTY**

Carload Shipments Direct  
from Our Own Mills

**519 Bank of Commerce**

**Ozark Cooperage Co.**

**WE BUY STOCKS READY CUT OR CONTRACT FUTURE OUTPUT**

Four Inspectors in the South

Direct Shipments from mill stocks { COTTONWOOD, CYPRESS, GUM, OAK. } MAIN OFFICE, FRISCO BUILDING

**CHAS. F. LUEHRMANN HARDWOOD LUMBER COMPANY**

Carry a complete stock of Hardwood and are constantly in the market to purchase large blocks of stock for cash. Are also the largest manufacturers of the famous St. Francis Basin Red Gum.

General Offices: 148 Carroll Street

**W. R. CHIVVIS,** Lesperance Street and Iron Mountain Railroad.

**WHOLESALE HARDWOODS**

**BLACK WALNUT LUMBER MY SPECIALTY.** Always in the market to buy Walnut and Cherry Lumber. Pay spot cash and take up at shipping point when amounts justify.

**Wanted—Cypress, Ash and Cottonwood**

INSPECTION AT POINT OF SHIPMENT WHEN QUANTITY JUSTIFIES

**Hafner Manufacturing Co.**

CYPRESS, HARDWOODS

Mail orders receive our immediate attention.

YARDS: FOOT OF DOCK STREET

**Stoneman-Zearing Lumber Co.**

*203 Frisco Building*

We have the following Dry Stock for sale piled at our mill:

<b>QTD. WHITE OAK :</b>	<b>COTTONWOOD :</b>
3 Cars 4/4 Common.	3 Cars 1" 1 and 2.
2 Cars 4, 4 Common and Better Strips.	1 Car 1x13 to 17" Box Boards.
<b>GUM :</b>	<b>ELM :</b>
5 Cars 1" Common Red.	1 Car 6.4 Log Run.
1 Car 1x13 to 17" Box Boards.	4 Cars 4" Log Run.
1 Car 2" 1 and 2 Sap.	
6 Cars 1 1/2 Common and Better Sap.	

This Stock is All Band Sawed and Equalized

**Thomas & Proetz Lumber Co.**

CASH BUYERS OF OAK, ASH, CYPRESS, POPLAR, CHERRY AND ALL

**HARDWOODS**

SEND INSPECTOR WHEN QUANTITY JUSTIFIES

Office and Yards: Hall and Angelrodt Sts.

**SIX MILLION FEET**

Ash, Oak, Cypress, Poplar, Etc.

READY FOR PROMPT SHIPMENT

**STEELE & HIBBARD**

NORTH BROADWAY, DOCK AND HALL STREETS



# Swann-Day Lumber Company

MANUFACTURERS OF

## POPLAR AND OAK

PLANING MILL STOCK, BOX SHOOKS  
AND HARDWOOD DIMENSION

CLAY CITY, KENTUCKY

### Are You in the Market ?

Send us your inquiries for prices on  
the following

## HARDWOODS

100M ft. 1" Com. and Better Quartered Red Oak.  
100M ft. 1" Com. and Better Quartered White Oak. E  
75M ft. 1½" Com. and Better Quartered Red Oak.  
25M ft. 1½" Com. Quartered White Oak.  
25M ft. 1½" 1st and 2nds Quartered Red Oak.  
50M ft. 3" Com. and Better Quartered White Oak.  
50M ft. 3" Com. and Better Plain White Oak.  
100M ft. 1" Com. Plain Birch.  
50M ft. 1" Com. Red Birch.  
50M ft. 1½" Com. and Better Plain Birch.  
100M ft. 1" Com. and Better Hard Maple.  
100M ft. 1½" Com. and Better Hard Maple.  
100M ft. 1" Com. and Better Soft Elm.

## UPHAM & AGLER

Distributing Yards: CAIRO, ILL.

Main Offices :: American Trust Building, CHICAGO

**—have you positive knowledge  
of the accuracy of your books?**

### A Certified Report

showing the exact condition of  
your business, locating possible  
errors, and offering *practical sug-  
gestions* for improving your sys-  
tem of accounting — furnished  
with our disinterested audit—

**will answer this query**



**Standard Audit Company**

Suite 335

Marquette Building, CHICAGO

# PAEPCKE-LEICHT LUMBER COMPANY

MANUFACTURERS OF

## COTTONWOOD GUM AND OTHER HARDWOODS

Large stocks of well seasoned Lumber always carried at our yards and mills.

General Offices: 140 W. Chicago Ave., CHICAGO. Mills: Cairo, Ill., Marked Tree, Ark., Greenville, Miss., Arkansas City, Ark., Blytheville, Ark.

# THE EAST

BOSTON NEW YORK PHILADELPHIA

## Charles S. Wentworth & Co.

WHOLESALE LUMBER MERCHANTS

147 Milk Street  
BOSTON

We are in the Market for POPLAR, PLAIN OAK, CYPRESS and NORTH CAROLINA PINE LUMBER; also OAK, MAPLE and BIRCH FLOORING, and would appreciate correspondence from manufacturers in position to supply any of the stock named.

## Wistar, Underhill & Co.,

WHOLESALE  
HARDWOOD LUMBER

816 Real Estate Trust Building, PHILADELPHIA.

## Holloway Lumber Company

WHOLESALE HARDWOODS

In the market for all thicknesses of OAK, ASH and CHESTNUT. 312 Arcade Building, PHILADELPHIA, PA.

# WILLIAM WHITMER & SONS, Inc.

MANUFACTURERS OF

## HARDWOODS

We are always in the market for round lots of well manufactured stock, and shall be pleased to enter into correspondence with manufacturers with a view to purchase.

PHILADELPHIA  
New York, Boston, Pittsburg

### DO YOU WANT MUCH OR LITTLE, SPECIAL OR ORDINARY LUMBER, ON HARDWOODS OR SOFT WOODS.

We have millions of feet of desirable, dependable lumber from Ash to Walnut with which to fill your orders promptly and satisfactorily. Whatever are your lumber needs, write us to-day for prices on same.

CONSULT JULY "LUMBER NEWS."

### J. Gibson McIlvain & Co.

58th St. and Woodland Ave., PHILADELPHIA, PA.

## STEVENS-EATON CO.

Buyers of  
ROUND LOTS  
of

### Hardwoods

No 1 Madison  
Avenue,  
NEW YORK

ESPECIALLY IN MARKET FOR PLAIN RED OAK

## WM. E. LITCHFIELD

MASON BUILDING, BOSTON, MASS.

Specialist in Hardwoods

Manufacturers are requested to supply lists of stock for sale

## Jones Hardwood Co.

(INCORPORATED)

### WANTS

Poplar, Plain Oak, Quartered Oak and Cypress

Manufacturers please send stock lists and prices

147 MILK STREET, BOSTON, MASS.

## H. D. Wiggin Wholesale Hardwoods

Specialties: Poplar, Chestnut, Canadian  
Hardwoods, and Mahogany Veneers.

FISKE BUILDING

BOSTON, MASSACHUSETTS

J. H. SCHOFIELD

R. W. SCHOFIELD

## SCHOFIELD BROTHERS WHOLESALE LUMBER

Hardwoods a  
Specialty.

1020-22 Pennsylvania Building  
PHILADELPHIA

# NASHVILLE

HEADQUARTERS FOR ALL SOUTHERN HARDWOODS

## JOHN B. RANSOM & CO.,

NASHVILLE, TENNESSEE

We want to move quickly the following old dry stock. All of it has been on sticks 6 to 18 months. Write us for delivered prices. We are prepared to furnish promptly mixed cars of rough and dressed hardwoods of all kinds:

QUARTERED WHITE OAK	QUARTERED RED OAK
90 M 4 4 first and second	100 M 4 4 first and second
15 M 5 4 first and second	58 M 6 4 first and second
80 M 6 4 first and second	15 M 8 4 first and second
10 M 10 4 first and second	95 M 4 4 No. 1 Common
120 M 4 4 No. 1 Common	84 M 6 4 No. 1 Common
65 M 6 4 No. 1 Common	72 M 8 4 No. 1 Common
58 M 8 4 No. 1 Common	
20 M 10 4 No. 1 Common	<b>PLAIN OAK</b>
70 M 5 8 first and second Poplar	50 M 4 4 1st and 2nd White
80 M 5 8 No. 1 Common Poplar	100 M 4 4 No. 1 Common White
15 M 4 4 1st and 2d Quartered Sycamore	100 M 4 4 first and second Red
10 M 4 4 No. 1 Com. Quart'd Sycamore	100 M 4 4 No. 1 Common Red

## Nashville Hardwood Flooring Co.

Manufacturers of

### "Acorn Brand"

THE FAMOUS FAULTLESS FLOORING  
IN OAK AND BEECH.

Car Lots and Less Than Car Lot  
Orders Solicited. Write for Prices.

Nashville, Tennessee

## INDIANA LUMBER CO.

Manufacturers Lumber  
DIMENSION STOCK A SPECIALTY.

Office and Mills: Corner Oldham  
Street and Cumberland River

NASHVILLE, TENN.

## LOVE, BOYD & CO.

Offer:

5,000,000 ft. Quartered White Oak.  
2,000,000 ft. Quartered Red Oak.  
1,000,000 ft. Plain White Oak.  
1,000,000 ft. Plain Red Oak.  
1,000,000 ft. Poplar.  
2,000,000 ft. Chestnut, Ash, Hickory, Red Cedar, Etc.

Our Own Manufacture.  
Prompt Service.  
Dry Stock.

MAIN OFFICE,  
NASHVILLE, TENNESSEE

## GEO. C. BROWN & CO.

MANUFACTURERS AND WHOLESALE DEALERS IN

Hardwood Lumber

Tennessee Red Cedar Lumber a Specialty.

NASHVILLE, TENNESSEE

## The Kentucky Lumber & Veneer Co.

HARDWOOD MANUFACTURERS

Post Office and Band Mill,  
ROBBINS, KY.

Shipping Point and Telegraph Office,  
JACKSON, KY.

Specialties:

**PLAIN WHITE OAK OAK PLANKING**  
**YELLOW POPLAR RAILROAD TIES**

We manufacture all the lumber we sell from original forest timber. Therefore the lengths and widths are good. All logs are manufactured in ten to thirty days after being felled, insuring bright, new stock, free of sap worms and rot

WRITE OR WIRE FOR PRICES.

No. 1, No. 2 and No. 3 Common  
Poplar, 4-4, 5-4, 6-4, 8-4. For sale by

## The Loomis & Hart Manufacturing Co.

Chattanooga, Tennessee

WRITE FOR PRICES

# W. H. Dawkins Lumber Co.

Manufacturers of Band Sawed

## Yellow Poplar

ASHLAND, KY.

# PITTSBURG

HARDWOOD DISTRIBUTING CENTER OF PENNSYLVANIA

## A. M. Turner Lumber Company

Everything in lumber. We buy hardwoods as well as sell them. If you have anything to offer, please submit same to us. : :

## Linehan Lumber Company

PERFECT

## MAPLE FLOORING

SEND US YOUR INQUIRIES

## Willson Bros. Lumber Co.

MANUFACTURERS

## WEST VIRGINIA HARDWOODS

FARMERS BANK BLDG. :: PITTSBURG, PA.

## Hardwoods a Specialty

FOR SALE

POPLAR	CHESTNUT	PLAIN OAK
125,000' 4 4 1s and 2s	200,000' 4 4 Sound Wormy	60,000' 4 4 No. 1 Com.
40,000' 4 4 No. 1 Com.	80,000' 5 4 Sound Wormy	18,000' 4 4 No. 2 Com.
325,000' 4 4 No. 2 Com.	100,000' 6 4 Sound Wormy	<b>QUARTERED OAK</b>
228,000' 4 4 No. 3 Com.	48,000' 8 4 Sound Wormy	2 cars 4 4 No. 1 Com.
150,000' 4 Mill Cull		1 car 4 4 No. 2 Com.

OAK TIMBERS SAWED TO ORDER.  
WRITE FOR PRICES.

CHEAT RIVER LUMBER COMPANY, Pittsburg, Penna.

## Babcock Lumber Co.

MANUFACTURERS OF  
**PENNSYLVANIA  
HARDWOODS**  
23,000,000 FEET ANNUALLY

LONG ON MAPLE  
AND CHERRY

MILLS AND OFFICE  
ASHTOLA, PA.

## Dry Stock for Quick Shipment:

12,189 ft 4 4 clear Quartered Oak	66,232 ft 4 4 No. 1 Common Poplar
14,570 ft 4 4 1st & 2ds qtd. Red Oak	10,315 ft 6 4 1st & 2ds Poplar
30,302 ft 4 4 No. 1 Com. Red Oak	56,000 ft 4 4 1st & 2ds Cottonwood
63,204 ft 4 4 No. 1 Com. Pl White Oak	119,000 ft 4 4 No. 1 Com. Cottonwood
4,417 ft 5 4 No. 1 Com. Pl White Oak	150,000 ft No. 2 Common Cottonwood
5,934 ft 6 4 No. 1 Com. Pl White Oak	90,000 ft 4 4 Mill Cull Cottonwood
23,473 ft 4 4 1st & 2ds Plain Red Oak	110,000 ft 5 4 No. 1 Com. Cottonwood
14,168 ft 4 4 1st & 2ds Poplar	40,000 ft 5 4 No. 2 Com. Cottonwood

## American Lumber & Mfg. Co.

PITTSBURG, PA.

## The Nicola Lumber Company

One million feet 4-4 Bay Poplar.  
Can be shipped log run, or sold  
on grade. Bone dry; band  
sawed. Send your inquiries

## Flint, Erving & Stoner Co.

Wholesale Lumber  
Northern and Southern Hardwoods

Beech and Maple Timbers a Specialty

## "Ideal" Steel Burnished Rock Maple Flooring

is the flooring that is manufactured expressly to supply the demand for the best. It is made by modern machinery from carefully-selected stock and every precaution is taken throughout our entire system to make it fulfill in every particular its name—"IDEAL."

Rough or Finished Lumber—All Kinds

Send us Your Inquiries

**The I. Stephenson Company**  
WELLS, MICHIGAN

## White and Red Oak

Secure our special prices on the following dry stock. :: We need the piling room.

30,000 feet 7-4 and 8-4 Quarter Sawn.  
150,000 feet 4-4 1st and 2nds Clear Plain Sawn.  
200,000 feet 4-4 No. 1 Common Plain Sawn.  
200,000 feet 4-4 No. 2 Common Plain Sawn.

We also manufacture chair and table stock. Let us figure with you. Address all communications to

**Dierks Lumber & Coal Company**  
Mills: DE QUEEN, ARK. KANSAS CITY, MISSOURI

## "Michigan" Maple Flooring

Our model factory is equipped with the highest class tools and appliances made for Flooring production.

We produce our lumber from the best rock Maple area in Michigan and have 20 years' supply.

Our brand "Michigan" is a guaranty of quality. Perfect mill work and excellent grades distinguish our Flooring and our prices are reasonable.

**WARD BROS., Big Rapids, Mich.**

## Wolverine Brand Maple Flooring = "THERE IS NONE BETTER" =



It is the same old story, but we want you to know what WOLVERINE BRAND will do for you, and what it will cost you. We want to do this before you place your next order. If we make you quotations, we expect the quality and prices will get your order. TRY US.

**BLISS & VAN AUKEN**  
900 S. Niagara St., Saginaw W. S., Mich.

## OAK FLOORING

Kiln Dried  
Bored  
Polished



Hollow  
Backed  
and  
Bundled

## Timber Bonds

SECURED BY FIRST MORTGAGE ON TIMBER LANDS

**H. C. Barroll & Co.**  
BANKERS, First National Bank Building, CHICAGO,

H. B. LEAVITT, PREST.  
E. H. ADAMS, SECY.

B. F. RICHARDSON, VICE-PREST.  
J. G. LEAVITT, TREAS.

## THE LEAVITT LUMBER CO.

MOST COMPLETE STOCK OF HARDWOODS IN  
**CHICAGO**

MAKE KNOWN YOUR WANTS AND GET  
**IMMEDIATE RESULTS**

Mills:  
WISCONSIN  
TENNESSEE  
ARKANSAS  
LOUISIANA  
MISSISSIPPI

General Office and Yard  
CENTER AVE. NEAR 35TH ST.  
Southern Office:  
715 TENNESSEE TRUST BLDG.  
MEMPHIS, TENN.

## THE "FINEST" MAPLE FLOORING

**W. D. YOUNG & CO.**  
BAY CITY, MICHIGAN.

Producers from TREE to TRADE of the highest type of Michigan Forest Products. Large stock of Maple Flooring and 15,000,000 feet of Hardwoods—1 to 4 inches thick—on hand.

**Maple, Birch and Beech Lumber**

# Hardwood Record

Published in the Interest of Hardwood Lumber, American Hardwood Forests, Wood Veneer Industry, Hardwood Flooring, Hardwood Interior Finish, Wood Chemicals, Saw Mill and Woodworking Machinery.

Vol. XXII.

CHICAGO, JUNE 25, 1906.

No. 5.

Published on the 10th and 25th of each month by

## THE HARDWOOD COMPANY

HENRY H. GIBSON, President

FRANK W. TUTTLE, Sec-Treas.

### OFFICES

Sixth Floor Ellsworth Bldg., 355 Dearborn St. Chicago, Ill., U.S.A.

Telephones: Harrison 4960 Automatic 5659

### TERMS OF ANNUAL SUBSCRIPTION

In the United States, Canada, Philippine Islands and Mexico . . . \$2.00  
In all other countries in Universal Postal Union . . . . . 3.00

Subscriptions are payable in advance, and in default of written orders to the contrary are continued at our option.

The entire contents of this publication are covered by the general copyright, and articles must not be reprinted without special permission.

Entered at Chicago Postoffice as Second Class Matter.

Advertising copy must be received five days in advance of publication date. Advertising rates on application.

### General Market Conditions.

While the hardwood demand the country over remains in very good shape, there are indications that the active buying season is pretty well over for at least two months. In a good many quarters in apparent sympathy with the decline of value experienced by yellow pine, hemlock and some of the other building woods, hardwoods seem to have slightly dropped off in price. During the last month yellow pine, especially in sides and their resultant product, has declined. Hemlock is being offered for a dollar less than it was a month ago, and it is not surprising that hardwoods should suffer a little in the general decline. It is not to be understood that there is any particular weakening in hardwood values beyond an occasional instance where manufacturers or jobbers are attempting to force the market on some particular line. For months past a great many kinds and grades of hardwoods have been in such short supply that buyers were falling over each other to obtain even a modicum of the stock their trade demanded, but today the majority of items can be obtained in fair supply and without premium on account of shortage. Conditions are entirely healthy and every indication points toward an early and strong fall trade.

The demand for plain white oak is still slightly in excess of the supply. There seems to be a little improvement in the call for quartered white oak, but prices still range relatively low. Plain red oak is growing into fair supply and the demand still remains good. There is more quartered red oak than the market readily absorbs.

The immense demand for box and crating stock still keeps the low end of cottonwood and gum right up to green stock. There seems to be no prospect of a diminution in the demand. Strictly red gum, from the widening consuming demand, is not readily obtainable, and the good end of cottonwood is almost equally short.

There is an undeniable shortage in all grades of poplar, while the demand is steady, with reasonably strong prices. If a June tide prevails, which does not always happen, there is enough log supply in the upper streams of the Kentucky, Tennessee and West Virginia rivers to show a reasonably fair supply of poplar for the fall and early winter trade, otherwise all grades of poplar will reach high premium before the year is over.

Good chestnut remains in excellent demand, and the casket people seem to have pretty close picking to secure enough sound wormy to keep them going.

In the northern woods the sales of inch maple to flooring manufacturers still remain active, and there is very little unsold dry stock in the hands of manufacturers. Prices still remain not unduly high, but there is a good prospect of an increased value in four-quarter stock before there is any more in first hands ready for shipment. Thick maple still remains slow, owing to the decreased demand for the wood in the agricultural implement and machinery frame construction trade; however, there is very little thick stock being sawed. Manufacturers are cutting almost the entire log into inch, owing to the excellent demand that is prevailing for this thickness.

The coarse end of basswood is closely picked up by the box trade, and the better qualities are selling fairly well.

Gray elm and birch are both accumulating in first hands, and in the face of very low prices are dragging. This seems to be a remarkable condition to prevail for two as high-class woods as these, considering the active demand and high price of woods of inferior quality that come into competition with them.

Rock elm and black ash are practically out of the market. The area of growth of both these woods has become very limited and the supply is entirely inadequate to meet the demand. The same can be said of hickory and the white ash of the South.

Flooring people, by exercising a good deal of conservatism in the quantity of their output, are still having an excellent demand, and undeniably are making some money.

Mahogany seems to be improving in demand, but the price still ranges remarkably low for this aristocratic wood.

The situation in cherry and black walnut is featureless; even foreign demand for the latter is more or less spotted, and the prices obtained for this splendid wood are undeniably very much below the values it should command.

Both the veneer and panel people are reasonably busy. The veneer men have not yet succeeded in establishing very much uniformity in manufacture, grading and value for their output, with the result that prices under varying conditions show a wide latitude. A few concerns in the business are making considerable money; others are running along about at cost of production, and still others are losing considerable sums.

### Hardwood Flooring Situation.

Manufacturers of oak, maple and beech flooring have enjoyed a very prosperous season. The hardwood flooring business has fallen for the most part into the hands of a group of very able men, sagacious enough to understand that they must not overload the market if they would have a fair price for their product. The maple and beech flooring plants, which are very largely located in Michigan, have an annual capacity of more than 300,000,000 feet. The output of these plants for the past year has been considerably less than 200,000,000 feet. Every producer has awakened to the necessity of keeping his output down to market requirements. There is a general impression that maple flooring manufacture is highly profitable, and as usual under such conditions competitive plants are constantly being built, with the idea of getting "a piece of easy money." These would-be breakers into a "good game" are not as thoroughly



posted on what they are going against as they should be, or they would not be so zealous to get into the flooring making trade.

Hardwood flooring manufacture is a distinct calling, and every man who has ever gone into it has spent a lot of money in paying for experience. In the history of northern hardwood flooring production there is no concern with a small plant which has ever made any money: on the other hand the big plant calls for an investment running from \$100,000 to \$250,000 for factory, raw material, flooring stock and the carrying of accounts. It requires experienced and skilled workmen to produce a good quality of maple or beech flooring. Buyers view with suspicion the output of a new plant, knowing that it takes time to educate a force up to the high standard of manipulation and accuracy necessary for the production of high-class flooring from these very refractory woods. Manufacturers have in the past been obliged to spend nearly twice as many dollars per thousand feet in the actual production of maple flooring as have experts in that line during the last year or two. The manufacturer who has paid dearly for his experience is able to produce maple flooring at a profit, on a price basis that would mean loss to the amateur in the trade. There is no demand for any more of these plants at the present time, and the average producer of maple lumber will find his bank balance in as good shape, at least at the end of the first few years, if he sells his lumber to existing maple flooring factories, as by entering upon the production of the flooring himself.

In the oak flooring business the situation is somewhat different. Oak has not nearly so refractory working qualities as maple, and the demand for oak flooring is still in excess of the supply. Good oak flooring is a mighty good seller at the present time, and even if the output were increased fifty per cent the business would still be a profit-bearing proposition. However, persons figuring on entering the oak flooring business should exercise a good deal of caution in tying up a large sum of money unless they have positive assurance of a source of supply for a good many years. Oak stumpage is growing remarkably scarce, and the demand for the wood for other purposes than flooring is so strong that they must needs expect to pay almost fancy prices for rough stock from now on. The end of even maple stumpage may be seen today, but the maple flooring producer is in better shape than the oak man, for the reason that there is not an extraordinary demand for maple lumber for any other purpose.

### Philadelphia Lumber Promotion Enterprise.

The HARDWOOD RECORD adds another chapter to the history of the International Lumber & Development Company of Philadelphia in this issue. This story tells in detail the methods employed by this extensively advertised "promotion" scheme and the peculiar system of bookkeeping by which it claims to be making such remarkable earnings, and which, according to good authorities, it has thus far paid in dividends. It is an interesting story and well worth reading.

### Hardwood Lath.

A number of Michigan hardwood operators have been able to solve the problem of profitable disposition of their refuse this year by entering upon the production of hardwood lath. Owing to the shortage of white pine, hemlock, yellow pine and cypress lath, prices have climbed very high, and buyers and consumers who up to this time would not listen to a suggestion of the utilization of hardwood lath have been purchasing them with a good deal of freedom during the last three or four months, and are coaxing their house builders and lathers into their use. This hardwood lath product has actually shown manufacturers a price of \$20 a thousand feet board measure for their refuse.

While hardwood lath are selling fairly well during this particular period of high values of softwood lath, it must not be presumed by any means that at all times it will be possible to manufacture them at a profit. Today it is simply a matter of the extreme short supply of softwood lath that makes it possible to get the maple and other hardwood substitutes upon the market.

Ordinarily, and especially at present current values, the manufacture of dimension stock should be a much surer profit-making

proposition than the making of lath, but inasmuch as a lath outfit is inexpensive a good many mills might logically be equipped with it for the purpose of taking advantage of lath making when the market warrants their production. There is no argument against hardwood lath as compared with softwood, save that it costs more to nail them on. They make a stiffer foundation for plaster, but lathers seriously object to the extra expense involved in nailing. It is therefore safe to presume that hardwood lath should be manufactured in preference to dimension stock only when the extraordinary prices of the last few months prevail.

### Pacific Coast Hardwood Freight Rate.

A meeting of the Transcontinental Freight Committee is scheduled to be held at Chicago today, which has the making of freight charges on the several transcontinental lines. There will be presented to this committee from the National Lumber Manufacturers' Association, the Hardwood Manufacturers' Association of the United States, the National Hardwood Lumber Association, the Wisconsin Hardwood Lumbermen's Association and the producers of maple and oak flooring, a mass of evidence pertaining to the injustice of the current rate of eighty-five cents a hundred on hardwood lumber and flooring from Mississippi valley points to the Pacific coast, and strong arguments will be presented urging the Transcontinental Freight Committee to reduce this rate to at least sixty cents, thus placing producers of hardwood lumber and flooring in an equitable position for the building up of trade on the Pacific coast. Several prominent railroad men who are interested in transcontinental shipments confess that the rate is out of proportion to the eastbound rate on forest products.

It is to be hoped that the committee will take a favorable view of the claims of hardwood producers and cut the existing rate to a price that shall be fairly just. In that event undeniably at least four times the present quantity of hardwood lumber and flooring could be sold in Pacific coast states, and the strong competition that now exists with foreign hardwoods imported in that part of the country almost entirely eliminated. It is simply a question of the freight. If the transcontinental lines can afford to haul lumber from Portland to Minneapolis at from forty to fifty cents a hundred, and to Chicago and even further east at from fifty to sixty cents a hundred, it will certainly be a revenue producing proposition to quadruple their westbound lumber shipments by making a lower rate.

### Free Alcohol.

Since the free denatured alcohol bill has become a law extensive experiments are planned by Secretary Wilson of the Department of Agriculture to determine how best the farmers and manufacturers of the United States are to take advantage of the new legislation. In the opinion of the secretary it is wise that this investigation be thorough, and include, for example, a study of the white potatoes that grow abundantly in Maine, Michigan and Colorado; of the sweet potato and yam, cassava and cocoye of the South; of the sorghum throughout the central portions of the country; of the stalk of Indian corn in other localities; and the possibilities of producing alcohol direct from the sugar beet in Michigan, California and other regions where this variety of vegetable may be grown in abundance. Mr. Wilson thinks experimental work should be done by the government toward adapting a small still to the use of localities. He has decided that the opinion of many farmers that small alcohol stills can be run on the farm is chimerical.

It is passing strange that this series of experiments at government expense to determine the actual benefits to accrue to the poor farmer should not have been made in advance of the enactment of legislation that has materially handicapped the possibilities of making money out of mixed hardwood forests. The government has never spent any vast sum of money in an effort to teach lumbermen how to make money out of forest refuse, but lumbermen have themselves expended hundreds of thousands of dollars in experimenting, and have eventually succeeded in producing wood alcohol, acetate and charcoal iron by utilizing what has heretofore been known as forest and sawmill refuse. Then out of a clear sky comes this legislation, entirely experimental, which, wholly conjectural in its advantage to the farmers of the country, depreciates the value of the millions of dollars invested in hardwood timber lands and in chemical, charcoal and iron plants anywhere from fifty to seventy-five per cent. If ever there was a premature, foolish and iniquitous piece of legislation it is the free denatured alcohol bill.

# Pert, Pertinent and Impertinent.

## Good Fellows.

Here's to all good fellows, friends,  
In this world and the next;  
A toast I drink to you tonight—  
Good fellowship's my text.

Not he who calmly takes your hand,  
In an idling hour, you know;  
Not he who slaps you on the back  
As long as the highballs flow—

But the chap who speaks the kindly word  
When things have all gone wrong;  
The fellow that smiles as he grasps your hand  
And tells you life's a song.

What if you know the sucker lies—  
What if he knows it, too;  
There are times in life when the friend that  
lies  
Is the only friend that's true.

Cavil and rant, ye prudes that will,  
Of the evils of wine and gin—  
But somehow the real true things we feel  
Slip out when the wine slips in.

The fool is a fool, and the cad is a cad,  
Whoever God means him to be,  
But the man that's a man won't forget he's a  
man,  
Though he's out on a hell of a spree.

So drink to this toast from your hearts, my  
friends,  
From a heart to a heart let it run—  
Here's to good fellows all over the world—  
Their health, and God bless every one!

## Get a Transfer.

If you are on the gloomy line,  
Get a transfer!  
If you're inclined to fret and pine,  
Get a transfer!  
Get off the track of doubt and gloom,  
Get on the sunshine train—there's room.  
Get a transfer! —W. of O.

## What's the Use?

It is impossible to  
defeat an ignorant  
man in an argument.

## Geod Thing.

Money talks, and  
very often it stops  
talk.

## Grasping.

Give some men a  
fair start and they  
will take an unfair  
advantage.

## Fellows Suit!

When a wise man  
does a favor, he for-  
gets it; when a fool  
receives a favor he  
does likewise.

## Both Fail.

A woman will keep  
an expense account  
just about as long as  
a man will keep a  
diary.

## But Only He.

Cheek is often mis-  
taken for tact by the  
person who makes use  
of it.

## Poor Success.

Many a man's suc-  
cess leaves a bad  
taste in his mouth.

## Not the Same.

Notoriety is often  
mistaken for fame.

## The Point.

Opportunity makes  
the man—after the  
man has made the op-  
portunity.

# A SUGGESTION.

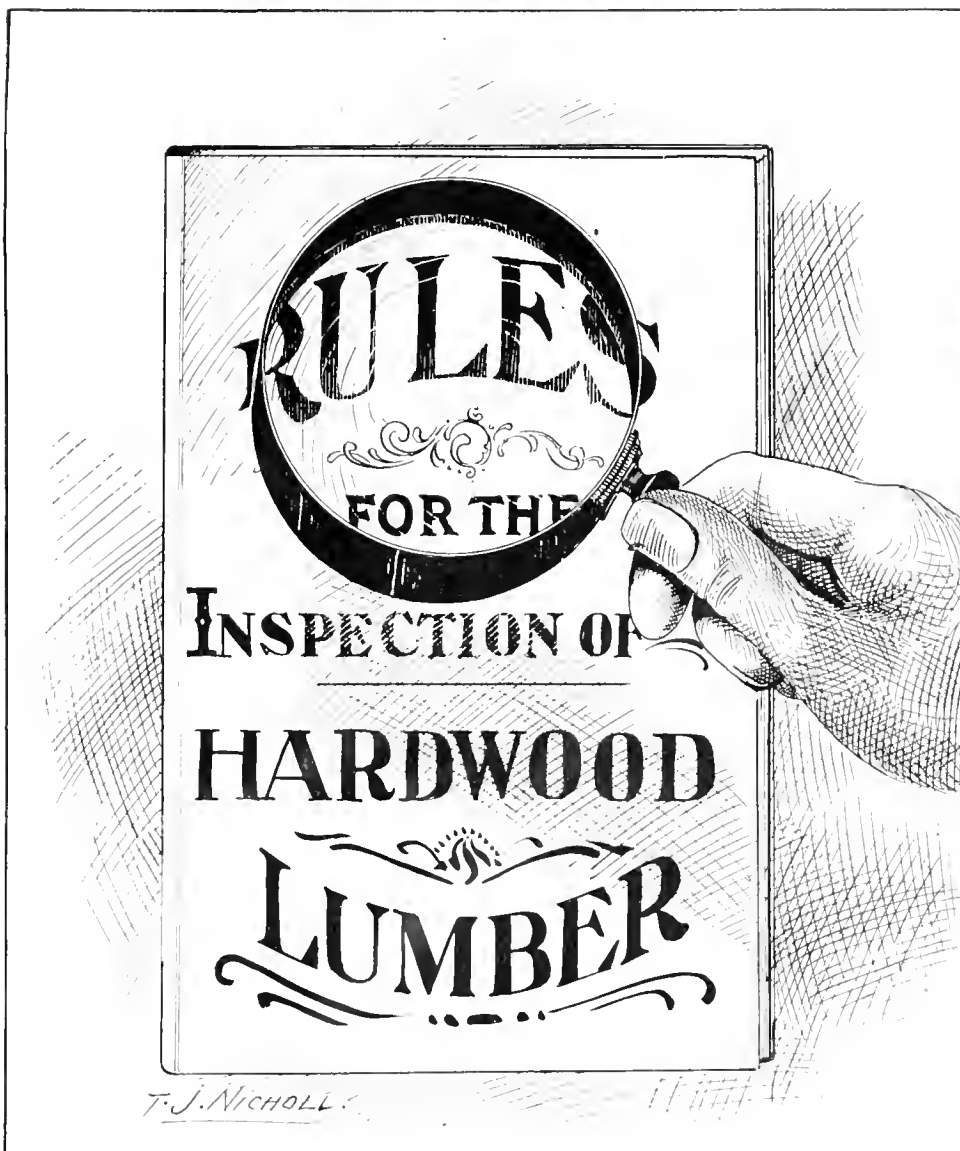

Lumbermen who do not recognize the value of rules for the universal and uniform inspection of Hardwood Lumber should have recourse to this simple expedient.

## Den't Fret.

The calamities we  
actually face are as  
nothing when com-  
pared to those we  
manufacture.

## True.

Life's real com-  
pensations do not  
come in pay envel-  
opes.

## The Difference.

The only apparent  
difference between  
some men and sponges  
is that sponges will  
take water.

## Net Worth Much.

A compliment given  
apropos is only half  
a compliment.

## Always.

Overcautious men  
invariably look be-  
fore they creep.

## Very Few.

There are few peo-  
ple who make good in  
an emergency.

## Intoxicating.

Beauty is worse  
than booze; it intoxi-  
cates both the holder  
and the beholder.

## Just an Excuse.

An apology is a  
poor excuse at best.

## Constancy.

Constancy is sup-  
posed to be a virtue,  
but in advertising it  
is a necessity.

## Exchange.

The world owes you a living but you owe  
the world a life.

## Everybody.

Everybody wants to boss somebody, and it  
is not unusual to find somebody who wants  
to boss everybody.

## Usually Wins.

The man who is determined to succeed  
works without a time table.

## Gift of Gab.

A man is not necessarily full of bright  
ideas because he can hand out a long line  
of talk.

## The Only Way.

Cultivate the habit of forgetting if you  
would be happy.

## The Consequence.

People who try to keep up appearances  
often find it necessary to keep up disap-  
pearances later on.

## Tree Growth and the Physics of Wood.

One of the interesting and important subjects that should attract the attention of lumbermen, and especially hardwood lumbermen, at this period of development of this great industry, is the study of tree growth and the physical qualities with which woods are endowed.

The HARDWOOD RECORD deems it wise to interrupt its series of American Forest Trees, which has occupied an important place in every issue since Jan. 1, 1905, to print a number of articles on this subject. In this connection quotations will be made from leading authorities, and this information supplemented by a series of special articles on various divisions of the general subject, by writers who have given particular attention to the study of tree growth and the physics of wood.

It is believed that this series of articles will prove timely, interesting and instructive. Apropos of this study, it may be wise to paraphrase some of the observations of Herbert Stone, F. L. S., who is the author of a work on *The Timbers of Commerce and Their Identification*, published by Wm. Rider & Son of London. Mr. Stone says:

It would be a difficult task to answer the question why some plants possess the property of forming wood, while others, nearly related, do not. Why some plants run their course in the brief period of a year, and perish as soon as they have given birth to another generation, while others persist and augment their bulk year by year for centuries. There is much food for reflection here.

Such plants as are endowed with the faculty of secreting a substance which resists decomposition for a long time, and of fortifying their tissues with it, play a very different part in the world's economy to that of their herbaceous relatives, which today are, and tomorrow are cast into the oven. They exist long enough to acquire an individual history. This history may not be written in human records, but it has a record of another kind, which may be read in the structure of the tree itself, which, like the nautilus, adds a chamber to its habitation every year by surrounding itself with a fresh layer of wood.

These layers are perhaps the most familiar feature with which all those who have used timber, or have noted the cut ends of fallen trees, are acquainted, but it occurs to few that the innermost tiny ring enclosing the pith is the section of a stick that was once the seedling tree. The seedling is a small object, a few inches high at most, and the layers which have been added year by year, were it possible to separate them, would appear as long taper tubes of wood.

The annual addition to a tree's growth is, in fact, a conical sheath tapering to a point, and capable of accommodating the plant

within to its topmost bud. A seedling is two years old, but not as a child, who is two years old to his innermost parts, for the tree is only one year old as regards its outer portion. The two layers are not merged in one another; the second is merely added. In the case of a full-grown oak, a century old, only the pith and first coat of wood bear that age; the next coat is only ninety-nine years old, and the outermost but one. Moreover the topmost branches are quite young, and their innermost parts, scores of feet above the tip of the little seedling from which they have grown, are scores of years younger, even to their pith. Of an ancient hollow tree it may be said that perhaps Robin Hood dined beneath its branches. The

all trees, for some exhibit no distinction in this respect and are the so-called sap-wood trees, though even here changes take place which bring the timber to maturity. In a living heart-wood tree there can be distinguished the pith, heart-wood, sap-wood, the active living layer or cambium, the bast and the bark. The cambium layer is a very delicate sheath of thin tissue which is the source of the new wood, and which by the multiplication of its elements or cells adds layer upon layer to the wood already formed. On its outer side it adds to the bast, but in a much smaller degree.

The bark, enclosing all in an impervious clothing, serves the purpose of checking the evaporation which would endanger the existence of the delicate cambium layer within.

The young wood lying nearest the outside partakes of the nature of the cambium at first, but rapidly becomes altered. The walls of its cells, originally thin, become thickened and woolly, but for some time they retain their capacity for absorbing water, and form the channel by which the water from the roots ascends to the leaves. The further from the bark, the less is this capacity possessed by the wood, and though it is rarely if ever quite lost, yet the difference in the rate of absorption of water by the sap-wood and heart-wood is considerable, as can be seen by moistening the cut surface of a piece of wood where both are present. While the water sinks rapidly into the sap-wood it sensibly lingers on the surface of the riper part. The vital processes which constitute the physiology of plant life are beyond the scope of this work, which deals solely with their product—the wood, which while living is a tree, but being dead is timber.

As, then, a tree consists of concentric cones of wood, if it is sawn into planks the outermost plank will be a curved ditch of bark, with some sap-wood on its inner side. The next plank will have sap-wood down the edge, and a strip of heart-wood down the middle, which strip will increase in width, plank by plank, until the center of the tree is reached. Lines which mark off

cone from cone (that is, annual ring from annual ring) may be seen parallel at the lower end, but will join as loops at the upper. It is only when the section approaches the horizontal that the annual rings approach the circular, so that oblique cuts show an almost infinite variety of form. In fact, two planks are never alike in every detail of figure except by accident.

I have referred to the Autumn and Spring zones as though all woods possessed them, and it will be found that the same expressions are generally employed in the literature of forestry. They are of course only appropriate in connection with those species which grow in temperate climates, as the period of greatest vigour in tropical trees is not necessarily that of Spring, while it is possible that there is no resting period like our Winter. Judging from the structure this state of things is by no means unusual,

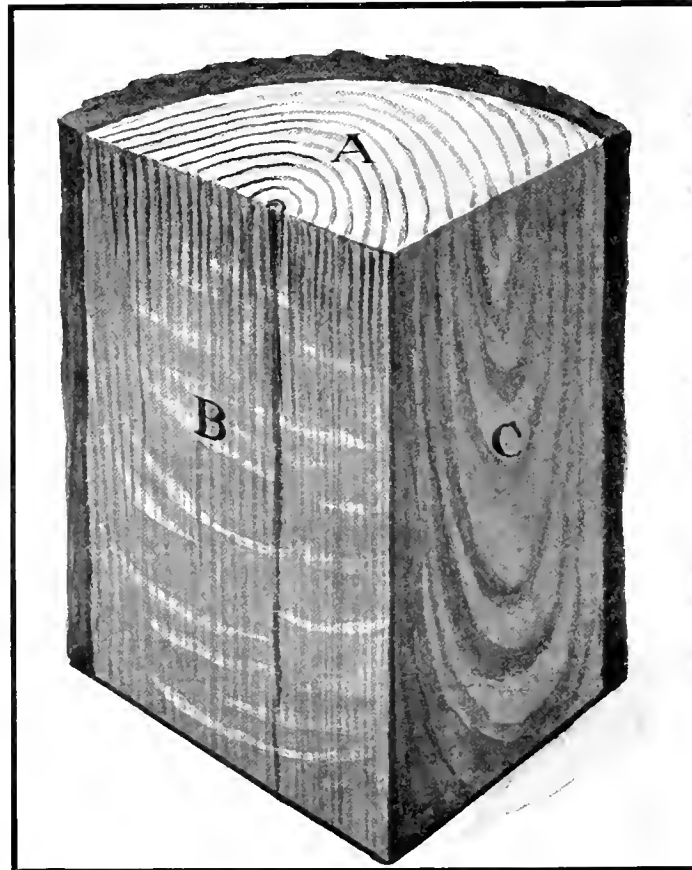

WAYS IN WHICH RADIAL WOOD MAY BE CUT: A, CROSS SECTION; B, RADIAL SECTION; C, TANGENTIAL SECTION.

general impression is correct, but the fact is not precise; for the tree is no older than its component parts, which, being entirely outparts, are merely the growth of the last fifty years or so, as a section of the wood will prove.

A tree, then, is a living organism whose component parts are of various ages; and upon it arise successive generations of leaves, much as a city rears its people or a coral reef its polyps. The living portion is renewed from time to time, adds something to the tree, and passes away. Time too brings other changes due to other causes than the nourishment afforded by the yearly labor of the leaves, and as year by year a new coat of wood is added, so does an inner layer lose its vitality and become inert, and so does a still deeper layer undergo still further changes which produce the heart-wood. This heart-wood will not be found in

and from British Guiana come a number of species which display no indications whatever of a regular alternation of seasons.

In most works on forestry much stress is laid upon the width of the annual rings and careful measurements have been made to ascertain the average width, in order to supply data for estimating the probable annual production of wood. As this is the measure of profit the importance of these figures cannot be overrated, but inasmuch as they have little if any value for the purpose of identification, they are only mentioned by the way. The annual increase of rock elm is naturally slow, perhaps as little as 1-16 of an inch per annum, while its near relative the white elm is enabled to put on as much as half an inch in the same time, and seldom less than 1/8 inch.

Mr. Stone calls attention to the fact that a knowledge concerning the rings of growth is useful in the study of woods. Some are regular, some are toothed, some are convoluted, and the boundary which may be formed by a fine line of dense Autumn wood, a line of contrast between the lax wood of Spring following upon the dense wood of Autumn, or a similar contrast formed by a pore ring in the Spring wood, or the boundary may be vague in some woods and entirely fail in others. It must be borne in mind, however, that the boundaries of the rings of woods may be very clear at times, and can vary much in the same piece of wood. In an analysis of tree growth care must always be taken to avoid confusing bands of pigment with annual rings. In the rosewoods the black zones are usually concentric, and only on close examination are they found to be out of harmony with the structure. Another good illustration can be seen in olive wood, often made up into articles of virtu and decoration, in which the black zones are always eccentric to a great degree. There is an Australian growth known as the gimlet wood, which invariably grows on a twist. The true annual rings in this wood are manifest, but as the stem of the tree is three-lobed or buttressed as it were, it gives a very peculiar appearance in the cross section. The silver grain which forms the beautiful flakes so much esteemed in oak timber, and which is composed of fragments of tissue called medullary rays, has the appearance in the cross section, of a giant spider's web. As these rays proceed from the center outward, it is only on those saw-cuts which follow a radial direction—that is, in quarter-sawn lumber—that they appear at their best. As is well known, all woods do not show this feature in so marked a degree as the oaks. On the contrary, this highly esteemed figure is obscure in most species. There is, however, no wood in which it may not be found. There are some kinds which do not show the annual rings; others which lack other features present in the oaks, such as the pores or the soft tissue, but none of the conifers or broad-leaved trees can be found that does not show these rays of silver grain.

To continue the quotation from Mr. Stone's work:

The pores just mentioned are the little grooves seen upon the surface of cut planks which give to them the appearance known as coarseness of grain. They are little tubes technically called "vessels," whose openings can be seen at the end of a plank, transverse or horizontal section, closely arranged in the annual ring in various ways. The pores become smaller and smaller as they approach the Autumn or outer boundary, until they seem to disappear from very tenacity and both plankwise and across-grain, require a lens to follow them. In the oak, which is the easiest and best example, these smaller pores are arranged in little tree-like patches, imbedded in a mass of light-colored soft tissue. This is composed of short, thin-walled cells unlike the mass or ground tissue of the wood, which is chiefly built up of long spindle-shaped fibres with thick, woody walls, imparting the qualities of hardness and tenacity to the timber. The soft tissue, on the other hand, lacks these properties, but has a peculiar significance, inasmuch as it is frequently the character which declares to which division or group the wood belongs. The conspicuous "pore-ring" the character of which most strikes the eye in many woods, has but a trifling value in this respect, for there are many species of oak in which the pore-ring fails altogether, and even the annual ring is difficult to make out, while the little strings of branching pores, along with their attendant soft tissue, are always present.

It is a singular fact that as the tree ages the size of its cells and pores increases ring by ring and year by year, so that upon the surface of a plank "cut on the quarter" i. e., in the plane of the radius, very narrow pores lie near the pith and large ones near the bark, with all intermediate sizes between. Thus a plank may be "fine grained" in one part and "coarse grained" in another, whereas if the plank is cut from the outside of the tree (tangentially) the grain or size of the pores and cells may be nearly uniform throughout. This increase in the size of the pores and cells ceases at a certain age in each species. The oak and hickory exhibit this phenomenon in a striking degree. The tree at the period at which this increase stops may be said to be in its prime, for the wood then produced possesses greater strength, weight, tenacity, etc., than that produced either before or after. From a lumberman's point of view this question of growth is an important one, and it must be borne in mind that it is wood and not cavities that the user of timber wants; the greater the proportion of pores, the less wood and the less weight and strength the timber will possess.

A slow grown piece of oak is a mere succession of pore-rings, i. e., of little tubes, whereas well and fast grown oak has a large proportion of hard woody ground-tissue outside the pore-ring, in which the rapidly diminishing pores form a comparatively restricted area. There is no strength in holes, and the fewer there are the better. In coniferous wood, which is free from true pores, the slowly-grown wood, unlike the faster grown, is small-celled and dense. It is merely a question of solid matter of which the weight supplies a good indication.

The counting of the rings is not an infallible indication of age, even when they are counted at the butt of the tree. There are causes which disturb the even succession, such as the destruction of the leaves by insects during the growing period, in which case the ring is prematurely closed, much after the manner of usual Autumn cessation of growth. If, as is sometimes the case, the tree has power to put forth fresh leaves, the growth recommences with a pore-ring or other lax tissue, as in the normal Spring

zone. Thus two rings arise instead of one for the same year. It has been suggested that in tropical climates two independent seasons of growth may cause two fresh rings every year, but the idea needs experimental verification, though not of itself improbable. For the most part the annual rings of tropical trees are difficult to deal with; they are often entirely absent and no rhythm of structure indicates the periods of growth, and in several instances, to be mentioned later, the pores and other elements steadily increase in size, indefinitely, from the pith outward to the bark.

The heart-wood and sap-wood so familiar in the oak, are by no means universal. Familiar examples of trees without heart-wood are the beech, sycamore and birch. American birch, by the way, has both sap-wood and heart-wood. Sometimes the two kinds of wood are distinct from each other, as in the ebony, where the sap is white and the heart black, while in others the former seems to acquire the characteristic colour gradually, and melts insensibly into the darker heart-wood.

The pith frequently exercises some influence upon the contour of the rings. The common oaks have a five-lobed pith, and the young layers of wood follow it closely, and it is not till the tree has arrived at a considerable age that the influence of the pith is lost. The hornbeam retains it for an even longer period, and instead of the rings becoming gradually more regular the lobed form seems to become more pronounced so that the bark, though externally smooth and cylindrical, is internally thickened where the hollows of the waves occur, and is very thin above their crests.

The pith of all true boxwoods is lozenge-shaped in section, or like a narrow bar with a circular swelling in the middle. The West Indian boxwood, on the contrary, has a round pith that is nearly always cracked, so that this feature is often sufficient to distinguish the true from the false boxwood. All species of walnut have a most remarkable pith consisting of a series of diaphragms dividing the tubular cavity into a number of small chambers, as may easily be seen by cutting a twig from a walnut tree. Workmen are familiar with this rather unwelcome peculiarity, as it forms a serious defect in the center plank of every log. Although the original pith of the tree-trunk may not often be accessible, yet small knots here and there exhibit this feature.

The bark has always been considered a most useful aid in identifying woods, and in some cases is the only decisive detail. The terms used to describe the bark, such as corky, wrinkled, leathery, fibrous, etc., explain themselves; but as the small breathing holes which perforate it are not familiar objects, the botanical term lenticels must be employed. These lenticels are perhaps most conspicuous upon the bark of the silver birch, where they form the centres of long horizontal stripes, that become longer as the tree increases in girth. Each species of tree has its peculiar kind of lenticel. The bark at the base or butt of the tree frequently differs from that which clothes the upper portion. In the birch again we have an example, for its bark, though smooth and laminated like paper above, is usually rough, fissured and corky at the foot. If a section of the lower part be taken a mass of hard, root-like, light-coloured bodies will be seen imbedded. This may serve as a type of that which is to be observed in other species, but in addition it must be noted whether the bark is in two distinct layers and also whether the ends of the rays leave their impression upon the inside of the bark, or again, if they are apparently continued some distance into the bark with the woody part

of the ray connected to the distal portion by a "tongue and groove."

If the bark be deciduous, as in the familiar plane or button-ball tree of the London squares, it will naturally be but seldom found upon a log that has travelled, nor will it be otherwise if it be not firmly adherent. Some barks shrink more rapidly in a vertical direction than the cylinder of wood within, and thus detach themselves, while others are firmly attached to the wood and separated with difficulty.

The outer surface of the log corresponds with the inner surface of the bark, unless there is a considerable thickness of bast between them. In any case the markings on this outer surface may not only serve as a means of identification, but also to show in what manner the grain or fibre of the tree runs, whether spirally, as in the *Lignum vitae*, or sinuously, as in the Australian gum trees—both also important items from a technical point of view.

Beneath the bark of trees many insects find food and shelter, chiefly the larvae of beetles and moths. Some eat their way into the solid wood to form cylindrical holes or galleries such as may occasionally be seen in ebony and the Australian ironbark. Others confine themselves to galleries made in the newly-formed wood immediately beneath the bark, and travel in a peripheral direction only. As the wood removed by these parasites is still in the living condition, the gaps made in the tissue are promptly filled up with a brownish mass of cells almost as soon as they are made. Whether these cells be tyloses or callus, I am not in a position to decide. \* \* \* The resulting brown flecks are as characteristic of the species as any other feature, because the grub is faithful to its special tree and prefers it to all others, therefore as a series of years can scarcely pass without the presence of the grub, no log of wood of a susceptible species of tree will be found without these traces. A section of English birch will often display these flecks in hundreds. A peculiarity of the flecks is their property of giving rise to new rays in abundance, sometimes amounting to a dense brush-like tail. Similarly the bird's-eye figure of maple arises from the attacks of an insect. In this case the repair of the injury causes a little dimple-like depression in the outside of the wood, which is faithfully overlaid by every subsequent annual ring. The dimple is therefore a miniature hollow, containing a number of strata, and if the wood be sawn tangentially, the top of the hollow is removed and the edges of the successive strata exposed in concentric circles, resembling the contours on a geological map where a bend in the strata has been denuded. The tails or brushes of rays may be seen in either radial or transverse sections, thus indicating their origin, even if the seat of injury be not evident in the specimen examined.

Having dealt with the general structure of wood, it is necessary to consider the form in which the elements are arranged. It is not the intention here to go into microscopical details concerning the cells themselves. \* \* \* It is enough to say that every part of a piece of wood consists originally of cells, or closed cavities, which in the case of the pores or vessels become modified into tubes; even in these the remains of the original partitions are to be seen. These cells are of various forms; round, polygonal, spindle-shaped, rectangular, etc., and are usually characteristic of the tissue they assist in forming, as will be seen when referring to each special class. The chief feature of the wood of all coniferous and broad-leaved trees is the system of rays, not only because rays are never absent, but because they are a most im-

portant factor in the classification of wood.

In a piece of beech on a transverse section, these rays arise in a fine point, increase in width and again decrease until they taper away again to a vanishing point. By observing the tangential section, as is easily done by removing the bark, it is seen that, though much shorter, they preserve the same form, i. e., that of a spindle or tip-cat, tapering at both ends. Laterally, in a radial section, it is almost impossible to make out their shape, for they never remain uninjured; still, from their form on the two sections already described, their shape may be deduced. This I believe to be a double-edged, double-ended blade; something resembling the outline of a fish, such as the dace or minnow, but of course very much longer in proportion to its depth. \* \* \*

The form of the rays is an exceedingly important factor in the composition of the "figure of timber," and a clear idea upon this point will often enable one to deduce the figure from a small fragment of wood taken in any section, such as a chip from the corner of a log.

The greater number of species of trees have merely one kind of ray, but in the oaks there are two kinds, large and small. The large rays are usually very broad and deep in a tangential section, and are seen to be composed of an irregular mass of small cells, while the smaller rays, on the contrary, possess much larger cells, usually in a single row one above another, and are difficult to see in any section. Furthermore, the large rays are frequently compound, or composed of many rows of cells, and run direct from point to point, whereas the small rays appear to avoid all the large pores which lie in their course, or to be pushed aside by them. This latter character is found with great frequency in woods having rays of uniform size, whether they are broad and firm, or merely like fine threads meandering amongst the pores. In point of size the rays may vary considerably from the broad ones in the classes mentioned, through all possible grades to the excessively fine ones of the horse-chestnut. They vary greatly in the same piece of wood, or in different individuals of the same species, or in the wood of allied species; but like all the other characteristics, there is a limit, a maximum and a minimum, fixed for each kind. It often happens that the limit of length is difficult to fix unless a very large piece of wood is available, as it is not unusual for a ray to extend from ring to ring through thirty years' growth or more before commencing to taper. The very large rays often seem to dilate outwards indefinitely and in some cases may do so, while others run their course in the space of two or three annual rings only.

As the circumference of the annual rings enlarges, the original rays become wider and wider apart, and new rays arise from time to time in sufficient numbers to keep the proportion of the rays to the mass of the wood fairly uniform. These new rays obviously have nothing to do with the pith, and being indistinguishable from the older ones cannot be called in any sense "medullary," and even those of the first year's wood have not intimate connection with the pith, which may perish entirely without any apparent disturbance of the function of the rays. I therefore use the word rays without the usual qualifying adjective. \* \* \*

The pores are narrow tubes running vertically up the stem, and having the function of conveying air and fluids for the service of the plant. It is not known how long these minute tubes may be. I have blown bubbles through an apparently solid stiek of Norwegian birch four feet long, and I pumped air through the whole length of a

pole 11¾ feet long, and further I have pumped water in a continuous stream through a piece of American birch ten inches long by one inch diameter, from which it ran as fast as it would have done from an open tube of ¼ inch bore. I see no reason why these limits should not be exceeded with proper apparatus, especially if straight, well-grown, uninjured poles of oak are used.

In all but the very young wood the pores contain either air or the accumulations of by-products of the vital activity of the leaves, chiefly gums and resins, and sometimes a curious tissue like a mass of bubbles, which arises as follows: The walls of the cells and pores, when examined under a high power of magnification, are seen to be pitted all over in spots where the tissue is extremely thin. In fact these pits are holes closed by an excessively thin membrane, and are usually opposite to similar perforations in the next adjoining cells or pores. If one of the latter becomes empty, this membrane is forced out into the cavity accompanied by some of the living contents, which subsequently divide and multiply after the manner of the cambium already spoken of as lying under the bark. There is, however, this difference, that instead of wood-cells, they give rise to this bubble-like transparent mass of tissue called tyloses. This will frequently be met with in pores of large diameter where the wood has not the property of filling its pores with gum or resins. Another kind of filling occurs in certain tropical woods, especially teak, and appears to be of a mineral nature. It is very hard and rapidly dulls the edge of cutting tools. In a certain species of wood from British Guiana I have seen accumulations of this substance accompanying decomposition, practically replacing the inner rings of the center of the tree and forming masses of stone weighing many ounces.

In the course of the building up of the wood by the cambium, the pores are produced at intervals among the wood cells and arise not in haphazard fashion but in rhythmic succession. At times they are produced in such abundance and so closely crowded that this rhythm cannot be traced, but \* \* \* in a great many cases a definite order can be seen. The pores may be arranged in undulating festoons, as in the common elm, or in radial, tree-like groups, or as most frequently in our European woods, in a ring of pores in the early Spring zone of the annual ring. For the most part, as already stated, the pores are smaller if not less numerous in the Summer and Autumn zones, the latter being frequently very poorly provided with them. If it should happen that a wood has more pores in the Autumn than in the Spring zone, that wood is surely coniferous, but these pores will be found to be of quite different nature to those just described, in fact they are glands containing resin and are more properly called resin-canals or ducts. Their presence is an indication that the species belongs to one of a limited number of genera allied to the pine trees. Many kinds of wood have pores in small closed groups which convey the impression that a mother-pore has become subdivided into a number of pores, not merely pressed or crowded together but clearly indicating a common origin. \* \* \* If the wood be cut in a radial direction, a row of closely arranged pores may be exposed at the same time, so that the wood will appear very "course-grained." On the other hand, if the cut be tangential, the radial row of pores will be cut at right angles, and only one of the series will appear on the surface. Confusion can easily arise from this cause, and no small demand is made upon the imagination to reconcile the differences shown by an oval-pored wood cut on the quarter (radial





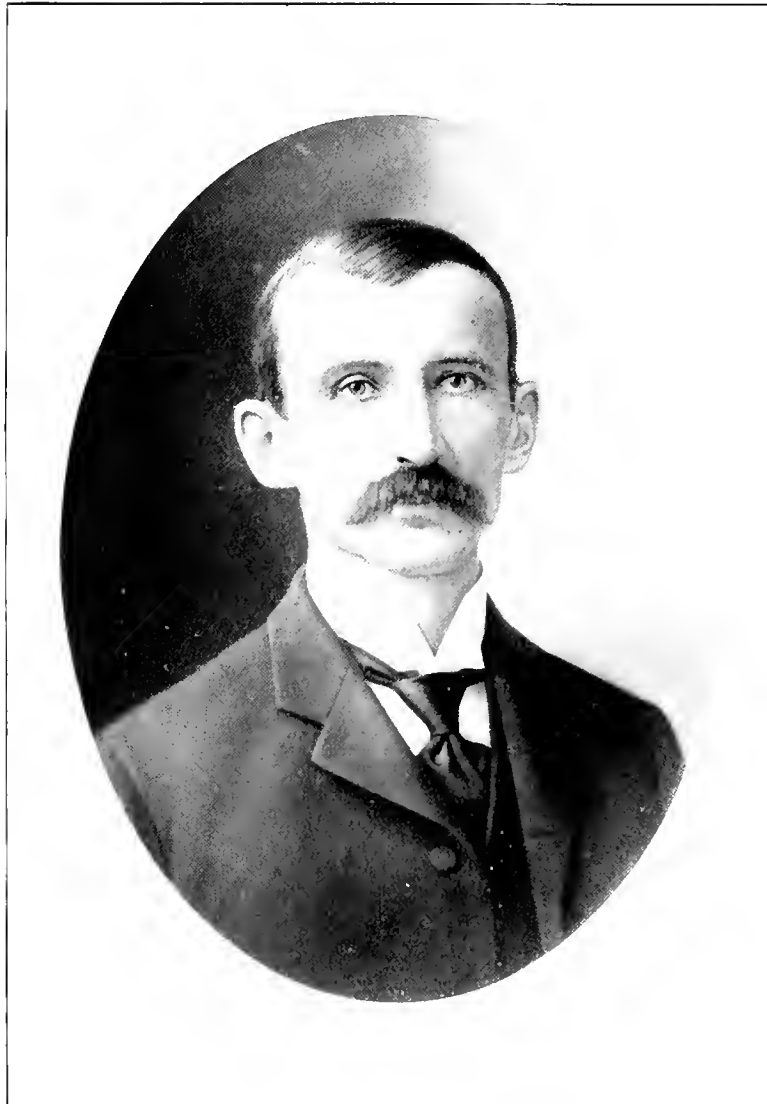

HENRY C. CHRISTY  
CLEVELAND, O.

section) with its abundant coarse grooves and showy "silver-grain" and another piece of the same wood cut plank-wise (tangential section) on which but few narrow pores and no silver-grain are to be seen. The horse-chestnut, the box-tree and a great number of others do not display any pores which are visible to the naked eye, but it must not be concluded that the woods are coniferous because the pores are not visible. The lens or even the microscope must be called in, when they will appear as minute apertures or grooves as the case may be. No broad-leaved tree entirely lacks pores except a very curious one called *drimys chilensis*, a relative of the magnolias.

In all cases where the arrangement of the pores takes definite form, such as festoons, tree-like or flame-shaped groups, they strike the eye as an independent portion of the wood, especially when they are compacted together into masses by the "soft-tissue" or short, thin-walled wood-cells. The commonest form of soft-tissue is a coat of delicate cells which clothes the pores and appears as circles round their orifices, or as borders by their sides in a vertical section. If the latter section be in the least oblique, as is usually the case, the soft-tissue looks like a tail or fringed continuation of the pore. Often the coat of soft-tissue is so narrow that it is only by careful search for these continuations that it can be detected. Inasmuch as the oblique section of any figure exhibits greater breadth than a transverse section, it is a wise plan to use the knife freely in all directions, to show up obscure details. This coat of soft-tissue may be traced in transverse section in all grades of complexity. The simple uniform sheath is sometimes laterally extended into wings or diamond-shaped patches having a large pore or pore-group as centre, or into concentric rings, or oblique, cross-shaped or undulating lines of bands, which look like designs in lace when viewed as transparent objects. Some are of great beauty and many are so characteristic that they at once declare that such a timber belongs to such and such a genus. For the most part the pores and soft-tissue together produce this tracery, but occasionally the soft-tissue is quite independent of the pores, and nearly always is of a lighter color than the ground tissue.

The term soft-tissue is rather a defective expression. Soft-tissue may be a very hard tissue at times, but it is always softer than the wood fibres of the same timber, and to the lay mind the term has the advantage of conveying the meaning intended, for in

looking at a section of wood no one would misapprehend it.

Soft-tissue is usually present among the dense mass of pores in the pore-rings of woods that possess them, but it should not be considered in the same light as a zone enclosing the pores, but as the result of crowding, and may be ignored as of little significance. As the pores diminish towards the Autumn zone, and the intervals increase, the soft-tissue will be seen to increase, and develop its characteristic arrangement.

Although many woods display great individuality in their characters, it must not be supposed that every wood can be clearly described so that it may be recognized on sight. Among a limited number of woods a description may suffice, but the larger the variety, and the more numerous the species of closely related woods, the more difficult their discrimination becomes, and it is as well to define the limits which are set by Nature in this respect. Just as the flowers of all species of ash tree are modeled upon the same plan, so is their wood. A few species of ash may present some peculiarity, but most are practically indistinguishable from other members of the genus by the structure alone. The common elm cannot be mistaken for the American or white elm, though their structure proclaims their mutual relationship, but sufficiently precise language cannot be found to describe the difference between the wood of the latter and of the American rock elm. Again, all the members of the silky-oak family are sufficiently alike to be recognizable at a glance, but in many orders it is difficult to discover two genera bearing any resemblance to each other in their wood.

Besides all this, it must be clearly stated that no varieties such as are due to different conditions of growth, climate, locality or other external conditions, can be distinguished by their structure. It is hardly possible to find language which will enable a reader to tell Honduras from Tobasco mahogany, or even American from African mahogany. There are characters which strike the eye in the St. Domingo variety and distinguish it from the others, but let anyone attempt to put upon paper a description which will enable a second person to tell for certain which is which, and he will admit that the time is not yet come to essay it, notwithstanding the fact that upon the log as it comes to market there are often indications of its origin, but these are for the most part the outcome of the dressing by human hands.

wholesale grocery houses in Cleveland he is a factor in the food-stuff industry of Ohio. A little inquiry will divulge the fact that he is one of the principal owners of the largest brick plant in the country. Not content with these numerous outlets for an energy which seems tireless, Henry C. Christy is the head of a large steel range manufactory at Warren, O. That he has engaged in many lines of commercial enterprise is not remarkable, although it is often the misfortune of many men who have success in one branch of industry to lose all in some other business, presumably unfamiliar to them, in which they embark. The significance of Mr. Christy's achievements is in the fact that he has been eminently successful in every enterprise in which he has engaged. Of course it goes without saying that a man interested in such diversified pursuits must be a tremendous worker, and withal a man alert to the smallest opportunity—able to judge quickly and positively.

In 1867 Mr. Christy entered the lumber business, in partnership with Isaac Kirk, at Warren. For a good many years this firm was the largest producer of ties, piling and timbers in the country, but with the rapidly lessening supply of suitable timber for this line its operations became more diversified until in 1895, when the firm was merged in the corporation of the Kirk-Christy Company and moved its offices to Cleveland, it was among the largest hardwood producers of the country. In 1902 the Advance Lumber Company was formed, and this concern took over the active lumber interests of the Kirk-Christy Company. White and yellow pine were added and a business of considerably over 100,000,000 feet per year built up. Mr. Christy is at its head.

The first business venture of Mr. Christy, the Warren Hardware Company, of which he is still president, distributes steel ranges from the Atlantic to the Pacific. He is also president of the McCarty-Christy Company, of Cleveland, a wholesale grocery house doing an annual business of more than \$3,000,000. He is vice-president and chairman of the discount committee of the Union National Bank at Cleveland, one of the foremost banking institutions of the country; president of the Empire Lumber Company of Buffalo, N. Y.; a director and actively interested in the Cuyahoga Lumber Company, the Northern Ohio Lumber Company, the Worden Lumber & Manufacturing Company, the Cleveland Land & Timber Company, all of Cleveland, and of the Mud Lake Lumber Company, of Reber, Mich., and the West Virginia Timber Company of Charleston, W. Va. The last named concern owns over 40,000 acres of fine hardwood timber, its own railroads, and several large mill operations.

Having such a multiplicity of interests it is quite apparent that Henry C. Christy, who is still under sixty, is a tireless worker. He is a man who decides without hesitation, seeming to see the real issue immediately. His kindness upon greeting a stranger or welcoming a friend makes him seem younger than he is. His only hobby is automobiling, and most of his recreation hours are given to it. Naturally he is devoted to business, and he seems to get from a variety of interests the change essential to a well-rounded life.

## Builders of Lumber History.

NUMBER XXVIII.

Henry C. Christy.

(See *Portrait Supplement*.)

In nearly all the addresses made by prominent men before the classes to be graduated from the numerous colleges this spring the great text has been "concentration." "Don't flinch, don't fowl, and buck the line hard," is Roosevelt's characteristic way of putting it, and others have followed suit in more or less picturesque language. This advice is probably best for the average young business man. Usually, the prosperous and successful man is the man of one idea, but in every walk of life there are exceptions which prove the rule.

Perhaps the most notable hardwood lumberman who has been eminently successful in many widely different commercial pursuits is Henry C. Christy of Cleveland, O., and yet so quietly and modestly has he built up a

number of great enterprises that comparatively few men know the wide scope of his activity and the importance of his achievements outside of their own particular business interests. Mr. Christy is so reserved in character that he rarely speaks of himself; in fact, it is almost impossible to find out from him anything that would in any way give the listener an idea of his really wonderful diversity of business talent.

To the hardwood trade Henry C. Christy was formerly well known as the general manager of the Kirk-Christy Company, manufacturers of hardwood lumber, with headquarters at Cleveland, O. He is likewise well known among the financial men of that city, being actively connected with one of the largest banking institutions in the state, also with several important out-of-town banks.

As the financial head of one of the largest

## Muck Rake Department.

### The International Lumber & Development Company.

Considerable has been told in previous issues of the *HARDWOOD RECORD* concerning the men who act as figureheads for the International Lumber & Development Company. It has become apparent that the people who actually conduct the enterprise are John R. Markley, I. B. Miller and C. M. McMahon. These men formerly lived for some time in Chicago, and it is thus that the Great and Windy derives the credit of sending such a coterie of "development" experts into the wise and effete East to teach even the past masters in financial matters how to handle big game and handle it right.

The International Lumber & Development Company is one of a number of enterprises, all similar, with the exception of the lumber feature, known as the "Markley group," operated by John R. Markley and I. B. Miller. Another is the Mexican Plantation Company of Philadelphia which has connected with it another of the group of officials, C. M. McMahon, who acts for it and the International in the capacity of secretary and treasurer. The Mexican Plantation Company has paid during the six years of its existence dividends amounting to forty per cent and over, but not on the sale of mahogany or other hardwoods, of which it has none, but on the sale of rubber, coffee, and other tropical fruits. It was said by people interested in the Mexican Plantation Company that there had been timber on the land but that it was burned off to make ground for the planting of crops. Many of the stockholders in the first company also have shares in the International.

Markley and Miller, who are developing the land for the Mexican Company, are also under bond to develop the land for the International Lumber & Development Company. Their contract extends seven years.

Markley was formerly a lawyer in St. Louis, but thinking that his talents would find a fitter field in other pursuits, removed to California where he became a horticulturist. About twenty years ago he went to Mexico and has been interested in operations in that country ever since. As far as can be learned he never had any experience as a practical lumberman except in working out the mahogany alleged to have been sent to the United States by the International Lumber & Development Company. A man who has been intimately connected with the company in Philadelphia, and is in a position to know the facts, was asked how Markley could do so well if he had never had any previous experience in the lumber business. "Oh, but he is an experienced lumberman, now," was the answer, leaving the applicant for information to understand that the getting out of the logs sent to this country had made him a finished lumberman even

though previously he had done no practical work in that line.

I. B. Miller was in business in the States previously to being connected with the International. He now acts as purchasing agent for the company, buying machinery, tools, and other supplies needed on the plantation.

C. M. McMahon was formerly a real estate operator in Chicago. He has had no practical experience in the lumber business, solely acting as secretary and treasurer for the companies.

W. H. Bell, said to be for many years a timber expert getting out fancy hardwoods with C. L. Willey, of Chicago, was the expert who estimated the amount of mahogany on the ground. Bell had headquarters at Laguna, State of Campeche, Mexico, and was at one time U. S. consular agent at that place, which is in the vicinity of the International's plantation. It is not known what price was paid Bell for his services, but he was sent as inspector to the company's estate and the result of his tour of inspection was the estimate of 396,000,000 feet of marketable timber in sight. His method was to select a stated amount of ground at various points in the estate, and measuring the mahogany and other woods growing thereon, make a computation of the whole number of feet of lumber contained on the timbered land.

The dividends paid by the International Lumber & Development Company are not the net earnings on the whole amount of stock sold or on the capitalization—they are simply the receipts from sales of timber and other products applied to the money paid in in the nature of dividends. The contract of the company in one place states as follows:

"... and as fast as any cabinet woods or other merchantable timber and dyewoods are cut and made ready for shipment, or any chicle and rubber extracted; or horses, mules, cattle, hogs and goats, are ready to be sold, the said first party (the company or its contractors) shall sell the same at the highest obtainable price to the best possible advantage, and all the proceeds derived from such sales, after deducting the actual and necessary expenses of harvesting, curing, and marketing the said crop products and cutting, shipping and selling the said cabinet and other merchantable timber and dyewoods, extracting and marketing the said chicle and rubber, and raising and disposing of said live stock, shall be promptly accounted for by any such agent or contractor and forthwith paid over to the said company, who shall thereupon deposit the same to the credit of said company in such bank or banks of established financial credit in the city of Philadelphia, as they may select."

Further on the contract of stock says:

"And it is further agreed that the net profits derived as aforesaid from the cultivation and use of said land, and any money realized from said premises from any source whatever, shall be used solely and exclusively for the payments of dividends to be duly declared semi-annually, upon amounts due from and paid by purchasers to the company \* \* \* and no part of said dividend fund shall be applied to the payment of salaries and other corporate expenses."

From reliable sources connected with the company it was learned that all the development expenses and all the office expenses are paid out of the receipts from the sale of stocks, and that the results of any sales are declared dividends on such receipts, the expenses having been paid by the money subscribed.

Stocks cannot be paid up in full, payments of five dollars a month only being allowed, so that it takes at the least five years to pay up the \$300 which entitles the purchaser to a certificate of stock. During these five years money keeps constantly coming in as installments and is applied to development expenses.

If any default by non-payment of the installments due occurs the company has the right to forfeit the sum paid and consider it as liquidated damages arising through failure to carry out the agreement, provided that no such forfeiture shall be incurred until thirty days after the delinquent has been notified.

One of the solicitors was approached by a *HARDWOOD RECORD* representative and asked whether it was true dividends were being paid. He strongly asserted that it was. When he was confronted with the evidence that the so-called dividends were not dividends at all, but merely the application of receipts from the sales of lumber to the sums paid in without deducting the running expenses, and that therefore the assertion that dividends were paid was unfair, he replied, "No, it isn't. We pay dividends on the sum of money paid in. If you pay us \$300, we pay you dividends on it. We never claimed to pay dividends on the whole sum of money invested, or on the total capitalization, but only on the amount of installments turned into the company's treasury." When asked if he believed that the company could really carry through successfully such a scheme of not applying the results of sales to the liquidation of office expenses and other necessary outlays, he launched forth into such a description of future wealth as would make the El Dorado dreams of the Spanish conquistadores pale away into nothingness.

The operations of this company will be of interest for some time to come from the fact that 200,000 acres of the 288,000 are said to be timbered with mahogany and other

hardwoods and, as a consequence, a great part of the concern's operations will be in the line of lumber development for some time to come.

The company claims that the estates surrounding their own are extremely valuable and that they cannot be bought for \$1,000 an acre. They bought their own land from Markley and Miller, the contractors, and must have paid for it because they claim to have owned it in fee simple and to have turned it over to a trust company for the protection of their stockholders. Even if they paid as low as two dollars an acre this would still leave them with the tremendous initial expense of \$576,000, and if the dividends were really being earned, it would be a stupendous proposition. When it is taken into consideration, however, that the company has a very modern method of declaring dividends, the problem becomes easy of solution.

Under date of June 9 the International Lumber & Development Company issued a letter to its representatives urging them to renew their efforts to gather in stock subscriptions. It is not presumed that this document will induce any vast amount of subscriptions from the lumber trade, but it is published to exhibit with what persistence this outfit is attempting to unload its alleged securities on people who are entirely unfamiliar with commercial affairs. The company's letter follows:

To our Representatives:

On May 25, 1906, our Mr. W. H. Armstrong, Jr., recently returned from a business trip from our plantation in Mexico, where he has been since Feb. 25, 1906. He reports everything in good condition.

Enclosed you will find copy of letter written by him on the plantation to Mr. Francis Powell, assistant secretary of this company. This letter will be of interest to you.

Our stock is being purchased very rapidly and we cannot urge you too strongly to make a special effort to place as many shares of the capital stock of this company before they are all taken. Would recommend that you push the sale of shares with energy and determination.

It is quite gratifying to the management of this company to note that the old stockholders are increasing in many cases in large blocks the shares originally held and it is quite noticeable that a large number of new stockholders are being rapidly added to our list who have subscribed for large blocks of 20, 30, 40, 50 and in one case recently 100 shares.

Also remember that this company expects to increase the selling price of our shares, with or without notice, to at least \$350, or \$50 above par.

There are only a limited number of these shares to be sold at par value. Hope you will place your proportionate amount of these shares amongst your prospective purchasers before they are taken.

At the close of business tonight we have 1,134 individual stockholders upon our books who have purchased from one to 310 shares each.

Yours very truly,

INTERNATIONAL LUMBER & DEVELOPMENT CO.,  
C. M. McMahon, Treasurer.

#### Consumers' Lumber Company.

There is a concern said to have headquarters at 113 West Twenty-third street, New York City, known as the Consumers

Lumber Company, which advertises as having been established in 1881 and as being incorporated with a capital of \$125,000. The company announces itself as being "lumber dealers, general commission merchants, and manufacturers' agents." It issues pamphlets and other literature in abundance, which it persistently mails—very largely to the small mill men throughout the country—and attempts to secure consignments of these manufacturers' lumber, on the argument that the company places such small producers in direct touch with the consumer, effecting a great saving in the cost of handling, "and putting the profit of the wholesaler, retailer and speculator into the pocket of the producer." The company's literature further alleges:

"It has proven so much more economical that of late years the direct distribution of lumber by the carload has almost entirely superseded the old methods of delivery through wholesale and retail yards, with attendant expense and delays. As we guarantee sales you make no bad debts. We know whom to sell to and whom not to sell. This, together with the fact that we save handling, enables us to sell consumers at a lower price than they can buy from the retailer, and at the same time pay the mill man more for his stock than he can realize by selling it in any other way.

"All consignments will be sold for the shipper at the full price quoted in our price list, and prompt returns made, less \$1 per thousand feet, which is our commission.

"The prices quoted by us in our price list are correct and can be relied upon, as they are the prices at which we guarantee to sell all stock that is consigned to us f. o. b. cars this city."

The literature of the alleged lumber company continues in the same strain, with a bunch of specious arguments to induce small mill men to place their lumber in its hands for disposition. The pamphlet referred to is a very alluring one to a manufacturer who is not acquainted with metropolitan lumber conditions.

The documents issued by the Consumers Lumber Company bear all the earmarks of the authorship of one Horton, who has been preying on the lumber trade of the country for many years. He has done business under various company names for a long time. One of his old institutions was the Consolidated Lumber Company of 73 Bedford avenue, Brooklyn. For irregular transactions in connection with the enterprise on May 9, 1900, he was held in \$500 bail by Magistrate Flanner on the charge of larceny. The National Wholesale Lumber Dealers' Association at this time charged Horton with defrauding many lumbermen by ordering lumber and paying some of the dealers in part and others not at all; with preying for five years previously on small lumber dealers not members of the association, and with doing business under the firm names of the Consolidated Lumber Company, the J. W.

Martin Lumber Company and W. H. Horton. It is very difficult to actually identify this shark Horton with the Consumers Lumber Company, but to the mind of most people familiar with Horton methods in New York City, it is a safe guess that he is back of this new game. The literature of the old Consolidated Lumber Company and of the Consumers Lumber Company is practically identical.

In spite of the advertised capital of the Consumers Lumber Company being \$125,000 and that it claims to have existed since 1881, the commercial reports state, under a late date in 1905, that the company was recently incorporated under New Jersey laws, with J. M. Davis as president and N. J. Cahill as secretary and treasurer. It claims to have a paid-up capital of \$2,500, and declines to make further statements at this time, as it alleges that it has a number of stockholders who are mill owners located in the southern states, who do not care to have their names made public until such time as the company can make a good showing. Very little can be learned concerning either Cahill or Davis, but authorities consulted regarding the company claim to have positive information that C. J. Horton is the promoter of the enterprise. Horton has operated under several styles, and has endeavored as far as possible for the past few years to maintain his connection with any lumber enterprise a secret. In the past he has taken advantage of the bankrupt law and in bankruptcy proceedings acknowledged a heavy indebtedness to various creditors distributed over the country, and no assets. The reports further say that the New York trade would decline to give any concern with which Horton was thought to be connected the slightest consideration. Reports from one house in the South, which had the temerity to make a shipment of lumber to the Consumers Lumber Company, would indicate by the settlement that the latter concern is doing business strictly on the lines of the old Horton management—the total net avails offered for the carload of lumber being less than \$10.

It should be unnecessary to utter any further word of warning to HARDWOOD RECORD clients in this matter.

#### An "Operator" at Rochester and Stanley, New York.

There is a man named F. A. Booth, now said to reside at Stanley, N. Y., who formerly lived at Rochester, with whom the lumber selling public will do well to transact business only on the basis of getting cash in advance. It is charged that this man has defrauded people out of goods to the amount of many thousands of dollars during the last three or four years. His letter-head would indicate that he is a dealer in threshing and well drilling machinery, steam and gasoline engines, boilers, wagons, farm implements, furniture, musical instruments, wind-mills, pumps, tanks, lumber, groceries and sundry other commodities. He was convicted in 1904

of using the mails for fraudulent purposes, and was sentenced to Auburn prison for eighteen months. He was indicted for grand larceny in Elmira during the same year. Frequent jail sentences do not seem to faze him as he immediately follows the same tactics as before. It is alleged that he does not pretend to pay for anything he gets, and apparently there is no question as to his unreliability. He is so wise in concealing his ill-gotten gains that commercial agencies report as uncollectable all claims presented against him.

Further comment is deemed unnecessary.

#### McMahon of Syracuse.

John O. McMahon, attorney and counselor at law, 32 Everson building, Syracuse, N. Y., and more latterly with office at 112 West One Hundred and Twenty-eighth street, New York City, is still sending out half printed half written letters, asking for consignments of all sorts and varieties of lumber. He

seems desperately anxious to break into the lumber business, although in a letter recently printed in the *HARDWOOD RECORD* he confesses that he knows nothing of the subject.

There is no evidence thus far to show that McMahon is a crook, but there is a lot of it which indicates that he is either a crank or a fool. One of his recent stock arguments is the following: "I buy and sell lumber products both between wholesaler and dealer, and between retailer and builder. Wholesale prices will not be divulged to dealers; therefore state whether your prices are for dealers or builders." He further advertises that he is putting together a combination of manufacturers with mills located within cheap transportation of a distributing yard to be located in New York City.

It will not be necessary to suggest to *RECORD* readers that they had better say "twenty-three" to McMahon.

## Hardwood Record Mail Bag.

[In this department it is proposed to reply to such inquiries as reach this office from the *HARDWOOD RECORD* clientele as will be of enough general interest to warrant publication. Every patron of the paper is invited to use this department to the fullest extent, and an attempt will be made to answer queries pertaining to all matters of interest to the hardwood trade, in a succinct and intelligent manner.]

#### Criticizes the Forest Service.

The following letter from John P. Brown, editor of *Arboriculture*, Connersville, Ind., contains several suggestions of essential value to lumbermen on the subject of forest and mill economy and the planting of timber for future supply. Mr. Brown is a confirmed advocate of the planting of *Catalpa speciosa*, which he regards as the ideal tree for quick growth for a future supply of posts, poles, ties, etc. His observations concerning the real timber conditions existing in eastern Tennessee and western North Carolina are verified by the facts. It is with much satisfaction that the *Record* prints this letter from Mr. Brown, and it is hoped that he will contribute much more information on reforestry and kindred topics, with which he is so familiar.—EDITOR.

On Train en route South, June 5. Editor *Hardwood Record*: I shall be very glad to give you, from time to time, some suggestions in regard to forest policy. I am perfectly independent, do not fear to attack any policy which seems vicious or unwise, and having no aspirations politically shall not hesitate to criticize the government or state policies. I consider the governmental forest policy as extremely dangerous and tending to the speedy destruction of American forests.

Two things are highly essential: First, to warn manufacturers, lumbermen and timber owners of the near approach to exhaustion of our timber supply and the necessity of economy in its use. Second, the planting of immense forests to provide a quick supply of timber. The area destroyed each year is very far beyond what any man has yet told. The government authorities seem to wish to create the impression that we have a never ending supply.

In the eight years of Mr. Pinchot's administration of the Forestry Bureau he has only spent \$2,741.25 in planting trees, the total number of

which is 1,275,000 trees in eight years, out of an appropriation of nearly a million dollars yearly. I have myself in this same time spent \$50,000, and planted, or caused to be planted, 20,000,000 trees, through the society which I represent. My book on *Practical Arboriculture* will tell you why I am "possibly a *Catalpa speciosa* crank," as the *Record* states. If any man can point to any tree which has so many valuable qualities as the *catalpa*—one which will grow in a brief period into lumber, and a tree which is so cosmopolitan in character, growing everywhere—I shall be glad to learn of it.

I am impressed more and more in my observations in the North Carolina mountains with the fact that little timber of real value exists. Here are hundreds of square miles of mountain land, all covered with what looks to be forest. The general impression upon the average traveler is that inexhaustible forests of heavy timber cover these mountains. But let a practical lumberman go into the woods seeking trees for lumber, and the real situation will be learned. Most of the alleged forest consists of brush which will require a hundred years to mature, all of present value has been culled and removed. Hemlock, birch, sycamore, chestnut, black locust and oak thickly cover the land, but the very density of the stuff prevents growth. Yet the forestry experts at Washington include all these thousands of acres of scrub brush in their valuable estimates of forests of which the United States is the proud possessor.

There are positively no estimates made by any individual of the quantity of commercial timber existing which have any value whatever. I question if any man living has had better opportunities for observation than I, or has traveled over more territory, or been more observant, and I would not pretend to even guess at the number of feet board measure existing. But I do know that it is only a fraction of the quantity generally supposed. And I also know that men sitting in their offices in Washington talk and write very unintelligently about the vastness of our timber possessions. The rapidity with which lumber has advanced in price, the difficulty in obtaining supplies of good lumber, the great number of very inferior logs being sawed all demonstrate the nearness of the end.

We cannot depend upon the natural forest growth longer than to the end of the first quarter of this century, and I can see no other solution of the problem than the planting of vast areas to trees. Meantime greater economy than

has ever been thought necessary among owners of timber lands will be necessary to make our supply last even as long as I have predicted.

When timber land owners come to see the lumber prospects as they really exist, and learn that forest planting is so simple and of so little cost, its returns coming in so short a time, then I trust they will rise to the emergency and their privilege and plant new forests on their cut-over lands.

JOHN P. BROWN.

#### Wants Walnut, Hickory and Persimmon Dimension Stock.

LONDON, ENGLAND, June 9.—Editor *HARDWOOD RECORD*: I am in the market for walnut shorts and should like to be put into communication with reliable shippers that you can recommend to me. I also want second growth hickory squares, only in the best wood, for golf shafts, and also persimmon blanks for golf heads. The blanks for heads are cut to pattern 2x3—6 and 8 inches long. They should be free from black stain and bark. Am also in the market for a variety of sizes in hickory squares, to be cut from firm hard wood— — — — COMPANY.

The *HARDWOOD RECORD* will be pleased to place anyone desiring to market the commodities named in communication with this inquirer, which is a reliable London house.—EDITOR.

#### In Market for Built-Up Table Legs.

JETERSONVILLE, IND., June 11. Editor *HARDWOOD RECORD*: Will you kindly give us the names and addresses of firms engaged in the manufacture of built-up table legs? We will appreciate any information you can give us on this subject. — — — — MANUFACTURING CO.

If makers of this kind of furniture material will kindly supply their addresses they will be forwarded the name of a prospective customer.—EDITOR.

#### Wants Thick Rock Elm.

CINCINNATI, O., June 21.—Editor *HARDWOOD RECORD*: Can you assist us in locating a carload of 2½-inch mill run rock elm for which we are in the market?— — — — COMPANY.

If any reader of the *Record* can supply this want, will he kindly communicate the information to this office?—EDITOR.

#### New Kentucky Flooring Plant.

The International Hardwood Company is the name of a new institution at Cadetsburg, Ky., which has recently placed in commission a modern plant for the production of plain and quartered oak flooring. W. A. Smith, formerly president of the Kenova Poplar Manufacturing Company, is president; F. H. Van Antwerp is secretary and treasurer, and L. Merrill is vice president. The company produces a high-class, kiln-dried, correctly manufactured flooring, and is now making about 15,000 feet per day. The machinery is of the famous type manufactured by the Berlin Machine Works of Beloit, Wis.

The oak in the Ashland district of Kentucky, near which this plant is situated, is of a very superior quality for flooring purposes, and the product of the International Hardwood Company is such that it has immediately gained favor among consumers. A particular feature of the business of the company is the fact that it has already developed a large demand for its product in nearby cities, which consume a large proportion of its entire output. Cadetsburg is very favorably situated for the delivery of flooring in the many prosperous towns of Ohio, West Virginia and Kentucky. The surplus product of the plant is being shipped to the large commercial centers of the East, West and North.

# Meeting of National Veneer and Panel Manufacturers' Association.

A semi-annual meeting of the National Veneer & Panel Manufacturers' Association was held at the Grand Hotel, Cincinnati, on Wednesday, June 29. Those present were:

E. W. Benjamin, Cadillac Veneer Co., Cadillac, Mich.

S. G. Boyd, C. C. Boyd & Co., Cincinnati, Ohio.

C. C. Boyd, C. C. Boyd & Co., Cincinnati, O.  
W. C. Calhoun, Frost's Veneer Seating Co., Sheboygan, Wis.

M. C. Dow, Goshen Veneer Co., Goshen, Ind.  
E. H. De-laugh, Barrel and Box, Louisville, Ky.

Lewis Doster, secretary Hardwood Mfg. Assn., Chicago, Ill.

F. W. Eggers, F. Eggers Veneer Seating Co., Two Rivers, Wis.

L. P. Groffmann, St. Louis Basket & Box Co., St. Louis, Mo.

Henry H. Gibson, Hardwood Record, Chicago, Ill.

D. E. Kline, Louisville Veneer Mills, Louisville, Ky.

E. M. Lord, Chicago Veneer Co., Burnside, Ky.

H. M. McCracken, Kentucky Veneer Works, Louisville, Ky.

W. E. Moher, National Veneer Co., Charleston, W. Va.

W. G. Munyan, Virginia Veneer Co., Keezletown, Va.

L. N. Phillips, Linwood Mfg. Co., Linwood, N. C.

John N. Roberts, Roberts & Connor Veneering Co., New Albany, Ind.

F. A. Richardson, Michigan Veneer Co., Alpena, Mich.

Z. T. Robinson, Robinson Veneer Works, Owensboro, Ky.

William Seiber, Central Veneer Co., Central City, W. Va.

Charles J. F. Steiner, Baltimore Veneer Panel Co., Baltimore, Md.

Kent Sheppard, Globe Veneer Co., Baltimore, Md.

D. S. Thomas, North State Veneer Co., Statesville, N. C.

J. Crow Taylor, Louisville, Ky.

J. A. Underwood, Underwood Veneer Co., Wausau, Wis.

W. S. Walker, Portsmouth Veneer & Panel Co., Portsmouth, O.

O. E. Williamson, Baltimore, Md.

Nathan M. Willson, Pearl City Veneer Co., Jamestown, N. Y.

The meeting was called to order at 10:30 a. m. by President D. E. Kline of Louisville. Mr. Kline congratulated the association on the progress it has made in its work. The reading of the minutes of the Chicago meeting, held early in the year, was dispensed with. Mr. Kline gave the details of what transpired at the Asheville meeting, held April 16. He said that the producers of veneers in the vicinity of Asheville had formed an organization known as the Southeastern Veneer Association, with a membership of seventeen, and that this association desired to become affiliated with the national organization as a southeastern branch under certain conditions, which he named. These conditions provided for some changes in grading, and the altering of base widths on one line of stock.

On motion of Mr. Groffmann it was decided to admit the members of the Southeastern organization as members of the national order.

On motion the chair was instructed to appoint a committee on the grading of thin veneers, drawer bottoms and glass backs, to report at the next session. The chair appointed as such committee: Messrs. Roberts,

Benjamin, Sheppard, Underwood and Groffmann.

The secretary-treasurer submitted a report of the finances of the association, showing total receipts of \$243.81, and expenditures of \$115.66, leaving a balance of \$128.65. He stated that there was a sum of \$230 coming to the association from dues.

The secretary read a communication from the secretary of the American Forestry Association, soliciting a sustaining membership from the Veneer & Panel Association at a cost of \$25. On motion of Mr. Walker, the secretary was instructed to purchase the membership on behalf of the association.

The president then introduced Lewis Doster, stating that he was experienced in association work, and that he had very kindly consented to give the veneer people present a brief address on the subject of the methods and achievements of the Hardwood Manufacturers' Association, of which he is secretary. Mr. Kline explained that the methods employed by an association which had achieved



D. E. KLINE, PRESIDENT, LOUISVILLE, KY

such eminent success in the handling of hardwood affairs should be not only interesting, but of manifest advantage to the embryo association of veneer makers.

Mr. Doster addressed the meeting substantially as follows:

This is one of the first opportunities I have ever had to discuss or explain the methods of association work to others who are not exactly hardwood producers, but are immediately interested in the development of the industry, and it is a pleasure to be able to accept the kind invitation of your president.

The necessity of having a hardwood manufacturers' association became manifest in 1902 and after the objective points were decided upon it became a study to discover the best methods to pursue in carrying out the details, which included a careful study of other successful associations in the lumber line. Before the association was formed there was quite a variety of opinion as to grades; various retail and buying organizations in the different cities had adopted all kinds of grading rules impractical from a timber standpoint, and which caused not only consternation, but a variety of opinion between the shipper and buyer. It was discovered that to procure a legitimate basis for uniform prices it was necessary to establish uniform grading rules for the inspection of the class of material to be covered by the organization and to protect the manufacturers against unfair methods.

In framing the organization it adopted for its policy securing a full understanding of the conditions surrounding the lumber market in the territory covered by the organization, not only to establish uniform grades, but to establish uniform customs and usages among the manufacturers to develop economical production, for the purpose of lengthening the life of the forest, and to inaugurate a system by which the welfare of the manufacturers would always be maintained and defended in case of necessity, by reason of any inimical legislation from outside sources.

To obviate any difficulties or to prevent any dissensions it was decided that only producers of lumber who operate sawmills and manufacture their product from timber lands were eligible to membership, with the result that it became a producers' organization.

Owing to the fact that of a number of different classes of wood, some are competitive, the association adopted a rule by which only those vitally interested in the manufacture of certain classes of products can vote or legislate upon the grading or value of the commodity. Every state interested in the association—over seventeen in number—is represented by a vice president and two directors on the board of directors; the vice president acts as chairman of the state districts, and the directors are geographically distributed to secure the best results in organization work. Numerous committees are appointed, covering in their entirety the different classes of woods, both as to values and as to grades, and they work together for the purpose of eliminating bad legislation. These committees are composed of men of high intelligence, who are not only thoroughly familiar with the production of the raw material, but have had vast experience in marketing the stock to the people who consume it, and knowing their wants, are able to properly legislate for carrying on the trade between themselves and the buyers.

After months of study to inaugurate grading rules and working them out to eliminate any conflicting ones or any which were not in line with market wants, they were placed in print by thousands and distributed among not only producers but consumers. They are written in such an intelligent manner that the inspectors of lumber thoroughly understand how to interpret the grading laws as laid down in this book of rules. When such grading laws became effective it was found that the inspectors of lumber, even those working for one class of shippers, were not working in proper accord, and it became necessary to place a corps of inspectors at work upon the mill men for the purpose of education at the producing end and to establish uniformity. It was found justifiable to start at the beginning and endeavor to eliminate trouble at destination by a thorough understanding of how to ship a uniform grade from points of production.

Even with such work it was discovered that the entire subject of "trouble at destination," or in consuming markets, was not eliminated, and therefore a corps of inspectors who were men working exactly on the same lines as those at the mills, were employed for the purpose of traveling from point to point among the consuming markets to take care of the producers' and consumers' complaints. I might add that very often this corps of inspectors changes—at stated intervals—the ones working at the mills working in the consuming markets, and vice versa. This department of grading is one of the most important parts of organization work in the lumber line, where grading is the basis of values, and it is also the most expensive department of our work. Inspectors employed are high class men—above reproach as to integrity and sobriety, and they work absolutely impartially to obtain satisfactory results.

It is well known that there are commercial agencies established to supply to the shippers of lumber financial reports of prospective buyers, or of customers with whom shippers deal, but at the same time, in the lumber business there are conditions which often necessitate more information than is contained in these reports where the question of moral turpitude is of equal or more importance to the mill men than the financial report. Questionable complaints regarding interpretation of the rules, terms of sale, discounts, etc., are always confronting the shipper and therefore we inaugurated a plan of reports by which any member of the association can ask the standing of the buyer and a thorough canvass is made of the membership, which represents over 100 mills, and replies are received in the secretary's office.



and compiled, showing actual business experience with the buyer in question. These reports are collected and sent to all members, whether they have asked for them or not, and by being filed become a valuable asset for future reference. This information is held absolutely confidential and never given to any but members of the association, at the same time the name of everyone reporting on this as well as on all statistical work is confidential with the secretary.

In the development of all organization work the question of supply and demand is one of vital importance, and therefore various statistical matter is gathered for the purpose of determining further legislation, and with the support of every member of the association it will always result in something beneficial; for when money is expended for the purpose of a systematic research it is done for the purpose of benefitting the producer, as it is of vast importance to the industry.

In a former part of my talk I referred to the methods by which the different kinds of wood are classed and represented by the different states on committees, both as to grades and values. These committees are canvassed from time to time to discover the true market conditions. In my travels about the country I study the conditions among the mill men. The consuming markets are also canvassed as to the true conditions existing therein, with the result that any publication of values is based on the true state of the market—what the people are paying and what the manufacturers are obtaining for the same items. No secret methods are employed in the development of this plan; in fact, I have been asked by a great many people after submitting reports of conditions to all members of the association what recourse we have in case of price lists not being maintained. Gentlemen, we never have made any binding price agreement, nor do we think in our association work that it is necessary to do so, but our endeavor is to place before the manufacturer and producer statements of true conditions and we find a great many firms study the markets in advance of others, and they naturally obtain higher prices than other operators. Such market conditions are naturally based on values obtained by hustling ability, and are therefore a target for the industry, and it is our endeavor at all times to assist those who cannot obtain the prices, to market their stocks and obtain as good a value as the market can afford to pay.

The good results obtained through our association work, and the money expended for the development of them, makes them permanent, due largely to the frank and earnest manner in which the manufacturer takes hold of association work. Every member realizes that he is a part of that body and the more actively he is engaged in the work, the more successful it becomes. The office of the secretary is nothing but a machine, which is at the call of the various committees, appointed to legislate plans for the secretary's office to put into effect.

One point I might make is that the formation of the association and of the current rules has been greatly assisted by the secretary's traveling over the various states where production is represented and holding district meetings for the purpose of assisting in the legislation of matters vital to the interests of those districts. They outline the policies to pursue and give to the secretary their orders as to what to carry out, providing, naturally, that it does not conflict with the rules of the National body as a whole. The large producer and the small producer are shoulder to shoulder in carrying out this system and it has uplifted the trade.

Good results are obtained by watching the manufacture, and the economy of properly manufacturing stock is being appreciated by the consumer. This assists the manufacturer to put his lumber upon the market and find a ready sale for it, owing to its being in such condition. From the good results we have obtained it has been felt that the money expended has been returned a thousand fold, and every department of our association is watched closely by members and used at all times for the betterment and development of their business conditions.

Gentlemen, I thank you for this opportunity to meet with you today and fully appreciate it, and hope that my invitation to anyone visiting Chicago to see our office and the manner in which its detail systems are worked out will be accepted, when we can explain more fully any matters conducive to the good of the shipper and to the benefit of your industry, and the plan of organization which has been carried out. We will be pleased to outline to you men of intelligence, who are thoroughly familiar with your industry and who are the men to frame the policy of such an organization, the advantage of a machine such as we have to extend the plans you have adopted at your meetings. I trust that your deliberations will result in

the establishment of methods conducive to the good of the business, individually and as a whole.

The secretary then commented on the value of local meetings and of district organizations in connection with the work of securing new members. He stated that at the present time the membership of the association numbered fifty-five out of a possible two hundred and twenty-five engaged in the pursuit, and that before the year was over it should have at least a hundred members, which would represent fully seventy-five per cent of the total veneer production of the United States. A member inquired concerning other allied associations in the veneer business, and President Kline replied that there was an association known as the Sawed Veneer Association, with headquarters at Indianapolis, but which apparently had fallen into desuetude.

Mr. Groffmann complimented Mr. Doster on the address he had delivered, and observed that the members of the National Veneer & Panel Manufacturers' Association must now begin to realize the work they had ahead of them. As for association work, he said that



J. A. UNDERWOOD, VICE PRESIDENT, WAU-  
KESHA SAW CO., WIS.

any man must be blind who does not regard it as extremely beneficial to his pursuit.

On motion, the president was instructed to appoint a committee to audit the accounts of the treasurer. He appointed as such Messrs. Walker, Dow and Munyan.

Adjournment was taken until 2:30 p. m.

#### AFTERNOON SESSION.

Although the association was scheduled to have a meeting during the afternoon, many of the members interested in the production of made-up veneer work gathered for conference, and deemed it expedient, inasmuch as for the most part they were buyers of veneers and therefore more interested in panel production than in the manufacture of the veneer itself, to organize separately, at least temporarily. Originally offered as a suggestion, this idea prevailed, and under the title of The Panel Club, a tentative organization was effected with W. S. Walker of the Portsmouth Veneer & Panel Company, Portsmouth, O., as chairman, and E. H. Defebaugh, secretary. The session of those interested in panel production, which comprised fully half of those present, continued all the afternoon, and therefore the continuation of the work of the association proper was postponed until 7:30 in the evening.

The Panel Club appointed a Committee on Grades and Prices, consisting of Messrs. Kline,

Willson, Richardson, Calhoun and Steiner, and appointed a second committee on permanent organization, consisting of Messrs. Dow, Groffmann and Phillips.

It was resolved to hold an exclusive meeting of The Panel Club at the Cadillac Hotel, Detroit, on Tuesday and Wednesday, Aug. 14 and 15. At this time it is expected that the committees will be able to report the details and complete plans for the establishment of uniformity in sizes, grades and values on all classes of made-up stock.

#### EVENING SESSION.

The auditing committee reported that it had examined the accounts of the treasurer, found them correct and recommended that they be approved, which recommendation prevailed.

Chairman Roberts of the committee appointed to revise the rules governing rotary cut drawer bottom and glass back stock reported as follows:

"Your Committee on Grades and Rules governing drawer bottom and glass back stock of rotary cut oak veneers recommend that they shall be manufactured and sold under the following grades and rules:

No. 1 Faces.

No. 2 Faces.

Backs.

No. 1 Faces shall consist of veneers 6 to 24 inches wide, not to contain more than ten per cent of 6 inch; in 6 to 13 inch widths, to be free from all defects; veneers 13 to 18 inches will admit of one standard defect; veneers 18 to 21 inches, two standard defects; veneers 21 to 25 inches, one small knot and three standard defects. This grade will admit of one inch sap on the edges on all veneers 18 inches and over in width.

No. 2 Faces shall be 6 to 24 inches wide, to contain not more than ten per cent of 6 inch widths, and will admit of all standard defects, but not more than one pin-worm hole to the square foot. Clear sap admitted to this grade, and not to be considered a defect.

Backs to be 6 to 21 inches in width, but to contain not more than ten per cent of 6 inch widths; will admit of sap and all standard defects, sound knots and holes not over one-half inch in diameter and splits not to exceed one-half inch in width.

What is understood by standard defects shall consist of streaks not over three inches long; brown spots; spot-worms; closed checks not over 6 inches long, and open checks not over 3 inches long, open not to exceed one-fourth inch.

Considerable discussion ensued over the recommendations of this committee, some thinking that buyers would object to the establishment of the grades as outlined. President Kline observed that the sooner buyers are educated to take the full product of the log, so much better will it be for the manufacturers of veneers.

On motion the above rules as applied to oak drawer bottoms and glass back stock in log run were approved. These rules will therefore alter those adopted at the Chicago meeting early in the year, which divided rotary cut stock into the two grades of faces and backs—and the three grades will be substituted.

In reply to a query as to how hardwood lumber organizations establish a mutually satisfactory system of inspection, Henry H. Gibson, editor of the *Hardwood Record*, stated that this result is reached by the appointment of a small committee well versed in each particular wood, who formulate a set of inspection rules and then submit these rules to every member of the association interested in the product. On the return of these suggestions they revise the rules to meet the opinion of the majority, and then submit them in open convention for approval. He further stated that this is the only logical way to

arrive at a mutually satisfactory system of rules and regulations governing any line of trade.

The Southeastern branch of the National association asked permission to change the base of drawer stock from 15 to 20 inches on sales in their local territory, inasmuch as that had been the custom in that section for years, and they feared detrimental influences to their trade if they attempted to enforce the 15 inch standard. On motion the request of this branch was allowed with the distinct understanding that sales on this base be confined to their local territory.

Henry H. Gibson addressed the convention, stating that the efficiency of inspection from the manufacturer's viewpoint consists primarily in establishing grades best suited to the consumer's wants in so far as they may be made to utilize the full product of the log with economy. He referred to the address of Secretary Doster, saying that the latter had told of the aims, methods and accomplishments of his association, but nothing concerning the cost of this work, which has amounted to well toward \$150,000, thus showing that an efficient organization is necessarily very expensive. He stated that one individual member said that had he paid the entire bills of the Hardwood Manufacturers' Association he would feel amply repaid by the benefits which had accrued to him.

In the speaker's opinion there was a direct relation between hardwood lumber producers and veneer manufacturers. Both enter the same market for their supply of logs, and both sell to the same trade. The veneer and panel makers produce a substitute for solid wood, and therefore there should be a close analogy in value between the output of the hardwood sawmill and of the veneer factory. If veneers in their laminated form produce a

piece of material of more value than a solid piece of lumber for a specific use in the production of doors, furniture, etc., the veneer men should have a higher price for it. Under prevailing conditions in prices of laminated woods, consumers of this material are buying the product for less money than they are hardwood lumber. He therefore offered as a suggestion that the logical way for veneer manufacturers to work out their problem of uniformity of grades and values would be not to attempt the continuation of a small and comparatively weak organization, but to ally themselves with an association of hardwood manufacturers and thus secure the vast benefits that would accrue to them through having adequate established machinery for the conduct of their affairs. He further stated that he had no suggestion from the hardwood association that the veneer men would be welcomed to it, but that if such an alliance could be made, it was worthy of consideration. He further observed that by such a connection the veneer manufacturers would not lose their identity, but would have their particular branch or branches of association work entirely under their own control, and still have the work executed for them at a minimum cost as compared with any effort that they themselves might make.

While there was no action taken on these suggestions, there was much favorable comment made both during and after the meeting.

On motion of W. S. Walker, Secretary DeFebaugh was instructed to confer with members to find out whether it was their desire to employ a permanent secretary on a salary, to attempt to carry on the work outlined by the association.

At eleven o'clock the meeting adjourned, to meet six months hence, the specific date and place to be named by the president.

## Hardwood Manufacturers in District Meetings.

### Gathering at Hot Springs.

On June 9 a meeting of the hardwood manufacturers of Arkansas was held at the Arlington Hotel, Hot Springs. J. L. Lane of the Lane-White Lumber Company, Ft. Smith, was chosen chairman of the meeting and Lewis Doster secretary. The meeting was held for the purpose of discussing various subjects pertinent to the trade, including the rapid depletion of forests, cheapening the cost of production, and uniform methods of grading and manufacture. Howard Coles of the Bliss-Cook Oak Company, Blissville, delivered an interesting address on the subject of land taxation, which was also fully discussed. F. E. Gary, P. L. Throne and G. V. Nash spoke upon general association work, and Lewis Doster, secretary of the Hardwood Manufacturers' Association of the United States, addressed the meeting on the work being done by his association, calling particular attention to its commercial reports, stock sheets, market reports, membership, etc. A motion was then made by J. L. Lane that the assembled body organize and that all manufacturers present become members of the Hardwood Manufacturers' Association, although continuing their state meetings for furthering local interests. The motion was carried unanimously, and all who were not members of the Manufacturers' Association presented their applications.

A Committee on Resolutions and Recommendations consisting of Howard Coles, F. E. Gary and P. L. Throne was appointed.

This committee recommended that vacancies on the regular standing committee on Oak Grading of the Hardwood Manufacturers' Association be filled by G. V. Nash and J. L. Lane, and that the vacancy on the Committee

on Walnut Grading be filled by J. L. Lane.

A Committee on Statistics was appointed as follows: Benj. Emmons, E. C. Lippman, G. V. Nash, F. E. Gary and Thos. W. Fry.

A Committee on Log Specifications was appointed, consisting of P. L. Throne, G. V. Nash, A. C. Lange, J. W. Wheeler, J. L. Lane, W. W. Fort, H. W. Mosby, Howard Coles.

A resolution was adopted recommending to the Hardwood Manufacturers' Association that in its statements of market conditions prices on thin plain oak be published.

There were present:

Howard Coles, Bliss-Cook Oak Co., Blissville, Ark.

S. B. Anderson, Anderson-Tully Co., Memphis, Tenn.

G. V. Nash, Wisarkana Lumber Co., Nettleton, Ark.; also Forrest City Mfg. Co., Forrest City, Ark.

Benj. Emmons, Brinkley Car Works & Mfg. Co., Brinkley, Ark.

C. T. Schleicher, Branch Saw Co., St. Louis, Mo.

W. P. Anderson, Gideon-Anderson Lumber Co., Gideon, Mo.

J. M. Countiss, J. M. Countiss Lumber Co., Doron, Ark.

E. C. Lippman, L. Lippman, Tupelo, Ark.

J. L. Lane, Lane-White Lumber Co., Ft. Smith, Ark.

M. P. Fulton, Ind. & Ark. Lbr. & Mfg. Co., Marianna, Ark.

F. E. Gary, Baker Lumber Co., Turrell, Ark.

P. L. Throne, American Washboard Co., Fair, Ark.

Ed. Lazalier, Knobel Lumber Co., Knobel, Ark.

Thos. W. Fry, C. F. Leuhrmann Hardwood

Lumber Co., St. Louis, Mo.

W. W. Fort, Fort Lumber Co., Brinkley, Ark.

A meeting will be held in Little Rock, Ark.



J. L. LANE, FORT SMITH, ARK.

at Hotel Gleason, June 23, at which will be represented not only the hardwood interests of the state but also the yellow pine interests.

### Morehouse Meeting.

On June 12 another meeting of hardwood manufacturers was held at the Forest Hotel, Morehouse, Mo., in the same interests, of which J. H. Himmelberger was unanimously chosen chairman and Lewis Doster secretary.

After Chairman Himmelberger had explained the objects of the meeting, Messrs. Laming and Garetson reviewed the benefits of being members of the Hardwood Manufacturers' Association of the United States.

Lewis Doster then took the floor and gave a talk on the past work of the Hardwood Manufacturers' Association of the United States, of which he is secretary; what it has accomplished up to the present time; and the work to be taken up in future. He also explained the state work developed by the sectional meetings held in various parts of the country, the rules formulated covering the different matters of importance in each state which were put into effect. Mr. Doster dwelt at some length on the meeting of hardwood manufacturers of Arkansas held at Hot Springs, on the 9th inst., explaining the work started at that time on log specification.

Chas. M. Fletcher of Bernie, Mo., suggested to the meeting his ideas of the benefits of such an organization and his willingness to co-operate in such a movement. A general discussion was held on various topics of interest to Missouri manufacturers which was participated in by all present.

In line with Mr. Doster's report of the Arkansas meeting, a motion was carried to have a committee of seven appointed by the chair to take up the question of log specifications, which committee was appointed as follows: J. H. Friant, G. L. Roper, H. H. McLeod, Chas. M. Fletcher, M. J. Blackwell, Frank E. Hilton, W. D. Knott.

Chief Inspector J. V. Hill of the Hardwood Manufacturers' Association of the United States gave a talk on the subject of instruction of inspectors at mills, on the uniformity of grading and manufacture and the benefits to manufacturers and consumers of the inspections made on disputed shipments in the consuming markets.

Recess was taken for luncheon from 12:30 to 2:30, during which time the saw mills, planing

mills and dry kilns of the Himmelberger-Harrison Lumber Company were visited and the latest log loading and handling devices being used inspected.

The meeting reconvened at 2:40 p. m. and further discussion was had on the subject of log specifications, after which the committee above appointed returned a report as follows, which was accepted:

"Your Committee on Log Specifications has decided to allow each member of the committee to draw up their ideas and present them to the chairman, this committee to meet tonight and also at a later date at Morehouse at the call of the chairman. This committee also to decide the adoption of the official scale as well as the specifications."

Motion was made and carried that the next



J. H. HIMMELBERGER, MOREHOUSE, MO.

meeting of the manufacturers of hardwood in Missouri meet the second Tuesday in September, the eleventh, at Cape Girardeau, Mo.

The guests were much pleased with the excellent accommodations accorded them by the Forest Hotel and a number of them decided to stay over a day or two longer for the purpose of visiting the log camps in the vicinity of Morehouse, and fishing.

There were present the following:

John H. Himmelberger, Himmelberger-Harrison Lumber Co., Morehouse, Mo.

W. H. Harrison, Himmelberger-Harrison Lumber Co., Morehouse, Mo.

Howard Rule, Himmelberger-Harrison Lumber Co., Morehouse, Mo.

Charles L. Harrison, Himmelberger-Harrison Lumber Co., Morehouse, Mo.

F. A. Garetson, Garetson-Greaseon Lumber Co., San Diego, Cal.

M. J. Blackwell, Lee Wilson & Co., Wilson, Ark.

J. S. Garetson, Garetson-Greaseon Lumber Co., St. Louis, Mo.

M. E. Leming, M. E. Leming, Cape Girardeau, Mo.

E. E. Ruddell, Bement & Largent Lumber Co., Buckeye, Mo.

A. N. Durnell, A. N. Durnell, Bridges, Mo. Albert Kaechele, Albert Kaechele, Cape Girardeau, Mo.

Frank E. Hilton, Garetson-Greaseon Lumber Co., Campbell, Mo.

Jno. T. Baldwin, Jr., Jno. T. Baldwin & Son, Ironton, Mo.

R. T. Largent, Bement & Largent Lumber Co., Buckeye, Mo.

G. W. Richey, Buckeye, Mo.

Dr. J. A. Atkinson, Morehouse, Mo.

Guy E. Higley, Kennett Cypress & Hardwood Lumber Co., Kennett, Mo.

H. W. Lucas, Dexter Saw & Planing Mill, Dexter, Mo.

W. D. Knott, Mishler Lumber Co., New Madrid, Mo.

A. V. Stewart, Risco, Mo.

Frank E. Gideon, Gideon-Anderson Lumber & Mill Co., Gideon, Mo.

Chas. H. Stevens, C. P. & St. L. Ry., St. Louis, Mo.

Lewis Doster, secretary Hardwood Manufacturers' Association of the United States, Chicago.

J. V. Hill, chief inspector Hardwood Manufacturers' Association of the United States, Chicago.

J. G. Griffith, Garetson-Greaseon Lumber Co., Fisk, Mo.

H. A. Richards, Grand Trunk Ry. System, St. Louis, Mo.

G. Crow, Essex, Mo.

G. L. Roper, Senath, Mo.

G. W. Schwartz, Vandalia R. R., St. Louis, Mo.

D. E. Rice, Garetson-Greaseon Lumber Co., Green Bay, Wis.

H. H. McLeod, Hoosier Stave & Lumber Co., Hough, Mo.

W. G. Holley, Holley-Matthews Mfg. Co., Sikeston, Mo.

Chas. M. Fletcher, Fletcher & Mills Bros., Bernie, Mo.

#### Louisville Meeting.

A meeting of hardwood manufacturers of Kentucky was held at the Galt House, Louisville, Ky., at 10:30 a. m. June 16. Edward L. Davis was appointed chairman and Lewis Doster secretary.

The meeting was called for the purpose of thoroughly discussing conditions existing in the different hardwood markets. Mr. Doster outlined the general objects and results of district meetings held in various sections and the matters taken up and developed by the local manufacturers and by the Hardwood Manufacturers' Association, of which he is secretary. He also explained the details of association work, particularly as carried on by his organization in its efforts to benefit producers of hardwoods.

Those present felt that meetings should be continued in the Louisville district, especially as the state ceremonies in celebrating the "Home Comers" caused the attendance at this one to be considerably smaller and not as representative as was desired. It was decided to hold a meeting later, date and place yet to be determined.

There were present the following:  
Edward L. Davis, Edward L. Davis & Co., Louisville, Ky.

C. M. Clark, Swann-Day Lumber Co., Clay City, Ky.

J. C. Rash, Brodhead-Garrett Co., Clay City, Ky.

F. H. Duling, Kentucky Lumber Co., Cincinnati, O.

W. E. Delaney, Kentucky Lumber Co., Cincinnati, O.

R. McCracken, Kentucky Lumber Co., Cincinnati, O.

Albert R. Kampf, Albert R. Kampf, Louisville, Ky.

J. Crow Taylor, Louisville, Ky.

Geo. R. Berry, U. S. Timber Co., Cincinnati, O.



EDWARD L. DAVIS, LOUISVILLE, KY.

Willis Green, S. Green & Son, Falls of Rough, Ky.

A. W. Brucken, Anton Brucken, Evansville, Ind.

A. A. Andridge, U. S. Timber Co., Cincinnati, O.

Anton Brucken, Anton Brucken, Evansville, Ind.

Lewis Doster, secretary Hardwood Manufacturers' Association, Chicago.

## Manufacture of the Tight Barrel.

Some remarkable changes have occurred in the manufacture of tight barrels in recent years. Formerly barrel makers performed a great deal of the work by hand; slow and crude processes were in vogue, and yet a very strong and durable barrel resulted. In those days, in many cooperage shops workmen constructed tight barrels at odd hours, and there were not a few factories where reconstructing new barrels from old was the only work done. The staves of the old barrel were recut, the bend remodelled, the head reshaped and with new hoops it presented a very different appearance and oftentimes sold as new. Modern machinery has been universally introduced in this line of work, and first-class tight barrels are produced and sold at retail at less than \$1 each, with a liberal profit to the maker. With barrels at these prices, the man who used to make a fair income by

overhauling and remodelling second hand barrels, has been forced out of business.

White oak is preferred by tight barrel manufacturers to any other wood, but other kinds of oak, and in fact many varieties of hardwoods are utilized quite extensively. White oak is becoming very scarce, and this fact alone has resulted in the employment of other woods to a considerable degree. Firm grained wood free from knots is essential. As timber entirely free from knots cannot be had in the bulk, one of the first operations in manufacturing involves the removal of knots, or the sawing free of knotty sections. Sometimes one side of the cut is knotty and the other side clear, in which event the clear side alone is used.

Figure 1 is a drawing of the log sawed the proper length for making staves. The cut is split or sawed into stave bolts as the case demands. In sawing, the cut is

marked off as indicated by the heavy lines in Figure 2, the resulting quarter section is exhibited in Figure 3. The sawing of the stave bolt into staves next follows, the sawn bolt presenting the appearance exhibited in Figure 4. Although buyers nowadays expect to get barrels at about one quarter the prices paid previous to the extensive use of machinery, they also expect perfect articles, and will reject as "seconds" barrels with the slightest flaw. Hence manufacturers are obliged to carefully inspect staves before they are adjusted for the setting up. After the trimming, shaping and bending operations are completed, the staves are subjected to the inspector for assorting. Figures 5, 6, 7 and 8 illustrate the varying conditions in which staves are found, from the perfect one in Figure 5 to the absolutely useless one in Figure 8. Some are warped so badly that they must be discarded, others can be remodelled under pressure; others are sprung and split at the ends, due to the use of imperfect stock. Knots and knot holes usually necessitate casting out a stave entirely, although occasionally it may be saved by plugging or patching.

The kiln drying processes are so effective in these days that the plant which is properly furnished with an improved kiln produces thoroughly seasoned stock. Some of the smaller tight barrel factories, however, season stock in crudely constructed apparatus of their own erection, and bad work naturally results. After the staves are ready, the setting-up operation illustrated in Figure 9 is the next step. The grooves in the setting-up device are adjusted to receive the lower ends of the bevelled staves, and the required bulge is obtained in adjusting the hoops. After the staves are properly arranged in the setting-up device, they are drawn together to receive the hoops by means of a windlass as shown.

Then comes the making of the head. The head bolts are turned out in the same way as the stave bolts, from shorter cuts, and sawed through as indicated in Figure 10. Naturally the headings are set up square or

according to the shape of the two or more pieces of wood used in the head. The circular head is then sawed out as in Figure 11, and the edges properly scored for adjustment in the barrel head.

Figures 12, 13, 14 and 15 show the different kinds of hoops and lap. The sheet metal hoop is of course used almost exclusively on tight barrels. There are types of cider and vinegar barrels, however, which are put up with wood hoops. Corrugated sheet metal hoops are used to some extent.

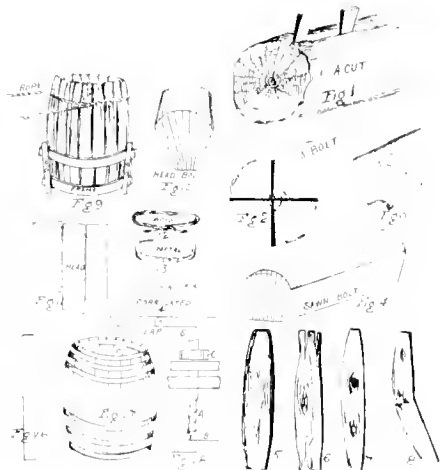

A groove is cut around the barrel into which the corrugated hoop fits. In making the plugs for the bung holes a bolt is cut from hardwood stock to the required diameter, Figure 16, and the right lengths are cut off, tapered and the surfaces smoothed, and the plugs are ready for use.

Figure 17 shows the finished barrel. Figure 18 illustrates the final operation on the barrel, the making of the bung hole. The drill A is provided with a set cam C, which can be adjusted up or down on the shaft of the drill to regulate the distance the bore is to extend into the barrel head or side, B. Hence the drill penetrates only a certain distance each time, and does not pass too far into the work after the hole is finished. "ARTISAN."

## News Miscellany.

### Expansion of Southern Cypress Association.

The Southern Cypress Manufacturers' Association held a special session at the Willard Hotel, Atlanta, Ga., June 11 and 12, at which South Carolina, Florida, Georgia and Louisiana interests were represented. R. H. Downman was chairman and George E. Watson secretary. Informal discussion and reports of various committees brought out the work being accomplished by the association, and gave the southeastern representatives some idea of its objects and scope.

A. T. Gerrans of the fire insurance committee reported having attended a meeting of insurance men at Shreveport, La., and stated that important concessions were made, viz., that mill product may hereafter be insured to its full market value; that standard mills will be allowed to run all night without penalty, while those with slight deficiencies will be penalized at only thirty per cent of the deficiency excess; that lumber sheds will be permitted adjacent to planing mills, without in-

crease of premium, if not exceeding in size the mill structure itself.

R. H. Downman stated for the committee on transportation that the Illinois Central and Pennsylvania railroads had agreed to equip some of their flat cars with the telescopic stake at their own expense, for experimental purposes, with the probability of their use being continued if satisfactory.

An interesting discussion on terms of sale, form of price list, experiments with tupelo gum, freight rates, etc., followed, after which the question of grades was introduced, that the southern manufacturers might see wherein they agreed or differed with those from the lower Atlantic coast mills. The question of stocks was brought up and Secretary Watson explained how monthly statistics were secured, and the benefit to members of their distribution.

C. F. Smith then addressed the assembly in a humorous style, welcoming the Louisiana delegation, and referring to the relative merits

of southern and eastern cypress, he was well answered by R. H. Downman, after which the meeting adjourned.

A delightful dinner was served at 8 p. m., at which the Louisiana delegation were the hosts, and R. H. Downman toastmaster.

The next day's session was a continuation of the experience meeting previously inaugurated. The duty of \$2 on cypress shipped to Cuba was condemned, inasmuch as no such tax is put upon spruce and similar northern softwoods. Lumber mutual insurance matters were brought up and experiences related in this connection, and regarding the shipper's relation to the buyer; also concerning the matter of including moldings in mixed cars at the regular lumber rate; the discount to wholesalers on block purchases, criticisms and suggestions on grading rules, etc.

It was thought best to hold another eastern meeting within the next month and Jacksonville, Fla., was decided upon, the date to be fixed by the chairman. Southeastern manufacturers expressed their willingness to make a tour of inspection among Louisiana mills after the next meeting. Much enthusiasm was manifest among all present over the success of the Atlanta gathering and it was felt that much had been accomplished toward furthering the desire of members of the Southern Cypress Manufacturers' Association to extend it over the entire cypress-growing territory.

The session adjourned at 1 p. m.

The following concerns were admitted to the association, bringing the total membership up to forty-six:

- Williams & McKethan Lumber Co., Lumber, S. C.
- Everglade Cypress Lumber Co., Loughman, Fla.
- Eddy Lake Cypress Co., Eddy Lake, Fla.
- Hodges & O'Hara, Buffalo Bluff, Fla.
- Gardner & Lacey Lumber Co., Georgetown, S. C.
- Ocmulgee River Lumber Co., Lumber City, Ga.
- Wilson Cypress Co., Palatka, Fla.
- Those present at the meeting were:
- R. H. Downman, New Orleans, La.
- R. H. Knox, Hilton & Dodge Lumber Co., Dublin, Ga., and Vale-Royal Manufacturing Co., Savannah, Ga.
- Horace Brownell, Brownell-Drews Lumber Co., Morgan City, La.
- E. G. Westmoreland, Des Allemands Lumber Co., Ltd., Des Allemands, La.
- L. M. Williams, F. B. Williams Cypress Co., Ltd., Patterson, La.
- O. M. George, Odenwayer Cypress Lumber Co., New Orleans, La.
- W. E. Mount, Gibson Cypress Lumber Co., Gibson, La.
- E. B. Wright, Butters Lumber Co., Boardman, N. C.
- David Burns, Everglade Cypress Lumber Co., Loughman, Fla.
- J. E. Wigington, Bowie Lumber Co., Bowie, La.
- A. T. Gerrans, St. Louis Cypress Lumber Co., Houma, La.
- S. R. Ely, R. H. Downman, New Orleans, La.
- L. W. Gilbert, Dibert, Stark & Brown Cypress Co., Downer, La.
- F. H. Wilson, Wilson Cypress Co., Palatka, Fla.
- S. M. Bloss, Lyon Cypress Co., Garyville, La.
- H. H. Gardner, Gardner & Lacey Lumber Co., Georgetown, S. C.
- E. B. Gardner, Gardner & Lacey Lumber Co., Georgetown, S. C.
- Thomas L. Ross, Red Cypress Lumber Co., Pretoria, La.
- John A. Bruce, Owl Bayou Cypress Co., Strader, La.

C. F. Smith, Ocmulgee River Lumber Co., Sumter City, Ga.

R. Lee Riggs, Riggs Cypress Co., Patterson, La.

#### G. W. Jones Lumber Company.

The G. W. Jones Lumber Company of Appleton, Wis., which is represented in Chicago by A. H. Ruth, a director of the company, whose offices are at 1717 Railway Exchange, is rapidly extending its operations. Recently the company secured a large holding of timber at Forrest City, Ark., where under the name of the Forrest City Manufacturing Co. it operates a modern sawmill. Besides this, the parent house has a large band mill at Wabeno, Wis., cutting about 10,000,000 feet of hardwoods per year; two large modern mills at Nettleton, Ark., under the title of the Wisconsin Lumber Company; and altogether produces and handles well toward 50,000,000 feet of lumber annually. It is one of the largest and best-known concerns in the country engaged in the manufacture and jobbing of hardwoods, and by its distributed sources of supply is equally well known to buyers of northern and southern hardwoods. G. W. Jones is president and treasurer of the company, R. H. Jones secretary and H. C. Humphrey vice president.

#### Meeting Executive Committee National Hardwood Lumber Association.

The first meeting of the executive committee of the National Hardwood Lumber Association since the May election was held at the offices of that organization in the Rector building, Thursday and Friday, June 14 and 15. The full executive board was present. It consists of W. H. Kusse, chairman, Earl Palmer, G. J. Landeck, C. H. Barnaby and O. O. Agler. Also meeting in conference with the board were W. W. Knight, chairman of the inspection bureau committee, Theodore Fathauer, chairman of the inspection rules committee, T. B. Stone and Max Sandheimer.

A considerable mass of inspection matters coming over from the inspector-general's office was gone over and adjudicated.

A committee on the car stake controversy, consisting of W. W. Knight, G. J. Landeck and E. F. McMillan, was appointed, to be present at the next meeting, and it was given full power to act in the premises on behalf of the association.

Discussion prevailed concerning the appointment of an inspector abroad, as suggested at the annual meeting at Memphis in May, butasmuch as the committee which was appointed to confer with the Exporters' association had not yet made its report, no definite action was taken.

The committee in charge of the San Francisco sufferers' fund reported the total collection for this charity amounted to \$1,045.00. This sum was remitted to Jas. J. Phelan, treasurer of the Red Cross Society at San Francisco.

A number of applications for membership were received, of which eighteen were accepted and three rejected.

A resolution prevailed giving Secretary Fish full charge of the office of the association, including the conduct of the correspondence incident to the inspection department. It was arranged that the surveyor-general should continue to spend practically his full time in road work, lining up inspectors, and in supervision of inspection matters.

#### Sawmills Needed in Japan.

Consular Agent E. J. King reports from Hakodate that the development of the railway tie business in northern Japan should prove a good opportunity for the sale of American sawmill and other woodworking machinery. Mr. King writes:

"American railway ties have been shut out of China by the cheaper hardwood ties from Japan. The latter have mostly been hand-hewn, but machinery is now being introduced, and quite a number of small steam sawmills are now working. A new impetus has been given to the exportation of Japanese railway ties by the demand from the west coast of Mexico, where they will again come into competition with American ties. Already one shipment of 83,000 ties has left Hakodate for Guaymas, Mexico, and arrangements are being made to ship 700,000 ties this year. They are delivered in Mexico for 56 cents gold each. The most of the sawmill machinery now used on the island of Hokkaido is English make, and American manufacturers of band and circular saws and of other woodworking machinery would do well to pay some attention to this trade opening. For their benefit I submit a list of names and addresses of some of the principal users of woodworking machinery. Riuyemon Zaimoku Kaisha, Hakodate. The Mitsui Bussan Kaisha and The Teshiwo Zaimoku Kaisha, Sapporo; The Hayakita Zaimoku Kaisha, Hayakita, and Mororan Mokuzai Kaisha, Mororan, all on Hokkaido Island, Japan."

#### Value of Quarter-Sawed Poplar for Pattern Making.

A writer in one of the technical magazines calls attention to the fact that quarter-sawed lumber is infinitely the best stock to use for thin patterns that have no ribs to hold them

made with the length of the bottom piece running from one rib to the other, as the bottom will stay straight and the side will always draw. If made like Figs. 8 and 9 the effect shown will result, which will distort the ribs so that the pattern will not draw. When the grain of the wood can be put in to run in the same direction as the line of draft a slight warping will not affect the drawing of the pattern. This cannot always be done as patterns thus made would be weak in vital parts.

#### Cutting Hardwoods in Panama.

Consul James C. Kellogg, of Colon, writes that the new sawmill on the Triana river near Porto Bello, Panama, is now in full operation sawing the many valuable hardwoods of the district, including lignum vitae, mahogany, cocobolo, ebony and black palm. The many contracts for the supply of these woods in Colon are being filled. The parties interested in this new enterprise are Messrs. Nonte, Horatio Stevenson and A. Barrier, of Porto Bello and Colon.

#### New Hardwood Lumber Company.

The Batchelor Timber Company of Saginaw, Mich., which is made up of Henry A. Batchelor, J. T. Wylie and other stockholders interested in the Wylie & Ruell Lumber Company, and which is the owner of a large area of hardwood timber land near Frederick, Mich., on the Mackinaw Division of the Michigan Central, has purchased the milling plant

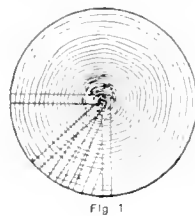

Fig. 1



Fig. 2

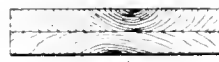

Fig. 3

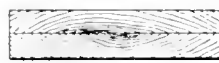

Fig. 4



Fig. 5

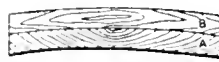

Fig. 6

is not always easy to obtain. A salesman for one of the leading poplar houses of the country says that he has sold many of the larger manufacturers for use in their pattern shops, rift-sawed poplar, and that the users are all enthusiastic over its high value for the purpose named.

As is well known, quarter-sawed boards are cut radially, as indicated in Fig. 1, and but comparatively little quarter-sawed stock is obtained from each log, owing to the relatively wasteful method of this kind of manufacture. Quarter-sawed lumber is practically free from any tendency to warp under varying atmospheric conditions. A flat-sawed poplar board like Fig. 2 will not stay straight and in correct line required for patterns. However, when two pieces of flat-sawed stock are glued together, as indicated in Fig. 3, the warping of one piece counteracts that of the other, and the joints will not readily open at the edges as they will if the pieces are laid as indicated in Figs. 4 and 5. If one piece is glued across another, the effect shown in Fig. 6 will result, unless the glue does not hold or the piece splits in shrinking. Board A pulls enough in shrinking to bend board B in its length. When absolutely dry lumber of four or more thicknesses is employed, the cross-graining of the stock is effective in holding it straight.

A pattern like Fig. 7 is more serviceable

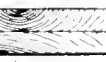

Fig. 7



Fig. 8



Fig. 9



Fig. 9

of the Gale Lumber Company at West Branch, Mich. The Batchelor Timber Company is engaged in entirely rebuilding the sawmill and will log its timber and move it by rail to the mill for sawing. As an adjunct of this enterprise the company proposes to build an up-to-date flooring plant to provide an outlet for its maple and beech product. A general office has been opened in the Bearinger building, Saginaw, which will be the headquarters of the company.

#### Possibilities in Santo Domingo.

A recent statement of the foreign commerce of the Republic of Santo Domingo showing the possibilities for the development of American trade in that country, says that the island has an area of about 18,000 square miles, and that probably no country on earth of equal extent has so many natural elements of prosperity within its borders. The agricultural, mineral and forest resources, although heretofore somewhat neglected, are remarkably varied and important. The wood products are extremely rich, including mahogany, satinwood, lignum-vitae, lancewood, oak, pine, logwood, fustic, several species of palms, and many valuable fiber-producing and medicinal plants. Several fields of domestic enterprise await profitable occupation, notably sawmill operation and railroad construction.

### Bavarian Furniture Market.

A recent consular report from Munich, Bavaria, says that country is an unknown quantity to American furniture exporters, and predicts that success would follow a well directed exploitation of American furniture. The native woods of the southern and central parts of Europe are few and not particularly adaptable to furniture making and are very high priced. Thus furniture in southern Germany is exceedingly costly an ordinary suit bringing about double the price received for it here. The furniture is mostly veneered, made from thin stock, and hence not durable, since it warps and cracks quickly.

One disagreeable feature of the market, however, is the fact that the long credit system obtaining in southern Germany must be considered for a time at least. Bills are sent out by some tradesmen only once in six months, or even only at the beginning of a new year.

In spite of freight charges, duty, etc., the American manufacturer could undoubtedly place superior furniture upon the market at a lower price than the home product, and still profit by the transaction. Showrooms possess great advantages over the catalog system of introducing goods, since the average merchant is not familiar with English, and an exhibition in charge of an energetic, well-posted business man speaking German fluently would bring more trade in one year than catalogs would in many. The field is undoubtedly an excellent one.

### Japanese Hardwood Market.

It is stated on good authority that there is no reason why hardwoods from the United States and the Philippines should not find a good market in certain parts of Japan, if efforts were made to meet the requirements of the trade. Teak is a wood which resembles some varieties of oak, and which is particularly favored in shipbuilding. American oak and other hardwoods should find a ready sale as substitutes for it.

Japanese importations of teakwood from Siam and Dutch India were, for 1905, \$368,466, against \$73,445 in 1904, most of which was entered at Kobe. This gives an idea of the growing demands for hardwoods for vessels, buildings and the manufacture of furniture. Teak logs arrive in 17 to 45-foot lengths. Teak planks, 15 to 25 feet in length are 8 inches wide, 4 inches thick and up, smallest size, while the 20-foot or more lengths are 12 to 20 inches wide and 2 1/4 to 6 inches thick, those 30 feet long running as high as 7 1/2 inches thick. They are required to be without worm holes or cracks. Teak deck planks must likewise be sound, and run from 20 to 30 feet long, 5 to 5 1/8 by 2 1/2 to 3 3/8 inches.

### Forest School in South Africa.

According to recent consular reports, the possibilities of forestry in South Africa have led a number of young residents to go to Europe and the United States to study the question. The cost of this training has been so great and so much of what was learned proved useless in the climatic conditions of South Africa that a forest school has been established there. The cost of a two-year course will be about \$1,250, as against \$5,000 abroad. The training at the new institution will comprise practical work on the government experimental reservation at Tokai, near Cape Town, where are grown practically all species of trees known in the country. Cape Colony now pays on an average \$2,500,000 yearly for imported timber, while the total South African timber bill is said to be not less than \$7,500,000.

### Hardwood Distillation.

Reports made to the United States Forest Service by fifty-eight hardwood distillers have

been compiled, and the following statement shows the number of cords used in this industry in Pennsylvania and Michigan and the volume and kind of products. The woods almost universally used are beech, birch and maple, only about 1 per cent being oak and chestnut.

Pennsylvania used 208,861 cords of wood and produced 2,242,890 gallons of alcohol, 39,573,508 pounds of acetate and 7,899,346 bushels of charcoal. Michigan used 239,992 cords of wood, its product being less than Pennsylvania's, as follows: Alcohol, 1,246,121 gallons; acetate, 14,778,635 pounds; charcoal, 8,193,387 bushels. The total wood used in the United States for this purpose was 570,411 cords.

### Miscellaneous Notes.

H. P. Baker & Co. recently established a handle plant at Columbia, Mo.

A veneer factory is to be erected at Asheville, N. C., by the J. S. Bailey Company.

The Big Sandy Telephone Pin & Bracket Company will build a factory at Louisa, Ky.

Fred M. Davis will engage in the manufacture of woodenware at Joplin, Mo., in the near future.

The Loedler Wagon Company of Tampa, Fla., is planning the erection of a large factory there.

The Bender Wagon Company was recently organized at Texarkana, Ark., with \$25,000 capital stock.

The Knoxville (Tenn.) Table & Chair Company has increased its capital stock from \$50,000 to \$100,000.

Robert Dickinson and George Boyle will establish a chair factory at Huntsville, Ala., in the near future.

The new handle factory at Pleasanton, Kan., is completed and in operation turning out fifty dozen handles a day.

The Lang-Decker Molding & Manufacturing Company of St. Louis, Mo., was recently organized with \$3,000 capital stock.

The Mount Vernon Lumber Company of New Orleans, La., has changed its title to the Mount Vernon Hardwood Company.

The Forrest City Manufacturing Company, Forrest City, Ark., has completed its new sawmill, which has a capacity of 59,990 feet a day.

It is reported that a handle factory is to be established at Fayetteville, Ark., by the Charlesworth Lumber Company of Dutton, Ark.

About \$35,000 will be expended on a handle plant to be erected at Memphis, Tenn., by the Brown, Haman & Huntington Company of that city.

The Jefferson Pin Company has been incorporated at Charlestown, W. Va., to manufacture pins, cross arms, etc., for telephone and telegraph lines.

Plans are in preparation for a showcase factory to be erected at Houston, Tex., by the Bender-Brown Company, recently incorporated with \$10,000 capital.

The Marshfield Land & Lumber Company, Marshfield, Wis., has been purchased by the great United States Leather Company. The price paid is said to be in the neighborhood of \$500,000.

Articles of incorporation have been filed by the Chicago Walnut Company, Chicago, with \$2,500 capital stock. H. C. Bangs, Francis E. Matthews and Elmer Schiesinger are the incorporators.

James A. Buch, Joseph Rosenheimer and Victor Husting are the incorporators of the Badger State Stave and Lumber Company, recently organized at Milwaukee, Wis., with a capital of \$85,000.

A. H. Stange of Merrill, Wis., has purchased for \$40,000, from E. S. Barnes and J. F. Swezey of Janesville, 3,700 acres of fine hardwood timber land in Lincoln County, west of the Wisconsin River.

A new butter-dish and tooth-pick factory is being erected by the Union Dish Company at Johnsburg, Pa. From seventy-five to eighty men will be employed and the output will be a carload a day.

A site at Johnson City, Tenn., has been purchased and active measures are being taken toward the erection of a plant thereon for the manufacture of interior finish, hardwood doors, mantels, etc. C. E. Allen and others are interested.

Yongling Bros. of Monroeville, O., who recently purchased 3,500 acres of fine hardwood timber lands in Cleveland County, Arkansas, besides numerous other tracts in the vicinity of Pine Bluff, will engage in the manufacture of hardwoods in that city.

The Cleveland, O., plant of the Frankfort (Ind.) Handle Company, lately purchased by G. J. Burrell and others, will be completely overhauled, extensive alterations and additions made, and will be operated by the purchasers within a few weeks.

The Pacific Coast Hardwood Manufacturing Company is a new Portland, Ore., concern recently incorporated by George F. Martin, Alexander Kunz and William T. Muir. The capital stock is \$30,000, and the company will conduct a general timber, lumber and saw-mill business.

The new Hartwell Brothers handle factory at Mammoth Spring, Ark., uses four cords of hickory a week, in making about 1,900 handles.

The new Palmetto Manufacturing Company of Nashville, Tenn., of which W. H. Cooper is president, is installing machinery and will be ready for operation at an early date.

Extensive repairs are being made by Maxwell Bros. in their plant at Mellroe, Wis., which has been idle for several years, and the sawing of hardwoods, of which the firm has a liberal supply available, will be commenced in the fall. It is rumored that they will also build a planing mill and box factory at Mellroe.

The Saluda Pin & Bracket Manufacturing Company, Saluda, N. C., organized by E. E. Andrews and Ben Drearybury, is now operating its plant in that city manufacturing locust and oak telephone pins and brackets. The company has orders ahead for over 1,500,000 pins, and the plant has a capacity of 800 pins and brackets per day.

Three men were burned to death in a fire which practically destroyed the excelsior works and butter tub manufactory of Charles M. Allen at Fulton, N. Y. The great mass of excelsior bales and butter tub bottoms and covers furnished excellent fuel and was entirely consumed. The loss on building and contents has not yet been estimated.

The Cleveland, Cincinnati & St. Louis Railroad Company has purchased a site at Indianapolis, Ind., on which is being erected shops for the building of cars and locomotives.

Plans have been completed and work will soon commence on the erection of a new wagon factory for the Harrison Wagon Works of Grand Rapids, Mich. The estimated cost is \$15,000.

The Frary Manufacturing Company, wood turners of Charlemont, Mass., recently greatly increased its capacity by installing two new lathes and a new steam plant. The concern enjoys an extensive export business, as well as shipping its products to all parts of the United States. The company is composed of men of long experience in this line of manufacture; George H. Frary, treasurer, is of the third generation of wood turners.



Advices from Eoonville, Ind., say that buyers of hardwood have bought up every piece of timber that can be purchased in the county at a high price. But little oak remains and owners have placed an extraordinary price on the trees to keep them as long as possible. The price offered for timber at present is more than was given for land and timber together five years ago. As high as \$2.50 a hundred feet has been paid for oak timber suitable for quarter sawing.

Howard County, Missouri, is doing quite an extensive walnut export business. Logs to the value of \$17,500 have recently been shipped to Hamburg, Germany, and the total shipments of walnut from all parts of the county to this same importer amount to \$25,000.

Robert McMillen of Oshkosh, Wis., died June 20, after a long illness. He was president of a large sash and door concern, and his father was the late Robert McMillen, a pioneer lumberman.

The Ohio Manufacturing Company has been organized at Asheville, N. C., with \$25,000 capital stock, to manufacture oak and hickory carriage and wagon woodwork. The officers are: A. F. Hill, secretary and treasurer of the W. T. Mason Lumber Company, president; F. Littlefield, secretary and treasurer, and S. J. Taylor, general manager. Later the company expects to extend its operations, and to establish mills in a number of the southern states. Headquarters will be maintained at Asheville, where commodious offices

have been leased in the new Adelaide building.

The Moline Plow Company, Moline, Ill., is erecting buildings at Rock Island, Ill., for its woodworking department. The company's lumber yards will be consolidated and all work in this line will be done at Rock Island when the plant is completed. The wood shop will be 120 by 183 feet, one story and basement, with saw-tooth roof. North of this will be a building for storing finished work, 27 by 40 feet at the east end, narrowing to conform to the railroad track. Connecting therewith a 20-foot shipping platform will be built, from which the railroad will take the woodwork to cars bound for the main factory. The plant will also include a boiler house 20 by 40 feet and a modern dry kiln about the same size.

A new industry for Mason City, Ia., is assured by the sale of the sash and door manufacturing plant of Davy Bros. to the Weir Wardrobe Company, lately organized with a capital stock of \$100,000. The new company will begin at once the manufacture of a patented fixture for stores, especially clothing stores, and private houses. The officers of the company are: President, I. W. Keel, Iowa State Bank, Mason City; general manager, A. E. Shotts, Mason City. Directors: William Georgeson, Winnipeg, Canada; C. H. Newton and T. A. Potter, Mason City. The stockholders of the concern include the officers, Davy Bros. and Charles Webster of Waucoma, Iowa. The plant will be enlarged and will employ forty men.

struction will begin at once. The territory traversed by this new line is extremely rich in hardwood timber.

The Erie Railroad's recent report for the past nine months, showing a gross earning of \$37,880,906, justifies the expectation that the company will earn upwards of \$50,000,000 during the fiscal year, and that it will show returns equal to three per cent on the common stock for that period. This is considerably in excess of any earnings shown by the company for many years.

The meeting of the Michigan Maple Company, which was scheduled for June 26, has been postponed to Friday, June 29, at 2 p. m., at the company's general offices in Grand Rapids.

There is a movement on foot for a general meeting of the hardwood manufacturers of Michigan, which will probably be called at Grand Rapids either during the first or second week of July. The meeting is for the purpose of a better acquaintance among hardwood producers, an analysis of trade conditions, and for making an attempt to widen the distribution of Michigan forest products. It is expected that the meeting will call out practically every hardwood producer in the state.

Robert Maisey of Maisey & Dion, Chicago hardwood wholesalers, is home from a northern purchasing trip.

The Leavitt Lumber Company is moving its office headquarters from Thirty-fourth street and Centre avenue to its new office and yard on Lullin street, south of Twenty-second. The company has arranged very handsome quarters for carrying on its business at the new plant. The old yard will be used for storage purposes, but the principal distribution will be from the new plant, which has a capacity for piling 6,000,000 feet of lumber.

F. S. Hendrickson of the F. S. Hendrickson Lumber Company, accompanied by his wife, will sail from New York for France next Thursday. They will make an extended continental trip and expect to reach home in September.

Franklin Greenwood, manager of the Southern Cypress Lumber Selling Company, Ltd., of New Orleans, was a Chicago visitor last week. He reports a slight lull in cypress demand, but on the whole finds trade in a very excellent condition.

Casket makers held a session at the Stratford Hotel, June 21, at which the principal theme discussed was the price of their product. Manufacturers maintain that trade conditions justify higher prices, and some favor an increase of thirty per cent—others ten. Action on the matter was deferred until the next meeting.

#### Boston.

Frank Lawrence of Lawrence & Wiggin has returned from a trip to New York. Mr. Lawrence played in the trade golf tournament.

Gardner I. Jones of the Jones Hardwood Company, Boston, has been in New York and was also present at the golf tournament held there.

The J. O. Wetherbee Co., for many years located in Boston, has moved to East Cambridge.

Hugh McLean of Hugh McLean Lumber Company of Buffalo, N. Y., visited Boston during the past fortnight.

William W. Reilly, also of Buffalo, was in Boston recently.

The woodworking establishment of Lord & Kitchen, Foxcroft, Me., has been visited by fire, causing a total loss of the drying room.

J. E. Lauder of Toronto, Can., has been making his headquarters in Boston for a few days.

Charles S. Wentworth of Charles S. Wentworth & Co. has been in Maine on a business trip.

The H. E. Stebbins Lumber Company has

## Hardwood News.

(By HARDWOOD RECORD Special Correspondents.)

### Chicago.

Among the prominent hardwood lumbermen who have visited Chicago during the past few days are W. H. Russe of Memphis, president of the National Hardwood Lumber Association; Earl Palmer of the Ferguson & Palmer Company, Paducah, Ky.; Gus J. Landeck of the Page & Landeck Lumber Company, Milwaukee, Wis.; C. H. Barnaby, Greencastle, Ind.; W. W. Knight of the Long-Knight Lumber Company, Indianapolis; T. B. Stone of the T. B. Stone Lumber Company, Cincinnati; Max Sondheimer of the E. Sondheimer Company, Memphis, Tenn.; W. A. Bonsack of the Bonsack Lumber Company, St. Louis, Mo.; Carroll F. Sweet of the Fuller & Rice Lumber & Manufacturing Company, Grand Rapids, Mich.; M. S. Baer of R. P. Baer & Co., Baltimore, Md.; Thomas Moore of the Moore Company, St. Louis, Mo., and D. F. Clark of Osborne & Clark, Minneapolis, Minn.

The receipt is acknowledged through the courtesy of George K. Smith, secretary, of a pamphlet containing the proceedings of the fourth annual meeting of the National Lumber Manufacturers' Association, held at St. Louis, May 8 and 9.

The Hardwood Record has just printed and delivered to the secretary of the National Hardwood Lumber Association a large edition in book form of the report of the ninth annual meeting held at Memphis, Tenn., May 3 and 4. The book includes forty-eight pages and cover, and incorporated therein are handsome duotone gravure portraits of William H. Russe, president, and of Earl Palmer, retiring president, as well as smaller pictures of the other officers, board of directors and chairmen of committees. The pamphlet shows the list of officers and committees, includes the proceedings of the convention, list of those present, and concludes with a complete roster of the members of the association up to June 1, 1906. This work will be mailed to every member of the association; others interested desiring a copy can obtain it on application to Frank F. Fish, secretary, 1012 Rector building, Chicago.

H. T. Benham, advertising manager of E. C.

Atkins & Co., Inc., Indianapolis, has had a reprint made of the story entitled "Shorty," which appeared in the Hardwood Record of May 25, and of the illustrations accompanying it. Mr. Benham has issued an edition of 25,000 of these attractive little booklets, and is having them distributed in every woods camp in the United States. This is an entirely new advertising proposition, and the Hardwood Record and the author of the story both appreciate the compliment and the credit given them.

D. S. Hutchinson, the popular and energetic sales manager of the Nashville Hardwood Flooring Company, made a brief visit to Chicago the first of last week. Mr. Hutchinson reports the demand for oak flooring very strong.

Lewis Doster, secretary of the Hardwood Manufacturers' Association, is back at the home office for a few days from one of his tours for holding district meetings in various parts of the country.

A welcome caller at the Record office on Thursday was M. E. Thomas, sales manager of Cobbs & Mitchell, Inc., and of the Mitchell Brothers Company of Cadillac, Mich. Mr. Thomas is just starting out on a several weeks' cruise among the western clients of the big flooring concerns he represents.

Although no report has been received at this office, there must have been "doings" at Little Rock, Ark., on Saturday, June 22, as on that date were scheduled a retail lumber convention, a district meeting of the Hardwood Manufacturers' Association and a Hoo-Hoo and Osirian (Joister "fundom."

The Illinois Central Railroad, which already penetrates a large portion of the hardwood timber area of the South, is reported as reaching out in a new direction. The engineering forces of that road are engaged in making surveys in the states of Mississippi and Alabama, in contemplation of the building of a branch line to Birmingham. The road will leave the main line at Jackson, Miss., and run through the Pearl River Valley to Columbus, Miss., and from there straight to Birmingham. It is said that the work of con-

secured new quarters in the Mason building and will remove there from 153 Milk street shortly.

The Lumber Trade Club of Boston held its regular monthly meeting at the Exchange, Boston, Thursday, June 11.

#### New York.

The lumbermen's golf tournament inaugurated by local wholesalers some months ago occurred at the Nassau Country Club, Nassau, L. I., on June 12 and 13 and was participated in by an enthusiastic number of lumbermen golfers from all over the East, and was so successful and enjoyable that it resulted in the formation of a permanent organization to be known as the Lumbermen's Golf Association. W. D. Gill of Baltimore was elected president; E. B. Witherbee of Boston vice-president, and Henry Cape, 1 Madison avenue, New York, secretary and treasurer. The next contest will be held at Baltimore.

Among recent New York visitors was W. O. Hughart, Jr., of Hughart & Kendal and the Union City Lumber Company of Grand Rapids, Mich., who spent several days in the interest of business. Mr. Hughart reported the western hardwood conditions exceedingly satisfactory. His concerns are making a specialty of thin oak for export, and it was for extending trade in that line primarily that he made the visit.

R. T. Cooper, the well known Memphis hardwood lumberman, also spent several days here renewing acquaintances in the trade.

T. H. Gamble of Gamble Bros., Louisville, Ky., large manufacturers of piano dimension stock, etc., was a recent visitor to the many customers of the firm in this market.

R. H. Downman, the distinguished manufacturer of New Orleans and president of the Cypress Manufacturers' Association, spent several days here on a long pleasure trip.

Fire caused \$35,000 damage to the yard of Joseph Cohn, 608-612 Rockaway avenue, Brooklyn, June 6.

W. A. Eaton of the Stevens-Eaton Company, 1 Madison avenue, has the sympathy of the trade in the loss of his father, Major Samuel C. Eaton, who died at Nyack, June 6, at the age of 76 years. Major Eaton was associated for many years with the government assayer's office and was widely known in that line.

J. C. Turner, the prominent express operator, 1123 Broadway, is off on a southern trip to his various interests in Georgia and Florida.

C. B. Lloyd, Jr., manager of the sales department of the Cherry River Boom & Lumber Company, Philadelphia, was a recent visitor to the district. Mr. Lloyd is a firm believer in present lumber values and believes that any lack of activity in buying at the present time is simply due to buyers generally having made their purchases earlier this year than usually.

W. A. Powell of the W. A. Powell Company, Ltd., large exporters of New Orleans, was here the first of the month on matters in connection with the export trade.

Russell T. Starr, who is associated with Frederick W. Starr, Brooklyn, was united in marriage at the Plymouth Church, that borough, on June 7, to Miss Alice Gertrude P. Staples. Mr. Starr is well known in the local trade and is receiving the hearty congratulations of his friends.

J. H. Dickinson, manager of the logging department of the Lidgerwood Manufacturing Company, extensive manufacturer of logging and cableway machinery, this city, left for the South this week on an extended business tour.

R. C. Scatford of the Batavia-New York Woodworking Company, Batavia, N. Y., spent several days during the fortnight here looking after some extensive contracts of his company.

#### Philadelphia.

The Wilmington Sash, Door & Blind Company, which formerly did business at 1319 West Fourth street, Wilmington, Del., has removed its establishment to Front and Madison streets, the same city, where a modern building, 169x120 feet has been erected and a plot of ground extending the length of a square purchased. The company will do a general wholesale and retail business in hardwoods and other lumber, besides the sash and door business. The officers are as follows: S. M. Dillon, president; J. C. Dillon, vice-president, and S. C. Dillon, secretary and treasurer.

The Philadelphia team which attended the lumbermen's golf tournament at Glen Cove, L. I., covered itself with glory and reflected great credit on Philadelphia. Besides other prizes, the local contingent won the team prize in competition with teams from Baltimore, Boston and New York.

A meeting of the creditors of Geo. B. Gardiner & Co., the defunct lumber concern through whose failure many lumbermen suffered, was held on June 18, before Theodore M. Etting, referee in bankruptcy. The company has been adjudged an involuntary bankrupt. An investigation is now on foot, which is expected to clear up the operations of this concern, and the general trade, besides the hardwood men who have lost money, may look forward to having the methods and operators of this company exposed.

The regular monthly financial meeting of the Pennsylvania Lumbermen's Mutual Fire Insurance Company was held last week at the Drexel building. Preparations are being made for the semi-annual meeting of the company and officers of the concern say that a splendid increase of business will be shown. Mr. Henson, the president, who is now in Europe, whither he went in search of health, is expected back the last of June, much improved.

H. N. Pattison of the Philadelphia Hardwood Lumber Company, reports that the concern has enough orders on its books to keep going four or five months. This firm does a splendid business in red and white oak. Mr. Pattison will visit the company's buyer at Elkins, W. Va., next week and confer with him about the purchase of more stocks. He will also visit mill points throughout Maryland, West Virginia and western Pennsylvania.

Benj. Ketcham, Jr., who recently rented the Benmers lumber yard in West Philadelphia, has bought that property and will use it, together with his yard on North Broad street, as city distributing points. The West Philadelphia yard has good railroad facilities and will be used as the unloading point.

Frank T. Rumbarger has just returned from an extensive trip to East Tennessee, where he reports that the interests of his firm are in good shape. John J. Rumbarger, who has been ill for some time, is now able to attend to business regularly. John L. Rumbarger, son of John J., has been appointed to take charge of the Pulaski, Va., yard of the company. The young man has shown such an aptitude and talent for the business that the company feels justified in placing this responsibility on his shoulders.

F. A. Kirby of the Cherry River Boom & Lumber Company returned recently from an extensive western trip. He will spend the present week at the company's main office at Scranton, Pa. A. R. Atkins, purchasing agent for the company, is ill and confined to his home at Haddonfield, N. J.

Owen M. Bruner announces that business with his firm is very good. Henry Whelpton, secretary and treasurer of the Bruner concern, has been spending some time in Buffalo, looking after the interests of the company.

J. R. Williams has returned from a two weeks' trip through New York state. Jos. P. Lunwoody spent last week in New York. Geo. F. Craig is at the mills of Geo. Craig & Son, Winterburn, W. Va.

Franklin H. Smith of the Producers' Lumber Company announces that he has purchased the holdings of Harold Weston in that concern. This company has been established for five years and about six months ago started to deal in hardwoods.

Chas. F. Felin & Co. have plans completed for a new wharf and dock, to be built at Delaware avenue and Westmoreland street, where the company owns a frontage of 500 feet on the river. The dock will be 180x650 feet and one of the largest in Philadelphia. Chas. F. Felin, who has been spending some time in California, is now visiting the home office.

L. D. Miller & Co., who have had their sales office for three years in the Real Estate Trust building, will remove it to Baker's Mines, Va., where the mills of the company are located.

Horace E. Bates of Wister, Underhill & Co., who has been ill and convalescing at Ocean City, N. J., has returned to business. Jacob Isenberger, superintendent of the Evergreen Lumber Company, is in town conferring with Wistar, Underhill & Co., sales agents for the company. Mr. Isenberger reports that business is brisk and that the improved equipment lately installed in the mills permits of faster sawing and shipping than ever.

Harry Solde of Solde Bros. left on June 18 for an extended visit to mill points. This company will soon be in a position to offer to the trade some choice lots of Pennsylvania hardwoods, having recently acquired the output of one of the largest hardwood mills in this state.

Schofield Bros. report business in splendid condition. John Schofield has just returned from a trip to the South, where he was looking after shipments due the firm and also inspecting choice lots of hardwoods with a view to purchase.

Charles L. Robinson of the firm of Chas. Benton, 1193 South Front street, died June 17 of acute indigestion. His loss is widely felt in lumber circles for he had been identified with the trade for over forty years. He was a member of the Lumbermen's Exchange of Philadelphia, and of several Masonic and beneficial orders.

#### Pittsburg.

J. B. Flint of the Flint, Erving & Stoner Company has his arm in a sling as the result of a collision with a "circumstance," as he puts it, which dislocated the bones of the shoulder. He and his associates are getting their big operation at Dunlevie, W. Va., well under way, and will make this point one of the largest producers of hardwood lumber in the Mountain State.

I. E. Bidsley, hardwood manager for Willson Brothers, is enthusiastic over the prospects for a brisk hardwood market all summer. Willson Brothers are getting a firm hold on the eastern trade and had two splendid months in May and June.

The coal strike in western Pennsylvania has curtailed the call for coke oven lumber and general mining supplies to quite an extent. This is most noticeable in the neighborhood of PUNXSUTAWNEY, where the Pittsburg wholesalers are accustomed to do a fine business in hardwoods in the summer.

Municipal questions have agitated Pittsburg lumbermen considerably of late. They welcome the annexation of Allegheny, which was openly favored at the election June 12, as the means of ridding the lumber firms and contractors of the heavy bridge tolls and also of stimulating a building movement in Allegheny. Another advantage which is expected to follow is the establishment of many small

factories of different kinds on the north side, which will be steady buyers of the better grades of hardwoods. Along with this question of annexation the problem of subways and elevated roads, which is nearing a crisis in Pittsburg, is of special interest to lumbermen, as it will necessitate the purchase of an enormous amount of oak.

The American Lumber & Manufacturing Company is keeping up its swift pace in the hardwood trade. Its big purchases made through J. N. Woollett last winter in West Virginia and Kentucky enable it to place its goods on the market very promptly in comparison with the firms which are now out of logs to cut.

The Beulah Lumber Company, of which William M. Pownall is local manager, is cutting 50,000 feet of lumber a day at its plant at Beulah, W. Va., mostly spruce and oak. The company is now delivering 18 cars of lumber a week in the metropolis, all of which comes from West Virginia. It is also shipping much ash and birch to the eastern market.

F. X. Diebold of the Forest Lumber Company sends in an encouraging report of hardwood conditions in West Virginia, where he is on a trip among the mills. The company's call for oak and poplar has been very satisfactory of late and both F. X. and A. J. Diebold have been out of the city looking up stocks.

E. V. Babcock & Co. lost 1,500,000 feet of logs in the early June floods in the upper Allegheny valley. These logs were largely oak and hemlock and were valued at \$16,000. Another mishap was the burning of the kindling wood plant of the Standard Wood Company, which adjoined the Babcock plant at Arrow, Pa., and used the slabs from the latter under contract.

Fred R. Babcock of the firm of E. V. Babcock & Co. is building a \$65,000 mansion in Woodland road, Squirrel Hill. The residence, which will probably be the finest erected in Pittsburg this summer, will contain 35 rooms, and will be beautifully finished in a variety of the finest hardwoods.

A new firm in Pittsburg is J. R. Wheeler & Co., which has secured convenient quarters at 1099 Park building.

O. H. Rectanus of the A. M. Turner Lumber Company announces a very good condition of affairs in the hardwood trade as it affects his firm. The Turner interests in the South are very busy getting orders taken last winter cleaned up.

The Linehan Lumber Company's ability to fill orders with good stock and quickly has of late brought to it an amount and kind of business that is eminently satisfactory and is bringing broad smiles to both J. C. and J. J. Linehan, who are hustlers.

The Paine Lumber Company, Ltd. is profiting considerably by the carpenters' strike by getting some big orders that would otherwise have come to the local mills. In the city, however, it notes a diminution of demand, traceable to the fact that house building has been almost at a standstill since the carpenters went out. Last month the company added to its line of finely finished stock stair rails and balusters of original designs, which are made of oak and birch. These are furnished also in ash and butternut, the latter being quite a favorite with local architects.

The Cheat River Lumber Company is sawing 100,000 feet of lumber a day at its plant at Burkeville, Va., where Robert K. Herberston is in charge. The company is getting into the manufacturing business as fast as possible to enable it to keep up with its orders and avoid the delays that harassed it last winter, when it depended to a large extent on the stocks bought from other mills.

#### Buffalo.

As a member of the Buffalo Maple Flooring Company, M. M. Wall of the Buffalo Hard-

wood Lumber Company speaks of the flooring business as in decidedly good shape. The company's mill is running strong now.

The trip of A. W. Kreinbender to Kentucky and Tennessee to look after the business of the Standard Hardwood Lumber Company was necessarily rather short, as he had a Doo-Hoo meeting to look after.

Hugh McLean is one of the great hardwood salesmen on the road today and he is always adding to his experience. Quartered oak is one of his specialties, with mills back of him to produce excellent stock.

G. Elias & Bro. are still keeping up their all-round timber yard, but find that they need a good many woods to make up a complete stock—hemlock, Norway and yellow pine and Washington fir, as well as oak and ash.

Thick plain oak in increased amounts is one of the late export orders filled by O. E. Yeager. He gets the stock largely from the West, some from Ohio by rail; later on there will be cargoes in by lake.

Beyer, Knox & Co. have not patrolled the territory from Pennsylvania southward to the Gulf for nothing, for they report a yard full of well-assorted stock, and active sales all along the line.

Several cars of good chestnut, also a lot of oak and cherry, were among the late receipts from the South at the yard of L. N. Stewart & Bro., with H. A. Stewart down that way most of the time digging it out.

A. Miller lately added to his already good general hardwood stock twenty cars of birch of all thicknesses, and he is always able to take care of orders for basswood.

The best of reports come from the big hardwood door mill at Batavia, which is controlled by Scatcherd & Son. Orders are coming in much faster than they can be filled, and all for fancy work.

Having two good men on the spot, F. W. Vetter and H. S. Jones, ready to take up the southern hardwood problem anywhere, the Empire Lumber Company will soon be represented again by them in person in North Carolina and Arkansas.

#### Detroit.

Chas. R. Roche, inspector for the National Hardwood Lumber Association for Detroit, has been taking a week's vacation in New York City.

The McClure Lumber Company is closing out its stock of hardwood in the Detroit yard, and will in future conduct only an office here, making shipments direct from the mill at Eutaw, Ala.

The Thomas Forman Company is receiving maple lumber by vessel quite rapidly, keeping one steam barge in this trade regularly.

The Dwight Lumber Company has leased its docks to a white pine concern, and is receiving its extensive purchases of maple and other hardwoods entirely by rail.

Within fifteen miles of the Detroit city hall there is a heavily timbered tract of 240 acres consisting of white and red oak, elm, basswood, etc. A small band mill has just been installed for the manufacture of this timber. The stock goes to Brownlee & Co.

The schooner "Ellen Williams" on its way from Alpena to Tonawanda, with a cargo of maple lumber, went on the rocks at the Lime Kiln Crossing, eighteen miles below Detroit, and was sunk. The cargo was sold by the underwriters to Brownlee & Co., who have just finished putting the stock in cross pile on their yard. The same firm is now handling over its docks 950,000 feet of basswood from the Green Bay district. They report the basswood market considerably stronger and more active than a few months ago.

The entire lumber trade of Detroit is in mourning over the death of Joseph Myles of Hutton, Myles & Weeks, which occurred at his home on June 15. The immediate cause of Mr. Myles' death was valvular lesions of the heart. He has been ill for more than five months. Mr. Myles was held in extreme affection by the entire lumber trade of the Wolverine state, and his demise is a severe blow to thousands of friends,

#### Grand Rapids.

Otis A. Folger, secretary of the Hackley-Phelps-Bonnell Company, left June 20 on a business trip throughout the South.

The Harrison Wagon Works of this city is turning out automobiles as a side line.

P. C. Fuller of the Fuller & Rice Lumber & Manufacturing Company has gone east to spend the summer in the Adirondacks.

O. H. L. Wernicke, manager of the Macey Company, is touring several of the western states in his new National. He is accompanied by Mrs. Wernicke and they expect to return about June 25.

W. H. White, president of the W. H. White Company, Boyne City, was in Muskegon recently and placed an order for a battery of boilers of 400 horsepower, to be added to the power plant of the White Company's new hardwood plant. The boilers are to be delivered within 60 days.

The Potato Implement Company of Traverse City has been doing a rushing business at its factory since the reorganization in January.

West side manufacturers and business men have formed an Improvement Association with Roy Harrison of the Harrison Wagon Works as chairman of the executive committee, F. Stuart Foote of the Imperial Furniture Company, Carroll F. Sweet of the Fuller & Rice Lumber & Manufacturing Company, and Alexander Dodds as chairmen, respectively, of the following committees: Prevention of floods, public improvement and transportation.

The Cleveland-Cliffs Iron Company has bought the Russell Hotel at Ishpeming and it is the plan of President Mather to convert the house into a home for the Young Men's Christian Association.

Allen McKee left Manistee last week for Tacoma, Wash., to take charge of the work of installing machinery in the new mill of the Dempsey Lumber Company. It is expected that the mill will be one of the largest in the United States, with daily cutting capacity of a quarter of a million feet.

J. M. Cooper, superintendent of the Kelley Lumber & Shingle Company's mill at Traverse City, has had seven years' experience as fire chief, which served the company well when the roof of the plant caught fire recently. Under his supervision and his direction the valuable plant was saved.

I. F. Holmes and son, Dr. H. A. Holmes, of Manton have bought a tract of timber and a sawmill plant in Mississippi, which will be operated by Mr. Holmes, Sr. The timber is largely oak and gum, with some hickory. A million and a half feet of gum lumber has been contracted for by Grand Rapids furniture manufacturers.

The steam barge India of Kingston, Ont., recently loaded 500 rock elm ship timbers in Pentwater Lake. They were cut in the vicinity of Hart, one of them being over 70 feet long. It is figured that they cost, loaded on the boat, an average of \$50 each, or a total of \$25,000. The boat loaded about 1,000 additional timbers at Traverse City, before proceeding to Kingston. The square timbers are rafted from Kingston to Quebec, going by boat from that point across the Atlantic to English shipyards.

The East Shore Company at Frankfort has built a two-story addition to the factory, and about fifteen men will be added in the new clothes pin and wooden novelty department to be established therein. The butter dish and broom handle machines are kept busy.

S. G. McClellan, manager of the Simmons Lumber Company, Simmons, Mich., and J. S. Weidman of Mt. Pleasant, head of the Weidman Timber Company, were in Grand Rapids June 11.

E. N. Salling of the Salling-Hanson Company,

Grayling, was in the city Monday, June 18.

The summer sales of furniture opened June 18, with nearly forty buyers on hand, coming mostly from New York and the larger cities of the East. Outside manufacturers were slow in getting their lines ready for inspection. The rush will be on about July 10 and a good business is anticipated.

#### Asheville.

The lumbermen of western North Carolina will have a good time in Asheville on Tuesday aft noon and evening, July 3. Tuesday afternoon the Asheville Lumber Exchange will hold its regular semi-annual meeting, while Tuesday night Hoo-Hoo will gather for a banquet and the "putting through" of a number of kittens. In view of the fact that the following day is the Fourth and a general holiday, a large attendance is expected. The most important matter that will come before the Lumber Exchange will be the report of the committees appointed at the last meeting to confer with the freight officials of the Southern Railway relative to rates on lumber. These committees will meet the freight officials at Lake Toxaway this month and their reports will be of much interest to the trade in this section. The committees will ask for a reduction of rates on hemlock, oak and chestnut.

The timber interests of the Whittier Lumber Company, located in Swain County, North Carolina, will be sold at public auction August 6, to satisfy a judgment of \$432,000. The bonds issued by the Whittier Lumber Company were originally held by the Morton Trust Company of New York, and it was this company that asked for a judgment of sale. Although the lands will be sold at auction, a deal has already been consummated whereby the Whittier holdings have been transferred to a North Carolina company and the sale of the lands under the decree of the court is a mere matter of form. The lands have been purchased by Chas. J. Harris and Mr. Woodbury and the company now owning the property is known as the Harris-Woodbury Company. The lands embrace 70,000 acres, and are valued at half a million dollars.

#### Bristol, Va.-Tenn.

A deal is being negotiated between New York capitalists and the Virginia Iron, Coal & Coke Company of this city, for the purchase by the latter of about \$100,000 worth of rich timber and mineral lands in Carter and Johnson counties.

The Tug River Lumber Company is replacing the band mill recently destroyed by fire at Mabe, Scott County, Va., with a large circular mill.

The Kingsport Lumber Company is a new corporation organized by the George L. Carter syndicate. This company has its general offices in Bristol and will manufacture lumber on the line of the new South & Western Railway being constructed by Mr. Carter, Thomas F. Ryan, Alfred Walter, the latter president of the Seaboard Air Line, and others. The company will dispose of about 15,000,000 feet of lumber on the yards of the Caretta Lumber Company, another Carter concern, at Caretta, McDowell County, W. Va.

Paul W. Fleck of the Paul W. Fleck Lumber Company of Philadelphia is in Bristol and will spend several days looking after his company's business in this section.

George B. Peter spent last week in Shady, Johnson County, Tenn., where he went to hurry up orders at the mills and ship out considerable stuff.

John T. Dixon of the John T. Dixon Lumber Company of Elizabethton, Tenn., and Dixon & Dewey of New York was in Bristol last week en route from Ronceverte, W. Va., to Elizabethton. Mr. Dixon says that business with his concerns is good and he is pleased with the outlook.

G. L. Wood, Asheville, N. C., and R. E. Wood,

Baltimore, Md., of the R. E. Wood Lumber Company were recent visitors to Bristol.

J. A. Wilkinson has lately made a tour of inspection of his country mills in Virginia and West Virginia, and reports good business and heavy shipments.

Frank Price of Price & Heald, the Baltimore exporters, has been in this section for several days in company with the local representative of the concern, Fred W. Hughes. Mr. Price and Mr. Hughes are closing up several big log contracts in this section.

M. Dreyfus and N. Dreyfus, representing big lumber importing interests in Paris, France, have been spending several days in Bristol studying the lumber conditions of the South. They will make heavy contracts before returning to their native land and will visit other parts of the South.

H. W. Neely, who represents the Rumlanger Lumber Company of Philadelphia in this section reports heavy shipments and business good. This company, besides controlling the entire output of the mills of the Unaka Lumber Corporation of Johnson City, Tenn., operates extensively in eastern Tennessee and western North Carolina and has big contracts at Abingdon City, Tenn., and Madison, S. C., which Mr. Neely looks after.

John A. Sproles, manager of the yards and office of J. A. Wilkinson at Butler, Tenn., was married in Bristol last week to Miss Elizabeth Butler, daughter of Dr. and Mrs. Roy E. Butler of Johnson County. Mr. Sproles is a promising young lumberman, while his bride is a young woman of strong character and high ideals and comes of a prominent family.

H. C. Travis, who has for several years been connected with the Bristol Door & Lumber Company as superintendent of its big saw and planing mills in Bristol and was later associated with the Stone-Huling Lumber Company, has gone to Brunswick, Ga., to engage in the lumber business.

The Southern Milling & Construction Company was incorporated at Princeton, W. Va., last week, with a capital stock of \$25,000 by R. B. Bird, W. C. Broyles, J. E. T. Smitz, J. R. Henry and W. J. Lyon. The company will engage in buying, manufacturing and shipping lumber and building material. Under its charter the company can own as much as 10,000 acres of timber land or real estate.

#### Cincinnati.

The annual outing of the Lumbermen's Club was held at the Zoo Saturday, June 16, and was pronounced by the members to be the most enjoyable of any of the yearly affairs given by the club. An informal reception early in the evening was followed by an elaborate banquet on the veranda of the clubhouse. The menu cards were unique, the covers being of veneer wood from Japan, no thicker than an ordinary calling card. President T. J. Moffett was toastmaster.

Arrangements have been made for a concatenation of Hoo-Hoo in this city on Saturday, June 30. The program includes daylight and moonlight excursions on the Ohio, with music and dancing, besides a banquet. It is expected that many members with their ladies will attend. J. E. Tutthill of this city is Vice-governor Snark for southern Ohio. This will be the first Hoo-Hoo convention held at Cincinnati for a long time, and all resident members are especially invited to be on hand.

In speaking of the hardwood situation Chester F. Korn of the Farrin-Korn Lumber Company says: "Conditions at present are peculiar. Hardwood buyers, who were holding off expecting a decline in sympathy with that in yellow pine, have come into the market again. With a scarcity of dry stocks prices are well maintained. It is likely that prices will remain as at present until the new crop of logs arrives in normal quantities. Adverse-weather conditions have materially interfered with production and I believe it will be as late

as September 1 before receipts assume satisfactory proportions."

Fred W. Pierce of the Pierce Lumber Company, London, O., and Mrs. Barbara Bailey of the same town were wedded in this city on June 10. The ceremony was quiet, after which the couple left for a brief tour.

M. B. Farrin, accompanied by his family, will leave for their summer home in Michigan the fore part of next month. Mr. Farrin will return two weeks later, but the family will remain.

Joseph B. Cochran, president of the Cochran Lumber Company, filed a petition in bankruptcy in the Federal court recently. He was located at 1213 Gest street, but some time ago the business was placed in the hands of a receiver. Mr. Cochran's liabilities were placed at \$20,531.65. The assets amount to less than \$800.

John C. Bowling of the Bowling-Short Company, D'way, Ky., has visited local dealers several times within the month on business connected with his firm.

The Queen City Furniture Club has admitted W. T. Duhlmeier of Duhlmeier Bros. and R. S. Wiggers, another hardwood lumberman, to membership. The club has indorsed the action of the Manufacturers' Club in its campaign to secure a belt line around Cincinnati. T. J. Moffett is chairman of the committee of the Manufacturers' Club having the belt line proposition in charge.

Harry Froberg, president of the Froberg Lumber Company, is in Canada on business. He will shortly return.

R. J. Darnell of Memphis and Charles W. Hincley of Chicago were recent callers on the local trade.

August H. Struble has been appointed administrator of the estate of William J. Struble, his brother, who owned 25,000 acres of timber and coal lands in Pulaski and Wayne counties, Kentucky, and Scott county, Tennessee.

#### Nashville.

Local planing mills and interior woodworking plants report an increase in business of from 25 to 40 per cent over the first six months of last year. As may be imagined from this, the mills are all busy turning out material for the hundreds of houses in course of erection here. A revision of the local building laws is being considered by the Nashville city council and it is probable that in the future heavier material will be put in all houses.

The fire loss on the furniture stock of the Greenfield-Talbot-Finney-Battle Furniture Company has been adjusted by the insurance companies. The salvage invoiced at \$10,000 and was taken charge of by the insurance companies, and in turn placed by them in the hands of the Samuel Gans Company of Chicago, handlers of salvage merchandise. The latter company will sell out the stuff in the near future in Nashville.

Gallatin, Tenn., boasts of a brave man. A few days ago a big swarm of bees lighted in the branches of a big oak tree in that town and a large crowd was attracted. Various methods of enticing the honey makers to leave their lofty position and come down where they could be used were unavailing. Finally a man, more resourceful and likewise-gamer than the rest, climbed the tree. Taking a handsaw he sawed off the limb. He then returned the fallen swarm to a hive, amid the shouts of the crowd.

A noise that was really the blowing of a safe by dynamite was mistaken at Springfield, Tenn., for blasting on railroad work. By reason of the mistake burglars got a small sum from the safe of the Springfield Planing Mill and had time to make their escape before any one learned the true cause of the explosion.

Col. A. G. Goodlett of Nashville has gone to Smith county to look after the survey of

a large tract of timber lands sold recently by him to Philadelphia capitalists. There are some 76,000 acres embraced in the area and the property lies in Smith, Warren, White and De Kalb counties.

The stove factory of the A. L. Hayes Company of Nashville narrowly escaped loss by fire recently. Fire was discovered in the boiler room before it gained any headway.

### Memphis.

The Memphis Log Loading Company has been formed here for the purpose of facilitating the loading of cars in Mississippi and Arkansas with timber to be shipped to the mills of Memphis. The capital stock is \$20,000. W. H. Russe of Russe & Burgess is president; J. W. Dickson of the J. W. Dickson Company, vice president; W. A. Dolph of I. M. Darnell & Sons Company, treasurer, and W. B. Turner, secretary and superintendent. Mr. Turner is an old traffic man. Application for cars and their distribution will be made direct to the railroads through Superintendent Turner instead of through members of various firms. Practically all manufacturers of hardwood lumber having plants here have stock in the company, and the general plan as outlined is favored by the railroads. It is believed that this will insure a more equitable distribution of cars and that it will likewise give a better timber supply to local mills.

The Anderson-Tully Company, North Memphis, is putting in a new box factory with daily capacity of about three cars of boxes and box shooks. The plant is to be a duplication of the one now operated by the company, except that it is to be fitted with machinery for the manufacture of box-corner box material. The plant will be in operation in about ninety days and will give the company a daily output of six cars. The Anderson-Tully Company also manufactures hardwood lumber, owning and operating a large mill in North Memphis, which was purchased from the Bennett Hardwood Lumber Company.

E. H. and L. C. Nolan, who some time ago withdrew from the Bacon-Nolan Hardwood Company, and who have been engaged for some time in the erection of a tight heading mill in South Memphis, are preparing for the erection of a planing mill for the manufacture of gum ceiling, siding and other products of this wood.

The Supreme Court of Tennessee has reversed the ruling of Chancellor Heiskell of Memphis in the case of I. M. Darnell & Son Company vs. the City of Memphis, involving the taxation of logs brought into Memphis from Arkansas and Mississippi, holding that they are subject to tax. Chancellor Heiskell took the ground that it was in violation of interstate commerce law for logs to come in free from Tennessee and not free from Mississippi and Arkansas. It is understood that the case will be carried to the Supreme Court of the United States on a writ of error, and that such taxes will be paid under protest until final disposition is made of the matter.

The plant being erected by Moore & McFerrer, in North Memphis, to replace the one burned in April, will be completed within the next three or four weeks and placed in operation. It will have a daily capacity of about four cars. Following the completion of the plant work will begin on the warehouse, which was also burned.

Weather conditions during the past fortnight have been very favorable and much better progress is reported in the sawing of hardwood lumber in this district. Prospects for production are much brighter than for some time, though none will admit that there is possibility of any decided accumulation of stock unless there is an appreciable decrease in the demand. There are more mills operating in the interior now than there have been for possibly twelve months.

The C. E. Kelly Lumber Company, whose failure to meet its obligations some time ago caused the closing down of the Bank of Newport, Newport, Ark., will probably be thrown into bankruptcy, a petition to that effect having been filed in the Federal Court at Little Rock. The liabilities are estimated by the petitioners at \$150,000 and the assets at \$125,000. The assets of the company were to have been sold under the receivership plan July 7, but bankruptcy proceedings take precedence over all other litigation.

The Lumbermen's Club of Memphis has suspended regular meetings until September. In the event of any important business, there will be a called meeting. This was decided upon at a meeting at the Hotel Gayoso, June 16, at which an exceptionally delightful luncheon was served.

Contract has been let by the Hotel Gayoso Company for the erection of a six-story front on Main street, which will add seventy rooms to this hostelry, which is headquarters for lumbermen who visit Memphis. The addition will have a frontage of almost 50 feet on Main, and will cost \$195,000.

W. K. Barksdale, president of the Lumbermen's Club, has been presented with a hardwood gavel, which he will use in future when presiding over the deliberations of that body. The presentation speech was made by R. J. Burnell, whom Mr. Barksdale succeeded. During the course of his talk, Mr. Darnell said that the wood from which the gavel was made was taken from the "Constitution," and, while President Barksdale replied in a neat little speech of acceptance, he showed clearly enough that he was not willing to swallow whole the "Constitution" theory.

H. G. Saigent, who has been identified with hardwood lumber shippers here for some years as commercial agent of the St. Louis, Iron Mountain & Southern, has resigned, and will be succeeded by Charles Rippen, who comes from a similar position, which he has filled for the Seaboard Air Line at St. Louis for several years. Just now C. H. Oglesby is looking after the duties of this position, pending the arrival of Mr. Rippen.

The Schuh-Miller Lumber Company at Selma, Ala., which has been cutting hardwood lumber ever since it was established, will in future cut yellow pine. This decision was reached when the company was reorganized a short time ago. Under the old regime the output of the company was handled through the J. W. Thompson Lumber Company, but this will be handled direct by the firm hereafter.

J. W. Connelly of the Connelly Hardwood Lumber Company, of Kansas City, Mo., was in the city this week.

Mr. Stembach, manager of the hardwood department of the Northern Lumber Company of New York, was a recent visitor here.

William I. Palmer of Palmer, Parker & Co. of Boston, Mass., was circulating among lumbermen here a few days ago.

Rapid progress is being made in the financial reorganization of the St. Louis & North Arkansas Railroad Company, \$3,000,000 having been subscribed to the \$6,000,000 gold note issue decided upon by the directors this week. The road will be extended to Neosho, Ark., where connection will be made with the Kansas City Southern, and eastward to Memphis or Helena, Ark., a distance of 100 miles, where it will connect with the Illinois Central. The road taps a splendid hardwood timber section.

Receiver John P. Edmondson of the Merchants' Trust Company, in which a number of lumbermen here were interested as stockholders and depositors, has received a final order from the Chancery Court for the distribution of the remaining money due creditors, amounting to ten per cent of the total, or about \$175,000. Three previous dividends have been declared before, each being thirty

per cent. Following the payment of depositors in full, there will be a distribution to stockholders, who, it is estimated, will receive about forty per cent of the par value of their stock. This is even better than some expected when the institution first closed its doors.

The Central Lumber Company has filed suit against the T. J. Orr Land & Lumber Company, formerly of Memphis, but lately of Beth, Ark., asking for damages in the sum of \$18,000, alleging breach of contract to furnish the mill of the former with good merchantable timber from June 11, 1905, till June 14, 1908, to be cut from a tract near Beth, and further alleging the defendant did attempt to carry the contract out for a while, but has since broken the agreement and torn down the mill, entailing a loss to the plaintiff of the amount demanded.

Russe & Burgess are getting in a nice supply of timber now from their land near Marks, Miss., where a siding was put in to convey the logs from the river to the railroad. The plant of the company is now running full time, having recovered completely from the damage following the bursting of the flywheel on the engine operating the re-saw.

J. W. Thompson of the J. W. Thompson Lumber Company, in conversation a few days ago, expressed the view that there was a better demand from some sections than there had been during the preceding month.

Thompson & McClure report considerable progress in cutting lumber at their mill in Mississippi.

### New Orleans.

J. W. Strong of the J. W. Strong Milling Company of Baton Rouge, who was recently adjudged a bankrupt on the involuntary petition of the American Hardwood Lumber Company of New Orleans, has filed schedules setting forth his assets and liabilities. The total liabilities are \$74,627.46, the assets \$30,445. Most of these claims are held by lumber companies, among them the American Hardwood and others. The bankrupt was engaged in the manufacture of hardwood lumber, and the American Hardwood Lumber Company forced him to appear in court and confess his insolvency. Below is a copy of his schedule:

LIABILITIES.	
Taxes due state and municipalities.....	\$ 50.40
Secured claims.....	4,500.00
Unsecured claims.....	17,243.98
Notes and bills that ought to be paid	
by other parties.....	22,260.36
Accommodation paper.....	30,572.72
Total.....	\$74,627.46
ASSETS.	
Real estate.....	\$ 6,000.00
Bills, notes and securities.....	6,000.00
Horses, cows and other animals.....	1,155.00
Carriages and other vehicles.....	500.00
Machinery, tools, etc.....	8,940.00
Other personal property.....	1,350.00
Unliquidated claims.....	6,200.00
Exempted property.....	500.00
Total.....	\$30,445.00
Liabilities in excess of assets.....	\$44,182.46

At Clarksdale, Miss., the Hudson-Dugger Company was recently organized with a capital of \$100,000 to manufacture staves, heading and other products from oak and other hardwoods. The organizers are Charles Hudson, John F. Dugger, Charles L. Duff and associates.

The Southern Spoke & Manufacturing Company, domiciled at Shelby, Bolivar county, Mississippi, has been organized to manufacture hardwood products, making a specialty of spoke and spoke butts. The incorporators

are T. J. Poitevant, H. E. Denton and C. E. Nance.

The charter of the H. D. Engelman Lumber & Export Company of New Orleans was filed a few days ago. The company is capitalized at \$25,000 and its officers are H. D. Engelman, president; H. H. Maloney, vice-president; H. M. Engelman, secretary and treasurer.

The Pioneer Coopersage Company of St. Louis, Mo., is building a new town in this state and will erect there one of the largest coopersage factories in the South. It owns in the vicinity of Pioneer, the new town, large tracts of hardwood timber lands, and already has a big mill in operation. This mill is now cutting timber to be used in erecting the houses, sheds, etc., the former being intended for the 500 or more men who will be given employment. W. Palmer Clarkson and J. D. Brown, president and vice-president of the company respectively, recently visited Pioneer and inspected the work going on.

**Louisville.**

The middle of June was a busy time for Louisville lumbermen with the Home Coming Week, and a gathering of Kentucky manufacturers of hardwood lumber. The Home Coming prevented the attendance at the district gathering of manufacturers from being as large as it would have been had not people throughout the state been busy with Home Comers.

Among those who attended the meeting were R. H. McCracken and W. E. De Laney of the Kentucky Lumber Company of Cincinnati. Mr. McCracken says the poplar business with them is in good shape and there is nothing to worry about, except to get logs to make enough lumber to supply the demand.

Anton Brucken, Evansville, Ind., was at the meeting accompanied by his son, A. W. Brucken. In addition to hardwood lumber he makes some vehicle woodstock, including rims and spokes. Trade in this line has been fairly good, the main trouble being to get timber. He has a tract of small hickory he expects to work up into buggy spokes this fall.

The United States Timber Company, Cincinnati, was represented by George R. Berry and A. A. Andridge, secretary and president of the company respectively. This company has been doing mostly domestic trade, but of late has been developing the export trade, which is now taking on a rather encouraging tone that gives promise of good business in the future.

J. C. Rash of the Broadhead-Garrett Company, Clay City, Ky., says his company has been giving most of its attention this year to sawing Kentucky white pine and not getting out much oak except in ties and beer staves.

C. M. Clark of the Swann-Day Lumber Company, Clay City, Ky., says business is brisk from the manufacturer's standpoint up his way, the scarcity and high price of timber the only troublesome features.

Fred Bruening, representing Henry Bruening, Bremen, Germany, was a recent Louisville visitor. In the hardwood line Mr. Bruening's main interest while here seemed to be hickory stock. He buys large quantities of hickory handles from the E. F. Feroe Handle Company, New Albany, Ind., and is also buying some pitch pine in the South.

Sam W. Calloway, who makes a specialty of railway material, says the business is excellent, but he needs more than he can get and sometimes has to turn down a good order for lack of material with which to fill it.

Albert R. Kampf reports that the car companies are manifesting a willingness to contract for oak car material for future delivery at current prices.

**Ashland, Ky.**

The following lumbermen have visited Ash-

land this week. From Chicago, Ed Miller, representing Harvey S. Hayden; J. C. Cowen of Schultz Bros. & Cowen, and Lewis Doster, secretary of the Hardwood Manufacturers' Association. From Louisville, J. L. Ballard of the Ohio River Saw Mill Company.

Jas. A. Walkinshaw of Huntington, W. Va., has established a large lumber camp near Pikeville, Ky.

The June rise has not yet arrived in the smaller streams, and lumbermen are worried. They usually get out a lot of logs on the June rise and this season has been a disappointment so far.

The United States Timber Company of Cincinnati has purchased 2,000,000 feet of extra fine timber on the C. & O. Railroad, in the Big Sandy Valley.

The Clearfield Lumber Company of Clearfield, Va., purchased the Morehead & West Liberty Railroad recently, and has begun work on an extension which will go through about fifteen miles of its timber and coal lands. This is the road which was commenced over a year ago by Philadelphian parties. Three miles were graded out of Morehead and the track laid. At this point the work ceased, and nothing more was heard of it until within the past two weeks. The Clearfield company has opened an office at Morehead. The road is to be standard gauge, and is to be used to haul the company's logs and lumber to the plant at Morehead. It will be called the Morehead & North Fork Railroad.

The Norwood Lumber Company of Kimball, McDowell County, W. Va., with chief works in Browns Creek district, McDowell County, West Virginia, has been incorporated to buy, sell and deal in timber and manufacture the same, capital stock \$100,000, of which a considerable amount has been subscribed and paid. The incorporators are Louis Carr of Gatto, W. Va.; Joseph Keys and Jas. E. Walker of Ashland, Ky., and Warren A. Wilson and I. J. Rhoades of Welch, W. Va.

The Meadow River Lumber Company of Evenwood, W. Va., has been established with operations in the Meadow Bluff district, Greenbrier County, and elsewhere in the state, to cut, handle, manufacture, finish, buy, sell and deal in logs and all kinds of lumber and timber and to buy, lease, sell and let mineral rights and to build railroads, tramways, etc. Capital stock \$600,000, of which amount \$325,500 has been subscribed, and \$323,400 paid. The incorporators are T. W. W. Raine, Evenwood, W. Va.; John Raine, Granville, O.; E. E. Carrier, Kane, Pa.; H. W. Raine and L. R. F. Preysz of Evenwood, W. Va.

The McKean Lumber Company of Gill, Lincoln County, Ga., has been granted a charter to engage in the manufacture of lumber; authorized capital \$20,000, of which \$10,000 has been subscribed and \$6,000 paid in. The incorporators are J. C. Steele, Henrietta B. Steele, C. M. Leete of Farmers Valley, Pa.; E. A. Tanner of Bradford, Pa., and E. R. Berry of Ridgeway, Pa.

R. H. Vansant of Vansant, Kitchen & Co. spent the past week at Asheville, N. C., looking after business.

W. R. Vansant is in the South looking over the timber prospects.

The first fruits of the government improvement of the Big Sandy River are being reaped by lumbermen, who have been taking advantage of the slack water to bring out the hundreds of rafts that were left in the Big Sandy River by the last tide. The new locks are working beautifully, and a recent trial showed 18 feet of water above the dam, giving permanent boating stage as far as Georgia's Creek, 40 miles. In one day there were 25 large rafts locked through, and quite a number during the week following.

L. E. Hunter, manager of the Keyes Planning Mill, Graham, Va., owned by the Keyes-Fannin Lumber Company of this city, was quietly married on Tuesday, June 12, to Miss Stella Spencer, a prominent young society woman of Ironton, O. The young couple will reside at Graham, after an eastern trip of two or three weeks.

**Minneapolis.**

Reports from the Wisconsin and Minnesota mills show that the cut of northern oak is going to be much lighter this year than last. There is hardly any old stock left, and the new cut, which will not be on the market for a month or more, is not going to figure as much in the trade as it has heretofore. Dealers are making connections with southern mills to supply a very large share of their trade with oak.

The building movement in the two cities continues very active. Minneapolis building is not quite as strong as last season, which was phenomenal, and could hardly be equalled again. St. Paul, however, is making a steady increase. Minneapolis permits for May were 576 in number, with an estimated total cost of \$846,560. For the same month last year there were 691 permits, total cost \$1,131,780. St. Paul permits were 871,250 in value, a gain of 49 per cent over last year. The building is largely of an expensive character, calling for a great deal of hardwood flooring and finish.

P. R. Hamilton of the Minneapolis Lumber Company says that while it is the rule that June is a poor month for hardwood sales, his company is doing a nice business right along, not heavy, but very good for the season. The factories are all running with an excellent line of orders, and are buying in small lots, but will be actively in the market by another month or six weeks.

E. Payson Smith of the Payson Smith Lumber Company is making a business trip in Missouri, where he has connections with several good hardwood mills.

C. E. Osborne of Osborne & Clark reports that they have already contracted for all the rock elm at their disposal, to be shipped from time to time. The implement trade is asking for rock elm, and there has been a rush to get adequate supplies for this year's operations.

**Hardwood Market.**

(By HARDWOOD RECORD Exclusive Market Reporters.)

**Chicago.**

There is not very much action in the Chicago market at the present time. Trade can be said to be only fair. The period of the semi-annual furniture sales, which will be indicative of the fall lumber requirements of the furniture manufacturing trade, does not commence until next week, and furniture manufacturers will not buy any lumber until they can approximately tell what their requirements are going to be for the next six months. It is safe to assume that there will not be

much buying in this line for a month. The interior finish people are buying with considerable freedom, and a large quantity of coarse lumber is still being bought by the box and crating manufacturers. The demand for plain-sawed oak still continues strong, but offerings of quartered white and red, and plain-sawed red are quite plentiful. Another item of stock that is apparently in very short supply and is commanding good figures, is popular in all grades. Local jobbers anticipate a fair consuming trade, but think there will



be a let-up in extremely active buying until fall. The general situation is healthy and the year promises to round out well.

#### Boston.

There has been no particular change in the local hardwood market. Those dealers who make a specialty of expert business report a slightly better inquiry and all agree that if prices were lower they could do a much larger foreign business. The yards in this section are all fairly well supplied with lumber, yet there is no surplus, especially of the desirable grades. Advices from mill points for the most part report a shortage of dry stock, but it is the consensus of opinion that there will be plenty of lumber within a few weeks. The manufacturers of interior finish are fairly busy and they as well as furniture manufacturers are interested in anything that looks like a bargain. Some of the latter have larger stocks on hand than regular lumber yards and most of this was bought at prices under those ruling today.

Plain oak is not in large offering although some state that there is more to be had now than a few weeks ago. Quartered oak moves in a moderate way at very firm prices. Brown ash attracts a fair business. Stocks are small, especially in the most desirable grades. Birch is firm and in small offering. Maple flooring is not in active demand, but no weakness in prices is reported. Whitewood is in fair call at firm prices.

The market for cypress is very firm. Many complain of the way they are obliged to buy from the large selling company. They claim that there is very little to be made by selling on a commission basis today when all the selling company will allow them from the list is four per cent. They also complain of the methods. In buying they must remit the full amount to the mill and later the selling company will return the four per cent, providing there has been no claim for shortage made. If there has been a claim oftentimes there is no commission allowed. Many dealers are buying outright and then putting on their own prices.

#### New York.

Leaving the manufacturing interests out of the question and taking the consuming end of the business as a barometer, which is really a true one, there is practically no complaint so far as the Metropolitan District is concerned as to general demand for hardwood lumber. Dealers all report that they are doing a good volume of business, not quite as large as last year, but more than is usual in normally good years. There are no labor troubles of a general nature and universally the movement of lumber is free and stocks are being moved out in such volume as will bring about an active buying period within a short time. Hence, so far as the Metropolitan District is concerned, it may be said that conditions are good and will continue so, provided that the wholesaler and manufacturer handle the present situation intelligently.

There are no surplus stocks of hardwoods, and in fact supplies generally are not of sufficient volume to create a temptation to push the market. The demand is very fair; any great increase in the call for the leading hardwoods would immediately create a shortage, and such an increase is looked for within a very brief period. The hardwood yards have fair stocks, but the manufacturing trade is running close on supplies and all orders are for rush shipment. Ash, birch, plain oak and chestnut are still the leaders in demand. Dry stocks are by no means plentiful and any holders of these stocks have a profitable asset. Maple and quartered oak are quiet, but poplar is moving steadily, particularly in the lower grades. Buyers returning from purchasing trips to the mills all bring the same tale of light supplies.

#### Philadelphia.

The market is quiet. The lull is looked upon as the usual condition that marks early summer business and consequently is not causing any alarm. In certain quarters there is a tendency to regard the market as weak, and in others the wholesalers say business was never better, but the average firm undoubtedly finds sales in general a trifle slow.

Red and white oak have been doing well, as have chestnut and poplar, some low grades of poplar, especially, being very scarce. A feature of the market is the volume of business being done in cypress and basswood, cypress coming into the market in the same heavy quantities as it was some weeks ago, and basswood being received largely by the box makers, who seem to be extremely busy.

The retail yards, especially those supplying timber for railroad and bridge work, are busy. Stocks are fairly plentiful among them, but the scarcity of dry stocks at the mills tends to keep the market up all around.

#### Pittsburg.

Every line of hardwood lumber is moving well and prices are firm. Oak still leads the procession, if we except poplar, which is sold two months ahead in some quarters. For heavy oak timbers the inquiry is better if anything than in April and May. Railroads are calling for an enormous amount of oak timbers for bridge and trestle work, as well as ties, and the local traction companies are sure to place some big orders very soon. The better grades of oak for finishing lumber are selling well, chiefly in the surrounding towns, where building is more active than in Pittsburg. Chestnut shows a slight falling off, notably in sound wormy, from the rate of sale a few weeks ago. Maple is being taken in good quantities by the local wholesalers from the small mills in Ohio and Pennsylvania, and is finding a ready market among the furniture manufactories of the East. Recently ash has been much more active in the local market.

In general the local demand for all sorts of lumber is poor at present. The carpenters' strike has delayed building to a large extent and has forced a shut-down of a good proportion of the planing mills in the Greater Pittsburg district. Unless some settlement is reached soon the planing mills of this territory will be practically out of business, for the owners are almost a unit in declaring that they will not pay the \$4.00 a day minimum scale demanded.

A feature of the hardwood market just now is the large amount of lumber being shipped to Ohio. Within the last two weeks a dozen or more big orders have been secured by local companies for Ohio delivery at points which have hitherto been supplied chiefly by Ohio concerns. Handle and spoke manufacturers are taking a good part of this stock, and at prices that encourage Pittsburg dealers to go over the Ohio territory with larger forces of salesmen and much more carefully than hitherto.

#### Buffalo.

Sales are good, but it is necessary to patrol wider districts every year to keep up even fairly complete stocks. Maple is no longer cheap and plentiful as it used to be. It is possible that there is a little more birch on the market than there was, and though it runs heavily to white dealers say it sells well.

There is a little better report of chestnut, some being bought green to come in when dry, so that the yards bare of this wood will not continue so through the season, though it does not appear that there are sufficient quantities of the wood to last very long.

There are still reports of sales of low-grade hardwood here and there, some going into regular consumption as an evidence that con-

sumers are making up their minds that they must lower their standards of quality.

The demand for poplar is greater than it has been for some time, and stocks are short. Unless there are freshets through the summer it will not be at all equal to the demand.

It appears that the fears that leading hardwoods, oak with the rest, would run very low are not to be realized. The stock of basswood is also quite good and it is selling better, as is also elm, though both are regarded as rather high for the eastern trade yet.

The problem of securing stock grows more difficult, but the Buffalo hardwood dealer by being continually on the outlook is getting his full share.

#### Detroit.

The hardwood market in the lower peninsula of Michigan is somewhat spotted. Basswood shows considerable improvement, being on the average \$2.00 per thousand higher than a few months ago. Hard maple and beech are about stationary, but with a firm tendency in 5, 4 and thicker maple. Birch is decidedly quiet in this section, although a very good market in Buffalo and east of there is reported. Black ash is in scant supply, and dealers have no difficulty in putting through at top notch prices all they can get hold of. The same is true of red oak. Soft elm continues the weakest item on the list, and dealers are backward about taking hold of stocks of this wood.

#### Bristol, Va.-Tenn.

Trade conditions in this section continue good and the tendency of the market seems to be toward higher prices. The country mills are all running regularly, many of them overtime, in an effort to catch up with orders and get out as much stuff as possible while the roads are in good condition and it can be hauled to the shipping stations.

#### Cincinnati.

The hardwood market the past two weeks has developed nothing of especial significance. There has been little or no alleviation in the stringency of dry stocks in suitable lots, and prices have held their own. The usual lull in trade which appears about this time of the year is beginning to be felt.

Plain oak in desirable thicknesses continues to be the feature of the market, with firmness prevailing. Ash and cypress were fairly active. Cottonwood remains in good request and red gum is not far behind. Poplar is moving slowly.

#### Nashville.

The local market is reported as very firm in all departments, with plenty of inquiries and a tendency to increased prices. Poplar is steadily going up, so heavy is the demand. A slight advance is noted in plain oak. No red oak is being quarter-sawn, however, owing to the excellent demand for plain, at advanced prices. Ash and chestnut are hard to get, as usual, and bringing excellent prices.

#### Memphis.

There is somewhat of a lull in the demand for hardwood lumber, compared with the latter part of May and the earlier portion of the current month. The volume of business, however, is reported satisfactory by both manufacturers and wholesalers, and conditions are regarded wholesome. The most noticeable feature is the disposition of consumers to buy only to meet immediate requirements, being under the impression that the volume of lumber now going on sticks in the South will have the effect of reducing prices to some extent. This belief is not strongly held here and some of the best informed say that unless there is a very decided slackening in demand or a wonderful increase in production, there is not going to be enough surplus stock next fall to warrant any depreciation in hardwood lum-

ber. Much of the business now being put through is on old bookings, there being enough inquiry some time ago and enough orders placed to insure continued operations for a considerable period. This business, however, is naturally supplemented by the current demand.

The decline in the price of pig iron in the Birmingham district and the tightness of money in New York and all over the country are regarded as rather unfavorable collateral developments, but these are quite offset by the fact that crop prospects throughout the South, Southwest and West are all that can be desired, thus insuring a high degree of prosperity for lumber and all allied industries. Building operations are on a large scale and the railroads are rapidly increasing their equipment, thus contributing to the demand for hardwood material. Moreover, the furniture people are in the market for considerable requirements and their buying is expected to prove a sustaining influence. The implement and wagon manufacturers, too, are backed by the prosperity of the agricultural interests of the country and they should afford, in the opinion of the trade, a considerable demand.

Plain oak, in both red and white, continues a ready seller at full prices, though there is no improvement noted in the demand for quarter-sawn stock. This latter condition is attributed to the fact that so much more veneer is used now than ever before, making quarter-sawn oak requirements much less.

Ash is a good seller. There is not much for sale here and prices are firmly held. The thicker stock is more wanted than any other kind, but there is no particular trouble encountered in disposing of inch and five and six quarter stock. In fact, ash is scarce and buyers are not any too choicé about what they purchase.

Cypress is in good request at very steady prices. The offerings are perhaps rather more liberal than they were six or seven weeks ago, but there is no surplus dry stock and those who are in the market are not having any very easy time getting what they want without paying full values therefor. The higher grades are in rather better request than the lower.

Cottonwood is a splendid seller, especially in the lower grades, No. 1 and No. 2 box common. There is a phenomenal demand for box material, and this accounts for the fact that this class of cottonwood is so much wanted. Box manufacturers are heavily sold ahead on their output and in many instances they are short of the lumber, with the result that their competitive bidding for stock in the open market is expected to give continued strength and firmness. The higher grades of cottonwood are somewhat easier, possibly, than they have been heretofore, though there is no great amount of this class of material to be had.

Gum is steady, with probable tendency toward easiness. There is a fairly good demand for red firsts and seconds and clear saps, especially in thin, while there is a moderate movement of inch stock. The lower grades are holding their own under the stimulus of a fair request. There is some disposition among small manufacturers to contract their output and this is calculated to give an easier tone to this wood.

The poplar situation shows no material change. There is little to be had here, while the demand in Memphis is not particularly large.

#### New Orleans.

The last fortnight has brought about little change in the condition of the hardwood market in this section. Stocks still remain low, though efforts are being made to replenish those which during the last few months have been drained to the lowest ebb. Even though the buyers are not operating to any great ex-

tent, exports continue good and the prices are just what a good demand and low stocks always makes them.

#### Louisville.

The Louisville hardwood market is in very satisfactory shape. A few of the dealers here have an idea that the furniture factories will not buy very heavily during July, but that is not worrying them, as the majority have plenty of orders ahead, and would just as soon buy as sell lumber right now.

One feature of the market of late has been an inquiry for thin plain sawed oak. This is rather a new departure to the trade here. Those who make quartered oak carry thin stock, both  $\frac{3}{4}$  and  $\frac{5}{8}$ , but heretofore there has not been any demand for  $\frac{3}{4}$  plain sawed to inspire the mills to cut it and keep it in stock. It may be that this is just a special requirement and does not indicate a growing demand for this class of oak, but it is the opinion of some that since oak has grown so valuable it may be expected that the future demand will include more and more of this thin stock, even in plain sawed. The logic of this is found in the fact that in ordinary lumber widths  $\frac{3}{4}$  inch oak lumber should be cheaper than three ply  $\frac{3}{4}$  made of veneer, with a plain oak face. Of course, when it comes to larger panels the veneer stock would have the advantage, but as long as it can be used in stock lumber widths the odds seem in favor of the  $\frac{3}{4}$  inch plain sawed oak lumber. At any rate, it is a new and interesting question, and one that sawmill men will do well to watch. It should be borne in mind in this connection that it is not a good idea to try resawing dry plain one-inch oak boards into this  $\frac{3}{4}$  stock. Lewis Foster, secretary of the Hardwood Manufacturers' Association, who is quite an authority on cutting and caring for hardwood lumber, says that it is not advisable to resaw dry plain oak, as it warps badly and the cull account outweighs the advantage gained. The only successful way is to make it thin while green.

Poplar continues to be a strong element in this market, and cottonwood is keeping it close company. Common gum is still on the uncertain list, although among the cooperage people there is a note of improvement, especially in the manufacture of tight staves where a year ago it was down in the dumps.

#### Minneapolis.

Dealers in the twin cities report an active demand for some hardwoods, while others are slow. The new cut of ash is just coming on the market, being in condition now to ship and put in the dry kiln, and consumers who have been waiting for ash stock for a while are now rushing shipments. There has been a rush also for rock elm, and there is very little of that lumber left unsold, even counting the logs that have not reached the saw. The large manufacturing concerns that have adopted rock elm as a substitute for oak have been cleaning it up so fast that it is now almost in the oak class as to price and scarcity.

Birch is moving fairly well, and is abundant. Prices, however, are holding fairly steady. Basswood is slow here, although it sells well in some other markets, and at firm prices. The old stock was well cleaned up, and reports from the mills indicate that the basswood output is not going to be what it was last year. The culls will go quickly, and there will not be any considerable surplus of the upper grades. The retail yards are taking considerable oak yard stock again, having sold into their early supply. Factory trade in oak is rather slow just now, and is being supplied entirely from the South. The factories are not expected to buy any stock in large quantities before August 1. Their hardwood stocks are low, and they are only buying to fill immediate needs. Flooring is quiet, and many

builders are complaining of high prices which they claim are reducing the use of hardwood flooring.

#### Liverpool.

Arrivals during May were moderate, according to Dobell's report, and consumption may be considered satisfactory, although business generally has rather disappointed sanguine expectations.

There has been fair inquiry for oak, and fresh arrivals should meet with ready sale. Stocks of rock elm remain light and values firm. Birch logs have been liberally received and although there has been a fair consumption, lower prices have had to be taken for market parcels; planks are arriving too freely, as the stock is heavy, with only moderate demand and prices easier. Walnut logs of prime quality and large are scarce, and shipments can be recommended; medium and inferior grades are well stocked and quotations are steady; planks and boards have arrived freely and values are therefore lower. White-wood logs of good sizes and first quality are in demand and would realize satisfactory prices, for planks and boards the demand is only fair, as stocks are heavy. Arrivals of ash and hickory round logs have been heavy and prices are easier. The import of staves has been enormous and values are lower. Mahogany sales have been well attended and competition for sound logs and figured wood was exceptionally keen, extreme prices being obtained for Cuban wood of the latter description. Inquiry for all kinds is good; large sound logs and figured wood would meet with ready sale. Lignum vitae is in request, and prime, round, straight thin-sapped wood would come to a welcoming market.

#### London.

The hardwood market is not brisk, as there is little stock offering, and although the rising prices tend to restrict business somewhat, goods offered are bringing high prices.

In oak there is a supply of plain boards in medium quality which is ample for the demand, but thicker stock is scarce and good prices are paid for arrivals. Quartered oak is being asked for, and strips are selling well at advanced prices. Ash planks are selling at a remunerative price to shippers, but there is only one grade wanted for this market and that is prime. Logs are difficult to dispose of. Whitewood boards of all grades are in demand at top prices, and the stocks of planks which had accumulated are going into consumption slowly; the demand is limited. Walnut is wanted, but this want will be supplied, as one of the walnut shippers whose brands and grading are well known here is shortly expected to send large quantities. Arrivals of satin walnut are small, but quite equal to the demand.

Churchill & Sim's wood circular, under date of June 5, states that the London market has shown little change during the past few weeks; general conditions are fair, and although prices have advanced on a few items, this is indicative rather of a scarcity of the stocks than of increased demand.

The three mahogany auction sales held last month were well supported, and the sales effected thereat will further reduce already well-nigh depleted stocks; quotations are non and as there appears to be every prospect of imports continuing light there is good reason to expect prices to rise in the near future. In American black walnut, sizable prime logs find ready takers at remunerative prices, but inferior lots should not be shipped; planks and boards continue in active request. Whitewood logs should be shipped only if large and prime, the demand is dull for planks, but there is good call for planed boards. In lignum vitae, well-grown sizable wood is wanted but inferior parcels are invariably rejected.

# AT COST

IS AN UNCOMMON TERM AS APPLIED TO INSURANCE

But this is the actual price of Indemnity against Fire Loss furnished by the

## Manufacturing Lumbermen's Underwriters

THE STRONGEST INSURANCE ORGANIZATION  
TO-DAY IN AMERICA

The saving is not on a small portion of your insurance but on the entire line.

There are other advantages equally interesting.



Only well built plants with adequate protection and at least five years timber supply are considered eligible.

FOR LIST OF MEMBERS AND FURTHER INFORMATION, ADDRESS

**HARRY RANKIN & CO. :: Kansas City, Mo.**

# Wanted and For Sale -SECTION-

Advertisements will be inserted in this section at the following rates:

For one insertion ..... 20 cents a line  
 For two insertions ..... 35 cents a line  
 For three insertions ..... 50 cents a line  
 For four insertions ..... 60 cents a line  
 Eight words of ordinary length make one line.  
 Heading counts as two lines.  
 No display except the headings can be admitted.

Remittances to accompany the order. No extra charges for copies of paper containing the advertisement.

## EMPLOYES WANTED.

### WANTED.

A young man to keep books and inspect hard and soft woods. Write, marking envelope "Personal," H. D. BILLMEYER, Cumberland, Md.

### WANTED.

Competent sawmill man owning a small 5 or 6 ft. band mill to cut hardwoods in North Carolina by the thousand; ample log supply. Would consider buying a band mill for responsible party. Address "A. L. V.," care HARDWOOD RECORD.

## LUMBER WANTED

### WANTED WALNUT LUMBER

We are cash buyers of walnut lumber 1" and thicker, all grades, green or dry. Advise what you have to offer. Address BOX NO. 780, South Bend, Ind.

### WANTED—HARDWOOD LOGS.

200 M feet 28-inch and up White Oak logs.  
 200 M feet 12-inch and up Walnut logs.  
 50 M 12-inch and up Cherry logs.  
 50 M ft. 12-inch and up Cherry logs.  
 C. L. WILLEY,  
 Blue Island Av. and Robey St., Chicago.

### OAK.

We are in the market for plain sawed oak, all grades and thicknesses. P. G. LODGE & CO., 2416 Lumber St., Chicago.

### WHITE ASH, DRY OR GREEN.

350 pcs. 4 1/4 x 8—12 ft. Com. & Bet.  
 110 pcs. 2 1/2 x 8—20 ft. Com. & Bet.  
 20 M ft. 2x6" and wider Com. & Bet.  
 40 M ft. 2x6" and wider Com. & Bet.  
 NICHOLS & COX L. CO., Grand Rapids, Mich.

### WANTED.

2x5 and wider Cypress S' No. 1 Com., select or better.  
 1x1 and 6" Tupelo Gum D. & M. No. 1 & No. 2 Com.  
 1x6" and wider Tupelo Gum S18 No. 1 & No. 2 Com.  
 AMERICAN LBR. & MFG. CO., Pittsburg, Pa.

### WE DESIRE TO PURCHASE

On contract carloads of Oak Boxes assembled, round corners, made of 1" stock, with cover made of 1 1/4" stock. Also other Oak woodwork machined and sanded ready to varnish, K. D., crated in bulk. Address "CASH," care HARDWOOD RECORD.

### WANTED.

Locust, Bois D'Arc or Osage Orange and Mulberry, log run. Write for specifications and prices. THE PILLIOD LUMBER CO., Swanton, O.

### WANTED—DIMENSION HICKORY.

Send for our specifications. MUNCIE WHEEL & JOBBING CO., Muncie, Ind.

### SMALL HICKORY DIMENSION.

First-class material from waste of wagon stock. Sizes wanted furnished upon application. L. T. La BAR, Hackettstown, N. J.

### OAK WANTED.

3 and 4 inch White Oak; also Mixed Oak; also 12x12 Timbers and Piling of all kinds. CONTINENTAL LUMBER CO., 1213 Monadnock Bldg., Chicago, Ill.

### WALNUT ONLY.

Wanted, Walnut lumber, green or dry, all grades, all thicknesses, log run or on grades. Highest market price paid. Liberal inspection. C. J. FRANK, 2440 N. New Jersey St., Indianapolis, Ind.

## LUMBER FOR SALE.

### HARD MAPLE DIMENSION.

9,598 ft. 1 1/2" x 1 1/2" x 18, 24, 30 & 36"  
 9,240 ft. 4 1x2" and wider 12 and 24" long  
 10,255 ft. 4 1x2" and wider 18" long.  
 2,670 ft. 4 1x2" and wider 30" long.  
 1,515 ft. 4 1x2" and wider 36".  
 THE CADILLAC HANDLE CO., Cadillac, Mich.

### 6/4" NO. 1 COMMON RED OAK.

30,000 feet. Good widths and lengths. Thoroughly dry. Bag up grade. THE M. B. FARRIN LUMBER CO., Cincinnati, O.

### WAGON STOCK FOR SALE.

We are in position to furnish wagon manufacturers with wagon tongues, axles, reaches and bolsters. GAYOSO LUMBER CO., Memphis, Tenn.

### FOR SALE.

Common and better Hickory, 5,277 feet of 2 1/2", 1,092 feet of 3" and 1,024 feet of 4", dry, good quality. LOVE, BOYD & CO., Nashville, Tenn.

## BUSINESS OPPORTUNITIES

### WOODWORKERS.

Excellent opportunities for woodworking establishments are found at a number of points on the North-Western line in the timber country of Wisconsin and Michigan. Parties dealing in cooperation will be furnished with reference to sections where this business may be conducted favorably. Address INDUSTRIAL DEPARTMENT, CHICAGO & NORTH-WESTERN RAILROAD, Chicago.

### HARDWOOD TIMBER.

A number of good mill propositions along the Cotton Belt Route. Tracts ranging from five hundred to twenty thousand acres, principally Oak, Hickory, Gum, Cypress, some Ash, Cottonwood and other hardwoods. Can be secured at very reasonable figures now—in some cases at less than \$1 per thousand stumpage. Choice openings for hardwood lumber mills, handle and spoke factories, slack cooperage plants and other hardwood enterprises.

A number of points on the Cotton Belt offer free sites or will raise cash bonus or take stock in practical propositions. Let us have your wants and see what we can do for you.

E. W. LA BEAUME, G. P. & T. A., COTTON BELT, St. Louis, Mo.

## MISCELLANEOUS

### FACTS FROM PRACTICAL MEN.

The HARDWOOD RECORD is always in the market for articles on any and every feature of the hardwood industry. It wants practical statements of fact from practical men who know how certain things can be done in the best way. Literary quality not essential. Liberal pay for acceptable articles. Address Editor HARDWOOD RECORD.

## MACHINERY WANTED

### AT ONCE.

If you are in need of machinery—new or second hand—a few lines in this column will place your wants before those who have such goods for sale. For particulars address HARDWOOD RECORD, Chicago, Ill.

## MANUFACTURERS

Contemplating establishing plants in the West should take advantage of a location on



## Chicago & North-Western Ry.

which reaches the famous

**WATER POWERS,  
 COAL FIELDS,  
 IRON ORE RANGES,  
 HARD AND SOFT  
 LUMBER DISTRICTS,  
 MINING DISTRICTS**

of the West and Northwest, and affords the best means of transportation to the markets of the world.

FOR FURTHER PARTICULARS APPLY TO

MARVIN HUGHITT, Jr., E. D. BRIGHAM,  
 Freight Traffic Manager, Gen'l Freight Agent,

GEO. BONNELL,  
 Industrial Agent,

NW513 CHICAGO.

## Locations for Industries

### ON THE ERIE, THE COMMERCIAL RAILROAD CHICAGO TO NEW YORK

The Erie Railroad System's Industrial Department has all the territory traversed by the railroad districted in relation to resources, markets and advantages for manufacturing, can advise with manufacturers of specific products as to suitable locations, and furnish them with current information of a comprehensive nature dealing with the project in its full relation to manufacture and commerce.

The Erie is one of the greatest of trunk lines. Its own rails connect the two largest cities of America. Every section of the System has its particular merits. Profitable locations exist. It has great general and coal, oil and natural gas resources.

It is important in this age of modern facilities for manufacturers to locate where they can obtain side tracks so as to receive from and ship directly into cars at the factory. Information can be promptly furnished in this connection about every point on the system between New York and Chicago.

Manufacturers' inquiries as to locations are treated in strict confidence and absolutely reliable information, so as to promote permanent traffic, is furnished. Address

### LUIS JACKSON

Industrial Commissioner  
 Erie Railroad Company  
 21 Cortlandt Street, New York

# Advertisers' Directory

## NORTHERN HARDWOODS.

American Lumber & Mfg. Co.	9
Arpin Hardwood Lumber Co.	44
Babcock Lumber Company.	9
Barnaby, C. H.	43
Beyer, Knox & Co.	51
Bliss & Van Auken.	10
Boyle, Clarence, Lumber Company	50
Boyne City Lumber Company.	47
Briggs & Cooper Company.	4
Brightingham & Young Company.	44
Brownlee & Company.	46
Buffalo Hardwood Lumber Co.	51
Canadian Handle Company.	3
Cheat River Lumber Company.	9
Cherry River Boom & Lbr. Co.	1
Chivvis, W. R.	5
Cincinnati Hardwood Lumber Co.	49
Cobbs & Mitchell, Inc.	3
Crosby & Beckley Company, The	44
Crosby, C. P.	44
Cummer, Digins & Co.	3
Davis, John R., Lumber Company	44
D'Heur & Swain Lumber Co.	43
Dennis Bros.	47
Dennis & Smith Lumber Company	46
Dixon & Dewey.	48
Dublmeier Bros.	48
Dulweber, John, & Co.	49
Elias, G., & Bro.	51
Empire Lumber Company, Buffalo	51
Estabrook-Skeele Lumber Co.	50
Fall, E. H.	5
Flint, Erving & Stoner Company.	9
Freiburg Lumber Company, The.	49
Fullerton-Powell Hardwood Lumber Company.	43
General Lumber Company.	48
Goldie, J. S.	47
Haak Lumber Company.	47
Hackley-Phelps-Bonnell Company.	47
Hayden, Harvey S.	47
Heath-Witbeck Company.	50
Holloway Lumber Company.	7
Ingram Lumber Company.	7
Jenks, Robert H., Lumber Co.	45
Jones, G. W., Lumber Company.	44
Jones Hardwood Company.	1
Kampf, Albert R.	2
Keith Lumber Company.	50
Kelley Lumber & Shingle Co.	46
King & Bartles Lumber Company	45
Leavitt Lumber Company.	10
Lesh & Matthews Lumber Co.	50
Linehan Lumber Company.	50
Litchfield, William E.	7
Long-Knight Lumber Company.	43
McClure Lumber Company.	47
McIlvain, J. Gibson, & Co.	7
McLean, Hugh, Lumber Company	51
MacBride, Thos., Lumber Co.	47
Maley, Thompson & Moffett Co.	49
Maley & Wertz.	43
Martin-Barriss Company.	45
Miller, Anthony.	51
Mitchell Bros. Company.	3
Mowbray & Robinson.	49
Murphy & Higgins.	1
Nicola Lumber Company, The.	9
No. Vernon Pump & Lbr. Co.	2
Norman Lumber Company.	2
North Shore Lumber Company.	4
North Western Lumber Company	44
Page & Landeck Lumber Co.	44
Perrine-Armstrong Company.	43
Peters, R. G., Salt & Lumber Co.	47
Price, E. E.	7
Radina, L. W., & Co.	49
Rumbarger Lumber Company.	46
Salling, Hanson & Co.	46
Scatcberd & Son.	51
Schofield Bros.	7
Schultz Brothers & Cowen.	41

Simmoos Lumber Company.	47
Soble Brothers.	7
Southern Oak Lumber Company.	50
Standard Hardwood Lumber Co.	51
Stephenson, The L., Company.	10
Stewart, J. N., & Bro.	51
Stimson, J. V.	43
Sullivan, T., & Co.	51
Tegge Lumber Company.	9
Turner, A. M., Lumber Company	6
Upham & Agler.	47
Van Keulen & Wilkinson Lumber Company	44
Vollmar & Below.	47
Wagstaff, W. J.	50
Ward Lumber Company.	7
Wentworth, Chas. S., & Co.	46
White, W. H., Company.	7
Whitmer, Wm., & Sons, Inc.	7
Wiborg & Hanna Company.	49
Wiggin, H. D.	7
Willson Bros. Lumber Company.	9
Wistar, Underhill & Co.	7
Yeager, Orson E.	51
Young & Cutsinger.	43
Young, W. D., & Co.	10

## SOUTHERN HARDWOODS.

Advance Lumber Company.	45
American Lumber Company.	42
American Lumber & Mfg. Co.	9
Anderson-Tully Company.	4
Atlantic Lumber Company.	1
Bacon-Nolan Hardwood Company	4
Beck, E. E., Lumber Company.	49
Beyer, Knox & Co.	51
Bennett & Witte.	49
Black, F. W., Lumber Company.	50
Bliss-Cook Oak Company.	35
Boyle, Clarence Lumber Co.	50
Briggs & Cooper Company.	4
Brown, Geo. C., & Co.	3
Crown, W. P., & Sons Lbr. Co.	2
Buffalo Hardwood Lumber Co.	51
Carrier Lbr. & Mfg. Company.	10
Cherry River Boom & Lbr. Co.	1
Chicago Veneer Company.	34
Chivvis, W. R.	5
Cincinnati Hardwood Lumber Co.	49
Coleman, J. S., Lumber Co.	42
Crandall & Brown.	50
Crane, C., & Co.	49
Crosby & Beckley Company, The	44
Cypress Lumber Company.	48
Davis, Edw. L., & Co.	2
Davidson-Benedict Company.	1
Dennis & Smith Lumber Company	46
D'Heur & Swain Lumber Co.	43
Dierks Lumber & Coal Company.	10
Dixon & Dewey.	48
Dublmeier Bros.	48
Dulweber, John, & Co.	49
Elias, G., & Bro.	51
Empire Lumber Co., Buffalo.	51
Estabrook-Skeele Lumber Co.	50
Fall, E. H.	5
Farrin-Korn Lumber Company.	48
Flint, Erving & Stoner Company	9
Freiberg Lumber Company.	49
Fry-Buchanan Lumber Company.	42
Fullerton-Powell Hardwood Lumber Company.	43
Gayoso Lumber Company.	4
Garretson-Greaser Lumber Co.	5
Hackley-Phelps-Bonnell Company.	47
Hafner Mfg. Company.	45
Hamilton, J. V.	50
Heath-Witbeck Company.	50
Himmelbeiger - Harrison Lumber Company	1
Indiana Lumber Company.	8
Jenks, Robert H., Lumber Co.	45
Jones, G. W., Lumber Company.	44
Jones Hardwood Company.	7

Kampf, Albert R.	2
Keith Lumber Company.	50
Kentucky Lumber Company.	48
Kentucky Lumber & Veneer Co.	8
King & Bartles Lumber Company	45
Lane-White Lumber Company.	10
Leavitt Lumber Company.	10
Lesh & Matthews Lumber Co.	50
Linehan Lumber Company.	9
Litchfield, Wm. E.	7
Long-Knight Lumber Company.	43
Loomis & Hart Mfg. Company.	8
Love, Boyd & Co.	8
Luehrmann, Chas. F., Hardwood Lumber Company	5
McClure Lumber Company.	47
McIlvain, J. Gibson, & Co.	7
McLean, Hugh, Lumber Company	51
Maley, Thompson & Moffett Co.	49
Martin-Barriss Company.	45
Miller, Anthony.	51
Nicola Lumber Company, The.	9
Norman Lumber Company.	2
Ozark Coopage Company.	5
Paepeke-Leicht Lumber Company	6
Page & Landeck Lumber Company	44
Price, E. E.	7
Rhubesky, E. W.	2
Radina, L. W., & Co.	49
Ransom, J. B., & Co.	8
Ritter, W. M., Lumber Company	52
Roy Lumber Company.	35
Rumbarger Lumber Company.	4
Scatcberd & Son.	51
Schofield Brothers.	7
Smith, W. E., Lumber Company.	4
Southern Lumber Company.	2
Southern Oak Lumber Company.	50
Standard Hardwood Lumber Co.	51
Steele & Hibbard.	5
Stewart, J. N., & Bro.	51
Stevens-Eaton Company.	7
Stimson, J. V.	43
Stoneman-Zearing Lumber Co.	5
Stutz Lumber Company, Inc.	2
Sullivan, T., & Co.	51
Swann-Day Lumber Company.	6
Thomas & Proetz Lumber Co.	5
Three States Lumber Company.	4
Turner, A. M., Lumber Company.	9
Upham & Agler.	4
Vestal Lumber & Mfg. Company.	42
Ward Lumber Company.	50
Wentworth, Chas. S., & Co.	7
Whitmer, Wm., & Sons, Inc.	7
Wiborg & Hanna Company.	49
Wiggin, H. D.	7
Willson Bros. Lumber Company.	9
Yeager, Orson E.	51

## COTTONWOOD AND GUM.

Anderson-Tully Company.	4
Bacon-Nolan Hardwood Company	4
Farrin-Korn Lumber Company.	48
Himmelbeiger - Harrison Lumber Company	1
Luehrmann, C. F., Hardwood Lumber Company	5
Ozark Coopage Company.	5
Paepeke-Leicht Lumber Company	6
Smith, W. E., Lumber Company	4
Stoneman-Zearing Lumber Co.	5
Stutz Lumber Company, Inc.	2
Three States Lumber Company.	4

## CYPRESS.

Crandall & Brown.	50
Cypress Lumber Company.	48
Hafner Mfg. Company.	5
Lothman Cypress Company.	5
Thompson, J. W., Lumber Co.	4

## HARDWOOD FLOORING.

Bliss-Cook Oak Company.	35
Bliss & Van Auken.	10
Carrier Lbr. & Mfg. Company.	10
Cobbs & Mitchell, Inc.	3
Cummer, Digins & Co.	3
Haak Lumber Company.	47
Kerry & Hanson Flooring Co.	46
Mitchell Bros. Company.	3
Nashville Hardwood Flooring Company	8
Pease Company, The.	48
Schultz Bros. & Cowen.	41
Stephenson, The L., Company.	10
Wood Brothers.	10
Wood Mosaic Flooring Company	2
Young, W. D., & Co.	10

## SAW MILL MACHINERY.

Mershon Company, The.	36
Phoenix Mfg. Company.	36

## WOOD WORKING MACHINERY

American Wood Working Machinery Company.	40
Berlin Machine Works, The.	37
Denance Machine Works.	35
Ober Mfg. Company, The.	35
Sulth, H. B., Machine Company.	4

## VENEER MACHINERY.

Coe Manufacturing Company.	39
----------------------------	----

## LOGGING MACHINERY.

Clyde Iron Works.	36
Lidgerwood Mfg. Company.	41
Overpack, S. C.	46
Russell Wheel & Foundry Co.	45

## DRY KILNS AND BLOWERS

Morton Dry Kiln Company.	42
--------------------------	----

## LUMBER INSURANCE.

Adirondack Fire Insurance Co.	1
Lumber Insurance Company of New York	1
Lumber Mutual Fire Insurance Company, Boston.	1
Lumber Underwriters.	1
Pennsylvania Lumbermen's Mutual Fire Insurance Company.	32
Rankin, Harry, & Co.	32
Toledo Fire & Marine Ins. Co.	1

## SAWS, KNIVES AND SUPPLIES

Atkins, E. C., & Co.	38
Hanchett Swage Works.	36
Champion Saw Company.	35 & 41
Shimer, S. J., & Sons.	41

## MISCELLANEOUS.

Barroll, H. C., & Co.	10
Childs, S. D., & Co.	35
Lacey, J. D., & Co.	48
Lumbermen's Credit Association.	48
Pease Company, The.	42
Schenck, C. A., & Co.	42
Standard Audit Company.	6

# CHICAGO VENEER COMPANY

(INCORPORATED)

BURNSIDE, KENTUCKY

## Bored Poplar Posts for Porch Columns

66 to 96 INCHES LONG, 8 and 10 INCHES DIAMETER

Write us for Prices and Particulars

# "DEFIANCE" WOOD-WORKING MACHINERY

COMPLETE EQUIPMENTS OF  
**HIGH GRADE TOOLS**

FOR MAKING

Hubs, Spokes, Wheels,  
Wagons, Carriages,  
Rims, Shafts, Poles,  
Neck-Yokes,

Single Trees, Hoops,  
Handles, Bobbins, Spools,  
Insulator Pins and  
Oval Wood Dishes.

INVENTED AND BUILT BY

The **DEFIANCE MACHINE WORKS**  
DEFIANCE, OHIO.

Send for 500 Page Catalogue

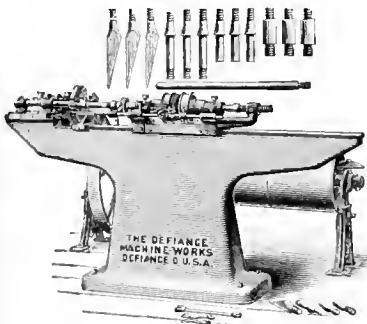

Automatic Threading Machine.

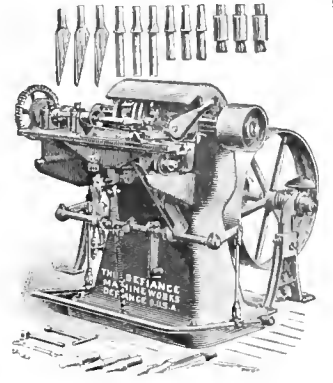

Insulator Pin Lathe.

## KNIVES

A man who has been in the presence of angels discloses the fact by his action: Just one reason for our talking good machine knives, good veneer knives or knives of any kind that do good work.

**CHAMPION SAW COMPANY,**  
BEAVER FALLS, PA.

## HARDWOOD TIMBER

There is no section with so fine and large a supply of hardwood timbers of various kinds left for the lumbermen as that portion of the South in Alabama, Georgia, Kentucky, Mississippi, North Carolina, South Carolina, Tennessee and Virginia served by the lines of the

Southern Railway  
and  
Mobile & Ohio Railroad

There are oak, poplar, hickory, gum, cypress, ash, elm, buckeye, balsam, spruce, chestnut, and other varieties. There are also available pine lands.

These timber resources and many other important features bearing on the cost of manufacture and marketing give special advantages and opportunities for EVERY KIND of WOOD USING INDUSTRY. We have information about the best locations in the country at towns in these States and in Southern Indiana and Southern Illinois, which will be given if requested. All correspondence in regard to timber lands or factory locations will be given prompt and confidential attention. Address your nearest agent.

M. V. RICHARDS,  
Land and Industrial Agent,  
Washington, D. C.  
CHAS. S. CHASE, Agent,  
622 Chemical Building,  
St. Louis, Mo.  
M. A. HAYS, Agent,  
225 Dearborn Street,  
Chicago, Ill.

## BLISS=COOK OAK COMPANY

BLISSVILLE, ARK.

MANUFACTURERS

**Hardwood  
Lumber**  
and  
**Flooring**

We manufacture 15,000,000 feet of Oak Lumber per year for export and domestic markets, from 3/8 to 4 inches thick.

Also Quartered and Plain Polished Oak Flooring, kiln dried, end matched, hollow back.

Mills and Flooring Plants at  
SHULTS AND BLISSVILLE, ARKANSAS

GUS. KITZINGER  
**Michigan Hardwoods**  
By Car or Cargo. Manistee, Mich.

## Novelties for Advertisers

FOBS, POCKET PIECES,  
BUTTONS,  
LETTER OPENERS, SCARF PINS,  
TRAYS, ALUMINUM GOODS,  
PAPER WEIGHTS.

**ALL NEW IDEAS**

Send us 50c and we will send you a  
Beautiful Watch Fob

**S. D. CHILDS & CO.**  
200 Clark Street, CHICAGO



WALNUT.  
OAK,  
ASH,  
POPLAR.

You want to reach Buyers of  
**FURNITURE LUMBER**

**The HARDWOOD RECORD**

will do it for you.



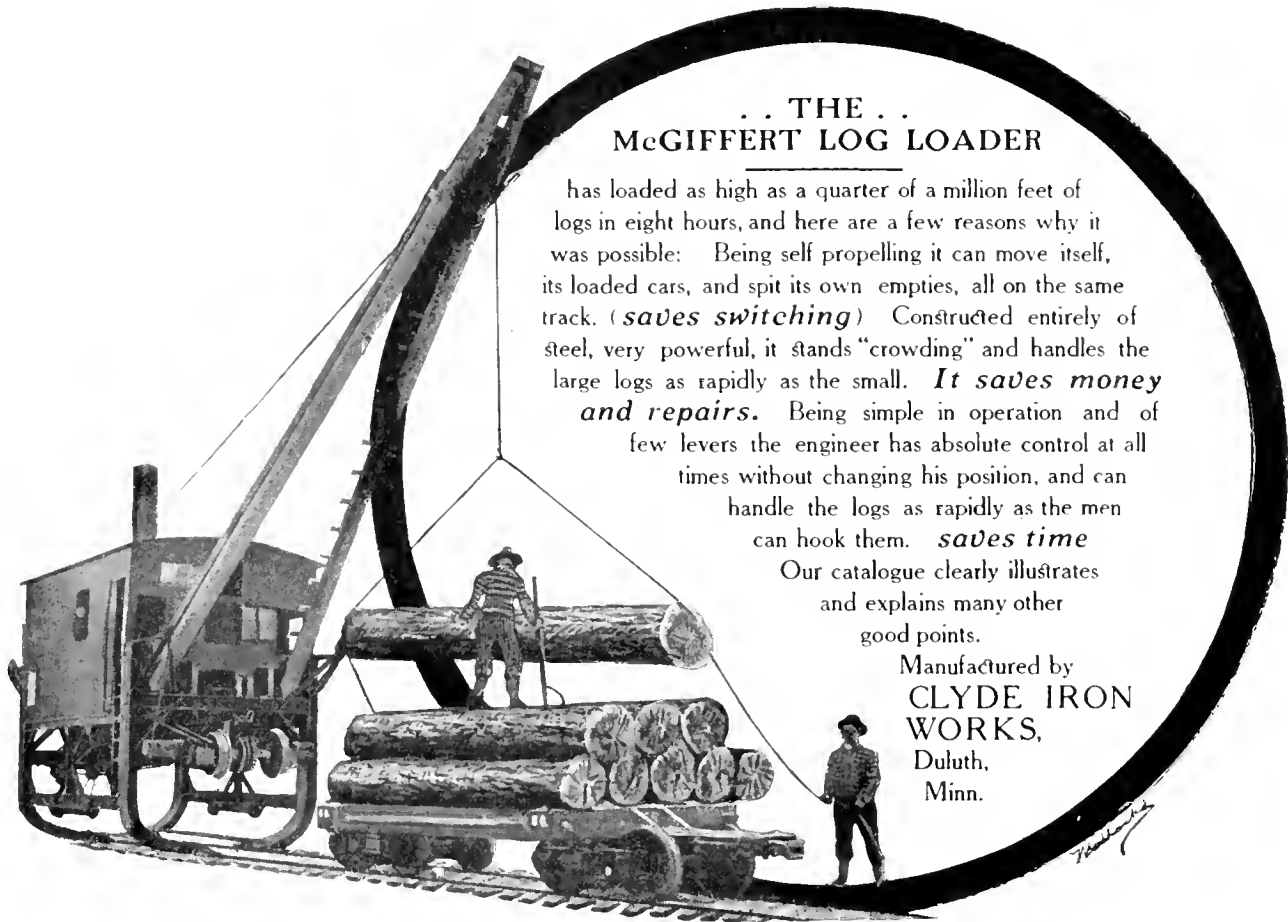

... THE ...  
**McGIFFERT LOG LOADER**

has loaded as high as a quarter of a million feet of logs in eight hours, and here are a few reasons why it was possible: Being self propelling it can move itself, its loaded cars, and spit its own empties, all on the same track. (*saves switching*) Constructed entirely of steel, very powerful, it stands "crowding" and handles the large logs as rapidly as the small. *It saves money and repairs.* Being simple in operation and of few levers the engineer has absolute control at all times without changing his position, and can handle the logs as rapidly as the men can hook them. *saves time*

Our catalogue clearly illustrates and explains many other good points.

Manufactured by  
**CLYDE IRON WORKS,**  
Duluth,  
Minn.

**-UP=TO=DATE-**

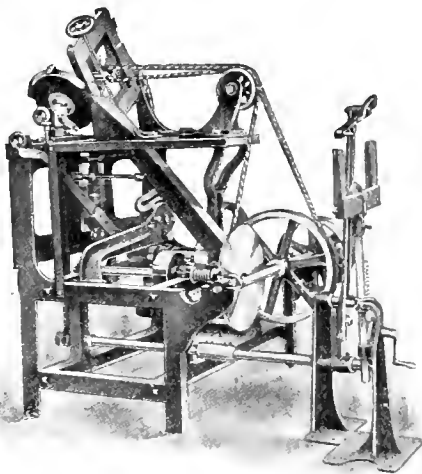

**Hanchett Automatic Band Saw Sharpener**

This is one of our full line of modern filing room machinery. Let us send you our new Catalogue No. 10.

**HANCHETT SWAGE WORKS**

BIG RAPIDS, MICH.

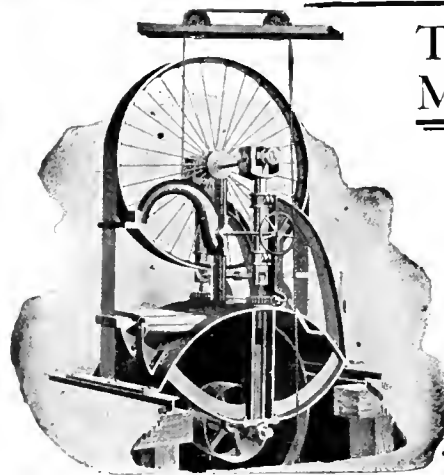

**Ten per cent  
More Profit**

The profits of a saw mill can readily be increased ten per cent by using a band mill instead of a rotary. The price of this mill with six foot wheels for saws eight inches wide is readily within the reach of all. It cuts smooth and perfect lumber and has a capacity of 25,000 feet to 35,000 feet per day. It runs with less expenditure of power than a rotary and puts only half as much of the log into saw dust as does the circular saw.

**PHOENIX MFG. COMPANY,**  
EAU CLAIRE, WIS.

**FRAMES FOR HARDWOOD RECORD SUPPLEMENTS**

Complete with backing, but without the glass, made from Flemish Oak, are to be had delivered by express, charges prepaid to any point east of the Missouri river, at 50 cents each; or at the HARDWOOD RECORD office, at 30 cents each. Prepay orders with two-cent stamps or postal notes, addressed

Hardwood Record, 355 Dearborn Street, Chicago

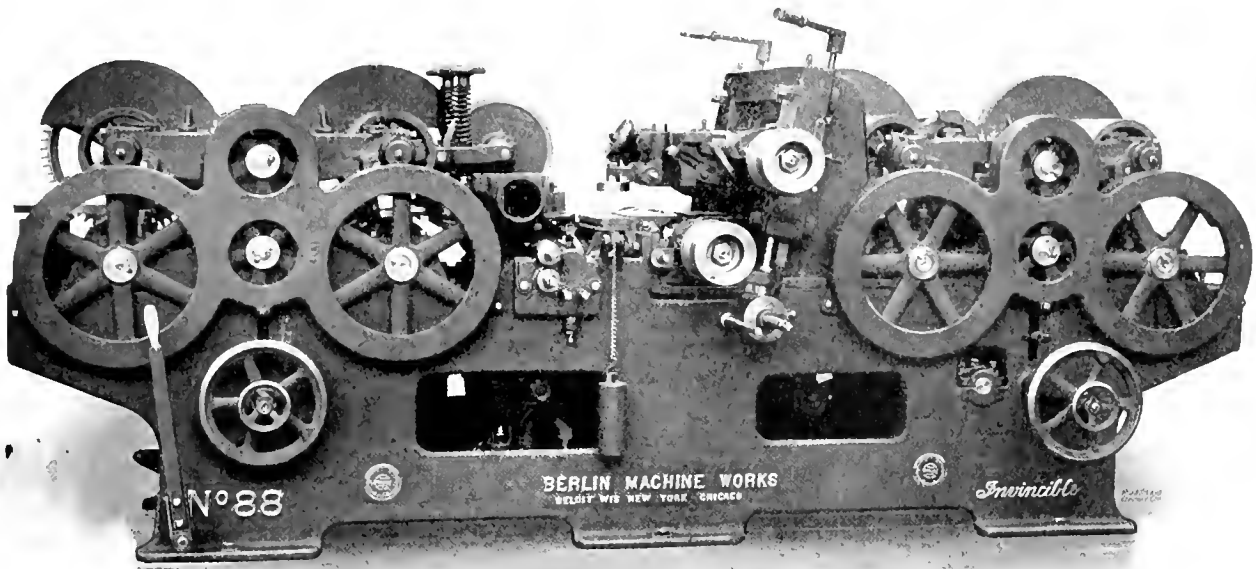

## Berlin No. 88 Hardwood Matcher

The only machine in existence capable of producing the highest grade of hardwood flooring at fast feeds.

The entire frame is cast in one piece, forming a solid foundation for all working parts.

When we ship a No. 88, no matter whether the distance is 50 or 5,000 miles, we know all the working parts will be in alignment and the machine ready for work when it arrives at its destination.

There's a lot of satisfaction in that for us—how about you?

But the frame is not the only part of the machine that's built to stand hard knocks.

The cutter heads, on which there is a great strain, are so constructed that there is no chance for vibration.

The top and bottom cylinders are placed very

close to each other, so that the thickness of stock is absolutely uniform.

The pressure bar after the cut of the top head and over the lower one is built in one piece—no chance for vibration and another help to make the thickness of finished stock uniform.

The "Side-Head Hold Down" is another one of the good features.

Two narrow rollers hold the stock tight to the bed at the point where the side heads cut. A perfect match is the result.

Stock having short crooks in it is matched without any trouble, for we have crowned the bed piece directly below these rollers to meet this condition.

We shall be glad to send you a large picture and complete description of this machine if you are interested.

What is your address?

## THE BERLIN MACHINE WORKS, Builders

Beloit, Wisconsin, U. S. A.

BRANCHES: NEW YORK, CHICAGO, BOSTON, SAN FRANCISCO, SEATTLE, NEW ORLEANS and MACON, GA.

The  
Happy  
Woodsmen  
and His

**Atkins**

Saw



He knows a good saw  
when he sees it.

Your dealer has  
them or write us.  
"Happy Woodsmen"  
Booklet, by  
mail, free.

**E. C. Atkins  
& Co., Inc.**

The Silver Steel  
Saw People

Home Office and Factory:  
**INDIANAPOLIS, IND.**

BRANCHES:  
CHICAGO,  
MINNEAPOLIS,  
ATLANTA,  
MEMPHIS,

Six other Branches in U. S.  
and Canada.

Cuts faster—easier—  
Goes longer without sharpening.

**It's Silver Steel** 

that's why.

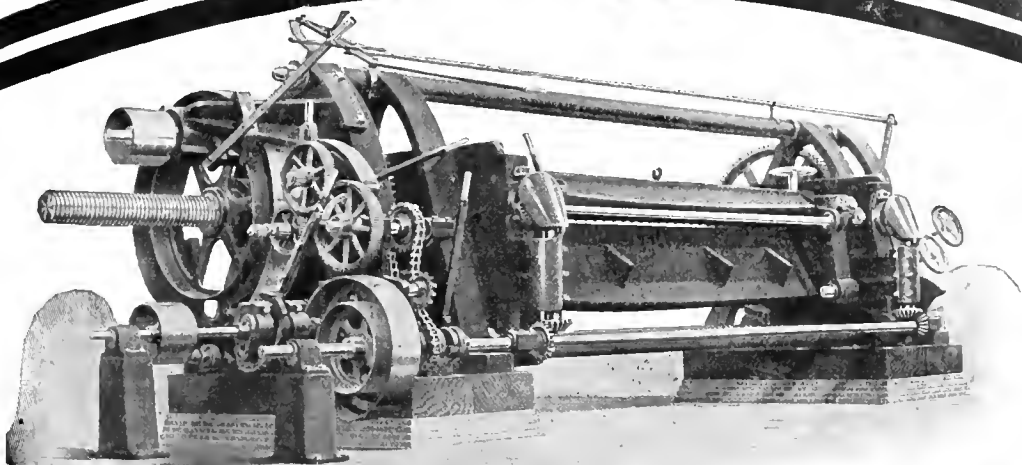

## The 100" Veneer Cutter

is rapidly becoming the standard for fine work. There are five times as many of our 100 in. machines in use than those of other manufacturers put together. The following are a few of our more recent orders for these machines:

Asheville Veneer Co., Pittsburg & Southern Veneer Mfg. Co., H. C.

Hossafous, Escanaba Woodenware Co., Theo. Kundtz, American Veneer & Lumber Co., Set-



ter Bros. Co., Salamanca Veneer & Panel Co., Falconer Veneer Co., White Veneer Co., Choctaw Lumber & Veneer Co., Louisville Veneer Mills, Mayhew-Compo Board Company.

What more eloquent testimonial of the popularity of our machines can we give? There are all sorts of reasons why our 100 in. Cutters are the best, but space compels us to refer you to our No. 5 Catalog for these. Write for a copy. It is a valuable book for the veneer men or timber owners.

**The Coe Manufacturing Co.** 105 Bernard Street **Painesville, O.**

# American No. 50 Improved Double Surfacar

Capacity 26" or 30" wide by 8" thick. Four Rolls. Heavily geared. Infeeding roll divided into four sections. No. 51 is built as a Six Roll Machine, 30" x 8". Address nearest salesroom for full particulars.

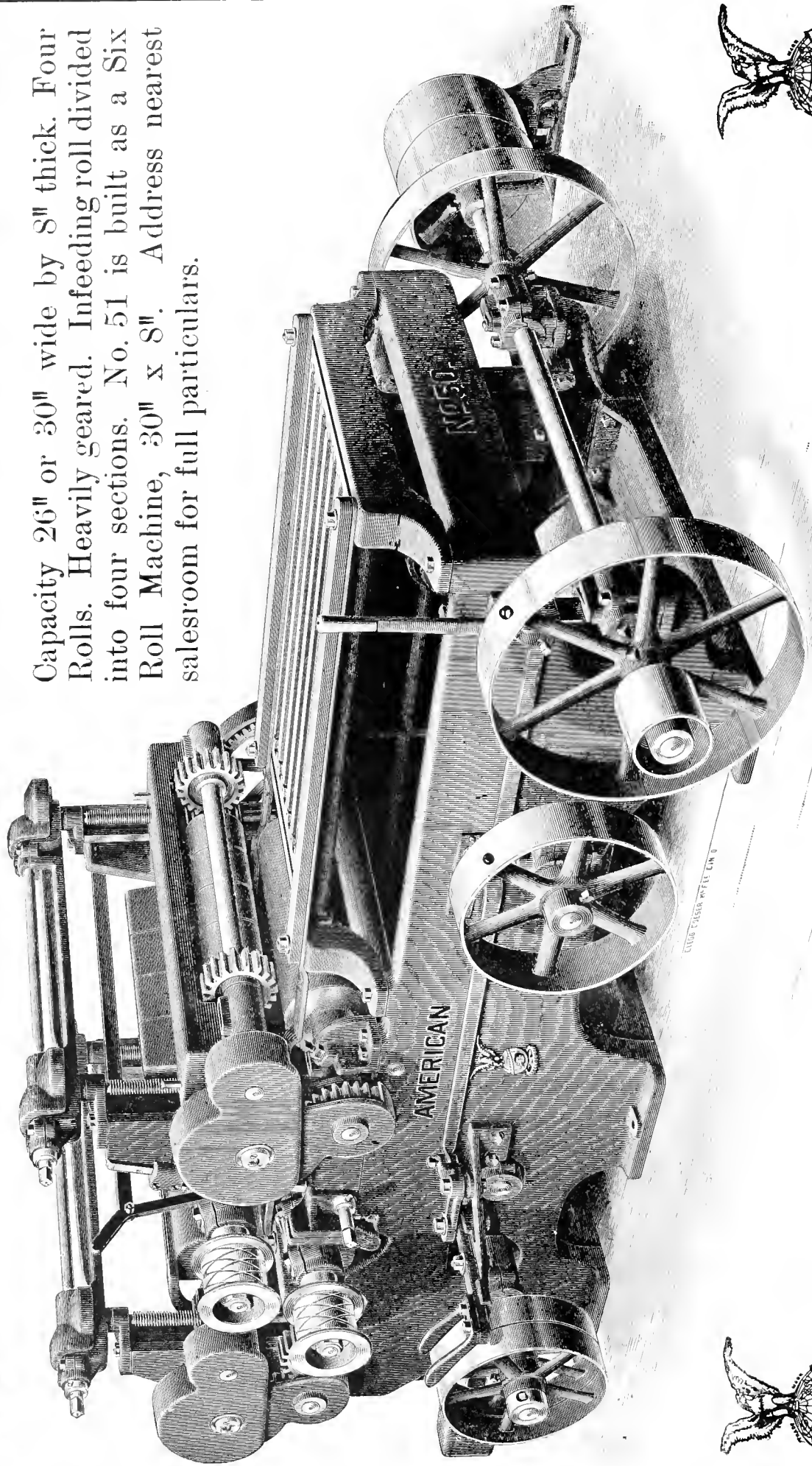

U.S. PAT. OFF. DES. 1875-1876

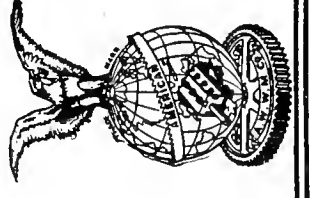
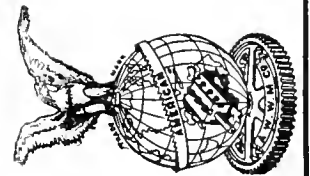

**AMERICAN WOOD WORKING MACHINERY CO.**

NEW ORLEANS

CHICAGO

NEW YORK



# Schultz Brothers & Cowen

WE ARE IN THE MARKET TO BUY

**POPLAR—OAK—ASH—CHESTNUT**

AND OTHER HARDWOODS—ALL GRADES AND THICKNESSES

1225 to 1240 OLD COLONY BUILDING, - - - - -

CHICAGO

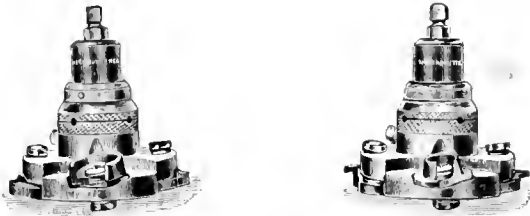

## MILL MEN! STOP THE LEAKS!

You would not tolerate leaks in your boiler and system of steam pipes because you burn coal without receiving value therefor, and sustain not only inconvenience and absolute loss, deterioration of property through neglect as well. Yet you permit a good workman to labor earnestly and faithfully, but unsuccessfully, in an endeavor to make things count by sharpening and fitting Straight Bits day after day, resulting in needless waste of time and effort, when The Shimer Cutter Heads and Bits will save all of the fitting. Do you see the force of this comparison?

Stop the little Leaks that Curtail your Output.  
Use the Shimer Cutter Heads.

It has been demonstrated many times that monies invested in a small outfit of The Shimer Cutter Heads will save their cost in a few weeks use. They are built for business, having within their makeup the principles required to reduce to a system the routine of keeping the knives in perfect order. Address:

**SAMUEL J. SHIMER & SONS,**  
MILTON, PENNSYLVANIA

# SAWS

You will know positively of the merits and economy of these band saws when you have tried them out.

Our service to you means economy—rational saving.

**CHAMPION SAW CO.**

BEAVER FALLS, PA.

# LIDGERWOOD MACHINES

WILL STOCK YOUR MILL

SKIDDERS  
SNAKERS  
YARDERS

LOADERS  
PULL BOATS  
CABLEWAYS

**LIDGERWOOD MFG. CO.**

96 Liberty St., New York.

NEW ORLEANS

ATLANTA

SEATTLE





# EASTERN TENNESSEE—WESTERN NO. CAROLINA

ASHEVILLE KNOXVILLE BRISTOL

## HARDWOODS

From the famous Asheville district:  
Superior in quality, manufacture and  
gradings. For stock list and prices,  
address

**J. S. COLEMAN LUMBER CO.**  
ASHEVILLE, N. C.

## Fry-Buchanan Lumber Co.

INCORPORATED.

Manufacturers and Wholesalers  
**Hardwood Lumber**

Choicest Varieties. ∴ Full Grades.

POPLAR SQUARES  
A Specialty.

Asheville, N. C.

## All Lumbermen, Attention!

We do what you can't do.  
We measure your stumpage correctly.  
We make your maps correctly.  
Bank references: Asheville, N. C.

**C. A. Schenck & Co.** Biltmore,  
North Carolina.

## On the Spot

We are located right in the heart of this moun-  
tain country producing the best hardwoods in  
existence.

We are headquarters with ample stock, and  
can interest you both as to assortment and  
price. Write us.

**American Lumber Company**

ASHEVILLE, N. C.

## Vestal Lumber & Mfg. Co.

Manufacturers and Wholesalers  
of all kinds of

## HARDWOODS

BEVELED SIDING A SPECIALTY.  
UNSURPASSED FACILITIES  
FOR DELIVERING.

Knoxville  
Tennessee

## The Morton Dry Kiln

MOIST AIR SYSTEM

Recording  
Ther-  
mometers.  
Transfer  
Cars.

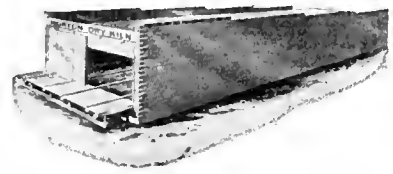

Trucks.  
Canvas  
Doors.

**HOW TO DRY LUMBER**

As exemplified in our Catalog D. Free on application.

**MORTON DRY KILN CO., Chicago, Ills.**

## Wood Working Plants

Manufacturers seeking locations for Saw  
Mills, Stave and Heading Factories and  
other Wood Working Plants in the Cen-  
tral Southern States, can secure full and  
accurate information as to Sites, Timber  
Tracts, Fuel, Transportation Facilities,  
etc., by addressing

G. A. PARK, General Immigration and Industrial Agent,  
**Louisville & Nashville Railroad Company**  
LOUISVILLE, KENTUCKY

## Industries are Offered Locations

WITH SATISFACTORY INDUCEMENTS, FAVORABLE  
FREIGHT RATES, GOOD LABOR CONDITIONS,  
HEALTHFUL COMMUNITIES, on the lines of

**The Illinois Central R. R. and the  
Yazoo & Mississippi Valley R. R.**

For full information and descriptive pamphlet address

J. C. CLAIR, Industrial Commissioner, 1 Park Row, Chicago, Ill



# INDIANA



WHERE THE BEST HARDWOODS GROW

THE WOODS FOR WHICH INDIANA IS FAMOUS.

Quart'r'd White Oak

Plain White Oak

Quartered Red Oak

Plain Red Oak

White Ash

Poplar

Black Walnut

Cherry

Sycamore

Red Gum

Hickory

Beech

Maple

Veneers of

Indiana Hardwoods

## J. V. STIMSON

All Kinds of Hardwood Lumber Manufactured

HUNTINGBURG, IND.

## YOUNG & CUTSINGER

Manufacturers and Wholesalers

Our Specialty Fine Figured Quartered Oak

EVANSVILLE, IND.

## CHARLES H. BARNABY

Manufacturer of Band Sawed Hardwoods

Quarter Sawed Indiana White Oak a Specialty

GREENCASTLE, IND.

## D'HEUR & SWAIN LUMBER CO.

Manufacturers and Wholesalers

Our Specialty Quartered Oak and Sycamore

SEYMOUR, IND.

## LONG-KNIGHT LUMBER CO.

MANUFACTURERS AND DEALERS

Quarter Sawed White and Red Oak a Specialty

INDIANAPOLIS, IND.

## MALEY & WERTZ

Manufacturers, Wholesalers and Exporters of Hardwood Lumber

EVANSVILLE, IND.

## FULLERTON-POWELL HARDWOOD LUMBER CO.

SOUTH BEND, IND.

## PERRINE-ARMSTRONG CO.

Long Timber up to 60 feet—Hardwood Specialties

The largest Band Mill in Indiana.

FORT WAYNE, IND.

**WISCONSIN**  
WHERE THE FINEST NORTHERN HARDWOODS GROW

**C. P. CROSBY**  
RHINELANDER : : WISCONSIN

**Wholesale Hardwood Lumber**

Hard Maple a Specialty in all thicknesses from 1 inch to 4 inch. Finest Birch in Wisconsin. Black Ash, Rock Elm, Soft Elm, Red and White Oak. : :

DIFFICULT AND MIXED ORDERS A SPECIALTY

**Special Attention**

Is called to the following, and to the close prices made on same upon receipt of your inquiries:

50M ft. 2" Com. and Bet. Plain Birch 80M ft. 2½" Com. and Bet. Plain Birch 100M ft. 1" 1sts and 2nds Plain Birch 150M ft. 1" No. 1 Com. Plain Birch 12M ft. 2" 1sts and 2nds Red Birch 200M ft. 2" Com. and Bet. Hard Maple	50M ft. 2" Bridge Plank 30M ft. 1½" No. 2 Com. & Bet. Hickory 30M ft. 1½" No. 2 Com. & Bet. Hickory 100M ft. 1" Com. & Bet. Plain Red Oak 150M ft. 1" Com. & Bet. Qtd. Red Oak 10M ft. 1" No. 3 Com. & Bet. Walnut 75M ft. 1½" No. 2 Com. & Bet. Elm 150M ft. 1" No. 1 Com. Red Gum
--	--

Above is all cut from choice Wisconsin timber, is bone dry and well manufactured. Above is choice Southern stock.

In addition to the foregoing, we have full stocks of Basswood, Birch and Soft Elm and a full selection of Red and Sap Gum. We guarantee our grades to be made strictly in accordance with National Hardwood Association rules of inspection.

**G.W. JONES LUMBER CO., Appleton, Wis.**

MIXED CARS - EVEN GRADES - PROMPT SHIPMENT

**Wisconsin Hardwoods**

SPECIAL OFFERINGS:  
 1" No. 1 Common and Better Birch (Red in)  
 1" No. 1 Common and Better Basswood  
 1" No. 1 Common and Better Hard Maple  
 Also Elm, Pine, Cedar Products, and "SHAKELESS" Hemlock.

**John R. Davis Lumber Company**  
PHILLIPS, : : : : WISCONSIN

**BRITTINGHAM & YOUNG CO.**

**Hardwood Lumber**  
Manufacturers and Wholesalers

MADISON, . . . WISCONSIN

Send us a list of your wants.  
No trouble to answer correspondence.

**ARPIN HARDWOOD LUMBER CO.**  
GRAND RAPIDS, - - - WISCONSIN  
Saw and Planing Mill at Atlanta, near Bruce, Wis., on Soo Lines.

Manufacturers

**Wisconsin Hardwoods**  
PINE AND HEMLOCK

WRITE US FOR PRICES ON  
 1", 1¼", 1½", 1¾" and 2" Plain and Red Birch; Red Birch Flooring and 1" to 2" Quarter Sawed Red Oak; Basswood Ceiling and Siding; 1" Birdseye Maple; Birch, Maple and Hardwood Flooring.

**VOLLMAR & BELOW**  
MARSHFIELD, WISCONSIN

**Basswood, Birch**  
and Other Wisconsin Hardwoods

LET US KNOW WHAT YOU ARE IN THE MARKET FOR

<p><b>NORTHERN STOCK</b></p> <p>Hemlock Birch Basswood Rock Elm Soft Elm Ash Oak</p>	<p><b>SOUTHERN STOCK</b></p> <p>Quartered White and Red Oak Plain White and Red Oak Sycamore Poplar Cypress Gum</p>
--	---

**PAGE & LANDECK LUMBER CO.**  
Wells Building - - - MILWAUKEE, WIS.

**North Western Lumber Co.**  
General Offices EAU CLAIRE, WIS. Mills at STANLEY, WIS.

BAND SAWED

**Wisconsin Hardwoods**  
CAREFUL GRADINGS, PROMPT SHIPMENTS

SPECIAL OFFERINGS:

3 cars 1½" to 2" Scoot Hardwood. 1 car 1½" No. 1 Common Basswood. 1 car 1½" 1st and 3d Clear Basswood.	½ car 2" 1st and 3d Clear Basswood. Large stock No. 2 Common Birch. Large stock No. 3 Common Birch.
--	---

# CLEVELAND

HARDWOOD DISTRIBUTING CENTER OF NORTHERN OHIO

## MARTIN-BARRISS COMPANY

Importers and Manufacturers

### MAHOGANY AND FINE HARDWOODS

## We Solicit Inquiries

FOR THE FOLLOWING:

- 2 cars 1x4" Clear Birch Strips
- 2 cars 1x5" and 6" Clear Birch Strips
- 1 car 3" No. 1 Com. and Better Birch, unselected
- 1 car 1" 1sts and 2nds Curly Red and White Birch
- 2 cars 1x1" Clear Basswood Siding Strips
- 2 cars 1x5" and 6" Clear Basswood Siding Strips

## The King & Bartles Lumber Company

1955-2025 Scranton Road N. W., Cleveland, Ohio

## THE ROBERT H. JENKS LUMBER COMPANY

### FOR SALE

- 60 M feet 1" 1st and 2ds Poplar
- 223 M feet 1" No. 1 Common Poplar
- 125 M feet 1" No. 2 Common Poplar
- 26 M feet 2" 1st and 2nd Poplar, 14" and up
- 125 M feet 8 4" Sound Wormy Chestnut
- 275 M feet 1" Sound Wormy Chestnut
- 153 M feet 1" 1st and 2nd Plain White Oak
- 85 M feet 1" 1st and 2nd Plain Red Oak
- 125 M feet 1" No. 1 Common Plain Red Oak

**Quartered White and Red Oak.**—We have a good assortment of dry stock,  $\frac{3}{8}$  to  $\frac{1}{4}$  inches thick. Your inquiries solicited.

**Plain White and Red Oak.**—A limited amount of nice stock, ready for shipment.

## Do You Want It? What? Money?

What have you in lumber to exchange for it? We want particularly Plain Oak, Chestnut, Poplar, Basswood, Ash.

What Have You?

## The Advance Lumber Co.

13th Floor  
Rockefeller Bldg. CLEVELAND, OHIO

Memphis Office, No. 56 Randolph Building.

J. E. MEADOWS, Mgr.

# RUSSEL WHEEL & FOUNDRY COMPANY

Builders of  
**Logging Cars**  
And **Logging  
Machinery**

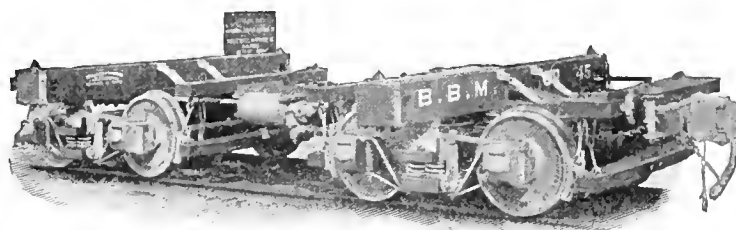

ARE ALWAYS PLEASED TO  
HAVE OPPORTUNITY OF  
POINTING OUT ADVAN-  
TAGES OF THEIR  
EQUIPMENT.

Detroit, Mich.

# MICHIGAN

FAMOUS FOR HARD MAPLE AND GREY ELM

## SALLING, HANSON & CO.

MANUFACTURERS OF

### Michigan Hardwoods

GRAYLING, MICHIGAN

## "Chief Brand" Maple Flooring

Will commend itself to you and your trade on its merits alone. \* Comprises all the features desirable in good flooring. † Made by the latest, most approved machinery methods and best skilled labor. ‡ We believe we can make it to your interest to handle our "Chief Brand" and will appreciate your inquiries.

### Kerry & Hanson Flooring Co.

GRAYLING, MICHIGAN

"THE THICK MAPLE FOLKS"

## BROWNLEE & COMPANY

DETROIT MICHIGAN

TWO-INCH SOFT MAPLE  
TWO-INCH BASSWOOD  
THREE-INCH HARD MAPLE

## JUNE STOCK LIST

MAPLE		BIRCH		BASSWOOD	
1 1/4 in.	2,000,000 ft.	1 in.	500,000 ft.	1 in.	300,000 ft.
1 1/2 "	100,000 "	1 1/2 "	100,000 "	1 1/4 "	30,000 "
2 "	1,000,000 "	2 1/2 "	50,000 "	1 1/2 "	50,000 "
2 1/4 "	200,000 "	3 "	75,000 "	3 "	4,000 "
2 1/2 "	500,000 "	ROCK ELM		GRAY ELM	
3 "	500,000 "	2 in.	25,000 ft.	1 in.	300,000 ft.
4 "	400,000 "	2 1/4 "	50,000 "	1 1/2 "	200,000 "
BEECH		WHITE MAPLE		3 "	200,000 "
1 in.	500,000 ft.	End Piled		ASH	
1 1/4 "	250,000 "	1 in.	100,000 ft.	1 in.	500,000 ft.
1 1/2 "	400,000 "	1 1/2 "	20,000 "		
2 "	100,000 "	2 "	50,000 "		
2 1/2 "	200,000 "				

KELLEY LUMBER & SHINGLE CO., Traverse City, Mich.

W. H. WHITE, Pres.  
JAS. A. WHITE, Vice-Pres.

W. L. MARTIN, Secy.  
THOS. WHITE, Treas.

## W. H. WHITE COMPANY

BOYNE CITY, MICHIGAN

Manufacturers of Hardwood and Hemlock Lumber, Cedar Shingles,  
White Rock Maple Flooring.

## Michigan Logging Wheels



Have made them 23 years and know how. Easy and cheap way of logging. **S. C. OVERPACK** MANISTEE, MICHIGAN

## DENNIS & SMITH LUMBER CO.

### Wholesale Hardwood Lumber

Office and Yards, FOURTH AND HOLDEN AVENUES,  
DETROIT, MICH.

MILLS AT: Heaters, W. Va. Valley Bend, W. Va. Diana, W. Va. Parkersburg, W. Va. McNutt Siding, W. Va.

**M I C H I G A N**  
FAMOUS FOR RED BIRCH AND BASSWOOD

**OUR MAPLE FLOORING**

is as near perfection, in every particular, as it is possible to make it, for we personally supervise every step in its manufacture, from the stump to the shipping of the finished product. Our prices will interest and a trial convince you.

**HAAK LUMBER COMPANY**  
HAAKWOOD, MICHIGAN

**Hackley-Phelps-Bonnell Co.**

MANUFACTURERS OF

**Northern and Southern  
Hardwood Lumber**

Main Office, Michigan Trust Company Building  
GRAND RAPIDS : : : MICHIGAN

**DENNIS BROS.**

GRAND RAPIDS, : : : MICHIGAN

MANUFACTURERS OF

**Hardwood Lumber, Perfect  
Birch and Maple Flooring**

DRY STOCK AT BAROAIN PRICES:

2 cars 8/4 Basswood, No. 1 Common and Better.	Main Office : 205-209 Michigan Trust Company Building
3 cars 5/4 Basswood, No. 2 Common and Better.	
15 cars 4/4 Birch, No. 1 and 2 Common	
1 car 1x4 Clear Birch Strips.	
2 cars 4/4 No. 3 Common Cherry.	
60M feet 12/4 Hard Maple.	
245M feet 8/4 Hard Maple.	
40M feet 8/4 Hard Maple, No. 3 Common.	

**Thos. MacBride Lumber Company**

HEADQUARTERS FOR

**HARDWOODS**

I N M I C H I G A N

Michigan Trust Building, Grand Rapids, Mich.

**BIRCH**

This is our specialty. We are in the heart of the best Birch section. Have good stock, Common and better, 4-4, 5-4, 6-4, 8-4, 10-4, 12-4, and 16-4. Let us figure with you.

**Simmons Lumber Company**  
SIMMONS, MICHIGAN

**McCLURE LUMBER COMPANY**

MANUFACTURERS OF

**Hardwoods**

Main Offices, DETROIT, MICH.  
Mills, : EUTAW, ALA.

SPECIAL OFFERINGS:

3 cars 2" Red and White Oak	2 cars 2" Black Ash
3 cars 2", 2 1/2", 3" and 4" White Ash	10 cars 1" to 4" Dry Hard Maple
2 cars 1" 6, 4 White Ash	5 cars 1" Log Run Birch
1 car 6 4 and 8 4 Hickory	

**BOYNE CITY LUMBER COMPANY**

BOYNE CITY

**MICHIGAN ROCK MAPLE and other HARDWOODS**

LARGE CAPACITY PROMPT SHIPMENTS RAIL OR CARGO

 **J. S. GOLDIE**

Cadillac, : : Michigan.

SPECIAL PRICES on 500M pieces  
1" to 3" Maple Squares 16" to 27" long.  
1" to 3" Soft Elm Lumber.

INQUIRIES SOLICITED FOR MICHIGAN LUMBER.

**SOFT ELM AND ROCK ELM**

FOR SALE BY

**The R. G. Peters Salt & Lumber Co.**  
EASTLAKE, MICHIGAN

**VAN KEULEN & WILKINSON LUMBER COMPANY**

Manufacturers and Wholesalers of

**HARDWOOD LUMBER and CRATING STOCK**

Complete Stocks of Michigan Hardwoods—Maple, Beech, Birch, Elm, Ash and Basswood for sale.

Grand Rapids, : : : Michigan



# CINCINNATI

THE GATEWAY OF THE SOUTH

## WANTED

Oak  
Walnut  
Gum  
Cottonwood  
Poplar  
White Pine  
Hemlock  
Yellow Pine

Will inspect at shipping point when quantity justifies and pay cash. Can use entire mill cuts. Write us before selling elsewhere. We can also handle mixed cars of dressed stock. Send us your list with prices.

**Kentucky Lumber Co.**

Suite 508 First National Bank Bldg.

Cincinnati, Ohio.

Formerly of Burnside, Ky.

## "BUY GUM"

We are in the market to buy Dry Gum Lumber in any quantity, from a single car load to a million feet. Will take all grades and thicknesses. We receive lumber at shipping point, pay cash and are liberal in inspection.



**THE FARRIN-KORN LUMBER COMPANY**

General Office, Yards,  
Planing Mills, Dry Kilns,  
Cincinnati, Ohio  
Purchasing Office,  
Randolph Building,  
Memphis, Tenn.  
Cypress Red Gum Oak

FRAMES,  
SASH, DOORS,  
BLINDS, MOULDINGS,  
COLUMNS, GLASS,  
STAIRWORK,  
INTERIOR TRIM.



PAINTS,  
BUILDERS' HARDWARE,  
MANTELS, ETC.  
LARGE CINCINNATI FAC-  
TORIES MAKE PROMPT  
SHIPMENTS POSSIBLE.

**THE GENERAL LUMBER COMPANY**

**HARDWOODS**  
HEMLOCK, YELLOW PINE.

**COLUMBUS**

**OHIO**

## PLAIN OAK—BASSWOOD

Are what we want. All thicknesses and grades. Spot cash. Send us list of your offerings with prices.

**DUHLMEIER BROS.,**

**CINCINNATI, O.**

The only trade paper reaching all classes of hardwood consumers

**HARDWOOD RECORD**  
355 Dearborn St., Chicago

## CYPRESS LUMBER CO.

Manufacturer of Hardwoods and Cypress

Plain and Quartered White and Red Oak, Yellow Poplar, Yellow Pine, Walnut, etc. Mills in Tenn., Ala. and Va.

OFFICE AND YARDS, GEST AND DALTON AVE., CINCINNATI, OHIO.

# Save Your Money

By Using the

## RED BOOK

Published Semi-Annually  
in January and July

It contains a carefully prepared list of the buyers of lumber in car lots, both among the dealers and manufacturers.

The book indicates their financial standing and manner of meeting obligations. Covers the UNITED STATES and MANITOBA.

The trade recognizes this book as the authority on the lines it covers.

A well organized Collection Department is also operated and the same is open to you.

WRITE FOR TERMS.

**LUMBERMEN'S CREDIT ASSOCIATION,**  
ESTABLISHED 1878.

1402 Great Northern Building, CHICAGO  
18 Broadway, - - NEW YORK CITY

# LOCATIONS FOR NEW INDUSTRIES

can be secured on the lines of the

## Chicago, Milwaukee & St. Paul Railway

In the great middle west. It reaches the Copper Country and the pine and hardwood areas of Northern Michigan, the lead, zinc and iron regions of Wisconsin, the coal fields of Illinois, Iowa and Missouri.

Traverses the great agricultural and manufacturing states of Iowa, Minnesota, North and South Dakota. Operates 7,000 miles of thoroughly equipped railroad.

Correspondence is solicited with eastern manufacturers who desire to move their factories to, or establish branches in the West. Co-operation with Business Men's Associations on the lines of this railway in all matters affecting mutual interests is assured.

Inquiries should be as definite as possible.

Address

**Industrial Department**  
**Chicago, Milwaukee & St. Paul Railway,**  
**Room 1327, Railway Exchange**  
**Chicago**

# CINCINNATI

THE GATEWAY OF THE SOUTH

IN THE MARKET FOR

## OAK—ASH—POPLAR

ALL GRADES AND THICKNESSES

### MOWBRAY & ROBINSON

Office:  
1219 West Sixth Street

Yards:  
Sixth Street, below Harriet

Poplar, Oak,  
Ash, Chestnut,  
Sycamore,

W. Va. Spruce,  
Pine and Elm

## C. Crane & Co.

We would like to buy

2,000,000 feet Dry Oak  
2,000,000 feet Dry Poplar

Mostly heavy stock. Quotations Solicited.

BILLS AND YARDS  
CINCINNATI, O.

YEARLY CAPACITY  
100,000,000 FT.

LONG BILL STUFF  
A SPECIALTY

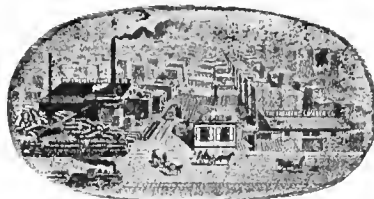

### THE FREIBERG LUMBER CO.

Manufacturers of

Tabasco Mahogany  
Walnut, Oak

Poplar, McLean and Findlay Aves.  
CINCINNATI, O.

# THE WIBORG & HANNA COMPANY

CINCINNATI, OHIO

PLAIN  
AND  
QUARTER  
SAWED

## White and Red Oak

CHESTNUT  
POPLAR  
GUM AND  
CYPRESS

Flooring, Siding, Ceiling, Base, Case and Molding. Rough, Dressed and Re-sawed. Mixed Carloads.

## THE MALEY, THOMPSON & MOFFETT CO.

Always in the Market for  
BLACK WALNUT LOGS,  
SELECTED WHITE OAK LOGS,  
LUMBER OF ALL KINDS.

CINCINNATI, : : : OHIO

## L. W. RADINA & COMPANY

Correspondence Solicited with Buyers and Sellers of All Kinds of

### HARDWOODS

Wanted for cash—desirable blocks of 1 inch to 4 inch Poplar, all grades,  
Especially 1½-inch stock, for immediate shipment.

CLARK STREET AND DALTON AVENUE

## Cincinnati Hardwood Lumber Co.

GEST AND SUMMER STREETS

Wholesalers Mahogany, Thin Lumber, Veneers

Finely figured quarter sawed oak veneers a specialty.

## BENNETT & WITTE

MANUFACTURERS OF SOUTHERN HARDWOODS

THAT ARE SOLD  
ON NATIONAL HARDWOOD LUMBER ASSOCIATION  
INSPECTION ONLY.

Plain and Quartered . . } White and Red Oak  
Red and Sap Gum

Cottonwood, Ash, Cypress, Poplar, Soft Maple, Tulelo  
Gum and Chestnut. We cut Gum and Oak in Thick-  
nesses of 3/8 to 4 inches. EXPORT AND DOMESTIC.

224 W. 4th Street, CINCINNATI, OHIO

Branch: 1301-2 Tenn. Trust, Memphis, Tenn.

WHAT HAVE YOU FOR SALE IN

## Red and White OAK Qtd. and Plain

ALSO POPLAR, CHESTNUT, WALNUT, ETC.

JOHN DULWEBER & CO., CINCINNATI, OHIO

## THE E. E. BECK LUMBER COMPANY

Cash Buyers

### Poplar, Oak, Chestnut

And Other Southern Hardwoods

ALL GRADES AND THICKNESSES.

WE BUY MILL CUTS.



# BUFFALO

THE GREAT WHOLESALE LUMBER CENTER OF THE EAST



Manufacturers and  
Dealers in

- Ash  
White and Brown
- Basswood
- Birch  
Red and White
- Butternut
- Cherry
- Chestnut
- Cottonwood
- Cypress
- Elm  
Soft and Rock
- Gum  
Red and Tupelo
- Hickory
- Maple  
Hard and Soft
- Red Oak  
Plain and Quartered
- White Oak  
Plain and Quartered
- Black Walnut
- White Wood  
Poplar



## BEYER, KNOX & COMPANY

ALL KINDS OF HARDWOODS

Office and Yards, 69 LEROY AVENUE

## BUFFALO HARDWOOD LUMBER CO.

We want to buy for cash:  
Oak, Ash and other Hardwoods, all grades and thicknesses.  
Will receive and inspect stock at shipping point.

518 RANDOLPH BLDG., MEMPHIS, TENN.

940 SENECA STREET.

## EMPIRE LUMBER COMPANY

Our specialties are PLAIN and QUARTERED OAK and ASH.

1142 SENECA STREET.

## G. ELIAS & BROTHER

BUY AND CARRY LARGE QUANTITIES OF ALL KINDS OF HARDWOODS

955 TO 1015 ELK STREET

## HUGH McLEAN LUMBER COMPANY

Specialty: INDIANA WHITE OAK

940 ELK STREET

## ANTHONY MILLER

HARDWOODS OF ALL KINDS

893 EAGLE STREET

## SCATCHERD & SON

HARDWOODS ONLY

Yard, 1555 SENECA STREET

Office, 886 ELLICOTT SQUARE

## STANDARD HARDWOOD LUMBER CO.

OAK, ASH AND CHESTNUT

1075 CLINTON STREET

## I. N. STEWART & BROTHER

Specialties: CHERRY AND OAK

892 ELK STREET

## T. SULLIVAN & COMPANY

Specialties: BROWN ASH, BIRCH, PACIFIC COAST FIR AND SPRUCE

50 ARTHUR STREET

## ORSON E. YEAGER

Specialties: OAK, ASH AND POPLAR

932 ELK STREET

# Vansant, Kitchen & Co.



NEW ASHLAND MILL

Old-Fashioned

## SOFT YELLOW POPLAR

Ashland, Ky.

5-8 AND 4-4 IN WIDE STOCK, SPECIALTY

# YELLOW POPLAR

Manufacturers  
BAND SAWED  
POPLAR LUMBER

ALL GRADES

**DRY** 5-8, 4-4, 5-4, 6-4, 8-4, 10-4, 12-4, 16-4  
Bevel Siding, Lath and Squares  
Specialty, Wide Stock.

# LUMBER CO.

COAL GROVE, OHIO, U. S. A.

## W. M. Ritter Lumber Company

COLUMBUS, OHIO

### 6,000 Car Loads

Sawed and shipped yearly of band-sawed Yellow Poplar, White Pine, White Oak, Basswood, Chestnut, Hemlock and Ash. Planing Mill and Dry Kiln. ☛ If you are in a hurry to get your order placed, call our nearest salesman.

Salesman	Headquarters	Telephone
Fred A. Wilson.....	Portsmouth, Ohio.....	Bell 4392
E. E. Eaton.....	New York City, 158 W. 81st St.....	Riverside 7390
James B. Patton.....	Buffalo, N. Y., Rockford Hotel.....	Bryant 1335-R
A. Wallace Irwin.....	Baltimore, Md., Eutaw Hotel.....	
Frank B. Pryor.....	Pittsburgh, Pa., 7th Avenue Hotel.....	
E. E. Ginn.....	Jamestown, Ohio.....	Bell Phone
A. J. Williams.....	Cleveland, Ohio, Eastman, Detroit St.....	Ridge 593-R
L. G. Anderson.....	Franklin, Ohio.....	Bell 4S2
James H. Lang.....	Detroit, Mich., Hotel Ste. Claire.....	
W. H. Matthias.....	Chicago, Ill., 1448 Addison St.....	Lakeview 1493
Geo. H. Haganir.....	Philadelphia, Pa., 901 N. 50th St.....	
F. H. Browning.....	Columbus, Ohio.....	Main 7S74
W. T. Baker.....	Graham, Va.....	

# Hardwood Record

Eleventh Year. }  
Semi-monthly. }

CHICAGO, JULY 10, 1906.

{ Subscription \$2.  
{ Single Copies, 10 Cents.

## CHERRY

C. E. LLOYD, JR.  
Manager Sales

## RIVER

GROWS IN  
WEST VIRGINIA

Sold by  
Cherry River Boom &  
Lumber Co.  
Offices: Philadelphia, Pa.

## LUMBER

## Himmelberger-Harrison Lumber Co.

## Red Gum Specialists

Morehouse,

Missouri

# CHEER UP!

You can reduce your fire insurance  
expense by taking one of our policies

PENNSYLVANIA LUMBERMEN'S MUTUAL FIRE INSURANCE CO.  
923 DREXEL BLDG., PHILADELPHIA, PA.

# RUMBARGER LUMBER COMPANY

**Ash.**  
5 cars 1 in., log run.  
3 cars 1½ in., log run.  
6 cars 2 in., log run.  
2 cars 2½ in. to 5 in., Com. & Better.  
**Basswood.**  
30 cars 1 in., log run.  
**Beech.**  
25 cars 1 in., log run.  
2 cars 2 in., log run.  
**Birch.**  
20 cars 1 in., log run.  
2 cars 1½ in., log run.  
1 car 2 in., log run.  
**Red Oak.**  
10 cars 1 in., log run.

**Cherry.**  
500,000 ft. 1 in., log run.  
1 car 1½ in., Nos. 1 & 2 & No. 1 Com.  
1 car 2 in., Nos. 1 & 2 & No. 1 Com.  
Choice old growth stock, good lengths  
and fine widths. Will sell on grades.  
**Chestnut.**  
10 cars 1 in., sound wormy.  
1 car 3 in., sound wormy.  
3 cars 2 in., log run.  
5 cars 1 in., Nos. 1 & 2 & No. 1 Com.  
2 cars 1½ in., Nos. 1 & 2 & No. 1 Com.  
**Cucumber.**  
7 cars 1 in., log run.  
**Maple.**  
20 cars 1 in., log run.  
10 cars 2 in., log run.

**Mountain Oak.**  
4 cars 2 in., Nos. 1 & 2.  
2 cars 2 in., No. 1 Common.  
10 cars 1 in., Nos. 1 & 2 & No. 1 Com.  
**White Oak.**  
1 car 1½ in., Nos. 1 & 2.  
**Quartered White Oak.**  
2 cars 1 in., Nos. 1 & 2.  
5 cars 1 in., No. 1 Common.  
5 cars 1 in., No. 2 Common.  
1 car 1 in., Clear Strips.  
This stock shows an exceptionally fine  
figure.  
**Quartered Red Oak.**  
1 car 1 in., Nos. 1 & 2.  
2 cars 1 in., No. 1 Common.  
1 car 1 in., No. 2 Common.

**Hardwood, No. 3 Common.**  
¾ car 1 in., rough.  
3 cars 1 in., surfaced 1 side.  
4 cars 2 in., either rough or surfaced.  
**Clear Spruce.**  
3 cars 1 in., Nos. 1 & 2.  
5 cars 2 in., Nos. 1 & 2.  
**Poplar.**  
Have a fair stock of 1 in., 1½ in., 1½  
in. & 2 in.  
**White Pine.**  
12,000,000 feet No. 3 Barn & Better.  
500,000 feet Box.  
1 in., 1½ in., 1½ in. & 2 in., either  
rough or worked.

MAIN OFFICE: 808 HARRISON BUILDING, 15TH AND MARKET STREETS, PHILADELPHIA, PA.

NEW YORK OFFICE: 8018 METROPOLITAN BLDG., 1 MADISON AVENUE.

PITTSBURG OFFICE: 701 KEYSTONE BUILDING.

## LUMBER INSURANCE COMPANY of NEW YORK

66 Broadway, New York.  
Statement December 31, 1905

<b>Assets:</b>		<b>Liabilities:</b>	
Cash in Banks	\$ 77,371.23	Reserve for Reinsurance	\$85,720.13
Approved Bonds	301,742.50	Losses in Process of Ad- justment	6,181.88
Agents' Balances and Pre- miums in Process of Col- lection	21,291.57	Surplus to Policy-holders:	
Accrued Interest	3,387.06	Capital	\$200,000.00
	\$403,792.36	Surplus,	111,890.35 311,890.35
			\$403,792.36

## ADIRONDACK FIRE INSURANCE COMPANY

66 Broadway, New York.

Commenced Business May 1, 1906

<b>Assets</b>		<b>Liabilities</b>	
Cash in Banks	\$300,000.00	Surplus to Policy-holders:	
		Capital	\$200,000.00
		Surplus	100,000.00 300,000.00
	\$300,000.00		\$300,000.00



# LOUISVILLE

MANUFACTURING AND DISTRIBUTING CENTER OF KENTUCKY

## The Norman Lumber Co., Inc.

Manufacturers and Wholesalers of

### Hardwood Lumber

FOR SALE

Seasoned Ash, Oak, Poplar, and Walnut Lumber

WANT TO BUY

Walnut, Oak, Ash, Hickory and Poplar Logs and Lumber

Office and Yards: Third Street, H to K Streets  
LOUISVILLE, KY.

## EDWARD L. DAVIS & CO.

OFFER FOLLOWING STOCKS:

<b>POPLAR.</b>	<b>OAK WAGON TONGUES.</b>
30,000 ft. 4/4 1st & 2d.	12,000 ft. 4x4"x1x2"—12', 1-6 mos. dry.
50,000 ft. 4/4 Common.	800 ft. 3 x4 "—12', 12-18 mos. dry.
15,000 ft. 5/4 Common.	400 ft. 3 1/2 x4 1/2 "—12', 12-18 mos. dry.
<b>QUARTERED RED OAK.</b>	300 ft. 3 1/2 x4 1/2 "—12', 12-18 mos. dry.
50,000 ft. 4/4 1st & 2d.	250 ft. 3 1/2 x4 1/2 "—12', 12-18 mos. dry.
50,000 ft. 4/4 Common.	800 ft. 3 1/2 x4 1/2 "—12', 12-18 mos. dry.
<b>QUARTERED WHITE OAK.</b>	180 ft. 3x4" & Lgr.—14', 12-18 mos. dry.
50,000 ft. 4/4 1st & 2d.	
30,000 ft. 5/4 1st & 2d.	<b>REACHES.</b>
20,000 ft. 6/4 1st & 2d.	1 car 2x4" and larger, dry.
10,000 ft. 8/4 1st & 2d.	<b>BOLSTERS.</b>
50,000 ft. 4/4 Common.	2 cars 3x4" and larger, dry.
5,000 ft. 5/4 Common.	<b>HICKORY AXLES.</b>
5,000 ft. 6/4 Common.	1,500-3 x4 "—6', 1-6 mos. dry.
20,000 ft. 8/4 Common.	1,500-3 1/2 x4 1/2 "—6', 1-6 mos. dry.
10,000 ft. 2 1/2" Common.	2,000-4 x5 "—5', 1-6 mos. dry.
40,000 ft. 3" Common.	1,000-4 1/2 x5 1/2 "—6', 1-6 mos. dry.
1 car Hickory Plank, 1 1/2 to 4"—	1,000-5 x6 "—6', 1-6 mos. dry.
8" to 16".	

# W. P. Brown & Sons Lumber Co.

## WHOLESALE HARDWOODS

### Louisville, Ky.

## Ornamental Hardwood Floors

400 STYLES AND PATTERNS

Illustrated Catalog on Application

### WOOD-MOSAIC FLOORING CO.

Rochester, N. Y. New Albany, Ind.

### Albert R. Kampf

Manufacturer  
Hardwood Lumber and Timber  
Dimension Stock  
Board of Trade Bldg., Louisville, Ky.

### E. W. Rhubesky

Wholesale  
Poplar, Rough and Dressed.  
Oak, Chestnut and Other  
Hardwoods

### North Vernon Pump & Lumber Co.

Band Sawed Plain and Quartered  
Oak and Poplar.  
North Vernon, Ind., and  
Louisville, Ky.

### Southern Lumber Co.

Oak, Poplar and  
Chestnut.  
Louisville, Ky.

## We wish to move and will quote low prices on the following:

1 Car 6 4 1st and 2nd Qtd. White Oak, Wide in  
1 Car 8 4 1st and 2nd Qtd. White Oak, Wide in  
1 Car 4 4 No. 1 Com. Qtd. White Oak  
1 Car 6 4 No. 1 Com. Qtd. White Oak  
2 Cars 8 4 No. 1 Com. Qtd. White Oak  
1 Car 12 4 No. 1 Com. Qtd. White Oak  
1 Car 4 4 1st and 2nd Qtd. Red Oak, Wide in  
1 Car 4 4 No. 1 Com. Qtd. Red Oak, Wide in  
1/2 Car 6 4 Com. and Bet. Qtd. Red Oak, 50% each  
1/2 Car 8 4 Com. and Bet. Qtd. Red Oak, 50% each  
1 Car 12 4 Com. and Bet. Qtd. Red Oak, 50% each  
1 Car 6 4 Com. and Bet. Plain Red Oak, 50% each  
2 Cars 12 4 Com. and Bet. Plain Red Oak, 50% each

1 Car 4 4 2 1/2 to 5 1/2" 1st & 2nd Qtd. White Oak Strips  
1/2 Car 4 4 2 1/2 to 5 1/2" No. 1 Com. Qtd. White Oak Strips  
1 Car 4 4 No. 2 Com. Qtd. White and Red Oak  
1/2 Car 5 4, 6 4 and 8 4 No. 2 Com. Qtd. White and  
Red Oak

1 Car 4 4 No. 2 Com. Plain Red Oak  
1 Car 5 4, 6 4, and 8 4 No. 2 Com. Plain Red Oak  
2 Cars 4 4 No. 3 Com. Plain Red and White Oak  
1 Car 6 4 1st and 2nd Poplar, 7 to 18"  
5 Cars 4 4 No. 1 Com. Poplar (Selects in)  
1 Car 4 4 No. 1 Com. and Bet. Bay Poplar  
1 Car 4 4 to 8 4 Com. and Bet. White Ash  
1 Car 4 4 No. 2 Com. and Sound Wormy Chestnut

We have in pile at mills 3,000,000 ft. Plain and Quartered Red and White Oak, Poplar, Chestnut and some Ash, in thickness 1/2" to 16-4. This will be ready for market in 60 to 90 days. We also handle all kinds of Yellow Pine, Cypress, White Pine, Red and White Cedar, Lumber, Lath and Shingles and all kinds of Hardwood Flooring. Write us for prices.

## STOTZ LUMBER COMPANY

KELLER BUILDING :: :: LOUISVILLE, KY.

# CADILLAC

CELEBRATED FOR HIGH STANDARD OF QUALITY AND MILL WORK

## Thick Hard Maple

Cut during the winter of 1904-5.

10-4 1's and 2's . 51,000 ft.

12-4 1's and 2's . 55,000 ft.

16-4 1's and 2's . 10,000 ft.

This stock was sawed in our own mill and has been seasoned in a first-class manner. It is largely 12 inch and wider and very choice.

We also have end-dried in shed :

4-4 Birdseye Maple, 8,000 ft.

5-4 White Maple . 21,000 ft.

PLEASE SEND US YOUR INQUIRIES.

## Mitchell Brothers Company

CADILLAC, MICHIGAN

## Cummer, Diggins & Co.

MANUFACTURERS

"CUMMER" MAPLE  
AND BEECH FLOORING

## MICHIGAN HARDWOODS

Good assortment of dry stock on hand ready for immediate shipment in Hard Maple, Beech, Birch, Soft Elm and Cherry.

SEND US A LIST OF YOUR REQUIREMENTS.

## MURPHY & DIGGINS

Offer all grades of the following special dry stock

MAPLE—5/4, 6/4, 8/4, 10/4, 12 4, 14/4, 16/4

GRAY ELM—4 4, 12 4

BASSWOOD—4 4

BIRCH—6/4, 8 4

Our own manufacture. Perfect Mill Work. Uniform Grades.

LET US FIGURE ON YOUR HARDWOOD WANTS.

## The Cadillac Handle Co.

. . . Band Sawn . . .  
Michigan Hardwoods

We offer for Rail Shipment from Cadillac.  
2 cars 8 4 Maple, No 1 Com. & Better  
1 car 5x5 Maple, Select Stock  
2 cars 4 4 Basswood, No 2 Com & Bet.  
2 cars 4 4 Birch, No. 2 Com. & Bet.

Also the following for Water Shipment:  
100,000 feet of 4 4 Basswood  
100,000 feet of 4 4, 8 4 and 12 4 Soft  
Elm  
150,000 feet of 4/4, 5 4 and 6 4 Birch

## DRY STOCK

We have a choice line of

Michigan Hard Maple  
and  
Soft Gray Elm

In placing your orders, re-  
member also our famous  
"ELECTRIC" BRAND  
MAPLE FLOORING

Be Friendly.

Write Us.



**COBBS & MITCHELL**  
(INCORPORATED)  
**GADILLAC, MICHIGAN**



# MEMPHIS

THE HUB OF THE HARDWOOD WORLD

F. W. GILCHRIST, President  
W. A. GILCHRIST, Vice President  
W. E. SMITH, Sec'y and Treasurer

## W. E. SMITH LUMBER CO.

Manufacturers of  
**HARDWOOD LUMBER**

Mills, Tennessee, Arkansas, Mississippi  
Distributing Yards, Cairo, Illinois  
General Office, Tennessee Trust Bldg.

MISSISSIPPI VALLEY COTTONWOOD

F. W. GILCHRIST, Pres. W. A. GILCHRIST, Vice-Pres.  
W. E. SMITH, Sec'y and Treas.

## Three States Lumber Co.

MANUFACTURERS OF

Mills: Hardwood Lumber Office  
Arkansas Cottonwood and Gum Tennessee Trust Building

GET OUR PRICES, TRY OUR LUMBER  
WE SHIP ROUGH, DRESSED, RESAWED

COTTONWOOD GUM

## Briggs & Cooper Company, Ltd.

MANUFACTURERS

### NORTHERN SOUTHERN HARDWOODS

GET OUR PRICES ON THESE ITEMS:

- 1,000,000 feet Soft Grey Elm, 1 to 3".
- 500,000 feet Unselected Birch, 1 to 3".
- 3,000,000 feet Michigan Hard Maple, 1 to 6".
- 350,000 feet End Dried White Maple, 1 to 1 1/2".
- 625,000 feet No. 1 Common and Better Winter Sawed Basswood, 1 to 3".
- 150,000 feet Selected White Basswood, 1", 1 1/4" and 1 1/2".
- 210,000 feet Plain and Quartered White and Red Oak, 1 to 2".

YARDS AT

SAGINAW, CHICAGO AND MEMPHIS

## BACON-NOLAN HARDWOOD CO.

Manufacturers of

### Band Sawn Oak, Ash Gum, Cypress, Etc.

Office,  
Memphis, Tenn.

Mills,  
Chancy, Miss.

Address all correspondence to Memphis office.

**WE** have in all thicknesses the following kinds and amounts of lumber at places designated. Kindly send us your inquiries.

MEMPHIS YARD:

- Ash..... 680,000 feet
- Quartered White Oak.. 75,000 feet
- Plain White Oak..... 140,000 feet
- Quartered Red Oak.... 225,000 feet
- Plain Red Oak..... 410,000 feet
- Cypress..... 225,000 feet
- Cottonwood..... 200,000 feet
- Poplar..... 308,000 feet

SELMA YARD

- Poplar..... 409,000 feet
- Bay Poplar..... 857,000 feet
- Red Gum..... 55,000 feet
- Cypress..... 787,000 feet

BERCLAIR YARD

- Bay Poplar..... 100,000 feet
- Cypress..... 800,000 feet

OTHER YARDS

- Plain Red Oak..... 350,000 feet

## J. W. THOMPSON LUMBER COMPANY

Office and Yards: Randolph Road and I. C. R. R. : : MEMPHIS, TENN.

J. B. Ransom, Pres. A. B. Ransom, V.-Pres. W. A. Ransom, Sec. C. R. Ransom, Treas.

## GAYOSO LUMBER CO., Inc.

MANUFACTURERS AND DEALERS IN

### SOUTHERN HARDWOODS

Also make a specialty of Wagon Stock in rough, such as Tongues, Axles, Reaches, Bolsters, and 6-4 to 16-4 Hickory.

## ANDERSON-TULLY COMPANY

STOCK LIST

COTTONWOOD.

- 20 M ft. 7/8" 1st & 2nd, 8" up
- 200 M ft. 4/4" 1st & 2nd, 6" up
- 14 M ft. 4/4" 1st & 2nd, 7"-10"
- 25 M ft. 4/4" 1st & 2nd, 11"-12"
- 40 M ft. 4/4" 1st & 2nd, 18" up
- 15 M ft. 5/4" 1st & 2nd, 6" up
- 20 M ft. 5/4" 1st & 2nd, 12"
- 35 M ft. 5/4" 1st & 2nd, 11" & 12"
- 45 M ft. 6/4" 1st & 2nd, 6" up
- 50 M ft. Wagon Box Boards, 9" to 12"
- CYPRESS.
- 20,000 ft. 4/4" Clear Strips, 2 1/2" to 5 1/2"
- WHITE OAK.
- 4,000 ft. 4/4" 1 & 2 Quartered
- 6,500 ft. 4/4" Com. Quartered

ASH.

- 15,000 ft. 4/4" 1st & 2nd Strips, 2 1/2" to 5 1/2".
- 5,000 ft. 4/4" Common.
- 12,000 ft. 5/4" & 6/4" No. 3 Common.
- GUM.
- 60,000 ft. 4/4" 1st & 2nd Saps, 13" to 16".
- 60,000 ft. 4/4" 1st & 2nd Saps, 16" and up.
- 50,000 ft. 4/4" No. 1 Common Red.
- 100,000 ft. 4/4" No. 1 Common Sap.
- 60,000 ft. 4/4" 1 & 2 Red Strips, 2 1/2" to 5 1/2".
- POPLAR.
- 20,000 ft. 4/4" Common & Better.
- RED OAK.
- 1,750 ft. 4/4" Quartered 1 & 2.
- 2,930 ft. 4/4" Quartered Common.
- 14,440 ft. 4/4" Plain 1 & 2, 12" and up.
- 80,000 ft. 4/4" Nos. 2 & 3 Com. Red & White.

## FENN BROS. COMPANY

MANUFACTURERS OF

### Oak Flooring

QUARTERED WHITE HOLLOW BACKED  
QUARTERED RED END MATCHED  
PLAIN WHITE POLISHED  
PLAIN RED BORED

Memphis, Tenn.

**ST. LOUIS**

LARGEST OF ALL HARDWOOD MARKETS

**Thomas & Proetz Lumber Co.**

CASH BUYERS OF OAK, ASH, CYPRESS, POPLAR, CHERRY AND ALL

**HARDWOODS**

SEND INSPECTOR WHEN QUANTITY JUSTIFIES

Office and Yards: Hall and Angelrodt Sts.

**Stoneman-Zearing Lumber Co.**

203 Frisco Building

We have the following Dry Stock for sale piled at our mill:

QTD. WHITE OAK:	COTTONWOOD:
3 Cars 4 4 Common	3 Cars 1" 1 and 2
2 Cars 4 4 Common and Better Strips.	1 Car 1x13 to 17" Box Boards.
GUM:	ELM:
5 Cars 1" Common Red.	1 Car 6 4 Log Run.
1 Car 1x13 to 17" Box Boards.	4 Cars 4" Log Run.
1 Car 2" 1 and 2 Sap.	
6 Cars 1 3/4 Common and Better Sap.	

This Stock is All Band Sawed and Equalized

**LOTHMAN CYPRESS CO.**

AIR DRIED

**Louisiana Red Cypress**

FOOT OF ANGELICA STREET

**Garetson-Greason Lumber Co.**

MANUFACTURERS OF SOUTHERN HARDWOODS

**GUM LUMBER  
OUR SPECIALTY**

Carload Shipments Direct  
from Our Own Mills

519 Bank of Commerce

Roland F. Krebs **Ozark Cooperage Co.** Hardwood Department  
Manager

**WE BUY STOCKS READY CUT OR CONTRACT FUTURE OUTPUT**

Four Inspectors in the South

Direct Shipments from mill stocks of COTTONWOOD, CYPRESS, GUM, OAK. MAIN OFFICE, FRISCO BUILDING

**W. R. CHIVVIS,** Lesperance Street and Iron Mountain Railroad.

WHOLESALE HARDWOODS

**BLACK WALNUT LUMBER MY SPECIALTY.** Always in the market to buy Walnut and Cherry Lumber. Pay spot cash and take up at shipping point when amounts justify.

**CHAS. F. LUEHRMANN HARDWOOD LUMBER COMPANY**

Carry a complete stock of Hardwood and are constantly in the market to purchase large blocks of stock for cash. Are also the largest manufacturers of the famous St. Francis Basin Red Gum.

General Offices: 148 Carroll Street

**Wanted—Cypress, Ash and Cottonwood**

INSPECTION AT POINT OF SHIPMENT WHEN QUANTITY JUSTIFIES

**Hafner Manufacturing Co.**

CYPRESS, HARDWOODS

Mail orders receive our immediate attention.

YARDS: FOOT OF DOCK STREET

**SIX MILLION FEET**

Ash, Oak, Cypress, Poplar, Etc.

READY FOR PROMPT SHIPMENT

**STEELE & HIBBARD**

NORTH BROADWAY, DOCK AND HALL STREETS

## Thomas Forman Company

MANUFACTURERS OF HIGH-GRADE

### Maple and Oak Flooring

New York Branch:  
McGovern & Bowen,  
29 Broadway

And Hardwood Lumber

**DETROIT,  
MICHIGAN**

## The Tegge Lumber Co.

MILWAUKEE  
WISCONSIN

BUYERS OF  
ALL KINDS OF

**HARDWOOD LUMBER**

# WILLIAM WHITMER & SONS, Inc.

MANUFACTURERS OF

## HARDWOODS

We are always in the market for round lots of well manufactured stock, and shall be pleased to enter into correspondence with manufacturers with a view to purchase.

**PHILADELPHIA**  
New York, Boston, Pittsburg

## Are You in the Market ?

Send us your inquiries for prices on  
the following

## HARDWOODS

100M ft. 1" Com. and Better Quartered Red Oak.  
100M ft. 1" Com. and Better Quartered White Oak.  
75M ft. 1 1/4" Com. and Better Quartered Red Oak.  
25M ft. 1 1/4" Com. Quartered White Oak.  
25M ft. 1 1/2" 1st and 2nds Quartered Red Oak.  
50M ft. 3" Com. and Better Quartered White Oak.  
50M ft. 3" Com. and Better Plain White Oak.  
100M ft. 1" Com. Plain Birch.  
50M ft. 1" Com. Red Birch.  
50M ft. 1 1/4" Com. and Better Plain Birch.  
100M ft. 1" Com. and Better Hard Maple.  
100M ft. 1 1/2" Com. and Better Hard Maple.  
100M ft. 1" Com. and Better Soft Elm.

## UPHAM & AGLER

Distributing Yards: CAIRO, ILL.

Main Offices :: American Trust Building, CHICAGO

JOHN T. DIXON

HARRY S. DEWEY



We are not **Wizards** in making new grades to fit a price.  
No tricks in our methods of making shipments. The  
straight grades are good enough for us.

If you will give us a trial order for **POPLAR, OAK,  
ASH, CHESTNUT** or **OAK, MAPLE** and **YELLOW  
PINE FLOORING**, we believe we can demonstrate our  
ability to please you.

## DIXON & DEWEY

716 and 716 A, Flatiron Building,

NEW YORK

# THE EAST

BOSTON NEW YORK PHILADELPHIA

## Jones Hardwood Co.

(INCORPORATED)

### WANTS

Poplar, Plain Oak, Quartered Oak and Cypress

Manufacturers please send stock lists and prices

147 MILK STREET, BOSTON, MASS.

WE MUST MOVE AT ONCE  
6 Cars 4-4 1's and 2's Red Oak

High Grade Stock, good widths and lengths  
PRICE RIGHT. Send us your inquiries

## SCHOFIELD BROTHERS

1020-22 Pennsylvania Building, PHILADELPHIA

## Wistar, Underhill & Co.,

WHOLESALE

### HARDWOOD LUMBER

816 Real Estate Trust Building, PHILADELPHIA.

## Charles S. Wentworth & Co.

WHOLESALE LUMBER MERCHANTS

147 Milk Street  
BOSTON

We are in the Market for POPLAR, PLAIN OAK, CYPRESS and NORTH CAROLINA PINE LUMBER; also OAK, MAPLE and BIRCH FLOORING, and would appreciate correspondence from manufacturers in position to supply any of the stock named.

## Holloway Lumber Company

WHOLESALE HARDWOODS

In the market for all thicknesses of  
OAK, ASH and CHESTNUT.

312 Arcade Building,  
PHILADELPHIA, PA.

J. J. SOBLE

H. I. SOBLE

## SOBLE BROTHERS

Wholesale Hardwoods

911-912 Land Title Bldg. PHILADELPHIA

WANTED: 20 cars Common and Better Chestnut, all thicknesses

## The Crosby & Beckley Company

### HARDWOODS

We are  
In the Market for Choice Stock  
WRITE US

No. 1 Madison Ave.,  
New York, N. Y.

New Haven,  
Connecticut.

BALTIMORE BUYER AND  
MARYLAND E. E. PRICE EXPORTER OF

## Hardwoods, Poplar and Logs

I am always in the market for nice lots of dry and well manufactured lumber. I inspect at point of shipment. Correspondence solicited.

## STEVENS-EATON CO.

Buyers of  
ROUND LOTS  
of

### Hardwoods

No 1 Madison  
Avenue,  
NEW YORK

ESPECIALLY IN MARKET FOR PLAIN RED OAK

## What Lumber Do You Want? Read July "Lumber News."

You can find in our stocks many special things in hardwoods. Our regular stocks hold millions of feet of good lumber awaiting your orders. Here's two items:

1,000,000 ft. Poplar, 4-4 to 12-4, mostly Common and Better.

2,000,000 ft. Chestnut, one-third Common and Better.

Send in your inquiries to-day.

## J. Gibson McIlvain & Co.

WHOLESALE LUMBER DEALERS

58th St. and Woodland Ave.

PHILADELPHIA, PA.

## WM. E. LITCHFIELD

MASON BUILDING, BOSTON, MASS.

### Specialist in Hardwoods

Manufacturers are requested to supply lists of stock for sale

## H. D. Wiggin Wholesale Hardwoods

Specialties: Poplar, Chestnut, Canadian  
Hardwoods, and Mahogany Veneers.

FISKE BUILDING

BOSTON, MASSACHUSETTS



# NASHVILLE

HEADQUARTERS FOR ALL SOUTHERN HARDWOODS

## GEO. C. BROWN & CO.

MANUFACTURERS AND WHOLESALE DEALERS IN

### Hardwood Lumber

Tennessee Red Cedar Lumber a Specialty.

NASHVILLE, TENNESSEE

## INDIANA LUMBER CO.

### Manufacturers Lumber

DIMENSION STOCK A SPECIALTY.

Office and Mills: Corner Oldham  
Street and Cumberland River

NASHVILLE, TENN.

## JOHN B. RANSOM & CO.,

NASHVILLE, TENNESSEE

We want to move quickly the following old dry stock. All of it has been on sticks 6 to 18 months. Write us for delivered prices. We are prepared to furnish promptly mixed cars of rough and dressed hardwoods of all kinds:

QUARTERED WHITE OAK	QUARTERED RED OAK
90 M 4 4 first and second	100 M 4 4 first and second
15 M 5/4 first and second	58 M 6 4 first and second
80 M 6 4 first and second	15 M 8 4 first and second
10 M 10 4 first and second	95 M 4 4 No. 1 Common
120 M 4 4 No. 1 Common	84 M 6 4 No. 1 Common
65 M 6 4 No. 1 Common	72 M 8 4 No. 1 Common
58 M 8 4 No. 1 Common	
20 M 10 4 No. 1 Common	PLAIN OAK
70 M 5 8 first and second Poplar	50 M 4 4 1st and 2nd White
80 M 5 8 No. 1 Common Poplar	100 M 4 4 No. 1 Common White
15 M 4 4 1st and 2d Quartered Sycamore	100 M 4 4 first and second Red
10 M 4 4 No. 1 Com. Quart'd Sycamore	100 M 4 4 No. 1 Common Red

## LOVE, BOYD & CO.

Offer:

5,000,000 ft. Quartered White Oak.  
2,000,000 ft. Quartered Red Oak.  
1,000,000 ft. Plain White Oak.  
1,000,000 ft. Plain Red Oak.  
1,000,000 ft. Poplar.  
2,000,000 ft. Chestnut, Ash, Hickory, Red Cedar, Etc.

Our Own Manufacture.  
Prompt Service.  
Dry Stock.

MAIN OFFICE,  
NASHVILLE, TENNESSEE

## Nashville Hardwood Flooring Co.

Manufacturers of

### "Acorn Brand"

THE FAMOUS FAULTLESS FLOORING  
IN OAK AND BEECH.

Car Lots and Less Than Car Lot  
Orders Solicited. Write for Prices.

Nashville, Tennessee

# Swann-Day Lumber Company

MANUFACTURERS OF

## POPLAR AND OAK

PLANING MILL STOCK, BOX SHOOKS  
AND HARDWOOD DIMENSION

CLAY CITY, KENTUCKY

# PAEPCKE-LEICHT LUMBER COMPANY

MANUFACTURERS OF

## COTTONWOOD GUM AND OTHER HARDWOODS

Large stocks of well seasoned Lumber always carried at our yards and mills.

General Offices: 140 W. Chicago Ave., CHICAGO. Mills: Cairo, Ill., Marked Tree, Ark., Greenville, Miss., Arkansas City, Ark., Blytheville, Ark.

# PITTSBURG

HARDWOOD DISTRIBUTING CENTER OF PENNSYLVANIA

## The Nicola Lumber Company

One million feet 4-4 Bay Poplar.  
Can be shipped log run, or sold  
on grade. Bone dry; band  
sawed. Send your inquiries.

## Flint, Erving & Stoner Co.

Wholesale Lumber  
Northern and Southern Hardwoods

Beech and Maple Timbers a Specialty

## A. M. Turner Lumber Company

Everything in lumber. We buy hardwoods  
as well as sell them. If you have anything  
to offer, please submit same to us. : :

## Linehan Lumber Company

PERFECT

## MAPLE FLOORING

SEND US YOUR INQUIRIES

## Willson Bros. Lumber Co.

MANUFACTURERS

## WEST VIRGINIA HARDWOODS

FARMERS BANK BLDG. :: PITTSBURG, PA.

## Hardwoods a Specialty

FOR SALE

POPLAR	CHESTNUT	PLAIN OAK
125,000' 4 4 1s and 2s	200,000' 4 4 Sound Wormy	60,000' 4 4 No. 1 Com.
40,000' 4 4 No. 1 Com.	80,000' 5 4 Sound Wormy	18,000' 4 4 No. 2 Com.
325,000' 4 4 No. 2 Com.	100,000' 6 4 Sound Wormy	<b>QUARTERED OAK</b>
228,000' 4 4 No. 3 Com.	48,000' 8 4 Sound Wormy	2 cars 4 4 No. 1 Com.
150,000' 4 4 Mill Cull		1 car 4 4 No. 2 Com.

OAK TIMBERS SAWED TO ORDER.  
WRITE FOR PRICES.

CHEAT RIVER LUMBER COMPANY, Pittsburg, Penna.

## Babcock Lumber Co.

MANUFACTURERS OF  
PENNSYLVANIA  
HARDWOODS  
23,000,000 FEET ANNUALLY

LONG ON MAPLE  
AND CHERRY

MILLS AND OFFICE  
ASHTOLA, PA.

## Dry Stock for Quick Shipment:

12,189 ft 4 4 clear Quartered Oak	66,232 ft 4 4 No. 1 Common Poplar
14,570 ft 4 4 1st & 2ds qtd. Red Oak	10,315 ft 6 4 1st & 2ds Poplar
30,302 ft 4 4 No. 1 Com. Red Oak	76,000 ft 4 4 1st & 2ds Cottonwood
63,204 ft 4 4 No. 1 Com. Pl White Oak	119,000 ft 4 4 No. 1 Com. Cottonwood
4,417 ft 5 4 No. 1 Com. Pl White Oak	150,000 ft No. 2 Common Cottonwood
5,934 ft 6 4 No. 1 Com. Pl White Oak	90,000 ft 4 4 Mill Cull Cottonwood
23,473 ft 4 4 1st & 2ds Plain Red Oak	110,000 ft 5 4 No. 1 Com. Cottonwood
14,168 ft 4 4 1st & 2ds Poplar	40,000 ft 5 4 No. 2 Com. Cottonwood

## American Lumber & Mfg. Co.

PITTSBURG, PA.

H. B. LEAVITT, PREST.  
E. H. ADAMS, SECY.

B. F. RICHARDSON, VICE-PREST.  
J. G. LEAVITT, TREAS.

## THE LEAVITT LUMBER CO.

MOST COMPLETE STOCK OF HARDWOODS IN  
**CHICAGO**

MAKE KNOWN YOUR WANTS AND GET  
**IMMEDIATE RESULTS**

Mills:  
WISCONSIN  
TENNESSEE  
ARKANSAS  
LOUISIANA  
MISSISSIPPI

General Office and Yard:  
CENTER AVE. NEAR 35TH ST.  
Southern Office:  
715 TENNESSEE TRUST BLDG.  
MEMPHIS, TENN.

## THE "FINEST" MAPLE FLOORING

**W. D. YOUNG & CO.**  
BAY CITY, MICHIGAN.

Producers from TREE to TRADE of the highest type of Michigan Forest Products. Large stock of Maple Flooring and 15,000,000 feet of Hardwoods—1 to 4 inches thick—on hand.

**Maple, Birch and Beech Lumber**

## "Ideal" <sup>Steel Burnished</sup> Rock Maple Flooring

is the flooring that is manufactured expressly to supply the demand for the best. It is made by modern machinery from carefully-selected stock and every precaution is taken throughout our entire system to make it fulfill in every particular its name—"IDEAL."

Rough or Finished Lumber—All Kinds

Send us Your Inquiries

**The I. Stephenson Company**  
WELLS, MICHIGAN

## White and Red Oak

Secure our special prices on the following dry stock We need the piling room.

30,000 feet 7-4 and 8 4 Quarter Sawn.  
150,000 feet 4-4 1st and 2nds Clear Plain Sawn.  
200,000 feet 4-4 No. 1 Common Plain Sawn.  
200,000 feet 4-4 No. 2 Common Plain Sawn.

We also manufacture chair and table stock Let us figure with you. Address all communications to

**Dierks Lumber & Coal Company**  
Mills: DE QUEEN, ARK. KANSAS CITY, MISSOURI

## "Michigan" Maple Flooring

Our model factory is equipped with the highest class tools and appliances made for Flooring production.

We produce our lumber from the best rock Maple area in Michigan and have 20 years' supply.

Our brand "Michigan" is a guaranty of quality. Perfect mill work and excellent grades distinguish our Flooring and our prices are reasonable.

**WARD BROS., Big Rapids, Mich.**



## Wolverine Brand Maple Flooring.

"THERE IS NONE BETTER."

The same story we have told before. A reminder that now as well as for all time to come Wolverine Brand will be prepared from the tree to the finished product for the especial purpose of filling your orders right. You send the order, we do the rest.

**BLISS & VAN AUKEN COMPANY**  
900 S. Niagara St., SAGINAW, W. S., MICH.

## OAK FLOORING

Kiln Dried  
Bored  
Polished



Hollow  
Backed  
and  
Bundled

## Timber Bonds

SECURED BY FIRST MORTGAGE ON TIMBER LANDS

**H. C. Barroll & Co.**

BANKERS, First National Bank Building, CHICAGO.

# Hardwood Record

Published in the Interest of Hardwood Lumber, American Hardwood Forests, Wood Veneer Industry, Hardwood Flooring, Hardwood Interior Finish, Wood Chemicals, Saw Mill and Woodworking Machinery.

Vol. XXII.

CHICAGO, JULY 10, 1906.

No. 6.

Published on the 10th and 25th of each month by

## THE HARDWOOD COMPANY

HENRY H. GIBSON, President

FRANK W. TUTTLE, Sec-Treas.

### OFFICES

Sixth Floor Ellsworth Bldg., 355 Dearborn St. Chicago, Ill., U.S.A.

Telephones: Harrison 4960 Automatic 5659

### TERMS OF ANNUAL SUBSCRIPTION

In the United States, Canada, Philippine Islands and Mexico . . . \$2.00  
In all other countries in Universal Postal Union . . . 3.00

Subscriptions are payable in advance, and in default of written orders to the contrary are continued at our option.

The entire contents of this publication are covered by the general copyright, and articles must not be reprinted without special permission.

Entered at Chicago Postoffice as Second Class Matter.

Advertising copy must be received five days in advance of publication date. Advertising rates on application.

### General Market Conditions.

The hardwood trade of the country is generally moving on in a steady and fairly satisfactory manner. As is natural at this time of year, there is not the activity and vim in the business that has prevailed during earlier months, but prices are well maintained and the outlook is excellent.

The woods in particularly short supply, which are doing extraordinarily well in the market, are plain white oak, poplar, cypress and cottonwood. Red oak seems to be getting back into fair supply in first hands, and apparently there is not an excess of quarter-sawed stock either in white or red being produced at this time.

June tides in the rivers of the poplar district have not materialized and the larger proportion of the river mills, which produce about half the poplar manufactured, are either shut down or about to be for want of log supply. Every variety of dry poplar at the mills is shipped or sold and there is comparatively little in sight for the remainder of the year. Cottonwood is also short. There is a tendency to advance values on the better grades.

Cypress stocks are decidedly scant and in rather indifferent assortment. The good end of this wood is especially low. Prices are firm, tending toward advancing values.

In northern woods inch maple is the best seller, the demand still being very heavy from the flooring makers, but the price is relatively low. Basswood has done better for some weeks, but still it has not achieved a value on a par with poplar and cottonwood. The market in gray elm, birch and beech is featureless.

The flooring makers are generally busy, but with the constantly increasing factory capacity being provided it is doubtful if the demand will take up all the flooring made in maple for all time. Oak flooring production is also increasing at a rapid rate, and the inroads of this high-class flooring will surely have a telling effect on the call for maple.

Reports from the veneer makers are somewhat spotted. Some are busy at alleged good prices, and others claim the call is slack and prices are off.

### Woods for the Refrigerator Trade.

In the manufacture of refrigerators it is necessary to secure hardwoods that are entirely free from odor, and those that are least

susceptible to climatic changes and moisture. In the construction of these useful devices for household economy, it is necessary that they be made so that they can be satisfactorily used in all parts of the country. In some sections of the United States, especially along the Atlantic and Pacific and the Gulf of Mexico, the air is full of humidity which causes the wood to swell, while in other sections, where the air is very dry, the wood remains in practically the same condition as when it left the factory of the manufacturer.

Ash seems to have been found to be the most satisfactory wood for making refrigerators, and the two chief varieties of ash, the brown of the North and the white of the South, are the favorite materials for this purpose. These woods take a good finish, are fairly easy to work, the glue joints hold well, and in the mind of manufacturers at any rate, are least susceptible to the action of alternate heat and moisture. These woods grow in nearly all parts of the United States, although in general hardwood growths are found in comparatively small quantities. They are odorless and can be employed for either inside or outside construction; thus the lower grades may be used in inside work, and the good lumber on the outside.

Refrigerator manufacturers very often receive complaints apparently based on the assumption that the boxes are made of green lumber, for the reason that if the door swells people have that idea, not realizing that the very fact of its swelling shows it to have been previously kiln-dried.

Some people house their refrigerators in the kitchen near a stove; others place them on a porch outside the house; and it is, therefore, very difficult for the manufacturer to insure construction from any kind of wood, that will neither shrink nor swell under varying conditions.

In the eastern part of the United States many refrigerators and ice-boxes are made of softwood, but very little softwood is used in their manufacture in the middle and far West. Up to twenty years ago a large portion of the refrigerators were made in Buffalo and farther east. At the present time Michigan and Wisconsin are the heaviest producers, with Michigan far in the lead.

The growing scarcity of both white and brown ash is a matter of concern to refrigerator manufacturers, as their experience teaches them that ash is the best wood that can be employed for this purpose. Hundreds of experiments have been made with other kinds of wood, but nothing seems so satisfactory as the first choice. Refrigerator makers would consider it a boon and a solution of their wood problems if some material could be presented to them at moderate cost that would be satisfactory for this work.

### The Resawed Lumber Controversy.

It will be recalled that early in the year the United States Board of General Appraisers at New York handed down a decision in the matter of the duty to be assessed on thin lumber, contending that the law contemplated that the collection of \$2 per thousand feet on stock imported into the United States should apply in the same sum to the surface measure of stock resawed to thin boards, even to the thinness of picture-backing. The subject was taken up by the National Wholesale Lumber Dealers' Association at its annual meeting in March, and the hearing was reopened before the General Appraisers. After evidence was presented before them, showing that custom and law had always held that a piece of lumber twelve

inches long, twelve inches wide, and one inch thick constituted a foot, by which all boards, whether over or under one inch in thickness, should be assessed, they reversed their former decision and fully sustained the contention of the importers of this lumber.

### Provisions of the Railroad Rate Law.

On June 30 President Roosevelt signed the railroad rate bill, thus making it a law. It is by far the most important piece of legislation enacted by any Congress since the time of the Spanish-American war. The bill will go into effect sixty days from the date of its signing. Its provisions are drastic and, in short, are as follows:

**GENERAL PROVISIONS**—The railroad rate bill requires all interstate carriers to make through routes and reasonable joint rates. It makes oil pipe line companies, express companies and sleeping car companies common carriers and subject to the law. Railways are forbidden from engaging in any other business than transportation. Pipe lines are excluded from this prohibition.

**PRIVATE CARS**—While permitting railways to use private freight cars, it requires that all incidental charges arising from refrigerating and other services be incorporated in the transportation charge.

**PUBLIC RATES**—It requires publication of all rates, fares, or charges, and forbids changes save on thirty days' notice. Jurisdiction is conferred upon the Interstate Commerce Commission to hear complaints of unjust and unreasonable rates, and to fix rates that are just and reasonable.

**REBATES**—Rebates and other discriminatory practices are forbidden and subject to penalties.

**COURT REVIEW**—A limited review of orders or requirements of the commission may be made by the courts, but no injunction interlocutory order, or decree suspending or restraining the enforcement of an order of the commission shall be granted except after not less than five days' notice to the commission.

**NO PASSES**—Free transportation is limited to certain specified persons.

The Interstate Commerce Commission is enlarged to seven members, whose compensation is fixed at \$10,000 annually.

With this law in effect there is encouragement to believe that the present unjust and discriminatory freight rate of 85 cents from Mississippi valley points to the Pacific coast on hardwood lumber and flooring will be reduced to approximately 60 cents. If this should be the only benefit that the hardwood trade achieves through this legislation it should be grateful for the passage of the bill.

### Permanency of Hardwood Values.

On another page of this issue of the *HARDWOOD RECORD* will be found a comparative statement of hardwood values, obtained from the price lists of the Hardwood Manufacturers' Association for the years 1902-6 inclusive. The values expressed are averages for each year up to this date, and are f. o. b. Ohio river points. The schedule contains prices on a few of the principal items of inch lumber, of the chief southern woods going into general consumption—oak, ash, poplar, chestnut, cottonwood and gum. An analysis of this list shows in nearly every instance a steady accretion in value for the last five years. The only exception is quarter sawed white oak, which had a little higher range of price during 1904 than it has at the present time. White oak during these five years has shown an average advance of about \$8; white ash, about \$6; poplar, about \$8; chestnut, nearly \$9; cottonwood, between \$5 and \$6; and gum, better than \$3.

Perhaps the average accretion in value of these principal southern woods can safely be placed at \$7.50 a thousand during this time. There is no official price list or scheme of values by which an intelligent deduction can be made covering northern hardwoods during the same time. However, they have not advanced in any such proportion as has the southern product. With the exception of black ash and rock elm the average accretion in value of northern woods during the last five years has scarcely been more than \$2.50 a thousand. This is true of maple, gray elm, birch, basswood and beech.

There is no gainsaying the fact that, relative value considered, the price of northern hardwoods is very much lower than that of southern woods. To a large extent this condition may be attributed to the fact that the producers of southern woods have been very well organized for some years, and by the exchange of opinion and by a

thorough system of handling their affairs have kept each other posted, not only on market requirements but on the exact condition of stocks on hand. This system of information has resulted in keeping hardwood stocks in the middle South in good balance at all times. Every manufacturer allied with this association work has been able to saw his timber to such thicknesses as were in best demand, and to avoid over-stocking on unsalable items. Again, this element of the trade has been a very persistent advertiser of its product and the consuming trade has been educated up to the use of certain woods, notably cottonwood and gum, during the last few years, to a wonderful extent. As a matter of fact, five years ago the use of cottonwood and gum for many purposes where it is now employed, was scouted at as being entirely impractical. The demand and breadth of distribution of both these woods has now so far increased that cottonwood is selling at a good premium above list price, and many items of gum are in exceedingly short supply.

It would seem to the *HARDWOOD RECORD* that the permanency of these latter established values on all southern hardwoods is well insured for the present, and that the tendency will be toward increase of price rather than lowering for a good while to come. The assumption is also safe that the price of the chief northern hardwoods will soon enhance to a parity with southern woods of corresponding worth, as they are now from 20 to 25 per cent lower.

It is manifest to every student of lumber values that there is no item in the hardwood list that is not materially lower in relative value than any of the building woods. White pine, norway, yellow pine and hemlock are very much higher priced materials than hardwoods.

The *Timber Trades Journal* of London, which is looked upon as an authority on foreign timber and lumber conditions, says, under date of June 23, that the question of the permanency of lumber values looms large in English trade circles.

Admittedly, values are enormously enhanced. The moot point to be considered is, Are they permanent?

As a trade journal we have realized that the cost of timber must naturally tend to advance, and to that extent which, if considered in connection with the low freights which have been current for a considerable period, would only tend to show that the free-on-board values are considerably higher than the mere c. i. f. values would indicate in the abstract.

However much the trade may grumble at high prices, which, without doubt, make business not only difficult but unprofitable to the merchant, we think that it is futile and gratuitous to anticipate any material drop in values. Of course, it goes without saying that the market will naturally ebb and flow, but in the main the flow will be the stronger current. \* \* \*

At this juncture the great point which the trade here should recognize is that England is not now the only nerve center to control values of such woods as command sales by reason of their own intrinsic worth, such as Baltic goods, pitch pine and American lumber generally, to say nothing of mahogany and kindred woods.

Our export returns prove very strongly, notwithstanding the cloud under which the timber trade is depressed, that as an industrial nation we are by no means decadent; at the same time, England is not the only pebble on the world's beach.

We have so frequently pointed out that other nations are relatively forging ahead in a greater degree than ourselves, and are thereby keen competitors for what only a few years ago England was the only dumping ground, so that we cannot expect to obtain timber at our own valuation. We have so frequently enlarged upon the internal prosperity of the United States, and how the domestic demand absorbs the increased output of the mills there, along with the greater percentage of the Canadian product; then, in addition, there is an ever swelling continental demand, to say nothing of the South American requirements, which our shipping reports so forcibly demonstrate.

With all these facts before us, we cannot think that there is the remotest prospect of any slump in timber values, and we rather think that the causes which are at work will tend to make the position of the timber trade here in the near future even more difficult than it appears at present.

It is well to have the English market aroused to the fact that it is not the "only pebble on the beach." The home requirements, especially in hardwoods, are such today that if our manufacturers did not have a dollar's worth of English business they would not seriously miss the trade, and it is not at all certain that if every foot

of hardwood lumber that has been marketed in Great Britain in the last twelve months had been sold at home, fully as much profit would have accrued to the producer.

This great country, prolific as it has been in years past in hardwood growth and the production of hardwood lumber, must needs be awakened to the fact that the vast inroads made upon hardwood forests have cleaned the nation of its principal stores of timber wealth. Practically every chief hardwood producing section of the United States is under operation today, and from the older regions of the country the only source of supply is the inferior quality of second growth, coming largely from the wood lot of the farmer.

The HARDWOOD RECORD can make no analysis of hardwood lumber conditions that does not clearly point to a constant and steady accretion of hardwood values.

**Conference of Michigan Hardwood Producers.**

On July 2 the following call was sent out to the hardwood manufacturers of the state of Michigan, calling for a meeting of all operators interested in this line of production at Ottawa Beach, July 13 and 14:

You are cordially invited to attend a conference of hardwood manufacturers of the state of Michigan at the Hotel Ottawa, Ottawa Beach, Mich., on Friday and Saturday, July 13 and 14. The first session will be held at 10:30 a. m. This meeting is called for the following purposes:

1. To promote better acquaintance among hardwood lumber manufacturers of the state.
2. To analyze the conditions of stocks, grading and values of northern hardwoods.
3. To organize, if deemed expedient, either an independent hardwood manufacturers' association of the state of Michigan, or a division of some existing hardwood manufacturers' association, for the purpose of agreeing on uniform methods; for the exploitation of Michigan hardwoods, thus broadening the demand therefor; and to attempt to achieve prices commensurate with existing stumpage values and manufacturing cost.

There will be present at this meeting several hardwood lumbermen from other sections of the country, prominent in association work, who have achieved great success for the industry through the channels of organization, who will address those present.

It is the belief of those subscribing to this call that this meeting will result in great advantage to you as individuals, as well as to the hardwood industry of the state.

We trust you will not only be present yourselves, but will induce hardwood manufacturers of your vicinity to join in this movement.

Very truly yours,

- W. H. WHITE COMPANY, Boyne City, Mich.
- COBBS & MITCHELL, INC., Cadillac, Mich.
- SALLING, HANSON & Co., Grayling, Mich.
- I. STEPHENSON COMPANY, Wells, Mich.
- MITCHELL BROTHERS COMPANY, Cadillac, Mich.
- R. G. PETERS SALT & LUMBER COMPANY, Eastlake, Mich.
- KNEFLAND-BIGELOW COMPANY, Bay City, Mich.
- BUTTERS SALT & LUMBER COMPANY, Ludington, Mich.
- H. M. LOU'S SONS COMPANY, Au Sable, Mich.
- CUMMER, DIBBINS & Co., Cadillac, Mich.
- SIMMONS LUMBER COMPANY, Simmons, Mich.
- EAST JORDAN LUMBER COMPANY, East Jordan, Mich.
- BATCHELOR TIMBER COMPANY, Saginaw, Mich.
- STEARNS SALT & LUMBER COMPANY, Ludington, Mich.
- G. VON PLATEN, Boyne City, Mich.
- HACKLEY-PHELPS-BONNELL COMPANY, Grand Rapids, Mich.

From numerous and enthusiastic responses received, indications are that this meeting will be attended by more than half the hardwood manufacturers of the state. Beyond the discussions of subjects named in the call it is proposed to present several attractive and educational features in the form of brief addresses by gentlemen thoroughly versed in particular phases of the trade. These speeches will be made by those prominent in association work, by experts in skidding and logging by steam, and prominent railroad officials, and there will be at least one address on the subject of forestry. The meeting promises to be one of the most interesting and valuable ever held in connection with the hardwood industry of the country.

The place of meeting, Hotel Ottawa, at Ottawa Beach, Mich., has many things to recommend it for a summer convention. The hotel is a modern summer resort structure, capable of housing 600 guests, under the management of J. Boyd Pantlind, the famous Boniface of Grand Rapids, and is located on the estuary connecting Black Lake

with Lake Michigan, about thirty miles southwest of Grand Rapids. Ottawa Beach is reached by both railroad and trolley lines from Grand Rapids, Chicago and Holland, and also from Chicago by a twice-daily service of steamships of the Graham & Morton line. Outside its value to the hardwood trade the affair promises to be a pleasant outing that will constitute a very agreeable memory to those who attend.

**Woodworking Machinery Market.**

For the last year manufacturers of sawmill, planing mill and minor woodworking machinery have been loaded with orders to the extent that the average house was from three to six months behind requisitions. This situation generally prevails even today. However, there has been a marked let-up in the placing of orders for delivery months hence during the last two or three weeks. Machinery people recognize this condition and now expect to be able to catch up with their sales. Manufacturers are pleased with this situation, as they are anxious to clean up their order books and get a fresh start on business.

There are quite a number of new and important tools, which have only reached the drawing-table stage, that manufacturers would like to have time to build and put upon the market. For months there have been few improved types of machines offered to the trade in any line, manufacturers having been so busy that they did not have time for experiment. There is every prospect of the recurrence of a strong demand for machinery after midsummer, and the wise lumberman who expects to need new equipment for early fall will get his orders in promptly.

**Northern Hardwood Cut.**

On the basis of the statistics gathered by the Forest Service in cooperation with the National Lumber Manufacturers' Association, the cut of hardwoods in the chief producing states of the North during 1905 was as follows: Michigan, 581,000,000 feet; Wisconsin, 350,000,000 feet; Pennsylvania, 344,000,000 feet; New York, 86,000,000 feet; Indiana, 350,000,000 feet, and Maine, New Hampshire, Vermont, Massachusetts, Minnesota and Illinois 294,000,000 feet. This makes a total output of northern hardwoods of upwards of 2,000,000,000 feet.

It is not presumed that these statistics are complete, and the quantity doubtless is in excess rather than below these figures. It is noted in the report that it covers the statistics of only 11,649 concerns manufacturing all classes of woods the country over. This compilation of figures shows the cut of wood by species and indicates the relative position each occupies in the lumber cut of the country. The figures show an output of 507,000,000 feet of maple, 275,000,000 feet of birch, 227,000,000 feet of basswood, 214,000,000 feet of elm and 206,000,000 feet of beech.

The greater portion of these woods originate in the northern forests, although a comparatively small quantity of basswood, elm and beech may be credited to southern producing territory. The hardwood production of the northern states of the Union will doubtless increase during 1906 over the previous year, and it is perfectly safe to assume that the total will be considerably in excess of two thousand million feet during 1906. It will be seen that Michigan is by far the leader in the production of what is known as northern hardwoods, while Wisconsin, Pennsylvania and Indiana run about alike. It can be figured that the Michigan output will doubtless hold its own for some years to come; that Wisconsin will show a considerable increase for the next few years, and that Pennsylvania, Indiana and the other western and eastern states named will materially fall off in their aggregate production.

On the basis of the report quoted the total hardwoods produced last year in all other states of the Union than those named was 2,605,000,000 feet. It is to be understood that these figures are relative and do not pretend to be complete. As before stated, they are doubtless far below the actual quantity of hardwoods produced, but will readily indicate the relative importance of the northern hardwood production as compared with the southern.



## Pert, Pertinent and Impertinent.

*Dum Vivimus Vigilamus.*

Turn out more ale, turn up the light;  
I will not go to bed tonight;  
Of all the foes that man should dread  
The first and worst one is a bed.  
Friends I have had, both old and young,  
And ale we've drunk, and songs we've sung;  
Enough you know, though this is said,  
That one and all they died in bed.  
In bed they died, and I'll not go  
Where all my friends have perished so;  
Go you who fain would buried be,  
But not tonight a bed for me.

For me tonight no bed prepare,  
But set me out my oaken chair;  
And bid no other guests beside  
The ghosts that shall around me glide;  
In curling smoke wreaths I shall see  
A fair and gentle company.  
Though silent all, rare revellers they,  
Who will not leave till break of day.  
Go you who would not daylight see,  
But not tonight a bed for me;  
For I've been bord and I've been wed—  
A greater peril waits in bed.

And I'll not seek, whate'er befall,  
Him who unbidden comes to all—  
A grewsome guest, a lean-jawed wight—  
God send he do not come tonight;  
But if he do, to claim his own,  
He shall not find me lying prone;  
But blithely, bravely sitting up,  
And holding high the stirrup-cup.  
Then if you find a pipe unfilled,  
An empty chair, the brown ale spilled,  
Well may you know, though naught be said,  
That I've been borne away to bed.  
—CHARLES HENRY WEBB.

### Good Reason.

The less popular a man is with his associates the more popular he is with himself.

### Tomorrow.

Tomorrow is the soft couch on which the weak human will lie down to rest.

### What Follows.

Trouble is said to drive men to drink, and drink drives them to more trouble.

### Easy Work.

Lazy men are always willing to work—other people.

### Poor Thing!

A man may do the best he can and still get the worst of it.

### Only Then.

There are men who every time they see a sight draft envy the blind.

### Might and Right.

Might may make right, but it does not always make good.

### Will Out.

It's a very difficult matter to keep family secrets in the closet.

### Hard to Find.

Misery loves company—the kind that will listen to hard-luck stories.

### Always Hoping.

Some men always nurse the hope that they may some day encounter an easy mark who has more dollars than sense.

### Humiliating Conditions.

More men would learn if knowledge could be acquired without the humiliation of being taught.

### Has Neither.

The man that boasts that he has no enemies rarely has occasion to boast of his friends.

### Much Better.

It is better to overestimate your own worth than to waste all you have envying that of others.

### Pessimists.

Most pessimists look as though they were afraid it would cost them a few cents to look pleasant.

### In Defense.

Whiskey may be a deadly drink, but water is responsible for more cases of typhoid fever.

## OVERLOOKED.

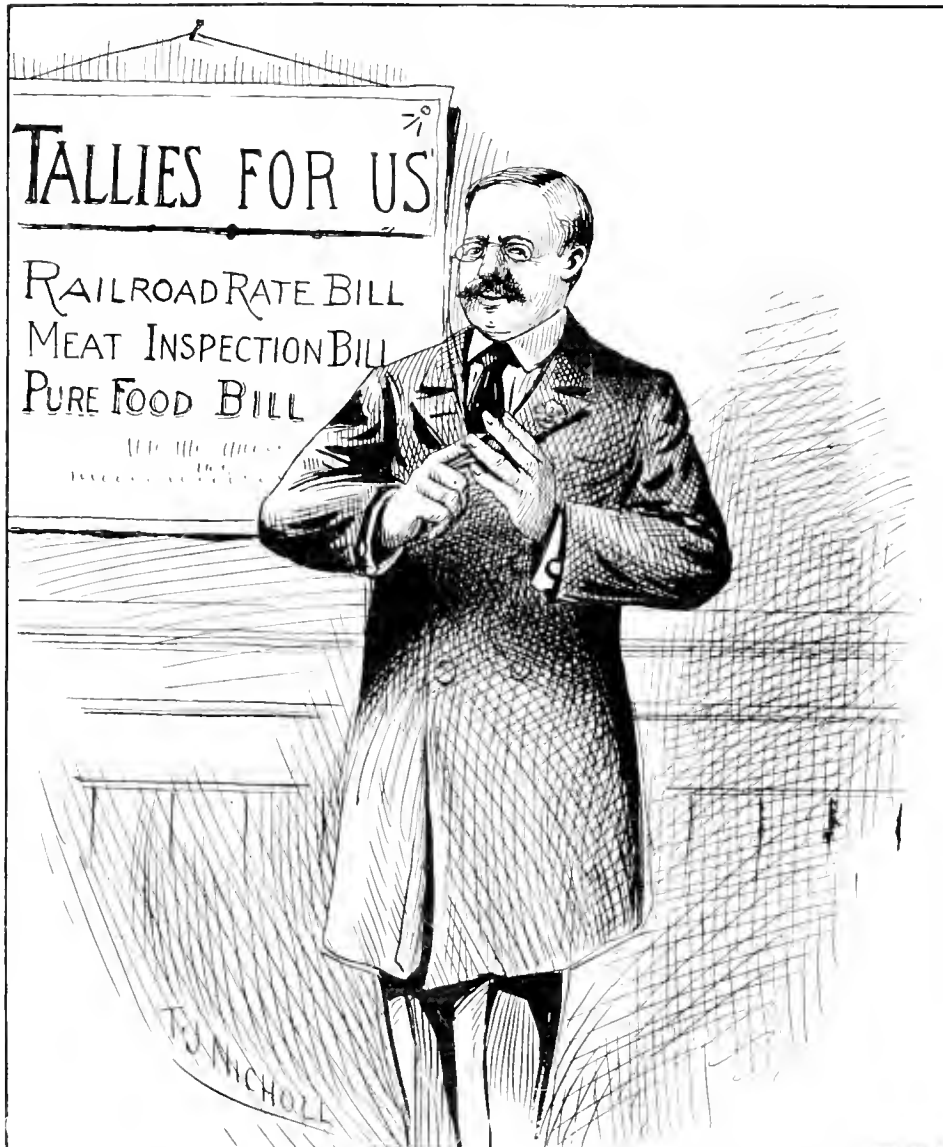

Roosevelt: Pretty good record; but if half I hear is true, some legislation on hardwood inspection would have been a good addition to the list.

### Crooked.

In not a few instances men gain the upper hand by using underhand methods.

### Not Interesting.

You must have either dollars or sense in very large quantities if you expect others to consider your troubles interesting.

### One Consolation.

At least, the less talking a man does the less apologizing he has to do.

### True.

Common sense is none too common.

### Easy.

The easier a man makes his money the easier it is for other people to separate him from it.

### Practice, Don't Preach.

Upright walking is the strongest talking.

### Waiting.

Waiting works wonders if you work while you wait.

### Own and Only.

Virtue is its only reward.

### Spoiled.

A great many so-called friendships have been spoiled by marriage.

## Tree Growth and the Physics of Wood.

A tree is a perennial woody plant, having a single self-supporting stem or trunk, the whole ranging above ten feet in height.

Although nearly five hundred more or less distinct species of tree growth thrive in this country as natives, and many others can be successfully cultivated here, the bulk of the wood used for general purposes is taken from a comparatively small number of these many and varied forms. According to government statistics, the principal timbers of commerce of the United States are known popularly as pine, fir, oak, hickory, ash, maple, walnut, poplar, spruce, cedar and cypress. Where the requisition is for size or quantity, rather than for beauty of finish, the varieties of poplar, gum and cottonwood are employed. Where a handsome appearance is required, as in furniture manufacture and decorative work, oak, maple, walnut and ash figures show to be most frequently used. Where hardness, uniformity and close grain must be insured, as in imple-

ists as *Juglans nigra*. The first or generic name applies to any one of the numerous varieties in the group, while it is to the second that we look for positive identification of species. These botanical terms often differ with authorities, so that it is customary to suffix the name of the botanist making the classification, as *Juniperus monosperma* Sargent.

Snow's definition of wood is as follows: "Wood is made up of cell-structures, as, the true fiber, which originates from several cells; the tracheid, which originates from one; the vessel, which is a short, wide tube joined vertically end to end with others of its kind; the pith-ray; the resin-duct, and others, all of which are often popularly referred to as fibers. The character and arrangement of cell-structures differ with species. Wood is hard, soft, light, heavy, tough, porous, elastic or otherwise because of these differences."

The qualities of wood vary greatly with surroundings, climatic conditions, etc., and are easily affected by various agents. Weight, for instance, differs from one season, or even day, to another, as water is taken up or evaporated. Strength varies with grain, age, and even atmospheric conditions. Figures pertaining to the physical qualities of timber cannot be too much relied upon, owing to these varying tendencies. Statements and statistics concerning certain specimens may be absolutely correct as regards the specimens themselves, but should be applied with caution to the species in general. The differences which exist in tree forms, due to age, to their appearance in the forest, under cultivation, etc., often make it a difficult matter to distinguish between the many varieties.

Trees are divided into two great classes—exogens and endogens—according to the way in which new material or growth is added to them. These divisions correspond to dicotyledons and monocotyledons, respectively, which classification is made according to whether there are two or one seed-leaf. Exogenous trunks are built out by layers or rings being formed one upon the other. Among them are nearly all the well-known timbers of commerce—the pines, maples, oaks, and others. Endogenous trunks increase in diameter by the interposition of new cellular and vascular tissue irregularly among that already formed, rather than by the formation of concentric rings. While the growth of a tree in diameter is by one of these two methods, it lengthens by a sort of "telescopic extension at the buds or extremities," which in their turn attain the size and strength of branches.

A cross section of an exogenous tree shows the stem to consist of pith, wood and bark. New wood is porous and offers free passage to the sap; hence its name, sapwood. As annual ring upon annual ring forms about the sapwood, it becomes compact and its tiny passages fill with deposits or gums, its color is altered, and the so-called heartwood results. In some trees this process is slow, so that

large sections of sapwood are found, while in others the change is rapid, and almost the entire trunk appears to be heartwood. It is in the latter that the qualities most valued in construction are found—toughness, weight, strength and durability, although heartwood is not necessary to the life of the tree. It is in the sapwood that vitality exists, but for building purposes it is not nearly so valuable. The pliability of sapwood, however, makes it useful in cabinet and furniture construction.

Wood varies according to the seasons in which it is formed. These differences in deposits mark the boundaries of the annual or complete rings. In certain trees, the hickory for instance, spring wood shows many more pores than does the summer growth, and in the pines even greater contrast is seen, the spring and summer woods appearing as distinct bands.

A cross section of an endogenous stem presents a dotted, pith-like appearance, due to

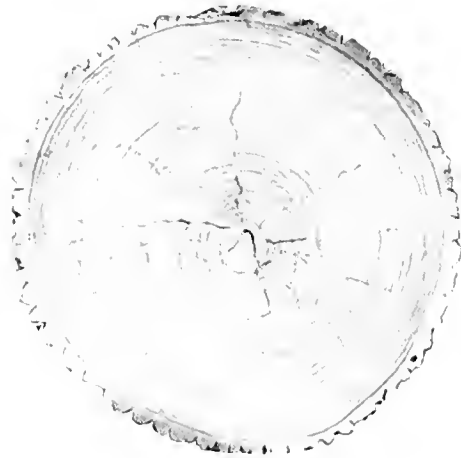

CROSS SECTION EXOGENOUS STEM -  
POPLAR.

ment handles and in the manufacture of countless novelties and small articles, hickory and rock elm are the most prominent woods.

The great confusion which exists almost universally regarding the proper classification of nearly every kind of wood can be avoided only by the use of the strict botanical name for each variety. In the different lumber markets and in many localities which produce the same species, it is known by as many different names, making it impossible to place the tree without a careful examination and botanical classification. Thus, on hearing the term "ironwood" used in New York, "blue beech" in Pennsylvania or "hornbeam" in Maine, it might be impossible to tell whether the *Carpinus caroliniana* of one botanist, the *Ostrya virginiana* of another, or the *Guajacum sanctum* of still another was referred to. One distinct species of pine is called in the various markets and lumber camps of the country by not less than thirty names.

The usual botanical designation of a plant consists of two terms; the first signifies genus and the second species; thus, the ordinary black walnut of commerce is known to scient-

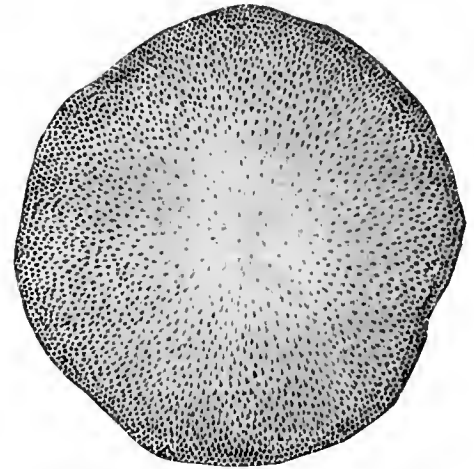

CROSS SECTION ENDOGENOUS STEM -  
PALM.

the fact that the new fibers intermingle with the old and push outward irregularly through the porous tissue. Bark is not common to the family. The bamboo, palm and yucca are endogens.

The wood of an endogenous tree is hardest and most compact on the outside. The inside may be either solid, as in the palm, or hollow, as are some of the rapidly growing grasses—the bamboo notably. The hollow center is due to the fact that the central pith grows more slowly than the new outer tissue, so that it is finally forced to disrupt and disappears as a central core. Joints or knots appear distinctly on the stem of the cane or bamboo, and the intervening spaces show the amount or length of annual growth.

Endogenous stems are rarely cut into the form of lumber, but are used in segments or whole. The bamboo is useful for a variety of purposes, especially maritime, and is made into rafts, masts, yards, spears, pipes, fans and boxes of all kinds. Most of the endogens are herbs and grasses—the cornstalk, wheat, rye, maize, sugar-cane, rattans and Joshua tree all belong to this great tribe, in addition to those heretofore mentioned.

# Builders of Lumber History.

NUMBER XXIX.

Henry C. Barroll.

(See Portrait Supplement.)

Henry C. Barroll of Chicago is a man who has evolved an idea, or, more correctly speaking, has adapted an idea to a specific purpose. He is at the head of the only banking institution of recognized standing in the United States engaged solely in the loaning of money on large operations in the lumber business.

Mr. Barroll was born near St. Louis, Nov. 14, 1868, of Maryland and Virginia ancestry, and since his early youth has been engaged in the banking business. Although still young in years he is old in financial experience. For a number of years he was associated with Blair & Company, the well-known bankers of New York, and afterward with the great banking and bond house of N. W. Harris & Company of Chicago and New York, and incidentally with other well-known banking institutions. The particular feature of the business in which he has had long and careful training is the purchase and sale of municipal and corporation bonds. He is an authority on this subject, and latterly became an important factor in the business.

Lumber is one of the principal staples entering into every activity of civilized life and its manufacture and sale constitutes one of the four chief industries of the United States. From these facts Mr. Barroll deduced that by giving his specific attention to the base of lumber values—the forest—he could carve out a unique and desirable special feature in banking enterprises. He recognized that more than a hundred years of settlement had gradually depleted the forests of this country, and that the steady growth in population meant a constant increase in the value of forest lands. He analyzed the financial history of timber investments for many years past, and found that there was no commodity in the United States more stable in price and more readily salable than good timber lands, hence there was no security upon which money could be loaned with greater safety.

Mr. Barroll associated with himself Clark L. Poole and Edward C. Cronwall, two young men who had been brought up in business with him, and organized the banking firm of H. C. Barroll & Co. of Chicago. Since that time he has devoted his entire energy to the exclusive business of financing large timber and lumber operations. His house follows closely the instinct and training of its principal in exercising what may be termed ultra-conservatism in placing its loans, which are made in the form of bonds secured by first mortgages on large tracts of high-class pine and hardwoods. Millions of dollars in these timber bonds have been marketed among banks, lumbermen and other investors, and so well have the loans been safeguarded that no case of default has ever occurred, and every investment has proven highly satisfactory. These mortgage bond issues have been

made on a basis of not over fifty per cent of the current market value of the timber properties. They are payable serially, a portion of the principal every six months, and thus indebtedness is constantly reduced and the security constantly strengthened.

No newly organized companies or new development enterprises of any kind are exploited or financed by Mr. Barroll. He does not loan to small concerns, nor on small tracts of timber, but confines his operations only to large, well-established lumber operations, whose management is distinctly successful and where the timber is well located and of good physics. He does not float stock nor handle bonds or loans for any company unless it has a high mercantile rating and a good reputation in the trade.

Since the organization of this banking house, it has placed bond issues for the Long-Bell Lumber Company of Kansas City, Mo.; the Stearns Salt & Lumber Company of Ludington, Mich.; the Hudson River Lumber Company of De Ridder, La.; the W. R. Pickering Lumber Company of Kansas City, Mo.; the King-Ryder Lumber Company of Bon Ami, La.; the Weed Lumber Company of San Francisco, Cal.; the Ozan Lumber Company of Prescott, Ark.; the Rapides Lumber Company of Woodworth, La.; the Lufkin Land & Lumber Company of Lufkin, Tex., and the Stearns Lumber Company of Stearns, Ky. The fact that the firm of H. C. Barroll & Co. has had entrusted to it the handling of bond issues for these great concerns is prima

facie evidence of its reliability and standing in the financial world.

It goes without saying that this new departure in financing large and important enterprises must inspire absolute confidence on the part of investors; the company issuing the bonds must be well established and of high credit; its officers and managers must be thoroughly experienced and in good standing among lumbermen. The lands upon which the bonds are issued must be well located; must contain strictly virgin timber of good quality; the amount of it must in every case be determined by capable and well-known estimators employed by the underwriting house; and the titles to the land must be examined and approved by legal counsel of high authority in such matters. Furthermore, the mortgage securing these bonds must contain strict provisions to insure the regular deposit of an agreed amount per thousand feet for all timber removed from the property; these deposits to be applied to the payment of the principal of the bonds as the several series become due.

Under such methods and restrictions the timber loans on first mortgage bonds handled by H. C. Barroll & Co. have become popular, not only with leading lumber manufacturing institutions for increasing their capital, either for operating or adding to their timber holdings, but are in equally good repute with a large and increasing clientele, who find in this form of securities a sterling investment for their surplus funds. Mr. Barroll has carved out a new and unique feature of the lumber business and the success which has attended his work is a matter of congratulation both to himself and to the trade.

## A Lumberman's Letters to His Son.

CHICAGO, July 5.

My Dear Son:—On the way back from the mill your mother and I stopped off at Memphis. Mamma has a prejudice against Memphis and insisted upon going home to spend the Fourth. She always did like the smell of powder and she was creditably informed that there wasn't enough to be burned at Memphis to cut any figure. Therefore she shellroaded me and went home.

On the basis of the price these Memphis sawmill men are paying for logs I am half inclined to believe that I would have been better off to sell them mine than to build a mill. There is certainly a lot of stock going through the mills there that will not much more than pay the saw bill.

By the way, I disposed of the three cars of miscuts you made in starting up while at Memphis. I did not get cash, but traded them for several stacks of blue chips. Am not quite as sore about the transaction as though I had paid money for the buttons. I wanted to get rid of the lumber anyhow. The hands that Memphis bunch hold are simply

marvelous! Those fellows can fill belly straights and three-card flushes oftener than the ordinary man can get a pair of trays. I have had enough of that game, and shall not try to "get my money back." You need not say anything to your mother about this transaction, because I had a good deal of difficulty in explaining to her the business necessity of leaving her on the way home. She never did approve of my sitting into a friendly game—unless I came out a winner.

I suppose you know that Max Sondheimer's restaurant has gone to the punk. Chicago was an easy thing for Max, but there evidently are quite a number of things at the hardwood hub of Tennessee that Max doesn't seem to be able to handle out with his old-time finesse. Up here we all wish he would get sick of Memphis and come back. The town never has seemed like home since he left it.

Your affectionate Father.

P. S.—No, I can't approve of your making a vacation trip to Atlantic City. A man isn't entitled to a vacation unless he has earned it; and besides, there are too many green veils down there!



HENRY C. BARROLL  
CHICAGO



## Muck Rake Department.

### Chicago Fake Enterprises.

The grilling that Judge Arthur H. Chetlain is receiving before the judiciary committee of the Chicago Bar Association while attempting to explain his numerous financial transactions and to show that his conduct has not been such as to cast reflections on the high office of judge of the Superior Court, is another exemplification of either the greed or carelessness of many men who have achieved high commercial and social prominence, but who lend their names to questionable enterprises. Some of these people apparently permit their names to be used in connection with undertakings of which they have no knowledge, for the sake of graft pure and simple, while others seem to be coaxed into them through friendship for promoters or promoters' associates in whom they have confidence.

In the case of Judge Chetlain his examination disclosed that he could not even remember whether or not he was an officer in many of the companies of which the record indicates that he was either president or secretary. One of these fake enterprises was the Porto Rico Gold Mining Company, of which the judge was set down as secretary. The company was capitalized at \$5,000,000. Chetlain put up \$2,500 in cash, gave his check for \$7,500, and received \$100,000 in stock per value. As an inducement to make this purchase and become a director of the company, he was presented with \$600,000 worth of stock. The judge used his influence to get up a syndicate of his personal friends to put up funds for the company to invest in hardwood and coal lands. The promoters used a large part of the money advanced for other purposes, without any authority whatever. Chicago experts report the hardwood proposition as absolutely a fake. The remainder of the money advanced, it is alleged, the promoters appropriated to their own use.

Another company with which Judge Chetlain was connected was the Rayon Mining Company of Old Mexico. This company was capitalized at \$1,000,000, and he was given \$50,000 in stock for \$5,500 in cash. The judge testified that no stock in this company had yet been sold to the public and that the original incorporators had only put up \$50,000. He pleaded that he did not even know who were the officers of the concern. The third company in which the judge was interested was the Chicago International Company, which he says owns 12,000 acres of rubber lands a hundred miles west of Chihuahua, Old Mexico. This company is capitalized at \$100,000, and the land was put into the company at that figure. None of the stock was paid for at the time of the organization. Attorney Baldwin, for the committee, attempted to show that fifty-one per cent of the stock of the Chicago International Company had been hypothecated with four men at Muncie, Ind., with the understanding

that they could buy it for ten cents on the dollar, but after investigating the proposition they refused to take it.

### International Lumber & Development Company.

The methods of exploitation and sale of stock used by the International Lumber & Development Company of Philadelphia have received considerable attention in the columns of the HARDWOOD RECORD. It might be well to say a word about the persons who occupy the positions of figureheads in this corporation. William H. Armstrong, president, is a prominent Philadelphia lawyer, and an ex-commissioner of railroads. He is well known in political and legal life. There is no evidence to show that he knows anything concerning either the foreign or domestic lumber business. His son, William Armstrong, Jr., is office manager of the company.

Col. A. K. McClure, vice president, was editor in chief of the Philadelphia Times from 1873 to 1901. He has divided his life work between a newspaper shop, politics and the law; has been prothonotary of the Supreme Court of Pennsylvania since 1904. He is now seventy-eight years old, but there is no suspicion that he has any knowledge whatever of the lumber business.

One of the directors of this company is Victor Du Pont, Jr., one of the vice presidents of the famous Du Pont Powder Company, who has charge of the latter's real estate department at Wilmington, Del. Mr. Du Pont was interviewed a few days ago

by a representative of the HARDWOOD RECORD. He was asked how he happened to become a member of the company. He answered: "From a sentimental rather than a business reason. I inherited some stock in the Mexican Plantation Company of Philadelphia, on the death of my brother, Charles I. Du Pont. This concern is very similar to the International Lumber & Development Company and was managed by John R. Markley and I. B. Miller. The same contractors were working the plantation of the International company. My brother thought well of this investment, and I therefore became a stockholder in the new one. Besides, I have great confidence in Judge Armstrong and Colonel McClure."

It developed that Mr. Du Pont holds only five shares in this "millionaire corporation," and that he is paying for them on the installment plan, just as the country preacher, the cross-roads schoolmar'am, and the street-car conductor are paying for theirs. How much stock Judge Armstrong and Colonel McClure own is unknown.

Mr. Du Pont is undeniably an upright business man, as he is of a family that has been noted for straightforward dealings and a long and honorable commercial history. He apparently knows nothing that is worth while concerning the company of which he is a director, as is evidenced by his interview, but though he owns only five shares of the stock, he is exploited as a director and as being largely interested in the corporation simply to give prestige to the institution and to gain investments from people who have confidence in the Du Pont commercial history and reputation.

## Hardwood Record Mail Bag.

[In this department it is proposed to reply to such inquiries as reach this office from the HARDWOOD RECORD clientele as will be of enough general interest to warrant publication. Every patron of the paper is invited to use this department to the fullest extent, and an attempt will be made to answer queries pertaining to all matters of interest to the hardwood trade, in a succinct and intelligent manner.]

### About White Holly.

ROCHESTER, N. Y., July 3, 1906.—Editor HARDWOOD RECORD: Some months ago among the articles which you published on different trees you had one on holly. We find one of the authorities gives its family as *Aquifoliaceae*, and classifies it as *Ilex opaca*, saying the wood is brown, sapwood paler brown; light, tough, close-grained, susceptible to a brilliant polish, and used for whip-handles, engraving blocks and cabinet work. We do not see just where the pure white of holly, as it is used in cabinet work, comes in in this description. We use some holly in our business, and a customer asks us for something of a history of certain fancy woods we put in floor work for him. This botanical description does not sound correct for the white holly that we use. Would be glad if you could send us the article we mention, by early mail. Yours truly, ..... Company.

Holly, commonly known as white holly, is the only high-class commercial wood of this species. It is of the family *Aquifoliaceae*, genus *Ilex*, species *opaca*. The description of the tree as quoted by you is far from

agreeing with the best authorities. A much better one is given in Rogers' "The Tree Book," published by Doubleday, Page & Co., New York. This is true of holly: To preserve the highest and most permanent character of this wood, i. e., an ivory-white color, it must be sawn and carefully handled in cold weather. It almost invariably stains and yellows when felled or sawn in warm weather. This result will always obtain when the logs are steamed and sliced or rotary cut. The wood should never be steamed if it is desired to preserve the fine white color. EDITOR.

### Approves Flooring Editorial.

DETROIT, MICH., June 26, 1906.—Editor HARDWOOD RECORD: I have read with great pleasure your very correct editorial headed "Hardwood Flooring Situation" in your issue of June 25. You have certainly set forth the situation just exactly as it is at the present time, and by so doing you have rendered valuable service to the industry. Very truly yours, THOMAS FORMAN.

BIG RAPIDS, MICH., June 26, 1906.—Editor HARDWOOD RECORD: We read with much interest and pleasure your editorial in the issue of June 25, referring to the flooring business. The thanks of the flooring trade is due you as well as thanks from those contemplating going into the business without providing themselves with ample timber supply and fully considering the



other very important point, namely, that the normal capacity of the plants now in operation greatly exceeds the normal demand. Very truly yours, WARD BROS.

**Solid Fret Woods Wanted.**

LONDON, ENGLAND, June 23, 1906.—Editor HARDWOOD RECORD: We should be obliged to you for names of reliable shippers of solid fret woods. We want stock 3 1/2 inch thick after planing, and 12 to 18 inches wide, 3 to 4 feet long, in walnut, maple, oak, sycamore, birch, satin walnut, etc. Of course these woods would have to be prime and show as little sap as possible. Also want the names of some people who will cut cottonwood box shooks. Thanking you in advance, Very truly yours,..... & Co.

Clients of the HARDWOOD RECORD who can furnish the above material, and who would like to enter into correspondence with the writer, kindly send their addresses to this office.—EDITOR.

**Wants Thick Gum and Oak.**

SHREVEPORT, LA., July 7.—Editor HARDWOOD RECORD: We would appreciate very much if you

can put us into communication with some one who now has on hand 3-inch yard dry No. 1 and No. 2 common gum. We are also in the market for some 2-inch No. 1 and No. 2 common oak. MANUFACTURING COMPANY.

If any of the readers of the HARDWOOD RECORD have either of these items for sale and would like the address of a prospective customer they can secure it by writing to this office.—EDITOR.

**Wants Pins and Cross Arms.**

The HARDWOOD RECORD is in receipt of the following letter from an eastern electrical supply house and will gladly communicate the names of makers of the material named to this concern on application.—EDITOR.

PHILADELPHIA, July 6.—Editor HARDWOOD RECORD: We would appreciate it very much if you would furnish us with a list of people who manufacture and can make reasonable deliveries on best pins, oak pins and yellow pine cross arms. — ELECTRIC COMPANY.

**News Miscellany.**

**Concerning Black Walnut.**

Walnut operators have for years been persistently scouring the country for that wood, until at the present time it has been followed westward almost to its limit of growth. Many of the western streams have along their banks, or have had in the past, abundant supplies of the timber. Even the narrow canyons of the Canadian, the Cimarron and other rivers in sections as remote as Oklahoma and Texas, contain considerable quantities of good-sized trees of excellent quality, which may have been planted by the Indians years ago. A block of walnut was recently purchased in that country a large per cent of which was from twenty to thirty inches in diameter at the top end, which had been lifted almost perpendicularly from a deep canyon with ropes and capstan. The walls and slopes of these canyons are often from fifty to 150 feet or more in height, and the top branches of the trees project but little if any above the level surface of the surrounding country. It is not the rule, however, to encounter such difficulties in logging in the Southwest, but on the contrary, hauling is usually good, with no mud or steep pulling after the uplands are reached.

The foregoing interesting information regarding walnut was furnished by J. V. Hamilton of Fort Scott, Kan., who is a lumberman of a good deal of experience in this line. Mr. Hamilton was buyer for the Hoffman Lumber Company of Fort Wayne at one time, which concern had one of the finest walnut band mills west of the Mississippi. He was later in business with Gustavus Tiedman of New York, whose brother was a large timber merchant of St. Petersburg, Russia. To him most of the consignments were made. The prices realized were then more satisfactory than returns from the more extensive markets of Hamburg and London, but the great objection to the Russian market is the early freezing of the seas, which prevents freight from going into the ports for several months in the year. Mr. Hamilton later drifted into the mahogany business and was with the C. C. Mengel & Brother Company in Spanish Honduras for a time. On his return to the States he reentered the walnut business at Fort Scott, in which vicinity there are considerable quantities of walnut.

**New Type End Matcner.**

A. J. Schindler of 441-443 West Twenty-first street, Chicago, has lately perfected a new type of end matcher machine which is being warmly welcomed by manufacturers of flooring. The

new machine matches face upward instead of downward, thereby very materially reducing the cost and labor of the work. Mr. Schindler claims for his new machine that it will save cutting and handling, thus reducing the expense about 20 per cent. One machine does the butting and matching which otherwise required two machines to do.

Technically speaking, the new combined end matcher sorts, butts and end matches flooring or siding from three-eighths to one and one-quarter inches or more in thickness, and from one to five inches in width. Being a combined machine, it will butt without matching, or match without butting; or it will sort, butt and

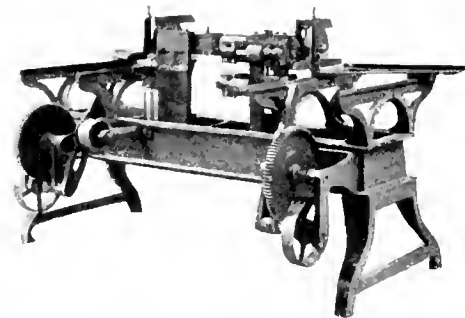

COMBINED END MATCHER BUILT BY A. J. SCHINDLER, CHICAGO.

match. The capacity of the machine is eighty feet per minute, sorting, butting and end matching.

Mr. Schindler has been in the manufacturing business for twenty-five years. About eight years ago he invented a combined end matcher which has had a wide success among flooring manufacturers. This machine matched face downward. Several months ago the inventor sought to improve this machine, with the result that it has been adopted by the largest flooring manufacturers in the country.

Among the concerns using the Schindler machine are: South Side Lumber Company, Chicago; Nashville Hardwood Flooring Company; Arthur Hardwood Flooring Company, Memphis; Langstaff-Orm Manufacturing Company, Paducah, Ky.; Farrin-Korn Lumber Company, Cincinnati; Woodcock Bros., Edwards, N. Y.

**Practical Accounting.**

Increased detail is a natural result of present day business concentration; yet nothing is more trying on the man of affairs than the exercise

of proper care and supervision of these details. Happily, as in most problems, current conditions have developed a means of relief both for employer and employee in the form of thoroughly organized auditing or accounting companies duly licensed under rigid state laws.

Business men are rapidly learning the privilege of consulting those who have made a study of business methodizing. Aside from this feature there is no longer question as to the value and necessity of having books of account and general business affairs regularly audited by a responsible company whose certificate is a guarantee of the actual condition of the institution examined. Such a comprehensive, reliable and concise statement furnishes a valuable kind of insurance to the small copartnership or corporation as well as to the larger one.

Too great emphasis cannot be laid upon the importance of a system of accounting which safeguards personal and corporate interests. The Standard Audit Company, with offices in the Marquette building, Chicago, affords a practical illustration of what can be done in this field of work. This company devises practical plans for the reorganization or reconstruction of enterprises; furnishes practical corporate plans for raising working capital for existing concerns or projected enterprises; provides efficient systems for perpetuating any individual business or partnership. It prepares statements showing actual earnings and complete assets and liabilities, investigates irregularities in accounting or the handling of funds. This company also takes charge of accounts for trustees, receivers, executors, guardians, etc.

**Comparison of Hardwood Values.**

The following outline of prices (f. o. b. Ohio river points) was taken from the price lists, 1902 to 1906 inclusive, of the Hardwood Manufacturers' Association of the United States:

INCH PLAIN WHITE OAK.					
	1902	1903	1904	1905	1906
1s and 2s	\$34.00	\$37.50	\$40.00	\$45.00	\$47.00
No. 1 Common	24.00	26.00	28.00	31.00	31.00
No. 2 Common	15.00	15.00	18.00	19.00	19.00
INCH QUARTERED WHITE OAK.					
1s and 2s	58.00	64.00	75.00	70.00	70.00
No. 1 Common	36.00	42.00	50.00	45.00	45.00
No. 2 Common	28.00	28.00	25.00	25.00	25.00
INCH ASH.					
1s and 2s	36.00	38.00	40.00	40.00	43.00
No. 1 Common	26.00	24.00	27.00	27.50	29.50
No. 2 Common	13.00	13.00	15.00	18.00	18.00
INCH POPLAR.					
1s and 2s	37.00	45.00	54.00	43.00	47.00
No. 1 Common	26.00	30.00	34.00	29.00	30.00
No. 2 Common	20.00	22.00	24.00	20.00	20.50
Boxboards, 8-12"	34.00	37.00	45.00	36.00	42.00
Boxboards, 13-17"	40.00	45.00	51.00	47.00	53.00
INCH CHESTNUT.					
1s and 2s	35.00	42.50	42.50	40.00	47.00
No. 1 Common	25.00	27.00	28.00	28.00	34.00
Sound Wormy	12.00	14.00	15.00	16.00	17.00
INCH COTTONWOOD.					
1s and 2s	26.00	30.00	26.00	31.00	
No. 1 Common	22.00	24.00	22.00	22.00	
No. 2 Common	16.00	16.00	14.50	18.00	
Boxboards, 8-12"	20.00	34.00	33.00	39.00	
Boxboards, 13-17"	33.00	40.00	38.00	45.00	
INCH GUM.					
1s and 2s	27.00	27.00	26.00	31.00	
No. 1 Common	14.50	16.00	15.00	16.00	
No. 2 Common	11.00	12.50	11.00	13.00	
Boxboards, 8-12"	19.00	20.00	20.00	23.00	
Boxboards, 13-17"	24.00	27.00	22.00	29.00	

**Meeting of Wheel Makers.**

For several years wheel manufacturers have been much exercised over the steadily decreasing supply of hickory suitable for the manufacture of their product, and for which there seems to be no substitute. Various wheel manufacturers have had considerable correspondence with the United States Forestry Bureau in an endeavor to secure some information showing the length of time necessary to grow hickory trees to a commercial size, the kind of soil best adapted for

rapid and hardy growth, and the acreage required for the annual production of any given quantity.

It has been determined by the wheel manufacturers to call a special convention of all interested not only in preserving but increasing the present supply of hickory, and to adopt some plan that in the course of time may insure a larger source of supply nearer to their doors. This meeting will convene at the International Hotel, Niagara Falls, N. Y., on Friday, July 13. John W. Herron, Jr., of Cincinnati, chairman of the forestry committee of the Western Wheel Manufacturers, has the meeting in charge, and has asked representatives of the wagon and carriage industries and spoke, rim and gear makers to be present, as well as all the wheel manufacturers of the country. The meeting will doubtless be pregnant in results, and if such a desideratum be possible will probably arrive at some practical solution of the hickory problem. In a letter to the *Hardwood Record* Mr. Herron suggests that the subject under discussion should be of manifest interest to producers of hickory dimension stock, and he would be pleased to have them present at this conference.

**Building Operations for June.**

The building operations of the country continue in great volume, and in the aggregate are increasing over the showing made in 1905, which was a remarkable year in construction. The American Contractor of Chicago shows the following tabulated report, city by city, for the month. One of the most gratifying features of this report is the general distribution of the gains, thus demonstrating prosperity in all parts of the country. While Chicago shows a loss of fifteen per cent, it must be remembered that the operations of June, 1905, were enormous.

City—	June, 1906, const.	June, 1905, const.	Per cent gain.	Per cent loss.
Atlanta	8675,972	8284,797	146	..
Baltimore	1,954,000	851,000	23	..
Birmingham	134,305	.....	..	..
Bridgeport	256,376	149,031	65	..
Buffalo	1,932,615	906,376	14	..
Chicago	6,492,500	7,710,520	..	15
Cincinnati	846,000	625,760	33	..
Davenport	81,009	79,807	65	..
Dallas	631,777	633,900	43	..
Denver	1,246,997	761,436	63	..
Des Moines	112,989	114,309	..	11
Detroit	968,800	932,400	4	..
Duluth	409,955	137,505	198	..
Evansville	97,084	55,720	170	..
Grand Rapids	214,063	150,855	62	..
Harrisburg	199,105	229,310	..	13
Hartford	299,025	273,710	9	..
Kansas City	1,453,140	1,921,940	41	..
Knoxville	111,639	76,070	45	..
Louisville	365,060	196,464	85	..
Los Angeles	2,371,620	1,525,879	55	..
Milwaukee	1,145,325	1,196,523	..	18
Minneapolis	686,915	577,820	19	..
Memphis	596,944	388,197	55	..
Mobile	298,635	58,345	360	..
Nashville	239,647	198,521	20	..
Newark	1,185,950	1,187,218	..	..
New Orleans	616,159	508,265	21	..
Brooklyn	7,771,658	6,773,781	14	..
Bronx	2,839,520	4,589,950	..	..
Aliteration	78,215	57,325	..	38
New York	10,680,393	11,121,056	..	..
Omaha	399,625	277,560	33	..
Philadelphia	3,484,999	4,567,520	..	23
Paterson	156,313	226,497	..	29
St. Louis	3,910,668	2,163,148	85	..
St. Paul	890,661	1,316,019	..	39
Syracuse	451,245	261,335	72	..
Salt Lake City	115,310	152,480	..	23
Topeka	105,551	88,720	18	..
Toledo	450,285	225,165	100	..
Wilkesbarre	263,653	312,740	..	14
Tacoma	263,310	121,630	119	..
Washington	1,138,647	1,361,969	..	17

**New Plans of Mississippi Operators.**

The Chicago-Mississippi Land & Lumber Company, of which J. A. Lewis is president, and whose headquarters are in the First National

Bank building, Chicago, has been conducting a hardwood lumber operation at Napanee, Miss., for several years, but has recently made some important changes in its operating plans. This company has 5,000 acres of oak, gum, cottonwood and other woods in Washington county, Mississippi, about fifteen miles southeast of Greenville, and has been manufacturing its lumber at its plant at Napanee. For economic reasons it has concluded to change the seat of sawmill operations to Greenville, Miss., and has leased, with the privilege of purchase, the modern single band sawmill and yards of the Planters' Lumber Company there, where the timber will be sawn in future.

J. L. Strickland, formerly vice president and general manager of the Planters' Lumber Company, becomes general manager of the new deal, and hereafter will have charge of the logging, sawmilling and marketing of the hardwood



J. L. STRICKLAND, GREENVILLE, MISS.

product. The company will produce about 35,000 feet of hardwoods daily, and has completed its logging plans, so that the mill will be fully stocked every day of the year. The logs will be transported to Greenville over a branch of the Yazoo & Mississippi Valley railroad. Mr. Strickland has made a fine record in his management of Planters' Lumber Company, and with his thorough familiarity with Mississippi hardwoods and lumber conditions should do himself and the Chicago-Mississippi Land & Lumber Company great credit in this new undertaking.

**A Magnificent Work.**

American Woods is the title of a unique work of which Romeyn B. Hough, B. A., Lowville, N. Y., is author and publisher. It possesses unusual interest to lumbermen and others appreciative of American woods and the trees which produce them. It treats of the various kinds of native and naturalized trees of the United States and Canada, and is illustrated by actual specimens of their woods. These illustrations are in the form of thin sections, about 2x5 inches in size and 1-100 of an inch thick, showing transverse, radial and tangential views of the grain in the language of lumbermen, cross, quarter and slab cuts. They represent high art in wood cutting and are produced by a process invented by Mr. Hough himself. No one who has not seen them can form an adequate conception of their beauty and interest. They are mounted in separable pages, to facilitate comparison and study, and the accompanying text gives full information in regard to the distribution and botanical classification of the various trees, their physical properties, and the uses of their woods. The pages containing specimens

and text fit into an ingenious book-like cover, and can be kept on a library shelf or table like an ordinary volume.

The work is issued in parts, each covering twenty-five species, and it is the author's intention to cover all the important woods of the United States and Canada in a series of fifteen volumes. Ten have already been issued, and the price (85 or 87.50 the volume, according to style of binding) is very moderate for so instructive and valuable a book.

Detailed information and specimen pages may be obtained without cost by addressing the author, and anyone who will call at the office of the *Hardwood Record* may at any time examine the copies which have recently been added to its library. Such a review will well repay a visit for that specific purpose.

**United States Veneer Company.**

The United States Veneer Company, incorporated recently at Winston-Salem, N. C., will attempt a conspicuous place in the veneer world as the owner of the United States and foreign patents on a new and improved rotary veneer slicing machine. The machine was invented by C. R. Traxler and built by the United Engineering & Foundry Company, of Pittsburg, Pa., at its branch plant at Youngstown, O. It is the largest woodworking machine in the world and it is said that it has a capacity of over 100,000 feet of veneer per ten-hour day. It will produce veneer of any thickness, and as thin as 1/140 of an inch. The wheel is 35 feet in diameter, the main shaft 18 feet 10 inches in length. This immense rotary disc is propelled by a 120-horsepower twin engine.

Although of such gigantic proportions the machine is comparatively simple in construction, and it is claimed runs with great ease. By the use of a rotary disc or carriage equipped with steam-heated staylogs, the veneer blocks are held at a uniform temperature while being sliced. The blocks are first cut to the required length, boiled, and then automatically conveyed to the staylogs. The log is held in place by steam chucks and as the wheel revolves is forced against a stationary knife 10 feet 8 inches long, set to cut the veneer the required thickness.

The officers of the United States Veneer Company are: E. H. Hanes, president; W. P. Hill, vice-president; W. E. Dalton, secretary and treasurer, and C. R. Traxler, the inventor of this great machine, manager. The capital stock is \$150,000, of which amount \$25,000 is preferred stock, which the concern is preparing to increase within a short time to \$60,000, and \$125,000 common stock.

**New Oak Flooring Plant in Operation.**

The oak flooring plant of the Fenn Brothers Company, recently erected at Memphis, is now in full operation, producing a high-class product in quartered white, quartered red, plain white and plain red oak. The flooring is hollow-backed, bored, end-matched and polished. The operation of the institution is under the superintendence of W. Goodjohn, an experienced operator in high-class woodwork. The principals of the Fenn Brothers Company are A. A. Fenn and R. H. Fenn of the Broadway Manufacturing Company, veteran producers of doors and interior finish, at Leavenworth, Kan., together with W. C. Fenn, who is in direct charge of the Memphis flooring plant.

The factory is equipped with Berlin flooring machines and Whitney scrapers. Almost at the very start of this enterprise the owners find that they must needs largely increase their output to keep pace with the demand for flooring, and therefore contemplate immediately quadrupling the size of the factory. The Morton moist air dry kiln system which they have installed is a very large one, and

is requisite to the handling of a much larger quantity of lumber than the present factory can make into flooring.

### Cypress Manufacturers' Meeting.

There will be a meeting of manufacturers of cypress and bay poplar at the Continental hotel, Atlantic Beach, near Jacksonville, Fla., at 10 a. m. Tuesday, July 17, to continue for two days. At a meeting held June 11 at Atlanta, it was discovered that although the different producing districts were selling in the same territory, there was a decided lack of uniformity in grading rules, terms of sale and business methods, and the specific purpose of the Florida meeting is to have a thorough discussion of these and other matters, and to bring about the desired uniformity. The Atlanta meeting took a long step in the right direction, as is shown by the enthusiasm of all who were present, but complete success will only come from a very large attendance at Atlantic Beach. Those expecting to attend should notify Geo. E. Watson, secretary, Liverpool & London & Globe Bldg., New Orleans, La.

### Concatenation at Atlantic City.

Jerome H. Sheip, vicegerent snark for the eastern district of Pennsylvania, will hold a Hoo-Hoo concatenation at the Royal Palace Hotel, Atlantic City, N. J., on Saturday, July 14, at 3:30 p. m., in the large convention hall owned by the hotel company. Dinner will be served in this hall immediately after the close of the concatenation. Mr. Sheip is very anxious to have a large number of southern and western members of the order present on this occasion, and hopes that all those intending to visit Atlantic City or vicinity this summer will make it convenient to be there at this time. The easterners intend to "whoop it up" for the annual to be held at that resort in 1907.

Accommodations should be engaged in advance, and the management should be notified regarding intended length of stay. The Hoo-Hoo dinner will be free to those stopping at the Royal Palace, but to others the price will be \$2 per plate. No further charges or assessments will be made. Those intending to be present should so inform Jerome H. Sheip, 820 North Lawrence street, Philadelphia.

### Lumbering in Honduras.

Consul D. R. Wood, writing from Ceiba, says that the receipt of quite a number of letters regarding the prospect of developing the timber lands in Honduras shows that the people interested in the lumber industry in the United States are beginning to look abroad, where there are enormous tracts yet untouched by the ax, for a future supply. The consul adds:

"There are in the interior of this country large tracts of pine lands of virgin forest. A few sawmills are in operation, but their production is very small. All of the lumber used in this town and vicinity for building and construction purposes is imported from the United States, mostly through southern ports. A small amount of the mahogany, cedar and other hardwoods has been cut near the rivers. Many concessions for exploiting mahogany lands in this district have recently been granted by the Honduras government, and short tramways are being planned to get out the logs. The exportation of mahogany from here should show a decided increase in the next few years.

"At present there does not appear to be any way to utilize the pine timber resources of Honduras—as the pine is found mostly in the interior—until the country is provided with transportation by railroads. Still, this day may not be a long way off, as short railroads and tramways, intended for transporta-

tion of bananas, have been built and are in operation in many places on the coast, and after the coast is furnished with ample transportation facilities it will not be such a difficult matter to make extensions to tap the interior."

### New South Wales Export Trade.

New South Wales engages to a considerable extent in the exportation of its various native woods, among the most important of which are ironbark, grey gum, tallow wood, white stringywood, turpentine, red mahogany, woollybutt, white mahogany, grey box and blackbutt. A code of regulations was recently formulated to control government inspection and classification of woods for export. Every timber passed is stamped with a brand adopted for the particular wood and bearing some distinguishing mark, either a letter or number or a special outline of figure, by which the inspector making the inspection can be identified.

### Wood Antiques.

But a small part of the mahogany furniture of antique design and appearance is as old as the spectator may think, for even "heirlooms" may be made to order, and so skillfully that even a connoisseur will be hoodwinked. Mahogany is usually thought of as being dark red, while as a matter of fact it is light when new and unstained, and becomes somewhat golden when treated with certain preparations. It darkens with age, however, and the genuine article only attains its rich tints through long use.

Although mahogany is a costly wood, Circassian walnut is valued even higher. Birds-eye maple is likewise much prized on account of its peculiar grain, and the great difficulty experienced in treating it. Its eccentric grain causes its density to vary so in places that the wood is prone to crack and split. The Veris Martin style of furniture was a favorite in the time of Louis XV, and its popularity has continued to the present day. This gold dust and painted combination is very effective for certain uses.

### Miscellaneous Notes.

It is reported that a furniture factory is to be established at Arcadia, Mich.

J. P. Angleberger recently opened a cabinet-making establishment at Marysville, Kan.

It is reported that Montgomery Ward & Co. will erect a furniture factory at Rockford, Ill.

R. S. Reynolds is head of a company recently organized to manufacture furniture at Bristol, Va.

The Cook Furniture Factory has been established at Jonesboro, Ark., with \$20,000 capital stock.

The St. John's Table Company of Cadillac, Mich., recently increased its capital stock from \$100,000 to \$150,000.

The Bradley Folding Chair Company of Chesterton, Ind., has filed articles of incorporation; capital stock, \$25,000.

The Mount Vernon Lumber Company of New Orleans, La., has changed its title to the Mount Vernon Hardwood Company.

The plant of the Gray Veneer & Panel Company of China Grove, N. C., recently destroyed by fire, will be rebuilt immediately.

The Piedmont Buggy Company of Monroe, N. C., desires to correspond with operators of veneer mills with a view to securing stock.

The T. & N. O. Lumber Company has been incorporated at Applegate, Tex., to manufacture hardwood and yellow pine lumber; capital stock, \$200,000.

A charter has been granted to the J. H. Coffey Wagon Company of Lenoir, N. C. The capital stock is \$6,000 and J. H. Coffey, H. T. Newland and others are the incorporators.

The South Atlantic Lumber Company of Greensboro, N. C., capitalized at \$50,000, has

been organized to manufacture all kinds of woodwork, also spokes and hobbins. W. L. Clement is the prime factor in the enterprise.

The Muskogee Sash & Door Company is the name of a new institution at Muskogee, I. T. T. H. Martz, M. R. Williams, W. S. Collins and A. Z. English are the incorporators. Capital, \$50,000.

The Stalz Piano Case Company has been incorporated at New York City, with \$10,000 capital stock, to manufacture piano cases. Harry Harris, Henry F. Hartjen and Julius Mandelbaum are the incorporators.

The Banner Furniture Company was recently incorporated at Jamestown, N. Y., to manufacture case goods. The directors are August S. Soderstrom, Paul B. Rosenkrantz, Andrew Norlander and Charles Johnson.

The Virginia Hardwood Lumber Company has been incorporated at Danville, Va., with John T. Watson as president and treasurer; Arthur E. Fox, general manager, and N. S. Fox, secretary. The capital stock is \$10,000.

The Kelsey Hickory Company of Detroit, Mich., has filed articles of incorporation with a capital of \$25,000. The incorporators are John Kelsey, Henry J. Herbert and William H. Du Charme. It will deal in lumber and wagon material.

The Crescent Machine Company of Leetonia, O., well known manufacturer of woodworking machinery, is engaged in the erection of a new plant which will largely increase its facilities. The new shops will be completed about the first of the year.

Darling Bros. of Cape Girardeau, Mo., are erecting a mill near Prescott, Mo., to cut timber from a tract of 1,300 acres of hardwood lands recently purchased. The plant will have a capacity of from 25,000 to 40,000 feet a day.

The Meriman-Perkey Hardwood Lumber Company has been organized at Sergeant, Ky., by W. B. Meriman and Peter Perkey, both of Lee county, Kentucky, to develop a tract of 23,000 acres of hardwood timber lands in Blount county, Tennessee. Capital stock is \$45,000.

A deal was recently closed at Shreveport, La., whereby Francis E. Watros and James L. Snyder of Wellsboro, Pa., acquired 3,500 acres of hardwood timber lands near Philadelphia, Miss. The consideration was \$428,000 cash. A plant will be established and a railroad constructed by the purchasers to develop the property.

McGee & Alford of Ackerman, Miss., have just completed the establishment of a planing mill department in connection with their extensive operations at that place, and are now in position to supply Mississippi woods manufactured in any way desired. The firm handles white oak, poplar and yellow pine, making a specialty of poplar.

A branch factory will be established at Sioux Falls, S. D., by Farley & Mitchell, manufacturers of sash, doors, blinds, etc., at Dubuque, Iowa. They have already let the contract for the erection of a large factory building which will be rushed to completion. From forty to fifty persons will be given employment at the new plant.

A new organization has been formed to take over the business of the Hubbard & Eldredge Company, furniture manufacturers of Rochester, N. Y.—Hubbard, Eldredge & Miller. The capital stock is \$330,000, all of which sum has been paid in. The plant of the Hubbard & Eldredge Company at Rochester will be completely overhauled and a large addition thereto erected.

Fremont H. Wright & Co. of Aburndale, Mass., recently purchased 3,400 acres of timber land from Evans & Bugbee of Bennington, Vt. The property is located in the vicinity of Woodford and Stamford, Vt., and is covered with hardwoods mostly, the pine and spruce having already been cut off. Mr. Wright with others controls about 80,000 acres of timber lands in various sections of Vermont.

John W. Smith of Fayette, Mo., last month shipped twenty-two carloads of walnut logs to the Singer Sewing Machine Company at Cairo, Ill. There were 112,000 feet in the lot, which he was twenty-seven months in collecting. The highest price paid for a single tree was \$50; it contained about 1,000 feet. Mr. Smith has already begun collecting more walnut trees and is buying everything of value in sight.

The Karner Bros. Milling Company was recently established at Mexia, Tex. The company has an up-to-date plant, nearing completion, about sixteen miles from Mexia on a branch of the Houston & Texas Central railway. About 30,000,000 feet of timber is controlled by the concern in that section, which consists largely of oak, elm and ash. W. T. Smith, late of Birmingham, Ala., an expert hardwood operator, will have charge of the plant.

C. C. Putnam & Son of Putnamville, Vt., recently installed a second complete set of clothespin machines in their new factory, which has now been running about a year. This concern, in addition to running large saw and planing mills, has also built up quite a business in clothespins, making the small spring pin exclusively. Stock for these pins is worked from the edgings and clippings left from cutting hardwood flooring which the concern manufactures in large quantities.

The factory at Charlotte, Mich., which the John Widdicombe Company of Grand Rapids has been operating for some time, has been purchased by Colonel Brinkerhoff & Son of Jackson

and G. A. Knight of Denver, Colo. It will be used for the manufacture of pianos and increased in capacity so as to turn out six instruments a day. The purchasers are experienced piano men, Mr. Brinkerhoff having been with the Kimball Piano Company for years, and Mr. Knight being the largest retailer of pianos in Denver.

The longest tow of hardwood timber seen in the Neches river in many years recently left Beaumont, Tex., for Port Arthur. The timber is the property of F. E. Howard Newcomb of Lake Charles and contains 170,000 feet of oak, walnut and ash. The longest stick in the bunch was eighty four feet and the shortest sixty feet. The rafts were strung out in ten sections and covered an aggregate length of 2,500 feet. The timber was collected and brought down the Neches river from the tributaries of the stream in Jasper, Tyler and Angelina counties. It will be exported to England.

The new sawmill which the Little River Lumber Company of Townsend, Tenn., has been building to replace the one destroyed by fire some months ago has been completed and is now running at its greatest capacity. It is practically a duplicate of the old mill, a double hand, and will cut from 80,000 to 90,000 feet of hardwood per day. During the present season it will cut out a total of about 15,000,000 feet. The product will run about one-third poplar, one-third hemlock and the balance white pine, chestnut, oak, ash and other hardwoods. The stock is sold through the office of W. M. McCormick of Philadelphia, who is president of the Little River Lumber Company.

Charles C. Batchelder, treasurer of the Boston Lumber Company, has opened his summer home, which is also situated in Bolton.

Fred D. Stimpson, representing Brawley & Smith, of Philadelphia, has been spending a few days in this city.

Andrew W. Leatherbee, who was injured in an accident about two weeks ago, has recovered.

The firm of Barker & Co. has been organized in Boston with a capital stock of \$100,000. The incorporators are George J. Barker, Grosvenor Calkins and Thomas B. Hinkley.

The C. W. Leatherbee Lumber Company, Boston, whose property was recently visited by fire, has practically finished rebuilding the shed for the storage of hardwood lumber.

The C. E. White Lumber Company of Andover, Conn., has been incorporated with a capital of \$60,000. The incorporators are C. E. White, Edgar D. White and Eva M. White.

The L. F. Robbins Lumber Company, Plymouth, Mass., has succeeded to the business of the late Leavitt Robbins.

Charles E. Hayes, Marlboro, Mass., has been making a business trip in West Virginia.

George K. Nason, one of the best known lumber dealers in New England, died at his home in Willimantic, Conn., on June 21 after an operation for appendicitis.

#### New York.

The Beulah Lumber Company, Pittsburg, Pa., manufacturers of hardwood, spruce and hemlock, have opened a New York selling office at 18 Broadway under the management of W. M. Pownall.

The Iroquois Door Company, of Buffalo, N. Y., which is operating a local exhibition and sales room at 18 Broadway, this city, has just received at the latter place a complete set of samples of its fine hardwood and veneer doors and general mill work, which is one of the handsomest exhibits ever made of this class of work. The company is experimenting successfully with some beautiful and unique finishes and its samples now on exhibition illustrate the possibilities in the way of up-to-date finish. Manager Salmon reports business as very satisfactory, and says that the local exhibit is being visited by a large number of buyers.

At a special meeting of the stockholders of Stevens-Eaton Company on June 20 to elect a president and director to fill the vacancy caused by the death of Pendennis White, George A. Mitchell, of White, Gratwick & Mitchell, North Tonawanda, was elected president; W. H. Gratwick, vice-president, and T. S. Miller, director. Mr. Miller has been manager of the hardwood department for the past year and a half and his election is an acknowledgment of his valued services to the corporation through his department. He is one of the most popular hardwood salesmen of the local district, and has many friends to congratulate him on his advancement. Wm. A. Eaton continues as secretary and George M. Stevens, Jr., as treasurer.

At a meeting of the board of trustees of the New York Lumber Trade Association held June 20, the following new members were elected: Wm. M. Pownall, of the Beulah Lumber Company, 18 Broadway; the Cascaedia Manufacturing & Trading Company, Arthur H. Campbell, resident agent, 1 Madison avenue; C. Schmitz & Co., J. A. Lacy, New York representative, 162 Greene street, and E. H. Daley, Flatiron building. Routine reports were also rendered, which showed the work of the association to be progressing actively.

Barker & Co., incorporated with \$100,000 capital, under Massachusetts laws, will have headquarters at 18 Broadway, city. George J. Barker, of the Wood-Barker Company, Bos-

## Hardwood News.

(By HARDWOOD RECORD Special Correspondents.)

#### Chicago.

C. M. Clark of the Swann-Day Lumber Company, Clay City, Ky., was in Chicago several days last week. Mr. Clark has started on an extended western trip for pleasure as well as business.

R. S. Cooper, Memphis manager of the Briggs & Cooper Company, Ltd., Saginaw, Mich., dropped into the RECORD office on Thursday last on his way back to the South from a little fishing trip in the north woods country.

One of the callers at the RECORD office a few days ago was E. W. Leech, a well-known hardwood lumberman of Detroit.

J. L. Lane of the Lane-White Lumber Company, Fort Smith, Ark., was a welcome visitor to his many friends in the trade on Monday and Tuesday.

Wagstaff, Lumber, Oskosh, was a recent visitor. Mr. Wagstaff has a large clientele at Chicago and sells a large quantity of hardwoods in this market yearly.

John P. Brown, editor of Arboriculture, Connersville, Ind., was a caller at this office recently. Mr. Brown was en route west on a timber investigating expedition.

The HARDWOOD RECORD acknowledges receipt from Forestry Commissioner C. C. Andrews of St. Paul, of a copy of the eleventh annual report of the forestry commission of Minnesota. The volume comprises nearly 150 pages and is well printed and illustrated. It contains summaries of forest and prairie fires; a review of the operation of the law for preventing fires; extracts from reports of fire wardens; sketches of forests that have been investigated, including the Burntside forest; an object lesson in forestry, and practical accounts of forest management in sixteen different European countries. The book is a valuable document for the citizens of Minnesota, and possesses special interest to all students of forestry. The report shows that there are 12,000,000 acres of arable land in central and northern Minnesota not under cultivation, and besides there are fully 3,000,000 acres in scattering localities of rocky, hilly or sandy land that is only suitable for reproduction of coniferous forests, which it is recom-

mended that the state acquire as an investment and hold perpetually for forest purposes. It says that on an average only about twenty per cent of cut-over pine land reforests itself naturally.

Of late weeks there has been a general emigration of lumber dealers from the outlying districts to the downtown office buildings. Among these movers was the R. A. Wells Lumber Company, formerly located at Clark and Twenty-second streets, which is now housed in a handsomely appointed suite of offices at 234 La Salle street. The company will still maintain yards at the old stand, in addition to shipping direct from the timber lands.

M. M. Wall, treasurer of the Buffalo Hardwood Lumber Company, was in town a few days ago and announces that his company has purchased ten acres of land on the Belt Line in Memphis, Tenn., and will open a branch distributing yard there. It therefore happens that the company will be in the market for round lots of all kinds, grades and thicknesses of hardwoods, green or dry, for some months to come, and will send inspectors to take up lumber at any points contiguous to Memphis, if quantity warrants, and will pay cash for all lumber purchased. The company's Memphis office is located at Room 262 Randolph building.

#### Boston.

The Lumber Dealers' Association of Rhode Island, through the secretary, G. Waldo Parrott, sent out an announcement stating that the mid-summer outing of the association will be held at King Town Farm, R. I., the property of James S. Kenyon, ex-president of the association. The outing will be held July 12, 1906.

Charles H. Elliott, a lumber dealer of Chichester, N. H., died June 21 at the age of 67 years.

Henry A. Porter, a retired lumber dealer of Marblehead, Mass., died June 21 at the age of 87 years. Mr. Porter retired from active business about fifteen years ago.

William E. Litchfield, the well-known hardwood lumberman of Boston, has opened his summer home at Bolton, Mass.

ton, is president, and J. M. Bond, local manager of that company, treasurer. A general wholesale hardwood and yellow pine business will be conducted along the same lines as followed by the Wood-Barker Company. The latter company will fulfill all contracts to date, and from now on the new corporation will assume the new business.

The Stalz Piano Case Company has been incorporated in this city to manufacture piano cases by H. Harris, H. F. Hartjen and J. Mandelbaum, all of New York. The capital is \$10,000.

George J. Barker of the Wood-Barker Company of Boston, arrived last week from a two months' pleasure trip abroad.

The Frantz Lumber Company has been incorporated at Yonkers, N. Y., to conduct a general lumber business with a capital of \$20,000, by W. H. Frantz and W. W. Heidelberg of Lancaster, Pa., and Robert C. Lowrey of Yonkers.

W. M. Ritter, the distinguished Columbus, O., lumberman, has been spending several days in town during the fortnight in the interest of business.

E. W. Robbins of the Maley, Thompson & Moffett Company, Cincinnati, O., is here visiting the local operation of the company at the foot of East 31st street, going over matters at this end of the line. He expresses himself as very well satisfied with the New York end of the business.

W. M. Dwight, the prominent maple flooring manufacturer of Detroit and head of the Dwight Lumber Company, has been here renewing acquaintances in the trade.

Harry S. Dewey, Dixon & Dewey, Flatiron building, expresses himself as very well satisfied with current conditions. They are enjoying a good trade in hardwoods and are very active in their Pacific Coast trade. The John A. Briggs has just arrived from the Coast with 1,500,000 feet of big fir timbers and is now discharging at the various points in the harbor. Mr. Dewey anticipates a trip to the Coast in a short time.

L. P. Hollowell, the veneer manufacturer of 31st street and First avenue, has just returned from a trip to Indianapolis in the interest of business, where he spent several days with the Indiana Veneer & Saw Company, whose stock he handles in this vicinity.

Charles F. Fischer, Chas. F. Fischer Lumber Company, 1820 Park avenue, is spending the summer with his family at Good Ground, L. I.

### Philadelphia.

Kirby & Hawkins, who are making more and more of their own stock, are arranging to put in two more mills on the 1,350-acre tract which they lately acquired in Virginia.

H. H. Mans & Co. have added a considerable tract of land to their already extensive holdings in the western part of Virginia. They are erecting mills on the ground, and expect to keep them busy on their new acquisition for the next five years.

Dorace G. Hazard returned last week from an extensive trip to Florida and extreme southern points. On his way back he spent some days in Savannah, where his firm has heavy interests.

William S. Harvey, president, and George W. Cox, secretary of the National Timber Company, which owns extensive tracts of land in Florida, are making a trip through the South.

Horace G. Williams, receiver for the Beaver Creek Lumber Company, which has been in the hands of a receiver for four years, expects to clear things up this week. Every dollar owed by the company will be paid.

John W. Coles, formerly of the Richter-Parry Lumber Company, has made a splendid record for himself during the year and a half he has been in business. He recently returned from a trip to southern and other points where he con-

tracted for the output of several mills and secured a nice lot of timber which he is offering to the trade.

J. Wistar Evans, vice president of the Philadelphia Veneer & Lumber Company, who was married on June 28 to Miss Susan Elizabeth Barlow of New York, is visiting his mother at Church Lane, Germantown. He will leave for Knoxville, Tenn., shortly.

Fire was discovered on the morning of July 1 at the planing mills of Frank Snedacker, Ninth and Tioga streets, but was checked in time to save the valuable stock and its buildings. The fire is thought to have been caused by combustion in the shaving pit. The loss is trifling.

Articles of incorporation were filed at Trenton, N. J., on June 27 for the formation of J. Gahagan's Sons, a corporation chartered to carry on the business of woodworking. J. Alfred Gahagan is the agent in charge of the New Jersey office and the incorporators are James Gahagan, William A. Gahagan and J. Alfred Gahagan. The company is capitalized at \$60,000.

Arrangements have been completed with the Crozer building which will probably result in that place being the future location of the Lumbermen's Exchange of Philadelphia. The suite selected is situated on the third floor, and the contract will be signed in a few days. E. S. Enderhill, Charles P. Maule and Frank M. Gillingham, the committee in charge of securing new quarters, reported the result of their work to the board of directors at the regular meeting on Thursday, July 5. It is expected that the Exchange will be installed in the new location by September 1, if the arrangements under way now go through.

R. E. Diffenderfer, vice president and general manager of the Virginia & Southwestern Coal & Timber Company, has just returned from a visit to the company's holdings, where he made an estimate on a new lot of timber land for the concern. The company expects to take up several extensive tracts in West Virginia and Tennessee and to be in working shape by September 1.

Henry Whelpton, secretary and treasurer of the Owen M. Bruner Company, has returned from a trip to northern New York and the South. While away he bought and sold considerable high-grade lumber.

F. A. Kirby and C. E. Lloyd, Jr., alternate in charge of the Philadelphia office of the Cherry River Boom & Lumber Company. While one spends a week at the main office of the concern at Scranton, Pa., the other has charge of the Philadelphia office, and vice versa. In this way the high efficiency of the sales office is maintained.

At the annual meeting of the Producers' Lumber Company, on Friday, June 29, a dividend of 10 per cent was declared. Franklin A. Smith, president, and Franklin A. Smith, Jr., secretary, were re-elected to office. The firm reports that the hardwood department has been a gratifying success.

The Messrs. Schofield spent a few days last week at Angelsea, N. J., where they enjoyed some fine fishing. Owen M. Bruner is spending a short vacation at Atlantic City, N. J.

J. S. Steele, buyer for the Rumbarger Lumber Company, at Elkins, W. Va., is in town visiting his firm. F. T. Rumbarger and J. J. Rumbarger spent some days of last week at Cumberland, Md. During the hot weather of the past few weeks Frank Rumbarger has been staying at Atlantic City, coming up to Philadelphia each day on business.

Among the visitors to the trade last week were Mr. Henderson of the Henderson Lumber Company, Stony Bottom, W. Va.; J. M. Bernhardt of Lenoir, N. C.; Mr. Farrington of the Farrington-Rubyon Company, Perth Amboy, N. J., and Edmund A. Gaskell of the Little Creek Lumber Company, Sne, W. Va.

S. B. Vrooman sailed for Europe on the Lucania on July 7 to be gone several weeks. While abroad he will look up foreign timber.

William R. Gately is taking a much needed vacation in Virginia. He expects to be gone several days.

John J. Sobie of Sobie Bros. recently returned from a three weeks' trip in New York state. The firm finds trade going well and have no complaint to make.

William B. Allen of the Colonial Lumber Company has returned from a six weeks' trip to the company's mills in Virginia. While there operations were so strenuously carried on that the company got out over a million feet of lumber. Mr. Allen, while as robust as ever, has some interesting experiences to relate of the doings and grub of a logging camp.

### Baltimore.

The concatenation of the Baltimore members of the Order of Hoo-Hoo held on June 18 at the Maryland Country Club brought together a large number of members and proved exceptionally enjoyable. The special occasion for the gathering was the initiation of eleven Kittens. After the ceremonies an enjoyable dinner was served, at which Vice-president Snark George E. Waters and others made addresses. The table decorations were a feature, cut flowers being arranged in beds, and smilax trailing from one cover to another, a most artistic effect. The dinner was served in excellent style. Those present included a number of out-of-town guests.

The N. W. James Lumber Company gives notice by advertisement that it has succeeded to the business of the firm of N. W. James & Co., Aliceanna street, and will hereafter take care of all orders in the hands of the firm. The company was incorporated June 13 with a capital stock of \$200,000, divided into \$100 shares, the incorporators being Nathaniel W. James, Norman James, George B. Hunting, Frederick A. Ascherfeld, and Alexander Campbell. The Messrs. James were also prominent in the affairs of the old firm, being the sons of the late Henry James, the founder of the firm of Henry James & Co., which the firm of N. W. James & Co. succeeded. An incorporation was effected in order to insure continuance of the business and to leave the Messrs. James more time for looking after other investments. Norman James and Charles I. James, another brother, are extensively interested in the Pigeon River Lumber Company, which is undertaking an extensive development in western North Carolina and eastern Tennessee. The officers of the N. W. James Lumber Company are Nathaniel W. James, president; Norman James, vice president; George B. Hunting, secretary-treasurer, and Frederick A. Ascherfeld, general manager. Messrs. Hunting and Ascherfeld have been for years in the employ of the old firm and are familiar with all the details of the business.

M. S. Baer of the hardwood firm of R. P. Baer & Co. returned two weeks ago from an extended trip of three months in the South. He went to Mobile, Ala., to look after the operation of the firm's mill there. He also visited other lumber concerns and among the contracts closed was one for the entire cut of a mill. He returned by way of St. Louis, Memphis, Cincinnati and other cities, also stopping at Chicago. He reports that business in the Central West is better than in the East and that all the mills are busy. R. P. Baer of the same firm recently spent several weeks in southwestern Virginia and in North Carolina.

Robert H. Smith, Charles S. Rich and Edward Duffy have been appointed receivers for the assets of Henry C. Chipman, a chair manufacturer conducting business under the firm name of George Chipman & Son, on Boston street, this city. Mr. Chipman had previously been declared a bankrupt on the petition of



several banks and a shipbuilding company which are creditors. The liabilities are placed at \$200,000, and the assets are valued at half that sum. The chair manufacturing business appears to have been profitable, but Mr. Chipman engaged in outside ventures which proved unsuccessful. A movement is on foot among the lumbermen, several of whom are creditors, to continue the factory in operation, as it has been using a grade of lumber for which another market is not easily available.

L. Methudy, a well-known lumberman of St. Louis, who was at the Johns Hopkins Hospital here for some weeks to undergo an operation, has entirely recovered and returned home.

Sidney Rubenstein, managing director of the Great Eastern Timber Company, Ltd., London, was here several weeks ago on the way South in search of prime poplar, this being the main object of his trip, which will cover a considerable part of the United States.

Luther Berry of Sutton, W. Va., who was among the recent visitors to Baltimore, stated that he was negotiating for a tract of timber near Piedmont, on the West Virginia Central Railroad, and if successful, intended to establish a mill and manufacture staves for export.

### Pittsburg.

The Warland Lumber Company has been formed by C. D. Armstrong, J. E. Quigley and M. K. Salisbury. It will operate under a Pennsylvania charter and will open offices in Pittsburg shortly.

H. E. Dombhoff of the Cheat River Lumber Company took as his life partner last week Miss Harriet Grundisch, a well known society woman of the East End. The couple went to Canada for their wedding tour, and will reside in Pittsburg on their return. Mr. Dombhoff is a hustler in the sales field.

R. H. Erving of the Flint, Erving & Stoner Lumber Company has had plans prepared for a \$40,000 residence which he will build at Point Breeze, East End, on a site recently bought. Mr. Erving with his family is now at his summer home at Muscooca Lake, Canada.

Fred R. Babcock has been appointed by Mayor George W. Guthrie a member of the Pittsburg Subways Commission, which will have a general oversight of the municipal interests concerned with the plans of the Pittsburg Subways Company, which proposes to build subways to the main residence localities in the East End.

E. V. Babcock of E. V. Babcock & Co., is summering at his country residence at Ashtota, Pa., where the firm is making things hum in a lumber way.

F. X. Diebold of the Forest Lumber Company is on another long tour of inspection among the West Virginia mills.

George W. Nicola, president of the Nicola Lumber Company, has bought the well-known Miller and McVay tracts on Sewickley Heights for \$60,000, or \$1,000 an acre. The two farms comprise one of the most beautiful country building sites in the entire Taxedo district and are within five minutes' walk of the palace of the Allegheny Country Club and surrounded by the country homes of some of Pittsburg's best known millionaires.

W. D. Johnston, president of the American Lumber & Manufacturing Company, is one of the Pittsburg lumbermen who look for a first-class trade along all lines this fall. The American is having a very busy summer in hardwood and is finding the big lots of hardwood timber which were bought through its hardwood manager, J. N. Woollett, last fall and winter, mighty acceptable in filling its orders.

The Pittsburg Wholesale Lumber Dealers' Association held its annual picnic at Ross Grove on Saturday, June 23, the affair being strictly of the "skidoo" type, owing to the fact that

there are but twenty-three firms in the association. An excellent time was reported.

The Buckeye Lumber Company, which was recently organized and has offices in the Ferguson building, is pushing right to the front under the direction of Manager Wickersham. This concern has some splendid New York connections and is going to make a mark in the hardwood field.

The Clay-Schoppe Lumber Company, of which W. A. Clay is president and Julius Schoppe secretary, is a new firm at 803 House building. Both men are from Ligonier, Pa., where they own 1,200 acres of fine hardwood timber in addition to a good sized tract of hardwood at Bolivar, Pa., on the main line of the Pennsylvania railroad. The former tract is now cutting 100,000 feet a month, which will be marketed in the Pittsburg territory.

The firm of Flyte & Mackey are starting a big hardwood operation at Darlington, Pa., on the Ligonier Valley railroad. They have about 3,000,000 feet of hardwood in that locality which will be cut off as soon as possible.

Reports from the West Virginia Lumber Company show that its hardwood business, especially in chestnut, was better by 20 per cent in June than in May. Most of its stock was cut at its plant at Johnson City, Tenn., where it is now sold up close to the saw.

The mills of the A. M. Turner Lumber Company are putting in a busy summer. It keeps the company busy to keep its stock list ahead of its order books and in its southern plants it has very small accumulation of lumber at present.

The Lincham Lumber Company says that there is a considerable call for beech and maple to be used in false work in river dam construction instead of the usual oak timbers. Where these woods are under water and not exposed to the action of the atmosphere they serve the purpose very well and this summer are much easier to get. From the west and southwest J. J. Lincham writes that trade conditions in hardwoods are remarkably good and that prospects for a busy six months the remainder of this year are strictly No. 1.

The Flint, Erving & Stoner Lumber Company is cutting about 75,000 feet a day at its new plant at Lumbervie, W. Va., which it bought two months ago. Most of this is spruce, but there is a good sprinkling of hardwood in the stock. The company's mills in northern Pennsylvania are getting out a fine lot of hemlock and hardwood. The company will run all summer its new mill at Millport, Pa., which is the best in that section.

Wilson Brothers, through their hardwood manager, I. E. Baisley, are hustling for hardwood business this summer in a way that keeps an energetic bookkeeper up to his ears in work.

The L. L. Sattler Lumber Company has finished buying all the holdings of the Blackstone Lumber Company at Blackstone, Va., a part of which, including 9,300 acres near Lunenburg, Va., it secured a short time ago. The last purchase was made by L. L. Sattler and J. S. McNaughter, respectively president and secretary of the company, and gives the firm 10,000 acres of choice timber land with all machinery, cars, live stock and buildings belonging to the old company. The branch office recently established at Blackstone will be managed by Benham Marshall, who was connected with the Blackstone company for several years. A large part of the lumber will be taken direct to tidewater by way of the James, Nottoway, Blackwater and Southampton rivers, thus greatly reducing the cost of transportation. The company expects to cut 15,000,000 feet a year from the two tracts. The first one will be run under the name of the Nottoway Lumber Company and the last one by the L. L. Sattler Lumber Company.

### Buffalo.

A. Miller has received about thirty cars of birch from Canada and is finding that the de-

mand for it is as good as ever. He also gets birch from other sources and keeps a good assortment of it.

The yard men of the Standard Hardwood Lumber Company are more perplexed than ever in their effort to pile up oak and other hardwoods high enough to keep the tracks and alleys free, which means that business is brisk.

The new yard of the Buffalo Hardwood Lumber Company in Memphis is beginning to blossom out with stock, and an all-round stock is to be put in as soon as possible. The Buffalo yard is carrying a big line, with a fine supply of oak.

There is much complaint of oak shortage from the office of Scatcherd & Son, though the firm appears to get enough of it somehow to keep up its regular trade. All grades and sizes are in demand.

Angus McLean is off again on one of his regular trips of inspection, being in Louisville at last accounts. He will also visit the Chattanooga and Bedford, Ind., mills of the company. All are in active operation.

H. A. Stewart will tour West Virginia soon in search of oak and cherry. The yard here is in good shape, having had a big run on chestnut this season, when everybody else was finding it so hard to get.

A. J. Elias has the satisfaction of carrying through all the Buffalo river improvement schemes he has had in mind so long has secured a big steel plant on it and will soon see other industries coming his way.

F. W. Vetter is back from North Carolina, where he went to continue the operations in oak and ash for the Empire Lumber Company. He finds that the export demand for ash is very fine and at top prices.

The trade of O. E. Yeager has been good enough lately to make it hard to keep certain scarce woods in full assortment. He is getting good prices, especially for ash, of late.

Beyer, Knox & Co. find that trade is good for this season, and will see that their southern connections turn out oak, ash and the like enough to meet all their wants in that line.

The Buffalo Hardwood Lumber Exchange, at its last meeting elected the following officers: G. Elias, president; J. N. Stewart, vice-president, and F. A. Beyer, secretary and treasurer. The plan has been to hold meetings weekly, but as this will not be kept up through the summer, the meeting adjourned subject to the call of the president. The first outing of the Lumber Exchange, an automobile trip on June 26, was an entire success, about sixty members and their guests attending. Supper at Clarence and a run home by moonlight concluded the day.

### Detroit.

Charles R. Roche, Detroit inspector for the National Hardwood Lumber Association, has resigned, to devote more time to his private interests in connection with the hardwood firm of Leech, Roche & Co.

George L. Smith, surveyor-general of the National Hardwood Lumber Association, Chicago, has been in Detroit the past few days looking over the field with a view to selecting a successor for Mr. Roche.

H. P. Dutton, salesman for the Worcester Lumber Company, of Chassell, Mich., was in Detroit this past week on business, leaving for Buffalo.

Charles McClellan, of the Simmons Lumber Company, of Simmons, Mich., was in Detroit recently.

H. W. Russell, representing the Fenwood Lumber Company and the Ingram Lumber Company of Wausau, Wis., was another Detroit visitor.

The Russel Wheel & Foundry Company has been so busy the past month that it has actually had to turn down several orders, but now has the rush well in hand so it can take care of all future business.

Brownlee & Co. are receiving much basswood at their Detroit docks. They report a greatly improved demand for that wood.



Eastern capitalists who are contemplating locating a large factory in Detroit are trying to secure a site the retail yards of the McClure Lumber Company. The McClure brothers are gradually disposing of their retail stock that they can give more time to their large mills in Alabama.

The Standard Tie Company of Detroit has just completed the purchase, through O. B. Law, timber broker of that city, of a 9,000-acre tract of fine hardwood timber land in Desha county, Arkansas, known as the St. Louis & Arkansas Lumber & Manufacturing Company's property. This timber was owned and operated by the Paddock-Hawley Iron Company of St. Louis. The consideration is private. The Standard Tie Company will commence lumber operations at once.

#### Saginaw Valley.

Speaking of conditions Chas. A. Bigelow, manager of the Kneeland-Bigelow and the Kneeland, Buell & Bigelow mill plants at Bay City, said: "Everything is moving nicely, the mills are cutting out a lot of stock, much of which is sold long ahead and some for the entire season, and trade in all kinds of hardwood lumber is good. There isn't any accumulation of dry lumber and we are shipping some that is green. In fact, we have been loading cars with maple timber sold to Ohio and Pennsylvania concerns that is almost green from the saw."

The Eastman Flooring Company is putting out a lot of fine maple flooring and is building a pair of cement dry-kilns, which will increase the capacity of the plant. Mr. Eastman has returned from the East, coming back in a new touring auto.

W. D. Young & Co. are hurrying forward the work on a new warehouse at their plant, the contract for which was let some ten days ago. The building is 209 feet long and 24 feet wide, and is of brick with cement foundation. There is a space of 100 feet between the old warehouse and the new one, which is to be roofed in and machinery installed, which will increase the facilities of the plant. The firm is doing a remarkably fine business and the plant is operated by day and night shifts.

A great deal of hardwood lumber is being turned out this season by portable sawmills between Bay City and the straits of Mackinaw. These small plants cut from 6,000 to 15,000 feet a day, and they find plenty of business. There are small lots of timber averaging from 200,000 to a million or more feet scattered all through this part of the state that are out of reach of the large railroad mill plants, and this timber is being converted into lumber by the portable mill. Probably twenty-five of these mills are in operation in the territory referred to. Great improvements have been made in these mills and they are now so constructed that they can be packed up and moved about as handily as a circus.

Robert Mitchell is buying and shipping hardwood lumber by rail from Millersburg, and will move a number of million feet during the summer.

It is estimated that there is enough hardwood timber in Presque Isle county to stock the mills there fifteen years, and a lot of timber is being cut and piled to Alpena.

The Kneeland-Bigelow Company and the Kneeland, Buell & Bigelow Company have more than 200,000,000 feet of timber to come to Bay City to be converted into lumber, enough to stock the two mills for twenty years, and they are negotiating for some 50,000,000 feet more.

H. A. Batchelor of the Batchelor Timber Company says it will take more time than was first calculated to place the Gale mill at West Branch, recently purchased, in proper condition. The stock will come to the mill by rail from Crawford and Otsego counties, having been purchased some years ago from the Ward estate.

Charles O. Rodgers, formerly of the Rodgers-Allison Lumber Company, operating a sawmill

at Logan, north of Bay City, three weeks ago bought 3,000 acres of hardwood land of the Chocolate Land Company in the upper peninsula. The deal also included a sawmill. Mr. Rodgers had an opportunity to make a good thing and he has resold to Louis Jensen of Gaylord. The sawmill has a capacity of 20,000 feet a day and is in operation. It is announced that Mr. Jensen will organize a company with a capitalization of \$400,000, purchase additional acreage and operate on an extensive scale.

There are many hardwood logging camps in operation north of Bay City and the summer has been cool and nice for logging. The Kneeland, Buell & Bigelow Company is running seven camps and the Kneeland-Bigelow Company four.

As fine a lot of white birch timber as ever came in contact with axe and saw is coming to the Saginaw river over the Mackinaw Division of the Michigan Central, to be used in the manufacture of toothpicks and other specialties. It was cut on Bois Blanc island some few miles from Cheboygan.

Extensive improvements have been made at the Hanson-Ward veneer plant in Bay City and it is running overtime, having orders booked way ahead. Some fine birch and maple are cut into wide sheets a thirty-second of an inch in thickness.

John J. Flood is still cutting hardwood logs for W. D. Young & Co. He has a contract to manufacture a quantity of maple into lumber for Salling, Hanson & Co.

E. Germain is using a lot of native hardwoods in the manufacture of pianos besides the mahogany he has imported from Africa. He has a large number of hands engaged in this business and has made of it a marked success.

#### Grand Rapids.

The Thomas MacPride Lumber Company of this city, operating mills at Laketon, Luce County, and at Buckley, formerly New Wexford, in Wexford County, has increased its capital stock from \$30,000 to \$40,000.

The Henderson-Ames Company of Kalamazoo has leased the factory formerly occupied by the Kalamazoo Wagon Company and will start the manufacture of lodge furniture, employing at the outset 150 men. The company is operating a similar factory in Columbus, O.

President Chas. W. Garfield of the Michigan Forestry Commission has received a number of letters from owners of timber lands in the state with reference to the need of fire laws for better protection of young forest growth. J. D. Hawks of Detroit, president of the Detroit & Mackinac railroad, writes that he will give hearty support to such a measure.

The D. Perkins Refrigerator Company of Battle Creek will remove its plant to Port Huron.

Up to July 4, 4,200 furniture buyers had registered in this market, and they have placed very liberal orders. There are about 175 manufacturers showing their lines in the downtown exhibition buildings, while the local concerns as usual are exhibiting their lines in their factory show rooms.

The manufacturers are working into better lines of stuff. Genuine leather has supplanted the various imitations in covered goods and the cheaply finished Mission furniture is fast giving place to the early English, which is practically an improved Mission. It is the opinion of some dealers that the Mission style, even in the better grades, has had its day, but this opinion is by no means general.

The Carrollton Furniture Company of Carrollton, Ky., showing a fine line of dressers, chiffoniers, etc., in this market, is operating its own band sawmill, cutting walnut, poplar, oak, ash and other woods on its lands in Kentucky, and rafting them down the Ohio river to the mill. The mill has been burned three times during the past nine years. It was rebuilt in May, and is now equipped with sprinklers. All oak is quartered, the walnut is

cut into firsts and seconds, and with the pains taken in sawing first grade lumber the mill cuts only about 30,000 feet a day.

An eastern manufacturing concern is showing very clever "American" mahogany pieces made of birch, and "American" quartered oak made of plain white oak. The difference in price between the real and the imitation in this furniture will average about twenty-five per cent. The treatment of the wood is made with such skill that men who call themselves experts cannot tell the genuine from the imitation.

#### Milwaukee.

The John Schroeder Lumber Company has taken out a permit for a dry kiln addition to its large plant on Walnut, Cape and Commerce streets. The new structure will be as nearly fireproof as possible, and cost about \$25,000. Work has already commenced and will be pushed to an early completion. It will add three more kilns to the company's already extensive plant.

The Washburn, Wis., mill of the Edward Hines Lumber Company of Chicago was destroyed by fire July 1, causing a loss of \$100,000, covered by insurance. Repairs costing \$7,000 had just been completed when the fire broke out.

Evidence tending to show an alleged attempt to defraud the government being lacking, Court Commissioner D. E. McDonald of Oshkosh discharged Leander Choate, Benjamin Doughty, James Doughty, James M. Bray and Thomas Daly of Oshkosh, under indictment by an Oregon grand jury for alleged land frauds. The government to sustain the charges in the indictment had brought Henry J. Cole, Jefferson Howard, Butler F. Helman and Sumner Park from Oregon as witnesses.

#### Asheville.

The Asheville Lumber Exchange, recently organized, held its semi-annual meeting here Tuesday afternoon, July 3. There were fully fifty lumbermen and manufacturers from this and other sections of the state in attendance. The report of the committee, of which Dr. C. A. Schenck is chairman, on securing better freight rates on hardwoods from this section, in effect stated that the committee had met Mr. Thompson of the Southern Railway, and that it felt certain concessions would be made. The committee also reported that the freight officials of the Southern did not meet at Lake Toxaway last month as expected and that the committee therefore had had no opportunity to present the request of the Asheville Lumber Exchange for lower rates on certain hardwoods. The committee was instructed to continue its efforts, and to secure an audience with the freight officials at as early a date as possible. Trade was reported to be in good shape in North Carolina. There is a continued healthy demand for hardwoods, while prices remain firm.

The Three M Lumber Company of Swain county, North Carolina, has sold its holdings to William S. Harvey of Philadelphia, who will transfer the property to the Southern Spruce Company, a corporation chartered under the laws of the state of New Jersey. The Three M Lumber Company's holdings consist of 31,000 acres of virgin forest lands in Swain county, together with railway tracks, locomotive and other property, including sawmills. George W. Morris was vice president of the Three M company.

The Hoo-Hoo of western North Carolina had a great time here the evening of Tuesday, July 3. After the initiation of seventeen kittens the Hoo-Hoo were transported to the Kenilworth Inn by special car, where an elaborate banquet was served. One of the features of initiation was driving the kittens over the principal streets of the city chained together like convicts. Judge H. B. Stevens of Asheville, a prominent lawyer, jurist and now lumberman, led the procession.

Those initiated were: C. E. Schaefer of Waynesville, C. M. Jennings of Bryson City, A. R. Stimpson of Penrose, Lynn Evans Reighard of Swannanoa, W. C. Pryor of Asheville, Judge H. B. Stevens of Asheville, Dr. Carl A. Schenck of the Vanderhill estate, J. E. Lentz of Asheville, Robert A. Gaither of Statesville, W. M. Tabor of Swain county, J. B. A. Bennett of Asheville, C. E. Quinland of Waynesville, L. M. Eubank of Andrews, W. T. McKinney of Bryson City and John E. Patton of Swannanoa. The banquet was thoroughly enjoyed, as were also a number of short talks. Dr. Schenck invited the Hoo-Hoo to hold their next meeting on the summit of Mount Pisgah, and the invitation was speedily accepted.

#### Bristol, Va.-Tenn.

The Richland Lumber Company has been organized in Bristol with a capital stock of \$25,000, fully paid in. The officers of the new lumber corporation are: President, J. H. Bryan of the Bryan Lumber Company; vice president, Maj. Paul Devine, treasurer of the Soldiers' Home at Johnson City; secretary-treasurer and general manager, J. Alwyn Cannon of the Citizens' bank of Bristol. The new concern owns a large body of valuable hardwood timber along the banks of the Wateree river, between Sumpter and Columbia, S. C., and will at once install mills and prepare to begin cutting by September 1. The company will have general offices in Bristol and Mr. Cannon will have charge of all business. It is in the market for all kinds of mill and logging equipment, office supplies, etc. The directors are: J. A. Cannon, J. H. Bryan, Maj. Paul Devine, Dr. T. S. West and E. T. Brown.

J. A. Wilkinson announces that he will at once begin the erection of a mill, to cost about \$50,000, on the Southern Railway yards at South Bristol. He has purchased a good-sized mill site and will be much better equipped than heretofore. This mill is being built to supplant the one which was burned in this city some three months ago. Mr. Wilkinson will also maintain an assorting yard in Bristol.

Invitations have been issued to the approaching marriage of Ewell Lee Warren, southern manager of the R. E. Wood Lumber Company of this city, to Miss Trula Leigh Keenan of Trenton, Tenn., July 11. Mr. Warren and his bride after a short honeymoon trip will be at home in Bristol.

Richard N. Jackson of the Kingston Lumber Company, of Laurel, Miss., accompanied by his friends, Messrs. Curry and Davis, of Birmingham, came to Bristol last week in Mr. Johnson's big touring car and made the trip from Laurel to Baltimore overland. J. Alwyn Cannon joined the party at Bristol and accompanied them to Baltimore.

C. J. Morrow, a prominent hardwood lumberman and manager of the properties of the North Carolina Land & Timber Company of Putnam, N. C., came to Bristol last week and spent several days buying hardwood lumber for shipment to the east.

Tom H. Mason, a prominent hardwood lumber buyer of Fort Smith, Ark., is the guest of relatives and friends at Bristol and Abingdon. Mr. Mason made the trip from his Arkansas home to Bristol overland in an automobile. He is an old Virginia lumberman and will spend several days in this section.

Frank Price of Price & Heald has returned to his home at Baltimore after looking after the company's business interests in this section for several days in conjunction with the local manager, F. W. Hughes.

N. B. Bradley, of Bay City, Mich., of N. B. Bradley & Sons and the Bradley Lumber Company, came to Bristol last week and is spending some time in this section as the guest of his son, E. E. Bradley, of Elizabethtown.

About a dozen of J. A. Wilkinson's inspectors and buyers spent the Fourth in Bristol and were entertained at a banquet given at Hotel

Tip Top on the evening of the Fourth by Mr. Wilkinson. H. M. Hoskins, E. H. Wilkinson and J. A. Wilkinson of Bristol were the only Bristol people present.

J. E. Brading of Brading & Marshall of Johnson City was in Bristol on business last week.

W. H. Hensley of Scott county, Virginia, was in the city on business last week.

The Penland Lumber Company has been organized at Marion, Va., with a capital stock of \$200,000 and will do a general lumber manufacturing business. W. S. Burger is president and general manager of the company, C. W. Anslar vice president and E. M. Campbell treasurer. The company is organized to develop extensive timber lands in southwest Virginia and is backed by Pennsylvania capitalists.

The construction of the Black Mountain railway in Lee county, Virginia, which is being backed by Bristol capitalists, is in progress, and it is said the road will be completed within a few months. The road is being built to afford an outlet for timber and coal, and lumber concerns will be organized to develop the timber properties on Black Mountain.

Lloyd Hughes, son of O. F. Hughes, a veteran lumberman of Bristol, has returned from West Virginia, where he has been engaged in the lumber business for the past year and a half.

Valentine Luppert and J. W. Tarman of the Luppert Lumber Company, Inc., of Butler, Tenn., were in Bristol on business last week.

John W. Coles of Philadelphia, a hardwood lumberman, is in Bristol buying stock.

#### Cincinnati.

The movement of lumber last month according to Chamber of Commerce records was as follows: Receipts, 7,522 cars; shipments, 6,086 cars. For the same month last year the receipts were 6,311 cars and shipments 5,052 cars.

In June there were issued 361 building permits, as against 444 for the corresponding month in 1905. However, the value of improvements for June this year was \$846,000, compared to \$635,760 in June, 1905.

Fred Furgason, for years a well known lumberman, has been appointed to succeed Wm. Stewart as deputy national inspector at Cincinnati. The change was made after a visit by G. L. Smith, surveyor general of the National Hardwood Lumber Association.

C. E. Korn, of the Farrin-Korn Lumber Company, has returned from a short business trip to Cairo, Ill.

T. B. Stone, of the T. B. Stone Lumber Company, is back from a two weeks' visit to various hardwood centers.

I. M. Asher has resigned as local agent for the Nicola, Stone & Meyers Company of Cleveland. He has been succeeded by Mr. Morgan. Mr. Asher, together with J. E. Austin, O. L. Layne, P. N. Simon and Fred Frazer, has formed the I. M. Asher Lumber Company. The capital stock, half of which will be 6 per cent preferred, is \$20,000. The company will be ready for business in a few weeks.

A woodworking plant at present located in a large eastern city, has written the Industrial Bureau that it will remove to this city providing a building with at least 75,000 feet of floor space can be obtained. Such a building is now being looked for by officers of the Industrial Bureau, who are keeping the name of the company a secret for the present.

M. E. Farrin, of the M. E. Farrin Lumber Company, has returned from Grand Point, Mich., where his family will spend the summer. Mr. Farrin is arranging his work so that he can make frequent trips during the hot weather to Grand Point.

The mills of the Kentucky Lumber Company at Burnside and Williamsburg, Ky., and at Haversham, Tenn., have been forced to suspend operations. In the meantime, however, the company is stocking its yards in this city with desirable lots of hardwoods.

The constitution and by-laws of the Cincinnati Lumbermen's Club will be changed. President Moffett has appointed the following committee to perform that duty: C. F. Korn, chairman; J. W. Darling and Wm. Stone.

For more than twenty miles above the city C. Crane & Co. have logs along the shore of the Ohio river. They were fortunate in getting many of their logs out of the mountains of Kentucky and West Virginia before the streams became too low to permit their floating. All of the Crane Company's mills are running full time to keep up with the great rush of orders on hand.

Samuel W. Richey of the Richey, Halsted & Quick Company is in Portland, Ore., where on June 27 he was wedded to a charming young lady of that city. Mr. Richey's lumbermen friends here have secured the famous oil painting by John Hauser of this city of "Quick Ball," one of the few Indian chiefs left on the government reservation. The painting will be given to Mr. Richey when he returns next month with his bride.

#### Nashville.

A syndicate of Nashville lumbermen, headed by A. E. Baird, has just closed a deal for a half million acres of timber lands in Mexico near Durango. The property is said to have an abundance of giant white oak and yellow pine. A railroad line has been surveyed from Durango, through the tract, to Mazatlan.

D. S. Hutchinson, of the Nashville Hardwood Flooring Company, is figuring on a handsome home to be built in the Murphy addition, a fashionable residence portion of the city.

John W. Love, of Love, Boyd & Co., is now living in his new home on West End avenue, his place adjoining that of John B. Ransom.

Among the recent visitors to the Nashville market were Martin J. Musselman, of the Mehler Lumber Company, of Louisville, Ky., and A. J. Gall, of the Gall Lumber Company, Ltd., of Toronto, Canada. Mr. Musselman bought several cars of hardwood, and Mr. Gall looked extensively at local stocks.

Hamilton Love, of Love, Boyd & Co., has returned from a stay of several weeks at Mount Clemens, Mich., where he went to take the mud baths for rheumatism. He is somewhat improved.

M. F. Green, of the Davidson-Benedict Company, has returned from a tour of inspection of the properties of the company in South Carolina and Georgia.

The E. & N. Manufacturing Company, one of the largest manufacturers of interior finishing products in the south, has been awarded the contract of furnishing the interior finishings of the new department store that is being erected by the Casner-Knott Dry Goods Company on Church street. Mahoganyized birch will be the wood principally employed.

What is known as the Hill lands, have been sold at Tracy City, Tenn., to C. F. Barnes, William Barnes and W. T. Moody, of Texas, and Clarity Hall, of Chattanooga, for \$20,000. The deal includes several thousand acres of virgin timber.

A copy of the charter of the Wiborg & Hanna Company, of Cincinnati, Ohio, has been registered at the office of Secretary of State John W. Morton. The company will do a lumber and sawmill business in Tennessee. It is incorporated at half a million dollars.

#### Memphis.

The issuance of a circular by the Missouri Pacific system, announcing that a minimum of 40,000 pounds of lumber must be loaded in a 60,000-pound capacity car and 35,000 pounds minimum in a car with stated capacity of 40,000 pounds, has aroused vigorous protests from lumbermen, on the ground that such action is unfair and places them under a handicap which is somewhat serious. One lumberman has already written to the general freight agent of the road declaring that it is impossible to load a mini-

minum of 40,000 pounds in a car of 60,000 pounds capacity in the case of bone-dry cottonwood, cypress, poplar and other similar woods, also that it is impossible to load 35,000 pounds in a car of 40,000 pounds capacity. Other lumbermen are writing in similar strain.

Following are the more important movements among the tow boats handling lumber and logs on the Mississippi river during the past fortnight: The Fred Hartweg has passed up the Mississippi river from the lower bends loaded with lumber for Ohio river points; the Joy Patton has brought in a large load of logs from points above for Memphis firms; the tow boat Dolphin No. 3, the property of the Anderson-Tully Company, has brought in three barges loaded with logs for the mill of the company in North Memphis; the Harry Lee has arrived with a large consignment of persimmon logs for the Anchor Block Mills to be manufactured into tackle blocks, shoe lasts and other hardwood specialties; the tow boat Katherine has passed up from the lower bends of the Mississippi with a barge of lumber for a firm at Cairo, Ill.

C. R. Palmer, who has spent some time at the offices of the L. H. Gage Lumber Company at Memphis, has returned to Providence, R. I., and will be gone all summer. He was accompanied by his wife, who came south only a short time before his departure.

The Buffalo Hardwood Lumber Company has purchased seven acres of land in North Memphis and will establish a hardwood lumber plant thereon, to be operated as a branch of the home concern. The land purchased adjoins the tract purchased some time ago by the E. Sondheimer Company. The plant will, it is understood, be in operation here some time this fall.

Dispatches received here from Clarksville, Tenn., are to the effect that a company is being formed there for the manufacture of wagons, with an annual capacity of 10,000.

Building permits taken out here during June were the largest in the history of this city for this particular period, reaching 8569,000, against 8388,000 last year. This brings the total to date this year to \$2,484,000, against \$1,955,000 for the corresponding period last year.

A well-known manufacturer, who has traveled over a considerable portion of eastern Arkansas, is authority for the statement that there are more mills running now than for a long while. However, he says there are very few small mills doing anything, as most of these quit the field during the trying experience of the preceding twelve months. Weather conditions during the past fortnight have been very satisfactory, and most of the mills, especially the larger ones, are better supplied with timber than they have been for some time.

John P. Hanna of the Wiborg & Hanna Company of Cincinnati, O., who has been visiting the branch office of the company in the Tennessee Trust building, this city, has returned to headquarters.

John W. McClure of Thompson & McClure, hardwood lumber dealers and manufacturers, has returned from a recent pleasure trip to middle and east Tennessee.

W. H. Russe, president of the National Hardwood Lumber Association and of the National Lumber Exporters' Association, who went to Indiana two weeks ago for the benefit of his health, has returned to Memphis, but says he has not been much improved by his trip.

Fire at the plant of the American Car & Foundry Company at Binghamton, one of the largest woodworking concerns in the city, which occurred a few days ago, entailed a loss of about \$15,000.

#### New Orleans.

J. W. Strong, proprietor of the J. W. Strong Milling Company of Baton Rouge, which was recently adjudged bankrupt, has been arrested in this city for interfering with the keeper appointed to take charge of some goods seized

and held under the proceedings which took place in the federal district court. Mr. Strong is also charged with assaulting the United States marshal. As the offense was committed in the Baton Rouge district, the accused lumberman was taken before the United States commissioner at that place and entered a plea of not guilty. He was placed under bonds of \$500 to appear before the United States circuit court for the eastern district of Louisiana for trial during the November term. The schedule recently filed by Mr. Strong showed that his company, which had been engaged in the hardwood lumber business, had liabilities amounting to \$74,627.46 and assets that would total only \$30,445.

H. L. Dinkins, representing the Delta Realty Company of Vicksburg, Miss., has just closed a big deal in realty selling to the Southern Land & Lumber Company of Bardwell, Ky., a fine tract of land which was owned by N. T. Burroughs of Chicago and which is located in Caldwell parish, near Monroe and Riverton, the hardwood section of the state. The tract contains 42,283 acres and sold for \$359,000. It is stated that the purchasers will build mills to cut the timber and then resell the land in small tracts.

The charter of the New Orleans Chair Company, a \$50,000 corporation which will manufacture chairs and other products from hardwoods, has been filed in this state. The company will be domiciled in New Orleans and will make a specialty of office furniture and fixtures, chairs, tables, etc. H. H. Connart, E. Rubenstein and H. H. Waters are among its organizers.

The Washburn Lumber Company of Shreveport, La., has been incorporated with a capital stock of \$25,000. The officers are: T. E. Stephenson, president and treasurer; D. A. Thompson, vice president; T. H. Thurmond, secretary.

R. B. Blanks recently transferred to W. K. Rideout a fine tract of land in Ouachita and Caldwell parishes in this state, receiving \$100,000 in cash for his property, which consisted of 12,669 acres of fine pine and hardwood timber lands.

Exports of lumber from Pensacola, Fla., during June were greater than those of any other month during the last two years. Over 40,000,000 feet were shipped out of the Pensacola port to foreign countries and a large quantity was sent on coastwise vessels to New York and Philadelphia. The exports were as follows: Austria, \$6,808; France, \$44,269; Germany, \$27,000; Italy, \$124,463; Netherlands, \$39,479; Spain, \$29,000; England, \$431,001; Scotland, \$64,328; British Honduras, \$5,858; Argentina, \$147,015; Brazil, \$100,142; Uruguay, \$9,528; total, \$1,010,981.

Hawkins & Co. of Hattiesburg, Miss., have closed a deal for 3,400 acres of timber in Lamar county, paying \$127,000, or something over \$37 per acre, for the tract. There is considerable hardwood on the property, and this will be used by the several spoke and handle factories in that vicinity.

Steamboats plying out of New Orleans in what is known as the Ouachita and Black rivers trade have for the last few weeks made a specialty of shipments of persimmon logs which they are bringing from the Black river territory and exporting to foreign countries, where they are being manufactured into shuttles and shoe lasts. Persimmon is a hard, dry wood, and because it does not shrink is especially adapted to these uses.

A valuable addition to the large number of woodworking plants in the vicinity of Jackson, Miss., is that of Cambria Brothers, which will be opened in the next few days. The company will manufacture stair cases and other articles from hardwood, making a specialty of scroll work.

The Jackson (Miss.) Furniture & Casket Com-

pany has completed its plant and will begin operations in a few days. It will give employment to about 100 men.

The Silsbee mills of the Kirby Lumber Company, with 5,000,000 feet of all kinds of lumber and numerous other buildings, were burned July 4. The total loss is estimated at \$700,000. It is said to be covered by insurance.

Part of the big plant of the W. T. Adams Machinery Works, near Corinth, Miss., was destroyed by fire July 4. This is one of the biggest lumber machinery supply houses in Mississippi. The loss is estimated at \$150,000. The machinery shop, old pattern shop, sawmill and foundry were destroyed and the new pattern shop was badly damaged.

#### Minneapolis.

Indications from the building trade are for a good hardwood business this summer and fall. The volume of building in the twin cities keeps pace with last year. St. Paul shows a good increase. Minneapolis made a remarkable record last year, and is not quite keeping to the same rate this season, but the activity here is much above the average. Building permits for this city were for a value of \$68,815 in June, compared with \$57,900 in the same month a year ago. The total for six months is \$4,147,650, compared with \$4,787,870 for the same six months in 1905. Considering that there have been no skyscrapers started this year, this showing is remarkable. The receipts of lumber here are also on the advance, showing increasing local consumption. June receipts were 15,696,000 feet, compared with 14,624,000 feet in June of last year.

W. H. Still of the Minneapolis Lumber Company has returned from a business trip to Chicago and Wisconsin points. They are enjoying a fair trade for the time of year, and had stocks on hand at the mills generally less than last year at this time.

E. Payson Smith of the Payson Smith Lumber Company is back from a business trip in Missouri. The former quarters of the company have been outgrown and it has moved into more commodious ones at 519 Andrus building. A. S. Bliss says June was the best month the company ever had, and it is looking for a big fall trade.

F. M. Bartelme has returned from a two weeks' trip through Wisconsin and a side trip down to Chicago. He found decidedly small stocks of hardwood at the mills, with the exception of birch and basswood, which are fairly plentiful. Wholesale trade he finds quiet, except sales to retail yards, but business is all that could be expected at this season.

Osborne & Clark, the local hardwood wholesalers, are building a large shed in connection with their mill at Ladysmith, Wis. They manufacture considerable pine and hemlock there besides hardwood and sell the soft lumber at retail on the ground. The hardwood is shipped into this market. Mr. Osborne says they are enjoying a big carload trade from their retail yard customers. They have in many cases exhausted the stock bought in the spring, and are forced to buy again to stock up for summer. Many shipments are going long distances.

I. P. Lennan of I. P. Lennan & Co. says he is finding a better trade in other lines than in hardwood, as the factory trade is not going after stock very actively at present.

A. E. Butler of Antigo, Wis., representing the C. Wunderlich Lumber & Manufacturing Company of Antigo, and H. S. Wunderlich of Koepenick, Wis., was in Minneapolis a few days ago calling on customers to interest them in his line of hardwood.

A new sash and door factory is running at Thief River Falls, Minn. It is called the Pioneer Sash & Door Company, and has \$50,000 capital.

**Ashland.**

The manufacturing lumber business is very quiet and unless there is an early rise most of the mills will be shut down. The customary June rise in the Big Sandy tributaries has failed to materialize, in consequence of which the timber men are feeling decidedly blue. There is little doing at present, for the dealers are all away on their summer vacations.

The W. H. Dawkins Lumber Company bought up the entire cut of poplar of the Ironton Lumber Company, of Ironton, Ohio. This comprises between 1,000,000 and 5,000,000 feet. This company is away behind in filling orders, and inquiries are being turned down every day.

Mrs. R. H. Vansant and children are spending a few weeks at Pence Springs, W. Va.

W. L. Watson, and son, Dennis, were at home for the 14th of July from Mabau, W. Va., where they are looking after Mr. Watson's extensive lumber interests.

A fine son has arrived to gladden the home of J. E. Walker of the Keyes-Fannin Lumber Company of this city.

W. R. Vansant has returned from North Carolina, where he has been looking over the ground with a view to locating in the lumber business.

The following companies have been incorporated under the laws of West Virginia: The Janny Gap Coal & Land Company of Charleston, chief works in Raleigh county; for the purpose of buying and selling coal, coke and timber, and carrying on a general merchandise business. Capital \$50,000, of which \$3,000 has been subscribed, and \$300 paid. The Chelyan Coal & Land Company of Charleston, chief works in Cabin Creek district, to mine and sell coal, manufacture coke, buy and sell timber lands, build and operate railroads, steamboats and barges, carry on a general merchandise business, etc. Incorporators, E. W. Grice, O. O. Cooper, W. H. Garnett, R. B. Miller, R. F. Dunlap, of Hinton. Capital \$20,000, \$4,500 subscribed, \$450 paid.

**Louisville.**

Fire visited the mills on the Point a few days ago, destroying the sawmill and planing mill of W. H. Concher. The mill was entirely wiped out. Just the amount of insurance carried is not known, but it was nothing like the full value of the mill. However, Mr. Concher is going to work to rebuild the plant again. The fire department turned their hose into the Louisville Point Lumber Company's plant and did some damage to belts and the filing room, but this concern suffered no loss from fire.

The Perry-Davis Saw Mill Company is very busy, cutting oak almost exclusively. A little walnut is also cut, but most of the work is oak bill stuff, car material and plain sawed lumber. The company is not making a great deal of quartered stock just now, the logs not running very well for that class of work.

R. M. Cunningham says that while he has nothing exciting personally to report in the hardwood market, it appears to be stiffening right along, and it is not much trouble to sell anything in hardwood at a reasonably fair price.

W. C. Ballard of Wehnhoff & Ballard sold a block of half a million feet of No. 2 cottonwood the past week. He says the cottonwood market is climbing right along and practically everything the mills have in stock has been cleaned up, the only thing his concern has in sight being a little bunch of No. 1 common.

The Mengel Box Company, which cuts considerable hardwood for the furniture and factory trade along with box factory stock at its mills down in the country, reports a splendid demand for hardwood and is kept sold out pretty clean, having disposed of quite a lot of stock this spring and summer.

Ed Rhubesky says there are more inquiries for hardwood than there are offerings right now,

but the mills are making very good time and supplies are coming along as well as might be expected under the circumstances.

**Wausau.**

The Wilson-Weber Lumber Company of Menominee has purchased the entire retail lumber business of N. C. Foster of Fairchild. The purchase includes six retail yards at Mondovi, Fairchild, Humbird, Osseo, Strum and Eleva.

The G. W. Jones Lumber Company of Appleton has purchased the entire hardwood cut of the Jacob Mortenson Lumber Company of Wausau and will ship most of the same to its Appleton yards. There is about 3,000,000 feet of stock, cut last winter.

The Maxwell Lumber Company of Rosholt, which handles hardwood entirely, is building a planing mill.

An involuntary petition in bankruptcy has been filed in the United States court in Milwaukee against the South Arm Lumber Company. The combined claims of the creditors, which are for notes, amount to \$9,909.70. The petition alleges that prior to the beginning of bankruptcy proceedings the company knowing itself to be insolvent transferred lands in Wisconsin and Michigan to the Milwaukee Trust Company for the benefit of the Milwaukee First National bank, and the court is asked to set aside the transfer. The officers of the company are: Theodore Plathner, president; W. S. Johnson, secretary; S. S. Johnson, treasurer.

The Murphy Lumber Company has about completed operations at Armstrong creek. It has been cutting hardwood there for ten years.

The Marshfield Land & Lumber Company, of which ex-Gov. W. H. Upham of Marshfield was one of the principal owners, has disposed of its entire interests to the Copper River Land Company. The property sold includes 22,241 acres of hardwood lands in the vicinity of Athens and Medford, the logging railway and logging cars, and a mill at Marshfield. The considera-

tion was something over half a million dollars. The former owners will retain possession of the mill for one year.

J. J. Russell, E. C. Bert, E. H. Mathis and L. E. Glynn, of Minneapolis, have secured an option on the Tomahawk Stave & Veneer Company's manufacturing plant at Tomahawk. They own a large cooper plant in Minneapolis and intend purchasing the Mohawk works and using them for a stave factory.

The Roddis Lumber & Veneer Company of Marshfield is receiving carload shipments of mahogany lumber, which is being cut up into veneer.

W. C. Culbertson, who recently died at the age of eighty-one years, was the founder and president of the Girard Lumber Company of Dunbar.

Fred R. Pollard has resigned as manager of the retail yard of the Marshfield Land & Lumber Company at Upham and will embark in business for himself. He has already purchased some stocks of hardwood and hemlock.

Robert McMillan, president of the R. McMillan Company, one of the largest hardwood manufacturing companies of Oshkosh, died recently of tuberculosis, aged thirty-four years. He came into great wealth at the death of his father in 1898 and shortly thereafter reorganized the company. He was a very successful business man.

The Wolf River Company, with capital stock of \$300,000, has been organized and taken hold of the Wisconsin Chair Company's plant at New London. The business will be enlarged and the lines of manufacture increased. It is said a capitalist of Buffalo, N. Y., will be the president of the new concern.

At the annual meeting of the Coye Furniture Company of Stevens Point, held recently, 677 shares of stock were represented, and the following officers elected: D. E. Frost, president; F. A. Southwith, vice-president; W. H. Coye, treasurer; W. S. Young, secretary. Reports showed that the business the past year had increased 70 per cent, while the operating expenses had decreased.

## Hardwood Market.

(By HARDWOOD RECORD Exclusive Market Reporters.)

**Chicago.**

The Chicago hardwood market is featureless. There is some desultory buying going on, but little action in the local trade. Manufacturing institutions producing furniture and interior finish are fairly well stocked and seem to prefer not to place many orders for lumber until later in the season. It is not an unexpected or unnatural condition at this time of year, and the trade generally is very optimistic regarding an exceedingly active fall business.

**Boston.**

The market for hardwoods has shown considerable firmness during the past two weeks. Letters received from mill points state that dry stock is in small supply. Dealers here who have been west and south report a fair amount of logs on hand, but confirm the reports of generally small supplies of dry lumber.

Manufacturing consumers in this city and vicinity are fair buyers, but there is not enough new business to bring about an active market. Many of these consumers have very good stocks and are, therefore, only taking on additional supplies when a lot is offered that looks like a bargain. Some of the furniture manufacturers are still bothered by labor troubles, but this does not hinder them from buying when they consider the price right. The export demand is of very moderate proportions for the most part. Quartered oak and walnut are in fair call from exporters.

The demand for plain oak is not active; in some instances it is reported that lots

have been offered at concessions. Quartered oak is firmly held. A prominent dealer stated recently that anyone who had quartered oak to sell could do better a little later than they could by pushing for business now. Some export business is reported. Chestnut is in very good call and offerings are not large. The demand for maple flooring is moderate. Brown and white ash are very firm and offerings small. Whitewood is firm, especially in the better grades. A fair volume of new business is reported. Cypress for the most part is firmly held, but the demand is not large.

**New York.**

The general movement of hardwood lumber in the local market is reported fair. The amount of good dry lumber at mill points is sufficiently small to eliminate any forcing of the market by wholesale or manufacturing interests. There are excellent prospects for an active fall trade. All the yard dealers, particularly those catering to the building trades, report a big volume of business, with more coming out all the time, and there is every indication that 1906 will compare very favorably with last year and be considerably ahead of 1904. The yard trade in hardwoods is somewhat light, in view of the heavy early purchases of the dealers for their summer wants, but the manufacturing trade is very fair and buyers in this latter line are sailing so close to the wind that their orders are all of the rush nature. The local situation can truly be said to be in very fair shape.

Plain oak is holding stiff on light supplies and good demands. Quartered oak, while showing some improvement, is still not enjoying the activity or value which it should. There seems to be more than enough stock for current wants, and while there are not very many concessions being made, prices are not on the level which they should be. Poplar is enjoying a good call and stocks are ample for current wants. Low grade stock is more active possibly than the better grades and is particularly so in the manufacturing trade. Prices are holding firm and the market is in good shape. Chestnut is active and the better grades are scarce owing to the natural production of more of the lower grade stock than of firsts and seconds. The low grades, however, are holding firm and better grades are very stiff in price. Ash is in good call, stocks are scarce and prices firm. There is sufficient maple for all current wants and prices are easy. Gum is having a fair call, and beech is being called for freely, particularly for temporary construction work and special lines.

#### Philadelphia.

During the last two weeks there has been considerable quartered oak and poplar coming into the market. Birch has been moving well, and there has been a good demand for thick oak. Ash has also been in request, and some of the big retail yards have been handling a good bit of cypress.

The concerns that deal in railroad ties, posts, etc., find business extremely good. Most of them in Philadelphia are going into the manufacturing end of the business more and more, finding that their ends can be best attained if they manufacture their own stock, although they are all in the market for a certain amount of made-up stuff. One of the best proofs of their prosperity is the fact that they are enlarging their holdings of timber lands and erecting mills.

Among the wholesalers in general there is a feeling of dullness, which, however, is not alarming, as a slow season is expected at this time of the year. A good season is predicted by the biggest firms who find that the orders from the retail yards are increasing slightly over those of the previous fortnight.

#### Baltimore.

While certain aspects of the lumber trade here tend to create an impression of quiet, stocks are moving in fair quantities and the business generally is in good shape. Stocks are arriving with some freedom. The distribution in the East does not at present compare with the demand in the Middle West, but the range of prices is quite as high as it has been for nearly all kinds of lumber. As was to be expected, oak planks continue to head the list, being eagerly sought. No advance in the list has taken place of late, but the quotations are steady.

The exporters report the foreign situation rather quiet, but this is always the case during the heated period. The export demand for oak planks is fair, and stocks are being moved in liberal quantities. Recently the belief gained some currency that values here would not be maintained, and this tended to make the European buyers hesitate in the hope that prices would ease off. They realize by this time, however, that such expectations are not likely to be borne out and stocks are being taken once more with somewhat greater freedom.

The domestic market is being aided by the railroads and car building concerns, which are making large requirements. The shortage of labor in the sawmills is another factor that tends to make buyers eager to place orders and serves to keep up the lists. Ash is a strong second to oak, being in good request both here and abroad, and bringing prices that stimulate production. Walnut remains

in favor among a certain class of domestic buyers, while the foreign trade is always ready to take desirable stocks. Values are well sustained. Chestnut, beech, hickory and other hardwoods all move freely at satisfactory figures. Poplar has not lost any of its strength, being called for in quantities at home as well as in foreign countries. The range of prices is proportionately higher here than on the other side of the Atlantic, and reports are frequent that manufacturers, shipping direct, make sacrifices in order to prevent accumulations here. Some of the exporters criticize this policy as short-sighted because, they say, the exporter is thus in a measure shut out of the foreign market because the prices he must pay do not permit him to compete with the direct shipping manufacturer. The exporter, therefore, does not buy lumber, so that in the end the total of the shipments is no larger than it would be if the export business were done entirely by those engaged therein.

#### Pittsburg.

The hardwood market in Greater Pittsburg maintains a buoyancy that is almost unaccountable in view of the adverse conditions that have greatly reduced the volume of trade in other lines of lumber. Reports from the largest hardwood firms for June indicate that it was one of the best months they have had for years. Unlike other woods in this market hardwoods are not accumulating to any great extent in the local yards and retailers who have not given an order for pine for weeks are buying freely of the hardwoods at better prices than prevailed May 1. This month gives promise of being an exceptionally active mid-summer period and dealers are looking forward to a busy summer.

The carpenters' strike, which has been on since May 1 and which involved about 1,700 workmen, has been the one great drawback to the sales of all kinds of lumber. The planing mills of Allegheny county, which have been practically idle for six weeks, are making a determined effort to start this week on the open shop plan and at the old wages of \$3.50 per day of eight hours. Mill owners have received enough applications from carpenters in nearby small towns, where wages are about half the Pittsburg rate, to give them considerable assurance that they can man most of the mills with outside help if necessary. Unless this is done with comparatively little trouble it will result in some of the mills going out of business, for they have been running on a very low margin of profit for months, owing to the fact that the outside mills are coming into active competition with them in stocking this market.

Oak is in the best demand since 1901. From heavy timbers for bridge work and river contracts to the finest grades of finishing lumber, everything is selling well. Prices are shading upward.

Other hardwoods are favored with a fine inquiry. Maple flooring is one of the best notes in the budget at present and prices are firm. Low-grade chestnut is again a leader in the market and stocks are reported only fair. Considerable beech and maple are being sold as substitutes for oak in river construction false work. Last month the call from the furniture dealers for birch, ash, maple and cherry was largely increased. Salesmen who travel Ohio, Indiana and Michigan, as well as those who visit the large cities in the East, report conditions generally very favorable to the hardwood trade and prices right and collections above the average.

#### Buffalo.

Hardwood trade here is reported fair, with prices firm. Stocks are fairly good, with the exception of chestnut and ash, which are not to be kept in full assortment henceforward.

There is a good call for oak, some dealers

reporting the sale of grades and cuts that they had not considered at all fast sellers. It is true that the better supply of birch has made it easier to keep a stock of oak on hand. The consumer has found that he can give white, or sap, birch a fine mahogany stain and that is all he wants to know. So birch, which now runs so largely to white, is all right, even if it is rather plentiful.

It does not appear that the effort to keep up a stock of white ash is to succeed, for the supply has suddenly given out all along the line. Not only maple, but Washington fir is being offered in its place and seem to answer the purpose.

There is no report of an increased poplar supply, though Canadian lumbermen are getting water enough this summer to float their logs, which were mainly stranded early in the season. Poplar is scarce and high.

There is a good sale of maple and oak flooring. In fact, all the mills in the city are running strong on account of the activity in building.

#### Detroit.

Market conditions in southern Michigan show very little change. Birch is still inclined to be quiet, while basswood is considerably stronger. The stiff advance in gum has greatly helped basswood in this section. Maple continues to be picked up closely, and the mills are cutting practically nothing but 4-4 and 5-4, avoiding the thicker stock, which has been a drag on the market for the past year.

Factories are all very busy, and the consuming demand seems fully up to the normal, though there is no evidence of a desire to buy very far ahead of actual needs.

#### Saginaw Valley.

Trading in hardwood lumber is good for this season of the year. Prices are better than a year ago and the conviction is there will be an advance before the season closes, as the prices in pine and hemlock are out of proportion to those of hardwood. Manufacturers state that there is no surplus of dry stock, but lumber cut in the winter and early spring will soon come on the market.

There is more ash being picked up this year than usual and it is a good seller at firm prices. Basswood is also doing well, with a demand particularly for culls for box shooks. Considerable quantities of elm will be manufactured this season. Birch is not so plentiful, yet lots of a few hundred thousand each are picked up here and there. There is maple in sufficient supply. A number of million feet of maple timber is being manufactured at Bay City and at An Sable for government use in harbor work and for bridges and large buildings.

Maple flooring is also doing better than usual. A large portion of the output here goes abroad. No labor troubles have interfered with operations this season. Not only local mills, but those along the lines of road and on the Lake Huron shore are busy and the output will be about equal to that of last year.

#### Milwaukee.

Market conditions have assumed a firmer tone within the last few weeks. The demand for stock has shown a perceptible increase and buyers appear more anxious to place orders. This condition is making itself especially felt in southern woods, but northern woods are being affected sympathetically. Dealers expect a still more healthy situation within the next few weeks, as indications all point to a reaction from the abnormally poor condition since last February. Prices under the circumstances remain firm and will continue without fluctuation.

#### Bristol, Va.-Tenn.

The lumbermen in this city and section seem to be very busy, and the cry of scarcity of stock



has almost been hushed, though nearly all lumber concerns are short on poplar and are confronted with a serious proposition. It is evident that there is not a great amount of poplar standing in this section and the yards are nearly all depleted. No trouble is encountered in marketing the stock, and the lumbermen are not apprehensions of the danger of overproduction. Some of the mills report a shortage of logs and others closed a few days to catch up on logs.

#### Cincinnati.

The gist of opinion among wholesale hardwood dealers is that the market in its present state is entirely satisfactory, considering the season. In former years at this time mid-summer dullness has existed, but this year it has not appeared, so far at least, and dealers can be found who express the belief that there will be no appreciable falling off in trade during the balance of this month and next.

Prices are not yielding in the least, although receipts have increased, enabling some stacking to be done in the yards for future wants. In the last week the weather has been favorable to building operations, after a fortnight's stretch of intolerable conditions. Fair inquiries are being received from export sources, while road men are sending in good orders, with advices that in the fall there will be a great demand likely from the country trade.

Plain oak firsts and seconds have been the market leaders, selling at best prices without urging. Quartered oak is in about the same position as for some time, a fair amount of business being put through, which shades only when compared to the activity in plain grades.

Cypress sales have been of moderate volume and the same can be said for ash, chestnut and hickory. Prices for these three items are stiff. Mahogany is moving with customary freedom, the demand being largely from eastern markets. Cottonwood has sold nicely in the last two weeks and red gum has followed it closely. Poplar firsts and seconds continue to bring full quotations.

#### Nashville.

July 1 statements, covering the business in lumber in Nashville during the first six months of 1906, show a splendid increase in volume over a corresponding period of 1905. The increase is said to average as much as 20 to 25 per cent with many firms. A good deal of activity is noted in the local market at present. The river is low and few logs are being brought to the city that way, but the railroad lines are bringing in a lot of timber. Good firm poplar, in all grades in shipping condition, is being picked up readily. The same is true of chestnut, oak and ash. Local stock is reported considerably lower than was the case on January 1.

#### Memphis.

The midsummer season finds only a moderate demand for hardwood lumber, but it likewise finds less dry stock than has been held in this section for a number of years, so that the market displays a healthy undertone. There is an apparent disposition on the part of buyers to secure nothing beyond immediate requirements, but this is not causing sellers to lose any sleep, as they feel that there will not be any accumulation of stock and that, consequently, there will not be any falling off in prices. There are more mills in operation than for some time as a result of the favorable weather; but the receipts of lumber here are not large, and manufacturers say that it will take them some time to restore their yard holdings to the normal condition.

The foreign demand is only moderate, though it is felt that there will be some picking up in both the domestic and foreign trade during the latter part of this month.

Ash is as strong as heretofore. The demand for it is very good and offerings light. The demand is good for all grades, though the preference is given for thick stock. Cypress is another

ready seller, with only moderate offerings. Prices are firmly maintained at the recent level. All grades are wanted.

Cottonwood is much wanted in the lower grades by box manufacturers. There is a pronounced scarcity of this lumber, which is an added feature of strength. High-grade cottonwood, with the exception of box boards, which are in splendid request, is possibly not quite as strong as a short time ago, though there is not much of this for sale.

There is a moderate demand for red firsts and seconds gum, though sap gum is not much wanted. Low-grade gum is in excellent request. Low-grade gum is quite firm, while a steady tone prevails in all other grades.

Plain white oak continues in healthy position. Demand is good, especially in the higher grades. Plain red oak may be a shade easier than heretofore, though there is no special difficulty encountered in disposing of high-grade stock. Quarter-sawed white oak is a good seller at fairly satisfactory prices, but there is not much movement in quarter-sawed red. The increasing tendency to cut quarter-sawed oak into veneer is regarded as the principal reason for the small business done in this wood as compared with recent years.

#### New Orleans.

The hardwood market here is dull. Stocks have not been replenished and are still low. The demand is light because the buyers both here and on the other side have practically suspended operations. Prices remain practically as they were sixty days ago. Exports are falling off and not a great amount of lumber is being shipped to foreign countries. This is due to the inactivity on the part of the European buyers. They are said to be holding off slightly in hopes that lower prices will come with the temporary depression which obtains now. The conditions prevailing at present are not unusual for this season of the year and no decided change is looked for within the next sixty days. The first of September, however, will in all probability result in a decided change in the conditions.

#### Louisville.

It's the mill man's market in this vicinity all the way around, and every mill is busy. There has been some active moving of cottonwood, with prices of this wood climbing right along with poplar. The local box factory trade has not taken kindly to advanced prices, but those having cottonwood to offer have found no serious difficulty in finding a market at better figures for box factory stock than is generally obtained here. Poplar, of course, is leading the list in strength. The demand for oak, especially for car stock and bill stuff, is very active. The furniture trade, while it is not expected to buy heavily these days, is taking a very nice volume, not only of plain oak, but of quartered oak. Good prices on walnut lumber stimulated the trade early in the season to gather in all the walnut that could be picked up, and the local mills are still getting in more and sawing it up. There is not a great deal of it that is big and extra fine, but there has been an unusually large quantity altogether brought in for cutting this season. The local demand for hardwood flooring continues good, in fact, there is more sold here than the trade anticipated. The hardwood market generally is good, the only variation about it is that now and then some wood will take on an unusual spurt in the way of activity.

#### Minneapolis.

The feature of the market in the Northwest is a revival of buying from the retail yards. Both single yards and line yard buyers are coming into the market for hardwood, the chief item in demand being oak yard stock and wagon material. A good deal of flooring is called for. The demand is to a large

extent for straight cuts of hardwood, but there is considerable also taken in mixed cuts. Factory demand in the small towns is taking considerable wagon stock just now, and the volume of business is surprising for this season of the year.

The city trade is just reasonable. Sash and door factories and furniture people are not stocking up heavily yet. They are buying to a fair extent for immediate needs, all being busy and running rather low on stock, but they will not contract much or buy over a carload at a time till the new stock of hardwood is pretty well available or until they know more about fall prospects in the light of the grain crops of the Northwest. There is a brisk demand for such northern oak as can be offered, but the supply is running low. Red oak in northern stock is practically gone. There is some quartered oak offered, but plain oak is scarce, and the main supply will have to come from the South. There is no difficulty now in securing shipments from southern mills, and prices are a trifle easier than they were. Birch is ample in supply, except No. 1 in thick stock. There is a good demand for all kinds of birch. Basswood is selling fairly well. The mills have notified buyers of basswood culls that there will be a \$2 advance on August 1, and this has stimulated buying somewhat. An even greater scarcity of cull lumber is expected next winter than was experienced last winter and spring.

#### Liverpool.

Trade is still very quiet and does not show any activity. Two mahogany sales take place shortly and only a small quantity of African wood will be offered, the greater amount being Cuban. Prices should be well maintained. The slackness of trade throughout the United Kingdom may eventually lower prices somewhat, but it is thought they will be well maintained until the end of the year. Buyers are only holding off in the hope of better things in the way of prices.

The various hardwoods still continue firm in price, but few sales are made for large quantities. The turn of the half-year, which is of course now close at hand, may see better things. Many buyers at the moment refuse to buy on the plea of stock-taking.

Ash and oak logs and planks would come to a good market, but it is doubtful if buyers would risk buying "to arrive" at the prices shippers are asking. Hickory is much firmer in price and prime parcels are finding a quick sale. Birch is extremely weak and buyers of wood on contract will drop a bit of money if they sell on current market prices.

#### London.

There is little of particular interest to report in this market; prices are firm, but there is very little demand.

The "war" between the dock companies has terminated by mutual consent and the gainers have been the importers, as the companies have agreed to stand by their rates for the next twelve months. There is a possibility of all the London docks being taken over by one of the local governing bodies, hence the termination of the fight.

Walnut has been in better demand for cull and medium boards.

In oak 1½, 2, 3, and 4-inch planks are none too plentiful in any grade, and are in very great request; 1-inch boards are slow of sale, but stock does not accumulate.

In satin walnut only medium quality is asked for at the moment.

Several parcels of ash planks recently arrived on consignment have sold at very good prices and other parcels would sell readily, but this stock is better sold on contract.

Mahogany still remains firm and good prices with eager competition is the rule for any parcels which come to public auction.



# AT COST

IS AN UNCOMMON TERM AS APPLIED TO INSURANCE

But this is the actual price of Indemnity against Fire Loss furnished by the

## Manufacturing Lumbermen's Underwriters

THE STRONGEST INSURANCE ORGANIZATION  
TO-DAY IN AMERICA

The saving is not on a small portion of your insurance but on the entire line. There are other advantages equally interesting.



Only well built plants with adequate protection and at least five years timber supply are considered eligible.

FOR LIST OF MEMBERS AND FURTHER INFORMATION, ADDRESS

**HARRY RANKIN & CO.      Kansas City, Mo.**

# Wanted and For Sale -SECTION-

Advertisements will be inserted in this section at the following rates:

For one insertion ..... 20 cents a line  
For two insertions ..... 35 cents a line  
For three insertions ..... 50 cents a line  
For four insertions ..... 60 cents a line

Eight words of ordinary length make one line. Heading counts as two lines. No display except the headings can be admitted.

Remittances to accompany the order. No extra charges for copies of paper containing the advertisement.

## EMPLOYES WANTED.

### WANTED.

Competent hardwood inspector and buyer, familiar with rough wagon material. Good job for right man. Address "K. 46," care HARDWOOD RECORD.

### WANTED.

A hardwood lumber inspector. H. C. HOW & CO., 218 La Salle St., Chicago.

## LUMBER WANTED

### OAK TIES WANTED.

Standard White, Rock and Burr Oak ties, 6"X8"X8' and 7"X8" to 12"X8 1/2'. Send description of what you have and price. G. ELIAS & BRO., 965 Elk St., Buffalo, N. Y.

### WANTED WALNUT LUMBER

We are cash buyers of walnut lumber 1" and thicker, all grades, green or dry. Advise what you have to offer. Address BOX NO. 780, South Bend, Ind.

### WANTED—HARDWOOD LOGS.

200 M feet 28-inch and up White Oak logs.  
200 M feet 12-inch and up Walnut logs.  
50 M ft. 12-inch and up Cherry logs.  
C. L. WILLEY,  
Blue Island Av. and Robey St., Chicago.

### OAK.

We are in the market for plain sawed oak, all grades and thicknesses. P. G. DODGE & CO., 2116 Lumber St., Chicago.

### WANTED.

2x5 nud wider Cypress 8' No. 1 Com., select or better.  
1x4 and 6" Tupelo Gum D. & M. No. 1 & No. 2 Com.  
1x6" and wider Tupelo Gum SIS No. 1 & No. 2 Com.  
AMERICAN LBR. & MFG. CO., Pittsburg, Pa.

### WE DESIRE TO PURCHASE

On contract carloads of Oak Boxes assembled, round corners, made of 1" stock, with cover made of 1 1/4" stock. Also other Oak woodwork machined and sanded ready to varnish, K. D., crated in bulk. Address "CASH," care HARDWOOD RECORD.

### WANTED.

Locust, Bols D'Arc or Osage Orsnge and Mulberry, log run. Write for specifications and prices. THE PILLIOD LUMBER CO., Swanton, O.

### WANTED—DIMENSION HICKORY.

Send for our specifications. MUNCIE WHEEL & JOBBING CO., Muncie, Ind.

### WALNUT ONLY.

Wanted, Walnut lumber, green or dry, all grades, all thicknesses, log run or on grade. Highest market price paid. Liberal inspection. C. J. FRANK, 2440 N. New Jersey St., Indianapolis, Ind.

### SMALL HICKORY DIMENSION.

First-class material from waste of wagon stock. Sizes wanted furnished upon application. L. T. La BAR, Hackettstown, N. J.

### OAK WANTED.

3 and 4 inch White Oak; also Mixed Oak; also 12x12 Timbers and Piling of all kinds. CONTINENTAL LUMBER CO., 1213 Monadnock Bldg., Chicago, Ill.

## TIMBER LANDS FOR SALE

### FOR SALE.

3,550 acres of Georgia hardwood, estimated to cut as follows:  
8,800,000 feet White Oak.  
3,500,000 feet Hickory.  
5,500,000 feet Red Oak.  
1,750,000 feet White Ash.  
High grade stock suitable for wagon and carriage manufacture.  
3 1/2 miles from railroad; river joins track. Ten years to remove timber.  
JOHN H. HOYT, Delaware, N. J.

## LUMBER FOR SALE.

### HARD MAPLE DIMENSION.

9,598 ft. 1 1/2" x 1 1/2" x 18, 24, 30 & 36".  
9,240 ft. 4/4x2" and wider 12 and 24" long.  
19,255 ft. 4/4x2" and wider 18" long.  
2,670 ft. 4/4x2" and wider 30" long.  
1,515 ft. 4/4x2" and wider 36".  
THE CADILLAC HANDLE CO., Cadillac, Mich.

### WAGON STOCK FOR SALE.

We are in position to furnish wagon manufacturers with wagon tongues, axles, reaches and bolsters. GAYOSO LUMBER CO., Memphis, Tenn.

### FOR SALE.

Common and better Hickory, 5,277 feet of 2 1/2", 1,092 feet of 3" and 1,024 feet of 4", dry, good quality. LOVE, BOYD & CO., Nashville, Tenn.

## BUSINESS OPPORTUNITIES

### TO LOG AND SAW HARDWOOD.

We want to contract with a reliable party to saw three to ten million feet of Oak and Chestnut in Virginia, hand mill preferred; contract to include from stump to car. VIRGINIA TIMBER CO., W. C. Bates, Treas., 70 Kilby St., Boston, Mass.

### FOR SALE.

The only sawmill in Ripley, a town of 3,000 people. Mill, sheds and all new. 20,000 feet capacity. White Oak and Poplar. Price and description upon request. W. B. JOHNSON, Ripley, Tenn.

### WOODWORKERS.

Excellent opportunities for woodworking establishments are found at a number of points on the North-Western line in the timber country of Wisconsin and Michigan. Parties dealing in coopeage will be furnished with reference to sections where this business may be conducted favorably. Address INDUSTRIAL DEPARTMENT, CHICAGO & NORTH-WESTERN RAILROAD, Chicago.

### HARDWOOD TIMBER.

A number of good mill propositions along the Cotton Belt Route. Tracts ranging from five hundred to twenty thousand acres, principally Oak, Hickory, Gum, Cypress, some Ash, Cottonwood and other hardwoods. Can be secured at very reasonable figures now—in some cases at less than \$1 per thousand stumpage. Choice openings for hardwood lumber mills, handle and spoke factories, slack coopeage plants and other hardwood enterprises. A number of points on the Cotton Belt offer free sites or will raise cash bonus or take stock in practical propositions. Let us have your wants and see what we can do for you. E. W. LA BEAUME, G. P. & T. A., COTTON BELT, St. Louis, Mo.

## MACHINERY WANTED

### AT ONCE.

If you are in need of machinery—new or second hand—a few lines in this column will place your wants before those who have such goods for sale. For particulars address HARDWOOD RECORD, Chicago, Ill.

## Locations for Industries

### ON THE ERIE, THE COMMERCIAL RAILROAD CHICAGO TO NEW YORK

The Erie Railroad System's Industrial Department has all the territory traversed by the railroad districted in relation to resources, markets and advantages for manufacturing, can advise with manufacturers of specific products as to suitable locations, and furnish them with current information of a comprehensive nature dealing with the project in its full relation to manufacture and commerce.

The Erie is one of the greatest of trunk lines. Its own rails connect the two largest cities of America. Every section of the System has its particular merits. Profitable locations exist. It has great general and coal, oil and natural gas resources.

It is important in this age of modern facilities for manufacturers to locate where they can obtain side tracks so as to receive from and ship directly into cars at the factory. Information can be promptly furnished in this connection about every point on the system between New York and Chicago.

Manufacturers' inquiries as to locations are treated in strict confidence and absolutely reliable information, so as to promote permanent traffic, is furnished. Address

**LUIS JACKSON**  
Industrial Commissioner  
Erie Railroad Company  
11 Broadway, New York

## MANUFACTURERS

Contemplating establishing plants  
in the West should take advantage  
of a location on



### Chicago & North-Western Ry.

which reaches the famous

**WATER POWERS,  
COAL FIELDS,  
IRON ORE RANGES,  
HARD AND SOFT  
LUMBER DISTRICTS,  
MINING DISTRICTS**

of the West and Northwest, and affords the best means of transportation to the markets of the world.

FOR FURTHER PARTICULARS APPLY TO

**MARVIN HUGHITT, Jr.,** E. D. BRIGHAM,  
Freight Traffic Manager, Gen'l Freight Agent,  
**GEO. BONNELL,**  
Industrial Agent,  
NW513 CHICAGO.

# Advertisers' Directory

**NORTHERN HARDWOODS.**

American Lumber & Mfg. Co. . . . . 9  
 Arpin Hardwood Lumber Co. . . . . 43  
 Babcock Lumber Company . . . . . 9  
 Barnaby, C. H. . . . . 41  
 Beyer, Knox & Co. . . . . 51  
 Bliss & Van Auken . . . . . 10  
 Boyne City Lumber Company . . . . . 45  
 Briggs & Cooper Company . . . . . 4  
 Brittingham & Young Company . . . . . 43  
 Brownlee & Company . . . . . 44  
 Buffalo Hardwood Lumber Co. . . . . 51  
 Cadillac Handle Company . . . . . 3  
 Cheat River Lumber Company . . . . . 9  
 Cherry River Boom & Lbr. Co. . . . . 1  
 Chivvis, W. R. . . . . 5  
 Cincinnati Hardwood Lumber Co. . . . . 49  
 Cobbs & Mitchell, Inc. . . . . 3  
 Crosby & Beckley Company, The . . . . . 7  
 Crosby, C. P. . . . . 43  
 Cummer, Diggins & Co. . . . . 3  
 Darling, Chas. & Co. . . . . 47  
 Davis, John R. Lumber Company . . . . . 43  
 DeHeur & Swain Lumber Co. . . . . 41  
 Dennis Bros. . . . . 45  
 Dennis & Smith Lumber Company . . . . . 44  
 Dixon & Dewey . . . . . 6  
 Duhlmeier Bros. . . . . 48  
 Dulweber, John, & Co. . . . . 49  
 Elias, G. & Bro. . . . . 51  
 Empire Lumber Company, Buffalo . . . . . 51  
 Fall, E. H. . . . . 48  
 Flint, Erving & Stoner Company . . . . . 9  
 Freiburg Lumber Company, The . . . . . 49  
 Fullerton-Powell Hardwood Lumber Company . . . . . 41  
 General Lumber Company . . . . . 48  
 Goldie, J. S. . . . . 45  
 Haak Lumber Company . . . . . 45  
 Hackley-Phelps-Bonnell Company . . . . . 45  
 Hayden, Harvey S. . . . . 49  
 Heath-Witbeck Company . . . . . 41  
 Holloway Lumber Company . . . . . 7  
 Ingram Lumber Company . . . . . 42  
 Jenks, Robert H., Lumber Co. . . . . 50  
 Jones, G. W., Lumber Company . . . . . 43  
 Jones Hardwood Company . . . . . 7  
 Kampf, Albert R. . . . . 47  
 Keith Lumber Company . . . . . 47  
 Kelley Lumber & Shingle Co. . . . . 44  
 King & Bartles Lumber Company . . . . . 50  
 Leavitt Lumber Company . . . . . 10  
 Lesh & Matthews Lumber Co. . . . . 47  
 Linehan Lumber Company . . . . . 9  
 Litchfield, William E. . . . . 7  
 Long-Knight Lumber Company . . . . . 41  
 McClure Lumber Company . . . . . 45  
 McLean, J. Gibson, & Co. . . . . 7  
 McLean, Hugh, Lumber Company . . . . . 51  
 MacBride, Thos., Lumber Co. . . . . 45  
 Maley, Thompson & Moffett Co. . . . . 49  
 Maley & Wertz . . . . . 41  
 Martin-Barriss Company . . . . . 50  
 Miller, Anthony . . . . . 51  
 Miller Brothers . . . . . 47  
 Mitchell Bros. Company . . . . . 3  
 Mowbray & Robinson . . . . . 49  
 Murphy & Diggins . . . . . 3  
 Nicola Lumber Company, The . . . . . 9  
 Norman Lumber Company . . . . . 2  
 North Shore Lumber Company . . . . . 44  
 North Western Lumber Company . . . . . 43  
 No. Vernon Pump & Lbr. Co. . . . . 2  
 O'Brien, John, Land & Lumber Co. . . . . 46  
 Page & Landeck Lumber Co. . . . . 43  
 Perrine-Armstrong Company . . . . . 41  
 Peters, R. G., Salt & Lumber Co. . . . . 45  
 Price, E. E. . . . . 7  
 Radina, L. W., & Co. . . . . 49  
 Richmond, Park & Co. . . . . 46  
 Rumbarger Lumber Company . . . . . 1  
 Ryan & McFarland . . . . . 46  
 Salling, Hanson & Co. . . . . 44  
 Sateberd & Son . . . . . 51  
 Schofield Bros. . . . . 7  
 Schultz Brothers & Cowen . . . . . 46

**SOUTHERN HARDWOODS.**

Advance Lumber Company . . . . . 50  
 American Lumber Company . . . . . 42  
 American Lumber & Mfg. Co. . . . . 9  
 Anderson-Tully Company . . . . . 4  
 Atlantic Lumber Company . . . . . 4  
 Bacon-Nolan Hardwood Company . . . . . 49  
 Beck, E. E., Lumber Company . . . . . 4  
 Beyer, Knox & Co. . . . . 51  
 Bennett & Witte . . . . . 49  
 Black, E. W., Lumber Company . . . . . 47  
 Briggs & Cooper Company . . . . . 4  
 Brown, Geo. C. & Co. . . . . 8  
 Brown, W. P., & Sons Lbr. Co. . . . . 2  
 Buffalo Hardwood Lumber Co. . . . . 51  
 Carrier Lbr. & Mfg. Company . . . . . 10  
 Cherry River Boom & Lbr. Co. . . . . 1  
 Chicago Veneer Company . . . . . 32  
 Chivvis, W. R. . . . . 5  
 Cincinnati Hardwood Lumber Co. . . . . 49  
 Coleman, J. S., Lumber Co. . . . . 42  
 Crandall & Brown . . . . . 47  
 Crane, C., & Co. . . . . 49  
 Crosby & Beckley Company, The . . . . . 7  
 Cypress Lumber Company . . . . . 48  
 Darling, Chas. & Co. . . . . 47  
 Davis, Edw. L., & Co. . . . . 2  
 Davidson-Benedict Company . . . . . 44  
 Dennis & Smith Lumber Company . . . . . 44  
 DeHeur & Swain Lumber Co. . . . . 41  
 Dierks Lumber & Coal Company . . . . . 10  
 Dixon & Dewey . . . . . 6  
 Duhlmeier Bros. . . . . 48  
 Dulweber, John, & Co. . . . . 49  
 Elias, G. & Bro. . . . . 51  
 Empire Lumber Co., Buffalo . . . . . 51  
 Fall, E. H. . . . . 48  
 Farrin-Korn Lumber Company . . . . . 48  
 Flint, Erving & Stoner Company . . . . . 9  
 Freiburg Lumber Company . . . . . 49  
 Fry-Bichanan Lumber Company . . . . . 42  
 Fullerton-Powell Hardwood Lumber Company . . . . . 41  
 Gayoso Lumber Company . . . . . 4  
 Gareton-Greason Lumber Co. . . . . 5  
 Hackley-Phelps-Bonnell Company . . . . . 45  
 Hafner Mfg. Company . . . . . 45  
 Hamilton, J. V. . . . . 42  
 Heath-Witbeck Company . . . . . 7  
 Himmelberger-Harrison Lumber Company . . . . . 1  
 Indiana Lumber Company . . . . . 8  
 Jenks, Robt. H., Lumber Co. . . . . 50  
 Jones, G. W., Lumber Company . . . . . 43  
 Jones Hardwood Company . . . . . 7  
 Kampf, Albert R. . . . . 2  
 Keith Lumber Company . . . . . 47

**KENTUCKY LUMBER COMPANY.**

Kentucky Lumber Company . . . . . 48  
 King & Bartles Lumber Company . . . . . 50  
 Lane-White Lumber Company . . . . . 36  
 Leavitt Lumber Company . . . . . 10  
 Lesh & Matthews Lumber Co. . . . . 47  
 Linehan Lumber Company . . . . . 9  
 Litchfield, Wm. E. . . . . 41  
 Long-Knight Lumber Company . . . . . 41  
 Loomis & Hart Mfg. Company . . . . . 5  
 Love, Boyd & Co. . . . . 8  
 Luehrmann, Chas. F., Hardwood Lumber Company . . . . . 5  
 McClure Lumber Company . . . . . 45  
 McIlvain, J. Gibson, & Co. . . . . 7  
 McLean, Hugh, Lumber Company . . . . . 51  
 Maley, Thompson & Moffett Co. . . . . 49  
 Martin-Barriss Company . . . . . 50  
 Miller, Anthony . . . . . 51  
 Minor Brothers . . . . . 47  
 Nicola Lumber Company, The . . . . . 9  
 Norman Lumber Company . . . . . 2  
 O'Brien, John, Land & Lumber Co. . . . . 46  
 Ozark Cooperage Company . . . . . 5  
 Paepeke-Leicht Lumber Company . . . . . 8  
 Page & Landeck Lumber Company . . . . . 43  
 Price, E. E. . . . . 7  
 Radina, L. W., & Co. . . . . 49  
 Ransom, J. B., & Co. . . . . 8  
 Rhubsky, E. W. . . . . 2  
 Richmond, Park & Co. . . . . 46  
 Ritter, W. M., Lumber Company . . . . . 52  
 Roy Lumber Company . . . . . 33  
 Rumbarger Lumber Company . . . . . 1  
 Ryan & McFarland . . . . . 46  
 Sateberd & Son . . . . . 51  
 Schofield Brothers . . . . . 7  
 Slinger, J., & Co. . . . . 47  
 Smith, W. E., Lumber Company . . . . . 4  
 Southern Lumber Company . . . . . 2  
 Southern Oak Lumber Company . . . . . 46  
 Standard Hardwood Lumber Co. . . . . 51  
 Steele & Hibbard . . . . . 5  
 Stewart, I. N., & Bro. . . . . 51  
 Stevens-Eaton Company . . . . . 7  
 Stimson, J. V. . . . . 41  
 Stoneman-Zearing Lumber Co. . . . . 5  
 Stutz Lumber Company, Inc. . . . . 2  
 Sullivan, T., & Co. . . . . 51  
 Swann-Day Lumber Company . . . . . 8  
 Thomas & Proetz Lumber Co. . . . . 5  
 Three States Lumber Company . . . . . 4  
 Turner, A. M., Lumber Company . . . . . 9  
 Upham & Agler . . . . . 6  
 Vestal Lumber & Mfg. Company . . . . . 42  
 Ward Lumber Company . . . . . 47  
 Wentworth, Chas. S., & Co. . . . . 7  
 White Lumber Company . . . . . 46  
 Whitmer, Wm., & Sons, Inc. . . . . 6  
 Wiborg & Hanna Company . . . . . 49  
 Wiggin, H. D. . . . . 7  
 Willson Bros. Lumber Company . . . . . 9  
 Wisconsin Timber & Lumber Co. . . . . 47  
 Wistar, Underhill & Co. . . . . 7  
 Yeager, Orson E. . . . . 51

**COTTONWOOD AND GUM.**

Anderson-Tully Company . . . . . 4  
 Bacon-Nolan Hardwood Company . . . . . 4  
 Farrin-Korn Lumber Company . . . . . 48  
 Himmelberger-Harrison Lumber Company . . . . . 1  
 Luehrmann, C. F., Hardwood Lumber Company . . . . . 5  
 Ozark Cooperage Company . . . . . 5  
 Paepeke-Leicht Lumber Company . . . . . 8  
 Smith, W. E., Lumber Company . . . . . 4  
 Stoneman-Zearing Lumber Co. . . . . 5  
 Stutz Lumber Company, Inc. . . . . 2  
 Three States Lumber Company . . . . . 4

**CYPRESS.**

Crandall & Brown . . . . . 47  
 Cypress Lumber Company . . . . . 48  
 Farrin Mfg. Company . . . . . 5  
 Loftman Cypress Company . . . . . 5  
 Thompson, J. W., Lumber Co. . . . . 4

**HARDWOOD FLOORING.**

Bliss & Van Auken . . . . . 10  
 Carrier Lbr. & Mfg. Company . . . . . 10  
 Cobbs & Mitchell, Inc. . . . . 3  
 Cummer, Diggins & Co. . . . . 3  
 Fein Bros. Company . . . . . 4  
 Forman, Thos., Company . . . . . 6  
 Haak Lumber Company . . . . . 45  
 Kerry & Hanson Flooring Co. . . . . 44  
 Mitchell Bros. Company . . . . . 3  
 Nashville Hardwood Flooring Company . . . . . 8  
 Pease Company, The . . . . . 48  
 Schultz Bros. & Cowen . . . . . 41  
 Stephenson, The I., Company . . . . . 10  
 Ward Brothers . . . . . 10  
 Wood Mosaic Flooring Company . . . . . 2  
 Young, W. D., & Co. . . . . 10

**SAW MILL MACHINERY.**

Mershon Company, The . . . . . 36  
 Phoenix Mfg. Company . . . . . 34

**WOOD WORKING MACHINERY**

American Wood Working Machinery Company . . . . . 40  
 Berlin Machine Works, The . . . . . 3  
 Defiance Machine Works . . . . . 33  
 Ober Mfg. Company, The . . . . . 35  
 Smith, H. B., Machine Company . . . . . 39

**VENEER MACHINERY.**

Coe Manufacturing Company . . . . . 37

**LOGGING MACHINERY.**

Clyde Iron Works . . . . . 34  
 Lidgerwood Mfg. Company . . . . . 35  
 Overpack, S. C. . . . . 3  
 Russell Wheel & Foundry Co. . . . . 30

**DRY KILNS AND BLOWERS**

Morton Dry Kiln Company . . . . . 34

**LUMBER INSURANCE.**

Adirondack Fire Insurance Co. . . . . 1  
 Lumber Insurance Company of New York . . . . . 1  
 Lumber Mutual Fire Insurance Company, Boston . . . . . 1  
 Lumber Underwriters . . . . . 1  
 Pennsylvania Lumbermen's Mutual Fire Insurance Company . . . . . 1  
 Rankin, Harry, & Co. . . . . 30  
 Toledo Fire & Marine Ins. Co. . . . . 30

**SAWS, KNIVES AND SUPPLIES**

Atkins, E. C., & Co. . . . . 35  
 Hanchett Swage Works . . . . . 34  
 Champion Saw Company . . . . . 33 & 36  
 Shimer, S. J., & Sons . . . . . 35

**MISCELLANEOUS.**

Barroll, H. C., & Co. . . . . 10  
 Childs, S. D., & Co. . . . . 33  
 Lacey, J. D., & Co. . . . . 7  
 Lumbermen's Credit Association . . . . . 33  
 Pease Company, The . . . . . 48  
 Schenck, C. A., & Co. . . . . 42  
 Standard Audit Company . . . . . 42

# CHICAGO VENEER COMPANY

(INCORPORATED)

BURNSIDE, KENTUCKY

## Bored Poplar Posts for Porch Columns

66 to 96 INCHES LONG, 8 and 10 INCHES DIAMETER

Write us for Prices and Particulars

# "DEFIANCE" WOOD-WORKING MACHINERY

COMPLETE EQUIPMENTS OF  
**HIGH GRADE TOOLS**

FOR MAKING

Hubs, Spokes, Wheels, Single Trees, Hoops,  
Wagons, Carriages, Handles, Bobbins, Spools,  
Rims, Shalts, Poles, Insulator Pins and  
Neck-Yokes, Oval Wood Dishes.

INVENTED AND BUILT BY  
**The DEFIANCE MACHINE WORKS**  
DEFIANCE, OHIO.

Send for 500 Page Catalogue

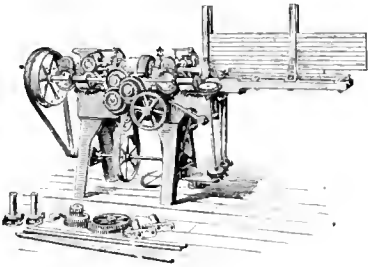

Automatic Long Handle Lathe.

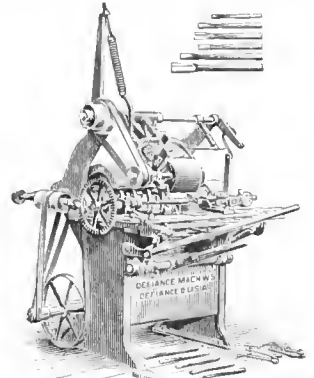

Hammer and Hatchet Handle Lathe.

## KNIVES

A man who has been in the presence of angels discloses the fact by his action: Just one reason for our talking good machine knives, good veneer knives or knives of any kind that do good work.

**CHAMPION SAW COMPANY,**  
BEAVER FALLS, PA.

### Save Your Money

By Using the

## RED BOOK

Published Semi-Annually  
in January and July

It contains a carefully prepared list of the buyers of lumber in car lots, both among the dealers and manufacturers.

The book indicates their financial standing and manner of meeting obligations. Covers the UNITED STATES and MANTOBA.

The trade recognizes this book as the authority on the lines it covers.

A well organized Collection Department is also operated and the same is open to you.

WRITE FOR TERMS.

### Lumbermen's Credit Association

ESTABLISHED 1878

1405 Great Northern Building, : CHICAGO  
16 Beaver Street, : NEW YORK CITY

MENTION THIS PAPER

## HARDWOOD TIMBER

There is no section with so fine and large a supply of hardwood timbers of various kinds left for the lumbermen as that portion of the South in Alabama, Georgia, Kentucky, Mississippi, North Carolina, South Carolina, Tennessee and Virginia served by the lines of the

Southern Railway  
and  
Mobile & Ohio Railroad

There are oak, poplar, hickory, gum, cypress, ash, elm, buckeye, balsam, spruce, chestnut, and other varieties. There are also available pine lands.

These timber resources and many other important features bearing on the cost of manufacture and marketing give special advantages and opportunities for EVERY KIND of WOOD USING INDUSTRY. We have information about the best locations in the country at towns in these States and in Southern Indiana and Southern Illinois, which will be given if requested. All correspondence in regard to timber lands or factory locations will be given prompt and confidential attention. Address your nearest agent.

M. V. RICHARDS,  
Land and Industrial Agent,  
Washington, D. C.  
CHAS. S. CHASE, Agent,  
622 Chemical Building,  
St. Louis, Mo.  
M. A. HAYS, Agent,  
225 Dearborn Street,  
Chicago, Ill.

### Novelties for Advertisers

FOBS, POCKET PIECES,  
BUTTONS,  
LETTER OPENERS, SCARF PINS,  
TRAYS, ALUMINUM GOODS,  
PAPER WEIGHTS.

ALL NEW IDEAS

Send us 50c and we will send you a  
Beautiful Watch Fob

**S. D. CHILDS & CO.**  
200 Clark Street, CHICAGO



WALNUT.  
OAK,  
ASH,  
POPLAR.

You want to reach Buyers of

**FURNITURE LUMBER**

**The HARDWOOD RECORD**

will do it for you.

# UP=TO=DATE

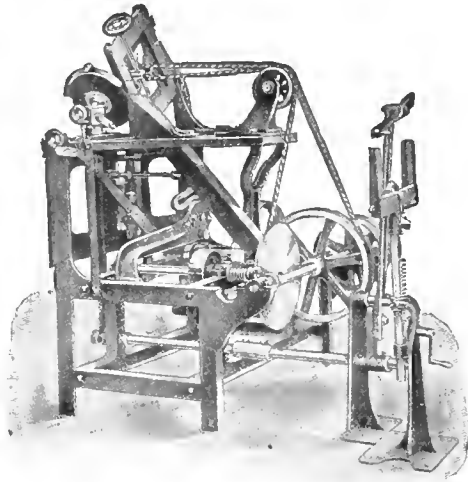

## Hanchett Automatic Band Saw Sharpener

This is one of our full line of modern filing room machinery. Let us send you our new Catalogue No. 10.

## HANCHETT SWAGE WORKS

BIG RAPIDS, MICH.

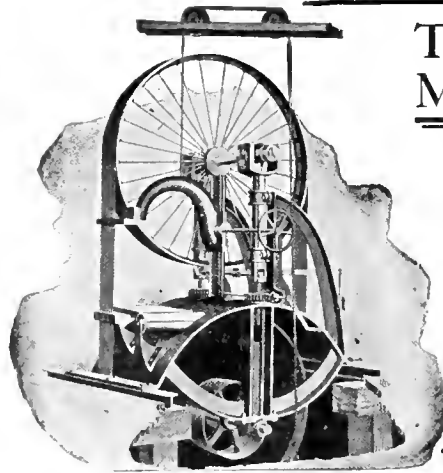

## Ten per cent More Profit

The profits of a saw mill can readily be increased ten per cent by using a hand mill instead of a rotary. The price of this mill with six foot wheels for saws eight inches wide is readily within the reach of all. It cuts smooth and perfect lumber and has a capacity of 25,000 feet to 35,000 feet per day. It runs with less expenditure of power than a rotary and puts only half as much of the log into saw dust as does the circular saw.

PHOENIX MFG. COMPANY,  
EAU CLAIRE, WIS.

## The Morton Dry Kiln

MOIST AIR SYSTEM

Recording Thermometers. Transfer Cars.



Trucks. Canvas Doors.

### HOW TO DRY LUMBER

As exemplified in our Catalog D. Free on application.

MORTON DRY KILN CO., Chicago, Ills.

## ... THE ... McGIFFERT LOG LOADER

has loaded as high as a quarter of a million feet of logs in eight hours, and here are a few reasons why it was possible: Being self propelling it can move itself, its loaded cars, and spit its own empties, all on the same track. (*saves switching*) Constructed entirely of steel, very powerful, it stands "crowding" and handles the large logs as rapidly as the small. *It saves money and repairs.* Being simple in operation and of few levers the engineer has absolute control at all times without changing his position, and can handle the logs as rapidly as the men can hook them. *saves time*

Our catalogue clearly illustrates and explains many other good points.

Manufactured by  
CLYDE IRON WORKS,  
Duluth,  
Minn.

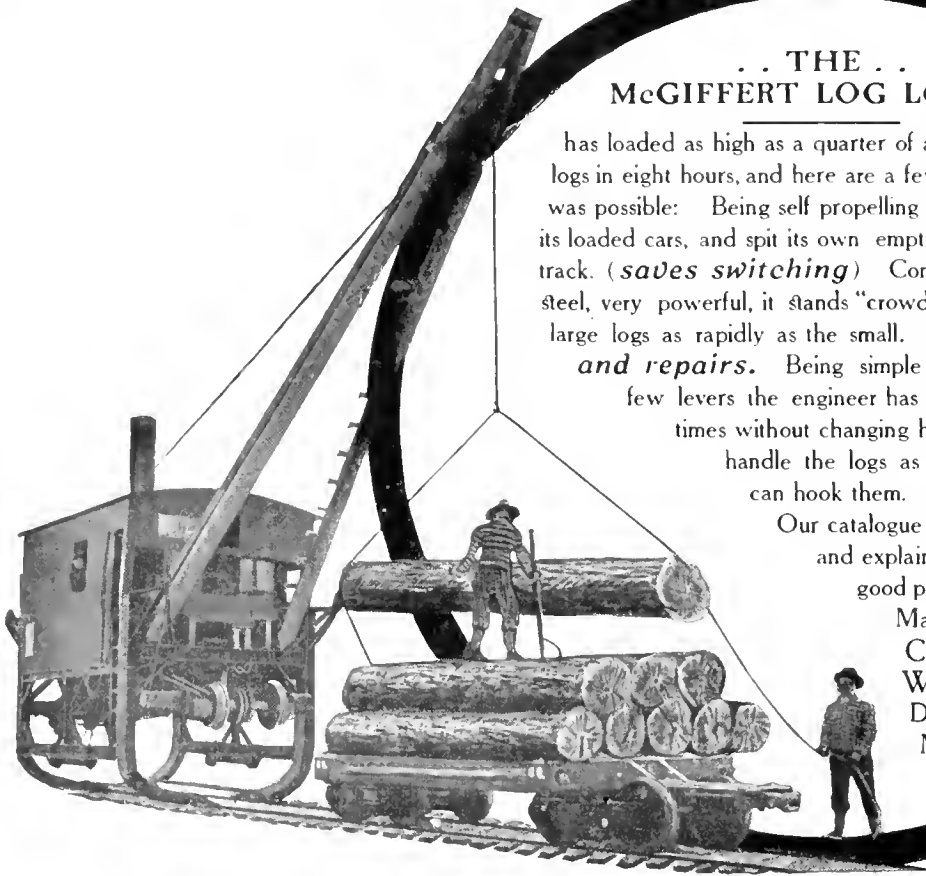

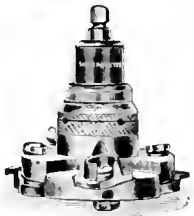

# In Choosing Cutter Heads

PRICE IS BUT A FIGURE

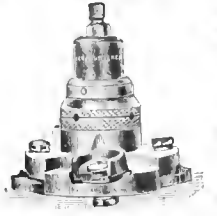

If you buy a CHEAP HEAD, you buy often  
 If you buy a GOOD HEAD, it serves as a permanent Fixture to your Machine.  
 The Shimer Cutter Head is designed for a purpose which has for its object the direct saving of labor and material. Its construction agrees with the special class of work it is to perform. It is first made to suit the machine—it is next made to suit the work. Every detail is carefully formed to give a free cut—to hold a uniform shape—to be durable. These features establish a permanent make-ready, which demonstrates that this "Best of All Cutter Heads" makes a safe and profitable investment.  
 In the construction of these tools every improvement is carefully developed, adopted and given to the public at the mere cost of production. That is why they have grown to be popular. Their merit has earned for them a place as permanent in the mills as the hand saw or the wood chisel in the hands of the carpenter. To study them means to appreciate them. Every user of a matcher or moulder should try them 30 days and determine for himself whether or not he can longer afford to be without them. Address

**SAMUEL J. SHIMER & SONS, - - Milton, Penn.**

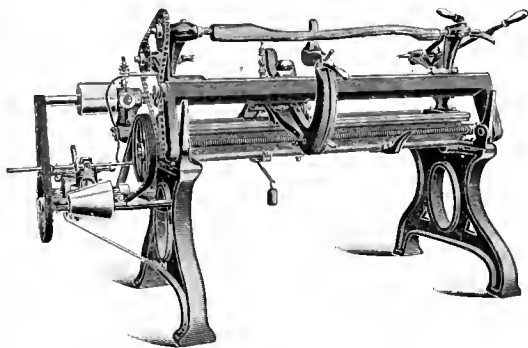

This cut shows the **No. 1 OBER LATHE** for turning Axe, Adze, Pick, Sledge, Hammer and Hatchet Handles, Spokes, Whiffletrees, Gun Stocks, Lasts and other irregular work.

**Simple, Strong, Durable, Economical**

We also manufacture other lathes for making handles, spokes and variety work, sanders, shapers, boring and chucking machines, rip saws, etc., etc. Complete catalogue and price list free.

**THE OBER MFG. CO.**

28 Bell St., Chagrin Falls, O., U. S. A.

**THE HAPPY WOODSMAN**



# ATKINS

TRADE MARK  
**SILVER-STEEL**

# SAWS

are happy saws all the way round. They run easier, cut faster, and go longer without sharpening than any other

A PERFECT SAW FOR EVERY PURPOSE.  
 YOUR JOBBER HAS THEM OR WRITE US.

**E. C. ATKINS & CO., Inc.**

THE SILVER STEEL SAW PEOPLE

HOME OFFICE AND FACTORY, INDIANAPOLIS, U. S. A.

Branches: Atlanta, Chicago, Memphis, Minneapolis, New York City, New Orleans, Portland, San Francisco, Seattle, Toronto.



# MERSHON

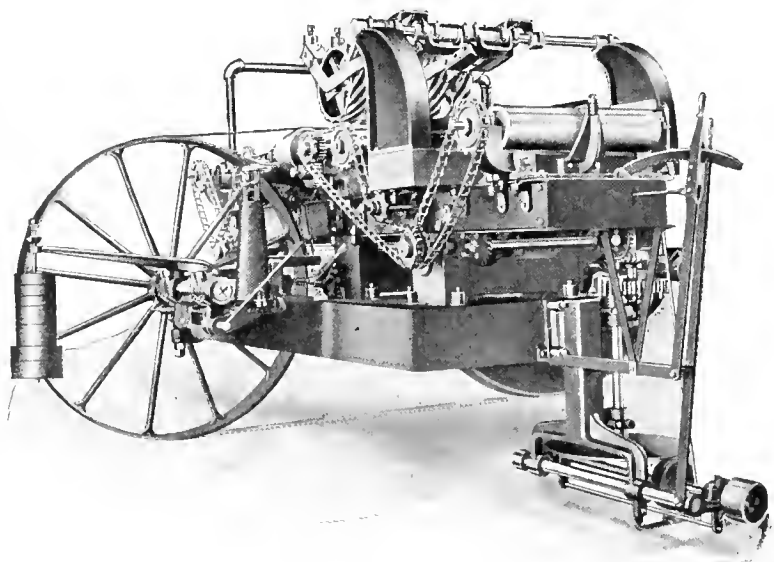

MERSHON NEW HORIZONTAL BAND RESAW FOR SAW MILLS

ALLIS-CHALMERS COMPANY, Seattle, Wash., Agents for Northern Pacific Territory.

Band Resawing  
Machinery  
for all requirements

**WM. B. MERSHON  
& CO.,**

**Saginaw, = Michigan**

THE EBY MACHINERY CO., San Francisco, Cal., Agents for California and Nevada.

## SAWS

I tell you, Mr. Mill Man, there is merit in these saws. Dependable stuff that is made right, will work right, and last the life of good saw material.

**CHAMPION SAW CO.**

BEAVER FALLS, PA.

**LANE-WHITE LUMBER CO.**

MANUFACTURERS AND WHOLESALERS OF

**HARDWOOD LUMBER**

Our Specialty:

**OAK, ASH AND WALNUT**

ALWAYS IN THE MARKET FOR WALNUT LOGS

MAIN OFFICE AND  
BAND MILL AT **FORT SMITH, ARK.**

**Hardwood Board Rules  
FOR HARDWOOD LUMBERMEN**



**Best Goods, Prompt Shipment**

Send your orders to the HARDWOOD RECORD, 355 Dearborn Street

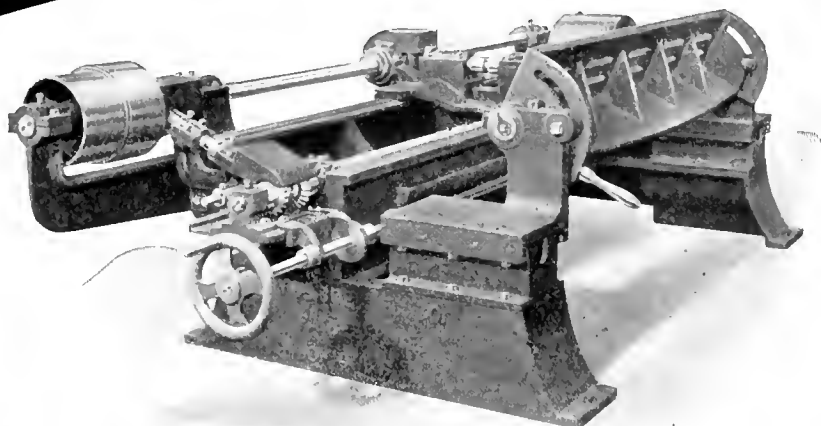

## The Coe Knife Grinder

was designed for the finest grinding and most exacting service. It is built on new lines and has completely overcome the objections to other grinders. The knife is held rigidly while the stone travels back and forth. There is no chance for

vibration, consequently no unevenly ground knives. Entirely automatic in ac-



tion, no ropes or chains. All moving parts operated by cut steel gears, noiseless in operation, will grind straight or hollow bevel. Feeds 1-1000 to 4-1000 for each travel of the stone, very heavy and compact, occupying small floor space. Made in seven sizes to grind up to 168 in.

It is fully described in our catalog No. 5, which we will be glad to send to interested parties.

**The Coe Manufacturing Co.** 105 Bernard Street **Painesville, O.**

**Skidders**

**Snakers**

**Lidgerwood Machines  
Will Stock Your Mill**

**Lidgerwood Skidders**

**Lidgerwood Snakers**

**Lidgerwood Yarders**

**Lidgerwood Roaders**

**Lidgerwood Pull Boats**

**Lidgerwood Cableways**

**LIDGERWOOD MFG. CO.**

**NEW YORK**

**ATLANTA**

**SEATTLE**

**NEW ORLEANS**

**Loaders**

**Cableways**

**SMITH of  
SMITHVILLE**

**The Profit Builder**

**SMITH of  
SMITHVILLE**

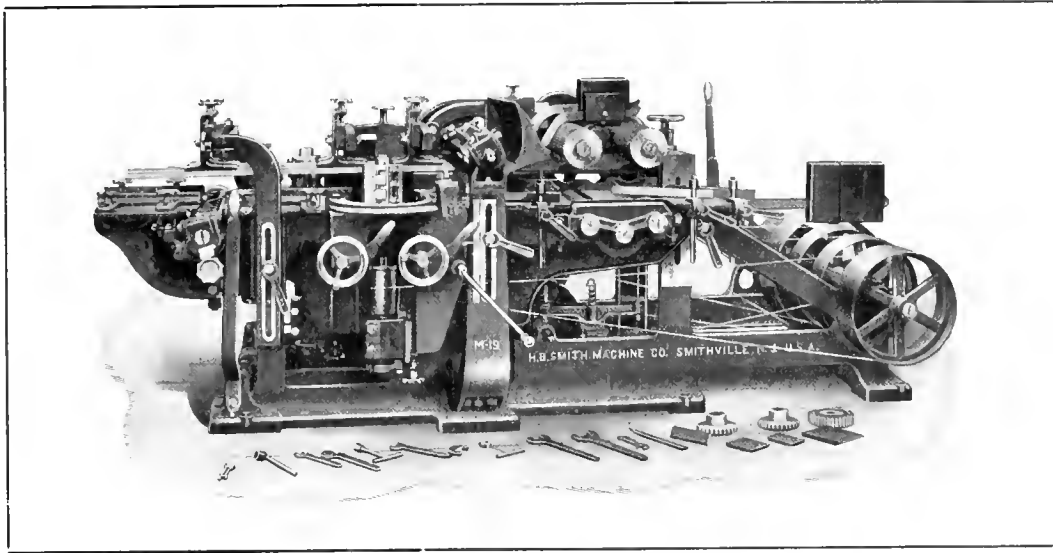

NO. 105-A, EXTRA HEAVY 12-INCH MOULDER



IT HAS been our purpose during the last half century to develop a line of wood working machines containing the best workmanship and material that American skill and wisdom can afford. This fact we are proud to say is well established in the minds of our many patrons. We have, however, now exceeded ourselves by the development of a remarkable Moulder, the excellence of which is due to our obtaining written suggestions from more than a thousand operators throughout America. This machine stands alone as being the composite idea of the thinking operators of this country. One year's test of its work has convinced us that it is impossible for you to compete successfully against the Smith Moulder with any other machine. Can't we send you prices and literature?

**Branches:**  
New York, Chicago,  
Boston

**H. B. SMITH MACHINE CO.**  
SMITHVILLE, N. J., U. S. A.

**Branches:**  
New York, Chicago,  
Boston

# American 30" Hardwood Power-Feed Gang Edger and Ripper

Especially designed for the accurate cutting of strips for flooring. Investigate its merits.

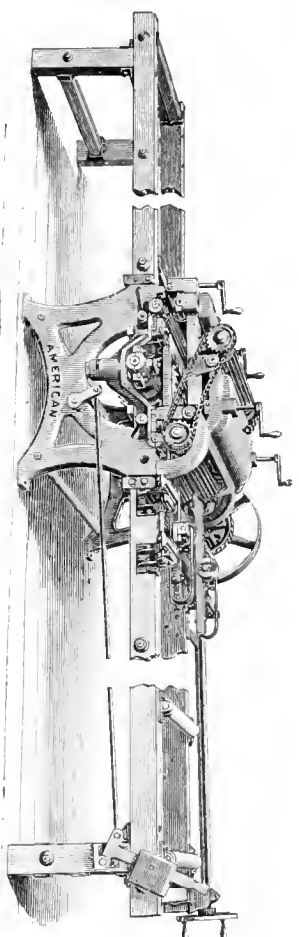

LEFT HAND SIDE

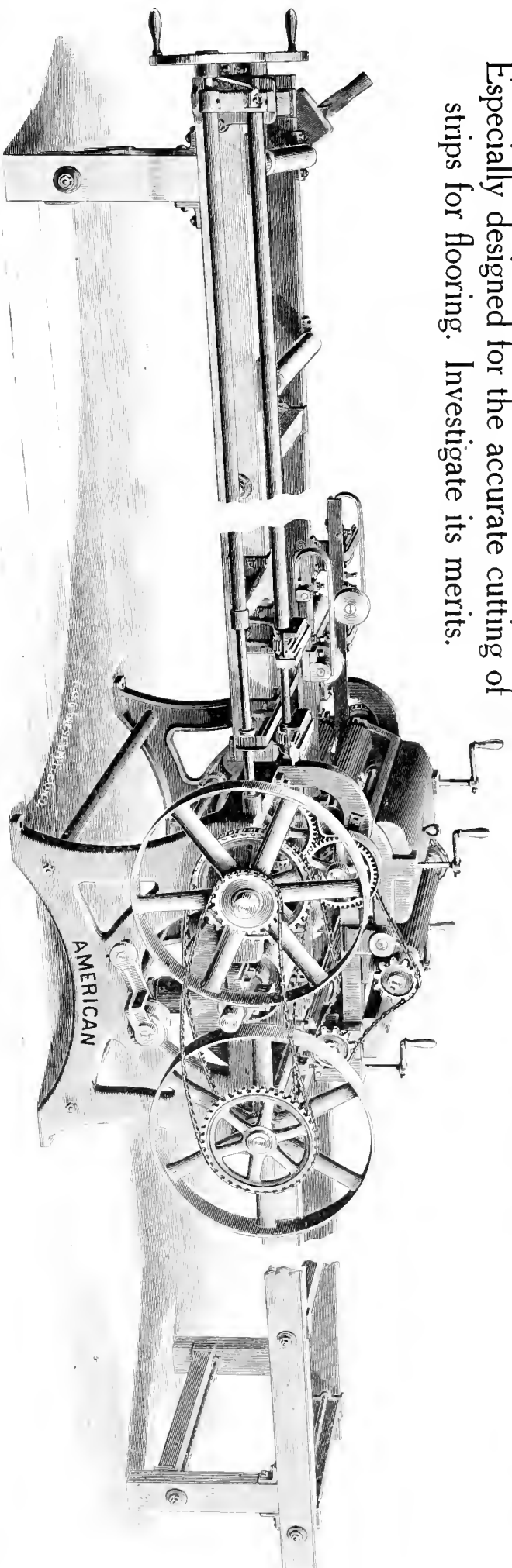

RIGHT HAND SIDE

## American Wood Working Machinery Co.

New Orleans

Chicago

New York

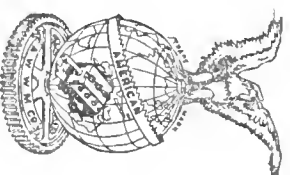
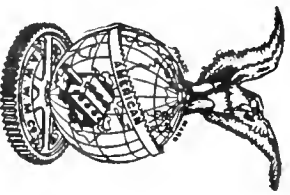



# INDIANA



WHERE THE BEST HARDWOODS GROW

THE WOODS FOR WHICH INDIANA IS FAMOUS.

- Quart'r'd White Oak
- Plain White Oak
- Quartered Red Oak
- Plain Red Oak
- White Ash
- Poplar
- Black Walnut
- Cherry
- Sycamore
- Red Gum
- Hickory
- Beech
- Maple
- Veneers of
- Indiana Hardwoods

## PERRINE-ARMSTRONG CO.

Long Timber up to 60 feet—Hardwood Specialties

The largest Band Mill in Indiana.

FORT WAYNE, IND.

## J. V. STIMSON

All Kinds of Hardwood Lumber Manufactured

HUNTINGBURG, IND.

## YOUNG & CUTSINGER

Manufacturers and Wholesalers

Our Specialty Fine Figured Quartered Oak

EVANSVILLE, IND.

## CHARLES H. BARNABY

Manufacturer of Band Sawed Hardwoods

Quarter Sawed Indiana White Oak a Specialty

GREENCASTLE, IND.

## D'HEUR & SWAIN LUMBER CO.

Manufacturers and Wholesalers

Our Specialty Quartered Oak and Sycamore

SEYMOUR, IND.

## LONG-KNIGHT LUMBER CO.

MANUFACTURERS AND DEALERS

Quarter Sawed White and Red Oak a Specialty

INDIANAPOLIS, IND.

## MALEY & WERTZ

Manufacturers, Wholesalers and Exporters of Hardwood Lumber

EVANSVILLE, IND.

## FULLERTON-POWELL

## HARDWOOD LUMBER CO.

SOUTH BEND, IND.





*J. V. Hamilton.*

Dealer in Walnut Logs, neatly hewn for export, and lumber handled carefully and sawn accurately. I am located in the best walnut producing territory in the United States. Write me to  
**FORT SCOTT, KANSAS**

*Ingram Lumber Co.*  
 WAUSAU, WIS.

**BASSWOOD, BIRCH**  
*We cut four million feet of each annually  
 Your inquiries and orders solicited*

MILL AND YARDS AT INGRAM, WISCONSIN

**EASTERN TENNESSEE—WESTERN NO. CAROLINA**  
 ASHEVILLE KNOXVILLE BRISTOL

**Vestal Lumber & Mfg. Co.**  
 Manufacturers and Wholesalers  
 of all kinds of  
**HARDWOODS**

BEVELED SIDING A SPECIALTY.  
 UNSURPASSED FACILITIES  
 FOR DELIVERING. Knoxville  
 Tennessee

**HARDWOODS**

From the famous Asheville district.  
 Superior in quality, manufacture and  
 gradings. For stock list and prices,  
 address

**J. S. COLEMAN LUMBER CO.**  
 ASHEVILLE, N. C.

**On the Spot**

We are located right in the heart of this mountain country producing the best hardwoods in existence.  
 We are headquarters with ample stock, and can interest you both as to assortment and price. Write us.

**American Lumber Company**  
 ASHEVILLE, N. C.

**Fry-Buchanan Lumber Co.**  
 INCORPORATED.

Manufacturers and Wholesalers  
**Hardwood Lumber**

Choicest Varieties. ∴ Full Grades.

POPLAR SQUARES  
 A Specialty. Asheville, N. C.

**All Lumbermen, Attention!**

We do what you can't do.  
 We measure your stumpage correctly.  
 We make your maps correctly.  
 Bank references: Asheville, N. C.

**C. A. Schenck & Co.** Biltmore,  
 North Carolina.

**Industries are Offered Locations**

WITH SATISFACTORY INDUCEMENTS, FAVORABLE  
 FREIGHT RATES, GOOD LABOR CONDITIONS,  
 HEALTHFUL COMMUNITIES, on the lines of

**The Illinois Central R. R. and the  
 Yazoo & Mississippi Valley R. R.**

For full information and descriptive pamphlet address  
 J. C. CLAIR, Industrial Commissioner, 1 Park Row, Chicago, Ill.

# WISCONSIN

WHERE THE FINEST NORTHERN HARDWOODS GROW

## NORTHERN STOCK

Hemlock  
Birch  
Basswood  
Rock Elm  
Soft Elm  
Ash  
Oak

## SOUTHERN STOCK

Quartered White and Red Oak  
Plain White and Red Oak  
Sycamore  
Poplar  
Cypress  
Gum

## PAGE & LANDECK LUMBER CO.

Wells Building - - - MILWAUKEE, WIS.

## North Western Lumber Co.

General Offices - EAU CLAIRE, WIS. MILLS at STANLEY, WIS.

BAND SAWED

## Wisconsin Hardwoods

CAREFUL GRADINGS, PROMPT SHIPMENTS

### SPECIAL OFFERINGS:

3 cars 1½" to 2" Scoot Hardwood. ½ car 2" 1st and 2d Clear Basswood.  
1 car 1½" No. 1 Common Basswood. Large stock No. 2 Common Birch.  
1 car 1½" 1st and 2d Clear Basswood. Large stock No. 3 Common Birch.

## C. P. CROSBY

RHINELANDER : : WISCONSIN

## Wholesale Hardwood Lumber

Hard Maple a Specialty in all thicknesses from 1 inch to 4 inch. Finest Birch in Wisconsin. Black Ash, Rock Elm, Soft Elm, Red and White Oak. : :

DIFFICULT AND MIXED ORDERS A SPECIALTY

## Special Attention

Is called to the following, and to the close prices made on same upon receipt of your inquiries

50M ft. 2" Com. and Bet. Plain Birch	50M ft. 2" Bridge Plank
80M ft. 2½" Com. and Bet. Plain Birch	30M ft. 1½" No. 2 Com. & Bet. Hickory
100M ft. 1" 1sts and 2nds Plain Birch	30M ft. 1½" No. 2 Com. & Bet. Hickory
12M ft. 1" No. 1 Com. Plain Birch	100M ft. 1" Com. & Bet. Plain Red Oak
150M ft. 1" 1sts and 2nds Red Birch	150M ft. 1" Com. & Bet. Qld. Red Oak
200M ft. 2" Com. and Bet. Hard Maple	10M ft. 1" No. 3 Com. & Bet. Walnut
	75M ft. 1½" No. 2 Com. & Bet. Elm
	150M ft. 1" No. 1 Com. Red Gum

Above is all first choice Wisconsin lumber, is bone dry and well manufactured.  
Above is choice Southern stock.

In addition to the foregoing, we have full stocks of Basswood, Birch and Soft Elm and a full selection of Red and Sap Gum. We guarantee our grades to be made strictly in accordance with National Hardwood Association rules of inspection

**G. W. JONES LUMBER CO., Appleton, Wis.**

MIXED CARS - EVEN GRADES - PROMPT SHIPMENT

## Wisconsin Hardwoods

### SPECIAL OFFERINGS:

1" No. 1 Common and Better Birch (Red in)  
1" No. 1 Common and Better Basswood  
1" No. 1 Common and Better Hard Maple  
Also Elm, Pine, Cedar Products,  
and "SHAKELESS" Hemlock.

## John R. Davis Lumber Company

PHILLIPS, : : : : WISCONSIN

## BRITTINGHAM & YOUNG CO.

## Hardwood Lumber

Manufacturers and Wholesalers

MADISON, . . . WISCONSIN

Send us a list of your wants,  
No trouble to answer correspondence

## ARPIN HARDWOOD LUMBER CO.

GRAND RAPIDS, WISCONSIN

Saw and Planing Mill at Atlanta, near Bruce, Wis., on Soo Lines.

### WRITE FOR OUR PRICES ON

THREE INCH FLOORING.	BIRCH
1 car Clear Plain Red Oak	2 cars 1" Com. and Bet. Curly Red
1 car Factory Red Oak	2 cars Com. and Bet. Red
3 cars Clear Birch	1 car 1½, 1½, 2" Curly
1 car Factory Birch	2 cars 1½, 1½, 2" Com. & Bet. Red
½ car Clear Red Birch	1 car 2" Plain log run
3 cars Common Maple	1 car 2½ and 3" Plain
1 car Factory Maple	
LUMBER	QUARTER SAWED RED OAK
2 cars log run Hard Maple	2 cars 1½ and 1½" Com. and Bet.
	¼ car 1¾ and 2" Com. and Bet.

## VOLLMAR & BELOW

MARSHFIELD, WISCONSIN

## Basswood, Birch

and Other Wisconsin Hardwoods

LET US KNOW WHAT YOU ARE IN THE MARKET FOR

**M I C H I G A N**  
FAMOUS FOR HARD MAPLE AND GREY ELM

**The North Shore Lumber Co.**  
MANUFACTURERS  
Hardwood and Hemlock  
Lumber, Cedar Products.  
Rail and water shipments  
**THOMPSON :: :: MICHIGAN**

**DENNIS & SMITH LUMBER CO.**  
Wholesale Hardwood Lumber  
Office and Yards, **FOURTH AND HOLDEN AVENUES,**  
**DETROIT, MICH.**  
MILLS AT: Heaters, W. Va. Valley Bend, W. Va. Diana, W. Va. Parkersburg,  
W. Va. McNutt Siding, W. Va.

**SALLING, HANSON & CO.**  
MANUFACTURERS OF  
**Michigan Hardwoods**  
GRAYLING, MICHIGAN.

**"Chief Brand"**  
**Maple Flooring**  
Will commend itself to you and your trade on its merits alone. \* Comprises all the features desirable in good flooring. \* Made by the latest, most approved machinery methods and best skilled labor. \* We believe we can make it to your interest to handle our "Chief Brand" and will appreciate your inquiries.  
**Kerry & Hanson Flooring Co.**  
GRAYLING, MICHIGAN

**BROWNLEE & COMPANY**  
DETROIT MICHIGAN  
OUR BARGAIN COUNTER  
BASSWOOD SOFT ELM  
4-4 to 8-4 6-4 log run  
BIRCH HARD MAPLE  
4-4 No. 1 and 2 Common 12-4 No. 1 Common

**JULY STOCK LIST**

<b>MAPLE</b>		<b>BIRCH</b>		<b>BASSWOOD</b>	
1 in.	2,000,000 ft.	1 in.	500,000 ft.	1 in.	300,000 ft.
1 1/4 "	100,000 "	1 1/2 "	100,000 "	1 1/4 "	30,000 "
1 1/2 "	400,000 "	2 "	100,000 "	1 1/2 "	50,000 "
2 "	1,000,000 "	2 1/2 "	50,000 "	2 "	75,000 "
2 1/4 "	200,000 "	3 "	75,000 "	3 "	4,000 "
2 1/2 "	500,000 "	<b>ROCK ELM</b>		<b>GRAY ELM</b>	
3 "	500,000 "	2 in.	25,000 ft.	1 in.	300,000 ft.
4 "	400,000 "	2 1/4 "	50,000 "	1 1/2 "	200,000 "
<b>BEECH</b>		<b>WHITE MAPLE</b>		<b>ASH</b>	
1 in.	500,000 ft.	End Piled		1 in. 500,000 ft.	
1 1/4 "	250,000 "	1 in.	100,000 ft.		
1 1/2 "	400,000 "	1 1/2 "	20,000 "		
2 "	100,000 "	2 "	50,000 "		
2 1/2 "	200,000 "				

**KELLEY LUMBER & SHINGLE CO., Traverse City, Mich.**

W. H. WHITE, Pres.  
JAS. A. WHITE, Vice-Pres.

W. J. MARTIN, Secy.  
THOS. WHITE, Treas.

**W. H. WHITE COMPANY**  
BOYNE CITY, MICHIGAN  
Manufacturers of Hardwood and Hemlock Lumber, Cedar Shingles,  
White Rock Maple Flooring.

# MICHIGAN

FAMOUS FOR RED BIRCH AND BASSWOOD

## SOFT ELM AND ROCK ELM

FOR SALE BY

**The R. G. Peters Salt & Lumber Co.**

EASTLAKE, MICHIGAN

## VAN KEULEN & WILKINSON LUMBER COMPANY

Manufacturers and Wholesalers of

**HARDWOOD LUMBER and CRATING STOCK**

Complete Stocks of Michigan Hardwoods — Maple, Beech, Birch, Elm, Ash and Basswood for sale.

Grand Rapids, : : : Michigan

## BOYNE CITY LUMBER COMPANY

BOYNE CITY

**MICHIGAN ROCK MAPLE and other HARDWOODS**

LARGE CAPACITY PROMPT SHIPMENTS RAIL OR CARGO



## J. S. GOLDIE

Cadillac, : : Michigan.

SPECIAL PRICES on 500M pieces  
1" to 3" Maple Squares 16" to 27" long.  
1" to 3" Soft Elm Lumber.

INQUIRIES SOLICITED FOR MICHIGAN LUMBER.

## OUR MAPLE FLOORING

is as near perfection, in every particular, as it is possible to make it, for we personally supervise every step in its manufacture, from the stump to the shipping of the finished product. Our prices will interest and a trial convince you. : : :

## HAAK LUMBER COMPANY

HAAKWOOD, MICHIGAN

## Hackley-Phelps-Bonnell Co.

MANUFACTURERS OF

**Northern and Southern  
Hardwood Lumber**

Main Office, Michigan Trust Company Building

GRAND RAPIDS : : : MICHIGAN

## DENNIS BROS.

GRAND RAPIDS, : : : MICHIGAN

**HARDWOOD LUMBER (by water or rail)  
"NATIONAL" MAPLE & BIRCH FLOORING**

SPECIAL BARGAINS IN THE FOLLOWING:

300M feet 4 4 Log Run Birch  
186M feet 5 4 Log Run Birch  
1 Car 8 4 No. 1 Com. Birch  
1 Car 1 4 Clear Birch  
50M feet 4 4 No. 1 Com. Sap Birch  
40M feet 4 4 No. 1 Com. Red Birch  
All thicknesses and grades Hard Maple  
150M feet 5 4 Log Run Beech  
2 Cars 4 4 No. 3 Com. Cherry

Main Office :  
205-209 Michigan  
Trust  
Company  
Building

## Thos. MacBride Lumber Company

HEADQUARTERS FOR

**HARDWOODS**

IN MICHIGAN

Michigan Trust Building, Grand Rapids, Mich.

## BIRCH

This is our specialty. We are in the heart of the best Birch section. Have good stock, Common and better, 4-4, 5-4, 6-4, 8-4, 10-4, 12-4, and 16-4.

Let us figure with you.

## Simmons Lumber Company

SIMMONS, MICHIGAN

## McCLURE LUMBER COMPANY

MANUFACTURERS OF

**Hardwoods**

Main Offices, DETROIT, MICH.  
Mills, : EUTAW, ALA.

SPECIAL OFFERINGS:

3 cars 2" Red and White Oak  
3 cars 2", 2 1/2", 3" and 4" White Ash  
2 cars 1" 6 4 White Ash  
2 cars 2" Black Ash  
10 cars 1" to 4" Dry Hard Maple  
5 cars 1" Log Run Birch  
1 car 6 4 and 8 4 Hickory

**CHICAGO**

THE GREATEST HARDWOOD MARKET IN THE WORLD

# Schultz Brothers & Cowen

WE ARE IN THE MARKET TO BUY

**POPLAR—OAK—ASH—CHESTNUT**

AND OTHER HARDWOODS—ALL GRADES AND THICKNESSES

1225 to 1240 OLD COLONY BUILDING,

CHICAGO

## PARK RICHMOND & CO.

Wholesale

Hardwood Lumber

67 West Twenty-second St.

Chicago

—have you anything to offer in  
hickory, white ash, thick plain  
oak and wagon stock?

WE ARE CASH BUYERS  
PLEASE SEND US YOUR STOCK LISTS

## Ryan & McParland

Office and Yards  
Robey St. and Blue Island Ave

Chicago

## SOUTHERN OAK LUMBER CO.

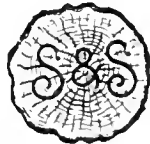

WE WANT TO BUY FOR CASH

**OAK**  
**CYPRESS**  
**ASH**

MILL CUTS OR ROUND LOTS

910 CHAMBER OF COMMERCE 1217 TENNESSEE TRUST BLDG.

**CHICAGO** **MEMPHIS**

YARDS: NORTH MEMPHIS

## White Lumber Company

Dealers in Hardwood Lumber

ALL KINDS

ALL GRADES

Cherry Lumber a  
Specialty



Laflin @ 22d Sts.  
Chicago

## John O'Brien Land & Lumber Co.

MANUFACTURERS AND DEALERS IN

**Hardwood Lumber**

Of All Kinds

OFFICE AND YARDS  
873 to 881 So. Laflin Street  
MILL: PHILIPP, MISS.

Chicago

# CHICAGO

THE GREATEST HARDWOOD MARKET IN THE WORLD

## Heath-Witbeck Company

### Hardwood Lumber

We have for quick shipment 170,000 feet DRY BIRCH, First and Seconds and Common 2, 2½, 3 and 4 inch.

Main Office, 6 Madison St. Yards, Loomis and 22nd St.  
CHICAGO

## CHAS. DARLING & CO.

### Southern Hardwoods

22nd Street and Center Avenue - CHICAGO

## Crandall & Brown

LOUISIANA RED CYPRESS  
Yellow Pine, Oak, Poplar and Maple

We have in Chicago for quick delivery  
100,000 1½" 1st and 2nds La. Red Cypress, thoroughly dry.  
14,000 3x14" Shop Com. Cypress  
We are in the market for Ash and Cottonwood

Office and Yards: 3300 Center Avenue, CHICAGO.

## WISCONSIN TIMBER & LUMBER CO.

BUY AND SELL  
Yellow Pine and Hardwood Lumber

Want thick hardwoods and wagon box boards.  
Monadnock Bldg., CHICAGO, ILL.

## Lesh & Matthews Lumber Co.

1649-50 MARQUETTE BUILDING

Are now offering bone dry BIRCH, ROCK ELM, BLACK ASH, etc., Wisconsin stock. Also PLAIN AND QUARTERED OAK, POPLAR, etc., from our Memphis yard. We are constant buyers.

## J. Slimmer & Company

### Hardwood Lumber

Office and Yard: 65 W. Twenty-second St. CHICAGO

## THE WARD LUMBER COMPANY

MANUFACTURERS OF  
HARDWOODS  
CHAMBER OF COMMERCE BUILDING - CHICAGO

FRED W. BLACK, President      HORACE W. BLACK, Secretary  
**FRED W. BLACK LUMBER COMPANY**  
MANUFACTURERS OF  
HARDWOOD LUMBER  
305 Old Colony Building

## The Keith Lumber Company

HARDWOOD, POPLAR & SOUTHERN PINE LUMBER.

MAHOCANY,  
REDWOOD,  
RED CEDAR,



CYPRESS,  
CHESTNUT,  
SPRUCE.

MAPLE FLOORING, OAK TIMBERS & WAGON STOCK.  
Office and Yards: Fourteenth and Wood Streets.

Chas. Miller      Milton Miller

## MILLER BROS. Hardwood Lumber

Main Office, 208 WILLOUGHBY BLDG.,  
6 E. MADISON STREET.

YARDS:  
Loomis St., S. of 22nd St.,  
Chicago, Ill.  
Houston, Miss.  
Macon, Miss.

CHICAGO, ILL.  
Phone CENTRAL 1363



# CINCINNATI

THE GATEWAY OF THE SOUTH

## WANTED

Oak  
Walnut  
Gum  
Cottonwood  
Poplar  
White Pine  
Hemlock  
Yellow Pine

Will inspect at shipping point when quantity justifies and pay cash. Can use entire mill cuts. Write us before selling elsewhere. We can also handle mixed cars of dressed stock. Send us your list with prices.

**Kentucky Lumber Co.**

Suite 508 First National Bank Bldg.  
Cincinnati, Ohio.  
Formerly of Burnside, Ky.

## CYPRESS LUMBER CO.

Manufacturer of Hardwoods and Cypress

Plain and Quartered White and Red Oak, Yellow Poplar, Yellow Pine, Walnut, etc. Mills in Tenn., Ala. and Va.

OFFICE AND YARDS, GEST AND DALTON AVE., CINCINNATI, OHIO.

### "BUY GUM"

We are in the market to buy Dry Gum Lumber in any quantity, from a single car load to a million feet. Will take all grades and thicknesses. We receive lumber at shipping point, pay cash and are liberal in inspection.



**THE FARRIN-KORN LUMBER COMPANY**

General Office, Yards, Planing Mills, Dry Kilns, Cincinnati, Ohio  
Purchasing Office, Randolph Building, Memphis, Tenn.

Cypress Red Gum Oak

THE GENERAL LUMBER COMPANY

**HARDWOODS**  
HEMLOCK, YELLOW PINE.

COLUMBUS

OHIO

FRAMES,  
SASH, DOORS,  
BLINDS, MOULDINGS,  
COLUMNS, GLASS,  
STAIRWORK,  
INTERIOR TRIM.



PAINTS,  
BUILDERS' HARDWARE,  
MANTELS, ETC.  
LARGE CINCINNATI FAC-  
TORIES MAKE PROMPT  
SHIPMENTS POSSIBLE.

The only trade paper reaching all classes of hardwood consumers

HARDWOOD RECORD  
355 Dearborn St., Chicago

## PLAIN OAK—BASSWOOD

Are what we want. All thicknesses and grades. Spot cash. Send us list of your offerings with prices.

**DUHLMEIER BROS., CINCINNATI, O.**

## E. H. FALL

EXPORTER  
OF

WALNUT, POPLAR  
AND  
BIRDSEYE MAPLE LOGS

Cash paid for Black Walnut Logs at point of shipment. If you have any walnut logs to offer, write me.

I have some Sycamore, Red Oak, Ash and other hardwood logs which I am prepared to saw to order. Correspondence solicited.

Can also supply Black Walnut lumber, sawed to any specification required.

PORT CLINTON : OHIO

## Wood Working Plants

Manufacturers seeking locations for Saw Mills, Stave and Heading Factories and other Wood Working Plants in the Central Southern States, can secure full and accurate information as to Sites, Timber Tracts, Fuel, Transportation Facilities, etc., by addressing

G. A. PARK, General Immigration and Industrial Agent,  
**Louisville & Nashville Railroad Company**  
LOUISVILLE, KENTUCKY

# W. H. Dawkins Lumber Co.

Manufacturers of Band Sawed

## Yellow Poplar

ASHLAND, KY.

# CINCINNATI

THE GATEWAY OF THE SOUTH

## BENNETT & WITTE

MANUFACTURERS OF SOUTHERN HARDWOODS

THAT ARE SOLD ON NATIONAL HARDWOOD LUMBER ASSOCIATION INSPECTION ONLY.

Plain and Quartered . . . } White and Red Oak  
 Cottonwood, Ash, Cypress, Poplar, Soft Maple, Tupelo  
 Gum and Chestnut. We cut Gum and Oak in Thick-  
 nesses of 3/8 to 4 inches. EXPORT AND DOMESTIC.

224 W. 4th Street, CINCINNATI, OHIO

Branch: 1301-2 Tenn. Trust, Memphis, Tenn

## THE E. E. BECK LUMBER COMPANY

Cash Buyers

### Poplar, Oak, Chestnut

And Other Southern Hardwoods

ALL GRADES AND THICKNESSES. WE BUY MILL CUTS.

Poplar, Oak,  
 Ash, Chestnut,  
 Sycamore,

## C. Crane & Co.

We would like to buy

2,000,000 feet Dry Oak  
 2,000,000 feet Dry Poplar

W. Va. Spruce,  
 Pine and Elm

Mostly heavy stock. Quotations Solicited.

MILLS AND YARDS  
 CINCINNATI, O.

YEARLY CAPACITY  
 100,000,000 FT.

LONG BILL STUFF  
 A SPECIALTY

IN THE MARKET FOR

## OAK-ASH-POPLAR

ALL GRADES AND THICKNESSES

## MOWBRAY & ROBINSON

Office:

1219 West Sixth Street

Yards:

Sixth Street, below Harriet

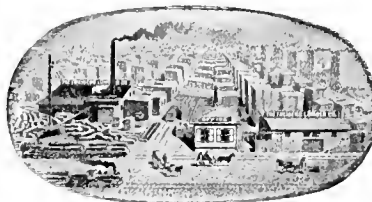

## THE FREIBERG LUMBER CO.

Manufacturers of

Tabasco Mahogany  
 Walnut, Oak

Poplar, McLean and Findlay Aves.  
 CINCINNATI, O.

## L. W. RADINA & COMPANY

Correspondence Solicited with Buyers and Sellers of All Kinds of

### HARDWOODS

Wanted for cash—desirable blocks of 1 inch to 4 inch Poplar, all grades,  
 Especially 1 1/4-inch stock, for immediate shipment.

CLARK STREET AND DALTON AVENUE

# THE WIBORG & HANNA COMPANY

CINCINNATI, OHIO

PLAIN  
 AND  
 QUARTER  
 SAWED

## White and Red Oak

CHESTNUT  
 POPLAR  
 GUM AND  
 CYPRESS

Flooring, Siding, Ceiling, Base, Case and Molding. Rough, Dressed and Re-sawed. Mixed Carloads.

## THE MALEY, THOMPSON & MOFFETT CO.

Always in the Market for  
 BLACK WALNUT LOGS,  
 SELECTED WHITE OAK LOGS,  
 LUMBER OF ALL KINDS.

CINCINNATI, : : : OHIO

Cash buyers for stock in our line.

## Cincinnati Hardwood Lumber Co.

GEST AND SUMMER STREETS

Wholesalers Mahogany, Thin Lumber, Veneers

Finely figured quarter sawed oak veneers a specialty.

WHAT HAVE YOU FOR SALE IN

## Red and White OAK Qtd. and Plain

ALSO POPLAR, CHESTNUT, WALNUT, ETC.

JOHN DULWEBER & CO., CINCINNATI, OHIO

# CLEVELAND

HARDWOOD DISTRIBUTING CENTER OF NORTHERN OHIO

## THE ROBERT H. JENKS LUMBER COMPANY

### FOR SALE

60 M feet 1" 1st and 2ds Poplar  
223 M feet 1" No. 1 Common Poplar  
125 M feet 1" No. 2 Common Poplar  
25 M feet 2" 1st and 2nd Poplar, 14" and up  
125 M feet 8 4" Sound Wormy Chestnut  
275 M feet 1" Sound Wormy Chestnut  
153 M feet 1" 1st and 2nd Plain White Oak  
85 M feet 1" 1st and 2nd Plain Red Oak  
125 M feet 1" No. 1 Common Plain Red Oak

**Quartered White and Red Oak.**—We have a good assortment of dry stock,  $\frac{3}{8}$  to 4 inches thick. Your inquiries solicited.

**Plain White and Red Oak.**—A limited amount of nice stock, ready for shipment.

## Do You Want It? What? Money?

What have you in lumber to exchange for it? We want particularly Plain Oak, Chestnut, Poplar, Basswood, Ash.

What Have You?

## The Advance Lumber Co.

13th Floor  
Rockefeller Bldg. CLEVELAND, OHIO

Memphis Office, No. 56 Rauldolph Building.

J. E. MEADOWS, Mgr.

## The Martin-Barriss Company

Importers and Manufacturers

## MAHOGANY

and Fine Hardwoods

## We Solicit Inquiries

FOR THE FOLLOWING:

- 2 cars 1x4" Clear Birch Strips
- 2 cars 1x5" and 6" Clear Birch Strips
- 1 car 3" No. 1 Com. and Better Birch, unselected
- 1 car 1" 1sts and 2nds Curly Red and White Birch
- 2 cars 1x4" Clear Basswood Siding Strips
- 2 cars 1x5" and 6" Clear Basswood Siding Strips

## The King & Bartles Lumber Company

1955-2025 Scranton Road N. W., Cleveland, Ohio

## LOCATIONS FOR NEW INDUSTRIES

can be secured on the lines of the

## Chicago, Milwaukee & St. Paul Railway

in the great middle west. It reaches the Copper Country and the pine and hardwood areas of Northern Michigan, the lead, zinc and iron regions of Wisconsin, the coal fields of Illinois, Iowa and Missouri.

Traverses the great agricultural and manufacturing states of Iowa, Minnesota, North and South Dakota. Operates 7,000 miles of thoroughly equipped railroad.

Correspondence is solicited with eastern manufacturers who desire to move their factories to, or establish branches in the West. Co-operation with Business Men's Associations on the lines of this railway in all matters affecting mutual interests is assured.

Inquiries should be as definite as possible.

Address

Industrial Department  
Chicago, Milwaukee & St. Paul Railway,  
Room 1327, Railway Exchange  
Chicago

# BUFFALO

THE GREAT WHOLESALE LUMBER CENTER OF THE EAST



Manufacturers and Dealers in

**Ash**

White and Brown

**Basswood**

**Birch**

Red and White

**Butternut**

**Cherry**

**Chestnut**

**Cottonwood**

**Cypress**

**Elm**

Soft and Rock

**Gum**

Red and Tupelo

**Hickory**

**Maple**

Hard and Soft

**Red Oak**

Plain and Quartered

**White Oak**

Plain and Quartered

**Black Walnut**

**White Wood**

Poplar



## ORSON E. YEAGER

Specialties: OAK, ASH AND POPLAR

932 ELK STREET

## BEYER, KNOX & COMPANY

ALL KINDS OF HARDWOODS

Office and Yards, 69 LEROY AVENUE

## BUFFALO HARDWOOD LUMBER CO.

We want to buy for cash:

Oak, Ash and other Hardwoods, all grades and thicknesses.  
Will receive and inspect stock at shipping point.

518 RANDOLPH BLDG., MEMPHIS, TENN.

940 SENECA STREET.

## EMPIRE LUMBER COMPANY

Our specialties are PLAIN and QUARTERED OAK and ASH.

1142 SENECA STREET.

## G. ELIAS & BROTHER

BUY AND CARRY LARGE QUANTITIES OF ALL KINDS OF HARDWOODS

955 TO 1015 ELK STREET

## HUGH McLEAN LUMBER COMPANY

Specialty: INDIANA WHITE OAK

940 ELK STREET

## ANTHONY MILLER

HARDWOODS OF ALL KINDS

893 EAGLE STREET

## SCATCHERD & SON

HARDWOODS ONLY

Yard, 1555 SENECA STREET

Office, 886 ELLICOTT SQUARE

## STANDARD HARDWOOD LUMBER CO.

OAK, ASH AND CHESTNUT

1075 CLINTON STREET

## I. N. STEWART & BROTHER

Specialties: CHERRY AND OAK

892 ELK STREET

## T. SULLIVAN & COMPANY

Specialties: BROWN ASH, BIRCH, PACIFIC COAST FIR AND SPRUCE

50 ARTHUR STREET

# W. M. Ritter Lumber Company

COLUMBUS, OHIO

## 6,000 Car Loads

Sawed and shipped yearly of band-sawed Yellow Poplar, White Pine, White Oak, Basswood, Chestnut, Hemlock and Ash. Planing Mills and Dry Kilns. ☛ If you are in a hurry to get your order placed, call our nearest salesman.

Salesman	Headquarters	Telephone
Fred A. Wilson.....	Portsmouth, Ohio.....	Bell 4392
E. E. Eaton.....	New York City, 158 W. 81st St.....	Riverside 7390
James B. Patton.....	Buffalo, N. Y., Rockford Hotel.....	Bryant 1335-R
A. Wallace Irwin.....	Baltimore, Md., Eutaw Hotel.....	
Frank B. Pryor.....	Pittsburgh, Pa., 7th Avenue Hotel.....	
E. E. Ginn.....	Jamestown, Ohio.....	Bell Phone
A. J. Williams.....	Cleveland, Ohio, Eastman, Detroit St.....	Ridge 593-R
L. G. Anderson.....	Franklin, Ohio.....	Bell 482
James H. Lang.....	Detroit, Mich., Hotel Ste. Claire.....	
W. H. Matthias.....	Chicago, Ill., 1448 Addison St.....	Lakeview 1493
Geo. H. Huganir.....	Philadelphia, Pa., 901 N. 50th St.....	
F. H. Browning.....	Columbus, Ohio.....	Main 7874
W. T. Baker.....	Graham, Va.....	

# Vansant, Kitchen & Co.

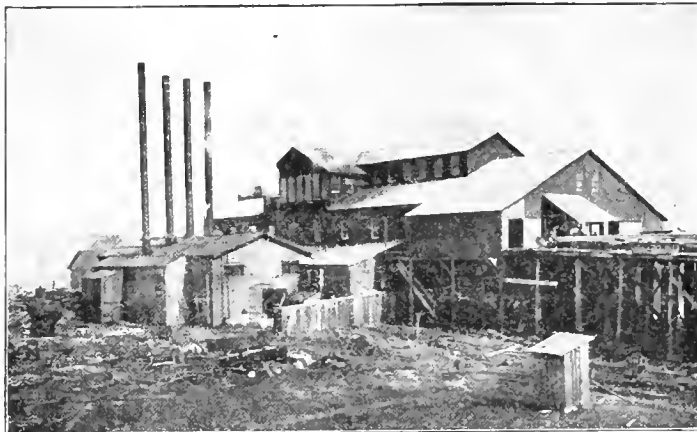

NEW ASHLAND MILL

Old-Fashioned

## SOFT YELLOW POPLAR

Ashland, Ky.

5-8 AND 4-4 IN WIDE STOCK, SPECIALTY

# YELLOW POPLAR

Manufacturers  
BAND SAWED  
POPLAR LUMBER

ALL GRADES

**DRY** 5-8, 4-4, 5-4, 6-4, 8-4, 10-4, 12-4, 16-4  
Bevel Siding, Lath and Squares  
Specialty, Wide Stock.

# LUMBER CO.

COAL GROVE, OHIO, U. S. A.

# Hardwood Record

Eleventh Year. {  
Semi-monthly. }

CHICAGO, JULY 25, 1906.

{ Subscription \$2.  
Single Copies, 10 Cents.

## CHERRY

C. E. LLOYD, JR.  
Manager Sales

## RIVER

## LUMBER

GROWS IN  
WEST VIRGINIA

Sold by  
Cherry River Boom &  
Lumber Co.  
Offices: Philadelphia, Pa.

## Himmelberger-Harrison Lumber Co.

## Red Gum Specialists

Morehouse,

Missouri

For relief from increased rates  
which are now imminent, apply to

## The Lumber Mutual Fire Insurance Company

141 Milk Street, Boston, Mass.

PRESENT CASH DIVIDEND TO POLICY HOLDERS, 33 $\frac{1}{3}$  PER CENT.

## The Davidson-Benedict Company

NASHVILLE, TENNESSEE

Everything in

## Southern Hardwoods

POPLAR, CHESTNUT, ASH, OAK  
(Plain and Quartered.) Straight or Mixed Cars.

DRESSED POPLAR ANY  
WAY YOU WANT IT.

YOU GET WHAT YOU BUY FROM  
US. ASK FOR OUR DELIVERED  
PRICES, ANY RAILROAD POINT.

— WE WANT TO MOVE —

## QUARTERED WHITE OAK

125,000 1 inch No. 1 and No. 2.  
500,000 1 inch No. 1 Common.  
300,000 1 inch No. 2 Common.  
100,000 2 inch No. 1 Common Red Oak.  
400,000 1 inch Sap Cull Poplar  
STOCK TWO YEARS DRY.

## THE ATLANTIC LUMBER CO.

2 Kilby Street,

BOSTON, MASS.

The combined facilities of the **LUMBER INSURANCE COMPANY OF NEW YORK** and the **ADIRONDACK FIRE INSURANCE COMPANY**, and allied organizations, constitute a great insuring opportunity for any owner of a first-class lumber or mill risk. Ask for lines and rates.

## LUMBER INSURERS GENERAL AGENCY, Underwriting Managers

66 BROADWAY, NEW YORK



# LOUISVILLE

MANUFACTURING AND DISTRIBUTING CENTER OF KENTUCKY

**We wish to move and will quote low prices on the following:**

- |   |  |
|---|--|
| 1 Car 6 4 1st and 2nd Qtd. White Oak, Wide in]    | 1 Car 4 4 2 1/2 to 5 1/2" 1st & 2nd Qtd. White Oak Strips    |
| 1 Car 8 4 1st and 2nd Qtd. White Oak, Wide in]    | 1/2 Car 4 4 2 1/2 to 5 1/2" No. 1 Com. Qtd. White Oak Strips |
| 1 Car 4 4 No. 1 Com. Qtd. White Oak               | 1 Car 4 4 No. 2 Com. Qtd. White and Red Oak                  |
| 1 Car 6 4 No. 1 Com. Qtd. White Oak               | 1/2 Car 5 4, 6 4 and 8 4 No. 2 Com. Qtd. White and Red Oak   |
| 2 Cars 8 4 No. 1 Com. Qtd. White Oak              |  |
| 1 Car 12 4 No. 1 Com. Qtd. White Oak              |  |
| 1 Car 4 4 1st and 2nd Qtd. Red Oak, Wide in       | 1 Car 4 4 No. 2 Com. Plain Red Oak                           |
| 1 Car 4 4 No. 1 Com. Qtd. Red Oak, Wide in        | 1 Car 5 4, 6 4, and 8 4 No. 2 Com. Plain Red Oak             |
| 1/2 Car 6 4 Com. and Bet. Qtd. Red Oak, 50% each  | 2 Cars 4 4 No. 3 Com. Plain Red and White Oak                |
| 1/2 Car 8 4 Com. and Bet. Qtd. Red Oak, 50% each  | 1 Car 6 4 1st and 2nd Poplar, 7 to 18"                       |
| 1 Car 12 4 Com. and Bet. Qtd. Red Oak, 50% each   | 5 Cars 4 4 No. 1 Com. Poplar (Selects in)                    |
| 1 Car 6 4 Com. and Bet. Plain Red Oak, 50% each   | 1 Car 4 4 No. 1 Com. and Bet. Bay Poplar                     |
| 2 Cars 12 4 Com. and Bet. Plain Red Oak, 50% each | 1 Car 4 4 to 8 4 Com. and Bet. White Ash                     |
|   | 1 Car 4 4 No. 2 Com. and Sound Wormy Chestnut                |

We have in pile at mills 3,000,000 ft. Plain and Quartered Red and White Oak, Poplar, Chestnut and some Ash, in thickness 3/4" to 16-4. This will be ready for market in 60 to 90 days. We also handle all kinds of Yellow Pine, Cypress, White Pine, Red and White Cedar, Lumber, Lath and Shingles and all kinds of Hardwood Flooring. Write us for prices.

**STOTZ LUMBER COMPANY**  
KELLER BUILDING :: :: LOUISVILLE, KY.

## The Norman Lumber Co., Inc.

Manufacturers and Wholesalers of

### Hardwood Lumber

FOR SALE

Seasoned Ash, Oak, Poplar, and Walnut Lumber

WANT TO BUY

Walnut, Oak, Ash, Hickory and Poplar Logs and Lumber

Office and Yards: Third Street, H to K Streets  
LOUISVILLE, KY.

## EDWARD L. DAVIS & CO.

OFFER FOLLOWING STOCKS:

- |   |  |
|---|--|
| <b>POPLAR.</b>                              | <b>OAK WAGON TONGUES.</b>                    |
| 30,000 ft. 4/4 1st & 2d.                    | 12,000 ft. 4x4"x4x2"-12", 1-6 mos. dry.      |
| 50,000 ft. 4/4 Common.                      | 800 ft. 3 x4 " -12", 12-18 mos. dry.         |
| 15,000 ft. 5/4 Common.                      | 400 ft. 3 1/2 x4 1/2 " -12", 12-18 mos. dry. |
| <b>QUARTERED RED OAK.</b>                   | 300 ft. 3 1/2 x4 1/2 " -12", 12-18 mos. dry. |
| 50,000 ft. 4/4 1st & 2d.                    | 250 ft. 3 1/2 x4 1/2 " -12", 12-18 mos. dry. |
| 50,000 ft. 4/4 Common.                      | 800 ft. 3 1/2 x4 1/2 " -12", 12-18 mos. dry. |
| <b>QUARTERED WHITE OAK.</b>                 | 180 ft. 3x4" & Lgr. -14", 12-18 mos. dry.    |
| 50,000 ft. 4/4 1st & 2d.                    | <b>REACHES.</b>                              |
| 10,000 ft. 5/4 1st & 2d.                    | 1 car 2x4" and larger, dry.                  |
| 20,000 ft. 6/4 1st & 2d.                    | <b>BOLSTERS.</b>                             |
| 10,000 ft. 8/4 1st & 2d.                    | 2 cars 3x4" and larger, dry.                 |
| 50,000 ft. 4/4 Common.                      | <b>HICKORY AXLES.</b>                        |
| 5,000 ft. 5/4 Common.                       | 1,500-3 x4 " -6", 1-6 mos. dry.              |
| 5,000 ft. 6/4 Common.                       | 1,500-3 1/2 x4 1/2 " -6", 1-6 mos. dry.      |
| 20,000 ft. 8/4 Common.                      | 2,000-4 x5 " -5", 1-6 mos. dry.              |
| 10,000 ft. 2 1/2" Common.                   | 1,000-4 1/2 x5 1/2 " -6", 1-6 mos. dry.      |
| 40,000 ft. 3" Common.                       | 1,000-5 x6 " -6", 1-6 mos. dry.              |
| 1 car Hickory Plank, 1 1/2 to 4"-8' to 16'. |  |

## Dry Stock W. P. Brown & Sons Lumber Co. Louisville, Ky.

- |                           |                           |                             |                          |                                     |
|---------------------------|---------------------------|-----------------------------|--------------------------|-------------------------------------|
| <b>PLAIN RED OAK.</b>     | 14,000' 1 1/2" 1st & 2d.  | 50,000' 2" No. 1 Com.       | <b>ASH.</b>              | <b>POPLAR.</b>                      |
| 55,000' 1" 1st & 2nd.     | 5,000' 2" 1st & 2d.       | 17,000' 2 1/2" No. 1 Com.   | 9,000' 1" 1st & 2d.      | 12,000' 1" 1st & 2d.                |
| 25,000' 1 1/4" 1st & 2d.  | 15,000' 1" No. 1 Com.     | 22,000' 3" No. 1 Com.       | 65,000' 1 1/4" 1st & 2d. | 12,000' 1 1/4" 1st & 2d.            |
| 49,000' 1 1/2" 1st & 2d.  | 7,000' 1 1/2" No. 1 Com.  |                             | 16,000' 1 1/2" 1st & 2d. | 11,000' 1 1/2" 1st & 2d.            |
| 57,000' 2" 1st & 2d.      | 13,000' 2" No. 1 Com.     | <b>QUARTERED WHITE OAK.</b> | 10,000' 2" 1st & 2d.     | 12,000' 2" 1st & 2d.                |
| 18,000' 2 1/2" 1st & 2d.  |                           | 50,000' 1" 1st & 2d.        | 8,000' 2 1/2" 1st & 2d.  | 8,000' 2 1/2" 1st & 2d.             |
| 16,000' 3" 1st & 2d.      | <b>PLAIN WHITE OAK.</b>   | 28,000' 1 1/4" 1st & 2d.    | 14,000' 3" 1st & 2d.     | 6,000' 3" 1st & 2d.                 |
| 131,000' 1" No. 1 Com.    | 80,000' 1" 1st & 2d.      | 45,000' 1 1/2" 1st & 2d.    | 6,000' 4" 1st & 2d.      | 50,000' 1" No. 1 Com.               |
| 84,000' 1 1/4" No. 1 Com. | 28,000' 1 1/4" 1st & 2d.  | 49,000' 2" 1st & 2d.        | 5,000' 1" No. 1 Com.     | 28,000' 1 1/4" No. 1 Com.           |
| 44,000' 1 1/2" No. 1 Com. | 12,000' 1 1/2" 1st & 2d.  | 19,000' 2 1/2" 1st & 2d.    | 4,000' 1 1/4" No. 1 Com. | 10,000' 1 1/2" No. 1 Com.           |
| 47,000' 2" No. 1 Com.     | 42,000' 2" 1st & 2d.      | 18,000' 1" No. 1 Com.       | 6,000' 1 1/2" No. 1 Com. | 16,000' 2" No. 1 Com.               |
| 8,000' 2 1/2" No. 1 Com.  | 23,800' 2 1/2" 1st & 2d.  | 30,000' 1 1/4" No. 1 Com.   | 8,000' 2" No. 1 Com.     | 15,000' 1" 1 1/2" & up 1st & 2d.    |
| 15,000' 3" No. 1 Com.     | 16,000' 3" 1st & 2d.      | 40,000' 1 1/2" No. 1 Com.   | 3,000' 2 1/2" No. 1 Com. | 8,000' 2" 1 1/2" & up 1st & 2d.     |
| <b>QUARTERED RED OAK.</b> | 227,000' 1" No. 1 Com.    | 22,000' 2" No. 1 Com.       | 2,000' 3" No. 1 Com.     | 6,000' 2" 2 1/4" & up 1st & 2d.     |
| 13,000' 1" 1st & 2d.      | 60,000' 1 1/4" No. 1 Com. | 10,000' 3" No. 1 Com.       | 1,000' 4" No. 1 Com.     | 4,000' 1 1/2" 1 1/2" & up 1st & 2d. |
|                           | 80,000' 1 1/2" No. 1 Com. |                             |                          | 3,000' 1 1/2" 2 1/4" & up 1st & 2d. |

All thicknesses in cull poplar, ash, chestnut. Your inquiries will be appreciated. Prompt delivery guaranteed.

## Ornamental Hardwood Floors

400 STYLES AND PATTERNS

Illustrated Catalog on Application

### WOOD=MOSAIC FLOORING CO.

Rochester, N. Y. New Albany, Ind.

### Albert R. Kampf

Manufacturer  
Hardwood Lumber and Timber  
Dimension Stock  
Board of Trade Bldg., Louisville, Ky.

### E. W. Rhubesky

Wholesale  
Poplar, Rough and Dressed.  
Oak, Chestnut and Other  
Hardwoods

### North Vernon Pump & Lumber Co.

Band Sawn Plain and Quartered  
Oak and Poplar.  
North Vernon, Ind., and  
Louisville, Ky.

### Southern Lumber Co.

Oak, Poplar and  
Chestnut.  
Louisville, Ky.

**CADILLAC**

CELEBRATED FOR HIGH STANDARD OF QUALITY AND MILL WORK

**Thick Hard Maple**

Cut during the winter of 1901 5.

10-4 1's and 2's . 51,000 ft.

12-4 1's and 2's . 55,000 ft.

16-4 1's and 2's . 10,000 ft.

This stock was sawed in our own mill and has been seasoned in a first-class manner. It is largely 12 inch and wider and very choice.

We also have end-dried in shed :

4-4 Birdseye Maple, 8,000 ft.

5-4 White Maple . 21,000 ft.

PLEASE SEND US YOUR INQUIRIES.

**Mitchell Brothers Company**

CADILLAC, MICHIGAN

**Cummer, Diggins & Co.**

—MANUFACTURERS—

“CUMMER” MAPLE  
AND BEECH FLOORING

**MICHIGAN HARDWOODS**

Good assortment of dry stock on hand ready for immediate shipment in Hard Maple, Beech, Birch, Soft Elm and Cherry.

SEND US A LIST OF YOUR REQUIREMENTS.

**MURPHY & DIGGINS**

Offer all grades of the following special dry stock

MAPLE—5/4, 6/4, 8/4, 10/4, 12/4, 14/4, 16/4

GRAY ELM—4/4, 12/4

BASSWOOD—4/4

BIRCH—6/4, 8/4

Our own manufacture. Perfect Mill Work. Uniform Grades.

LET US FIGURE ON YOUR HARDWOOD WANTS.

**The Cadillac Handle Co.**

. . . Band Sawn . . .  
**Michigan Hardwoods**

We offer for Rail Shipment from Cadillac.  
2 cars 8/4 Maple, No. 1 Com. & Better  
1 car 5x5 Maple, Select Stock  
2 cars 4/4 Basswood, No. 2 Com. & Bet.  
2 cars 4/4 Birch, No. 2 Com. & Bet.

Also the following for Water Shipment:  
100,000 feet of 4/4 Basswood  
100,000 feet of 4/4, 8/4 and 12/4 Soft Elm  
150,000 feet of 4/4, 5/4 and 6/4 Birch

**DRY STOCK**

We have a choice line of

**Michigan Hard Maple**

and

**Soft Gray Elm**

In placing your orders, remember also our famous “ELECTRIC” BRAND MAPLE FLOORING

Be Friendly.

Write Us.



**COBBS & MITCHELL**  
(INCORPORATED)  
**GADILLAC, MICHIGAN**

# MEMPHIS

THE HUB OF THE HARDWOOD WORLD

## ANDERSON-TULLY COMPANY

STOCK LIST

<b>COTTONWOOD.</b>		<b>GUM.</b>	
32M ft. 7" 1st & 2d, 8" up wide	4M ft. 3 8" 1st & 2d Red, 16" & 1p.	7M ft. 1 2" 1st & 2d Red, 16" & 1p.	
20M ft. 1" 1st & 2d, 8" up wide.	7M ft. 1 2" 1st & 2d Red, 16" & 1p.	30M ft. 1 2" 1st & 2d Sap, 6" & 1p.	
63M ft. 1" 1st & 2d, 7" to 10" wide.	30M ft. 1 2" 1st & 2d Sap, 6" & 1p.	80M ft. 4 4" 1st & 2d Sap, 13" to 15".	
19M ft. 1" 1st & 2d, 11" wide.	30M ft. 4 4" No. 1 Com. Red.	60M ft. 4 4" No. 1 Com. Sap.	
24M ft. 1" 1st & 2d, 12" wide.	60M ft. 4 4" Cir. Red Strips, 2 1/2" x 5 1/2".	18M ft. 5 4" No. 1 Com. Sap.	
200M ft. 1" 1st & 2d, 13" up wide.	18M ft. 5 4" No. 1 Com. Sap.	30M ft. Wagon Box Brds., 13" to 17".	
45M ft. 1" 1st & 2d, 18" up wide.			
35M ft. 1 1/4" 1st & 2d, 8" up wide.	<b>POPLAR.</b>		
30M ft. 1 1/4" 1st & 2d, 11" wide.	27,100 ft. 4 1/2" Com. & Bet. Strips,		
30M ft. 1 1/2" 1st & 2d, 8" up wide.	2 1/2" to 5 1/2".		
150M ft. Wag. Box Brds., 9"-12" wide.			
500M ft. 1" No. 2 Com.	<b>RED OAK.</b>		
500M ft. 1" No. 3 Com.	400 ft. 4 1/2" 1st & 2d Quartered.		
	3,700 ft. 4 4" Com. Quar.		
<b>CYPRESS.</b>		4,000 ft. 4 4" No. 2 & No. 3 Com.	
19,600 ft. 4 4" Cir. Strips, 2 1/2" x 5 1/2" wide.		Ph. Red & White.	
5,000 ft. 4 4" Select.		<b>WHITE OAK.</b>	
5M ft. 4 1 Com. Strips, 2 1/2" x 5 1/2" wide.	1,000 ft. 4 1/2" 1st & 2d Quartered.		
12M ft. 5 4 & 6 4 No. 3 Common.	10,910 ft. 4 4" Com. Quartered.		

## FENN BROS. COMPANY

MANUFACTURERS OF

# Oak Flooring

QUARTERED WHITE      HOLLOW BACKED  
 QUARTERED RED      END MATCHED  
 PLAIN WHITE      POLISHED  
 PLAIN RED      BORED

Memphis, Tenn.

F. W. GILCHRIST, President  
 W. A. GILCHRIST, Vice President  
 W. E. SMITH, Sec'y and Treasurer

## W. E. SMITH LUMBER CO.

Manufacturers of  
**HARDWOOD LUMBER**

Mills, Tennessee, Arkansas, Mississippi  
 Distributing Yards, Cairo, Illinois  
 General Office      Tennessee Trust Bldg.

MISSISSIPPI      VALLEY      COTTONWOOD

J. B. Ransom, Prest.      A. B. Ransom, V.-Prest.      W. A. Ransom, Sec.      C. R. Ransom, Treas.

## GAYOSO LUMBER CO., Inc.

MANUFACTURERS AND DEALERS IN

# SOUTHERN HARDWOODS

Also make a specialty of Wagon Stock in rough, such as Tongues, Axles, Reaches, Bolsters, and 6-4 to 16-4 Hickory.

## Briggs & Cooper Company, Ltd.

MANUFACTURERS

# NORTHERN SOUTHERN HARDWOODS

GET OUR PRICES ON THESE ITEMS:

- 1,000,000 feet Soft Grey Elm, 1 to 3".
- 500,000 feet Unselected Birch, 1 to 3".
- 3,000,000 feet Michigan Hard Maple, 1 to 6".
- 350,000 feet Erd Dried White Maple, 1 to 1 1/2".
- 625,000 feet No. 1 Common and Better Winter Sawn Basswood, 1 to 3".
- 150,000 feet Selected White Basswood, 1", 1 1/4" and 1 1/2".
- 210,000 feet Plain and Quartered White and Red Oak, 1 to 2".

YARDS AT

SAGINAW, CHICAGO AND MEMPHIS

F. W. GILCHRIST, Pres.      W. A. GILCHRIST, Vice-Pres.  
 W. E. SMITH, Sec'y and Treas.

## Three States Lumber Co.

MANUFACTURERS OF

Mills:      **Hardwood Lumber**      Office  
 Missouri      Cottonwood and Gum      Tennessee  
 Arkansas      Trust  
 Tennessee      Building

GET OUR PRICES. TRY OUR LUMBER  
 WE SHIP ROUGH, DRESSED, RESAWED

COTTONWOOD — GUM

**W**E have in all thicknesses the following kinds and amounts of lumber at places designated. Kindly send us your inquiries.

MEMPHIS YARD:

Ash.....	680,000 feet
Quartered White Oak.....	75,000 feet
Plain White Oak.....	140,000 feet
Quartered Red Oak.....	225,000 feet
Plain Red Oak.....	410,000 feet
Cypress.....	225,000 feet
Cottonwood.....	200,000 feet
Poplar.....	308,000 feet

SELMA YARD

Poplar.....	409,000 feet
Bay Poplar.....	857,000 feet
Red Gum.....	55,000 feet
Cypress.....	787,000 feet

BERCLAIR YARD

Bay Poplar.....	100,000 feet
Cypress.....	800,000 feet

OTHER YARDS

Plain Red Oak.....	350,000 feet
--------------------	--------------

## J. W. THOMPSON LUMBER COMPANY

Office and Yards: Randolph Road and I. C. R. R.      MEMPHIS, TENN.

## BACON-NOLAN HARDWOOD CO.

Manufacturers of

# Band Sawn Oak, Ash Gum, Cypress, Etc.

Office,  
 Memphis, Tenn.

Mills,  
 Chancy, Miss.

Address all correspondence to Memphis office.

**ST. LOUIS**

LARGEST OF ALL HARDWOOD MARKETS

**Wanted—Cypress, Ash and Cottonwood**

INSPECTION AT POINT OF SHIPMENT WHEN QUANTITY JUSTIFIES

**Hafner Manufacturing Co.**

CYPRESS, HARDWOODS

Mail orders receive our immediate attention.

YARDS: FOOT OF DOCK STREET

**CHAS. F. LUEHRMANN HARDWOOD LUMBER COMPANY**

Carry a complete stock of Hardwood and are constantly in the market to purchase large blocks of stock for cash. Are also the largest manufacturers of the famous St. Francis Basin Red Gum.

General Offices: 148 Carroll Street

**Thomas & Proetz Lumber Co.**

CASH BUYERS OF OAK, ASH, CYPRESS, POPLAR, CHERRY AND ALL

**HARDWOODS**

SEND INSPECTOR WHEN QUANTITY JUSTIFIES

Office and Yards: Hall and Angelrodt Sts.

**Stoneman-Zearing Lumber Co.**

203 Frisco Building

We have the following Dry Stock for sale piled at our mill:

QTD. WHITE OAK :	COTTONWOOD :
3 Cars 4/4 Common.	3 Cars 1" 1 and 2.
2 Cars 4/4 Common and Better Strips.	1 Car 1x13 to 17" Box Boards.
GUM :	ELM :
5 Cars 1" Common Red.	1 Car 6/4 Log Run.
1 Car 1x13 to 17" Box Boards.	4 Cars 4" Log Run.
1 Car 2" 1 and 2 Sap.	
6 Cars 1 1/2 Common and Better Sap.	

This Stock is All Band Sawn and Equalized

**LOTHMAN CYPRESS CO.**

AIR DRIED

**Louisiana Red Cypress**

FOOT OF ANGELICA STREET

**Garetson-Greason Lumber Co.**

MANUFACTURERS OF SOUTHERN HARDWOODS

**GUM LUMBER  
OUR SPECIALTY**

Carload Shipments Direct from Our Own Mills

519 Bank of Commerce

**Ozark Cooperage Co.**

WE BUY STOCKS READY CUT OR CONTRACT FUTURE OUTPUT

Four Inspectors in the South

Direct Shipments from mill stocks (COTTONWOOD, CYPRESS, GUM, OAK.) MAIN OFFICE, FRISCO BUILDING

**W. R. CHIVVIS,** Lesperance Street and Iron Mountain Railroad.

WHOLESALE HARDWOODS

BLACK WALNUT LUMBER MY SPECIALTY. Always in the market to buy Walnut and Cherry Lumber. Pay spot cash and take up at shipping point when amounts justify.

**SIX MILLION FEET**

Ash, Oak, Cypress, Poplar, Etc.

READY FOR PROMPT SHIPMENT

**STEELE & HIBBARD**

NORTH BROADWAY, DOCK AND HALL STREETS

# PAEPCKE-LEICHT LUMBER COMPANY

MANUFACTURERS OF

## COTTONWOOD GUM AND OTHER HARDWOODS

Large stocks of well seasoned Lumber always carried at our yards and mills.

General Offices: 140 W. Chicago Ave., CHICAGO. Mills: Cairo, Ill., Marked Tree, Ark., Greenville, Miss., Arkansas City, Ark., Blytheville, Ark.

# Swann-Day Lumber Company

MANUFACTURERS OF

## POPLAR AND OAK

PLANING MILL STOCK, BOX SHOOKS  
AND HARDWOOD DIMENSION

CLAY CITY, KENTUCKY

# WILLIAM WHITMER & SONS, Inc.

MANUFACTURERS OF

## HARDWOODS

We are always in the market for round lots of well manufactured stock, and shall be pleased to enter into correspondence with manufacturers with a view to purchase.

PHILADELPHIA  
New York, Boston, Pittsburg

TO NEW YORK OVER NIGHT

# The 20th Century Limited

Via the LAKE SHORE and NEW YORK CENTRAL  
The Route of the Government Fast Mail Trains

## CHICAGO - NEW YORK 18-HOUR TRAIN

IT SAVES A DAY

FROM LA SALLE ST. STATION  
CHICAGO

Leave Chicago at 2.30 p. m.  
Arrive New York at 9.30 a. m.

FROM GRAND CENTRAL STATION  
THE ONLY TERMINAL IN NEW YORK

Leave New York at 3.30 p. m.  
Arrive Chicago at 8.30 a. m.

W. J. LYNCH, Passenger Traffic Manager, Chicago, Ill.

# THE EAST

BOSTON NEW YORK PHILADELPHIA

## What Lumber Do You Want? Read July "Lumber News."

You can find in our stocks many special things in hardwoods. Our regular stocks hold millions of feet of good lumber awaiting your orders. Here's two items:  
1,000,000 ft. Poplar, 4-4 to 12-4, mostly Common and Better.  
2,000,000 ft. Chestnut, one-third Common and Better.  
Send in your inquiries to-day.

### J. Gibson McIlvain & Co.

WHOLESALE LUMBER DEALERS  
58th St. and Woodland Ave. PHILADELPHIA, PA.

## Thomas Forman Company

MANUFACTURERS OF HIGH-GRADE

### Maple and Oak Flooring

New York Branch:  
McGovern & Bowen, 29 Broadway  
And Hardwood Lumber  
DETROIT, MICHIGAN

## Jones Hardwood Co.

(INCORPORATED)

### WANTS

Poplar, Plain Oak, Quartered Oak and Cypress

Manufacturers please send stock lists and prices

147 MILK STREET, BOSTON, MASS.

## WM. E. LITCHFIELD

MASON BUILDING, BOSTON, MASS.

### Specialist in Hardwoods

Manufacturers are requested to supply lists of stock for sale

WE MUST MOVE AT ONCE

### 6 Cars 4-4 1's and 2's Red Oak

High Grade Stock, good widths and lengths  
PRICE RIGHT. Send us your inquiries

## SCHOFIELD BROTHERS

1020-22 Pennsylvania Building, PHILADELPHIA

## Charles S. Wentworth & Co.

WHOLESALE LUMBER MERCHANTS

147 Milk Street  
BOSTON

We are in the Market for POPLAR, PLAIN OAK, CYPRESS and NORTH CAROLINA PINE LUMBER; also OAK, MAPLE and BIRCH FLOORING, and would appreciate correspondence from manufacturers in position to supply any of the stock named.

## Wistar, Underhill & Co.,

WHOLESALE

### HARDWOOD LUMBER

816 Real Estate Trust Building, PHILADELPHIA.

## Holloway Lumber Company

### WHOLESALE HARDWOODS

In the market for all thicknesses of  
OAK, ASH and CHESTNUT. 312 Arcade Building,  
PHILADELPHIA, PA.

## YOUR VACATION

WHERE TO GO  
HOW TO GET THERE  
AND WHAT IT WILL COST

All this will be found in the book of specially selected vacation tours, combining rail and water routes,

ISSUED BY THE

## MICHIGAN CENTRAL

"The Niagara Falls Route"

SEND FOR A COPY NOW

W. J. LYNCH,  
Pass. Traffic Mgr.,



CHICAGO

O. W. RUGGLES,  
Gen'l Pass. Agt.,

## STEVENS-EATON CO.

Buyers of  
ROUND LOTS  
of  
Hardwoods

No 1 Madison  
Avenue,  
NEW YORK

ESPECIALLY IN MARKET FOR PLAIN RED OAK

## THE GENERAL LUMBER COMPANY

### HARDWOODS HEMLOCK, YELLOW PINE.

COLUMBUS OHIO



# NASHVILLE

HEADQUARTERS FOR ALL SOUTHERN HARDWOODS

## JOHN B. RANSOM & CO.,

NASHVILLE, TENNESSEE

We want to move quickly the following old dry stock. All of it has been on sticks 6 to 18 months. Write us for delivered prices. We are prepared to furnish promptly mixed cars of rough and dressed hardwoods of all kinds:

QUARTERED WHITE OAK	QUARTERED RED OAK
90 M 4/4 first and second	100 M 4 4 first and second
15 M 5/4 first and second	58 M 6 4 first and second
80 M 6/4 first and second	15 M 8 4 first and second
10 M 10/4 first and second	95 M 4 4 No. 1 Common
120 M 4/4 No. 1 Common	84 M 6 4 No. 1 Common
65 M 6/4 No. 1 Common	72 M 8 4 No. 1 Common
58 M 8/4 No. 1 Common	
20 M 10 4 No. 1 Common	
	PLAIN OAK
70 M 5/8 first and second Poplar	50 M 4 4 1st and 2nd White
80 M 5/8 No. 1 Common Poplar	100 M 4 4 No. 1 Common White
15 M 4/4 1st and 2d Quartered Sycamore	100 M 4 4 first and second Red
10 M 4 4 No. 1 Com. Quart'd Sycamore	100 M 4 4 No. 1 Common Red

## Nashville Hardwood Flooring Co.

Manufacturers of

### "Acorn Brand"

THE FAMOUS FAULTLESS FLOORING  
IN OAK AND BEECH.

Car Lots and Less Than Car Lot  
Orders Solicited. Write for Prices.

Nashville, Tennessee

## INDIANA LUMBER CO.

Manufacturers Lumber  
DIMENSION STOCK A SPECIALTY.

Office and Mills: Corner Oldham  
Street and Cumberland River

NASHVILLE, TENN.

## GEO. C. BROWN & CO.

MANUFACTURERS AND WHOLESALE DEALERS IN

### Hardwood Lumber

Tennessee Red Cedar Lumber a Specialty.

NASHVILLE, TENNESSEE

## LOVE, BOYD & CO.

Offer:

5,000,000 ft. Quartered White Oak.  
2,000,000 ft. Quartered Red Oak.  
1,000,000 ft. Plain White Oak.  
1,000,000 ft. Plain Red Oak.  
1,000,000 ft. Poplar.  
2,000,000 ft. Chestnut, Ash, Hickory, Red Cedar, Etc.

Our Own Manufacture.  
Prompt Service.  
Dry Stock.

MAIN OFFICE,  
NASHVILLE, TENNESSEE

## Are You in the Market ?

Send us your inquiries for prices on  
the following

# HARDWOODS

100M ft. 1" Com. and Better Quartered Red Oak.  
100M ft. 1" Com. and Better Quartered White Oak.  
75M ft. 1½" Com. and Better Quartered Red Oak.  
25M ft. 1½" Com. Quartered White Oak.  
25M ft. 1½" 1st and 2nds Quartered Red Oak.  
50M ft. 3" Com. and Better Quartered White Oak.  
50M ft. 3" Com. and Better Plain White Oak.  
100M ft. 1" Com. Plain Birch.  
50M ft. 1" Com. Red Birch.  
50M ft. 1½" Com. and Better Plain Birch.  
100M ft. 1" Com. and Better Hard Maple.  
100M ft. 1½" Com. and Better Hard Maple.  
100M ft. 1" Com. and Better Soft Elm.

## UPHAM & AGLER

Distributing Yards: CAIRO, ILL.

Main Offices :: American Trust Building, CHICAGO

—have you positive knowledge  
of the accuracy of your books?

### A Certified Report

showing the exact condition of  
your business, locating possible  
errors, and offering *practical sug-  
gestions* for improving your sys-  
tem of accounting — furnished  
with our disinterested audit—

**will answer this query**



Standard Audit Company

Suite 335

Marquette Building, CHICAGO

# PITTSBURG

HARDWOOD DISTRIBUTING CENTER OF PENNSYLVANIA

## Babcock Lumber Co.

MANUFACTURERS OF  
**PENNSYLVANIA  
HARDWOODS**  
23,000,000 FEET ANNUALLY

LONG ON MAPLE  
AND CHERRY

MILLS AND OFFICE  
ASHTOLA, PA.

## Dry Stock for Quick Shipment:

12,189 ft 4 4 clear Quartered Oak	66,232 ft 4 4 No. 1 Common Poplar
14,570 ft 4 4 1st & 2ds qtd. Red Oak	10,315 ft 6 4 1st & 2ds Poplar
30,202 ft 4 4 No. 1 Com. Red Oak	16,000 ft 4 4 1st & 2ds Cottonwood
63,244 ft 4 4 No. 1 Com. Pl White Oak	119,000 ft 4 4 No. 1 Com. Cottonwood
4,417 ft 5 4 No. 1 Com. Pl White Oak	150,000 ft No. 2 Common Cottonwood
5,934 ft 6 4 No. 1 Com. Pl White Oak	90,000 ft 4 4 Mill Cull Cottonwood
23,473 ft 4 4 1st & 2ds Plain Red Oak	110,000 ft 5 4 No. 1 Com. Cottonwood
14,168 ft 4 4 1st & 2ds Poplar	40,000 ft 5 4 No. 2 Com. Cottonwood

## American Lumber & Mfg. Co.

PITTSBURG, PA.

## The Nicola Lumber Company

One million feet 4-4 Bay Poplar.  
Can be shipped log run, or sold  
on grade. Bone dry; band  
sawed. Send your inquiries.

## Flint, Erving & Stoner Co.

### Wholesale Lumber

Northern and Southern Hardwoods

Beech and Maple Timbers a Specialty

## A. M. Turner Lumber Company

Everything in lumber. We buy hardwoods  
as well as sell them. If you have anything  
to offer, please submit same to us. : :

## Linehan Lumber Company

PERFECT

## MAPLE FLOORING

SEND US YOUR INQUIRIES

## Willson Bros. Lumber Co.

MANUFACTURERS

**WEST VIRGINIA  
HARDWOODS**

FARMERS BANK BLDG. :: PITTSBURG, PA.

## Hardwoods a Specialty

FOR SALE

POPLAR	CHESTNUT	PLAIN OAK
125,000' 4/4 Is and 2s	200,000' 4/4 Sound Wormy	60,000' 4 4 No. 1 Com.
40,000' 4/4 No. 1 Com.	80,000' 5/4 Sound Wormy	18,000' 4, 4 No. 2 Com.
325,000' 4/4 No. 2 Com.	100,000' 6 4 Sound Wormy	<b>QUARTERED OAK</b>
228,000' 4/4 No. 3 Com.	48,000' 8 4 Sound Wormy	2 cars 4/4 No. 1 Com.
150,000' 5/4 Mill Cull		1 car 4/4 No. 2 Com.

OAK TIMBERS SAWED TO ORDER.  
WRITE FOR PRICES.

CHEAT RIVER LUMBER COMPANY, Pittsburg, Penna.

# CHICAGO

THE GREATEST HARDWOOD MARKET IN THE WORLD

## SOUTHERN OAK LUMBER CO.



WE WANT TO BUY FOR CASH

OAK  
CYPRESS  
ASH

MILL CUTS OR ROUND LOTS

910 CHAMBER OF COMMERCE 1217 TENNESSEE TRUST BLDG.

CHICAGO MEMPHIS

YARDS: NORTH MEMPHIS

## White Lumber Company

Dealers in Hardwood Lumber

ALL KINDS

ALL GRADES

Cherry Lumber a  
Specialty



Laflin @ 22d Sts.  
Chicago

## John O'Brien Land & Lumber Co.

MANUFACTURERS AND DEALERS IN

### Hardwood Lumber

Of All Kinds

OFFICE AND YARDS  
873 to 881 So. Laflin Street  
MILL: PHILIPP, MISS.

Chicago

# Schultz Brothers & Cowen

WE ARE IN THE MARKET TO BUY

POPLAR—OAK—ASH—CHESTNUT

AND OTHER HARDWOODS—ALL GRADES AND THICKNESSES

1225 to 1240 OLD COLONY BUILDING, . . . . . CHICAGO

## PARK RICHMOND & CO.

Wholesale

### Hardwood Lumber

67 West Twenty-second St.

Chicago

—have you anything to offer in  
hickory, white ash, thick plain  
oak and wagon stock?

WE ARE CASH BUYERS  
PLEASE SEND US YOUR STOCK LISTS

## Ryan & McParland

Office and Yards  
Robey St. and Blue Island Ave.

Chicago

**CHICAGO**

THE GREATEST HARDWOOD MARKET IN THE WORLD

**The Keith Lumber Company**  
 HARDWOOD, POPLAR & SOUTHERN PINE LUMBER,

MAHOCANY,

REDWOOD,

RED CEDAR,



CYPRESS,

CHESTNUT,

SPRUCE,

MAPLE FLOORING, OAK TIMBERS & WAGON STOCK.

Office and Yards: Fourteenth and Wood Streets.

**CHAS. DARLING & CO.**

Southern  
 Hardwoods

22nd Street and Center Avenue - CHICAGO

**Heath-Witbeck Company**

Hardwood Lumber

We have for quick shipment 170,000 feet DRY BIRCH, First and Seconds and Common 2, 2½, 3 and 4 inch.

Main Office, 6 Madison St. Yards, Loomis and 22nd St.  
 CHICAGO

Chas. Miller

Milton Miller

**MILLER BROS.**

**Hardwood Lumber**

Main Office, 208 WILLOUGHBY BLDG.,  
 6 E. MADISON STREET,

YARDS:

Loomis St., S. of 22nd St.,  
 Chicago, Ill.  
 Houston, Miss.  
 Macon, Miss.

CHICAGO, ILL.

\*Phone CENTRAL 1363

**Crandall & Brown**

LOUISIANA RED CYPRESS  
 Yellow Pine, Oak, Poplar and Maple

We have in Chicago for quick delivery  
 100,000 1½" 1st and 2nds La. Red Cypress, thoroughly dry.  
 14,000 3x14" Shop Com. Cypress  
 We are in the market for Ash and Cottonwood

Office and Yards: 3300 Center Avenue, CHICAGO.

**WISCONSIN TIMBER & LUMBER CO.**

BUY AND SELL

Yellow Pine and Hardwood Lumber

Want thick hardwoods and wagon box boards.

Monadnock Bldg., . . . . . CHICAGO, ILL.

**Lesh & Matthews Lumber Co.**

1649-50 MARQUETTE BUILDING

Are now offering bone dry BIRCH, ROCK ELM, BLACK ASH, etc., Wisconsin stock. Also PLAIN AND QUARTERED OAK, POPLAR, etc., from our Memphis yard. We are constant buyers.

**J. Slimmer & Company**

Hardwood  
 Lumber

Office and Yard:  
 65 W. Twenty-second St.

CHICAGO

FRED W. BLACK, President

HORACE W. BLACK, Secretary

**FRED W. BLACK LUMBER COMPANY**

MANUFACTURERS OF

**HARDWOOD LUMBER**

305 Old Colony Building

**THE WARD LUMBER COMPANY**

MANUFACTURERS OF

**HARDWOODS**

CHAMBER OF COMMERCE BUILDING :: CHICAGO

# OAK FLOORING

Kiln Dried  
Bored  
Polished



Hollow  
Backed  
and  
Bundled

# Timber Bonds

SECURED BY FIRST MORTGAGE ON TIMBER LANDS

## H. C. Barroll & Co.

BANKERS, First National Bank Building, CHICAGO.

H. B. LEAVITT, PREST.  
E. H. ADAMS, SECY.

B. F. RICHARDSON, VICE-PREST.  
J. G. LEAVITT, TRAS.

## THE LEAVITT LUMBER CO.

MOST COMPLETE STOCK OF HARDWOODS IN  
CHICAGO

MAKE KNOWN YOUR WANTS AND GET  
IMMEDIATE RESULTS

Mills:

WISCONSIN  
TENNESSEE  
ARKANSAS  
LOUISIANA  
MISSISSIPPI

General Office and Yard:  
22ND AND LAFLIN STREETS,  
Southern Office:  
808 TENNESSEE TRUST BLDG.  
MEMPHIS, TENN.

## THE "FINEST" MAPLE FLOORING

### W. D. YOUNG & CO.

BAY CITY, MICHIGAN.

Producers from TREE to TRADE of the highest type of Michigan Forest Products. Large stock of Maple Flooring and 15,000,000 feet of Hardwoods—1 to 4 inches thick—on hand.

## Maple, Birch and Beech Lumber

## "Ideal" <sup>Steel Burnished</sup> Rock Maple Flooring

is the flooring that is manufactured expressly to supply the demand for the best. It is made by modern machinery from carefully-selected stock and every precaution is taken throughout our entire system to make it fulfill in every particular its name—"IDEAL."

Rough or Finished Lumber—All Kinds

Send us Your Inquiries

## The I. Stephenson Company

WELLS, MICHIGAN

## White and Red Oak

Secure our special prices on the following dry stock. We need the piling room.

30,000 feet 7-4 and 8-4 Quarter Sawn.  
150,000 feet 4-4 1st and 2nds Clear Plain Sawn.  
200,000 feet 4-4 No. 1 Common Plain Sawn.  
200,000 feet 4-4 No. 2 Common Plain Sawn.

We also manufacture chair and table stock. Let us figure with you. Address all communications to

## Dierks Lumber & Coal Company

Mills: DE QUEEN, ARK. KANSAS CITY, MISSOURI

## "Michigan" Maple Flooring

Our model factory is equipped with the highest class tools and appliances made for Flooring production.

We produce our lumber from the best rock Maple area in Michigan and have 20 years' supply.

Our brand "Michigan" is a guaranty of quality. Perfect mill work and excellent grades distinguish our Flooring and our prices are reasonable.

## WARD BROS., Big Rapids, Mich.

## Wolverine Brand Maple Flooring

== "THERE IS NONE BETTER" ==



It is the same old story, but we want you to know what Wolverine Brand will do for you, and what it will cost you. We want to do this before you place your next order. If we make you quotations we expect the quality and prices will get your order.

TRY US.

## BLISS & VAN AUKEN

900 S. Niagara Street, Saginaw W. S., Mich.

# Hardwood Record

Published in the Interest of Hardwood Lumber, American Hardwood Forests, Wood Veneer Industry, Hardwood Flooring, Hardwood Interior Finish, Wood Chemicals, Saw Mill and Woodworking Machinery.

Vol. XXII.

CHICAGO, JULY 25, 1906.

No. 7.

Published on the 10th and 25th of each month by

## THE HARDWOOD COMPANY

HENRY H. GIBSON, President

FRANK W. TUTTLE, Sec.-Treas.

### OFFICES

Sixth Floor Ellsworth Bldg., 355 Dearborn St. Chicago, Ill., U.S.A.

Telephones: Harrison 4960 Automatic 5659

### TERMS OF ANNUAL SUBSCRIPTION

In the United States, Canada, Philippine Islands and Mexico . . . \$2.00  
In all other countries in Universal Postal Union . . . . . 3.00

Subscriptions are payable in advance, and in default of written orders to the contrary are continued at our option.

The entire contents of this publication are covered by the general copyright, and articles must not be reprinted without special permission.

Entered at Chicago Postoffice as Second Class Matter.

Advertising copy must be received five days in advance of publication date. Advertising rates on application.

### MEETING MICHIGAN HARDWOOD MANUFACTURERS' ASSOCIATION.

A meeting of the Michigan Hardwood Manufacturers' Association will be held at the John Jacob Astor House, Island of Mackinac, Mich., at 10 a. m. on Wednesday, Aug. 8. It is anticipated that this meeting will call out the attendance of the majority of hardwood manufacturers of the state. The Island can be reached by the Pere Marquette Railway, via Petoskey; Grand Rapids & Indiana, via Mackinaw City; Michigan Central, via Mackinaw City; Detroit & Mackinaw via Cheboygan and boat; Duluth, South Shore & Atlantic and "Soo" Line, via St. Ignace; or from Chicago via steamer Manitou, leaving at 11:30 a. m. Monday, Aug. 6, and arriving at the Island at the same hour on Tuesday, Aug. 7.

### General Market Conditions.

From an analysis of the hardwood market reports contained in this issue of the HARDWOOD RECORD it will be noted that the general conditions this year are far above the average for midsummer, as compared with like seasons of many years in the past. To be sure, in some trade centers plain white oak still leads the van in strength of demand, with plain red a strong second. Quarter-sawed stock in both varieties is doing fairly well. The demand for chestnut is phenomenal, and seems to be increasing.

The demand and breadth of distribution of red gum is daily widening. Sales of large blocks of stock have been made within the last two weeks. The buying public the country over has at last awakened to the superb qualities of red gum and are buying it freely.

No variety of the minor southern hardwoods has accumulated in any quantity. The call for hickory and other wagon material is way beyond the possibilities of producers to supply. The mail of the HARDWOOD RECORD is deluged for information as to possible sources of supply for these materials. There is a movement on foot at the present time to advance prices on both wagons and carriages to provide for increased cost.

In the northern woods there is less activity than in the southern lines of production. Inch maple is fairly well contracted for up to the saw by the flooring producers, but there is still a slight surplus of thick stock. There seems to be an increased call for birch, but not so strong as the merits of the wood would naturally warrant. Basswood, owing to the shortage of competitive woods, is doing much better, and dry stocks are closely picked up. Gray elm is not nearly so active in demand as it should be, considering the fine qualities of this wood. Black ash and rock elm are practically out of the market, having been contracted ahead even before the trees were felled.

Poplar, owing to the lack of tides in the southern mountain district, which have failed to turn out any considerable quantity of logs this year, is in remarkably short supply, and there is lots of trading among manufacturers to take care of even a modicum of the business that is offered them. This condition is having the effect of materially stimulating values of cottonwood and basswood. In fact the cottonwood situation is approximately in the same shape that poplar is. All grades are very short. The demand for box cottonwood is fully fifty per cent in excess of the supply.

The immense quantity of new building operations going on is keeping the hardwood flooring people busy. The trade in both maple and oak flooring is the largest ever known in the history of this part of the lumber business.

There seems to be an increased call for dimension material for wagon purposes and for furniture and chair making, and buyers seem to be perfectly willing to pay prices for this class of material that approximate thirty per cent above those realized a year ago. Unquestionably the demand is very much in excess of the supply.

The mahogany, walnut and cherry trade is pursuing the even tenor of its way. In mahogany there is somewhat increased consumption, but values do not seem to be stimulated even by the demand.

### An Analysis of Lumber Product by the Tree.

The Forest Service has issued a bulletin covering the result of an analysis that has been made by one of its assistant foresters to determine the average amount of lumber and the grade obtained from varying sizes and lengths of poplar timber in two different sections of growth.

An excuse for this bulletin may be found in the introduction, which says that a definite need of the lumber manufacturer today is exact and detailed information concerning the quality of the product which his trees yield. It states that every sawmill produces a large amount of lumber of inferior grades which is difficult to sell, and which usually brings a price less than the average cost of production; that poor grades come in highest proportion from small trees; that as a tree increases in size the proportion of choice grades increases. It alleges that lumbermen plan to cut only trees which will yield enough good lumber to more than pay for the loss incurred in handling the poor grades. Because lumbermen have no precise knowledge as to the dividing line between profitable and unprofitable trees, and from lack of this information many are cutting a good deal of timber at an actual loss, these investigations were made and this paper produced.

The Forest Service has endeavored to determine, in typical localities and under good conditions of manufacture, the grade, yield and money value of poplar, yellow birch, sugar maple and beech. The pamphlet discloses the information that the character of timber changes in different localities and in different situations within the same locality. It also discovers that the necessity for inspecting



lumber while green interferes somewhat with the accuracy of the results, and that some boards, especially yellow poplar saps, present an entirely different appearance when seasoned than when green. The document alleges that drying often sweats out stains which in green boards appear as defects, and sometimes drying exposes hidden knots, or, if improperly done, causes stains.

Undeniably there is a great deal of work being done by the Forest Service which is of manifest advantage to those interested in forestry, timber and lumbering, and the deductions given to the public are valuable. Unfortunately, in the case of the bulletin in question, the information imparted is not particularly new to even a tyro in the lumber business, and it seems to have nothing whatever to do with the subject of forestry, with which the Forest Service is supposed to deal.

There can be no tape rule system devised that will guarantee to a lumberman whether a certain tree in the forest will prove profitable to cut or not. Judgment, based on experience, will tell a lumberman of even ordinary intelligence that it is economy to leave certain timber in the woods, and to fell other trees.

The forest assistant suggests some improvements in logging methods, stating that a woods superintendent who can judge accurately from the appearance of a log what kind of wood it contains inside, is in a position to save his employer a great deal of money. He can do this largely by a better arrangement of his log lengths; too many fourteen and sixteen foot lengths come to the mill which are clear at the ends but have a bad defect in the middle, and much of the lumber from these logs is reduced in grade because of the single defect. He says a tree may be damaged twenty-five per cent by such methods, and that the defective part should be put into a short log, say eight feet long, and if the defect is bad and extends throughout the log, the piece should be cut out and left in the woods. He argues against the sending of crooked logs to the mill and advises that the crooked piece should be either cut out and left or sent as a short log. He insists that hollow butt logs also entail a loss, and that swollen, hollow or wormy butts should either be left in the woods or be brought in as short logs. He alleges that the price of milling depends to a considerable extent upon the sawyer, the edgerman and the trimmerman.

There is more "information" of the same kind contained in this pamphlet, which will be rich reading for any lumberman of experience, whether or not he agrees with the tenets laid down by the young man who conducted the experiments and made the deductions.

Perhaps there is one bit of information in the pamphlet that may be of conjectural interest to the lumber trade, and that is that, based on a six months' study, the young man discovered that the average price received for poplar lumber at the mill where he made his experiments was \$24.66 per thousand, which price corresponds within a few cents to the value per thousand feet of the lumber contained in an average thirty-six inch poplar tree.

One other deduction which the author makes may be interesting to the seller of poplar stumpage, and that is that while a thirteen-inch poplar tree is worth only \$1.10, a seventy-inch poplar is worth \$237.21. This information will lead all prospective purchasers of poplar stumpage in the future to seek poplar growth in which the trees are at least seventy inches in diameter!

### New Hardwood Lumber Association.

A few days ago there was launched at Ottawa Beach the Michigan Hardwood Manufacturers' Association. This project has long been contemplated by many of the leading hardwood producers of that state, as a movement well worth their attention and cooperation. As stated in the new association's constitution its objects are to secure a full understanding of the conditions surrounding the hardwood lumber markets in the territory it covers; the establishment of uniform grades for the inspection of lumber; the establishment of uniform customs and usages among manufacturers of hardwoods; the procuring and furnishing to its members of information which may protect them against the unbusinesslike methods of some of those with whom they deal, and the gathering and disseminating of statistics covering stocks of lumber on hand and prospective output.

The Michigan Hardwood Manufacturers' Association is started

with the approval and with the assurance of the cooperation of lumbermen controlling more than seventy-five per cent of the hardwood production of the state. Holding the position of officers and directors are the leading hardwood producers of Michigan, who are men of character and wealth, and whose reputations for doing business in an honest and straightforward way extends far beyond the boundaries of their commonwealth. The association has its inception under perhaps more favorable auspices than those surrounding the establishment of any other lumber association hitherto formed, and its success in this much-needed line of endeavor, looking primarily to uniform inspection and business methods, is assured.

The features that contributed materially to the pleasure of organizing this association was the location of the meeting—Hotel Ottawa, Ottawa Beach, Mich., which proved to be an ideal spot for the purpose, and the presence of several gentlemen allied with both the national hardwood associations, who contributed their advice, based on long experience in association work. A full account of the proceedings will be found in this issue of the HARDWOOD RECORD.

### Rivals in Furniture Manufacturing.

It is universally conceded that Chicago is one of the greatest hardwood consuming markets in the country. And among the various consuming interests furniture manufacture holds a conspicuous place. Grand Rapids is widely known as the "Furniture City," but had not the manufacturing interests of the "Windy City" been so varied and numerous and had there not been so many of perhaps more importance than furniture making, Chicago might have won that appellation. The following table, giving comparative figures for the furniture industry of Chicago and Grand Rapids for 1904, will bear out these statements:

	Chicago, 1904.	Grand Rapids, 1904.
Factories	153	38
Capitalization	\$13,588,155	\$8,004,713
Clerical force	866	397
Salaries	\$1,026,055	\$558,219
Wage earners	9,612	6,654
Wages	\$5,328,896	\$3,239,748
Value of product	\$17,488,257	\$9,109,097

These figures were taken from an advance bulletin prepared by the Census Bureau of the Department of Commerce and Labor, and are the first of authenticity since the census report of 1900. Elsewhere the bulletin states that the total output of all the factories in the state of Michigan was \$18,421,735 in 1904; Chicago factories during that year turned out \$17,488,257 worth of furniture—the entire state of Michigan exceeding Chicago by only \$933,478. Chicago has perhaps shown a greater advance in furniture manufacture from 1900 to 1904, when the number of its factories was increased by 39 and the total value of the product increased by \$5,143,747, than any other city in the country. During that time Michigan added to its list ten factories and increased its total output by approximately \$4,000,000.

Plans are under way for the erection of another building at Chicago for the exhibition of furniture. It is to be 71x171 feet in dimensions, eight stories high and to cost about \$150,000. Chicago surely stands foremost as a market for the high-class hardwoods used in the manufacture of furniture.

### Railroad Earnings.

Although official figures showing the earnings of railroads of the United States will not be available for some time to come, the preliminary report of the Interstate Commerce Commission would indicate that there will be a gain of 10 per cent over the last fiscal year, which ended June 30, 1905, when their gross receipts were \$2,073,000,000. Estimating from monthly increases this prophecy will doubtless be fulfilled and the present season will thus prove a banner one for the railroads of this country, which cover approximately 219,000 miles. Every section and community has profited by the excellent conditions which have prevailed during the past year, and money has been liberally spent in improvements of all kinds; expenditures for bettering the roads themselves and the service have been heavy, but their net earnings have been exceedingly large.

# Pert, Pertinent and Impertinent.

## A Hot Weather Wish.

Oh, to be a turtle,  
A slow, lethargic turtle,  
With nothing in the world to do,  
But crawl around the whole day through,  
To lie upon a mossy log,  
And idly gossip with a frog;  
To wallow in the marshy pool,  
Amid the reeds and rushes cool,  
And to know, no matter what befell,  
I could but crawl within my shell  
And let the whole world go to hell!  
Oh! To be a Turtle.

GOLDEN RULE SAM JONES



## The Woodcock.

The woodcock haunts the bosky dell  
He is a modest sinner,  
His name the menu cards will tell  
At a "real stylish" dinner,  
He does not shun the hunter's aim  
But rises in the air,  
Although he knows they will make game  
Of him on bills of fare.

WALTER KING STONE



## An Opportunity for Omar.

A book of verse, a jug of wine,  
Beside him in the wilderness,  
The Persian poet in rhythmic line  
Proclaimed of old their blessedness,  
But could he know my mountain lake  
And with its joys find sweet commune,  
His soulful lyre again he'd take  
And sound their praise to statelier tune  
The pirate pick'rel's fearsome dash,  
The bass-line's cheery swish and chug,  
The straggling trout in rainbow flash  
Are dearer far than Omar's jug

W. H. RICHARDSON.

## Companions.

When riches come  
in at the window  
friends flock in at  
the door.

## Wise.

It's the wise travel-  
ing man who knows  
when and where to  
stop.

## Success.

Some people seem  
to think that nothing  
succeeds like a  
successful failure.

## Ever Wanting.

The beautiful  
things are the things  
that do not concern  
us.

## Magnanimity.

If you chance to  
live on easy street  
don't think less of  
those who live some  
distance away.

## All Fail.

The man who can't  
meet failure sensibly  
had better give up  
the fight.

## Sports.

Many a so-called  
sport can't sport  
himself.

## Surely.

The more money  
a man has in the  
bank the more inter-  
est he takes in life.

## A Fact.

The more we rest  
the more we rust.

## AT THIS TIME OF YEAR.



**Hardwood Lumberman: The lumber business? Don't ask me about the lumber business! Can't you see I'm busy?**

## Protection.

People who make  
promise of big things  
invariably insert a  
little "it."

## Little Used Standard.

All that glitters is  
not gold, nor can it  
be measured by the  
golden rule.

## True.

A man who bor-  
rows trouble gives up  
his peace of mind as  
collateral.

## One Advantage.

The man at the  
bottom possesses one  
advantage over the  
one at the top—he  
doesn't have so far  
to fall.

## Often Disappointed.

In life as in busi-  
ness too many people  
expect to get some-  
thing out of it with-  
out putting anything  
into it.

## Experience.

Ability comes with  
experience; ability  
without experience  
is of no more worth  
than experience with-  
out ability.

## Compensation.

As a rule worthless  
people have the best  
dispositions.

## Money.

Money makes the  
world go — wrong,  
very often.

## Good Plan.

The suspicious man keeps one eye on his  
neighbor, but the wise man keeps both eyes  
on himself.

## Genius.

Genius is a rare metal, but it needs the  
alloy work to give it strength and useful-  
ness.

## Very Often.

It often happens that a man puts his foot  
in it while endeavoring to put his best foot  
forward.

## One Good Brand.

There is grafting in every business and in  
every walk in life, but the only honest  
grafting has to do with trees.

## Greedy.

As Mark Twain says, Give some men a  
constellation and they will want the Milky  
Way.

## Good Way.

You can please a great many people by  
asking their advice, and please yourself  
about taking it.

## Tree Growth and the Physics of Wood.

### Composition and Functions of Bark and Cambium.

A dissection and analysis of the body of an exogenous tree discloses intricate and varied parts, each performing a distinct function, and each having an important work to do toward the construction and perfection of the whole.

First comes the outer covering or bark, which cloaks the tree completely from tip of smallest root to end of topmost twig. The body being thus protected by an impervious sheath, evaporation which would endanger the life of the delicate layer below the bark is checked. Bark is always of great aid in identifying trees, and often presents the most or even the only decisive feature. At the base of the trunk the bark is frequently quite different from that which is found on the upper portion. In birch, for instance, it is usually smooth and even above, but rough and coarse at the

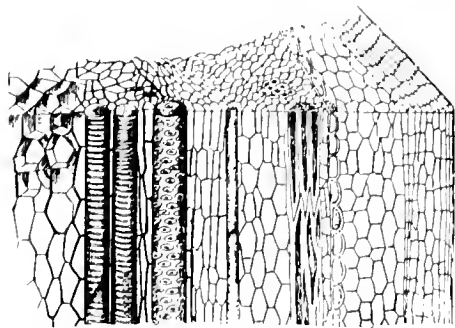

STRUCTURE OF EXOGENOUS TRUNK

bottom. The bark is wrinkled, corky and fissured, as applied to it are self-explanatory; but the small pores or breathing spaces are not so well known to the casual observer, and to them the botanical term lenticels is applied. Their function is to admit air to the cambium layer. Birch also presents a good illustration of this feature, the lenticels being exceedingly conspicuous and forming the centers of long stripes which increase in length as the tree becomes greater in diameter. These lenticels are not distinct canals or holes, susceptible to clogging with dust or foreign particles, but consist of porous tissue that filters the air as it is taken into the cambium layer. The twigs of many trees shed their smooth outer covering or epidermis as their heavier bark begins to form and gradually becomes thick and fissured. Although this process does not completely obliterate the lenticels, it tends to make them obscure. Some trees, notably cherry, retain their glossy, gossamerlike cloak on large branches, and even on their trunks patches of it may often be seen, where the tiny air passages appear as horizontal slits, parallel to one another, sometimes open, but more often filled with the characteristic, cork-like tissue.

The outer bark is composed of soft cel-

lular tissue. Early in the life of the tree this covering forms, and it is in substance the same as our ordinary cork. In its green or lining layer the cells are close and delicate and contain a green pigment similar to that found in the leaves. The bast or liber comes next to it, and is commonly known as the inner bark. In it the cells are closer and finer than in the wood proper; they are long, slender and tough, appearing more like fibers, and imparting strength to the tissue. In the outer or true bark, as commonly understood, the green lining grows very little after the first year; and the corky layer does not long continue to increase itself, but becomes dormant. Its exposure to storm and damage from other outside sources tends to thicken it, and the more rapid growth beneath strains it and causes it to spread and split, often forming great rifts. These fissures are patched by new corky layers, which in turn are subjected to the same strain. Thus the outer and older portions are continually decaying and falling away.

The liber or inner bark, as well as the wood, makes an annual growth, but toward the inside rather than outward. These two parts of the stem are the only ones which form a new yearly addition. Between the liber and the wood itself is the delicate cambium layer, composed of young and tender life cells, billions in number, which forms a continuous undergarment or separating membrane, clothing the entire tree, between the wood and bark of every twig and root, as well as of the trunk and larger branches.

When spring comes the rich mucilaginous sap circulates freely and supplies the cambium with renewed vigor so that its cells begin to increase, the outer ones attaching themselves to and partaking of the nature of the liber or under bark, while the inner become identified with the wood rings. Thus it is that year by year the life of the stem is renewed.

The idea that winter weather drives the sap entirely out of a tree is not now in accord with the theories held by the best authorities. Undoubtedly there is a specific period (winter) for rest, and during that time trees do not grow, in either the southern or northern states. All during this stated time there is considerably less moisture in the living wood and bark—due to alterations in the nature of the cell contents at the termination of the season's growth—than at any other period of the year. Although no comparative deductions have been made of the contents in moisture of northern and southern woods of the same variety, there is nothing to bear out the contention that there is a great difference between the amount contained in a tree cut in the far south during winter, and a tree of comparable variety, age and density

which has been felled in winter in the extreme north.

The nourishment flowing freely throughout the cambium cells bears starch and oxygen. Thus the cell is fed and given the power to divide and subdivide, which process goes on at a rapid rate during the growing season. In the course of this life process the cells are not formed in hit-or-miss fashion, but arise in "rhythmic succession" or in uniform groups. Often this regularity cannot be traced because of their abundance. A single cell divides into two smaller ones, which soon become as large and as prolific as the parent cell, being restricted only by a diminishing supply of food and oxygen.

After a season's growth, the cambium layer proper still remains a membrane of the last-formed, most fertile cells, while its margins are a mass of cells whose walls have become dense, and whose protoplasm is dormant, belonging on the one side to the

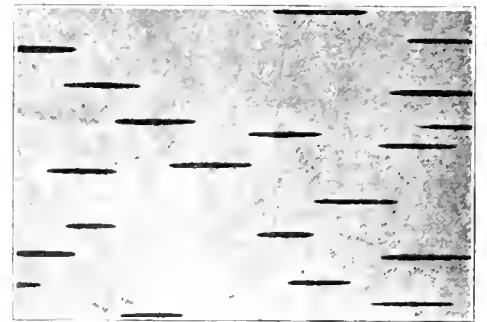

BARK OF BIRCH SHOWING LENTICELS.

East or liber, and on the other to the new wood tissue, as explained above.

Thus a cell which once belonged in the heart of the cambium layer, and contained the active life principle, becomes a hollow wood fiber—a part of the sapwood—through which the secretion ascends to the twigs and leaves. Gradually starchy and mineral deposits form within it, it becomes compact and no longer permits the sap to flow freely through it, but forces it to seek other and newer channels. Finally it grows hard and dark colored; many layers of annual growth interpose between it and the new formations, until at last it finds itself a part of the core or heartwood of the tree; while its fellow pores, originating at the same time and from the same source, have many of them been crowded in the opposite direction, and have long since lost their vitality and moisture by contact with the outer air, or have disappeared entirely from the surface of the tree.

One of the illustrations accompanying this article shows the structure of a trunk, and from right to left displays the epidermis, corky layer, green lining, vessels, hard bast cells, soft bast cells, sieve tubes, cambium layer, dotted ducts, wood, medullary sheath and central pith.





**THE TOTE BOY**

Drawing by T. J. Nicholl from photo by Henry H. Gibson.

A DRAMATIC WOODS STORY

.....BY.....

Idah McGlone Gibson

## WHEN SORREL-TOP MADE GOOD

SUPPLEMENT DRAWING

.....BY.....

Thomas J. Nicholl

"Who's the strange kid out there, Barney?"

"Don't know, I'm sure," answered the cook, as he deftly pulled the big pan of light bread out of the oven. "He's been hanging 'round all day. Never saw him before—must be from over the other side of the ridge."

Just then the boy outside seemed to take a sudden resolution, evidenced by the straightening up of the shambling figure. That it was not easy for him to do the thing he intended was made clear by the furtive look he cast toward the cook shanty, as he pulled off his old slouch hat and nervously wiped his forehead with the sleeve of his ragged coat.

The sun was just passing below the mountain top and its last rays played about the head of the lad, and turned its thatch to burnished gold. Every hair seemed to fairly leap out of the lengthening shadows and he stood with his face encircled in a nimbus of startling brilliancy.

"I'll be damned if he ain't a red-head," chuckled Jim, the boss. "It's a fox cross out to a buck saw that he didn't come by that hair honestly. His daddy never came from 'over the ridge'. No one in these mountains ever sported red hair and had a 'sager' for a father."

Big Jim stepped through the low door of the shack and, in a cheerful tone that might have been heard a mile, inquired, "Hello, Sorrel-top, what do you want?"

The boy put his hat on his head quickly and pulled it down over the offending hair while a surge of color rushed over his freckled face.

"Yo ah the boss, I reckon?" The sentence was made a question by its rising inflection, and the lad's nervously hopeful attitude.

"That's what they call me at Camp Six, kid."

"Kin I see yuh foh a minute, suh? I've come foh yuh to teek me on."

"So you want a job, hey?" said the woods boss with a smile. "Don't you know you're not heavy enough to fell timber or load logs? Why, kid, that's a man's work," and the autocrat of Camp Six unconsciously drew himself up to his full six-feet-three and filled out his brawny chest, making the boy beside him look smaller and thinner than ever.

"Can't yuh jus' fin' somethin' I kin do? I'm pow'ful willin'. Maw says I'm more 'count than most boys, ca'se I'm adhus willin'."

"But you oughtn't to be workin' yet, my lad. Where's your father? Tell him to come over and I'll give him a job, and you stay 'round the house and help your ma."

"I hain't got no paw, suh," answered the

boy, and again the surge of red went over his face. "Yuh see maw, she needs meat and steam-jeans and coffee pow'ful bad, and I reckon I must done get hit foh her. So I aim to get work or leave yere, one."

Big Jim looked with a new interest into the youthful face that was set with determination to get "jeans and coffee for maw," as he said, "You come in and get some grub anyway, and I guess I'll find something for you to do in the morning."

The boy followed the big Irishman into the cook house and then and there "Sorrel-top" became one of the outfit of Camp Six.

The next morning he was made the "woods Jimmy" and at noon he started up the cove with the men's victuals. As he came along the path beside the logging road it seemed as though the lad's face had changed in the night. Even in the noonday sun much of the indecision of the mountain type had gone from it. His brows had straightened across his forehead and his chin looked as though it had squared a bit. His shoulders did not bend forward, instead they easily bore the burden of food which the half barrel strapped to his back contained. His arms stretched down with the weight of the well-filled buckets of beans and potatoes, but his head was up and his old slouch hat was pushed back on his red hair. His whole attitude spoke of added self-respect.

"There is that kid now," said one of the men who were sitting about waiting for their dinner. "Do you know him, Dave? He allows he came from over the ridge, but a red-headed sager beats my time!"

The lank form of the man addressed raised from where it had been stretched at full length on the ground, and he shaded his eyes as he looked at the lad coming so confidently towards them. Then he spat with deliberate aim and forever sullied the beautiful white blossom of the wild cucumber at a little distance from him, before he answered, "Yes, I know him; he's Mary Ellen's young'un. His paw was a red-headed Irishman what got mixed up in a feud. She's been mightly uppish ever since, and keeps to herself, but if Jim's named the young'un Sorrel-top hit's a good thing, foh he hain't got no name what belongs to him."

The tote-boy was near enough to hear the last words, and he dropped his load with a thud. "Now, yuh Dave Lumley, look-a-heah! Don't yuh say a word about my maw! If you do I'll fight yuh," and then his voice cracked with youth and rage as he burst into tears.

"My, but yuh're a o'nery cuss," answered the man with a sneer. "I don't fuss with weepin' young'uns. I don't mean nothin' about yuh maw no how, 'cept what every-

body knows. Wait till yuh kin make good 'fore yuh git to fussin'."

The boy started for the man blindly, but was caught in the arms of Big Jim.

"See here, Lumley, if ever I hear another damned word of this again, I'll beat hell out of your rotten hide. Get this grub into you quick and go to work, all of you; we've got to get a train loaded before supper. Here, kid, I've broke my axe helve; see if you can fix it."

"I don't min' yuh callin' me Sorrel-top, Mr. Johnson," said the boy. "Yuh see, suh, hit's all so. My daddy was red-headed—and he was Irish—and he was killed 'fore the preacher-man got 'round to marry him to my maw. And my maw she had to bring me up. She's glad I'm a boy, though, foh she says as how this county is all right foh men, but hit's hell for a woman who's man gets killed 'fore the preacher-man comes 'round."

"Don't you mind 'em, sonny," said the boss. "You stick to me and I'll see you through."

"Yes, suh, I'll stick to yuh; I'll stick to yuh—ca'se yuh've been right good to me and my maw," said the boy earnestly. He drew nearer his friend, who placed his hand almost caressingly on the shock of red hair.

Big Jim's word was law in Camp Six, and there was no more rough joking of the boy about his peculiarly colored hair or his chivalrous love of his mother, and the Lumley incident was quite forgotten. Indeed, so ready was Sorrel-top with his help, and so wide his smile of good nature that everyone in camp came to have a sneaking fondness for him.

The woods work went on with its usual monotony, and the foreman was glorying in the fact that the outfit of Camp Six would turn in at the mill a bigger cut than any other crew on the job. Late in the fall he was working his men and equipment to the last ounce of energy. The timber was coming from the upper end of the cove, where the spur was laid on better than a ten percent grade. One afternoon when the great steam log loader was starting on the last car, the engineer of the Shay gave the whistle a little toot and yelled, "I'm going down for water."

"Get back in a hurry," called out the boss, "for there's a storm coming up. Now then you, Lumley, get a move on you and see that all the brakes are set, and 'scoteh' the front trucks; if these seven cars and that loader turn loose it means seven thousand cars of equipment gone to hell!"

The foreman was so busy finishing out his load that he did not notice that after blocking the wheels Lumley had forgotten all about the brakes.



The afternoon sunlight suddenly grew into twilight, and then strangely darkened into night. Great funnel-shaped clouds of deepening black literally tumbled over the ridge and settled down on the mountain side. There was a sighing sound among the tree-tops as though they knew what was coming and were pathetically begging the storm god to pass them by. The moans of the wind-tossed branches came faster and the swirling leaves almost hid the great log-loader from the forward car. Swifter came the rush of the monstrous mass of black that obscured the heavens. At its violence the grandest trees in the forest bowed in humiliation. Suddenly the whole side of the mountain was lighted with a sheet of pinkish orange that faded into cold gray, and blotted itself out with a rumble of discontent at its futile battle with the gathering darkness. Lower and lower bent the trees. Then pandemonium broke loose. Cries that were almost human rang through the woods and down the mountain. The forest answered the wind with a defiant roar as it marshalled all its armament against its foe. Angriily the clouds opened and a thousand brilliant forked tongues gave utterance to a thunderous roll which died away only to begin again. The sound of falling limbs and the crash of giant trees accented the deepening and insistent cry of the forest, as the wind lashed it into greater fury. Now the whole landscape seemed a sheet of flame-lit, swaying limbs and the echoes of the thunder reverberated from mountain top to mountain top. Then the rush of low-hanging clouds shut out everything but the agonizing sound of wind-torn trees. The great log-loaded train swayed and trembled, and the intermittent glare of lightning showed Jim frantically trying to make himself heard above the awful din.

In the moment's hush that preceded the rain he shouted, "Two of you at every brake and hold her!"

There was another and more blinding flash whose bolt struck a huge tree near the track.

"Hold her, boys, the blocking's slipped," yelled Big Jim, not knowing that with the exception of Sorrel-top and himself, every man had jumped from the train when it started.

"My God, she's turned loose," he said to the boy who stood beside him. For a moment the seven log-loaded cars with the great loader behind seemed to pause as though getting ready to spring, and then plunged to a race of destruction.

"Damn their rotten souls," said the Irishman, as another flash of lightning told him he and Sorrel-top were alone on the train.

"You'd better jump, kid," he shouted, close to the boy's ear.

"Ain't you'uns goin' to stick?" asked the boy.

Jim looked death in the face and nodded. "Then I stick," said the boy, vainly tugging at a brake.

They were nearing the bottom now and the speed was so terrific that the earth seemed dropping from beneath them.

Jim caught sight of the lights of the returning engine and saw the engineer jump—then the crash came. The sky rained saw logs and bits of steel—and he knew no more.

When he regained consciousness water was rushing over him where he was pinioned beneath a log, and he heard Sorrel-top sobbing and saying, "I'll move it, Mr. Johnson, I'll make good if I do have to beller."

The train had telescoped and landed in the creek at the foot of the cove. The rain was quickly making the stream a raging torrent. Jim tried to move but found it impossible. The boy tugged at the log with a cant-hook, which had fallen from the train, and with almost superhuman effort raised it enough to release the foreman. As the log turned over the oncoming rush of waters hurled boy, log and cant-hook into the swirling debris of mid-stream. Jim crawled slowly out and looked about for Sorrel-top. Like a wild man he peered among the

piled-up logs that the water was fast converting into a jam. Just as the men came dashing down from the spur he discovered a hand sticking out from under a pile of drift.

"Come on, you infernal cowards," he shouted, "and help me get the only man worth a damn in the whole camp out of this! Don't one of you hold back or I'll brain ye," he yelled and picked up a rock as they hesitated.

The boy was taken from out the awful pile and laid on the bank. He breathed faintly and big Jim unaffectedly knelt beside him and wept. It seemed to call the boy back from the great beyond. He opened his eyes and looking up into the boss' face whispered, "Have I made good, Mr. Johnson?"

Big Jim nodded. Then the boy's eyes wandered about the group of men until they rested on Lamley and he said, "Tomorrow, Dave Lamley, I'll fight—"

The effort was too much and the eyes closed, but the lips froze into a determined smile that even death could not obliterate.

## Hardwood Record Mail Bag.

[In this department it is proposed to reply to such inquiries as reach this office from the HARDWOOD RECORD clientele as will be of enough general interest to warrant publication. Every patron of the paper is invited to use this department to the fullest extent, and an attempt will be made to answer queries pertaining to all matters of interest to the hardwood trade, in a succinct and intelligent manner.]

### Wants Car Oak.

PITTSBURG, PA., July 18.—Editor HARDWOOD RECORD: We are anxious to get in touch with a dozen or so reliable mills that can produce oak bill stuff such as freight car oak and dimension sizes in 6X6, 8X8, 10X10, etc., who are equipped to surface this stock on four sides.

—LEMBER COMPANY.

The HARDWOOD RECORD will be glad to supply the addresses of any of its clients to the corporation making this inquiry, if they are forwarded to this office.—EDITOR.

### Best Thicknesses in Beech.

CLEVELAND, OHIO, July 10.—Editor HARDWOOD RECORD: We have quite a quantity of beech timber at one of our West Virginia mills. Will you kindly advise us what you think is the best thickness into which to manufacture this stock and where the best demand for beech lies?

—COMPANY.

From a casual knowledge of this subject, it has been recommended to the correspondent to cut his beech largely to 1½", 5" and 1". The demand for beech lies quite largely with the furniture trade.—EDITOR.

### Echo from Pittsburg Fuel Company.

BUCKHANNON, W. VA., July 10.—Editor HARDWOOD RECORD: Should you know anything more about the Pittsburg Fuel Company, we would be glad to hear from you personally or through the columns of your paper. We have a note against these people which became due and was protested for non-payment. We have not been able up to date to locate any of the parties interested in the firm in order to attempt to make a collection.

—COMPANY.

The loss sustained by the Buckhannon correspondents is to be regretted, but their chances of "getting even" with this bunch are very remote. They never have been known to pay a note. The RECORD supposed that it

gave the trade warning in time to secure lumbermen from being robbed by these fakers.—EDITOR.

### Wants White Oak, Ash and Hickory.

NEW YORK, July 9.—Editor HARDWOOD RECORD: I am in the market for firsts and seconds white oak and ash 1 to 4 inches in thickness, 10 inches and up wide, and 12 to 20 feet long; hickory, 9 to 12 inches and up of same dimensions. I expect this stock will have to be sawed to order and should be pleased to have you put me in communication with mills that can supply any of the material.

The HARDWOOD RECORD will be glad to put any of its clients in communication with this correspondent on application.—EDITOR.

### About Black Walnut.

BINGHAMTON, N. Y., July 18.—Editor HARDWOOD RECORD: Should like to have information about black walnut and the demand and approximate price of the wood. JONES OF BINGHAMTON.

Black walnut is produced in this country at an annual rate of about 33,000,000 feet. The larger portion of it now comes from southwestern Missouri, Arkansas, Oklahoma and Indian Territory, although there is some scattering growth still picked up in Indiana, Ohio, Tennessee and West Virginia. The most considerable stand of the wood remaining east of the Mississippi is on the upper waters of the Guyandotte river in West Virginia, where C. Crane & Co. of Cincinnati own about 20,000 trees. The home demand for black walnut lumber is only for comparatively small quantities. Its use is largely confined to gun stocks, novelties, electrical work, etc. The chief demand for walnut comes from Germany and Hamburg is the commercial center of the market. The larger portion of the choice logs are faced on four sides and shipped to this market in that form. Specific prices cannot be supplied, because black walnut varies much in quality. The general range is from \$125 to \$150 for firsts and seconds, and about \$75 for rejects, and \$30 to \$50 for shipping culls.—EDITOR.

# Michigan Hardwood Manufacturers' Association.

On Friday and Saturday, July 13 and 14, there was launched at Ottawa Beach, Mich., an association of the hardwood manufacturers of the state of Michigan, under most favorable auspices. The conference that led up to this organization has been projected for several years by leading hardwood operators of the state, and the meeting was based on the following call, sent out July 2 by the *HARDWOOD RECORD* at the request of a number of the foremost producers of the state:

### The Call.

You are cordially invited to attend a conference of hardwood manufacturers of the state of Michigan at the Hotel Ottawa, Ottawa Beach, Mich., on Friday and Saturday, July 13 and 14. The first session will be held at 10:30 a. m. This meeting is called for the following purposes:

1. To promote better acquaintance among hardwood lumber manufacturers of the state.
2. To analyze the conditions of stocks, grading and values of northern hardwoods.
3. To organize, if deemed expedient, either an independent hardwood manufacturers' association of the state of Michigan, or a division of some existing hardwood manufacturers' association, for the purpose of agreeing on uniform methods; for the exploitation of Michigan hardwoods, thus broadening the demand therefor; and to attempt to achieve prices common-

- BACHELOR TIMBER COMPANY, Saginaw, Mich.
- SPEARNS SALT & LUMBER COMPANY, Ludington, Mich.
- G. VON PLATEN, Boyne City, Mich.
- HACKLEY PHILIPS BONSELL COMPANY, Grand Rapids, Mich.

### FRIDAY'S SESSION.

In response to this invitation the following named gentlemen gathered at the Hotel Ottawa, Ottawa Beach, Mich., on Friday, July 13:

- Henry Falbon, Cobbs & Mitchell, Inc., Cadillac.
- C. S. Bacon, Bacon Lumber Company, Grand Rapids.
- R. J. Clark, Peninsula Bark & Lumber Company, South St., Marie.
- W. T. Christine, American Lumberman, Chicago.
- C. Crane, C. Crane & Co., Cincinnati, O.
- H. C. Crawford, Russel Wheel & Foundry Co., Detroit.
- J. E. Delebaugh, American Lumberman, Chicago.
- Lewis Foster, secretary Hardwood Manufacturers' Association, Chicago.
- Geo. B. Duntun, Thos. MacBride Lumber Company, Grand Rapids.
- T. S. Estabrook, Estabrook-Skeele Lumber Company, Chicago.
- F. H. Freeman, Engadine Lumber Company, Engadine.
- Edw. Fitzgerald, Mitchell Brothers Company, Cadillac.
- Theodore Fathauer, Theodore Fathauer Company, Chicago.
- Frank F. Fish, secretary National Hardwood Lumber Association, Chicago.
- M. J. Fox, G. Von Platen, Boyne City.
- Wm. F. Gustine, A. E. Anderson, Cadillac.
- Henry H. Gibson, *HARDWOOD RECORD*, Chicago.
- A. E. Gordon, *HARDWOOD RECORD*, Chicago.
- W. H. Grebb, Three States Lumber Company, Memphis, Tenn.
- Henry S. Idema, Grand Rapids.
- E. A. Johnson, American Lumberman, Chicago.
- S. G. McClellan, Simmons Lumber Company, Simmons.
- W. W. Mitchell, Mitchell Bros. Co. and Cobbs & Mitchell, Inc., Cadillac.
- W. L. Martin, Embury-Martin Lumber Company, Cheboygan.
- Francis Marshall, Bacon Lumber Company, Grand Rapids.
- H. W. Newark, Cadillac Handle Company, Cadillac.
- Bruce Odell, Cummer, Diggins & Company, Cadillac.
- H. R. Reynolds, The Gillespie Reynolds Company, Chicago.
- W. H. Russe, Russe & Furgess, Memphis, Tenn.
- Carroll F. Sweet, Fuller & Rice Lumber & Manufacturing Company, Grand Rapids.
- R. H. Vansant, Vansant, Kitchen & Co., Ashland, Ky.
- Wm. H. White, W. H. White Company, Boyne City.
- Chas. Wescott, International Harvester Company, Chicago.
- John S. Weidman, Weidman.

Agreeable to previous arrangement, William H. White of Boyne City acted as chairman, and Henry H. Gibson of Chicago as secretary. Mr. White addressed those present as follows:

Gentlemen and Brother Lumbermen: It is not necessary for me to say what we are here today for. In the circular which has been sent you, the *HARDWOOD RECORD* and the American Lumberman have given the matter sufficient publicity. I will read a letter written to myself:

Gentlemen of the Convention: This is quite a surprise to me and yet it is a long-looked-for desire that has been fulfilled.

I have talked over this matter with several of our manufacturers and also with some of the members of the Hardwood Manufacturers' Association of the United States, but we have always been pushing it a year away, saying that we would then get together and have an organization of the manufacturers of Michigan, to make rules for the grading of lumber, also to discuss the true methods of manufacture and to ascertain the thickness that each manufacturer should cut to fill the demands of the market, also to keep their supply barely equal to the demand of the market so as to stimulate prices and put a just value on our product.

We should also have uniform inspection, and I believe, gentlemen, that the best side of lumber should be considered when inspecting it as well as the poor side, and the decision be made between the best side and the poor side, for, as I understand it, ninety per cent of all hardwood lumber is worked from the best side, that is, the best side will show the finish and the poor side be blank, or in other words, not show any finish. Therefore, our manufacturers ought to get to-

gether, work out and formulate a plan that would be to the best interests of the manufacturers and stumpage holders of our state, bearing in mind that no radical changes be made that would attempt to work hardship on the dealer or consumer.

The manufacturer or mill man thinks he is selling his lumber at a fair price, but if he will stop to figure up he is simply selling his stumpage and getting nothing for his investments in plants, risk of marketing, not for the hard work he has to put into manufacture and working out the details in order to put the stock on the market. When I say this I mean maple and beech, which kinds of lumber predominate in our state today, especially in certain localities. The market price for maple today, 4 4 and 5 4 in thickness, is \$9.00 for No. 3 common, \$11.00 for No. 2 common, \$17.00 for No. 1 common and \$23.00 for firsts and seconds.

Taking a thousand feet of lumber as follows:

30% No. 3 common	8 9.00	\$2.70
16% No. 2 common	11.00	1.76
34% No. 1 common	17.00	5.78
20% firsts and seconds	23.00	4.60

makes a total of 100 per cent, or the full product of the log at \$14.84 per M for No. 3 common and better, and the manufacturer, without stopping to figure, will think he is getting \$18.00 or \$19.00 per M for his log run, according to the grade of logs he is cutting into lumber, but when you figure that you only get 70% of No. 2 common and better out of the log and 30% No. 2 common, you get the following result: Take 70% at \$19.00 and 30% at \$9.00 and it will give you the price you receive per M for your maple, namely, \$16.00; or you can



WM. H. WHITE, BOYNE CITY, PRESIDENT MICHIGAN HARDWOOD MFRS. ASSN.



W. W. MITCHELL, CADILLAC, FIRST V. P. MICHIGAN HARDWOOD MFRS. ASSN.

surate with existing stumpage values and manufacturing cost.

There will be present at this meeting several hardwood lumbermen from other sections of the country, prominent in association work, who have achieved great success for the industry through the channels of organization, who will address those present.

It is the belief of those subscribing to this call that this meeting will result in great advantage to you as individuals, as well as to the hardwood industry of the state.

We trust you will not only be present yourselves, but will induce hardwood manufacturers of your vicinity to join in this movement.

Very truly yours,

- W. H. WHITE COMPANY, Boyne City, Mich.
- COBBS & MITCHELL, Inc., Cadillac, Mich.
- SALLING, HANSON & Co., Grayling, Mich.
- F. STEPHENSON COMPANY, Wells, Mich.
- MITCHELL BROTHERS COMPANY, Cadillac, Mich.
- R. G. PETERS SALT & LUMBER COMPANY, East Lake, Mich.
- KNEELAND-BIGELOW COMPANY, Bay City, Mich.
- BUTTERS SALT & LUMBER COMPANY, Ludington, Mich.
- H. M. LOUD'S SONS COMPANY, Au Sable, Mich.
- CUMMER, DIGGINS & Co., Cadillac, Mich.
- SIMMONS LUMBER COMPANY, Simmons, Mich.
- EAST JORDAN LUMBER COMPANY, East Jordan, Mich.

figure your maple stumpage at \$4.00 per M, if you please (I have known some cases where it has sold for \$5.00, logging \$4.00, sawing \$3.00, freight \$1.75, interest and taxes \$1.00 and general expense \$1.00, making a total of \$14.75 per M cost).

Now, where is the use of taking the chances, risk, work and worry to manufacture the stock when you can sell your stumpage by simply offering it and have no worry, no trouble of details? So you can readily see that maple lumber is not bringing the price today that it should bring compared with other woods, and compared with what it is worth according to the value of the material. Further, we are cutting our lumber too thick. Hemlock and pine is cut 15 16 for inch, 17, for 2 inch, Maple is cut 1 1 16 for inch, and 2 1/2, for 2 inch, and I see no good reason why maple should be cut any thicker than other woods if the trade were educated up to it.

Maple flooring today is worked to 13 14, 8 x you see lumber cut 15 16 would dry and dress to this thickness without any trouble.

Beech lumber is suffering still more, and I could make you a more startling statement on that than on maple. The only men making money out of handling lumber today is the dealer and commission man. The manufacturer is simply selling his stumpage.

We should establish an inspection bureau, make plans for a corps of inspectors and work,

out the whole plan in detail for our best interests. We must not expect to perfect this matter all at once, but as weeks and months go by after we have started, necessity will show us what is needed to develop our lumber interests and add the necessary details to perfect our organization.

I understand that the Hardwood Manufacturers' Association of the United States have been very successful in their plans, and I also understand they are willing to allow us to profit by their years of hard labor, expense and unflinching energy, and to turn over to us any of the knowledge that will help us, as manufacturers of the South should be helpful to the manufacturers of Michigan. It seems nearly impossible now to go single handed and accomplish the desired results which are expected from the lumber business, and which can be gotten if we work and pull together.

I am ready now to take hold of this matter and work with the manufacturers if we can outline a policy that will be beneficial and helpful to promote the welfare of the lumber industry of Michigan and brother manufacturers of the United States.

I would advise organizing a strictly Michigan association for the present until we get all the desired details worked out and see whether we want to affiliate with the Manufacturers' Association later on, and in the meantime work in harmony with them.

It does me good to see some of the members of the Hardwood Manufacturers' Association here today, with whom I have worked for some years. One man here is very well posted in their work, and will be able to tell you what the association has done for its members. I refer to R. H. Vansant of Ashland, Ky., who will please favor us with a talk.

#### R. H. Vansant Addresses Meeting.

Mr. Vansant: I am not accustomed to making public addresses, and I have made no preparation for this one. However, in 1902 the manufacturers of the South and Southwest found the condition of their business very deplorable. Hardly any two manufacturers did business in the same manner. Some of the manufacturers of poplar lumber early in the year 1902 called a meeting at Lexington, and there was organized a Poplar Manufacturers' Association. Some time later a further meeting was held at St. Louis and the Hardwood Manufacturers' Association of the United States was organized. This was and is strictly a manufacturers' association. No others are permitted to have membership in it. We do not mean that those who are not members are not legitimate dealers in lumber, but we have always thought that the progressive manufacturers, especially of Michigan, know best what the log will produce and what the consuming trade demands in the way of grades.

In the year 1902 we had 46 members, with 46 mills and an output of 200,000,000 feet; 1903, 100 members, 175 mills, 500,000,000 feet; 1904, 150 members, 250 mills, 950,000,000 feet; 1905, 175 members, 325 mills, 1,150,000,000 feet; Jan. 1, 1906, 210 members, 400 mills, 1,200,000,000 feet; July 1, 1906, 240 members, 450 mills, 1,350,000,000 feet.

I am getting these statistics from the secretary's report. There has been a steady increase in membership and production, and this year more rapidly than ever before. The basis and aims of the association are to give everyone a fair deal, and to educate the manufacturer who is not up to date. We have been much annoyed by what we call inexperienced or smaller mill men. In the Southwest there are a larger number of small mills than in any other section. Getting these men into line has incurred considerable expense. Today, however, our association is in a more flourishing condition than ever before. Our methods are familiar to some of you, and any details can be readily given by the secretary, who is present, and we invite you to go into our Chicago offices and see how the business is conducted, and see our list of membership, methods of disseminating information, etc.

We have found it absolutely necessary that one manufacturer assist the other manufacturer. We do not believe that any one man can start out and reach the highest point of excellence in the manufacture of lumber without assistance from outside parties. One man cannot study out all the details of a business; at least he will become an old man before he gets to that point of excellence.

Our association has proven very profitable to the manufacturers. We have done this by keeping the market price before all our manufacturers.

The secretary's office keeps in touch with the consuming trade and with the manufacturer. If there is too much of one thickness being manufactured, he tries to post our members so as not to have an over-production in any one item or thickness. We also have a method of reporting on grades, and a system which shows how those who buy lumber treat the shipper. This is reported only to members. For instance, all manufacturers are asked for a report on a certain buyer, and the reports that come in are

distributed back to all the members. A great many details regarding our methods it is impossible to go into.

We are very glad to meet with you and would be very glad to receive every one of you as members of our association. I feel that we could be of as much advantage to you as you would be to us. Our rules are formed by those who manufacture different classes of wood. We have not had any members who manufacture maple as yet, a wood which belongs exclusively to the North. When it comes to adopting rules on a certain wood, no one is entitled to have a voice except those who manufacture that wood. We do not think you as maple manufacturers would adopt a set of rules not suitable to cover requirements of the consumers. We have confidence that you would not take such a step as that. You would get together and discuss market conditions and your own views. The poplar men would have nothing to say about maple whatever. All the business of the country is studied very thoroughly through the secretary's office, as we will show you if you will come to Chicago.

I am glad to meet you gentlemen, and to tell you that the average increase in value of our lumber since our association was formed is about \$7.50 a thousand. Some kinds of lumber have advanced more than that, and of course this has been extremely advantageous to all manufacturers of hardwoods. We shall be very glad to meet you at any time, and if you unite with us, to hold our annual meetings in a section which will be convenient to you. But



BRUCE ODELL, CADILLAC, ACTING SECRETARY  
MICHIGAN HARDWOOD MFRS. ASSN.

whether you become affiliated with us or not, we are always glad to be with you as fellow lumbermen. You are most welcome to the benefit of our experience, and we heartily invite you to become members of the Hardwood Manufacturers' Association of the United States if your consideration deems fit. Gentlemen, I thank you.

Mr. White: We would be glad to hear from the secretary, Lewis Doster.

#### Lewis Doster Talks.

Mr. Doster: After Mr. Vansant's comprehensive talk I can hardly explain anything but the intricate parts of association work which I have studied very carefully in the last five years. We organized in 1902 and to forego the trouble which Mr. White brought out so plainly in his address that the principal work of an association in adopting systems is to study the conditions and operations of other successful associations. It became necessary on organizing to study the successful work of other associations, and looking over others resulted in our adopting the association system which prevailed among manufacturers of white and yellow pine. These people operated in white pine for twenty years successfully, and we found the yellow pine people had been adopting their rules and regulations with success and so we naturally adopted their methods. Since then the cypress association has been formed and has adopted similar system, and later some of the west coast manufacturers did the same. So our work is in line with other associations and adopted by every producing element. I had the honor to be under the tutelage of Mr. George K. Smith, secretary of the Yellow Pine and of the National Lumber Manufacturers' Association. After we formed our plans of association work,

it naturally became our aim to get on a firm basis: to have a full understanding that all manufacturers should consult with each other; to formulate rules for their protection; to procure full information; to carry on statistical work, and to promulgate other ideas that would be of benefit to every member of the association. After we formed these plans we got up to methods of grading. We discovered that the manufacturers who formed this association were intelligent; they had been sawing and marketing lumber for years, and they were perfectly familiar with what the trade wanted. The grading rules which we formed for southern hardwoods were adopted on the line of what the consuming market wanted. After making rules, which was a long and hard matter to accomplish, we published over 50,000 copies of them, for it was our intention to place them in the hands of the consumer as well as of the manufacturer, so that both could understand what the one was making and what the other was buying. We found it was necessary to establish a system whereby every manufacturer could make a uniform grade, for unless we had this we found that we could not maintain a uniform market. This resulted in plans for educational work. We found a great deal of trouble with the market because of lack of uniform manufacture and grading, and our work was to employ inspectors and place them at different mills to educate the local inspectors and manufacturers up to a uniform system. This was successfully done, although by hard work. We increased this corps of inspectors and had them travel about from place to place. They are men above the average in intelligence. This department is the most expensive, but the most vital one of our work. The men we hire we get with the idea that they will always carry out a square deal, and wherever they have been they invariably have left the impression that they have acted fair with both buyer and seller. Our inspection force often travels about the mills to educate the inspectors employed there. We move them from one market to another, believing that an inspector is only an average man and that influence might possibly be brought to bear which would lead him astray. So we endeavor to keep them going from one place to another.

Unjust complaints are often made, so that we finally caused a system to be inaugurated which should give members full information regarding who made complaints and who did not make them legally or illegally. A great many times after lumber had been consumed a man was still making complaints about it. We found many cases where they refused to pay for the lumber, our members, as a result of our now comprehensive system of information, have caused Dunn and Bradstreet to be put on the lower shelf, and use our files for the purpose of getting the exact status of a man. We do not delve into financial standing because we have discovered that some of the best rated institutions are the hardest to please. We give to members of the association an insight into moral conditions which are of more importance for them to know than mere financial standing, and which no credit bureau ever gives. We have compiled a system whereby any member of the association can ask the standing of a buyer and a thorough canvass is made of the membership for information about him. All replies are compiled and the result represents actual business experience. These reports are sent only to members, but are sent to all members, whether asked for or not, which makes excellent future reference.

Our organization has a vice president representing every state, with a number of directors elected from each in proportion to the output of the state. The vice president is chairman for his state, and the directors are elected geographically, to form a state organization. When committees are appointed on the different woods they also are represented in different states; thus with the vice president, and two or three directors, who are members of different committees, any legislation which may be necessary for that locality can readily be obtained.

Our organization is carried on so that the business of every state in the hardwood producing section is controlled through the secretary's office, which is the hub. We found that in the South we had a great many competitive woods of about the same value. We found a difference of \$20 a thousand feet in some instances, as our figures published in the last issue of the *Hardwood Record* will show. We have made a specialty of compiling and distributing statistics, with very beneficial results. We find a great many firms are able to obtain more money for their output than other concerns, and it is our idea to establish so just a basis of values that all can get it. Our target is the highest possible price that is reasonable and we want to educate the poor marksmen how to shoot.

We have our offices in Chicago, close to you. We have a systematic manner of carrying on our work, and the offices are open to all manufacturers. I certainly would be delighted to have anyone visiting Chicago at any time come in and see how our work is carried on. I might add something Mr. Vansant referred to—that in the development of our grading rules we have

not formulated any for northern hardwoods but left the subject open until we knew what the manufacturers of Michigan and Wisconsin wanted. If any organization is effected here, we will be subject to any rules which you may deem wise and formulate. I thank you, gentlemen, for this opportunity of addressing you.

**C. Crane Says a Word.**

Mr. Crane: I have never taken part in any of the detail work in the Manufacturers' Association like the others, and am not capable of saying much, but want to add just this: I know the information we have in our own office, and if I started out to get it single-handed I don't believe I could get it for fifty thousand dollars, and I am sure I wouldn't take a hundred thousand for it! That is what I have to say. Whenever any of you people come to Cincinnati I shall always be glad to welcome you.

Mr. White: I would like to have Mr. Gilson read some letters which he has received regard ing this meeting.

The secretary then read extracts from letters and telegrams which had reached him from various individuals who had expected to be present, as follows:

**Extracts from Letters and Telegrams.**

CHICAGO, July 12: Kindly state to the gentlemen present that I exceedingly regret the necessity of my absence, and that I trust the meeting will be very successful and will result in a closer connection between our association and the northern manufacturers of hardwoods. WILLIAM WILMS, president Hardwood Manufacturers' Association of the United States.

GRAND RAPIDS, July 14: My partner is absent, and find it impracticable to get away to join you.—McGEORGE BONDY.

CADILLAC, July 12: Conditions such that I cannot be present, but our Mr. Bruce Odell will attend the meeting and represent our company. I believe a Michigan hardwood manufacturers' association, organized along the right lines and carefully and conscientiously managed by its members after organization, can be of much value to the industry. May you have a pleasant and successful meeting.—D. E. BIGGINS.

GLEN HAVEN, July 10: I find it impossible to get away for the meeting. I approve of a Michigan association and would propose for the present an exclusive Michigan association; then when we can get them all interested in the movement and organized strong enough to protect our policy, we can affiliate with a national association best suited to our purpose. D. H. DAY.

DETROIT, July 12: Sorry not to be with you, but am obliged to go to New York tonight. A. PATRIARCHE.

EASTLAKE, July 12: Just returned from Chicago this morning, and find my business forbids my presence at the meeting, which I sincerely regret. At the next meeting I hope to be present.—R. G. PETERS.

LIVINGSTON, July 12: I do not think it will be possible for me to attend the meeting of the manufacturers, but wish to say I am in favor of the organization and will be with the majority.—M. F. HETHERS.

SAGINAW, July 11: Am disappointed in not being able to join you and shake hands with my many friends among your number, but I have an important engagement which I cannot forego.—ARTHUR HILL.

RAY CITY, July 10: I hope to be able to attend the meeting at Ottawa Beach on Friday, but if unable to be present you may be sure of my hearty co-operation in any action the convention may take for the advancement of the hardwood lumber industry of this state.—TAYLOR A. FIDELOW.

WEIDMAN, July 10: I have your announcement and will try to be with you at the hardwood meeting.—JOHN S. WEIDMAN.

CADILLAC, July 12: My business engagements preclude the possibility of my being present in person at Ottawa Beach, July 13 and 14, but Wm. E. Gustine will be there and represent me.—A. P. ANDERSON.

NASHVILLE, TENN., July 9: Regret that I cannot attend the meeting of our Michigan brother lumbermen, but I have made all arrangements to leave with my family on Saturday morning for Nova Scotia. Trust that much

good will result from the meeting. JOHN W. LOVE.

CLEVELAND, O., July 10: Hope to be with you at the Ottawa Beach meeting to represent the Mud Lake Lumber Company of Raber. JOHN H. JENKINS.

DETROIT, July 9: I have yours of July 5 in regard to the meeting of hardwood manufacturers at Ottawa Beach, July 13 and 14. It will be impossible for me to be present at the meeting. I hope, however, that the question of forest fires will be given due consideration. So long as the state of Michigan allows squatters to start fires for the sake of freshening up feed for a few head of live stock, which they are pasturing on state land, it is idle to talk about forestry in the districts where forestry would help the country the most, viz., the unsettled northern part of the lower peninsula. Of course, the state does not ask these lawless people to set the fires, but so long as they are allowed to do it without hindrance, and the state takes no measures to check the spread of such fires, there can be no progress made in forestry on a large scale. My own personal experience in fighting fires last May has convinced me that one squatter can burn up second growth faster than a thousand men can set it out. J. D. HAWKS, president and general manager Detroit & Mackinac Railway Company.

MANISTEE, July 6: Beg to advise that our president, R. W. Smith, will try to arrange to be with the manufacturers at Ottawa Beach on Friday and Saturday.—LOUIS SANDS, SALT & LUMBER COMPANY, Geo. M. Clifton, secretary.

COAL GROVE, O., July 5: Regret that other commitments prevent my attending the Michigan meeting. Hope you will have a good meeting and accomplish all you wish and should. T. C. FISCHER.

GRAYLING, July 3: We will come over and attend the meeting if possible as we are inter-

ested in anything that will promote the interests of hardwood lumber, and it is our duty to do what we can for the cause at any and all times, and we certainly want to do it.—SALLING, HANSON & Co., by R. Hanson.

WELLS, July 5: I hope to be able to join you July 13, but cannot say definitely at the present time.—I. STEPHENSON COMPANY, R. E. MacLean, secretary and treasurer.

SARAS, MISS., July 7: You have no idea how I hate to miss this meeting, but it is impossible for me to attend owing to the illness of Mrs. Carrier. I feel that I owe it to my associates in the trade to go, and furthermore I would enjoy it very much.—R. M. CARRIER.

NASHVILLE, TENN., July 7: I would like very much to be present at this meeting but it will be impossible for me to attend owing to the absence of my brother on his vacation. I know you will have a good time and accomplish much good.—JOHN B. RANSOM.

ALPENA, July 12: We are in receipt of your invitation to be present at a meeting to be held by the hardwood manufacturers of Michigan for the purpose of effecting an organization. We may not be able to meet with you this time but I hasten to assure you of our earnest desire to see such a step taken and to pledge our allegiance to this much needed association. We presume you will follow the custom of holding meetings at various points in the state and will make it our aim to be represented next time. Asking to be enrolled as a member, and wishing you all success in your commendable undertaking.—KIMBALL LUMBER COMPANY, Robt. H. Rayburn, general manager.

CINCINNATI, O., July 6: If possible I will be at the meeting at Ottawa Beach. I believe it will be one of the most important hardwood meetings ever held in the United States. One of the main questions should be the price of

lynn, for it is surely a nice wood and ought to be right along with poplar and within 85 of the price. There was a time when it was used exclusively for wagon boxes and buggy bodies, etc., and although I am only sixty years old I can remember the time when a lynn tree was worth double what a poplar was, and the character of the wood has not changed a bit, and I don't believe men are any smarter now than they were then.—CLINTON CRANE.

GRAND RAPIDS, July 14: Have been away on some important business, and am sorry I am unable to attend the meeting. I trust you will have a satisfactory one and hope a lot of good may come of it.—SILVERMAN SALT & LUMBER COMPANY, by E. C. Groeschel.

CHASSSELL, July 6: We are in receipt of your circular letter of July 2, calling a meeting of hardwood manufacturers of Michigan. We regret that we will be unable to be present at this meeting, but will be glad to co-operate with you in any way possible, and would ask that we be furnished a copy of the proceedings of the meeting. We think this move is along the right lines. WORCESTER LUMBER COMPANY, Ltd.

CHEBOYGAN, July 11: Your invitation to attend the meeting at Ottawa Beach received. I should very much like to attend but am too busy at this time to get away. Hope that you will have a very successful meeting. M. D. OLDS.

**Expressions of Opinion.**

Mr. White: I would like to hear from every manufacturer here, saying whether he is in favor of appointing a committee for a temporary organization, and giving his views regarding this matter.

Mr. Mitchell: I am in favor of a committee being appointed to see if there is not some way in which Michigan people can get together. I would make that as a motion, Mr. President.

Mr. White: You have heard the motion, gentlemen, and I would like to hear from anyone else with a word on the subject.

Mr. Bacon: I would like to amend the motion to read that Mr. White be made a member and chairman of the committee.

The motion as amended was voted upon and carried.

Mr. White: Let us hear from others, and get the sense of all those present. I will call on several people for their opinions.

Mr. Ballou: I do not know that I can say much on this subject, but the people in our territory are favorable to associations, and if anything is done along this line, I presume it would go with them. In Michigan when they start out to do a thing they generally see it through.

Mr. Newark: Our section has already spoken and I do not know that I can add anything.

Mr. Clark: Nothing that I can say will make much difference; I am here for information. I want to hear the other heads make a few remarks.

Mr. Debohaugh: I am always in favor of association work for all branches of the trade, and my presence here today is an indication of that fact. I have often wondered why there was lack of co-operation among Michigan manufacturers, and could see no reason for it, except that the work of that state is somewhat sectional, and the state is divided in one sense. At the same time there are common interests and I think you would take a very wise step in following the proposition made by Mr. Mitchell, so that you can get together and ultimately accomplish a great deal of good for yourselves. I do not know of any other state of any importance that has not joined in with some national movement or has a local one of some strength. For a great many years to come Michigan will be depended upon for supplies of certain classes of hardwoods. I think when you



HOTEL, OTTAWA, OTTAWA BEACH, WHERE MICHIGAN HARDWOOD MANUFACTURERS' ASSOCIATION WAS ORGANIZED.

rested in anything that will promote the interests of hardwood lumber, and it is our duty to do what we can for the cause at any and all times, and we certainly want to do it.—SALLING, HANSON & Co., by R. Hanson.

WELLS, July 5: I hope to be able to join you July 13, but cannot say definitely at the present time.—I. STEPHENSON COMPANY, R. E. MacLean, secretary and treasurer.

SARAS, MISS., July 7: You have no idea how I hate to miss this meeting, but it is impossible for me to attend owing to the illness of Mrs. Carrier. I feel that I owe it to my associates in the trade to go, and furthermore I would enjoy it very much.—R. M. CARRIER.

NASHVILLE, TENN., July 7: I would like very much to be present at this meeting but it will be impossible for me to attend owing to the absence of my brother on his vacation. I know you will have a good time and accomplish much good.—JOHN B. RANSOM.

ALPENA, July 12: We are in receipt of your invitation to be present at a meeting to be held by the hardwood manufacturers of Michigan for the purpose of effecting an organization. We may not be able to meet with you this time but I hasten to assure you of our earnest desire to see such a step taken and to pledge our allegiance to this much needed association. We presume you will follow the custom of holding meetings at various points in the state and will make it our aim to be represented next time. Asking to be enrolled as a member, and wishing you all success in your commendable undertaking.—KIMBALL LUMBER COMPANY, Robt. H. Rayburn, general manager.

CINCINNATI, O., July 6: If possible I will be at the meeting at Ottawa Beach. I believe it will be one of the most important hardwood meetings ever held in the United States. One of the main questions should be the price of

have settled the question thoroughly you will realize the importance of comparing and getting together on matters of common interest. I have been preaching this subject for twenty years, because I see good coming from it all the time.

Mr. White: I feel there is one thing we need just at present, and that is to get acquainted. I do not know the names of all of you, and I would like to call on others to give us something on this subject.

Mr. McClellan: I think we all feel that we ought to join the parent organization eventually, and I think an organization of Michigan manufacturers would be a good thing for the present. I believe there is a lot of enthusiasm here that has not come to light yet.

Mr. Freeman: I never made a speech in my life, but I am here to talk this matter over and I think this is a very good thing to do. It looks all right to me as far as I can see. Our cedar association has done us a good deal of good in a way. I am willing to do all I can toward this movement.

Mr. Fox: I think this organization would be a great benefit to everybody concerned. I cannot see any reason why it would not.

Mr. Odell: It seems to me that there is considerable room for an organization along the line we have been talking about when we look around and see what other organizations have done. One thing I have in mind at present is that gum very recently was a despised wood, and is now selling in Chicago at the same price as our Michigan birch. Our cull hardwood especially is selling anywhere from \$7 to \$9, with cull hemlock from \$14 to \$16. We all know our cull hardwood is worth as much as cull hemlock. If we could do nothing more than get a price for our cull hardwood lumber it would be well worth while.

Mr. White: I wish to present to you H. M. Crawford, manager of the machinery department of the Russel Wheel & Foundry Company, Detroit, who will address the meeting on the subject of hardwood logging by steam.

#### Hardwood Logging by Steam.

A number of years ago, I am told, a Michigan lumberman first conceived the idea of handling logs from the stump by steam power. He believed in that way better results could be obtained than by means of the method then employed of using horses or oxen for pulling logs to loading ground and loading with animals.

After more or less experimenting with varying degrees of failure and partial success only, the plan was practically abandoned in Michigan and for a number of years thereafter, while the ox soon gave way to the more lively horse, animal power was practically the only power used in this state in moving logs from stump to loading point.

Year after year rolled around with practically no change in general methods of logging as regards power employed in getting the logs to transportation point.

During these years, however, logging railroads were introduced, proving in a great majority of cases popular, and in increasing rapidly both in number and mileage until, at the present day, as you doubtless all know, it is in a great majority of cases unquestionably the most desirable way of moving logs.

Some five or six years ago an active effort was made to introduce steam loading machines in Michigan, which after some setbacks proved successful, and today a large proportion, at least of the larger operators in Michigan, consider a steam loading machine as necessary to their logging equipment as anything they have.

A few steam skidding plants have been in practical use for several years in this state, but as far as my observations go, they have been used by smaller operators only. Steam skidding has been for a number of years regarded by the larger lumbermen of Michigan as impossible from a practical point of view, admitted to be practical for various other lumber sections, but impractical for Michigan.

Meanwhile in other lumber sections where the physical and climatic conditions were less favorable, or rather more unfavorable, to animal power logging than they were in Michigan, news had traveled of the Michigan steam skidder, and in the course of a few years from those so-called failures of logging by steam in Michigan were developed several types of machines, which not only revolutionized logging methods in certain sections, but also made available several valuable woods, which otherwise would probably never have been prominently on the market, at

least for this generation, on account of the excessive cost of getting out the logs by animal power.

These developments in other sections just referred to soon proved practical two general methods of skidding, the trolley system and the ground or drag system. These two systems are today the recognized ways of skidding logs, and with more or less special features brought out by different manufacturers, i. e. the ones universally used.

You gentlemen are all doubtless well aware of general methods employed in these two systems of steam skidding, making a description of them unnecessary.

Taking up the two systems separately, I call your attention to, first, the trolley system.

Starting from, as it did originally, a small light outfit with engines of 15 to 20 horsepower, heavier machinery has been gradually employed until now trolley system machines with engines developing as high as 100 horsepower are not uncommon; ones that handle, from a distance of 1,000 to 1,200 feet, several logs at one time, a single load or draw 2,500 feet being, while possibly not often accomplished, made at times and could be made often were timber located so that a quantity could be readily "tonged" at one time.

The advantage of the trolley system as used in recent years are, first, its successful adaptability in very rough, broken country, where stony ground, deep ravines and tangled underbrush and windfalls interfere very little if any with operation of a machine. Second, its adaptability in very wet swampy country. Third, its operation, requiring no animal power whatever, all parts of work not done by machine itself being done by men employed on machine. This is so universally so that the trolley machine that has use for any animals is now very rare.

These three advantages would seem to make this system the ideal one for all conditions, and for a number of years it was generally believed that it was the only successful system that could be used in a steam skidder, no matter what the conditions of the operation were. The developments of the last few years, however, have shown that while under certain conditions the trolley system is unquestionably the proper one, a great majority of conditions can be handled in a better way. So with this brief statement of the trolley system I will pass to the second or ground system.

I have been unsuccessful, so far at least, in learning who the originator of this system was, and have about come to the conclusion that like the famous "Pop-Sy," it just "grewed."

It stands today, however, the most used method of steam skidding, and is now being used successfully in places, where even a short time ago no one, even those best posted on the subject, would have had the temerity to try or even recommend any other system than the trolley, the last three years particularly having shown very rapid advances in its development and use, more, probably, than in any previous ten years.

Compared with the trolley system its advantages are found to be as follows: First, adaptability to thin timbered land. Second, simplicity of equipment and consequent ease of operation. Third, ease of change of movement from one point or "set" to another. Fourth, the absence of necessity for those skilled men called "triggers," without which a trolley machine accomplishes little.

Heretofore ground system skidders have largely been used with horse or mule rehaul, viz. when a draw of log or logs is made, the line is pulled back by horse or mule to next log desired, the horse following load in and then dragging it back.

This method of rehauling empty line limits: First, size of line used; second, radius of action.

It has been shown that a good-sized horse can handle only about 900 feet of 3/4-inch line, and a proportionate length of larger line and even then can stand only about five hours per day of such work, while a machine can be operated continuously.

Various power rehaul systems for getting line back from machine to tree have been employed, so far used but infrequently except in places where it is impossible on account of swampy ground to get line back by animal power.

There is unquestionably, however, a strong probability that before even the present year is gone there will be in operation powerful machines operating under the drag system and pulling timber in quantities from a much longer distance than now generally thought practical, where line will be rapidly rehailed by power and where operation will be conducted entirely without the use of animals.

Referring directly to the subject of my paper, "Hardwood Logging by Steam," I believe that in a great majority of cases a properly designed and built steam skidding machine will prove invaluable to the hardwood operator of any size, not only in Michigan, but also in hardwood sections of other states; that the

steam operated machine has now been developed to the point where competent management will prove that fact, and that the time is not far distant when their use even in our own conservative Michigan will be more universal than the steam leader is today.

Looking ahead a short time (probably a shorter time than most of you would grant) I can picture a new kind of logging camp—a logging camp on wheels. For with the animal eliminated from the logging proposition, no barns, large store houses, teamsters and hostlers will be required, and with the number required to man a certain sized operation greatly reduced, who, will prevent having a logging camp on wheels moved each time the skidder is moved and keeping men always right at the scene of action, and the employment also of, perhaps, a different class of men, all of whom will be working within such a small radius from the machine or central point that each man will be under the eye of the foreman, with his part of the work, allotted in advance, to keep up.

The short space of time allotted me permitted only generalities on this subject. Allow me in conclusion to thank you for the opportunity given to appear before you to talk "shop," as well as for the courtesy of your attention bestowed.

The chairman then called for further expressions from those present.

Mr. Gustine: I do not know as I have anything to add. There is no question in my mind, however, that the manufacturers of Michigan are proceeding along the right line; if they can organize under proper conditions I believe within the next two or three years the price of maple will advance at least from \$3 to \$5 a thousand, in other words, that manufacturers will be benefited to that extent. There is no question that those assembled here recognize association work as a good thing. Maple flooring never had its proper place until it was taken up by the Maple Flooring Association. The advantages thus derived these men know best themselves. As the representative of one of the manufacturers of Michigan I certainly will do all in my power to keep Mr. Anderson in line and a member of this proposed association. The question has arisen in my mind whether the association would not accomplish better work through being affiliated with one of the national bodies. That will have to be discussed by the committee and I think will probably be brought up more fully tomorrow. But, gentlemen, I assure you that I believe you are on the right track, and that the sooner you can form an organization and get it truly established, the better it will be for the manufacturer of hardwood lumber in Michigan.

Mr. Greble: Gentlemen, I, as a representative of southern manufacturers, have really nothing to say this afternoon. I think this is all for Michigan manufacturers. Probably tomorrow I will say something.

Chairman White then called upon Charles Westcott of the International Harvester Company, Chicago, for some remarks.

Mr. Westcott: I do not know that my remarks will be of interest. I never expect to make any maple in Michigan. I did jot down a few notes as I listened this afternoon. It occurred to me that there was some danger in the remark that association work was responsible for advanced prices. The consuming demand regulates that matter entirely. The price must be a matter to be adjusted between the buyer and seller, and will be regulated by the demand of the market. It seems to me that association work is rather to bring buyer and seller together. I believe that ninety per cent of the lumber, save maple flooring, requires four-side inspection. I want to say freely and frankly that we must have four-side inspection in our business.

Mr. White: What per cent of Michigan hardwoods goes into implement manufacture?

Mr. Westcott: I do not know exactly. I haven't much more to say on this subject, except that the Michigan men don't know at the present time how the consuming trade uses the lumber; that they will learn in time, and I shall be very glad when they do.



### Committee on Temporary Organization.

The chairman then appointed the committee on temporary organization, as follows: Messrs. White, Bailon, Fitzgerald, McClellan and Clark.

Mr. Gibson: It occurred to me, gentlemen, that possibly not all of you had analyzed the importance of Michigan as a hardwood manufacturing state, as compared with the total output of the country. We are manufacturing in the United States today upwards of five billion feet of hardwood lumber, of which Michigan during 1905 manufactured considerably more than six hundred million. The total output of what we know as northern hardwoods, as compared with southern, is about in the proportion of two to three. There is a little less than three billion feet of hardwoods made in the south country and considerably over two billion feet made in the northern section of the country. Michigan is the leading producer of hardwoods in the northern range of states. Speaking specifically of maple, the total output of maple last year was estimated at 570,000,000 feet, and of that Michigan made 341,000,000 feet. These figures are a little less than the actual output. Therefore, what Michigan does toward organization in northern hardwoods will be a particularly important feature for other states interested in the production to follow.

In Mr. Vausant's address to you he showed you that southern hardwoods had achieved an average accretion in value in the last four and a half years of about 87.50 a thousand feet. In that same period Michigan hardwood values, as I estimate it, I think with considerable accuracy, have shown an accretion of only about \$2.50. Perhaps we can account for this as a natural increment, owing to the demand being up to the supply, but it does seem to me that there is an excess of 85 there which these southern people have achieved, as compared with the price of northern woods. It would seem that the full range of northern hardwood values is from twenty to twenty-five per cent below the price achieved by the southern woods. Judge it as you will, that is the condition, for we know that these southern woods are largely handled through association work; if it has been a good thing for them, it is worth your trying. It seems to me that with a good organization you can learn the requirements of your trade more closely, and thus avoid overstocking on particular items, differences in grading, etc. You can better your condition by working in close harmony with the requirements of the trade.

Mr. White: There is a gentleman in our audience that I have known for some time, and been with a good deal in association work. We would like to hear from him. I refer to W. H. Russe.

### W. H. Russe Speaks.

Mr. Russe: I thank you for calling on me. I have my family up here or I would not be with you. I think it would be a wise thing to organize, but I do not agree with some of the speakers that have preceded me that organization means higher prices. I do not believe that the comparison Mr. Gibson made with southern hardwoods is just and right. We are not cutting the grade of stock you are cutting up here. As far as average width is concerned, we give wider stock and get more money for it. I believe it is a good thing to keep your small competitors in line, but in requirements the demand makes the price. I can remember when the price for poplar was put up, and they had to put it down again. Why? The demand was not there. But I believe in organization. If you accomplish nothing but getting well acquainted with each other, it will be a good thing. I believe that if in your organization you have a weak member who never attends meetings or reads papers and doesn't know what he is doing, he will get information. I think we all pick up information by meeting with men in our own line of work. But organization will not make the price of lumber. If we have strikes today, if we have failure of crops, where are your prices going to? You always have men with stocks on hand who must realize on them. I am surprised to find so many men from other sections here, as I thought this was a Michigan crowd. I think the principal thing is to get uniform inspection. If you once accomplish that the price follows. The

grades you furnish a man is what he pays for. I have always been on the other side of the fence in these disputes. Have taken the position that when you furnish a good grade you get a good price, and that if I furnish a good grade and my competitor furnishes a poor one, I will get the better price. I do not believe that I want to say anything on behalf of the National Hardwood Lumber Association. We think that is up to you. We are doing a good work, of course, but as I said, that is up to you. But as far as your organization is concerned, you would do a wise thing in organizing. You cannot miss it on that proposition. I have never seen an organization yet that did not do some good, even though it lasted but a few years. I think you would make a mistake if you didn't organize. I am sorry you are not very much enthused over the prospect. The amount of work organizations have done ought to prove to all of you that it is a good thing to get together. I believe it would be a good thing for the Michigan manufacturers and for the trade.

Chairman White then called upon Theodore Fathauer, who spoke as follows:

### Address of Theodore Fathauer.

Mr. Fathauer: There was one remark or one passage in the letter which Mr. White read which I think is questionable; viz., that the manufacturers of hardwood lumber in the state of Michigan are working for the dealer and for the commission man. Of course, you can readily realize that inasmuch as I am a dealer I do wish that statement was correct from a selfish motive. It was also with interest that I listened to the argument in which it was stated and proven that the manufacturers of Michigan produce hardwood lumber at no profit—that they are merely selling their stumpage. I wish to congratulate you that you have been so eminently successful in doing this. I also would like to call attention to the statement made by my townsman, the editor of the *Hardwood Record*, in which he draws the comparison against Michigan hardwoods. I think your percentage of gain has been as much as southern hardwoods for the reason that the South produces lumber of very high value, whereas your northern hardwoods are of a lower grade. I believe if Mr. Gibson will take the pains to figure out the percentages again, he will find that Michigan hardwood manufacturers are not trailing behind the men of the South. I would also like to call attention to the fact that no lumber has advanced more than rock elm. Also in reference to inspection, the statement is made that ninety per cent of hardwood lumber is used one face. Four faces are used on more of it. I also would call attention to the fact that when the National Hardwood Lumber Association was organized we took particular pains to have the manufacturers of the state of Michigan with us, for when you draft inspection rules you should have the two elements of the trade with you the producers and the buyers. The producer must guard against making rules too severe. The rules of the National Hardwood Lumber Association take care of everything produced. You will also agree with me that no class of men is better qualified to understand the wants of the trade than are the dealers, and I believe that when you organize a body of lumbermen in a state and undertake to make inspection rules where you only hear one end of the subject, viz., the manufacturer's end, that you are very liable to draft inspection rules that do not represent the custom of the country. When you bring the buyer and seller together in a common organization, such as we have, you follow the lines of Americanism—representation—which is the common spirit in this country.

Mr. White: I am afraid, Theodore, that you have been a little selfish; you haven't been as liberal as your president.

A motion to adjourn being made and carried, the convention dispersed, to meet again the following day.

### SATURDAY'S SESSION.

Chairman White opened the meeting by calling for the report of the committee on temporary organization.

### Report of Committee on Temporary Organization.

Your committee begs leave to report as follows:

After thoroughly considering the conditions surrounding hardwood affairs in Michigan, we believe that it is to the best interests of this state to organize an association and adopt a constitution, covering our needs for the protection of the industry, as follows:

### CONSTITUTION.

#### NAME.

The name of this association shall be Michigan Hardwood Manufacturers' Association.

#### OBJECTS.

The object of this association shall be to secure a full understanding of the conditions surrounding the lumber market in the territory covered by this association; the establishment of uniform grades for the inspection of lumber as the only legitimate basis; to establish uniform customs and usages among manufacturers of lumber; to procure and furnish to its members such information as may tend to protect them against unbusinesslike methods of those with whom they deal, and such other information as may be for the benefit of the members; and to propose and carry out such other measures as may be deemed for the welfare and in the interest of the manufacturers of lumber, who shall be members of this association.

#### ELIGIBILITY.

Any manufacturer of hardwood lumber and owner of stumpage is eligible to membership, subject to the approval of the committee on membership.

The executive board shall pass upon the eligibility of such applicants, and if in its opinion the character of the business of such individual, firm or corporation does not correspond to that of members actually manufacturing their own lumber and merchandising it in a wholesale way, the application for membership may be declined.

#### OFFICERS.

The officers of the association shall consist of a president, two vice-presidents, a treasurer, a secretary, and twelve directors geographically distributed to cover the producing sections of the entire state.

The president, vice-presidents and treasurer shall be members, by virtue of their office, of the board of directors, of which the president shall be chairman.

#### BOARD OF DIRECTORS.

The board of directors shall have the power to appoint a committee of three of its members to constitute an executive board. This board shall employ a secretary who shall print and circulate documents, raise funds and appropriate the same to devise and carry into effect such measures as it may deem expedient to promote the objects of the association; and the secretary shall at all times be subject to its direction.

#### DUES.

Members shall pay an initiatory fee of \$10, and such assessments as may be found necessary to carry on the work of the association; these assessments to be made pro rata to the shipments of each member, and not to exceed two cents per thousand feet.

If any member shall neglect to pay the assessments made by the board of directors within sixty days after due notice by the secretary, the secretary is authorized to cancel the name of such delinquent from membership in this association.

#### QUESTIONS IN ISSUE.

Members shall not be privileged to vote on questions affecting the grading and classification of lumber of which they are not manufacturers. In case of disagreement about grading rules, members, whose product is largely of the kind of lumber in dispute, may determine such questions as are in issue.

#### COMMITTEES.

The president shall appoint standing committees as follows:

**ON GRADES:** Consisting of nine members; this committee to be divided into sub-committees of three each, covering the kinds of lumber in which their members are chiefly interested.

**ON MARKER CONDITIONS:** This committee to be established in the same manner as the committee on grades.

#### DUTIES OF OFFICERS.

The president shall preside at all meetings of the association and shall call meetings thereof wherever requested by a majority of the board.

In the absence of the president the first vice-president shall perform the duties of the president, or in the absence of both president and first vice-president, the second vice-president shall preside.

The treasurer shall keep account of all moneys received and expended for the use of the association, and shall make disbursements only upon vouchers issued by the secretary.

It shall be the duty of the secretary to give notice of and attend all meetings of the association and of the board of directors; to keep a record of all their doings; to keep a list of all the members of the association; collect all assessments and pay them over to the treasurer; to prepare under the direction of the executive board, an annual report of their transactions and the condition of the association, and perform any and all duties which shall be required of him by the board, and generally to devote his best efforts to forward the interests of the association.



## ELECTION OF OFFICERS.

The president, vice-presidents, treasurer and board of directors shall be elected by ballot at each annual meeting and they shall continue in office for the term of one year, or until their successors are elected and qualified.

In case of vacancies on the board or in any of the official positions the same shall be filled by the executive board at any meeting.

## MEETINGS.

Meetings shall be called from time to time in various sections of the state agreed upon by the executive board at the request of those interested in the development of the association work.

## EXECUTIVE BOARD.

The executive board shall exercise all the power of the board of directors at all times when the board of directors is not in session.

## OFFICIAL HEADQUARTERS.

The official headquarters of this association shall be located at Cadillac, Mich.

## BY-LAWS.

## 1. Order of business:

Roll call.

Reading of minutes of last meeting.

Enrollment of new members.

Reports of secretary and treasurer.

Reports of committees.

General business.

Election of officers (at annual meeting).

Selection of location for next meeting.

2. The board of directors shall make such additional by-laws and rules for the transaction of the business of this association as they may deem its development to require, and five of such directors shall constitute a quorum for the transaction of business at any meeting.

3. Absent members of this association may be represented and vote by proxy given in writing to any member of the association, or to any employee of said firm or company, provided that no person shall vote more than two proxies besides that of the firm or company of which he shall be a member or employee. The secretary of any regular meeting shall make a register of all those present entitled to vote, with a record of the proxies held, and the number of votes entitled to be cast by each individual present.

Respectfully submitted,

WM. H. WHITE,  
E. FITZGERALD,  
R. J. CLARK,  
S. G. McCLELLAN,  
HENRY BALLOU.

Mr. White: Gentlemen, you have heard the report. What will you do with it?

Mr. Mitchell: I move that the report be accepted and adopted.

This motion being duly seconded, it was put to vote and carried.

## Election of Officers.

Mr. White: You will notice, gentlemen, that this report calls for election of officers.

A motion was made by Mr. Dunton, seconded and carried to the effect that a committee of three be appointed to select such names for officers and directors as they deemed desirable, for presentation to the meeting. The chairman appointed as such committee Messrs. Clark, Gustine and Martin, who after due deliberation presented their selection as follows:

President, William H. White.

First vice-president, W. W. Mitchell.

Second vice-president, R. Hanson.

Treasurer, D. F. Diggins.

Board of directors, H. Ballou, Cadillac; R. E. McLean, Wells; G. Von Platen, Boyne City; R. G. Peters, Eastlake; C. A. Bigelow, Bay City; W. L. Martin, Cheboygan; S. G. McClellan, Simons; D. H. Day, Glen Haven; H. A. Batchelor, Saginaw; R. J. Clark, Sault Ste. Marie; E. Fitzgerald, Cadillac; H. M. Loud, Au Sable.

The committee further recommended the adoption of the following resolutions: 1. That the president appoint at this meeting the standing committees provided for in the report of the committee on organization. 2. That the president and first and second vice-presidents act as the executive board. 3. That suggestions be requested from all members as to the proper person to be selected for the position of secretary of the association.

Mr. Clark: I move that the secretary pro tem be instructed to cast the unanimous vote of this meeting for the officers suggested, and that the resolutions be adopted.

Duly seconded and carried.

Chairman White then appointed the committees as follows:

Grading committee: Wm. H. White, Henry Ballou, R. J. Clark, G. Von Platen, C. A. Bigelow, Fred A. Diggins, D. H. Day, A. F. Anderson, Bert Cook.

Committee on market conditions: Bruce Odell, H. M. Loud, W. L. Martin, A. W. Newark, John S. Weidman, S. G. McClellan, E. C. Rust, C. L. Hull, F. L. Richardson.

Mr. White: I have looked over the geographical situation of the lumber interests in our state and have selected these men accordingly, so that each town and locality is represented and we hope to get them all out for the next meeting.

I wish to thank you for the honor bestowed upon me here today, gentlemen. I am a very busy man, but I am much interested in this

work and in hardwood manufacture, and will do all I possibly can; but I want the cooperation of every manufacturer here and everyone who joins this association. I would not have taken hold of this matter, but for the promise that Mr. Mitchell here, would be vice-president. He is really the logical man to be president of this body, for he is a larger manufacturer than I am, but he is naturally a little modest, and he pushed me to the front, and so—as I am somewhat susceptible to flattery—I took it. I think we should have another meeting as soon as possible and would like to have the matter talked over and decided upon.

After some discussion it was agreed to hold the next meeting at the John Jacob Astor House, Island of Mackinac, Wednesday, August 8, at 10 a. m.

On motion the meeting adjourned.

## Meeting National Association of Hickory Consumers.

Thirty very earnest men met in the Red Room of the Cataract Hotel, Niagara Falls, N. Y., on July 13, to take up a question which concerns the very existence of the vast industry they represented, and which is of vital moment to the welfare of the whole country. Those present represented the principal consumers of hickory in the country, manufacturers of vehicle woodstock, carriages, wagons, agricultural implements, etc. The supply of hickory timber in this country has been practically exhausted, and it is stated that in a dozen years or so the vehicle and allied interests, and all the industries dependent on such manufactures, will be crippled, as there has as yet been no substitute for hickory found, either in this country or elsewhere.

The meeting was the result of some good work undertaken of late by a few members of the hickory trade, led by John W. Herron of the Royer Wheel Co., Cincinnati, O., and O. B. Bannister of the Muncie Wheel Co., Muncie, Ind., who had formed themselves into an informal committee and sent letters broadcast among hickory consumers. Some branches of the industry are organized, some are not, and it was found that there are about fourteen divisions of hickory consumers. One of the first steps taken at the meeting was to form a general committee composed of representatives of each of these divisions to take up the work of furthering the hickory interests of the country. Mr. Herron was chosen chairman of the meeting and Mr. Bannister secretary.

It was very gratifying to find so numerous and enthusiastic an attendance and it was felt that but for an unfortunate conflict in dates—there being a meeting of Michigan hardwood manufacturers at Ottawa Beach on the same day—there would have been a much larger attendance. There were close to a hundred letters of regret sent in, all expressing the utmost concern for the future of hickory and promising the prompt cooperation in whatever should be done.

One of the principal objects of the meeting was to enlist the aid of the government forestry experts. Several were present and gave very valuable talks. A very interested attendant was Prof. Golden of Purdue University, which institution it is expected will take an active part in the work.

After reading the letters from those unable to attend, Chairman Herron called on Wm. L. Hall of the Forest Service to give an outline of government work along this line. Mr. Herron said that it had been estimated that the interests represented at the meeting were using about 250,000,000 feet of hickory annually, and that every serious-minded man connected with the industry was convinced that before long

some other wood would have to be used in place of hickory, and yet so far there had been no substitute found for it.

Mr. Hall, however, did not favor the idea of substitution. He stated that there was really no other wood to take its place entirely, although some might be found to fill certain uses very well. He mentioned only the eucalyptus of southern California as a possibility, and said that even the substitution of metals was quite impractical. At the same time, hickory stumpage is rapidly being diminished. It is not known exactly how much there is now, as it is so widely scattered, but certain it is that the supply is very limited and the question of who is to take up the problem and solve it is one that demands prompt attention. Mr. Hall stated that the government has gone into timber raising and has large reserves, but so far very little but the soft woods have been considered. A hardwood reserve has not been provided. An effort has been made to secure an appropriation to establish a reserve for hardwoods in the Appalachians of Pennsylvania, but the bill has only passed the senate. In the end from \$12,000,000 to \$15,000,000 would be needed. He said that there was a great area of land in Pennsylvania suitable for hickory raising, and that Ohio and Indiana came next in availability, but he did not favor the Adirondack region of New York. Mr. Hall's conclusion was that while the government would undoubtedly take steps in the matter in time, immediate measures were absolutely necessary. The raising of hickory must be begun at once by either associations or individuals in the trade.

Chairman Herron varied the discussion by calling on members of the trade, who proceeded to pile up the evidence as to the scarcity of hickory and the great need of prompt action toward insuring a future source of supply.

W. A. Snyder of the Pioneer Pole & Shaft Company, Piqua, O., said his company was operating west of the Mississippi and had always tried to get the owners of tracts to bring the timber to the mills, but that this could not always be done. Long hauls, bad weather, water and the quarantine were among the difficulties of the situation as viewed by his company. It takes what appears to be a heavy growth of timber to make even 600 to 700 feet of lumber to the acre, and it would not pay to put in a portable mill for less than 100,000 feet. He did not believe that the supply would last more than from 12 to 15 years.

D. P. Cooper of the J. A. & D. P. Cooper Company, Struthers, O., who next took the floor was of the opinion that the matter of hickory cultivation lay with future generations, as he said it would take 60 to 200 years to grow trees such as the trade needs. He advocated

the increase of prices so that hickory would be made prohibitory to other users.

Mr. Herron said that there were consumers who were cutting their tracts over year after year, so there was more than one side to the question.

H. D. Hartley of the Windsor Turned Goods Company, Windsor, Ont., introduced the question of saving hickory by reinforcing various manufactures by steel.

E. S. Darlington, Hoopes Bros. & Darlington, West Chester, Pa., and H. J. Wildermuth, Wildermuth Bending Co., Columbus, O., took up the matter of supply from various standpoints, and Geo. H. Maxwell of the National Irrigation Association, Chicago, urged prompt action in timber raising.

Ernest A. Sterling and R. S. Kellogg of the Forest Service, on invitation, took up the future of the hickory industry. Mr. Sterling said that this growth was propagated both by sprouts and seedlings. His plan was to select lands already producing hickory timber, clear off the brush, cut out other timber, take care of the sprouts and fill in gaps with seedlings. Sprouts grow quite rapidly and ought to make usable timber in 30 to 40 years. In the meantime husband the available timber and use substitutes where possible in certain parts of vehicles. He said that while it would not be possible to do much yet on government lands, for none had been selected suitable to hickory culture, and while hickory had not been studied as soft-woods had, there was sufficient general knowledge to enable the forestry men to assist greatly in the work.

Mr. Kellogg spoke of the prodigal use of lumber in this country. Too much wood oftentimes was put into manufactures. A system of tests was to be instituted soon, he said, that would point out where too much material is put in, so that no part of a wheel or wagon need be made too heavy.

As to the size of a tract needed Mr. Sterling said that 10,000 acres would be small enough, as both timber and experiment work would come from it. He advised taking up several tracts, so that the best natural conditions could be secured, with timber already growing on them.

Fred A. Curtis of the Vehicle Woodstock Company, Chicago, brought up the question of grading hickory. He said that there was much waste on account of the lack of a good grading system, that the plan had apparently been to reject everything that could be rejected, instead of accepting everything that could be accepted. After this interesting discussion the remaining time was given over to organization.

A general committee was appointed of fifteen members, one from each of the fourteen divisions of the hickory consumers and two from the western wheel interests, as follows:

- Western Wheel—J. W. Herron, Cincinnati;
- O. B. Bannister, Muncie, Ind.
- Eastern Wheel—E. Stinson, Baltimore.
- Rim—Fred A. Curtis, Chicago.
- Spoke—Peter Lesh, Memphis, Tenn.
- Gear—D. P. Cooper, Struthers, O.
- Shaft and Pole—W. A. Snyder, Piqua, O.
- Wagon—E. W. McCullough, Wilmette, Ill.
- Carriage—E. Louis Kuhns, South Bend, Ind.
- Singletree and Neckyoke—C. S. Hartwell, Chicago Heights, Ill.
- Hammer Handles (not represented)—R. F. Reuther, Nashville, Tenn.
- Agricultural Implements and Vehicles—J. A. Sanford, Chicago.
- Sucker Rods—George Kile, Akron, O.
- Dimension Stock—Lewis Doster, Chicago.
- Shafts, Bars and Gears—C. F. Coville, Mt. Vernon, O.

On final adjournment such members of the committee as were present met and elected the following officers:

- President, John W. Herron, Cincinnati.
- First vice-president, C. F. Huhnlein, Louisville, Ky.

Second vice-president, B. F. Von Behren, Evansville, Ind.

Third vice-president, D. P. Cooper, Struthers, O.

Treasurer, W. A. Snyder, Piqua, O.  
Secretary, O. B. Bannister, Muncie, Ind.

As there were so few members of the general committee present it was agreed to submit all organization work done at this meeting to the full committee when assembled, some changes in the make-up of the committee being probable, as one or two members had consented to act only temporarily. On this account also there was no talk of the work before the committee and all suggestion of finance was ignored.

After some discussion, it was agreed to name the new organization the National Association of Hickory Consumers, and every man on the list is prepared to make it an association of hickory producers just as soon as possible. The meeting adjourned subject to the call of the president, who will bring the committee together just as soon as the minutes of this meeting, which are to be published, are in their hands, so that they can proceed intelligently from the point at which the first meeting stopped.

While it cannot be said that the cultivation of hickory timber was determined upon, it was made very plain that such a course was the only one that promised any relief from the present dilemma, and it is expected that the general committee will grapple with that side of the problem just as soon as it is assembled. It is hoped that a full committee meeting can be had inside of a month.

Those present were:

- Joseph W. Downing, New York, Wilmington Wheel Manufacturing Company.
- John W. Herron, Cincinnati, O., Royer Wheel Company.
- Walter E. Buckley, John Buckley Hub, Spoke & Wheel Company.

H. C. Lindermuth, Wilmington, Del., Wilmington Wheel Manufacturing Company.  
Fred A. Curtis, Chicago, Vehicle Woodstock Company and Cleveland Union Bow Company.  
R. S. Kellogg, Washington, D. C., Forest Service.

D. E. Allen, Wilmette, Ill., National Wagon Manufacturers' Association.  
George H. Maxwell, Chicago, National Irrigation Association.  
Ernest A. Sterling, Washington, D. C., Forest Extension.

R. W. Jessup, Newark, N. Y., Wayne Wheel Company.  
E. C. Witwer, South Bend, Ind., Studebaker Bros. Manufacturing Company.  
C. B. Hayes, Flint, Mich., Imperial Wheel Company.

W. A. Snyder, Piqua, O., Pioneer Pole & Shaft Company.  
W. W. Wood and W. P. Nolan, New York, Wagon Builder.

J. J. Wisner, Miamisburg, O., Hookwaller Wheel Company.

C. F. Ferguson, Defiance, O., Turnbull Wagon Company.

J. W. Heyes, Terre Haute, Ind., Standard Wheel Company.

E. S. Darlington, West Chester, Pa., Hoopes Bros. & Darlington.

W. J. Golden, Lafayette, Ind., professor Practical Mechanics, Purdue University.

J. A. Sanford, Chicago, National Association Agricultural Implement & Vehicle Manufacturers.

C. F. Colville, Mount Vernon, O., Metropolis Building Company.

D. P. Cooper, Struthers, O., J. A. & D. P. Cooper Company.

William L. Hall, Washington, D. C., Forest Service.

H. J. Wildermuth, Columbus, O., Wildermuth Bending Company.

G. A. Farrall, Batavia, N. Y., Johnston Harvester Company.

H. D. Hartley, Windsor, Ont., Windsor Turned Wood Company.

Carl D. Fisher, Wapakoneta, O., Wapakoneta Wheel Company.

F. L. Schneider, York, Pa., Wilbur A. Eberly Wheel Works.

O. B. Bannister, Muncie, Ind., Muncie Wheel Company.

John Chamberlain, Hardwood Record, Buffalo, N. Y.

## News Miscellany.

### Atlantic City Concatenation a Success.

An enjoyable time was had at Atlantic City, N. J., on July 14, when Jerome Sheip, vicegerent snark of the Penn-Eastern District, led a crowd of Hoo-Hoo down to the seashore to disport themselves at a concatenation. The occasion was a very symbolic one, ninety-nine cats being present and nine candidate kittens. The ceremonies began at nine minutes past three and at nine minutes past seven a banquet was held at which there were nine speeches. The kittens initiated were the following: Chester B. Foster, American Woodworking Machinery Co.; Charles P. Dyer, Geo. W. Stoker & Son; Charles Mayo Hamlin; Charles August Aughter of Kolb Bros.; Edward Eugene Kuehne of J. A. Fay & Egan Company, Cincinnati; Charles "Transmission" Bond; William Niles Lawton of Kolb Bros.; Samuel Hecker Magargal of Geissel & Richardson and F. J. Byrne of the HARDWOOD RECORD.

Almost the entire colony of Hoo-Hoo established at Atlantic City for the summer lent the occasion the charm of their presence and contributed to the merry making. E. Stringer Boggs, Jabberwork of the Supreme Nine, complimented Snark Sheip on the showing and the quality of his candidates. Ex-Snark Frank Rumbarger made a speech in which he advocated the bringing of the next annual meeting to Atlantic City. Ex-Snark John J. Rumbarger, who acted as toastmaster, paid a splendid tribute to Snark Sheip, and in a review of his work drew attention to the fact that he had held four concatenations and had brought into the order sixty-four men, all of splendid reputation in the trade. John J. Canavan, ex-snark of New York state, who acted as scribe, also drew great applause when he announced himself in favor of Philadelphia as the next meeting place. Snark Sheip made a speech in which he outlined a pol-

icy for a regular campaign to be waged to secure the 1907 annual for Philadelphia.

The "on the roof" features of the gathering were furnished by the members themselves, who sang and told stories. After the gathering had left the Royal Palace Hotel they visited the various gardens for which Atlantic City is noted and made the night enjoyable by the discharge of fire crackers and explosive matches supplied by William B. Allen of the Colonial Lumber Company. The outing was unanimously declared the best ever held in the district.

### The Okeeta Planing Mill Co.

A new concern the success of which can be predicted from the splendid business acumen of its organizers and officers is the Okeeta Planing Mill Company, recently chartered to manufacture poplar bevel siding and a full line of planing mill work at Okeeta, Va. The plant of the concern is located on the Clinch Valley Railroad, about one mile from Honaker, Va.; the main building is 50x150 feet in dimensions. It is equipped with modern machinery throughout and will employ at the outset about forty men, increasing the number as the factory gets into smoother running order. The officers are: W. J. Newenham, president; G. D. Fletcher, vice president, and H. I. Soble, secretary and treasurer.

Mr. Newenham is president of the Long Pole Lumber Company and is widely and favorably known to the trade. G. D. Fletcher occupied a responsible position in the planing mill of the Pullman Company at St. Louis and also ran a planing mill at Honaker, Va., where he has a splendid reputation as a successful manager. H. I. Soble is of the firm of Soble Bros. of Philadelphia and one of the best known lumbermen in the Quaker City. During the time he has been in business in that city he has acquired an en-

viable reputation as a progressive and far-seeing lumberman.

The board of directors will include the officers of the company and John J. Soble of Soble Bros., who has made a gratifying success in the sales department of his firm. The company is capitalized at \$25,000 and is a close corporation, the stock being held by the officers named. The company expects to be in operation in a few weeks and the output will be largely handled by Soble Bros. of Philadelphia.

#### The Coe Veneer Knife Grinder.

No phase of knife grinding presents so many difficulties as does the grinding of veneer knives. There is a vast amount of difference between grinding a short planer and a fourteen-foot veneer slicer knife. If a grinding

The heavy cross-head on which the grinder mandrel runs slides between parallel planed ways, insuring for the stone an exact line of travel without end-play or vibration. It is fed back and forth along the knife by heavy steel feed screw. The machine is entirely automatic in every way, and can be set so the stone will only travel the length of the knife, though this be much shorter than the full length of the machine itself. The knife bar to which the knife is attached while being ground is one solid piece of iron, heavily reinforced and incapable of spring. It is held absolutely rigid during grinding so that there is no possible chance for vibration. It is so arranged as to permit a perfect adjustment of the knife, and is fed toward the stone by

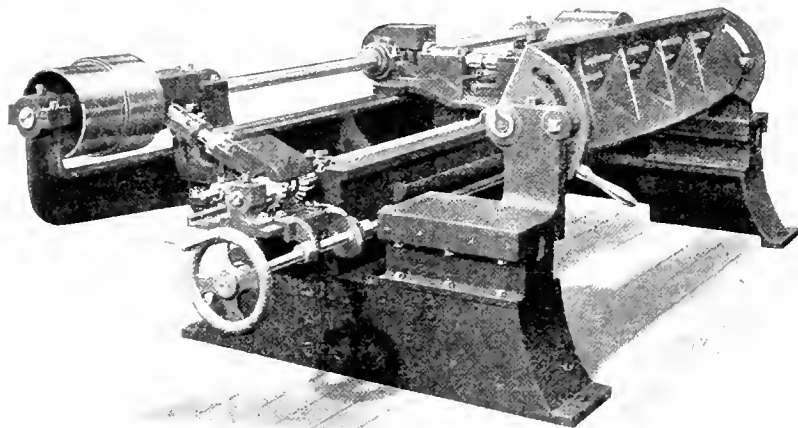

END VIEW COE VENEER KNIFE GRINDER.

machine is not absolutely perfect in construction or operation, a cracked or burned blade results, and the owner sustains a loss of anywhere from \$50 to \$350.

For a number of years the Coe Manufacturing Company tried to find a machine which would satisfactorily grind its famous veneer knives, but without success, and it was finally driven to design one of its own to accomplish the desired results. This machine should be of particular interest to veneer manufacturers operating slicers, as these knives are extremely hard to grind, and until the appearance of the Coe machine on the market, have never been satisfactorily ground. By using this method perfect grinding is assured, and the yearly knife bill greatly reduced in consequence.

In designing the machine illustrated in the accompanying cuts, the Coe Manufacturing Company broke away from old ideas and worked along new and original lines. The company believes this machine to be the only one which will always grind a perfectly straight, true edge, and it is guaranteed to produce a perfect cutting edge on the knife. This means veneers of uniform quality and thickness, and is an important point for the manufacturer to consider.

In most machines the knife is bolted to a carriage, which travels back and forth past the grinding wheel. At either end of the route the knife carriage overhangs the base of the machine several feet. This construction cannot be made stiff enough to keep the knife from springing, consequently grinding is uneven and poor veneer results.

In the Coe machine the stone travels back and forth, while the knife is held rigidly in place. There is no overhanging; the base of the machine is as long as the machine itself.

cut steel screws. The feed is entirely automatic, and can be adjusted from 1-1000 of an inch to 4-1000 of an inch for each travel of the stone. The grinding mandrel is adjustable, so that the operator can grind either a straight or hollow ground bevel. The frame is made exceptionally heavy and strong, as can be seen from the cuts. Cut steel gears are used throughout, and on the mandrel drive a rawhide pinion is used so that the machine is practically noiseless. No belts or ropes are used, except for the main drive; the machine is self-contained and compact. It will grind either wet or dry and to the full length of knife up to 168 inches. Its long list of users may be of interest to prospective buyers, as it shows the popularity of this machine with

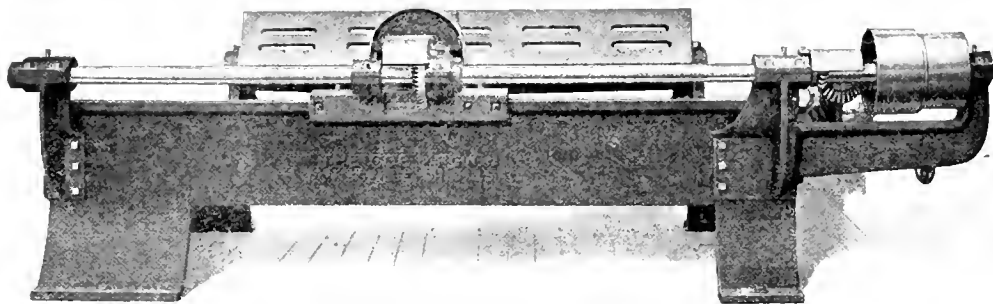

BACK VIEW COE VENEER KNIFE GRINDER.

the veneer trade; these names may be had upon application to the makers.

Anyone interested in grinding veneer knives should write at once to the Coe Manufacturing Company, Painesville, O., for catalog number 5, in which the machine is fully illustrated.

#### A Handsome Gift.

A remarkably fine example of inlaid work in the form of a ruler was recently presented to Speaker Cannon at Washington. The presentation was made by Congressman Mann, of Chicago, on behalf of the skilled woodworkers and artisans of the Pullman Car Company, Pullman, Ill. The ruler was composed of 1,864 pieces of wood in marquetry work, put together in a most artistic manner. The expert artisan responsible for this beautiful piece of work is Peter Lenzen. The wood contained in the ruler comprises hundreds of different varieties, and in its finished state shows nearly all the colors of the rainbow.

#### New Sulphur Process for the Preservation of Wood.

United States Consul R. M. Bartleman, of Seville, Spain, gives an interesting outline of a new process for the preservation of wood. This question has been the subject of much discussion and experimentation, and a new system will doubtless prove of interest to many. Mr. Bartleman says:

"All the wood preservative methods now employed are defective in so far as they make use of solutions the evaporative nature of which makes their action upon the wood effectual only for a certain time. The new method in question, which has been patented in Germany, goes further and utilizes a fixed body which becomes solid upon being instilled into the pores of the wood. This substance is sulphur, the physical properties of which offer interesting advantages, being fusible at about 115°, a temperature which the wood can support without any perceptible change. The sulphur is applied in liquid form, and in hardening completely fills up all the interstices of the fibrous tissue.

"Although sulphur oxidates easily if subjected to a high temperature, at a medium temperature it remains impassive, resisting not only the influence of water, but also that of acids, concentrated or diluted, and alkaline solutions, if cold. The reason why the utility of sulphur in the direction indicated had not been recognized ere now was on account of its small mechanical resistance, pure sulphur being very brittle and pulverous. But as wood possesses the quality of mechanical resistance of which sulphur is devoid, the compound of these two bodies may, under the proper conditions, easily acquire valuable industrial properties, as, for instance, the vulcanized caoutchouc, which wood, impregnated with sulphur, resembles a good deal.

"To protect wood by means of sulphur the following must be observed, viz: Sulphur is

tused in a befitting receptacle, making use of steam to avoid an excess of heat, which deteriorates the sulphur. Into this liquid, and at a temperature of about 140°, are steeped the boards which are to receive the treatment, care being taken to immerse them completely. The foam which gathers at first,

called forth by the separation from the wood of the air and humidity it contains, disappears at the moment the wood thoroughly assimilates the temperature of the bath, which is then lowered to 110°. At this point the sulphur becomes hard and, while the air con-

& Brother Company of Louisville, Ky. It was cut into three logs fifteen feet in length. The butt cut measured forty-eight inches in diameter at the top end, the second cut measured forty-four inches in diameter, the top log about thirty-six inches in diameter

from it. This tree is such a remarkable specimen of mahogany that the illustrations will possess marked interest to both dealers and consumers of fancy mahogany.

**Destruction of Uptegrove Veneer Plant.**

The great veneered cigar box plant of Wm. E. Uptegrove & Bro., of New York City, located at Johnson City, Tenn., was completely destroyed by fire on July 12. The loss is estimated at from \$150,000 to \$200,000. Insurance is only partial. The loss includes the main building and machinery, a large amount of stock and finished product and three or four storage warehouses adjacent to the main plant.

This institution was the largest in Johnson City and employed about one hundred and fifty men. The origin of the fire is unknown. The plant was devoted to the slicing of poplar cigar box lumber, on which were glued thin veneers of red cedar, the resultant product being known as imitation cigar box lumber. Whether or not the plant will be rebuilt is unknown, but it is more than likely that the Uptegrove company will promptly rebuild either at Johnson City or in some nearby locality where an ample supply of poplar is readily obtainable.

**Atkins Always Ahead.**

Another evidence of the fact that the motto chosen by E. C. Atkins & Co., Inc., the great saw manufacturers of Indianapolis, Ind., is being lived up to in every department of the institution is



BUTT CUT OF REMARKABLE CURLY MAHOGANY LOG.

tracts itself, the sulphur penetrates into the fibrous tissues, propelled by atmospheric pressure. The boards are then slowly withdrawn from the bath, allowing a thin and even coat of sulphur to form and cover the wood, as any superfluous surcharge can be removed only with the greatest difficulties afterwards. This coat of sulphur has a vitreous appearance and forms a very tenacious crust, excluding all tendencies to chip or break.

The degree to which the wood is impregnated varies according to the nature of the wood, the temperature, and the duration of the bath. It may be gauged by the increase in weight of the boards, which amounts to from 30 to 35 per cent where the process is conducted in an open receptacle, and to 100 per cent if in a vacuum pan. Theoretically it may be said that a complete filling of the pores of the wood would increase its weight by 200 per cent.

In numerous experiments poplar was the best wood to take the sulphur treatment. Oak and pine do not admit of the process quite so favorably, because their dry distillation begins at 140°, which can be proved simply by observing that while the wood is immersed in the bath bubbles are continually rising, marking the escape of volatile substances. Moreover, the resin blackens the sulphur. The process in question has up to date been applied only to thin boards, but in view of the satisfactory results the hope is entertained of its becoming soon very popular.

there being in the three logs about 4,000 feet Scribner's measure.

These logs were shipped via New Orleans to Louisville and thence to Baltimore to be worked into veneers, of which they will make approximately 100,000 feet. Although a perfect specimen of Honduras wood of beautiful



SECOND LOG OF THE MAGNIFICENT TREE.

color and texture, it is on account of its wonderful figure that this tree was especially remarkable. It was covered all over the exterior surface with a strong "roll figure," such as has frequently been found in walnut and ash trees, but very rarely in mahogany of any nativity. It is indeed doubtful if a

to be seen at Hartford, Mich., a pile of apple lumber such as could probably not be duplicated anywhere else in the world. It is to be used by the company for making saw handles at its plant at that place. There are over 100,000 feet in the lot, mostly short boards, as it is rare that an apple tree will cut lumber over six or eight feet long. Representatives of the concern scoured Van Buren and Allegan counties for apple trees and many old orchards contributed to the pile.

No other kind of lumber is so well suited to the making of saw handles as apple wood and the large manufacturers will use no other when they can get enough of it. It is hard, tough and has little grain, and once it is framed into shape never splits; it is indeed the ideal wood for saw handles.

**New Wisconsin Concern.**

The Wolf River Company has been incorporated, with \$200,000 capital stock, under the laws of Wisconsin to manufacture veneers and furniture, making a specialty of chairs, and to buy and sell lumber. The incorporators are Mildred Ward, Frank S. Rickford, J. M. Holden and Theodore Knapstein.

The company will have its offices and plant at New London, Wis., and has taken hold of the Wisconsin Chair Company's factory, which will be improved and enlarged.

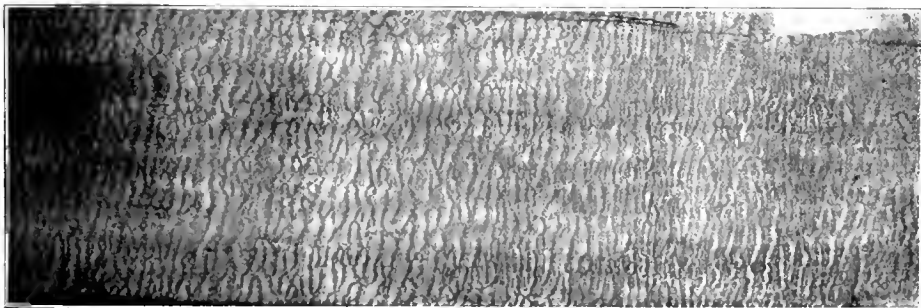

SPECIMEN OF VENEER CUT FROM MENDEL CURLY MAHOGANY LOG.

**A Remarkable Mahogany Tree.**

Recently there was cut into veneers at the mills of the Williamson Veneer Company, Baltimore, Md., one of the most remarkable mahogany trees ever felled. This tree was found in British Honduras, near the border of Guatemala, by the agents of the U. C. Mangel

mahogany tree has ever been discovered heretofore which has possessed this curl in such great strength and beauty.

The pictures on this page show both the butt end and the second log of this remarkable mahogany tree. The upper picture is from a specimen of one of the sheets of veneer cut

### Active Campaign in Westbound Freight Matter.

An active campaign has been instituted by the various hardwood lumber associations and the National Lumber Manufacturers' Association in an attempt to secure a lower and more equitable freight rate on hardwood lumber and flooring from the middle West to the Pacific coast.

At an adjourned meeting of the Transcontinental Freight Association, held at its office in Chicago on July 18, appeared E. P. Arpin, of Grand Rapids, Wis., acting on behalf of the committee appointed by the National Lumber Manufacturers' Association, of which he is chairman. There were also present at this conference the following committee of the National Hardwood Lumber Association: O. O. Agler, J. M. Pritchard and G. J. Landeck; also Lewis Doster, secretary of the Hardwood Manufacturers' Association of the United States, representing that organization. Mr. Arpin was the chief spokesman of the lumber delegation and presented a mass of evidence showing the injustice of the present rate and instancing a great many comparisons with the eastbound tariff covering like commodities. Mr. Arpin backed up his evidence by a succinct and forceful address, bringing forth convincing arguments in favor of a reduction of the westbound rate. O. O. Agler and G. J. Landeck also spoke briefly on the same subject.

The meeting between the lumber delegates and the Freight Association was marked by thorough good feeling and the members of the association were apparently markedly impressed by the forceful way in which Mr. Arpin presented the claim on behalf of his lumbermen colleagues. The association agreed to take the matter under advisement and to report its decision at an early date.

### Florida Cypress Meeting.

The Southern Cypress Manufacturers' Association held a meeting at Atlantic Beach, near Jacksonville, Fla., July 18 and 19. The meeting was very well attended.

The result of experiments made in drying tupelo gum were thoroughly discussed. The committees on insurance, railroad transportation, market conditions and terms of sale made brief reports. The committee on market conditions reported that the demand for cypress is notably better, and that the volume of orders received in the last four weeks was greater than any previous period of like duration. The association completed its arrangement for the installation of local inspectors at quite a number of mills, under the general direction of Chief Inspector B. R. Ellis, who was appointed at the Atlanta meeting. The visitors indulged in a banquet at the Continental Hotel at the conclusion of the first day's session.

The second day was devoted entirely to the consideration of the reports of the committees on grading rules and specifications. Some changes were made in grading rules, especially in the matter of measurement. In future, in measuring and tallying random widths, all fractions of a foot, one-half a foot and less will not be counted, and all fractions of a foot more than one-half will be counted as one foot, i. e., the give-and-take method on the alternate half foot. A small knot was specifically designated to be a knot not over three-fourths of an inch in diameter. The reference to "small sound knots" in No. 1 shop was stricken out. The grade of C finish will in future be known as shop finish, so that the trade will know how calculations are made for a loss of ten per cent on account of defects. A grade of D finish to be known as A was added, which provides for consuming lumber that could not be used in C finish. The grading rules for siding were also somewhat amended.

The next meeting of the association will be held at New Orleans, the date to be determined later. At this meeting the Atlanta and Florida cypress operators will be the guests of the Louisiana members.

### Doings of Florida Hardwood Company.

The West Florida Hardwood Company of Marysville, Fla., held its election of officers July 10 and George V. De Gruy was made president and general manager and E. B. Nettleton, secretary and treasurer. Mr. De Gruy is a practical hardwood man and Mr. Nettleton will be well recalled as an experienced lumberman by the many friends who knew him in connection with various lumber enterprises at Philadelphia.

The company has started one of its mills and is sawing cottonwood at the present time. It has been logging for about a year and has quite an accumulation of cottonwood and ash logs in boom at its mills. The West Florida Hardwood Company controls a large holding of fine southern hardwoods and expects to be in the manufacturing business at Marysville for many years.

### Changes in National Inspection Force.

The Inspection Bureau Committee of the National Hardwood Lumber Association is actively engaged in organizing a complete corps of deputy inspectors for all the chief hardwood markets of the country. Recent changes and additions to the force are as follows:

E. P. Southgate, who has done such excellent work for the association in St. Louis for the past year, has been transferred to New York City. His permanent address there will be announced later.

J. Rosewarne, an experienced inspector, succeeds Mr. Southgate in the St. Louis market. His address is 719 North Garrison avenue.

D. R. Finney has been appointed deputy inspector for New England, with headquarters at the Hotel Ferrin, Providence, R. I.

J. E. McQuady has been appointed deputy inspector at Louisville, and his address is 3020 Fifth street.

A new deputy inspector has been selected for Baltimore. As soon as he has qualified the complete announcement of this appointment will be made.

### A Handsome Booklet.

The Russel Wheel & Foundry Company of Detroit, Mich., particularly known to the lumber trade in connection with the production of logging cars and skidding and loading machinery, is out with a handsome pamphlet exhibiting the work it does in lines largely remote from the lumber industry. The work contains a group of very handsome halftone engravings. The frontispiece is a view of the immense plant of the company at Detroit, and following are views of its steel-stock yards and more than a score of steel structures that it has recently erected in various places throughout the United States. These views are of steel plants, coke sheds, rolling mills, foundries, paper mills, grand stands, apartment houses, bridges, ornamental iron stairways, government lighthouses, various types of power cranes, etc. In conclusion the book has illustrations of upwards of thirty types of standard cars which are a part of the output of the company.

Copies of this handsome pamphlet can be obtained by addressing the Russel Wheel & Foundry Company at Detroit, which concern will supply on request catalogs of its line of logging cars, logging machinery, dump cars, and cars and light railways for industrial purposes. This company has developed into one of the greatest structural steel houses in the United States, besides being the foremost institution in the production of logging railway equipment.

### Miscellaneous Notes.

The Turner-White Coffin & Casket Company, North Wilkesboro, N. C., has increased its capital stock from \$50,000 to \$125,000.

The Francis-Eure Veneer Company, capital stock \$100,000, has been incorporated at Jamesville, N. C., to manufacture veneers.

A new concern at New Orleans, La., is the Royal Trunk Company, incorporated with \$5,000 capital stock, to manufacture trunks.

The Philadelphia Rapid Washer Company, Philadelphia, Pa., to manufacture washing machines, has a capital stock of \$100,000.

The Howard Cooprage & Lumber Company, Ltd., domiciled at Ridgetown, Canada, has been incorporated with \$30,000 capital stock.

A woodworking plant will be established at East Orange, N. J., by Spanger Brothers, recently incorporated with \$100,000 capital.

The Schell-Dempfle Furniture Manufacturing Company has been incorporated with a capital of \$30,000 to manufacture furniture at Keokuk, Iowa.

The Missouri Amusement Swing Company, recently organized at St. Louis, Mo., will manufacture swings and operate a woodworking plant; capital \$5,000.

D. W. Peoples, Clyde Mansfield, Guy D. Nonna, Grinda E. Peoples and J. N. Foster are the incorporators of the Veneered Door Company of Athens, O., capital \$15,000.

The Brazos Hardwood Lumber Company has been incorporated with a capital of \$15,000 at Marlin, Tex. R. E. Pool, T. S. Henderson and J. N. Bradshaw are the incorporators.

The saw and heading mill operated by Rice & George at Addison, Mich., was damaged by fire recently, entailing a loss of about \$6,000. It is reported that the mill will be rebuilt at once.

The Lee Veneer Company, Lexington, Ky., recently incorporated with \$10,000 capital stock, has purchased a site on which will be erected a two-story frame building 50x100 feet in dimensions.

The Hackettstown Woodworking Company, Hackettstown, N. J., has been incorporated with \$25,000 capital. The incorporators are: E. H. Gay and L. Hooper of Boston, Mass., and J. Karr of Hackettstown.

Newport, Ark., has a new veneer plant which represents an investment of about \$20,000 and will employ about seventy-five men. It has not yet commenced operations, but will be ready for business in the near future.

The Perry Lumber Company of Webbers Falls, I. T., has been incorporated with a capital of \$20,000 to do a general lumber and hardwood manufacturing business. C. H. Perry, O. L. Hayes and J. J. McGarth are interested.

The veneer plant at Narrows, W. Va., will soon be completed, and will be one of the largest in the country. It will give employment to 320 men and will turn out 1,000 feet of finished material a minute, loading several cars a day.

The National Fireproof Sash & Door Company, to manufacture fireproof trim and building materials, has been incorporated with \$30,000 capital stock at New York City. M. N. Keshin, I. Blitstein, R. Landon, C. Greenberg are the incorporators.

The maple flooring plant of Gerber & Strable, Reed City, Mich., was badly damaged by fire recently. Two dry kilns, containing 140,000 feet of rough maple lumber, were destroyed. The loss is estimated at \$25,000, fully covered by insurance. The firm will rebuild.

Silas Chesebrough of Carey, O., has purchased the saw and planing mill of John Wisdom & Son at Sycamore. He has made extensive improvements in the plant and is now operating it at its fullest capacity. John Wisdom & Son will operate a saw and stave mill at Sabul, Iowa.

Sash, doors, blinds, mouldings and building materials will be manufactured by the Goldingay Brothers Company, recently incorporated at Newark, N. J., with \$100,000 capital stock.



Charles Goldingay, Thomas Goldingay and Frank P. Lord, all of Newark, are the incorporators.

Fire in the handle factory operated by John M. Cherry at Adrian, Mich., a few days ago caused an estimated loss of \$5,000. The property was insured at only \$1,400. Two carloads of finished handles, as well as a quantity of material, were destroyed. Mr. Cherry has not decided as yet whether he will rebuild or not.

Z. T. Robinson, of Owensboro, Ky., inventor of the tilting stay-log for making quarter-sawn veneer, who operates two saws equipped with this device at Owensboro under the firm name of the Robinson Veneer Works, is interested in the promotion of a company which will establish a veneer mill at Owensboro equipped with ten saws. He did not originally intend to put the machines on the market, but has made a few sales with such great success that he may put them on the market regularly.

A local paper is responsible for the assertion that New York state will refuse to consider the offer of the Brooklyn Cooperage Company to abandon its claim to lumber certain portions of the state lands under a contract entered into with the Cornell School of Forestry, provided a claim for so-called actual damages, amounting

to about \$400,000, is recognized and paid by the state. It is maintained that the Cornell School of Forestry had no right to enter into such a contract, and therefore it is null and void.

The Badger Stave & Lumber Company, recently incorporated at Milwaukee, Wis., with a capital stock of \$85,000, has chosen the following officers: Joseph Rosenheimer, president; Victor Husting, vice president; John A. Christnacht, treasurer, and M. G. Fleckenstein, secretary. The company owns 2,323 acres of land in Issaquena county, Mississippi, 800 of which have been cleared and planted to cotton. It also owns 1,647 acres in Madison Parish, Louisiana, most of which is virgin timber land, which will be cleared at once.

The National Handle Company, Fort Wayne, Ind., has started operations after a week's shut-down to allow for taking the annual inventory and for repairing the plant. Records of the work done by this company during the fiscal year ended June 30, 1906, show a very healthy condition of business. During the year the company handled 1,200 carloads of handles of every description. The Fort Wayne factory is the northern division of the National Handle Company, the main plant of which is at Cleveland, O.

## Hardwood News.

(By HARDWOOD RECORD Special Correspondents.)

### Chicago.

N. A. Gladding, sales manager of E. C. Atkins & Co., Inc., of Indianapolis, came to town last week to attend the meeting of the yellow piners, but found time to drop in at the Record office for a friendly call.

Among the welcome callers at the Record office July 17 were Cash Carrier and A. P. Steele of the Carrier Lumber & Manufacturing Company, Sardis, Miss. Mr. Carrier had just reached Chicago from an extended Pacific Coast trip and was joined here by Mr. Steele, manager of the plant, for a conference.

J. B. Montgomery, secretary of the American Lumber & Manufacturing Company of Pittsburg, called at the Record office on July 17, on his way to the Northwest, on a buying trip. Mr. Montgomery reports the business of his company very active.

E. P. Arpin of the Arpin Hardwood Lumber Company, Grand Rapids, Wis., was a Chicago visitor last week, and paid his respects to the Record. Mr. Arpin is very much interested in getting together a mass of evidence to show that the rate on hardwood lumber from the middle West to the Pacific coast is unjust and unreasonable for presentation to the Transcontinental Freight Committee. He is very sanguine that the evidence he will present will be sufficient to gain a marked reduction in this rate.

Among the new Chicago wholesale lumber houses is The Gillespie-Reynolds Company, corner Lumber and Seward streets. This company is made up of Robert H. Gillespie, well known in the local trade, and H. R. Reynolds of Manistee, who has long been identified with the lumber business on the west shore of Michigan. It is Mr. Reynolds' intention to move to Chicago this fall and take an active part in the affairs of the company.

C. S. Bacon, president of the Bacon Lumber Company, Grand Rapids, Mich., called at the Record office a few days ago on his way to visit the company's mills at Tremont, La.

G. E. W. Luehrmann of the Chas. F. Luehrmann Hardwood Lumber Company of St. Louis, was a Chicago visitor on Monday last.

Gus J. Landeck of the Page & Landeck Lumber Company, Milwaukee, Wis., was in the city on Monday.

F. M. Kinderman of the General Lumber Company, Columbus, O., was in town on July 20.

Scrivener J. H. Baird announces that mem-

bers of the order of Hoop-Hoo have been accorded a rate of one fare plus \$2 to the annual meeting at Oklahoma City by the Southwestern Excursion Bureau, and that the same rate will doubtless be extended by other passenger associations. Dates of sale, return limits and other details are being rapidly arranged and will be announced later.

A law suit has been started in Arkansas which from every appearance is indicative of spite work. The complainant is one William E. Beckman and the suit is instituted against Herman Paepcke of Chicago and others. The bill recites that the complainant is the owner of five shares of stock in the Chicago Mill & Lumber Company of Chicago and Cairo, Ill., and that the defendants have prevented him from deriving any benefit from his interest. He further represents that Mr. Paepcke and his associates have been fathering "a giant pool, trust, combination, agreement or understanding since 1900 to unlawfully regulate and fix the price of boxes in the United States." The bill contains a vast quantity of rot of similar character with little analogy to existing and well-known facts. It is pretty well known that the complainant is a discharged employe of the Paepcke-Leicht Lumber Company, and that he has taken this means to annoy the concern with an idea of "getting even." It is doubtful if any reputable court will ever permit the case to come to trial.

The North Branch Lumber Company has been reorganized. W. C. Hull of the Oval Wood Dish Company of Traverse City, Mich., has purchased a controlling interest therein, and a new corporation, the North Branch Flooring Company, with a capitalization of \$100,000, to engage in the manufacture of hardwood flooring, has been organized. Extensive improvements have been made in the plant at the Western avenue bridge, this city, and new machinery, dry kilns and boilers added. The management of the plant will remain in the hands of H. P. Brand, who has filled that position very creditably for a number of years.

Fire in the factory of the Foster & Munger Company, manufacturers of sash, doors and blinds at Twentieth and Sangamon streets, recently damaged \$500 worth of property.

The Hardwood Record office was graced a few days ago by the presence of H. A. Perkins, general superintendent, and Joel B. Ettinger, western manager of the S. A. Woods Machine Company, Boston, Mass. They report that busi-

ness is very active with this great eastern wood-working machinery house. Mr. Ettinger, whose office is in the Railway Exchange, this city, has been particularly fortunate in securing a large volume of business during the season. Mr. Perkins is making one of his periodical trips to visit the company's general agencies.

The Hardwood Record had the pleasure of a call on July 19 from John E. Williams, the able editor of the New Orleans Lumber Trade Journal. Mr. Williams and his family are domiciled at Chicago for the summer months.

W. S. Hollister, of The Pine Plume Lumber Company, Montgomery, Ala., who was formerly associated with the Empire Lumber Company of Buffalo, made a call at the Record office on July 19.

John H. Jenks, vice-president of the Robt. H. Jenks Lumber Company of Cleveland, and associated with the big yellow pine interests at Tremont, La., attended the meeting of the "yellow piners" in Chicago last week.

The report of the creditors' attorneys in the case of the National Lumber Manufacturing Company of this city, bankrupt, has just been filed. Analysis is made of the properties of this company in West Virginia and Alabama, and the attorneys believe that a considerable sum in net assets can be achieved by the creditors by their carefully being handled. Investigation shows about 12,000,000 feet of stumpage, and a mill and railroad in West Virginia which cost about \$40,000, against which there is a bonded indebtedness of \$47,000. Alabama property consists of 15,000 acres of timber leases, saw mill, steambot and a barge line. The provable liabilities of the company are estimated at about \$150,000.

The Vehicle Woodstock Company, of which Fred A. Curtis of Chicago is secretary, held a business meeting at the Great Northern Hotel on Wednesday, July 18. Only routine business was transacted.

W. P. Powell, sales manager of W. B. Mershon & Co., the well-known band sawing machinery people of Saginaw, was a Chicago visitor July 18. Mr. Powell advises that E. C. Mershon, the mechanical expert and head of Mershon & Co., has arrived safely on the other side of the Atlantic for a business and pleasure trip. Mr. Powell says that the call for Mershon band sawing machinery is still up to the capacity of the recently enlarged plant, and that orders for eleven machines have been booked in the last ten days.

Ed Heath of the Heath-Witbeck Company, who has been abroad since early in May, is now in London. Mr. Heath anticipates returning home about Aug. 15, but will leave his family abroad some months longer.

Chicago had the yellow piners in its midst last week, the Yellow Pine Manufacturers' Association having held its semiannual meeting at the Chicago Beach Hotel, Tuesday and Wednesday, July 17 and 18. While they did not call it a cut in price, they "amended" their list. The yellow pine contingent will eventually discover that the way to maintain a market is to cut output and not prices.

### Boston.

J. W. Willis of J. W. Willis Lumber Company, Washington Court House, Ohio, was a recent Boston visitor. Mr. Willis is also president of the Washington Manufacturing Company, manufacturers of chairs, at that place. He was accompanied on his eastern trip by his two eldest daughters.

W. B. Pope & Co. of Boston, whose yard has been located in Albany street for about twenty years, have withdrawn from business. Mr. Pope started in business with a partner under the firm name of Pope & Paul. Some time ago Mr. Paul retired from the firm and Mr. Pope continued the business.

The National Hardwood Lumber Association has appointed D. R. Finney Inspector for New



England. For the present Mr. Finney will be located at Hotel Perrin, Providence, R. I. This appointment fills a long felt want in this section.

F. M. Ward of Ward Bros., Big Rapids, Mich., manufacturers of maple flooring, is making an eastern trip and was in Boston recently. Mr. Ward states that prices of hardwoods are very firm and that he can see nothing that would indicate a decline. While many are short of dry stock, his firm is having no trouble in that direction, as it is cutting from its extensive timber tracts. This firm is furnishing the 350,000 feet of maple flooring to be used in the new H. B. Stebbins building in New York. Before returning home Mr. Ward will visit New York and vicinity.

The H. B. Stebbins Lumber Company has moved into new quarters, Room 68 Mason Building.

Another concern which moved into the Mason Building is Charles S. Wentworth & Co., which is located in Room 38.

Lesley B. Littlefield, eldest son of T. B. Littlefield, well known lumber dealer of Somerville, Mass., was recently married to Miss Clara Frevert.

Fred D. Clapp has purchased the business of the Stoughton Lumber Company, Stoughton, Mass. Mr. Clapp is thoroughly familiar with the lumber trade, having been associated with his father, E. P. Clapp, for some time.

William E. Litchfield, president of the Virginia Timber Company, and W. C. Bates, treasurer of this company, returned about two weeks ago from Virginia.

C. S. Robinson of the Chicago Lumber & Coal Company, Chicago, recently visited the trade in this vicinity.

The carriage woodworking business in East Hampton, Conn., has been sold to J. H. Stocking.

John A. Dann, president of Dann Bros. & Co., manufacturers of carriage woodwork at New Haven, Conn., died July 8 of apoplexy. He was 76 years of age. Mr. Dann invented the first folding camp chair, for which there was an immediate demand. He leaves a widow and seven children.

### New York.

Horace F. Taylor of Taylor & Crate, Buffalo, spent several days here last week in the interest of insurance affairs. He is one of the lumber underwriters of 66 Broadway and vice president of the Lumber Insurance Company and the Adirondack Fire Insurance Company of this city. The underwriters were in session on July 12 considering important matters.

W. L. Sykes of the Emporium Lumber Company, Keating Summit, Pa., spent several days here last week with C. O. Shepherd, local representative.

Other visitors noted were F. M. Sullivan, T. Sullivan & Co., Buffalo; M. B. Wilkenson, M. B. Wilkenson Lumber Company, Asheville, N. C., and M. W. Hard, Boston. Mr. Hard was en route home after a lengthy trip to the hardwood mills in West Virginia and Tennessee and expressed himself as sanguine of a stiff hardwood market for some time to come. He found prices at mill points very bullish and stocks scarce.

H. McKenzie of Sydney, Australia, a prominent woodwork manufacturer, was a recent arrival from abroad.

C. H. Ruddock and T. H. McCarthy of the Ruddock-Orleans Cypress Company, New Orleans, La., were recent visitors preparatory to sailing for Europe. Both gentlemen embarked on the America for a summer tour abroad. W. L. Burton of the Burton-Schwartz Cypress Company was also here.

E. C. Mershon of W. B. Mershon & Co., the well known resaw manufacturers of Saginaw, Mich., sailed for Europe last week for a brief stay abroad.

J. Gahagan's Sons, large trim manufacturers of Hoboken, N. J., have incorporated under the same style with a capital of \$50,000. J. C.

W. A. and J. A. Gahagan are the incorporators.

Willson, Adams & Co., retailers of 149th street and Harlem River, have sold their entire river front holdings to the Erie Railroad for a freight terminal. They will continue business on the balance of their property.

The Cypress Selling Company, Ltd., of New Orleans, La., has opened a local sales office at 18 Broadway under the management of L. F. Wood.

Charles D. Chase, a well known credit man of Chicago, has succeeded C. F. Towles as manager of the local office of the Red Book, 18 Broadway. Mr. Towles resumes the lead for the association.

S. Hornstadt, the hardwood wholesaler of 66 Broadway, has given up a large part of his business to assume charge of the retail operation of Charles R. Partridge at the foot of East Ninety-ninth street, Manhattan. He continues his own business in a small way, but in the main will devote his attention to Mr. Partridge's affairs.

H. E. Wofford, sales agent of the Emerson Company, manufacturers of the Emerson dry kiln at Baltimore, Md., was a recent visitor and reported business as excellent. Mr. Wofford is installing two bar kilns 100 feet long for the fine new plant which Jacob Bell, piano manufacturer, is installing on the Southern boulevard, Bronx, to take the place of his factory recently burned. Mr. Wofford is particularly pleased at this sale, and construes it as a high testimonial to the Emerson kiln in view of the very particular work necessary to dry stock for piano manufacture.

The Fairwood Lumber Company of Fairwood, Va., spruce and hardwood manufacturers, have opened a selling office at 18 Broadway in charge of E. A. Pope.

G. A. Mitchell of Buffalo, the newly elected president of the Lumber Insurance Company and the Adirondack Fire Insurance Company of this city, spent last week at headquarters, 66 Broadway, giving attention to insurance affairs.

E. A. Wilson, Wilson Cypress Company of Palatka, Fla., passed through the city last week en route home after a visit to Michigan points and a brief stay at Saginaw Lake in the Adirondacks. His mills have been producing about two million feet per month so far this year and he is well satisfied with the present and prospective cypress market.

### Philadelphia.

The fifteenth semiannual meeting of the Lumbermen's Association, Inc., was held at Mount Airy, Pa., on July 11, 12 and 13. Delegates were in attendance from all parts of Pennsylvania. Besides the executive work done at the various meetings, excursions were made to points of interest in the vicinity in company with the ladies who made part of the gathering.

The president and board of directors of the American Forestry Association have informed the Lumbermen's Exchange of Philadelphia that it has been elected to membership in that body.

Since the announcement that the Lumbermen's Exchange of Philadelphia would move to a more central location seven new applications for membership have been received and more are promised. Among those whose names will shortly be balloted upon for admission are the following: Atlantic Coast Lumber Corporation, by T. A. Dudley, Crozer Building; Coppock, Warner Lumber Company, 1826 Land Title Building; Horace B. Hazard, Drexel Building; Frank C. Kolla, 3840 Spring Garden street; Righter-Parry Lumber Company, 520 Land Title Building; Tomb Lumber Company, Real Estate Trust Building; and J. Randall Williams & Co., 516 Arcade Building.

Jerome H. Sheip of Sheip & Vandegriff, who has been ill for some time, is now completely recovered and took occasion during the last week to visit New York and attend to some matters there connected with his firm which needed his attention.

Francis Goodhue, Jr., secretary and treasurer of the Philadelphia Veneer & Lumber Company, has taken summer quarters at Medford, N. J., with a party of congenial friends.

A. Will & Sons find their business in mill work and fixtures rapidly improving. Since the closing of the strike some weeks ago they are greatly increasing their output.

Fessenden Hall, one of the heaviest mahogany and veneer men in Philadelphia, reports that June was the greatest in volume of business that his company has had for a long time, and he looks for a continuation of the good business.

Thomas W. Skinner of Tunis & Skinner is preparing for a trip to Arizona in August. Mr. Skinner's visit will consume an indefinite time and while he is in the West he will look up timber tracts.

The mills of the Little River Lumber Company at Townsend, Tenn., are now running at their full capacity. The company has also several of the dry kilns that they lately constructed in operation.

Mr. Mings of William McCormick, who has been touring Europe for some time, sailed for home July 14 and expects to be back to work about the end of July.

Max Pease of Galloway Pease Company, Johnson City, Tenn., has been visiting the trade during the past week.

Frank Holloway of the Holloway Lumber Company is touring West Virginia in the interests of his firm.

J. W. Warner of the Coppock Warner Lumber Company is making an extensive visit through the South and reports from him indicate that the mills of the concern are turning out lumber in good shape.

C. E. Johnson of the Producers' Lumber Company left for the South last Wednesday and will be gone for some time. His trip is to be an extensive one, he will secure stocks of hardwood timber.

### Baltimore.

The logs of a walnut tree that is said to be the largest ever brought to Baltimore have been received here, consigned to John L. Alcock & Co. It is of the black variety and was cut on the farm of E. Pettibone, Anne Arundel county, by E. M. McClintock. This tree yielded not less than thirty nine logs, thirty eight of them averaging eight feet in length and running in diameter from 16 to 40 inches, while the butt end is twelve feet long and measures at the top 6 feet 2 inches in diameter and at the ground end 8 feet 8 inches. As the butt shows considerable figure, the piece of wood, it is thought, will be especially valuable to veneer manufacturers.

A certificate of amendment to the charter of the R. E. Wood Lumber Company of this city, to increase the capital stock from \$500,000 to \$1,500,000, has been filed for record in the courts at Dover, Del., and at Baltimore. The company, together with its connected interests, the Montvale Lumber Company, which is the real estate holding company, and still another corporation has undertaken various extensive improvements and has attained a very prominent place in the hardwood trade. It maintains a suite of offices in the Continental Building here and has branches in a number of places. R. E. Wood, president of the company, has just returned from Forest, Va., where he attended the wedding of Edwell Lee Warren, the company's representative at Bullock, Carter county, Tenn., to Miss Trula Leigh Keenan.

The Tinley Brothers Company has been incorporated here to succeed the firm of Tinley Bros., manufacturers of sash, doors and frames on West Pratt street, near Fremont avenue. The capital stock is \$100,000. Frederick G. Tinley, Sidney H. Tinley, Alfred J. Tinley, B. C. Tinley and William Robbins are the incorporators. The firm some time ago outgrew its present quarters and early in the year purchased a large lot in Southwest Baltimore, where a modern plant of large capacity is being erected.

The buildings will all be of brick and will be equipped with the latest machinery.

The contract for the erection of the new saw and planing mill for the Baltimore & Ohio Railroad Company at Mount Clare has been awarded to Edward Brady & Son. The building will be of brick and steel and will have every modern facility.

Thomas Hughes of the hardwood firm of Carter, Hughes & Co., Union Dock, is on a trip to Troutdale, Va., where the Iron Mountain Lumber Company, an allied concern, is conducting saw mill operations under the personal supervision of David T. Carter, another member of the firm. En route Mr. Hughes stopped at a number of mills, with which the firm has business relations, and made arrangements for the shipment of stocks.

James H. Cranwell of the J. H. Cranwell Company, United States Fidelity Building, has been on a trip to West Virginia and Tennessee, where his company operates a sawmill.

John L. Aleock of John L. Aleock & Co. spent a week or so the early part of this month in West Virginia, in the course of which he visited the firm's offices in Clarksburg and other places and looked over the trade situation. He found the mills busy and stocks, especially of oak, hard to get.

The stockholders of the Gunpowder Lumber Company filed a petition in the Circuit Court at Towson, Baltimore county, asking that the company be dissolved, as it has stopped business. Attorney John Mays Little was appointed receiver to wind up the affairs of the company. The assets and liabilities are small.

### Pittsburg.

The regular weekly dinner at the Union Club July 17, the Pittsburg Wholesale Lumber Dealers' Association unanimously reported a most enjoyable occasion. The association is saying its members nice sums of money this year by putting them "wise" to the financial frailties of several seemingly prosperous retail concerns in the Greater Pittsburg district, some of which have already "gone to the wall."

The genial countenance of S. E. Coons is missing from the office of William Whitmer & Sons, Inc., in the Empire Building. In two weeks he will be back from an extended vacation trip. The firm has made all sorts of new records since January 1 in the sales of spruce and had a semi-yearly report to submit that would have brought smiles to a veteran lumberman.

Pittsburgers have lately had an object lesson in the cost of foundation work that has been exceedingly profitable for lumber dealers. The A. & S. Wilson Company, which is erecting the two 20-story skyscrapers of the Union National Bank and the Commonwealth Trust Company at Fourth avenue and Wood street, had to go down 65 feet for a solid bed. Skyscrapers stand on the other three corners and there are probably more street cars rounding that corner than any other in Pittsburg. Before the workmen were down to the rock the streets began to cave and the most serious results were threatening. To ward off the peril the contractors literally filled the big 65-foot excavation with yellow pine and oak timbers, over 500,000 feet in all, shoring and bracing and wedging them in every direction to prevent the streets caving in. Between these sticks the great steel girders and posts have been let down one by one and as fast as one section is completed the timbers are removed.

The L. L. Sattler Lumber Company is getting affairs shaped up for a big campaign this fall in Nettoway and adjoining counties in Virginia, where it recently acquired an immense tract of timber. It is estimated that the tract will give the company a ten year's cut, and its facilities for getting the lumber to tidewater by way of the James river and other streams are such as to warrant the assumption that it will be a most formidable competitor in all the seaboard cities.

Not a little of the lumber will be cut for export trade.

The Ambridge Lumber Company, which has been doing business at the new town of Ambridge, sixteen miles down the Ohio river from Pittsburg, has gone into the hands of a receiver, the International Savings & Trust Company of Pittsburg. The liabilities are reported at \$12,000.

The Leshner Lumber & Supply Company has applied for a Pennsylvania charter. It is a family concern, being composed of Frank, James M., Edgar J. and Elizabeth Leshner, and will do business from Pittsburg offices.

The W. M. Gillespie Lumber Company of which the well-known "Billy" Gillespie is the head is getting into the hardwood market with a vim from its fine suite of offices in the Farmers' Bank Building. Mr. Gillespie has some of the best connections out of Pittsburg and his intimate acquaintance with the local market makes the success of the firm practically assured.

Oscar H. Babcock of the firm of E. V. Babcock & Co. is in the Northwest looking up the situation as bearing on next year's trade. The firm will have some very large contracts placed there shortly.

R. A. Allen surprised his friends in June by taking into himself for a life partner Miss Martha Avery, a well known society young lady of this city. The couple spent their two weeks' honeymoon on the lakes. Mr. Allen is connected with the firm of Willson Brothers, which is getting to be known as one of the most hustling and successful concerns that goes after hardwood orders in this market.

The Linahan Lumber Company is having a splendid trade in hardwood in the manufacturing towns of the Middle West. J. J. Linahan notes also a distinct improvement in the tone of the local market, due chiefly to the break in the carpenters' strike. There is much more inquiry the last week, he says, and more of a disposition among yard men to replenish stocks. The company is getting most of its oak from its Kentucky mills and finds that there is a good demand for "shorts" among the mills as well as for the best grades of lumber.

The Flint, Erving & Stoner Company is pushing operations at its small mills in Northern Pennsylvania which are cutting hardwood mostly. A large part of this lumber finds a market in Buffalo and the lake towns where building is active this summer. The company's big operation in West Virginia is being organized in good shape and by fall it will be in a position to supply much larger lots of lumber on short notice than the great majority of the Pennsylvania firms.

Frank W. Willson of the Willson Brothers Lumber Company is at Conway, S. C., where the firm is getting out fifty cars of lumber a month. Fred C. Emley, head travelling man for the Willsons, is cooling off for a couple of weeks up the lakes.

The Clear River Lumber Company reports that mill cut chestnut is getting plenty but is selling in large quantities. Last week the company booked orders for twenty-five cars of this lumber at an average of \$18 per thousand. The company's Ohio trade is picking up fast this month and from this section it is getting some choice orders for hardwood for furniture and handle manufactures.

J. M. Hastings, president of the J. M. Hastings Lumber Company, is back again from Nova Scotia, where he spends a good part of his time overseeing the enormous operation of the Davidson Lumber Company, of which he is also the head. Over 700 men are now employed by this company and the monthly output of lumber runs from 5,000,000 to 6,000,000 feet. Of this about 25 per cent goes down to New York. Agents of the company are working up a fine trade for its lumber in South American ports, and from the best it has had a good market in England. Mr. Hastings makes the interesting announcement

that English capital is seeking five hundred million in the Canadian provinces chiefly in the purchase of comparatively small tracts of timber land, which are rapidly increasing in value. Such tracts are now sold at 85 per acre or less, depending on their accessibility, but the work of the Davidson Lumber Company and one or two other big concerns is opening the eyes of the land owners to the value of their holdings, and prices are going up.

Talking of orders, J. N. Woodley, sales manager of the American Lumber & Manufacturing Company has just got on his books an order for 700,000 feet of oak to be cut in Arkansas, Louisiana and Tennessee and shipped to New Orleans for export. This is one of the many big contracts that the American has lately secured in hardwood and is very satisfactory as it opens up a comparatively new field for work. J. F. Montgomery, secretary of the American, is taking his two weeks' "roll" in the wilds of Wisconsin.

### Buffalo.

The hardwood yards this summer are closing on Saturday afternoon during July and August. Half an hour is added to the usual ten-hour day during the first five days of the week and the other two and a half hours are given to the employees, for no change is made in the pay on that account.

The death of Franklin Lee July 9 removes a member of the Buffalo lumber, and especially the woodworking, trade of long standing, though he was not at the time of his death in active business. The old firm of Lee, Holland & Co. having merged in to that of Montgomery Bros. & Co. several years ago. He was an uncle of George R. and H. E. Montgomery and was 80 years old.

Scatcherd & Son, having their Memphis mills running in good form now, hope to keep them supplied with logs the rest of the season. There will be none too much oak to supply the trade even then.

Reyer, Knox & Co. are going quite heavily into cherry of late, considering the scarcity and the high price of this wood, and will carry an assortment of it right along hereafter.

H. A. Stewart is off to West Virginia again and will not return till he digs out a lot of oak and cherry lumber. He seems to know the spot where good stuff in those lines is to be found.

The southern trip of A. Miller is more and more productive of good stock, especially oak and poplar, though it was made in May. There is nothing like doing business on the spot.

The old specialty of ash and elm from the upper lakes is again making the docks of T. Sullivan & Co. active. A big lot of birch is now also added, so that the force is large in the handling line just now.

G. Elias & Eric make two water routes meet now in their yard, the lake and the canal, and when the Buffalo river is deepened on the plan for which the city is indebted to A. J. Elias there will be no rail transfer between.

Campbellsville, Ky., is one of the supply centers of the Standard Hardwood Lumber Company, which will get several million feet from there this year, including oak, ash, chestnut and poplar.

J. B. Wall is off to the New York Furniture Exposition in the interest of the table factory controlled by members of the Buffalo Hardwood Lumber Company.

The yard of O. P. Yeager is receiving a new supply of plain oak and as usual is carrying a good assortment of everything, though trade is good enough to make it hard to keep large stocks of all varieties.

The amount of new lumber in the yard of the Empire Lumber Company shows that the old plan of giving up the yard is not to be carried out right away. Some very fine oak is coming in from the Arkansas mills now.

Members of the Hoch McLean Lumber Co.

pany are looking to the fishing preserve owned by them in northern Canada now and R. D. McLean is taking the initial vacation in that direction. Yard business is strong.

#### Detroit.

The death of Rudolph Boltz occurred recently after a long illness from dropsy. He was one of the first manufacturers of special furniture and store fixtures in Detroit and was an extensive user of hardwoods.

Hertz & Hoshach, hardwood finishers, Fourth and Holden avenues, have secured the contract for the interior finish and sash work of the new Country Club at Gross Pointe, which is being erected at a cost of \$60,000. The woods used are oak and whitewood.

J. H. P. Smith, of Parkersburg, W. Va., was a visitor in Detroit on business in connection with the Dennis & Smith Lumber Company, Detroit, of which he is a member. A. S. Dennis, the other partner, expects to leave for Virginia in a week to visit the firm's various hardwood mills in that state.

There is a good movement of hardwood lumber considering the season, all the factories in Detroit and vicinity reporting plenty of orders. One of the signs of the times is the decline of wagonload trade in hardwood lumber, and several of the yards which have in former years depended upon this trade are going out of the yard business and will confine their attention to direct shipments from mill points. Practically all hardwood lumber consumers nowadays are able to buy in carload lots, which makes it hard sledding for the retail hardwood yards.

Col. George F. Lound of the H. M. Lound's Sons Company at Au Sable, Mich., was in the city this week. He states that his firm still has fifteen or twenty years' cut at Au Sable, the stock being practically all hemlock and hardwood.

Walter R. Hall, of Walter R. Hall & Brother sailed this week for a short vacation trip to Europe. He was accompanied by his father, who is past seventy years of age. The firm's interests will be looked after in his absence by Thomas A. Hall, the junior partner.

Owing to the sharp advance in hemlock prices during the past year end hardwood is being used to a considerable extent for construction purposes. Brownlee & Co. are making a specialty of it and report a large business in this line.

#### Saginaw Valley.

Mershon, Schuette, Parker & Co. have started the manufacture of box shooks of hardwood. For some grades of boxes it works admirably and it is likely it will be utilized extensively.

Handy Bros. bought all the beech culls manufactured by Kneeland, Buell & Bigelow Company which are utilized in the making of boxes, and they also contracted all the basswood culls this concern will cut this year, which will go into box material.

It is estimated there is nearly 1,000,000,000 feet of hardwood timber tributary to the Detroit & Mackinac railroad between Bay City and Cheboygan, and there is a much larger quantity tributary to the Mackinac division of the Michigan Central.

Hundreds of thousands of feet of hardwood logs are lying along the track of the Detroit & Mackinac railroad between Alpena and Cheboygan. They are picked up by a train and loaded with a steam loader, then freighted to manufacturing points along the line. Many of them are hauled into Alpena.

Lumbermen cutting hardwood logs in the woods state that it is impossible to get men enough to handle the business; in fact, help was never so scarce.

The Lohdell-Bailey Manufacturing Company at Onaway is turning out spindles for grill work which is used over arches in private residences, having placed machinery in its plant for the purpose. This company is also manufacturing

handles, flooring, bicycle rims and other specialties besides sawing about 16,000,000 feet of lumber every season.

Will McCormick of the McCormick-Hay Lumber Company of Saginaw says that his firm is having a fine trade, almost everything in the shape of lumber being wanted. The company has handled more or less southern oak, but will go into it heavier than ever this fall and winter. Mr. McCormick says he finds prices generally firm. He has bought a quantity of elm recently and says ash is particularly strong and basswood is selling well.

Large quantities of hardwood go into the manufacture of woodenware, staves and heading in this section. At LaRoque, north of Alpena, a bowl factory is in active operation. A. Wheeler is operating a large stave and heading factory at Bay City. Bousefield & Co., also of Bay City, operate the largest woodenware factory in the world, using several million feet of basswood and other hardwoods annually, as does also the Palmerton Woodenware Factory at Saginaw. Gardner and Peterman of Saginaw operate a stave and heading plant at Twining, another at Onaway, and still another at Millersburg. The Chicago Last Factory Company is operating a plant at West Branch and the Dayton Last Works at Gaylord both use hundreds of thousands of feet of maple in the manufacture of shoe lasts.

#### Grand Rapids.

Edward C. Allen of the Gibbs, Hall & Allen Company visited the company's office in this city last week. Mr. Allen is operating a hardwood mill at South Leroy on the G. R. & L., which has been in operation for the past thirty years, and enough timber still remains in that vicinity for a cut of several years' duration.

John Hawkes, a veneer salesman of Cincinnati, who has been in this market during the furniture exposition, sold American walnut crotches in this city thirty-three years ago. He introduced French walnut burls here, now known as Circassian walnut, and this class of veneers is being used extensively in the better lines of bedroom furniture.

George B. Daniels has resigned his position with the Acme Lumber Company.

The furniture sales just closing in this market have been of such volume as to insure busy factories throughout the year. Though not a recordbreaker in volume, the sales have been quite a percentage heavier than a year ago, especially in furniture of the better grades. Among the last to leave the market were the Pacific coast buyers, and they have been liberal purchasers of the medium and better stuff, in spite of predictions that San Francisco would not be in position to want furniture for some time to come.

#### Indianapolis.

Papers were recently filed with the secretary of state showing the consolidation of the Crescent Handle Works of Evansville and the Hartley Handle Company of Muncie, the new firm to be known as the Globe Handle Company. The capital stock is \$50,000, with the following directors: William A. Hamilton, Albert J. Ott, John K. Slack, Baird W. Hale and George E. William A. and Harry D. Hartley. The new concern will operate at Evansville, the Muncie plant being moved there.

The Home Planing Mill at Muncie has been incorporated with a capital stock of \$15,000. Directors: William S. Perdine, Daniel B. Miller, Irvin L. Morrison, Insley J. Moser, John F. Wright, John T. Clark and William O. Bowers.

The Cardwell Lumber Company of Decatur has been incorporated with a \$10,000 capital stock. Directors: Rufus K. Allison, John W. Vail, Aaron T. Vail, Joseph E. Thomas, Don L. Quinn, Charles S. Niblack and French Quinn.

Because of a scarcity of lumber in its vicinity the heading factory owned by Samuel Dunbar

of Wabash, Ind., has been moved to Quigley, Ark.

Mrs. Calvin Myers of Bentonville, Ind., recently sold four large poplar trees that brought her a total of \$275. The trees yielded a total of 13,000 feet of lumber, the yield of the largest one being 5,000 feet.

#### Asheville.

Trade has been dull in Asheville and western North Carolina during July. This, however, is nothing more than the hardwood dealers expect, as July and August are always dull. The buyers are off on summer vacations and few contracts are made during these two months. The mills are not idle, however, and when the season again opens in September all the mills will have good supplies of the best woods.

The secretary of state this week chartered the Plymouth Lumber Company of Plymouth, N. C., with \$150,000 capital stock, 6 per cent of which is preferred and \$50,000 paid in. E. J. Conklin of Plymouth and New York parties are the stockholders.

The Enterprise Lumber Company's plant of Goldsboro, N. C., was badly damaged by fire recently. The property destroyed amounted to about \$15,000, covered by insurance. The planing mills and the dry houses were not damaged.

Joseph S. Stone of Lumberton, N. C., was recently instantly killed by the explosion of a boiler at his sawmill at Long Branch, six miles from Lumberton. He was attempting to remedy some irregularity while the regular engineer was away when the boiler exploded, killing him instantly.

#### Bristol.

Ewell Lee Warren and bride, formerly Miss Trula Leigh Keenan, who were married on July 11 at Trenton, Tenn., have returned to Bristol and will reside here until September, when they will move to Baltimore, Md. Mr. Warren is prominently associated with the R. E. Wood Lumber Company of Baltimore, which operates largely in this section.

William E. Uptegrove of William E. Uptegrove & Brother, New York City, announces that the \$110,000 cigar box lumber plant of the company at Johnson City, Tenn., which was recently destroyed by fire, will be rebuilt and the work of reconstruction will begin at a very early date. The work of liquidating the \$75,000 insurance which was carried on the plant has been begun.

W. R. Stone, Jr., of the Stone-Huling Lumber Company, has returned from a delightful vacation in Virginia.

W. O. Came, president of the Bristol Door & Lumber Company, is now in a hospital at Boston to undergo an operation for appendicitis.

G. F. McCain of W. G. McCain & Sons of Johnson county, Tennessee, was over from Nevada this week.

Lemuel Gardner, who for several years represented the A. M. Turner Lumber Company of Pittsburg as buyer and inspector at Damascus, Va., and other points in the South, died in Bristol last week of softening of the brain. He resided at Boston and has a family in that city. The remains were shipped to his old home in Wisconsin for interment.

J. Alwyn Cannon of the Richland Lumber Company has returned from Baltimore and Ocean City, where he spent a delightful vacation as the guest of E. E. Jackson, Jr., of the Kingston Lumber Company of Laurel, Miss.

D. W. Nelly of the Rumbarger Lumber Company of Philadelphia; J. H. Folsom, representing the Rode-Horne Lumber Company of New York; E. H. Hollman of the E. H. Hollman Lumber Company of Philadelphia were in Bristol last week on business.

Among other visitors to Bristol the past week were: E. R. Miller, representing Harry S. Hayden of Chicago; W. L. Douglas of the Crosby-Beckley Company of New York City; John T. Dixon of the John T. Dixon Lumber Company at Elizabethton, Tenn.; George H. Mell of Kane, Pa.; William M. Dickey of

Brookville, Pa.; Joe A. Wilson and F. B. Vines of the lumber firm of Vines & Wilson of Johnson City, Tenn.

J. A. Wilkinson has begun active work on his new \$50,000 lumber plant in South Bristol and will push the mill to completion. He will also establish assorting yards, etc., on the site.

The Bryan Lumber Company reports excellent business conditions and heavy shipments. This company is doing a big export business and is handling a large amount of stock.

#### Cincinnati.

The Cincinnati Lumbermen's Club will have a joint exhibit at the coming Fall Festival. This was decided upon at a meeting held at the Business Men's Club last week. The exhibit will cost in the neighborhood of \$1,000. A committee, of which George Littleford is chairman, was named to arrange for the exhibit. The club has also written to the National Hardwood Lumber Association to learn why it was not consulted regarding the appointment of Fred Ferguson as deputy inspector here to succeed Wm. Stewart. While there is no opposition to Mr. Ferguson, the club desires to learn why it was overlooked.

John P. Hanna of the Wiborg & Hanna Company has returned from a ten days' stay in Tennessee on business. The company reports its business in excellent shape.

A salt well which is issuing 500,000 gallons of water has been discovered at the M. B. Farrin Lumber Company's yards, Winton place, by workmen who were digging for fresh water to be used at the new pulp plant the company is erecting.

Everything is in tip-top order at the Talbert Lumber Company's plant in Winton place. The concern recently removed to this city from Greensburg, Ind.

The directors of the Industrial Bureau are negotiating with two large woodworking concerns who have declared a willingness to locate here provided certain arrangements are made. One of the plants is at present in New Jersey and the other in Kentucky. Names have not been divulged.

Leland G. Banning, who has been touring Europe for several months, was in an automobile accident at a town in Denmark a fortnight ago. At first news was received in this city that he was seriously injured, but later accounts say only slightly. Mr. Banning's cousin, Mrs. Love of this city, and J. C. Brenner, a lumber exporter at Norfolk, Va., were the other occupants of the automobile. They fortunately escaped with a few bruises.

Hardly any local hardwood lumbermen have made arrangements for a vacation as yet. Business cares have occupied their attention and it is not likely that vacation will be thought of for another month.

#### Chattanooga.

The Hugh McLean Lumber Company is operating day and night in order to dispose of a surplus of logs. The concern recently closed down for general repairs on the plant and a band mill of 20,000 feet daily capacity was installed.

W. M. Fowler, treasurer of the Case Lumber Company and president of the Fowler-Personett Lumber Company of Birmingham, Ala., is spending his vacation at Lake Tamagami in Michigan. He will return about the first of August.

John Cathcart of New York, who owns a mill at Decatur, Ala., passed through this city recently from Decatur en route home.

J. W. Thompson of the J. W. Thompson Lumber Company, Memphis, Tenn., was a recent visitor among local lumbermen.

J. M. Card of the J. M. Card Lumber Company has returned from a business trip through Alabama and Mississippi, where the concern is doing a large business.

A. A. McGregor, a prominent stave and barrel manufacturer of this city, is inspecting one of his plants at Paint Rock, Ala.

D. W. and W. B. Hughes of the Central Manu-

facturing Company and their families have gone on a trip to Scotland.

#### Nashville.

John W. Love, the popular Nashville lumberman, of Love, Boyd & Co., has gone for a stay of several weeks to his summer hotel at Markland, Nova Scotia. Mr. Love is largely interested in what has proved a good investment there, and being a great fisherman always enjoys his Markland trip keenly. He is accompanied by Mrs. Love and the children.

Nat Baxter, Jr., and S. R. Sanford of Nashville have recently become interested in a large lumber project in Texas. Together with L. E. Sullivan of Florida they have acquired a tract in Titus and Morris counties containing 40,000 acres of hardwood lands. Two mills will be erected, one on the Cotton Belt road and the other on the tramway connecting with that railroad. About \$250,000 will be spent in machinery and equipment for business. All kinds of articles manufactured from hardwoods will be turned out. The company is known as the Sanford Sullivan Lumber Company and it has a paid up capital of \$500,000. Mr. Baxter, who will be general manager of the concern, is one of the wealthiest capitalists in Tennessee.

Nashville's lumber interests have suffered two fires in the past few days. A few nights since a blaze was discovered at the big plant of the E. & N. Manufacturing Company that threatened the entire establishment. The fire lasted several hours, but by good work firemen confined it to a couple of dry kilns. In these, however, was stored a quantity of fine lumber, some 250,000 feet of various grades. The loss was about \$12,500 and was covered by insurance. More recently the E. & O. Cedar Company, located at North Nashville, burned out. This company manufactured lead pencil material in the rough and was owned by capitalists of New York and Berlin. They have establishments like it in various parts of Tennessee and the plant here was a small one. The loss was about \$7,000, with insurance of about \$5,000.

Lumber business at Tullahoma, Tenn., in Coffee county, is reported quite active. A factory that will work 100 men and manufacture all the wooden portions of buggies and wagons is to be located there in the near future. A stave and barrel factory is also to move to Tullahoma shortly. The latter will work sixty men at first.

At a recent session of the Nashville Association of Wagon & Carriage Makers the invitation of the Atlanta Vehicle Club to attend the convention of National Association of Carriage Builders, convening in that city next October, was accepted.

A special from McEwen, Tenn., reports that P. H. Clark, a prominent stave and lumber dealer of that place, was severely injured recently by a bad fall.

Dr. J. T. Bray's sawmill at Camden, Tenn., was destroyed by fire last week. A spark from the smoke stack did the work.

Robert Dyas of Nashville is at the head of the Arrow Furniture Company of New Decatur, Ala. The plant is being enlarged to twice its former size. Although only a few years old, this is one of the leading establishments in that part of the South.

John B. Ransom of John B. Ransom & Co. leaves shortly for Nova Scotia, where he will join Mr. and Mrs. John W. Love at Markland.

Nashville is soon to have new building laws. The city council has been at work for some time on a new draft covering and curing many former deficiencies. Heavy timbers and scantlings will be used in the future and architects and contractors will have to be more careful. The bill comprises about 160 typewritten pages.

#### Memphis.

The latest purchase of timber lands by a Memphis lumber firm is a deal involving 4,000

acres in Grenada, Tunica and Tate counties, Mississippi, made by the Memphis Rim & Bow Company. The tract is well timbered with hard woods, and is touched by the Illinois Central and Yazoo & Mississippi Valley Railroads, so that development will prove an easy matter. The timber will be brought to the Memphis mill of the company. The amount involved is about \$50,000.

The Hugh McLean Lumber Company's mill in New South Memphis will be closed down during the current week. Scarcity of timber on the yards is the reason for the suspension of operations. The company has plenty of logs on the railroad, but it is unable to get the timber transported to the city as rapidly as it is needed. O. M. Krebs, one of the managers, says the company will soon be getting logs from other roads than the Y. & M. V. When it does it will not have the interruptions which have occurred recently on account of log short age.

The Wolverine Manufacturing Company has begun the operation of its plant here, cutting dimension stock to be shipped to the Cadillac Cabinet Company, Detroit, Mich. It is now operating seven or eight machines and has a monthly capacity of 300,000 feet. For the present it will cut only oak, but gum is to be used to a considerable extent hereafter. The company, according to George A. Blessed, the manager, has made plans for the addition of five or six more machines early this fall. While the first requisite is the cutting of dimension stock for the northern plant of the company, stock will also be manufactured to be sold in the open market.

J. E. McSweyn of Grand Rapids, Mich., arrived in Memphis a few days ago to take charge of the plant of Hugart & Kendal in New South Memphis. Both Messrs. Hugart and Kendal make their headquarters in Grand Rapids. Certain improvements are contemplated by the management, but nothing is ready for publication.

The Fenn Brothers Manufacturing Company, manufacturers of hardwood flooring, has been in operation about a month, but the building is much crowded and things are not going as smoothly as desired. W. Goodjohn, the manager, however, says that everything will be in splendid shape within another month and that the capacity of the plant will be materially increased.

R. J. Darnell of R. J. Darnell, Inc., sailed for Europe from New York July 19, accompanied by his son, Roland, who is about nineteen years old. George D. Burgess of Russe & Burgess sails early next week and will be gone the entire summer.

The Cochran Lumber Company, of which R. T. Cooper is president, has sold to the Tyrone Lumber Company of Earle, Ark., a tract of 5,100 acres of hardwood timber lands near Earle. Mr. Cooper has also sold a strip of land in North Memphis from the old yards of the Cochran Lumber Company to the Lat'ede gas interests of St. Louis, who are erecting a gas and electric lighting plant in this city. The box plant of the Cochran Lumber Company is now being operated under lease by Moore & McFerrer.

The Briggs & Cooper Company, Ltd., of Saginaw, Mich., has removed its yards from North Memphis to a tract of land near the Dudley Lumber Company's yards in South Memphis.

Two significant deals in gum have been closed here within the past fortnight. One involves the sale of 1,000,000 feet of low-grade gum lumber by a single firm to a large box manufacturer and the other is the closing of a contract with a box user for 50 carloads of gum box shooks. The idea has been gaining ground rapidly during the past few months that gum must be substituted for cottonwood in box manufacture because of the scarcity of cottonwood and these two deals suggest that the movement is beginning to get well under way.

The Green River Lumber Company of this city has purchased, through the Standard Land

company. Senatobia, Miss., a large tract of hardwood timber lands near Savage, Miss., formerly owned by E. J. Parker, a prominent millman of Wildersville, Tenn. Mr. Parker sells in order to concentrate his interests. He has recently purchased considerable timber lands near Goshorn, Miss. The Green River Lumber Company has a large hardwood mill in North Memphis. The price was \$44,500 cash.

The Tight Stave Manufacturers' Association has been in session here this week with a large attendance. One of the most significant features of the meeting was the report of Secretary E. H. DeFolough of Louisville, Ky., showing a shortage of 20,000,000 staves during the past season. Mr. DeFolough points out that the prospects are for a good business during the forthcoming season, though there will be increased difficulty in manufacture because of the scarcity of labor and because of the greater distance timber must be hauled. The meeting adjourned to convene in January at Memphis, when the election of officers will occur.

W. H. Groble of the Three States Lumber Company and the W. E. Smith Lumber Company has returned from an extended trip to points in Michigan.

A. N. Thompson of Thompson & McClure has just gotten back from a business trip to Cincinnati.

The tow boats on the Mississippi river are very busy handling timber from below Memphis. They are making an effort to get the logs from the tributaries of the Mississippi before the water gets too low. There is consequently some difficulty in getting boats to bring timber down from above, and there is therefore some talk of rafting it. Several firms here have received consignments of river logs during the past fortnight, while some logs have passed up the river to Cairo and Ohio river points.

S. Willner, general manager of the Memphis Art Wood Company of South Memphis, has returned from a trip to Europe. The plant of the company is not operating just now owing to trouble encountered from the action of the chemicals employed when they come in contact with water. The company, however, is making efforts to relieve this condition.

The Arrow Furniture Company of New DeKalb, Ala., has decided to double its capacity, although it is already one of the largest in the state. Robert Dias, formerly of Nashville, Tenn., is in charge.

One of the most important meetings of the Lumbermen's Club of Memphis this year was held at the Gayoso Hotel July 21. It was called for the purpose of taking action regarding the minimum freight ruling of the Missouri Pacific System, but several other matters of interest were also disposed of. The attendance was the largest for some time, there being twenty-four lumber firms represented.

Memphis lumbermen have been protesting individually against the hardship occasioned by the new minimum weight ruling in question, but, finding that individual action failed, it was decided to call a meeting so that the entire club might take up the matter. George C. Ehemann of Bennett & White introduced resolutions which formed the basis of discussion which, with slight changes, were adopted, as follows:

Whereas, the Missouri Pacific Railway has issued the following amendment to its lumber tariffs, effective June 1, 1906, to-wit:

"Refer to tariff and cancel minimum weight named therein and apply the following: Minimum weight of car 40,000 pounds per car when car used is of greater capacity than 40,000 pounds; minimum weight 35,000 pounds per car when car used is 40,000 pounds capacity or less, but in no case shall the minimum exceed the capacity of the car. When car is loaded to full visible physical capacity, actual weight will apply, subject to a minimum weight of 24,000 pounds."

And as said amendment in the shipment of lighter woods, such as cypress, gum, cottonwood, elm, etc., owing to the impracticability of securing cars of certain sizes and of at all times loading cars to their full visible physical capacity, is working a hardship on shippers, and as our

past experience indicates that the minimum weight will be assessed regardless of the fact that cars are loaded to their full visible physical capacity, therefore be it

Resolved, That the Lumbermen's Club of Memphis, Tenn., protests against said amendment which has been issued without consideration of lumber shippers and is arbitrary and unjust, and if continued in effect will cost them large sums of money annually; and be it further

Resolved, That a committee of five be appointed to act in conjunction with other organizations and confer with Missouri Pacific officials with a view to having the former basis of minimum weight restored.

The other organizations referred to are the Lumbermen's Club of St. Louis and the Memphis Freight Bureau, the idea being that, since the Iron Mountain is largely a St. Louis road, nothing can be accomplished except through the cooperation of the lumbermen of that city. It was the consensus of opinion that, if the ruling is enforced, lumbermen will have to pay at the new minimum weight regardless of the loading of cars to full visible physical capacity. The following committee was appointed by President Barksdale: George C. Ehemann, E. E. Goodlander, James E. Starke, S. C. Major and J. W. McClure.

W. A. Dolph of the I. M. Darnell & Son's Company, through whom the suit was brought regarding the payment of state, county and municipal taxes on lumber manufactured from logs brought into Memphis from other states, precipitated a lively discussion by suggesting that Memphis lumbermen bear the entire cost of this suit. The case was won in the lower courts by I. M. Darnell & Son's Company, but was reversed by the Supreme Court of Tennessee. It has now been appealed to the United States Court and there is considerable expense attached thereto. It was finally decided that Nashville, Chattanooga and Knoxville lumbermen ought to contribute on the ground that these cities will be benefited as much by winning the case as Memphis lumbermen, and resolutions were adopted instructing Secretary Ehemann to notify lumber manufacturers and dealers in the larger cities of Tennessee to that effect. Lumbermen are confident of winning the suit, as, since Tennessee law exempts products of the soil of this state, including lumber, from taxation, it is an interference with interstate commerce regulations to discriminate against products of the soil from other states.

Mr. Russe introduced a change in schedule on the Yazoo & Delta branch of the Yazoo & Mississippi Valley Railroad, which operates very seriously against lumbermen of this city having interests in northern Mississippi. The members want a morning and evening train that will enable them to come and go the same day to any point on the Y. & D., and to this end the club authorized President Barksdale to appoint a committee to draw up resolutions to be presented to S. S. King, superintendent of the Y. & M. V., requesting him to put on another train. H. E. Bacon, J. B. Grant and J. P. McIntyre were appointed on this committee.

### New Orleans.

The recent organization in Mississippi of the Pearl River Valley Lumber Company and the development of the plans of the big concern are of considerable interest to all engaged in the lumber business. The company will build a new road from Jackson to Birmingham, Ala., by the most direct route and will open up an entirely new country, at the same time tapping some of the finest timber lands in Mississippi. On this land is a large amount of hardwood. The Herrick-Hogue lumber syndicate, organizer of the \$1,000,000 Interior Lumber Company which will build at Jackson, is behind the Pearl River Valley scheme and the Illinois Central is also said to be among its backers. The capital of the company is \$1,000,000, and it will also float a \$2,000,000 bond issue. Surveys are now being made and before long construction work will be started. It is understood that the road will be built along the north side of Pearl river and will cross at Jackson, near the point where the plant of the Interior Lumber Company will

be located. The officers of the big company are Fred Herrick, president; C. F. Lattimer, vice president; Arthur L. Hogue, secretary, and Roy L. Hogue, treasurer.

The Petit & Boh Company has taken charge of its new factory at Lafayette avenue and Chartres street, in this city. It is manufacturing store, office and bank fixtures, and doing considerable interior hardwood work.

The Mississippi Seating Company, recently organized at Jackson, Miss., is now making arrangements to begin operations. Its stock has been fully subscribed, and within a few days it will announce the location of the site it has selected. It will manufacture opera chairs, school desks and other articles of hardwood.

The Rouse Lumber Company of Collins, Miss., has charged the Mississippi Central Railroad with discriminating against it in the matter of cars and in a lengthy petition submitted alleges that the discrimination was the result of a conspiracy between the railroad company and the J. J. Newman interests. The case is attracting a good deal of interest. It was decided once before, but on being taken to the higher court was sent back to the Circuit Court to be retried.

The Frost Trigg Lumber Company of St. Louis has sued the Hamilton Lumber Company of Jackson, Miss., for breach of contract. It is alleged that the defendant company failed to fulfill a contract in which it agreed to furnish petitioners with 224,000 feet of lumber at \$15.25 per M feet. The damages asked are \$539.21.

The Gulf, Colorado & Santa Fe Railroad Company has notified all shippers that rates on stuff consigned to Texas ports and intended for export will be materially increased. In this particular the railroad company contends that the Railroad Commission has no right to regulate the rates on export goods and is consequently ignoring the commission's order in the case. The point is now in litigation and the railroad has taken it to the Federal Supreme Court, the case having been decided against by the Texas courts. Texas railroad commissioners have notified the shippers that they may sue to recover any freight paid in excess of the rate fixed by the commission. A fine of \$100 to \$500 is also imposed in these cases.

Lumbermen throughout this territory are much exercised over the action of the attorney general of the United States, who in a letter recently renewed his request for the testimony taken in the investigation conducted by the committee named by the Mississippi legislature to determine whether or not there was a lumber trust in that state. This letter has been forwarded to Hon. W. M. McAlister of Wayne, who was chairman of the committee. It will be remembered that in the report of the joint legislative committee it was stated that a timber trust existed in the state and legislation to remedy the conditions was advised. Shortly after the report was published the attorney general wrote for the testimony, announcing his intention to follow up the investigation. He has renewed that request and it is very evident that he intends to push the matter.

The Adams-Duson Lumber Company has been organized at Crowley, La., to develop timber lands in Acadia and St. Landry parishes, where there is a good deal of hardwood. The company is capitalized at \$50,000 and its incorporators are: W. W. Duson, Crowley; Isaac R. and James T. Adams, Catahonia parish; John E. Adams, Rapides parish; Allen T. Adams, St. Landry parish. The officers are: John E. Adams, president; W. W. Duson, vice president; James E. Adams, secretary and treasurer.

The plant of the Vinegar Bend Lumber Company at Dwight, Ala., was damaged by fire a few days ago. The loss was \$20,000, with no insurance.

The McCarthy Lumber Company has been organized in this city with a capital of \$25,000. Its organizers are William R. McCarthy, A. M. Cooke and Joseph Birg.

### Minneapolis.

Considerable hardwood timber on the shore of Leech Lake, Minnesota, is held by the Leech Lake Lumber Company, which is building a sawmill on the shore of the lake, near Walker. The company was recently incorporated with \$50,000 capital stock, and is building a single band mill. It will manufacture pine lumber chiefly, but will also turn out oak, elm, ash and basswood, which are abundant along the lake shore.

E. Payson Smith of the Payson Smith Lumber Company has gone for another business trip into the South. The company is enjoying a good run of business for the time of year and has made contracts for some long lines of stock. It has a good line of southern oak, which is selling freely.

J. C. Nolan and E. H. Nolan of the Bacon-Nolan Hardwood Company, Memphis, Tenn., were recent visitors to St. Paul, where they were formerly engaged in business. They have sold out their timber land and mill at Chaney, Miss., and have bought 10,000 acres of hardwood and gum timber land near Memphis. They are putting in a sawmill and cooperage plant, to turn out staves and heading. They are using red and white oak now in manufacturing heading, and are turning out 30,000 sets a day, and will begin making staves later. The sawmill is also a future proposition. It will run largely to gum, and the oak will be used chiefly for cooperage material.

Frank H. Lardoe, manager of the plant of the Fenwood Lumber Company of Wausau, Wis., was in Minneapolis on business a few days ago. He reports an active demand and good prices.

W. H. Sill of the Minneapolis Lumber Company says the factory trade is rather dull now, with little prospect of improvement for thirty days. He assures a heavy fall trade, however, and judging by the present condition of hardwood stocks and the outlook for consumption, he expects to see hardwood scarcer than ever next spring and stronger in price. There is little or no stock in rock elm, ash and northern oak.

C. F. Osborne of Osborne & Clark reports an excellent demand from the retail yards. They expect the supply of northern oak for wagon stock and other purposes to run low even earlier than last year.

A. E. Hein of Tony, Wis., president of the John Hein Lumber Company, was in Minneapolis a few days ago, looking over the market.

F. J. Lang, representative of the Wisconsin Land & Lumber Company, Hermansville, Mich., has opened temporary offices in Minneapolis again, as he usually does for a short time twice a year.

Halstead & Boegren, the new hardwood dealers of St. Anthony Park, a suburb of St. Paul, have moved their offices to rooms near the main door of the Northwestern Furniture Exposition Company. They are handling southern hardwood, also lath and shingles, in addition to northern oak, elm, birch, ash, basswood and maple.

The St. Paul Hardwood Door Company had a slight loss by fire on the evening of July 14. Its offices at 180 West Fourth street, St. Paul, were scorched, the loss amounting to about \$300.

An addition is being built to the plant of the Villaume Box & Lumber Company in St. Paul. It will cost \$13,000.

### Louisville.

The hot weather is sending local hardwood lumbermen off on vacations, but getting out material requires such strenuous attention these days that not a few have to spend their vacation period out in the woods. Edward L. Travis is off on a vacation, and H. M. Overstreet of the Southern Lumber Company is out of town, but is down among the mills, hardly on a vacation.

W. A. McLean of the Wood-Mosaic Flooring Company is going north next week. Speaking of business here, Mr. McLean says that his com-

pany is busy both in New Albany and at the Highland Park plant and is managing to keep logs enough to operate its mills right along, although only by steady hustling. Among the products at New Albany is quarter-sawn veneer. The company operates three veneer saws in addition to its sawmill, wood mosaic flooring and carpet works there.

The Stotz Lumber Company reports busy times in its hardwood department. It has orders ahead that are cleaning up stock pretty closely, so that it has to hustle for supplies most of the time. In fact, everything in hardwood is moving briskly and the general tendency of prices is upward.

R. M. Cunningham is on the sick list this week and T. Smith Milton, his right bower, has both hands full.

Among the out of town hardwood visitors here during the week was George N. Welch, Monterey, Tenn. He says the hardwood business is satisfactory with the exception of the timber supply, and he finds no difficulty in disposing of all the stock cut, mostly poplar and oak.

W. K. Knox of Lucas E. Moore & Co., New York, stopped here en route home from the Memphis stove meeting. Mr. Knox says his concern has been having some trouble getting enough lumber to supply its contracts, but expects to be a little better fixed in this respect hereafter, as it has the cut of a new mill contracted for, the stock from which will be available in a short while.

### London.

Visitors from America recently have been John N. Penrod of walnut fame, Kansas City, Mo.; G. M. Spiegle, Mr. Elwood and Mr. English.

## Hardwood Market.

(By HARDWOOD RECORD Exclusive Market Reporters.)

### Chicago.

There is no gainsaying the fact that the local hardwood trade is quiet. However, prices on such stock as is moving are being well maintained. This is not an unexpected condition to materialize in Chicago at this season, and in fact the trade is much better than it was at a corresponding period last year. The furniture manufacturers, who consume a large quantity of hardwoods locally, have been too busy in selling goods for the last month to pay much attention to supplementing their lumber stocks. There is every indication, however, that this consuming demand will be large during the fall. The interior finish and flooring people are buying with considerable freedom to keep up with the immense demand on their plants. There is a strong call for freight and passenger car material not only locally but in all parts of the country, on which Chicago dealers are realizing a very hard some trade.

### Boston.

In the local hardwood market the demand is not active. The majority of yards in this vicinity are fairly well stocked and in some instances consuming manufacturers are carrying larger stocks than the ordinary yard. Prices generally are well held, although buyers show no disposition to purchase beyond their immediate wants. Many are apparently holding off, expecting to be able to obtain slight concessions. Although the demand is quiet here now a good fall business is confidently expected. Dealers report a much better demand in other sections of the country than in New England, and for this reason salesmen are making more frequent trips away from home than usual. The export demand is moderate. Exporters state that foreign buyers consider prices too high. Furniture manufacturers, especially those who give their attention to office furniture, are very busy. A car shortage is reported.

Moir & Co., prominent dealers of this city and well known in the United States, failed recently.

The following clipping from the Timber Trades Journal of June 30, 1906, should interest American hardwood shippers.

"Buyers of American oak scantling in wagon sets who have old contracts on hand have not found themselves much 'torrader' in the way of delivery than two or three months ago. One excuse after another has been put forward, but with the exception of some few instances, buyers are still waiting for their shipping documents. In this matter it is not only the small men who it is well known avidly take up large contracts upon the most unsubstantial expectations of full filling them, but also a number of shippers of repute men who stand high in the hardwood world who have practically defaulted in their contracts for oak planks. It is hardly nice to think that certain well known shippers who have done a large trade, and, presumably, a profitable trade with this country in oak planks for years should now, when values have gone against them to the extent of a few cents per foot, ignore their delivery dates in the calm manner in which they are now doing. We know of instances where, through nondelivery of American scantling, wagon builders have bought freely of Baltic oak logs, and if the present neglect of their engagements continues, shippers may find, on a return to more normal times, that their trade in this country has reverted to another and older channel. We think this is a matter in which trade associations on this side might well make representations to the organizations on the other side entrusted with the care of shippers' interests."

The demand for plain oak, one inch, is quiet and offerings are slightly larger. Quartered oak is in larger offering, but values are not materially easier. Black walnut is not in large offering and values are well held. Brown ash is not in as active request as it was. Maple flooring attracts a fair volume of business. More demand is reported from New York than from Boston. Whitewood moves in a moderate way with prices steady. Cypress is steady.

### New York.

A careful survey of local hardwood conditions leaves no doubt but that the market is a little off, not so much as regards a falling off in consumption as in the curtailment in buying. Consumption is recognized to be about normal for this season of the year, but as dealers and manufacturers accumulated so much stock earlier in the year they have ample supplies for current wants.

On the other hand, both manufacturers and wholesalers made equally sure provisions as to supplying the trade, with the result that buyers have been in receipt of late of more stock than they could use or handle and considerable stock is reported being thrown back on the seller or by special arrangement held up at shipping points. This creates a very unsatisfactory condition and increases the temptation to force sales, and it must be admitted that the past fortnight has witnessed too much of a tendency in the latter direction. It is generally believed that the present situation will speedily adjust itself with the current movement in consuming channels and that by fall a brisk demand will again assert itself. It is further agreed that the local conditions in the respect as noted above do not reveal actual conditions in the hardwood trade by any means, but are simply local and due to heavy purchases.

In such business as is offering chestnut in the better grades and in common has the best call. In fact, the demand is very active and



stocks exceedingly scarce, with prices bullish. Wholesalers report their ability to sell all they can get.

Birch is also in fair call with dry stocks small and prices firm. Plain oak has eased off considerably and is reported slow. Quartered oak and maple are very quiet and prices are easy. Poplar has also lost considerable and prices are a bit shaky. Ash is firm and cypress holding its own.

#### Philadelphia.

During the past fortnight most of the wholesalers professed to seeing a slight pick-up in trade and a tendency to return to more rapid buying. There has been quite an impetus in the sale of oak, chestnut and poplar, and as these woods are nearly always a barometer of the state of market it can be safely said that the rosy views of some of the big firms in regard to a quick picking-up in trade are correct.

The heavy movement that was manifest in cypress some weeks ago is disappearing and although there are considerable quantities of the wood being sold the demand is not as great as it was some time ago.

A satisfactory feature of the local market is that the retailers are all extremely busy. Many have been forced to take on extra wagons and the rapid deliveries which they are making will soon relieve the congestion under which they have been laboring resulting from the extremely heavy spring buying. The yards have been buying more during the last fortnight and conditions point to a quick resumption of fairly heavy trade in the latter part of August and the first of September.

#### Baltimore.

The hardwood trade continues buoyant. Oak planks do not go forward in sufficient quantities to meet the expectations of the foreign buyers, and the English trade journals have lately fallen to criticizing American exporters for what is represented as bad faith. It is asserted that the exporters are not shipping oak planks in adequate quantities and are ignoring their contracts. It is threatened that if this state of affairs continues British consumers will go to other countries for their oak planks, and then the American exporter will simply be out of business. It may be said, however, that English buyers never showed any particular partiality for the American exporter and simply bought American oak because it was not only of better grade than European, but what was equally important, the United States could furnish oak enough to meet the British trade requirements. As to holding back shipments because of high prices at home, such is said not to be the case. Exporters are merely unable to get the stock and must wait for deliveries. The absorption at home is large enough to take up the output of the mills, and manufacturers are of necessity slighting the exporters. The American railroads are buying large quantities of lumber, and this helps to create an exceptional demand.

Other woods, though not exactly scarce, find a ready market and command high prices, the entire range of values being very steady, though it must be said that this is the uneventful season in the trade and a feeling of quiet prevails. Poplar is holding its own exceedingly well at the figures quoted some time ago, and chestnut, beech, birch and other woods are also in active request.

#### Pittsburg.

For the midsummer period the hardwood market shows a remarkably good front. With the break in the carpenters' strike which occurred last week more bills are coming forward to be figured and this week the hardwood firms are busier than for some time. Hardwood trade was, however, held back less by the local strike than the trade in hemlock and the pines, so that the resultant gain in business is not so large proportionately. In general dealers are well

satisfied with the outlook and expect that the market will show a noticeable improvement by September 1. Building is six weeks behind schedule in this city, and this alone is bound to shove a good part of the hardwood business into the fall and winter months when the structures recently started will be ready for finish. The local yards after a long period of slack buying are beginning to stock up again and will likely be good buyers from this time on.

Oak continues to lead. The scarcity of the better grades is very noticeable, as is the demand for bridge timbers and ties. The lower grades are being picked over rapidly and a good part of the stock sold at higher prices than prevailed June 1. The outlook for a good fall trade in oak is the very best.

This month the other hardwoods are picking up steadily in the Pittsburg market. Dealers report a very good call for basswood, ash and hickory, most of which will go to the eastern cities and towns. Birch, cherry and maple are also in better call, the buyers being the furniture and manufacturing firms of Indiana, Michigan and Ohio. Chestnut, notably the better grades, is moving a little better and poplar still shows but little signs of weakening in price. The hardwood mills of western Pennsylvania and Ohio are especially busy this month and find a ready market for every stick they can cut as fast as it is dry enough to ship. From the big plants in West Virginia and Kentucky local firms are receiving reports that indicate a full run all around and no accumulation of stocks.

#### Buffalo.

The demand has kept up so well to this time that very little falling off is looked for during the remainder of the warm season. Those who are in touch with the furniture trade are looking for liberal fall buying and there is an increased use of hardwood lumber in Buffalo. Prices are strong and there is no complaint of narrow margins on the part of the jobbers.

Plain oak is going fast, so that some yards report that it is in great part sold before it arrives and needs merely to be assorted before it goes out again. Some dealers still find quartered oak moving rather slow, but that is because it has to be held so much higher than plain and also because there is birch and other woods to take its place at a much lower price.

There is a generally better feeling in elm and basswood, though some of the trade have not tried to push these woods lately and do not get much out of them. The maple trade is good, with inch taking the lead, though flooring is moving at a very good rate. Prices are firm.

#### Detroit.

The hardwood lumber market in lower Michigan has developed nothing new that is of consequence during the fortnight. The expected improvement in the price of thick maple has not as yet appeared, and this class of stock is still inclined to drag. Inch maple continues to be picked up closely by the flooring manufacturers. The improvement in basswood noted a couple of months ago seems to have worn itself out, and this lumber is decidedly quiet just now. Soft elm continues to be slow, and the small country mills are having quite an effect on the market. The building boom in Detroit and vicinity continues unabated, and the better end of birch, red oak and other woods used for finishing purposes is selling rapidly at good prices.

#### Saginaw Valley.

"The only weak commodity in the entire hardwood list," said a manufacturer here recently, "is maple." It is purely a matter of overproduction, there being more maple lumber manufactured than the trade can take care of. It does not affect some firms on this river who contracted their entire output early in the year. There should be united effort made to lessen production until the demand catches up with the supply.

Beech is showing more strength, with a good demand. Birch is in slight demand, although the prices hold up well. Maple is sluggish. Ash is strong; all that is produced in this section of the state sells readily. Considerable elm has changed hands during the last ten days. Basswood sells readily.

On the whole every dealer and manufacturer in this section is pleased with hardwood conditions and all express the opinion that the fall business will be excellent.

#### Indianapolis.

Because the demand for all kinds of building material continues excellent here hardwood lumber is naturally in strong demand. Hardwood dealers throughout the city report a satisfactory trade so far this year. The carpenters' strike that continued from May 1 to July 1 had a depressing effect upon business. This, however, was not sufficient to make things at all dull. Dealers in every line of building stuff say they have never known a season when there was more general building going on than now. Most of it is being done in the city, but in all the small towns there is a great deal, with the material being purchased from our dealers. To make the situation more gratifying, there is no sign of a let-up in demand. This year promises to be the best the building trade generally has ever known. All of which accounts for the fact that Indianapolis lumbermen are wearing the smiles that won't come off.

#### Bristol.

Business in this section has picked up considerably within the past two weeks, and while there is a marked scarcity of several items shipments are heavy and conditions are regarded by lumbermen as satisfactory. The greatest scarcity of stock is in poplar. The majority of lumbermen say that they cannot secure enough poplar to fill orders. A large amount of poplar and hardwood timber land will be opened up all over this section by the completion of the South & Western Railway, which will extend through eastern Kentucky, southwest Virginia, eastern Tennessee and western North Carolina, and intersect one of the richest timber belts in the South.

#### Minneapolis.

This is normally a dull season in the northwestern hardwood trade. As far as the factory trade is concerned, that holds good, but dealers who cater to retail yard business report a lively demand. All sorts of yard stock are being called for. Oak in good quantities and fair amounts of rock elm and ash are being moved to the retail yards and the small shops and factories scattered over the northwestern states. Northern oak is on the market, but going fast to this trade. Most of the hardwood is going out in mixed cars. The factories are holding off in their buying till they know for a certainty about the crop returns this fall and can predict fall trade. This does not apply to the sash and door people, who have a great deal of special work on hand calling for hardwood, but are cleaning up old stock and only buying for immediate needs. They know considerable hardwood, especially birch, will be necessary to fill their orders, but they are in no hurry about buying. There is an abundance of birch in the country and it is not selling very well at present.

#### Cincinnati.

Business is keeping up remarkably well in this market, considering the season. Principal buying interest is centered in plain oak. With dry stocks at a low ebb and no relief in store for the immediate future, the market has exhibited decided strength. Quarter-sawn white oak is moving fairly well, but red is rather quiet. Ash and cypress are in excellent request and chestnut occupies nearly as good a position. Red

gum and cottonwood continue in steady demand and the market is in excellent shape. Big dealers in poplar report the market strong. Offerings are selling as fast as put up. Trade the last two weeks has been from domestic sources. Most dealers have enough orders booked to carry them through until fall.

#### Chattanooga.

There has been little cessation in activity in this vicinity since the early spring, the usual dullness at this season not having materialized as yet. Lumbermen here say that business is better than is expected at this season of the year and there is only one thing that is worrying them—the problem of dry stocks. Dry stocks are about as scarce as they have been at any period within the past year. The river mills are arranging to close down, and some have already suspended business because of the few logging tides which have failed to bring down the usual amount of logs this season. There is now, however, a tide on which will bring probably a million feet of logs. The Emory river is rising and the Tennessee is rising rapidly above Kingston. There is also a rise in the Clinch and Powell rivers.

The demand for oak, poplar and chestnut is strong and prices are holding their own. The lower grades of poplar are in unusual demand.

The export mills are doing a good business, shipping many grades of hardwoods to Great Britain, Germany, Holland, Belgium and Denmark. The local mills furnish Great Britain with a large supply of white poplar.

#### Nashville.

Little change has been noted in the local market for the past two weeks. A very small supply of low grade poplar is noticed and the better grades are none too plentiful. This wood is now quoted at prices that are higher than ever known here before. Some improvement is noted in quartered oak. None of the dealers are overstocked with it, as has been the case in the recent past. Inquiries for plain oak show little if any decrease in spite of the summer season. Prices remain quite firm. All grades of chestnut are in strong demand and there is little of it to be had. Many of the local lumbermen are now taking their vacations, but good men are left in charge. Building continues brisk and the woodworking and interior finishing plants are kept quite busy as a result.

#### Memphis.

While there is no large amount of business doing here in hardwoods there is a steady run of inquiries, more than the average for this time of the year. A number of lumbermen are commenting on the improvement which has taken place during the past two or three weeks. Prices are generally well maintained. Production is making better headway, but there is nothing suggestive of an accumulation of stock that will prove burdensome, especially when the present broken condition of holdings is taken into consideration. The export business is fairly good, though there is some fear expressed that the unsettled conditions in Russia may again unfavorably affect the export business in hardwood lumber.

Ash and cypress are in excellent request, and prices are firm. There is not much of either to be had, which, coupled with the brisk demand, is responsible for the strength displayed.

Plain oak continues to sell well, with rather more strength in white than red. There does not appear to be any great quantity of either for sale. Quarter-sawed white oak in five, six, seven and eight quarter is selling very well, but there is not much demand for other grades or descriptions of quarter-sawed stock. Quarter-sawed red is dull in most directions, though some firms are placing a little.

Cottonwood in firsts and seconds is probably not so active as it was a short time ago, and

prices in some quarters are said to be slightly easier. In box boards, however, there is an excellent demand at very satisfactory prices. The lower grades, which enter largely into box manufacture, if anything are the strongest feature of the cottonwood situation. The call for these grades is exceptionally heavy, with a scarcity of this class of material reported.

Red firsts and seconds gum is in good demand and prices are steady, while the lower grades are firm. There is a rapidly increasing demand for low grade gum in box manufacture and this is largely responsible for the fact that the lower grades are in better shape than the higher. One million feet of low grade gum lumber has been sold by a single firm during the past few days, while a box manufacturer has placed fifty cars of gum box shooks. Clear sap gum appears to be in only moderate request at unchanged prices. Poplar is a fairly good seller.

#### New Orleans.

The hardwood market here is practically unchanged and no different conditions from those which prevailed two weeks ago obtain today. The demand is not heavy; exports are light because the European markets are not taking very much stuff and stocks are still short. Within the next sixty days, however, these stocks will be replenished and much better conditions are looked for.

#### Rhineland.

Trade in Wisconsin hardwoods is very fair, much better than it usually is in July, and all wholesale firms are busy. With the exception of birch, there is no overstock of lumber, nor anything even approaching a full supply, and a decided scarcity of rock elm and ash. Basswood is selling well in a wide range of country, though the bulk of it does not go east of Indiana or west of Iowa. The common grades are in the best demand, but firsts and seconds also sell well.

Birch is moving out about the same as usual, although some of the best customers in the western states seem to be filled up for the present. A new market is opening up for it in Indiana and Ohio, as well as New York, and a good deal of stock is going in that direction.

Soft elm crating stock is selling well, both for boxes and for buggy crates. The price on it is strong. In fact, there is not a weak spot in the hardwood line in Wisconsin. The fact is there is not now enough hardwood lumber in Wisconsin to last the trade, at present rate of consumption, till new stock is dry next year.

#### Louisville.

At present the most active thing in a generally active market seems to be railway cross ties. Car material continues quite active also, and some orders have been booked lately at an advance of \$1 over former prices. In poplar the slowest item is No. 1 Common, and this is slow only in comparison with other grades of poplar, because there is really nothing slow on the hardwood list, and especially in poplar. No. 1 Common has been the uncertain factor in poplar so long, however, that there still clings to it a feeling of more or less uncertainty as to what it is going to do next, and those that have any stock of it are letting it go sparingly and keeping on the lookout for stiffer prices.

What is attracting most attention in this market just now, however, is not the price and active demand for hardwood lumber but the scarcity and rapidly advancing value of hard wood stumpage. At times it seems as if hard wood stumpage values are going wild, but the more one studies the situation the stronger becomes the impression that these higher values are not only here to stay but in the course of events will undoubtedly climb higher.

#### Liverpool.

Trade is considerably brisker with the turn of the half-year, and if only consumers could be

made to understand that present prices cannot be reduced for some time to come, things would be much better. Shippers are, however, much to blame if they will insist on shipping large lines on consignment; it only means that prices will have to come down.

Only recently a steamer brought 454 ash logs, none of which had been sold before arrival, and which are now being hawked about the market and offered by brokers at prices which cannot realize a profit when freight and all other charges have been paid.

This is the kind of thing that encourages consumers to hold off from buying, and if shippers will insist on doing these things they must pay the consequences.

For several weeks hickory suffered from the same cause, and to prove that the cause of the weakening of price was the shipping of goods on consignment it is only necessary to point to the position of this wood: prices are back again at the old figures, and if shippers had only obtained orders before shipping there would have been no reason why they should not have obtained full contract prices for the wood they have so needlessly sacrificed.

Oak, quartered and plain, is still in active request and stocks are low. Walnut is firm and stocks low.

Other woods remain much as before, with birch and maple slightly better. The recent mahogany sales were well attended and bidding active. Prices were firm and with a distinct tendency to advance.

Edward Chaloner & Co.'s wood circular of recent date states that on oak logs values are steady and stocks only moderate; on wagon planks firm prices may be realized if of first-class character—stocks of this description are very light. The import of elm has been fair, with only small consumption and prices unchanged. Of ash there has been a fair import, but only a light consumption; stocks are ample and prices easier. Walnut logs of good to prime quality and of good average size are in request and obtain full prices; other descriptions sell at moderate rates. Boards and planks of the better grades realize fair prices. Satin walnut seasoned boards of good quality sell at fair prices. Logs are not in request. For mahogany the demand is fair. In the Cuban variety fine figured wood is in good request, and for plain, straight logs of large to medium dimensions there is a steady demand. The logs of these descriptions contained in the shipments offered by auction during the past few months realized satisfactory results, but a good proportion of the small-sized wood was withdrawn. Stocks consist of the unsold balances. In Tabasco wood there is a good demand for sound logs of medium to large dimensions and shipments largely composed of this class would sell at good prices. There is almost no stock of this variety.

#### London.

During the summer months the market here is generally slow, but at the present moment buyers are declining to face the advanced prices that are asked, the cabinet makers and other users of hardwood lumber being in such a bad way that they can hardly afford to pay the old prices for woods, and the talk of higher prices stops business. There has been a failure in this city of one of the lumber dealers located here and well known in the States.

Satin walnut medium boards are asked for; there is little demand for prime and not much offering. Oak, plain, 1½, 2, 3 and 4 inch planks are in good demand and fair prices are being paid. Walnut is in good request, but buyers are not meeting sellers' views at the moment.

Whitewood is in fair demand in all grades; cuts are not plentiful and are realizing full prices. Mahogany, the demand is not active, but all wood offered at auction is sold at brokers' limits and should an increasing demand spring up higher prices must result.

# AT COST

IS AN UNCOMMON TERM AS APPLIED TO INSURANCE

But this is the actual price of Indemnity against Fire Loss furnished by the

## Manufacturing Lumbermen's Underwriters

THE STRONGEST INSURANCE ORGANIZATION  
TO-DAY IN AMERICA

The saving is not on a small portion of your insurance but on the entire line.

There are other advantages equally interesting.



Only well built plants with adequate protection and at least five years timber supply are considered eligible.

FOR LIST OF MEMBERS AND FURTHER INFORMATION, ADDRESS

**HARRY RANKIN & CO.      Kansas City, Mo.**

# Wanted and For Sale -SECTION-

Advertisements will be inserted in this section at the following rates:

For one insertion ..... 20 cents a line  
For two insertions ..... 35 cents a line  
For three insertions ..... 50 cents a line  
For four insertions ..... 60 cents a line

Eight words of ordinary length make one line. Heading counts as two lines. No display except the headings can be admitted.

Remittances to accompany the order. No extra charges for copies of paper containing the advertisement.

## EMPLOYES WANTED.

### WANTED.

Competent hardwood inspector and buyer, familiar with rough wagon material. Good job for right man. Address "K. 46," care HARDWOOD RECORD.

### WANTED.

Competent Hardwood buyer and shipper, familiar with sources of supply. Address "WHOLESALEERS," care HARDWOOD RECORD.

## LUMBER WANTED

### OAK TIES WANTED.

Standard White, Rock and Burr Oak ties, 6"x8"x8" and 7"x8" to 12"x8 1/2". Send description of what you have and price. G. ELIAS & BRO., 965 Elk St., Buffalo, N. Y.

### WANTED—DRY CYPRESS.

2x7" and wider, 8 or 16'—1st and 2nds, or select, or sound common. AMERICAN LUMBER & MFG. CO., Pittsburg, Pa.

### IN THE MARKET FOR

White Oak and Ash, 1sts and 2nds, 1" to 4" thick, 10" and up wide, 12 to 20 feet long. Hickory, 9" and 12" and up, same dimensions. Also thin Bay Poplar. Stock sawed to order. Regular supply wanted. Address "EXPORTER," care HARDWOOD RECORD.

### WANTED—HARDWOOD LOGS.

200 M feet 28-inch and up White Oak logs.  
200 M feet 12-inch and up Walnut logs.  
50 M ft. 12-inch and up Cherry logs.  
C. L. WILLEY,  
Blue Island Av. and Robey St., Chicago.

### OAK.

We are in the market for plain sawed oak, all grades and thicknesses. P. G. DODGE & CO., 2116 Lumber St., Chicago.

### WANTED.

Locust, Bois D'Arc or Osage Orange and Mulberry, log run. Write for specifications and prices. THE PILLIOD LUMBER CO., Swanton, O.

### WANTED—DIMENSION HICKORY.

Send for our specifications. MUNCIE WHEEL & JOBBING CO., Muncie, Ind.

### SMALL HICKORY DIMENSION.

First-class material from waste of wagon stock. Sizes wanted furnished upon application. L. T. La BAR, Hackettstown, N. J.

### OAK WANTED.

3 and 4 inch White Oak; also Mixed Oak; also 12x12 Timbers and Piling of all kinds. CONTINENTAL LUMBER CO., 1213 Monadnock Bldg., Chicago, Ill.

## TIMBER LANDS FOR SALE

### HARDWOOD TIMBER LAND.

Western North Carolina, 1,463 acres, Oak, Chestnut, Hickory, Poplar, Pine, etc., estimated 6,000,000 ft. timber, 2,000 tons Chestnut Oak bark, \$8 per acre. W. M. PRATT, Marion, N. C.

### FOR SALE.

3,550 acres of Georgia hardwood, estimated to cut as follows:  
8,800,000 feet White Oak.  
3,500,000 feet Hickory.  
3,500,000 feet Red Oak.  
1,750,000 feet White Ash.  
High grade stock suitable for wagon and carriage manufacture.  
3 1/2 miles from railroad; river joins tract. Ten years to remove timber. Address "H. H.," care HARDWOOD RECORD.

## LUMBER FOR SALE.

### FOR SALE.

Common and better Hickory, 5,277 feet of 2 1/2", 1,092 feet of 3" and 1,024 feet of 4", dry, good quality. LOVE, BOYD & CO., Nashville, Tenn.

### FOR SALE.

One car clear Hickory cuttings, dry, 1"x1 1/2" x19" to 24", 1"x1 1/2" x28" to 36". Also 3,700 pieces dry second growth Ash, 1 1/2"x3 1/4"x26". THE J. A. & D. P. COOPER CO., Struthers, O.

### FOR SALE.

One or two cars 1x1 Oak Squares, any length, up to 31' long. ALBERT R. KAMPE, Louisville, Ky.

## BUSINESS OPPORTUNITIES

### FOR SALE.

The only sawmill in Ripley, a town of 3,000 people. Mill, sheds and all new. 20,000 feet capacity. White Oak and Poplar. Price and description upon request. W. B. JOHNSON, Ripley, Tenn.

### WOODWORKERS.

Excellent opportunities for woodworking establishments are found at a number of points on the North-Western line in the timber country of Wisconsin and Michigan. Parties dealing in coeprage will be furnished with reference to sections where this business may be conducted favorably. Address INDUSTRIAL DEPARTMENT, CHICAGO & NORTH-WESTERN RAILROAD, Chicago.

### HARDWOOD TIMBER.

A number of good mill propositions along the Cotton Belt Route. Tracts ranging from five hundred to twenty thousand acres, principally Oak, Hickory, Gum, Cypress, some Ash, Cottonwood and other hardwoods. Can be secured at very reasonable figures now—in some cases at less than \$1 per thousand stumpage. Choice openings for hardwood lumber mills, handle and spoke factories, slack coeprage plants and other hardwood enterprises.

A number of points on the Cotton Belt offer free sites or will raise cash bonus or take stock in practical propositions. Let us have your wants and see what we can do for you.

E. W. LA BEAUME, G. P. & T. A., COTTON BELT, St. Louis, Mo.

### WANTED.

Party with small capital to take an active interest in well established handle and lumber business. Entire output sold for four years. For further information write or call on H. F. CLARKE, Okolona, Miss.

### FOR SALE.

40,000,000 feet of standing hardwood timber, band sawmill of 35,000 feet daily capacity, dry kilns, etc.; plant located in healthy town of 2,500 inhabitants. Two railroad systems, making low rate to all hardwood markets. Splendid opportunity for party desiring a profitable milling property. Will be sold on stumpage basis or flat price. Retiring partner reason for desiring to sell. "D. G.," care HARDWOOD RECORD.

## MISCELLANEOUS

### FACTS FROM PRACTICAL MEN.

The HARDWOOD RECORD is always in the market for articles on any and every feature of the hardwood industry. It wants practical statements of fact from practical men who know how certain things can be done in the best way. Literary quality not essential. Liberal pay for acceptable articles. Address Editor HARDWOOD RECORD.

## MACHINERY WANTED

### AT ONCE.

If you are in need of machinery—new or second hand—a few lines in this column will place your wants before those who have such goods for sale. For particulars address HARDWOOD RECORD, Chicago, Ill.

## MACHINERY FOR SALE

### FOR SALE.

McGiffert Log Loader, used one year. Good as new. Now in service and doing excellent work on our property in Washington county, Miss. Address as below or Greenville, Miss. CHICAGO-MISSISSIPPI LAND & LUMBER CO., First National Bank Building, Chicago, Ill.

## RAILWAY EQUIPMENT

### RAILS AND LOCOMOTIVES.

All inquiries for industrial railway equipment listed before "Record" readers will find ready response. HARDWOOD RECORD, Chicago, Ill.

## MANUFACTURERS

Contemplating establishing plants in the West should take advantage of a location on



## Chicago & North-Western Ry.

which reaches the famous

**WATER POWERS,  
COAL FIELDS,  
IRON ORE RANGES,  
HARD AND SOFT  
LUMBER DISTRICTS,  
MINING DISTRICTS**

of the West and Northwest, and affords the best means of transportation to the markets of the world.

FOR FURTHER PARTICULARS APPLY TO

MARVIN HUGHITT, Jr., E. D. BRIGHAM,

Freight Traffic Manager, Gen'l Freight Agent,

GEO. BONNELL,

Industrial Agent,

NW513

CHICAGO.

Advertisers' Directory

NORTHERN HARDWOODS.

Table listing various lumber companies under Northern Hardwoods, including American Lumber & Mfg. Company, Babcock Lumber Company, Barnaby, C. H., etc.

Southern Oak Lumber Company

Table listing various lumber companies under Southern Oak Lumber Company, including Standard Hardwood Lumber Co, Stephenson, The L. Company, etc.

SOUTHERN HARDWOODS.

Table listing various lumber companies under Southern Hardwoods, including Advance Lumber Company, American Lumber Company, etc.

Leomis & Hart Mfg. Company

Table listing various lumber companies under Leomis & Hart Mfg. Company, including Love, Boyd & Co., Luederhann, Chas. F., etc.

POPLAR.

Table listing various lumber companies under Poplar, including Advance Lumber Company, Atlantic Lumber Company, etc.

Paepeke-Leicht Lumber Company

Table listing various lumber companies under Paepeke-Leicht Lumber Company, including Smith, W. E., Lumber Company, etc.

CYPRESS.

Table listing various lumber companies under Cypress, including Crandall & Brown, Cypress Lumber Company, etc.

HARDWOOD FLOORING.

Table listing various lumber companies under Hardwood Flooring, including Bliss & Van Anken, Carper Lbr. & Mfg. Company, etc.

SAW MILL MACHINERY.

Table listing various machinery companies under Saw Mill Machinery, including Mershon Company, The, Phoenix Manufacturing Company, etc.

WOODWORKING MACHINERY

Table listing various machinery companies under Woodworking Machinery, including American Wood Working Machinery Company, Berlin Machine Works, etc.

VENEER MACHINERY.

Table listing various machinery companies under Veneer Machinery, including Coe Manufacturing Company, etc.

LOGGING MACHINERY.

Table listing various machinery companies under Logging Machinery, including Clyde Iron Works, Lidgerwood Manufacturing Company, etc.

DRY KILNS AND BLOWERS

Table listing various machinery companies under Dry Kilns and Blowers, including Morton Dry Kiln Company, etc.

LUMBER INSURANCE.

Table listing various insurance companies under Lumber Insurance, including Adirondack Fire Insurance Company, etc.

SAWS, KNIVES AND SUPPLIES

Table listing various supply companies under Saws, Knives and Supplies, including Atkins, I. C. & Co, etc.

MISCELLANEOUS.

Table listing various miscellaneous companies, including Carroll H. C. & Co, Childs, S. D. & Co, etc.

CHICAGO VENEER COMPANY

(INCORPORATED)

BURNSIDE, KENTUCKY

Bored Poplar Posts for Porch Columns

66 to 96 INCHES LONG, 8 and 10 INCHES DIAMETER

Write us for Prices and Particulars

**Novelties for Advertisers**

FOBS, POCKET PIECES,  
BUTTONS,  
LETTER OPENERS, SCARF PINS,  
TRAYS, ALUMINUM GOODS,  
PAPER WEIGHTS.

**ALL NEW IDEAS**

Send us 50c and we will send you a  
Beautiful Watch Fob

**S. D. CHILDS & CO.**  
200 Clark Street, CHICAGO



**WALNUT.  
OAK,  
ASH,  
POPLAR.**

You want to reach Buyers of  
**FURNITURE LUMBER**  
**The HARDWOOD RECORD**  
will do it for you.

**Save Your Money**

By Using the

**RED BOOK**

Published Semi-Annually  
in January and July

It contains a carefully prepared list of the buyers of lumber in car lots, both among the dealers and manufacturers.

The book indicates their financial standing and manner of meeting obligations. Covers the UNITED STATES and MANTOBA.

The trade recognizes this book as the authority on the lines it covers.

A well organized Collection Department is also operated and the same is open to you.

WRITE FOR TERMS.

**Lumbermen's Credit Association**

ESTABLISHED 1878

1405 Great Northern Building, CHICAGO  
16 Beaver Street, NEW YORK CITY

MENTION THIS PAPER

**Locations for Industries**

ON  
**THE ERIE, THE COMMERCIAL RAILROAD**  
CHICAGO TO NEW YORK

The Erie Railroad System's Industrial Department has all the territory traversed by the railroad districted in relation to resources, markets and advantages for manufacturing, can advise with manufacturers of specific products as to suitable locations, and furnish them with current information of a comprehensive nature dealing with the project in its full relation to manufacture and commerce.

The Erie is one of the greatest of trunk lines. Its own rails connect the two largest cities of America. Every section of the System has its particular merits. Profitable locations exist. It has great general and coal, oil and natural gas resources.

It is important in this age of modern facilities for manufacturers to locate where they can obtain side tracks so as to receive from and ship directly into cars at the factory. Information can be promptly furnished in this connection about every point on the system between New York and Chicago.

Manufacturers' inquiries as to locations are treated in strict confidence and absolutely reliable information, so as to promote permanent traffic, is furnished. Address

**LUIS JACKSON**

Industrial Commissioner  
Erie Railroad Company  
11 Broadway, New York

**HARDWOOD  
TIMBER**

There is no section with so fine and large a supply of hardwood timbers of various kinds left for the lumbermen as that portion of the South in Alabama, Georgia, Kentucky, Mississippi, North Carolina, South Carolina, Tennessee and Virginia served by the lines of the

**Southern Railway  
and  
Mobile & Ohio Railroad**

There are oak, poplar, hickory, gum, cypress, ash, elm, buckeye, balsam, spruce, chestnut, and other varieties. There are also available pine lands.

These timber resources and many other important features bearing on the cost of manufacture and marketing give special advantages and opportunities for EVERY KIND OF WOOD USING INDUSTRY. We have information about the best locations in the country at towns in these States and in Southern Indiana and Southern Illinois, which will be given if requested. All correspondence in regard to timber lands or factory locations will be given prompt and confidential attention. Address your nearest agent.

M. V. RICHARDS,  
Land and Industrial Agent,  
Washington, D. C.

CHAS. S. CHASE, Agent,  
622 Chemical Building,  
St. Louis, Mo.

M. A. HAYS, Agent,  
225 Dearborn Street,  
Chicago, Ill.

**Hardwood Board Rules  
FOR HARDWOOD LUMBERMEN**



**Best Goods, Prompt Shipment**

Send your orders to the HARDWOOD RECORD, 355 Dearborn Street

**FRAMES FOR HARDWOOD RECORD  
SUPPLEMENTS**

Complete with backing, but without the glass, made from Flemish Oak, are to be had delivered by express, charges prepaid to any point east of the Missouri river, at 50 cents each; or at the HARDWOOD RECORD office, at 30 cents each. Prepay orders with two-cent stamps or postal notes, addressed

Hardwood Record, 355 Dearborn Street, Chicago



# "DEFIANCE" WOOD-WORKING MACHINERY

COMPLETE EQUIPMENTS OF

## HIGH GRADE TOOLS

✻ FOR MAKING ✻

Hubs, Spokes, Wheels,  
Wagons, Carriages,  
Rims, Shafts, Poles,  
Neck-Yokes,

Single Trees, Hoops,  
Handles, Bobbins, Spools,  
Insulator Pins and  
Oval Wood Dishes.

INVENTED AND BUILT BY

The **DEFIANCE MACHINE WORKS**

DEFIANCE, OHIO.

— Send for 500 Page Catalogue —

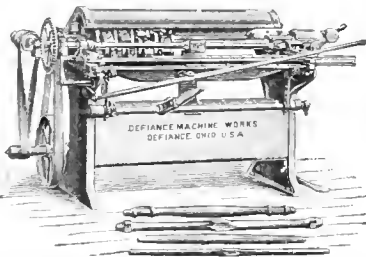

NECK-YOKE AND SINGLE-TREE LATHE

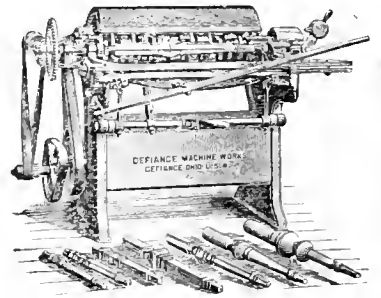

32" VARIETY TURNING LATHE

# KNIVES

A man who has been in the presence of angels discloses the fact by his action: Just one reason for our talking good machine knives, good veneer knives or knives of any kind that do good work.

# CHAMPION SAW COMPANY,

BEAVER FALLS, PA.

## ... THE ... McGIFFERT LOG LOADER

has loaded as high as a quarter of a million feet of logs in eight hours, and here are a few reasons why it was possible: Being self propelling it can move itself, its loaded cars, and spit its own empties, all on the same track. (*saves switching*) Constructed entirely of steel, very powerful, it stands "crowding" and handles the large logs as rapidly as the small. *It saves money and repairs.* Being simple in operation and of

few levers the engineer has absolute control at all times without changing his position, and can handle the logs as rapidly as the men can hook them. *saves time*

Our catalogue clearly illustrates and explains many other good points.

Manufactured by  
**CLYDE IRON  
WORKS,**  
Duluth,  
Minn.

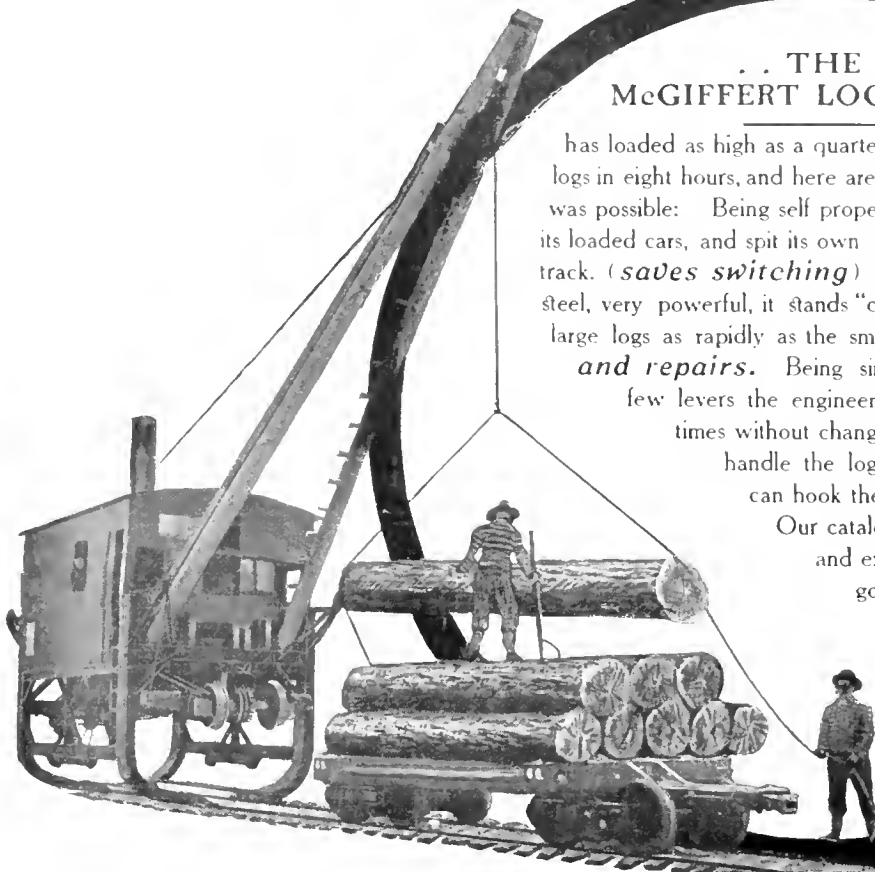

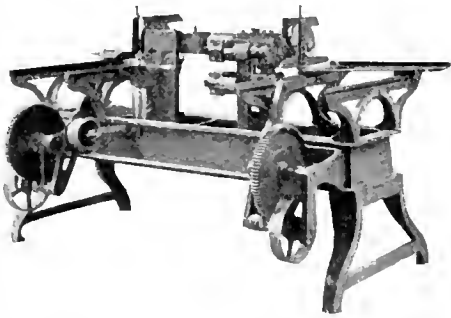

## New Type of Combined End Matcher

SAVES 20 PER CENT. TIME, COST AND LABOR.  
USED BY THE LARGEST FLOORING CONCERNS.

Write for particulars to

**A. J. SCHINDLER, 441-443 W. 21st Street, CHICAGO**

## LIDGERWOOD MACHINES

WILL STOCK YOUR MILL

SKIDDERS  
SNAKERS  
YARDERS

LOADERS  
PULL BOATS  
CABLEWAYS

**LIDGERWOOD MFG. CO.**

96 Liberty St., New York.

NEW ORLEANS

ATLANTA

SEATTLE

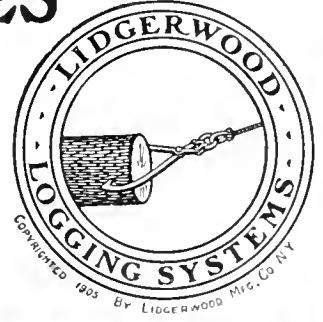
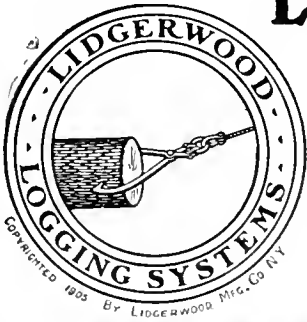

**THE  
HAPPY  
WOODSMAN**



# ATKINS

TRADE  
SILVER-STEEL  
MARK

# SAWS

are happy saws all the way round. They run easier, cut faster, and go longer without sharpening than any other

A PERFECT SAW FOR EVERY PURPOSE.  
YOUR JOBBER HAS THEM OR WRITE US.

**E. C. ATKINS & CO., Inc.**

THE SILVER STEEL SAW PEOPLE

HOME OFFICE AND FACTORY, INDIANAPOLIS, U. S. A.

Branches: Atlanta, Chicago, Memphis, Minneapolis, New York City, New Orleans, Portland, San Francisco, Seattle, Toronto.

# American

☞ No. 200. Automatic Knife Grinder with Pump Attachment, for Wet Grinding, when desired.

☞ A Strictly Automatic Machine in every particular.

☞ Place the Knife---Set the Machine---It will do the rest.

Investigate

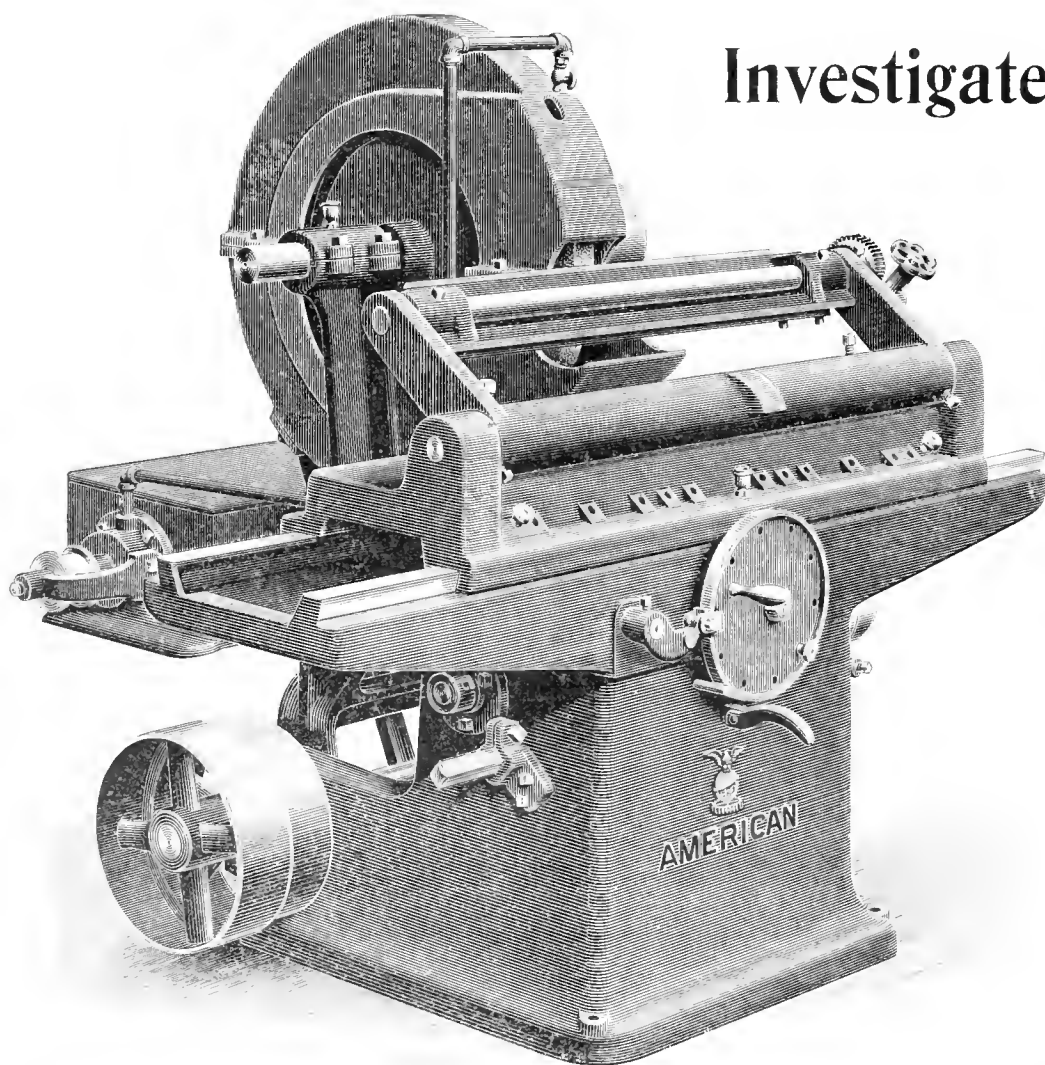

**American**  
**Wood Working Machinery Co.**

New Orleans

Chicago

New York



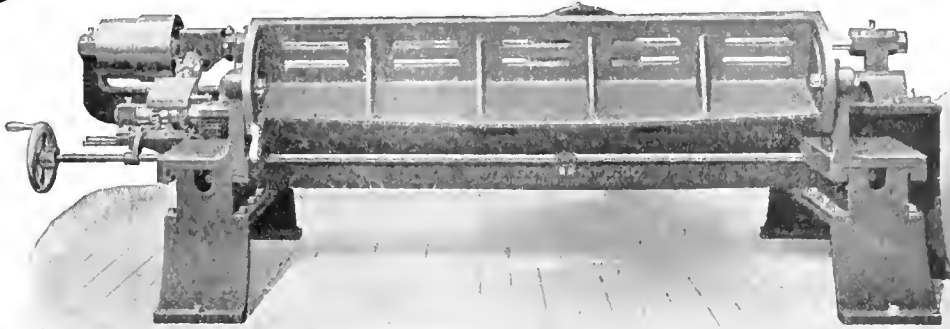

## The Coe Knife Grinder

was designed for the finest grinding and most exacting service. It is built on new lines and has completely overcome the objections to other grinders. The knife is held rigidly while the stone travels back and forth. There is no chance for

vibration, consequently no unevenly ground knives. Entirely automatic in ac-



tion, no ropes or chains. All moving parts operated by cut steel gears, noiseless in operation, will grind straight or hollow bevel. Feeds 1-1000 to 4-1000 for each travel of the stone, very heavy and compact, occupying small floor space. Made in seven sizes to grind up to 168 in.

It is fully described in our catalog No. 5, which we will be glad to send to interested parties.

The Coe Manufacturing Co. 105 Bernard Street Painesville, O.

## LANE-WHITE LUMBER CO.

OAK, ASH AND WALNUT  
OUR SPECIALTY

**Hardwoods** ALWAYS IN THE MARKET  
FOR WALNUT LOGS

MAIN OFFICE AND BAND MILL at FORT SMITH, ARK.

The only trade paper reaching all classes  
of hardwood consumers

**HARDWOOD RECORD**  
355 Dearborn St., Chicago

## Ten per cent More Profit

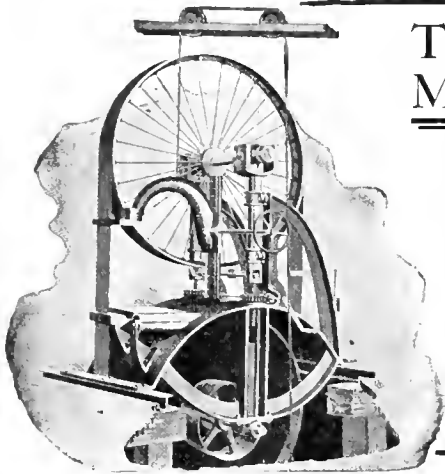

The profits of a saw mill can readily be increased ten per cent by using a band mill instead of a rotary. The price of this mill with six foot wheels for saws eight inches wide is readily within the reach of all. It cuts smooth and perfect lumber and has a capacity of 25,000 feet to 35,000 feet per day. It runs with less expenditure of power than a rotary and puts only half as much of the log into saw dust as does the circular saw.

PHOENIX MFG.  
COMPANY,  
EAU CLAIRE, WIS.



Best of All, Fig. 202 and Fig. 203.

## The Shimer Cutter Head

Is within the Reach of  
Every Flooring Maker

No reason why any man in the business should follow "out-of-date" methods with his cast iron blocks and straight knives when the actual "hit and try" of it is automatically arranged for in the construction of The Shimer Circular Cutter and alternate seat clearance feature. YOU SAVE THE TIME--THE WORRY--THE ANNOYANCE necessitated by hand fitting, hence you have something to gain in the adoption of the only tools that have developed by deliberation and forethought to keep pace with the growing needs of the trade.

AND THEY GO TO YOU ON TRIAL

for thirty days--returnable if unsatisfactory--when you send us carefully taken measurements of your machine. Send for question blank and full particulars. Address

**SAMUEL J. SHIMER & SONS,**  
MILTON, PENNSYLVANIA

# SAWS

I tell you, Mr. Mill Man, there is merit in these saws. Dependable stuff that is made right, will work right, and last the life of good saw material.

## CHAMPION SAW CO.

BEAVER FALLS, PA.

## UP=TO=DATE

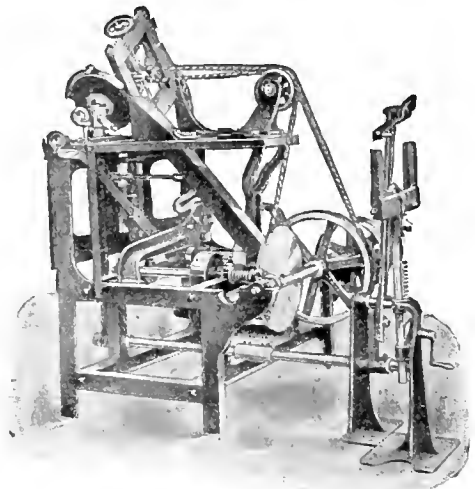

### Hanchett Automatic Band Saw Sharpener

This is one of our full line of modern filing room machinery. Let us send you our new Catalogue No. 10.

## HANCHETT SWAGE WORKS

BIG RAPIDS, MICH.

**EASTERN TENNESSEE—WESTERN NO. CAROLINA**

ASHEVILLE KNOXVILLE BRISTOL

**On the Spot**

We are located right in the heart of this mountain country producing the best hardwoods in existence.

We are headquarters with ample stock, and can interest you both as to assortment and price. Write us.

**American Lumber Company**

ASHEVILLE, N. C.

**Vestal Lumber & Mfg. Co.**

Manufacturers and Wholesalers  
of all kinds of

**HARDWOODS**

BEVELED SIDING A SPECIALTY.  
UNSURPASSED FACILITIES  
FOR DELIVERING.

Knoxville  
Tennessee

**Fry-Buchanan Lumber Co.**

INCORPORATED.

Manufacturers and Wholesalers

**Hardwood Lumber**

Choicest Varieties. ∴ Full Grades.

POPLAR SQUARES  
A Specialty.

Asheville, N. C.

**HARDWOODS**

From the famous Asheville district.  
Superior in quality, manufacture and  
gradings. For stock list and prices,  
address

**J. S. COLEMAN LUMBER CO.**

ASHEVILLE, N. C.

**All Lumbermen, Attention!**

We do what you can't do.  
We measure your stumpage correctly.  
We make your maps correctly.  
Bank references: Asheville, N. C.

**C. A. Schenck & Co.** Biltmore,  
North Carolina.

**The Morton Dry Kiln**

MOIST AIR SYSTEM

Recording  
Ther-  
mometers.  
Transfer  
Cars.



Trucks.  
Canvas  
Doors.

HOW TO DRY LUMBER

As exemplified in our Catalog D. Free on application.

**MORTON DRY KILN CO., Chicago, Ills.**

**RUSSEL WHEEL & FOUNDRY COMPANY**

Builders of  
**Logging Cars**  
And **Logging  
Machinery**

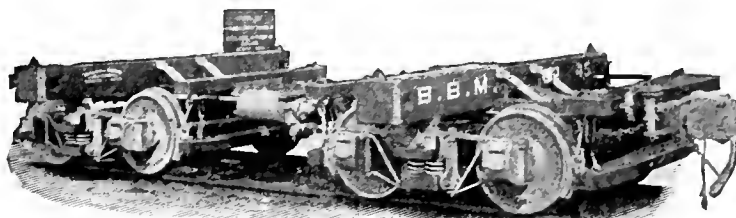

ARE ALWAYS PLEASSED TO  
HAVE OPPORTUNITY OF  
POINTING OUT ADVAN-  
TAGES OF THEIR  
EQUIPMENT.

Detroit, Mich.



# WISCONSIN

WHERE THE FINEST NORTHERN HARDWOODS GROW

## ARPIN HARDWOOD LUMBER CO.

GRAND RAPIDS, WISCONSIN

Saw and Planing Mill at Atlanta, near Bruce, Wis., on Soo Lines.

WRITE FOR OUR PRICES ON

THREE INCH FLOORING	BIRCH
1 car Clear Plain Red Oak	2 cars 1 1/2" Com. and Bet. Curly Red
1 car Factory Red Oak	2 cars Com. and Bet. Red
3 cars Clear Birch	1 car 1 1/4, 1 1/2, 2" Curly
1 car Factory Birch	2 cars 1 1/4, 1 1/2, 2" Com. & Bet. Red
1/2 car Clear Red Birch	1 car 2" Plain log run
3 cars Common Maple	1 car 2 1/2 and 3" Plain
1 car Factory Maple	QUARTER SAWEED RED OAK
LUMBER	2 cars 1 1/4 and 1 1/2" Com. and Bet.
2 cars log run Hard Maple	1/2 car 1 1/2 and 2" Com. and Bet.

## VOLLMAR & BELOW

MARSHFIELD, WISCONSIN

### Basswood, Birch

and Other Wisconsin Hardwoods

LET US KNOW WHAT YOU ARE IN THE MARKET FOR

### NORTHERN STOCK

Hemlock  
Birch  
Basswood  
Rock Elm  
Soft Elm  
Ash  
Oak

### SOUTHERN STOCK

Quartered White and Red Oak  
Plain White and Red Oak  
Sycamore  
Poplar  
Cypress  
Gum

## PAGE & LANDECK LUMBER CO.

Wells Building - - - MILWAUKEE, WIS.

## North Western Lumber Co.

General Offices - EAU CLAIRE, WIS. Mills at STANLEY, WIS.

BAND SAWEED

### Wisconsin Hardwoods

CAREFUL GRADINGS, PROMPT SHIPMENTS

SPECIAL OFFERINGS:

3 cars 1 1/4" to 2" Scoot Hardwood. 1/2 car 2" 1st and 2d Clear Basswood.  
1 car 1 1/2" No. 1 Common Basswood. Large stock No. 2 Common Birch.  
1 car 1 1/2" 1st and 2d Clear Basswood. Large stock No. 3 Common Birch.

## C. P. CROSBY

RHINELANDER : : WISCONSIN

### Wholesale Hardwood Lumber

Hard Maple a Specialty in all thicknesses from 1 inch to 4 inch. Finest Birch in Wisconsin. Black Ash, Rock Elm, Soft Elm, Red and White Oak. : :

DIFFICULT AND MIXED ORDERS A SPECIALTY

## Special Attention

Is called to the following, and to the close prices made on same upon receipt of your inquiries:

50M ft. 2" Com. and Bet. Plain Birch	50M ft. 2" Bridge Plank
80M ft. 2 1/2" Com. and Bet. Plain Birch	30M ft. 1 1/2" No. 2 Com. & Bet. Hickory
100M ft. 1" 1sts and 2ods Plain Birch	30M ft. 1 1/4" No. 2 Com. & Bet. Hickory
150M ft. 1" No. 1 Com. Plain Birch	100M ft. 1" Com. & Bet. Plain Red Oak
12M ft. 2" 1sts and 2ods Red Birch	150M ft. 1" Com. & Bet. Qid. Red Oak
200M ft. 2" Com. and Bet. Hard Maple	10M ft. 1" No. 3 Com. & Bet. Walnut
Above is all cut from choice Wisconsin timber, is bone dry and well manufactured.	75M ft. 1 1/2" No. 2 Com. & Bet. Elm
	150M ft. 1" No. 1 Com. Red Gum
	Above is choice Southern stock.

In addition to the foregoing, we have full stocks of Basswood, Birch and Soft Elm and a full selection of Red and Sap Gum. We guarantee our grades to be made strictly in accordance with National Hardwood Association rules of inspection.

G. W. JONES LUMBER CO., Appleton, Wis.

## John R. Davis Lumber Company

PHILLIPS, WISCONSIN

The Leading Manufacturers

### Wisconsin Hardwoods

"SHAKELESS" HEMLOCK and WHITE CEDAR PRODUCTS

NOW READY

4/4 No. 1 COMMON AND BETTER BIRCH (RED IN)  
4/4 No. 1 COMMON AND BETTER HARD MAPLE  
4/4 No. 2 COMMON AND BETTER BLACK ASH

Write for our Price Lists and Stock Sheets

Mixed Cars, Even Grades Prompt Shipments

## BRITTINGHAM & YOUNG CO.

### Hardwood Lumber

Manufacturers and Wholesalers

MADISON, . . . WISCONSIN

Send us a list of your wants. No trouble to answer correspondence.

# CLEVELAND

HARDWOOD DISTRIBUTING CENTER OF NORTHERN OHIO

## We Solicit Inquiries

FOR THE FOLLOWING:

- 2 cars 1x4" Clear Birch Strips
- 2 cars 1x5" and 6" Clear Birch Strips
- 1 car 3" No. 1 Com. and Better Birch, unselected
- 1 car 1" 1sts and 2nds Curly Red and White Birch
- 2 cars 1x4" Clear Basswood Siding Strips
- 2 cars 1x5" and 6" Clear Basswood Siding Strips

### The King & Bartles Lumber Company

1955-2025 Scranton Road N. W., Cleveland, Ohio

## The Martin-Barriss Company

Importers and Manufacturers

# MAHOGANY

and Fine Hardwoods

## Do You Want It? What? Money?

What have you in lumber to exchange for it? We want particularly Plain Oak, Chestnut, Poplar, Basswood, Ash.

What Have You?

## The Advance Lumber Co.

13th Floor  
Rockefeller Bldg. CLEVELAND, OHIO

Memphis Office, No. 56 Randolph Building.

J. E. MEADOWS, Mgr.

## THE ROBERT H. JENKS LUMBER COMPANY

### FOR SALE

- 60 M feet 1" 1st and 2ds Poplar
- 223 M feet 1" No. 1 Common Poplar
- 125 M feet 1" No. 2 Common Poplar
- 25 M feet 2" 1st and 2nd Poplar, 14" and up
- 125 M feet 8.4" Sound Wormy Chestnut
- 275 M feet 1" Sound Wormy Chestnut
- 153 M feet 1" 1st and 2nd Plain White Oak
- 85 M feet 1" 1st and 2nd Plain Red Oak
- 125 M feet 1" No. 1 Common Plain Red Oak

**Quartered White and Red Oak.**—We have a good assortment of dry stock,  $\frac{3}{8}$  to 4 inches thick. Your inquiries solicited.

**Plain White and Red Oak.**—A limited amount of nice stock, ready for shipment.

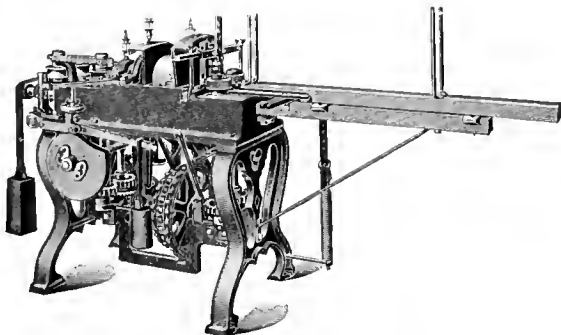

This is a cut of the **No. 10 OBER LATHE** for Turning Fork, Hoe, Rake, Mop, Broom and Ice Hook Handles, Pike Poles, Trolley Poles, Tent Poles, Curtain Poles, Chair Bows, Dowels, Rods and similar work.

## Simple, Strong, Durable, Economical

We also manufacture other Lathes for making Spokes, Handles, and Variety Work, Sanders, Shapers, Boring and Chucking Machines, etc., etc. Complete Catalogue and Price List Free.

**THE OBER MFG. CO., No. 28 Bell St., CHAGRIN FALLS, O., U. S. A.**

# MICHIGAN

FAMOUS FOR HARD MAPLE AND GREY ELM

W. H. WHITE, Pres.  
JAS. A. WHITE, Vice-Pres.

W. L. MARTIN, Secy.  
THOS. WHITE, Treas.

## W. H. WHITE COMPANY

BOYNE CITY, MICHIGAN

Manufacturers of Hardwood and Hemlock Lumber, Cedar Shingles,  
White Rock Maple Flooring.

### Michigan Logging Wheels

Have Made More Than 1,000 and Know How.

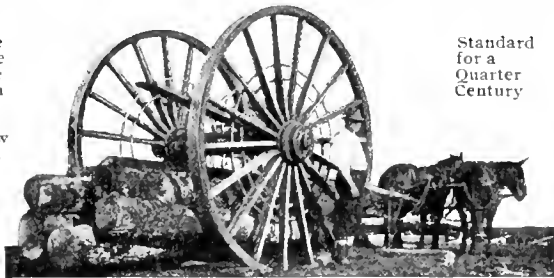

Standard for a Quarter Century

Cheap and easy logging. Write for circular & prices.

S. C. OVERPACK MANISTEE, MICH.

### DENNIS & SMITH LUMBER CO.

Wholesale Hardwood Lumber

Office and Yards, FOURTH AND HOLDEN AVENUES,  
DETROIT, MICH.

MILLS AT: Heaters, W. Va. Valley Bend, W. Va. Diana, W. Va. Parkersburg, W. Va. McNutt Siding, W. Va.

### SALLING, HANSON & CO.

MANUFACTURERS OF

## Michigan Hardwoods

GRAYLING, MICHIGAN

### "Chief Brand" Maple Flooring

Will commend itself to you and your trade on its merits alone. \* Comprises all the features desirable in good flooring. \* Made by the latest, most approved machinery methods and best skilled labor. \* We believe we can make it to your interest to handle our "Chief Brand" and will appreciate your inquiries.

### Kerry & Hanson Flooring Co.

GRAYLING, MICHIGAN

## BROWNLEE & COMPANY

DETROIT MICHIGAN

**Our Bargain Counter:**

BASSWOOD

SOFT ELM

4-4 to 8-4

6-4 log run  
12-4 No. 1 Common

BIRCH

HARD MAPLE

4-4 No. 1 and 2 Common

12-4 No. 1 Common

### JULY STOCK LIST

MAPLE		BIRCH		BASSWOOD	
1 in.	2,000,000 ft.	1 in.	500,000 ft.	1 in.	300,000 ft.
1 1/2 "	100,000 "	1 1/2 "	100,000 "	1 1/2 "	30,000 "
2 "	400,000 "	2 "	100,000 "	2 "	50,000 "
2 1/2 "	1,000,000 "	2 1/2 "	50,000 "	2 1/2 "	75,000 "
3 "	200,000 "	3 "	75,000 "	3 "	4,000 "
3 1/2 "	500,000 "	ROCK ELM		GRAY ELM	
4 "	400,000 "	2 in.	25,000 ft.	1 in.	300,000 ft.
BEECH		2 1/4 "	50,000 "	1 1/2 "	200,000 "
1 in.	500,000 ft.	WHITE MAPLE		3 "	200,000 "
1 1/4 "	250,000 "	End Piled		ASH	
1 1/2 "	400,000 "	1 in.	100,000 ft.	1 in. 500,000 ft.	
2 "	100,000 "	1 1/2 "	20,000 "		
2 1/2 "	200,000 "	2 "	50,000 "		

KELLEY LUMBER & SHINGLE CO., Traverse City, Mich.

# MICHIGAN

FAMOUS FOR RED BIRCH AND BASSWOOD

## BIRCH

This is our speciality. We are in the heart of the best Birch section. Have good stock, Common and better, 4-4, 5-4, 6-4, 8-4, 10-4, 12-4, and 16-4. Let us figure with you.

**Simmons Lumber Company**  
SIMMONS, MICHIGAN

## McCLURE LUMBER COMPANY

MANUFACTURERS OF  
**Hardwoods**

Main Offices, DETROIT, MICH.  
Mills, : EUTAW, ALA.

SPECIAL OFFERINGS:  
3 cars 2" Red and White Oak      2 cars 2" Black Ash  
3 cars 2", 2½", 3" and 4" White Ash      10 cars 1" to 4" Dry Hard Maple  
2 cars 1" 6-4 White Ash      5 cars 1" Log Run Birch  
1 car 6-4 and 8-4 Hickory

## SOFT ELM AND ROCK ELM

FOR SALE BY

**The R. G. Peters Salt & Lumber Co.**  
EASTLAKE, MICHIGAN

## VAN KEULEN & WILKINSON LUMBER COMPANY

Manufacturers and Wholesalers of

**HARDWOOD LUMBER and CRATING STOCK**

Complete Stocks of Michigan Hardwoods—Maple, Beech, Birch, Elm, Ash and Basswood for sale.

Grand Rapids, : : : Michigan

## BOYNE CITY LUMBER COMPANY

BOYNE CITY

**MICHIGAN ROCK MAPLE and other HARDWOODS**  
LARGE CAPACITY      PROMPT SHIPMENTS      RAIL OR CARGO



**J. S. GOLDIE**  
Cadillac, :: Michigan.  
SPECIAL PRICES on 500M pieces  
1" to 3" Maple Squares 16" to 27" long.  
1" to 3" Soft Elm Lumber.  
INQUIRIES SOLICITED FOR MICHIGAN LUMBER.

## OUR MAPLE FLOORING

is as near perfection, in every particular, as it is possible to make it, for we personally supervise every step in its manufacture, from the stump to the shipping of the finished product. Our prices will interest and a trial convince you.

**HAAK LUMBER COMPANY**  
HAAKWOOD, MICHIGAN

## Hackley-Phelps-Bonnell Co.

MANUFACTURERS OF

**Northern and Southern  
Hardwood Lumber**

Main Office, Michigan Trust Company Building  
GRAND RAPIDS : : : MICHIGAN

## DENNIS BROS.

GRAND RAPIDS, : : : MICHIGAN

**HARDWOOD LUMBER (by water or rail)**  
**"NATIONAL" MAPLE & BIRCH FLOORING**

SPECIAL BARGAINS IN THE FOLLOWING:  
300M feet 4-4 Log Run Birch  
186M feet 5-4 Log Run Birch  
1 Car 8-4 No. 1 Com. Birch  
1 Car 1-4 Clear Birch  
50M feet 4-4 No. 1 Com. Sap Birch  
40M feet 4-4 No. 1 Com. Red Birch  
All thicknesses and grades Hard Maple  
150M feet 5-4 Log Run Beech  
2 Cars 4-4 No. 3 Com. Cherry

Main Office :  
205-209 Michigan  
Trust  
Company  
Building

## Thos. MacBride Lumber Company

HEADQUARTERS FOR

**HARDWOODS**

IN MICHIGAN

Michigan Trust Building, Grand Rapids, Mich.

# CINCINNATI

THE GATEWAY OF THE SOUTH

## PLAIN OAK—BASSWOOD

Are what we want. All thicknesses and grades. Spot cash. Send us list of your offerings with prices.

**DUHLMEIER BROS.,** CINCINNATI, O.

## "BUY GUM"

We are in the market to buy Dry Gum Lumber in any quantity, from a single car load to a million feet. Will take all grades and thicknesses. We receive lumber at shipping point, pay cash and are liberal in inspection.



## THE FARRIN-KORN LUMBER COMPANY

General Office, Yards,  
Planing Mills, Dry Kilns,  
Cincinnati, Ohio  
Purchasing Office,  
Randolph Building,  
Memphis, Tenn.  
Cypress Red Gum Oak

FRAMES,  
SASH, DOORS,  
BLINDS, MOULDINGS,  
COLUMNS, GLASS,  
STAIRWORK,  
INTERIOR TRIM.



PAINTS,  
BUILDERS' HARDWARE,  
MANTELS, ETC.  
LARGE CINCINNATI FAC-  
TORIES MAKE PROMPT  
SHIPMENTS POSSIBLE.

## CYPRESS LUMBER CO.

Manufacturer of Hardwoods and Cypress

Plain and Quartered White and Red Oak, Yellow Poplar,  
Yellow Pine, Walnut, etc. Mills in Tenn., Ala. and Va.

OFFICE AND YARDS, GEST AND DALTON AVE., CINCINNATI, OHIO.

# W. H. Dawkins Lumber Co.

Manufacturers of Band Sawn

## Yellow Poplar

ASHLAND, KY.

## The Farmer in the Southwest Prospers

Because he pays from \$8 to \$15 an acre for land that produces as good crops as land in Illinois and Indiana which sells for \$75 to \$100 an acre. The mild climate gives him earlier crops and the short winter makes stock-raising less expensive.

**You** have the same chance to prosper that is being taken by hundreds of the northern and eastern farmers.

Write for free copies of our illustrated books on Texas and Oklahoma.

Low rates to all points in the Southwest on the first and third Tuesdays of each month via



**CHICAGO @ EASTERN ILLINOIS R. R.**

W. H. RICHARDSON, G. P. A., Chicago, Ill.

## Wood Working Plants

Manufacturers seeking locations for Saw Mills, Stave and Heading Factories and other Wood Working Plants in the Central Southern States, can secure full and accurate information as to Sites, Timber Tracts, Fuel, Transportation Facilities, etc., by addressing

G. A. PARK, General Immigration and Industrial Agent,

**Louisville & Nashville Railroad Company**

LOUISVILLE, KENTUCKY

## Industries are Offered Locations

WITH SATISFACTORY INDUCEMENTS, FAVORABLE FREIGHT RATES, GOOD LABOR CONDITIONS, HEALTHFUL COMMUNITIES, on the lines of

**The Illinois Central R. R. and the Yazoo & Mississippi Valley R. R.**

For full information and descriptive pamphlet address

J. C. CLAIR, Industrial Commissioner, 1 Park Row, Chicago, Ill.

# CINCINNATI

THE GATEWAY OF THE SOUTH

## THE MALEY, THOMPSON & MOFFETT CO.

Always in the Market for  
**BLACK WALNUT LOGS,  
 SELECTED WHITE OAK LOGS,  
 LUMBER OF ALL KINDS.**

CINCINNATI, : : : OHIO

WHAT HAVE YOU FOR SALE IN  
**Red and White OAK** Qtd. and Plain  
 ALSO POPLAR, CHESTNUT, WALNUT, ETC.  
**JOHN DULWEBER & CO., CINCINNATI, OHIO**

Cash buyers for stock in our line.  
**Cincinnati Hardwood Lumber Co.**  
 61ST AND SUMMIT STREETS  
 Wholesalers Mahogany, Thin Lumber, Veneers  
 Finely figured quarter sawed oak veneers a specialty.

## WANTED

**Oak  
 Walnut  
 Gum  
 Cottonwood  
 Poplar  
 White Pine  
 Hemlock  
 Yellow Pine**

Will inspect at shipping point when quantity justifies and pay cash. Can use entire mill cuts. Write us before selling elsewhere. We can also handle mixed cars of dressed stock. Send us your list with prices

**Kentucky Lumber Co.**

Suite 508 First National Bank Bldg  
 Cincinnati, Ohio.  
 Formerly of Burnside, Ky.

**THE E. E. BECK LUMBER COMPANY**  
 Cash Buyers  
**Poplar, Oak, Chestnut**  
 And Other Southern Hardwoods  
 ALL GRADES AND THICKNESSES. WE BUY MILL CUTS.

Poplar, Oak, Ash, Chestnut, Sycamore,  
**C. Crane & Co.**  
 We would like to buy  
 2,000,000 feet Dry Oak  
 2,000,000 feet Dry Poplar  
 W. Va. Spruce. Pine and Elm  
 Mostly heavy stock. Quotations Solicited.

MILLS AND YARDS  
 CINCINNATI, O.  
 YEARLY CAPACITY  
 100,000,000 FT.  
 LONG BILL STUFF  
 A SPECIALTY

IN THE MARKET FOR

## OAK-ASH-POPLAR

ALL GRADES AND THICKNESSES

## MOWBRAY & ROBINSON

Office:  
 1219 West Sixth Street

Yards:  
 Sixth Street, below Harriet



**THE FREIBERG LUMBER CO.**  
 Manufacturers of  
**Tabasco Mahogany  
 Walnut, Oak**  
 Poplar, McLean and Findlay Aves.  
 CINCINNATI, O.

**L. W. RADINA & COMPANY**  
 Correspondence Solicited with Buyers and Sellers of All Kinds of  
**HARDWOODS**  
 Wanted for cash—desirable blocks of 1 inch to 4 inch Poplar, all grades, Especially 1 1/2-inch stock, for immediate shipment.  
 CLARK STREET AND DALTON AVENUE

# THE WIBORG & HANNA COMPANY

CINCINNATI, OHIO

PLAIN  
 AND  
 QUARTER  
 SAWED

## White and Red Oak

CHESTNUT  
 POPLAR  
 GUM AND  
 CYPRESS

Flooring, Siding, Ceiling, Base, Case and Molding. Rough, Dressed and Re-sawed. Mixed Carloads.





# INDIANA



WHERE THE BEST HARDWOODS GROW

THE WOODS FOR  
WHICH INDIANA  
IS FAMOUS.

Quart'r'd White Oak

Plain White Oak

Quartered Red Oak

Plain Red Oak

White Ash

Poplar

Black Walnut

Cherry

Sycamore

Red Gum

Hickory

Beech

Maple

Veneers of

Indiana Hardwoods

## FULLERTON-POWELL HARDWOOD LUMBER CO.

SOUTH BEND, IND.

## PERRINE-ARMSTRONG CO.

Long Timber up to 60 feet—Hardwood Specialties

The largest Band Mill in Indiana.

FORT WAYNE, IND.

## J. V. STIMSON

All Kinds of Hardwood Lumber Manufactured

HUNTINGBURG, IND.

## YOUNG & CUTSINGER

Manufacturers and Wholesalers

Our Specialty Fine Figured Quartered Oak

EVANSVILLE, IND.

## CHARLES H. BARNABY

Manufacturer of Band Sawed Hardwoods

Quarter Sawed Indiana White Oak a Specialty

GREENCASTLE, IND.

## D'HEUR & SWAIN LUMBER CO.

Manufacturers and Wholesalers

Our Specialty Quartered Oak and Sycamore

SEYMOUR, IND.

## LONG-KNIGHT LUMBER CO.

MANUFACTURERS AND DEALERS

Quarter Sawed White and Red Oak a Specialty

INDIANAPOLIS, IND.

## MALEY & WERTZ

Manufacturers, Wholesalers and Exporters of Hardwood Lumber

EVANSVILLE, IND.

# BUFFALO

THE GREAT WHOLESALE LUMBER CENTER OF THE EAST



Manufacturers and  
Dealers in

**Ash**

White and Brown

**Basswood**

**Birch**

Red and White

**Butternut**

**Cherry**

**Chestnut**

**Cottonwood**

**Cypress**

**Elm**

Soft and Rock

**Gum**

Red and Tupelo

**Hickory**

**Maple**

Hard and Soft

**Red Oak**

Plain and Quartered

**White Oak**

Plain and Quartered

**Black Walnut**

**White Wood**

Poplar



## T. SULLIVAN & COMPANY

Specialties: BROWN ASH, BIRCH, PACIFIC COAST FIR AND SPRUCE

50 ARTHUR STREET

## ORSON E. YEAGER

Specialties: OAK, ASH AND POPLAR

932 ELK STREET

## BEYER, KNOX & COMPANY

ALL KINDS OF HARDWOODS

Office and Yards, 69 LEROY AVENUE

## BUFFALO HARDWOOD LUMBER CO.

We want to buy for cash:  
Oak, Ash and other Hardwoods, all grades and thicknesses.  
Will receive and inspect stock at shipping point.

518 RANDOLPH BLDG., MEMPHIS, TENN.

940 SENECA STREET.

## EMPIRE LUMBER COMPANY

Our specialties are PLAIN and QUARTERED OAK and ASH.

1142 SENECA STREET.

## G. ELIAS & BROTHER

BUY AND CARRY LARGE QUANTITIES OF ALL KINDS OF HARDWOODS

955 TO 1015 ELK STREET

## HUGH McLEAN LUMBER COMPANY

Specialty: INDIANA WHITE OAK

940 ELK STREET

## ANTHONY MILLER

HARDWOODS OF ALL KINDS

893 EAGLE STREET

## SCATCHERD & SON

HARDWOODS ONLY

Yard, 1553 SENECA STREET

Office, 886 ELLICOTT SQUARE

## STANDARD HARDWOOD LUMBER CO.

OAK, ASH AND CHESTNUT

1075 CLINTON STREET

## I. N. STEWART & BROTHER

Specialties: CHERRY AND OAK

892 ELK STREET

# YELLOW POPLAR

Manufacturers  
BAND SAWED  
POPLAR LUMBER

ALL GRADES

**DRY** 5-8, 4-4, 5-4, 6-4, 8-4, 10-4, 12-4, 16-4  
Bevel Siding, Lath and Squares  
Specialty, Wide Stock.

# LUMBER CO.

COAL GROVE, OHIO, U. S. A.

## W. M. Ritter Lumber Company

COLUMBUS, OHIO

### 6,000 Car Loads

Sawed and shipped yearly of band-sawed Yellow Poplar, White Pine, White Oak, Basswood, Chestnut, Hemlock and Ash. Planing Mills and Dry Kilns. ☛ If you are in a hurry to get your order placed, call our nearest salesman.

Salesman	Headquarters	Telephone
Fred A. Wilson.....	Portsmouth, Ohio.....	Bell 4392
E. E. Eaton.....	New York City, 158 W. 81st St.....	Riverside 7390
James B. Patton.....	Buffalo, N. Y., Rockford Hotel.....	Bryant 1335-R
A. Wallace Irwin.....	Baltimore, Md., Eutaw Hotel.....	
Frank B. Pryor.....	Pittsburgh, Pa., 7th Avenue Hotel.....	
E. E. Ginn.....	Jamestown, Ohio.....	Bell Phone
A. J. Williams.....	Cleveland, Ohio, Eastman, Detroit St.....	Ridge 593-R
L. G. Anderson.....	Franklin, Ohio.....	Bell 482
James H. Lang.....	Detroit, Mich., Hotel Ste. Claire.....	Lakeview 1493
W. H. Matthias.....	Chicago, Ill., 1448 Addison St.....	
Geo. H. Haganir.....	Philadelphia, Pa., 901 N. 50th St.....	Main 7574
F. H. Browning.....	Columbus, Ohio.....	
W. T. Baker.....	Graham, Va.....	

## Vansant, Kitchen & Co.

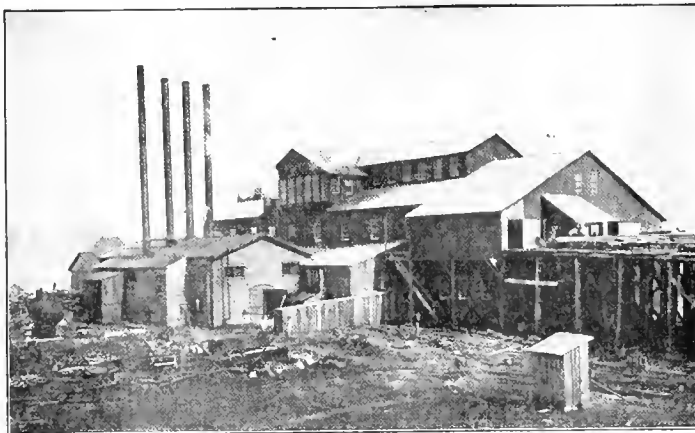

NEW ASHLAND MILL

Old-Fashioned

### SOFT YELLOW POPLAR

Ashland, Ky.

5-8 AND 4-4 IN WIDE STOCK, SPECIALTY

# Hardwood Record

Eleventh Year.  
Semi-monthly.

CHICAGO, AUGUST 10, 1906.

Subscription \$2.  
Single Copies, 10 Cents.

## CHERRY

C. E. LLOYD, JR.  
Manager Sales

## RIVER

## LUMBER

GROWS IN  
WEST VIRGINIA

Sold by  
Cherry River Boom &  
Lumber Co.  
Offices: Philadelphia, Pa

## Himmelberger-Harrison Lumber Co.

## Red Gum Specialists

Morehouse,

Missouri

## A Great Mistake

### To Be Without Our Policy.

**PENNSYLVANIA LUMBERMEN'S MUTUAL FIRE INSURANCE CO.**  
923 Drexel Bldg., PHILADELPHIA, PA.

## RUMBARGER LUMBER COMPANY

<p><b>Ash.</b> 1 car 4 1, little 5 4, some S 4, Nos. 1 &amp; 2 &amp; No. 1 Common. 30 cars 4 4, log run, 1 3 car 5 1, log run. <b>Basswood.</b> 5 cars 4 4, log run; choice stock. 17 cars 4 4, log run; wormy stock. <b>Beech.</b> 71 cars 4 4, log run, 1 car 5 4, log run. 3 cars 6 4, log run, 12 cars S 4, log run. <b>Birch.</b> 21 cars 4 4, log run, 1/2 car S 4, log run. Choice wide stock. Will sell on grades. 3 cars 4 4, log run. <b>Chestnut.</b> 5 cars 4 4, Nos. 1 &amp; 2 &amp; No. 1 Common. 1 car 4 4, S 4, Nos. 1 &amp; 2 and No. 1 Common; half S 4.</p>	<p>7 cars 4 4, sound wormy 2 cars 6 4, sound wormy. <b>Plain Red Oak.</b> 11 1/2 cars 4 4, Nos. 1 &amp; 2 3 cars 4 4, Nos. 1 &amp; 2 &amp; No. 1 Common 3 cars 6 4, Nos. 1 &amp; 2 &amp; No. 1 Common 1 car 4 4 &amp; 5 4, Nos. 1 &amp; 2 and No. 1 Common; half each thickness. 11 1/2 cars 4 4, No. 1 Common 1 car 4 4, No. 2 Common. 8 cars 4 4, log run. <b>Plain Rod and White Oak.</b> 1 car 4 4, Nos. 1 &amp; 2. 3 cars 4 4, No. 1 Common. Mostly red oak, only small percent white oak. <b>Plain White Oak.</b> 1 car 4 4, Nos. 1 &amp; 2 &amp; No. 1 Common. 1/2 car 4 4, No. 1 Common. 2 cars 4 4, No. 2 Common. 2 cars 4 4, log run. <b>Plain White and Red Oak.</b> 1 car 5 1, 6 4, S 4, Nos. 1 &amp; 2 &amp; No. 1</p>	<p>Common, mostly W O, only small percent R O. 1 car S 4, Nos. 1 &amp; 2 &amp; No. 1 Common, mostly W O, only small percent R O. 3 cars 4 4, log run, mostly W O, only small percent R O. 4 cars 4 4, No. 2 Common, 1/2 each white oak and red oak. <b>Quartered Red Oak.</b> 1 car 4 4, Nos. 1 &amp; 2 1 car 4 4, clear strips (narrow). 1 car 4 4, No. 1 Common. <b>Quartered White Oak.</b> 1 car 4 4, Nos. 1 &amp; 2 2 cars 4 4, clear strips (narrow). 9 cars 4 4, No. 1 Common. <b>White Pine.</b> 210,000 ft. 4 4, log run. 16,000 ft. 6 4, log run. 16,000 ft. S 4, log run. 1,000,000 ft. 4 4 to S 4 sorted as to grades and widths: rough or worked</p>	<p><b>Poplar.</b> 2 cars 5 S, Nos. 1 &amp; 2. 4 cars 4 4, Nos. 1 &amp; 2. 1 car 5 4, Nos. 1 &amp; 2. 1 car S 4, Nos. 1 &amp; 2. 1 car 5 S, clear saps. 2 cars 4 4, clear saps. 1 car 5 4, clear saps. 7 cars 4 4, No. 1 Common. 3 cars 5 4, No. 1 Common. 11 1/2 cars 6 4, No. 1 Common. 2 cars S 4, No. 1 Common. 7 cars 4 4, No. 2 Common. 1 car 6 4, No. 2 Common. 1 car 16 4, Nos. 1 &amp; 2 &amp; No. 1 Common. 11 cars 4 4, log run. 1 car 4 4, Nos. 1 &amp; 2, 2 1/2 to 36' wide. <b>Clear Spruce.</b> 1 1/2 car 7 S. 1 car S 4. <b>Spruce Box.</b> 30 cars 4 4, rough. 10 cars 4 4, S 2 S. 5 cars 4 4, S 1 S.</p>
--	---	---	---

Main Office: 808 Harrison Bldg., 15th and Market Sts., Philadelphia, Pa. New York Office: 8018 Metropolitan Bldg., 1 Madison Av. Pittsburgh Office: 701 Keystone Bldg.

The combined facilities of the stock lumber insurance companies  
**LUMBER INSURANCE COMPANY OF NEW YORK**  
 and the **ADIRONDACK FIRE INSURANCE COMPANY**  
 and allied organizations, constitute a great insuring opportunity for any owner of a first-class lumber or mill risk.  
 Ask for lines and rates. **LUMBER INSURERS GENERAL AGENCY, Underwriting Managers**  
**66 Broadway, New York**

# LOUISVILLE

MANUFACTURING AND DISTRIBUTING CENTER OF KENTUCKY.

## The Norman Lumber Co., Inc.

Manufacturers and Wholesalers of

### Hardwood Lumber

FOR SALE

Seasoned Ash, Oak, Poplar, and Walnut Lumber

WANT TO BUY

Walnut, Oak, Ash, Hickory and Poplar Logs and Lumber

Office and Yards: Third Street, H to K Streets  
LOUISVILLE, KY.

## EDWARD L. DAVIS & CO.

OFFER FOLLOWING STOCKS:

<b>POPLAR.</b>	<b>OAK WAGON TONGUES.</b>
30,000 ft. 4/4 1st & 2d.	12,000 ft. 4x4"x1x2"-12', 1-8 mos. dry.
50,000 ft. 4/4 Common.	800 ft. 3 x4 "12', 12-18 mos. dry.
15,000 ft. 5/4 Common.	400 ft. 3 1/2 x 4 1/2 "12', 12-18 mos. dry.
<b>QUARTERED RED OAK.</b>	300 ft. 3 1/2 x 4 1/2 "12', 12-18 mos. dry.
50,000 ft. 4/4 1st & 2d.	250 ft. 3 1/2 x 4 1/2 "12', 12-18 mos. dry.
50,000 ft. 4/4 Common.	800 ft. 3 1/2 x 4 1/2 "12', 12-18 mos. dry.
<b>QUARTERED WHITE OAK.</b>	180 ft. 3x4" & 1 gr.-14', 12-18 mos. dry.
50,000 ft. 4/4 1st & 2d.	<b>REACHES.</b>
10,000 ft. 5/4 1st & 2d.	1 car 2x4" and larger, dry.
20,000 ft. 6/4 1st & 2d.	<b>BOLSTERS.</b>
10,000 ft. 8/4 1st & 2d.	2 cars 3x4" and larger, dry.
50,000 ft. 4/4 Common.	<b>HICKORY AXLES.</b>
5,000 ft. 5/4 Common.	1,500-3 x4 "6', 1-6 mos. dry.
5,000 ft. 6/4 Common.	1,500-3 1/2 x 4 1/2 "6', 1-6 mos. dry.
20,000 ft. 8/4 Common.	2,000-4 x5 "5', 1-6 mos. dry.
10,000 ft. 2 1/2" Common.	1,000-4 1/2 x 5 1/2 "6', 1-6 mos. dry.
40,000 ft. 3" Common.	1,000-6 x6 "6', 1-6 mos. dry.
1 car Hickory Plank, 1 1/2 to 4"-	
8' to 16'.	

## We wish to move and will quote low prices on the following:

- |   |  |
|---|--|
| 1 Car 6 4 1st and 2nd Qtd. White Oak, Wide in     | 1 Car 4 4 2 1/2 to 5 1/2" 1st & 2nd Qtd. White Oak Strips    |
| 1 Car 8 4 1st and 2nd Qtd. White Oak, Wide in     | 1/2 Car 4 4 2 1/2 to 5 1/2" No. 1 Com. Qtd. White Oak Strips |
| 1 Car 4 4 No. 1 Com. Qtd. White Oak               | 1 Car 4 4 No. 2 Com. Qtd. White and Red Oak                  |
| 1 Car 6 4 No. 1 Com. Qtd. White Oak               | 1/2 Car 5 4, 6 4 and 8 4 No. 2 Com. Qtd. White and Red Oak   |
| 2 Cars 8 4 No. 1 Com. Qtd. White Oak              | 1 Car 4 4 No. 2 Com. Plain Red Oak                           |
| 1 Car 12 4 No. 1 Com. Qtd. White Oak              | 1 Car 5 4, 6 4, and 8 4 No. 2 Com. Plain Red Oak             |
| 1 Car 4 4 1st and 2nd Qtd. Red Oak, Wide in       | 2 Cars 4 4 No. 3 Com. Plain Red and White Oak                |
| 1 Car 4 4 No. 1 Com. Qtd. Red Oak, Wide in        | 1 Car 6 4 1st and 2nd Poplar, 7 to 18"                       |
| 1/2 Car 6 4 Com. and Bet. Qtd. Red Oak, 50% each  | 5 Cars 4 4 No. 1 Com. Poplar (Selects in)                    |
| 1/2 Car 8 4 Com. and Bet. Qtd. Red Oak, 50% each  | 1 Car 4 4 No. 1 Com. and Bet. Bay Poplar                     |
| 1 Car 12 4 Com. and Bet. Qtd. Red Oak, 50% each   | 1 Car 4 4 to 8 4 Com. and Bet. White Ash                     |
| 1 Car 6 4 Com. and Bet. Plain Red Oak, 50% each   | 1 Car 4 4 No. 2 Com. and Sound Wormy Chestnut                |
| 2 Cars 12 4 Com. and Bet. Plain Red Oak, 50% each |  |

We have in pile at mills 3,000,000 ft. Plain and Quartered Red and White Oak, Poplar, Chestnut and some Ash, in thickness 3/4" to 16-4". This will be ready for market in 60 to 90 days. We also handle all kinds of Yellow Pine, Cypress, White Pine, Red and White Cedar, Lumber, Lath and Shingles and all kinds of Hardwood Flooring. Write us for prices.

**STOTZ LUMBER COMPANY**  
KELLER BUILDING :: :: LOUISVILLE, KY.

## Ornamental Hardwood Floors

400 STYLES AND PATTERNS

Illustrated Catalog on Application

### WOOD=MOSAIC FLOORING CO.

Rochester, N. Y. New Albany, Ind.

### Albert R. Kampf

Manufacturer  
Hardwood Lumber and Timber  
Dimension Stock  
Board of Trade Bldg., Louisville, Ky.

### E. W. Rhubesky

Wholesale  
Poplar, Rough and Dressed.  
Oak, Chestnut and Other  
Hardwoods

### North Vernon Pump & Lumber Co.

Band Sawn Plain and Quartered  
Oak and Poplar.  
North Vernon, Ind., and  
Louisville, Ky.

### Southern Lumber Co.

Oak, Poplar and  
Chestnut.  
Louisville, Ky.

## Dry Stock W. P. Brown & Sons Lumber Co. Louisville, Ky.

<b>PLAIN RED OAK.</b>	14,000' 1 1/2" 1st & 2d.	50,000' 2" No. 1 Com.	<b>ASH.</b>	<b>POPLAR.</b>
55,000' 1" 1st & 2d.	5,000' 2" 1st & 2d.	17,000' 2 1/2" No. 1 Com.	9,000' 1" 1st & 2d.	12,600' 1" 1st & 2d.
25,000' 1 1/2" 1st & 2d.	15,000' 1" No. 1 Com.	22,000' 3" No. 1 Com.	65,000' 1 1/4" 1st & 2d.	12,600' 1 1/4" 1st & 2d.
49,000' 1 1/2" 1st & 2d.	7,000' 1 1/2" No. 1 Com.		16,000' 1 1/2" 1st & 2d.	11,000' 1 1/2" 1st & 2d.
57,000' 2" 1st & 2d.	13,000' 2" No. 1 Com.		10,000' 2" 1st & 2d.	12,000' 2" 1st & 2d.
18,000' 2 1/4" 1st & 2d.		<b>QUARTERED WHITE OAK.</b>	8,000' 2 1/4" 1st & 2d.	8,000' 2 1/4" 1st & 2d.
16,000' 3" 1st & 2d.	<b>PLAIN WHITE OAK.</b>	50,000' 1" 1st & 2d.	14,000' 3" 1st & 2d.	6,000' 3" 1st & 2d.
131,000' 3" No. 1 Com.	80,000' 1" 1st & 2d.	18,000' 1" No. 1 Com.	6,000' 4" 1st & 2d.	50,000' 1" No. 1 Com.
84,000' 1 1/2" No. 1 Com.	28,000' 1 1/4" 1st & 2d.	30,000' 1 1/4" No. 1 Com.	5,000' 1" No. 1 Com.	28,000' 1 1/4" No. 1 Com.
44,000' 1 1/2" No. 1 Com.	12,000' 1 1/2" 1st & 2d.	45,000' 1 1/2" 1st & 2d.	4,000' 1 1/4" No. 1 Com.	10,000' 1 1/2" No. 1 Com.
47,000' 2" No. 1 Com.	42,000' 2" 1st & 2d.	49,000' 2" 1st & 2d.	6,000' 1 1/2" No. 1 Com.	16,000' 2" No. 1 Com.
8,000' 2 1/2" No. 1 Com.	23,800' 2 1/2" 1st & 2d.	19,000' 2 1/2" 1st & 2d.	6,000' 1 1/2" No. 1 Com.	15,000' 1" 18" & up 1st & 2d.
15,000' 3" No. 1 Com.	16,000' 3" 1st & 2d.	18,000' 1" No. 1 Com.	8,000' 2" No. 1 Com.	8,000' 2" 18" & up 1st & 2d.
<b>QUARTERED RED OAK.</b>	227,000' 1" No. 1 Com.	30,000' 1 1/4" No. 1 Com.	3,000' 2 1/2" No. 1 Com.	6,000' 2" 24" & up 1st & 2d.
13,000' 1" 1st & 2d.	60,000' 1 1/2" No. 1 Com.	40,000' 1 1/2" No. 1 Com.	2,000' 3" No. 1 Com.	4,000' 1 1/2" 18" & up 1st & 2d.
	80,000' 1 1/2" No. 1 Com.	22,000' 2" No. 1 Com.	1,000' 4" No. 1 Com.	3,000' 1 1/2" 24" & up 1st & 2d.

All thicknesses in cull poplar, ash, chestnut.

Your inquiries will be appreciated.

Prompt delivery guaranteed.

# CADILLAC

CELEBRATED FOR HIGH STANDARD OF QUALITY AND MILL WORK

## MICHIGAN RED OAK

- ☪ As fine stock as was ever cut in the famous Cadillac district.
- ☪ We have some of this choice 4-4 Red Oak which will soon be in shipping condition.
- ☪ If you are in the market, we can please you both in quality and price.
- ☪ We also have some nice Soft Gray Elm in 4-4, 6-4, 8-4 and 12-4. It's Bone Dry.

## Mitchell Brothers Company

CADILLAC, MICHIGAN

## Cummer, Diggins & Co.

—MANUFACTURERS—  
 "CUMMER" MAPLE  
 AND BEECH FLOORING

## MICHIGAN HARDWOODS

Good assortment of dry stock on hand ready for immediate shipment in Hard Maple, Beech, Birch, Soft Elm and Cherry.

SEND US A LIST OF YOUR REQUIREMENTS.

## MURPHY & DIGGINS

Offer all grades of the following special dry stock

MAPLE—5, 4, 6, 4, 8, 4, 10, 4, 12, 4, 14, 4, 16, 4  
 GRAY ELM—4, 4, 12, 4  
 BASSWOOD 4, 4  
 BIRCH—4, 4, 6, 4

Our own manufacture. Perfect Mill Work. Uniform Grades.

LET US FIGURE ON YOUR HARDWOOD WANTS.

## The Cadillac Handle Co.

. . . Band Sawn . . .  
 Michigan Hardwoods

<p><b>For Rail Shipment from Cadillac.</b>                  2 cars 8-4 Maple, No. 1 Com. &amp; Better                  15 cars 4-4 Maple, on Grades.                  2 cars 4-4 Basswood, No. 2 Com. &amp; Bet.                  2 cars Basswood, No. 2 Com. &amp; Bet.</p>	<p><b>For Water Shipment:</b>                  120,000 feet of 4-4 Basswood                  160,000 feet of 4-4, 5-4 and 6-4 Birch                  100,000 feet of 4-4, 8-4 and 12-4 Soft Elm                  10,000 4-4 Ash.</p>
--	--

## DRY STOCK

### Cadillac Hard Maple

88M 4-4 No. 3 Common.  
 265M 5-4 No. 1 & 2 Common.  
 325M 6-4 No. 1 & 2 Common.  
 105M 6-4 1's & 2's.  
 44M 12-4 1's & 2's.  
 3½M 16-4 No. 2 & Better.

The above stock is our own manufacture and we can ship promptly.

Be Friendly. Write Us.



**COBBS & MITCHELL**  
 (INCORPORATED)  
**CADILLAC, MICHIGAN**





# MEMPHIS

THE HUB OF THE HARDWOOD WORLD

**WE** have in all thicknesses the following kinds and amounts of lumber at places designated. Kindly send us your inquiries.

### MEMPHIS YARD:

Ash..... 680,000 feet  
Quartered White Oak..... 75,000 feet  
Plain White Oak..... 140,000 feet  
Quartered Red Oak..... 225,000 feet  
Plain Red Oak..... 410,000 feet  
Cypress..... 225,000 feet  
Cottonwood..... 200,000 feet  
Poplar..... 308,000 feet

### SELMA YARD

Poplar..... 409,000 feet  
Bay Poplar..... 857,000 feet  
Red Gum..... 55,000 feet  
Cypress..... 787,000 feet

### BERCLAIR YARD

Bay Poplar..... 100,000 feet  
Cypress..... 800,000 feet

### OTHER YARDS

Plain Red Oak..... 350,000 feet

## J. W. THOMPSON LUMBER COMPANY

Office and Yards: Randolph Road and I. C. R. R. : : MEMPHIS, TENN.

## BACON-NOLAN HARDWOOD CO.

Manufacturers of

### Band Sawn Oak, Ash Gum, Cypress, Etc.

Office,  
Memphis, Tenn.

Mills,  
Chancy, Miss.

Address all correspondence to Memphis office.

## ANDERSON-TULLY COMPANY

### STOCK LIST

#### COTTONWOOD.

32M ft. 7" 1st & 2d, 8" up wide  
200M ft. 1" 1st & 2d, 8" up wide.  
63M ft. 1" 1st & 2d, 7" to 10" wide.  
19M ft. 1" 1st & 2d, 11" wide.  
24M ft. 1" 1st & 2d, 12" wide.  
200M ft. 1" 1st & 2d, 13" up wide.  
45M ft. 1" 1st & 2d, 18" up wide.  
35M ft. 1 1/2" 1st & 2d, 8" up wide.  
39M ft. 1 1/2" 1st & 2d, 12" wide.  
39M ft. 1 1/2" 1st & 2d, 11" wide.  
39M ft. 1 1/2" 1st & 2d, 8" up wide.  
150M ft. Wag. Box Brds., 9" 12" wide.  
500M ft. 1" No. 2 Com.  
500M ft. 1" No. 3 Com.

#### CYPRESS.

19,699 ft. 4/4 Cir. Strips, 2 1/2" 5 1/2" wide.  
5,000 ft. 4/4 Select.

#### ASH.

5M ft. 1 1/4 Com. Strips, 2 1/2" 5 1/2" wide.  
12M ft. 5/4 & 6/4 No. 3 Common.

#### GUM.

4M ft. 3 8" 1st & 2d Red, 16" & 1 1/2.  
7M ft. 1 1/2" 1st & 2d Red, 16" & 1 1/2.  
39M ft. 1 1/2" 1st & 2d Sap, 6" & 1 1/2.  
80M ft. 4 1/2" 1st & 2d Sap, 13" to 15".  
40M ft. 4 1/2" No. 1 Com. Red.  
50M ft. 4 1/2" No. 1 Com. Sap.  
60M ft. 4 1/2" Cir. Red Strips, 2 1/2" 5 1/2".  
18M ft. 5 1/4" No. 1 Com. Sap.  
30M ft. Wagon Box Brds., 13" to 17".

#### POPLAR.

27,100 ft. 4 1/2" Com. & Bet. Strips,  
2 1/2" to 5 1/2".

#### RED OAK.

400 ft. 4 1/2" 1st & 2d Quartered.  
2,700 ft. 4 1/2" Com. Quar.  
4,000 ft. 4 1/2" No. 2 & No. 3 Com.  
1 1/2" Red & White.

#### WHITE OAK.

1,100 ft. 4 1/2" 1st & 2d Quartered  
10,910 ft. 4 1/2" Com. Quartered.

## FENN BROS. COMPANY

MANUFACTURERS OF

### Oak Flooring

QUARTERED WHITE HOLLOW BACKED  
QUARTERED RED END MATCHED  
PLAIN WHITE POLISHED  
PLAIN RED BORED

Memphis, Tenn.

F. W. GILCHRIST, President  
W. A. GILCHRIST, Vice President  
W. E. SMITH, Sec'y and Treasurer

## W. E. SMITH LUMBER CO.

Manufacturers of  
**HARDWOOD LUMBER**

Mills, Tennessee, Arkansas, Mississippi  
Distributing Yards, Cairo, Illinois  
General Office, Tennessee Trust Bldg.

MISSISSIPPI VALLEY COTTONWOOD

J. B. Ransom, Pres. A. B. Ransom, V. Pres. W. A. Ransom, Sec. C. R. Ransom Treas.

## GAYOSO LUMBER CO., Inc.

MANUFACTURERS AND DEALERS IN

### SOUTHERN HARDWOODS

Also make a specialty of Wagon Stock in rough, such as Tongues,  
Axles, Reaches, Bolsters, and 6-4 to 16-4 Hickory.

## Briggs & Cooper Company, Ltd.

MANUFACTURERS

NORTHERN SOUTHERN **HARDWOODS**

GET OUR PRICES ON THESE ITEMS:

1,000,000 feet Soft Grey Elm, 1 to 3".  
500,000 feet Unselected Birch, 1 to 3".  
3,000,000 feet Michigan Hard Maple, 1 to 6".  
350,000 feet Erid Dried White Maple, 1 to 1 1/2".  
625,000 feet No. 1 Common and Better Winter Sawn Basswood, 1 to 3".  
150,000 feet Selected White Basswood, 1", 1 1/4" and 1 1/2".  
210,000 feet Plain and Quartered White and Red Oak, 1 to 2"

YARDS AT

SAGINAW, CHICAGO AND MEMPHIS

F. W. GILCHRIST, Pres. W. A. GILCHRIST, Vice-Pres.  
W. E. SMITH, Sec'y and Treas.

## Three States Lumber Co.

MANUFACTURERS OF

Mills:  
Missouri  
Arkansas  
Tennessee

### Hardwood Lumber Cottonwood and Gum

Office  
Tennessee  
Trust  
Building

GET OUR PRICES, TRY OUR LUMBER  
WE SHIP ROUGH, DRESSED, RESAWED

COTTONWOOD GUM

# ST. LOUIS

LARGEST OF ALL HARDWOOD MARKETS

Roland F. Krebs **Ozark Cooperage Co.** Hardwood Department  
Manager

**WE BUY STOCKS READY CUT OR CONTRACT FUTURE OUTPUT**

Four Inspectors in the South

Direct Shipments (COTTONWOOD, WALNUT, CHERRY, GUM, OAK) from mill stocks MAIN OFFICE, FRISCO BUILDING

**Garetson-Greason Lumber Co.**

MANUFACTURERS OF SOUTHERN HARDWOODS

**GUM LUMBER  
 OUR SPECIALTY**

Carload Shipments Direct from Our Own Mills

**519 Bank of Commerce**

**W. R. CHIVVIS,** Lesperance Street and Iron Mountain Railroad.

**WHOLESALE HARDWOODS**

**BLACK WALNUT LUMBER MY SPECIALTY.** Always in the market to buy Walnut and Cherry Lumber. Pay spot cash and take up at shipping point when amounts justify.

**Wanted—Cypress, Ash and Cottonwood**

INSPECTION AT POINT OF SHIPMENT WHEN QUANTITY JUSTIFIES

**Hafner Manufacturing Co.**

CYPRESS, HARDWOODS

Mail orders receive our immediate attention.

**YARDS: FOOT OF DOCK STREET**

**CHAS. F. LUEHRMANN HARDWOOD LUMBER COMPANY**

Carry a complete stock of Hardwood and are constantly in the market to purchase large blocks of stock for cash. Are also the largest manufacturers of the famous St. Francis Basin Red Gum.

**General Offices: 148 Carroll Street**

**Thomas & Proetz Lumber Co.**

CASH BUYERS OF OAK, ASH, CYPRESS, POPLAR, CHERRY AND ALL

**HARDWOODS**

SEND INSPECTOR WHEN QUANTITY JUSTIFIES

**Office and Yards: Hall and Angelrodt Sts.**

**Stoneman-Zearing Lumber Co.**

*203 Frisco Building*

We have the following Dry Stock for sale piled at our mill.

<b>QTD. WHITE OAK:</b>	<b>COTTONWOOD:</b>
3 Cars 1 4 Common	3 Cars 1" 1 and 2.
2 Cars 1 4 Common and Better Strips.	1 Car 1x13 to 17" Box Boards.
<b>GUM:</b>	<b>ELM:</b>
5 Cars 1" Common Red.	1 Car 6 4 Log Run
1 Car 1x13 to 17" Box Boards.	4 Cars 4' Log Run.
1 Car 2" 1 and 2 Sap.	
6 Cars 1 3 4 Common and Better Sap.	

This Stock is All Band Sawed and Equalized

**LOTHMAN CYPRESS CO.**

AIR DRIED

**Louisiana Red Cypress**

**FOOT OF ANGELICA STREET**

**SIX MILLION FEET**

**Ash, Oak, Cypress, Poplar, Etc.**

READY FOR PROMPT SHIPMENT

**STEELE & HIBBARD**

NORTH BROADWAY, DOCK AND HALL STREETS

# WILLIAM WHITMER & SONS, Inc.

MANUFACTURERS OF

## HARDWOODS

We are always in the market for round lots of well manufactured stock, and shall be pleased to enter into correspondence with manufacturers with a view to purchase.

PHILADELPHIA  
New York, Boston, Pittsburg

JOHN T. DIXON

HARRY S. DEWEY



We are not **Wizards** in making new grades to fit a price. No tricks in our methods of making shipments. The straight grades are good enough for us.

If you will give us a trial order for **POPLAR, OAK, ASH, CHESTNUT** or **OAK, MAPLE** and **YELLOW PINE FLOORING**, we believe we can demonstrate our ability to please you.

### DIXON & DEWEY

716 and 1716 A, Flatiron Building,

NEW YORK

## Two pertinent questions

1. Has your business outgrown your system of accounting?
2. Do you know the actual mill cost of your product?

Successful management necessitates independent audits of all operations

Write



**Standard Audit Company**

Suite 335

Marquette Building, CHICAGO

## The Tegge Lumber Co.

MILWAUKEE  
WISCONSIN

BUYERS OF  
ALL KINDS OF

### HARDWOOD LUMBER

## A flooring that is everlasting

Of finest Maple that grows. Kiln dried, end matched, steel polished, hollow backed, bored and bundled

Try "**Nichol's**" Make

Full line of Michigan and Southern Hardwoods.

### Nichols & Cox Lumber Co.

Grand Rapids, Mich.

**T H E E A S T**

BOSTON      NEW YORK      PHILADELPHIA

**Charles S. Wentworth & Co.**  
**WHOLESALE LUMBER MERCHANTS**

147 Milk Street  
**BOSTON**

We are in the Market for POPLAR, PLAIN OAK, CYPRESS and NORTH CAROLINA PINE LUMBER; also OAK, MAPLE and BIRCH FLOORING, and would appreciate correspondence from manufacturers in position to supply any of the stock named.

**STEVENS-EATON CO.**  
 Buyers of **Hardwoods** No. 1 Madison Avenue, NEW YORK  
 of **ROUND LOTS**  
 ESPECIALLY IN MARKET FOR PLAIN RED OAK

J. J. SOBLE      H. I. SOBLE

**SOBLE BROTHERS**  
 Wholesale Hardwoods  
**911-912 Land Title Bldg. PHILADELPHIA**  
 WANTED: 20 cars Common and Better Chestnut, all thicknesses.

**If Value Is Not in It,  
 A Guaranty Doesn't Put It in.**

One hundred and eight years of lumber dealing has handed down to us a large experience in buying lumber, which makes it safe to deal with us on the basis of quality. Here are some items:

150M ft. Ash, one to six inches thick.  
 1,500M ft. Hemlock, boards and sizes.  
 130M ft. Spruce, boards and sizes.  
 300M ft. Quartered White Oak.  
 600M ft. Yellow Pine Flooring, ceiling and sizes.

Send us in your orders to-day.      See August Stock List.

**J. Gibson McIlvain & Co.**  
 56th to 58th Streets and Woodland Avenue,      PHILADELPHIA, PA.

**WM. E. LITCHFIELD**  
 MASON BUILDING, BOSTON, MASS.  
**Specialist in Hardwoods**  
 Manufacturers are requested to supply lists of stock for sale

**H. D. Wiggin Wholesale Hardwoods**  
**Specialties:** Poplar, Chestnut, Canadian Hardwoods, and Mahogany Veneers.  
 FISKE BUILDING      BOSTON, MASSACHUSETTS

**Thomas Forman Company**  
 MANUFACTURERS OF HIGH-GRADE  
**Maple and Oak  
 Flooring**

New York Branch:      **DETROIT, MICHIGAN**  
 McGovern & Bowen,      And Hardwood Lumber  
 29 Broadway

WE MUST MOVE AT ONCE  
**6 Cars 4-4 1's and 2's Red Oak**  
 High Grade Stock, good widths and lengths  
 PRICE RIGHT. Send us your inquiries  
**SCHOFIELD BROTHERS**  
 1020-22 Pennsylvania Building, PHILADELPHIA

**Wistar, Underhill & Co.,**  
 ——— WHOLESALE ———  
**HARDWOOD LUMBER**  
 816 Real Estate Trust Building,      PHILADELPHIA.

**The Crosby & Beckley Company**  
**HARDWOODS**

We are  
**In the Market for Choice Stock**  
 WRITE US

No. 1 Madison Ave.,      New Haven, Connecticut.  
 New York, N. Y.

**Holloway Lumber Company**  
**WHOLESALE HARDWOODS**  
 In the market for all thicknesses of      312 Arcade Building,  
 OAK, ASH and CHESTNUT.      PHILADELPHIA, PA.

**JONES HARDWOOD CO.**  
 INCORPORATED  
**WANTS: Poplar, Plain Oak, 147 MILK STREET**  
**Quartered Oak and Cypress. BOSTON, MASSACHUSETTS**  
 Manufacturers please send stock lists and prices.

# NASHVILLE

HEADQUARTERS FOR ALL SOUTHERN HARDWOODS

## INDIANA LUMBER CO.

Manufacturers Lumber  
DIMENSION STOCK A SPECIALTY.

Office and Mills: Corner Oldham  
Street and Cumberland River

NASHVILLE, TENN.

## GEO. C. BROWN & CO.

MANUFACTURERS AND WHOLESALE DEALERS IN

Hardwood Lumber

Tennessee Red Cedar Lumber a Specialty.

NASHVILLE, TENNESSEE

## JOHN B. RANSOM & CO.,

NASHVILLE, TENNESSEE

We want to move quickly the following old dry stock. All of it has been on sticks 6 to 18 months. Write us for delivered prices. We are prepared to furnish promptly mixed cars of rough and dressed hardwoods of all kinds:

QUARTERED WHITE OAK	QUARTERED RED OAK
90 M 4 4 first and second	100 M 4 4 first and second
15 M 5 4 first and second	58 M 6 4 first and second
80 M 6 4 first and second	15 M 8 4 first and second
10 M 10 4 first and second	95 M 4 4 No. 1 Common
120 M 4 4 No. 1 Common	84 M 6 4 No. 1 Common
65 M 6 4 No. 1 Common	72 M 8 4 No. 1 Common
58 M 8 4 No. 1 Common	
20 M 10 4 No. 1 Common	PLAIN OAK
70 M 5 8 first and second Poplar	50 M 4 4 1st and 2nd White
80 M 5 8 No. 1 Common Poplar	100 M 4 4 No. 1 Common White
15 M 4 4 1st and 2d Quartered Sycamore	100 M 4 4 first and second Red
10 M 4 4 No. 1 Com. Quart'd Sycamore	100 M 4 4 No. 1 Common Red

## LOVE, BOYD & CO.

Offer:

5,000,000 ft. Quartered White Oak.  
2,000,000 ft. Quartered Red Oak.  
1,000,000 ft. Plain White Oak.  
1,000,000 ft. Plain Red Oak.  
1,000,000 ft. Poplar.  
2,000,000 ft. Chestnut, Ash, Hickory, Red Cedar, Etc.

Our Own Manufacture.  
Prompt Service.  
Dry Stock.

MAIN OFFICE,  
NASHVILLE, TENNESSEE

## Nashville Hardwood Flooring Co.

Manufacturers of

“Acorn Brand”

THE FAMOUS FAULTLESS FLOORING  
IN OAK AND BEECH.

Car Lots and Less Than Car Lot  
Orders Solicited. Write for Prices.

Nashville, Tennessee

# Swann-Day Lumber Company

MANUFACTURERS OF

## POPLAR AND OAK

PLANING MILL STOCK, BOX SHOOKS  
AND HARDWOOD DIMENSION

CLAY CITY, KENTUCKY

# PAEPCKE-LEICHT LUMBER COMPANY

MANUFACTURERS OF

## COTTONWOOD GUM AND OTHER HARDWOODS

Large stocks of well seasoned Lumber always carried at our yards and mills.

General Offices: 140 W. Chicago Ave., CHICAGO. Mills: Cairo, Ill., Marked Tree, Ark., Greenville, Miss., Arkansas City, Ark., Blytheville, Ark.

# PITTSBURG

HARDWOOD DISTRIBUTING CENTER OF PENNSYLVANIA

## Willson Bros. Lumber Co.

MANUFACTURERS

### WEST VIRGINIA HARDWOODS

FARMERS BANK BLDG. :: PITTSBURG, PA.

## Hardwoods a Specialty

FOR SALE

POPLAR	CHESTNUT	PLAIN OAK
125,000' 4 4 1s and 2s	300,000' 4 4 Sound Wormy	60,000' 4 4 No. 1 Com.
40,000' 4 4 No. 1 Com.	80,000' 5 4 Sound Wormy	18,000' 4 4 No. 2 Com.
325,000' 4 4 No. 2 Com.	100,000' 6 4 Sound Wormy	<b>QUARTERED OAK</b>
228,000' 4 4 No. 3 Com.	48,000' 8 4 Sound Wormy	2 cars 4 4 No. 1 Com.
150,000' 2 4 Mill Cull		1 car 4 4 No. 2 Com.

OAK TIMBERS SAWED TO ORDER.  
WRITE FOR PRICES.

CHEAT RIVER LUMBER COMPANY, Pittsburg, Penna.

## STOCK LIST

12,500 ft. 4x4 Maple No. 1 Com. & Bel.	192,000 ft. 4x4 Poplar Log Run
8,000 ft. 4x4 Maple No. 1 Common	4,000 ft. 8x4 Poplar Log Run
48,000 ft. 5x4 Maple No. 1 Com. & Bel.	23,500 ft. 12x4 Poplar Good
21,000 ft. 5x4 Maple 1sts and 2nds	2,500 ft. 6x4 Basswood Log Run
12,000 ft. 5x4 Maple No. 1 Common	2,200 ft. 8x4 Basswood Log Run
18,000 ft. 6x4 Maple No. 2 Com. & Bel.	1 Car 4x4 Basswood Log Run
3,000 ft. 6x4 Maple 1sts and 2nds	62,000 ft. 4x4 Cherry Log Run
3,000 ft. 8x4 Maple No. 2 Com. & Bel.	25,000 ft. 5x4 Cherry Log Run
29,000 ft. 8x4 Maple No. 1 Common	23,000 ft. 6x4 Cherry Log Run
13,000 ft. 10x4 Maple 1sts and 2nds	26,000 ft. 8x4 Cherry Log Run
15,000 ft. 12x4 Maple No. 2 Com. & Bel.	1 Car 4x4 White Birch 1sts & 2nds

FAVORABLE FREIGHT RATES TO THE EAST

**Babcock Lumber Co.**  
ASHTOLA, PA.

## Dry Stock for Quick Shipment:

12,189 ft 4 4 clear Quartered Oak	66,232 ft 4 4 No. 1 Common Poplar
14,570 ft 4 4 1st & 2ds qtd. Red Oak	10,315 ft 6 4 1st & 2ds Poplar
30,302 ft 4 4 No. 1 Com. Red Oak	56,000 ft 4 4 1st & 2ds Cottonwood
63,204 ft 4 4 No. 1 Com. Pl White Oak	119,000 ft 4 4 No. 1 Com. Cottonwood
4,417 ft 5 4 No. 1 Com. Pl White Oak	150,000 ft No. 2 Common Cottonwood
5,934 ft 6 4 No. 1 Com. Pl White Oak	90,000 ft 4 4 Mill Cull Cottonwood
23,473 ft 4 4 1st & 2ds Plain Red Oak	110,000 ft 5 4 No. 1 Com. Cottonwood
14,168 ft 4 4 1st & 2ds Poplar	40,000 ft 5 4 No. 2 Com. Cottonwood

**American Lumber & Mfg. Co.**  
PITTSBURG, PA.

## The Nicola Lumber Company

One million feet 4-4 Bay Poplar.  
Can be shipped log run, or sold  
on grade. Bone dry; band  
sawed. Send your inquiries.

## Flint, Erving & Stoner Co.

**Wholesale Lumber**  
Northern and Southern Hardwoods

Beech and Maple Timbers a Specialty

## A. M. Turner Lumber Company

Everything in lumber. We buy hardwoods  
as well as sell them. If you have anything  
to offer, please submit same to us. : :

## Linehan Lumber Company

PERFECT

## MAPLE FLOORING

SEND US YOUR INQUIRIES



# CHICAGO

THE GREATEST HARDWOOD MARKET IN THE WORLD

## Harvey S. Hayden

IN THE MARKET FOR  
**POPLAR**

50,000 ft. 1½ in. No. 1 Common  
80,000 ft. 2 in. No. 1 Common  
25,000 ft. 2½ in. No. 1 Common  
50,000 ft. 3 in. No. 1 Common

511 Railway Exchange, - Chicago

—have you anything to offer in  
hickory, white ash, thick plain  
oak and wagon stock?

WE ARE CASH BUYERS  
PLEASE SEND US YOUR STOCK LISTS

## Ryan & McParland

Office and Yards  
Robey St. and Blue Island Ave.

Chicago

## PARK RICHMOND & CO.

Wholesale

### Hardwood Lumber

67 West Twenty-second St.

Chicago

## R. A. WELLS LUMBER CO.

Manufacturers of All Kinds of

### HARDWOOD LUMBER

Fine Quartered Oak a Specialty

234 LA SALLE STREET

Yards at Canal and 21st Sts.

CHICAGO, ILL.

## SOUTHERN OAK LUMBER CO.



WE WANT TO BUY FOR CASH

**OAK**  
**CYPRESS**  
**ASH**

MILL CUTS OR ROUND LOTS

910 CHAMBER OF COMMERCE 1217 TENNESSEE TRUST BLDG.

**CHICAGO**      **MEMPHIS**

YARDS: NORTH MEMPHIS

## White Lumber Company

Dealers in Hardwood Lumber

ALL KINDS

ALL GRADES

Cherry Lumber a  
Specialty



Laflin @ 22d Sts.  
Chicago

## John O'Brien Land & Lumber Co.

MANUFACTURERS AND DEALERS IN

### Hardwood Lumber

Of All Kinds

OFFICE AND YARDS:  
873 to 881 So. Laflin Street  
MILL: PHILIPP, MISS.

Chicago

**C H I C A G O**

THE GREATEST HARDWOOD MARKET IN THE WORLD

**J. Slimmer & Company**

Hardwood  
Lumber

Office and Yard:  
65 W. Twenty-second St.

CHICAGO

**CHAS. DARLING & CO.**

Southern  
Hardwoods

22nd Street and Center Avenue - CHICAGO

Chas. Miller

Milton Miller

**MILLER BROS.**

**Hardwood Lumber**

Main Office, 208 WILLOUGHBY BLDG.,  
6 E. MADISON STREET,

YARDS:

Loomis St., S. of 22nd St.,  
Chicago, Ill.  
Houston, Miss.  
Macon, Miss.

CHICAGO, ILL.

Phone CENTRAL 1363

**The Keith Lumber Company**  
HARDWOOD, POPLAR & SOUTHERN PINE LUMBER,

MAHOGANY,

REDWOOD,

RED CEDAR,



CYPRESS,

CHESTNUT,

SPRUCE,

**MAPLE FLOORING, OAK TIMBERS & WAGON STOCK.**

Office and Yards: Fourteenth and Wood Streets.

**Heath-Witbeck Company**

**Hardwood Lumber**

We have for quick shipment 170,000  
feet DRY BIRCH, First and Seconds  
and Common 2, 2½, 3 and 4 inch.

Main Office, 6 Madison St. Yards, Loomis and 22nd St.

CHICAGO

**THE WARD LUMBER COMPANY**

MANUFACTURERS OF  
**HARDWOODS**  
CHAMBER OF COMMERCE BUILDING - CHICAGO

**WISCONSIN TIMBER & LUMBER CO.**

BUY AND SELL

Yellow Pine and Hardwood Lumber

Want thick hardwoods and wagon box boards.

Monadnock Bldg.,

CHICAGO, ILL.

**Crandall & Brown**

LOUISIANA RED CYPRESS  
Yellow Pine, Oak, Poplar and Maple

We have in Chicago for quick delivery

100,000 1½" 1st and 2nds La. Red Cypress, thoroughly dry.  
14,000 3x14" Shop Com. Cypress

We are in the market for Ash and Cottonwood

Office and Yards: 3300 Center Avenue, CHICAGO.

**Lesh & Matthews Lumber Co.**

1649-50 MARQUETTE BUILDING

Are now offering bone dry BIRCH, ROCK ELM, BLACK ASH, etc., Wisconsin stock. Also PLAIN AND QUARTERED OAK, POPLAR, etc., from our Memphis yard. We are constant buyers.

**The Columbia Hardwood Lumber Co.**

Wholesale and Retail

Telephone NORTH 223 **HARDWOOD LUMBER** 47 Dominick St. CHICAGO

## "Michigan" Maple Flooring

Our model factory is equipped with the highest class tools and appliances made for Flooring production.

We produce our lumber from the best rock Maple area in Michigan and have 20 years' supply.

Our brand "Michigan" is a guaranty of quality. Perfect mill work and excellent grades distinguish our Flooring and our prices are reasonable.

**WARD BROS., Big Rapids, Mich.**



## Wolverine Brand Maple Flooring

Carefully prepared, and certainly "There is none better"

We are ready to make you special quotations on

7/8 in. x 2 1/4 in. Factory 7/8 in. x 3 1/4 in. Factory  
7/8 in. x 2 1/4 in. Clear 7/8 in. x 3 1/4 in. Clear

If you have never tried Wolverine Brand this will give you a chance to do so.

**Bliss & Van Auken** 900 S. Niagara St.  
Saginaw, W. S. Mich.

## OAK FLOORING

Kiln Dried

Bored

Polished



Hollow

Backed

and

Bundled

## Timber Bonds

SECURED BY FIRST MORTGAGE ON TIMBER LANDS

## H. C. Barroll & Co.

BANKERS, First National Bank Building, CHICAGO

H. B. LEAVITT, PREST.  
E. H. ADAMS, SECY.

B. F. RICHARDSON, VICE-PREST.  
J. G. LEAVITT, TREAS.

## THE LEAVITT LUMBER CO.

MOST COMPLETE STOCK OF HARDWOODS IN CHICAGO

MAKE KNOWN YOUR WANTS AND GET IMMEDIATE RESULTS

Mills:  
WISCONSIN  
TENNESSEE  
ARKANSAS  
LOUISIANA  
MISSISSIPPI

General Office and Yard:  
22ND AND LAFLIN STREETS.  
Southern Office:  
808 TENNESSEE TRUST BLDG.  
MEMPHIS, TENN.

## THE "FINEST" MAPLE FLOORING

## W. D. YOUNG & CO.

BAY CITY, MICHIGAN.

Producers from TREE to TRADE of the highest type of Michigan Forest Products. Large stock of Maple Flooring and 15,000,000 feet of Hardwoods—1 to 4 inches thick—on hand.

## Maple, Birch and Beech Lumber

## "Ideal" Steel Burnished Rock Maple Flooring

is the flooring that is manufactured expressly to supply the demand for the best. It is made by modern machinery from carefully-selected stock and every precaution is taken throughout our entire system to make it fulfill in every particular its name—"IDEAL."

Rough or Finished Lumber—All Kinds

Send us Your Inquiries

**The I. Stephenson Company**  
WELLS, MICHIGAN

## AUGUST STOCK LIST

MAPLE		BIRCH		BASSWOOD	
1 in.	2,000,000 ft.	1 in.	500,000 ft.	1 in.	300,000 ft.
1 1/4 "	100,000 "	1 1/2 "	100,000 "	1 1/4 "	30,000 "
1 1/2 "	400,000 "	2 "	100,000 "	1 1/2 "	50,000 "
2 "	1,000,000 "	2 1/2 "	50,000 "	2 "	75,000 "
2 1/4 "	200,000 "	3 "	75,000 "	3 "	4,000 "
2 1/2 "	500,000 "	ROCK ELM		GRAY ELM	
3 "	500,000 "				
4 "	400,000 "	2 in.	25,000 ft.	1 in.	300,000 ft.
BEECH		2 1/4 "	50,000 "	1 1/2 "	200,000 "
		WHITE MAPLE		3 "	200,000 "
1 in.	500,000 ft.	End Piled		ASH	
1 1/4 "	250,000 "	1 in.	100,000 ft.	1 in. 500,000 ft.	
1 1/2 "	400,000 "	1 1/2 "	20,000 "		
2 "	100,000 "	2 "	50,000 "		
2 1/2 "	200,000 "				

**KELLEY LUMBER & SHINGLE CO., Traverse City, Mich.**

# Hardwood Record

Published in the Interest of Hardwood Lumber, American Hardwood Forests, Wood Veneer Industry, Hardwood Flooring, Hardwood Interior Finish, Wood Chemicals, Saw Mill and Woodworking Machinery.

Vol. XXII.

CHICAGO, AUGUST 10, 1906.

No. 8.

Published on the 10th and 25th of each month by

## THE HARDWOOD COMPANY

HENRY H. GIBSON, President      FRANK W. TUTTLE, Sec.-Treas.

### OFFICES

Sixth Floor Ellsworth Bldg., 355 Dearborn St. Chicago, Ill., U.S.A.  
Telephones: Harrison 4960      Automatic 5659

### TERMS OF ANNUAL SUBSCRIPTION

In the United States, Canada, Philippine Islands and Mexico . . . . . \$2.00  
In all other countries in Universal Postal Union . . . . . 3.00

Subscriptions are payable in advance, and in default of written orders to the contrary are continued at our option.

The entire contents of this publication are covered by the general copyright, and articles must not be reprinted without special permission.  
Entered at Chicago Postoffice as Second Class Matter.

Advertising copy must be received five days in advance of publication date. Advertising rates on application.

### General Market Conditions.

There is no new feature to recount in the prevailing situation in hardwood lumber. In the chief trade centers, owing to the vacation period, there has been a decided diminution in the placing of orders, but this is not at all unexpected, and manufacturers and dealers are surprised at the really excellent volume they have had considering the season of the year.

The furniture sales season is just over, and, as recounted elsewhere, the volume of business has shown up fully twenty-five per cent in excess of a year ago. This surely means an extraordinary demand for all classes of furniture wood for the rest of the year. Only a glance at the building permits issued in all the chief commercial centers is necessary to demonstrate that the demand for all varieties of hardwood utilized in interior finish is going to be strong for months to come. The flooring trade is keeping up in wonderfully good shape, with a demand that is taxing the capacity of all the old established flooring factories. A continued demand for oak, maple, beech and birch in four-four stock is therefore assured.

Specifically, plain oak is still the strong feature of the market, the demand being fully up to the supply, and in plain white much in excess thereof. Poplar is becoming scarcer and scarcer as the days roll by, and there seems to be no prospect of early tides in the mountain streams. It will therefore transpire that there will be no new stock of poplar in shipping condition from the river mills until late next spring. As the situation now stands the railroad operators in poplar are at their wits' end to supply enough lumber to take care of the trade. Cottonwood still remains in short supply and is being sold close up to the saw in all grades. The poplar and cottonwood condition is such that basswood is being sold very freely at good values.

The call for chestnut in all grades is still beyond the possibilities of output, and the same may be said of all the minor southern woods. The demand for hickory is probably ten times as much as manufacturers are able to supply, and every possible substitute is being experimented with, the idea being to replace hickory with some wood that will even partially take its place.

Northern hardwoods are doing a little better, but still birch,

gray elm and maple are sold at a price considerably lower than their real value. Black ash and rock elm are sold ahead of the saw.

The demand and range of distribution of red gum is increasing by leaps and bounds. People who never before employed this wood are now making experimental purchases of quantities of the stock, while manufacturers who have hitherto employed it to a considerable extent are increasing the quantity of their purchases. The demand on cypress stock has been so great that it has been sold up closer to green lumber than ever before in the history of the trade. Tupelo gum seems to be coming into favor in a good many localities, and the increased production of this wood would indicate that it will soon become a standard commodity in many lines of factory use. There is a manifestly increased call for mahogany, but values still range remarkably low for this aristocrat of woods. There seems to be an increasing domestic call for black walnut and cherry, which is made up of a multitude of small orders, and in the aggregate there may be said to be a renaissance in the demand for these two magnificent cabinet woods.

There is an increased call for veneers and laminated woods. While this important part of the lumber industry is still in embryonic state, there is wonderful promise for the future of the industry.

### Lumber in Railroad Construction.

It is said that railway ties of wood have not been used as intelligently in this country as they might since it has been demonstrated that where American lines get approximately nine years' service from a tie, English roads get twenty-one years, and this, too, in spite of the fact that the atmosphere of Great Britain is much more humid than that of America. The reason for this is stated to be the fact that a large majority of wooden ties used in Great Britain are creosoted, about 2½ gallons being used per tie. A large tie-plate is used under the rail, and between tie-plate and sleeper soft felt is interposed as an added protection. The tie-plate, or, as it is known to the English, the chair, is secured to the tie by spikes made of close grain fibrous iron, sometimes by iron bolts or by trenails.

The Germans have demonstrated by long experiment that the usefulness of a beech railroad tie may be prolonged from eight to ten years by a preservative process in which creosote oil is used. The method employed in Germany is expensive in the United States, owing to the high price of the oil, which is a by-product of gas plants, formerly discarded as waste. A certain company, however, discovered that it had a specific value and made a long-time contract with gas-making companies for the entire output. This creosote oil and its prices are regulated by a monopoly.

The steel tie has been advocated as a substitute for wood, and has been experimented with extensively, but there are objections to the steel tie which make its use impracticable. It does not last as long as the wood tie when the latter is properly treated; it has not the resiliency of a wood tie, and does not act as a cushion to counteract the repeated shocks of a train in motion; also the steel tie represents a greater outlay in first cost.

From reports received by the Forest Service from 750 railroad companies, having an aggregate trackage of 278,262 miles, or ninety-five per cent of the total in the United States, the consumption of railway ties by steam railways is estimated to be more than 84,000,000 ties annually, which represent 3,000,000,000 feet of lumber, board measure. To this may be added the no inconsiderable quantity

used by trolley lines. In addition to ties, the street railways are now using a large amount of lumber in construction work. On top of the ties boards are laid which cover all the space between the rails. The object of this is to afford support to the pavement, so that its surface will not be uneven, caused by depression between the ties, as has been the case heretofore. To show the vast amount of lumber required in this work, the city of Philadelphia, for example, has 500 miles of street railway tracks, presenting a surface of 10,000,000 square feet to be overlaid with boards.

Statistics furnished by the Forest Service of the United States Department of Agriculture show the consumption of wood for railway construction to be greater now than ever before. With such an enormous annual outlay of material it becomes a task of most vital importance to both steam and street railways to discover the most efficient means of prolonging the life of the wood used on their lines.

### Car Shortage.

The outlook for an adequate car supply this fall, although apparently disregarded by a great majority of lumbermen, is nevertheless unfavorable. Lumbermen the country over have been fairly busy during the past few months and have had their orders handled by the railroads with considerable dispatch. Because this favorable condition has recently prevailed is no reason why lumbermen should ignore impending difficulty in this direction at this season when for several years past a scarcity of cars has actually existed.

Crops for 1906 promise to exceed those of 1905, and will soon be taxing the capacity of transportation companies; manufacturers everywhere are exceedingly busy; then, too, retailers and the large consumers of lumber have been buying on a hand-to-mouth policy for some time and must of necessity come into the market for large supplies very soon. Considering these facts the prospects for quick car service can hardly be said to be encouraging.

### Woods Labor.

The woods labor problem is still a very serious one in all parts of the lumber producing country. There has rarely been a time when competent woodsmen have been as difficult to secure as at the present. This difficulty is not confined to any particular locality, but exists the country over. Both in the north and south woods country even mere boys can now secure good wages for woods work, and the percentage of elderly men employed who ordinarily would be regarded as superannuated is very large in all operations.

The "lumber jack" and the "hick" are very independent individuals at the present time, and throw up their jobs for very trivial reasons, well knowing that they can secure another situation at the first woods camp they encounter. Every effort is being made on the part of operators to hold their employees. There never was a time when the denizens of the woods were so well fed and housed and given shorter hours and better pay than they are now. The harvest period in the western wheat country is here, and wages that would be astounding in normal times are offered to assist in harvesting the crops. This feature of the labor situation is making it still very difficult to keep a full crew of men in the woods. It is anticipated that after harvest labor will be more plentiful.

### The Furniture Trade.

The semiannual furniture sale, which takes place very largely through the exhibitions at Chicago and Grand Rapids in January and July of each year, has just closed. The recent sales season has been entirely satisfactory to the manufacturers, and the volume of business has materially exceeded their most sanguine expectations. It is estimated that sales fully twenty-five per cent in excess of those of July, 1905, were made. About 1,700 buyers visited the Chicago exposition, and more than 1,000 were in attendance at the Grand Rapids show. This attendance is the largest in the history of either city. The increase in business over a year ago has not been shared alike by all producers, some having secured a volume of trade nearly fifty per cent above what they had last year, but practically every manufacturer's sales book shows a handsome increase.

There are no striking features or new departures in furniture making shown, but there seems to be a tendency toward goods of higher grade and a renaissance of plain and more substantial designs. There is a large increase in the production of mahogany furniture and of imitation mahogany. Oak, however, is still the standard wood for nearly every line of case goods.

### Crop Prospects.

In almost every product, according to the interpretation of the government crop report for the month of July, made by the New York Produce Exchange, this year's harvest will be well ahead of that of 1905. The wheat and corn harvest for 1906 promises to be very near the high record mark. Prospects are that the corn crop will show an increase of 50,000,000 bushels over that of a year ago, or a total production of 2,703,641,000 bushels. It is estimated that there will be harvested this season 429,534,000 bushels of winter wheat, about 1,000,000 bushels more than last year. Spring wheat promises 29,000,000 bushels more than 1905, so the combined wheat outlook is for a crop 30,000,000 bushels in excess of last year. Barley also shows prospects for an increased yield, probably of 10,000,000 bushels more than last season, but the outlook in oats is for a diminution.

The prosperity of the entire country, as is well known, is influenced by the success or failure of crops. So large an increase as is here promised, and which is undoubtedly a very correct estimate, presages a large and successful year in many lines of industry.

### The News.

It is scarcely necessary to call the attention of the readers of this paper to its news reports emanating from every important hardwood trade center in the United States and abroad. The news feature of the HARDWOOD RECORD is unequalled by that of any other lumber trade newspaper in the country, and it is particularly proud of its corps of competent correspondents who fortnightly contribute a record of the local happenings in their respective cities and the surrounding territory.

It is the opinion of the HARDWOOD RECORD that there is no service which it performs that is more highly esteemed than this news service. The prevailing call is "news, news, news," and to the best of its ability the paper is giving its readers what they ask for.

For actual commercial value it is probable that the analysis of local market conditions of these several trade centers is more highly appreciated by some, but undoubtedly the feature that makes the HARDWOOD RECORD popular with its thousands of readers is its news service.

### Buying Riches on the Installment Plan.

A review of the evidence presented in the Muck Rake Department of this issue of the HARDWOOD RECORD will reveal the true inwardness of the "system" by means of which the promoters of the stock selling International Lumber & Development Company of Philadelphia hope to achieve fortunes for themselves and promise riches to their installment-plan investors.

It is the same old story. Get rich quick is the inspiration, and the word "lumber"—all lumbermen get rich—is the bait. The installment-plan feature and "your money back if you die" are the new frills to an old game.

Verily, "a sucker is born every minute"—and so are men of former good repute who for a consideration will lend their names and act as stool-pigeons to questionable enterprises.

### Rainfall and Tree Growth.

On the authority of Harper's Weekly there is a close analogy between rainfall and tree growth. In fact, the growth of trees depends primarily upon rainfall; not only is this true in the case of young growth, but in an investigation extending over a period of twelve years, in which the rings of annual growth of older trees were carefully examined, during an annual precipitation of from thirty to thirty-five inches a width of rings was produced varying from .11 to .15 of an inch. On the other hand, an unusually large or small rainfall in any given year was followed by a corresponding tree growth during the following year.

# Pert, Pertinent and Impertinent.

## An Ad—dition.

A man who owns a great big store,  
With stocks of goods on every floor,  
May, to his keenest sorrow, find  
The public to his wares is blind.  
And though he add all he may guess  
Would likely add to his success,  
His bank account may never rise  
Till he concludes to add vertise.

## Sentenced.

"Is it hot enough for you?"  
They asked the ice man,  
And when he answered "No"  
They told him where to go,  
And named a place repellent to a nice man.  
—Philadelphia Ledger.

## The Wise Man.

There was a man in our town, and he was wondrous wise;  
He had a quarrel with his wife, who scratched his face and eyes;  
And when his friends the scratches saw, and asked about the fuss,  
He pointed to a bramble bush and swore he got them thus.  
Life

## Expensive.

A lumberman that speaks from experience says that it costs almost as much to keep his automobile in repair as it does to keep his wife in clothes.

## Omnipresent.

It sometimes happens that a man's past is an ever-present difficulty.

## Modern Way.

In these progressive days he who sows wild oats will reap them with a patent binder.

## Little Valued Then.

At the age of 60 most famous folks would gladly exchange their laurel wreaths for hair.

## Notice!

For shooting the "is-it-hot-enough-for-you" fiend this is the open season.

## Very Mean.

He is a mean man indeed who will try to work off a bad dollar on his better half.

## Preferable.

The "bighead" is not a pleasant person to associate with, but of the two he is usually more welcome than the whiner.

## THE M. & M. PIPE LINE.

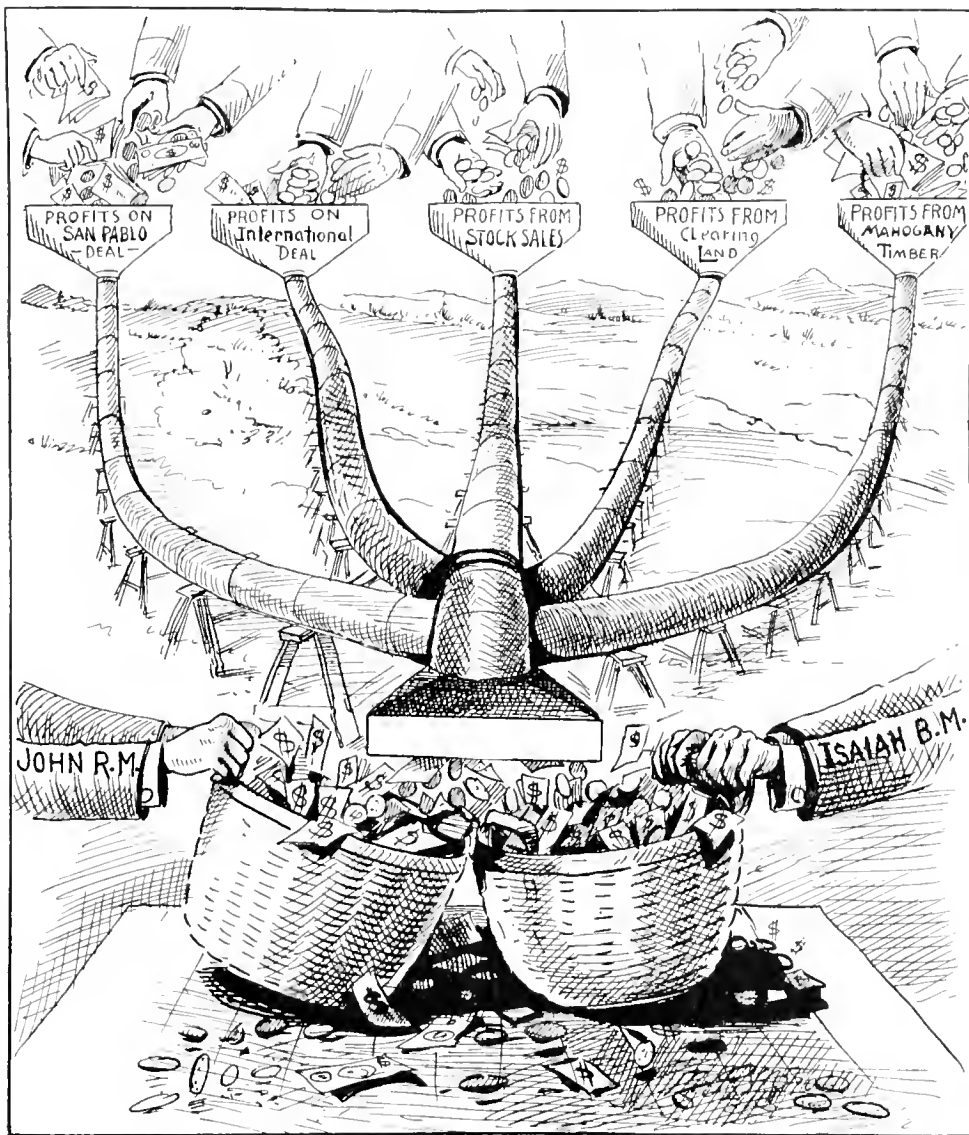

Do you see anything coming to International stockholders?

## Frolific Causes.

To sarcasm in men and stubbornness in women may be traced a great deal of human misery.

## Time.

Time amends a great many promises.

## Luck and Pluck.

Success is much less apt to be a question of luck than of pluck.

## Varies.

A man's bravery is often influenced by the knowledge of whether or not the other fellow is more or less of a coward than he is.

## Good Rule.

Men and women should look during courtship and over-look after marriage.

## Misfits.

Misfits are a great deal more common in business than the right man in the right place, and the more of a misfit a man is the poorer are his chances for success.

## Never Satisfied.

Never put off till tomorrow what you can do today—and tomorrow you will wish you had done the other thing.

## The Summer Man.

My son, consider now the summer man. He that hath trousers which seem even as though they had been fashioned for the elephant.

For great is the fullness thereof, and likewise great is the emptiness of the fullness;

They flap about his knees, and at his ankles they roll up even as a scroll;

And his coat, it hath buttons up the sides thereof, even unto his armpits.

And the waist is pinched in upon him, and the tails of his coat stick out even as a shelf;

Yea, and he weareth socks that make a louder sound than the glass crash in "Lohen-

grin"; and his necktie and his handkerchief, do they not match for hue?

And his hat, hath it not a band of many colors, like unto the festive barber pole?

And he buyeth soda water and talketh in a loud voice of golf, and eke of automobilloging;

And the mosquito biteth him not, for it is afraid.

My son, when men speak unto thee against the summer woman and tell thee that the peckaboo waist and the squintaboo hosiery are wrong.

Listen not unto them, but tell them to be on their way and to beat it and to skiddoodle.

For the summer man taketh the badge.

Yet is he glad, for some one hath told him that he looketh like unto an actor who acteth in the slapstick melodrama.

And his heart is large within him.

And he studieth the thermometer and the mirror.

Is it not so, even as we have torn it from the inner consciousness of this typewriter with the strabismus of the l key?

Even so.

Selah.

—W. D. NESBIT.



## Tree Growth and the Physics of Wood.

### Formation and Function of the Leaf.

John Ruskin, in *Modern Painters*, says of the leaf-worker: "It leads a life of endurance, effort, and various success, issuing in various beauty; and it connects itself with the whole previous edifice by one sustaining thread, continuing its appointed piece of work all the way from top to root."

Not until we interest ourselves thoroughly in tree life do we begin to realize how strenuous a worker and builder the leaf is, and how important a part it plays, not only in the life of a plant itself, but in our own lives, which are inseparably connected with the trees and greatly influenced by them. Accustomed as we are to their presence, we are prone to underestimate and even ignore their value to us. The average child is of an investigating turn of mind, and as time goes on, becomes familiar with most of the commoner objects about him, yet how many play for years under the shade of familiar trees, without being able to tell an ash leaf from an elm, or a maple leaf from an oak!

To understand the growth and importance of tree life, it is not enough to be able to distinguish one tree from the other; it is necessary to become familiar with the objects of their existence, and the manner in which those objects are attained. These facts are revealed in no small degree by the leaves.

No two leaves are exactly alike, neither are any two trees. The great diversity of form in leaves is likewise found in the trees themselves. In a measure, a leaf may be an index to the life of its parent. The pine needle is slim, sharp, wiry and repellent, and these very qualities enable the conifer to lead a rugged, stormy but successful existence upon some barren ridge. The shiny, gossamer-like leaf of the beech is characteristic of its careless, uneventful life, which would be quickly snuffed out were it subjected to the fierce gales which the pine triumphantly weathers.

Trees grow in two ways—they thicken and lengthen. The former method of growth has been discussed in a previous paper. The latter takes place by a sort of "telescopic extension" at the buds or extremities. These in turn thicken and become branches. Thus it is that a nail driven into a tree-trunk at a given distance from the ground is never any further from it.

The perfect symmetry with which leaves are placed upon a stem is maintained in much the same way, even though the plant becomes a great tree. The branches partake of this symmetry to a greater or less degree, inasmuch as they follow in the wake of the leaves which preceded them. In the spring in the axils of the leaves buds put in their ap-

pearance. These tiny peepers are the sources of later branches. In their growth they follow the same process of development as did the original little stem which burst from the embryo between the cotyledons, the only difference being that the new leaves and branches derive their nourishment from the parent stem, while the tiny germ contained within itself the life principle, and possessed the power to extend itself upward, and downward into the ground as well. They grow with the same symmetry and by the system of progression, one joint upon the other, each lengthening and in its turn producing leaves at its end. Then other buds develop in their

rudimentary blossoms already formed, and most wonderfully and carefully protected by Nature from cold and dampness.

These sheaths or chambers are in many and varied forms. Those of the horse-chestnut are composed of many scales, so overlapped about the delicate parts within as to insure their preservation. The buttonwood has what appears to be a peculiar extension or enlargement of the base of the leaf-stalk, but when the stalk is detached from its branch it is found to be hollow and to fit down tightly over the projecting leaf-bud. In northern climates the leaf-scales which enclose the bud are often lined with a downy substance, and are rendered impervious to dampness by a sort of glazing without. "To open one of these strong buds seems almost like prying into futurity." All that a tree will ever possess of beauty or vigor originates in the tiny buds, enclosed all winter in their protecting scales, but ready, as spring advances, to respond to the slightest touch of sun and warm south wind.

The stipules, or the pair of tiny appendages at the base of the young shoot, are an added protection to it. Most of them remain with the leaf until it matures, and then fall away, but others, notably the large, triangular ones of the black willow, are persistent. The stipules are varied in form; sometimes they are in the form of tendrils; again they are scales or spines; those of the beech are long and strap-like.

After they are once expanded and strengthened by the light of day, the leaves take up vigorously the work for which they are created. While these visible changes are taking place above ground the roots, hidden away in the earth, are also at work branching and multiplying in order to hold the tree firm as it increases in size. Often the simple root which was first sent down by the embryo remains the main one, from which branches spring outward, but usually it divides, and the branches thus formed send out others.

The young roots absorb large quantities of nourishment from the soil. To facilitate this process they are frequently covered thickly with root hairs, which easily imbibe the moisture into their canals.

It is from these rich young roots that the sap is drawn upward to feed the leaves. This ascension takes place principally through the wood cells, although, contrary to the common theory, these chambers are not connected with each other in any way. The process of sap progression is by transfusion—it passing through thin places in the walls of these cells. Although at first thought, the rise of the sap into the topmost branches and leaves of a tree seems contrary to Nature's laws, there



FOLIAGE AND FRUIT OF WHITE PINE.

axils and gradually become prolific branches; again and again is this wonderful process repeated until the entire tree is formed and matured.

Ocasionaly the axillary buds commence their activity soon after first making their appearance in the angles of the leaves, but more often they remain dormant until the following spring, when suddenly, within the space of a few days or a week, a touch of green appears about the edges of the protecting scales, they loosen and drop away, to liberate the imprisoned shoot, which quickly expands and extends to the sun its wrinkled leaves. The tender bud is a complete shoot in miniature—its little leaves and even the





HENRY E. BACON  
MEMPHIS, TENN.

is one which applies directly to this circumstance, and by means of which this important process is consummated. Whenever two fluids of different densities are separated from each other by a membrane, the heavier fluid will attract the lighter one, until both become of the same density. Inherent in the little cells of the root is a quantity of their life substance—mucilage and protoplasm, which forms a fluid denser than the moisture from the earth, which is therefore attracted to them. The leaves cast off a vast amount of the moisture they contain, in the form of vapors, leaving the substance remaining much

find their way to the tiny laboratories. From the water is taken the necessary moisture to keep the leaves of the right consistency, and also the materials needed to furnish hydrogen and oxygen for starch-making. Most of the water which reaches the leaves through the roots is liberated by evaporation.

Starch is composed of hydrogen, oxygen and carbon—the two former in the same proportion as in water, while the latter is received from the atmosphere in the form of carbon dioxide, as explained above. Thus it is that these three elements come into contact with each other through the medium of the leaves, and the fluid and gas are broken down by the force which the chlorophyll, or leaf green, is able to absorb from the sun—only to be reunited in the form of starch.

This resultant product of crude sap and atmospheric properties which enters into the

circulation and is carried back into the tree is known as the elaborated sap—the source of vitality, and the nourishment upon which every living cell from root to top depends for its existence and multiplication.

This work of forming starch is carried on more or less vigorously during the leaf-bearing season, according as the day is bright or gloomy. With night the process stops, but distribution of the supply at hand goes on continually. More oxygen is supplied to the little laboratories than is required for the manufacture of their starch, and the accumulating gas passes away into the air, in the form of oxygen. Thus a dual service is rendered, and the great purpose of the vegetable world accomplished—to absorb deleterious matter and give out pure, and by means of this process to facilitate the formation of food for the animal kingdom.



FOLIAGE AND FRUIT OF RED MAPLE.

denser than that within the branches and twigs. As a result of this evaporation and consequent density, the leaves call upon the adjoining stems and they in turn on the branches, for their contents, until finally the chain is complete.

Every leaf is a miniature laboratory in which the manufacture of starch is continually carried on. The leaf has been described as an "outward extension of the living cambium, thrust out beyond the thick, hampering bark, and specialized to do its specific work rapidly and effectively." Each leaf has a fine transparent covering, with innumerable tiny openings called stomatas, upon its lower surface, which open and shut. They are the transpiratory organs of the leaf. Beneath this delicate membrane is the leaf pulp and the framework of ribs and veins, the latter giving form and support to the pulp and furnishing a part of the wonderful system whereby the incoming and outgoing currents of sap are kept in circulation. On the surface of the leaf, which naturally turns toward the sun, are found the palisade cells, regular in shape and very abundant.

The large amount of carbon which exists in a tree comes in through its leaves, as carbon dioxide—a gas. The sap ascending brings with it water, in which mineral salts are held in solution. Potassium, phosphorus, magnesium, nitrogen, calcium, sulphur and iron thus

## Builders of Lumber History.

NUMBER XXX.

Henry E. Bacon.

(See Portrait Supplement.)

In the last year and a half it has been the privilege of the HARDWOOD RECORD to publish the business histories of many men distinguished in the hardwood lumber industry. In each one it has been the endeavor to emphasize those character attributes which have made for success. Something beside the idea of hard work and ceaseless energy enter into the calculations of the man who courts success in the business world. Integrity, not only of action, but of thought, should perhaps be named first, with keen judgment of men and events next in order.

A friend of Henry E. Bacon, of Memphis, Tenn., whose portrait is given with this edition of the HARDWOOD RECORD as its pictorial supplement, handed his photograph to a stranger the other day and asked: "What would you say of that man?" "I would say he was kindly, diplomatic, shrewd, decided, firm in his likes and dislikes, optimistic and thoroughly honest in action and thought." "You are a good reader of a man from his pictured face," said Mr. Bacon's friend, "for you have given to Henry E. Bacon, treasurer and manager of the Bacon-Nolan Hardwood Company, and manager of the Lamb Hardwood Company of Memphis, his salient character points. Mr. Bacon would go a long way to help a friend and perhaps a longer distance to circumvent some one whom he decided was doing him a wrong."

Henry E. Bacon was born in Portland, Me., of New England parentage, in 1847, and received his education in the schools of that place. The resinous breath of the Maine woods called him, and early his vocation in life was decided upon, his first business interests being with a retail lumber yard in his native town. In 1883 Mr. Bacon went to La Crosse, Wis., where he was employed by R. M. Mooer as manager of a pine saw mill and retail yard. Short-

ly afterward Mr. Mooer, his principal, became interested in mining enterprises and went to California to look after them. In 1884 Mr. Bacon was called to California to look after Mr. Mooer's interests. He returned, however, in 1885 to La Crosse, where he took charge of one of John Paul's branch yards. At this time Mr. Paul had numerous yards in Minnesota and the Dakotas, and of these Mr. Bacon became eventually general manager.

In 1899 the John Paul retail yards, numbering thirty-five, and scattered over a wide range of territory and a half dozen states, were sold to the Lamb Lumber Company, of Minneapolis. Of this entire system Mr. Bacon was continued as general manager.

In 1904 these retail yards, which had been increased in number to eighty-five, were sold or closed out, and during that year the Lamb interests, with headquarters at Clinton, Ia., consisting of Lafayette Lamb, Chauncey R. Lamb, his son, and Garret E. Lamb, his nephew, together with Mr. Bacon and Mr. Nolau, bought a tract of 10,000 acres of hardwood timber land in Quitman County, Miss., and organized the Bacon-Nolan Hardwood Company, of which Mr. Bacon was made treasurer and manager. A year later they built a mill at Chaney on the Yazoo & Mississippi Valley railroad. Shortly afterward Messrs. Lamb, together with Mr. Bacon, made a second investment in Tallahatchie County, Miss., of 45,000 acres of hardwood timber land, and they are at present engaged in the completion of a large saw mill at Charleston, Miss., on the Illinois Central. These two hardwood plants have a capacity of 125,000 feet per day, the output consisting of about fifty per cent oak, forty per cent gum and the remainder ash, hickory and cypress. Mr. Bacon is also interested in the manufacture of flooring, and is a director in the Arthur Hardwood Flooring Company, of Memphis, a large operator in oak flooring.

Mr. Bacon is married and has one daughter and four sons.

## Muck Rake Department.

### The True Inwardness of the International Lumber & Development Company.

There is a legend to the effect that when certain people fall out, honest men get their due. Apropos of the considerable free advertising that the HARDWOOD RECORD has bestowed upon the International Lumber & Development Company of Philadelphia, and other places, for some months past, it here-with adds a most interesting chapter to the record of this remarkable institution.

It seems that one Walter H. Bell, resident of Chicago, has filed before the Chancery Court of Cook County a bill of complaint against John R. Markley, Isaiah B. Miller, the San Pablo Company and the International Lumber & Development Company. The full text of this document will prove of particular interest to stockholders in the International Lumber & Development Company, and to the thousands of others who have been solicited to embark their money in this enterprise, and it is herewith printed in full:

State of Illinois, County of Cook, ss.

In the Circuit Court of Cook County.

To the Honorable Judges of the Circuit Court, in Chancery Sitting:

Your orator, Walter H. Bell, a resident of Chicago, in the county and state aforesaid, brings this his bill of complaint against John R. Markley and Isaiah B. Miller, residents of Chicago, in the county and state aforesaid, the San Pablo Company, a corporation organized under the laws of the state of New Jersey, and International Lumber & Development Company, a corporation organized under the laws of the state of Delaware (hereinafter for convenience called International Company), who are made parties defendant to this bill, and thereupon your orator complains and says:

1st. That the said defendant, San Pablo Company, was organized in the year 1900 with a capital stock of \$1,500,000, divided into 120,000 shares of preferred and 180,000 shares of common stock, making 300,000 shares of the par value of \$5 per share, and that of this stock your orator owns 1,754 shares of the preferred and about 6,000 shares of the common stock; that said 1,754 shares are reasonably worth par, and that said common shares have no definite value; that said corporation acquired by purchase 288,000 acres of land situated in the District of Champeon in the State of Campeche, Mexico, having paid for same the sum of \$350,000 in Mexican silver, or about \$180,000 in United States money, and that the business that the said San Pablo Company proposed to engage in was that of timber, lumber, cattle, dyewoods, ehicle, etc., and that said business was carried on by said corporation from about the date of its organization until the middle of the summer of 1904, at which time the business of the company was sold to be unprofitable.

2nd. That upon July 30th, 1904, a proposition was sent out to the stockholders of the said San Pablo Company over the signature of

the then president of the company, John R. Markley, one of the defendants in this bill, stating that the business had not met the expectations of the management, and that an opportunity had arisen for the sale of the entire assets of the San Pablo Company upon reasonable terms, and that the board of directors of said company had recommended such sale, and a special meeting of the stockholders had been ordered to act upon said proposition.

3rd. That at a meeting of the stockholders of said San Pablo Company held in the month of August, 1904, the proposed plan of selling all of said assets was adopted, and shortly thereafter, as your orator is informed and believes and so states the fact to be, a contract was made by the said company with a trustee for the benefit of said defendant, International Company, in and by which it was agreed that the San Pablo Company would sell said 288,000 acres of land and all other assets of the San Pablo Company at an agreed price of \$450,000, payable in two equal installments, the first installment to be due in three years after date of the contract, and the second installment to be due five years after the contract date, said deferred payments to bear interest at 5 per cent

accordance with the proper interest of each stockholder.

5th. Your orator is further informed and believes that the stipulations in the said agreement of sale made as aforesaid have been violated, and that there has been a default in the payment of interest due upon said purchase price, and that the products of the forest and other products have been removed from the said 288,000 acres of land without a proper accounting and payment being made for same to the said San Pablo Company.

6th. That in the fall of the year 1904, and about the date that said sale contract was made, the defendant, John R. Markley, and other persons interested with him organized the said defendant International Lumber & Development Company, with a capital stock of \$6,000,000 and that said corporation was organized for the purpose expressed by the organizers of developing not less than 20,000 acres of land, being a part of the said 288,000 acres of land above referred to; that the said capital stock was divided into 20,000 shares of capital stock of the par value of \$300 each, it being represented by said organizers that each of said shares would represent one acre of said land brought to maturity of rubber, sisal, bananas, etc.; that your orator is informed and

believes that the said contract of sale aforesaid made by said San Pablo Company was made for the benefit of said International Company, or was afterwards transferred to said International Company.

7th. That on February 4, 1905, your orator, at the request of the defendant, John R. Markley, made and executed a promissory note for the sum of \$671.50 to the order of City National Bank of Mason City, Iowa, and delivered the same to said Markley, said Markley agreeing that he would see that the same was paid at maturity; that prior to the making of said note your orator had deposited for safe keeping with the defendants Markley and Miller the shares of stock and 500 shares of common stock in said San Pablo Company; that at the time that said Markley obtained said promissory note, he informed your orator that he had obtained about \$1,000 from one H. A. Merrill, president of the said City National Bank, and that he had deposited the said stock of your orator as collateral security for \$600 of said amount; that thereafter the said note of \$671.50 was delivered by the said Markley to said City National Bank.

8th. That said note was paid to said City National Bank out of dividends or interest upon the said 1,754 shares of preferred stock; that on July 6, 1906, said note was received by your orator, duly canceled, through the United States mail from the trustee of the said San Pablo Company, together with a check for the sum of \$183.90 made by the said San Pablo Company to your orator's order and purporting to be the balance due to your orator for interest or dividends upon said 1,754 shares of preferred stock after the payment of the balance due on said promissory note; that prior to said last mentioned date, and for a long time prior thereto, your orator was ready and willing and had offered to pay

## I. L. & D. COMPANY

Home Office, 701-715 Draxel Building, Philadelphia, Pa.

Pres., HON. WM. H. ARMSTRONG  
Ex-U. S. Railroad Commissioner  
Philadelphia, Pa.

Vice-Pres., COL. ALEX. K. MCCLURE  
Ex-Editor *The Times*  
Philadelphia, Pa.

Sec. and Treas., C. M. McMAHON  
Sec. and Treas. I. L. & D. Co.  
Philadelphia, Pa.

# 16%

### Dividends Paid Since March, 1905

July 31, 1906, a special extra dividend of 2% will be paid over and above the regular guarantee. This is the third dividend this year; 10% paid last year instead of 8%, as guaranteed. Next semi-annual dividend period, October 1, 1906.

### Eight Per Cent. Guaranteed.

(Basis, Land (283,000 Acres), Lumber, Cattle, Railroad and Improvements)

### WHAT IT WILL COST YOU

Five dollars or more a month, for a few months, buys protected interest in this great enterprise.

Each member has equal voting power. In case of death money will be returned to heirs, if desired. (This is not life insurance.) Let us explain. Space forbids here.

Fill in and tear off attached card. Put postage stamp on it and mail it. Do it now, as only a limited number of shares are for sale at par, and soon all shares will be taken. **YOU MUST ACT SOON.**

COPY OF ALLURING POSTAL CARD SENT BROADCAST BY THE INTERNATIONAL LUMBER & DEVELOPMENT COMPANY.

per annum, payable semi-annually, and that it was agreed that the net proceeds of all products of the forest or property of any kind included in said sale that should be removed from the said land until said purchase price was completely paid, and should be paid over to the San Pablo Company to apply on said purchase price. And your orator is further informed that proper conveyances were made conveying all of the assets of the said San Pablo Company, and that a deed was executed to the United Security Life Insurance and Trust Company of Pennsylvania as trustee for said International Company, and that said deeds and other conveyances were deposited in escrow, with the understanding that the same were not to be delivered and that the title to said property was not to pass until all of the said purchase price had been paid in the time and manner specified in the contract of purchase.

4th. That since the said sale and transfer the said San Pablo Company has done no business whatever, except to receive from the trustee named in said sale contract such interest as has been paid to it on account of said purchase price, and to disburse among the stockholders of said San Pablo Company the amounts so received in

the balance due on said note, but that said City National Bank and H. A. Merrill, its president, had refused to receive payment from your orator, and refused to deliver the said shares of stock to your orator, and said Merrill informed your orator that the said defendant Markley had instructed said Merrill to deliver said stock to said Markley and not to your orator, although the said Markley and Miller have no interest whatever in said stock; that your orator has made a demand upon the said Markley for the said shares, but the said Markley refused to deliver the said shares of stock to your orator.

9th. That on or about the date that the said International Company was organized, said corporation entered into an agreement in writing with the defendants, John R. Markley and Isaiah B. Miller, wherein it was agreed that the said defendants last named should be the contractors for the clearing, planting and bringing to maturity of 20,000 acres of land in tropical fruit, rubber, sisal, etc., said 20,000 acres being a part of said 288,000 acres aforesaid, and the said defendants, John R. Markley and Isaiah B. Miller, to receive as their compensation for said work the net proceeds arising out of the sale of the entire shares of the capital stock of said International Company, amounting at par to \$6,000,000, less the commissions paid by the International Company in disposing of said stock, and less also the sum of \$450,000 principal and interest thereon for the purchase price of said 288,000 acres of land, and other assets of the San Pablo Company as aforesaid; that the cost to said defendants Markley and Miller of doing all of the said work of clearing, etc., including the entire expenses incurred by said defendants in connection with performing all of their agreements with said International Company in said contract mentioned would be about the sum of \$75 for each acre of said 20,000 acres; that the total expenses and commissions to be paid out by said International Company in the sale and disposition of said 20,000 shares of stock would not exceed the sum of \$100 for each share, which would leave a net sum of \$200 per share to be paid over to said defendants; that the total net profit to said defendants arising out of the said contract when all of the said 20,000 shares of stock have been sold, would be not less than \$125 for each share of stock or upon each acre cleared and developed, aggregating a total sum of about \$2,500,000, less, as your orator is informed and believes, the sum of \$450,000, being the purchase price of all of the assets of said San Pablo Company aforesaid.

10th. Your orator is informed and believes and so states the fact to be that under and by virtue of the contract aforesaid between the defendants, International Company, John R. Markley and Isaiah B. Miller, the said two last named defendants have a secret contract or agreement between themselves and the selling agents at the general office of said International Company, by which agreement the said Markley and Miller are to receive as additional consideration for the carrying out of the said contract aforesaid a large portion of the amount of the commissions charged by the said International Company for selling said stock, and that said defendants Markley and Miller share profits from this source of about the sum of \$300,000.

11th. That in the month of April last past the defendant, John R. Markley, stated that there had been sold up to that time 11,000 shares of stock of the said International Company; that all of said shares of stock have been sold at par value of \$200 per share, payable in installments and otherwise, and that said International Company has received up to the time of filing this your orator's bill, from the sale of said stock, an average price of about, as your orator is informed and believes and so states the fact to be, \$60 net for each share of stock sold, and that there have been sold up to the date of the filing of your orator's bill about 12,000 shares, and that the total sum received by said International

Company from the sale of said shares up to this time is about the sum of \$700,000, that said International Company has paid out of the sums so received by it for interest on the purchase price of \$150,000 for the assets of said San Pablo Company three half yearly installments of interest of 5 per cent each, or a total of \$33,725, that the sums received above this sum by said International Company, as your orator is informed and believes and so states the fact to be, amounting to more than \$650,000 have been paid over and delivered to the defendants, John R. Markley and Isaiah B. Miller under the terms of the said contract aforesaid between said defendants and the defendant International Company.

12th. That on February 4, 1905, the said defendants John R. Markley and Isaiah B. Miller entered into a contract in writing with your orator, in words as follows, to wit:

"In consideration of personal services of Mr. Walter H. Bell of Vicksburg, Miss., heretofore rendered and hereafter to be rendered, in the management of the Estate of the International Lumber & Development Company in the state of Campeche, Mexico, with which company we have a contract to clear, plant, mature and bring to development 20,000 acres in henequen, rubber, bananas, oranges, etc., as per prospectus of said company at this date; and in consideration of his past and future personal services as our manager under said contract we agree to have said Bell employed by said International Lumber & Development Company as the manager of its estate and property in Mexico, and we, the undersigned, do hereby agree to employ him as our manager and pay to the said Walter H. Bell one full tenth part of the value of all profits to be made by us in the aforesaid contract between us and the said International Lumber & Development Company, also one tenth part of the value of the profits that may be derived by us in all business pertaining therein, both at the time and as the same shall mature and accrue to us.

"It is further agreed that we also shall pay the said Walter H. Bell, or to his order, the sum of \$125 monthly and his expenses during the time he may under his contract render such personal services.

"It being distinctly understood that Mr. Bell shall be under the orders only of ourselves, or the board of directors of the said International Lumber & Development Company. Should he, for good and sufficient reasons, return to this country, it is agreed that he shall devote his time to the sale of the stock of the said International Lumber & Development Company, but instead of receiving the aforesaid sum of \$125 monthly and his expenses, he shall receive a commission of \$50 for each share of stock that he shall sell or cause to be sold, and shall be given certain territory that may not already be given out to other general agents, said commission to be paid him on the same terms and conditions as the company may have with its other general agents.

"This contract shall be binding upon ourselves, our heirs, executors, administrators and assigns. This contract shall be legal and binding on said Markley and Miller only until such time as they shall deliver to W. H. Bell a certificate of beneficial interest of the same word or wording as the certificates to others having beneficial interests therein, and the said certificate shall entitle the said W. H. Bell to one-tenth interest in the profits to be derived from the development contracts entered into between the International Lumber & Development Company, and the said Markley and Miller.

"JOHN R. MARKLEY,  
"ISAIAH B. MILLER."

"Dated February 4, 1905."

That, as stated in said contract, the consideration passing to said defendants Markley and Miller for the agreements to be kept and performed on their part was the personal services of your orator rendered prior to and to be

rendered subsequent to the making of said contract.

13th. That in the year 1904 your orator, at the request of the defendant John R. Markley, made a number of visits to Mexico and investigated the conditions upon the land then owned by the San Pablo Company, and reported the same from time to time to the said defendant, that in the latter part of the year 1904 the defendant Markley was about to enter into a partnership agreement with the defendant Isaiah B. Miller, with reference to making the contract aforesaid with said International Company, and that after the partnership agreement was made by said defendants Markley and Miller, and prior thereto, your orator performed many services covering a long period of time during the year 1904, and prior thereto, in connection with investigations in the district of Champoton, state of Campeche, Mexico, and which said services were included and referred to in said contract as having heretofore been rendered by your orator.

14th. That immediately after the making of said contract between your orator and said defendants Markley and Miller, and in accordance with said agreement, your orator proceeded to Laguna, Mexico, and was prepared and ready and offered to take up his work as manager of the estate of said International Company and as manager for the said defendants Markley and Miller, and that shortly after your orator's arrival at Laguna, at which point the general offices of the International Company and of said defendants last named were located, the defendant John R. Markley stated to your orator that on account of existing labor troubles on the estate of said International Company it would be advisable for your orator to return to Chicago, and that after a number of consultations between your orator and the said defendant, the said defendant Markley directed your orator to return to Chicago and await further instructions from him with reference to future services to be rendered by your orator under said contract, and that thereupon your orator returned to the city of Chicago; that about two weeks after your orator's return to Chicago and in the absence of said defendants Markley and Miller your orator went to the general offices of said International Company situated in Philadelphia, Pa., and reported to the treasurer of said company that he had been sent back to the United States by the defendant Markley, and stated that he was prepared to devote his entire time to the sale of the stock of said International Company, and requested the treasurer to assign to him some territory or place where your orator could engage in selling said stock, and that said treasurer assigned to him the city of Dayton, Ohio, and vicinity thereof, and that your orator thereupon opened an office for the sale of the stock of said International Company and has carried on and is still carrying on in said territory the sale of the said stock; and that your orator has in all other things fully performed all of the conditions and agreements on his part to be performed in said contract mentioned.

15th. That upon your orator's return to Chicago in accordance with the instructions of said Markley, as aforesaid, your orator received the sum of \$125, and that no other sum whatever has been paid to your orator since said date except the commissions provided in said contract for the sale of stock, and that the defendants John R. Markley and Isaiah B. Miller have refused to give your orator information as to the moneys received and disbursed under the said contract between said defendants and said International Company, and have refused to render your orator any statements in the premises and have refused to turn over and deliver to your orator a certificate of beneficial interest for one-tenth interest in the profits to be derived from said contract between said Markley and Miller and said International Company as provided in your orator's contract with said last mentioned defendants.



16th. Your orator is informed and believes and so states the fact to be that the defendants Markley and Miller are removing forest products and personal property from the said 288,000 acres of land under some agreement with the said International Company, and that neither the said defendants Markley and Miller or the said International Company are paying over to the said San Pablo Company or its trustee the net proceeds arising out of the sale of said products and other property so being removed, and that the acts and doings of said defendants Markley and Miller and said International Company are contrary to the contract existing between said International Company and said San Pablo Company aforesaid, and are depriving the stockholders of said San Pablo Company of the security without payment therefor; and that your orator is further informed and believes the fact to be that the said International Company is paying dividends upon its shares of capital stock sold out of the profits derived from the proceeds arising from the sale of forest products and other property aforesaid.

17th. Your orator is further informed and believes and so states the fact to be that the said defendants Markley and Miller, and other persons to your orator unknown, have confederated and conspired together to control the affairs of the said International Company for their own personal gains, and that said defendants Markley and Miller, by reason of their being familiar with the said Mexican lands, etc., are able to and are diverting to their own use and to the use of other persons associated with them, to your orator unknown, the profits belonging to the said International Company, and which should be by said International Company received and applied to the use of the said San Pablo Company until the entire purchase value is paid said San Pablo Company.

18th. That in the month of February, 1905, and following the making of said agreement between your orator and the said defendants Markley and Miller, the said Markley stated to your orator that the contract made between said defendants Markley and Miller and said International Company was of great value to the said defendants Markley and Miller, and that your orator's 10 per cent share in said profits might amount to the sum of \$200,000, and would not be less than the sum of \$100,000.

19th. That the said defendants Markley and Miller have possession of the books and accounts relating to the partnership business of your orator and said defendants, that the said defendants have refused to permit your orator to see and inspect said books of account, and refuse to render to your orator any account of the copartnership moneys received and disbursed by them; that upon a just and true statement of the accounts of said partnership business between your said orator and said defendants, Markley and Miller, it would appear that there is a large balance due from the said defendants last named to your orator, in respect to the business done by the said defendants Markley and Miller under the contract with said International Company.

20th. That the defendant International Company has possession of the original books of entry relating to and showing the number of shares of the capital stock of said company which have been sold and the amount of money received by it from the sale of said shares, and the amount of moneys paid out by it for commission on the sales of stock, and also the amount of money paid over to the trustee of the San Pablo Company for the principal amount of said purchase price of all the assets of said last named company, and for interest thereon, and the amount paid over by said International Company to said defendants Markley and Miller on account of said contract existing between said defendants, International Company, John R. Markley and Isaiah B. Miller, as aforesaid; that the evidence in relation to said facts last above in this paragraph set forth rest exclu-

sively in the knowledge of said defendant, International Company, and that your orator expects to establish the truth of said facts by the discovery sought of said defendant International Company.

21st. That the said defendants Markley and Miller are using the funds of said partnership business for their own account, and your orator fears and charges that he is in danger of losing the amount due him from the said defendants in respect to the said copartnership dealings and transactions, and by reason whereof the said defendants Markley and Miller ought to be enjoined and restrained by the injunction of this honorable court from further collecting the said copartnership accounts, and from using and applying the funds of said partnership to their own use; that said Markley and Miller ought to be enjoined and restrained by the injunction of this honorable court from receiving, selling or dealing with the said 1,754 shares of preferred and 500 shares of common stock of said San Pablo Company; and that some suitable person ought to be appointed by this honorable court to receive and take charge of the books of account of said firm and collect the accounts due said firm and collect the accounts due said John R. Markley and Isaiah B. Miller under said contract with said International Company, and to collect the accounts so due under same.

For as much therefore as your orator is without adequate remedy in the premises except in a court of equity, and to the end that the said John R. Markley, Isaiah B. Miller, International Lumber & Development Company, a corporation, and San Pablo Company, a corporation, who are made parties to this bill, may be required to make full and direct answer to the same, but not under oath, the answer under oath being hereby waived; that the said defendant International Company may be required to answer and set forth.

First: A true and exact copy of the contract or contracts between it and the defendants John R. Markley and Isaiah B. Miller, in relation to clearing, planting and bringing to development 20,000 acres of land situated in the state of Campeche, Mexico.

Second: A true and exact copy of any other contract between it and said defendants John R. Markley and Isaiah B. Miller.

Third: The number of shares of its capital stock issued and sold by it up to the date of the filing of this bill.

Fourth: The total amount of cash received by it from the sale of shares of its capital stock.

Fifth: The total amount of money disbursed by it for commissions upon the sales of its capital stock, and what if any part of said commissions have been paid to the defendants John R. Markley and Isaiah B. Miller, or to any other party for the benefit of said defendants Markley and Miller.

Sixth: Whether it has paid any part of the purchase price or interest on same of the 288,000 acres of land and other assets formerly belonging to the San Pablo Company, and if any payment or payments have been made on such account, the amount of each and all of such payments, and what amount of same was applied on principal and what amount was applied on interest.

Seventh: Whether any moneys have been by it paid to the defendants Markley and Miller, and if so, the amount of each and every payment, the date when same was made and the purpose for which such payment was made.

That said defendants John R. Markley and Isaiah B. Miller may fully set forth a true and just account of all their actings and doings in respect to said copartnership business; and that an account may be taken under the direction of this honorable court of all and every the said copartnership dealings and transactions, and that the same may be fully adjusted, and that the respective rights of your orator and the defendants John R. Markley and Isaiah B. Miller ascertained, and that the defendants Markley and Miller may be decreed to pay to your orator

what if anything shall appear upon such account to be due him; your orator being ready and willing and hereby offers to pay to the defendants Markley and Miller what if anything shall appear to be due the said defendants from your orator; and that some proper person may be in the meantime appointed by the court as receiver to take charge of the books of account relating to the partnership business existing between your orator and the said defendants Markley and Miller by virtue of the aforesaid contract hereinafore set forth, and collect whatever money or property may be due or owing to the said defendants Markley and Miller under said agreement with said International Company; and that your orator may have such other and further relief in the premises as equity may require and to the court shall seem meet.

May it please the court to grant the writ of summons in chancery directed to the sheriff of said county of Cook, commanding him that he summon the defendants John R. Markley, Isaiah B. Miller, International Lumber & Development Company, a corporation, and San Pablo Company, a corporation, to appear before the said court on the first day of the next August term thereof to be held at the court house in Chicago, in the county aforesaid, then and there to answer this bill, etc.

And may it please the court to grant to your orator the people's writ of injunction to be directed to the said John R. Markley and Isaiah B. Miller, restraining them, their agents and attorneys, from disposing of, collecting or receiving any of the debts due and owing to the said defendants last named and the said International Company, and from using and applying any of the funds derived from said source for their own use, until the further order of this court.

WALTER H. BELL.

State of Illinois, County of Cook, ss.

Walter H. Bell being first duly sworn, on oath says that he has read the above and foregoing bill of complaint subscribed by him, and knows the contents thereof, and the same is true of his own knowledge except as to the matters which are therein stated to be upon information and belief, and as to those matters he believes it to be true.

WALTER H. BELL.

Subscribed and sworn to before me this 6th day of July, A. D. 1906.

WINIFRED E. LAPHAM,  
Notary Public.

State of Illinois, County of Cook, ss.

Otto Schusterman, being duly sworn, deposes and saith, that he was in the filing room of the Chancery Court and personally saw the signature or purported signature of Walter H. Bell to a certain petition known and designated as General No. 273110, and Term No. 18224, in case of Walter H. Bell, orator, versus John R. Markley, Isaiah B. Miller, the San Pablo Company and International Lumber & Development Company, which instrument was presumably acknowledged by Winifred E. Lapham on the 6th day of July, 1906, having his seal thereon.

OTTO SCHUSTERMAN.

Subscribed and sworn to before me, this 30th day of July, A. D. 1906.

HENRY KAPLANSKY,  
Notary Public.

According to the testimony of his friends, Walter H. Bell, the orator in this case, has spent a considerable portion of his life in Mexico investigating timber and agricultural properties. His aforementioned friends tell very good stories about him. They say he is a man of good judgment on the value of properties of this kind; that he is industrious, truthful and plays fair; they also say that his ideas are somewhat visionary at times, as would naturally befall the opinion of any man devoting his energies to promotion enter-

prises of any sort. Mr. Bell made a report on the properties alleged to be owned by the International Lumber & Development Company in the district of Champoton, state of Campeche, Mex., and it is alleged that Mr. Bell states his report to this company was falsified when it was issued in printed form. It is further alleged that Mr. Bell has stated that his estimate of the mahogany growing on the timbered sections of the property in question was about 400 feet to the acre.

The HARDWOOD RECORD has comparatively little knowledge of John R. Markley and Isaiah B. Miller, save that they have been engaged in promotion enterprises covering mines, timber properties and agricultural propositions for a number of years. They have an office in the Tribune building, Chicago, the legend on their door modestly announcing that they are "contractors."

If the allegations put forth by Walter H. Bell in his bill of complaint to the Circuit Court in Chancery sitting are worthy of belief (which they probably are) they demonstrate:

First: That through himself and others a certain San Pablo Company was organized in 1900; that this company acquired 288,000 acres of land in the district of Champoton, state of Campeche, Mex., and paid for it about \$180,000 United States money; that this company was carried on until Midsummer, 1904, when it was alleged to be unprofitable.

Second: That in Midsummer, 1904, John R. Markley, president of the company, stated that the business had not met the expectations of the management, called a meeting and submitted a proposition to the stockholders looking to the sale of the property.

Third: That at this stockholders' meeting the sale of the property was authorized at an agreed price of \$450,000 with the understanding that the title to the property was not to pass until the purchase price had been paid.

Fourth: That in 1904 John R. Markley and others organized the International Lumber & Development Company, with an alleged capital stock of \$6,000,000 divided into 20,000 shares, with a par value of \$300 each.

Fifth: That about the date of this organization the International Company entered into an agreement with John R. Markley and Isaiah B. Miller to become the contractors for the clearing, planting and bringing to maturity 20,000 acres of the aforementioned land, they to receive as compensation the net proceeds arising out of the sale of the entire shares of the capital stock of the International Company, less the sum of \$450,000 principal and interest, covering the agreed purchase price; that the total expenses to be incurred by the International Company in selling the stock should not exceed \$100 for each share, i. e. a net sum of \$200 per share to be paid over to Markley and Miller.

Sixth: That the complainant believes that Markley and Miller have an agreement by which they are to receive an additional con-

sideration out of the profits arising from the sale of the stock.

Seventh: That the orator believes that \$60.00 net for each share of stock sold is about the sum that has been received by the International Company, and that up to date of filing the bill about 12,000 shares had been sold; that the International Company has paid nothing on the purchase price of the San Pablo property save three half-yearly instalments of interest, amounting to a total of \$33,725.

If the above allegations are true, the International Lumber & Development Company owns the 288,000 acres comprising the San Pablo property just about as much as it does the state of Ohio; that the much vaunted deed of the property which the company alleges is deposited in the hands of a trust company for the benefit of its shareholders, is deposited there for the security of the San Pablo company; that the International Company's exclusive business is the sale of its stock, and that any possible profits arising from the deal are being pretty thoroughly absorbed by Markley and Miller. It is alleged and probably true, that the sundry cargoes of mahogany timber that are being taken from the land are immediately becoming the property of Markley and Miller; that the much talked of ship Vueltabajo which carries logs from the property to Mobile is either owned or handled in the interest of Markley and Miller; that the much talked of mahogany sawmill at Mobile does not belong to the International Lumber & Development Company, but to the Markley and Miller interests; that Markley and Miller are receiving a fancy profit on such lands as they prepare for cultivation on the property.

It is beyond question that there are quite a number of straightforward but very foolish business men of decent reputation mixed up in this International enterprise, and through their connection it is equally true that a good many people have been in-

duced to buy the stock. One of the alluring bits of literature that the company is flooding the country with is reproduced on another page. On the second postal of this return card is printed: "8 per cent guaranteed—22 per cent estimated. This is not a chance to lose, but a certainty to win. Men of national reputation are at the head of it. Over 7,000 persons now drawing large and increasing profits from similar enterprises under same management. Some have received as high as 57 per cent in dividends. Fill in your name and address below. Place a postage stamp on the other side of this card and mail it, and you will receive information that will be valuable to you."

Following is another letter sent to the company's stock-selling agents, under date of June 23:

"Yesterday, June 22d, the ninth steamship load of this company's mahogany reached Mobile, Ala., and will soon be sawed into lumber and veneers. The eighth steamship load of our mahogany arrived May 25th, making less than one month's time between these last two shipments.

"At the close of business tonight we have 4,321 individual stockholders upon our books. Shares are being taken up very rapidly. Yesterday we sold 102 shares.

"We would again very urgently recommend that you push the sale of the shares of our stock very energetically, working early and late. There is only a comparatively small number of shares yet remaining unsold that can be obtained at par value and in a short time all the shares of our stock will be taken. We hope you will be able to place a large number of these remaining shares.

"We cannot too earnestly recommend that you push the sale of our shares. Will supply you with all printed matter and literature which you can use to advantage.

"Yours very truly,

"INTERNATIONAL LUMBER & DEVELOPMENT CO.

"C. M. McMahon, Treasurer.

It is scarcely necessary to comment further on the International Lumber & Development Company enterprise. To the mind of any competent business man it is simply marvelous that 4,321 suckers can be picked up in the United States at one swoop.

## Hardwood Record Mail Bag.

[In this department it is proposed to reply to such inquiries as reach this office from the HARDWOOD RECORD clientele as will be of enough general interest to warrant publication. Every patron of the paper is invited to use this department to the fullest extent, and an attempt will be made to answer queries pertaining to all matters of interest to the hardwood trade, in a succinct and intelligent manner.]

### In Market for Tupelo or Poplar Electric Casing.

NEW ORLEANS, LA., July 27.—Editor HARDWOOD RECORD: We do a considerable export business and should esteem it a favor if you could place us in communication with parties on this side that manufacture electrical casing and capping from poplar or tupelo. We have a large order offered us at present; also about forty cars of tupelo strips for mouldings.

— LUMBER COMPANY.

If any of our readers would like to be put in communication with a possible buyer of a large order for tupelo or poplar electric casing and capping for export, the RECORD will be glad to supply the address of the inquirer. EDITOR.

### Wants Exchange Table.

NEW ORLEANS, LA., July 20.—Editor HARDWOOD RECORD: Please advise me where we can find a book of tables converting pounds, shillings and pence per cubic feet into dollars per thousand feet; also converting francs per cubic meter into dollars per thousand feet.

— LUMBER COMPANY.

If any readers of the RECORD know of a book of such tables, or employ such a set in their own work, we would be glad to have a copy of it, and also would like a table of values converting marks in the same way.—EDITOR.

### Wants Gum Dimension Stock.

PHILADELPHIA, PA., July 27.—Editor HARDWOOD RECORD: We want to find out where we can get 1-inch gum boards S2S and resawed, 4 to 9 inches wide, and 1 1/4-inch common, S2S, 6 inches and wider, stock suitable for making mouse traps.

— LUMBER COMPANY.

Anyone interested in the above inquiry will be put in communication with the writer on application to this office.—EDITOR.

# Meeting Michigan Hardwood Manufacturers' Ass'n.

The second meeting of that most lusty association infant, the Michigan Hardwood Manufacturers' Association, was held at the John Jacob Astor House, Mackinac Island, on Wednesday, Aug. 8. The meeting was held for the dual purpose of increasing the membership and for compiling a set of inspection rules to be submitted to all members for suggestions before final adoption by the association. Both of these objects were accomplished, and the association started off at the end of this meeting with an alliance of forty-eight hardwood manufacturers representing approximately ninety per cent of the total hardwood output of the state.

The entire work of the association was carried on with the utmost harmony and there were many pleasant features in connection with the meeting. The number of ladies accompanying their husbands was not-



WM. H. WHITE, PRESIDENT MICHIGAN HARDWOOD MANUFACTURERS' ASSOCIATION.

ably large, and their presence added much to the pleasure of the gathering. Another noteworthy attendant was E. P. Arpin of Grand Rapids, Wis., president of the Wisconsin Hardwood Lumbermen's Association.

The morning was spent by the committees appointed at the Ottawa Beach meeting in preparing their reports, and the regular session was not convened until 2 p. m.

## The Meeting.

Wm. H. White, of Boyne City, president, occupied the chair and after roll call addressed the meeting.

President White: On July 14 we made an organization at Ottawa Beach, and this meeting is a continuation of it, our particular object at this time being to get more members. We selected this place because it is handy for all interested. If there is anyone here today who is not a member we want him to come up and become a member, so he will have the power to talk on any subject pertaining to his business in this association. We have here the minutes of the meeting at Ottawa Beach, but unless some of you particularly wish it, we will not read them. I wish to say further that we have a grading committee that will report here today, and also a marketing committee, but we want it

understood that none of these reports are for adoption. They are simply for discussion and study, and if it is the sense of the directors that each member have a copy, we will so instruct our secretary, but they are not to be scattered broadcast until they are actually adopted. It is also the sense of the grading committee that no rules be adopted until they are tried out on the lumber pile. I understand some people think we are going to make some radical changes, but this is a mistake—we are not. We are going to go very slowly in every step we take, and do our work very carefully and thoroughly. We will read the rules we have been working on here today but it may take us some time to perfect them, and they will not be adopted until then, even if it takes a year.

Secretary Odell then reported a membership of thirty-four at the close of the Ottawa Beach meeting, stating that since that time the membership had been increased to forty-eight. The list follows:

## Members of the Association.

Anderson, A. F., Cadillac.  
 Batchelor Timber Co., Saginaw.  
 Butters Salt & Lumber Co., Ludington.  
 Boyne City Lumber Co., Boyne City.  
 Cook, Curtis & Miller, Petoskey.  
 Cadillac Handle Co., Cadillac.  
 Cobbs & Mitchell, Inc., Cadillac.  
 Cummer, Diggins & Co., Cadillac.  
 Churchill Lumber Co., Alpena.  
 Day, D. H., Glen Haven.  
 Dalton Lumber Co., New Dalton (P. O., Skandia).  
 Danther Hardwood Lumber Co., Dollarville.  
 Elk Rapids Iron Co., Elk Rapids.  
 East Jordan Lumber Co., East Jordan.  
 Embury-Martin Lumber Co., Cheboygan.  
 Engadine Lumber Co., Engadine.  
 Gilchrist, F. W., Alpena.  
 Hackley-Phelps-Bonnell Co., Grand Rapids.  
 Harbor Springs Lumber Co., Harbor Springs.  
 Haak Lumber Co., Haakwood.  
 Johannesburg Mfg. Co., Johannesburg.  
 Jamison, John A., St. Ignace.  
 Kimball Lumber Co., Alpena.  
 Kneeland-Eigelow Co., Bay City.  
 Kelley Lumber & Shingle Co., Traverse City.  
 Loud's Sons Co., H. M., Au Sable.  
 Murphy & Diggins, Cadillac.  
 MacBride Lumber Co., Grand Rapids.  
 Mitchell Bros. Co., Cadillac.  
 Michelson & Hanson Lumber Co., Lewiston.  
 McMillan, C. V. Co., Ontonagon.  
 Northern Lumber Co., Birch.  
 Oval Wood Dish Co., Traverse City.  
 Peters, R. G., Salt & Lumber Co., Eastlake.  
 Peninsula Park & Lumber Co., Sault Ste. Marie.  
 Richardson Lumber Co., Alpena.  
 Stearns Salt & Lumber Co., Ludington.  
 Sands, Louis, Salt & Lumber Co., Manistee.  
 Salling, Hanson & Co., Grayling.  
 Stephenson, The I. Co., Wells.  
 Simmons Lumber Co., Simmons.  
 J. Sullivan, Cedar.  
 von Platen, G., Boyne City.  
 Weidman, J. S., Weidman.  
 Worcester Lumber Co., Chassel.  
 White, W. H. Co., Boyne City.  
 Wagner & Gilmore, Marion.  
 Williams Bros. Co., Cadillac.

Mr. Odell then read a telegram from R. Hanson, of Salling, Hanson & Co., Grayling, as follows: "Will not be able to attend meeting but hope you will have a good attendance, and we promise our heartiest cooperation in whatever measures are adopted." Also a letter from the Michigan Manufacturers' Association of Detroit, inviting the association to affiliate with them, which on motion was ordered filed.

The report of the grading committee was then read in the form of suggestions for a code of rules covering the manufacture and grading of Michigan hardwoods.

Mr. White: Any suggestion or criticisms from anyone present will be helpful to us.

Here followed much interesting discussion on how to prevent lumber from staining, which brought out many expert opinions.

Mr. Klise addressed the convention at some length advising conservatism in the legislation of the association on the subject of grades and methods of conducting the hardwood manufacturing business of the state.

## Address of G. B. Dunton.

Mr. Dunton: A good many years ago my father was manufacturing fanning mills in Grand Rapids. We used to buy poplar and we went down to the mill and picked out the kind of lumber we wanted. There was no grading in those days. Afterward we went up north to a pine sawmill man and showed him the grades we wanted, so that he could know just what our requirements were. In those days there were no jobbers, but the man who wanted lumber simply went to the mill. We came back and told a planing mill man in Grand Rapids that we could buy pine up there real cheap. Others went up there and did the same thing. The consumers went to the manufacturers and told them what they wanted and paid the price for it. Now when the hardwood men came onto the carpet a whole lot of jobbers sprang up. They came to the hardwood man to buy his lumber. They didn't know whom they were going to sell it to. They didn't know what was to be



E. P. ARPIN, PRESIDENT WISCONSIN HARDWOOD LUMBERMEN'S ASSOCIATION.

done with it. So they got up a set of rules to cover everything. Men in the old days used to buy clear lumber, when they could just as well have used something cheaper. As I understand the business of this association, it is to get closer to the consumer, supply him with just what he wants, and not ask him to buy firsts and seconds when he could use No. 1 common. If customers could all come to the manufacturer and tell him just what they wanted, I will guarantee that you would get from \$3 to \$5 a thousand more for your lumber. Hardwood is getting pretty scarce in Michigan. The pine men awakened long ago to the state of affairs, and are thoroughly organized.

Mr. White then introduced Mr. E. P. Arpin, president of the Wisconsin Hardwood Lumbermen's Association, who addressed the meeting as follows:

## Address of E. P. Arpin.

In regard to the matter just spoken about I presume I know as little as anyone. I was one of the organizers of the Wisconsin Hardwood Lumbermen's Association eleven years ago, and we have done a good deal of good to ourselves individually and to the lumber trade as a whole. As I understand the contention now, it is simply a matter of making a larger number of grades and defining them. The original rules were elastic. They would cover various cases and grades. I am here at the invitation of President White and am glad you are forming an association because we know it will do you a lot

of good, and general co-operation is certainly of benefit to the entire hardwood industry. To illustrate, we have now taken up the subject of the western freight rate matter. At the time I was elected president of our association—it was a year ago—it occurred to me that the western rate of eighty-five cents to the west coast was out of proportion to the present rates going east. Our association appointed a committee to take the matter up with the National Association of Lumber Manufacturers and at this meeting they appointed a committee and passed a set of resolutions that this committee should appear before the Transcontinental Freight Bureau in Chicago and see what it thought about a reduction. The first committee appointed by our association prior to this did not get the satisfaction they thought they should, and thought that the national association, having all the lumber associations back of it, would meet with a larger measure of respect. So it proved, for they granted us a hearing which they did not grant the first committee. We had a meeting last month with them, and presented our case at leisure and I think we gave it very detailed attention and proved to the railway people that they are losing business in not granting the request. We showed to their satisfaction that there is now in the neighborhood of 15,000,000 feet of hardwood being shipped to west coast points. This is about 6,000,000 feet from the national association, the same from the Manufacturers' Association, 1,000,000 from our association, 1,000,000 from Michigan, and an odd million from other sources, making 15,000,000 in all.

courage through their excessive rates the importation of lumber into the United States. At the same time they have injured themselves as much or more than they have the lumbermen. Up to the present time, however, we have not been informed that we will get any satisfaction, rather the other way.

The rate out of Chicago to the Pacific coast is 85 cents, against 60 cents from the coast to Chicago points. The railroads do not give any reason for this. They simply say they can get it. But I understand that the northern lines are in favor of a reduction. They like the lumber traffic. It gives them a long haul with full carloads, and they like the business. But the southern lines, those that go into San Francisco, evidently think they will have all they can do in hauling lumber at 85 cents. I think possibly that later on they may make a reduction after the needs of the city of San Francisco have been met. Now they encourage the importation of foreign lumber. I do not know what the position of the National Lumber Manufacturers' Association will be in regard to this matter, but from the sentiment of most of its members I think they will feel like bringing the matter up before the Interstate Commerce Commission. With that in view, I think it would be well for you to suggest the advisability of co-operating with us on this line, appointing a committee to take the matter up with our committee, and do whatever is necessary for the good of the industry.

I am pleased indeed to come here and visit you gentlemen and consider it an honor to our association to be invited to attend your meeting. I have not had an opportunity to confer with the directors, but have had a number of letters, and all seem to be of the same opinion, that our work and yours are on the same lines, and anything we can do to co-operate will help each other. It occurred to me that possibly there may be some work in which we can pull together. To illustrate, the pine and hemlock people of our state have the same secretary. The work he does is much more efficient than if he acted only for one association. A secretary that would act for both our associations would be able to devote his entire time to collecting such information as we would all like to have. Our woods and markets are similar, and there is no reason why our two states could not work together. I just make this suggestion, however, so that later on it may be deemed a wise thing for us to amalgamate in some way. If there is any information I can give you, I would be pleased to give it, and that is one of the reasons that brought me here. I thought I might possibly be of some aid, and would be pleased to be of service in any way possible.

F. A. Diggins: I have just drafted a resolution which I wish to present, which I believe states about what the committee had in their minds when they drafted the rules.

**RESOLVED**, That the secretary of this association cause the report of the grading committee to be printed, and a copy of the report sent to each member for their consideration, accompanied by a request that said members shall submit suggestions for such changes as may occur to them.

That the grading committee shall meet and consider these suggestions and then formulate a set of rules which shall be submitted by a sub-committee to the grading committee of the national association and an earnest effort made to have our proposed changes incorporated in their rules, to the end that there may be no conflict between the two associations.

That pending the adoption of a set of grading rules by this association, the rules of the National Hardwood Lumber Association be used by the members of this association.

Mr. Diggins spoke briefly in support of his resolution and moved its adoption. The motion was carried by rising vote.

Mr. Day: The rules do not so much matter as the way they are interpreted. I think that while some changes are necessary in the rules, there should be something done in the matter of inspectors. According to my opinion they are almost wholly controlled by the jobbers, who get the benefit if there is any to be gotten. It would look to me that we should do something more on that line. I want to say that an inspector does not have to know very much about lumber. All he has to do is to give a bond. That makes it all right with the jobber, and the manufacturer seldom troubles him.

Mr. Hull: I do not wish to be understood as opposing a modification of the rules, but what I do insist upon is to make them so plain that so much will not be left to the judgment of the inspectors, for their opinions vary greatly. I want them plain enough that

an inspector can intelligently put the board where it belongs.

Mr. von Platen: I have worked on grading committees for seven or eight years, and have met with some very fair men on the other side. I think we should take the consumer into consideration, if not the middleman. My aim is to make the middleman sell the same grade to the consumer that I give him, and I think when we get the grade where the middleman cannot manipulate it we have done everything we can. I do not believe it is best for us to get up a set of rules and say that such and such must constitute grades. I do not believe we can make it work. It might not be best to confer with the national people, but we must get at the consumer and see what he thinks best in the case. I do not think it best to force on a man lumber that he cannot use, and I have worked for that point and to get grades to satisfy the consumer. I think that defects should be according to the number of feet in the surface measurement in a board, instead of in width. That would help the flooring man because he wants long lumber. I would like to see consumers on that committee but not middlemen. Of course they are fighting us inch by inch. I am not in favor of changing the rules to any extent at present.

Mr. Cook: The consumer should be brought very close to any changes that are made in rough lumber, and the trouble as I view it, from the national association, is that it is largely made up of middlemen, and every inch you get you have to fight for because



W. W. MITCHELL, V. P. MICHIGAN HARDWOOD MANUFACTURERS' ASSOCIATION.



LEWIS DOSTER, SECY HARDWOOD MANUFACTURERS' ASSOCIATION OF THE UNITED STATES.

At the rate at which it is being shipped it is assumed by the people in the west coast cities, who use it, that under a reasonable rate they would be able to treble the consumption of hardwoods. If this is so, it would seem an object for the railway people to make a reduction in the rate. They admit that one-third of their cars going west go empty. We offered to load those cars at a lower rate, and give them the extra business. The lumber that they force east on a low rate is not a benefit to them. In other words I saw a house today finished in yellow pine. That means a carload of lumber in the South somewhere was shipped up here. Now in this way the road got an extra car to haul. Otherwise they would have got none.

The railway people have seemed to take it on themselves that they didn't want any lumber to go west. They have sawmills out there and the lumber ought to satisfy the people there, and so they have not favored a movement of lumber to the west. Wisconsin manufacturers feel they are entitled to a broader market in that direction. Some lumber is even shipped in from Japan. Recently there was made a contract for 1,500,000 oak ties to be shipped to Mexico for the Harriman lines. That means 50,000,000 feet of lumber. So there is evidently some timber in Japan. It appears that there is a cause for apprehension on the part of the manufacturers of the United States regarding the shipping in of foreign lumber. I had a letter sent me by a manufacturer in which the writer stated that he wanted to know what rates they might get to ship some of this Japanese lumber right into Chicago. So the railroads en-

his profit at the present time, of any size, results almost exclusively in the manipulation of the grade which you sell him, and it would seem to me that it is essential that a grade of firsts be established; then the seconds, and along down the list; so closely specified that when you get done with the grading the basis will be found simple and there can't be any manipulation. It is certainly essential to change the grades of lumber, just as it is the grades of maple flooring. The flooring men do it and nobody kicks about it because everybody does it. The grade on flooring is 2 feet and up. It seems to me that grades should be changed from time to time to cope with the situation, as manufacturing conditions change. As for doing it at once, you are on ground that needs careful and thorough investigation, and must needs be carefully and slowly covered. Radical changes today, with the market as it is, need serious thought. I should say that if we could understand the basis of supply and demand from the viewpoint of the manufacturer we could maintain better values, we could maintain better grading values and get more out of the product of the log.

**Market Condition Committee Report.**

Chairman Odell presented the report of the committee on market conditions, as follows:

Your committee on market conditions begs to report as follows concerning stock on hand and stock sold on unfulfilled orders.

Your acting secretary sent blanks to all manufacturers of hardwood in Michigan requesting them to report the amount of stock on hand and unfiled orders July 1, 1906. Fifty-nine manufacturers reported and among these most of the larger manufacturers, although ten to twelve of the largest manufacturers did not report their stock.

From such deductions as we have made from a compilation of the stocks reported we think it probable that fifty of the largest manufacturers produce in the neighborhood of 90 per cent of the hardwoods cut in Michigan. Twenty-nine out of fifty-nine reporting, or a little less than 50 per cent of those reporting, have 92½ per cent of the stock reported. The woods on which we have reports are maple, beech, birch, elm and basswood. This report shows the amount of the above woods in feet only and does not show sizes or grades.

From such information as this committee is able to secure, it appears that there is considerably less hardwood lumber in the hands of manufacturers than there was at this time last year, and that the demand is sufficient to consume all of it at fully as good prices and in some instances at much better prices than have prevailed during the present year.

Thick maple is in much better demand and stocks much lighter than at any time during the past two years, and probably will be scarce before next winter's cut is in condition to market. The amount of beech lumber in stock is very well covered by orders and there seems to be no surplus. Beech has been used very largely as a substitute wood, the purpose generally being to secure something cheaper than had been used before and from its use in this way many consuming manufacturers have come to know that beech is a valuable wood for many purposes. We expect to see the use of beech increase both because of its merits and because for some time at least it will be the cheapest of hardwoods. Either of these reasons should be sufficient to help the price of beech.

The stocks of birch are no doubt much lighter than they were at the beginning of the year, owing to a very much increased demand, due likely to concessions in prices.

Basswood has remained practically unchanged during the past year, the supply about equalling the demand. We can learn of no accumulation in stocks, neither does there seem to be any marked decrease in stocks.

Elm has not maintained the position taken by it early in the year, as there has been some decline in prices and a slight increase in stock due probably to the use of substitute woods.

It is the opinion of this committee that the general conditions and outlook for Michigan hardwoods, taken as a whole, are probably better than at any time in their history.

Respectfully submitted,

Bruce Odell,  
W. L. Martin,  
A. W. Newark,  
W. C. Hull,  
W. N. Kelley,  
S. G. McClellan,  
Committee.

Mr. Odell: A summary of the reports of stocks on hand which have been received should be information for members only, and will be furnished any members wanting them. We will also get out statistics on other lines, which will be of benefit.

Mr. White: I wish to say that this association is very fortunate. Cummer, Diggins & Co. have allowed Mr. Odell to carry on this work until we decide fully what we are going to do. I have therefore arranged with Mr. Odell today to fix up an office at Cadillac, hire a stenographer and carry on this work for the time being.

I think this association should have a traffic committee of three to co-operate with the Wisconsin association in this west-bound freight question and other matters. What is your pleasure?

#### Freight Committee.

A motion was made and carried that a freight committee be appointed in accordance with the president's suggestion, and the following were named: B. F. Cook, Fred Diggins and C. A. Bigelow.

Secretary Odell then addressed the convention on the value of statistical reports of stocks on hand, etc., and made an urgent plea that requests for information be promptly attended to, in order that the data obtained may be complete. He also proposed a vote of thanks to Lewis Doster and other members

of the Hardwood Manufacturers' Association for their assistance in organizing the Michigan hardwood manufacturers, in the form of a resolution, adopted as follows:

**RESOLVED**, That this association hereby extends to the Hardwood Manufacturers' Association of the United States its hearty appreciation of the valuable assistance rendered us at the time of our organization by the presence of their very efficient secretary, Mr. Doster, and other prominent members of their association, including R. H. Vansant, their former president. We have found their suggestions most beneficial and helpful, and we hereby wish to record our obligation to their association.

Mr. Day: I move that the executive committee appoint a man to canvass this state and get every manufacturer and stumpage owner to join this association. Carried.

#### Newspaper Men Talk.

Mr. DeFebaugh: I do not think it necessary for me to go on record regarding association work, as I have for about twenty years been trying to assist in my humble way in the establishment of associations in all lines of the trade, believing that just such conferences as you are having today are useful to yourselves and to the trade at large. I never saw one of them that was not productive of good where there was mutual confidence and action. I know very well many of you have done a lot of work in association lines. I remember of going over in this state a few

the other, and you eventually eliminate unintelligent competition. You achieve a high standard and therefore it is worth all the time and money you spend on it. All the associations that have been organized in a logical way have been successful. Every association effort has made money for its members, and I want to congratulate you on this one because you have started right and you are going to benefit yourselves.

In the matter of grades the correct theory of grading lumber from the manufacturers' viewpoint is to establish grades that the wholesale consumer may use to his satisfaction, just so far as they can be made, and saw logs to good advantage. You do not want to waste your timber. You must practice forest and sawmill economy. You will find the time very close at hand when you are going to take your low grade stock and refuse and make dimension material. You will find this will be a great thing for you from a financial viewpoint, and that is what you all naturally have in view.

Mr. Barns: I have nothing to say. My distinguished confreres are the orators of the lumber trade press. I am up here rusticiating nearby and I spend the happiest part of my life in Michigan; that is in summer, when I have nothing to do but catch your fish, play your slot machines and have a good time.

As to associations, we have one in St. Louis that is almost a model of all those in the country. There are pretty hard-headed men in the yellow pine fraternity, and it is very plain that they would not spend their money unless they saw practical benefits. Their association is expending a good deal of money every year, and they are doing it for a purpose, you can depend. I am very glad indeed to be present here today, and to have this opportunity of meeting all of you.

#### Secretary Doster Explains.

Mr. White: Mr. Doster is with us today, and has certainly been a great aid to us in getting into shape. We would be glad to have him give us a few words on the methods he carries out in his association work.

Mr. Doster: I certainly appreciate your kind expression of thanks, which has more than repaid me for the extra work I have done on your behalf. It has been my pleasure in association work to establish a system of travels, and I have never traveled to a better state than Michigan, or met more association people than I have here. There is no question but that you will get some excellent results. I have in the past explained my work wherever I have been.

In 1902 the manufacturers of the South covering fourteen states were up against it in the way you are. They were being forced to ship their lumber under all sorts of conditions. There were no intelligent grading rules on the market to form a basis, and they organized to protect themselves. Our object is to inform our fellow manufacturers of the conditions existing in every section of the country, and to advise each other of unbusinesslike methods of such persons who endeavor to take advantage of the manufacturing element. After we formed our organization we discovered that to adopt grading rules we had to go further along the line. The question of interpretation of the rules was one of vital importance and it was discovered that the only way to obtain good results was to have inspectors who would report on the lumber that was being objected to by buyers, with the result that we put in a fully organized corps of inspectors to travel over the United States, wherever lumber is consumed. At the same time we discovered that the question of shipping lumber was one of vital importance. We established an educating department and have our traveling inspectors visit the sawmills. The manufacturers of the South never wanted to make a grade of lumber that could not be sold, and every point we have taken up in our association work has given to the consumers of lumber something better than they have obtained before. Prior to 1902 everybody was working in the dark with the sole aim of producing a large amount of lumber rather than producing a limited amount at a larger price. Our inspectors study what the consumer wants and how to make it, and manufacturers and consumers are thus working together in harmony. We only allow manufacturers and stumpage owners in our organization. We are composed of men thoroughly familiar with the consuming markets, and consumers are always taken into consideration before any radical move is made. We have also established a plan in which we study competitive woods, and attempt to keep values in just proportion. When we organized we had poplar as our highest priced commodity, and we naturally studied what was going to take its place, and how to secure a fair price for it.

In your own trade you will find that people are buying basswood from the South. I know today that our basswood in the South is



BRUCE ODELL, SECY MICHIGAN HARDWOOD MANUFACTURERS' ASSOCIATION.

years ago to assist in the organization of a maple flooring association and I believed there was a field here for that association. I went to one city in this state where we labored from early morning until midnight to induce one concern to become members, with the result that they signed about midnight. Any of us who have assisted in building up these associations have done a good work. Mr. Arpin here is doing a good work by his self-sacrifice along the lines of reducing freight rates to the coast, and it will result in good I am sure. The Southern Pacific and some of the other roads all fear anything like a revolution in rates. They say the moment they make a change in rates on lumber to the coast they will have to put in machinery, furniture and other products. But there will be a change in rates to the coast, nevertheless, without any doubt. People are now asking some of the roads for cars, which they cannot supply. That is true of Pacific coast roads. We are now coming to what is going to be the car shortage of history, this fall. Every commodity is being offered now in tremendous quantities, and the roads are going to be powerless in sixty days to meet the demands upon them. I think all associations fairly well organized will bring to their members almost untold good in the next twelve months.

Mr. Gibson: You all know my interest in association work. I have seen its effects for years and know its value. Beyond grading rules and all this sort of thing the great value of association work is this acquaintance, this friendship, and the fact that you get a mutual education. One man learns from



being held back until the manufacturer becomes thoroughly acquainted with the conditions surrounding it. This association work helps him to do.

We have a system of statistics which we send out to members, and I want to say that the way to make such information valuable is for everyone to reply to all inquiries from the secretary's office promptly and fully. I have been closely connected with Mr. Odell while he has been taking up this new work, and I say to you that I have seldom if ever found a man so thoroughly adapted to do association work. You have certainly placed the right man in the right place. A point in our association similar to yours is that manufacturers of a certain class of lumber are the only people who can legislate on the rules covering that commodity. Manufacturers of poplar lumber have nothing to say about rules for other woods, with the result that we divide all our interests into separate departments. We have no conflict in our association at all, for we simply adopt the recommendations of the principal manufacturers of each wood. Our members never adopt measures that are going to harm themselves. Our work is endeavoring to develop along the best possible lines. We have never adopted specific grading rules on the woods of Michigan and Wisconsin, for the simple reason that we have never been organized in those sections, and as we do not make rules on what we do not manufacture, we are ready to practically adopt your ideas on those things. Our association was formed because grading rules had been established wherein the manufacturer graded his lumber on one side and it was re-sold on the other, maybe being turned over in the car in transit. These conditions the sawmill man in the South confronted, and he was forced to organize. We believe that there is a place for the middleman. We believe that he is necessary for a larger element of our people than he is for your people here. We have more small producers to the square mile than you have. The small man must sell through somebody as he cannot afford to establish a selling agency of his own. We like to take the middleman and consumer into consideration and try to work in close touch with everybody connected with the trade. We have spent over \$150,000 since 1902 for the purpose of establishing the principle that a man shall not "monkey with grades." We find that mixed grades will cause competitors to constantly lower their prices to meet this mixed grade competition. We adopt plans to protect our members. We adopted a plan of measuring on the half foot, and we have no trouble on this score with consumers. We never have any trouble with them or they with us. All the difficulty comes from the middleman who is endeavoring to either find something easy to sell or wants to make an unfair profit.

We also have a credit rating department which is nothing more than individual business methods thoroughly recorded, especially those which are unjust. We have market conditions and price committees which study grades, stocks on hand, consuming market conditions, values of different commodities, and act in accordance with what is found. Twice a month we issue a stock sheet showing items of surplus stock by thicknesses and grades. In the last two or three years it has not been used very much because there have been no surplus stocks. The result is that manufacturers are always working on thicknesses which are short. Thus we are covering in a businesslike way the entire United States. You have conditions existing here in Michigan and Wisconsin which are very closely united, and I know the results you will achieve will be satisfactory. I have had the honor of being present here and I appreciate it.

Mr. White: I appreciate very much the seriousness with which Mr. Day takes the membership business of this association and the necessary work to be done, and I think everyone here who is a member should go home with the understanding that he will do everything possible to get members for the next meeting. We must fight our matters out on our own lines and put our plans into shape, and when we have done this we can present them to any other association which we want to join, but we can't do it now for we are in our infancy. Mr. von Platen touched the vital point on this rule matter when he said we must make a set of rules which the middleman cannot manipulate. That is what we should do. Make a set of rules for the manufacturer and consumer of the product. I hope you will all go home to work with us in every way possible, and we want to beat every association in our work and enthusiasm—even the Wisconsin men.

President White announced that the executive committee had appointed B. H. Cook on the market conditions committee in place of

E. C. Rust who was unable to serve; also that the correct initials of Mr. Hull of the same committee are "W. C."

On motion the meeting adjourned, after deciding to hold the next gathering at Traverse City, the time to be decided upon and announced later.

**Those Present.**

- A. E. Anderson, Cadillac.
- E. P. Arpin, president Wisconsin Hardwood Lumbermen's Association, Grand Rapids, Wis.
- Chas. A. Bigelow, Kneeland-Bigelow Co., Bay City.
- Henry Ballou, Cobbs & Mitchell, Inc., Cadillac.
- W. E. Barns, St. Louis Lumberman, St. Louis, Mo.
- John W. Blodgett, Grand Rapids.
- R. J. Clark, Peninsular Bank & Lumber Co., Sault Ste Marie.
- F. Collier, Boyne City.
- M. E. Collins, Engadine Lumber Co., Engadine.
- E. G. Carey, Harbor Springs Lumber Co., Harbor Springs.
- B. H. Cook, Curtis & Miller, Petoskey and Grand Marais.
- Rush Culver, Northern Lumber Co., Birch and Marquette.
- W. T. Christine, American Lumberman, Chicago.
- J. E. Defebaugh, American Lumberman, Chicago.
- Lewis Doster, secretary Hardwood Manufacturers' Association, Chicago.
- F. A. Diggins, Murphy & Diggins, Cadillac.
- D. F. Diggins, Cummer, Diggins & Co., Cadillac.
- C. B. Drake, Michelson Lumber Co., Lewiston.
- G. B. Dunton, MacBride Lumber Co., Buckley.
- John Dalton, Dalton Lumber Co. (Skandia P. O.), New Dalton.
- James Danaber, Jr., Danaber Hardwood Lumber Co., Dollarville.
- D. H. Day, Glen Haven.
- G. E. Daniels, Grand Rapids.
- W. L. DeWitt, Kelley Lumber & Shingle Co., Traverse City.
- C. R. Duggan, Tindle & Jackson, Pellston.

- Edward Fitzgerald, Hitchell Bros. Co., Cadillac.
- F. H. Freeman, Engadine Lumber Co., Engadine.
- Chas. W. Fish, Hackley-Phelps-Bonnell Co., Grand Rapids.
- F. W. Fitchrist, Alpena.
- Henry H. Gibson, Hardwood Record, Chicago.
- Bruce Green, Williams Bros. Co., Cadillac.
- A. E. Gordon, Hardwood Record, Chicago.
- E. S. Harris, Dalton Lumber Co., Skandia.
- C. E. Haak, Haak Lumber Co., Hawkwood.
- J. A. Hynes, Sault Ste Marie.
- H. S. Hull, The Oval Wood Dish Co., Traverse City.
- W. W. Johnson, Johnson & Crawl, Petoskey.
- J. A. Jamieson, St. Ignace.
- A. B. Klise, A. B. Klise Lumber Co., Sturgeon Bay.
- F. A. Kimball, Churchill Lumber Co., Alpena.
- W. N. Kelley, Kelley Lumber & Shingle Co., Traverse City.
- W. W. Mitchell, Mitchell Bros. Co. and Cobbs & Mitchell, Inc., Cadillac.
- W. L. Martin, Boyne City Lumber Co., Boyne City.
- Wm. F. McKnight, The Northern Lumber Co., Birch.
- Joseph Murphy, Murphy & Diggins, Cadillac.
- S. G. McClellan, Simmons Lumber Co., Simmons.
- W. L. Martin, Embury-Martin Co., Cheboygan.
- H. Nichols, Charlevoix Lumber Co., Charlevoix.
- A. W. Newark, The Cadillac Handle Co., Cadillac.
- Bruce Odell, Cummer, Diggins & Co., Cadillac.
- W. P. Porter, East Jordan Lumber Co., East Jordan.
- C. A. Phelps, Hackley-Phelps-Bonnell Co., Grand Rapids.
- Robert H. Rayburn, Kimball Lumber Co., Alpena.
- E. C. Rust, Elk Rapids Iron Co., Elk Rapids.
- F. L. Richardson, Richardson Lumber Co., Alpena.
- H. P. Sutton, Worcester Lumber Co., Ltd., Chassell.
- G. von Platen, Boyne City.
- W. H. White, W. H. White Co., Boyne City.
- Thos. White, W. H. White Co., Boyne City.
- P. B. Wachtell, Petoskey.

**News Miscellany.**

**Btg West Virginia Deal.**

The largest timber deal made in West Virginia in some time was consummated a few days ago when C. Crane & Co. of Cincinnati, O., paid over half a million dollars for a tract of 60,000 acres of the best hardwood timber land in that state. This latest purchase gives C. Crane & Co. domain over about 400,000 acres of the richest timber land in West Virginia.

The property just acquired lies in Wyoming and Raleigh counties and is at the headquarters of Coal creek, the Guyandotte and Buffalo rivers, all of which flow into the Kanawa, and the timber will be easily gotten out by this means.

It is estimated that C. Crane & Co. have sufficient timber land to last twenty-five years, estimating their aggregate annual cut at 100,000,000 feet.

**Foremost in Its Line.**

To cater to the whims of those idols of the public, baseball players, taxes the resources of the oldest and most experienced workers in wood to furnish a bat which will meet the approval of these critical professionals. At Pontiac, Mich., the Pontiac Turning Company operates a bat factory which is probably the largest institution of the kind in the world. This company's products have a reputation which extends the country over and has even penetrated into the Philippines.

The wood from which these sticks are made is of the finest growth white hickory and ash, straight grained and absolutely free from knots. It comes mostly from Michigan and Ohio, though every part of the United States where desirable trees are grown contributes more or less. Each year finds the acreage of hickory and ash diminishing, making the task of the buyer more difficult.

The logs employed in the manufacture of bats are from six to twenty-eight inches thick. They are cut lengthwise in multiples of thirty-eight inches, called bolts. Besides what are sawed in this factory many squares are bought from other factories, ready for the lathe. During the busy season bats are turned out at the rate of over a thousand a day.

Such parts of the bolt as are left over are usually large enough to use for handles, of which the factory makes even more than it does of bats. Handles for pickaxes, hammers, sledges, hoes, forks and in fact all kinds of tools are turned out, making a separate business in itself.

The lathe which takes the squares and shapes them into the rough semblance of the finished product consists of a number of chisel-like knives, which in an incredibly short time give the ungainly billet the lines of the finished bat. A turn on the sand belts makes the bats smooth as satin. They are then taken to another room where they are given a coat of filling—green, black, brown or antique, according to specifications. Some of them are burned in the flame of a torch while at the same time the brand is burned in. Then they are carefully shellacked. Finally they are put in individual paper bags and packed in crates, a dozen to the crate.

The factory turns out three standard styles of bats. There are as many odd notions in the bat business as can be found in almost any line that we might mention.

Many famous ball players visit this factory annually for the purpose of selecting a bat from the large stock or suggesting some improvement upon the present models.

It takes from one to three years from the time the logs are brought in to season them and get them ready for the lathe.



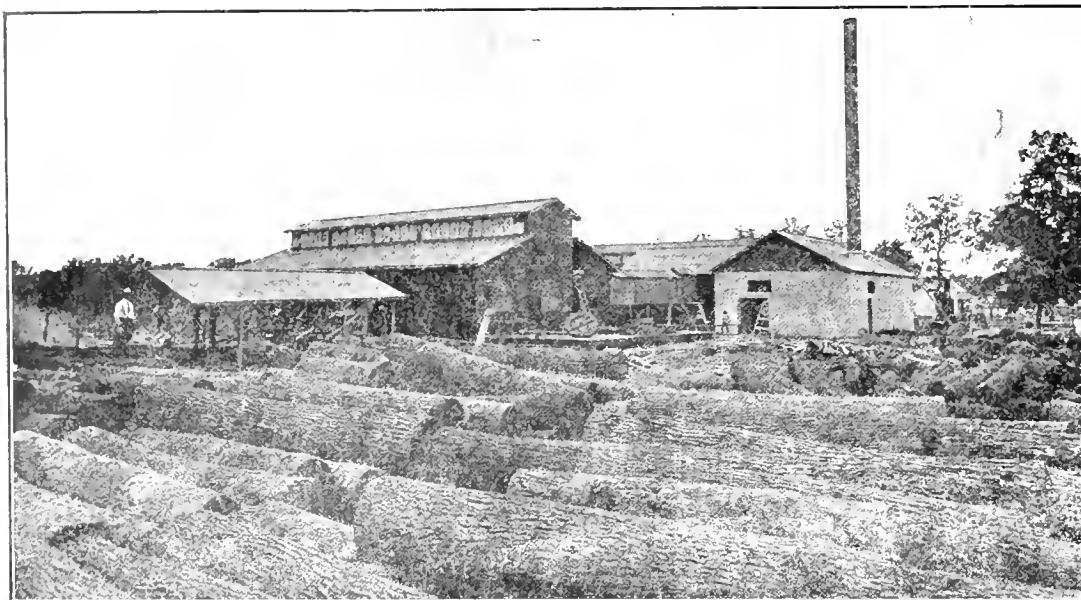

LOG YARD, CHOCTAW LUMBER &amp; VENEER COMPANY, GARVIN, I. T.

### A Model Veneer Mill.

One of the finest veneer mills in the United States was recently built at Garvin, I. T., by the Choctaw Lumber & Veneer Company of Chicago. Veneer has been made for years, but the tremendous growth of this industry since 1904 has completely revolutionized its manufacture, and from a somewhat insignificant place in the lumber business it has sprung to the front rank. This change is reflected in the modern mills which completely eclipse their humble predecessors of a few years ago. The accompanying cuts give a good idea of the Garvin mill, which is a fine example of the modern veneer plant.

The Choctaw Lumber & Veneer Company was organized last winter by a number of Chicago capitalists having large timber properties in Indian Territory. Their holdings comprise several million feet of the finest white and red oak now standing in the United States, and they control enough to run their mill for twenty years. The large cut gives some idea of the average run of the logs.

Realizing that the manufacture of veneer is a very profitable branch of the lumber business, the Choctaw Lumber & Veneer Company decided to erect a thoroughly modern plant of great capacity for that purpose. That it has been successful is patent to every one familiar with the industry. Inside and out the mill is a model of convenience and substantial construction. Particular attention has been paid by the owners to machinery equipment, the complete outfit being supplied by the Coe Manufacturing Company of Painesville, O., whose reputation in this line is world-wide. Every known device

for rapid and economical handling of raw material and finished product is used, and the mill is so arranged that there is no unnecessary handling, and the stock from the very first operation is kept continually moving towards the shipping department.

In the yard the logs are handled by a yarding

machine. A modern six foot band mill is used for cutting blitches for the veneer saws and a Coe knife grinder takes care of that important part of the business. The power for the mill is provided by two 200 horsepower boilers and a Corliss engine of ample size. The mill has its own lighting plant and is so arranged that it can be run twenty-four hours a day if desired.

The success which has attended the efforts of this company from the start is largely due to the untiring energy and ability of E. E. Busby, president, R. C. Dayton, secretary, and E. T. Henry, superintendent. These gentlemen have built a model mill and with every condition so favorable, a

is sure to be the remarkably successful business result of their efforts.

Fire in the Adrian Handle Company's factory at Adrian, Mich., caused an estimated loss of \$10,000.



LOWER HOUSE, CHOCTAW LUMBER &amp; VENEER COMPANY, GARVIN, I. T.

machine engine and wire cable in connection with a mammoth derrick, and are cut to length by a heavy steam drag saw. The logs are conveyed to the boiling vats and thence to the cutting department by firm eye-beam trolleys of the latest design.

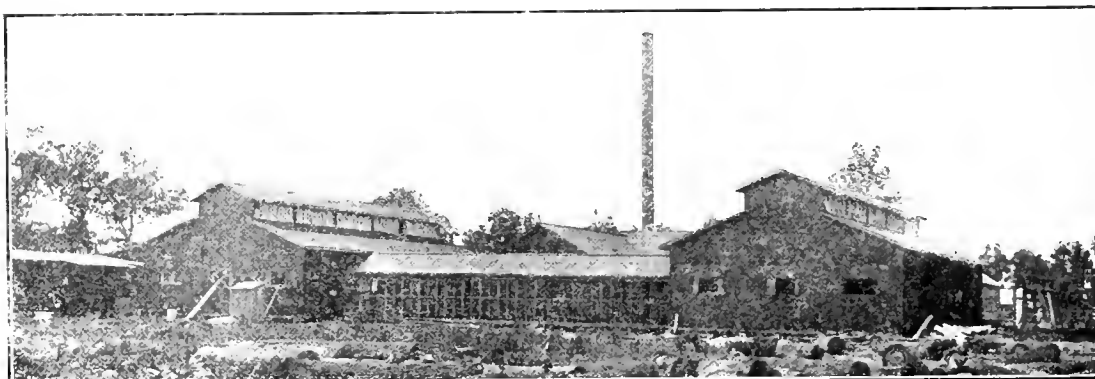

VENEER MILL, CHOCTAW LUMBER &amp; VENEER COMPANY, GARVIN, I. T.

**Approved Method of Quarter-Sawing.**

The Hardwood Manufacturers' Association of the United States, through its secretary, Lewis Doster, has issued a blue print exhibiting the most approved commercial method of quarter-sawing oak. This system is practiced by the most intelligent and successful operators in the country.

The first four figures in the cut on this page show the way to handle logs 20 inches and over in diameter, and are accompanied by the following directions:

Fig. 1 Slab log on one side and turn that side to knees, then cut from A to B, throwing C' back to deck.

Fig. 2 Turn slabbed side to head block, and cut from E to E', throwing G to deck.

Fig. 3 Turn slabbed side to angle of 45 degrees with head block, and cut from H to I or until the piece J has a sharp edge.

Fig. 4 Turn J over so that the line I is against the knees, and finish, being very careful not to make the last board a misent.

G is to be sawed same as shown in Figs. 3 and 4.

C' is to be sawed same as shown in Figs. 2, 3 and 4.

The figures from 5 to 10, inclusive, show the correct handling of logs less than 20 inches in diameter. It will be noted that it is recommended to cut the larger proportion of small

ing all the younger growths which have started and the seed as well, and seed trees from which future forests must be produced.

Including the consumption of wood for pulp and paper, lumber cut for export and for domestic use, telegraph poles, cross-ties, piling and fuel, of which much is still used in many locations, the timbers used in mining operations and that destroyed by forest fires, there are seventy-five billion feet of timber consumed each year, with an increased quantity yearly. It is evident therefore that we have not enough timber standing to continue commercially for more than twenty years in all the United States, including the Pacific coast forests.

"In estimating American forest areas a Washington City publication recently made ridiculous claims by States tending to prove that our forest possessions were so great as to be inexhaustible. In this estimate millions of acres were included which are brush lands from which all commercial timber has been removed and farms which have been cleared for forty or fifty years.

"There are in the Allegheny and Blue Ridge mountains and other rough localities large areas which are to some extent covered with scrubby growths but which will not mature for more than a century.

Other localities have swamps in which an

**New Dry Kiln System.**

The successful drying of lumber has long been a problem to lumber manufacturers. It is a question which has baffled the inventor with greater persistency than any other in connection with the lumber trade. All have striven toward the same goal—to dry lumber by artificial means, thoroughly and quickly, for Nature's method of drying is far too slow for these times, and man must needs intervene lest the wheels of commerce become clogged.

To a large extent the manufacturer has learned to look upon his dry kiln as a gamble. Often has his kiln failed at a crucial moment, spoiling a quantity of lumber and probably thereby wiping out the profit. The dry kiln up to date, with one or two exceptions, has been to a great extent a matter of speculation, and speculation is neither a safe nor satisfactory element to reckon with.

For years there has been an increasing call for a dry kiln that is safe and sure, one that will convert green lumber into a thoroughly dry marketable product in the shortest time and with the least loss to the manufacturer.

This was the necessity which set Z. Clark Thwing, manager of the Grand Rapids Veneer Works of Grand Rapids, Mich., to thinking some two years ago, resulting ultimately in the invention of a new dry kiln process, said to pos-

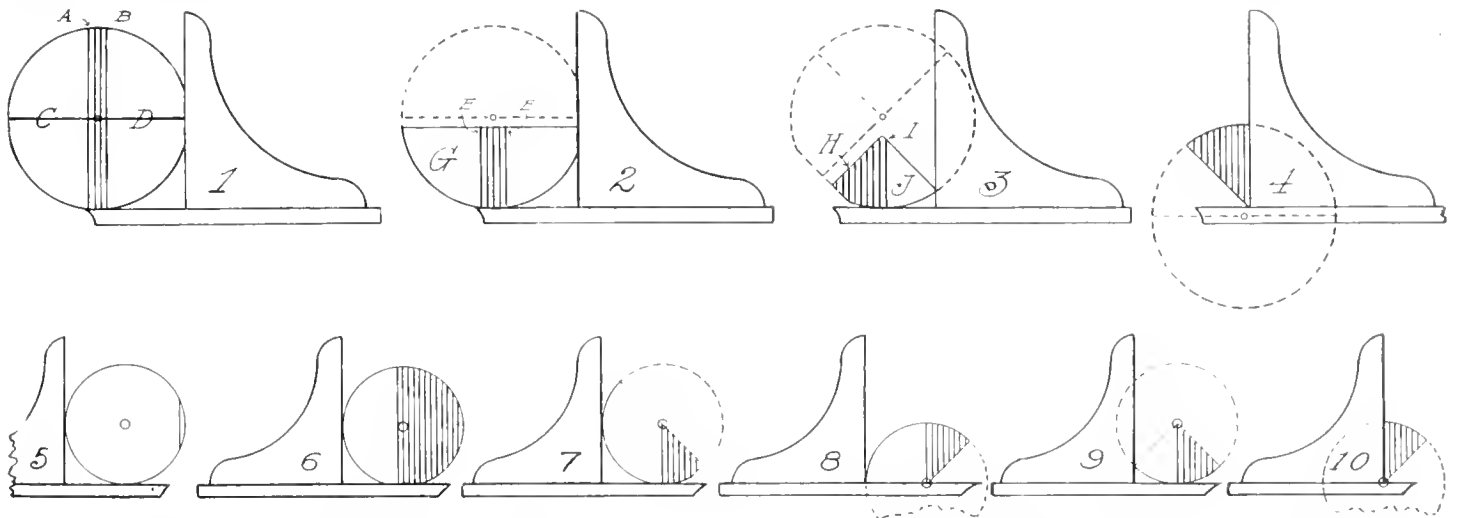

logs into plain sawed stock. Instructions for sawing these sizes are given as follows:

Fig. 5 Take a thin slab;

Fig. 6 Turn slabbed side down and saw one board past the heart;

Fig. 7 Turn remaining half to position indicated in this figure and saw to heart;

Fig. 8 Turn to position indicated and saw to heart;

Fig. 9 Turn remaining quarter to position indicated and saw to heart;

Fig. 10 Turn remaining eighth with heart to head and knee, and be careful to avoid mis-

cut. While there is nothing particularly new in the methods outlined, the diagrams will assist sawyers of oak who are not thoroughly familiar with quarter-sawing.

**A Note of Warning.**

Arboriculture, the magazine of the international society of that name, of Connersville, Ind., in referring to the facts brought out at the last meeting of the National Hardwood Lumber Association that at the present rate of cutting the total existing timber area of this country would be exhausted in thirty-three years, says:

"But there are several other contingencies which must be considered in such calculation. The annual fires in forests destroy an in-

credible quantity of standing timber, including inferior timber growth remains, giving the appearance of a forest, yet the commercially valuable trees have been removed.

"Under the best conditions there must be a long interval of seventy-five or more years from the year A. D. 1925 when the bulk of our trees will have been consumed and the beginning of the twenty-first century, when, if protected, these brush lands may become matured timber, during which long period the United States will be destitute of native lumber.

"It is none too soon therefore that some thing should be done, and done immediately."

"We have urged repeatedly that quickly maturing trees be planted in immense quantities to forestall the coming timber famine, and we now emphasize these statements, and again urge Government, States, lumbering companies, land corporations, and, above all, the farmers to plant trees as extensively as possible and without delay.

"So long as Congress insists upon placing a high premium upon national suicide by retaining the prohibitory duty on lumber, the only remedy lies in the planting of hundreds of millions of trees of such species as will grow in the briefest possible time, and which possess the qualification demanded for lumber, cross-ties and all commercial purposes.

ness every requisite for converting green stock into scientifically dried lumber in a remarkably short time.

Some three years ago the rapidly increasing business of the Grand Rapids Veneer Works made necessary some new and more expeditious method of drying lumber. The old kilns were overtaxed and could not be forced to dry oak thoroughly in less than three weeks without damage to the lumber. Yet no better system was available. The order books began to get perilously ahead of the shipping department and Mr. Thwing, in sheer desperation, began a series of experiments along entirely new lines. While it was found possible to dry the lumber a little more quickly by other methods, the product was invariably twisted and marked and checked around the knots. These experiments were continued nearly a year and failed to accomplish satisfactory results. Something was lacking. Some basic principle had as yet been undiscovered, though persistently sought for by Mr. Thwing and his mechanical engineer, A. D. Linn.

A little over a year ago Mr. Thwing became convinced that he was on the wrong track and he issued orders to tear out the apparatus with which the experiments had been conducted for so many months. The work of demolition was actually under way when Mr. Linn, quite by accident, discovered a peculiar condition. He stopped the work at once and began the con-

struction of a dry kiln containing the one great essential principle of the successful kiln drying of lumber. Upon the completion of the kiln test after test was made, each more exhaustive than its predecessor. Lumber directly from the kiln came out perfectly and scientifically dried in from one-third to one-half the time ordinarily required. It was further demonstrated that so uniformly was the lumber dried that all waste was practically eliminated, such as waste from checked, warped and twisted lumber, knot splits, etc.

In its own business the Grand Rapids Veneer Works uses principally plain and quarter-sawed oak. This stock goes into the kiln directly from the tree and is dried in from ten days' to two weeks' time, and every stick that goes into the kiln comes out nudaged.

Twelve months of rigid tests have proven that the scientific principle upon which the system depends is efficient, and the company is now installing the system in other plants. And here enters one of the surprising and best features of the invention—the system can be quickly and easily introduced in any dry kiln. Moreover the expense is not great.

The Grand Rapids Veneer Works, in order to preserve its secret, will install this system at a reasonable expense, under a guarantee that the kiln will do all that is claimed for it. In other words, the company agrees to install a system in present kilns at but little expense, which can be easily operated, which will dry lumber more perfectly, with less labor and expense than any other system.

#### Pianos in Cuba.

A correspondent at Cienfuegos writes that there is only one piano dealer in that city. He sells about twelve instruments each year, and at the present time has in stock seven new pianos and twenty others which he rents. The sales bring from \$260 to \$400 apiece and payment may be made on the installment plan at the rate of about \$10 a month. This dealer handles only one American make of piano, but four of European manufacture. Those which sell best are made in France and are small and plain. The finest ones have solid mahogany and cedar cases, rather than veneered, as the latter are not lasting in tropical climates, owing to the attacks of a certain kind of worm. The strings are plated or gilded, and the pegs and all other metal pieces nickel-plated, to prevent rust. The market calls for a seven-octavo three-pedal instrument. Cubans are exceedingly fond of music, and it is passing strange that a dealer in a city of 30,000 inhabitants cannot sell more than a dozen pianos a year.

#### Lumbering in Missouri.

Statistics show that the forest industries of Missouri are increasing, due to the fact that railroad building is opening up new sections previously inaccessible, with the result that the timber growing therein is being cut and placed on the market. The shipments of forest products made during 1905 represent a value of \$26,319,348, or an increase of about \$6,000,000 over the preceding year. The following summary is given in the report of Labor Commissioner Anderson:

Hardwood lumber, feet.....	246,987,982
Soft lumber, feet.....	221,555,668
Logs, feet.....	119,256,295
Walnut logs, feet.....	3,721,087
Railroad ties (ties).....	3,545,571
Piling, feet.....	3,311,134
Fence and mine posts.....	1,065,247
Cordwood, cords.....	201,895
Telegraph poles.....	46,016
Cooperage, cars.....	18,798
Walnut lumber, feet.....	11,302
Paper wood, cords.....	14,145
Apple wood, feet.....	9,000
Tar, barrels.....	5,984
Charcoal, cars.....	382
Excelsior and sawdust, cars.....	186
Pencil wood, cars.....	46

#### Where Quality Is First.

At Grand Rapids, Mich., is located the plant of the Gillette Roller Bearing Company, manufacturer of improved roller bearing axles, wagons, lumber carts, dry kiln trucks and boxes for shafting. This is a factory where quality is paramount—where only good material is pounded and sawed and planed and drilled into usefulness by skilled workmen—where the policy is to do everything as well as it can be done, and the wisdom of this policy is plain, for its adoption has given first place to Gillette vehicles and has made the Gillette trade mark a synonym for best.

The Gillette roller bearing axle, the heart of all Gillette vehicles, is an excellent example of the worth of this concern's product. A recent demonstration at the company's factory showed one of these axles carrying a heavy cart wheel raised free from the floor. The wheel was set spinning, and when it "ran down," it swung back and forth as a bicycle wheel does, until it finally stopped with the heavy side of the wheel down, evidence, first, of absence of friction, and second, that the cart bearing was made right. Men, bent on economy in lumber handling, have purchased upwards of \$5,000 worth of these vehicles for a single mill plant, believing in investing money in rather than wasting money on equipment.

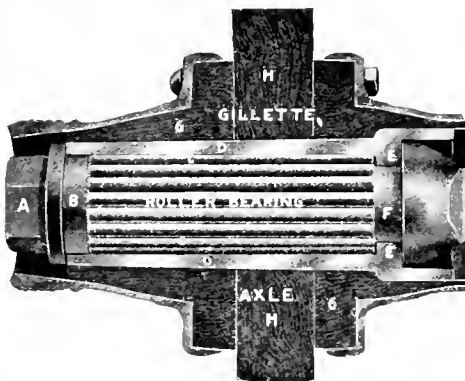

Throughout every department of this great institution, whether in the regular lines manufactured, such as dry kiln and factory trucks, or in special types of trucks and cars, there is present that evidence of care and painstaking which makes for economy and efficiency.

The accompanying cut shows the construction of the Gillette axle. The axle arm F is perfectly straight throughout its length. Around it are chambered solid steel rollers CC uniform in diameter and length. Every roller contacts its neighbor slightly, the result being that each roller helps to keep every other in place, and that all the rollers are held in perfect alignment. Clumsy "rages" are dispensed with. The rollers (C) are separated from the axle nut A by a loose collar or retaining ring B and from the axle collar by the inwardly projecting flange EE. The retaining ring B moves with the rollers at the slightest touch. The inwardly projecting flange EE moves with the wheel and rollers. A "live" or "movable" contact is thus presented to the rollers at both ends. The "end thrust" is fully provided for. All danger of the rollers sticking fast or twisting across the axle is avoided. The bearing is encased in the boxing DD within which it revolves freely with a minimum of friction. After six years of trying service it is today in use under hose wagons, piano wagons, furniture vans, logging trucks, lumber wagons, farm wagons, carts, trucks, and in fact under almost all types of vehicles of which axles form a part. And the "repeat" orders which are being received for it are the best evidence of the satisfaction it is giving.

A visit to the factory at Grand Rapids gives truth to the claim that Gillette vehicles are "the lightest running, longest lasting" ones on the market.

#### Cuban Refrigerator Trade.

An authority recommends that some firm put in a good line of refrigerators at Santiago de Cuba, displaying them attractively and advertising convincingly. He says that considerable ice is consumed, but in very small quantities, and that the people are not posted on the economical and desirable results to be obtained by the use of these devices. The hardware stores usually keep a few inferior ones in stock but ask high prices for them, and the good ones—what few are used—are usually bought direct from the manufacturer in the United States or through an agent.

#### Mexican Timber Purchase.

W. T. Thornton has sold the Cerro Gordo timber tract in the provinces of Jalisco and Colima, Mexico, to the Colima Lumber Company of New York. The price paid was \$235,000. The land comprises about 55,000 acres and represents about 250,000,000 feet of oak, 100,000,000 of cypress, cedar and pine, and railroad ties to the number of 5,000,000. The concern purchasing the tract was recently organized for that purpose and to cut and market the timber. A railroad will be built from Colima to the mountains on which most of the timber grows, and most of the oak will be marketed in California cities.

#### Ritter Lumber Company's Purchase.

The W. M. Ritter Lumber Company of Columbus, O., recently consummated a deal with James Strong & Co. of Philadelphia, Pa., whereby the large double band sawmill of the latter concern, located at South Bristol, Pa., passed into the hands of the Ritter company. The mill was erected in 1901 at a cost of \$100,000. It will be dismantled and taken to West Virginia, near Panther, in McDowell county.

The W. M. Ritter Lumber Company will build a standard gauge road through its recently purchased timber lands in Wyoming and Raleigh counties, West Virginia. This purchase includes about 300,000 acres of the finest timber and coal lands in the state, and the purchase price was something over \$500,000. The tract will be reached through a tunnel which will be cut from the headwaters of Milan's fork to the head of Slab fork, and will cost about \$55,000. This new road was a necessity in the development of the Ritter property, and will be of incalculable aid to that entire section of country.

#### Modern Logging Cars and Equipment.

With the growth of the lumber industry the demand for heavier logging car equipment has developed. Twenty years ago a twenty thousand pound capacity car amply met the requirements of most operators. Today many of the larger ones find it necessary to employ cars of fifty and sixty thousand pounds capacity built to specifications and equipped with air brakes and automatic couplers. In the same length of time the field in which such equipment is required has broadened until it stretches from the Great Lakes to the Gulf of Mexico and from one ocean to the other, bringing into the market immense tracts of timber that were formerly regarded as worthless because of their distance from driving streams.

The Russel Wheel & Foundry Company of Detroit, Mich., manufacturer of logging machinery, logging cars, light railway and cars for industrial purposes, has just issued a handsome catalogue particularly descriptive of its logging cars. The book is profusely illustrated with excellent half-tone engravings illustrating the great variety of goods manufactured by this concern and with fac-simile testimonial letters showing with what satisfaction and success its equipment is used. The new catalogue will be cheerfully furnished on application to the company's office at Detroit.

**Building Operations for July.**

Building operations in the large cities throughout the country have increased handsomely during the month of July, 1906, as compared with the same month of the past year with a few exceptions, notably that of Greater New York. According to official reports to The American Contractor, Chicago, and presented herewith, the gain in the majority of building centers is most gratifying and there are no indications that the maximum has been reached.

City—	July, 1906, cost.	July, 1905, cost.	Per cent gain.	Per cent loss.
All cities	472,686	284,798	65	0
Baltimore	1,067,000	765,900	50	1
Birmingham	432,500	369,000	16	0
Bridgport	291,157	304,284	2	2
Buffalo	1,028,500	555,284	87	1
Chicago	4,849,960	3,778,390	28	0
Chattanooga	109,575	129,643	16	1
Cincinnati	545,349	777,225	29	0
Dallas	234,886	217,674	8	0
Denver	432,340	356,438	21	0
Detroit	1,062,000	974,200	9	0
Duluth	183,715	113,865	61	0
Evansville	61,633	149,633	59	0
Grand Rapids	308,857	167,862	45	0
Harrisburg	192,950	252,185	16	1
Hartford	379,615	611,557	37	0
Jersey City	441,098	491,722	120	0
Kansas City	889,555	874,579	7	0
Knoxville	41,300	257,690	81	0
Little Rock	218,123	168,042	1.0	0
Louisville	937,575	408,865	129	0
Los Angeles	1,782,028	1,304,198	37	0
Manchester	67,000	81,120	17	0
Milwaukee	759,154	711,961	7	0
Minneapolis	1,006,820	881,975	81	0
Memphis	411,965	302,773	26	0
Mobile	75,082	42,924	76	0
Nashville	156,818	274,339	12	0
New Haven	229,847	163,063	31	0
Newark	1,231,228	892,663	48	0
New Orleans	465,617	343,835	28	0
Manhattan	8,349,600	16,430,501	49	0
Alteration	1,274,715	1,367,407	16	0
Brooklyn	8,066,721	6,872,822	16	0
Bronx	3,089,950	5,022,969	38	0
Alteration	34,455	17,879	30	0
New York	20,753,143	29,741,559	30	0
Omaha	352,550	1,043,650	66	0
Philadelphia	4,065,410	2,790,455	45	0
Pittsburgh	908,577	102,648	17	0
Pittsburg	1,586,283	1,369,791	16	1
Pueblo	49,829	21,144	2	0
Portland	741,476	277,735	166	0
Rochester	591,295	314,410	88	0
St. Louis	3,358,779	2,374,295	41	0
St. Paul	519,379	456,919	11	0
San Antonio	102,325	59,721	89	0
Scranton	298,705	203,040	47	0
Seattle	1,562,663	1,177,114	27	0
Spokane	391,557	295,800	32	0
South Bend	303,653	676,152	12	0
St. Paul	388,295	519,364	24	0
Salt Lake City	142,500	141,795	18	0
Topeka	171,950	65,700	161	0
Toledo	248,591	376,562	33	0
Terre Haute	87,795	97,075	13	0
Tacoma	287,090	162,352	74	0
Washington	988,451	1,271,279	22	0
Worcester	323,768	182,845	77	0
Wilkesbarre	175,808	265,565	11	0
Total	78,515,830	59,954,941	31	0

**A New Saw Gauge.**

Attention to small details, more than any other factor, has been the means of upbuilding some of the greatest American commercial institutions. Andrew Carnegie, the steel king, always paid generously for new ideas and new machinery which would simplify the process of making steel. The Chicago packers boast that they have so eliminated every element of waste in their business that there is "nothing left of a pig but the squeal." The successful sawmill man is he who strives to get as much out of the log and out of his men as he is entitled to. For those reasons he should be on the lookout for new inventions destined to save him money.

Francis Marshall of Grand Rapids, Mich., whose advertisement appears in the advertising display columns of the Hardwood Record, is manufacturing a device called an automatic swing saw gauge which is guaranteed to save ten per cent of the sawyer's time by enabling him to do his work without watching a chalk mark. Mr. Marshall, whose guarantee is good, agrees to effect a saving of \$1.80 per thousand feet on the average of various kinds of lumber cut, by doing away with the inaccuracy attendant upon any of the guess work devices now in use. Moreover, he will give any responsible concern thirty days' trial of a gauge in which to prove his claims.

With the saw gauge in use, absolute adjustment of the lumber on the saw table is permitted,

thus eliminating waste of lumber. Any number of lengths can be cut on the table without having to change the stop, thus eliminating waste of time. It stops automatically, and does not require the attention of the sawyer, thus giving him more time to grade the lumber carefully and increase the volume of work. Mr. Marshall makes a guarantee that by the use of this gauge anyone sawing 2,500 feet of lumber a day will save \$1,000 a year thereby; the gauge for a mill of this capacity costs but \$25.

**Effects of Sleet.**

During the winter of 1901-5 northern Georgia was visited by a very severe sleet storm. The coating of ice on the tree-tops became so heavy as to destroy quite a portion of valuable hardwood forest. The accompanying picture shows a hickory tree, fully twelve inches in diameter,



EFFECTS OF SLEET ON TREES IN NORTHERN GEORGIA.

which was literally torn to pieces as a result of this storm. The picture was made on the property of the Burford Lumber & Manufacturing Company at Kensington, Ga. The Hardwood Record is indebted to W. A. Bennett of Cincinnati for the loan of the interesting photograph from which this illustration was made.

**Some Kinks in Stair Building.**

Herewith are illustrated two valuable little "kinks" in stair building. Maple and oak are the recognized standard materials for stair treads. Up to this time stair treads have been made of one piece of lumber laid the long way of the stair, with the result that where the travel is heavy the wear coming across the grain the wood wears out very soon. Builders of stairs in factories, mills, stores, elevated railway stations, etc., will find that short ends of either seven-

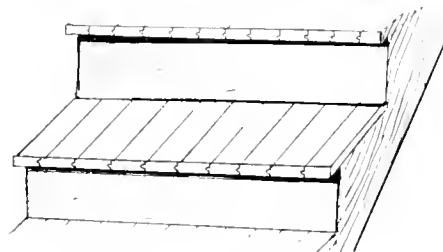

eighths maple or oak flooring made into a tread so that the wear will come endwise of the grain, as shown in the smaller cut on this page, will

last longer and prove generally more serviceable than double the thickness of step plank laid in the usual way. Besides there is a matter of

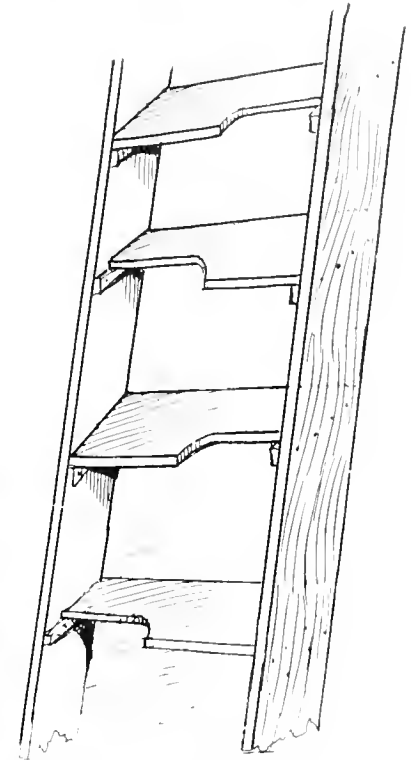

economy involved in the practice, as short flooring can be had at a low price.

The second cut illustrates a method of satisfactory stair building where one is short of room in mill or factory to secure the usual "run." Acceptable stairs can be built as shown in the picture of ordinary height within a space of six feet. The only objection to this form of construction is that the user must always start up or down with the "right foot first."

**Dahlstrom Metallic Door Company.**

The Dahlstrom Metallic Door Company of Jamestown, N. Y., has increased its capital stock from \$100,000 to \$150,000, and the capacity of the plant will be doubled by the erection of a large addition. The new building will be begun at an early date, in order to facilitate filling the \$200,000 worth of orders now on the company's books, which they have not been able to handle up to date, although the present plant is running to full capacity.

Metal seems to be rapidly coming into use as a substitute for hardwood in the manufacture of doors and interior finish, and in that it aids greatly in making a building fireproof should be very desirable.

**Japanese Railroad Ties.**

E. H. Harriman, president of the Southern Pacific Railroad Company, has become a good customer for Japanese railroad ties, which he is having delivered at Guaymas, Mex., at a cost of 56 cents each. A contract for 1,500,000 is now outstanding, and a shipload of 83,000 has already been received. President Harriman is building 700 miles of road in the states of Sonora and Sinaloa to connect with the Southern Pacific in the southern part of Arizona, and the ties are for use in this enterprise. They are of hardwood peculiarly adapted for road building in the climate where they are to be utilized.

**Miscellaneous Notes.**

A. H. Tardy, Little Rock, Ark., will establish a sawmill plant near Prescott.

The Uhlentant Brothers Wagon Company has been incorporated at St. Louis, Mo., with \$25,000 capital.

The Mohawk Desk Company has been incorporated at Herkimer, N. Y., with \$100,000 capital stock.

The Gorham Brothers Company, Mt. Pleasant, Mich., will erect a new veneer factory at Saginaw, Mich.

The Poughkeepsie Chair Company, Poughkeepsie, N. Y., will rebuild its plant burned some months ago.

A new concern at Augusta, Me., is the N. S. Stowell Spool & Wood Turning Company; capital \$50,000.

The A. R. T. Company, Timpson, Texas, has been incorporated with \$4,000 capital to manufacture handles.

The Burlington Art Woodworking Company has been incorporated at Burlington, N. J., with \$25,000 capital stock.

The Elgin Manufacturing Company, New York City, has been incorporated with \$10,000 capital to manufacture churns.

A new furniture plant is to be established at Farmington, Utah. T. W. Palmer and others are back of the movement.

The Portsmouth Veneer & Panel Company, Cincinnati, O., has increased its capital stock from \$50,000 to \$75,000.

The Charlotte Hardwood Specialty Company has been incorporated at Charlotte, N. C., with a capital stock of \$25,000.

The Lansing Wheelbarrow Company of Lansing, Mich., is planning the erection of a large addition to its plant there.

The Kentucky Singletree & Spoke Company of Knifby, Ky., is contemplating the establishment of a branch plant at Danville.

Fire in the Washington Manufacturing Company's plant at Washington, N. J., caused a loss of \$70,000; insurance \$30,000.

The New York Mahogany Company has been incorporated in that city with a capital stock of \$10,000 by J. Traugott, C. P. Caldwell and W. Robertson.

The City Sash & Door Company has been organized at Minot, N. D., by William L. Snell, Minot; B. W. Smith and S. H. Phillips of Minneapolis; capital stock, \$10,000.

The Odorless Refrigerator Company is the new name given to the Keyser Manufacturing Company of Hamilton county, Tennessee, by a recent amendment to its charter.

Fire recently damaged the plant of the Ozark Planing Mill & Lumber Company at Mountain Grove, Mo. The loss is estimated at \$15,000. The plant will be rebuilt shortly.

The Warren Vehicle Stock Company of Warren, Ark., was incorporated in February, 1906, and will commence sawing August 1. P. S. Donnelly is secretary and treasurer.

The Monroe Lumber Company of Monroe, La., sustained a loss of about \$100,000 by fire on July 25. The planing mill, together with three dressed lumber sheds, were destroyed.

The Des Moines Cabinet Company of Bedford, Iowa, has increased its capital from \$15,000 to \$25,000. The concern will install additional equipment to take care of growing business.

The Interior Hardwood Company, with a capital of \$10,000, has been incorporated at New York City by C. H. Ketcham and F. V. Ketcham of New York City and T. Adams of Queens.

The Campbell Handle Company has been incorporated with \$3,000 capital stock, half of which is paid in, at Campbell, Mo. W. B. Grant, L. Williams and L. D. Pellock are the incorporators.

A walnut log measuring nine feet in length and containing 1,300 feet was recently cut on the George Richmond farm, near Reeson's Station, Ind., and shipped to Cincinnati by Frank Morris of Milton.

A receiver has been appointed for the Lake Geneva Manufacturing Company of Lake Geneva, Wis. This concern manufactured piano stools. It is thought that its assets are at least equal to its liabilities.

The Maplewood Planing Mill & Stair Company has been incorporated at Maplewood, Mo., with

a capital stock of \$15,000. Thomas C. Bryant, James Hardie and Albert Blood are the promoters of the enterprise.

The L. A. Rink Lumber Company has been organized at Cairo, Ill., with a capital stock of \$7,000, to do a general lumber manufacturing business. L. A. Rink, Wilson West and Reed Green are the incorporators.

Robert Gerstner of Iron Mountain, Mich., purchased 1,600 acres of land near Mountain, Wis., which is heavily timbered with pine, hemlock, cedar, spruce and hardwoods. He will commence logging operations this winter.

The National Handle Company is making extensive improvements in its factories at Frankfort, Ind., and Findlay, O. Large warehouses are being constructed. The Fort Wayne, Ind., branch will doubtless be likewise improved.

J. M. Cherry of the Adrian Handle Factory has bought the old Lesh & Young sawmill at Adrian, Mich., and will convert it into a handle plant. Part of the old machinery will be utilized and some new equipment purchased.

The Gilchrist mill at Alpena, Mich., has finished sawing maple, beech, ash and other hardwoods for the season and has commenced on hemlock. Over 3,000,000 feet of hardwoods have been manufactured into lumber this year.

A charter has been granted to the American Tie & Timber Company of Brunswick, Ga., to engage in a general tie, timber and lumber business. The incorporators are A. J. Cravatt, Rolling Whitfield and J. W. Nussbaum of that city.

The Dearborn Desk Company, composed of Chicago capitalists, is pushing the construction of its plant at North Marion, Ind. Cabinet work of all descriptions will be manufactured by the company, which expects to begin operations within a few weeks.

An order which will require almost two years in the filling has recently been taken by the Franklinville Veneer Mill's of Franklinville, N. Y. About \$80,000 is involved in the contract. The force of men employed at the factory will be increased to handle the work.

The Lansing Veneered Door Company of Lansing, Mich., will start operations again the first of August, in charge of Receiver W. C. Brown. Orders on hand will be filled and new ones will probably be taken. Permission has been granted for a loan with which to pay employees.

The Merchants' & Manufacturers' Association

of Saginaw, Mich., has secured the new Struble maple flooring and crate plant for that city. The factory was formerly located at Reed City, but was destroyed by fire July 7. It will employ from seventy-five to 100 men and will operate the year round.

It is reported that the amount of lumber sent from Nova Scotia to American ports this year is very large. The cut in Annapolis and Cornwallis exceeds any cut known there for many years. The lumber shipped from Cornwallis is largely supplied by the New York Lumber Company, which owns 45,000 acres at Gasperaux lake.

The work of rebuilding the plant of the American Cigar Box Lumber Company of Johnson City, Tenn., of which William E. Uptegrove of Brooklyn, N. Y., is president, which was recently destroyed by fire at a loss of about \$90,000, has already commenced and it is expected that operations will be in full swing by September 1. The company owns some 40,000 acres of timber land near Johnson City.

P. M. Mishler of Hagerstown, Md., president of the Bear Pond Lumber Company, has sold 2,500 acres of timber land in Shenandoah county, Virginia, to Mowell & Brother of Hanover, Pa. The tract will cut approximately 15,000,000 feet of white oak and other hardwoods. The oak will be manufactured into plow handles and beams. It is said that the purchase price was \$10,000.

California capitalists have secured from the Mexican government a large tract of land in the state of Sinaloa, on which will be established a colony of 2,000 Americans. Part of the land is excellent for farming, sections are covered with rich hardwood growth and there are also mineral deposits of value. The colony will be on the line of the new Randolph road now under construction from Guaymas to Guadalupe.

Reports from Table Rock, Neb., say that farmers in that locality who are so fortunate as to own walnut timber are reaping a splendid harvest. Prices paid there recently range from \$15 to \$35 a thousand feet. Logs thirteen inches in diameter at the top were the minimum size accepted. More than 50,000 feet will be shipped from Pawnee county to Kansas City to be sawn and shipped to Europe, where it will be used in furniture construction.

## Hardwood News.

(By HARDWOOD RECORD Special Correspondents.)

### Chicago.

J. W. Thompson and E. E. Taenzer of Memphis, Tenn., were Chicago visitors the early part of the week.

G. J. Landeck of the house of Page & Landeck, Milwaukee, Wis., was in the city on a short business trip this week.

Park Richmond has been in the South this week, looking up stocks of hardwood. Mr. Richmond is chief inspector in this market for the National Hardwood Lumber Association.

F. C. Fischer of the Yellow Poplar Lumber Company, Coal Grove, O., spent a few days in Chicago recently.

The Leavitt Lumber Company of Chicago will henceforth make Cairo, Ill., headquarters for its southern business. The company has hitherto maintained an office at Memphis, Tenn., which will be discontinued. B. F. Richardson, vice president of the company, will make his home in Cairo and manage affairs in that section.

The firm of William Cappel & Co., 67 West Twenty-second St., is the latest addition to the hardwood contingent in this city. Mr. Cappel, the principal of the firm, came here from Dayton, O., many years ago. His first position was with Hayden Brothers; later he

obtained a position with C. L. Willey, which he has held until recently. Mr. Cappel's long experience in the trade and conservative methods of transacting business will doubtless bring him success in his new venture.

C. L. Willey left July 28 for a seven weeks' trip to Europe. Mr. Willey will visit the London and Liverpool markets in a search of fancy mahogany logs for his big veneer mill in this city.

Harry A. Gorsuch, the well known of Kansas City, called at the Record office July 27.

Floyd Tilghman Logan, secretary and treasurer of John A. Gauger & Co., manufacturers of sash and doors, died in Chicago July 26, at the age of forty-six. Mr. Logan was born in Newport, Ky., and became associated with Mr. Gauger in 1891. He was a Mason and belonged to several prominent Chicago clubs. His wife and one son survive him.

W. L. Wallace, the timber expert of the Star Insurance building, has recently returned from a four months' cruise of a large timber property in Mexico.

D. F. Clark of Osborne & Clark, Minneapolis, was in Chicago on business recently.

It is with much regret that the HARDWOOD RECORD learns that M. A. Hays, who for several years past has occupied the position of general

agent of the land and industrial department of the Southern railway at Chicago, has received the announcement that he is to be transferred to the charge of the company's industrial department in New York City. Mr. Hays during his residence in Chicago has endeared himself to everyone who has had occasion to do business with his department of the Southern railway. His transfer to New York is in the line of advancement, but still his many friends in Chicago will sincerely regret his leaving.

The story, "When Sorrel Top Made Good," published in the last issue of the *Hardwood Record*, has had encomiums from many sources, but not one that has been more appreciated than that from the *Toledo Blade*, which republished it in full. The *Blade* says: "The story is short in the telling, but unusually full, clear and comprehensive in its character drawing. Its types of men stand out like live people. One seems to have known them for years. The little tragedy of 'Maw' is sketched with just the right proportions, it is not over-elaborated, and yet one knows it all. The mountain storm is a superb description. There is grandeur in every sentence. One feels the mighty conflict. The story is a gem."

The *Hardwood Record* was favored with a call on August 4 from R. E. Wood, president of the R. E. Wood Lumber Company and of the Montvale Lumber Company of Baltimore, Md. Mr. Wood's operations in the lower Appalachian country are constantly increasing. He now has three sawmills in operation and a fourth mill about ready to start. At the end of the month Mr. Wood's companies will be producing upwards of 150,000 feet of hardwoods daily.

C. A. Phelps, manager of the Hackley-Phelps-Bonnell Company's operations at Hackley, Wis., spent August 2 in Chicago, en route to his home at Grand Rapids, Mich., for a few days' visit with his family and business associates.

W. E. Barrett of W. E. Barrett & Co., Stock Exchange, just returned from a northern purchasing trip. While Mr. Barrett's chief operations during the last few years have been in Pacific coast woods, he is now devoting considerable attention to northern and southern hardwoods.

Edward Hines, head of the great Edward Hines Lumber Company enterprises, is back for a few days from an extended trip in the Northwest. Up to this time Mr. Hines' company has paid very little attention to hardwoods, but from this time forward it will become quite a factor in maple, birch and basswood. The company has considerable timber of these varieties in its northern holdings which it will manufacture.

J. W. Embree of the Rittenhouse & Embree Company and Charles F. Thompson of the Mississippi Lumber Company have recently returned from a northern fishing excursion.

**Boston.**

The Boston hardwood trade were shocked to hear of the recent sudden death of J. W. Willis of J. W. Willis Lumber Company, Washington Court House, Ohio. Mr. Willis visited Boston and vicinity with his two eldest daughters about three weeks previous to his death.

At the recent meeting of the Blanchard Lumber Company Isaac Archibald was elected vice-president and Edward S. Loomis director.

Thomas H. Shepard of the Shepard-Morse Lumber Company has returned from a yachting trip along the coast of Maine. Mr. Shepard was accompanied by Herbert Blanchard of the Blanchard Lumber Company.

Ralph B. Woodbury, salesman for Charles S. Wentworth & Co., returned last week from a pleasure trip to Nova Scotia.

Summer & Tuttle, hardwood lumber dealers, Boston, have been succeeded by H. A. Tuttle & Co.

George M. Paul, who for several years has been engaged in the woodworking business in Haverhill, Mass., under the firm name of Paul & Jackson, died at his home, July 22, at the age of 63 years.

The Arcola Wood Working Company, Ltd., has been incorporated at Kittery, Me., with a capital of \$100,000. The incorporators are Horace Mitchell and M. G. Mitchell of Kittery and S. J. Morrison of Portsmouth, N. H.

The West India Mahogany Company has been organized in Belfast, Me., with a capital of \$500,000. The incorporators are, James W. Clow, Boston; Henry S. Park, Stockland Springs, and George R. Dunton, Belfast, Me.

E. M. Ward of Ward Bros., Big Rapids, Mich., who has been spending several weeks in Boston and vicinity, making his headquarters at Winthrop, left July 31 for New York en route home.

Charles S. Wentworth of Charles S. Wentworth & Co. left early in the month for a vacation in Ontario and Michigan.

The Hartford Builders' Finish Company, Hartford, Conn., has been visited by fire, which was confined to the boiler and kiln dry rooms. The damage is estimated at about \$5,000, covered by insurance.

The Winterville Veneer Company of Eagle Lake, Me., is rapidly completing its new hardwood mill.

**New York.**

J. C. Turner, the prominent express wholesaler and head of the J. C. Turner Lumber Company, has just returned from a trip to the Louisiana belt where he concluded purchases of about 15,000,000 feet of stock for shipment to the eastern yards of his company for distribution. In speaking of the general business situation Mr. Turner states that he found conditions prosperous all along the line. Being one of the shrewdest lumber operators and a close student of market conditions at all times Mr. Turner's heavy purchases are being taken generally as favorable indication of the future lumber market.

John H. Ireland of the Cross, Austin & Ireland Lumber Company, Brooklyn, surprised his many friends when it was announced that he had been united in marriage on July 14 to Miss Eleanor I. Cummings of that Borough. They sailed for Europe on the 2nd to be gone till fall.

C. R. Mengel of the C. C. Mengel & Bro. Company, Louisville, Ky., is in the East on his annual summer trip making his headquarters at Sagaponok, Long Island, with his family.

F. P. Southgate, the well-known hardwood inspector of Chicago and St. Louis, recently appointed deputy inspector in this city for the National Hardwood Lumber Association, has arrived here and will open permanent quarters in due course.

Col. J. S. H. Clark of J. S. H. Clark & Co., Newark, N. J., and president of the Building Material Men's Club of that city, entertained the members of the club at dinner at Long Branch, N. J., on July 31.

W. L. Sykes of the Emporium Lumber Company, Keating Summit, Pa., after spending a few days in town has located with his family at his fine new camp on Lake Griffith, Vt., which is located on the extensive spruce and hardwood tract which he bought this spring, comprising 50,000 acres of the old Silas Griffith estate.

Sam E. Barr, Flatiron building, is on a trip to the plant of the Dan Valley Lumber Company, Mt. Airy, N. C., the product of which he is handling. This plant is cutting a very choice run of hardwoods.

John T. Dixon, the prominent West Virginia hardwood manufacturer and partner in the local house of Dixon & Dewey, has been spending a few days in town visiting with H. S. Dewey. In speaking of the manufacturing end of the business Mr. Dixon stated that his several mills were running full on a choice lot of poplar and oak for fall shipments. He also expressed himself as well satisfied with the general selling market and looks for an active fall trade.

The Fremont Sash & Door Company has succeeded to the large manufacturing establishment of C. G. Schartz at 1060 Tremont avenue, Bronx, and will continue it on a still larger scale.

W. M. Pownall, head of the Beniah Lumber Company, Pittsburg, who has been in town for several weeks superintending the opening of a local office at 18 Broadway, has returned to Pittsburg. H. A. Maloney, local manager, reports business very satisfactory.

F. R. Whiting of the Janney Whiting Lumber Company, Philadelphia, was a recent New York visitor.

Among the new corporations just formed in the local market are the following: Northern & Southern Lumber Company, capital, \$500,000; Incorporators, H. S. Selleck, Riverside, Conn.; Charles Millsbaugh, Durbin, Conn., and James Brunton, New York; The Columbia Cypress Company, New York; capital, \$100,000; Incorporators, P. S. Russell, Great Neck, Long Island; J. Ingle, Jr., and G. H. Montagne of New York city; The Lumber Sales Corporation of New York, capital, \$25,000; Incorporators, W. H. Esblough, Montclair, N. J., W. H. Brown, Jr., Boston, and H. J. Chopin, New York; The New York Mahogany Company, capital, \$10,000; Incorporators, J. Tringott, C. P. Caldwell and W. Robertson of New York.

The yards of the S. F. Kellar Lumber Company, 78 Long Island avenue, were again visited by fire July 20, but the blaze was discovered before any great damage was done. This is the seventh or eighth attempt which has been made during the past four months by incendiaries.

R. W. Higbie, 15 Broadway, left last week for a brief northern trip, during which he will attend the semiannual meeting of the National Lumber Insurance Company of Buffalo, in which he is a stockholder and director.

Among the other visiting hardwood lumbermen during the fortnight were: R. B. Currier, Springfield, Mass.; Edward Easton, Albany; W. W. Mitchell, Cobbs & Mitchell, Cadillac, Mich.; D. F. Diggins, Cummey, Diggins & Co., Cadillac, Mich.; H. L. Koedler, Louisville, Ky.; R. J. Darnell, Memphis; J. L. Hamill, W. M. Ritter Lumber Company, Columbus, Ohio; J. B. Wall, Buffalo Hardwood Lumber Company, Buffalo; J. W. Defenderfer, J. W. Defenderfer Lumber Company, Philadelphia; F. L. Balsley, J. J. M. Wilson & Co., Pittsburg, Pa.; A. P. Bliss, Bliss & Van Anken, Saginaw, Mich.

Fire in the hardwood yards of the Ross Lumber Company, Manhattan, on July 29, did several thousand dollars' damage. Loss covered by insurance.

Surveyor General George L. Smith of the National Hardwood Lumber Association is in the city this week on a visit to the various eastern markets and reports matters as progressing very satisfactorily.

**Philadelphia.**

Philadelphia has a busy look these days. The center of the city is torn up with the construction of the new subway and the outskirts are alive with the building of new houses. This condition has resulted in a drain on the retailer that is beginning to show a corresponding beneficial effect on the wholesale trade.

The Pennsylvania Lumbermen's Mutual Fire Insurance Company held its regular semiannual meeting July 24. The attendance was one of the largest that ever obtained at a similar meeting. The secretary's, auditor's and treasurer's reports were presented and adopted, and the review of the business done showed that there had been a steady gain during the first six months of the year.

Measures have been adopted by the city government looking to the cleaning out of the docks and wharves belonging to the city, and otherwise improving the value of the shipping facilities along the river. This will have a decidedly beneficial effect on many of the lumbermen here, as in the case of some of the wharves rented from the city the approaches have been filled up to such a degree that it is very hard to dock and unload a ship properly.

Frederick C. Richter of the Richter Parry Lumber Company, which firm has lately established a hardwood department, finds business fair con-



sidering the usual dullness of midsummer. Mr. Righter has taken a house at Wyncote, Pa., for the summer, and Mr. Parry spends a good part of his time at one of the shore resorts in New Jersey.

H. I. Soble of Soble Bros. is taking his summer vacation in the North where he contemplates spending a couple of weeks fishing. During his absence John J. Soble of the sales department is in charge of affairs.

F. A. Underhill of Wistar, Underhill & Co. lately spent some time fishing at Anglesca, R. W. Wistar is making a trip through North Carolina and Tennessee.

The firm of Tunis & Skinner which some months ago opened an office in the Girard Trust building has moved its headquarters to Baltimore, Md., still retaining, however, an agency here. The firm has lately undertaken an operation, consisting of pine and hardwoods, in Virginia and finds that the location of Baltimore is more convenient.

Schofield Bros. have found the past month a fair one for business when the usual conditions of summer are taken into account. They have lately placed considerable stock with the Pennsylvania and New York furniture people with whom they deal. J. H. Schofield will start on his midsummer vacation in a few days, probably at Atlantic City or some other one of the New Jersey seaside resorts. R. W. Schofield who is now on a trip through New York State has sent in sufficient orders to keep the home office on the jump.

Francis Goodhue, Jr., secretary of the Philadelphia Veneer & Lumber Company, reports that the business done by his firm is very gratifying. He lately returned from an extensive trip through New York and eastern Pennsylvania and found business on the whole satisfactory.

The regular meeting of the Lumbermen's Exchange of Philadelphia was held last week and routine business transacted. Geo. Craig, president of the Exchange, is on an extensive trip south and will not return to the city before the first of September.

C. E. Lloyd, Jr., of the Cherry River Boom & Lumber Company returned lately from a vacation trip in the North. Mr. Lloyd together with Alfred Hendle and Albin Bell of Emil Guenther, and B. C. Currie, lately enjoyed a fishing trip down the Delaware Bay, the whole party going as guests of Mr. Currie.

W. H. Fritz & Co. have removed their offices from 304 to 603 1/2 Crozer building.

John J. Rumbarger, of the Rumbarger Lumber Company spent a portion of last week out of town. The midsummer season finds Mr. Rumbarger very busy, for besides his regular work, he is managing the team of the Lumbermen's Exchange which will shortly play ball with the Builders' Exchange.

J. A. Hollinger & Co. of Chambersburg, Pa., have announced that the concern has been bought out by J. A. Hollinger, who will hereafter conduct the business in his own name. Mr. Hollinger has taken over the debts of the concern and all bills should be paid to him.

Warren P. Hill of Samuel H. Shearer & Co. started on his summer vacation last week.

Visitors to the trade during the last fortnight included: Geo. Mitchell of White, Greatwick & Mitchell, Buffalo, N. Y.; J. B. Hatch of the Edward Hines Lumber Company, Pittston, Pa., and Charles Anderson of the Ohio-Pennsylvania Lumber Company, Axis, Ala.

### Baltimore.

Among the visiting lumbermen in Baltimore last week was G. W. Curtin of the Pardee & Curtin Lumber Company, Curtin, W. Va. Mr. Curtin was on his way to Atlantic City for a short stay with his family, who are summering there. Speaking of business, he stated that a brisk demand prevails generally for every kind of stock, and prices remain attractive. Mr. Curtin stated that the mill which his company is building at Curtin to take the place of the

one destroyed by fire some months ago is nearing completion and will likely be in operation by the first week in September. It will have a daily capacity of 120,000 feet of hardwoods and will be run day and night. The mill is of the double band variety.

On the petition of the National Union Bank of Baltimore, the Gallatin National Bank of New York and Ferdinand C. Fisher, receivers have been appointed for the Hiss Company, dealer in and manufacturer of interior woodwork and high class furniture, with a factory at 2 to 10 East North avenue, this city. According to the statement filed, the Hiss Company is indebted to the National Union Bank in the sum of \$36,500, chiefly on promissory notes, and to the New York bank in the amount of \$25,000.

Information has been received in this city from Hagerstown, Md., that the Bear Pond Lumber Company of Washington county, Maryland, has leased 1,000 acres of manganese land in Shenandoah county, Virginia, to Obey McCormack of Philadelphia, which will pay to the lessees \$100,000 and one-half of the profits from the working of the ore deposits. P. M. Mishler, president of the Bear Pond Company, has sold to the firm of Mowal & Bro. of Hanover, Pa., 9,600 acres of timber land adjoining the manganese property for \$100,000. The timber tract is estimated to contain 15,000,000 feet of white oak besides other timber.

Thomas Hughes of Currier, Hughes & Co. returned last week from a trip to Troutdale, Va., where the Iron Mountain Lumber Company, an allied concern, is operating a large sawmill. Mr. Hughes also visited a number of lumber mills en route and found them all active.

R. E. Wood of the R. E. Wood Lumber Company is on a western trip. He will be away about two weeks, and will go as far as Chicago, probably returning by way of Toledo, O., and Williamsport, Pa.

The Virginia Iron & Lumber Company has been incorporated with a capital stock of \$1,000,000. John M. Eley, an attorney of Fifteenth and Chestnut streets, Philadelphia, can give detailed information about the new enterprise.

John L. Alcock of J. L. Alcock & Co. returned last week from a trip to West Virginia. He visited the firm's offices at Clarksburg and other places.

### Pittsburg.

Local lumbermen to the number of six or eight will accompany the Merchants' & Manufacturers' Association on its next trip for trade extensions, which occurs October 22-26. President Fred R. Babcock has outlined a unique purpose for this excursion into the mountains, namely, to make the coal and lumber interests of West Virginia become better acquainted with Pittsburg's wonderful importance as a manufacturer of machinery.

Within the last week there have been several good inquiries for hard maple among big local firms. Very little is offering and this is not the sort of lumber that is salable to furniture firms or other manufacturers of high-class products. The small lots cut in western Pennsylvania and Ohio have been picked up as fast as they, and the portable mills are being shifted to other fields.

The Buckeye Lumber Company, which started in business a few months ago in the House building, under the direction of C. L. Wickersham, is working up a fine trade in white and red oak. This is obtained largely from West Virginia, and is sold chiefly in Indiana and the Middle West.

Warehouse building is again on the spur in Pittsburg. Some eight or ten buildings are proposed for fall building in addition to a dozen or more big warehouses which are now in course of erection. Orders are also being placed now for the hardwood finish of various kinds which will be used on the twenty-story skyscraper being erected by the Union National Bank and the Commonwealth Trust Company, and the sixteen-story Berger building.

D. J. Rex & Co., manufacturers of boxes, will build a large box factory in Locust street, doubling their present capacity.

John Lochrie of Windber, Pa., has invested about \$65,000 in timber land in South Carolina and Georgia. He gets 7,500 acres of land which, it is estimated, will cut 85,000,000 feet of hard wood, poplar and yellow pine. Operations will be started there at once.

Considerable interest is being taken by big local firms which have operations in Canadian territory over the proposed appointment of a commission to settle disputes in that country. The British ambassador at Washington has informed the Dominion government that the United States will name a commission to act with one from Canada in going fully into all matters in dispute over rights on the St. John river in New Brunswick. Rival interests clashed frequently there last winter and local concerns were very much interested in the troubles.

L. F. Baisley of the Willson Brothers Company is again in the South. He is on the scout for more hardwood stocks and is taking a careful survey of the hardwood situation at the company's mills and their other sources of supply.

The Farris Korn Lumber Company of Cincinnati, O., announces that it is laying a trade that fully justifies it in establishing a Pittsburg office. In cypress, gum and cottonwood it is getting a reputation in Pittsburg that is putting it in the front rank among local firms.

Mowal & Brother of Hanover, Pa., have bought a large tract of hardwood timber land in Shenandoah county, West Virginia, for \$10,000. They will develop the property this fall.

The J. L. Kendall Lumber Company has bought an additional tract of 200 acres in Garrett county, Maryland, making a total of 30,000 acres near Crellin, Md., which it now owns. To cut off the hardwood on this tract the company will at once extend its railroad and bring the logs down to the Crellin mill, where it is now cutting 75,000 feet a day.

The J. E. Coughney Lumber Company is pounding away on its oak orders with a vengeance. Not a few of these are placed with the river contractors, who are putting in new dams, etc. During the last sixty days the firm has sold over 800 pieces of oak to these contractors. It bought another small tract of very choice oak timber in Washington county, Pennsylvania, last week and will start an operation there in September.

J. N. Woolbert, sales manager of the American Lumber & Manufacturing Company, says that hardwoods are leading all stocks in demand. According to this company not over half of the planing mills in Allegheny county are working, a result which may be attributed directly to the carpenters' strike.

Pittsburg made an exceptionally good showing in building in July. New operations involving an estimated expenditure of \$1,586,359 were authorized. This compares well with a total of \$1,936,794 in July, 1905. Considering the fact that the carpenters' strike was not settled till about the middle of July, the showing is very encouraging to lumbermen.

Pittsburg lumber firms, hardwood concerns in particular, are getting very wary of the so-called timber broker. Too often within the last two years they have found him to be a "shyster" of the deepest hue. Not a hardwood firm in the city but that is visited by these sharks. They are profuse in their offerings of timber anywhere and everywhere in the Pittsburg freight radius. But when their propositions are sifted down it is usually found that they are offering "worn out" operations, small and inaccessible tracts, second growth timber that has not attained marketable size, or land to which a clear title cannot be obtained. Recently local firms have investigated thoroughly several tracts that were estimated by brokers to cut several million feet, and which, on examination, were found to be good for a bare half million feet of inferior timber.

**Buffalo.**

For the second time during the existence of Montgomery Bros. & Co. the big mill came very close to being wiped out. It is again doing business, although the fire of July 30 was a close call. Stock loss is estimated at \$60,000, with \$10,000 on the building, not to mention heavy losses by tenants. The office was damaged by water, but the books were not destroyed.

The Lumber Exchange at its last meeting voted against the increased minimum earload proposed by the Missouri Pacific railroad. The Exchange will take its second outing on August 9, going by water this time. The committee announces a novelty, but declines to say what it is to be.

O. E. Yeager has been very busy of late getting in a new stock of oak from Kentucky, which will again round out the general assortment of the yard, which is never allowed to run slack.

A. W. Kreinheder has planned to visit the Kentucky and Tennessee mills of the Standard Hardwood Lumber Company about the middle of this month, so that the stock can be started this way by early fall. It is largely oak.

H. A. Stewart is back from another long trip to West Virginia, where he bought mostly oak. The home yard of I. N. Stewart & Bro. is pretty well stocked.

T. Sullivan & Co., having been reinforced this summer in its selling trade by E. T. Sullivan, from the Pacific coast side of the business, the stock is moving fast, both Washington fir and lake hardwoods.

M. M. Wall lately made a trip to Canada to look after a big lot of birch that was some time ago bought by the Buffalo Hardwood Lumber Company, to add to the heavy yard stock of oak.

The new Memphis hardwood mill of the Hugh McLean Lumber Company is easily taking its place along with the older ones, so that the company's supply of oak, which it makes a specialty, is always good.

Beyer, Knox & Co. are resting easy on their laurels, which consist largely in getting started from the far south a lot of oak and other southern hardwoods and then adding to them a Pennsylvania supply.

F. W. Vetter is preparing to go South as soon as the Lumber Exchange outing is over to see how the oak and ash he is getting out for the Empire Lumber Company in North Carolina is looking.

Anthony Miller has a very well filled yard right along in spite of the good sales. His southern stock of oak and poplar is coming in strong and he sells basswood and elm at a good rate, not finding them dull.

G. Elias & Bro's mill is very active this summer. Business is good on account of the heavy building in operation in the city.

**Saginaw Valley.**

A. P. Bliss of Bliss & Van Auken states that everything is moving along nicely. The firm is producing large quantities of fine oak. They have markedly increased facilities for producing lumber products. The maple flooring plant of this firm at Saginaw is being operated day and night and prices are steady and as firm as during any time in the last three months.

The Briggs & Cooper Company, Ltd., is doing a heavier business than last year and finds conditions quite satisfactory. Inquiries for hardwoods are free, and enough stock is coming in to take care of the trade. The company handles a large quantity of oak picked up in the North as well as in the South.

The Hill-Drummond Lumber Company of Saginaw, which erected a sawmill at Baskin, La., and has been cutting oak the last three months, has shut down the mill for sixty days until additional facilities for cutting timber can be supplied.

The Gilchrist sawmill at Alpena has manu-

factured over 3,000,000 feet of hardwoods this season, a liberal portion of which is maple and goes into flooring, the firm operating a flooring plant.

The plant of the Tawas Manufacturing Company, which has been engaged in the manufacture of skewers and other hardwood novelties, has been shut down owing to financial embarrassment. It is expected the tangle will shortly be unraveled and the plant resume operations.

The plant of the Chicago East & Die Works at West Branch was destroyed by fire last week, involving a loss of \$2,500. The plant will be rebuilt.

The Michigan Central has 150 men at work extending what is known as the McGraw branch of the Mackinaw division six miles to reach 300,000,000 feet of timber belonging to the Kneeland, Buell & Bigelow Company, J. T. Wylie & Co. and Salling, Hanson & Co., a large portion of which is hardwood.

The Strable maple flooring and crate plant at Reed City is to be removed to Saginaw. When in operation it will employ about 100 hands.

The old mill at Gaylord, owned and operated for some years by Frank Buell of Bay City, has been sold to H. H. Denison of Boyne City and James Rowan and others of Grand Rapids, who will rebuild the mill and equip it with modern machinery. The purchasers have timber with which to stock the plant.

The plant of the Batchelor Timber Company at West Branch will shortly be ready to begin operations, extensive repairs having been made. Logs are coming to the mill by the trainload.

Some hardwood operators up north experience difficulty in getting enough help to handle their business expeditiously. Wages are high and grub good, yet there appears to be a scarcity of men.

W. D. Young & Co. have finished the new warehouse and have extended their facilities materially. The business of the firm holds good and the plant is operated day and night.

**Grand Rapids.**

Of the twenty-five sawmills in operation at Muskegon, on the south shore of the lake, in 1883, only two are now running—the Thayer mill and the Bigelow mill, both owned by the Thayer Lumber Company. Another mill is in operation there, but erected since 1883 when Muskegon reached its height as a lumber town, is that of Frank Alberts & Sons. There were twelve mills cutting lumber on the north shore of the lake twenty-three years ago and now there is one, that of Gow & Campbell. Muskegon has added many factories since the decadence of the lumber cutting industry and it seems strange, as the Chronicle of that city remarks, why most of these concerns have located at Muskegon Heights and other places, with miles of unoccupied land, mostly abandoned mill sites, on the lake front, offering unexcelled shipping facilities for manufacturers.

A controlling interest in the Grand Rapids Carved Moulding Company, with factory at Front and Myrtle streets, has passed from S. L. King to J. A. S. Verdier and Sybrant Wesselius of this city, who will continue the business.

The Grand River Valley Horticultural society will take forestry as its topic at the meeting to be held August 18 at the suburban home of J. C. West, Fisk lake. The program will include the following addresses: "The Future Supply of Raw Material for Our Woodworking Industries," by Wm. Widdicombe of the Widdicombe Furniture Company; "A Glimpse of the World's Forests," by Walter C. Winchester, recently returned from a trip around the world; "A Talk on Interesting Forest Conditions," by Chas. W. Garfield, president of the Michigan Forestry Commission; "A Proper Respect for Trees," by C. S. Edell; "The Farm Woodlot," by Mrs. M. E. Campbell; "The Problem of the Sand Plains," by Rev. F. P. Arthur.

The firm of Curtis Morrill, near Union City, Branch county, has a curiosity in tree growth.

Two rock elms, one twelve inches and the other about six in diameter, grow side by side, separated by about four inches, until they reach a height of eight feet, when the smaller tree makes a sharp bend and enters the larger, which at this point shows a bulge equal to the diameter of the intruder. Thus married they tower upwards nearly eighty feet.

H. R. Crocker succeeds I. D. Waters as chairman and manager of the National Woodenware Company of this city. Kitchen cabinets of white maple are an important part of the output of this concern.

C. L. Houseman of Muskegon has bought of Minneapolis parties 31,000 acres of hardwood pine and hemlock timber lands located near Nubinaway, in Mackinac county, and is installing a band mill at that point, with capacity for cutting ten million feet a year. The logs will be rafted down the Mille Coues river, which runs through the middle of the tract, and the Soo railroad is building a spur to the mill, a distance of 2½ miles from the main line. It is expected the mill will be in operation this fall.

The Buell mill property at Gaylord is being equipped for the manufacture of veneers. H. H. Denison, lately traffic manager of the Boyne City, Gaylord & Alpena railroad, and James Rowan of Gaylord, are associated with others in the enterprise and the plant will be in shape for operations in about six weeks.

Fire in the yards adjoining C. C. Potter & Co.'s band mill at Bellaire destroyed two piles of hardwood lumber belonging to C. L. Houseman of Muskegon.

**Asheville.**

The sale at public auction of the Whittier Lumber Company's boundary of hardwood in Swain county, North Carolina, on August 6, will attract a number of prospective purchasers. The lands, containing 78,000 acres, will be sold under order of the United States circuit court to satisfy bonds held by the Morton Trust Company of New York to the amount of \$400,000. The lands have really been sold at private sale, but if a higher bid is made than the price then agreed upon the auction bid will be accepted.

The plant of the Asheville Veneer Company located at Biltmore, two miles from Asheville, is complete and operations will commence within ten days. The company will at first cut veneer from oak, chestnut and poplar, but later from other woods.

**Bristol, Va.-Tenn.**

The Came-Wyman Lumber Company, with situs at Bristol, has been granted a charter and will enter the lumber field at once. At the head of the concern are W. O. Came and H. P. Wyman, who are also at the head of the Bristol Door & Lumber Company. Mr. Came was formerly in the lumber business at Malden, near Boston, Mass., and has been in this section for a number of years. Mr. Wyman is from Grand Rapids, Mich., and was formerly in the lumber business at Johnson City, Tenn. The new concern will do a general manufacturing and wholesale business. The company has an authorized capital stock of \$18,000.

The Black Mountain Land Company has been organized at Bristol by W. H. White, W. W. Bourne, J. A. Dickey, T. P. Trigg and others. The company will deal in timber and mineral lands.

W. O. Came of the Bristol Door & Lumber Company has returned from Malden, Mass., where he has been ill in a hospital for the past few weeks. Mr. Came underwent an operation for appendicitis and returns feeling much better.

James D. Wyman of Grand Rapids, Mich., has come to Bristol to learn the lumber business. He will be connected with his father, H. P. Wyman.

G. L. Wood and W. L. Taylor of the R. E. Wood Lumber Company, Asheville, N. C., were in Bristol on important business of the company last week.

George B. Peter of the Paul W. Fleck Lumber Company has returned from a visit to the company's mills in Johnson county.

William S. Whiting of the Whiting Manufacturing Company of Abingdon came to the city on business last week. Mr. Whiting reports that his company's big band mill at Abingdon is running regularly and business is good.

Fred W. Hughes, local manager of Price & Heald, the Baltimore exporters, has returned from a business trip in Virginia in the interest of his business.

E. S. Archer of the Unaka Lumber Corporation of Johnson City was in Bristol on business last week. Mr. Archer reports his company as doing a large business. The company's entire output is being handled by the Rumberger Lumber Company of Philadelphia.

The W. M. Ritter Lumber Company of Columbus, O., is extending its business in this region and is opening up a branch at Hampton, a small town on the East Tennessee & Western North Carolina railway. A new band mill with a capacity of 25,000 feet per day is being put in, also railroad tracks from the timber land to the mill. The road is to extend from the company's lands on Tiger creek to Hampton, a distance of eleven miles. The company owns 6,000 acres of land on Tiger creek, which contains some of the best hardwood timber in east Tennessee. The railroad will be completed by December.

Horace Hoskins of J. A. Wilkinson has returned from a business trip in Virginia and Tennessee.

### Chattanooga.

The lumbermen of this city are raising a big "kick" on account of the recent increase in the rates made on lumber by the Southeastern Freight Association between this point and Buffalo of 3 cents, making a total rate of 23 cents. The same rate has been made on lumber from Nashville and Knoxville.

The lumbermen of this city feel that this is an imposition on them which should not have been made and they claim that the railroads leading out of the three Tennessee cities will lose a great deal of tonnage by the increase in rates, because Buffalo and Rochester points will now begin to look westward to Kentucky and Virginia for their lumber supplies. The Louisville & Nashville road is looked upon as the prime cause of the increase and local lumbermen do not look for a change in rates until the railroad rate bill goes into effect the first of the year, if then.

F. W. Blair has sold the real estate upon which his yards are located to the Bluff View Land Company, which will erect residences upon it. He will remove his mill into the heart of the timber belt away from the city in the near future. He has not yet decided upon the location.

W. M. Fowler of the Case Lumber Company of this city and president of the Fowler-Peronett Lumber Company of Birmingham, Ala., has returned from a month's vacation at Lake Tama-gami, Canada.

George Gall of the Gall Lumber Company of Toronto, Can., was a recent visitor among the lumbermen here.

J. R. Lopez of the Regal-Mantel Lumber Company of Atlanta, Ga., was buying lumber here this week.

Capt. A. J. Cahagan, treasurer of the Loomis & Hart Manufacturing Company, has been elected a member of the new county court from the city district to serve six years. Captain Cahagan was formerly a member of the county court and takes great interest in public affairs. He was the only republican in the city who was elected at the August election.

C. C. Arnold of the Arnold Lumber Company is ill.

J. M. Card of the J. M. Card Lumber Company is visiting mills in Mississippi and Alabama.

Ferd Brenner who, with L. G. Banning, a prominent lumberman of Cincinnati, is touring Europe, has removed his yards from this city and consolidated them with his yards at Norfolk, Va.

F. W. Blair is buying logs on the Central of Georgia road.

### Memphis.

George C. Ehemann, chairman of the committee appointed by the Lumbermen's Club of Memphis to secure the co-operation of other lumber organizations in the effort to have the Missouri Pacific system rescind its new minimum weight ruling on lumber shipments, has secured the aid of a number of organizations. The St. Louis Lumber Exchange and the Buffalo Lumber Exchange have appointed committees to take up this matter, and the latter has already drawn up resolutions protesting strongly against the ruling. Commissioner Doyant of the Memphis Freight Bureau has been consulted by the committee also and, while he acknowledges that there are two sides to the question, yet he declares the Lumbermen's Club, with the aid of the other organizations, has a chance to win. A copy of the resolutions adopted by the Buffalo Exchange has been forwarded to the officials of the road at interest.

Weather conditions throughout the Memphis territory have shown further improvement during the past fortnight and lumber production is making good headway, though still rather below the average for this time of year. Most of the larger mills in this city and section are running and putting considerable lumber on sticks, but as it will be some time before this is ready for market, it is believed that there is nothing in sight now to suggest relief from the scarcity of dry stock which has been a pronounced feature of the Southern hardwood situation for a number of months.

If nothing happens to prevent, the Crittenden Railway Company, which has been building a line from Earl to Beth, Ark., connecting the Missouri Pacific and the Rock Island, for some months, will finish the work by the end of this month. The tracks connecting the large wheelbarrow plant of the Lansing Wheelbarrow Company with the road will likewise be finished within the period indicated.

The Illinois Central is now actively at work on the branch road which runs from Phillip City to Charleston, Miss. Local lumber interests have large timber holdings in the county in which Charleston is located, and steps are now being taken for their development. One exceptionally large plant is to be erected at that point, but the firm which is backing this movement is not ready to have its identity disclosed because the style of the corporation has not been agreed upon. Active work will begin on the erection of the buildings in a short time.

The Anderson-Polly Company has completed the foundation work on the large box factory which it is erecting in North Memphis, and rapid progress is now anticipated. The plant, which is to be a duplication of the one now in operation, with the exception that it is to be fitted with machinery for manufacturing lock-corner boxes, will have a capacity of about three cars of box shooks daily, thus doubling the present output of the concern.

Moore & McFerrin are now operating their new box factory in North Memphis, which was built to replace the one burned some months ago. In addition to manufacturing boxes, the company operates a planing mill and manufactures also gum, cottonwood and cypress lumber.

W. H. Russe, whose last name is the same as that of a man famous in the baseball world, has been secured as one of the nine men selected from the Memphis Cotton and Merchants' Exchanges to play a nine from the Business Men's Club for the benefit of the incipient Memphis zoo. This is a new role for the president of the National Hardwood Lumber Association.

Secretary E. M. Terry of the National Lumber Exporters' Association left for New York and other eastern points last week on business connected with the association, and will probably be gone a month. He may complete arrangements for the proposed midsummer annual meeting of the association, which, if held at all, will be at some eastern point. His trip will include Buffalo, Philadelphia, Baltimore and possibly other points. Mr. Terry sent his family east for the summer some time ago.

The Thomas Maddix Lumber Company of Calico Rock, Ark., has been granted a charter with capital stock of \$10,000, of which \$25,000 has been paid in. The incorporators are Woods Thomas, N. G. and J. W. Maddix.

The Buckeye Lumber Company of Hope, Ark., has been granted a charter under the laws of that state, with a capital stock of \$150,000, all of which has been subscribed. J. W. Willis, W. G. Foster and others are the incorporators.

The Sowell Lumber Company of Marked Tree, Ark., is another Arkansas concern to enter the field. It is capitalized at \$50,000, of which \$30,000 has been subscribed. E. Ritter, A. B. Sowell and H. B. Sowell are the incorporators.

Hotel facilities of Memphis are to be greatly increased. In addition to the building of a six-story front to the Gayoso, the Gayoso Hotel Company has taken a long-term lease on the Peabody Hotel, in the heart of the uptown district, and will control this hostelry. The annex to the building has been condemned, and a ten-story steel structure is to replace this at an approximate cost of \$350,000.

The Riverside Lumber Company has been chartered under the laws of Mississippi. The capital stock is \$10,000. It is domiciled at Marks, Quitman county.

An amendment to the charter of the Home Lumber Company, Montrose, Jasper county, Miss., has been secured, granting an increase to \$10,000 in the capital stock.

W. E. Trainer of Trainer Brothers Lumber Company of Chicago was a recent visitor in Memphis. A. J. McCausland of the W. E. Kelly Lumber Company of Chicago, which has a branch office here, was another Memphis visitor.

James Thompson of James Thompson & Company has gone to Cincinnati and other points in Indiana and Illinois.

S. C. Major of the S. C. Major Lumber Company is out of the city and will be gone for some days. His itinerary includes St. Louis, Chicago, Indianapolis and other northern points.

A. N. Thompson of Thompson & McClure has just returned from a trip into Arkansas.

### Louisville.

In the Parkland end of town ground has been purchased, the foundation laid out and some machinery bought for a new hardwood flooring plant. This operation is being established by a newly incorporated concern, the Kentucky Hardwood Flooring Company, capitalized at \$75,000, but the individual promoters of the enterprise are not new to the lumber trade here by any means. The officers, who are holders of the entire stock of the company, are Olaf Anderson, Emil Anderson and W. V. Shepardson. The Messrs. Anderson are proprietors of the Southern Planing Mill and are well known in lumber circles here, as also is Mr. Shepardson, who has been for some fifteen years with the Mengels. The new plant will start in with two S. A. Woods flooring machines, a resaw, double surfacer, rip saws, etc. The building is being constructed with a view to doubling and possibly quadrupling the capacity.

A. E. Norman of the Norman Lumber Company says that the company had a splendid six months' business in hardwood the first half of this year, and the outlook at present is practically all that could be desired.

Edward L. Davis recently came in from what he had intended to make a sort of holiday trip, but he had so much business to attend to that he didn't consider it much of a vacation, so he

is out again, looking for a place to hide from work for a while and have a little rest.

J. E. Buscher of the Louisville Spoke & Bending Company, says that vehicle wood stock is moving fairly well, but that prices on this class of stock are not high enough to be in harmony with the increased value of raw material, especially hickory, which is soaring high at the stumpage end.

Albert R. Kampf has been adding some to his timber holdings along the Illinois Central.

Ed Rubesky took a little jaunt to Evansville last week to see what is going on in that hardwood center. He says the market looks good, though there is nothing exciting in his line.

R. M. Cunningham, who has been ill, is now able to take up business again.

### Minneapolis.

The Northern Hardwood Lumber Company of Marshfield, Wis., has incorporated with \$50,000 capital stock, and will engage in the manufacture of hardwood lumber. The incorporators are Herman Langer, H. I. Kleeme and T. A. Tack.

The Parswell Lumber & Manufacturing Company of Minneapolis has increased its capital stock to \$60,000, for the purpose of expanding its operations. The company operates a mill at Baswell, Wis., manufacturing hemlock and hard wood, and is enjoying a good business. It is running the sawmill both night and day. F. W. Baswell, president of the company, has just paid a visit to the plant, which has planing machinery run by electric motors. W. H. Hogue, a prominent salesman of experience in northern territory, has entered the employ of this company and will represent it on the road in Illinois and Wisconsin territory.

E. Payson Smith of the Payson Smith Lumber Company is ill at Hot Springs and may remain in a physician's care there for a week or more. This is the second time within a year that Mr. Smith has been stopped on a southern trip by illness, and forced to put in to Hot Springs for repairs. He writes that he is not dangerously ill, although his temperature has been hovering around 101. A. S. Bliss of the same company says they have been enjoying a splendid summer business in all lines they handle, and they feel quite confident of a brisk fall trade.

J. C. Signor, head of Signor, Crisler & Co., manufacturers of hardwood and hemlock lumber at Signor and Conderay, Wis., was in Minneapolis on a business errand a few days ago. He says they have been hustling to keep enough dry lumber on hand to fill orders as they come.

The Wisconsin Lumber & Lumber Company of Hermansville, Mich., has issued a circular recommending general use for red birch flooring, which is sold at about \$10 over the price of hard maple, and is claimed to be little if any inferior to oak for the purpose.

C. F. Osborne of Osborne & Clark, the local hardwood wholesalers, has gone to look over their retail lumber yards at Erie, Ill., and other points. They are having a fine trade, especially in yard stock from the retail dealers.

J. H. Henderson of the Kendall Lumber Company, Pittsburg, Pa., stopped in this city a few days ago on his way home from the Pacific coast. The company is a large hardwood dealer, but contemplates a departure into the manufacture of fir lumber, and Mr. Henderson's trip west was for the purpose of investigating some propositions.

C. P. Coon of the Beldenville Lumber Company, Bruce, Wis., large hardwood producers, was looking over the Minneapolis market a few days ago.

The building activity in the twin cities is just as heavy as ever, and July came near setting a new mark for building permits in Minneapolis. The total estimated cost of permits issued was \$1,669,820. The record for the same month of last year, when building was also lively, was \$881,976. The total for seven months was \$5,763,570 for this year, and \$5,669,846 for 1905. Last year eclipsed all previous records,

and may be excelled by the total for this year. St. Paul's record for July was \$510,570, compared with \$456,910 in the same month last year. A large share of the building calls for hardwood floors and finish, and the factories have a larger proportion of this kind of work than ever.

### Ashland.

C. Crane & Co. of Cincinnati, O., have just closed a deal for 60,000 acres of timber land in the West Virginia mountains. The purchase involves more than \$500,000, and the territory thus acquired gives the concern dominion over more than 100,000 acres of the finest timber land in the state. The deal includes the standing timber on 60,000 acres of land in Boone, Wyoming and Raleigh counties. This purchase, which is the climax of several which have been made by this concern during the last few years, gives it enough timber to last nearly twenty-five years, estimating that 100,000,000 feet of lumber is cut each year. It will be ten or twelve years probably before cutting is begun on the new lands, the concern's plan being to make sure of a future supply.

W. R. Vansant is looking after his interests in North Carolina.

The big store of the Yellow Poplar Lumber Company at Coal Grove, O., is soon to be abandoned by the company, as it is found to be unprofitable. The large stock of goods will be shipped to one of the company's stores in the West Virginia mountains.

A mill will probably be located at Louisa, Ky., to manufacture hickory handles.

Sonny Blankenship of Cox's Landing, O., tried to get some timber up the Guyandotte river to a sawmill some time ago, and he alleges he could not do so on account of obstructions in the stream in the way of logs belonging to C. Crane & Co., so he sued the latter firm for \$300 damages. The case may bring up the right of log men to obstruct the channel of a river and end in the court of appeals.

A. L. Rogers of Ripley, W. Va., has purchased a fine tract of timber land in southern West Virginia. It contains several thousand acres of timber and coal land on the Lick Fork of Twelve Pole. It is rich in virgin poplar and oak, and contains a wealth of almost every kind of hardwood known to that section of the country. Preparations will begin at once to prepare the timber for market, and a number of mills will be installed. Cross ties will be cut, in addition to the vast quantity of high-grade lumber. Tramways will be built by which the product may be transported to the Norfolk & Western railway to be shipped to the various markets. It is Mr. Rogers' intention to engage in export trade also. The price paid for the land was \$200,000.

Thomas Newton, Jr., the 6-year-old son of T. N. Farrin of the Keyes Farrin Lumber Company, died on August 2 at Herndon, W. Va., where the family were spending the summer. The boy was brought home to Ashland for burial. The boy was a bright, sturdy lad, and his death is a great blow to his parents.

N. J. Pullings, of Windsor, Canada, was here this week looking over the market for heavy ship timber.

J. S. Walker of the J. S. Walker Lumber Company, Gray, W. Va., was transacting business in the city this week.

W. E. Berger of the W. H. Dawkins Lumber Company is stopping over the arrival of a son at his home, born August 4.

### Wausau.

The Kewaunee Casket & Manufacturing Company of Kewaunee, Wis., has been organized with a capital stock of \$60,000. John M. Borgman is president and L. A. Cowell, secretary.

Never before has there been such a scarcity of men in the woods of Wisconsin as at the present time. Timber that has been out for months still lies in the woods and it is impossible for lumbermen to secure men to haul it to cars and prepare it for market. No less than

1,000 men could find employment in northern Wisconsin woods. The situation is becoming alarming and every day that passes, under these conditions, has a tendency to increase the price of lumber.

William G. Foss of Tomahawk, a practical lumberman and manufacturer, has purchased the Tomahawk Stave & Veneer Company's plant in Tomahawk. Glenn Foss, a son, who has been attending the Wisconsin University, will have charge of the office work.

The factory of the Upham Manufacturing Company at Marshfield, which was closed down for six weeks for repairs, has been started in operation again with a full force. The company is shipping furniture in car lots to San Francisco.

The Brehmer sawmill in the town of Ethel, near Wausau, was recently totally destroyed by fire. The lumber in the yards was saved by cutting the tramways leading from the mill to the yards. The yards contained 3,000,000 feet of choice hardwood of last winter's cut. The mill, for its size, was the best equipped in northern Wisconsin, and was built exclusively for winter sawing. It will probably be rebuilt.

The Island Traffic Company has sold its last winter's cut of timber, and shipment of the same has begun. The hardwood, about 1,000,000 feet, has been sold to the Crocker Chair Company of Antigo. Mr. Rideout, owner and manager of the company, has a deal on for the sale of the mill, though he has taken a contract to plane 1,000,000 feet of maple flooring for the Edwards Lumber Company of Antigo.

The Northern Hardwood Lumber Company of Marshfield has been incorporated with a capital stock of \$50,000. The incorporators are Herman Langer, H. I. Kleeme and T. A. Tack.

The Wolf River Company, which recently purchased the plant of the Wisconsin Chair Company at New London, has incorporated under Wisconsin laws, with a capital stock of \$200,000. The officers are: F. M. Parke, Buffalo, N. Y., president; J. M. Holden, New London, Wis., vice president; E. C. Jost, New London, secretary and treasurer. The new company intends to enlarge the plant and to engage in additional lines of manufacture.

It is said that 20,000 acres of choice hardwood lands lying in the vicinity of Chandon will be logged next winter. Another railroad is being built to the town and new woodworking factories are going up.

### Toledo.

As one well-known hardwood dealer put it, "The midsummer trade in hardwood lumber was never better than it is this season." Stocks are ample for the demand, prices are firm and business is good.

J. B. Tennyson of Denance, O., has opened a lumber office on South street at the crossing of the Clover Leaf railroad. A. T. Noy of Findlay, O., has also opened an office opposite the Tennyson office.

John Wisdom & Son of Sycamore, O., have sold their mills to Silas Chesbrough of Carey. The Wisdoms have taken charge of a stave mill at Sabota, Ia.

The George Wilson & Sons Co. of Toledo has filed a motion for a new trial of the condemnation proceedings instituted by the Toledo Central Railway Company, in which the defendants were awarded \$7,800 for land appropriated.

C. W. Riegel of the Phoenix Box Company and his son have returned from an outing in Michigan.

J. H. Campbell of the Campbell Company has returned from a month's trip through the West.

Andrew Spears, formerly with the Rob River Lumber Company, has gone into business for himself at Monteville, O.

The building permits issued by the city building inspector for July number 121, with a valuation of nearly \$250,000, which is far in excess of the same period of a year ago.

# Hardwood Market.

(By HARDWOOD RECORD Exclusive Market Reporters.)

## Chicago.

There are no new features in the local hard wood trade. Business can be denominated as simply fair, which is saying a good deal for midsummer in Chicago, when very little business is done normally. It is well known that the furniture manufacturers' order books are well filled, which will mean a big fall trade for Chicago wholesalers. The interior finish people are also loaded with advance orders, and this line will also require some large quantities of hardwoods. The flooring people are also busy and will be obliged to put in additional stock. Altogether the outlook is most promising for the biggest fall and early winter hardwood trade ever enjoyed in this market.

## Boston.

In speaking of the local hardwood market dealers show no enthusiasm over present conditions, but for the future the outlook is considered good. Building operations which have been held up for months owing to the high prices of lumber are now starting up. It is reported that many plans that have been held in architects' offices for several months are now being figured with the intention of going right ahead with them. The signs of revival lead the manufacturers of interior finish to look for a much better demand. At present this branch of the hardwood industry is fairly busy, but the inquiry for lumber is not large. With the manufacturers of furniture business is fairly active and fair orders for stock are received. One large dealer states that his customers are making preparations to use southern and western hardwoods to a larger extent. They have been using native hardwoods, but owing to the difficulty in getting all that they require and because of the strong advance they plan to get supplies elsewhere.

Offerings are fairly large, and in some instances a surplus is reported. The demand for plain oak is not active. Offerings are larger and the market has developed an easier feeling, although prices are no lower than two weeks ago. Quartered oak does not show any activity, and prices are not as high in all instances as they were. Maple flooring is quiet here, but those who sell the New York and Pennsylvania trade report a fair demand. Prices are generally held right up to the list, with the exception of an occasional surplus stock. Rough maple is very firm and will have a tendency to keep up the price of flooring. The whitewood market is firmer, as the river mills are reported as shut down. Cypress is in moderate call, but firm.

## New York.

There is no denying the fact that there is much less complaint heard of business conditions than for some weeks past. Indeed, a trip through the district reveals a very fair volume of business in all branches of the trade, with prospects bright for an active fall. Stocks in the hands of buyers, however, are quite plentiful, which explains slow purchasing. Here and there some concessions are noted on small lots of hardwoods, but the salient feature of the wholesale market to-day is the manner in which the stronger interests are holding any stocks in hand rather than force or bear the market.

There is no question but that stocks of good, well manufactured hardwoods in shipping condition are light and badly broken. Such being the case, those houses having possession of any amount of good stock are not disturbed in the least over any lack of inquiry at this normally quiet season.

Business among the furniture, piano and novelty manufacturers is taking on more briskness to take care of the holiday goods, all of which will improve conditions from now on.

The leading stocks in current transactions are plain oak, ash, birch and chestnut, on all of which prices are very firm. Poplar is not quite so active, but prices are steady. Quartered oak and maple are quiet.

## Philadelphia.

A large proportion of the firms in the local market find conditions now much better than during the latter part of June and the first part of July. The outlook at that time was for a decidedly dull season in hardwoods and, although the situation to date has not come up to the standard of last year, the proportion of business done has been fairly satisfactory.

Chestnut and oak have been moving freely, with ash and basswood in good demand. Poplar continues a ready seller, and there is little difficulty in disposing of stocks. The furniture factories supplied by the Philadelphia trade seem to be well stocked, although they still buy in small lots.

One hopeful feature of the market is that business seems to be picking up and there are inquiries out for many new jobs that promise well. Prices are steadily maintained all along the line, and indications are that they will continue so.

## Baltimore.

The hardwood trade of this section keeps up surprisingly well. The leading woods are in active call and the usual quiet of midsummer has not been experienced. Oak continues to be very active, all the mills being busy and consumers placing orders whenever dealers are willing to take them. The range of values continues high, and manufacturers are able virtually to command their own terms.

The demand is also quite active from abroad, though foreign buyers continue to evince a disposition to insist upon lower prices, and complain because exporters decline to rush supplies at the values offered. There are allegations that exporters disregard their contracts because they have to pay more for lumber than they counted on when they took orders, and are evading shipments because they might lose a little money. As a matter of fact, there is no evading of contracts. Every shipper of standing will live up to his obligations, and if any default occurs, the offender is the irresponsible dealer, whom the foreign buyer or broker gives the preference because he names low prices. As a matter of fact, the production of lumber this summer has been rather below the average on account of bad weather and for other reasons. The railroads and other big users have been heavy buyers, so that stocks are low and difficult to get. If exporters are behind in deliveries, some good reason can be given for the delay.

Ash is almost as active as oak, and brings excellent prices. The mills have plenty of orders for ash and good stocks are quickly taken up. Chestnut, beech and all other hardwoods are moving freely at satisfactory prices. Poplar retains its hold upon the trade, with moderate prices; the wood took a turn upward, and long since regained everything it lost temporarily by the insistence upon inordinate figures. Manufacturers find it easy to dispose of their output, though the capacity of plants is being taxed to the utmost, and the trade is in fine condition. As for walnut, all the good lumber and logs that reach the market find buyers. Stocks are also being shipped abroad in considerable quantities, and the outlook is very favorable.

## Pittsburg.

There is snap to the hardwood market and the usual midsummer dullness has not been felt in Pittsburg. It's the hardwood men's inning. This summer they can sit in their offices and sell more lumber every day than their mills can cut. And they are getting prices for it, too.

There is no doubt but that hardwoods have held the center of the stage for the last three months in Pittsburg. Inquiry has been better even than was anticipated on account of the

labor troubles. In the face of this demand prices have taken an upward turn. For good stocks and quick deliveries premiums are being paid every day. From the mills there is practically one report coming, namely, that the capacity of the mills is being taxed to the utmost to supply the current demand, and that no stocks are being accumulated for fall and winter trade.

Oak is far and away the leader in this market. Prices are considerably higher than thirty days ago, and promise to be advanced again when the September market starts. All grades of oak are in most active demand, and it is simply a problem of getting stock that is fit for shipment and can be delivered promptly.

Chestnut is an active seller, although it is not moving as fast as several weeks ago. There is a steady call for cherry, walnut and birch from the furniture firms of Michigan and Ohio, as well as from Buffalo and other lake ports. Ties are wanted. Railroads are supplying a large portion of their own stocks, but the traction companies are and will be heavy buyers all fall. Long sticks are also in excellent demand and much oak is being used in the government repair work on the rivers. Maple is in good call, especially flooring. The demand for hickory and ash has increased within the last two weeks, and local firms are shipping some nice orders to the Middle West.

## Buffalo.

There is the same active tone to the hardwood trade that has prevailed all the season. It is true at least now that the hardwood trade has kept up all summer, while white pine has suffered a large falling off, with prices none too strong.

A few hardwood dealers say that plain oak is not as strong as it was, and while it is a fact that the supply is larger than was looked for, that is merely because it was predicted early that it would be very broken by midsummer. Dealers who have been to the furniture exhibitions and are acquainted with that trade say that the feeling there has been of the best, so that there is nothing to fear from such woods as plain oak.

Birch is more active and also more plentiful than for some time, and it has helped oak out very much, probably being responsible for the quiet condition of quartered oak right along. Still dealers are carrying more mahogany than they used to, so that price is not the whole of the matter.

There is no improvement in the supply of chestnut and ash, though the demand for them is such that dealers are picking up all they can find. Some dealers think poplar is a little more plenty, but others say it has not come their way.

There is quite an amount of Michigan hardwood coming in by lake, especially elm and hardwood, which have been quiet for a long time, but are now improving.

## Saginaw Valley.

July business was somewhat slow, but trade is showing more life than usual at this date in August, and dealers take it as an indication of assured activity later on. Prices hold firm and while there is considerable inquiry for stock, enough is coming in to keep supplies ample for requirements. Mills are running steadily and unless there should result an extraordinary volume of business there will be enough lumber to meet the demands of the trade. While some manufacturers sold their season output of maple early in the season and are consequently out of the market there is rather more maple manufactured than the trade can readily assimilate, and it has manifested more sluggishness than other varieties of hardwood with the possible exception of birch. Ash holds firm under limited stocks and elm is steady. Basswood is doing well; beech is a little stronger, but birch is rather slow in movement.

**Asheville.**

Trade in Asheville and western North Carolina continues dull, as it has been for more than thirty days. While there is not an overabundance of sawed lumber on the yards and at the railroads ready for shipment, the mills in the mountains have been busy during July, and much sawed hardwood is in the forests ready for hauling. Lumbermen are not selling at prevailing prices to any noticeable extent, preferring to hold and take chances on an increase in price.

**Bristol, Va.-Tenn.**

There is little change in the market conditions in the Bristol district. There obtains a heavy demand for all kinds of stock, with prices regarded as good.

The export market is declared by local exporters to be satisfactory, with prospects promising. Exporting is coming more into favor in this section, and many concerns which have hitherto confined their business exclusively to the domestic trade are experimenting, as it were, with the foreign trade.

There is a good supply of most hardwoods, except some grades of oak and poplar. There is a general scarcity of poplar and dealers and manufacturers are flooded with inquiries for this stock, but unable in most instances to supply the demand.

**Chattanooga.**

A careful canvass of the sawmills and lumber yards in Chattanooga shows the smallest stocks of shipping lumber now on hand since 1890. This condition is attributable to direct causes—the growing scarcity of merchantable timber and the unusual demand for all lumber products. There has never been a time when there has been such a great demand for low grade lumber of all kinds in this section. Low grade poplar and basswood have been slow of sale for some time, but now the box factories are using locally every foot of this grade of lumber they can get. The unusual amount of building that has been going on locally during the past eighteen months has drawn heavily upon local mills.

There has been a great activity also through all the mining sections and more railroad building is being carried on in the vicinity of Chattanooga than at any time within fifteen years.

Standing timber in this locality is being rapidly exhausted. Many tracts of land that have been cut over in the past are now being gone over the second or even the third time. In order to get an adequate supply of logs to keep the mills running operators are going back further into the mountains and up the smaller water courses and running out logs from localities that a few years ago would have been regarded as practically inaccessible for logging operations. On account of the scarcity of logs, a number of the Chattanooga mills have already gone out of business or have moved farther south where they will be more accessible to standing timber.

A few of the mills and lumber yards have a pretty good supply of lumber on hand. One of the largest lumber operators in Chattanooga was heard to remark a day or two ago that he had, for the first time in twenty years, under contract and in process of delivery every foot of spare lumber he had in his yard.

The furniture factories of Chattanooga are drawing upon the local mills and the surrounding territory for great quantities of lumber, especially oak. Poplar that a few years ago entered largely into the manufacture of cheap furniture is no longer used to any extent, on account of the advance in price.

**Memphis.**

There is further tendency toward increase in the volume of hardwood business, the last two weeks showing considerable gain. Manufacturers and wholesalers say they are not rushed to

the limit of their capacity, but they are doing a very satisfactory business, and that the outlook is for a splendid fall and winter trade. Crops throughout the South and West are exceptionally favorable. The furniture trade, the agricultural implement business, the manufacture of railroad equipment, building operations, the steel and iron industry and other indices of prosperous conditions are very wholesome, thus suggesting large consumptive requirements during the next few months.

Conditions surrounding production have been more favorable during the past fortnight, and good headway is being made in getting out lumber. However, there is no excess of dry stock in any direction, and for this reason prices are exceptionally well maintained.

Ash stands at the head of the list in point of strength. It is very scarce, and will not be moved except at very full prices. All grades are wanted and buyers are quite willing to pay the price when they are able to find what they want. Cypress continues a ready seller in all grades, though, if anything, the lower grades are more wanted in proportion to the supply than the higher. Prices are well maintained and the amount of stock is not burdensome by any means. Plain oak continues to move well. There was some lull in this about a month ago, but it is picking up again and is wanted steadily at very satisfactory prices for both red and white. The lower grades, especially common, are also wanted. There is no great movement in quarter-sawed oak, though this wood is holding its own. There is a splendid demand for cottonwood in all grades, with but a limited supply. The better call is for the lower grades and for box boards. Prices are very firm because cottonwood is developing into a rather scarce article and is likely to remain so until some of the stock now being produced has been cut sticks long enough to make it available. Gum is in good demand, with a better call, relatively, for the lower than for the higher grades, largely as a result of the scarcity and highness of cottonwood and other woods used in box factories. Poplar is without change.

**Liverpool.**

Some weeks ago it was stated that buyers of mahogany at prevailing sale prices would obtain good bargains, as the price was certain to rise. This statement was proved to be correct by the result of the late sales held here. A glance at the realized prices shows a sharp advance all around for all classes of this wood. From all appearance at sale yards these seem to be rapidly going into consumption, and it may be safely prophesied that still higher prices will rule at next sales.

General trade here, however, remains quiet, and prices generally of American hardwoods are easier. Pitch pine and ash logs have gone all to pieces, owing to excessive import. A quantity of the latter have been sold by brokers here as low as \$30. Numerous parcels that have arrived are very badly wormed and considerable loss has no doubt been caused to shippers from this cause. Ash and oak planks are very firm and merchants here have difficulty in securing the wood they have contracted for. Several contracts have been made some time ago by shippers at old prices and many merchants here are very much annoyed that they are not getting them now that the prices have risen. One contract where 1½-inch firsts and seconds white ash planks was sold about twelve months ago at \$50 ex quay Liverpool has not yet been delivered. Needless to say, the merchant in question can see a very nice profit if he could only get some delivered. It is certainly very exasperating when some of the smaller class of shippers plead "a fire or a flood" as an excuse until the market has eased in price. We really think the leading shippers, who are no doubt above such tactics, should take strong action to prevent this kind of thing. At any rate it does them a great deal of harm, as one repeatedly hears a

merchant say that all shippers adopt these tactics. This, however, we can testify from personal knowledge is not the case, but we simply quote "common gossip" to show the harm that is done.

**Louisville.**

Said a prominent sawmill man here in speaking of the hardwood situation: "What we need to have brought home to us till we realize it thoroughly is that stumpage is something that we can harvest only once in a lifetime, not till then can we properly appreciate the necessity of getting a good value for what lumber we sell." That's the way many millmen are looking at the market situation now, and especially those who have been out trying to buy stumpage. As a result the market is naturally very stiff and higher prices are being talked of. There is difference of opinion as to when further increases are due. Some think this fall, and in consequence are not willing to sell stock for future delivery, but others do not think values will change much this year.

It is taking some hustling on the part of local millmen to get logs enough to keep running steadily, but most of them manage to do so, and lumber deliveries from country mills are coming in freely. So, with a good demand, stiff prices and a fair volume of stock moving right along, the hardwood trade is in what might be termed a healthy condition. Ties are still scarce and in active demand; poplar seems to have more buyers than sellers, hickory is snapped up like live bait, and pretty much everything on the hardwood list is meeting with ready sale.

**Minneapolis.**

The main feature of hardwood trade is the revived activity in buying from factory sources. All summer there has been a fair amount of business from that quarter, but it has come in small quantities to supply immediate needs. Manufacturers got along on short stocks till the new cut of hardwood was offered, so they could hope for all possible latitude in price and quality of stuff. Now they are beginning to want lumber, and are buying more heavily. The trade is disposed to buy earlier on account of previous experiences with short stocks and stiff prices in the late fall and winter.

Oak is firm and selling freely, but very little northern stock is left in sight, and dealers are generally shipping from southern mills. There is an abundance of birch, and fair stocks of basswood, maple and soft elm. All these woods are moving in good volume, however, and birch is not going to be a drag on the market, judging by the size of the orders being placed and the contracts being written for delivery later. Prices are firm, and even on birch it is hard to find any concessions made for the purpose of moving lumber.

The retail yard trade continues good, and is somewhat improved over a month ago. The crop is so well assured that dealers are no longer hedging against failure, but are laying in what stock they expect to need this fall. There is a good demand for oak and maple wagon stock, also for maple flooring.

**London.**

Trade here is still very quiet and is not expected to improve till September. Buyers are slowly beginning to realize that to obtain the stocks they require much higher prices must be paid, but stocks sent by chance on consignment do not receive much attention.

Good dry oak is still in fair demand and is realizing shippers' ideas of prices. Prime white wood is not in great demand, but prices hold firm; culls are in demand at full prices. Satin walnut is not too plentiful and there is no demand for it. The mahogany branch of the trade holds to firm prices. Public auctions are well attended and prices realized show an advance.



# AT COST

IS AN UNCOMMON TERM AS APPLIED TO INSURANCE

But this is the actual price of Indemnity against Fire Loss furnished by the

## Manufacturing Lumbermen's Underwriters

THE STRONGEST INSURANCE ORGANIZATION  
TO-DAY IN AMERICA

The saving is not on a small portion of your insurance but on the entire line.

There are other advantages equally interesting.



Only well built plants with adequate protection and at least five years timber supply are considered eligible.

FOR LIST OF MEMBERS AND FURTHER INFORMATION, ADDRESS

**HARRY RANKIN & CO.      Kansas City, Mo.**

# Wanted and For Sale -SECTION-

Advertisements will be inserted in this section at the following rates:

For one insertion ..... 20 cents a line  
For two insertions ..... 35 cents a line  
For three insertions ..... 50 cents a line  
For four insertions ..... 60 cents a line

Eight words of ordinary length make one line. Headings count as two lines. No display except the headings can be admitted.

Remittances to accompany the order. No extra charges for copies of paper containing the advertisement.

## EMPLOYES WANTED.

### LOGGING CONTRACT TO LET.

We have 150 million feet mixed hemlock, hardwood and pine timber in northern Wisconsin, to be logged at the rate of 12 to 15 million feet per year. Want land cleaned of all timber, including pulpwood, cedar posts, poles, etc. Work to commence fall of 1907. Party must be financially responsible and experienced in logging mixed timber by rail. Send references, stating whom you have logged for before. Address "LOGGING CONTRACT," care HARDWOOD RECORD.

### SALESMAN WANTED.

One who has had experience in both Mahogany lumber and Veneers. State age and nationality, with information regarding previous or present position. Willingness to travel, habits, married or single, salary expected. Address "VENEERS," care HARDWOOD RECORD.

### WANTED.

Competent hardwood inspector and buyer, familiar with rough wagon material. Good job for right man. Address "K. 46," care HARDWOOD RECORD.

## LUMBER WANTED

### OAK TIES WANTED.

Standard White, Rock and Burr Oak ties, 6"x8"x8' and 7"x8' to 12"x8 1/2'. Send description of what you have and price. G. ELIAS & BRO., 965 Elk St., Buffalo, N. Y.

### WANTED—DRY CYPRESS.

2x5" and wider, 8 or 16'—1st and 2nds, or selects, or sound common. AMERICAN LUMBER & MFG. CO., Pittsburg, Pa.

### WANTED—HARDWOOD LOGS.

200 M feet 28-inch and up White Oak logs.  
200 M feet 12-inch and up Walnut logs.  
50 M ft. 12-inch and up Cherry logs.  
C. L. WILLEY,  
Blue Island Av. and Robey St., Chicago.

### OAK.

We are in the market for plain sawed oak, all grades and thicknesses. P. G. DODGE & CO., 2116 Lumber St., Chicago.

### WANTED.

Locust, Bois D'Arc or Osage Orange and Mulberry, log run. Write for specifications and prices. THE PILLIOD LUMBER CO., Swanton, O.

### WANTED—DIMENSION HICKORY.

Send for our specifications. MUNCIE WHEEL & JOBBING CO., Muncie, Ind.

### OAK WANTED.

3 and 4 inch White Oak; also Mixed Oak; also 12x12 Timbers and Piling of all kinds. CONTINENTAL LUMBER CO., 1213 Menadnock Bldg., Chicago, Ill.

## TIMBER LANDS FOR SALE

### FOR SALE.

3,550 acres of Georgia hardwood, estimated to cut as follows:  
8,800,000 feet White Oak.  
3,500,000 feet Hickory.  
5,500,000 feet Red Oak.  
1,750,000 feet White Ash.  
High grade stock suitable for wagon and carriage manufacture.  
3 1/2 miles from railroad; river joins tract. Ten years to remove timber. Address "H. H.," care HARDWOOD RECORD.

## LUMBER FOR SALE.

### WANTED.

Inquiries for Hemlock and Yellow Pine piece stock. Two million feet now on hand. S. M. BRADLEY, Morehead, Ky.

### FOR SALE.

Oak Squares for Chair Stock. E. DUNSTAN, Winona, Miss.

### GUM AND SYCAMORE BOARDS.

200,000 feet of 1-inch boards from 10 to 20 feet long. Apply to A. ROSENBAUM & SONS, Newport News, Va.

### FOR SALE.

Common and better Hickory, 5,277 feet of 2 1/2", 1,032 feet of 3" and 1,024 feet of 4", dry, good quality. LOVE, BOYD & CO., Nashville, Tenn.

### FOR SALE.

One car clear Hickory cuttings, dry, 1"x1 1/2" x19" to 24", 1"x1 1/2"x28" to 36". Also 3,700 pieces dry second growth Ash, 1 1/2"x3 1/4"x24". THE J. A. & D. P. COOPER CO., Struthers, O.

### FOR SALE.

One or two cars 1x1 Oak Squares, any length, up to 31" long. ALBERT R. KAMPE, Louisville, Ky.

## BUSINESS OPPORTUNITIES

### DESIRABLE LOCATIONS.

In the territory of splendid timber resources reached by The North-Western Line are several fine locations for new industries, especially in the woodworking lines. A suitable point for a large sawmill having excellent railroad service and a large tributary timber district is one of these. There is also a fine opportunity for securing a well equipped coeprage plant. Reference to these can be obtained upon request to the INDUSTRIAL DEPARTMENT, C. & N-W. Ry., Chicago.

### BAND MILL FOR SALE CHEAP.

One of Smith, Myers & Schreier band mill, with good power and all other necessary requirements for a first-class mill in good condition. Will send full description and price on application. SWAN CREEK LUMBER CO., Toledo, Ohio.

### LUMBER YARD FOR SALE.

On good site for manufacturing concern, lumber or coal yard. Planked with 2 inch oak. Fine office worth \$2,500. Address "YARD," care HARDWOOD RECORD.

### HARDWOOD TIMBER.

A number of good mill propositions along the Cotton Belt Route. Tracts ranging from five hundred to twenty thousand acres, principally Oak, Hickory, Gum, Cypress, some Ash, Cottonwood and other hardwoods. Can be secured at very reasonable figures now—in some cases at less than \$1 per thousand stump age. Choice openings for hardwood lumber mills, handle and spoke factories, slack coeprage plants and other hardwood enterprises.

▲ number of points on the Cotton Belt offer free sites or will raise cash bonus or take stock in practical propositions. Let us have your wants and see what we can do for you. E. W. LA BEAUME, G. P. & T. A., COTTON BELT, St. Louis, Mo.

### WANTED.

Party with small capital to take an active interest in well established handle and lumber business. Entire output sold for four years. For further information write or call on H. F. CLARKE, Okolona, Miss.

## MACHINERY WANTED

### AT ONCE.

If you are in need of machinery—new or second hand—a few lines in this column will place your wants before those who have such goods for sale. For particulars address HARDWOOD RECORD, Chicago, Ill.

## MACHINERY FOR SALE

### FOR SALE.

Two Nichol's Dryers in first-class condition. Can be seen in operation until August 30 at NATIONAL CASKET CO., E. Cambridge, Mass.

### SAW MILL FOR SALE.

We have the following circular sawmill with all appurtenances complete for sale at Habersham, on L. & N. R. R., in Campbell Co., Tenn.: One No. 3 Hart mill; capacity 25 M. per day. One 45-horsepower boiler. One 40-horsepower engine. Three headblocks with grip set rig. One 64-inch Hoe saw—inserted tooth. Two 64-inch Ohlen saws—inserted tooth. One three-saw gang edger. One two-saw trimmer. One slab saw or cut-off. One Hart friction digger or log turner. 80 feet of lumber rolls. This mill is fitted with the famous Osbourne feed rig and has 150 feet of 5/8 cable or rope feed. LOGAN & MAPHET LUMBER CO., Knoxville, Tenn.

## RAILWAY EQUIPMENT

### RAILS AND LOCOMOTIVES.

All inquiries for industrial railway equipment listed before "Record" readers will find ready response. HARDWOOD RECORD, Chicago, Ill.

## MANUFACTURERS

Contemplating establishing plants in the West should take advantage of a location on



## Chicago & North-Western Ry.

which reaches the famous

**WATER POWERS,  
COAL FIELDS,  
IRON ORE RANGES,  
HARD AND SOFT  
LUMBER DISTRICTS,  
MINING DISTRICTS**

of the West and Northwest, and affords the best means of transportation to the markets of the world.

FOR FURTHER PARTICULARS APPLY TO

MARVIN HUGHITT, Jr., E. D. BRIGHAM,  
Freight Traffic Manager, Gen'l Freight Agent,

GEO. BONNELL,

Industrial Agent,

NW513

CHICAGO.

Advertisers' Directory

NORTHERN HARDWOODS.

Table listing various lumber companies under Northern Hardwoods, including American Lumber & Mfg. Company, Alpin Hardwood Lumber Company, Babcock Lumber Company, etc.

Southern Oak Lumber Company...

Table listing various lumber companies under Southern Oak Lumber, including Standard Hardwood Lumber Co., Stephenson, The L. Company, etc.

SOUTHERN HARDWOODS.

Table listing various lumber companies under Southern Hardwoods, including Advance Lumber Company, American Lumber Company, American Lumber & Mfg. Company, etc.

Love, Boyd & Co....

Table listing various lumber companies under Love, Boyd & Co., including McClure Lumber Company, McIlvain, J. Gibson, & Co., McLean, Hugh, Lumber Company, etc.

POPLAR.

Table listing various lumber companies under Poplar, including Advance Lumber Company, Atlantic Lumber Company, Brown, W. P., & Sons, Lumber Co., etc.

COTTONWOOD AND GUM.

Table listing various lumber companies under Cottonwood and Gum, including Anderson-Tully Company, Bacon-Nolan Hardwood Company, etc.

CYPRESS.

Table listing various lumber companies under Cypress, including Crandall & Brown, Cypress Lumber Company, Hafner Manufacturing Company, etc.

HARDWOOD FLOORING.

Table listing various flooring companies under Hardwood Flooring, including Bliss & Van Auker, Carrier Lbr. & Mfg. Company, Cobbs & Mitchell, Inc., etc.

SAW MILL MACHINERY.

Table listing various machinery companies under Saw Mill Machinery, including Mershon Company, The, Phoenix Manufacturing Company, etc.

WOODWORKING MACHINERY

Table listing various machinery companies under Woodworking Machinery, including American Wood Working Machinery Company, Berlin Machine Works, etc.

VENEER MACHINERY.

Table listing various machinery companies under Veneer Machinery, including Coe Manufacturing Company, etc.

LOGGING MACHINERY.

Table listing various machinery companies under Logging Machinery, including Clyde Iron Works, Lidgerwood Manufacturing Company, etc.

DRY KILNS AND BLOWERS

Table listing various machinery companies under Dry Kilns and Blowers, including Grand Rapids Veneer Works, Morton Dry Kiln Company, etc.

LUMBER INSURANCE.

Table listing various insurance companies under Lumber Insurance, including Adirondack Fire Insurance Company, Lumber Insurance Company of New York, etc.

SAWS, KNIVES AND SUPPLIES

Table listing various supply companies under Saws, Knives and Supplies, including Atkins, E. C., & Co., Champion Saw Company, etc.

MISCELLANEOUS.

Table listing various miscellaneous companies, including Barroll, H. C., & Co., Gibbs, S. D., & Co., Gillette Roller Bearing Co., etc.

CHICAGO VENEER COMPANY

(INCORPORATED)

BURNSIDE, KENTUCKY

Bored Poplar Posts for Porch Columns

66 to 96 INCHES LONG, 8 and 10 INCHES DIAMETER

Write us for Prices and Particulars



**WALNUT.  
OAK,  
ASH,  
POPLAR.**

You want to reach Buyers of

**FURNITURE LUMBER**

**The HARDWOOD RECORD**

will do it for you.

**Novelties for Advertisers**

FOBS, POCKET PIECES,  
BUTTONS,  
LETTER OPENERS, SCARF PINS,  
TRAYS, ALUMINUM GOODS,  
PAPER WEIGHTS.

**ALL NEW IDEAS**

Send us 50c and we will send you a  
Beautiful Watch Fob

**S. D. CHILDS & CO.**  
200 Clark Street, CHICAGO

**Locations for  
Industries**

ON  
**THE ERIE, THE COMMERCIAL RAILROAD**  
CHICAGO TO NEW YORK

The Erie Railroad System's Industrial Department has all the territory traversed by the railroad districted in relation to resources, markets and advantages for manufacturing, can advise with manufacturers of specific products as to suitable locations, and furnish them with current information of a comprehensive nature dealing with the project in its full relation to manufacture and commerce.

The Erie is one of the greatest of trunk lines. Its own rails connect the two largest cities of America. Every section of the System has its particular merits. Profitable locations exist. It has great general and coal, oil and natural gas resources.

It is important in this age of modern facilities for manufacturers to locate where they can obtain side tracks so as to receive from and ship directly into cars at the factory. Information can be promptly furnished in this connection about every point on the system between New York and Chicago.

Manufacturers' inquiries as to locations are treated in strict confidence and absolutely reliable information, so as to promote permanent traffic, is furnished. Address

**LUIS JACKSON**  
Industrial Commissioner  
Erie Railroad Company  
11 Broadway, New York

**HARDWOOD  
TIMBER**

There is no section with so fine and large a supply of hardwood timbers of various kinds left for the lumbermen as that portion of the South in Alabama, Georgia, Kentucky, Mississippi, North Carolina, South Carolina, Tennessee and Virginia served by the lines of the

**Southern Railway  
and  
Mobile & Ohio Railroad**

There are oak, poplar, hickory, gum, cypress, ash, elm, buckeye, balsam, spruce, chestnut, and other varieties. There are also available pine lands. These timber resources and many other important features bearing on the cost of manufacture and marketing give special advantages and opportunities for EVERY KIND of WOOD USING INDUSTRY. We have information about the best locations in the country at towns in these States and in Southern Indiana and Southern Illinois, which will be given if requested. All correspondence in regard to timber lands or factory locations will be given prompt and confidential attention. Address your nearest agent.

M. V. RICHARDS,  
Land and Industrial Agent,  
Washington, D. C.

CHAS. S. CHASE, Agent,  
622 Chemical Building,  
St. Louis, Mo.

M. A. HAYS, Agent,  
225 Dearborn Street,  
Chicago, Ill.

**Save Your Money**

By Using the

**RED BOOK**

Published Semi-Annually  
in January and July

It contains a carefully prepared list of the buyers of lumber in car lots, both among the dealers and manufacturers.

The book indicates their financial standing and manner of meeting obligations. Covers the UNITED STATES and MANTOBA.

The trade recognizes this book as the authority on the lines it covers.

A well organized Collection Department is also operated and the same is open to you.

WRITE FOR TERMS.

**Lumbermen's Credit Association**  
ESTABLISHED 1878

1405 Great Northern Building, : CHICAGO  
16 Beaver Street, : NEW YORK CITY

MENTION THIS PAPER

**YOUR VACATION**

WHERE TO GO  
HOW TO GET THERE  
AND WHAT IT WILL COST

All this will be found in the book of specially selected vacation tours, combining rail and water routes,  
ISSUED BY THE

**MICHIGAN CENTRAL**

"The Niagara Falls Route"  
SEND FOR A COPY NOW

W. J. LYNCH,  
Pass. Traffic Mgr.,



CHICAGO

O. W. RUGGLES,  
Gen'l Pass. Agt.,

**A floor to adore**



For thirty-three years Wilce's Hardwood Flooring has been among the foremost on the market and because it stands today "unequaled" is the best evidence that its manufacturer has kept abreast of modern methods and the advanced demands of the trade. To convince yourself of the above statements, try our polished surface flooring, tongued and grooved, hollow backed, with matched ends and holes for blind nailing—you'll find it reduces the expense of laying and polishing.

Our Booklet tells all about Hardwood Flooring and how to care for it—also prices—and is free.

**The T. Wilce Company**  
22nd and Throop Sts. CHICAGO, ILL.

# R. E. Wood Lumber Company

☐ We own nearly a thousand million feet of virgin poplar, oak, chestnut and other hardwood timber, and operate our own band mills in West Virginia, Tennessee, North Carolina and South Carolina.

☐ Let us figure on your hardwood requirements.

GENERAL OFFICES:  
CONTINENTAL BUILDING.

Baltimore, Maryland

# Schultz Brothers & Cowen

WE ARE IN THE MARKET TO BUY

POPLAR—OAK—ASH—CHESTNUT

AND OTHER HARDWOODS—ALL GRADES AND THICKNESSES

1225 to 1240 OLD COLONY BUILDING,

CHICAGO

# History Repeats Itself

☐ From nominal values, White Pine timber property has achieved monumental figures.

☐ From cheap Yellow Pine stumpage, the advance in price has made fortunes.

☐ The same history is about to be repeated in Pacific Coast Timber and in the Hardwoods of the Middle South.

☐ We have made fortunes for others. We offer you our expert services. Let us know your timber wants.

## JAMES D. LACEY & CO.

608 Hennen Building,  
NEW ORLEANS

507 Lumber Exchange Building,  
SEATTLE, WASH.

1200 Old Colony Bldg.,  
CHICAGO

# "DEFIANCE" WOOD-WORKING MACHINERY

COMPLETE EQUIPMENTS OF  
**HIGH GRADE TOOLS**

✧ FOR MAKING ✧

Hubs, Spokes, Wheels,  
Wagons, Carriages,  
Rims, Shalts, Poles,  
Neck-Yokes,

Single Trees, Hoops,  
Handles, Bobbins, Spools,  
Insulator Pins and  
Oval Wood Dishes.

INVENTED AND BUILT BY  
**The DEFIANCE MACHINE WORKS**  
DEFIANCE, OHIO.

Send for 500 Page Catalogue

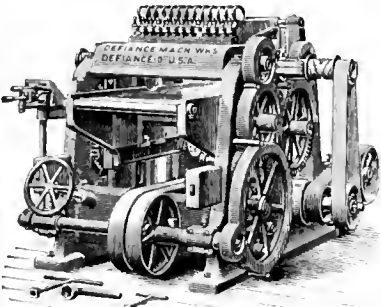

26" SINGLE SURFACER

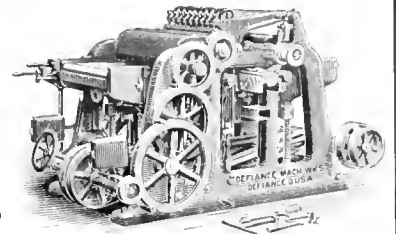

26" DOUBLE SURFACER

## A machine that declares saw mill dividends



AUTOMATIC SWING SAW GAUGE.

☐ An inexpensive little device that *saves a dollar a day* and upwards.

☐ Stops one of the biggest profit leaks at the mill. Pays for itself several times over during a year.

☐ Isn't it worth investigating?

**FRANCIS MARSHALL, - - Grand Rapids, Mich.**

## The Morton Dry Kiln

MOIST AIR SYSTEM

Recording Thermometers. Transfer Cars.



Trucks. Canvas. Doors.

**HOW TO DRY LUMBER**

As exemplified in our Catalog D. Free on application.

**MORTON DRY KILN CO., Chicago, Ills.**

## Ten per cent More Profit

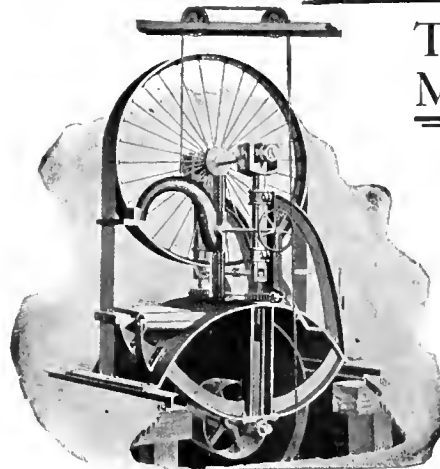

The profits of a saw mill can readily be increased ten per cent by using a band mill instead of a rotary. The price of this mill with six foot wheels for saws eight inches wide is readily within the reach of all. It cuts smooth and perfect lumber and has a capacity of 25,000 feet to 35,000 feet per day. It runs with less expenditure of power than a rotary and puts only half as much of the log into saw dust as does the circular saw.

**PHOENIX MFG. COMPANY,**  
EAU CLAIRE, WIS.

## KNIVES

A man who has been in the presence of angels discloses the fact by his action: Just one reason for our talking good machine knives, good veneer knives or knives of any kind that do good work.

**CHAMPION SAW COMPANY,**  
BEAVER FALLS, PA.



**THE  
HAPPY  
WOODSMAN**



# ATKINS

TRADE  
SILVER-STEEL  
MARK

# SAWS

are happy saws all the way round. They run easier, cut faster, and go longer without sharpening than any other

A PERFECT SAW FOR EVERY PURPOSE.  
YOUR JOBBER HAS THEM OR WRITE US.

## E. C. ATKINS & CO., Inc.

THE SILVER STEEL SAW PEOPLE

HOME OFFICE AND FACTORY, INDIANAPOLIS, U. S. A.

Branches: Atlanta, Chicago, Memphis, Minneapolis, New York City, New Orleans, Portland, San Francisco, Seattle, Toronto.

# MERSHON

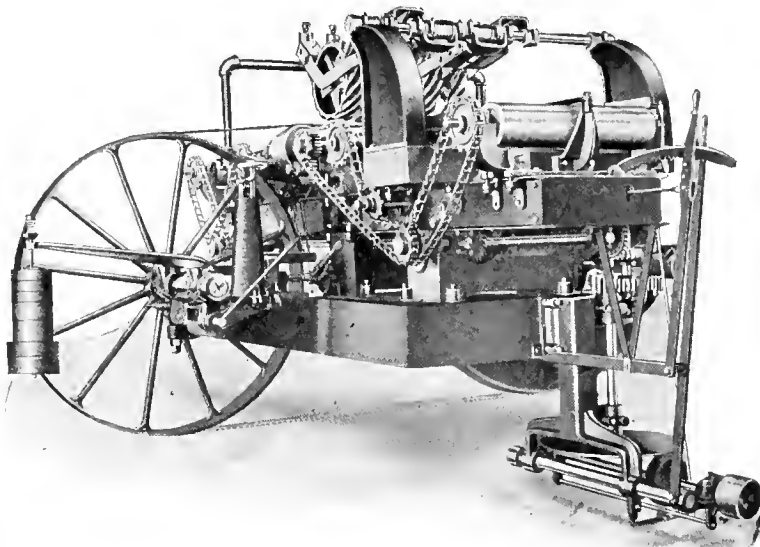

MERSHON NEW HORIZONTAL BAND RESAW FOR SAW MILLS

Band Resawing  
Machinery  
for all requirements

**WM. B. MERSHON  
& CO.,**

**Saginaw, = Michigan**

ALLIS-CHALMERS COMPANY, Seattle, Wash., Agents for Northern Pacific Territory.

THE EBY MACHINERY CO., San Francisco, Cal., Agents for California and Nevada.

**SMITH of  
SMITHVILLE**

**The Profit Builder**

**SMITH of  
SMITHVILLE**

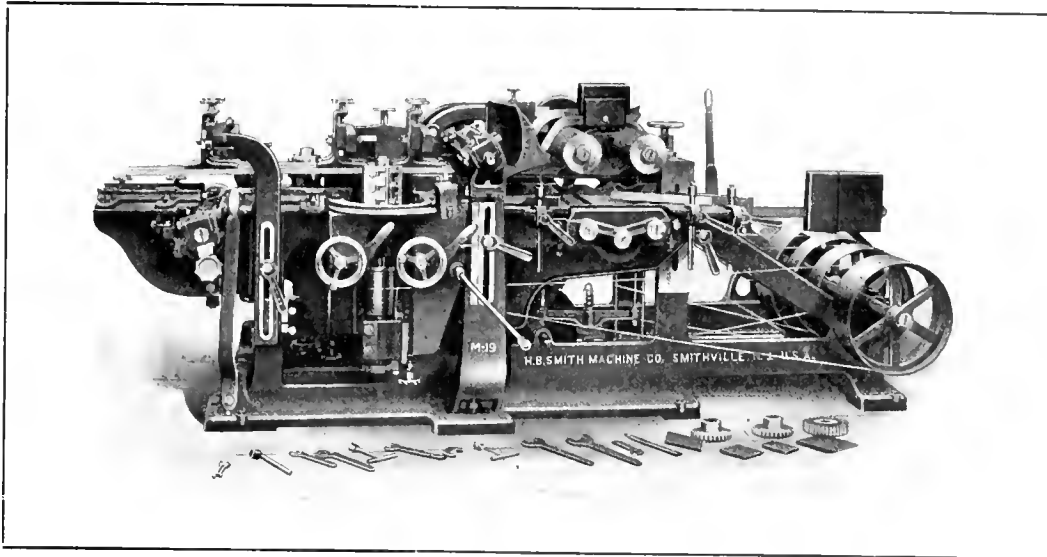

NO. 105-A, EXTRA HEAVY 12-INCH MOULDER



IT HAS been our purpose during the last half century to develop a line of wood working machines containing the best workmanship and material that American skill and wisdom can afford. This fact we are proud to say is well established in the minds of our many patrons. We have, however, now exceeded ourselves by the development of a remarkable Moulder, the excellence of which is due to our obtaining written suggestions from more than a thousand operators throughout America. This machine stands alone as being the composite idea of the thinking operators of this country. One year's test of its work has convinced us that it is impossible for you to compete successfully against the Smith Moulder with any other machine. Can't we send you prices and literature?

**Branches:**  
New York, Chicago,  
Boston

**H. B. SMITH MACHINE CO.**  
SMITHVILLE, N. J., U. S. A.

**Branches:**  
New York, Chicago,  
Boston



THE COMBINATION OF MECHANICAL PRINCIPLES  
FOUND IN

## The Shimer Cutter Head



Has forced it to the front as a never failing wood cutting tool to make single tongue and groove Flooring, Ceiling, Siding and Wainscoting.

It applies especially to the various patterns that come within the line of mill work where irregular and square offsets occur. We duplicate Cutters to the nicety and turnish at uniformly low prices. All kinds of knotty and cross-grained lumber is neatly and smoothly finished using faster feeds—reduced costs.

**SAMUEL J. SHIMER & SONS, - - Milton, Penn.**

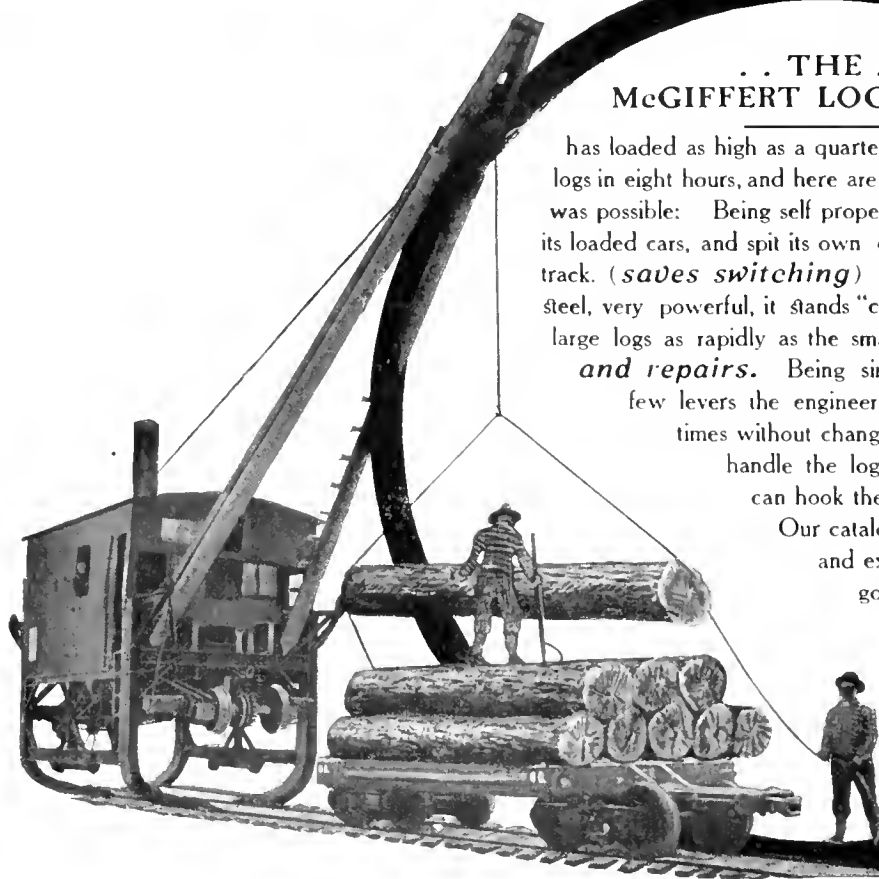

### ... THE ... McGIFFERT LOG LOADER

has loaded as high as a quarter of a million feet of logs in eight hours, and here are a few reasons why it was possible: Being self propelling it can move itself, its loaded cars, and spit its own empties, all on the same track. (*saves switching*) Constructed entirely of steel, very powerful, it stands "crowding" and handles the large logs as rapidly as the small. *It saves money and repairs.* Being simple in operation and of few levers the engineer has absolute control at all times without changing his position, and can handle the logs as rapidly as the men can hook them. *saves time*

Our catalogue clearly illustrates and explains many other good points.

Manufactured by  
**CLYDE IRON  
WORKS,**  
Duluth,  
Minn.

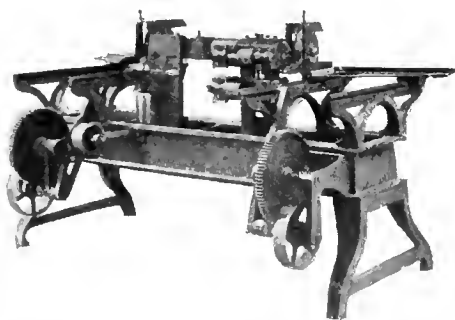

## New Type of Combined End Matcher

SAVES 20 PER CENT. TIME, COST AND LABOR.  
USED BY THE LARGEST FLOORING CONCERNS.

Write for particulars to

**A. J. SCHINDLER, 441-443 W. 21st Street, CHICAGO**

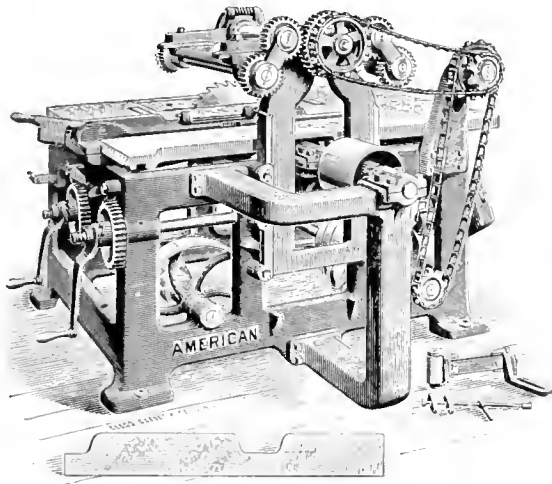

# No. 1 American Self-Feed Circular Rip Saw

Capacity, up to 20 in. wide and to 6 in thick. Instantaneous adjustment for feed works or table. Self-locking positive clamp on ripping gauge. Regarding other features address nearest salesroom.

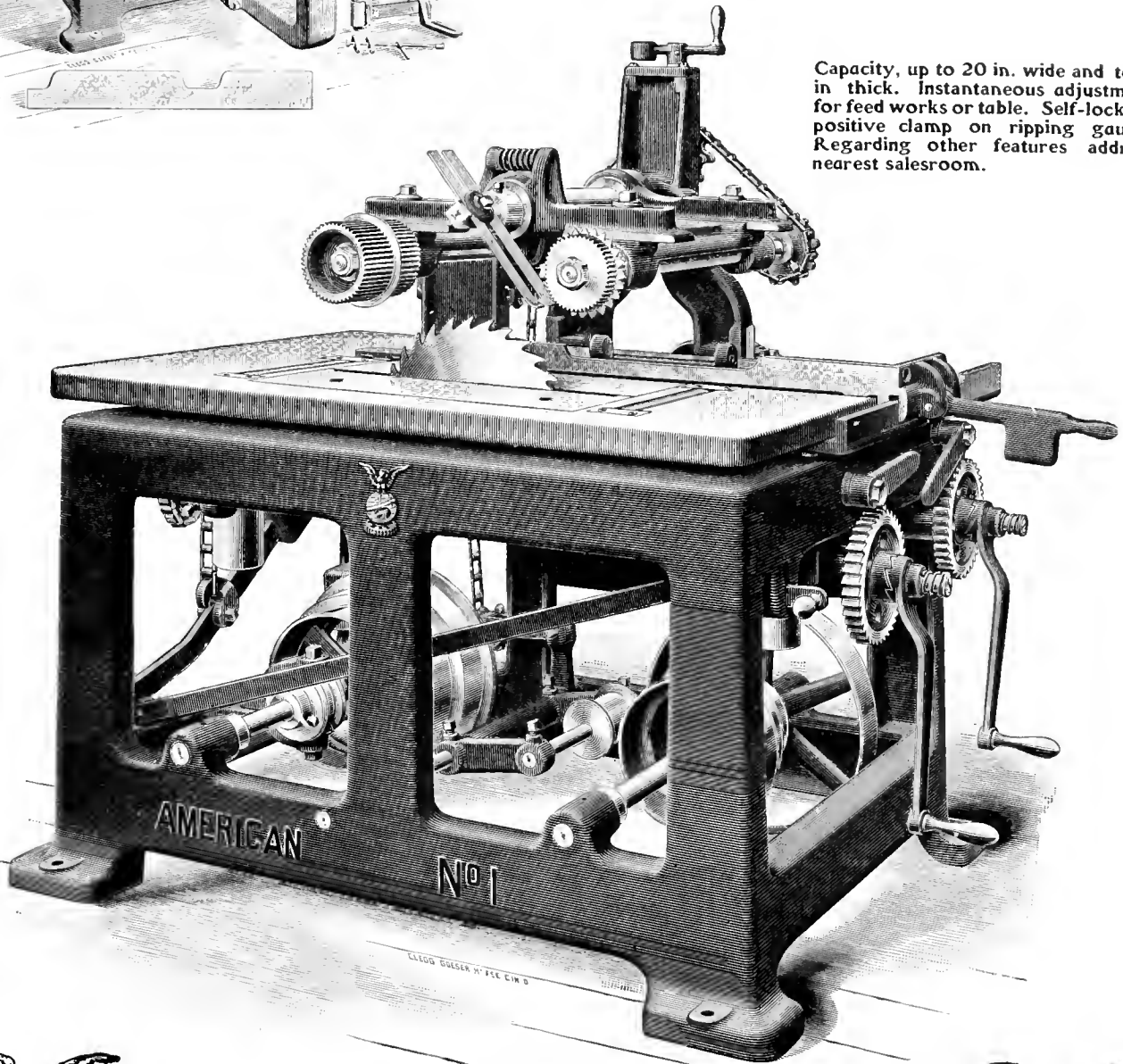

## American Wood Working Machinery Co.

New Orleans

Chicago

New York



We Guarantee  
to  
**KILN DRY OAK**

**IN A WEEK**

by the application of a  
new scientific principle

IN YOUR PRESENT  
**Old Kilns**

Grand Rapids Veneer Works  
DEPT. D., GRAND RAPIDS, MICH.

**A Valuable R Free**

¶ In cases of profit-killing costs in lumber handling, take the following: The Gillette Lumber Cart; ingredients, good material—honest workmanship—the Gillette Roller Bearing Axle. Increase the quantity or add a haul-off rig if necessary. Immediate relief guaranteed. Sample treatment—one cart on approval. Best in the world. Ask us why.

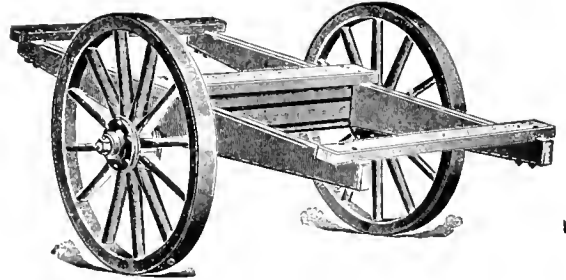

**Gillette  
Roller Bearing Company**

Patentees and Sole Manufacturers  
Grand Rapids, - - Michigan

**SAWS**

I tell you, Mr. Mill Man, there is merit in these saws. Dependable stuff that is made right, will work right, and last the life of good saw material.

**CHAMPION SAW CO.**

BEAVER FALLS, PA.

**UP=TO=DATE**

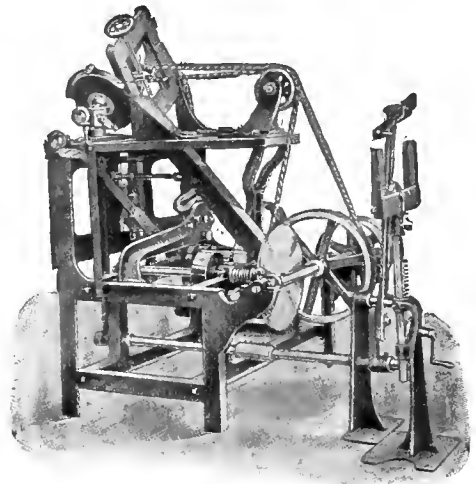

**Hanchett Automatic Band Saw Sharpener**

This is one of our full line of modern filing room machinery. Let us send you our new Catalogue No. 10.

**HANCHETT SWAGE WORKS**

BIG RAPIDS, MICH.



## The Coe Knife Grinder

was designed for the finest grinding and most exacting service. It is built on new lines and has completely overcome the objections to other grinders. The knife is held rigidly while the stone travels back and forth. There is no chance for

vibration, consequently no unevenly ground knives. Entirely automatic in ac-



tion, no ropes or chains. All moving parts operated by cut steel gears, noiseless in operation, will grind straight or hollow bevel. Feeds 1-1000 to 4-1000 for each travel of the stone, very heavy and compact, occupying small floor space. Made in seven sizes to grind up to 168 in.

It is fully described in our catalog No. 5, which we will be glad to send to interested parties.

**The Coe Manufacturing Co.** 105 Bernard Street **Painesville, O.**



**Skidders**

**Snakers**

**Lidgerwood Machines  
Will Stock Your Mill**

**Lidgerwood Skidders  
Lidgerwood Snakers  
Lidgerwood Yarders  
Lidgerwood Roaders  
Lidgerwood Pull Boats  
Lidgerwood Cableways**

**LIDGERWOOD MFG. CO.**

**NEW YORK  
ATLANTA  
SEATTLE  
NEW ORLEANS**

**Loaders**

**Cableways**

**EASTERN TENNESSEE—WESTERN NO. CAROLINA**

ASHEVILLE KNOXVILLE BRISTOL

**Fry-Buchanan Lumber Co.**

INCORPORATED.

Manufacturers and Wholesalers  
**Hardwood Lumber**

Choicest Varieties. ∴ Full Grades.

POPLAR SQUARES  
A Specialty.

Asheville, N. C.

**On the Spot**

We are located right in the heart of this mountain country producing the best hardwoods in existence.

We are headquarters with ample stock, and can interest you both as to assortment and price. Write us.

**American Lumber Company**

ASHEVILLE, N. C.

**HARDWOODS**

From the famous Asheville district. Superior in quality, manufacture and gradings. For stock list and prices, address

**J. S. COLEMAN LUMBER CO.**

ASHEVILLE, N. C.

**Vestal Lumber & Mfg. Co.**

Manufacturers and Wholesalers  
of all kinds of

**HARDWOODS**

BEVELED SIDING A SPECIALTY.  
UNSURPASSED FACILITIES  
FOR DELIVERING.

Knoxville  
Tennessee

**All Lumbermen, Attention!**

We do what you can't do.  
We measure your stumpage correctly.  
We make your maps correctly.  
Bank references: Asheville, N. C.

**C. A. Schenck & Co.** Biltmore, North Carolina.

**SYMBOLS for GRADE MARKS**

○  
△  
A  
B  
2  
S

Adopted by the Hardwood Manufacturers Association of United States.  
Every Manufacturer should stamp the grade on his Lumber.

Set of 10 Rubber Stamps, 1 1/2"x1 1/2" in size, Pad, Pint of Ink, and Spreader, packed for shipment \$3.50.

**MARTIN & CO.**

191 S. Clark St., CHICAGO, or

**LEWIS DOSTER, Sec'y**

Panel and Wide No. 1  
Wide No. 2  
Box Boards  
F. A. S. or Firsts & Seconds  
Saps

1535 First Nat. Bank Bldg.  
CHICAGO

△  
①  
②  
③  
④  
Selects  
No. 1 Common  
No. 2 Common  
No. 3 Common  
No. 4 Common

**Wood Working Plants**

Manufacturers seeking locations for Saw Mills, Stave and Heading Factories and other Wood Working Plants in the Central Southern States, can secure full and accurate information as to Sites, Timber Tracts, Fuel, Transportation Facilities, etc., by addressing

G. A. PARK, General Immigration and Industrial Agent,  
**Louisville & Nashville Railroad Company**  
LOUISVILLE, KENTUCKY

**Industries are Offered Locations**

WITH SATISFACTORY INDUCEMENTS, FAVORABLE  
FREIGHT RATES, GOOD LABOR CONDITIONS  
HEALTHFUL COMMUNITIES, on the lines of

**The Illinois Central R. R. and the  
Yazoo & Mississippi Valley R. R.**

For full information and descriptive pamphlet address

J. C. CLAIR, Industrial Commissioner, 1 Park Row, Chicago, Ill.

# WISCONSIN

WHERE THE FINEST NORTHERN HARDWOODS GROW

## John R. Davis Lumber Company

PHILLIPS, WISCONSIN

The Leading Manufacturers

## Wisconsin Hardwoods

"SHAKELESS" HEMLOCK and WHITE CEDAR PRODUCTS

NOW READY

4 4 No. 1 COMMON AND BETTER BIRCH (RED IN)  
4 4 No. 1 COMMON AND BETTER HARD MAPLE  
4 4 No. 2 COMMON AND BETTER BLACK ASH

Write for our Price Lists  
and Stock Sheets

Mixed Cars, Even Grades  
Prompt Shipments

## Ingram Lumber Co.

WAUSAU, WIS.

## BASSWOOD, BIRCH

We cut four million feet of each annually  
Your inquiries and orders solicited

MILL AND YARDS AT INGRAM, WISCONSIN

## ARPIN HARDWOOD LUMBER CO.

GRAND RAPIDS, WISCONSIN

Saw and Planing Mill at Atlanta, near Bruce, Wis., on Soo Lines.

WRITE FOR OUR PRICES ON

THREE INCH FLOORING

1 car Clear Plain Red Oak  
1 car Factory Red Oak  
3 cars Clear Birch  
1 car Factory Birch  
½ car Clear Red Birch  
3 cars Common Maple  
1 car Factory Maple

LUMBER

2 cars log run Hard Maple

BIRCH

2 cars 1" Com. and Bet. Curly Red  
1 car Com. and Bet. Red  
1 car 1½, 1½, 2" Curly  
2 cars 1½, 1½, 2" Com. & Bet. Red  
1 car 2" Plain log run  
1 car 2½ and 3" Plain

QUARTER SAWED RED OAK

2 cars 1½ and 1½" Com. and Bet.  
½ car 1½ and 2" Com. and Bet.

## VOLLMAR & BELOW

MARSHFIELD, WISCONSIN

## Basswood, Birch

and Other Wisconsin Hardwoods

LET US KNOW WHAT YOU ARE IN THE MARKET FOR

## NORTHERN STOCK

Hemlock  
Birch  
Basswood  
Rock Elm  
Soft Elm  
Ash  
Oak

## SOUTHERN STOCK

Quartered White and Red  
Oak  
Plain White and Red Oak  
Sycamore  
Poplar  
Cypress  
Gum

## PAGE & LANDECK LUMBER CO.

Wells Building - - - MILWAUKEE, WIS.

## North Western Lumber Co.

General Offices EAU CLAIRE, WIS. Mills at STANLEY, WIS.

BAND SAWED

## Wisconsin Hardwoods

CAREFUL GRADINGS, PROMPT SHIPMENTS

SPECIAL OFFERINGS:

3 cars 1½" to 2" Scoot Hardwood. ½ car 2" 1st and 2d Clear Basswood.  
1 car 1½" No. 1 Common Basswood. Large stock No. 2 Common Birch.  
1 car 1½" 1st and 2d Clear Basswood. Large stock No. 3 Common Birch.

## C. P. CROSBY

RHINELANDER : : WISCONSIN

## Wholesale Hardwood Lumber

Hard Maple a Specialty in all thicknesses from 1 inch  
to 4 inch. Finest Birch in Wisconsin. Black Ash,  
Rock Elm, Soft Elm, Red and White Oak. : :

DIFFICULT AND MIXED ORDERS A SPECIALTY

## HARDWOOD LUMBER-- NORTHERN AND SOUTHERN

All kinds of Northern and Southern Hardwoods for sale.

We call your attention to the following items which we have to offer, to-wit:

50M ft. 1" Curly Birch	30M ft. 1½" No. 2 Com. & Bet. Hickory
50M ft. 2" Com. and Bet. Plain Birch	30M ft. 1½" No. 2 Com. & Bet. Hickory
80M ft. 2½" Com. and Bet. Plain Birch	100M ft. 1" Com. & Bet. Plain Red Oak
150M ft. 1" No. 1 Com. Plain Birch	150M ft. 1" Com. & Bet. Qtd. Red Oak
12M ft. 2" 1sts and 2nds Red Birch	10M ft. 1" No. 3 Com. & Bet. Walnut
200M ft. 1" Com. and Bet. Hard Maple	75M ft. 1½" No. 2 Com. & Bet. Elm
200M ft. 2" Com. and Bet. Hard Maple	150M ft. 1" No. 1 Com. Red Gum
50M ft. 2" Bridge Plank—Oak	

In addition to the foregoing, we have full stocks of Basswood, Birch and Soft Elm and a full selection of Red and Sap Gum. We guarantee our grades to be made strictly in accordance with National Hardwood Association rules of inspection.

**G. W. JONES LUMBER CO., Appleton, Wis.**

CHICAGO OFFICE: 1717 RAILWAY EXCHANGE.

**CLEVELAND**

HARDWOOD DISTRIBUTING CENTER OF NORTHERN OHIO

**Do You Want It?  
What?  
Money?**

What have you in lumber to exchange for it? We want particularly Plain Oak, Chestnut, Poplar, Basswood, Ash.

**What Have You?**

**The Advance Lumber Co.**

13th Floor  
Rockefeller Bldg. CLEVELAND, OHIO

Memphis Office, No. 56 Randolph Building. J. E. MEADOWS, Mgr.

**THE  
ROBERT H. JENKS LUMBER  
COMPANY**

**FOR SALE**

60 M feet 1" 1st and 2ds Poplar  
223 M feet 1" No. 1 Common Poplar  
125 M feet 1" No. 2 Common Poplar  
25 M feet 2" 1st and 2nd Poplar, 14" and up  
125 M feet 8 4" Sound Wormy Chestnut  
275 M feet 1" Sound Wormy Chestnut  
153 M feet 1" 1st and 2nd Plain White Oak  
85 M feet 1" 1st and 2nd Plain Red Oak  
125 M feet 1" No. 1 Common Plain Red Oak

**Quartered White and Red Oak.**—We have a good assortment of dry stock,  $\frac{3}{8}$  to 4 inches thick. Your inquiries solicited.

**Plain White and Red Oak.**—A limited amount of nice stock, ready for shipment.

**E. H. FALL**

EXPORTER  
OF

**WALNUT, POPLAR  
AND  
BIRDSEYE MAPLE LOGS**

Cash paid for Black Walnut Logs at point of shipment. If you have any walnut logs to offer, write me.

I have some Sycamore, Red Oak, Ash and other hardwood logs which I am prepared to saw to order. Correspondence solicited.

Can also supply Black Walnut lumber, sawed to any specification required.

**PORT CLINTON : OHIO**

**The Martin-Barriss Company**

Importers and Manufacturers

**MAHOGANY**

**and Fine Hardwoods**

**TO NEW YORK OVER NIGHT**

**The 20th Century Limited**

Via the LAKE SHORE and NEW YORK CENTRAL  
The Route of the Government Fast Mail Trains

**CHICAGO - NEW YORK 18-HOUR TRAIN  
IT SAVES A DAY**

FROM LA SALLE ST. STATION  
CHICAGO

Leave Chicago at 2.30 p. m.  
Arrive New York at 9.30 a. m.

FROM GRAND CENTRAL STATION  
THE ONLY TERMINAL IN NEW YORK

Leave New York at 3.30 p. m.  
Arrive Chicago at 8.30 a. m.

W. J. LYNCH, Passenger Traffic Manager, Chicago, Ill.

# MICHIGAN

FAMOUS FOR HARD MAPLE AND GREY ELM

## BROWNLEE & COMPANY

DETROIT MICHIGAN

*Our Bargain Counter:*

BASSWOOD 4-4 to 8-4	SOFT ELM 6-4 log run 12-4 No. 1 Common
BIRCH 4-4 No. 1 and 2 Common	HARD MAPLE 12-4 No. 1 Common

## Evans & Retting Lumber Co.

Manufacturers and Wholesale Dealers

### Hardwood Lumber

RAILROAD TIMBERS, TIES AND SWITCH TIES

541 and 543  
Michigan Trust Building

Grand Rapids, Mich.

W. H. WHITE, Pres.  
JAS. A. WHITE, Vice-Pres.

W. L. MARTIN, Secy.  
THOS. WHITE, Treas.

## W. H. WHITE COMPANY

BOYNE CITY, MICHIGAN

Manufacturers of Hardwood and Hemlock Lumber, Cedar Shingles,  
White Rock Maple Flooring.

## The North Shore Lumber Co.

MANUFACTURERS

Hardwood and Hemlock  
Lumber, Cedar Products

Rail and water shipments

THOMPSON :: :: MICHIGAN

## DENNIS & SMITH LUMBER CO.

Wholesale Hardwood Lumber

Office and Yards, FOURTH AND HOLDEN AVENUES,  
DETROIT, MICH.

MILLS AT: Heaters, W. Va. Valley Bend, W. Va. Diana, W. Va. Parkersburg,  
W. Va. McNutt Siding, W. Va.

## SALLING, HANSON & CO.

MANUFACTURERS OF

Michigan Hardwoods

GRAYLING, MICHIGAN

## "Chief Brand" Maple Flooring

Will commend itself to you and your trade on its merits alone. \* Comprises all the features desirable in good flooring. \* Made by the latest, most approved machinery methods and best skilled labor. \* We believe we can make it to your interest to handle our "Chief Brand" and will appreciate your inquiries.

**Kerry & Hanson Flooring Co.**  
GRAYLING, MICHIGAN

**M I C H I G A N**  
FAMOUS FOR RED BIRCH AND BASSWOOD

**DENNIS BROS.**  
GRAND RAPIDS, MICHIGAN

**HARDWOOD LUMBER (by water or rail)  
"NATIONAL" MAPLE & BIRCH FLOORING**

SPECIAL BARGAINS IN THE FOLLOWING:  
300M feet 4 4 Log Run Birch  
186M feet 5 4 Log Run Birch  
1 Car 8 4 No. 1 Com. Birch  
1 Car 1 4 Clear Birch  
50M feet 4 4 No. 1 Com. Sap Birch  
40M feet 4 4 No. 1 Com. Red Birch  
All thicknesses and grades Hard Maple  
150M feet 5 4 Log Run Beech  
2 Cars 4 4 No. 3 Com. Cherry

Main Office :  
205-209 Michigan  
Trust  
Company  
Building

**Thos. MacBride Lumber Company**

HEADQUARTERS FOR  
**HARDWOODS**  
IN MICHIGAN

Michigan Trust Building, Grand Rapids, Mich.

**BIRCH**

This is our specialty. We are in the heart of the best Birch section. Have good stock, Common and better, 4-4, 5-4, 6-4, 8-4, 10-4, 12-4, and 16-4. Let us figure with you.

**Simmons Lumber Company**  
SIMMONS, MICHIGAN

**McCLURE LUMBER COMPANY**

MANUFACTURERS OF  
**Hardwoods**

Main Offices, DETROIT, MICH.  
Mills, EUTAW, ALA.

SPECIAL OFFERINGS:  
3 cars 2" Red and White Oak      2 cars 2" Black Ash  
3 cars 2", 2 1/2", 3" and 4" White Ash      10 cars 1" to 4" Dry Hard Maple  
2 cars 1" 6, 4 White Ash      5 cars 1" Log Run Birch  
1 car 6 4 and 8 4 Hickory

**SOFT ELM AND ROCK ELM**  
FOR SALE BY  
**The R. G. Peters Salt & Lumber Co.**  
EASTLAKE, MICHIGAN

**VAN KEULEN & WILKINSON LUMBER COMPANY**  
Manufacturers and Wholesalers of  
**HARDWOOD LUMBER and CRATING STOCK**  
Complete Stocks of Michigan Hardwoods—Maple, Beech, Birch, Elm, Ash and Basswood for sale.  
Grand Rapids, Michigan

**BOYNE CITY LUMBER COMPANY**  
BOYNE CITY  
**MICHIGAN ROCK MAPLE and other HARDWOODS**  
LARGE CAPACITY    PROMPT SHIPMENTS    RAIL OR CARGO

 **J. S. GOLDIE**  
Cadillac, Michigan.

SPECIAL PRICES on 500M pieces  
1" to 3" Maple Squares 16" to 27" long.  
1" to 3" Soft Elm Lumber.  
INQUIRIES SOLICITED FOR MICHIGAN LUMBER.

**OUR MAPLE FLOORING**

is as near perfection, in every particular, as it is possible to make it, for we personally supervise every step in its manufacture, from the stump to the shipping of the finished product. Our prices will interest and a trial convince you.

**HAAK LUMBER COMPANY**  
HAAKWOOD, MICHIGAN

**Hackley-Phelps-Bonnell Co.**

MANUFACTURERS OF

**Northern and Southern  
Hardwood Lumber**

Main Office, Michigan Trust Company Building  
GRAND RAPIDS MICHIGAN



# CINCINNATI

THE GATEWAY OF THE SOUTH

FRAMES,  
SASH, DOORS,  
BLINDS, MOULDINGS,  
COLUMNS, GLASS,  
STAIRWORK,  
INTERIOR TRIM.



PAINTS,  
BUILDERS' HARDWARE,  
MANTELS, ETC.  
LARGE CINCINNATI FAC-  
TORIES MAKE PROMPT  
SHIPMENTS POSSIBLE.

## CYPRESS LUMBER CO.

Manufacturer of Hardwoods and Cypress

Plain and Quartered White and Red Oak, Yellow Poplar,  
Yellow Pine, Walnut, etc. Mills in Tenn., Ala. and Va.

OFFICE AND YARDS, GEST AND DALTON AVE., CINCINNATI, OHIO.

## PLAIN OAK—BASSWOOD

Are what we want. All thicknesses and grades. Spot  
cash. Send us list of your offerings with prices.

DUHLMEIER BROS., CINCINNATI, O.

## "BUY GUM"

We are in the market to buy  
Dry Gum Lumber in any  
quantity, from a single car  
load to a million feet. Will  
take all grades and thick-  
nesses. We receive lumber  
at shipping point, pay cash  
and are liberal in inspection.



## THE FARRIN-KORN LUMBER COMPANY

General Office, Yards,  
Planing Mills, Dry Kilns,  
Cincinnati, Ohio  
Purchasing Office,  
Randolph Building,  
Memphis, Tenn.  
Cypress Red Gum Oak

# W. H. Dawkins Lumber Co.

Manufacturers of Band Sawed

## Yellow Poplar

ASHLAND, KY.

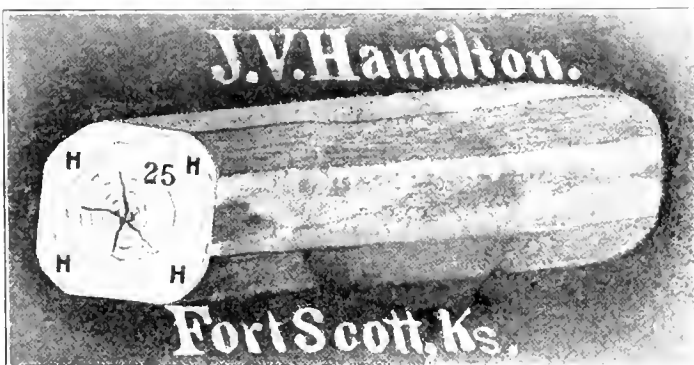

Export logs a specialty, dressed or in the round. WRITE ME.

## THE GENERAL LUMBER COMPANY

**HARDWOODS**  
HEMLOCK, YELLOW PINE.

COLUMBUS OHIO

## LANE-WHITE LUMBER CO.

OAK, ASH AND WALNUT **Hardwoods** ALWAYS IN THE MARKET  
OUR SPECIALTY FOR WALNUT LOGS

MAIN OFFICE AND BAND MILL at FORT SMITH, ARK.

## LOCATIONS FOR NEW INDUSTRIES

can be secured on the lines of the

## Chicago, Milwaukee & St. Paul Railway

in the great middle west. It reaches the Copper Country and the  
pine and hardwood areas of Northern Michigan, the lead, zinc and  
iron regions of Wisconsin, the coal fields of Illinois, Iowa and  
Missouri.

Traverses the great agricultural and manufacturing states of  
Iowa, Minnesota, North and South Dakota. Operates 7,000 miles of  
thoroughly equipped railroad.

Correspondence is solicited with eastern manufacturers who de-  
sire to move their factories to, or establish branches in the West.  
Co-operation with Business Men's Associations on the lines of this  
railway in all matters affecting mutual interests is assured.

Inquiries should be as definite as possible.

Address

**Industrial Department**  
Chicago, Milwaukee & St. Paul Railway,  
Room 1327, Railway Exchange  
Chicago

**CINCINNATI**

THE GATEWAY OF THE SOUTH

**THE WIBORG & HANNA COMPANY**

CINCINNATI, OHIO

PLAIN  
AND  
QUARTER  
SAWED

**White and Red Oak**

CHESTNUT  
POPLAR  
GUM AND  
CYPRESS

Flooring, Siding, Ceiling, Base, Case and Molding. Rough, Dressed and Re-sawed. Mixed Carloads.

**THE  
MALEY, THOMPSON & MOFFETT CO.**

Always in the Market for  
**BLACK WALNUT LOGS,  
SELECTED WHITE OAK LOGS,  
LUMBER OF ALL KINDS.**

CINCINNATI, : : : OHIO

WHAT HAVE YOU FOR SALE IN

Red and White **OAK** Qtd. and Plain

ALSO POPLAR, CHESTNUT, WALNUT, ETC

JOHN DULWEBER & CO., CINCINNATI, OHIO

Cash buyers for stock in our line.

**Cincinnati Hardwood Lumber Co.**

GENT AND SUMMIT STREETS

Wholesalers Mahogany, Thin Lumber, Veneers

Finely figured quarter sawed oak veneers a specialty.

**WANTED**

**Oak  
Walnut  
Gum  
Cottonwood  
Poplar  
White Pine  
Hemlock  
Yellow Pine**

Will inspect at shipping point when quantity justifies and pay cash. Can use entire mill cuts. Write us before selling elsewhere. We can also handle mixed cars of dressed stock. Send us your list with prices.

**Kentucky Lumber Co.**

Suite 508 First National Bank Bldg  
Cincinnati, Ohio.  
Formerly of Burnside Ky

**THE E. E. BECK LUMBER COMPANY**

Cash Buyers

**Poplar, Oak, Chestnut**

And Other southern Hardwoods

ALL GRADES AND THICKNESSES. WE BUY MILL CUTS.

Poplar, Oak,  
Ash, Chestnut,  
Sycamore,

**C. Crane & Co.**

We would like to buy

**2,000,000 feet Dry Oak  
2,000,000 feet Dry Poplar**

W. Va. Spruce,  
Pine and Elm

Mostly heavy stock. Quotations Solicited.

MILLS AND YARDS  
CINCINNATI, O.  
YEARLY CAPACITY  
100,000,000 FT.  
LONG BILL STUFF  
A SPECIALTY

— IN THE MARKET FOR —

**OAK—ASH—POPLAR**

ALL GRADES AND THICKNESSES

**MOWBRAY & ROBINSON**

Office:  
1219 West Sixth Street

Yards:  
Sixth Street, below Harriet

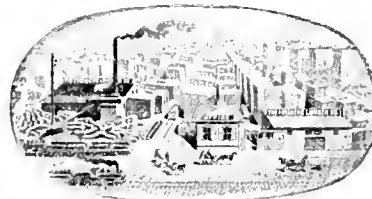

**THE FREIBERG LUMBER CO.**

Manufacturers of

**Tabasco Mahogany  
Walnut, Oak**

Poplar, McLean and Findlay Aves.  
CINCINNATI, O.

**L. W. RADINA & COMPANY**

Correspondence Solicited with Buyers and Sellers of All Kinds of

**HARDWOODS**

Wanted for cash—desirable blocks of 1 inch to 4 inch Poplar, all grades, Especially 1 1/2-inch stock, for immediate shipment.

— CLARK STREET AND DALTON AVENUE —



# INDIANA



WHERE THE BEST HARDWOODS GROW

THE WOODS FOR  
WHICH INDIANA  
IS FAMOUS.

## MALEY & WERTZ

Manufacturers, Wholesalers and Exporters of Hardwood Lumber  
EVANSVILLE, IND.

## FULLERTON-POWELL HARDWOOD LUMBER CO.

SOUTH BEND, IND.

## PERRINE-ARMSTRONG CO.

Long Timber up to 60 feet—Hardwood Specialties

The largest Band Mill in Indiana.

FORT WAYNE, IND.

## J. V. STIMSON

All Kinds of Hardwood Lumber Manufactured  
HUNTINGBURG, IND.

## YOUNG & CUTSINGER

Manufacturers and Wholesalers

Our Specialty Fine Figured Quartered Oak

EVANSVILLE, IND.

## CHARLES H. BARNABY

Manufacturer of Band Sawed Hardwoods

Quarter Sawed Indiana White Oak a Specialty

GREENCASTLE, IND.

## D'HEUR & SWAIN LUMBER CO.

Manufacturers and Wholesalers

Our Specialty Quartered Oak and Sycamore

SEYMOUR, IND.

## LONG-KNIGHT LUMBER CO.

MANUFACTURERS AND DEALERS

Quarter Sawed White and Red Oak a Specialty

INDIANAPOLIS, IND.

Quart'r'd White Oak

Plain White Oak

Quartered Red Oak

Plain Red Oak

White Ash

Poplar

Black Walnut

Cherry

Sycamore

Red Gum

Hickory

Beech

Maple

Veneers of

Indiana Hardwoods

# BUFFALO

THE GREAT WHOLESALE LUMBER CENTER OF THE EAST



Manufacturers and Dealers in

- Ash  
White and Brown
- Basswood
- Birch  
Red and White
- Butternut
- Cherry
- Chestnut
- Cottonwood
- Cypress
- Elm  
Soft and Rock
- Gum  
Red and Tupelo
- Hickory
- Maple  
Hard and Soft
- Red Oak  
Plain and Quartered
- White Oak  
Plain and Quartered
- Black Walnut
- White Wood  
Poplar



## I. N. STEWART & BROTHER

Specialties: CHERRY AND OAK

892 ELK STREET

## T. SULLIVAN & COMPANY

Specialties: BROWN ASH, BIRCH, PACIFIC COAST FIR AND SPRUCE

50 ARTHUR STREET

## ORSON E. YEAGER

Specialties: OAK, ASH AND POPLAR

932 ELK STREET

## BEYER, KNOX & COMPANY

ALL KINDS OF HARDWOODS

Office and Yards, 69 LEROY AVENUE

## BUFFALO HARDWOOD LUMBER CO.

We want to buy for cash:  
Oak, Ash and other Hardwoods, all grades and thicknesses.  
Will receive and inspect stock at shipping point.

518 RANDOLPH BLDG., MEMPHIS, TENN.

940 SENECA STREET.

## EMPIRE LUMBER COMPANY

Our specialties are PLAIN and QUARTERED OAK and ASH.

1142 SENECA STREET.

## G. ELIAS & BROTHER

BUY AND CARRY LARGE QUANTITIES OF ALL KINDS OF HARDWOODS

955 TO 1015 ELK STREET

## HUGH McLEAN LUMBER COMPANY

Specialty: INDIANA WHITE OAK

940 ELK STREET

## ANTHONY MILLER

HARDWOODS OF ALL KINDS

893 EAGLE STREET

## SCATCHERD & SON

HARDWOODS ONLY

Yard, 1555 SENECA STREET

Office, 886 ELLICOTT SQUARE

## STANDARD HARDWOOD LUMBER CO.

OAK, ASH AND CHESTNUT

1075 CLINTON STREET

# Vansant, Kitchen & Co.

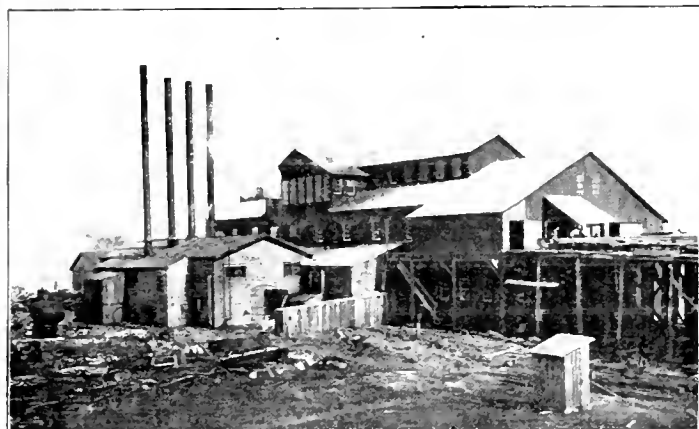

NEW ASHLAND MILL

Old-Fashioned

## SOFT YELLOW POPLAR

Ashland, Ky.

5-8 AND 4-4 IN WIDE STOCK, SPECIALTY

# YELLOW POPLAR

Manufacturers  
BAND SAWED  
POPLAR LUMBER

ALL GRADES

**DRY** 5-8, 4-4, 5-4, 6-4, 8-4, 10-4, 12-4, 16-4  
Bevel Siding, Lath and Squares  
Specialty, Wide Stock.

# LUMBER CO.

COAL GROVE, OHIO, U. S. A.

# W. M. Ritter Lumber Company

COLUMBUS, OHIO

## 6,000 Car Loads

Sawed and shipped yearly of band-sawed Yellow Poplar, White Pine, White Oak, Basswood, Chestnut, Hemlock and Ash. Planing Mills and Dry Kilns. ☐ If you are in a hurry to get your order placed, call our nearest salesman.

Salesman

Fred A. Wilson  
E. E. Eaton  
James B. Patton  
A. Wallace Irwin  
Frank B. Pryor  
E. E. Ginn  
A. J. Williams  
L. G. Anderson  
James H. Lang  
W. H. Matthias  
Geo. H. Haganir  
F. H. Browning  
W. T. Baker

Headquarters

Portsmouth, Ohio  
New York City, 158 W. 81st St.  
Buffalo, N. Y., Rockford Hotel  
Baltimore, Md., Eutaw Hotel  
Pittsburgh, Pa., 7th Avenue Hotel  
Jamestown, Ohio  
Cleveland, Ohio, Eastman, Detroit St.  
Franklin, Ohio  
Detroit, Mich., Hotel Ste. Claire  
Chicago, Ill., 1448 Addison St.  
Philadelphia, Pa., 901 N. 50th St.  
Columbus, Ohio  
Graham, Va.

Telephone

Bell 4392  
Riverside 7390  
Bryant 1335-R  
  
Bell Phone  
Ridge 593-R  
Bell 182  
  
Lakeview 1493  
Main 7874

# Hardwood Record

Eleventh Year.  
Semi-monthly.

CHICAGO, AUGUST 25, 1906.

Subscription \$2.  
Single Copies, 10 Cents.

## CHERRY

C. E. LLOYD, JR.  
Manager Sales

## RIVER

GROWS IN  
WEST VIRGINIA

Sold by  
Cherry River Boom &  
Lumber Co.  
Offices: Philadelphia, Pa.

## LUMBER

Himmelberger-Harrison Lumber Co.

## Red Gum Specialists

Morehouse,

Missouri

Why not grasp the opportunity for saving in cost of your insurance? Make a trial and be convinced.

## The Lumber Mutual Fire Insurance Company

Of Boston, Mass., 141 Milk Street.

CASH DIVIDENDS TO POLICY HOLDERS NOW 33 1/3 PER CENT.

## The Davidson-Benedict Company

NASHVILLE, TENNESSEE

Everything in

## Southern Hardwoods

POPLAR, CHESTNUT, ASH, OAK  
(Plain and Quartered.) Straight or Mixed Cuts.

DRESSED POPLAR ANY WAY YOU WANT IT. YOU GET WHAT YOU BUY FROM US. ASK FOR OUR DELIVERED PRICES, ANY RAILROAD POINT.

WE WANT TO MOVE

## QUARTERED WHITE OAK

125,000 1 inch No. 1 and No. 2.  
500,000 1 inch No. 1 Common.  
300,000 1 inch No. 2 Common.  
100,000 2 inch No. 1 Common Red Oak.  
400,000 1 inch Sap Cull Poplar

STOCK TWO YEARS DRY.

## THE ATLANTIC LUMBER CO.

2 Kilby Street, BOSTON, MASS.

The combined facilities of the stock lumber insurance companies

## LUMBER INSURANCE COMPANY OF NEW YORK

and the ADIRONDACK FIRE INSURANCE COMPANY

and allied organizations, constitute a great insuring opportunity for any owner of a first-class lumber or mill risk. Ask for lines and rates.

LUMBER INSURERS GENERAL AGENCY, Underwriting Managers  
66 Broadway, New York



# LOUISVILLE

MANUFACTURING AND DISTRIBUTING CENTER OF KENTUCKY

## Dry Stock **W. P. Brown & Sons Lumber Co.** Louisville, Ky.

<p><b>PLAIN RED OAK.</b>                  55,000' 1" 1st &amp; 2nd.                  25,000' 1 1/2" 1st &amp; 2d.                  49,000' 1 3/4" 1st &amp; 2d.                  57,000' 2" 1st &amp; 2d.                  18,000' 2 1/2" 1st &amp; 2d.                  16,000' 3" 1st &amp; 2d.                  131,000' 1" No. 1 Com.                  84,000' 1 1/2" No. 1 Com.                  44,000' 1 3/4" No. 1 Com.                  47,000' 2" No. 1 Com.                  8,000' 2 1/2" No. 1 Com.                  15,000' 3" No. 1 Com.</p>	<p>14,000' 1 1/2" 1st &amp; 2d.                  5,000' 2" 1st &amp; 2d.                  15,000' 1" No. 1 Com.                  7,000' 1 1/2" No. 1 Com.                  13,000' 2" No. 1 Com.</p> <p><b>PLAIN WHITE OAK.</b>                  80,000' 1" 1st &amp; 2d.                  28,000' 1 1/2" 1st &amp; 2d.                  12,000' 1 3/4" 1st &amp; 2d.                  42,000' 2" 1st &amp; 2d.                  23,800' 2 1/2" 1st &amp; 2d.                  16,000' 3" 1st &amp; 2d.                  227,000' 1" No. 1 Com.                  60,000' 1 1/2" No. 1 Com.                  80,000' 1 3/4" No. 1 Com.</p>	<p>50,000' 2" No. 1 Com.                  17,000' 2 1/2" No. 1 Com.                  22,000' 3" No. 1 Com.</p> <p><b>QUARTERED WHITE OAK.</b>                  50,000' 1" 1st &amp; 2d.                  28,000' 1 1/2" 1st &amp; 2d.                  45,000' 1 3/4" 1st &amp; 2d.                  49,000' 2" 1st &amp; 2d.                  19,000' 2 1/2" 1st &amp; 2d.                  18,000' 1" No. 1 Com.                  30,000' 1 1/2" No. 1 Com.                  40,000' 1 3/4" No. 1 Com.                  22,000' 2" No. 1 Com.                  10,000' 3" No. 1 Com.</p>	<p><b>ASH.</b>                  9,000' 1" 1st &amp; 2d.                  65,000' 1 1/2" 1st &amp; 2d.                  16,000' 1 3/4" 1st &amp; 2d.                  10,000' 2" 1st &amp; 2d.                  8,000' 2 1/2" 1st &amp; 2d.                  14,000' 3" 1st &amp; 2d.                  6,000' 4" 1st &amp; 2d.                  5,000' 1" No. 1 Com.                  4,000' 1 1/2" No. 1 Com.                  6,000' 1 3/4" No. 1 Com.                  8,000' 2" No. 1 Com.                  3,000' 2 1/2" No. 1 Com.                  2,000' 3" No. 1 Com.                  1,000' 4" No. 1 Com.</p>	<p><b>POPLAR.</b>                  12,000' 1" 1st &amp; 2d.                  12,000' 1 1/2" 1st &amp; 2d.                  11,000' 1 3/4" 1st &amp; 2d.                  12,000' 2" 1st &amp; 2d.                  8,000' 2 1/2" 1st &amp; 2d.                  6,000' 3" 1st &amp; 2d.                  50,000' 1" No. 1 Com.                  28,000' 1 1/2" No. 1 Com.                  10,000' 1 3/4" No. 1 Com.                  16,000' 2" No. 1 Com.                  15,000' 1" 18" &amp; up 1st &amp; 2d.                  8,000' 2" 18" &amp; up 1st &amp; 2d.                  6,000' 2" 24" &amp; up 1st &amp; 2d.                  4,000' 1 1/2" 18" &amp; up 1st &amp; 2d.                  3,000' 1 1/2" 24" &amp; up 1st &amp; 2d.</p>
---	---	--	---	--

All thicknesses in cull poplar, ash, chestnut. Your inquiries will be appreciated. Prompt delivery guaranteed.

## The Norman Lumber Co., Inc.

Manufacturers and Wholesalers of

### Hardwood Lumber

FOR SALE

Seasoned Ash, Oak, Poplar, and Walnut Lumber

WANT TO BUY

Walnut, Oak, Ash, Hickory and Poplar Logs and Lumber

Office and Yards: Third Street, H to K Streets  
 LOUISVILLE, KY.

## EDWARD L. DAVIS & CO.

OFFER FOLLOWING STOCKS:

<p><b>POPLAR.</b>                  30,000 ft. 4/4 1st &amp; 2d.                  50,000 ft. 4/4 Common.                  15,000 ft. 6/4 Common.                  50,000 ft. 4/4 1st &amp; 2d.                  50,000 ft. 4/4 Common.                  50,000 ft. 4/4 1st &amp; 2d.                  10,000 ft. 5/4 1st &amp; 2d.                  20,000 ft. 6/4 1st &amp; 2d.                  10,000 ft. 8/4 1st &amp; 2d.                  50,000 ft. 4/4 Common.                  5,000 ft. 5/4 Common.                  8,000 ft. 6/4 Common.                  20,000 ft. 8/4 Common.                  10,000 ft. 2 1/2" Common.                  40,000 ft. 3" Common.                  1 car Hickory Plank, 1 1/2 to 4" - 8' to 16'.</p>	<p><b>OAK WAGON TONGUES.</b>                  12,000 ft. 4x4"x4x2"-12', 1-6 mos. dry.                  500 ft. 3 x4 "-12', 12-18 mos. dry.                  400 ft. 3 1/2x4 1/2"-12', 12-18 mos. dry.                  300 ft. 3 1/2x4 1/2"-12', 12-18 mos. dry.                  250 ft. 3 1/2x4 1/2"-12', 12-18 mos. dry.                  800 ft. 3 1/2x4 1/2"-12', 12-18 mos. dry.                  180 ft. 3x4" &amp; Lgr.-14', 12-18 mos. dry.</p>
--	--

**REACHES.**

1 car 2x4" and larger, dry.  
**BOLSTERS.**  
 2 cars 3x4" and larger, dry.  
**HICKORY AXLES.**  
 1,500-3 x4 "-6', 1-6 mos. dry.  
 1,500-3 1/2x4 1/2"-6', 1-6 mos. dry.  
 2,000-4 x5 "-5', 1-6 mos. dry.  
 1,000-4 1/2x5 1/2"-6', 1-6 mos. dry.  
 1,000-5 x6 "-6', 1-6 mos. dry.

# We Will Make Close Prices on:

In Pile at Louisville Yard

- 1 Car 6 4 1st and 2nd Qtd. White Oak, Wide in
- 1 Car 8 4 1st and 2nd Qtd. White Oak, Wide in
- 1 Car 4 4 No. 1 Com. Qtd. White Oak
- 1 Car 6 4 No. 1 Com. Qtd. White Oak
- 2 Cars 8 4 No. 1 Com. Qtd. White Oak
- 1 Car 4 4 1st and 2nd Qtd. Red Oak, Wide in
- 1/2 Car 8 4 1st and 2nd Qtd. Red Oak, Wide in
- 1/2 Car 8 4 No. 1 Com. Qtd. Red Oak
- 1 Car 4 4 No. 1 Com. Qtd. Red Oak

- 3 Cars 4 4 No. 3 Com. Plain Red and White Oak
- 1 Car 6 4 No. 2 Com. and Sound Wormy Chestnut
- 1 Car 5 4 No. 2 Com. or Shipping Cull Poplar

At Tennessee Yard

- 1 Car 4 4 Clear Bright Sap Poplar
- 5 Cars 4 4 No. 1 Common Poplar (Selects in)
- 5 Cars 4 4 No. 2 Common or Shipping Cull Poplar
- 5 Cars 4 4 No. 2 Common and Sound Wormy Chestnut
- ISM ft. 5 4 Common and Better Plain Red Oak
- 8 Cars 4 4 No. 3 Com. Plain Red and White Oak

Write us for prices, delivered any point

## Stotz Lumber Company

KELLER BUILDING  
 LOUISVILLE, KY.

## Ornamental Hardwood Floors

400 STYLES AND PATTERNS

Illustrated Catalog on Application

## WOOD=MOSAIC FLOORING CO.

Rochester, N. Y. New Albany, Ind.

### Albert R. Kampf

Manufacturer  
 Hardwood Lumber and Timber  
 Dimension Stock  
 Board of Trade Bldg., Louisville, Ky.

### E. W. Rhubesty

Wholesale  
 Poplar, Rough and Dressed.  
 Oak, Chestnut and Other  
 Hardwoods

### North Vernon Pump & Lumber Co.

Band Sawn Plain and Quartered  
 Oak and Poplar.  
 North Vernon, Ind. and  
 Louisville, Ky.

### Southern Lumber Co.

Oak, Poplar and  
 Chestnut.  
 Louisville, Ky.

# CADILLAC

CELEBRATED FOR HIGH STANDARD OF QUALITY AND MILL WORK

## MICHIGAN RED OAK

- ☞ As fine stock as was ever cut in the famous Cadillac district.
- ☞ We have some of this choice 4-4 Red Oak which will soon be in shipping condition.
- ☞ If you are in the market, we can please you both in quality and price.
- ☞ We also have some nice Soft Gray Elm in 4-4, 6-4, 8-4 and 12-4. It's Bone Dry.

## Mitchell Brothers Company

CADILLAC, MICHIGAN

## Cummer, Diggins & Co.

—MANUFACTURERS—  
 "CUMMER" MAPLE  
 AND BEECH FLOORING

## MICHIGAN HARDWOODS

Good assortment of dry stock on hand ready for immediate shipment in Hard Maple, Beech, Birch, Soft Elm and Cherry.

SEND US A LIST OF YOUR REQUIREMENTS.

## The Cadillac Handle Co.

. . . Band Sawn . . .  
 Michigan Hardwoods

<p><b>For Rail Shipment from Cadillac.</b>                  2 cars 8 4 Maple, No. 1 Com. &amp; Better                  15 cars 4 4 Maple, on Grades.                  2 cars 4 4 Basswood, No. 2 Com &amp; Bet.                  2 cars Basswood, No. 2 Com. &amp; Bet.</p>	<p><b>For Water Shipment:</b>                  120,000 feet of 4 4 Basswood                  160,000 feet of 4 4, 5 4 and 6 4 Birch                  100,000 feet of 4 4, 8 4 and 12 4 Soft Elm                  10,000 4 4 Ash.</p>
---	--

## MURPHY & DIGGINS

Offer all grades of the following special dry stock

MAPLE—5/4, 6/4, 8/4, 10/4, 12/4, 14/4, 16/4  
 GRAY ELM—4/4, 12/4  
 BASSWOOD—4/4  
 BIRCH—4, 6, 8

Our own manufacture. Perfect Mill Work. Uniform Grades.

LET US FIGURE ON YOUR HARDWOOD WANTS.

## DRY STOCK

### Cadillac Hard Maple

88M 4-4 No. 3 Common.  
 265M 5-4 No. 1 & 2 Common.  
 325M 6-4 No. 1 & 2 Common.  
 105M 6-4 1's & 2's.  
 44M 12-4 1's & 2's.  
 3 1/2 M 16-4 No. 2 & Better.

The above stock is our own manufacture and we can ship promptly.

Be Friendly. Write Us.



**COBBS & MITCHELL**  
 (INCORPORATED)  
 CADILLAC, MICHIGAN



# MEMPHIS

THE HUB OF THE HARDWOOD WORLD

## Briggs & Cooper Company, Ltd.

MANUFACTURERS

### NORTHERN SOUTHERN HARDWOODS

GET OUR PRICES ON THESE ITEMS:

- 1,000,000 feet Soft Grey Elm, 1 to 3".
- 500,000 feet Unselected Birch, 1 to 3".
- 3,000,000 feet Michigan Hard Maple, 1 to 6".
- 350,000 feet Erd Dried White Maple, 1 to 1 1/2".
- 525,000 feet No. 1 Common and Better Winter Sawn Basswood, 1 to 3".
- 150,000 feet Selected White Basswood, 1", 1 1/4" and 1 1/2".
- 210,000 feet Plain and Quartered White and Red Oak, 1 to 2".

YARDS AT

SAGINAW, CHICAGO AND MEMPHIS

F. W. GILCHRIST, Pres. W. A. GILCHRIST, Vice-Pres.  
W. E. SMITH, Sec'y and Treas.

## Three States Lumber Co.

MANUFACTURERS OF

Mills: **Hardwood Lumber** Office  
Missouri **Cottonwood and Gum** Tennessee  
Arkansas Trust  
Tennessee Building

GET OUR PRICES, TRY OUR LUMBER  
WE SHIP ROUGH, DRESSED, RESAWED

**COTTONWOOD—GUM**

**WE** have in all thicknesses the following kinds and amounts of lumber at places designated. Kindly send us your inquiries.

MEMPHIS YARD:

- Ash..... 680,000 feet
- Quartered White Oak.. 75,000 feet
- Plain White Oak..... 140,000 feet
- Quartered Red Oak.... 225,000 feet
- Plain Red Oak..... 410,000 feet
- Cypress..... 225,000 feet
- Cottonwood..... 200,000 feet
- Poplar..... 308,000 feet

SELMA YARD

- Poplar..... 409,000 feet
- Bay Poplar..... 557,000 feet
- Red Gum..... 55,000 feet
- Cypress..... 787,000 feet

BERCLAIR YARD

- Bay Poplar..... 100,000 feet
- Cypress..... 800,000 feet

OTHER YARDS

- Plain Red Oak..... 350,000 feet

## J. W. THOMPSON LUMBER COMPANY

Office and Yards: Randolph Road and I. C. R. R. : : MEMPHIS, TENN.

## BACON-NOLAN HARDWOOD CO.

Manufacturers of

**Band Sawn Oak, Ash  
Gum, Cypress, Etc.**

Office,  
Memphis, Tenn.

Mills,  
Chancy, Miss.

Address all correspondence to Memphis office.

## STOCK LIST ANDERSON-TULLY CO. Memphis, Tenn.

- |  |  |   |  |
|--|--|---|--|
| ASH.   |  | GUM.                                    |  |
| 10M ft. 4 1/4" Clr. Stps., 2 1/4" to 5 1/4". | 4M ft. 3 8" 1st & 2d Red, 16" up.                      | 4M ft. 1 2" 1st & 2d Red, 16" up.       |  |
| 5M ft. 4 1/4" Com. Stps., 2 1/4" to 5 1/4".  | 100M ft. 4 1/2" 1st & 2d Saps, 6"-12".                 | 100M ft. 4 1/2" 1st & 2d Saps, 13"-15". |  |
| COTTONWOOD.                                  |  |   |  |
| 33M ft. 7 8" 1st & 2d, 8" & up.              | 40M ft. 4 1/2" 1st & 2d Saps, 16" up.                  | 50M ft. 4 1/2" Wg. Box Brds., 13"-17".  |  |
| 150M ft. 4 1/4" 1st & 2d, 6" & up.           | 200M ft. 4 1/2" No. 1 Common Saps.                     | 200M ft. 4 1/2" No. 2 Common.           |  |
| 70M ft. 4 1/4" 1st & 2d, 7" to 19".          | 200M ft. 4 1/2" No. 3 Common.                          |   |  |
| 20M ft. 4 1/4" 1st & 2d, 11".                | RED OAK.   |   |  |
| 25M ft. 4 1/4" 1st & 2d, 12".                | 22,000 ft. 4 1/2" 1st & 2d Plain, 12" & up, 14" & 16". |   |  |
| 100M ft. 4 1/4" 1st & 2d, 13" & up.          | 32,300 ft. 4 1/2" 1st & 2d Pln., 6" up.                |   |  |
| 25M ft. 4 1/4" 1st & 2d, 18" & up.           | 1,700 ft. 4 1/2" 1st & 2d Quartered.                   |   |  |
| 40M ft. 5 1/4" 1st & 2d, 6" & up.            | 8,800 ft. 4 1/2" No. 1 Com. Quartered.                 |   |  |
| 54M ft. 5 1/4" 1st & 2d, 11" & 12".          | WHITE OAK.   |   |  |
| 45M ft. 6 1/4" 1st & 2d, 6" & up.            | 6,530 ft. 4 1/2" 1st & 2d Plain.                       |   |  |
| 150M ft. 4 1/4" Wg. Box Brds., 9"-12".       | 10,700 ft. 4 1/2" No. 1 Com. Plain.                    |   |  |
| 60M ft. 4 1/4" Wg. Box Brds., 13"-17".       | 6,000 ft. 4 1/2" 1st & 2d Quartered.                   |   |  |
| CYPRESS.                                     |  |   |  |
| 14M ft. 4 1/4" Select.                       | 11,000 ft. 4 1/2" No. 1 Com. Quartered.                |   |  |
| 25M ft. 4 1/4" Shops.                        | POPLAR.  |   |  |
| 15M ft. 5 1/4" Select.                       | 35,000 ft. 4 1/2" Common & Cull.                       |   |  |
| 15M ft. 5 1/4" Shops.                        |  |   |  |

## FENN BROS. COMPANY

MANUFACTURERS OF

### Oak Flooring

QUARTERED WHITE HOLLOW BACKED  
QUARTERED RED END MATCHED  
PLAIN WHITE POLISHED  
PLAIN RED BORED

Memphis, Tenn.

F. W. GILCHRIST, President  
W. A. GILCHRIST, Vice President  
W. E. SMITH, Sec'y and Treasurer

## W. E. SMITH LUMBER CO.

Manufacturers of  
**HARDWOOD LUMBER**

Mills, Tennessee, Arkansas, Mississippi  
Distributing Yards, Cairo, Illinois  
General Office, Tennessee Trust Bldg.

MISSISSIPPI VALLEY COTTONWOOD

J. B. Ransom, Pres. A. B. Ransom, V.-Pres. W. A. Ransom, Sec. C. R. Ransom, Treas.

## GAYOSO LUMBER CO., Inc.

MANUFACTURERS AND DEALERS IN

### SOUTHERN HARDWOODS

Also make a specialty of Wagon Stock in rough, such as Tongues, Axles, Reaches, Bolsters, and 6-4 to 16-4 Hickory.

**ST. LOUIS**

LARGEST OF ALL HARDWOOD MARKETS

**LOTHMAN CYPRESS CO.**

AIR DRIED  
**Louisiana Red Cypress**

FOOT OF ANGELICA STREET

**Stoneman-Zearing Lumber Co.**

203 Frisco Building

We have the following Dry Stock for sale piled at our mill:

<b>QTD. WHITE OAK :</b>	<b>COTTONWOOD :</b>
3 Cars 3/4 Common.	3 Cars 1" 1 and 2.
2 Cars 1 1/4 Common and Better Strips.	1 Car 1x13 to 17" Box Boards.
<b>GUM :</b>	<b>ELM :</b>
5 Cars 1" Common Red.	1 Car 6 4 Log Run.
1 Car 1x13 to 17" Box Boards.	4 Cars 4" Log Run.
1 Car 2" 1 and 2 Sap.	
6 Cars 1 1/2 Common and Better Sap.	

This Stock is All Band Sawed and Equalized

Roland F. Krebs **Ozark Cooperage Co.** Hardwood Department  
Manager

**WE BUY STOCKS READY CUT OR CONTRACT FUTURE OUTPUT**

Four Inspectors in the South

Direct Shipments from mill stocks { COTTONWOOD, CYPRESS, GUM, OAK. } MAIN OFFICE, FRISCO BUILDING

**W. R. CHIVVIS,** Lesperance Street and Iron Mountain Railroad.

**WHOLESALE HARDWOODS**

**BLACK WALNUT LUMBER MY SPECIALTY.** Always in the market to buy Walnut and Cherry Lumber. Pay spot cash and take up at shipping point when amounts justify.

**Wanted—Cypress, Ash and Cottonwood**

INSPECTION AT POINT OF SHIPMENT WHEN QUANTITY JUSTIFIES

**Hafner Manufacturing Co.**

CYPRESS, HARDWOODS

Mail orders receive our immediate attention.

YARDS: FOOT OF DOCK STREET

**Thomas & Proetz Lumber Co.**

CASH BUYERS OF OAK, ASH, CYPRESS, POPLAR, CHERRY AND ALL

**HARDWOODS**

SEND INSPECTOR WHEN QUANTITY JUSTIFIES

Office and Yards: Hall and Angelrodt Sts.

**Garetson-Greaseon Lumber Co.**

MANUFACTURERS OF SOUTHERN HARDWOODS

**GUM LUMBER  
OUR SPECIALTY**

Carload Shipments Direct from Our Own Mills

519 Bank of Commerce

**CHAS. F. LUEHRMANN HARDWOOD LUMBER COMPANY**

Carry a complete stock of Hardwood and are constantly in the market to purchase large blocks of stock for cash. Are also the largest manufacturers of the famous St. Francis Basin Red Gum.

General Offices: 148 Carroll Street

**SIX MILLION FEET**

Ash, Oak, Cypress, Poplar, Etc.

READY FOR PROMPT SHIPMENT

**STEELE & HIBBARD**

NORTH BROADWAY, DOCK AND HALL STREETS

# Thomas Forman Company

MANUFACTURERS OF HIGH-GRADE

## Maple and Oak Flooring

New York Branch:  
McGovern & Bowen,  
29 Broadway

And Hardwood Lumber

**DETROIT,  
MICHIGAN**

## AUGUST STOCK LIST

MAPLE		BIRCH		BASSWOOD	
1 in.	2,000,000 ft.	1 in.	500,000 ft.	1 in.	300,000 ft.
1½ "	100,000 "	1½ "	100,000 "	1½ "	30,000 "
1½ "	400,000 "	2 "	100,000 "	1½ "	50,000 "
2 "	1,000,000 "	2½ "	50,000 "	2 "	75,000 "
2½ "	200,000 "	3 "	75,000 "	3 "	4,000 "
2½ "	500,000 "	<b>ROCK ELM</b>		<b>GRAY ELM</b>	
3 "	500,000 "	2 in.	25,000 ft.	1 in.	300,000 ft.
4 "	400,000 "	2½ "	50,000 "	1½ "	200,000 "
<b>BEECH</b>		<b>WHITE MAPLE</b>		3 "	200,000 "
1 in.	500,000 ft.	End Piled		<b>ASH</b>	
1½ "	250,000 "	1 in.	100,000 ft.	1 in.	500,000 ft.
1½ "	400,000 "	1½ "	20,000 "		
2 "	100,000 "	2 "	50,000 "		
2½ "	200,000 "				

**KELLEY LUMBER & SHINGLE CO.,** Traverse City, Mich.

## Are You in the Market ?

Send us your inquiries for prices on  
the following

# HARDWOODS

- 100M ft. 1" Com. and Better Quartered Red Oak.
- 100M ft. 1" Com. and Better Quartered White Oak.
- 75M ft. 1½" Com. and Better Quartered Red Oak.
- 25M ft. 1½" Com. Quartered White Oak.
- 25M ft. 1½" 1st and 2nds Quartered Red Oak.
- 50M ft. 3" Com. and Better Quartered White Oak.
- 50M ft. 3" Com. and Better Plain White Oak.
- 100M ft. 1" Com. Plain Birch.
- 50M ft. 1" Com. Red Birch.
- 50M ft. 1½" Com. and Better Plain Birch.
- 100M ft. 1" Com. and Better Hard Maple.
- 100M ft. 1½" Com. and Better Hard Maple.
- 100M ft. 1" Com. and Better Soft Elm.

## UPHAM & AGLER

Distributing Yards: CAIRO, ILL.

Main Offices :: American Trust Building, CHICAGO

## SOUTHERN OAK LUMBER CO.



WE WANT TO BUY FOR CASH

# OAK CYPRESS ASH

MILL CUTS OR ROUND LOTS

910 CHAMBER OF COMMERCE 1217 TENNESSEE TRUST BLDG.

CHICAGO MEMPHIS

YARDS: NORTH MEMPHIS

TO NEW YORK OVER NIGHT

# The 20th Century Limited

Via the LAKE SHORE and NEW YORK CENTRAL  
The Route of the Government Fast Mail Trains

## CHICAGO - NEW YORK 18-HOUR TRAIN IT SAVES A DAY

FROM LA SALLE ST. STATION  
CHICAGO

Leave Chicago at 2.30 p. m.  
Arrive New York at 9.30 a. m.

FROM GRAND CENTRAL STATION  
THE ONLY TERMINAL IN NEW YORK

Leave New York at 3.30 p. m.  
Arrive Chicago at 8.30 a. m.

W. J. LYNCH, Passenger Traffic Manager, Chicago, Ill.

**T H E E A S T**

BOSTON NEW YORK PHILADELPHIA

**For Your Good Money  
We Give You Good Value.**

Let the quality of our Lumber and the good service we can give you be the understanding between us. Do you want any of these to-day?

- 150,000 ft. Ash, from 1 to 6 inch thick.
- 3,875,000 ft. Chestnut, Common and Better.
- 1,420,000 ft. Poplar 1 and 2 and Common.
- 775,000 ft. White Pine No. 1 cuts and fine Common and Better.
- 1,800,000 ft. White and Red Oak.

**J. Gibson McIlvain & Co.**

56th to 58th Streets and Woodland Ave., PHILADELPHIA, PA.

**JONES HARDWOOD CO.**

INCORPORATED

WANTS: Poplar, Plain Oak, 147 MILK STREET  
Quartered Oak and Cypress. BOSTON, MASSACHUSETTS

Manufacturers please send stock lists and prices.

**STEVENS-EATON CO.**

Buyers of  
ROUND LOTS  
of

**Hardwoods**

No 1 Madison  
Avenue,  
NEW YORK

ESPECIALLY IN MARKET FOR PLAIN RED OAK

**Charles S. Wentworth & Co.**

WHOLESALE LUMBER MERCHANTS

147 Milk Street  
**BOSTON**

We are in the Market for POPLAR, PLAIN OAK, CYPRESS and NORTH CAROLINA PINE LUMBER; also OAK, MAPLE and BIRCH FLOORING, and would appreciate correspondence from manufacturers in position to supply any of the stock named.

**WM. E. LITCHFIELD**

MASON BUILDING, BOSTON, MASS.

**Specialist in Hardwoods**

Manufacturers are requested to supply lists of stock for sale

**WE MUST MOVE AT ONCE  
6 Cars 4-4 1's and 2's Red Oak**

High Grade Stock, good widths and lengths  
PRICE RIGHT. Send us your inquiries

**SCHOFIELD BROTHERS**

1020-22 Pennsylvania Building, PHILADELPHIA

BALTIMORE MARYLAND **E. E. PRICE** BUYER AND EXPORTER OF

**Hardwoods, Poplar and Logs**

I am always in the market for nice lots of dry and well manufactured lumber. I inspect at point of shipment. Correspondence solicited.

**Wistar, Underhill & Co.,**

WHOLESALE

**HARDWOOD LUMBER**

816 Real Estate Trust Building, PHILADELPHIA.

**The West Florida Hardwood Co.**

MILL ON APALACHICOLA RIVER  
MARYSVILLE, FLA.

Ash  
Hickory

Red and White Oak  
Yellow Cottonwood

Red Gum  
Tupelo Gum

LET US HAVE YOUR INQUIRIES

**Holloway Lumber Company**

**WHOLESALE HARDWOODS**

In the market for all thicknesses of  
OAK, ASH and CHESTNUT.

312 Arcade Building,  
PHILADELPHIA, PA.

**WILLIAM WHITMER & SONS, Inc.**

MANUFACTURERS OF

**HARDWOODS**

We are always in the market for round lots of well manufactured stock, and shall be pleased to enter into correspondence with manufacturers with a view to purchase.

**PHILADELPHIA**  
New York, Boston, Pittsburg



# NASHVILLE

HEADQUARTERS FOR ALL SOUTHERN HARDWOODS

## JOHN B. RANSOM & CO.,

NASHVILLE, TENNESSEE

We want to move quickly the following old dry stock. All of it has been on sticks 6 to 18 months. Write us for delivered prices. We are prepared to furnish promptly mixed cars of rough and dressed hardwoods of all kinds:

QUARTERED WHITE OAK	QUARTERED RED OAK
90 M 4 1/4 first and second	100 M 4 1/4 first and second
15 M 5 1/4 first and second	58 M 6 1/4 first and second
80 M 6 1/4 first and second	15 M 8 1/4 first and second
10 M 10 1/4 first and second	95 M 4 1/4 No. 1 Common
120 M 4 1/4 No. 1 Common	84 M 6 1/4 No. 1 Common
65 M 6 1/4 No. 1 Common	72 M 8 1/4 No. 1 Common
58 M 8 1/4 No. 1 Common	
20 M 10 1/4 No. 1 Common	
	PLAIN OAK
70 M 5 3/8 first and second Poplar	50 M 4 1/4 1st and 2nd White
80 M 5 8 No. 1 Common Poplar	100 M 4 1/4 No. 1 Common White
15 M 4 1/4 1st and 2d Quartered Sycamore	100 M 4 1/4 first and second Red
10 M 4 1/4 No. 1 Com. Quart'd Sycamore	100 M 4 1/4 No. 1 Common Red

## Nashville Hardwood Flooring Co.

Manufacturers of

### "Acorn Brand"

THE FAMOUS FAULTLESS FLOORING  
IN OAK AND BEECH.

Car Lots and Less Than Car Lot  
Orders Solicited. Write for Prices.

Nashville, Tennessee

## INDIANA LUMBER CO.

Manufacturers Lumber  
DIMENSION STOCK A SPECIALTY.

Office and Mills: Corner Oldham  
Street and Cumberland River

NASHVILLE, TENN.

## LOVE, BOYD & CO.

Offer:

5,000,000 ft. Quartered White Oak.  
2,000,000 ft. Quartered Red Oak.  
1,000,000 ft. Plain White Oak.  
1,000,000 ft. Plain Red Oak.  
1,000,000 ft. Poplar.  
2,000,000 ft. Chestnut, Ash, Hickory, Red Cedar, Etc.

Our Own Manufacture.  
Prompt Service.  
Dry Stock.

MAIN OFFICE,  
NASHVILLE, TENNESSEE

## GEO. C. BROWN & CO.

MANUFACTURERS AND WHOLESALE DEALERS IN

Hardwood Lumber

Tennessee Red Cedar Lumber a Specialty.

NASHVILLE, TENNESSEE

# PAEPCKE-LEICHT LUMBER COMPANY

MANUFACTURERS OF

## COTTONWOOD GUM AND OTHER HARDWOODS

Large stocks of well seasoned Lumber always carried at our yards and mills.

General Offices: 140 W. Chicago Ave., CHICAGO. Mills: Cairo, Ill., Marked Tree, Ark., Greenville, Miss., Arkansas City, Ark., Blytheville, Ark.

# Swann-Day Lumber Company

MANUFACTURERS OF

## POPLAR AND OAK

PLANING MILL STOCK, BOX SHOOKS  
AND HARDWOOD DIMENSION

CLAY CITY, KENTUCKY

# PITTSBURG

HARDWOOD DISTRIBUTING CENTER OF PENNSYLVANIA

## A. M. Turner Lumber Company

Everything in lumber. We buy hardwoods as well as sell them. If you have anything to offer, please submit same to us.

## Linehan Lumber Company

PERFECT

## MAPLE FLOORING

SEND US YOUR INQUIRIES

## Willson Bros. Lumber Co.

MANUFACTURERS

## WEST VIRGINIA HARDWOODS

FARMERS BANK BLDG. :: PITTSBURG, PA.

## Hardwoods a Specialty

FOR SALE

POPLAR	CHESTNUT	PLAIN OAK
125,000' 4 4 1s and 2s	200,000' 4 4 Sound Wormy	60,000' 4 4 No. 1 Com.
40,000' 4 4 No. 1 Com.	80,000' 5 4 Sound Wormy	18,000' 4 4 No. 2 Com.
325,000' 4 4 No. 2 Com.	100,000' 6 4 Sound Wormy	<b>QUARTERED OAK</b>
228,000' 4 4 No. 3 Com.	48,000' 8 4 Sound Wormy	2 cars 4 4 No. 1 Com.
150,000' 5 4 Mill Cull		1 car 4 4 No. 2 Com.

OAK TIMBERS SAWED TO ORDER.  
WRITE FOR PRICES.

CHEAT RIVER LUMBER COMPANY, Pittsburg, Penna.

## STOCK LIST

12,500 ft. 4 4 Maple No. 1 Com. & Bet.	192,000 ft. 4 4 Poplar Log Run
8,000 ft. 4 4 Maple No. 1 Common	4,000 ft. 8 4 Poplar Log Run
48,000 ft. 5 4 Maple No. 1 Com. & Bet.	23,500 ft. 12 4 Poplar Good
21,000 ft. 5 4 Maple 1sts and 2nds	2,500 ft. 6 4 Basswood Log Run
12,000 ft. 5 4 Maple No. 1 Common	2,200 ft. 8 4 Basswood Log Run
18,000 ft. 6 4 Maple No. 2 Com. & Bet.	1 Car 4 4 Basswood Log Run
3,000 ft. 6 4 Maple 1sts and 2nds	62,000 ft. 4 4 Cherry Log Run
3,000 ft. 8 4 Maple No. 2 Com. & Bet.	25,000 ft. 5 4 Cherry Log Run
29,000 ft. 8 4 Maple No. 1 Common	23,000 ft. 6 4 Cherry Log Run
13,000 ft. 10 4 Maple 1sts and 2nds	26,000 ft. 8 4 Cherry Log Run
15,000 ft. 12 4 Maple No. 2 Com. & Bet.	1 Car 4 4 White Birch 1sts & 2nds

FAVORABLE FREIGHT RATES TO THE EAST

**Babcock Lumber Co.**  
ASHTOLA, PA.

## Dry Stock for Quick Shipment:

12,189 ft 4 4 clear Quartered Oak	66,232 ft 4 4 No. 1 Common Poplar
14,570 ft 4 4 1st & 2ds qtd. Red Oak	10,315 ft 6 4 1st & 2ds Poplar
30,302 ft 4 4 No. 1 Com. Red Oak	16,000 ft 4 4 1st & 2ds Cottonwood
63,204 ft 4 4 No. 1 Com. Pl White Oak	119,000 ft 4 4 No. 1 Com. Cottonwood
4,317 ft 5 4 No. 1 Com. Pl White Oak	150,000 ft No. 2 Common Cottonwood
5,934 ft 6 4 No. 1 Com. Pl White Oak	90,000 ft 4 4 Mill Cull Cottonwood
23,473 ft 4 4 1st & 2ds Plain Red Oak	110,000 ft 5 4 No. 1 Com. Cottonwood
14,168 ft 4 4 1st & 2ds Poplar	40,000 ft 5 4 No. 2 Com. Cottonwood

## American Lumber & Mfg. Co.

PITTSBURG, PA.

## The Nicola Lumber Company

One million feet 4-4 Bay Poplar.  
Can be shipped log run, or sold  
on grade. Bone dry; baod  
sawed. Send your inquiries.

## Flint, Erving & Stoner Co.

### Wholesale Lumber

Northern and Southern Hardwoods

Beech and Maple Timbers a Specialty

**C H I C A G O**  
THE GREATEST HARDWOOD MARKET IN THE WORLD



**A floor to adore**

For thirty-three years Wilce's Hardwood Flooring has been among the foremost on the market and because it stands today "unequaled" is the best evidence that its manufacturer has kept abreast of modern methods and the advanced demands of the trade. To convince yourself of the above statements, try our polished surface flooring, tongued and grooved, hollow backed, with matched ends and holes for blind nailing—you'll find it reduces the expense of laying and polishing. *Our Booklet tells all about Hardwood Flooring and how to care for it—also prices—and is free.*

**The T. Wilce Company**  
22nd and Throop Sts. CHICAGO, ILL.

**John O'Brien Land & Lumber Co.**

MANUFACTURERS AND DEALERS IN

**Hardwood Lumber**  
Of All Kinds

OFFICE AND YARDS:  
873 to 881 So. Laflin Street  
MILL: PHILIPP, MISS.

**Chicago**

**Harvey S. Hayden**  
IN THE MARKET FOR

**POPLAR**

25 M ft. 1½" No. 1 Common, standard widths and lengths.  
40 M ft. 2" No. 1 Common, standard widths and lengths.  
25 M ft. 2½" No. 1 Common, standard widths and lengths.  
60 M ft. 3" No. 1 Common, standard widths and lengths.

**WHITE ASH**

30 M ft. 1" 1s and 2s, standard widths and lengths.  
75 M ft. 5 4" 1s and 2s, standard widths and lengths.  
50 M ft. 6 4" 1s and 2s, standard widths and lengths.  
50 M ft. 8 4" 1s and 2s, standard widths and lengths.  
25 M ft. 10 4" 1s and 2s, standard widths and lengths.  
50 M ft. 16 1" 1s and 2s, standard widths and lengths.  
(We can use a small percentage of No. 1 Common.)

**511 Railway Exchange, - Chicago**

**J. Slimmer & Company**

**Hardwood Lumber**

Office and Yard:  
65 W. Twenty-second St.

**CHICAGO**

**PARK RICHMOND & CO.**  
Wholesale

**Hardwood Lumber**

67 West Twenty-second St.  
**Chicago**

**R. A. WELLS LUMBER CO.**  
Manufacturers of All Kinds of

**HARDWOOD LUMBER**

Fine Quartered Oak a Specialty

234 LA SALLE STREET

Yards at Canal and 21st Sts. **CHICAGO, ILL.**

—have you anything to offer in hickory, white ash, thick plain oak and wagon stock?

WE ARE CASH BUYERS  
PLEASE SEND US YOUR STOCK LISTS

**Ryan & McParland**  
Office and Yards  
Robey St. and Blue Island Ave. **Chicago**

**White Lumber Company**  
Dealers in Hardwood Lumber

ALL KINDS  ALL GRADES

Cherry Lumber a Specialty **Laflin @ 22d Sts. Chicago**

**C H I C A G O**

THE GREATEST HARDWOOD MARKET IN THE WORLD

**Crandall & Brown**

LOUISIANA RED CYPRESS  
Yellow Pine, Oak, Poplar and Maple

We have in Chicago for quick delivery  
100,000 14" 1st and 2nds La. Red Cypress, thoroughly dry.  
14,000 3x14" Shop Com. Cypress  
We are in the market for Ash and Cottonwood

Office and Yards: 3300 Center Avenue, CHICAGO.

**CHAS. DARLING & CO.**

Southern  
Hardwoods

22nd Street and Center Avenue - CHICAGO

**The Keith Lumber Company**  
HARDWOOD, POPLAR & SOUTHERN PINE LUMBER,

MAHOCANY, CYPRESS,  
REDWOOD, CHESTNUT,  
RED CEDAR, SPRUCE.



MAPLE FLOORING, OAK TIMBERS & WAGON STOCK.  
Office and Yards: Fourteenth and Wood Streets.

**The Columbia Hardwood Lumber Co.**

Wholesale and Retail

Telephone NORTH 223 **HARDWOOD LUMBER** 47 Dominick St. CHICAGO

**Ben C. Keator—Wholesale Lumber**

**HARDWOOD AND PINE**

1003-4 Manhattan Building, CHICAGO

Chas. Miller

Milton Miller

**MILLER BROS.**

**Hardwood Lumber**

Main Office, 208 WILLOUGHBY BLDG.,  
6 E. MADISON STREET,

YARDS;  
Loomis St., S. of 22nd St.,  
Chicago, Ill.  
Houston, Miss.  
Macon, Miss.

CHICAGO, ILL.  
Phone CENTRAL 1363

**THE WARD LUMBER COMPANY**

MANUFACTURERS OF  
**HARDWOODS**  
CHAMBER OF COMMERCE BUILDING · CHICAGO

**WISCONSIN TIMBER @ LUMBER CO.**

BUY AND SELL

**Yellow Pine and Hardwood Lumber**

Want thick hardwoods and wagon box boards.

Monadnock Bldg., CHICAGO, ILL.

**Heath-Witbeck Company**

**Hardwood Lumber**

We have for quick shipment 170,000  
feet DRY BIRCH, First and Seconds  
and Common 2, 2½, 3 and 4 inch.

Main Office, 6 Madison St. Yards, Loomis and 22nd St.  
CHICAGO

**Lesh & Matthews Lumber Co.**

1649-50 MARQUETTE BUILDING

Are now offering bone dry BIRCH, ROCK ELM, BLACK ASH, etc., Wis-  
consin stock. Also PLAIN AND QUARTERED OAK, POPLAR, etc.,  
from our Memphis yard. We are constant buyers.

The only trade paper reaching all classes  
of hardwood consumers

**HARDWOOD RECORD**  
355 Dearborn St., Chicago

**"Ideal" <sup>Steel Burnished</sup> Rock Maple Flooring**

is the flooring that is manufactured expressly to supply the demand for the best. It is made by modern machinery from carefully-selected stock and every precaution is taken throughout our entire system to make it fulfill in every particular its name—"IDEAL."

Rough or Finished Lumber—All Kinds

Send us Your Inquiries

**The I. Stephenson Company**  
WELLS, MICHIGAN

**FIRE INSURANCE**



LET US SETTLE IT TOGETHER

**LUMBER UNDERWRITERS**

66 Broadway, New York

**"Michigan" Maple Flooring**

Our model factory is equipped with the highest class tools and appliances made for Flooring production.

We produce our lumber from the best rock Maple area in Michigan and have 20 years' supply.

Our brand "Michigan" is a guaranty of quality. Perfect mill work and excellent grades distinguish our Flooring and our prices are reasonable.

**WARD BROS., Big Rapids, Mich.**

**FLOORING**



**The Celebrated Wolverine Brand...**

We claim nothing new or original in point of manufacture on Wolverine Brand Hard Maple Flooring, but do claim by our method, we can produce a finer floor than by ordinary methods. It is bored, butted and end matched, and lays with all joints even.

**BLISS & VAN AUKEN**  
900 S. Niagara St., Saginaw, West Side, Michigan

**OAK FLOORING**

Kiln Dried  
Bored  
Polished



Hollow Backed and Bundled

**Timber Bonds**

SECURED BY FIRST MORTGAGE ON TIMBER LANDS

**H. C. Barroll & Co.**

BANKERS, First National Bank Building, CHICAGO.

H. B. LEAVITT, PRES.  
E. H. ADAMS, SECY.

B. F. RICHARDSON, VICE-PRES.  
J. G. LEAVITT, TREAS.

**THE LEAVITT LUMBER CO.**

MOST COMPLETE STOCK OF HARDWOODS IN CHICAGO

MAKE KNOWN YOUR WANTS AND GET IMMEDIATE RESULTS

Mills:  
WISCONSIN  
TENNESSEE  
ARKANSAS  
LOUISIANA  
MISSISSIPPI

General Office and Yard:  
22ND AND LAFLIN STREETS.  
Southern Office:  
808 TENNESSEE TRUST BLDG.  
MEMPHIS, TENN.

**THE "FINEST" MAPLE FLOORING**

**W. D. YOUNG & CO.**

BAY CITY, MICHIGAN.

Producers from TREE to TRADE of the highest type of Michigan Forest Products. Large stock of Maple Flooring and 15,000,000 feet of Hardwoods—1 to 4 inches thick—on hand.

**Maple, Birch and Beech Lumber**

# Hardwood Record

Published in the Interest of Hardwood Lumber, American Hardwood Forests, Wood Veneer Industry, Hardwood Flooring,  
Hardwood Interior Finish, Wood Chemicals, Saw Mill and Woodworking Machinery.

Vol. XXII.

CHICAGO, AUGUST 25, 1906.

No. 9.

Published on the 10th and 25th of each month by

## THE HARDWOOD COMPANY

HENRY H. GIBSON, President

FRANK W. TUTTLE, Sec-Treas.

### OFFICES

Sixth Floor Elsworth Bldg., 355 Dearborn St Chicago, Ill., U.S.A.

Telephones: Harrison 4960 Automatic 5659

### TERMS OF ANNUAL SUBSCRIPTION

In the United States, Canada, Philippine Islands and Mexico . . . \$2.00  
In all other countries in Universal Postal Union . . . 3.00

Subscriptions are payable in advance, and in default of written orders to the contrary are continued at our option.

The entire contents of this publication are covered by the general copyright, and articles must not be reprinted without special permission.

Entered at Chicago Postoffice as Second Class Matter.

Advertising copy must be received five days in advance of publication date. Advertising rates on application.

### General Market Conditions.

With the general undeniable shortage of several varieties of southern hardwoods the expected result has followed—an advance in prices. The market condition committee of the Hardwood Manufacturers' Association of the United States has suggested for immediate effect an advance on poplar, 7 to 17 inch firsts and seconds, of \$2 a thousand, making the current price of inch f. o. b. Ohio river points, \$49 a thousand. No. 1 common poplar is also advanced \$2 a thousand, or from \$30 to \$32. Selects are advanced \$1, or from \$36 to \$37. Saps, \$1, or from \$36 to \$37. No. 2 common is advanced \$1.50, or from \$20.50 to \$22. No. 3 common is advanced \$2, or from \$17 to \$19. The same advance in prices prevails on thicker than inch. Poplar squares are advanced in price from \$2 to \$5 a thousand. Box boards \$1 a thousand, making the price \$43 for from 8 to 12 inch, and \$54 for 13 to 17 inch. No. 1 and select 6 inch drop siding is advanced \$1 a thousand, or \$43 and \$37 respectively, and No. 1 common is advanced \$1.50, making the current price \$28.50.

Basswood in firsts and seconds and No. 1 common takes a \$2 advance, showing \$36 and \$26 respectively, f. o. b. Ohio river points. No. 2 common basswood is advanced \$4, or to \$20.

No. 1 common, 1 1/4 and 1 1/2 inch walnut is advanced \$2 a thousand, or to \$58, while No. 2 common, same thickness, is advanced \$1, or to \$32.

No. 1 common chestnut is advanced \$1, or to \$35 a thousand.

Soft elm and soft maple show an advance of from \$.50 to \$1.

The price on cottonwood is advanced \$1 on box woods only, which makes the current price on 8 to 12 inch, \$40, and on 13 to 17 inch, \$46.

Firsts and seconds plain white and red oak are advanced \$2, or to \$49. No. 1 common is advanced \$1, or to \$32. No. 2 common is advanced \$2, or to \$21. No. 3 common is advanced \$.50, or to \$16.50. Oak strips in all grades are advanced \$1, or to \$37 for clear face 2 1/2 to 5 1/2 inch, and \$26 for No. 1 common 2 1/2 to 5 1/2 inch. No change is recommended in the price of quartered white and red oak.

Nos. 1, 2, and 3 common red gum are advanced \$1, which makes the price f. o. b. Cairo or Thebes respectively \$17, \$14 and \$11.

Both hickory reaches and axles are advanced \$5 a thousand,

which makes the current price \$80 for reaches and \$55 to \$70 for axles.

The demand for all these items of stock, being in excess of the supply, the ancient law therefore prevails and the prices suggested are undeniably warranted, and it is confidently expected that they can be obtained.

From the previous lack of organization among hardwood operators of the North there is no indication of a very material advance in these woods just at the present time, although they fully deserve a manifest accretion in price. The extreme shortage of poplar and cottonwood in the South is helping basswood values somewhat, but still it is comparatively cheap. The price being received for gray elm and birch is still much lower than the merits of these woods warrant. The hard maple of the North that sterling wood—is comparatively low in price. However, it is now definitely known that the stocks of northern hardwoods in sight are remarkably low, probably twenty-five per cent less than they were a year ago, and the only reason northern operators are not getting more for their hardwood product is because they have not yet awakened to the situation, organized thoroughly and asked the price. On the basis of relative value northern hardwoods are anywhere from \$5 to \$10 lower than the prices being obtained for southern woods.

### Denatured Alcohol Proposition.

Congress at its recent session passed an act permitting the use of alcohol in the arts and industries free of tax when denatured, which law will go into effect Jan. 1 next. The passage of the act has created much interest in industrial circles, and in reply to the numerous inquiries that have been received by the several executive departments of the government, regulations for denaturing alcohol are in process of preparation by the treasury department. Officers of this department are also investigating conditions under which the work is carried on in foreign countries. The Department of Agriculture has engaged a Columbia University expert to analyze and report on the possibilities of alcohol as a fuel. Legislators prominent in securing the passage of the bill, which was carried through both houses of Congress as a piece of "good politics," allege that they expected that large quantities of denatured alcohol would be used for fuel in small engines, automobiles and motor boats, and furthermore that the demand would enable the farmer to utilize the by-products of the farm in the manufacture of alcohol. The government proposes to publish the result of its expert's experiments as well as those that have been carried on in foreign countries, and it invites persons who have patented vaporizers, carbureters or complete engines which it is desired to test, to send their apparatus to New York, where the tests will be conducted without expense to the owners, save for transportation.

In the daily consular and trade report of a recent date, published by the government, are printed replies from several of our consular officers located in the principal continental cities, covering what information they have been able to collect concerning denatured alcohol and its uses abroad.

The Milan consul reports that methyl (wood) alcohol has no market in Italy, and it is impossible to quote prices from manufacturers to first hands. He says there is no demand for alcohol as fuel in engines, autos, etc., in Italy.

The consul at Marseilles says that the last word in regard to the industrial uses of alcohol has not yet been said, nor does he antici-



gate that American expectations in regard to the general practicality of this fuel as a motive force are going to be at once realized. The French government has created a commission of analytical methods in regard to alcohol and is publicly offering prizes for the discovery of a more advantageous method rendering alcohol unfit for consumption than the one now employed. Another prize is offered to the person who shall discover an improved means of utilizing alcohol as an illuminant.

The consul at Berlin writes that about all the interest he sees manifest in denatured alcohol for industrial purposes without payment of the industrial tax is the numerous requests from interested Americans for names of manufacturers of apparatus in Germany for the use of denatured spirits.

The consul general at Havana says that the principal consumption of denatured alcohol up to the present time in Cuba is in the domestic household, and that the consumption in motive power is as yet insignificant as there are but few motors operated by the combustion of alcohol. He thinks that when the Cuban planter is convinced that there is money in using alcohol for fuel he will utilize the thousands of tons of saccharose in the making of it by setting up distilleries in connection with sugar factories.

The consul at Brussels, Belgium, reports that denatured alcohol for fuel is not allowed there, so that there is no demand for it for engines or autos.

If the foregoing reports are a criterion of others that naturally will follow from different parts of the civilized world, it is safe to assume that this tactful and patronizing government of ours has let its legislative gun off half-cocked. The use of denatured alcohol for the purposes alleged on the basis of which this bill was gotten through Congress is a very alluring subject of experimentation for many a scientific gentleman, but why the government of the United States should take it upon itself to jeopardize the business of a large number of its foremost citizens engaged in the manufacture of wood alcohol by such a law as it has passed is a good deal of a mystery. It is almost impossible today to find a market for such methyl alcohol as is now produced as the by-product in charcoal making. From the facts in the case presented it would look as though the denatured methyl alcohol proposition would never be very much of a business for anyone. If the government should set itself to work in discovering new uses for the present output of wood alcohol it would do the country a much greater service than it has in fostering an attempt to overstock the wood alcohol market with a substitute.

### Evolution in Hardwood Inspection.

A general sentiment prevails among hardwood manufacturers that changes in a number of details in the manufacture, measurement and inspection of lumber can logically be made and that the time is propitious for the introduction of such changes.

It is argued that hardwood lumber is now sawed a good deal thicker than the trade demands yellow pine, hemlock or Pacific coast woods to be cut, and further that the trade does not require lumber passing for inch to be sawed from 1 1/16 to 1 1/8 inches in thickness. It is also stated that approximately ninety-five per cent of all hardwood lumber is cut up into various smaller sizes before it reaches its eventual use in the form of finish or furniture, and that invariably the better side of the board is used for the face. Hence, it is contended that in inspection it is just to consider both sides of a piece of lumber in making the grade. There is also a feeling manifest that, inasmuch as hardwoods generally are cut up, producers of furniture, finish and like products would in no wise object to an occasional piece of odd length lumber. In recent years hardwoods have been trimmed to regular two-foot lengths of 6, 8, 10, 12, 14 and 16 feet. The innovation in length would mean that in place of trimming off a bad end to the extent of 12 to 18 inches a 12-inch length might be left on the board and thus effect a considerable economy of material in the sawmill, lengthen the life of the forest, and still render the lumber of the same or even higher value to the man who cuts it up.

The proposed reforms contemplate the essentially fair proposition of giving to the buyer all fractions of one-half foot or under as

shown on the board rule, and adding to the next higher foot measurement of fractions over one-half foot. This is practically the old give-and-take white pine method of measurement, save that all the exact half-foot measure goes to the buyer. Again it is argued that a just system of tally consists in making the surface measurement on all thicknesses of stock a basis, and multiplying this surface measure by the thickness of the stock, as in the case of 1 1/4, 1 1/2, 2, 2 1/2, 3 inches or thicker. Some manufacturers contend that to effect economy of production a slight wane on one edge of an inch board that will dress out should not constitute a defect.

There is nothing in these proposed amendments to hardwood inspection that in any wise reduces the quality of grades for the uses for which they are intended, and it is specially suggested that lumber sawed for wagons, carriages, implements and kindred work must be inspected with a view to the adaptability of the piece for its prospective use.

The question of sap is also arousing considerable attention. As is well known, for a good many purposes to which hardwood is placed, sap is not regarded as a defect. For example, the furniture man in the building of his goods pays no attention whatever to eliminating sap from dresser or table tops or other articles in furniture making. The piece is made "in the white" with sap edges on a great many strips, and then the wood is toned to a uniform color by the use of stains, pigments and fillers. It is contended that in the past too much lumber has been placed in a lower grade than need be by the provision that it shall be free from sap. There are some woods in general use today, notably hard maple and tupelo gum, where the sap is the good end of the product. It therefore seems logical that bright sap should not constitute a defect in many kinds and grades of hardwood. The question of stained sap is likewise under discussion and will probably always continue to be so. Stained sap that will surely dress off is not a defect; stained sap that will not dress off just as certainly is one. It is up to the manufacturing trade to discover an inspector who is sure enough to determine from external appearance whether stained sap will dress off or not. It would seem that in this case the buyer should be given the benefit of the doubt, and it is certainly up to the manufacturer to produce lumber free from stain.

It is logically argued that current grading specifications which provide for a certain and increasing number of defects dependent upon the width of a piece of lumber are unjust. It is contended that the increasing defects permissible in a board should be dependent rather upon the total area than on the width. That is, a 6-inch strip 16 feet long may have the same number of defects as are allowable in the grade in which a 12-inch board 8 feet long is placed. There seems to be manifest justice in the argument.

There is nothing revolutionary proposed in hardwood inspection in any section of the country; rather, the proposed changes stick very closely to the custom in the trade; but there are certainly points, small in themselves, which in the aggregate mean a good deal to the manufacturer who recognizes the necessity of forest and sawmill economy—which will doubtless be worked out to his advantage. There are a good many people who set up the contention that "no changes should be made in hardwood inspection," but such advocates of alleged conservatism have no tenable ground upon which to stand. Grading on all kinds of lumber has been subject to revolution ever since lumbering became a commercial pursuit. In the old days when nothing but the highest class timber was felled and sawed it was possible to make much better grades than in succeeding periods. With the present high value of stumps and the necessity of taking every merchantable tree out of the forests, grades cannot show the old-time qualities in length, width or percentage of good lumber.

Consumers and manufacturers are helping out the hardwood operator by amending the construction of their output to meet present lumber conditions. Formerly table tops, for example, were made of one or two pieces of lumber. Today every manufacturer will tell you that if his hardwood lumber reached him in boards 12 to 24 inches wide, before making them into furniture he would rip them up into strips, as he has learned that he can make better furniture from narrow, kiln-dried stock glued up than from wide boards which are prone to check and warp. Today buyers generally will not pay for wide lumber, as they have no use for it, except a few exceptional instances where it still seems to be a necessity, as in the manufacture of automobile sides, wagon boxes, etc.

# Pert, Pertinent and Impertinent.

### Is It Any Sin?

God made man frail as a bubble,  
God made love and love made trouble  
God made wine—is it any sin  
For man to drink wine to drown trouble in?

### Disregarded.

The world rolls round forever like a mill.  
It grinds out death and life and good and ill  
Man might know one thing were his sight less  
dim:  
That it whirls not to suit his petty whim,  
That it is quite indifferent to him."

### His Extremity.

Every weepson was the Fair  
Of young Abijah Root  
He sought the Hand of Sady Smith,  
And got her Father's Floor  
LITTLEWOODS

### Necessary.

Inspiration acts as a starter to the wheels of industry, but it takes perspiration to keep them going.

### True.

Some men are known by the work they rearse to do.

### Both Fall Down.

It takes a man to preach constancy and a woman to preach consistency, but neither practice either to any considerable extent.

### The Test.

Very few of us make good in an emergency.

### Wild Oats.

The trouble about sowing wild oats is that you have to buy your own crop and pay a good price for it.

### A Hint.

The man who has really made good doesn't have to blow his own horn.

### Scandal.

A bit of scandal gives a delightful flavor to one's coffee.

### Saturated.

Some men's highest idea of good is of itself evil.

### Spoiled.

A good story is often spoiled in the telling by the man who sits nervously in the crowd, afraid that he won't get a chance to spring his own story.

### Rara Avis.

Everybody has heard of the poor and proud, but who ever heard of the rich and humble?

### Alike.

Opportunities are like eggs in that they must be hatched while they are fresh.

### Egotism.

Egotism is a disease for which there seems to be no cure this side of the grave; and even then it often breaks out on the tombstone.

### Takes Diplomacy.

People are like pitchers—there is a handle to every disposition if you only know how to take hold of it.

### Opportunity.

"The space between a man's ideal and the man himself is his opportunity."

### Not Needed.

So many men have the faculty of never being on hand when wanted that the world soon learns to get along very nicely without them.

### The Point.

Certainly a satisfied customer is an excellent advertisement, but the difficulty is to get the customer to satisfy.

### Quite So.

It isn't what a man owes, but what he pays that keeps him poor.

## THE QUESTION.



Do you love me for myself alone?

## Tree Growth and the Physics of Wood.

### Composition and Structure of Wood.

Apropos of the study of wood physics, Herbert Stone, the eminent English authority, says:

"It would be a difficult task to answer the question why some plants possess the property of forming wood, while others, nearly related, do not. Why some plants run their course in the brief period of a year, and perish as soon as they have given birth to another generation, while others persist and augment their bulk year by year for centuries. There is much food for reflection here.

"Such plants as are endowed with the faculty of secreting a substance which resists decomposition for a long time, and of fortifying their tissues with it, play a very different part in the world's economy to that of their herbaceous relatives, which to-day are, and to-morrow cast into the oven. They exist long enough to acquire an individual history. This history may not be written in human records, but it has a record of another kind, which may be read in the structure of the tree itself."

Wood is made up largely of hydrogen, oxygen and carbon. When quite dry, about half its weight is carbon—the other half oxygen and hydrogen in about the same proportion as they are found in water. It contains also about one part in a hundred, by weight, of earthy constituents, and nitrogen in the same proportion. Trees draw their nourishment from two sources—the air and the earth. A stick thoroughly seasoned has lost the water it contained. If it is burned, only ashes remain. These two elements, the water and the ashes, were derived from the soil originally. Those parts which were obtained from the air return, during the burning process, to their gaseous form, while most of those which came from the earth assume once more their tangible existence, although some are converted by the heat into gases and also escape into the air.

If the dry stick be slowly smothered instead of burned in the open, it will emerge from the process as a piece of charcoal, with shape and structure intact. It has become carbon, with but one impurity—a trace of ashes. The smothering to which it has been subjected has caused what would otherwise have been liberated as carbonic-acid gas to remain in solid form, although flames have the power to free it even in this form.

Possibly the most familiar feature noted in wood structure is the annual ring with which the tree surrounds itself during each year of its growth. This periodical addition is a conical sheath which encircles the entire plant, partaking of the nature of the ring preceding it, but distinct from it. Thus it is that while a tree may be described as very ancient, the statement of its great age is true only of its innermost stem, the outer and upper parts being but recently acquired. With the advent of new living portions year by

year, certain inner layers lose their vitality, partially or entirely, and become part of the heartwood of the tree.

The Autumn and Spring zones, as exhibited by the annual ring, are not always distinct, although in trees which grow in temperate climates they are often exceedingly clear, owing to the difference in rapidity and vigor of growth between wood formed in the early spring and that produced later in the season. Although the term "annual rings" has sometimes been called into question, it is undoubtedly correct, for so long as a tree is healthy and thrifty a ring is formed each year. It is a fact that two false rings may appear during one growing season. But they are generally so much thinner than the rings on each side that they may be easily detect-

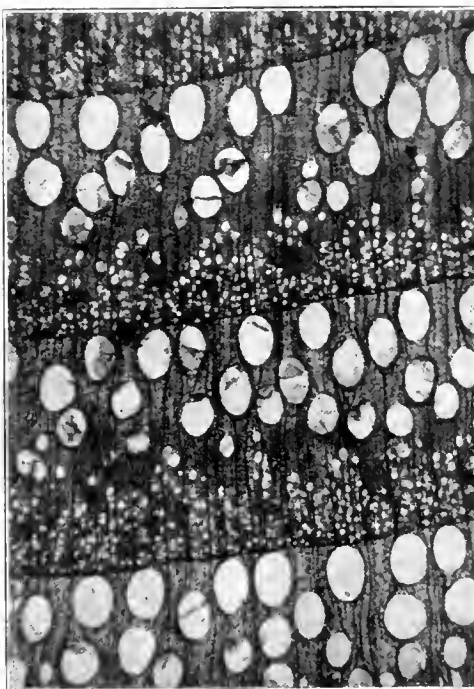

CROSS SECTION OF CHESTNUT MAGNIFIED TEN DIAMETERS.

ed. Sometimes they do not entirely encircle the tree, as does the true ring, provided the tree is in good condition. When growth is interrupted for a time, as is the case when the foliage is destroyed by worms or when the tree is subjected to a severe and prolonged drought—and then commences again during the same season—a false ring is occasionally formed. Insects inflict untold damage upon forests every year, eating the substance of the leaves and buds. Caterpillars, moths and beetles are among the most harmful, as are also the borers which infest solid wood, honeycombing it, and ruining it for timber, or prying through the bark and sapping the life of the cambium, which is so vital to the tree's healthy existence.

After an annual ring has been covered by other younger layers, it becomes gradually darker and harder. Its cell openings become

clogged in such a manner that sap can no longer circulate freely through them. From the live wood, representing the active principles of the tree, it becomes the so-called "heartwood," which is dead, and therefore not essential to the life of the organism, although it forms part of the strong framework which supports the living parts and gives strength and substance to the tree. Thus it is that hollow trees, if not subjected to strain from weight or gale, may flourish and even bear perfect fruit.

The living portion of the structure, "sapwood," decays more easily than does heartwood, because it absorbs water freely and therefore contains elements of food which are prone to decompose. Because the sapwood is the outer portion and the vehicle through which nourishment passes, the life of a tree is easily destroyed by girdling. Not all trees, however, form distinct heartwood, and in such varieties girdling is often survived for several years.

Every part of a piece of wood consisted originally of cells, or tiny, closed cavities. They are of various forms—some round, some several-sided, others square or spindle-shaped, and all bear some special relation to the life of the tree. Some of them conduct water from root to crown, others merely strengthen the structure. The wood of coniferous trees—the pines and spruces—has but few varieties of these cells, while the broadleaf trees, or hardwoods, show a much more complicated structure. With both, however, some of the cells have thick walls and others thin. In temperate climates, where a season of growth is followed by one of rest, the cells of the layer of new wood formed annually at the inner surface of the cambium, are arranged with great regularity. In the Spring a tree makes thin-walled cells, through which the abundant supply of water can rise rapidly to the new twigs and leaves. Later, when the food store has become abundant, and the demand for water is consequently less, the cells formed are narrow and thick-walled. Thus the wood grown in summer is heavier, stronger and darker than the spring wood of many trees, notably the chestnut.

The chief feature of the wood of conifers and hardwoods is the system of rays, which are always present, and which are exceedingly important in the classification of different species of wood. These rays bind the wood fibres together and are an important factor in the production of "figure." Most trees exhibit but one kind of ray, although in the oak two kinds are evident, large and small. The large rays are composed of irregularly arranged small cells, while the small ones are made up of larger cells. As the circumference of the annual rings becomes greater, the original rays become wider apart, and new ones arise frequently enough to preserve the proportion of rays to mass of wood. These new ones have nothing to do with the



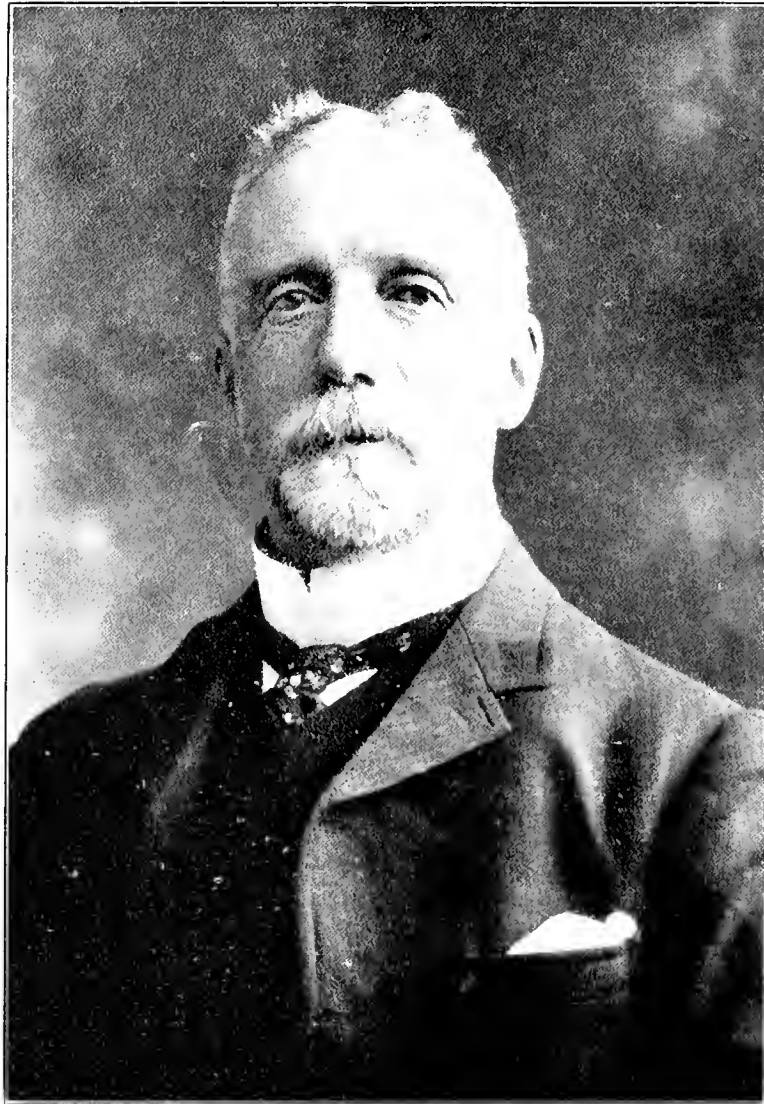

ALFRED DOBELL  
LIVERPOOL, ENGLAND

pith, for the latter may be destroyed without interfering with their production.

The pores of wood are minute tubes, which run vertically through the stem, and which convey air and fluids. All but those of very new wood contain air, gums and resins which have accumulated from rejection by the leaves, or occasionally peculiar tissue, which appears like a mass of bubbles. In certain tropical woods, teak for example, another sort of filling takes place, which seems to be of mineral origin. It is exceedingly hard, and dulls the edges of tools very quickly. Specimens of wood have been found in which accumulations of this substance have practically replaced the inner rings and formed a heavy, stony mass. The pores do not arise irregularly, but in "rhythmic succession." They may be seen in graceful festoons in the elm, or in tapering, plant-like clusters in other woods. If a tree is observed in which there are more pores in the Autumn than in the Spring zone, that fact is an indication that the tree is a conifer, and the pores will be found to contain resin, which is a further indication of its family.

Stone says: "If certain woods be cut in a radial direction, a row of closely arranged pores may be exposed at the same time, so that the wood will appear very 'coarse-grained.' On the other hand, if the cut be tangential, the radial row of pores will be cut at right angles, and only one of the series will appear on the surface. Confusion can

easily arise from this cause, and no small demand is made upon the imagination to reconcile the differences shown by an oval-pored wood cut on the quarter (radial section) with its abundant coarse grooves and showy 'silver-grain' and another piece of the same wood cut plank-wise (tangential section) on which but few narrow pores and no silver-grain are to be seen."

Woods display great individuality in their structure. Usually the fibres are parallel and the wood is called "straight-grained." The bundles vary in shape and size in the same species of oak, tapering and overlapping at the ends, thus making that wood harder to split than soft pine, for example, which has regular, cylindrical fibres, meeting end to end. Beside the natural irregularities in straight grain, caused by knots, there are odd and abnormal forms. A wavy grain is frequently exhibited; or the twisting of a tree while growing will throw the grain into spiral lines. The gums sometimes show a strong tendency of the grain to veer for a time to one side, then back to the other, a process which causes a "cross-grain" almost impossible to split. "Birdseye" and "curly" maple present a beautiful pattern and sheen when finished carefully, and in fact any extreme irregularity adds to the value of high-class woods, giving them a place in decorative art, for which no substitute can be found.

of the hammer sold 50 lots in an hour he thought he was doing well. This method of selling no doubt shortened the life of many of feeble constitution. The credit for remedying this barbarous method belongs to Alfred Dobell & Co., and they did it by erecting a saleroom where the auctions could be held with comfort and business-like decorum and despatch. Now, instead of the old rate of 50 lots an hour, the normal rate is 200 lots an hour. The innovation was so well supported and appreciated by buyers that the other brokers followed the example, and as a result the Liverpool mahogany sales are now conducted with such despatch and comfort that it makes us wonder why the old style of selling was allowed to exist as long as it did. The strides by which Alfred Dobell & Co. have placed themselves in the front rank of the mahogany brokers of the world may perhaps be best illustrated by the growth of their storage accommodation, which is almost entirely devoted to mahogany. In the old quarters at No. 1 Canada Dock in the year 1890 their accommodation was less than 3,000 square yards. As steadily as their mahogany business increased, so did they steadily keep pace with its requirements. They added area after area to their storage accommodation, and their total storage space is now no less than 21,000 square yards, or over four acres of land, all of which is covered by gantries and by steam or electric cranes. The rapidity of despatch which is practiced both in the in-coming as well as the out-going of mahogany is marvelous, and would not have been considered possible ten years ago."

In addition to their important pine and mahogany trade, Alfred Dobell & Co. do a large business as agents for American hardwood shippers. For this the experience of Mr. Dobell in his years of business in the United States particularly adapts him. He is conversant with American as with English methods of marketing lumber. Realizing this, John E. Moore & Co., of St. John, New Brunswick, made the firm their English brokers for their great spruce output. Alfred Dobell & Co. are also buying brokers for the entire timber requirements of the Great Central Railway, and by the appointment the English railroad officials paid compliment not only to the good judgment and business acumen of the firm's personnel, but also to their tact and integrity.

Mr. Dobell is married and has a family of four boys and four girls. He never took a very active part in politics but once in his life, when the Hon. George Curzon (now Lord Curzon of Kedleston) first contested the Southport Division of Lancashire. Mr. Dobell was then chairman of the Waterloo Conservative organization, and this district really won the election for Lord Curzon.

While Mr. Dobell has the reputation of a business man of indomitable perseverance and conservative judgment, yet his unflinching tact and great geniality make him one of the finest examples of the builders of lumber history.

## Builders of Lumber History.

NUMBER XXXI.

Alfred Dobell.

(See Portrait Supplement.)

As the subject of its pictorial supplement, the HARDWOOD RECORD takes great pleasure in presenting to the hardwood trade of the United States the president of the Timber Trade Federation of the United Kingdom, Alfred Dobell, of Liverpool, England.

Mr. Dobell, the senior member of the firm of Alfred Dobell & Co., was born in Liverpool in 1844. He is the seventh son of George and Elizabeth Dobell, and serves to illustrate the old tradition that the seventh son is born to success in anything he undertakes. However, others of the family have been famous as lumbermen, namely the late Hon. Richard R. Dobell, of Quebec, who had a world-wide reputation.

Alfred Dobell was educated at Bolfield House, Bowdon, Cheshire. At the age of sixteen he entered the timber office of Messrs. Farnsworth & Jardine as an apprentice, and four years afterward, at the end of his apprenticeship, was ordered to the Mediterranean and Egypt in search of health. He returned in the spring of 1865, but again finding the English winters too severe for him, he sailed in November of that year for Savannah, Ga., in the barque Lady Russell. Arriving at Savannah in January, 1866, he remained until the following May, when, after

a trip through the States and Canada, he returned to England.

In November of this year he returned to Savannah and entered the firm of Charles Green & Sons' Company as a partner. In 1872 he returned to England and started in business in Liverpool as a timber broker, and to-day his firm is quoted as the largest of its kind in the United Kingdom. He was, while in Savannah, one of the pioneer shippers of long-leaf pine to England, and after his return he created a large and important business in this wood. A few years after Mr. Dobell commenced business in Liverpool Charles E. Paynter, who had been associated with him in his office, became a partner. In 1876 Charles O. Hughes entered the office as apprentice, and was made partner in 1899.

The London Timber Trades Journal of recent date says:

"We well remember Mr. Dobell's *debut* as a mahogany auctioneer on the 19th December, 1890, when the catalogue consisted of only 56 lots of Panama mahogany, and the sale was upon the open quay of the Carrier's Dock. These were the days when public sales were held either upon open quays or in draughty sheds—the old time, when the auctioneer moved on from lot to lot with a crushing, crowding concourse of customers treading on his heels, and when the wielder



## Hardwood Record Mail Bag.

[In this department it is proposed to reply to such inquiries as reach this office from the HARDWOOD RECORD clientele as will be of enough general interest to warrant publication. Every patron of the paper is invited to use this department to the fullest extent, and an attempt will be made to answer queries pertaining to all matters of interest to the hardwood trade, in a succinct and intelligent manner.]

### Appreciative.

WEST VA., Aug. 15.—Editor HARDWOOD RECORD: We have your valued favor of the 13th relative to article published concerning the Pittsburg Fuel Company, Delaware Hardwood Lumber Company, etc., and also received the copy of your issue of May 10. We beg to thank you very kindly for your attention to this matter and assure you that same is appreciated, as it has assisted us in locating to a certainty a bunch of sharks that we shall always endeavor to steer clear of. We beg to offer our commendation of your wideawake policy, as you have supplied us with information that all of our commercial agencies have overlooked.—LUMBER COMPANY.

### Cigar Box Lumber.

HAMBURG, GERMANY, Aug. 6.—Editor HARDWOOD RECORD: We would be greatly obliged if you would give us the names of the firms in your country manufacturing cigar boxes or dealing in cigar box lumber or timber. Thanking you in anticipation of your kindness, and always at your service in return, we are, yours faithfully, — Company.

The writer of the above has been furnished the names of several producers, and if any others interested wish to communicate with the HARDWOOD RECORD they will be furnished with his address.—EDITOR.

### Southern Oak.

MILWAUKEE, WIS., Aug. 14. Editor HARDWOOD RECORD: Kindly inform me where I can get reliable information as to the quality of hardwood timber in the different sections of the South, if such can be secured at all. I am interested in a tract of hardwood timber, principally oak, in White county, Arkansas, and wish to find out what the quality of white oak in that section is. Thanking you for the courtesy of a reply, —

There is no cut-and-dried rule by means of which the quality of hardwood timber in the different sections of the South can be accurately analyzed from a distance. The physics of timber depends primarily upon the quality of the soil, rainfall, botany of the wood, latitude or compensating altitude. If you can supply the foregoing information, the value of the stumpage can be closely estimated. Otherwise, the best way to determine the facts would be to send a competent man to analyze the proposition on the ground, and report to you. There is no published information that will cover these points. White and neighboring counties in Arkansas contain a considerable quantity of very good oak. In this and other sections in the same locality some of the oak is defective, chiefly from too rapid growth and from wormholes.—EDITOR.

### Wants Birch or Maple Dimension.

NEW YORK, Aug. 13.—Editor HARDWOOD RECORD: We have an inquiry at present for a car of birch or maple dimension stock for shipment within forty-five to sixty days; stock to be clear and free from all defects; sizes to be exact after

pieces have been dressed on four sides. We would exceedingly appreciate hearing from you as to who would likely be able to execute such an order. Specifications furnished on application, and if the number of pieces given therein would not constitute a carload, could easily make up one.—COMPANY.

The above inquirer has been furnished with the addresses of several concerns which make a specialty of this stock. Any reader wishing to communicate with the writer, however, will be furnished the address upon application to this office.—EDITOR.

### Wants Oak for Export.

NEW ORLEANS, LA., Aug. 14. Editor HARDWOOD RECORD: As a subscriber of your paper I beg of you to favor me with some addresses of reliable manufacturers of plain white oak. I am in the market for about 500,000 feet of strictly firsts and seconds for export.—& Co.

A better list of reliable manufacturers of plain white oak could not be collated than that which may be obtained by checking up the advertising cards in the HARDWOOD RECORD. There are fully a hundred leading manufacturers in this list who are reliable producers of oak suitable for export.—EDITOR.

### Mistaken Identity.

GLEN HAVEN, MICH., Aug. 13.—Editor HARDWOOD RECORD: I notice in your report of the Michigan Hardwood Manufacturers' Association meeting held at Mackinac, Aug. 8, you credit me with some remarks on the subject of rules which were made by the gentleman who sat beside me. [Probably M. E. Collins.] I am perfectly willing to stand by my own utterances, but in this case I hardly agree with the remarks as made, and

wish you would make proper correction. Yours very truly, D. H. DAY.

The HARDWOOD RECORD regrets this confusion in regard to the author of the little speech on rules given at the recent Mackinac meeting. Singularly, both shorthand reporters who made the report, through mistaken identity, credited the speech to Mr. Day.—EDITOR.

### Accused of Larceny.

CADILLAC, MICH., Aug. 16.—Editor HARDWOOD RECORD: I note on page 28 of your last issue that you appear to be infringing on the ideas established by our people in the use of narrow flooring for stair steps. However, this may be of benefit to someone and therefore you are at perfect liberty to exploit it all you care to. There is another idea advanced on page 28, and that is the narrow steep emergency stairs. If a person is sober enough to start right he will probably get to the bottom without any trouble, but we note he is cautioned in this article to keep his right foot forward. These little things appear simple to a casual observer, at the same time they are quite often very important in a large manufacturing institution and I believe that little things of this kind are very readable for your patrons.—HENRY BALLOU, Manager Cobbs & Mitchell, Inc.

The RECORD will have to confess that it purloined the idea of the use of short, narrow maple flooring strips for stair treads from the writer of the above letter. Mr. Ballou has tried out this system of building stairs for many years, with the greatest success. While confessing, it might as well be stated that the idea of the recessed stair treads, which was illustrated in the same article, was taken from the practice of the Berkeley & Gay Furniture Company of Grand Rapids, Mich., which has several of these staircases in its factory.—EDITOR.

## Some Problems of Veneer Making.

Every branch of the woodworking industry has its problems, no matter how many of them may have been solved. At times there are more than at others, but it seems there is never an entire absence of troublesome questions. In the early stages of an industry there are of course many problems that need solution. In the manufacture of veneer topics that are getting considerable attention just now are the disposing of narrow stock; the cutting of uniform widths in quarter sawing and working out some rational basis on which veneer can be cut and kept in stock against possible needs.

The matter of narrow stock received quite a little discussion at the recent meeting of the veneer manufacturers in which it was brought out that some users of veneer do not care for stock unless it is 12 inches and up in width. Below 12 inches they count it practically worthless, for it costs as much to join and work it up as it does to buy more stock of the desired width. This is all very well for the user, but not for the manufacturers, and the grade committee having charge of the specifications made it a point to include widths from 6 to 24 inches in standard stock, making that above these widths special, while

that below 6 inches, of course, is practically worthless.

Taking the veneer panel, or the built-up lumber proposition as a whole, in comparison with hardwood lumber manufacture, it is easy to deduce logically that the point where the panel man gains in competition with the lumberman is in wide stock. Of the widths that come within the range of ordinary cuttings in sawmills, the sawmill man can furnish panels of solid stock cheaper than the veneer man can furnish the same panels of three-ply stock. Especially is this true if the panel is to be made both face and back of the same kind of wood. If, for example, the panel is to be made of oak 3 $\frac{1}{2}$  of an inch thick, with  $\frac{3}{8}$ -inch stock on front and back of oak, it does not matter how cheap a wood is used for the center, the cost of the veneer panel exceeds that of the same panel made of solid oak, provided the range of width stays within the general run of lumber stock at the mills. Veneer men do not always get more for such panels, but they should, since the cost is heavier in comparison than to make lumber. Where very thin veneer of extremely rare and expensive wood is used for face stock only, it is more prac-

tial and probably cheaper in some instances to make even ordinary widths of built-up lumber, because of the scarcity and high price of the face stock. The built-up panel has the most pronounced advantage, however, where stock is wanted wider than the average sawmill man can furnish in anything like large quantities.

All this, while it may explain why veneer users do not favor narrow widths, does not help in solving this problem. What veneer manufacturers need to get the right kind of profit and to incorporate the proper element of economy of timber in the work is a market for narrow stuff, and the needs in this line are so urgent that some satisfactory solution of the question is most imperative.

There is not a very great percentage of narrow stock in rotary cut veneer, when compared to the great proportion of narrow widths in lumber from the average sawmill. The percentage of veneer running under 12 inches in the average rotary plant cutting oak, for instance, is thought by manufacturers to seldom exceed 10 per cent, and frequently is not over 5 per cent, depending on the quality of the timber and on how the orders for stock fit in in working out so as to make a close clean-up. However, even at the lowest percentage given the narrow stock is an item worth saving. The question is, how is it to be done? The answer involves the co-operation of the consumer with the manufacturer. The consumer as well as the manufacturer should look to the future and he will see that unless this narrow stock is taken care of now he will have to pay a higher price for veneer very soon, than if he lends his aid in the work of planning to use stock down to the lowest practical width. It may be difficult for panel manufacturers to aid in this work, especially where their trade is in wide panels, not only because of the expense in matching up but because it does not give as even figured or good-looking a face to make joints in a panel. There are, however, certain other users of veneer that can assist materially in taking care of narrow stock, prominent among whom are furniture manufacturers. Although they require some wide stock, very wide in some instances, they also have numerous opportunities to utilize narrow widths. An instance was cited by a manufacturer recently of a purchaser of his stock who maintained that he could not use narrow widths, and yet a visit to his factory showed that he was not only using 2, 3 and 4 inch widths, but actually cutting up wide stock into 7/8-inch strips for banding table tops. This furniture manufacturer might have used lots of what is termed scrap stock that goes to waste, but he did not want to buy it because he could always cut wide stock down and make whatever smaller sizes he wanted, whereas, if he had bought some smaller sizes he might not have been able to use them up as rapidly as he would like.

It would seem that it is time for the buying trade to wake up and shake itself free from contrariness of this kind and show the right spirit and co-operation with the manu-

facturers. This does not mean that they should knuckle down and let manufacturers sell them anything, but that the user should not insist on the wide stock regardless of the welfare of the manufacturer, and each should strive, insofar as practical, to assist the other and aid in the economical use of wood products in the form of veneer.

In the manufacture of quarter sawed veneer a perplexing problem is to get uniformity in width, color and figure. The greatest uniformity in width is obtained by sawing logs into square-edged flitches and then working these flitches on the veneer saw. This gives one face of an even width and general tone of color on account of coming from the same piece of timber. The ideal figure in quarter sawing, however, comes from the sawing of what are known as havel flitches, obtained by keeping the saw as near as possible at right angles with the rings of growth, which involves more frequent turning or tilting of the quartered flitch and makes not only more narrow stock, but a different width for practically every cut. Therefore, to get any great number of a given width, it would become necessary to select them from different flitches, and this would give an undesirable variety of color and figure. Whether perfection of figure is to be sacrificed a little for uniformity in width, or whether uniformity in width is to give way to perfection of figure remains to be seen and depends somewhat on the demands and requirements of the users.

The problem of having standard widths of veneer so that manufacturers can cut rotary stock and carry it against the future needs of the trade is one that veneer manufacturers and users have not as yet faced squarely. Many seem to think that veneer can not be cut and kept in stock, because they do not know just what the user is going to call for, consequently it is necessary to wait until the

order is in and then fill it. Delving back into lumber history will reveal the fact that something of the same idea obtained in regard to cutting lumber in earlier days. There were no standard specifications as a basis to figure from, and when a man wanted lumber he had it cut to suit his own ideas. But by and by common usage gave certain ideas of standard thicknesses and finally certain widths and lengths, until the average user of lumber, instead of figuring out his wants according to his own notion, got into the habit of looking to the sawmill and fitting his wants to the sizes that were generally cut and kept in stock and he could get what he needed without having to wait to get it cut to order and seasoned. There is, of course, a great deal of special order stock, even in the lumber business, and always will be, but there is hardly a mill that does not also make large quantities of standard stock that finds a ready sale.

When the veneer men come to face this idea just right they will find too that the veneer business has possibilities along this line. It will never be entirely free, and need not aim to be, from cutting more or less stock to order, but the idea of developing standard specifications so that the stock can be cut in advance of sale with a fair degree of assurance that it will find a market should not only be kept in mind but should be pushed, because it means more satisfactory business in many ways. The buyer who is in a rush for a certain line of stock can find it on hand somewhere, and the manufacturer of veneer during slack times when orders are scarce, can, like the sawmill man, cut stock against the possible requirements of the future and not have to shut down his mill part of the time and run it overtime when the rush does come, while the user of veneer howls for stock.

## *Beer and Ale Staves.*

Beer and ale staves are made exclusively of white oak, and made in the rough by hand, so that the oak must not only be of the choice white variety, but it must be smooth and straight-grained, so that it will split well. Kentucky produces more beer staves than any other state in the Union, and might be termed the center of operations in this industry, with probably Tennessee coming next, and all the other states having good oak timber contributing more or less. No one has ever prepared statistics of the exact amount of oak timber used annually in beer staves. The Forest Service estimates that there are between 12,000,000 and 13,000,000 staves made a year, which probably represents the staves made to be sold on the open market. The trade generally estimates the total product at about 10,000,000 made by stave men and about 10,000,000 made by beer barrel coopers, who have their own stave plants. It would be a little difficult, however, even if exact figures were available, to determine how much

timber is required to produce this stock. Some timber works up more economically than others, and some crews of men can get more out of the same amount of timber than others, hence it would be almost impossible to estimate with any accuracy the total amount used, although it is undoubtedly much larger than even the trade believes. Staves are made in four sizes for beer and two for ale, the lengths running from 16 1/2 inches for the pony beer kegs to 40 inches for ale hogsheads. The sizes and specifications for beer and ale stock, as adopted by the beer stock association, are as follows:

### RULES FOR INSPECTION OF HOLLOWED, EQUALIZED AND LISTED BEER STAVES AND SAWED HEADS:

Beer staves must be made from sound white oak timber, free from short crooks and seed holes; two sound worm holes in a stave may be allowed, but ninety per cent of each lot must be free from such defects.

Grain They must be straight grain, or as nearly so as possible, and will be classed as culls if the grain has an angle of over 45 degrees.

## HARDWOOD RECORD



BILLETS PILED IN THE WOODS READY FOR THE COMING OF THE FINISHING PLANT

Checks. They must be free from heart checks of such a nature as to make them unfit for the purpose for which they were intended.

Streaks Staves may have black or red streaks on the inside, if they do not show through at any point between chimes, nor more than a quarter of an inch deep at end; on outside if they do not show through at any point between chimes, nor more than a quarter of an inch deep at end.

Minimum width of barrel staves is to be 3 1/2 inches; 1/2 and 1/4 barrel, 3 inches; 1/6 and 1/8 staves, 2 3/4 inches; measurement taken on back of stave at bilge, including 1/4 inch of sap.

### STAVE DIMENSIONS.

Size	Average Thickness			Should Bilge or
	Length	Width	End	
1/8	16 1/2 x 1 1/2	1 1/4 x 1 1/4	1 1/4	2 1/2
1/4	20 1/2 x 4 1/4	1 1/2 x 1 3/4	1 3/4	16 x 3
1/2	25 1/2 x 4 1/2	1 3/4 x 1 5/8	1 5/8	16 x 3 1/2
1-1	31	4 1/2 x 1 3/4	1 3/4	16 x 4
Ale hds.	34	4 1/2 x 1 3/4	1 3/4	
Ale hds.	40	4 1/2 x 1 3/4	1 3/4	

Beer heading, sawed or chipped. Specifications as to grain and quality to be the same as in staves, except that streaks shall be allowed on one side only, if same do not pass through the heads or through over one third of the thickness of the heads at the ends of same.

### HEADING SAWED OR CHIPPED.

Size	Average		
	Length	Width	Thickness
1/8	10 1/2 inches	5 1/4 inches	1 1/4 inches
1/4	13	6 1/2 inches	1 1/2 inches
1/2	16	8	1 3/4 inches
1-1	18 1/2 inches	6 1/4 inches	1 3/4 inches

The above widths mean clear of sap and apply to two-piece heading, except 1-1 heads, which apply to three-piece heads.

All of the above dimensions are for green stock, and a variation of 1/16 of an inch to be allowed on all thicknesses.

The process of manufacture followed in producing beer staves is in a class by itself,

differing materially from the manufacture of other staves. When timber for beer staves is secured, which is generally at a point some distance from a railroad, a crew is established and a mill set up, the timber is cut, the logs sawed up into stave lengths and these blocks split up into stave billets, right on the ground in the woods. This may seem somewhat similar to the method in vogue of making other tight barrel staves. The difference is that the modern method of making regular tight-barrel staves is for the crew in the woods to cut out stave bolts, that is, sticks of timber that can be sawed up with cylinder saws into a number of staves, whereas the beer stave crew splits the stock up into single stave billets or blanks.

Prior to starting a woods crew at work the foreman or manager of the enterprise looks over the territory and figures out some location where he can set up a finishing plant to put these stave billets in shape for the market. What he wants is some point where he can concentrate a quantity of billets sufficient to justify setting up a finishing plant. In the early days it was figured that one should get about 300 M staves to justify a set, but the scarcity of good timber of late years has trimmed down that figure materially, and to-day beer stave men are not only glad to get 100 M staves in a set, but sometimes make out with less.

The stave billets, as they are originally gotten out, are sorted or inspected and piled up in the woods right where the splitting is done. Then the haulers, who follow the woods crew, haul these billets to the point selected for making a set. At the place for the set they are piled up in long ricks like cord wood at an old-fashioned woodyard to await the coming of the finishing plant.

There are two methods of finishing beer and ale staves; one is to put them through what is known as a bucket, in which they are driven endwise by a power plunger between two curved knives, one of which trims the surplus wood off on the inside and one on the outside, leaving the finished stave in a circular form, as it is found in a barrel, on the face and back, with the edges still rough. This was the earliest method of finishing, and the staves were thus shipped to the cooper shop for jointing and hollowing out. Some staves are still finished in this way, but the



UNLOADING FINISHED BEER STAVES AT THE RAILROAD

majority of beer staves to-day are much better finished and by a very different process. The machinery equipment of the modern beer-stave plant varies a little, but the essential machines are an equalizer, to trim the stave billets to exact length, a stave dressing machine and a jointer. The stave-dressing machine is the most complicated, and carries two heavy cutterheads, somewhat after the style of a lumber planer, the knives on one of these heads being designed to give the curved shape to the outside of the stave, and the other shaping the inside as the blank is carried edgewise between the two cutters, clamped endwise between two cylindrical clamps. The staves are trimmed on an equalizer before they are put through the dressing machine, and after passing it they go to a jointer, which is an enormous disc wheel, carrying on its face knives to trim off the rough edges and sap and give it a smooth joint, at the same time making it narrower at the ends, thus giving what is called the bilge to the packages made from it. And so perfect is the work of these machines that staves taken from different yards, made by machines in different states, are as nearly alike as if made on the same machine.

The machinery described above, together with portable boiler and engine, usually ranging in size from 25 to 35 horse power, constitutes the modern beer-stave plant, and has a capacity of from 3,500 to 4,000 beer barrel staves a day, or about 5,000 half barrels. With this capacity, the annual output would be large, but quite a good deal of the life of such a plant is spent in moving from place to place.



A MODERN BEER STAVE FINISHING PLANT AT A SET

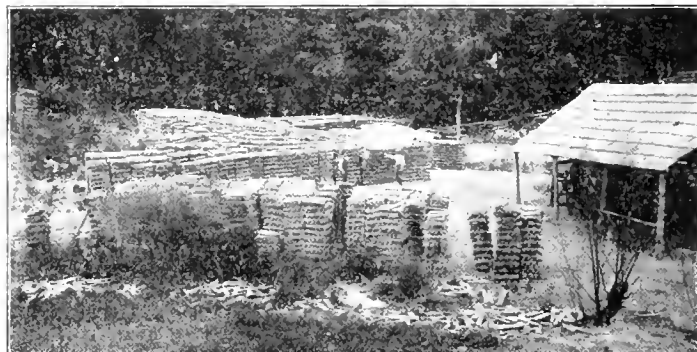

FINISHED STAVES CROSS PILED FOR DRYING

Naturally, the stave billets dry considerably while piled up waiting for the finishing plant, but they are seldom dry enough for marketing direct from the finisher, so they are usually cross piled on the yard after being finished and left from 30 to 90 days, as the occasion may require, before starting on their journey to market. At some seasons of

the year, when hauling is best, they may be taken to the railroad while green and piled for further drying there, so as to be available when wanted, but as these hauls are usually over long distances, it is important to reduce the weight as much as possible before hauling; consequently they are usually piled on the yard and allowed to dry there.

in a solid form at the left, and the partly cut toothpicks at the right. In the event of a knot or other defective portion coming under the action of the knives, the liability of the strip being broken is apparent. Hence care is taken to select timber which will pass through properly. Following the cutting of the points comes the burnishing process in the tumbler cylinder, Fig. 13. This device is used only on special toothpicks. The action of the rolling picks inside the cylinder tends to make them smoother, especially if polishing ingredients are introduced. The cylinder bears on a shaft and the latter revolves in bearings arranged in the uprights. The belt operates on the tight and loose wheels (d), and the wheel shaft carries the gear (e), which meshes with the large gear of the drum as shown.

## Hardwood Toothpicks.

Although the common toothpick is a very ordinary affair, it has formed an important factor in the wood-working industry in recent years. This is due to the demand for special kinds of toothpicks, such as those made of scented woods, specially designed, or engraved and elaborately stained and packed. While manufacturers in this country are not lacking in ingenuity in the production of artistically designed hardwood toothpicks, the most interesting kinds may be seen in the Orient. The natives are fine artisans in the line of engraving. Toothpicks appear to be their specialty.

Fig. 1 is a form of headed hardwood toothpick of Chinese design. The workman selects billets of hardwood and tediously works out the pieces with a single tool while squatted cross-legged on the floor. He does not care very much how long it takes; time is no object to him. He makes various kinds of toothpicks and goes about peddling them. The American manufacturer goes at it on a different scale. He undertakes to do away with as much hand labor as possible. He introduces machinery to work up the material and finish it. However, in catering to the prevailing demands of the market he must produce some elaborately carved and colored toothpicks, many kinds of which must be scented.

The feathered type of toothpick presented in Fig. 2 requires considerable material for the shaping of its fan-head. This is an American style of special toothpick, and the fan-like form is readily stamped out by means of cutters. The so-called "looped" toothpick is a copy of a design used in Manila. The hard, flint-like "bullet" wood of the islands is utilized for making these toothpicks by hand. The fiber of the tough wood develops a series of small circles in the tissue as shown, upon polishing. Among the chiefs of the Jolo island district can be seen toothpicks finely cut from hardwoods and richly ornamented at the head with pearls, as shown in Fig. 4.

The American manufacturer of hardwood toothpicks has various trials to meet. The use of unseasoned stock often brings on a "bowed" condition of the toothpicks, illustrated by Fig. 5. Splits (Fig. 6) not infrequently prevail unless a system of assortment is followed and defective picks taken out. Broken toothpicks are more common in hardwood stock than in softwood. Stubs prevail to some extent, but the popular form of pointed toothpick is shown in Fig. 9.

Maple and hickory are largely used in the

manufacture of the common styles of toothpicks today. The bolts are prepared for the machinery by cutting the pieces as shown in Figs. 10 and 11. While it is essential that stock which is free from knots be selected it is practicable to run uneven stuff to a certain extent. Much depends upon the character of

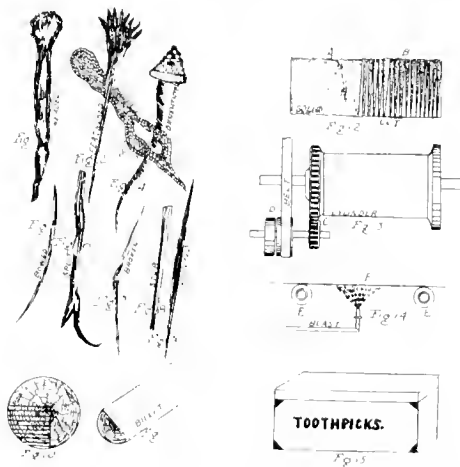

VARIETIES OF HARDWOOD TOOTHPICKS.

the automatic machinery. The hand-toothpick makers can utilize chosen portions of the stock, whereas machinery necessarily operates upon any sort of stock as it comes along. For example, in Fig. 12 we exhibit the sheet

required scenting to fancy toothpicks, the contrivance shown in Fig. 14 is employed. This consists of bearings (e, e) which carry rolls for supporting a moving perforated apron. The toothpicks are carried along on this apron in large numbers, evenly distributed. The air blast is carried through the pipe as shown, and this discharge carries with it the perfumed vapors. The nozzle is arranged so as to play the scented vapors up into the perforations of the moving apron (f). The saturation is ample to penetrate the fibers of the picks and each absorbs sufficient to assume a delicate perfume. In Fig. 15 we show the type of box ordinarily used for packing scented hardwood toothpicks. Necessarily they are more costly than the inferior pine stuffs. The average hardwood toothpick is even better made. The points are truer and better finished. Odors which often come from the pitch in pine are avoided. Dentists say it is best to use carefully assorted hardwood toothpicks.

## News Miscellany.

### The Wagon Industry.

Interesting statistics have been prepared by the Census Bureau of the United States regarding the wagon and carriage industry of the country. These figures are to form a part of the Census of Manufactures for 1905. It will be noted that there has been a substantial increase in this line of manufacture in the past five years. Following are the comparative figures for 1900 and 1905.

	1905	1900
Number of establishments	1,946	6,204
Capital	\$126,320,604	\$109,875,885
Salaried officials, clerks, etc.		
Number	5,058	4,003
Salaries	5,239,043	3,756,915
Wage earners:		
Average number	60,722	62,249
Wages	20,878,253	29,145,281
Miscellaneous expenses		
Cost of materials used	49,182,604	5,800,687
Producers' Total value of	125,332,976	113,234,590

The fact that there is a decrease in the number of wagon manufacturing establishments is because there has been a noticeable tendency to

consolidate, many of the smaller concerns discontinuing the manufacture of vehicles and confining their entire time to repair and custom work. The statistics, of course, do not include the operations of wheelwright plants, where all or at least the chief business is the repairing of vehicles.

The wagon industry of the country, turning out over \$125,000,000 worth of products yearly, is an important factor in the consumption of hardwoods.

### A Disastrous Fire.

Fire of unknown origin destroyed the contents and building of the Baxter Moulding Company, East St. Louis, Ill., August 18, entailing a loss of \$130,000, divided as follows: Building, \$35,000; machinery, \$40,000; contents, \$55,000. The company carried \$15,000 insurance on the building and \$55,000 on machinery and stock.

The officers of the company are: C. A. Anderson, president; Oscar Nieman, vice president and treasurer; J. C. Richards, secretary; E. Sattig, superintendent. The building was a two-story brick, 450x150 feet, and was erected in 1903 for the manufacture of mouldings, picture frames and framed show cards. The company had just installed machinery and stock costing \$25,000 and had completed an \$8,000 contract for an eastern concern, which was ready to load on cars. The factory will undoubtedly be rebuilt

**Michigan Hardwood Meeting.**

One of the pleasantest gatherings of the lumber fraternity ever held was the meeting of the Michigan Hardwood Manufacturers' Association at Mackinac Island, Wednesday, August 8. Many of the attendants, although lifelong residents of the state, had never before visited this attractive and historic little island in the Straits of Mackinac. A large number of the visitors arrived the day before and spent the afternoon in driving about and becoming acquainted with the many points of interest.

A large portion of Mackinac Island is covered with a dense second growth which includes white pine, Norway spruce, hemlock, balsam,

cedar, oak, maple, birch, beech and in fact nearly every variety of tree growth indigenous to the state of Michigan. The most conspicuous feature is old Fort Mackinac, which stands up almost out of the face of the rocks on the west end of the island. Arch Rock and Sugar Loaf are among the famous natural curiosities. Mackinac is fringed along the bluffs with fine hotels and the beautiful villas and cottages of people of wealth who enjoy its delightful climate throughout the summer season.

The Grand Hotel, a mammoth caravansary, is the most prominent object on the island and it houses thousands of resorters. The Michigan Hardwood Manufacturers' Association held its session in the old office building of the John Jacob Astor House, now its ballroom. This venerable hotel remains in nearly its original form, having been made up of the warehouses and office buildings of the old pioneer fur merchant. It was at this trading post that the foundation of the enormous Astor fortune was laid. The buildings comprising the hotel have been standing about a hundred years and are still in a most excellent state of preservation. The picturesque little town of Mackinac clusters at the foot of the cliffs on the west end of the island, which is about nine miles in circumference and in general altitude about 200 feet above the level of the surrounding strait, and 728 feet above sea level. Fine roads extend through the forest to the various points of interest, as well as a boulevard entirely around the island.

The place selected for the October meeting of the Michigan Hardwood Manufacturers' Association, Traverse City, will probably prove fully as attractive as Mackinac Island. It is one of the most beautiful little cities in the state, and



GROUP OF MEMBERS, TAKEN IN COURTYARD OF OLD JOHN JACOB ASTOR HOUSE.



E. P. ARPIN AND FRIENDS AT FOOT OF SUGAR LOAF, MACKINAC ISLAND.

stands at the head of Grand Traverse Bay. It boasts one of the best hotels in Michigan, the Park Place, which will probably be the meeting place of the convention. Traverse City is reached by several of the boat lines crossing Lake Mich-

igan, and also by the Pere Marquette, Grand Rapids & Indiana and Manistee & Northeastern railroads. Visitors at the next meeting can be assured of a most delightful time and a hearty welcome from the Traverse City members of the association.

**The Wilce End Matching Machine.**

The end matching machine manufactured by the T. Wilce Company of Chicago has been most cordially received by a large number of manufacturers of flooring. It was built originally to meet the requirements of the T. Wilce Company in its own business. Later the company went into the business of manufacturing the machine for the trade.

Speaking of the machine, Mr. Wilce says: "It is not an attachment to a matcher but a separate machine scientifically constructed for the sole purpose of making a tongue and groove on the ends of flooring. It is 2 feet 6 inches wide and 11 feet long, strongly built, with pipe frame and flat or table top. When it is set to do the end matching on flooring it is set back of the flooring machine far enough from it to permit the easy and convenient handling of flooring from 2 inches to twenty inches in length as it comes from the matchers. It is automatic in operation, making the end tongue on the left-hand side and the end groove on the right. The device for making the tongue consists of a combination cut-off saw and matcher head, while the groove is made by a saw and grooving head. These saws with the matcher and grooving heads are set exactly at right angles so that, when the flooring to be tongued and grooved on the ends is laid on the top of table of the machine, one stroke of the device is all that is needed to complete the operation, and this cannot fail to produce a perfect joint at right angles. The machine will end match flooring and ceiling in thicknesses from 3/4 inch to 1 3/4 inches and in widths from 5/8 inch to 3 1/2 inches. They require only one-half horsepower to operate."

W. S. Neely of Jonesboro, Ark., has tendered his resignation as manager of the Arkansas State Company and with associates will engage in the hardwood lumber business on a large scale. Mr. Neely recently acquired extensive timber holdings in northern Arkansas which he will develop.



HISTORICAL FORT AT MACKINAC ISLAND

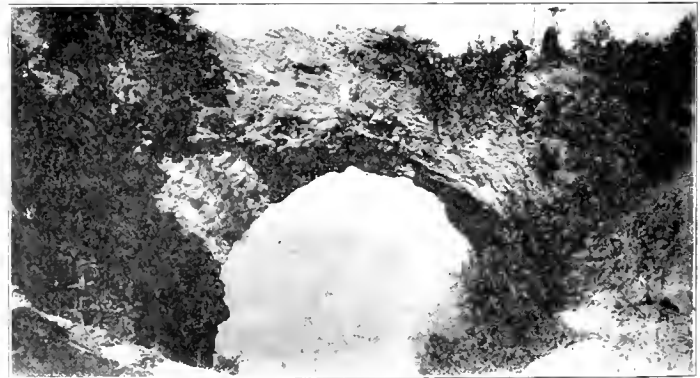

PICTURESQUE ARCH ROCK, MACKINAC ISLAND.





obligor or the portion replanted may be made a semistate forest.

"The government may constitute protection forests when it appears necessary for the following purposes:

"Preservation of soil on slopes and against erosion; protection against sand drift, stones and avalanches; for the maintenance of a water supply in springs and rivers; for the views of temples and old ruins. Land taken for these purposes is equitably paid for.

"Is it not strange that in our own country nothing is being done to reforest or to save the young trees which are left after the lumberman has cut off the merchantable timber? Michigan is doing something, but it is in a very tentative and ineffectual way. The strong hand of the government is needed to stay the terrible slaughter by fire and ax that is going on."

#### Car Stake Equipment Case.

Financial support has been asked of lumbermen all over the country to aid in the prosecution of the car stake equipment case before the Interstate Commerce Commission. The committee on ways and means has sent out an appeal which states that so much labor, time and money has been expended in this matter, and as a great deal yet remains to be done in the way of preparing evidence to submit to the commission and to pay the mechanical experts employed by the committee to discover the best form of stake to be used, that the help of lumbermen must be sought.

It is estimated that an average sum of \$20 from each lumberman would be sufficient to carry out these plans, but no limit is set; the sum may be \$20, more or less. Should the amount contributed be more than needed, the surplus will be refunded to the donors pro rata. Contributions should be made payable to the order of C. I. Millard, treasurer, or E. E. Perry, secretary, and sent to 66 Broadway, New York City.

#### Hoo-Hoo at Oklahoma City.

J. H. Baird, Scribe of the Concatenated Order of Hoo-Hoo, sends the *HARDWOOD RECORD* the official program of the September annual meeting at Oklahoma City, which is as follows:

Sept. 8—Morning, annual business assembly of Osirian Chapter; afternoon, annual Osirian initiatory session; evening, annual Osirian banquet.

Sept. 9—Morning, church service at Overholser Opera House, conducted by Rev. H. A. Porter of First Baptist Church.

Sept. 10—Morning, first business session of Hoo-Hoo open to the public at Overholser Opera House, addresses by Mayor Messenbaugh of Oklahoma City, R. D. Inman, I. N. Helcomb, A. D. McLeod, Scribe's report, appointment of committees; afternoon, annual concatenation, reception for visiting ladies; evening, concatenation for selected candidates on stage at Overholser Opera House, session on roof and other entertainment at Delmar Garden.

Sept. 11—Morning, business session; afternoon, entertainment at Colcord Park, consisting of match game of polo on Indian ponies and steer-roping contest between Ellison Carroll, famous champion of the Southwest, and Clay McConigill, twenty-year champion, defeated by Carroll in recent contest at El Paso; evening, vaudeville at Delmar Garden.

Sept. 12—Morning, business session concluding with election; afternoon, automobile ride for ladies, trolley ride for men; evening, public installation of new officers and embalment of Snark at Overholser Opera House.

#### A Popular Machine.

Although J. M. Nash moved into his new Milwaukee factory only a few months ago, he has been compelled to build an additional wing of almost sufficient capacity to double the output of his present quarters in order to keep pace with his increasing trade.

Mr. Nash makes an improved automatic round stock sander with which he claims that a boy can do the work of five men, producing a finish that saves from twenty five to fifty per cent in paint and varnish.

No. 3 sander is a heavy 18-inch cylinder machine for veneered columns, cant-hook handles, ten pins and other large work. It carries sand belts from 2 to 5 inches wide, according to length of work to be done, and will sand stock from  $\frac{3}{4}$  to  $4\frac{3}{4}$  inches in diameter, and can be specially made to take in 5 inches. No. 4 sander is intended for furniture factories, chair factories and other places where they want to sand short stock, and carries two sand belts from 3 to 4 inches wide, and will sand stock from  $\frac{3}{8}$  to  $2\frac{3}{4}$  inches in diameter. No. 5 sander is a regular handle sander and carries two 5 inch belts. It will sand stock 60 lineal feet per minute, running from seven to eight thousand broom handles per day, and any other work of the same class in the same proportion, and will sand stock from  $\frac{3}{8}$  to  $2\frac{1}{2}$  inches in diameter. No. 1 sander can be made to take in work as small as  $\frac{1}{4}$  inch in diameter and will sand and polish fishing rods, walking canes, billiard cues, hickory whip stocks and other very small swelled or tapered work.

#### New Filing Room Machinery House.

The Matteson Manufacturing Company, with headquarters at 128 130 South Clinton Street, Chicago, was recently incorporated for the purpose of manufacturing a line of modern machinery and tools for the care of saws and machine knives. As President Matteson aptly puts it: "We are a new concern with a new machine. Although the company is scarcely out

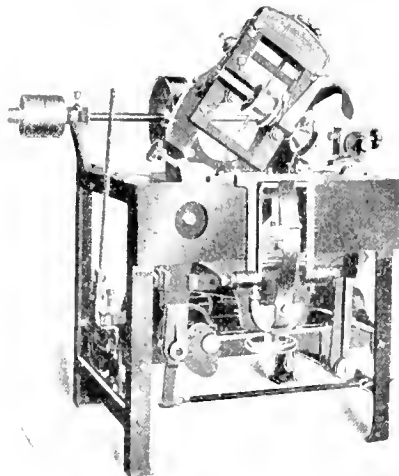

IMPROVED AUTOMATIC BAND SAW SHARPENER, MANUFACTURED BY THE MATTESSON MANUFACTURING COMPANY, CHICAGO

of its infancy it has enjoyed an almost phenomenal growth ever since the trade awakened to the fact that the concern had a line of equipment for the filing room which was worthy of investigation. From the appearance of the order book already it is evident that the claims of the company have not been found wanting by the investigators."

The officers of the company are A. D. Matteson, president; A. E. Thompson, treasurer, and James K. Chalmers, secretary. The business of the company will be under the personal management and direction of Mr. Matteson, who for sixteen years was superintendent of E. B. Rich & Son's plant. Although a mechanic himself, he has surrounded himself with a competent force of skilled workmen in every department. The sales department is in charge of Mr. Chalmers, who is a recognized expert operator of automatic machinery, also an inventor of several new devices and attachments, which he

will introduce to the public in the near future. He is also a practical saw maker, having served ten years in the factories of one of the largest saw manufacturing plants in the world. For the last two years he has been superintendent of the filing room of one of the largest and most modern equipped sawmills in operation, and his knowledge undoubtedly will be of great service in demonstrating the new line of machines. The accounting department is under the personal supervision of Mr. Thompson. He is a well known business man of wide experience.

One of the machines to which the new concern is calling especial attention is an improved hand saw sharpener, of which is claimed: "For neatness, durability, finish and simplicity this machine far exceeds. It is equipped with all modern appliances and adjustable cams. The unanimous approval of all purchasers of this machine justifies our giving unqualified guarantee."

#### July Red Book.

The Lumbermen's Credit Association has issued the July edition of their Red Book, which contains several improvements and additions. It has been carefully revised and about 3,000 names have been added, so that at present it contains over 60,000. Persons who are known as habitual fault-finders and as slow pay have been properly reported upon, and many changes made in financial ratings.

The association publishes a correction sheet twice a week; also a monthly supplement which gives all changes to the first of each month. In addition to the foregoing excellent service a collection department is maintained, equipped with every facility for handling collections in any part of the country.

#### Best Woods for Bending.

The following is an interesting article appearing in a recent issue of the *Barrel and Box*:

The bending woods in this country in extensive use are ash, hickory, white oak and elm. Ash is used extensively in handles of various kinds, and it is an excellent wood for bending. Ordinarily it is a stiff wood, until it receives a steam bath, when it becomes very pliable and can be bent to almost any desired shape. This is partially due to the soft growth between the grain, which "gives" when under the pressure of bending.

Hickory is a standard for bending in some branches of the industry. Owing to the close grain it is somewhat stiffer than ash, and will resist the bending process much more. The best results are obtained from the select part of the tree. There are four distinct species of hickory which furnish the best wood. They are the pecanutt, mocknut, shell bark and the tight-bark or niglett. The last named is extensively used on account of its extreme tenacity, it being preferred for bending purposes. The shellbark hickory is very elastic and some parts of it are very good for bending; it has a fine grain, but does not carry its toughness very far up the tree. The best part of it, for bending for all purposes, is found between the heart and sap, as indicated above in the one-half inch from the sap. Hickory to be of good, tough quality, must grow in rich soil and on low ground.

While there are almost innumerable species of oak grown in this and other countries, the kind most generally used for bending and many other purposes is white oak. It produces the best quality for bending when grown on rich soil in low ground. Under steam treatment it becomes very pliable and is a good bender. The best part of it in trees of ordinary size is found between the heart and sap, as indicated above in the hickory. There is what is known as second-growth white oak that is superior to hickory or the older oak.

Elm is of the hardwood family, and while not as hard and heavy as the above-mentioned woods, it has a fine, silken fiber, is easily worked and finishes well in oils and varnishes. Its bending



qualities exceed all the others when put through the same treatment. There are other woods suitable for bending not mentioned here, that can be utilized to a good advantage.

To make wood bending a success great care should be used in selecting the wood for the purpose. By careful study of the above suggestions much loss of time and labor may be avoided and the percentage of breakage greatly reduced.

In the bending process the impression is given that the wood stretches, and there has been some discussion on the point. Whenever wood commences stretching it is in its first stage of breaking. Successful bending is accomplished by the wood contracting. To force this contraction it becomes necessary to use a support to the side the strain is on and to hold the ends from giving. It will be seen from experiments that the outside of the curve is still the same length, while the inside is shortened. If it is dressed off on the side with a sharp plane it will be seen that the wood is pressed together and shows a wrinkled appearance. Trace the wrinkles to the edge of the upper or round side and they run out into the straight grain. It will thus be seen that this protection is necessary and should be made sufficiently strong for the purpose.

#### Woods of New South Wales.

It is said that the forests of New South Wales have an abundant supply of woods which are so varied in nature as to supply practically the requirements of the markets of the world. The hardwoods especially are said by experts to be particularly valuable. The colony engages to a considerable extent in the exportation of its forest products, which may be taken as proof of the foregoing statements.

A wood which has lately aroused a great deal of comment is mountain ash, which is admirably adapted for the making of handles, for wagon and carriage building, boat oars and sweeps and numerous similar purposes, as it is light, tough and very elastic. For these reasons it is claimed that it should make a very satisfactory substitute for American ash, which is used almost universally for the purposes named, but which as is only too well known here, is rapidly becoming exhausted.

Mountain ash, as the name implies, is essentially a timber indigenous to mountain ranges, and grows in abundance in the higher levels of the southern table-lands, more particularly with in the snow belt of the county of Selwyn (Tumut district), where one large forest reserve known as "Bago" exists, containing an area of upwards of 72,500 acres, densely covered with this valuable timber. This reserve is situated about thirty-five miles by road from Tumut, and will in the near future prove a source of great value to the state.

#### The Holland Veneering Company.

The Holland Veneering Company, Holland, Mich., has been organized to succeed the Michigan Toy & Novelty Works, which had developed into one of the best paying institutions in that city.

Lack of room and the desire to reach out for more business prompted the reorganization of the company. The capital stock of the old concern was largely increased, nearly all of which has been subscribed.

The company has acquired the two-story brick factory building formerly occupied by the Toronto Shoe Company, and the equipment will be moved from the West Eighth street factory to the new location early this fall. Additional land was purchased adjoining the new building and it is the plan of the company to build an addition to the new factory thereon.

Some of Holland's most prominent business men are identified with the new institution, for which, judging from the almost phenomenal success of its predecessor, a bright future can be predicted.

#### Kiln Drying of Tupelo.

The forest service has made a successful dem-

onstration of kiln drying tupelo, the experiment being undertaken in cooperation with a lumber manufacturer in Louisiana, who deals in tupelo, and with a wagon manufacturer in Michigan. The lumber was cut in the former state and shipped directly to the latter, where it was put through the dry kiln without preliminary seasoning. Tupelo is a wood suited to many commercial uses, and one to be profitably lumbered in connection with cypress, with which timber it occurs. A drawback to the use of tupelo has been the difficulty of seasoning, since it is subject to warping, checking and staining in the seasoning process. Hence a demonstration of success in kiln drying the wood without any of these defects is of great value to the tupelo industry.

In the experiments the kiln used is that known as the blower type, operated on the moist air principle of drying. The hot air is forced by fans into the dry end, thence passes back through the trucks of lumber to the wet end, and is returned to the engine room through a large drying chamber over the kiln itself. The whole structure is as nearly airtight as it can be made, consequently the same air, passing through the kiln and back over the steam-heating coils, is used over and over again. The necessary moisture is obtained from the green lumber as it is put into the wet end of the kiln.

The lumber should enter a temperature of about 93 degrees Fahrenheit at the wet end of the kiln. The temperature gradually increases as the truck moves toward the dry end, where it should stand in a temperature of 140 degrees to 150 degrees Fahrenheit for two or three days. In the experiment described the average temperature of the wet and dry ends was respectively 98 degrees and 133 degrees Fahrenheit. In this particular case the relative humidity at wet and dry ends was 81 per cent and 29 per cent respectively.

As has been demonstrated in air drying, so in kiln drying, the correct piling of lumber is of utmost importance. The piles on the trucks should be arranged so that the spaces between the boards are not obstructed by adjacent courses, but remain open so as to give an upward vent to aid the circulation of the drying air. This can be accomplished by piling the wide boards apart from the narrow ones, or by laying the wide boards so they do not extend over the open spaces. The old method of piling narrow and wide boards together so as to get horizontal and criss-cross circulation is satisfactory in the open air where there are strong winds; but in a kiln, with only a few inches of space about the stack for air circulation, the lumber must be piled as openly as economical operation of the kiln will allow.

The boards in this experiment were from eight to twelve inches wide, one inch thick and fourteen feet long. One truck was piled with the cross strips twelve inches apart, and another with strips eighteen inches apart. Equally good results were obtained by both methods. The lumber was in the kiln fifteen days, and when taken out was dried satisfactorily without molding, staining or stick-rotting. Only one board was checked as much as one foot from the end, and none of the other boards showed checks more than half an inch in length at the ends, while most were not checked at all. Five of the boards on the top course were slightly warped. There was a loss of 4,200 pounds, or one third of the green weight, and a shrinkage of 127.2 board feet or 4.4 per cent of the original scale.

The method here described is that regularly used at this kiln in the drying of red gum, which occupied other trucks at the same time. Thus it was shown that the tupelo can be kiln-dried by the same methods that are used for the red gum and with equal success.

There is now in preparation Forest Service Circular 40, a comprehensive treatment of the "Utilization of Tupelo," which will soon be ready for distribution.

#### Miscellaneous Notes.

A new veneer plant will be erected at Springfield, Mo.

The Marvel Furniture Company is a new concern at Jamestown, N. Y., capital \$400,000.

The Kendallville (Ind.) Furniture Company will locate a new furniture plant at Peru, Ind.

The Standard Veneer Company of Stockholm, Mo., is building a new plant at Winterville, Mo.

The Schmick Handle & Lumber Company has been organized at Atkins, W. Va., capital, \$25,000.

The Willingham Door Company has been incorporated at Montgomery, Ala., capital, \$30,000.

The Disbrow Sash & Door Company has been organized at Cedar Rapids, Iowa, with \$25,000 capital.

The Wagon Stock & Lumber Company has been incorporated at Nashville, Tenn., capital, \$10,000.

Fire in the National Veneer Company's plant at Charleston, W. Va., caused a loss of \$100,000, no insurance.

The Eggers Veneer Seating Company is making extensive improvements and additions in its plant at Two Rivers, Wis.

The Kellogg Switchboard & Supply Company of Chicago has decided to erect a woodworking factory at Cassopolis, Mich.

The piano factory belonging to H. J. Nelson & Co., at 175 181 Division street, Chicago, was badly damaged by fire a few days ago.

The H. Schwarzer Manufacturing Company has been incorporated at St. Louis, Mo., to manufacture plain and embossed wood mouldings.

A. J. Brake, J. M. Couchman, A. N. Couchman and others have incorporated the Brake Handle Company at Hough, Mo., capital stock, \$10,000.

The Empire Chair Company of Elizabethton, Tenn., has increased its capital from \$20,000 to \$30,000. The plant will be enlarged and new equipment added.

Spokes, wheels, etc., will be manufactured by the Eberley & Orris Manufacturing Company, recently incorporated with \$125,000 capital stock at Mechanicsburg, Pa.

Harry M. Glenn and others of Seneca, N. Y., have formed a company with a capital stock of \$39,000 to manufacture dump wagons. A new factory will be erected.

The Monroe Lumber Company of Monroe, La., will begin work at once on the erection of new buildings to take the place of some of those destroyed by fire recently.

The Kelsey Hickory Company of Detroit has been incorporated with a capital stock of \$50,000. John Kelsey, Henry J. Herbert and W. H. DuCharme are the directors.

The E. D. Albro Company of Cincinnati, O., has been taken out of the hands of the receiver and will henceforth be conducted under the style of the Albro Veneer Company.

August Kranke, John Zapf, H. P. Sult and C. M. Steele are the incorporators of the Zapf Wagon & Lumber Company of North Bend, O. The concern is capitalized at \$10,000.

The Consolidated Furniture Company has been incorporated at Greensboro, N. C., with capital \$250,000 to manufacture furniture. A new factory will be erected by the company shortly.

The Farbauld Furniture Company of Farbauld, Minn., is erecting a large addition to its factory there. The building will be three stories and basement and 50 by 70 feet in dimensions.

The Northern Pacific Railroad Company has decided on the erection of a plant at Brainerd, Minn., for preserving ties and timber. The building and machinery, it is said, will cost \$75,000.

The Rock Falls Rutter Tub Company, recently incorporated at Rock Falls, Ill., with \$18,000 capital, will build an addition to its plant 30 by 100 feet in dimensions and install machinery for the exclusive manufacture of litter tubs.

The Andrews Cabin Company, Andrews, Ind., has been incorporated by Ed. Colbert, with a capital stock of \$25,000. The company is now employing an increased force, and the incorporation was made to meet the growing demands of the business.

The Litchfield Manufacturing Company of Waterloo, Iowa, manufacturer of special farm machinery, has under way the erection of an addition to its woodworking department 50 by 100 feet, to cost \$5,000. An equal sum will be spent on equipment.

S. T. Alous & Co., box manufacturers of New Orleans, La., whose plant was recently destroyed at a loss of \$75,000, will erect two new buildings, one of them to cost about \$100,000. Both will be model factory structures, fitted up in the most approved style.

A. L. Burford, of Mount Pleasant, Tex., has recently filed a charter at Austin for the Cookville Coal & Lumber Company, capitalized at \$100,000 for the purpose of mining lignite and sawing hardwoods in Titus county. The timber to be sawed is white and red oak.

The Kelley Lumber & Shingle Company of Traverse City has purchased of Eugene Brainerd the timber on eighty acres of land fronting on East bay, consisting of about 700,000 feet of beech, maple and hemlock. The work of lumbering has already commenced and the logs are being towed to the company's mill at the head of the bay.

The Southern Handle & Lumber Company has secured a building at Corning, Ark., which will be overhauled and equipped with machinery for the manufacture of handles. About \$20,000 will be expended. The business will be carried on under the title of the Corning Handle Company. Especial attention will be given to export trade, and sixty men will be employed.

The Planet Manufacturing Company of LaPorte, Ind., organized about five years ago to manufacture picture frames and room moulding, was placed in the hands of a receiver August 7. The failures of the Bank of America and the Creelman Lumber Company of Chicago are indirectly responsible for the difficulty. The factory

will be continued in operation, however. It employs about 200 hands.

The Whitman & Barnes Manufacturing Company of Chicago is making an addition to its woodworking department which will increase the capacity in that line about 50 per cent. New machinery will be installed and a new dry kiln added. The company's woodworking department manufactures parts for goods of its own make, such as lawn mower handles and rollers, wrench handles, etc., and boxes for shipping these products.

The large hardwood mill of the Sullivan-Sanford Lumber Company, near Naples, Tex., is being rushed to completion. The foundation, which is of brick, is laid and several miles of railroad out to the timber is graded. The company is capitalized at \$500,000 and its promoters are all men of integrity, so that any project they undertake will be carried to a successful issue. They are planning the establishment of a large furniture factory as soon as the mill is started.

The lands of the Whittier Lumber Company, in Swain county, North Carolina, were purchased by Charles J. Harris of Dillsboro for \$439,024.05. Mr. Harris' bid was made on behalf of the Harris Woodbury Company of Bryson City, N. C., formed several months ago. The Whittier boundary was sold at public auction at Bryson City under a decree of the United States circuit court. The property contains more than 70,000 acres of land and is covered with virgin forests, including the more valuable hardwoods.

The Wilson Cypress Company of Palatka, Fla., will erect a new cypress mill at Mayo, in Lafayette county, Florida. It will be located on Half Moon lake. The work of construction will probably not begin until October. The company proposes to ship the product of the new mill to Palatka, where it will be loaded on vessels for the northern market. The capacity of the new plant will depend on the amount of timber to be cut; the company already owns approximately 150,000,000 feet of cypress in that locality, and if more can be purchased a mill of about the same capacity as the Palatka plant will be erected. It is a single band mill or one of about half the capacity will be built.

Ed Heath of the Heath-Witbeck Company, who has been abroad for some time, has returned to home and business, feeling much benefited by the trip.

H. G. Sheldon of Fremont and E. M. Sprague of Cincinnati, Ohio representatives of the Edward Hines Lumber Company of this city, were in town last week and paid the Record a friendly call.

William J. Wagstaff of Oshkosh, Wis., paid the Record office a welcome call on the 21st.

#### Boston.

Frank Lawrence and Harry Wiggin of Lawrence & Wiggin are spending the summer in the neighborhood of Gloucester. Mr. Lawrence is a guest at the Hotel Moreland, Bass Rocks, and Mr. Wiggin has his own cottage in Annisquam.

W. R. Chester of W. R. Chester & Co., Boston, has returned from his vacation spent in the Appalachian Camp, Lake Winnepesaukee. Harry Chester of the same firm has been spending a few days in Maine.

George H. Davenport of the Davenport-Peters Company is enjoying his spare hours at his summer cottage at Marblehead.

The executor of the estate of the late George K. Nason, Willimantic, Conn., has sold the lumber business to a new corporation known as the Willimantic Lumber & Coal Company. P. J. Twomey and F. J. Tilden, formerly yard foreman and bookkeeper, respectively, for the old concern, with Judge L. J. Storrs of Mansfield, are the incorporators of this concern.

L. Sweet of Sweet, Clark & Co., Providence, R. I., who has been making a tour of the mountains in his automobile, has returned.

Horace M. Andrews of Hartford, Conn., died at his home August 1. He was one of the organizers of the Big Rapids Door & Blind Manufacturing Company, Big Rapids, Mich. He is survived by a widow and one daughter.

John Vose of Marlboro, Mass., who for many years was engaged in the lumber business at Princeton, died at his home July 26. He is survived by his widow.

Charles S. Wentworth of Charles S. Wentworth & Co., Boston, is making a trip in New Brunswick.

Hugh McLean of the Hugh McLean Lumber Company, Buffalo, N. Y., visited the trade in this city last week.

William E. Litchfield reports that the mill owned and operated by Litchfield Bros., of which firm he is a member, at North Vernon, Ind., has been thoroughly equipped with modern machinery and enlarged, and is now ready for operation.

The J. H. Blake Lumber Company, Hartford, Conn., has been incorporated with a capital stock of \$50,000. This company is organized chiefly to deal in southern timber lands. The promoters are Noble E. Pierce, president; James R. Graham, Hartford, and K. L. Wolfe, Windsor.

J. J. Mead of Mead & Spear, Pittsburg, Pa., was a recent Boston visitor.

Charles O. Stone of Gardiner, Mass., has sold his woodworking business to Waldo H. Lowe. It is reported that Mr. Stone will continue in the manufacture of ladders and pumps.

#### New York.

Quite a stir was created in local wholesale circles recently by the announcement by one of the trunk lines that it would curtail lighterage limits by cutting out all points on the Gowanus canal, Brooklyn, one of the biggest receiving depots of the district, but through bringing pressure to bear it is believed that the decision will be reconsidered.

Labor troubles among the yards have broken out intermittently during the past few weeks in the efforts of the walking delegates to unionize the hands, but in each case the efforts have been vigorously opposed and all such cases are well in hand and the yards operating as usual with new help. There is no likelihood that the dis-

## Hardwood News.

(By HARDWOOD RECORD Special Correspondents.)

### Chicago.

E. C. Fischer, president of the Yellow Poplar Lumber Company, Coal Grove, O., spent several days in Chicago recently.

Edward Germain, the piano manufacturer and lumberman of Saginaw, Mich., was in the city on the 15th inst.

Oris A. Felger, secretary of the Hackley-Phelps-Bonnell Company of Grand Rapids, Mich., called at the Record office last week. Mr. Felger was enroute to the company's Evansville, Ind., and Helena, Ark., branches.

R. E. Wood, president, and J. K. Painter, secretary and treasurer of the R. E. Wood Lumber Company of Baltimore, Md., spent a couple of days in Chicago recently.

Lewis Doster left on Aug. 16 for a pleasure trip to eastern points. He will visit his mother in Philadelphia before returning to Chicago.

A meeting of the executive committee of the National Hickory Consumers' Association has been called for Wednesday, Aug. 29, at 10 a. m., at the Auditorium Annex, Chicago. The secretary has sent out an urgent call requesting the members of the committee to be present in full force, as at this time they will be called upon to decide just what the scope of the work to be undertaken by the association will be. Members who cannot be present are asked to send a representative empowered to act for them without fail.

Although only a two-year-old, the Wisconsin Timber & Lumber Company occupies a prominent place in the lumber world in general and

Chicago lumberdom in particular. This lusty infant was born at Jellico, Tenn., cutting Tennessee hardwoods. The main office is located in the Monadnock building, Chicago. In addition to this the company has a buying office at Houston, Tex., and one at McHenry, Miss. The company is a welcome addition to the lumber circle in Chicago. It manufactures and wholesales yellow pine, hardwood and Pacific coast products.

Representatives of the hardwood associations of the country met on Thursday of last week at the Auditorium hotel, Chicago, to talk over among themselves the matter of freight rates to the Pacific coast. A very interesting session was held and a committee appointed from among those present to draw up a report of the meeting covering the recommendations decided upon, which report will be submitted to all the associations interested. The following were in attendance: John B. Ransom, Nashville, Tenn.; E. P. Arpin, Grand Rapids, Wis.; O. O. Agler, Chicago; J. G. Landeck, Milwaukee, Wis.; J. M. Pritchard, Indianapolis, Ind.; Charles A. Bigelow, Bay City, Mich.; G. F. Moore, Boyne City, Mich.; Lewis Doster, Chicago.

James M. Schultz of Schultz Brothers & Cowen is in Mississippi on business. James C. Cowen of the same house is back from a recent trip through Kentucky and Tennessee.

H. Murphy, president of the Alabama Hardwood Lumber Company of Mobile, made a visit to Chicago last week.

O. O. Agler of Upham & Agler is home from a visit in Denver.

turbances will become at all general or affect business. The lockout in Hudson county, New Jersey, is also well in hand; in fact, the victory is practically won by the dealers, who have rearranged their labor on an entirely non-union basis and are running on full time.

W. W. Knight of the Long-Knight Lumber Company, Indianapolis, Ind., and trustee in the National Wholesale Lumber Dealers' Association, was here in connection with association affairs this week.

R. W. Higbie, 45 Broadway, has gone with his family to spend several weeks in camp at the scene of his new hardwood operations near Newton Falls, in the Adirondacks. His fine new mill is fast nearing completion and will be in active operation in the early fall.

David Goodman of Doernberg & Goodman has returned from a two months' European tour.

Secretary E. F. Terry of the National Wholesale Lumber Dealers' Association spent several days in Pittsburg beginning August 16 in connection with the car stake conference and association affairs.

Sam E. Barr, Flatiron building, after an active campaign in hardwoods, is spending a few days with his family at Atlantic City, N. J.

The Northern & Southern Lumber Company of this city, recently incorporated with a capital of half a million dollars, has acquired an extensive tract of hardwood and pine timber land in Marion county, South Carolina, which they will immediately take steps to develop. Headquarters will be maintained in this city.

The receivership of the Vossnaek Lumber Company, manufacturer and dealer in thin hardwoods, Long Island City, has been terminated with a final payment of 12½ cents on the dollar, making in all a total of 82½ cents which the creditors have received. The total credits paid amounted to \$27,000.

John H. Ireland of the Cross, Austin & Ireland Lumber Company, Brooklyn, accompanied by his bride, sailed for Europe Aug. 2 for a lengthy stay.

John R. Glover of W. R. Adams & Co., Brooklyn, has just returned from an extended pleasure tour of the Pacific coast, Arizona and New Mexico.

Dixon & Dewey, Flatiron building, wholesalers in hardwoods and Pacific coast lumber, just closed a big deal for four million feet of Pacific coast stock for the Philippine islands. They report both branches of their business very active.

Ralph E. Sumner of H. H. Salmon & Co. is taking a brief rest at Belmar, N. J.

Secretary E. M. Terry of the National Lumber Exporters' Association, Memphis, is spending several weeks in this vicinity, making his headquarters at the office of Price & Hart, 18 Broadway. He reports matters in connection with his association as very satisfactory.

Henry Cape, 1 Madison avenue, accompanied by J. M. Hastings of Pittsburg, left this week for a visit to the extensive operations of the latter in Nova Scotia.

C. W. Manning of 66 Broad street has been taking a brief rest at Tim Pond, Me.

Surveyor General George L. Smith of the National Hardwood Lumber Association has been spending several days in town in connection with the inspection bureau of that organization.

M. B. Wilkinson of Asheville, N. C., has been renewing acquaintances locally during the fortnight.

George D. Burgess of Russe & Burgess, Memphis, accompanied by Mrs. Burgess and their son, sailed for Europe during the fortnight on a business and pleasure trip.

The Lamb-Fish Lumber Company has been incorporated in Jersey City with a capital of \$1,500,000, to manufacture lumber, iron, steel, etc. No official announcement as yet has been made as to the backers of the enterprise.

The Yocum Company has been incorporated at

Newark, N. J., to manufacture lumber, leather, etc. Capital, \$50,000. Incorporators, J. H. and F. K. Yocum and C. S. Coe of Newark.

F. Mohr & Co., one of the largest furniture manufacturing concerns of the district, is in bankruptcy through several suits filed by creditors against the firm. Wilbur Larremore has been appointed receiver of the assets, which are placed at between \$200,000 and \$400,000. Liabilities estimated at \$125,000. The firm has stock on hand of \$50,000, as well as a large number of orders for manufactured goods, and it is believed will pay its creditors substantially in due course.

Bankruptcy schedules of G. L. Schnyder & Co., Inc., of Manhattan, who failed a year ago, show liabilities of \$53,063. Owing to the fact that the books and assets are in the hands of E. Blumensteel, the court receiver, the assets are not given, but at the time of his appointment he estimated them at \$65,885.

### Philadelphia.

Vicegerent Snark Jerome H. Sheip has just returned from a somewhat extended trip to the Adirondacks where he went in search of health, accompanied by Mrs. Sheip and his son Stanley.

A. W. Vandegrift of Sheip & Vandegrift is spending a two weeks' vacation at Eaglesmere.

John W. Coles has engaged the services of W. A. Lawton as salesman for Philadelphia and vicinity. Mr. Lawton was formerly with C. B. Goad of Amelia, Va., and also with Thos. B. Hammer & Co. of Philadelphia. He is well known in the local trade.

John B. Emery of Williamsport was a recent visitor to the Philadelphia trade. He is lately recovered from an attack of appendicitis.

N. W. Haws of Colleton, S. C., and Walter W. Mills of Kingston, N. C., visited the trade last week.

R. W. Wistar of Wistar, Underhill & Co. has been spending some time at Cape May where he participated in the golf tournament with great credit.

The Evergreen Lumber Company of Evergreen, N. C., for which Wistar, Underhill & Co. are selling agents, has decided to erect a modern planing mill, work on which will be begun shortly.

Fred Pyfer of the B. B. Martin Company of Lancaster, Pa., spent a portion of last week in Philadelphia.

J. W. Diffenderfer returned some time ago from an extensive trip to West Baden, Ind., where he went for his health. Later he spent a few days at Beach Haven, N. J., enjoying the fine fishing at that resort.

The J. G. Brill Company, manufacturer of cars, etc., has bought from the Schuylkill Improvement Company a tract of ten acres on the south side of Woodland avenue, between Fifty-eighth and Sixtieth streets. The land adjoins the present plant of the concern, which extends from Sixtieth to Sixty-third streets, running back to the Pennsylvania railroad. It is understood that a group of buildings will be erected on the land purchased.

H. H. Maus of H. H. Maus & Co. is on a trip south and while there will give his attention to matters connected with the Virginia mills of the concern.

Joseph P. Dunwoody returned recently from a southern trip. The firm finds business decidedly better than it has been for some time. S. Y. Warner is making a trip of a few days' duration in Maryland.

H. N. Pattison of the Philadelphia Hardwood Lumber Company is touring New York state. Reports from him state that business is generally good.

Owen M. Bruner has issued his annual advertising novelties which are always received with great interest by the trade. In the telephone lists for this year Mr. Bruner gives prominence to the National Hardwood Lumber Association inspector of the district.

Wm. H. Fritz and E. B. Hayman of Wm. H.

Fritz & Co. are taking an extended trip for business and pleasure through the south and will visit the mill points in which they are interested.

R. H. Schofield of Schofield Bros. and Geo. F. Lance, Jr., of the sales department of the firm are spending some time at Atlantic City.

Visitors to the trade during the last fortnight included: A. E. Pope of the Fairwood Lumber Company, Marion, Va.; F. J. Chapin of the West Branch Novelty Company, Milton, Pa.; E. S. Ziegler of the Hoover Wagon Company, York, Pa.

The Lumbermen's Exchange of Philadelphia is now comfortably housed in the new quarters in the Crozer building, having moved August 18. Owen M. Bruner, who was the first of the trade to call at the new quarters, presented the exchange with a large and beautiful United States flag which now waves over Chestnut street from the window of the rooms.

The baseball game which was postponed on account of bad grounds will be played on August 30, and is expected to be in every way a success. John J. Rumbarger, the manager of the lumbermen's team, has already taken in a considerable sum and expects the receipts to mount still higher before the day of the contest.

### Baltimore.

J. L. Gilbert of the J. L. Gilbert & Bro. Lumber Company, Canton and East Falls avenues, died on August 7 of stomach trouble, from which he had suffered for several years. The deceased was within three days of 54 years old and a native of Baltimore. After going through the public schools he entered the employ of a lumber firm and in the course of a few years he was able to establish himself in business, becoming a member of the firm of Kuegler & Gilbert. Mr. Gilbert later formed a partnership under the name of Adams & Gilbert, and in January, 1885, he founded the firm of J. L. Gilbert & Bro., having purchased the interest of Mr. Adams, who retired. The firm was very successful and in order to insure its continuance in the event of death was transformed into a close stock company under the name of the J. L. Gilbert & Bro. Lumber Company, last year. The deceased leaves a wife and six children. He was a member of the Lumber Exchange, a Mason and affiliated with other organizations. His demise will not make any changes in the conduct of the business.

L. E. Lawler of Norfolk, Va., has been chosen manager of the Memphis office of Price & Heald of this city to succeed Gustave A. Farber, who recently embarked in business on his own account. Mr. Lawler has for about ten years represented various firms in Arkansas and other southwestern states, and is said to be well qualified for the post. Frank Price of the same firm returned two weeks ago from a trip to West Virginia, southwestern Virginia and parts of Kentucky and Ohio, where he visited the various agents of the firm. He found that a great majority of the manufacturers have orders which will keep them busy for months to come, and that not a few are oversold. Thus, one millman had taken contracts for not less than 9,000,000 feet, while others had assumed obligations to furnish from 1,000,000 to 3,000,000 feet. Mr. Price consequently reached the conclusion that values will continue to rule high. He established a yard at Abingdon, Va. Richard W. Price, the senior member of the firm, spent a vacation of several weeks in Atlantic City.

A call has been sent out for a meeting of the special committee of the local Hoo-Hoo appointed to make a systematic effort to secure for Baltimore the national concatenation next year. As far as is known now, this city will be represented by Vicegerent Snark George R. Waters, John L. Alcock and W. O. Price.

E. M. Terry, secretary of the National Lumber Exporters' Association, was in Baltimore last week and called on various members of the or

ganization here with regard to the demands to be made upon the trans-Atlantic lines. The matter is in the hands of the transportation committee, but it is deemed desirable to get the opinions of the membership in order that the committee will have something definite to work on. It is considered likely that the next meeting of the association will be held in this city.

Lightning set fire to the large planing mill of the Norfolk & Western railroad at Roanoke, Va., August 9, and the plant was completely destroyed. The loss is estimated at not less than \$100,000, and 100 men are thrown out of employment until the mill can be rebuilt.

D. W. Simmons of Detroit, Mich., has sold to A. M. Nevin & Co. of Philadelphia the Sellwood tract of timber land in Stafford county, Virginia, near Fredericksburg, for \$7,000. The tract embraces some 1,300 acres and it is said that nearly two years will be required to cut the timber.

### Pittsburg.

The Cheat River Lumber Company is negotiating for a large tract of hardwood timber land adjoining its plant at Burkeville, Va. Its demand for oak and hickory is such that one of its mills will be put to cutting these woods exclusively after September 1. The company's hickory customers are mostly the wagon and agricultural implement manufacturers of Ohio, Indiana and Michigan, who are lively bidders this month for good stock.

The Blairsville Lumber & Manufacturing Company, which has offices in the Washington National Bank building in this city, is going out of business at Blairsville, Pa., and for this reason is selling its stock and machinery at that point. It has been quite a large manufacturer of hardwood railings, balustrades and ornamental woodwork. The Pittsburg offices will be retained for the present.

The Germain Lumber Company is having a good trade in oak and poplar. Louis Germain, Jr., president of the company, has taken a large block of stock in the newly organized Lewis Land & Lumber Company, with headquarters at Mobile, Ala. This company has a good tract of timber in that locality and will push an extensive operation this fall.

The Warland Lumber Company has been formed by C. D. Armstrong, M. K. Salisbury and J. E. Quigley. It has a capital of \$25,000 and will enter the Pittsburg field as quite an extensive dealer in hardwoods.

W. P. Craig, local manager for William Whitmer & Sons, Inc., has gone South again.

The J. M. Hastings Lumber Company has put in a new circular saw at its mill at Jacksonburg, W. Va., on the West Virginia Short Line railroad. This mill cuts nothing but oak and at its present rate of 20,000 feet a day has enough timber around it to last three years. The stock comes to the Pittsburg market largely.

J. J. Lincham of the Lincham Lumber Company is back from an extensive stay at the company's mills in Kentucky and Tennessee. Very few of the hardwood mills there are down for repairs, he reports, although a few of the river mills have shut down temporarily the last few days. Stocks are not large and the mill owners in those states seem determined to keep prices up to a profitable working notch.

W. D. Johnston, president of the American Lumber & Manufacturing Company, is in the South for two weeks.

Charles H. and Gustave A. Bruckman and Louis H. Baer have applied for a Pennsylvania charter for the Bruckman Lumber Company. The concern is well and favorably known in Greater Pittsburg and carries a big stock of hardwood building lumber.

F. W. Ruskauff, president of the Ruskauff Lumber Company, has gone west, and will visit the Pacific coast. His intention is to make some desirable connections with the big lumber firms in that district preparatory to pushing out his company's trade this fall and winter.

The Raleigh Lumber Company is going to build a railway up Piney creek, near Hinton, W. Va. Its cost, according to the contract awarded, will be fully \$225,000, and it will tap some of the richest timber and coal lands in the southern part of the state.

George W. Nicola, president of the Nicola Lumber Company, has become interested in the beautiful Sewrekey Heights district, where he recently purchased a 60-acre farm. Its location is about 1,300 feet above sea level, and Mr. Nicola intends to improve it next year.

Fred R. Babcock of the firm of E. V. Babcock & Co., is planning an aggressive campaign when he returns from his summer's vacation. He is president of the Merchants' & Manufacturers' Association, which will make a week's tour through West Virginia in October, and is also chairman of the rapid transit commission which was appointed by Mayor George W. Guthrie some time ago to analyze the subway and overhead traction propositions as they are submitted to the city by ambitious promoters.

### Buffalo.

Scotchard & Son find that the demand covers the list of hardwoods pretty generally, though they are as usual making efforts to meet the demand for oak, which is always good and active with them.

The receipts of the Standard Hardwood Lumber Company from its Kentucky mills are already liberal in oak and poplar, though when A. W. Kreinheder gets down there on his belated trip the flow will increase.

T. Sullivan & Co. are doing the usual rushing yard business in ash and birch, also in Washington fir, in which they are pioneers here.

The yard of A. Miller is always well filled with general hardwood lumber from various points, as he lays under contribution the South as well as all his old districts in Pennsylvania.

The Buffalo Hardwood Lumber Company has its office in its new yard at Memphis built and is putting in a stock of oak and other hardwoods found in that section and further south to aid in the company's general trade.

The addition of cherry to the stock of Beyer, Knox & Co. is right in their line of running an all round yard, and they carry a large stock as well as a finely assorted one.

There is always plenty of stock in the Buffalo yard of the Empire Lumber Company, which is still receiving from the Atlantic coast and Arkansas quantities of oak, ash, poplar and the like.

The Hugh McLean Lumber Company is still holding to its specialty of quartered oak, of which it produces, through branch companies, perhaps more than any other concern in the country.

H. A. Stewart went into oak mainly on his last trip to West Virginia, his firm making a specialty of that of late, along with cherry, so that high-priced lumber is the rule in that yard.

Quite a good lot of southern hardwoods, including oak and poplar, have come up of late from Campbellsville, Ky., for O. E. Yeager, who has long made that point one of his producing centers.

The only general occurrences in the local lumber trade of late are in the line of picnics, the Lumber Exchange going to Lockport on the 9th for its final outing, making the trip by boat by river and canal. The hardwood interests are always best represented in these outings, as the members are more closely united than the general trade is. The chief incident of the trip was the ball game, in which F. N. Stewart's nine took a fall out of the nine of A. W. Kreinheder to the score of 23 to 8.

### Grand Rapids.

The latest catalogue issued by the St. Johns Table Company of Cadillac shows that the company is making 111 different patterns of tables. This multiplicity of patterns reduces the profits of the furniture manufacturers everywhere.

J. H. Robbins of the Robbins Table Company, Owosso, reports that business this summer is the best that it has ever been. The factory is sixty days behind orders. This condition is true of nearly all the furniture concerns of the state.

W. W. Mitchell of Cadillac made the trip from Northville to Traverse City recently in his White steamer in an hour and fifty-five minutes.

O. A. Ward of this city, dealer in hardwood lumber, entertained a party of distinguished guests at his summer home at Northport Point, August 16. The party included Congressmen William Alden Smith and R. P. Bishop, State Superintendent of Public Instruction P. H. Kelly, Representative A. F. Banting and H. E. Gill, president of the Northport village.

The Holland Veneering Company, recently organized at Holland, has bought a brick factory, and land has been secured for a large addition to the plant.

C. S. Bacon & Co. have started suit in the superior court against the Crawford Chair Company, claiming damages to the amount of \$5,000 on the sale of lumber.

The Grand Rapids Herald in a recent issue pays a deserved tribute to J. E. Quigley for the enterprise and public spirit he has shown in helping to build up South Grand Rapids, in the Oakland Park district.

C. P. Lambert & Co., furniture manufacturers of Holland, have been incorporated; capital, \$100,000. The Lambert company recently removed from Grand Rapids and employs 150 men.

The Lumbermen's Association of Grand Rapids will hold its monthly meeting August 28 at the Lakeside Club. It is expected that F. E. Fish of Chicago, secretary of the National Hardwood Lumber Association, will be present.

### Asheville, N. C.

An important meeting of the Asheville Lumber Exchange was held in the offices of the Augusta Lumber Company here August 11 to consider plans for the more speedy collection of freight claims and the more prompt placing of cars for the loading of lumber, and the removal of these cars. The exchange, after some discussion, decided to appoint a committee to investigate further the propositions and report at a meeting of the exchange to be held early in September. The plans under consideration were not given out, the members deeming it wise not to take the public into their confidence until some definite action had been taken. The committee is composed of W. B. McEwen, C. A. Schenck and C. H. Hobbs. The lumbering interest in this section has been badly interfered with at times by the inability to have cars placed and removed promptly. Among those at the meeting were: W. T. Mason, president of the exchange; J. M. Burns, vice president; George A. Murray, C. H. Hobbs, E. E. Quinlan, C. E. Quinlan, Dr. C. A. Schenck, F. L. Winchester, W. B. McEwen, E. H. Hall, A. J. Combe, H. W. Fry, J. M. English, A. H. Winchester and Zeb Curtis.

The boundary of the Whittier Lumber Company, lying in Swan county, and containing 78,000 acres of finely timbered lands, was sold at public auction this month for \$449,000. The Harris Woodbury Company of Bryson City was the highest bidder. The lands were sold to satisfy outstanding notes and bonds held by the Morton Trust Company of New York.

The trade remains quiet in this territory and lumber dealers are skipping little lumber. Prices are slightly off and the dealers say that they are waiting for an increase that is sure to come.

### Bristol, Va.-Tenn.

William F. Rapp and A. A. Koop, representing the Yellow Poplar Lumber Company of Coal Grove, O., were visitors in Bristol this week, making heavy purchases of hardwoods for their company.

Joseph P. Dunwoody of Joseph P. Dunwoody

& Co., Philadelphia, spent a few days in Bristol and contingent territory last week. Mr. Dunwoody made numerous heavy purchases in this section.

Work on the new plant of the American Cigar Box Company at Johnson City is progressing, and will be pushed to completion. This plant is being erected to supplant the company's big operation at Johnson City which was destroyed by fire a few weeks ago.

E. L. Warren of the R. E. Wood Lumber Company is spending several days in Bristol on business. Mr. Warren reports that the company's mills at Buladeen, Carter county, Tennessee, are running regularly and turning out a large amount of stock.

The Kingsport Lumber Company of this city is putting on the market as rapidly as possible about 15,000,000 feet of hardwoods, consisting chiefly of oak and poplar, which has accumulated on their yards at Carreta, McDowell county, West Virginia, since their band mill was put in operation at that place some time ago. The company also has circular mills in operation in the same county.

Baumgardner Brothers, formerly of Akron, O., have located at Oconee, Ga., where they have installed a band mill. The firm has purchased considerable timber property near Oconee.

W. J. Cude of Kimmins, Tenn., has located at Cude, Miss., where he has installed a large band mill and is preparing to do an extensive manufacturing business.

The Came-Wyman Lumber Company, the new lumber concern of Bristol, has just consummated a deal whereby they come into possession of a tract of timber land of about 3,000 acres located at Elkannah, about eight miles from Bristol, on the Virginia & Southwestern railroad. The company expects to put in a mill at this place in the near future. In the meantime, however, the company will ship the logs to Bristol and cut them at its mill here. A logging railroad five or six miles in length, extending from the Virginia & South Western railroad line at Elkannah through the company's timber land, will be built at once.

M. N. Offett of the Tug River Lumber Company has gone on a business trip to West Virginia.

The Richland Lumber Company, recently organized in Bristol, which is headed by J. A. Cannon and J. H. Bryan, will begin manufacturing its timber on the Wateree river, near Sumpter, S. C., very soon. Mr. Bryan, who has just returned from South Carolina, states that he expects to begin cutting by Oct. 1. The company will have headquarters in Bristol, while J. A. Cannon will go to South Carolina and oversee operations and look after the interests of the company at that place.

William R. and James A. Stone of the Stone-Huling Lumber Company have as their guest just now Sam S. Stone, who is one of the most prominent architects of New Orleans.

### Nashville.

John B. Ransom of John B. Ransom & Co. has returned from a trip to Chicago, Chattanooga and Memphis. Mr. Ransom leaves shortly with his family for a pleasure trip through Colorado and Utah.

The Nashville lumbermen held a meeting Aug. 18 and appointed a special committee to take action in regard to a recent advance in railroad rates of three cents a hundred to Pittsburg and Buffalo territory. The members of the committee are: M. F. Greene of the Davidson-Benedict Company, Samuel Lieberman of Lieberman, Loveman & O'Brien and John B. Ransom of John B. Ransom & Co.

Arthur Ransom, accompanied by his family, has just returned from a trip to Denver.

Hamilton Love of Love, Boyd & Co. has returned from a trip to Michigan and is now summing at a resort near Nashville. John W. Love of this firm is still at Markland, Nova Scotia.

The Blue Mountain Stave Company, which was organized recently in Nashville, will operate extensively in Mississippi. S. G. Holland of Nashville has been elected president of the concern and J. McWright secretary. The sales offices are on the tenth floor of the First National Bank building.

S. Garth Gray, former assistant secretary of the Nashville Board of Trade, has resigned to accept a position with the T. J. Asher & Son's Lumber Company at Wauseta, Ky.

Considerable loss was sustained by the Hill Trunk Company recently by a fire which totally destroyed the trunk factory. The property was heavily insured.

Reports from McEwen, Tenn., state that over a million feet of lumber have been shipped from that point in the past thirty days. L. D. Baker in the past month has shipped 708,000 feet of lumber. The T. W. Black Lumber Company of Chicago has shipped more than a quarter of a million feet from that point in the past month, and the Heath Witbeck Company, also of Chicago, shipped a like quantity.

A charter has been granted to the Holston River Lumber Company with a capital stock of \$30,000. The incorporators are: W. B. Coon, T. A. Cox, E. J. Vaught, J. R. Gardner and L. Armbrust.

The Hankins-Spreck Lumber Company has been organized at Livingston, Tenn., with a capital of \$1,500. The company will run a saw mill near town and a planing mill in Livingston.

The Livingston Manufacturing Company is preparing to install additional machinery.

The Griffin Cooperae Company of Shelby county has been granted a charter. The capital is \$2,000. Incorporators: John Griffin, M. J. Griffin, B. J. Griffin, T. H. Griffin and L. F. Fitzhugh.

A new pin factory just opened up at Nolensville, Tenn., is doing a thriving business. Its proprietor, Mr. Cooper of Alabama is proving a bustling manager.

Several big local contracts have been captured by the Nashville Hardwood Flooring Company recently. This concern has supplied the firm of O'Bryan Bros., which recently burned out, with 40,000 feet of oak flooring and is furnishing the handsome new structure of the Methodist Publishing House with 50,000 feet. The best of all, however, is the contract for 200,000 feet of oak flooring for the new Stahlman building, a million dollar sky scraper being erected by the Meeklenberg Real Estate Company. The company also boasts of the sale of four cars of oak flooring in London.

Work on the locks and dams the government is building in the Cumberland river continues unabated, and lumbermen are viewing with satisfaction the completion of work that will give navigation all the year around to Carthage, and ultimately to a point above Burnside on the upper river.

Nashville parties have closed a deal whereby they purchase the Daniel tract of timber lands on White Oak Creek, near McEwen, Tenn., for \$32,000. There are 2,225 acres in the piece and it is covered with valuable hardwoods.

A special from Harriman states that John Hatfield of that city is now in Coldwater, Mich., in consultation with moneyed interests of that place with a view of securing investments in timber around Harriman.

A special from Bridgeport, Ala., to Nashville says that negotiations are under way to dispose of the old Bridgeport Pipe Works plant to Atlanta and Bridgeport capitalists for the establishment of an up-to-date sawmill. The concern is to be capitalized at \$300,000. Another special announces that the Tuthill & Patterson Manufacturing Company of Tusculum, Ala., has been incorporated with a capital stock of \$200,000. The company will deal in and manufacture lumber of all kinds. Sheffield will be the site of the principal office.

### Memphis.

The Frisco system has issued a circular to the lumber trade of Memphis, effective August 20, as follows:

"A charge of \$5 will be made on lumber the destination of which is ordered changed while the car is in transit, or after arrival at first destination, or at point where ordered held. When change of destination involves a back haul, or movement out of the regular route, as provided for in the tariff, an additional charge of one-half cent per ton per mile with a minimum of \$5 per car will be assessed for the extra or additional service performed; regular car service rates to be applied and charges therefrom to be in addition to the charge for changing destination."

This action has raised a storm of protest, especially among wholesalers. They have very little to say in regard to the back-haul charge, recognizing this as somewhat justifiable. James E. Stark of James E. Stark & Co. has written a very strong letter to General Freight Agent Verhees of the Frisco system at St. Louis. He points out that it does not cost the railroad anything for the shipper to change the consignee while in transit and declares that this will impose a decided handicap on the shipper who is often, as a matter of self-protection, both shipper and consignee. If he is not allowed the privilege of changing consignee Mr. Stark declares that the manufacturer through whom the shipment is made will get the name of the consignee and thus take from the wholesaler who placed the order the business which he has been doing. Other wholesalers are up in arms against the new ruling, and it is probable that action will be taken by the Lumbermen's Club of Memphis. Meantime, unless the other roads follow with a similar circular, the Frisco will have more difficulty than usual in securing business from wholesalers of this city and section.

The committee of the Lumbermen's Club of Memphis, appointed to act with similar committees from other organizations with a view to having the new minimum weight ruling of the Missouri Pacific system rescinded, intended holding a conference with officials of the Missouri Pacific in St. Louis August 20, but received a wire from headquarters of the system stating that the officials with whom the conference was desired could not be seen on this date, and the conference has therefore been postponed. George C. Ehemann, chairman of this committee, received a letter from the secretary of the Lumber Exchange of St. Louis to the effect that he would arrange for a conference with the officials in question and notify the committee here. Mr. Ehemann has also received from the secretary of the Lumber Exchange of St. Louis a copy of a strong petition presented to officials of the Missouri Pacific system by that organization asking that this action be rescinded. This petition is directly in line with that of the Lumbermen's Club of Memphis and the Buffalo Lumber Exchange. Other organizations to which appeals have been made are expected to take similar action.

It is rather striking that, while the lumbermen are making this fight on the railroads in question, mutterings are beginning to be heard regarding a car shortage. A prominent wholesale and manufacturing firm here states that it should have loaded ten cars on the Iron Mountain the past week, but received only two cars. A well known cooperae firm here reports a similar condition, declaring that it put in requisition the past week for nine cars and received only one. The cotton crop of the south this year promises to be of record proportions and buyers in this territory must expect delay in receiving what they want, as the railroads simply will not be able to handle lumber shipments promptly when there is so much general traffic ahead.

The Morgan West Box Company has applied for a charter with capital stock of \$30,000. The following are the incorporators, most of whom are interested in the Anderson Tully

Company. This was S. B. Anderson, H. B. Anderson, W. B. Morgan, H. C. Ward and John West. The company has taken over the holdings of the Walton-Knox Company at Madison, Ark., and will operate the plant of this company for the manufacture of shipping and packing boxes and fruit packages.

The Anderson-Tully Company has laid the foundation for its big box plant in North Memphis, which is to be a duplicate of its present plant and which is to have a capacity of three cars a day. It will be equipped with lock corner box facilities. The machinery has all been purchased and is now on the ground.

The Fourche River Lumber Company of Fourche, Perry county, Arkansas, has purchased from the Lindsey Land & Lumber Company of Iowa about 24,000 acres of hardwood timber lands in Perry and Pulaski counties for \$261,944.52. The purchasing company has executed a mortgage to the Central Trust Company of Illinois for \$160,000, covering the property. The Fourche River Lumber Company has a large plant at Fourche and has been for some time engaged in the construction of a railroad about forty miles long for the development of some of its timber holdings.

The Coche River Saw Mill Company has made application for a charter, with capital stock of \$20,000, copy of which has been filed with the register of this (Shelby) county. The incorporators are: T. J. Orr, John E. Orr, J. R. Thompson, A. W. and M. C. Ketchum. These gentlemen are also the principal stockholders of the T. J. Orr Land & Lumber Company which for some months had headquarters in this city and removed from here to Beth, Ark.

The Wynne, Newport & Western Railroad Company, capitalized at \$280,000, has filed articles of incorporation with the secretary of state of Arkansas for the purpose of building a line from Wynne to Newport, a distance of 48 miles. The road will furnish direct connection between the Missouri Pacific and Rock Island systems and will open up a section rich in hardwood timber and mineral resources.

W. E. Hyde of the W. E. Hyde Lumber Company, South Bend, Ind., has been in Memphis during the past fortnight making arrangements for establishing a branch office in this city, in charge of his brother, C. E. Hyde, who has traveled southern territory for some time in the interest of this firm.

A. L. Foster of the J. W. Thompson Lumber Company, who was called to West Point, Ark., a short time ago on account of the sudden death of his brother, Aubrey Foster, has returned to Memphis. He reports that his brother's death resulted from neuralgia of the heart. The deceased was engaged in the lumber business, making a specialty of the manufacture of cypress and cypress shingles.

Charles A. Price, for some years purchasing agent of the American Car & Foundry Company with headquarters at Detroit, Mich., has been appointed manager of the Binghamton plant of the American Car & Foundry Company here, one of the largest woodworking plants in this city. He succeeds George L. Henrion, who goes to Madison, Wis., to take charge of the plant of the company at that point. The change is effective September 1.

W. E. Smith, secretary of the Three States Lumber Company and the W. E. Smith Lumber Company, with headquarters in this city, is quite ill in a northern sanitarium. Mr. Smith left here early this summer suffering from nervous prostration and, while he improved for a time, his condition now is said to be quite critical. Hopes of his recovery are entertained, however, by his large circle of friends.

The A. L. Tenchout Stave Factory of Jackson, Tenn., will remove to Ackerman, Miss., within the next few weeks, because of the scarcity of timber in the section tributary to Jackson.

The Planters Lumber Company of Greenville, Miss., has passed into the hands of the

Chicago-Mississippi Land & Lumber Company, and J. L. Strickland, formerly vice-president and general manager of the concern, has been selected to look after the interests of the consolidated companies. The statement is made that the Neal interest in the Planters company alone has been purchased and that Mr. Strickland still holds the equivalent of his interest in the old concern in the new.

J. C. Cowen of Schulz Brothers & Cowen of Chicago, George Gall of the Gall Lumber Company, Toronto, Can., and James Hale, wholesale hardwood lumbermen of New York City, have been among the recent visitors in this city.

W. H. Russe, president of the National Hardwood Lumber Association and of the National Lumber Exporters' Association, has returned from a business trip to Chicago.

George C. Ehemann of Bennett & Witte is in Cincinnati, where he is visiting his mother and where he is incidentally in close touch with the headquarters of his firm.

W. R. Barksdale, president of the Lumbermen's Club of Memphis, has returned from a northern trip during which he did everything he could in favor of the move for a rescinding of the minimum weight ruling of the Missouri Pacific system.

W. H. Greble of the Three States Lumber Company and A. N. Thompson of Thompson & McClure have returned from a recent trip to points in Louisiana.

S. C. Major of the S. C. Major Lumber Company, who has been in the Northwest for some time, is expected home this week.

James Thompson of James Thompson & Co. has returned from a trip including Cincinnati and Chicago and he reports the outlook as very satisfactory for the fall and winter.

Weather conditions during the past fortnight have been moderately favorable but there are complaints yet of too much rain and bad roads resulting therefrom. One prominent firm is authority for the statement that none of its mills is cutting more than 50 per cent of its estimates and declares that the production of lumber in the Memphis territory is really very short for this time of the year. There are numerous reports of labor shortage and this feature will probably become more pronounced when cotton picking gets well under way.

#### New Orleans.

The Frank Brinker Manufacturing Company has been organized in this city with a paid-in capital of \$50,000 and will very shortly begin the manufacture of wagons here. The company has purchased a fine site containing a square of ground at Washington avenue and Claiborne street and expects to be ready for business by October 1. It will begin at once to build its factory. All of the necessary machinery has been secured. It is stated that the company will carry a stock of from seventy-five to 100 wagons on hand at all times.

Fred Muller has resigned as secretary of the Southwestern Lumber & Exporting Company and has left for Europe to study the lumber exporting business from that side. The present system of exporting at southern ports, as New Orleans, Mobile, Pensacola, Gulfport, Port Arthur, etc., is said to be without organization and cooperation among the exporters, and as a natural result depression of market prices occurs at a time when the logical position of the lumber business is bullish. Upon his return Mr. Muller will report his findings to the interests he represents and there is a strong probability that the methods of exporting from these ports will be subject to revolution. Incidentally, since so many mills are suffering from the scarcity of labor, Mr. Muller will endeavor to locate desirable mill hands and will try to induce them to emigrate to this country.

The Muller Furniture Company of New Orleans recently bought the building adjoining its already large factory in North Roman street

and will make extensive improvements therein. Work on the new addition will be begun shortly.

The Covington Contracting & Manufacturing Company, a new concern at Covington, La., is experimenting with gum as a substitute for oak and locust in the manufacture of foot-blocks, cross-arms, pins and brackets for use by the telephone companies. The new company is now preparing a trial carload of blocks, brackets, etc., and these will be shipped over the continent to be experimented with. The success of this experiment will mean that an entirely new market will be created for gum lumber.

The board of supervisors of Pearl River county, Mississippi, has raised the assessment on virgin timber lands to \$20 an acre.

The police in several of the timber parishes have been devoting themselves to running down timber depredators during the last few weeks, and only a few days ago arrested at Crowley four men who were charged with cutting timber from the lands of the Pacific Improvement Company. The affidavit charging these men, Maurice and Edward Darbonne, George Bourgeois and Arthur Boudreaux, with cutting timber was filed by W. W. Dason, the agent for the Pacific company. All four were released on bonds. Several other men of this class are said to be operating in Louisiana and are giving timbermen a great deal of trouble.

W. S. F. Tatum, buying for Wisconsin parties, recently paid \$392,500 for a two-thirds interest in a large tract of timber in Lamar and Rankin counties. There is said to be a large amount of hardwood on the tract. The sellers were John Landers, Springfield, Mo.; L. N. Anson, Merrill, Wis., and George F. Kirby, Oshkosh, Wis.

The Royal Lumber Company, Ltd., has been organized at Royal, ten miles east of Winnfield, La., on the new line of the Tremont and Gulf railroad. The company is capitalized at \$50,000 and will build immediately a saw and planing mill with a daily capacity of 50,000 feet. Dr. D. E. James of Royal is at the head of the organization.

George H. Spencer, a lumberman of Pearl River, La., has filed a petition in voluntary bankruptcy in the United States courts here. His liabilities will reach \$15,152.50, while his assets amount to \$9,300. Mr. Spencer's sawmill is listed at \$6,000.

V. M. Scanlan, F. W. Williams and others have organized the Lamar Lumber Company at Purvis, Lamar county, Miss. The capital is \$100,000.

Advices reaching here from Beaumont, Texas, state that a deal involving the transfer of a newly completed sawmill at Hyatt, with 180,000,000 feet of standing timber is now under way, but just who will get it has not been determined. The Kirby Lumber Company and several others are after it, and the bidding has been very sharp. It is understood that the Kirby people prefer to buy this and let one of their new mills go by default.

W. D. Washburn, attorney for D. S. Lansden, the trustee for the defunct F. E. Creelman Lumber & Manufacturing Company, was here recently looking around for assets of the insolvent concern. He announced that the assets would not be more than \$100,000. The Creelman Company borrowed nearly \$1,000,000 from banks in various parts of the country.

Two big factories, one of which will cost \$100,000, will replace the factory of S. T. Aleus & Co., which was destroyed by fire during the latter part of last month, entailing a loss of \$75,000 to \$80,000. One of the new factories will occupy a fine site on the New Basin Canal, while the other will very probably be built on a site adjoining that occupied by the structure which was destroyed. S. T. Aleus & Co. a few days ago closed a deal with the Illinois Central Railroad Company which involved something like \$250,000 and by the terms of which Aleus & Co. get two sites for the one they formerly



occupied. For the property bounded by Napoleon, avenue, Leake avenue, Telomptoulas and Jena streets and the Mississippi river the lumber manufacturing concern gets \$138,000 cash and a ten-year lease on nominal terms of ten squares of ground on the new basin. It is here that the \$100,000 plant of the Alcus people will be built. The former capacity of the Alcus factory will be doubled and employment will be given to about 350 men. The plant will consist of a main building, 300x200 feet, constructed of wood and steel; a large warehouse, a boiler room and an engine room. The rest of the property will be used for the storage of large quantities of material. It is stated that the new plant will be ready for operation in ten weeks. The Alcus people also bought recently a fine site adjoining that which they sold to the railroad company, paying \$27,500 cash therefor. Their second factory will in all probability be erected here.

#### Louisville.

Mr. Overstreet of the Southern Lumber Company says that there is no trouble in selling stock these days; in fact, his company is not making any effort to sell, but is bending all its energies to complete what orders are on hand and get a supply of lumber to the railroads from inland mills to take care of the fall orders as they come in. He says he expects to have four million feet of poplar piled at Somerset this fall. The company's oak output is already sold ahead at satisfactory prices, so there is no worry on that score.

The Stotz Lumber Company reports the hardwood market in excellent shape and says everything it can get hold of sells readily at fair prices. The concern finds the market especially strong on poplar.

The W. P. Brown & Sons Lumber Company reports things rushing at its yard. The main volume of the company's business is in oak, but it handles lots of poplar and other hardwoods.

The box factories here have been unusually busy all summer, but the heads of some of the institutions manage to get away for a little rest just the same. C. C. Mengel has gone to Europe for four weeks. H. P. Roberts of the Mengel Box Company has gone to Denver on a vacation trip, where his family preceded him, and Secretary Armstrong of the Tyler Box Company is taking a trip to New York City, where he will attend the summer meeting of the box manufacturers' association.

#### Minneapolis.

W. H. Sill of the Minneapolis Lumber Company says that while the volume of actual transactions just now is rather light, there is a big inquiry and every prospect of a splendid business to start early in September. One large customer has announced that he is ready to make his usual fall contract for basswood.

Robert Corbett of Ladysmith, Wis., a well-known hardwood producer, spent last week in Minneapolis, accompanied by Mrs. Corbett, and took in every feature of the Grand Army encampment. Mr. Corbett is a veteran and was in line on the day of the great parade.

George E. Foster of the Foster-Latimer Lumber Company, manufacturer of hardwood and hemlock lumber at Mellen, Wis., was here on a business errand a few days ago.

Among the visiting Grand Army men in Minneapolis last week was B. Miller of Kansas City, president of the L'Anquille Lumber Company, which has a hardwood mill at Marianna, Ark. Mr. Miller enlisted from Kansas and after the war went into the southern lumber field as one of its pioneers. His company makes a great deal of red gum lumber, and Mr. Miller says it is having a ready demand for everything it can manufacture. The company exports considerable hardwood by way of New Orleans. The company's band mill which was built eighteen years ago was the first one in that part of the country.

C. F. Osborne of Osborne & Clark is back

from a visit to their retail yards at and near Erie, Ill. He is very well pleased with the outlook for retail trade in that section. They are having a steady demand from the country yards for hardwood yard stock, and the country towns seem to be using more maple flooring than last year.

F. H. Lewis, the local wholesaler of hardwood and hemlock lumber, reports a much better demand from the large factory buyers than is usually experienced during August; also inquires which indicate a desire to make contracts and place large orders for supplies early.

E. Payson Smith of the Payson Smith Lumber Company, whose trip to southern points was interrupted by illness, returned from Hot Springs last week, and a few days at home quickly brought him around again. He is now making a short business trip in Wisconsin.

#### Ashland.

The lumbermen were disappointed over the small run of logs that came out of the Big Sandy on the recent rise. A large number of rafts were afloat, but the river fell too rapidly for them to reach the market. Good poplar is very scarce, and is bought up at any price. The mills hope to be able to accumulate sufficient dry stock for fall orders, but at present stocks are so broken that they can not fill orders for carload lots. Prices have advanced on poplar as follows:

\$1.00 on firsts and seconds.

\$1.00 on No. 1 common.

\$1.50 on No. 2 common.

\$1.00 on No. 3 common.

\$1.00 on box boards, both wide and narrow.

W. H. Dawkins and J. H. Kester, of the W. H. Dawkins Lumber Company, are recuperating and having a fine time in the East.

S. M. Bradley and J. T. Reynolds, prominent Morehead lumbermen, were among the week's visitors.

Mr. and Mrs. J. E. Walker are grieving over the death of their six weeks' old son, Eugene Ernest. He was an only child, which makes the blow doubly hard. The body was taken to Galipolis, O., for interment. Mr. Walker is connected with the Keyes-Pannin Company.

Giles Wright is in Cincinnati on a business trip.

Mrs. Wm. L. Watson is spending a month at

Mahan, W. Va., with her husband, who is looking after his large lumber interests there.

Mr. and Mrs. John W. Kitchen have arrived home from an extended trip through the East.

A deal has been closed in Huntington, W. Va., whereby Geo. L. Neal, John H. Holt, H. C. Duncan and Claude Ganjet sold the timber rights on 10,000 acres of land on Pigeon Creek, in Mingo county, to C. Crane & Co. of Cincinnati.

The Clearfield Lumber Company, of Morehead, is pushing work on the Morehead and West Liberty Railroad, recently purchased. The name has been changed to the Morehead & North Fork. This company owns between 40,000 and 50,000 acres of fine timber land in Rowan and Morgan counties, and the railroad will be extended to Paragon, the center of operations, where several large mills are located. Two long tunnels are to be built, and a large electric light plant has been installed that work may go on night and day.

Sam Beswick, of Huntington, W. Va., has sustained the loss of his lumber yards at that place by fire. Large quantities of lumber were totally destroyed. The engine room of the planing mill was burned down, and considerable damage done to the machinery. The warehouses, which were filled with paints, oils and other chemicals, together with their entire contents, were destroyed. On account of the high rates, Mr. Beswick carried no insurance on his lumber. The engine room was covered by insurance. The loss is estimated at from \$15,000 to \$20,000. About six years ago Mr. Beswick was burned out in the same way, and in almost the same locality. He will probably rebuild soon.

The Citizens' Bank & Trust Company has recently been organized in this city, capital stock, \$200,000. The incorporators are among the most prominent and influential business men of Ashland, including the following lumbermen: W. H. Dawkins, president W. H. Dawkins Lumber Company; W. E. Berger, treasurer W. H. Dawkins Lumber Company; M. W. Thomas, president M. W. Thomas Lumber Company; John W. Kitchen, treasurer Vansant-Kitchen & Co.; J. B. Kitchen, manager of the Standard Lumber & Planing Mill; S. M. Bradley of Morehead; H. X. Fisher of Webville. Ashland is a splendid location for such a bank, being a manufacturing center. It will be the largest bank in the Ohio valley outside of the large cities.

## Hardwood Market.

(By HARDWOOD RECORD Exclusive Market Reporters.)

#### Chicago.

While there was a little slackening in the demand for hardwoods in the Chicago consuming trade for July and the earlier part of August, there has been a manifest improvement in both inquiries and sales during the past few days. Even the most conservative of the jobbing trade believe that the Chicago wholesale people are going to have a remarkably strong trade for the remainder of the year.

It is known that the furniture, interior trim and flooring people all have booked heavy orders and the call for hardwoods from these sources alone will be enough to furnish a large volume of business to those who make Chicago their selling headquarters.

Chicago jobbers generally have taken advantage of the slight lull in general demand prevalent during the past few weeks to scout the producing districts pretty thoroughly, both personally and with the aid of their representatives, with the result that they have made large contracts for lumber in anticipation of a very healthy demand. Some jobbers report that they have a larger stock of lumber than ever before in their history, and all feel very optimistic over turning their purchases at a good profit. The remarkable shortage of poplar has stimulated the local sales in basswood and there is generally a fair call for northern hardwoods.

Both southern oak and the minor southern products are in excellent call with an advancing tendency in values.

#### Boston.

There has been very little activity in hardwoods in this vicinity during the past two weeks. Buyers are in the market, but show little anxiety to stock up beyond immediate needs. Prices are firm, with the tendency in some instances toward a higher level. The export demand is moderate only; for several weeks new business for export has been checked by the high prices. Furniture manufacturers are in the market and will take lumber in anticipation of future requirements if the price is attractive. Manufacturers of house finish are fairly busy and anticipate a good fall's business as there is considerable building in progress.

Cypress is in steady demand with prices for the most part well held. It is reported that dry stock at shipping points is difficult to secure. Whitewood is firmly held with the tendency toward advance. Desirable stock at mill points is not large. A moderate demand is reported for maple flooring. Prices hold firm. Rough maple is not in large offering and quotations are very firmly held. Chestnut is strong with a very good demand reported. Native



stock is not plentiful. Quartered oak is quiet offerings in most instances are of fair size. Plain oak is not in active demand. A few fair sized inquiries are received. Prices are not as high as they were two months ago.

#### New York.

There is a decidedly better tone to the hardwood situation than a month ago. The improvement bids fair to continue, as there is every indication that local consumption will be of good volume during the fall and winter, while reports received from manufacturing centers leave no doubt but that prices will be held stiff. Supplies in many sections are badly broken and short.

The local sash, door, trim, trunk, piano and general manufacturers have not accumulated any supplies ahead and for the most part are buying from hand to mouth, while the demands of their business keep them in the market right along. This class of buyers have purposely sailed close to the wind with an idea that stocks would be cheaper as the season advanced, but such has not been the case and the procrastination heretofore evident in this particular has to a large extent passed away and transactions are more free "at the market."

The stocks in next call are still led by chestnut, which is exceedingly scarce in the face of a very heavy call. All offerings are absorbed at good prices and plain oak has eased off a bit in demand, but prices are still firm. Poplar is fairly active; prices are well maintained, although there seem to be ample offerings for current wants. Quartered oak and maple are slow and the market featureless, generally speaking. Birch is having its usual good run and ash is quite readily salable, although its market is somewhat limited.

#### Philadelphia.

The movement of hardwoods for the month of August to date shows a tendency to increase. The better class of houses that demand hardwood finishings are now in condition to take this stock and the lumber in the retail yards is below the amount usually held. In spite of this, however, there seems to be a reluctance on the part of many of the yards to buy just now and this condition will probably result in hardship later on when the rush of business comes. From all indications here there will be a more pronounced shortage of cars than usual this season, owing to the enormous crops that are to be moved. If the expected demand for lumber occurs at the time that the railroads are engaged in transporting the harvests, the shortage will cause considerable trouble.

Oak, chestnut and poplar are in good shape and moving freely, especially good stocks of these woods. Cypress seems to be holding its own and good ash is in demand. Taken altogether, the summer season this far, although not notable for any remarkable activity in any line, has exhibited a steady selling quality that has caused satisfaction.

#### Baltimore.

No changes of note have taken place in the lumber trade of this city and section. All the woods in general use appear to be moving freely and the millmen say that they have orders in hand for their output for months to come. Rains, floods and other causes have served to curtail production, so that the quality of lumber available is only moderate, while the inquiry seems to be unabated and consumers are apparently eager to secure supplies. Under the circumstances it is only natural that the range of values should be firm. Good oak takes the lead. Railroads and other large buyers are in the market for large quantities and the available supplies are comparatively small as a result. The export business is uneventful for the reason that the needs of the domestic market do not leave foreign shippers much in the way of available stocks, and prices are consequently

high. Ash is in excellent demand at good values. Poplar is holding its own remarkably well. Good stocks are in strong request and the mills are able to dispose of their product without difficulty. The quantity of lumber available is rather small, while the consumption has for some time past attained an unusual volume. Lumber in considerable quantities is being sent abroad, and this helps to keep the local situation strong. Other hardwoods are firm, the entire trade being exceptionally active for this season of the year and keeping close to record figures in point of volume.

#### Pittsburg.

Vacation apathy is still strongly in evidence in the Pittsburg market. The majority of heads of firms are away, and none can boast of anything like a full count of men and women in their offices, for over half the forces are away on vacations. Consequently business is not brisk.

Hardwoods are still in the ascendancy so far as demand in local offices is concerned. There is a very encouraging firmness about hardwood prices in general. Stocks are also low, it is reported, and dealers look for still higher quotations when the fall market is fairly open.

The building situation in Pittsburg is once more in an aggravating state of chaos. Sympathetic strikes are the order of the day. A constant warfare is on between the labor unions and the Master Builders' Association, the occasion being the contention of the latter that an open shop policy shall rule and that the merit system shall be put in force throughout the Greater Pittsburg territory.

Oak leads the hardwood market in demand. Common oak planking has shown a slight weakness the last few days, due to oversupply among some of the main distributors in this territory. This is only temporary and is a decided exception to all other lines of oak lumber, which are extremely firm in price. Chestnut is firm with a slight increase in demand. Maple flooring is in much better call than the first of the month and some good local jobs are being figured. Hickory is wanted throughout Ohio and Indiana and some local firms are now preparing to make big cuts of hickory this fall.

#### Buffalo.

There is all of the former activity in the hardwood lumber trade, although dealers as a rule do not feel like urging sales at this time of the year as they would in spring or fall, as prices are seldom as strong in warm weather or in midwinter as they are the rest of the year.

The prices of hardwoods have been very uniform for some time since chestnut came up about to the level of plain oak, poplar alone continuing to advance. This is likely to continue as the reports from poplar producers are that logs are not coming in very freely and the supply will be very short. Those having or producing chestnut say that low grades are the main product now, but that everything sells. If the cheapest grades are wanted for nothing else they go to the box factories for crating.

The quietest wood now seems to be elm, the reason for this being the high price. However, the cooperage trade utilizes large quantities at prevailing high prices.

Basswood which had joined elm as an off wood, also on account of the high price, is now coming back into favor, probably on account of the high price of poplar, as the two largely go into the same trade. Dealers say now that it sells quite briskly again and are handling it if the mill prices are not too stiff. Oak, birch, maple and ash are as strong as ever.

#### Bristol, Va.-Tenn.

Trade conditions in this city and section remain practically unchanged. There is a fair demand for all kinds of stock. A shortage in poplar and oak, more especially the former, is apparent.

The car supply seems adequate and little

trouble has been encountered thus far in this respect.

This has been a banner season for the country mills. They are practically all running regularly and many of them overtime, in an effort to get out as much stuff as possible and get it to the railways before the roads become impassable. Some of the mills are complaining of an insufficiency of logs, but the majority seem to be well stocked.

#### Nashville.

The usual midsummer dullness has failed to materialize in the Nashville market this season. Inquiries and orders are as plentiful as in the busy spring. Though there are not as many visiting buyers here now, mail orders are making up for what they might purchase. Many of the dealers have put more orders on their books during the last two or three weeks than during the two months preceding. Dealers are most sanguine of the outlook for fall business.

The market is absolutely bare of chestnut and ash in all grades and thicknesses. Plain oak, red and white, common and clear, is bringing good prices, and the demand is active. Most of the mills have discontinued sawing quartered red. There is little of it on hand, and no great demand noticeable. Quartered white oak is moving at good prices. Dry poplar is almost unobtainable in any grade or thickness and some advance in price is expected. There is a good call for gum and sycamore, the former being used for boxes and coffins and the latter for tobacco boxes. Some gum is being used now for flooring purposes with evident success. Recent advances are noted in the price of hickory.

#### Memphis.

A better demand and increasing firmness are the characteristics of the hardwood lumber market in the Memphis territory. Consumers are beginning to show more interest in securing their requirements for the fall and winter and, with hardwood lumber so scarce in stock ready for immediate shipment, it is anticipated that there will be a lively demand during the next sixty days. And it is generally conceded that there is nothing to cause the price to give way even temporarily. On the other hand the feeling is gaining ground that there may be further appreciation in values. The influences bearing on hardwood consumption are very favorable at this time and hardwood interests believe that this means much for them. Stocks here are as badly broken as they have been at any time this season and, although production is increasing gradually, there is little likelihood that there will be a return to anything even approximating normal holdings within the next four or five months even if weather conditions should prove better than usual.

Ash is exceptionally strong. It is much wanted in all grades and thicknesses, with the result that prices are very firm.

Plain oak continues an excellent seller in all grades, there being marked improvement in the demand for No. 1 common. There is no surplus of any grade, either red or white, and manufacturers are asking full prices for what they have for sale. Quartered oak is attracting more favorable mention in white firsts and seconds, though there is no great demand for the lower grades of white. All grades of red are rather slow, but manufacturers continue to adhere to the belief that there will be a good demand even for the quartered red, and are quietly biding their time. There is no great amount of either red or white in quartered stock and this is regarded as a helpful influence.

Cypress is a good seller in all grades. There is more of the lower grades available than of the higher, but there is proportionately more call for the former, with the result that prices thereon are well maintained.

Cottonwood is in good call. This is particularly true of the box grades which are much sought by box interests. The supply is far

below normal for this time of the year and with the small cut of the spring and summer the outlook is for a continued shortage, with a consequent good demand and firm prices. There is very little in cottonwood box boards for sale and the market thereon is very firm. Wide-firsts and seconds are in good request and there is likewise a very satisfactory call for the narrower widths of the higher grades.

Gum is maintaining its recent pace without difficulty. It is developing that there is no great amount of gum lumber for sale in any grade and manufacturers are having very little trouble in disposing of well-handled stock at very satisfactory prices. Clear saps are perhaps slower than anything in the gum line. Prices obtained for gum are considered excellent in view of the figures which have prevailed on this lumber during the past few years. Poplar is without special feature, there being a moderate demand at very satisfactory prices.

### New Orleans.

The hardwood market here is good considering the season, and indications are that many of the undesirable conditions which have prevailed here recently are becoming extinct. The mills are cutting considerable timber and stocks are being replenished. Exports continue fair and prices are good. Buyers are not especially active, but it is expected that they will begin to be very much in evidence within the next sixty days.

### Louisville.

August is the vacation month in the Louisville territory and trading in lumber is usually a little slow. Mill men in this territory are striving to get their order books cleaned up and get a little lumber on sticks to take care of the fall demand. What they want now is lumber and orders later on, because they do not see any chance for prices to ease off, while they do see some chances for them to become better supplied for the brisk fall trade anticipated. There is quite a volume of business being done in small orders, and the whole situation is so satisfactory to the millmen that they are taking things easier as far as the market is concerned than ever before at this season.

Present conditions point strongly toward an unusual stir in gum this fall. Gum has not kept step with the other hardwoods during the summer and buyers have not apparently been so anxious for it, but when the box manufacturers, the furniture people and other users of common gum get to looking around for their winter and spring supplies they will likely find that they need more gum than usual. The box trade has been unusually busy this summer, and from this source the requirements will undoubtedly be large. Added to this is the scarcity of low grade poplar and cottonwood, so that it looks as if buyers will be forced to seek more gum than usual. Poplar and chestnut are about the stiffest items on the hardwood list here, but everything continues in good shape and the millmen say there is no cause for complaint on any score.

### Rhineland.

Trade in hardwoods is moving along at a very fair rate considering the hot weather. Some dealers report business quiet, while others have all they can handle. Birch is the staple here, and firsts and seconds have been and are still bringing good prices, but No. 1 common is dull and not bringing what it is intrinsically worth.

There is some demand for hard and soft maple. Basswood is selling well in the lower grades, but not so in No. 1 common and better. Two months ago basswood was the heaviest seller in this locality, but it has dropped to second place now. Birch is the leader and promises to continue so for the rest of the year. Soft elm is moving to some extent, but at rather low prices. Ash is strong, but not plentiful. Rock elm is scarce. Certain manufacturers and jobbers practically cornered the market on this wood last

winter. There is an increased movement of Wisconsin hardwoods to the eastern and middle states this year, and trade in those parts is larger than it has been for a number of years.

### Minneapolis.

There is an activity in hardwood that is really phenomenal in view of the extreme hot weather of the past few days. It does not seem to have stagnated the hardwood trade. The actual movement is not heavy, though it is better than usual at this season. The feature of the market is the brisk inquiry for large stocks for fall and winter delivery. The factories generally have had a busy summer and have worked up a large amount of hardwood. They have not bought to keep pace with consumption and have allowed their stocks to run low. The factory managers understand that there is a very limited stock in all hardwoods but birch and basswood, and so they are getting into the ring early. The buying movement that is usually opened along in September is under way to a large extent now. The biggest rush is for oak. Northern stocks are closed out, and no longer in the market. There has been a lively business in southern oak, and the mills which look for business in this territory report that they now have about all they can take care of.

There is no disposition on the part of the mills to rush business. They are satisfied that their stock can be disposed of at present prices or better. There is no surplus oak, ash or rock elm in sight and at the rate maple flooring has been going it will be well cleaned up also. The retail yard trade is taking a great deal of flooring as well as wagon stock, and this business is sure to hold up well during the fall, on account of the good crops and the prosperity that is prevalent in all the farming communities of the Northwest.

Basswood is going better this year. Low grade boards sell themselves and there is a good demand from factory users for upper grades. There is also a better movement in birch, and although stocks are plentiful in the Northwest it looks as though all the birch would be needed. Low grade stock is now largely used instead of pine or hemlock for grain doors, and this demand cleans it up close. The sash and door industry is using more birch every year for interior finish, because of the scarcity of oak, and the consumption of birch this summer has been heavy. Buying is not lively just now because the trade knows there is plenty of birch to be had when wanted.

### Liverpool.

Considerable regret has been felt at the death of Arthur Cross of the firm of Robert Coltart & Co. Aug. 7, at the early age of 49 years. Deceased had paid many visits to the United States, and must have been a well-known figure to a large number of American shippers. He will be much missed here, for a more straightforward gentleman it would be difficult to find.

Trade has been very quiet during the last week. Those who are not actually on holiday trips are talking about them, and nobody seems much inclined toward business. The mahogany sale yards bear an extraordinary appearance just now. Almost all the wood sold at the last sales has been removed, which of course means that the wood is going into consumption, and the yards are practically bare of good stock. Prices will inevitably rise considerably in the next few months.

Four or five cars of wagon oak planks have arrived on consignment for different brokers. On these cars they will no doubt get good prices, but it seems extreme folly to ship on consignment, as this only tends to lower the price, as is well known. From this side it is strongly advised that orders should be obtained before shipping, and that American shippers should not be led by brokers who promise excellent prices which they have little prospect of obtaining. Ash

planks continue firm in price, but it is doubtful whether many can be sold at present values. It would pay shippers best to fulfil the orders they have on hand and then to firmly decline to ship any planks until they have an order. It would pay, as they would surely get the order. Long ash 21 feet and up would obtain a good price. Quartered and plain oak boards find a quick sale at good prices. Hickory is also back at its old figure. Birch is improving now that the import of logs has almost finished.

Under date of August 1, Alfred Dohell & Co's Timber report says that considering the restricting effect of high prices conditions generally may be said to be satisfactory. Supplies have come forward during the past month on a fairly liberal scale; stocks generally are moderate and prices fairly steady.

Arrivals of round southern wood in oak have been moderate, and prices remain firm. Baltic more waney logs are in demand and parcels of prime fresh logs of good specifications would find a ready sale. Oak wagon planks are in active demand; the arrivals which have been heavy and chiefly under contract have gone freely into consumption. Only coffin planks of good specifications can be sure of a market, as stocks of medium and inferior grades are too heavy now. Walnut logs of good size and excellent specifications are in request and bring satisfactory prices; arrivals of planks and boards have been moderate and prices are firm. The import of whitewood logs has been considerable, and prices are lower. Stocks of whitewood planks and boards are heavy, especially in the inferior grades, with the demand only fair. Ash and hickory logs have arrived heavily and as the shipping season has passed parcels have either been forced off the market at very low prices or stored for shippers' account. Recent auction sales of mahogany were well attended, and nearly all the wood offered was sold at full prices. Stocks are low in most varieties.

### London.

At this time of the year buyers and sellers are holiday making and business is quiet. There is very little change to note at the moment, except that buyers are a little more inclined to meet shippers' ideas of prices, as they find that stocks on the docks are not heavy and their requirements are difficult to find. Those buyers who held off filling their orders for cheaper prices are now buying as small as possible.

Satin walnut is in good demand at fair prices, and arrivals are small. Walnut arrives slowly and if of fair quality realizes good prices. Only prime veneer logs are wanted. Oak is steady, at fair prices. Whitewood the large stock of planks which has been held here for some time having gone into consumption, buyers are contracting for fresh arrivals. Mahogany is very firm, although there is little business passing.

Churchill & Sim's wood circular of recent date states that trade during July may be considered satisfactory on the whole, in that buyers generally have confidence enough in the future to contract for their fall requirements at the higher range of prices now prevailing. This does not apply to the London trade which still is far behind that of 1905. London merchants have done a smaller business than usual, but on the whole trade has been sounder and more remunerative than in some years of big figures. In American black walnut, the circular states, logs, if large and prime, would realize good prices, but small rough wood should not be sent; planks and boards are in active request and stocks are low. Only small lots of large and prime whitewood logs are needed to fill the requirements of the market; there is a sufficiency of planks but planed boards, under one inch in thickness, are wanted. Arrivals of mahogany have been very light for some time past, and the market is in an exceptional position, there being not a single entire cargo of mahogany unsold; imports therefore would arrive at a welcoming market.

# AT COST

IS AN UNCOMMON TERM AS APPLIED TO INSURANCE

But this is the actual price of Indemnity against Fire Loss furnished by the

## Manufacturing Lumbermen's Underwriters

THE STRONGEST INSURANCE ORGANIZATION  
TO-DAY IN AMERICA

The saving is not on a small portion of your insurance but on the entire line.

There are other advantages equally interesting.



Only well built plants with adequate protection and at least five years timber supply are considered eligible.

FOR LIST OF MEMBERS AND FURTHER INFORMATION, ADDRESS

**HARRY RANKIN & CO.      Kansas City, Mo.**

# Wanted and For Sale -SECTION-

Advertisements will be inserted in this section at the following rates:

For one insertion ..... 20 cents a line  
For two insertions ..... 35 cents a line  
For three insertions ..... 50 cents a line  
For four insertions ..... 60 cents a line

Eight words of ordinary length make one line. Heading counts as two lines. No display except the headings can be admitted.

Remittances to accompany the order. No extra charges for copies of paper containing the advertisement.

## EMPLOYES WANTED.

### WANTED—EXPERIENCED MILL MAN

Who understands hardwoods, to take an interest in a band mill in the South, to saw for us and own 1/3 or 1/2 interest in the mill. This is a good thing for the right party. 5 to 8 years' sawing in a city of 20,000. Must have \$4,000 or a good up-to-date band mill. References required.

J. A. BROWNE & CO., INC.,  
North Manchester, Ind.

### LOGGING CONTRACT TO LET.

We have 150 million feet mixed hemlock, hardwood and pine timber in northern Wisconsin, to be logged at the rate of 12 to 15 million feet per year. Want land cleaned of all timber, including pulpwood, cedar posts, poles, etc. Work to commence fall of 1907. Party must be financially responsible and experienced in logging mixed timber by rail. Send references, stating whom you have logged for before. Address "LOGGING CONTRACT," care HARDWOOD RECORD.

### SALESMAN WANTED.

One who has had experience in both Mahogany lumber and Veneers. State age and nationality, with information regarding previous or present position. Willingness to travel, habits, married or single, salary expected. Address "VENEERS," care HARDWOOD RECORD.

## LUMBER WANTED

### WANTED—CRATING.

Cut to dimensioned sizes: 4"x32", 2"x48", etc., inch stuff in hardwood or any soft wood. Will order in car lots.

NATIONAL WOODENWARE CO., LTD.,  
Grand Rapids, Mich.

### WANTED.

White Oak logs and White or Gray Ash logs. Write for specifications.  
S. N. BROWN & CO., Dayton, Ohio.

### WANTED—DIMENSION HICKORY.

Hickory Pole and Shaft Strips. Also good man to travel, buying and inspecting same.  
TOLEDO CARRIAGE WOODWORK CO.,  
Toledo, Ohio.

### WANTED—HARDWOOD LOGS.

200 M feet 28-inch and up White Oak logs.  
200 M feet 12-inch and up Walnut logs.  
50 M ft. 12-inch and up Cherry logs.  
C. L. WILLEY,  
Blue Island Av. and Robey St., Chicago.

### OAK.

We are in the market for plain sawed oak, all grades and thicknesses.  
P. G. DODGE & CO., 2116 Lumber St., Chicago.

### WANTED.

Locust, Bois D'Arc or Osage Orange and Mulberry, log run. Write for specifications and prices.  
THE PILLIOD LUMBER CO., Swanton, O.

### WANTED—DIMENSION HICKORY.

Send for our specifications.  
MUNCIE WHEEL & JOBBING CO.,  
Muncie, Ind.

### OAK WANTED.

3 and 4 inch White Oak; also Mixed Oak; also 12x12 Timbers and Piling of all kinds.  
CONTINENTAL LUMBER CO.,  
1213 Monadnock Bldg., Chicago, Ill.

## TIMBER LANDS FOR SALE

### FOR SALE.

3,550 acres of Georgia hardwood, estimated to cut as follows:  
8,800,000 feet White Oak.  
3,500,000 feet Hickory.  
5,500,000 feet Red Oak.  
1,750,000 feet White Ash.  
High grade stock suitable for wagon and carriage manufacture.  
3 1/2 miles from railroad; river joins tract.  
Ten years to remove timber. Address "T. H." care HARDWOOD RECORD.

## LUMBER FOR SALE.

### FOR SALE.

200,000 feet common and better Quartered White Oak.  
SPENCER, YOUNG & CO., Glasgow, Ky.

### RED OAK TIES FOR SALE.

I wish to contract at once with reliable party a large quantity of Red Oak Ties.  
Address CHAS. SMITH, Free-town, Ind.

### FOR SALE.

Oak Squares for Chair Stock.  
E. DUNSTAN, Winona, Miss.

### GUM AND SYCAMORE BOARDS.

200,000 feet of 1 inch boards from 10 to 20 feet long. Apply to  
A. ROSENBAUM & SONS, Newport News, Va.

### FOR SALE.

Common and better Hickory, 5,277 feet of 2 3/4", 1,092 feet of 3" and 1,024 feet of 4", dry, good quality.  
LOVE, BOYD & CO., Nashville, Tenn.

### FOR SALE.

One car clear Hickory cuttings, dry, 1"x1 1/2" x19" to 24", 1"x1 1/2"x28" to 36".  
Also 3,700 pieces dry second growth Ash, 1 1/2"x3 1/2"x26".  
THE J. A. & D. P. COOPER CO.,  
Struthers, O.

## BUSINESS OPPORTUNITIES

### DESIRABLE LOCATIONS.

In the territory of splendid timber resources reached by The North-Western Line are several fine locations for new industries, especially in the woodworking lines. A suitable point for a large sawmill having excellent railroad service and a large tributary timber district is one of these. There is also a fine opportunity for securing a well equipped cooperage plant. Reference to these can be obtained upon request to the INDUSTRIAL DEPARTMENT, C. & N-W. Ry., Chicago.

### HARDWOOD TIMBER.

A number of good mill propositions along the Cotton Belt Route. Tracts ranging from five hundred to twenty thousand acres, principally Oak, Hickory, Gum, Cypress, some Ash, Cottonwood and other hardwoods. Can be secured at very reasonable figures now—in some cases at less than \$1 per thousand stumpage. Choice openings for hardwood lumber mills, handle and spoke factories, slack cooperage plants and other hardwood enterprises.

A number of points on the Cotton Belt offer free sites or will raise cash bonus or take stock in practical propositions. Let us have your wants and see what we can do for you.  
E. W. LA BEAUME, G. P. & T. A.,  
COTTON BELT, St. Louis, Mo.

### LUMBER YARD FOR SALE.

On good site for manufacturing concern, lumber or coal yard. Planked with 2-inch oak. Fine office worth \$2,500. Address "YARD," care HARDWOOD RECORD.

### BAND MILL FOR SALE CHEAP.

One of Smith, Myers & Schuer band mill, with good power and all other necessary requirements for a first-class mill in good condition. Will send full description and price on application.  
SWAN CREEK LUMBER CO., Toledo, Ohio.

### WANTED.

Party with small capital to take an active interest in well established handle and lumber business. Entire output sold for four years. For further information write or call on  
H. F. CLARKE, Okolona, Miss.

## MACHINERY WANTED

### AT ONCE.

If you are in need of machinery—new or second hand—a few lines in this column will place your wants before those who have such goods for sale. For particulars address  
HARDWOOD RECORD, Chicago, Ill.

## MACHINERY FOR SALE

### FOR SALE.

Skewer machinery outfit. Stickers and Pointers. Each machine guaranteed to turn out at least 100,000 sticks in ten hours. Address  
W. ROBINSON,  
1421 Main St., Buffalo, N. Y.

### FOR SALE.

Two Nichol's Dryers in first-class condition. Can be seen in operation until August 30 at  
NATIONAL CASKET CO., E. Cambridge, Mass.

### SAW MILL FOR SALE.

We have the following circular sawmill with all appurtenances complete for sale at Habersham, on L. & N. R. R., in Campbell Co., Tenn.:  
One No. 3 Hart mill; capacity 25 M. per day.  
One 45-horsepower boiler.  
One 40-horsepower engine.  
Three head-blocks with grip set rig.  
One 64-inch Hoe saw—inserted tooth.  
Two 64-inch Ohlen saws—inserted tooth.  
One three-saw gang edger.  
One two-saw trimmer.  
One slab saw or cut-off.  
One Hart friction nigger or log turner.  
80 feet of lumber rolls.  
This mill is fitted with the famous Osbourne feed rig and has 150 feet of 3/4 cable or rope feed.  
LOGAN & MAPLET LUMBER CO.,  
Knoxville, Tenn.

# MANUFACTURERS

Contemplating establishing plants in the West should take advantage of a location on



## Chicago & North-Western Ry.

which reaches the famous

**WATER POWERS,  
COAL FIELDS,  
IRON ORE RANGES,  
HARD AND SOFT  
LUMBER DISTRICTS,  
MINING DISTRICTS**

of the West and Northwest, and affords the best means of transportation to the markets of the world.

FOR FURTHER PARTICULARS APPLY TO

MARVIN HUGHITT, Jr., E. D. BRIGHAM,  
Freight Traffic Manager, Gen'l Freight Agent,  
GEO. BONNELL,  
Industrial Agent.  
NW513 CHICAGO.

Advertisers' Directory

NORTHERN HARDWOODS.

Table listing various lumber companies under the Northern Hardwoods category, including American Lumber & Mfg. Company, Apple Hardwood Lumber Company, Babcock Lumber Company, etc.

Standard Hardwood Lumber Co.

Table listing various lumber companies under the Standard Hardwood Lumber Co. category, including Stephenson, The L. Company, Stewart, E. N. & Bro., etc.

SOUTHERN HARDWOODS.

Table listing various lumber companies under the Southern Hardwoods category, including Advance Lumber Company, American Lumber Company, American Lumber & Mfg. Company, etc.

McClure Lumber Company

Table listing various lumber companies under the McClure Lumber Company category, including McClure Lumber Company, McLean, Hugh, Lumber Company, Maley, Thompson & Moffett Company, etc.

CYPRESS.

Table listing cypress-related companies, including Crandall & Brown, Cypress Lumber Company, Hafner Manufacturing Company, etc.

HARDWOOD FLOORING.

Table listing various hardwood flooring companies, including Bliss & Van Aulen, Carrier Lbr. & Mfg. Company, Colbs & Mitchell, Inc., etc.

SAW MILL MACHINERY.

Table listing saw mill machinery companies, including Mershon Company The, Phoenix Manufacturing Company.

WOODWORKING MACHINERY

Table listing woodworking machinery companies, including American Wood Working Machinery Company, Berlin Machine Works, etc.

VENEER MACHINERY.

Table listing veneer machinery companies, including The Manufacturing Company.

LOGGING MACHINERY.

Table listing logging machinery companies, including Clyde Iron Works, Lidgerwood Manufacturing Company, etc.

DRY KILNS AND BLOWERS

Table listing dry kilns and blowers companies, including Gordon Drys Veneer Works, Morton Rapid Kiln Company.

LUMBER INSURANCE.

Table listing lumber insurance companies, including Adirondack Fire Insurance Company, Lumber Insurance Company of New York, etc.

SAWS, KNIVES AND SUPPLIES

Table listing saws, knives and supplies companies, including Atkins, E. C. & Co, Champion Saw Company, etc.

MISCELLANEOUS.

Table listing miscellaneous companies, including Barroll, H. C., & Co., Gibbs, S. D. & Co., Gillette Roller Bearing Co., etc.

CHICAGO VENEER COMPANY

(INCORPORATED)

BURNSIDE, KENTUCKY

Bored Poplar Posts for Porch Columns

66 to 96 INCHES LONG, 8 and 10 INCHES DIAMETER

Write us for Prices and Particulars

You want to reach Buyers of  
**FURNITURE LUMBER**  
**The HARDWOOD RECORD**  
 will do it for you.



WALNUT.  
 OAK,  
 ASH,  
 POPLAR.

**NOVELTIES FOR ADVERTISERS**  
 FOBs, POCKET PIECES  
 BUTTONS,  
 LETTER OPENERS,  
 SCARF PINS, TRAYS,  
 ALUMINUM GOODS,  
 PAPER WEIGHTS.  
**ALL NEW IDEAS.**  
 Send us 50c. and we  
 will send you a  
 Beautiful Watch Fob  
**S. D. CHILDS & CO.**  
 200 CLARK ST. CHICAGO.

**RUSSEL WHEEL & FOUNDRY COMPANY**

Builders of  
**Logging Cars**  
 And **Logging Machinery**

ARE ALWAYS PLEASED TO  
 HAVE OPPORTUNITY OF  
 POINTING OUT ADVAN-  
 TAGES OF THEIR  
 EQUIPMENT.

**Detroit, Mich.**

**Locations for Industries**  
 ON  
**THE ERIE, THE COMMERCIAL RAILROAD**  
 CHICAGO TO NEW YORK

The Erie Railroad System's Industrial Department has all the territory traversed by the railroad districted in relation to resources, markets and advantages for manufacturing, can advise with manufacturers of specific products as to suitable locations, and furnish them with current information of a comprehensive nature dealing with the project in its full relation to manufacture and commerce.

The Erie is one of the greatest of trunk lines. Its own rails connect the two largest cities of America. Every section of the System has its particular merits. Profitable locations exist. It has great general and coal, oil and natural gas resources.

It is important in this age of modern facilities for manufacturers to locate where they can obtain side tracks so as to receive from and ship directly into cars at the factory. Information can be promptly furnished in this connection about every point on the system between New York and Chicago.

Manufacturers' inquiries as to locations are treated in strict confidence and absolutely reliable information, so as to promote permanent traffic, is furnished. Address

**LUIS JACKSON**  
 Industrial Commissioner  
 Erie Railroad Company  
 11 Broadway, New York

**Save Your Money**  
 By Using the  
**RED BOOK**

Published Semi-Annually  
 in January and July

It contains a carefully prepared list of the buyers of lumber in car lots, both among the dealers and manufacturers.

The book indicates their financial standing and manner of meeting obligations. Covers the UNITED STATES and MANITOBA.

The trade recognizes this book as the authority on the lines it covers.

A well organized Collection Department is also operated and the same is open to you.

**WRITE FOR TERMS.**

**Lumbermen's Credit Association**  
 ESTABLISHED 1878

1405 Great Northern Building, CHICAGO  
 16 Beaver Street, NEW YORK CITY

MENTION THIS PAPER

**HARDWOOD TIMBER**

There is no section with so fine and large a supply of hardwood timbers of various kinds left for the lumbermen as that portion of the South in Alabama, Georgia, Kentucky, Mississippi, North Carolina, South Carolina, Tennessee and Virginia served by the lines of the

**Southern Railway**  
 and  
**Mobile & Ohio Railroad**

There are oak, poplar, hickory, gum, cypress, ash, elm, huckeye, balsam, spruce, chestnut, and other varieties. There are also available pine lands.

These timber resources and many other important features bearing on the cost of manufacture and marketing gives special advantages and opportunities for EVERY KIND of WOOD USING INDUSTRY. We have information about the best locations in the country at towns in these States and in Southern Indiana and Southern Illinois, which will be given if requested. All correspondence in regard to timber lands or factory locations will be given prompt and confidential attention. Address your nearest agent.

**M. V. RICHARDS,**  
 Land and Industrial Agent,  
 Washington, D. C.

**CHAS. S. CHASE, Agent,**  
 622 Chemical Building,  
 St. Louis, Mo.

# "DEFIANCE" WOOD-WORKING MACHINERY

COMPLETE EQUIPMENTS OF

## HIGH GRADE TOOLS

✱ FOR MAKING ✱

Hubs, Spokes, Wheels,  
Wagons, Carriages,  
Rims, Shalts, Poles,  
Neck-Yokes,

Single Trees, Hoops,  
Handles, Bobbins, Spools,  
Insulator Pins and  
Oval Wood Dishes.

INVENTED AND BUILT BY

The **DEFIANCE MACHINE WORKS**  
DEFIANCE, OHIO.

Send for 500 Page Catalogue

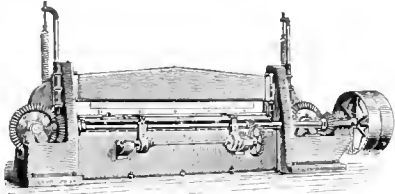

AUTOMATIC HOOP CUTTER

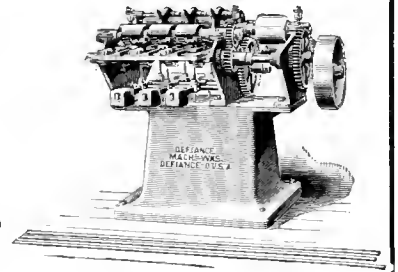

TRIPLE HOOP PLANER

## The Morton Dry Kiln

MOIST AIR SYSTEM

Recording  
Ther-  
mometers.  
Transfer  
Cars.

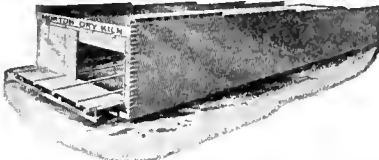

Trucks.  
Canvas  
Doors.

HOW TO DRY LUMBER

As exemplified in our Catalog D. Free on application

**MORTON DRY KILN CO., Chicago, Ills.**

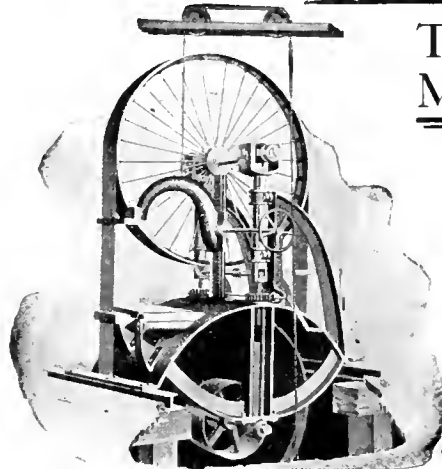

## Ten per cent More Profit

The profits of a saw mill can readily be increased ten per cent by using a band mill instead of a rotary. The price of this mill with six foot wheels for saws eight inches wide is readily within the reach of all. It cuts smooth and perfect lumber and has a capacity of 25,000 feet to 35,000 feet per day. It runs with less expenditure of power than a rotary and puts only half as much of the log into saw dust as does the circular saw.

**PHOENIX MFG. COMPANY,**  
EAU CLAIRE, WIS.

# KNIVES

A man who has been in the presence of angels discloses the fact by his action: Just one reason for our talking good machine knives, good veneer knives or knives of any kind that do good work.

**CHAMPION SAW COMPANY,**

BEAVER FALLS, PA.

## A machine that declares saw mill dividends



AUTOMATIC SWING SAW GAUGE

☐ An inexpensive little device that *saves a dollar a day* and upwards.

☐ Stops one of the biggest profit leaks at the mill. Pays for itself several times over during a year.

☐ Isn't it worth investigating?

**FRANCIS MARSHALL, - - Grand Rapids, Mich.**



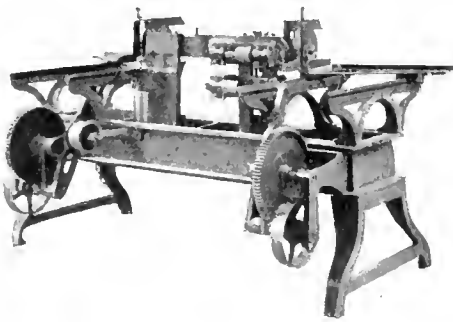

## New Type of Combined End Matcher

SAVES 20 PER CENT. TIME, COST AND LABOR.  
USED BY THE LARGEST FLOORING CONCERNS.

Write for particulars to

**A. J. SCHINDLER, 441-443 W. 21st Street, CHICAGO**

### STRONG, SAFE AND RELIABLE

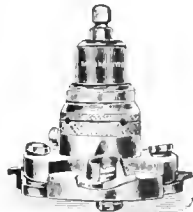

## The Shimer Cutter Heads

ARE BUILT FROM  
FORGINGS OF STEEL

and are finished throughout in the solid metal. This insures accuracy, durability and perfect mechanical adjustments.

They are appreciated by the user because they hold up under the severest tests. They cut easily all kinds of hard knotty and cross-grained lumber. If you make single tongue and groove Flooring, Ceiling and Wall-coating, buy THE SHIMER CUTTER HEADS and you will have no disappointment.

We make Heads for every class of work. A copy of our catalogue giving the uses to which they are put and the best styles for certain classes of work, will be sent free on request.

**SAMUEL J. SHIMER & SONS,**  
MILTON, PENNSYLVANIA

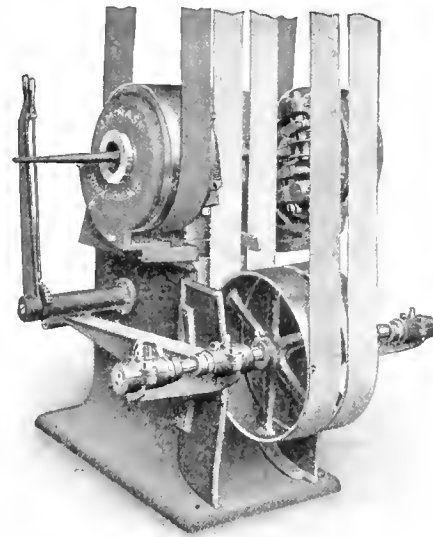

## The Nash Automatic Sander

FOR ALL ROUND STOCK WORK

A wonderful labor-saving machine  
Pays for itself in a short  
time. For particulars  
address

**J. M. Nash** 842-848 Thirtieth St.  
MILWAUKEE, WIS.

Broom,  
Hoe, Rake,  
Fork and  
Shovel  
Handles,  
Chair Stock,  
Dowel Rods,  
Curtain  
Poles,  
Shade  
Rollers,  
Whip Stocks,  
Canes,  
Veneered  
Columns,  
Ten Pins, &c.

## Improved Automatic Band Saw Sharpener

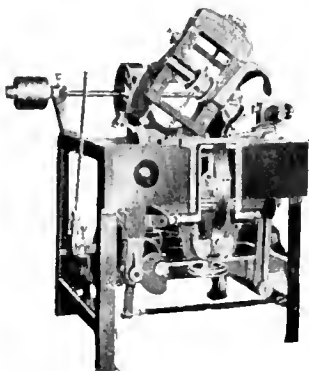

All  
Machines  
Fully  
Guaranteed

⌋ This machine excels all others for single cutting Band Saws from 8 to 14 inches. Its construction is mechanically correct, simple and durable, and does not possess any of the intricate complicated parts that confuse the operator. The head is adjustable so that straight wheels can be used with the same results as concave.

⌋ This represents just one type of machine. We make in addition a complete line of modern tools for the care of saws. For particulars address

**MATTESON MFG. CO.,** 120-128 S. Clinton St. **CHICAGO, ILLS.**

**Hanchett - Hanchett - Hanchett**

# Hanchett Saw Swage

Every one made Perfect  
The Swage with a Name

☞ A poor Swage Ruins a Good Saw, and for that reason the manufacturers of the **HANCHETT ADJUSTABLE SWAGE** employ only the Best Mechanics and use only the Best Material in their construction.

Send for Catalog No. 10 It tells you all about them

**It Pays Us to make The Best**      **It Pays You to use The Best**

MANUFACTURED BY

## Hanchett Swage Works

Big Rapids, Michigan

**Hanchett - Hanchett - Hanchett**

We Guarantee  
to  
**KILN DRY OAK**

IN A WEEK  
by the application of a  
new scientific principle

IN YOUR PRESENT  
**Old Kilns**

Grand Rapids Veneer Works  
DEPT. D., GRAND RAPIDS, MICH.

# Truck Truths

## 1--Framed to Fit Frames

A box nailed up tight at ends, sides, top and bottom is stronger than a box with top and bottom left off.

A Gillette truck, like a tight box, is stronger than a channel steel or wood frame truck, which, like a box with top and bottom knocked out, "has its failin's."

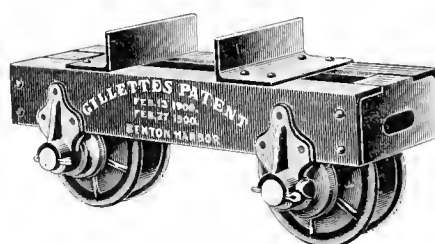

The cut shows the "why" of the strongest, lightest and most compactly built truck ever made. Ask for proofs and prices.

## Gillette Roller Bearing Co.

Patentees and Sole  
Manufacturers

### Grand Rapids, Michigan



# SAWS

I tell you, Mr. Mill Man, there is merit in these saws. Dependable stuff that is made right, will work right, and last the life of good saw material.

## CHAMPION SAW CO.

BEAVER FALLS, PA.



## The Coe Knife Grinder

was designed for the finest grinding and most exacting service. It is built on new lines and has completely overcome the objections to other grinders. The knife is held rigidly while the stone travels back and forth. There is no chance for

vibration, consequently no unevenly ground knives. Entirely automatic in ac-



tion, no ropes or chains. All moving parts operated by cut steel gears, noiseless in operation, will grind straight or hollow bevel. Feeds 1-1000 to 4-1000 for each travel of the stone, very heavy and compact, occupying small floor space. Made in seven sizes to grind up to 168 in.

It is fully described in our catalog No. 5, which we will be glad to send to interested parties.

**The Coe Manufacturing Co.** 105 Bernard Street **Painesville, O.**

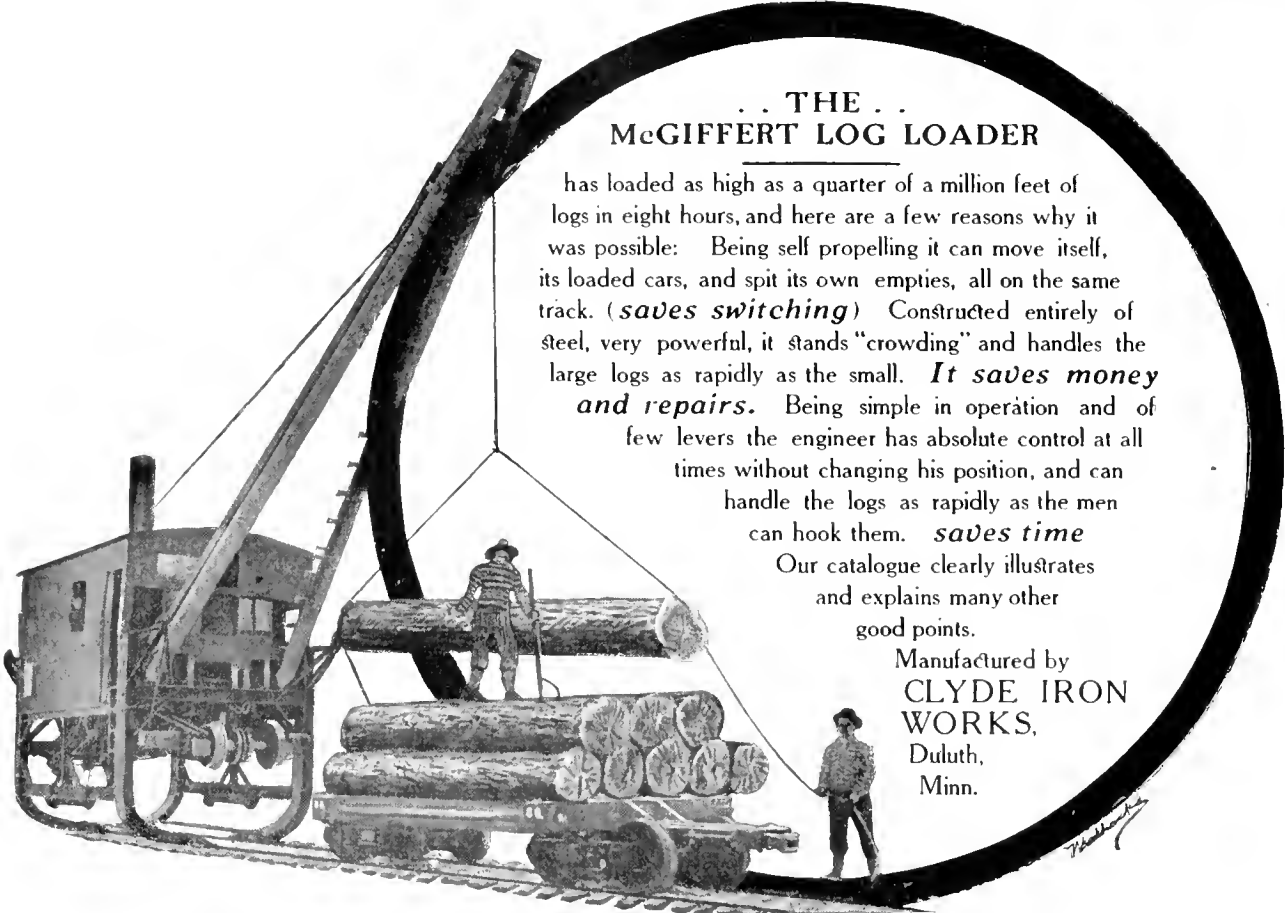

. . . THE . . .  
**McGIFFERT LOG LOADER**

has loaded as high as a quarter of a million feet of logs in eight hours, and here are a few reasons why it was possible: Being self propelling it can move itself, its loaded cars, and spit its own empties, all on the same track. (*saves switching*) Constructed entirely of steel, very powerful, it stands "crowding" and handles the large logs as rapidly as the small. *It saves money and repairs.* Being simple in operation and of few levers the engineer has absolute control at all times without changing his position, and can handle the logs as rapidly as the men can hook them. *saves time*

Our catalogue clearly illustrates and explains many other good points.

Manufactured by  
**CLYDE IRON WORKS,**  
Duluth,  
Minn.

**THE  
HAPPY  
WOODSMAN**



# ATKINS

TRADE  
MARK  
**SILVER-STEEL**

# SAWS

are happy saws all the way round. They run easier, cut faster, and go longer without sharpening than any other

A PERFECT SAW FOR EVERY PURPOSE.  
YOUR JOBBER HAS THEM OR WRITE US.

## E. C. ATKINS & CO., Inc.

THE SILVER STEEL SAW PEOPLE

HOME OFFICE AND FACTORY, INDIANAPOLIS, U. S. A.

Branches: Atlanta, Chicago, Memphis, Minneapolis, New York City, New Orleans, Portland, San Francisco, Seattle, Toronto.

# AMERICAN

No. 4 $\frac{1}{2}$ . Single or Double Surfacer for Producing extra fine work on all hard woods.

A careful investigation will convince you of their superiority.

There is no finer Surfacer built.

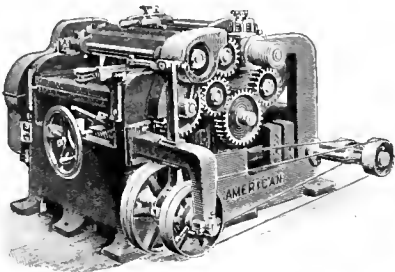

For full particulars address nearest salesroom.

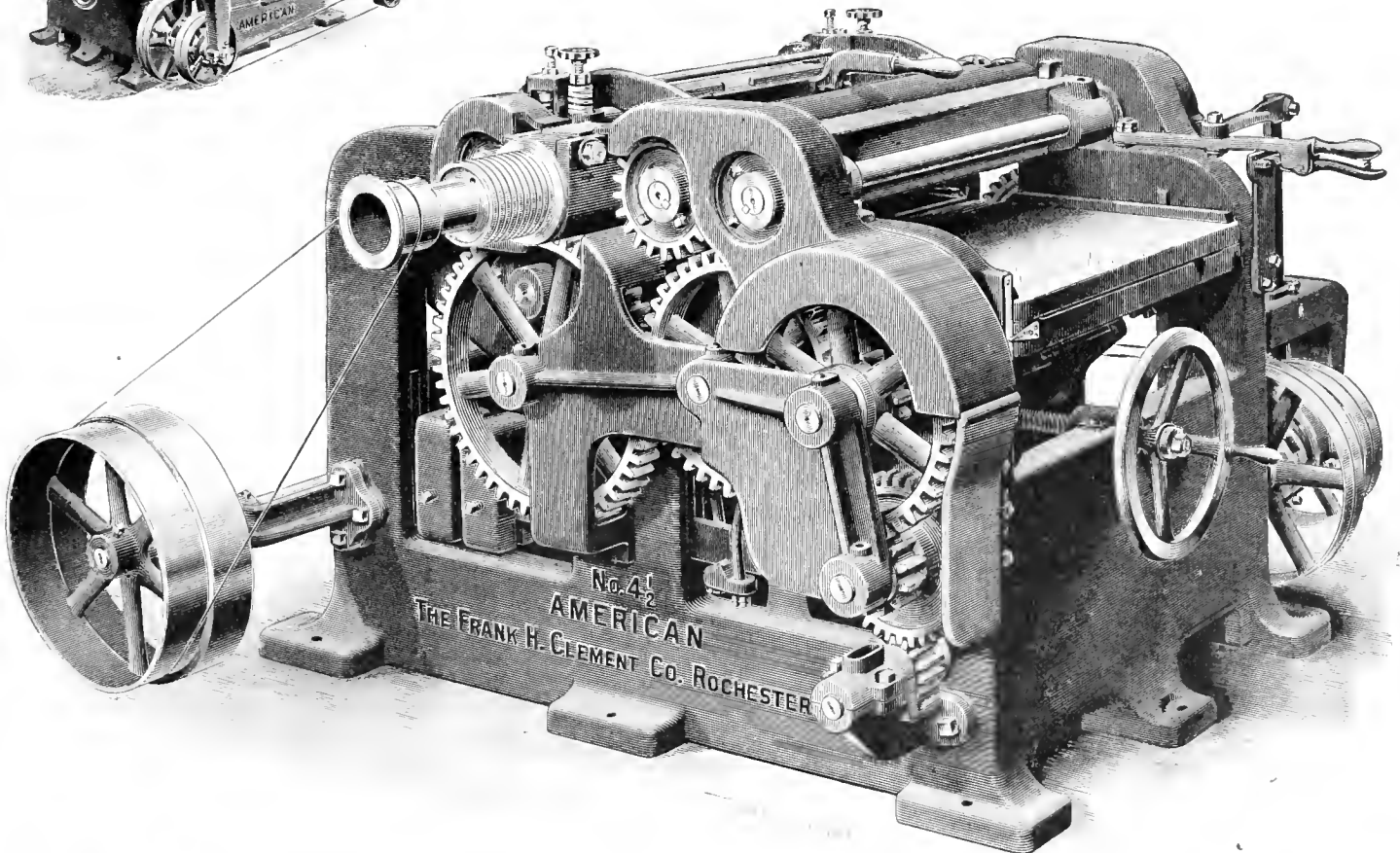

**American  
Wood Working Machinery Co.**

New Orleans

Chicago

New York



# A Study in Feeds

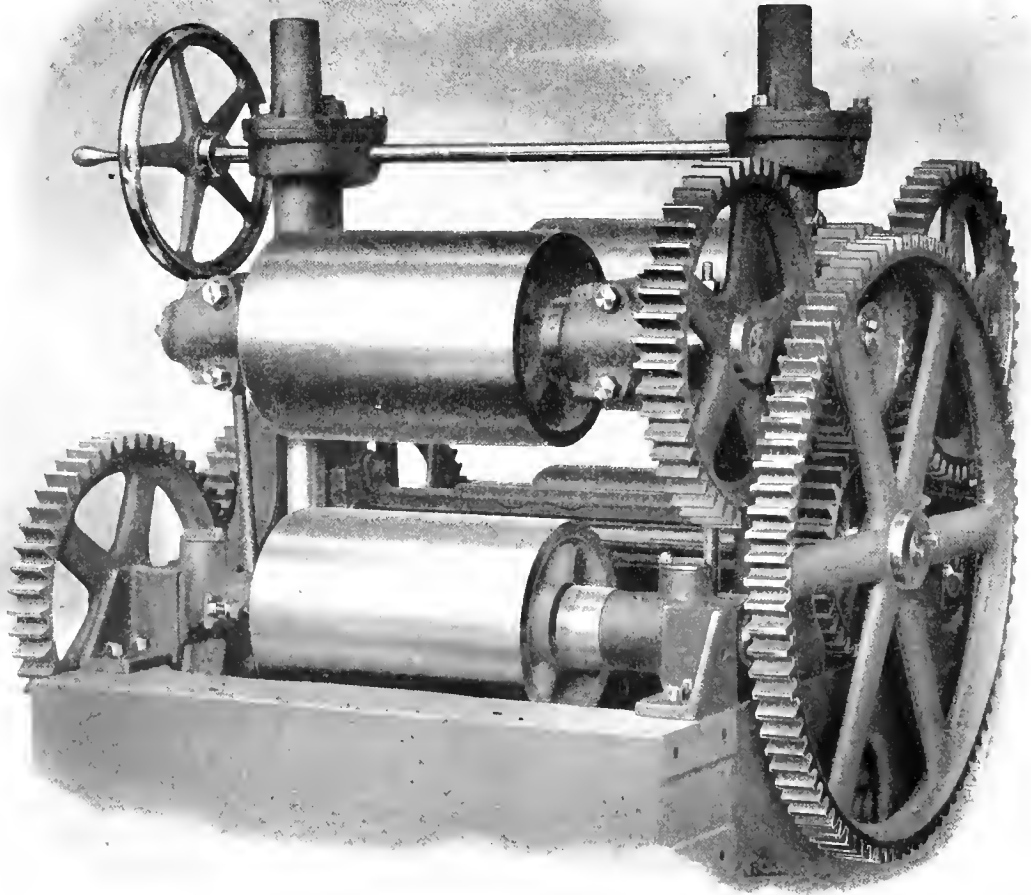

## THE BERLIN

### EIGHT Gears to Drive FOUR Feed Rolls

Here's a picture showing the construction of the feed works on the improved Berlin Matchers, Sizers, Inside Moulders and stationary bed Double Surfacers.

Notice that only eight gears are used to drive four feed rolls. Now look at the picture on the right-hand page. Here you find nine gears used to drive two feed rolls. The latter is the construction used on practically all machines except the new Berlin Series.

Study both illustrations carefully and note the advantages of the Berlin construction.

Each roll is driven by one gear about twice the size of the roll itself, and in no case is the power transmitted through one roll to drive another.

Branches { **NEW YORK**  
**CHICAGO**  
**BOSTON**

**THE BERLIN**  
BELOIT, WIS.



# orks Construction

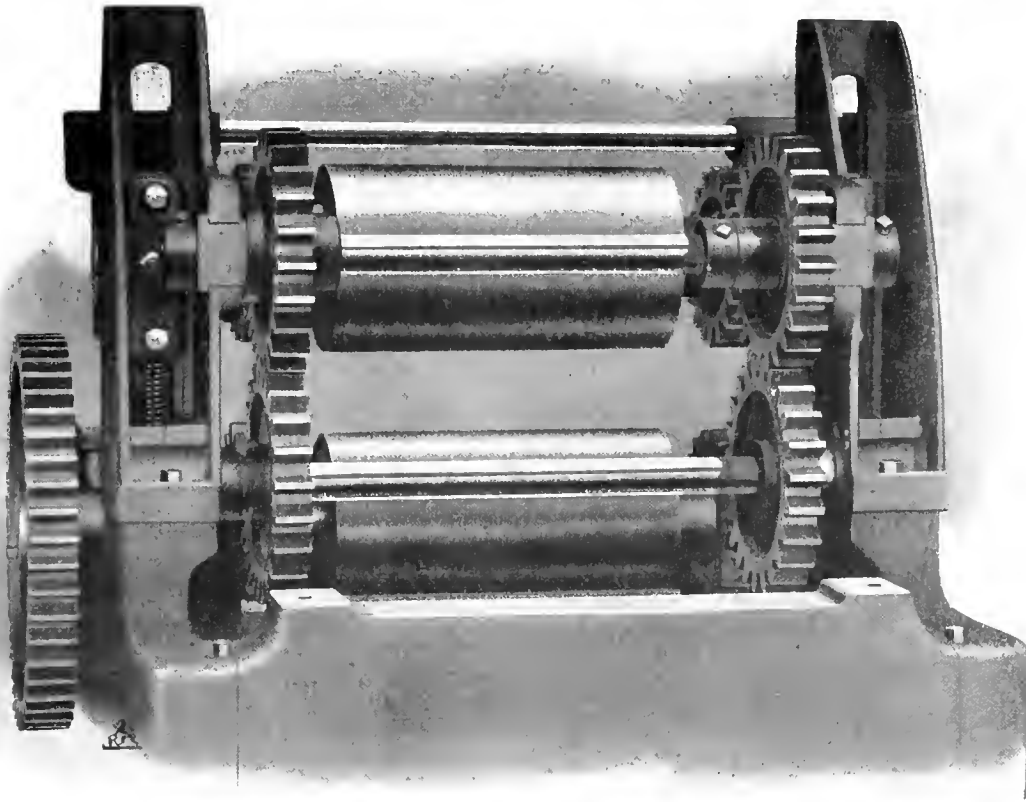

## THE OTHERS

### NINE Gears to Drive TWO Feed Rolls

In the other machines, the bottom roll is driven by one gear outside the machine and the power to drive the top is transmitted through the bottom roll. This is what we have heard some people call a "double-driven" feed

It is really only a "half-driven" roll.

We used to build our machines that way, until we discovered that it was a decided mistake. The pressure on the teeth of the gears in the new construction is just about one-half as much as in the old, and the gears will wear about half as long.

The yield of the top rolls to inequalities in the rough lumber is about three inches on the Berlin to one inch on our machines, making it impossible to damage the feed works by jamming in an extra thick piece or by getting one roll on top of another.

These are only a few of the good features. Let us tell you more about this new feed works and about the other good features of these improved machines. The line includes Matchers, Sizers, Inside Moulders and Double Surfacers.

**CHINE WORKS**  
IN, U. S. A.

**SAN FRANCISCO**  
**SEATTLE**  
**NEW ORLEANS**  
**MAGON, GA.** } **Branches**



W. H. WHITE, Pres.  
JAS. A. WHITE, Vice-Pres.

W. L. MARTIN, Secy.  
THOS. WHITE, Treas.

# W. H. WHITE COMPANY

BOYNE CITY, MICHIGAN

**Manufacturers of Hardwood and Hemlock Lumber, Cedar Shingles,  
White Rock Maple Flooring.**

# R. E. Wood Lumber Company

☞ We own nearly a thousand million feet of virgin poplar, oak, chestnut and other hardwood timber, and operate our own band mills in West Virginia, Tennessee, North Carolina and South Carolina.  
☞ Let us figure on your hardwood requirements.

**GENERAL OFFICES:  
CONTINENTAL BUILDING.**

**Baltimore, Maryland**

# Schultz Brothers & Cowen

WE ARE IN THE MARKET TO BUY

**POPLAR—OAK—ASH—CHESTNUT**

AND OTHER HARDWOODS—ALL GRADES AND THICKNESSES

1225 to 1240 OLD COLONY BUILDING,

CHICAGO

# LIDGERWOOD MACHINES

WILL STOCK YOUR MILL

SKIDDERS  
SNAKERS  
YARDERS

LOADERS  
PULL BOATS  
CABLEWAYS

**LIDGERWOOD MFG. CO.**

96 Liberty St., New York.

NEW ORLEANS

ATLANTA

SEATTLE



**EASTERN TENNESSEE—WESTERN NO. CAROLINA**

ASHEVILLE KNOXVILLE BRISTOL

**HARDWOODS**

From the famous Asheville district. Superior in quality, manufacture and gradings. For stock list and prices, address

**J. S. COLEMAN LUMBER CO.**  
ASHEVILLE, N. C.

**Fry-Buchanan Lumber Co.**

INCORPORATED.

Manufacturers and Wholesalers  
**Hardwood Lumber**

Choicest Varieties. Full Grades.

POPLAR SQUARES  
A Specialty.

Asheville, N. C.

**Vestal Lumber & Mfg. Co.**

Manufacturers and Wholesalers  
of all kinds of

**HARDWOODS**

BEVELED SIDING A SPECIALTY.  
UNSURPASSED FACILITIES  
FOR DELIVERING.

Knoxville  
Tennessee

**On the Spot**

We are located right in the heart of this mountain country producing the best hardwoods in existence.

We are headquarters with ample stock, and can interest you both as to assortment and price. Write us.

**American Lumber Company**

ASHEVILLE, N. C.

**All Lumbermen, Attention!**

We do what you can't do.  
We measure your stumpage correctly.  
We make your maps correctly.  
Bank references: Asheville, N. C.

**C. A. Schenck & Co.** Biltmore, North Carolina.

**SYMBOLS for GRADE MARKS**

○	Adopted by the Hardwood Manufacturers Association of United States.	△
△	Every Manufacturer should stamp the grade on his Lumber.	①
B	Set of 10 Rubber Stamps, 1 1/4"x1 1/4" in size, Pad, Pint of Ink, and Spreader, packed for shipment \$3.50.	②
②	<b>MARTIN &amp; CO.</b>	③
③	191 S. Clark St., CHICAGO, or	④
④	<b>LEWIS DOSTER, Sec'y</b>	
Panel and Wide No. 1	1535 First Nat. Bank Bldg.	Selects
Wide No. 2	CHICAGO	No. 1 Common
No. Boards		No. 2 Common
F. A. S. or Firsts & Seconds		No. 3 Common
Saps		No. 4 Common

**Wood Working Plants**

Manufacturers seeking locations for Saw Mills, Stave and Heading Factories and other Wood Working Plants in the Central Southern States, can secure full and accurate information as to Sites, Timber Tracts, Fuel, Transportation Facilities, etc., by addressing

G. A. PARK, General Immigration and Industrial Agent,  
**Louisville & Nashville Railroad Company**  
LOUISVILLE, KENTUCKY

**Industries are Offered Locations**

WITH SATISFACTORY INDUCEMENTS, FAVORABLE FREIGHT RATES, GOOD LABOR CONDITIONS HEALTHFUL COMMUNITIES, on the lines of

**The Illinois Central R. R. and the Yazoo & Mississippi Valley R. R.**

For full information and descriptive pamphlet address  
J. C. CLAIR, Industrial Commissioner, 1 Park Row, Chicago, Ill.

# WISCONSIN

WHERE THE FINEST NORTHERN HARDWOODS GROW

## C. P. CROSBY

RHINELANDER : : WISCONSIN

### Wholesale Hardwood Lumber

Hard Maple a Specialty in all thicknesses from 1 inch to 4 inch. Finest Birch in Wisconsin. Black Ash, Rock Elm, Soft Elm, Red and White Oak. : :

DIFFICULT AND MIXED ORDERS A SPECIALTY

## HARDWOOD LUMBER-- NORTHERN AND SOUTHERN

All kinds of Northern and Southern Hardwoods for sale.

We call your attention to the following items which we have to offer, to-wit:

- |  |  |
|--|--|
| 50M ft. 1" Curly Birch                   | 30M ft. 1 1/2" No. 2 Com. & Bet. Hickory |
| 50M ft. 2" Com. and Bet. Plain Birch     | 30M ft. 1 1/2" No. 2 Com. & Bet. Hickory |
| 80M ft. 2 1/2" Com. and Bet. Plain Birch | 100M ft. 1" Com. & Bet. Plain Red Oak    |
| 150M ft. 1" No. 1 Com. Plain Birch       | 150M ft. 1" Com. & Bet. Qld. Red Oak     |
| 12M ft. 2" 1sts and 2nds Red Birch       | 10M ft. 1" No. 3 Com. & Bet. Walnut      |
| 200M ft. 1" Com. and Bet. Hard Maple     | 75M ft. 1 1/2" No. 2 Com. & Bet. Elm     |
| 200M ft. 2" Com. and Bet. Hard Maple     | 150M ft. 1" No. 1 Com. Red Gum           |
| 50M ft. 2" Bridge Plank—Oak              |  |

In addition to the foregoing, we have full stocks of Basswood, Birch and Soft Elm and a full selection of Red and Sap Gum. We guarantee our grades to be made strictly in accordance with National Hardwood Association rules of inspection.

**G. W. JONES LUMBER CO., Appleton, Wis.**

CHICAGO OFFICE: 1717 RAILWAY EXCHANGE.

## John R. Davis Lumber Company

PHILLIPS, WISCONSIN

The Leading Manufacturers

### Wisconsin Hardwoods

"SHAKELESS" HEMLOCK and WHITE CEDAR PRODUCTS

NOW READY

- 4/4 No. 1 COMMON AND BETTER BIRCH (RED IN)
- 4/4 No. 1 COMMON AND BETTER HARD MAPLE
- 4/4 No. 2 COMMON AND BETTER BLACK ASH

Write for our Price Lists and Stock Sheets

Mixed Cars, Even Grades Prompt Shipments

## Ingram Lumber Co.

WAUSAU, WIS.

### BASSWOOD, BIRCH

We cut four million feet of each annually Your inquiries and orders solicited

MILL AND YARDS AT INGRAM, WISCONSIN

## ARPIN HARDWOOD LUMBER CO.

GRAND RAPIDS, WISCONSIN

Saw and Planing Mill at Atlanta, near Bruce, Wis., on Soo Lines.

WRITE FOR OUR PRICES ON

THREE INCH FLOORING

- 1 car Clear Plain Red Oak
- 1 car Factory Red Oak
- 3 cars Clear Birch
- 1 car Factory Birch
- 1/2 car Clear Red Birch
- 3 cars Common Maple
- 1 car Factory Maple

BIRCH

- 2 cars 1" Com. and Bet. Curly Red
- 2 cars Com. and Bet. Red
- 1 car 1 1/2, 1 3/4, 2" Curly
- 2 cars 1 1/2, 1 3/4, 2" Com. & Bet. Red
- 1 car 2" Plain log run
- 1 car 2 1/2 and 3" Plain

QUARTER SAWED RED OAK

LUMBER

- 2 cars log run Hard Maple

- 2 cars 1 1/2 and 1 3/4" Com. and Bet.
- 1/2 car 1 3/4 and 2" Com. and Bet.

## VOLLMAR & BELOW

MARSHFIELD, WISCONSIN

### Basswood, Birch

and Other Wisconsin Hardwoods

LET US KNOW WHAT YOU ARE IN THE MARKET FOR

### NORTHERN STOCK

- Hemlock
- Birch
- Basswood
- Rock Elm
- Soft Elm
- Ash
- Oak

### SOUTHERN STOCK

- Quartered White and Red Oak
- Plain White and Red Oak
- Sycamore
- Poplar
- Cypress
- Gum

## PAGE & LANDECK LUMBER CO.

Wells Building - - - MILWAUKEE, WIS.

## North Western Lumber Co.

General Offices: EAU CLAIRE, WIS. Mills at STANLEY, WIS.

BAND SAWED

### Wisconsin Hardwoods

CAREFUL GRADINGS, PROMPT SHIPMENTS

SPECIAL OFFERINGS:

- 3 cars 1 1/2" to 2" Scout Hardwood.
- 1 car 1 1/2" No. 1 Common Basswood.
- 1 car 1 1/2" 1st and 2d Clear Basswood.
- 1/2 car 2" 1st and 3d Clear Basswood.
- Large stock No. 2 Common Birch.
- Large stock No. 3 Common Birch.

**CLEVELAND**

HARDWOOD DISTRIBUTING CENTER OF NORTHERN OHIO

**Do You Want It?  
What?  
Money?**

What have you in lumber to exchange for it? We want particularly Plain Oak, Chestnut, Poplar, Basswood, Ash.

**What Have You?**

**The Advance Lumber Co.**

13th Floor  
Rockefeller Bldg. CLEVELAND, OHIO

Memphis Office, No. 56 Randolph Building. J. E. MEADOWS, Mgr.

**THE  
ROBERT H. JENKS LUMBER  
COMPANY**

**FOR SALE**

60 M feet 1" 1st and 2ds Poplar  
223 M feet 1" No. 1 Common Poplar  
125 M feet 1" No. 2 Common Poplar  
25 M feet 2" 1st and 2nd Poplar, 14" and up  
125 M feet 8 4" Sound Wormy Chestnut  
275 M feet 1" Sound Wormy Chestnut  
153 M feet 1" 1st and 2nd Plain White Oak  
85 M feet 1" 1st and 2nd Plain Red Oak  
125 M feet 1" No. 1 Common Plain Red Oak

**Quartered White and Red Oak.**—We have a good assortment of dry stock,  $\frac{3}{8}$  to 4 inches thick. Your inquiries solicited.

**Plain White and Red Oak.**—A limited amount of nice stock, ready for shipment.

**FRAMES FOR HARDWOOD RECORD SUPPLEMENTS**

Complete with backing, but without the glass, made from Flemish Oak, are to be had delivered by express, charges prepaid to any point east of the Missouri river, at 50 cents each; or at the HARDWOOD RECORD office, at 30 cents each. Prepay orders with two-cent stamps or postal notes, addressed

Hardwood Record, 355 Dearborn Street, Chicago

**The Martin-Barriss Company**

Importers and Manufacturers

**MAHOGANY**

**and Fine Hardwoods**

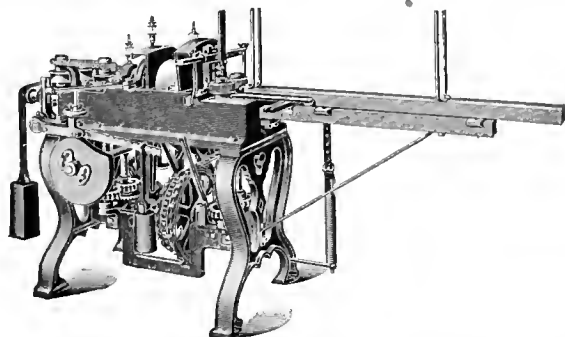

This is a cut of the No. 10 OBER LATHE for Turning Fork, Hoe, Rake, Mop, Broom and Ice Hook Handles, Pike Poles, Trolley Poles, Tent Poles, Curtain Poles, Chair Bows, Dowels, Rods and similar work.

**Simple, Strong, Durable,  
Economical**

We also manufacture other Lathes for making Spokes, Handles, and Variety Work, Sanders, Shapers, Boring and Chucking Machines, etc., etc. Complete Catalogue and Price List Free.

**THE OBER MFG. CO., No. 28 Bell St., CHAGRIN FALLS, O., U. S. A.**

**M I C H I G A N**  
FAMOUS FOR HARD MAPLE AND GREY ELM

**SALLING, HANSON & CO.**  
MANUFACTURERS OF  
**Michigan Hardwoods**  
GRAYLING, MICHIGAN

**“Chief Brand”  
Maple Flooring**

Will commend itself to you and your trade on its merits alone. \* Comprises all the features desirable in good flooring. \* Made by the latest, most approved machinery methods and best skilled labor. \* We believe we can make it to your interest to handle our “Chief Brand” and will appreciate your inquiries.

**Kerry & Hanson Flooring Co.**  
GRAYLING, MICHIGAN

**BROWNLEE & COMPANY**  
DETROIT MICHIGAN

**Our Bargain Counter:**

BASSWOOD 4-4 to 8-4	SOFT ELM 6-4 log run 12-4 No. 1 Common
BIRCH 4-4 No. 1 and 2 Common	HARD MAPLE 12-4 No. 1 Common

**Evans & Retting Lumber Co.**  
Manufacturers and Wholesale Dealers

**Hardwood  
Lumber**

RAILROAD TIMBERS, TIES AND SWITCH TIES

541 and 543  
Michigan Trust Building      Grand Rapids, Mich.

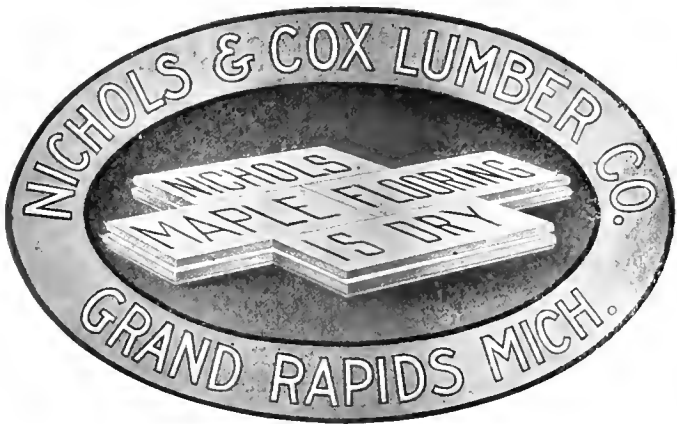

**DENNIS & SMITH LUMBER CO.**

Wholesale Hardwood Lumber

Office and Yards, FOURTH AND HOLDEN AVENUES,  
**DETROIT, MICH.**

MILLS AT: Heaters, W. Va. Valley Bend, W. Va. Diana, W. Va. Parkersburg,  
W. Va. McNutt Siding, W. Va.

**Michigan Logging Wheels**

Have made them 25 years and know how. Easy and cheap way of logging. **S. C. OVERPACK** MANISTEE, MICHIGAN

**YOUR VACATION**  
WHERE TO GO  
HOW TO GET THERE  
AND WHAT IT WILL COST

All this will be found in the book of specially selected vacation tours, combining rail and water routes,  
ISSUED BY THE

**MICHIGAN CENTRAL**  
*“The Niagara Falls Route”*

SEND FOR A COPY NOW

W. J. LYNCH, Pass. Traffic Mgr.,		O. W. RUGGLES, Gen'l Pass. Agt.,
CHICAGO		

# MICHIGAN

FAMOUS FOR RED BIRCH AND BASSWOOD

## OUR MAPLE FLOORING

is as near perfection, in every particular, as it is possible to make it, for we personally supervise every step in its manufacture, from the stump to the shipping of the finished product. Our prices will interest and a trial convince you.

**HAAK LUMBER COMPANY**  
**HAAKWOOD, MICHIGAN**

## Hackley-Phelps-Bonnell Co.

MANUFACTURERS OF

**Northern and Southern  
 Hardwood Lumber**

Main Office, Michigan Trust Company Building  
**GRAND RAPIDS** : : : **MICHIGAN**

## DENNIS BROS.

GRAND RAPIDS, : : : MICHIGAN

**HARDWOOD LUMBER (by water or rail)**  
**"NATIONAL" MAPLE & BIRCH FLOORING**

SPECIAL BARGAINS IN THE FOLLOWING:

- 300M feet 4 4 Log Run Birch
- 186M feet 5 4 Log Run Birch
- 1 Car 8 4 No. 1 Com. Birch
- 1 Car 1 4 Clear Birch
- 50M feet 4 4 No. 1 Com. Sap Birch
- 40M feet 4 4 No. 1 Com. Red Birch
- All thicknesses and grades Hard Maple
- 150M feet 5 4 Log Run Beech
- 2 Cars 4 4 No. 3 Com. Cherry

Main Office :  
 205-209 Michigan  
 Trust  
 Company  
 Building

## Thos. MacBride Lumber Company

HEADQUARTERS FOR

**HARDWOODS**

IN MICHIGAN

Michigan Trust Building, Grand Rapids, Mich.

## BIRCH

This is our specialty. We are in the heart of the best Birch section. Have good stock, Common and better, 4-4, 5-4, 6-4, 8-4, 10-4, 12-4, and 16-4. Let us figure with you.

**Simmons Lumber Company**  
 SIMMONS, MICHIGAN

## McCLURE LUMBER COMPANY

MANUFACTURERS OF

**Hardwoods**

Main Offices, DETROIT, MICH.  
 Mills, : EUTAW, ALA.

SPECIAL OFFERINGS:

- 3 cars 2" Red and White Oak
- 3 cars 2", 2½", 3" and 4" White Ash
- 2 cars 1" 6/4 White Ash
- 2 cars 2" Black Ash
- 10 cars 1" to 4" Dry Hard Maple
- 5 cars 1" Log Run Birch
- 1 car 6/4 and 8/4 Hickory

## SOFT ELM AND ROCK ELM

FOR SALE BY

**The R. G. Peters Salt & Lumber Co.**

EASTLAKE, MICHIGAN

## VAN KEULEN & WILKINSON LUMBER COMPANY

Manufacturers and Wholesalers of

**HARDWOOD LUMBER and CRATING STOCK**

Complete Stocks of Michigan Hardwoods—Maple, Beech, Birch, Elm, Ash and Basswood for sale.

Grand Rapids, : : : Michigan

## BOYNE CITY LUMBER COMPANY

BOYNE CITY

**MICHIGAN ROCK MAPLE and other HARDWOODS**

LARGE CAPACITY PROMPT SHIPMENTS RAIL OR CARGO



## J. S. GOLDIE

Cadillac, : : Michigan.

SPECIAL PRICES on 500M pieces  
 1" to 3" Maple Squares 16" to 27" long.  
 1" to 3" Soft Elm Lumber.

INQUIRIES SOLICITED FOR MICHIGAN LUMBER.

**CINCINNATI**  
THE GATEWAY OF THE SOUTH

**OUR AIM** is to ship the highest standard of lumber at lowest consistent price  
We are manufacturers and ship direct from our band mills  
Indiana Oak, **W. H. & G. S. St wart** Chestnut, Alabama  
Kentucky Poplar, Long Leaf  
Oak, Ash. Main Office: Cincinnati, Ohio, U. S. A. Yellow Pine

**"BUY GUM"**  
We are in the market to buy Dry Gum Lumber in any quantity, from a single car load to a million feet. Will take all grades and thicknesses. We receive lumber at shipping point, pay cash and are liberal in inspection.  
**THE FARRIN-KORN LUMBER COMPANY**  
General Office, Yards, Planing Mills, Dry Kilns, Cincinnati, Ohio  
Purchasing Office, Randolph Building, Memphis, Tenn.  
Cypress Red Gum Oak

FRAMES, SASH, DOORS, BLINDS, MOULDINGS, COLUMNS, GLASS, STAIRWORK, INTERIOR TRIM.  
**THE PEASE CO.**  
Wholesale Manufacturers of Building Material. CINCINNATI.  
PAINTS, BUILDERS' HARDWARE, MANTELS, ETC. LARGE CINCINNATI FACTORIES MAKE PROMPT SHIPMENTS POSSIBLE.

**CYPRESS LUMBER CO.**  
Manufacturer of Hardwoods and Cypress  
Plain and Quartered White and Red Oak, Yellow Poplar, Yellow Pine, Walnut, etc. Mills in Tenn., Ala. and Va.  
OFFICE AND YARDS, GEST AND DALTON AVE., CINCINNATI, OHIO.

**PLAIN OAK—BASSWOOD**  
Are what we want. All thicknesses and grades. Spot cash. Send us list of your offerings with prices.  
**DUHLMEIER BROS., CINCINNATI, O.**

**The Farmer in the Southwest Prospers**  
Because he pays from \$8 to \$15 an acre for land that produces as good crops as land in Illinois and Indiana which sells for \$75 to \$100 an acre. The mild climate gives him earlier crops and the short winter makes stock-raising less expensive.  
**You** have the same chance to prosper that is being taken by hundreds of the northern and eastern farmers.  
Write for free copies of our illustrated books on Texas and Oklahoma.  
Low rates to all points in the Southwest on the first and third Tuesdays of each month via  
  
**CHICAGO @ EASTERN ILLINOIS R. R.**  
W. H. RICHARDSON, G. P. A., Chicago, Ill.

**THE GENERAL LUMBER COMPANY**  
**HARDWOODS**  
HEMLOCK, YELLOW PINE.  
COLUMBUS OHIO

**LANE-WHITE LUMBER CO.**  
OAK, ASH AND WALNUT OUR SPECIALTY **Hardwoods** ALWAYS IN THE MARKET FOR WALNUT LOGS  
MAIN OFFICE AND BAND MILL at FORT SMITH, ARK.

**Q** For items of Hardwood Stock or Hardwood Machinery, you will find it advantageous to write our advertisers. Get in touch!

**W. H. Dawkins Lumber Co.**  
Manufacturers of Band Sawed  
**Yellow Poplar**  
ASHLAND, KY.



**CINCINNATI**  
THE GATEWAY OF THE SOUTH

IN THE MARKET FOR

**OAK-ASH-POPLAR**

ALL GRADES AND THICKNESSES

**MOWBRAY & ROBINSON**

Office: 1219 West Sixth Street      Yards: Sixth Street, below Harriet

**L. W. RADINA & COMPANY**  
Correspondence Solicited with Buyers and Sellers of All Kinds of  
**HARDWOODS**  
Wanted for cash—desirable blocks of 1 inch to 4 inch Poplar, all grades,  
Especially 1½-inch stock, for immediate shipment.  
CLARK STREET AND DALTON AVENUE

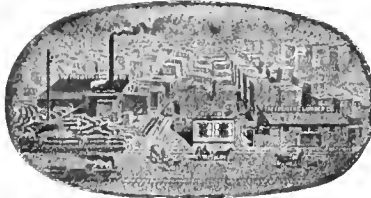

**THE FREIBERG LUMBER CO.**  
Manufacturers of  
**Tabasco Mahogany**  
**Walnut, Oak**  
Poplar, McLean and Findlay Aves.  
CINCINNATI, O.

**THE WIBORG & HANNA COMPANY**  
CINCINNATI, OHIO

PLAIN  
AND  
QUARTER  
SAWED

**White and Red Oak**

CHESTNUT  
POPLAR  
GUM AND  
CYPRESS

Flooring, Siding, Ceiling, Base, Case and Molding. Rough, Dressed and Re-sawed. Mixed Carloads.

**THE  
MALEY, THOMPSON & MOFFETT CO.**

Always in the Market for  
**BLACK WALNUT LOGS,  
SELECTED WHITE OAK LOGS,  
LUMBER OF ALL KINDS.**

CINCINNATI,      :      :      :      OHIO

WHAT HAVE YOU FOR SALE IN

Red and White **OAK** Qtd. and Plain

ALSO POPLAR, CHESTNUT, WALNUT, ETC.

**JOHN DULWEBER & CO., CINCINNATI, OHIO**

Cash buyers for stock in our line.

**Cincinnati Hardwood Lumber Co.**

WEST AND SUMMER STREETS  
Wholesalers Mahogany, Thin Lumber, Veneers  
Finely figured quarter sawed oak veneers a specialty.

**Kentucky Lumber Co.**

CINCINNATI, OHIO

Wholesale Buyers of

**HARDWOOD LUMBER**

ALWAYS IN THE MARKET  
TO BUY

**WRITE US WHEN YOU ARE READY TO SELL**

**THE E. E. BECK LUMBER COMPANY**  
Cash Buyers

**Poplar, Oak, Chestnut**

And Other Southern Hardwoods

ALL GRADES AND THICKNESSES.      WE BUY MILL CUTS.

Poplar, Oak, Ash, Chestnut, Sycamore, W. Va. Spruce, Pine and Elm	<b>C. Crane &amp; Co.</b> We would like to buy 2,000,000 feet Dry Oak 2,000,000 feet Dry Poplar Mostly heavy stock.      Quotations Solicited.	MILLS AND YARDS CINCINNATI, O. YEARLY CAPACITY 100,000,000 FT. LONG BILL STUFF A SPECIALTY
---	--	---



# INDIANA



WHERE THE BEST HARDWOODS GROW

THE WOODS FOR  
WHICH INDIANA  
IS FAMOUS.

Quart'r'd White Oak

Plain White Oak

Quartered Red Oak

Plain Red Oak

White Ash

Poplar

Black Walnut

Cherry

Sycamore

Red Gum

Hickory

Beech

Maple

Veneers of

Indiana Hardwoods

## LONG-KNIGHT LUMBER CO.

MANUFACTURERS AND DEALERS  
Quarter Sawed White and Red Oak a Specialty  
INDIANAPOLIS, IND.

## MALEY & WERTZ

Manufacturers, Wholesalers and Exporters of Hardwood Lumber  
EVANSVILLE, IND.

## FULLERTON-POWELL HARDWOOD LUMBER CO.

SOUTH BEND, IND.

## PERRINE-ARMSTRONG CO.

Long Timber up to 60 feet—Hardwood Specialties  
The largest Band Mill in Indiana. FORT WAYNE, IND.

## J. V. STIMSON

All Kinds of Hardwood Lumber Manufactured  
HUNTINGBURG, IND.

## YOUNG & CUTSINGER

Manufacturers and Wholesalers  
Our Specialty Fine Figured Quartered Oak  
EVANSVILLE, IND.

## CHARLES H. BARNABY

Manufacturer of Band Sawed Hardwoods  
Quarter Sawed Indiana White Oak a Specialty GREENCASTLE, IND.

## D'HEUR & SWAIN LUMBER CO.

Manufacturers and Wholesalers  
Our Specialty Quartered Oak and Sycamore  
SEYMOUR, IND.

# BUFFALO

THE GREAT WHOLESALE LUMBER CENTER OF THE EAST



Manufacturers and Dealers in

- Ash  
White and Brown
- Basswood
- Birch  
Red and White
- Butternut
- Cherry
- Chestnut
- Cottonwood
- Cypress
- Elm  
Soft and Rock
- Gum  
Red and Tupelo
- Hickory
- Maple  
Hard and Soft
- Red Oak  
Plain and Quartered
- White Oak  
Plain and Quartered
- Black Walnut
- White Wood  
Poplar



## STANDARD HARDWOOD LUMBER CO.

OAK, ASH AND CHESTNUT

1075 CLINTON STREET

## I. N. STEWART & BROTHER

Specialties: CHERRY AND OAK

892 ELK STREET

## T. SULLIVAN & COMPANY

Specialties: BROWN ASH, BIRCH, PACIFIC COAST FIR AND SPRUCE

50 ARTHUR STREET

## ORSON E. YEAGER

Specialties: OAK, ASH AND POPLAR

932 ELK STREET

## BEYER, KNOX & COMPANY

ALL KINDS OF HARDWOODS

Office and Yards, 69 LEROY AVENUE

## BUFFALO HARDWOOD LUMBER CO.

We want to buy for cash:  
Oak, Ash and other Hardwoods, all grades and thicknesses.  
Will receive and inspect stock at shipping point.

518 RANDOLPH BLDG., MEMPHIS, TENN.

940 SENECA STREET.

## EMPIRE LUMBER COMPANY

Our specialties are PLAIN and QUARTERED OAK and ASH.

1142 SENECA STREET.

## G. ELIAS & BROTHER

BUY AND CARRY LARGE QUANTITIES OF ALL KINDS OF HARDWOODS

955 TO 1015 ELK STREET

## HUGH McLEAN LUMBER COMPANY

Specialty: INDIANA WHITE OAK

940 ELK STREET

## ANTHONY MILLER

HARDWOODS OF ALL KINDS

893 EAGLE STREET

## SCATCHERD & SON

HARDWOODS ONLY

Yard, 1555 SENECA STREET

Office, 886 ELLICOTT SQUARE

# W. M. Ritter Lumber Company

COLUMBUS, OHIO

## 6,000 Car Loads

Sawed and shipped yearly of band-sawed Yellow Poplar, White Pine, White Oak, Basswood, Chestnut, Hemlock and Ash. Planing Mills and Dry Kilns. ☛ If you are in a hurry to get your order placed, call our nearest salesman.

Salesman	Headquarters	Telephone
Fred A. Wilson.....	Portsmouth, Ohio.....	Bell 4392
E. E. Eaton.....	New York City, 158 W. 81st St.....	Riverside 7390
James B. Patton.....	Buffalo, N. Y., Rockford Hotel.....	Bryant 1335-R
A. Wallace Irwin.....	Baltimore, Md., Eutaw Hotel.....	
Frank B. Pryor.....	Pittsburgh, Pa., 7th Avenue Hotel.....	
E. E. Ginn.....	Jamestown, Ohio.....	Bell Phone
A. J. Williams.....	Cleveland, Ohio, Eastman, Detroit St.....	Ridge 593-R
L. G. Anderson.....	Franklin, Ohio.....	Bell 482
James H. Lang.....	Detroit, Mich., Hotel Ste. Claire.....	
W. H. Matthias.....	Chicago, Ill., 1448 Addison St.....	Lakeview 1493
Geo. H. Haganir.....	Philadelphia, Pa., 901 N. 50th St.....	
F. H. Browning.....	Columbus, Ohio.....	Main 7874
W. T. Baker.....	Graham, Va.....	

# Vansant, Kitchen & Co.

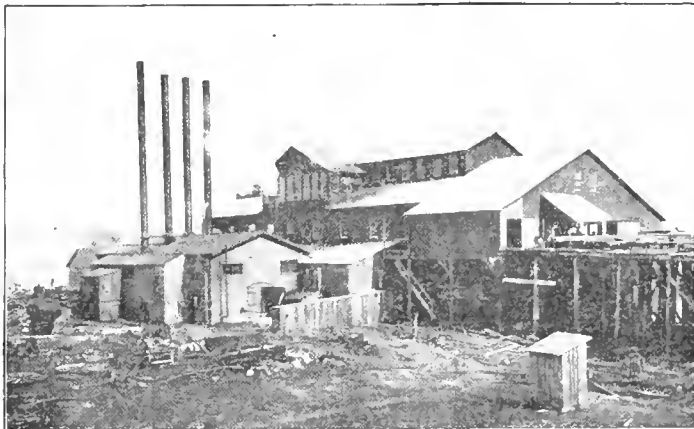

NEW ASHLAND MILL

Old-Fashioned

## SOFT YELLOW POPLAR

Ashland, Ky.

5-8 AND 4-4 IN WIDE STOCK, SPECIALTY

# YELLOW POPLAR

Manufacturers  
BAND SAWED  
POPLAR LUMBER

ALL GRADES

**DRY** 5-8, 4-4, 5-4, 6-4, 8-4, 10-4, 12-4, 16-4  
Bevel Siding, Lath and Squares  
Specialty, Wide Stock.

# LUMBER CO.

COAL GROVE, OHIO, U. S. A.

# Hardwood Record

Eleventh Year. /  
Semi-monthly. /

CHICAGO, SEPTEMBER 10, 1906.

Subscription \$2.  
Single Copies, 10 Cents.

## CHERRY

C. E. LLOYD, JR.  
Manager Sales

## RIVER

## LUMBER

GROWS IN  
WEST VIRGINIA

Sold by  
Cherry River Boom &  
Lumber Co.

Offices: Philadelphia, Pa

## Himmelberger-Harrison Lumber Co.

## Red Gum Specialists

Morehouse,

Missouri

# PROFIT-SHARING CONTRACTS

## Our Policies

## PENNA. LUMBERMEN'S MUTUAL FIRE INS. CO.

923 Drexel Bldg., Philadelphia, Pa.

# RUMBARGER LUMBER COMPANY

<p><b>Ash.</b> 1 car 1/4, little 5/4, some 8/4, Nos. 1 &amp; 2 &amp; No. 1 Common. 30 cars 4/1, log run. 13 car 5/1, log run <b>Basswood.</b> 5 cars 4/1, log run; choice stock. 17 cars 1/4, log run; wormy stock. <b>Beech.</b> 71 cars 4/4, log run. 4 cars 5/1, log run. 3 cars 6/4, log run. 12 cars 8/4, log run Choice wide stock. Will sell on grades <b>Birch.</b> 29 cars 1/4, log run. 12 car 8/1, log run. 3 cars 1/1, log run. <b>Cherry.</b> 5 cars 5/1, log run. 19 cars 6/4, log run. 33 cars 4/1, log run. 11 cars 8/4, log run. Choice wide stock. <b>Chestnut.</b> 5 cars 4/1, Nos. 1 &amp; 2 &amp; No. 1 Common. 1 car 4/1 &amp; 8/1, Nos. 1 &amp; 2 and No. 1 common; half 8/4.</p>	<p>7 cars 1/1, sound wormy 2 cars 6/4, sound wormy. <b>Plain Red Oak.</b> 1 1/2 cars 4/1, Nos. 1 &amp; 2. 3 cars 4/4, Nos. 1 &amp; 2 &amp; No. 1 Com. 3 cars 6/4, Nos. 1 &amp; 2 &amp; No. 1 Com. 1 car 1 1/4 &amp; 5/1, Nos. 1 &amp; 2 and No. 1 common; half each thickness 1 1/2 cars 4/4, No. 1 Common. 1 car 4/4, No. 2 Common. 8 cars 1/4, log run. <b>Plain Red and White Oak.</b> 1 car 1/4, Nos. 1 &amp; 2. 3 cars 1/1, No. 1 Common. Mostly red oak, only small percent white oak. <b>Plain White Oak.</b> 1 car 1/4, Nos. 1 &amp; 2 &amp; No. 1 Common. 1/2 car 1/1, No. 1 Common. 2 cars 1/4, No. 2 Common. 2 cars 1/4, log run. <b>Plain White and Red Oak.</b> 1 car 5/4, 6/1 &amp; 8/1, Nos. 1 &amp; 2 &amp; No. 1</p>	<p>Common; mostly W. O. only small percent R. O. 1 car 8/4, Nos. 1 &amp; 2 &amp; No. 1 Common; mostly W. O., only small percent R. O. 1 car 4/1, log run; mostly W. O., only small percent R. O. 4 cars 4/4, No. 2 common, 1/2 each white oak and red oak. <b>Quartered Red Oak.</b> 1 car 4/4, Nos. 1 &amp; 2. 1 car 1/4, clear strips (narrow). 1 car 1/1, No. 1 Common. <b>Quartered White Oak.</b> 1 car 1/4, Nos. 1 &amp; 2. 2 cars 4/4, clear strips (narrow). 9 cars 4/4, No. 1 Common. <b>White Pine.</b> 210,000 ft. 4/4, log run. 16,000 ft. 6/4, log run. 46,000 ft. 8/4, log run. 1,000,000 ft. 4/4 to 8/4 sorted as to grades and widths; rough or worked.</p>	<p><b>Poplar.</b> 2 cars 5/8, Nos. 1 &amp; 2 4 cars 4/4, Nos. 1 &amp; 2 1/2 car 5/4, Nos. 1 &amp; 2 1 car 8/4, Nos. 1 &amp; 2 1 car 5/8, clear saps. 5 cars 4/4, clear saps. 1 car 5/4, clear saps. 7 cars 4/1, No. 1 Common. 3 cars 5/1, No. 1 Common. 1 1/2 cars 6/1, No. 1 Common. 2 cars 8/1, No. 1 Common. 7 cars 4/4, No. 2 Common. 4 cars 6/4, No. 2 Common. 1 car 16/4, Nos. 1 &amp; 2 &amp; No. 1 Common 11 cars 4/4, log run; 2 &amp; 24" to 36" wide 1 car 4/4, Nos. 1 &amp; 2, 24" to 36" wide <b>Clear Spruce.</b> 13 car 7/8. 1 car 8/4 1 car 4/4 <b>Spruce Box.</b> 10 cars 4/1, S 2 S 5 cars 4/4, S 1 S.</p>
--	---	---	--

Main Office: 808 Harrison Bldg., 15th and Market Sts., Philadelphia, Pa. New York Office: 8018 Metropolitan Bldg., 1 Madison Av. Pittsburgh Office: 701 Keystone Bldg.

The combined facilities of the stock lumber insurance companies

## LUMBER INSURANCE COMPANY OF NEW YORK

## and the ADIRONDACK FIRE INSURANCE COMPANY

and allied organizations, constitute a great insuring opportunity for any owner of a first-class lumber or mill risk. Ask for lines and rates.

LUMBER INSURERS GENERAL AGENCY, Underwriting Managers  
66 Broadway, New York

# LOUISVILLE

MANUFACTURING AND DISTRIBUTING CENTER OF KENTUCKY

## We wish to move and will make close prices on:

- 1 Car 8 4 1st and 2nd Qtd. White Oak
- 2 Cars 8 4 Common Qtd. White Oak
- ½ Car 5 4 Common Plain Red Oak
- ½ Car 5 4 Common Plain White Oak
- 1 Car 6 4 Common Plain Red Oak
- 1 Car 4 4 Log Run Ash
- 3 Cars 4 4 No. 3 Common Plain Oak

- 1 Car 8 4 No. 3 Common Plain Oak
- 1 Car 4 4 No. 2 Common Plain Oak
- 3 Cars 8 4 No. 2 Common Plain Oak
- 2 Cars 5 4, 6 4 and 8 4 No. 2 Com. and Sound Wormy Chestnut

- 1 Car 4 4 No. 1 Common Poplar
- 1 Car 5 4 No. 2 Common Poplar
- 1 Car 1 4 Common and Better Bay Poplar

We are moving our local yard and wish to ship this at once. See Page No. 51 for list of Hardwoods for future shipment.

## Stotz Lumber Company

## Ornamental Hardwood Floors

400 STYLES AND PATTERNS

Illustrated Catalog on Application

## WOOD=MOSAIC FLOORING CO.

Rochester, N. Y. New Albany, Ind.

### Albert R. Kampf

Manufacturer  
Hardwood Lumber and Timber  
Dimension Stock  
Board of Trade Bldg., Louisville, Ky.

### E. W. Rhubesty

Wholesale  
Poplar, Rough and Dressed  
Oak, Chestnut and Other  
Hardwoods

### North Vernon Pump & Lumber Co.

Hand Sawn Plain and Quartered  
Oak and Poplar  
North Vernon, Ind. and  
Louisville, Ky.

### Southern Lumber Co.

Oak, Poplar and  
Chestnut,  
Louisville, Ky.

## Dry Stock W. P. Brown & Sons Lumber Co. Louisville, Ky.

<p><b>PLAIN RED OAK.</b> 55,000' 1" 1st &amp; 2nd. 25,000' 1½" 1st &amp; 2d. 49,000' 1½" 1st &amp; 2d. 57,000' 2" 1st &amp; 2d. 18,000' 2½" 1st &amp; 2d. 16,000' 3" 1st &amp; 2d. 131,000' 1" No. 1 Com. 84,000' 1½" No. 1 Com. 44,000' 1½" No. 1 Com. 47,000' 2" No. 1 Com. 8,000' 2½" No. 1 Com. 15,000' 3" No. 1 Com.</p> <p><b>QUARTERED RED OAK.</b> 13,000' 1" 1st &amp; 2d.</p>	<p>11,000' 1½" 1st &amp; 2d. 7,000' 2" 1st &amp; 2d. 15,000' 1" No. 1 Com. 7,000' 1½" No. 1 Com. 12,000' 2" No. 1 Com.</p> <p><b>PLAIN WHITE OAK.</b> 80,000' 1" 1st &amp; 2d. 28,000' 1½" 1st &amp; 2d. 12,000' 1½" 1st &amp; 2d. 42,000' 2" 1st &amp; 2d. 23,800' 2½" 1st &amp; 2d. 16,000' 3" 1st &amp; 2d. 227,000' 1" No. 1 Com. 60,000' 1½" No. 1 Com. 80,000' 1½" No. 1 Com.</p>	<p>50,000' 2" No. 1 Com. 17,000' 2½" No. 1 Com. 22,000' 3" No. 1 Com.</p> <p><b>QUARTERED WHITE OAK.</b> 50,000' 1" 1st &amp; 2d. 28,000' 1½" 1st &amp; 2d. 15,000' 1½" 1st &amp; 2d. 19,000' 2" 1st &amp; 2d. 19,000' 2½" 1st &amp; 2d. 18,000' 1" No. 1 Com. 30,000' 1½" No. 1 Com. 10,000' 1½" No. 1 Com. 22,000' 2" No. 1 Com. 10,000' 3" No. 1 Com.</p>	<p><b>ASH.</b> 9,000' 1" 1st &amp; 2d. 65,000' 1½" 1st &amp; 2d. 16,000' 1½" 1st &amp; 2d. 10,000' 2" 1st &amp; 2d. 8,000' 2½" 1st &amp; 2d. 14,000' 3" 1st &amp; 2d. 6,000' 4" 1st &amp; 2d. 4,000' 1½" No. 1 Com. 16,000' 1½" No. 1 Com. 8,600' 2" No. 1 Com.</p> <p><b>POPLAR.</b> 12,000' 1" 1st &amp; 2d.</p>	<p>12,000' 1½" 1st &amp; 2d. 11,000' 1½" 1st &amp; 2d. 12,000' 2" 1st &amp; 2d. 10,000' 2½" 1st &amp; 2d. 10,000' 3" 1st &amp; 2d. 50,000' 1" No. 1 Com. 28,000' 1½" No. 1 Com. 10,000' 1½" No. 1 Com. 10,000' 2" No. 1 Com. 15,000' 1" 18" &amp; up 1st &amp; 2d. 8,000' 2" 18" &amp; up 1st &amp; 2d. 6,000' 2" 24" &amp; up 1st &amp; 2d. 4,000' 1½" 18" &amp; up 1st &amp; 2d. 3,000' 1½" 24" &amp; up 1st &amp; 2d.</p>
---	---	--	--	--

All thicknesses in cut poplar, ash, chestnut.

Your inquiries will be appreciated.

Prompt delivery guaranteed.

## The Norman Lumber Co., Inc.

Manufacturers and Wholesalers of

### Hardwood Lumber

FOR SALE

Seasoned Ash, Oak, Poplar, and Walnut Lumber

WANT TO BUY

Walnut, Oak, Ash, Hickory and Poplar Logs and Lumber

Office and Yards: Third Street, H to K Streets  
LOUISVILLE, KY.

## EDWARD L. DAVIS & CO.

OFFER FOLLOWING STOCKS:

<p><b>POPLAR.</b> 30,000 ft. 4/4 1st &amp; 2d. 50,000 ft. 4/4 Common. 15,000 ft. 5/4 Common. <b>QUARTERED RED OAK.</b> 50,000 ft. 4/4 1st &amp; 2d. 50,000 ft. 4/4 Common. <b>QUARTERED WHITE OAK.</b> 50,000 ft. 4/4 1st &amp; 2d. 10,000 ft. 5/4 1st &amp; 2d. 20,000 ft. 6/4 1st &amp; 2d. 10,000 ft. 8/4 1st &amp; 2d. 50,000 ft. 4/4 Common. 5,000 ft. 5/4 Common. 5,000 ft. 6/4 Common. 20,000 ft. 8/4 Common. 10,000 ft. 2½" Common. 40,000 ft. 3" Common. 1 car Hickory Plank, 1½ to 4"— 8' to 16'.</p>	<p><b>OAK WAGON TONGUES.</b> 12,000 ft. 4x4"x4x2"—12", 1-6 mos. dry. 800 ft. 3 x4"—12", 12-18 mos. dry. 400 ft. 3½x4½"—12", 12-18 mos. dry. 300 ft. 3½x4½"—12", 12-18 mos. dry. 250 ft. 3½x4½"—12", 12-18 mos. dry. 800 ft. 3½x4½"—12", 12-18 mos. dry. 180 ft. 3x4" &amp; Lgr.—14", 12-18 mos. dry.</p> <p><b>REACHES.</b> 1 car 2x4" and larger, dry.</p> <p><b>BOLSTERS.</b> 2 cars 3x4" and larger, dry.</p> <p><b>HICKORY AXLES.</b> 1,500—2 x4"—6", 1-6 mos. dry. 1,500—3½x4½"—6", 1-6 mos. dry. 2,000—4 x5"—5", 1-6 mos. dry. 1,000—4½x5½"—6", 1-6 mos. dry. 1,000—5 x6"—6", 1-6 mos. dry.</p>
---	---

# CADILLAC

CELEBRATED FOR HIGH STANDARD OF QUALITY AND MILL WORK

## MICHIGAN RED OAK

- ☛ As fine stock as was ever cut in the famous Cadillac district
- ☛ We have some of this choice 4-4 Red Oak which will soon be in shipping condition.
- ☛ If you are in the market, we can please you both in quality and price.
- ☛ We also have some nice Soft Gray Elm in 4-4, 6-4, 8-4 and 12-4. It's Bone Dry.

**Mitchell Brothers Company**  
CADILLAC, MICHIGAN

## Cummer, Diggins & Co.

— MANUFACTURERS —

**"CUMMER" MAPLE  
AND BEECH FLOORING**

## MICHIGAN HARDWOODS

---

Good assortment of dry stock on hand ready for immediate shipment in Hard Maple, Beech, Birch, Soft Elm and Cherry.

---

**SEND US A LIST OF YOUR REQUIREMENTS.**

## The Cadillac Handle Co.

. . . Band Sawn . . .

### Michigan Hardwoods

<p><b>For Rail Shipment from Cadillac.</b></p> <p>2 cars 8-4 Maple, No. 1 Com. &amp; Better</p> <p>15 cars 4-4 Maple, on Grades.</p> <p>2 cars 4-4 Basswood, No. 2 Com. &amp; Bet.</p> <p>2 cars Basswood, No. 2 Com. &amp; Bet.</p>	<p><b>For Water Shipment:</b></p> <p>120,000 feet of 4-4 Basswood</p> <p>160,000 feet of 4-4, 5-4 and 6-4 Birch</p> <p>100,000 feet of 4-4, 8-4 and 12-4 Soft Elm</p> <p>10,000 4-4 Ash</p>
--	---

# DRY STOCK

## Cadillac Hard Maple

88M	4-4 No. 3 Common.
265M	5-4 No. 1 & 2 Common.
325M	6-4 No. 1 & 2 Common.
105M	6-4 1's & 2's.
44M	12-4 1's & 2's.
31M	16-4 No. 2 & Better.

The above stock is our own manufacture and we can ship promptly.

**Be Friendly. Write Us.**

### COBBS & MITCHELL

(INCORPORATED)

## CADILLAC, MICHIGAN

## MURPHY & DIGGINS

Offer all grades of the following special dry stock

MAPLE—5-4, 6-4, 8-4, 10-4, 12-4, 14-4, 16-4
GRAY ELM—4-4, 12-4
BASSWOOD—4-4
BIRCH—6-4, 6-4

Our own manufacture. Perfect Mill Work. Uniform Grades.

**LET US FIGURE ON YOUR HARDWOOD WANTS.**



# MEMPHIS

THE HUB OF THE HARDWOOD WORLD

F. W. GILCHRIST, President  
W. A. GILCHRIST, Vice President  
W. E. SMITH, Sec'y and Treasurer

## W. E. SMITH LUMBER CO.

Manufacturers of  
**HARDWOOD LUMBER**

Mills, Tennessee, Arkansas, Mississippi  
Distributing Yards, Cairo, Illinois  
General Office. Tennessee Trust Bldg.

MISSISSIPPI VALLEY COTTONWOOD

J. B. Ransom, Prest. A. B. Ransom, V. Prest. W. A. Ransom, Sec. C. K. Ransom Treas.

## GAYOSO LUMBER CO., Inc.

MANUFACTURERS AND DEALERS IN

### SOUTHERN HARDWOODS

Also make a specialty of Wagon Stock in rough, such as Tongues,  
Axles, Reaches, Bolsters, and 6-4 to 16-4 Hickory.

## Briggs & Cooper Company, Ltd.

MANUFACTURERS

### NORTHERN SOUTHERN HARDWOODS

GET OUR PRICES ON THESE ITEMS:

- 1,000,000 feet Soft Grey Elm, 1 to 3".
- 500,000 feet Unselected Birch, 1 to 3".
- 3,000,000 feet Michigan Hard Maple, 1 to 6".
- 350,000 feet Eud Dried White Maple, 1 to 1 1/2".
- 625,000 feet No. 1 Common and Better Winter Sawed Basswood, 1 to 3".
- 150,000 feet Selected White Basswood, 1", 1 1/4" and 1 1/2".
- 210,000 feet Plain and Quartered White and Red Oak 1 to 2"

YARDS AT

SAGINAW, CHICAGO AND MEMPHIS

F. W. GILCHRIST, Pres. W. A. GILCHRIST, Vice-Pres.  
W. E. SMITH, Sec'y and Treas.

## Three States Lumber Co.

MANUFACTURERS OF

Mills: Missouri Arkansas Tennessee  
**Hardwood Lumber  
Cottonwood and Gum**  
Office Tennessee Trust Building

GET OUR PRICES. TRY OUR LUMBER  
WE SHIP ROUGH, DRESSED, RESAWED

COTTONWOOD—GUM

**WE** have in all thicknesses the following kinds and amounts of lumber at places designated. Kindly send us your inquiries.

**MEMPHIS YARD:**

- Ash 680,000 feet
- Quartered White Oak... 75,000 feet
- Plain White Oak... 140,000 feet
- Quartered Red Oak... 225,000 feet
- Plain Red Oak... 410,000 feet
- Cypress... 225,000 feet
- Cottonwood... 200,000 feet
- Poplar... 305,000 feet

**SELMA YARD**

- Poplar... 409,000 feet
- Bay Poplar... 557,000 feet
- Red Gum... 55,000 feet
- Cypress... 787,000 feet

**BERCLAIR YARD**

- Bay Poplar... 100,000 feet
- Cypress... 800,000 feet

**OTHER YARDS**

- Plain Red Oak... 350,000 feet

## J. W. THOMPSON LUMBER COMPANY

Office and Yards: Randolph Road and I. C. R. R. : : MEMPHIS, TENN.

## BACON-NOLAN HARDWOOD CO.

Manufacturers of

### Band Sawed Oak, Ash Gum, Cypress, Etc.

Office,  
Memphis, Tenn.

Mills,  
Chancy, Miss.

Address all correspondence to Memphis office.

## STOCK LIST ANDERSON-TULLY CO. Memphis, Tenn.

**ASH.**

- 10M ft. 4/4" Clr. Stps., 2 1/2" to 5 1/2".
- 5M ft. 4/4" Com. Stps., 2 1/2" to 5 1/2".

**COTTONWOOD.**

- 33M ft. 7/8" 1st & 2d. 8" & up.
- 150M ft. 4/4" 1st & 2d. 6" & up.
- 70M ft. 4/4" 1st & 2d. 7" to 10".
- 20M ft. 4/4" 1st & 2d. 11".
- 25M ft. 4/4" 1st & 2d. 12".
- 100M ft. 4/4" 1st & 2d. 13" & up.
- 25M ft. 3/4" 1st & 2d. 18" & up.
- 40M ft. 5/4" 1st & 2d. 6" & up.
- 54M ft. 5/4" 1st & 2d. 11" & 12".
- 45M ft. 6/4" 1st & 2d. 6" & up.
- 150M ft. 4/4" Wag. Box Brds., 9"-12".
- 60M ft. 4/4" Wg. Box Brds., 13"-17".

**CYPRESS.**

- 10M ft. 4/4" Select.
- 25M ft. 4/4" Shops.
- 15M ft. 5/4" Select.
- 15M ft. 5/4" Shops.

**GUM.**

- 4M ft. 3.8" 1st & 2d Red, 16" up.
- 4M ft. 1.2" 1st & 2d Red, 16" up.
- 100M ft. 4/4" 1st & 2d Saps, 6"-12".
- 50M ft. 4/4" 1st & 2d Saps, 13"-15".
- 40M ft. 4/4" 1st & 2d Saps, 16" up.
- 50M ft. 4/4" Wg. Box Brds., 13"-17".
- 200M ft. 4/4" No. 1 Common Saps
- 200M ft. 4/4" No. 2 Common.
- 200M ft. 4/4" No. 3 Common.

**RED OAK.**

- 22,600 ft. 4/4" 1st & 2d Plain, 12" & up, 14' & 16".
- 32,300 ft. 4/4" 1st & 2d Pln., 6" up.
- 1,700 ft. 4/4" 1st & 2d Quartered.
- 8,800 ft. 4/4" No. 1 Com. Quartered.

**WHITE OAK.**

- 6,530 ft. 4/4" 1st & 2d Plain.
- 10,700 ft. 4/4" No. 1 Com. Plain.
- 6,000 ft. 4/4" 1st & 2d Quartered.
- 11,000 ft. 4/4" No. 1 Com. Quartered.

**POPLAR.**

- 35,000 ft. 4/4" Common & Call.

## FENN BROS. COMPANY

MANUFACTURERS OF

### Oak Flooring

QUARTERED WHITE HOLLOW BACKED  
QUARTERED RED END MATCHED  
PLAIN WHITE POLISHED  
PLAIN RED BORED

Memphis, Tenn.

**ST. LOUIS**

LARGEST OF ALL HARDWOOD MARKETS

**Thomas & Proetz Lumber Co.**

CASH BUYERS OF OAK, ASH, CYPRESS, POPLAR, CHERRY AND ALL

**HARDWOODS**

SEND INSPECTOR WHEN QUANTITY JUSTIFIES

Office and Yards: Hall and Angelrodt Sts.

**CHAS. F. LUEHRMANN HARDWOOD LUMBER COMPANY**

Carry a complete stock of Hardwood and are constantly in the market to purchase large blocks of stock for cash. Are also the largest manufacturers of the famous St. Francis Basin Red Gum.

General Offices: 148 Carroll Street

**LOTHMAN CYPRESS CO.**

AIR DRIED

**Louisiana Red Cypress**

FOOT OF ANGELICA STREET

**Stoneman-Zearing Lumber Co.**

203 Frisco Building

We have the following Dry Stock for sale piled at our mill:

QTD. WHITE OAK :	COTTONWOOD :
3 Cars 4/4 Common.	3 Cars 1" 1 and 2.
2 Cars 4 4 Common and Better Strips.	1 Car 1x13 to 17" Box Boards.
GUM :	ELM :
5 Cars 1" Common Red.	1 Car 6 4 Log Run.
1 Car 1x13 to 17" Box Boards.	4 Cars 4" Log Run.
1 Car 2" 1 and 2 Sap.	
6 Cars 1 3/4 Common and Better Sap.	

This Stock is All Band Sawed and Equalized

Roland F. Krebs Manager **Ozark Cooperage Co.** Hardwood Department

**WE BUY STOCKS READY CUT OR CONTRACT FUTURE OUTPUT**

Four Inspectors in the South

Direct Shipments from mill stocks { COTTONWOOD, CYPRESS, GUM, OAK. MAIN OFFICE, FRISCO BUILDING

**Garetson-Greason Lumber Co.**

MANUFACTURERS OF SOUTHERN HARDWOODS

**GUM LUMBER  
OUR SPECIALTY**

Carload Shipments Direct from Our Own Mills

519 Bank of Commerce

**W. R. CHIVVIS,** Lesperance Street and Iron Mountain Railroad.

WHOLESALE HARDWOODS

**BLACK WALNUT LUMBER MY SPECIALTY.** Always in the market to buy Walnut and Cherry Lumber. Pay spot cash and take up at shipping point when amounts justify.

**Wanted—Cypress, Ash and Cottonwood**

INSPECTION AT POINT OF SHIPMENT WHEN QUANTITY JUSTIFIES

**Hafner Manufacturing Co.**

CYPRESS, HARDWOODS

Mail orders receive our immediate attention.

YARDS: FOOT OF DOCK STREET

**SIX MILLION FEET**

Ash, Oak, Cypress, Poplar, Etc.

READY FOR PROMPT SHIPMENT

**STEELE & HIBBARD**

NORTH BROADWAY, DOCK AND HALL STREETS

# THE EAST

BOSTON

NEW YORK

PHILADELPHIA

## The Crosby & Beckley Company

### HARDWOODS

We are  
In the Market for Choice Stock  
WRITE US

No. 1 Madison Ave.,  
New York, N. Y.

New Haven,  
Connecticut.

## WM. E. LITCHFIELD

MASON BUILDING, BOSTON, MASS.

**Specialist in Hardwoods**

Manufacturers are requested to supply lists of stock for sale

## H. D. Wiggin Wholesale Hardwoods

**Specialties:** Poplar, Chestnut, Canadian  
Hardwoods, and Mahogany Veneers.

FISKE BUILDING

BOSTON, MASSACHUSETTS

JOHN T. DIXON

HARRY S. DEWEY



We are not **Wizards** in making new grades to fit a price.  
No tricks in our methods of making shipments. The  
straight grades are good enough for us.

If you will give us a trial order for **POPLAR, OAK,  
ASH, CHESTNUT or OAK, MAPLE and YELLOW  
PINE FLOORING**, we believe we can demonstrate our  
ability to please you.

## DIXON & DEWEY

716 and 716 A, Flatiron Building,

NEW YORK

## JONES HARDWOOD CO.

INCORPORATED

WANTS: Poplar, Plain Oak,  
Quartered Oak and Cypress.

147 MILK STREET  
BOSTON, MASSACHUSETTS

Manufacturers please send stock lists and prices.

## James & Abbot Company

Lumber and Timber

No. 165 MILK ST., BOSTON, MASS., and GULFPORT, MISS.

## Charles S. Wentworth & Co.

WHOLESALE LUMBER MERCHANTS

147 Milk Street  
BOSTON

We are in the Market for **POPLAR, PLAIN OAK, CYPRESS**  
and **NORTH CAROLINA PINE LUMBER**; also **OAK, MA-  
PLE and BIRCH FLOORING**, and would appreciate corre-  
spondence from manufacturers in position to supply any of the  
stock named.

# R. E. Wood Lumber Company

☛ We own nearly a thousand million feet of virgin poplar, oak,  
chestnut and other hardwood timber, and operate our own band mills  
in West Virginia, Tennessee, North Carolina and South Carolina.

☛ Let us figure on your hardwood requirements.

GENERAL OFFICES:  
CONTINENTAL BUILDING.

**Baltimore, Maryland**

**THE EAST**

BOSTON NEW YORK PHILADELPHIA

**WILLIAM WHITMER & SONS, Inc.**

MANUFACTURERS OF

**HARDWOODS**

We are always in the market for round lots of well manufactured stock, and shall be pleased to enter into correspondence with manufacturers with a view to purchase.

**PHILADELPHIA**

New York, Boston, Pittsburg

**JOHN L. ALCOCK & CO.**

BUYERS OF BLACK WALNUT LOGS,  
BOARDS AND PLANKS

Inspection at point of  
shipment. Spot cash.

Baltimore, Md.

**Holloway Lumber Company**

**WHOLESALE HARDWOODS**

In the market for all thicknesses of  
OAK, ASH and CHESTNUT.

312 Arcade Building,  
PHILADELPHIA, PA.

**STEVENS-EATON CO.**

Buyers of  
ROUND LOTS  
of

**Hardwoods**

No 1 Madison  
Avenue,  
NEW YORK

ESPECIALLY IN MARKET FOR PLAIN RED OAK

J. J. SOBLE

H. I. SOBLE

**SOBLE BROTHERS**

Wholesale Hardwoods

911-912 Land Title Bldg. PHILADELPHIA

WANTED: 20 cars Common and Better Chestnut, all thicknesses.

**For Your Good Money  
We Give You Good Value.**

Let the quality of our lumber and the good service we can give you be the understanding between us. Do you want any of these to-day?

150,000 ft. Ash, from 1 to 6 inch thick.  
3,875,000 ft. Chestnut, Common and Better.  
1,420,000 ft. Poplar 1 and 2 and Common.  
775,000 ft. White Pine No. 1 cuts and fine  
Common and Better.  
1,800,000 ft. White and Red Oak.

**J. Gibson McIlvain & Co.**

56th to 58th Streets and Woodland Ave., PHILADELPHIA, PA.

**WE MUST MOVE AT ONCE  
6 Cars 4-4 1's and 2's Red Oak**

High Grade Stock, good widths and lengths  
PRICE RIGHT. Send us your inquiries

**SCHOFIELD BROTHERS**

1020-22 Pennsylvania Building, PHILADELPHIA

**Wistar, Underhill & Co.,**

WHOLESALE  
**HARDWOOD LUMBER**

816 Real Estate Trust Building, PHILADELPHIA.

**Thomas Forman Company**

MANUFACTURERS OF HIGH-GRADE

**Maple and Oak  
Flooring**

New York Branch:  
McGovern & Bowen,  
29 Broadway

And Hardwood Lumber

**DETROIT,  
MICHIGAN**

**W. M. GILLESPIE LUMBER**

**HARDWOODS COMPANY** Farmers Bank Bldg.  
Oak a Specialty PITTSBURGH, PA.

**The West Florida Hardwood Co.**

MILL ON APALACHICOLA RIVER  
MARYSVILLE, FLA.

**Ash  
Hickory**

**Red and White Oak  
Yellow Cottonwood**

**Red Gum  
Tupelo Gum**

LET US HAVE YOUR INQUIRIES

# NASHVILLE

HEADQUARTERS FOR ALL SOUTHERN HARDWOODS

## GEO. C. BROWN & CO.

MANUFACTURERS AND WHOLESALE DEALERS IN

### Hardwood Lumber

Tennessee Red Cedar Lumber a Specialty.

NASHVILLE, TENNESSEE

## LOVE, BOYD & CO.

Offer:

5,000,000 ft. Quartered White Oak.  
2,000,000 ft. Quartered Red Oak.  
1,000,000 ft. Plain White Oak.  
1,000,000 ft. Plain Red Oak.  
1,000,000 ft. Poplar.  
2,000,000 ft. Chestnut, Ash, Hickory, Red Cedar, Etc.

Our Own Manufacture.  
Prompt Service.  
Dry Stock.

MAIN OFFICE,  
NASHVILLE, TENNESSEE

## INDIANA LUMBER CO.

### Manufacturers Lumber

DIMENSION STOCK A SPECIALTY.

Office and Mills: Corner Oldham  
Street and Cumberland River

NASHVILLE, TENN.

## Nashville Hardwood Flooring Co.

Manufacturers of

### "Acorn Brand"

THE FAMOUS FAULTLESS FLOORING  
IN OAK AND BEECH.

Car Lots and Less Than Car Lot  
Orders Solicited. Write for Prices.

Nashville, Tennessee

## JOHN B. RANSOM & CO.,

NASHVILLE, TENNESSEE

We want to move quickly the following old dry stock. All of it has been on sticks 6 to 18 months. Write us for delivered prices. We are prepared to furnish promptly mixed cases of rough and dressed hardwoods of all kinds:

QUARTERED WHITE OAK	QUARTERED RED OAK
90 M 4/4 first and second	100 M 4/4 first and second
15 M 5/4 first and second	58 M 6/4 first and second
80 M 6/4 first and second	15 M 8/4 first and second
10 M 10/4 first and second	95 M 4/4 No. 1 Common
120 M 4/4 No. 1 Common	84 M 6/4 No. 1 Common
65 M 6/4 No. 1 Common	72 M 8/4 No. 1 Common
58 M 8/4 No. 1 Common	
20 M 10/4 No. 1 Common	PLAIN OAK
70 M 5/8 first and second Poplar	50 M 4/4 1st and 2nd White
80 M 5/8 No. 1 Common Poplar	100 M 4/4 No. 1 Common White
15 M 4/4 1st and 2d Quartered Sycamore	100 M 4/4 first and second Red
10 M 4/4 No. 1 Com. Quart'd Sycamore	100 M 4/4 No. 1 Common Red

# Swann-Day Lumber Company

MANUFACTURERS OF

## POPLAR AND OAK

PLANING MILL STOCK, BOX SHOOKS  
AND HARDWOOD DIMENSION

CLAY CITY, KENTUCKY

# PAEPCKE-LEICHT LUMBER COMPANY

MANUFACTURERS OF

## COTTONWOOD GUM AND OTHER HARDWOODS

Large stocks of well seasoned Lumber always carried at our yards and mills.

General Offices: 140 W. Chicago Ave., CHICAGO. Mills: Cairo, Ill., Marked Tree, Ark., Greenville, Miss., Arkansas City, Ark., Blytheville, Ark.

# The Tegge Lumber Co.

MILWAUKEE  
WISCONSIN

BUYERS OF  
ALL KINDS OF

## HARDWOOD LUMBER

# Are You in the Market ?

Send us your inquiries for prices on  
the following

# HARDWOODS

- 100M ft. 1" Com. and Better Quartered Red Oak.
- 100M ft. 1" Com. and Better Quartered White Oak.
- 75M ft. 1 1/4" Com. and Better Quartered Red Oak.
- 25M ft. 1 1/4" Com. Quartered White Oak.
- 25M ft. 1 1/2" 1st and 2nds Quartered Red Oak.
- 50M ft. 3" Com. and Better Quartered White Oak.
- 50M ft. 3" Com. and Better Plain White Oak.
- 100M ft. 1" Com. Plain Birch.
- 50M ft. 1" Com. Red Birch.
- 50M ft. 1 1/4" Com. and Better Plain Birch.
- 100M ft. 1" Com. and Better Hard Maple.
- 100M ft. 1 1/2" Com. and Better Hard Maple.
- 100M ft. 1" Com. and Better Soft Elm.

# UPHAM & AGLER

Distributing Yards: CAIRO, ILL.

Main Offices :: American Trust Building, CHICAGO

## SEPTEMBER STOCK LIST

MAPLE		BIRCH		BASSWOOD	
1 in.	2,000,000 ft.	1 in.	500,000 ft.	1 in.	300,000 ft.
1 1/4 "	100,000 "	1 1/2 "	100,000 "	1 1/4 "	30,000 "
1 1/2 "	400,000 "	2 "	100,000 "	1 1/2 "	50,000 "
2 "	1,000,000 "	2 1/2 "	50,000 "	2 "	75,000 "
2 1/4 "	200,000 "	3 "	75,000 "	3 "	4,000 "
2 1/2 "	500,000 "	ROCK ELM		GRAY ELM	
3 "	500,000 "				
4 "	400,000 "	2 in.	25,000 ft.	1 in.	300,000 ft.
BEECH		2 1/4 "	50,000 "	1 1/2 "	200,000 "
1 in.	500,000 ft.	WHITE MAPLE		3 "	200,000 "
1 1/4 "	250,000 "	End Piled		ASH	
1 1/2 "	400,000 "	1 in.	100,000 ft.	1 in.	500,000 ft.
2 "	100,000 "	1 1/2 "	20,000 "		
2 1/2 "	200,000 "	2 "	50,000 "		

KELLEY LUMBER & SHINGLE CO., Traverse City, Mich.

# Now for a fact

Do you know the actual  
mill cost of your product?

or

Has your business outgrown  
your system of accounting?

Let us talk with you



## Standard Audit Company

Suite 335

Marquette Building, CHICAGO

# SOUTHERN OAK LUMBER CO.



WE WANT TO BUY FOR CASH

# OAK CYPRESS ASH

MILL CUTS OR ROUND LOTS

910 CHAMBER OF COMMERCE 1217 TENNESSEE TRUST BLDG.

CHICAGO MEMPHIS

YARDS: NORTH MEMPHIS

# CHICAGO

THE GREATEST HARDWOOD MARKET IN THE WORLD

—have you anything to offer in hickory, white ash, thick plain oak and wagon stock?

WE ARE CASH BUYERS  
PLEASE SEND US YOUR STOCK LISTS

## Ryan & McParland

Office and Yards  
Robey St. and Blue Island Ave.

Chicago

## White Lumber Company

Dealers in Hardwood Lumber

ALL KINDS

ALL GRADES



Cherry Lumber a  
Specialty

Laflin @ 22d Sts.  
Chicago

## A floor to adore



For thirty-three years Wilce's Hardwood Flooring has been among the foremost on the market and because it stands today "un-qualified" is the best evidence that its manufacturer has kept abreast of modern methods and the advanced demands of the trade. To convince yourself of the above statements, try our polished surface flooring, tongued and grooved, hollow backed, with matched ends and holes for blind nailing—you'll find it reduces the expense of laying and polishing. Our Booklet tells all about Hardwood Flooring and how to care for it—also prices—and is free.

## The T. Wilce Company

22nd and Throop Sts. CHICAGO, ILL.

## John O'Brien Land & Lumber Co.

MANUFACTURERS AND DEALERS IN

## Hardwood Lumber

Of All Kinds

OFFICE AND YARDS  
873 to 881 So. Laflin Street  
MILL: PHILIPP, MISS.

Chicago

## Harvey S. Hayden

IN THE MARKET FOR

### POPLAR

25 M ft. 1½" No. 1 Common, standard widths and lengths.  
40 M ft. 2" No. 1 Common, standard widths and lengths.  
25 M ft. 2½" No. 1 Common, standard widths and lengths.  
60 M ft. 3" No. 1 Common, standard widths and lengths.

### WHITE ASH

30 M ft. 1" 1s and 2s, standard widths and lengths.  
75 M ft. 5 4" 1s and 2s, standard widths and lengths.  
50 M ft. 6 4" 1s and 2s, standard widths and lengths.  
50 M ft. 8 4" 1s and 2s, standard widths and lengths.  
25 M ft. 10 4" 1s and 2s, standard widths and lengths.  
50 M ft. 16 4" 1s and 2s, standard widths and lengths.  
(We can use a small percentage of No 1 Common.)

511 Railway Exchange, - Chicago

## J. Slimmer & Company

## Hardwood Lumber

Office and Yard :  
65 W. Twenty-second St.

CHICAGO

## PARK RICHMOND & CO.

Wholesale

## Hardwood Lumber

67 West Twenty-second St.

Chicago

## R. A. WELLS LUMBER CO.

Manufacturers of All Kinds of

## HARDWOOD LUMBER

Fine Quartered Oak a Specialty

234 LA SALLE STREET

Yards at Canal and 21st Sts.

CHICAGO, ILL.



**CHICAGO**

THE GREATEST HARDWOOD MARKET IN THE WORLD

**Heath-Witbeck Company**

**Hardwood Lumber**

We have for quick shipment 170,000 feet DRY BIRCH, First and Seconds and Common 2, 2½, 3 and 4 inch.

Main Office, 6 Madison St. Yards, Loomis and 22nd St.  
**CHICAGO**

**CHAS. DARLING & CO.**

**Southern  
Hardwoods**

22nd Street and Center Avenue - **CHICAGO**

**Crandall & Brown**

**LOUISIANA RED CYPRESS  
Yellow Pine, Oak, Poplar and Maple**

We have in Chicago for quick delivery  
100,000 1½" 1st and 2nds La. Red Cypress, thoroughly dry.  
14,000 3x14" Shop Com. Cypress  
We are in the market for Ash and Cottonwood

Office and Yards: 3300 Center Avenue, **CHICAGO.**

**Lesh & Matthews Lumber Co.**

1649-50 MARQUETTE BUILDING

Are now offering bone dry BIRCH, ROCK ELM, BLACK ASH, etc., Wisconsin stock. Also PLAIN AND QUARTERED OAK, POPLAR, etc. from our Memphis yard. We are constant buyers.

**The Columbia Hardwood Lumber Co.**

Wholesale and Retail

Telephone **HARDWOOD LUMBER** 47 Dominick St.  
NORTH 223 **CHICAGO**

**The Keith Lumber Company**

**HARDWOOD, POPLAR & SOUTHERN PINE LUMBER,**

**MAHOCANY,**



**CYPRESS,**

**REDWOOD,**

**CHESTNUT,**

**RED CEDAR,**

**SPRUCE.**

**MAPLE FLOORING, OAK TIMBERS & WAGON STOCK.**

Office and Yards: Fourteenth and Wood Streets.

**Ben C. Keator—Wholesale Lumber**

**HARDWOOD AND PINE**

1003-4 Manhattan Building, **CHICAGO**

**THE WARD LUMBER COMPANY**

MANUFACTURERS OF  
**HARDWOODS**

CHAMBER OF COMMERCE BUILDING :: **CHICAGO**

Chas. Miller

Milton Miller

**MILLER BROS.**

**Hardwood Lumber**

Main Office, 208 WILLOUGHBY BLDG.,  
6 E. MADISON STREET,

**YARDS:**  
Loomis St., S. of 22nd St.,  
Chicago, Ill.  
Houston, Miss.  
Macon, Miss.

**CHICAGO, ILL.**  
Phone CENTRAL 1363

**WISCONSIN TIMBER @ LUMBER CO.**

— BUY AND SELL —

**Yellow Pine and Hardwood Lumber**

Want thick hardwoods and wagon box boards.

**Monadnock Bldg.. . . . CHICAGO, ILL.**

The only trade paper reaching all classes  
of hardwood consumers

**HARDWOOD RECORD**  
355 Dearborn St., Chicago

H. B. LEAVITT, PREST.  
E. H. ADAMS, SECY.

B. F. RICHARDSON, VICE-PREST.  
J. G. LEAVITT, TREAS.

## THE LEAVITT LUMBER CO.

MOST COMPLETE STOCK OF HARDWOODS IN  
**CHICAGO**

MAKE KNOWN YOUR WANTS AND GET  
**IMMEDIATE RESULTS**

Mills:  
WISCONSIN  
TENNESSEE  
ARKANSAS  
LOUISIANA  
MISSISSIPPI

General Office and Yard:  
22ND AND LAFLIN STREETS,  
Southern Office:  
808 TENNESSEE TRUST BLDG.  
MEMPHIS, TENN.

## THE "FINEST" MAPLE FLOORING

**W. D. YOUNG & CO.**  
BAY CITY, MICHIGAN.

Producers from TREE to TRADE of the highest type of Michigan Forest Products. Large stock of Maple Flooring and 15,000,000 feet of Hardwoods—1 to 4 inches thick—on hand.

**Maple, Birch and Beech Lumber**

## "Ideal" Steel Burnished Rock Maple Flooring

is the flooring that is manufactured expressly to supply the demand for the best. It is made by modern machinery from carefully-selected stock and every precaution is taken throughout our entire system to make it fulfill in every particular its name—"IDEAL."

Rough or Finished Lumber—All Kinds

Send us Your Inquiries

**The I. Stephenson Company**  
WELLS, MICHIGAN

## FIRE INSURANCE



LET US SETTLE IT TOGETHER

**LUMBER UNDERWRITERS**

66 Broadway, New York

## "Michigan" Maple Flooring

Our model factory is equipped with the highest class tools and appliances made for Flooring production.

We produce our lumber from the best rock Maple area in Michigan and have 20 years' supply.

Our brand "Michigan" is a guaranty of quality. Perfect mill work and excellent grades distinguish our Flooring and our prices are reasonable.

**WARD BROS., Big Rapids, Mich.**

## Wolverine Brand Maple Flooring

== "THERE IS NONE BETTER" ==



It is the same old story, but we want you to know what Wolverine Brand will do for you, and what it will cost you. We want to do this before you place your next order. If we make you quotations we expect the quality and prices will get your order.  
TRY US.

**BLISS & VAN AUKEN**

900 S. Niagara Street, Saginaw, W. S., Mich.

## OAK FLOORING

Kiln Dried  
Bored  
Polished



Hollow  
Backed  
and  
Bundled

## Timber Bonds

SECURED BY FIRST MORTGAGE ON TIMBER LANDS

**H. C. Barroll & Co.**

BANKERS, First National Bank Building, CHICAGO.

# Hardwood Record

Published in the Interest of Hardwood Lumber, American Hardwood Forests, Wood Veneer Industry, Hardwood Flooring, Hardwood Interior Finish, Wood Chemicals, Saw Mill and Woodworking Machinery.

Vol. XXII.

CHICAGO, SEPTEMBER 10, 1906.

No. 10.

Published on the 10th and 25th of each month by

## THE HARDWOOD COMPANY

HENRY H. GIBSON, President

FRANK W. TUTTLE, Sec.-Treas.

### OFFICES

Sixth Floor Ellsworth Bldg., 355 Dearborn St. Chicago, Ill., U.S.A.

Telephones: Harrison 4960 Automatic 5659

### TERMS OF ANNUAL SUBSCRIPTION

In the United States, Canada, Philippine Islands and Mexico . . . \$2.00  
In all other countries in Universal Postal Union . . . . . 3.00

Subscriptions are payable in advance, and in default of written orders to the contrary are continued at our option.

The entire contents of this publication are covered by the general copyright, and articles must not be reprinted without special permission.  
Entered at Chicago Postoffice as Second Class Matter.

Advertising copy must be received five days in advance of publication date. Advertising rates on application.

## COMING HARDWOOD ASSOCIATION MEETINGS

### Wisconsin Hardwood Lumbermen's Association

The eleventh annual meeting of this association will be held at Hotel Pfister, Milwaukee, Wis., Tuesday, September 18, at 10:00 a. m.

### Hardwood Manufacturers' Association

A district meeting of this association is scheduled to be held at Cape Girardeau, Mo., Tuesday, September 25.

### National Hardwood Lumber Association

A semi-annual meeting of this association will be held at Hotel Havlin, Cincinnati, on Thursday and Friday, October 25 and 26.

## General Market Conditions.

As evidenced by the reports from nearly all hardwood centers of the United States, general hardwood conditions may be regarded as entirely favorable, especially when the season of the year is considered. The slight lull in demand of the last two months is giving way to a steady inquiry and increased sales of hardwood from the Atlantic to the Pacific. Wood workers in all lines are enjoying a very remarkable trade, which has been secured at prices based on current lumber values. The little hesitancy in buying which has prevailed owing to a hope of diminution in prices seems to be giving way, and orders are being freely placed at as good prices as have prevailed at any time during the year.

The extra effort that has been made in the oak producing sections to increase stocks on hand has not been successful owing to bad weather conditions. The country is just as short of oak today as it has been at any time during the past two years.

The shortage of poplar and cottonwood is so marked that trading among manufacturers and wholesalers at the top of the price list

prevails to a considerable extent. There surely is not enough of either wood in sight to go around, and there is little hope of an increase in stocks for months to come.

The minor southern hardwoods are all in good call, of which hickory is perhaps the scarcest item. A part of the northern hardwoods are doing very well, but still there is little accretion in value anywhere along the line.

The hardwood flooring factories are still very busily employed, as the vast number of new high-class structures being erected throughout the country is making a tremendous call for both maple and oak flooring.

The veneer and panel people are having a good volume of business, but very few of them are satisfied with the prices being received.

Mahogany lumber is increasing in consumption, as its unusual merits and relative low cost as compared with high-class domestic woods become more fully realized by the trade at large. There also seems to be an increased demand for black walnut for both home and foreign consumption. The price of neither mahogany nor walnut is showing any advance.

Cypress is well picked-up and the prices ruling are high. It is doubtful if ever cypress comes on the market again in sufficient quantities to depress current values. Considering prevailing general commercial conditions the hardwood trade may be said to be enjoying its full measure of prosperity, and the fall trade in sight augurs to carry this condition forward for the remainder of the year.

## Association Meetings.

At the head of the editorial columns of this issue of the HARDWOOD RECORD will be found the announcement of three important hardwood meetings. The first is the annual meeting of the Wisconsin Hardwood Lumbermen's Association, which for many years has been an important function of the hardwood fraternity of the Badger state. This meeting, coming just before the opening of the fall trade, will probably call out an unusually large number of manufacturers and jobbers.

Another meeting announced is a district conference of the Hardwood Manufacturers' Association of the United States, to be held at Cape Girardeau, Mo.

The third meeting noted is an innovation of the National Hardwood Lumber Association—a semi-annual meeting at Cincinnati. The executive board of this association, in response to many requests, have deemed it wise to call this general meeting for the consideration of many subjects of importance that have transpired since the annual meeting held in Memphis early in May. It is understood that one important topic of consideration will be the admission of wholesale consumers of hardwoods throughout the United States as associate members. There are also some changes in the constitution and by-laws projected. This meeting will doubtless call out an attendance second only to that of the big Memphis annual meeting.

## Conservatism of Michigan Hardwood Men.

Early in July leading hardwood manufacturers of Michigan gathered in a conference to thresh out among themselves certain points of manifest interest. While the hardwood producing section of Michigan is of comparatively small area, although the annual output of the state is upwards of 600,000,000 feet, it was found that

very few operators were acquainted with each other. Primarily, therefore, they assembled together to promote acquaintance. Next, they determined to thoroughly analyze the conditions that surrounded their business. They desired to find out the total quantity of lumber of all kinds and grades in stock with hardwood manufacturers of the state, how much of this lumber is sold, and how much each man proposes to manufacture during the coming year. Furthermore, they wished to analyze requirements in the various kinds of lumber they produce. In other words, this conference was held for the purpose of getting at the question of supply and demand, that values might be intelligently fixed. This work has already progressed to a very satisfactory point.

Next in consideration came the always open problem of amending the manufacturing system and the rules of measurement and grading. These are points that the average coterie of lumbermen can rarely agree upon, but thus far the Michigan hardwood operators have handled the proposition with the utmost skill and finesse, and undoubtedly, when they fully determine what they consider best for their own interests, their recommendations will be found advantageous to the people who buy and utilize Michigan hardwoods as well, and much more satisfactory than the want of system which has prevailed in the past. Conservatism is marking every movement of these men skilled in the lumber manufacturing business. The grading committee of the Michigan Hardwood Manufacturers' Association, which thus far has had these matters in charge, has not advanced even a suggestion that is radical. Everybody is working on lines of conservatism and fairness. It seems to be the general desire to simply make the current and recognized hardwood trade ethics of the country universally standard. The grading committee announces that before it will even propose for adoption rules governing manufacture, measurement and grading, they shall be thoroughly tried out and satisfactorily demonstrated on the lumber pile.

These Michigan people have started in to do business on business principles, and it is the prophecy of the HARDWOOD RECORD that within the year they will have achieved more for the benefit of the manufacturing element of the state and for the consumers of Michigan hardwood products than has been accomplished in all the years of the past.

### A Pressing Need.

No graver problem is to be contended with in the lumber industry today than that which confronts the hickory interests. It is almost needless to reiterate again, as it is so well known generally, that the present stand of hickory is perilously near exhaustion. As no authoritative statistics have ever been collected on this subject, it cannot be stated with any degree of accuracy just how long this stand will last, but the statement has been made by those who are in position to know that thirty years would be a liberal estimate.

Hickory is a slow-growing tree, and while reforestation would be of great value to future generations, curtailment of consumption by the substitution of other woods for hickory and the introduction of more economical methods of manufacture are more rational methods for the immediate solution of the problem. The manufacture of handles, carriage and wagon woodwork and kindred lines utilizes enormous quantities of hickory annually. In these uses the need of substitution is most urgent, and even though it be found necessary to leave the United States in search of woods suitable for these purposes, the effort would certainly be worth while.

Thus it will be seen that there was an urgent need for the National Hickory Consumers' Association, recently organized at Chicago, and that it has before it a future of broad usefulness. The members of this organization are taking up the work with enthusiasm, and undoubtedly by the cooperation which the Forest Service promises the association much will be accomplished and great benefit will accrue to the trade at large.

### Hardwood Rate to the Pacific Coast.

The hardwood manufacturing and wholesale trade is just awakening to the importance of securing a more favorable freight rate from the hardwood producing centers of the country to the Pacific coast. This project, originally agitated by the Wisconsin Hardwood Lumbermen's Association, has latterly secured the cooperation of the

National Lumber Manufacturers' Association, the Hardwood Manufacturers' Association and the National Hardwood Lumber Association.

Under the interpretations made of the new interstate commerce law it is still questionable if the transcontinental lines can be legally forced to reduce the west-bound rate, and therefore all logical means should be exhausted to coax these roads into making a lower rate without having recourse to the law.

A case has recently been decided by the Interstate Commerce Commission, in which the question was a rate of forty-three cents per hundred pounds on unwashed wool from Fort Wayne to Philadelphia, and an exaction of sixty-two cents per hundred pounds was made on the same product from Philadelphia to Fort Wayne. The commission held, upon the evidence presented, that the west-bound rate was not shown to be unreasonable or unjust, and dismissed the complaint. The commission said that, while the law requires all rates to be reasonable and just and forbids unreasonable discriminations, it does not prescribe any measure or test of reasonableness in either case. It is manifest that the reasonableness of every rate or discrimination called into question must be determined and measured by the circumstances and conditions affecting the business. It analyzes that it cannot be required in reason that rates must in all cases be the same in both directions between the same points, any more than they can be made on a strictly uniform mileage basis. It is alleged that the cost of moving freight must be considered, as the difference in grades may in some cases justify a higher rate in one direction than in the opposite one; that the general movement of traffic in one direction may so preponderate as to require the movement of empty cars with its attendant expense; and that a great and increasing volume of freight is a factor of much influence towards the depression of rates.

In the existing contention for a lower freight rate on west-bound lumber, the railroads can set up very little claim on the ground of difference in grades, or that they would have to transport empty cars to the east for the sake of securing loads for the west. About the only logical argument they can present, according to the analysis of the commission, would be the preponderance of east-bound lumber shipment over that of west-bound.

It would seem both in equity and law that the west-bound freight rate on lumber should be reduced to a parity of that of kindred east-bound products, but it certainly would not be wisdom on the part of the various lumber associations to enter into a legal controversy with the transcontinental lines until all amicable means are exhausted to coax them into doing justice to the hardwood trade.

### The Car Stake Equipment Case.

Referring to the suit pending against railroads, instituted primarily by the National Wholesale Lumber Dealers' Association and supported by nearly all the other lumber associations of the country, as well as by many individuals, it cannot fail to be noted that on the whole the hardwood trade has been somewhat lax in its enthusiasm, as evidenced by their general want of financial aid in carrying forward this litigation.

From the fact that comparatively small quantities of hardwoods are shipped in open cars, the average hardwood man does not seem to realize the importance of a favorable decision to the lumber trade in this case. If a hardwood shipper does not forward more than ten cars a year on flat and gondola cars, a favorable outcome of this suit would be equivalent to \$50 a year to him. He certainly should be willing to contribute at least a ten-dollar bill to assist this desideratum. The committee having this suit in charge, after having done a tremendous amount of work and having spent a large sum of money, finds itself embarrassed for funds to continue its action. This very result is what was both hoped for and possibly expected by the defendant railroads. The present status of the case would indicate that the shippers can reasonably hope to win their contention if they have reasonable financial aid from those who will be manifestly benefited, and its appeal for material support should not go unrecognized. The HARDWOOD RECORD trusts that its clients who are shippers of hardwood lumber will interest themselves in this matter and take it up by mail with E. F. Perry, secretary of the committee, 66 Broadway, New York city, and tender him their contributions.

# Pert, Pertinent and Impertinent.

## The Old Fool.

"There is no fool like an old fool!"  
 When the siren on him smiles  
 And around him casts the network of her  
 fascinating wiles,  
 He forgets his hoary whiskers and his strag-  
 gling locks of gray,  
 And in apeing youth and vigor gets ridien-  
 lously gay.  
 He imagines she is smitten with his many  
 manly charms,  
 And is longing for the clasp of his emaciated  
 arms;  
 Longing for his age-dried kisses, that would  
 fall upon her lips  
 From a pair as far from ripeness as a pair  
 of hick'ry chips.

"There is no fool like an old fool!"  
 Though his joints be stiff and dry,  
 Though of ardent manly energy and vigor he  
 is shy,  
 Though his shoulders may be dropping and  
 his sight be growing dim,  
 He imagines there's a fountain of perpetual  
 youth in him.  
 He will meet the smile of siren with an age-  
 enfeebled grin,  
 And will stroke the bunch of whiskers, time-  
 frostbitten on his chin,  
 And his eyes will try to go-goo, try to an-  
 swer to the goo  
 Of the go-goo, shy and tempting, in her eyes  
 of liquid blue.

"There is no fool like an old fool!"  
 As he sighs each asked for check  
 Deeper sinks the dart of Cupid in the wrin-  
 kles of his neck,  
 For the sly god when the granddad with the  
 siren plays a part,  
 Never aims his pointed arrows at the old,  
 enfeebled heart.  
 Then there comes the sad awakening from his  
 idiotic dream,  
 And he learns that lovely women are not al-  
 ways what they seem;  
 As he figures up his losses, he remarks with  
 surly grunch:  
 "There is no fool like an old fool, and I guess  
 I lead the bunch!"

### Common Property.

Anybody possesses  
 the ability to be as  
 big a fool as he  
 pleases.

### Usually.

When a man's re-  
 ligious interferes with  
 his business, the  
 chances are it needs  
 to.

### Poor Advertising.

Advertising the  
 shortcomings of  
 others does not help  
 us to dispose of our  
 own.

### Tantalizing.

A wasted oppor-  
 tunity always comes  
 home to roost.

### Necessarily.

A true man is al-  
 ways a truthful man.

### Companions.

When opportunity  
 knocks at your door,  
 responsibility stands  
 immediately behind.

### Hardly.

Talk isn't neces-  
 sarily cheap when  
 money does the talk-  
 ing.

### Alike.

The scorn of ego-  
 tism is as harmless  
 as the slur of igno-  
 rance.

### That's All.

There is only a  
 few dollars' differ-  
 ence between ennu-  
 and laziness.

### Knows Her Subject.

Although the law holds a man innocent  
 until he has been proven guilty, a man's  
 wife is apt to hold him guilty until he has  
 proved his innocence.

### The Real Reason.

Most people could get along tolerably  
 well without servants, but it would deprive  
 them of a never-failing topic of conversa-  
 tion.

### Inexcusable.

There may be some excuse for blowing  
 about what you have done in this world, but  
 surely there is none for bragging about  
 what you are going to do.

## THE PITY OF IT.



The poor little chap is just waking up to the fact that he has been riding to  
 ruin—and hasn't been driving at all.

### Hot Air.

Some people's wis-  
 dom all escapes at  
 the mouth before it  
 has a chance to in-  
 fluence their actions.

### Kind of 'Em.

Popular ministers  
 avoid touching the  
 sore spots of their  
 congregations.

### Or the Manager's.

It's usually a  
 man's sense that en-  
 ables him to accumu-  
 late dollars.

### He Has the Time.

If a man is too  
 lazy to work he sets  
 himself up as a phil-  
 osophy dispenser.

### Easily Pleased.

Most people who  
 are satisfied with  
 themselves don't  
 want much.

### A Separator.

A successful finan-  
 cier is a man who  
 separates other men  
 from their hard-  
 earned coin without  
 using a sandbag.

### Take a Chance.

Chances are  
 against the man who  
 refuses to take  
 chances.

### It Is, Indeed.

One way to get  
 rich is by attending  
 to one's own busi-  
 ness—but it is aw-  
 fully monotonous.

# AMERICAN FOREST TREES.

THIRTY-SIXTH PAPER.

## Norway or Red Pine.

*Pinus resinosa*—Ait.

Norway pine grows from Newfoundland and the northern shores of the Gulf of St. Lawrence through Ontario and Manitoba and other southern Canadian provinces; through the northern states of the eastern section of this country, and as far west as Minnesota, Wisconsin and Michigan; as far south as Massachusetts, the mountains of Pennsylvania and sections of Ohio. It reaches its highest development and greatest abundance on the northern borders of the first named states. In southern Massachusetts and southward it is rare and local.

This tree thrives best in light sandy loam or upon rocky ridges. It is usually found scattered through forests of other northern conifers; when in groves, rarely covering any extensive area.

Various names are applied to trees of this botany. In Vermont, New Hampshire, New York, Wisconsin, Minnesota and Ontario they are called red pine; in Maine, New Hampshire, Vermont, Massachusetts, New York, Wisconsin, Michigan, Minnesota and Ontario, Norway pine; in Wisconsin, hard pine; in England, Canadian red pine.

The leaves of *Pinus resinosa* are needles, five to eight inches long, slender and flexible; simple; glabrous; growing in groups of two along the branches, and having a long sheath at the base of each; the under side is hollowed, the top surface rounded. The leaves cluster very thickly along the branches, particularly at the ends, their bold, vigorous outlines scarcely being excelled in beauty by the palm.

The bark is reddish brown, its appearance being responsible for the name "red pine" given to the tree in many localities. It is very smooth when young, but grows scaly with age.

The flowers of Norway pine appear in May or June. The staminate ones grow in dense spikes and are dark purple in color; the pistillate are scarlet, growing upon short stalks. The fruit of the tree is a cone, two to three inches long. In shape it is ovate-conical. Its scales are rounded at the base, devoid of prickly points, and are glabrous. They shed their seeds early in the Fall and usually remain on the branches until the following Summer. The seeds are oval and winged, with a thin dark shell.

In general appearance the tree is exceed-

ingly handsome, with its tall straight trunk and thick spreading branches, "pendulous, clothing the young stems to the ground and forming a broad irregular pyramid; in old age, an open round-topped picturesque

pine makes excellent flooring, and is particularly adapted to construction requiring great strength—ear sills, bridges, piles, masts, spars, posts, girders, sills and joist.

The wood is sometimes commercially handled with white pine, and is exported in considerable quantities from Canada to Great Britain. It is an unimportant factor in the manufacture of turpentine and resin, although its botanical name would indicate otherwise; the bark contains considerable tannin.

Notably in Chicago and surrounding territory, Norway joists, timbers, strips, etc., constitute an important part of lumber commerce. With the diminution of the forest area supplying Norway pine, the requirements formerly met by this wood are being filled very largely by yellow pine. Chicago is still the most important center for the distribution of Norway in the world, the Edward Hines Lumber Company of that city being the chief factor in the trade.

The first illustration accompanying this article depicts a perfect specimen, although not of unusual size, of Norway pine forest growth, and was photographed on the property of the Hackley-Phelps-Bonnell Company, near Hackley, Wis. The pictures on the opposite page were taken at operations of the Edward Hines Lumber Company of Chicago; one showing skidways of Norway pine logs on a northern Wisconsin property and the other unloading fine Norway timbers from a vessel at the company's Chicago yards. The etching shows a closed and an open cone, and a bit of straw.

### The Smallest Tree.

The midget of the entire tree family is said to be the Greenland birch. The bluffs along the east and southeast coast of Greenland are covered with a dense growth of this diminutive species of woody plant. Under the most favorable conditions of growth the tree seldom has been known to attain a height exceeding ten inches, and the general run are from six to eight inches high. However, it is well proportioned, and is in every sense of the word a perfect tree. It lives from seventy-five to one hundred and thirty years. Dense thickets of the species are found in Greenland in places where the soil is very poor and frozen from eight to ten months out of the year, which nevertheless flourish half a century without exceeding four inches in height.



TYPICAL FOREST GROWTH NORWAY PINE, NORTHERN WISCONSIN.

head." Norway pine is often planted by landscape gardeners, especially in parks, and is considered by them the most desirable pine tree for ornamental purposes found in the northern states.

The wood is light, hard, durable and not very resinous. Its grain resembles that of short-leaf yellow pine. In color it is pale red, the sapwood much lighter. The medullary rays are numerous and pronounced. The grain is very close. A cubic foot of seasoned wood weighs thirty-one pounds. Norway





UNLOADING NORWAY TIMBERS, YARDS EDWARD HINES LUMBER COMPANY, CHICAGO.



SKIWAY OF NORWAY LOGS, EDWARD HINES LUMBER COMPANY, NORTHERN WISCONSIN.

## National Hickory Consumers' Association Organized.

Delegates representing the largest holders of hickory timber as well as the largest consumers thereof met on Wednesday, August 29, at 10:00 a. m. in the Auditorium Annex, Chicago, and effected an organization to be known as the National Hickory Consumers' Association. This meeting was the outgrowth of that held at Niagara Falls, N. Y., July 13, when initiatory steps were taken toward the organization of the hickory interests, for the purpose of conserving the present supply of hickory stumpage, to promote the future growth of the wood and to determine the most economical methods of manufacture. The new association will work in harmony with the Forest Service in its efforts to provide a future supply of hickory.

The first session of the meeting was called to order at 10:00 a. m. in the Green Room of the hotel by John W. Herron, Jr., of the Royer Wheel Company, Cincinnati, president, pro tem. O. B. Bannister of the Muncie Wheel Company, Muncie, Ind., acted in the capacity of secretary.

After the minutes of the Niagara Falls meeting had been read and approved, Chairman Herron explained the objects of the organization for the benefit of those who were not present at that time. He then called upon the attendance for an expression of their opinions individually regarding the helpfulness which would be received by those who participated in the work of the proposed association. This discussion brought out some interesting information on the prevailing condition of the hickory industry.

H. C. Staver of the Staver Carriage Company of Chicago made some interesting remarks concerning hickory growth, which were occasioned by the statement often heard, although not based on reliable statistical data, that the present stand of hickory timber will be exhausted in twenty years at the present rate of consumption, and that to reproduce the stand would require thirty years, thus leaving ten years interim. Mr.

Staver said that he had practically lived in the woods since boyhood and that from observation he knows that it takes hickory saplings as long to reach a diameter of three inches as it does for them to grow from three to ten inches in diameter. For this reason the hoop pole industry is one of the chief factors in the destruction of merchantable hickory. He gave it as his opinion that hoop pole manufacturers should

particularly to hickory growth, but he thought that a great deal could be done by the government along this line, and that in the work the manufacturers and consumers of hickory could materially assist if they were so inclined, especially through such an organization as was now about to be perfected. He hinted at some tests which had been and were about to be made by the service which would give the exact breaking strength and resiliency of hickory and other woods, such as oak and long-leaf pine, with a view to their possible substitution for hickory.

The work before the association was discussed by F. A. Curtis of the Vehiele Woodstock Company of Chicago. He urged that the preliminaries of organization be disposed of as quickly as possible so that the real work might be undertaken. One of the first things to be accomplished, he believed, is the collection of statistics on the amount of hickory timber now standing, as it is impossible to tell at present whether the supply will last ten years or forty. He stated that he considered that it would be foolish to do anything toward providing for future supplies before it was known, at least approximately, how long the present stand will last.

C. S. Hartwell of Hartwell Bros., Chicago Heights, Ill., said that in his opinion the deadening of hickory, as practiced in the southern states, was a matter which the association might with profit take up with the government. He said that in the southern country thousands of acres of good timber was treated in this manner, the ground thereafter being rented for \$5 or \$6 an acre.

The planting of trees was discussed at length, Mr. Holroyd suggesting that the Forest Service in cooperation with the members of the new association should select species of fast growing, good quality timber best adapted to the sections to be forested.

Upon motion of Mr. Curtis, amended by Mr. Witmer, a committee of three was then appointed by the chair to act with the



STRAW AND CONE NORWAY PINE.

be induced to substitute other wood for hickory, thereby effecting a great saving. J. S. Dort of the Imperial Wheel Company of Flint, Mich., in a short but valuable talk, agreed with Mr. Staver in this view, as did also several others.

H. B. Holroyd of the Forest Service who is conducting a series of experiments in testing timbers, at Lafayette, Ind., was called upon to give an outline of the work which might be accomplished by the government with the assistance of the hickory interests in promoting the growth, preservation and economical use of hickory.

Mr. Holroyd said that the Forest Service had as yet secured but little data relating



temporary officers in drafting a constitution and by-laws, and to report at the afternoon session. The committee consisted of E. W. McCullough, J. A. Sanford and F. A. Curtis.

The meeting then adjourned.

#### Afternoon Session.

On reassembling in the afternoon Chairman Herron requested Mr. Holroyd to describe the work of the Forest Service in making tests on hickory spokes. Mr. Holroyd produced two parcels of inch oak spokes, embracing the grades A, B, C, D, E, and culls; also a blueprint on which were indicated in grams the results of various tests on individual spokes, a record having been made of the maximum load and the maximum strain at the elastic limit. This, he explained by stating that some spokes had been subjected to pressure sufficient to break some of the wood fibers, this being designated the maximum load test; others had been subjected to a strain almost to the breaking point, although no break actually occurred. The tests were arranged on the blueprint so that at a glance the relative strength and resiliency of the various grades of spokes might be seen.

Mr. Holroyd stated that it was a very common idea in the trade that red spokes are inferior to white, but that this is not true. He said that he would not say that red were better than white, but that they were certainly just as good. In a test recently made of 500 spokes, part red and part white, it was found that the red spokes were approximately of the same strength as the white, if there was any difference it was in favor of the red. He explained that it was not altogether the strength of the wood but the stiffness which determined its value as a spoke material. Mr. Curtis volunteered the information that the trade would pay 20 per cent more for white oak singletrees than for red, which statement was borne out by others present.

Mr. Holroyd said in connection with the explanation of the varying strengths of the different spokes that, their thickness being equal, the difference in the strength of the same species of wood was due to the density of the fibers, or in other words to the weight of the wood. This statement called forth the suggestion from Chairman Herron that grades might be determined by weight instead of according to present methods.

Mr. Holroyd made the statement that where defects occurred in a spoke its strength was decreased in the ratio of 10 per cent to 25 per cent as they occurred at the ends or in the middle.

The tests so far made at Lafayette have included only Indiana hickory, but the service now has in view the testing of northern and southern hickory to ascertain their relative strengths. These tests are quite expensive, costing about \$1 a spoke, and this fact has restricted operations considerably, as the appropriation for this work is not large.

Speaking of poles Mr. Holroyd said:

"We tested ten hickory poles, ten oak poles and ten southern pine poles. The idea in that line of tests was to get the relationship between the select poles, the common and common trussed and the relation that the southern pine bears to the oak. We tested these poles by subjecting them to maximum loads at the breaking point and maximum loads at elastic limit, that is to say, in the former case we loaded the poles as heavily as they would bear the weight, even if they split a little, and in the latter we subjected them to a strain which resulted in them being permanently deflected. Comparing oak select with the oak common for maximum load, the former of course is better, but the oak select and the oak common run about the same at the elastic limit. Longleaf southern pine is a little stronger than either the oak trussed or the oak common and nearly equal to the oak select. The pine used in the test was not wholly longleaf and as longleaf pine is the strongest of the pines, this fact is still more in its favor."

O. B. Bannister read a very interesting paper setting forth the advantages to be gained by the establishment of a government laboratory at Washington to be used by the Forest Service for experiments in the seasoning and preservation of timber. This matter was brought before Congress at its last session, but unfortunately it failed to pass, and a vigorous campaign is now being undertaken by the various trade associations.

The National Hickory Consumers' Association voted the appointment of a committee to work with committees from other associations in the hope of influencing Congress to make an appropriation for such a laboratory. The chair appointed as such committee Edward Stinson, E. S. Darlington and Fred A. Curtis.

The Committee on Constitution and By-laws then presented its report embodying a draft of the constitution and by-laws, which was adopted, as follows:

**WHEREAS**, It is recognized that the supply of hickory timber is being rapidly exhausted; and

**WHEREAS**, There is no known substitute for hickory; and

**WHEREAS**, A complete depletion of this material would greatly disturb and probably destroy the industries as now operated consuming this material, which would be a national calamity; and

**WHEREAS**, We, the users of approximately 250,000,000 feet per year, and representing practically all lines consuming hickory, here assembled, recognize these conditions and the importance of taking drastic measures to insure a future supply, be it

**Resolved**, That we form an association for the purpose of protecting, fostering and preserving the present supply of hickory timber and to encourage its future growth and to influence the government through its forestry department to make a commercial study of the hickory problem; be it further

**Resolved**, That we cooperate both with the government and among ourselves in seeking ways and means for the further economical use of this material.

#### CONSTITUTION.

##### ARTICLE I.

This association shall be known as the National Hickory Association.

##### ARTICLE II.

The object of this association shall be the promotion of the common interests of the consumers and producers of hickory timber.

##### ARTICLE III.

##### Membership.

**Sec. 1.** The active members of this association shall be persons or concerns engaged in the production or consumption of hickory timber in this country.

**Sec. 2.** The association may by vote admit to honorary membership any person who from eminence or for distinguished services shall seem entitled to such consideration; such honorary members shall have the benefit of all the rights and privileges of the association except that of voting.

##### ARTICLE IV.

The officers of this association shall consist of a president, a vice president, a secretary and a treasurer. The Executive Committee shall consist of the foregoing officers with three additional members. An Advisory Committee shall consist of one representative of each of the varied interests represented by this association.

##### ARTICLE V.

The constitution may be altered or amended by a two-thirds vote of those present at any annual meeting, a notice of such change having been given to each member of the association in writing at least thirty days before the date of said annual meeting.

##### BY-LAWS.

##### ARTICLE I.

The president shall preside at all meetings of the association; in his absence the vice president shall preside.

##### ARTICLE II.

**Sec. 1.** The duties of the officers shall be such as are common to such officers.

**Sec. 2.** It shall be the duty of the Executive Committee to see that the objects of the association shall be carried out to the best of their ability.

**Sec. 3.** The duties of the Advisory Committee shall be to represent the particular interests with which they are allied in an advisory capacity.

##### ARTICLE III.

##### Membership Dues.

The annual dues of ten (\$10) dollars shall be payable in advance on the first day of November of each year.

All applications for membership shall be made to the Secretary of the association and shall be accompanied by remittance covering the annual dues for the current year.

##### ARTICLE IV.

These by-laws may be changed or amended at any regular meeting of the association by a majority vote of those present.

It was moved and seconded that the chair appoint a nominating committee which should retire and make nominations for officers for the first year. Chairman Herron appointed as such committee J. S. Dort, E. W. McCullough and George Kile. They named J. W. Herron, Jr., for president; E. W. McCullough for vice president; W. A. Snyder for treasurer, and O. B. Bannister for secretary. Mr. Bannister requested to have his name withdrawn, on the plea of not having sufficient time to devote to the work to handle it creditably. The name of F. A. Curtis was substituted, and with this change the nominees were declared unanimously elected.

An executive committee consisting of E. C. Wittner, O. B. Bannister and Peter Lesh was chosen by the new president. This committee was authorized to appoint an advisory committee, which consisted of the following:

Western wheel manufacturers—C. D. Fischer, Wapakoneta, Ohio.

Eastern wheel manufacturers—E. Stinson, Baltimore, Md.

Kim manufacturers—B. F. Von Behren, Evansville, Ind.

Gear manufacturers—D. P. Cooper, Struthers, Ohio.

Shaft and pole manufacturers—W. A. Snyder, Piqua, Ohio.

Wagon manufacturers—E. W. McCullough, Wilmette, Ill.

Spoke manufacturers—Peter Lesh, Memphis, Tenn.

Carriage manufacturers—H. C. Staver, Chicago.

Singletree and neckyoke manufacturers—C. S. Hartwell, Chicago Heights, Ill.

Hammer handle manufacturers—William F. Reuther, Louisville, Ky.

Sucker rod manufacturers—George Kile, Akron, Ohio.

Dimension stock—Lewis Doster, Chicago.

This, closing the work of organization and incidental business to which it had

given rise, the meeting was declared adjourned.

Among those in attendance were:

- E. W. McCullough, secretary National Wagon Builders' Association, Wilmette, Ill.
- George Kile, Sucker Rod Corporation, Akron, Ohio.
- C. S. Hartwell, Hartwell Bros., Chicago Heights, Ill.

## Muck Rake Department.

### The Postal Authorities Step In.

The daily press of Aug. 23 announces that the Tobasco-Chiapas Trading & Transportation Company, an alleged \$2,000,000 shipbuilding, coffee-growing and river-trading Mexican plantation concern, with headquarters at 18 River street, Chicago, and with branch offices in Philadelphia and Mexico City, has tumbled down with a crash. The institution is charged with fleecing 2,800 stockholders out of \$851,000, using 32 per cent of this vast sum to pay dividends which were never earned. On Aug. 22 it was raided by the United States postoffice authorities. Henry D. Bushnell, Chicago, president, and Isaiah B. Miller, Chicago, treasurer of the company, were arrested by a deputy United States marshal on the complaint that they were using the mails to defraud the public. It is said that fully fifty agents of the Tobasco-Chiapas Company claim that they have been defrauded of \$1,000 each and have received no part of the \$200 monthly salary promised them.

The principal complainants are W. S. Sinclair of Boston, and A. L. Ensign, Chicago, who were stockholders to the extent of \$4,000 each. There are forty or fifty other complaints beside the agents. Warrants are also out for other principals in the concern.

Postoffice Inspector William Ketchum, who investigated the affairs of the company and caused the arrest of the officers, puts the case this way:

The government contends that this company secured titles to a piece of land in Frontera, Mexico, and capitalized under the laws of New Jersey for \$1,000,000. The company represented in the mails that it was earning sufficient money to justify it in the last five years in paying dividends amounting to \$2,000,000. Upon these rosy representations it realized \$851,000 in cash sales of stock.

The dividends paid never were earned from the shipbuilding, transportation and coffee industries of the company, and dividends were paid out of sales of stock to induce the public to purchase more stock.

A feature of the game was for the Lu-Me-Ha Mills Company, a subsidiary "coffee" business, to promise agents \$200 a month. When the agents secured jobs they were forced to invest \$1,000 in stock. The agents complain that when they got to the branch office they failed to hear from the house and received no salaries. We also charge that the company produces no coffee on its land, but buys in New York, and only gets its coffee in Chicago by paying for it in advance.

The man Bushnell is also president of a Mexican Plantation Association, with offices at 18 River street, and of the United States Peat Fuel Company, 134 Monroe street. Isaiah B. Miller, it will be recalled from the exposures which the HARDWOOD RECORD has been printing for months past, is one of the powers behind the throne of the Interna-

- J. S. Dort, Imperial Wheel Co., Flint, Mich.
- J. A. Sanford, secretary National Association of Implement Manufacturers, Chicago.
- F. A. Curtis, Vehicle Woodstock Co., Chicago.
- W. P. Nolan, Wagon Builder, New York.
- John W. Herron, Jr., Royer Wheel Co., Cincinnati, Ohio.
- H. B. Holroyd, Washington, D. C.
- D. E. Allen, Wilmette, Ill.
- H. C. Stayer, Stayer Carriage Co., Chicago.
- O. B. Bamister, Muncie Wheel Co., Muncie, Ind.

tional Lumber & Development Company of Philadelphia. These companies named are only a part of the various graft corporations which have been engineered by Bushnell, Miller and John D. Markley of Chicago, in which apparently the public has been fleeced to the extent of millions of dollars.

A sad feature of these "get-rich-quick" enterprises is that the stockholders are generally people of the poorer classes who have invested their savings with the companies in the hope of getting large returns from small investments. All the energies of this crowd have been devoted to the flotation and sale of stock upon which they have declared dividends from stock sales and which apparently never have earned a dollar.

The HARDWOOD RECORD has been aware for months that the International Lumber & Development Company was but one of a chain of kindred institutions that were being handled by this bunch of grafters, but inasmuch as the Philadelphia institution was the only one in which "lumber" was made a basis of inducing stock sales, it felt that it had no right to butt in on enterprises outside of the lumber business. This attack by the federal authorities will undoubtedly end in winding up the entire coterie of Mexican fake enterprises and will involve serious loss to many thousands of credulous investors throughout the United States, and should bring at least deep humiliation to individuals of former high character who have loaned their names and acted as stool pigeons for these deals.

## Hardwood Record Mail Bag.

[In this department it is proposed to reply to such inquiries as reach this office from the HARDWOOD RECORD clientele as will be of enough general interest to warrant publication. Every patron of the paper is invited to use this department to the fullest extent, and an attempt will be made to answer queries pertaining to all matters of interest to the hardwood trade, in a succinct and intelligent manner.]

### What Kind of Trees Are Hardwoods?

LESSLEY, MISS., AUG. 20.—Editor HARDWOOD RECORD: I have been referred to you for an opinion that would be authoritative on the following questions:

Which of the following timbers are strictly hardwoods: Hickory, blue and yellow poplar, white and red oak, elm, hackberry, pine, linn, magnolia, cottonwood, cypress and sweet gum?

If you should buy the right to cut the hardwood timber from a tract of land on which all of these varieties grew which trees would you cut and what authority would you cite in support of your right to do so?

Is there a commonly adopted commercial classification or custom or a technical definition of the terms hardwood and softwood that would govern in such a transaction?

The Mobile Register, Mobile, Ala., of Aug. 23 gives credit to the HARDWOOD RECORD for probing into the affairs of the International Lumber & Development Company for the benefit of the public, which has resulted in the raid of the postal authorities.

Markley, Miller & Co. have been trading at Mobile for some time as "contractors" for the International Lumber & Development Company, but it has been understood that they were the actual promoters of the institution. They have a re-built second-hand sawmill in commission at Mobile, in which they have been sawing mahogany timber secured from the lands of the San Pablo Company in Mexico, which was optioned to the International Lumber & Development Company of Philadelphia. This timber was transported to Mobile by means of a little steamer, either owned or controlled by Markley, Miller & Co.

A petition in bankruptcy has been filed against the Tobasco-Chiapas Trading & Transportation Company, but through some chicanery the information of this step was withheld by the counsel in the case for some days. The liabilities of the company are alleged by the creditors to be more than \$800,000. It is probable that the Bushnell-Miller syndicate has gotten away with such residue as they have not paid out as fictitious dividend earnings. It is understood that these people have been turned loose by the authorities on comparatively small bail bonds, which surely is unfortunate, as their financial operations certainly should be classed with those of Stensland, the Milwaukee Avenue State Bank wrecker, whom the United States government is now attempting to extradite from Morocco.

The only feature of the case that is deplored by the HARDWOOD RECORD is that it could not have secured more prompt action on the part of the postal authorities and thus save many thousands of dollars to innocent and credulous investors.

There is no botanical classification between hard and soft woods, but commercially, all broad leaf trees are recognized as hardwoods, while needle and cone bearing trees are known as softwoods. This distinction is recognized by the government Forest Service, by the lumber trade press and by all lumber associations. The only exception to this rule is cypress, which is a cone bearing tree but is ordinarily classed among the hardwoods, as it is very largely handled by the hardwood trade and its rules of grading, price lists, etc., are published either by exclusive cypress associations or by the hardwood associations.

Thus, among the woods mentioned, hickory, blue and yellow poplar, white and red oak, elm, hackberry, linn (linden), willow,

magnolia, cottonwood and red gum are all classed as hardwoods. Pines of all varieties are classified as softwoods, while as before noted the classification of cypress would, perhaps, be questionable. You can get further information on this classification from Gifford Pinchot, chief of Forest Division, United States Department of Agriculture; from Lewis Foster, secretary of the Hardwood Manufacturers' Association of the United States, First National Bank Building, Chicago; from Frank F. Fish, secretary of the National Hardwood Lumber Association, Rector Building, Chicago; from A. E. Beebe, secretary of the Wisconsin Hardwood Lumbermen's Association, McMillan, Wis.; from Bruce Odell, secretary of the Michigan Hardwood manufacturers' Association, Cabillac, Mich.; from J. N. Pritchard, secretary of the Indiana Hardwood Lumbermen's Association, Indianapolis, Ind.—EDITOR.

#### The Irrepressible McMahon.

PHILADELPHIA, Aug. 27.—Editor HARDWOOD RECORD: We are enclosing a communication just received from J. O. McMahon, which is interesting as an invitation to lumber dealers. We received a communication not long ago from this same party saying that he had a trade among wholesalers, retailers, consumers, builders and everyone else you could think of. We thought perhaps you had a representative in New York who could look up this man and post some of the hardwood mills about the country concerning him.—

Enclosed with this letter from our esteemed Philadelphia correspondent is a wretchedly printed circular letter from J. O. McMahon, "attorney and counsellor at law," 1387 Madison street, Brooklyn, N. Y., in which he says he has calls for the lumber products described within and asks for prices f. o. b. New York, Syracuse and Rochester. Very ingenuously he closes his letter with "do you offer these bargains to the wholesale or retail dealers?" In his communication he alleges that "large dealers in New York have given me their schedules of immediate lumber needs," and he would be happy to connect manufacturers with large dealers in New York "who want to buy what you want to sell." His list of stock includes poplar of all grades, ash, red gum, plain and quartered white and red oak, yellow pine, cypress, spruce, wormy chestnut, soft elm, sycamore, hickory, birch and "any similar kind of lumber."

The HARDWOOD RECORD has never heard of any business that has been transacted by this limb of the law and would-be lumberman, but it is possible that he may break into the lumber trade of New York and cut considerable ice. Other people who apparently had no more lumber sense than he evinces have done so in the past, with success.—EDITOR.

#### Wants Market for Persimmon.

ST. LOUIS, Mo., Aug. 24. Editor HARDWOOD RECORD: We are sawing some persimmon logs at our mills and will ask if you know of any parties who handle this wood.—

The writers of the above letter are among the largest producers of hardwoods in Missouri, and the RECORD has supplied them with the names of a few purchasers of this wood and would be glad to have those who have need of this class of stock supply their address, when it will be furnished to this company. A considerable portion of persimmon goes into export for the manufacture of golf heads and shuttle blocks and is exported in the form of bolts.—EDITOR.

#### Virginia Scrub Pine for Pulp Wood Purposes.

PERCELLVILLE, VA., Aug. 26.—Editor HARDWOOD RECORD: Is there a market for the scrub pine which abounds in this state for pulp wood purposes? The people I buy for use only poplar which is getting scarce in this section. I have asked the parties to whom I ship poplar but they do not seem to know, or if they do will not tell me.—

The above correspondent has been advised that so far as the HARDWOOD RECORD knows there is no market for Virginia scrub pine for pulp wood purposes. There has been a great deal of money spent in experimenting in the use of many varieties of yellow pine for this purpose, but thus far without commercial success, so far as is generally known. The difficulty in reducing yellow pine to pulp seems to be that in eliminating the resinous gums contained in the wood the strength of the fiber is so far disintegrated as to render the resultant product of no value for the purpose. Undoubtedly experiments with woods now unemployed for pulp purposes will eventually meet with success.—EDITOR.

#### Investment in Saw Mills in the United States.

PHILADELPHIA, Aug. 19.—Editor HARDWOOD RECORD: I want to know if you know and will advise me how much money is invested in sawmill plants, including the entire equipment but not including timber lands, in the United States?

The latest available data on this subject is Bulletin No. 203 of the twelfth census of the United States, published June 24, 1902. In table 13 of this report is summarized by states the invested capital in sawmill properties, based on statistics gathered in 1900. In this report the investment in planing mills and timber camps is excluded. The summary alleges that in 1900 there were 31,833 distinct sawmill establishments in the United States, in which there was invested capital of \$395,785,226. It is more than likely that the figures embraced in these government statistics are much below the total sum invested at the present time.—EDITOR.

#### Can Supply Oak, Hickory and Ash.

CRAB ORCHARD, KY., Aug. 20.—Editor HARDWOOD RECORD: In your mail bag section of July 25 is a query from someone who wants 1 to 4 inch first and second oak, hickory and ash, 10 inches and up wide, 12 to 20 feet long. I wish you would have them write me, as I can furnish

more or less of the stock, particularly in oak. Am also able to supply chestnut and red oak ties for trolley line purposes.—

The HARDWOOD RECORD's files fail to reveal the author of the communication referred to and has so advised its correspondent at Crab Orchard. If the writer of the original communication printed in the Hardwood Record of July 25 will kindly supply us his address it will be exchanged with our Kentucky correspondent.—Editor.

#### Wants Market for Magnolia Lumber.

SANDERSVILLE, MISS., Aug. 28.—Editor HARDWOOD RECORD: As a subscriber to your paper I beg to inquire whether you are able and would be so kind as to give me some information on the following: I am sawing a good deal of magnolia, which is very nice stuff. It is hand sawed and kiln dried. Can you tell me the name of some good concern using this class of lumber? It looks to me that it would make a very good substitute for poplar, as it runs very clear and very wide.—

The HARDWOOD RECORD regrets that it cannot at the present time suggest a market for magnolia lumber. Incidentally, it is known that magnolia is a wood of good grade, light in color and soft in texture, that grows in considerable quantity in the Gulf coast country. Throughout Florida, Alabama, Mississippi, Louisiana and Texas there should be a market developed for the wood, and it possibly would make a very good substitute for poplar, cottonwood and basswood. The HARDWOOD RECORD will describe this wood more fully in an early issue, with illustrations, and will analyze its wood physics and the possibilities of its use for a variety of purposes. In the meantime if any reader is interested in experimenting with this new lumber material he will be put in communication with the writer of the above letter on application.—Editor.

#### Wants Cedar for Boat Building.

POSSELDORF, GERMANY, Aug. 16.—Editor HARDWOOD RECORD: We beg to inform you that we have a demand for practically clear white cedar for boat building purposes and would be much obliged if you could put us in connection with a good firm manufacturing this stock.—

I anticipate that your inquiry may possibly be for the white cedar of the north. If such is the case, I fear that you will have considerable difficulty in securing suitable qualities of this wood for boat-building purposes, as it runs rather defective in character. A concern which might be able to supply it is the I. Stephenson Company, of Wells, Mich. If your inquiry is for western white cedar, would refer you to the Simpson Lumber Company, of North Bend, Ore. It could supply both the quality and quantity you require. If your requisition is for white cedar of the lower Atlantic coast, which is known locally as juniper and which is a very excellent cedar for boat-building purposes and the one usually employed by the United States government for its launches, would refer you to the John L. Roper Lumber Company, of Norfolk, Va., or the Richmond Cedar Works, of Norfolk, Va.—Editor.

# News Miscellany.

## New Kiln Drying Process.

The Grand Rapids Veneer Works, Grand Rapids, Mich., have advertised in the *HARDWOOD RECORD* for several issues past: "We guarantee to kiln dry oak in a week by the application of a new scientific principle in your present old kiln."

Z. Clark Thwing, vice president and manager of the Grand Rapids Veneer Works, believes that he has brought to perfection a new and decidedly improved process applicable to old kilns for the seasoning of hardwoods in an entirely satisfactory manner and on an economical basis. Mr. Thwing sends the *HARDWOOD RECORD* two specimens of lumber dried by this system. One is a sample of burr oak, notoriously the most difficult of all oaks to season thoroughly; and the other is a sample of Michigan black ash. From the end of both of these specimens, one-eighth inch sections have been sawed and these thin pieces have been placed on an engine cylinder for an hour and a half. Even after undergoing this intense heat, the test pieces again applied to the ends of the lumber from which they were removed show not the slightest variation from the original pieces.

The specimen of burr oak in question was in the kiln five days and fifteen hours, with the steam off over Sunday. The black ash was in the kiln forty-eight hours. Mr. Thwing is very anxious that the trade should understand what he has discovered in the way of kiln drying and that the results, as compared with ordinary kiln drying, are a little short of marvellous.

The specimens sent by the Grand Rapids Veneer Works would indicate that the process opens the pores of the wood and that the sap, albumen and other properties that contributed to the growth of the tree have been extracted without injury to the wood fibre, as the specimens are soft and have been seasoned flat and straight without the least evidence of checking.

Accompanying the specimen of burr oak is the dial from the recording thermometer, indicating the temperature prevailing in the kiln during the time of seasoning. It indicates that from 3 p. m. on Friday until 6 p. m. on the following Thursday a temperature of 140 to 160 degrees was maintained with comparative uniformity, save that between 3 p. m. on Saturday and midnight of Sunday there was no steam on in the kilns.

From the reputation of the Grand Rapids Veneer Works management and from the specimens showing results of their kiln drying, it would seem that every hardwood manufacturer should be enough interested in this new process to at least investigate Mr. Thwing's claims. The specimens referred to are at the office of the *HARDWOOD RECORD*, and it will be a pleasure to exhibit them to any one interested.

## Annual Meeting Wisconsin Hardwood Lumbermen's Association.

According to the announcement of Secretary A. E. Beebe, made by order of E. P. Arpin, president, the eleventh annual meeting of the Wisconsin Hardwood Lumbermen's Association will be held at the Hotel Elster, Milwaukee, Wis., Tuesday, September 18. The first session will be called at 10 a. m.

It is announced that many matters of importance are to be brought before the meeting and it is earnestly requested that every member of the association be present.

At this meeting will be presented a report showing the quantity of dry and green lumber and the logs now on hand in the state.

This association is one of the most energetic hardwood organizations in the country and is doing excellent work for its members. While Secretary Beebe's invitation does not so express itself, it has been the custom in the past, as it probably will be at the coming meeting, to welcome all hardwood lumbermen, whether members of the association or not, as guests to its conference.

## West India Mahogany Company.

The West India Mahogany Company is the name of a new corporation organized at Belfast, Me., with a capital stock of \$500,000. The

officers of the company are: Arthur Peer, president, Deal, N. J.; Henry S. Park, vice president, Stockton Springs, Me.; G. Foster Sanford, secretary, New York City, and James Wall Clow, treasurer, New York City.

The company owns extensive timber concessions in Hayti, producing mahogany, lignum vitae, Spanish cedar and logwood. The general offices of the company are located in the Broad Exchange building, 25 Broad street, New York City.

## Lumbermen Accused of Fraud.

A local daily newspaper, under date of August 31, announces that Philip Pfeil, president of the Pfeil Hardwood Lumber Company, with offices in the Masonic Temple, Chicago, was arrested on the previous day, charged with having secured \$21,000 on forged bills of lading. The warrant was issued on the complaint of Glen C. Forgy, a capitalist with offices in the First National Bank building.

Pfeil alleges that he is innocent, but insists that he is the victim of a \$21,000 robbery by H. Edwards, manager of one of his plants at Fay Star, Ala. It seems that Forgy advanced Pfeil \$21,000 on bills of lading, calling for lumber of an alleged value of \$25,000. Later, when he presented them, he was informed that no lumber had been shipped and that the bills were forgeries.

Mr. Pfeil is not well known in the Chicago lumber trade, but it is alleged that he has grown old in the lumber business. He does not deny securing the money from Forgy, but claims that this man Edwards has, without his knowledge, stolen the money dispatched him for weekly pay rolls, and in order to temporarily hide his thefts, forwarded him fictitious bills of lading for lumber to cover the amount.

## New Hardwood Operation.

T. J. Ellis & Co., who for some years have been manufacturing cypress lumber, shingles and lath at Hudspeh, Ark., have sold their sawmill and closed up their business at that place.

The concern has purchased 6,000 acres of hardwood timber lands in Bradley and Calhoun counties, Arkansas, near Levitt, Ark., and are now putting in a new Smith, Meyer & Schmier sawmill of 50,000 feet daily capacity at Levitt on the new extension of the Rock Island railroad. The firm will build five miles of logging railroad through their timber, and have bought a new Shay locomotive and logging cars for stocking the mill. They expect to have their mill in operation by November 15. The company's post-office address is Bab, Calhoun county, Arkansas.

## New Kentucky Hardwood Concern.

The Henderson Lumber Company has been incorporated at Henderson, Ky., with \$76,000 capital stock, of which amount one-half has already been paid in. The officers are William E. Elliott, president; G. T. McCain, vice president; C. L. Clay, general manager, and C. K. Elliott, secretary-treasurer. Mr. Elliott, president of the company, is president of the Farmers' Bank of Henderson; Mr. McCain, the vice president, is a well known capitalist of Kentucky; Mr. Elliott, the secretary-treasurer, is a prominent tobaccoist, and General Manager Clay is a well known sawmill operator, having operations on the Green and Pond rivers in Kentucky. The board of directors consists of these gentlemen and John Reichert, a prominent tobacco manufacturer of the state; H. Klemeyer, a large brick manufacturer of Kentucky, with yards at Owensboro, Henderson and Louisville, and James W. Clay, a foremost lawyer of the state.

The company has closed a deal with Russell E. Gardner of the Ozark Coeperage Company and the Banner Buggy Company of St. Louis, Mo., for 7,000 acres of hardwood timber lands in Grant, Cleveland and Dallas counties, Arkansas. The property abounds in hickory, gum, cypress, elm and ash, and there are large quantities of fine white oak. The company will at once begin the manufacture of its hickory timber, which will be disposed of largely to the various concerns in which Mr. Gardner is interested. Early next year the company will erect a modern sawmill on the recently purchased

tract with a daily capacity of 50,000 to 75,000 feet. Headquarters of the Henderson Lumber Company will be maintained at Henderson, Ky., and a mill be kept in operation near Rison, Ark.

## August Building Operations.

The *HARDWOOD RECORD* is indebted to the American contractor, Chicago, for the record of building operations in the chief cities of the United States for August. This list is not as complete as usual owing to Labor Day intervening, but is indicative that prosperity continues in the building trades. While some cities show a falling off, the loss is overbalanced more than two to one by gains. The present showing is exceedingly favorable.

City	August, 1906, cost	August, 1905, cost	Per cent gain	Per cent loss
Atlanta	399,144	254,128	57	..
Bridgeport	364,999	132,150	176	..
Buffalo	374,975	885,055	..	57
Chicago	5,439,175	6,401,150	..	15
Cincinnati	890,740	749,790	7	..
Dayton	28,820	51,625	..	45
Denver	807,316	490,338	65	..
Detroit	1,043,000	945,000	10	..
Duluth	150,778	192,449	..	21
Evansville	112,280	59,955	261	..
Grand Rapids	144,580	149,576	..	7
Harrisburg	118,850	406,525	..	53
Hartford	232,895	343,810	..	32
Kansas City	811,640	1,025,015	..	20
Louisville	424,195	863,373	..	50
Los Angeles	1,476,522	1,414,821	4	..
Milwaukee	854,738	840,577	16	..
Memphis	324,265	274,438	18	..
Mobile	267,161	19,932	1305	..
New Haven	183,197	154,545	18	..
Newark	1,106,386	759,749	46	..
New Orleans	334,573	1,013,906	..	67
New York—				
Manhattan	7,293,050	12,349,263	..	40
Alteration	1,734,996	1,102,227	..	..
Brooklyn	7,312,007	7,165,689	2	..
Mineapolis	1,147,695	684,445	67	..
Omaha	472,750	425,985	11	..
Philadelphia	3,434,405	2,876,200	19	..
Patterson	30,296	180,283	..	83
Portland	717,941	369,154	94	..
St. Louis	2,233,900	1,856,430	20	..
Seattle	754,359	449,778	68	..
Saranton	154,805	286,401	..	46
South Bend	296,177	83,370	256	..
Syracuse	249,275	129,580	93	..
Topeka	70,525	129,800	..	45
Toledo	839,210	255,961	280	..
Tacoma	373,295	205,470	82	..
Washington	1,093,425	954,690	14	..
Worcester	199,920	181,905	5	..
Wilkesbarre	191,312	86,678	122	..

\*A \$209,000 office building is included in the Mobile figures for last month.

## The Hoo-Hoo Annual.

As the *HARDWOOD RECORD* goes to press the hosts of Hoo-Hoo are engaged in the annual meeting at Oklahoma City. Among the notable affairs of this meeting is the production of a spectacular play in three acts, entitled "Hoo-Hoo," written by a founder of the order and that prince of good fellows, Bolling Arthur Johnson. It is with regret that the *HARDWOOD RECORD*, owing to the date of this meeting, is precluded from publishing a full account of it.

## A Unique Booklet.

The Arthur Hardwood Flooring Company of Memphis, Tenn., an extensive manufacturer of oak flooring, is putting out an attractive little booklet bound in the similitude of a piece of three-eighths inch flooring, with covers of oak. It is handsomely printed in red and green, and contains views of the company's main factory and power building, the dry kilns, warehouses and office structure. The little book should prove of great value to users of flooring, as it embraces much information of practical worth. Its contents include a short sketch on how to lay and finish oak floors; a price list; rules for grading oak flooring; a quick computation table, as well as other interesting matter.

The Arthur Hardwood Flooring Company is an exclusive manufacturer of oak flooring. Its plant at Memphis is a model in convenience of arrangement and completeness of equipment. The company constantly studies the best in forests of its customers, a recent evidence of which is the arrangement which has been made

with several of the leading lumber manufacturing concerns of Memphis to ship its flooring in cars with their lumber, thus making it possible for buyers to get less than carload shipments of flooring at carload prices. The perusal of the pages of this novel booklet give truth to the statement made by the company that "Arthur Memphis stamped on a piece of flooring is a guarantee that it is a little better."

#### Snap for Porch Column Builders.

In its manufacture of high-class veneers the Chicago Veneer Company of Burnside, Ky., has as a resultant product several carloads monthly of cores from their poplar logs. These cores are eight and ten inches in diameter and run in lengths of 60, 66, 72, 78, 84, 90 and 96 inches. As they are from the highest grade of poplar veneer logs and are solid heart, they constitute a very desirable basis for their speedy completion into sections or entire porch columns. The Chicago Veneer Company has placed a boring machine in commission at its big Burnside plant and bores these cores with a 3-inch hole to prevent checking, and offers them to the porch column building trade at a price very much below the cost of poplar squares. Only strictly No. 1 cores are bored and shipped.

S. G. Glanton, who represents the Chicago Veneer Company in Chicago, with offices at 810 Great Northern building, will be pleased to call on any of the trade in Chicago or vicinity which is interested in this product.

#### Miscellaneous Notes.

Fire in the plant of the Clarksville Hardwood property to the extent of \$4,000, insurance \$2,500.

The Amory Hardwood Company of Amory, Monroe county, Miss., has been organized by A. G. Thompson, E. D. Emure and others; capital, \$4,000.

The Oval Wood Dish Company of Traverse City, Mich., is making preparations to operate on the hardwood tract north of Hessel, Mich., which it purchased some time ago. It is estimated that there is a ten years' cut on the tract.

The Tuthill & Pattison Manufacturing Company has been incorporated under the laws of Alabama to manufacture and deal in lumber of all kinds, to manufacture special articles of hardwood, also veneers and veneered goods. The authorized capital is \$200,000, of which \$120,000 has been paid in. John R. Tuthill of Florence, Ala., Jesse A. Tuthill of Sheffield, Ala., and A. B. Pattison of Aurora, Ind., are the incorporators. Headquarters will be maintained at Sheffield.

The Rankin Lumber Company of Henderson, Ky., is erecting a large sawmill on the Louisville & Nashville railroad about five miles from Brownsville, Tenn. The company recently purchased what is known as the Shaw tract of timber lands in Haywood county, Tennessee, for \$22,000 cash, and it is this property which the new mill will cut from. Oak, gum, hickory, cypress and poplar are the principal woods on the tract.

A band mill with 200,000 feet daily capacity is being erected at Hampton, Tenn., by the W. M. Ritter Lumber Company of Columbus, O.

Work is being pushed on the erection of the planing mill at Mountain Grove, Mo., which the Ozark Lumber Company is building to replace the one recently destroyed by fire.

The sale of 5,537 acres of timber land in Craighead county, Arkansas, was recently made by Moore & McFerren of Memphis, Tenn., to the Allison Land Company, a concern allied to the Decatur Egg Case Company of Decatur, Ind. The purchase price was \$196,800. The timber on the property consists principally of gum, cypress, white oak, ash and oak, and the tract is unimproved except that Moore & McFerren have cut a small quantity of timber for use in their mills at Memphis. The purchasers will construct a railroad to the tract ten miles long, from Cardwell, Mo., the nearest point.

The Standard Stave & Lumber Company of Charleston, W. Va., has been incorporated by D. E. Matthews, Daniel Matthews and T. C. Matthews of Charleston and J. H. Maxwell, A.

A. Maxwell and J. H. Wagner of Tango; capital, \$50,000.

The Lamb Hardwood Company of Minneapolis, Minn., is erecting a plant to develop a tract of 10,000 acres of timber land.

The manufacture of caskets will be undertaken by B. Tanner of Sturgis, Mich. He will begin work shortly on the erection of a factory there, 30 by 80 feet in dimensions and two stories high, which will be fitted up with new machinery.

The lumber mill and basket factory of the Henry Starke Land & Lumber Company at Arcadia, Mich., was burned to the ground August 3. The loss is estimated at \$100,000, only partly covered by insurance. The company, it is reported, will rebuild immediately.

Geo. Webster & Sons of Swanton, Vt., have purchased a tract of timber land and a sawmill near Malone, N. Y., and will operate thereon this season. The timber on the property includes a variety of hardwoods and considerable spruce.

The Spartanburg Lumber Manufacturing Company of Spartanburg, S. C., has been incorporated with \$25,000 capital stock. Sash, doors and blinds, in addition to lumber, will be manufactured.

A factory building 52 by 150 feet in dimensions and three stories high will be erected by the Waverly Woodware Company of St. Joseph, Mich., for the manufacture of washing machines.

The Wycoff Lumber & Manufacturing Company of Ithaca, N. Y., has been incorporated with \$25,000 capital stock to manufacture portable houses and deal in lumber. Two large buildings are being constructed by the company in Ithaca, which will be equipped with the latest machinery.

The plant of the Eureka Refrigerator Company at Indianapolis, Ind., was recently destroyed by fire, entailing a loss of about \$60,000.

The Burke-Crain Furniture Company has been incorporated at Nacogdoches, Tex., to manufac-

ture furniture; capital stock, \$15,000. Ed Burke is at the head of the concern.

The Weber Brothers Piano Company, Oklahoma City, Okla., has arranged for the erection of a new \$30,000 factory.

T. R. Van Cleave and others have incorporated under the name of the Van Cleave Saw Mill Company at Little Rock, Ark., and will proceed to erect a plant. The capital stock of this corporation is \$15,000.

Wagner & Wiek, Rich Hill, Mo., have begun the erection of an addition to their factory at that place.

With a capital stock of \$100,000, the Houston Casket & Manufacturing Company has been incorporated by John McCallip and others of Houston, Tex. A large factory will be erected.

L. H. Murphy of Chicago, general manager of the American Seating Company, announces that the plant at Wabash, Ind., will be transferred to Chicago.

The Hastings Cabinet Company is a new concern at Hastings, Mich., formed by Lewis D. Waters, who has been interested in the National Woodenware Company of Grand Rapids, Mich. The company has a capital stock of \$30,000, and will erect a large factory.

The Lakeshore Woodworking Manufacturing Company is a new concern, incorporated by William Burney and others, to be located at Vermilion, O.; capital stock, \$25,000.

On Aug. 31 the mill property of the Empire Lumber Company at Empire, Mich., owned by the T. Wilce Company of Chicago, was destroyed by fire; loss, \$60,000.

The Garman Manufacturing Company's hardwood lumber mill at Tacoma, Wash., was destroyed by fire Aug. 24, the company sustaining a loss of \$60,000.

The Highland Carriage Manufacturing Company has been incorporated by Saul Zilonka and others at Elmwood Place, Cincinnati; capital stock, \$50,000.

## Hardwood News.

(By HARDWOOD RECORD Special Correspondents.)

### Chicago.

It is with the sincerest regret that the Hardwood Record makes announcement of the death of F. C. Fischer, the eminent lumber magnate at the head of the Yellow Poplar Lumber Company of Coal Grove, O. Mr. Fischer had been seriously ill at the Auditorium Annex, Chicago, for some weeks and about a month ago submitted to an operation on the nose for catarrhal trouble. The operation itself was not of serious nature, but unfortunately infection of the blood prevailed, and Mr. Fischer's condition rapidly became exceedingly critical. He was later removed to the Johns Hopkins Hospital, Baltimore, where he died Monday morning, September 10. The funeral services will be held at Ashland, Ky., September 11, at 3:30 p. m. Mr. Fischer was one of the most prominent men connected with the hardwood industry, and his unfortunate death will be mourned by a host of friends and business associates.

W. M. Kelly of the Kelley Lumber & Shingle Company, Traverse City, Mich., was in Chicago on business last week and dropped into the Record office on Friday for a friendly call.

John C. Spry of the Southern Oak Lumber Company and an extensive timber land holder of the Chamber of Commerce Building, is expected to arrive home from an extended European trip Sept. 11.

The McCauley-Saunders Lumber Company is the name of a new concern organized with \$50,000 capital stock to engage in the cypress business. The incorporators are Irvin McCauley, D. G. Saunders and John G. Hale. Mr. McCauley has been identified with the Chicago trade for the past three years in connection with the D. G. Saunders Lumber Company, which concern the new company will succeed. The company's offices are in the Fisher Building.

E. W. Pratt, Jr. of the Pratt-Worthington Company of Crofton, Ky., was a Chicago visitor Sept. 3 and made the Record office a friendly call.

C. M. Clark of the Swann-Day Lumber Company of Clay City, Ky., spent a few days in Chicago last week en route home from a trip to

the Pacific Coast and Alaska, and paid the Hardwood Record a welcome visit.

The Record office received a pleasant call on Saturday last from A. C. Fuller, advertising manager of the Hanchett Swage Works of Big Rapids, Mich.

### Boston.

George D. Emery of the George D. Emery Company, Chelsea, made an assignment Aug. 25 to Charles A. Vialle, president of the National Bank of the Republic and a director in the company, and Charles W. Noyes, an attorney. Mr. Emery is a stockholder in the First National Bank of Chelsea, which was recently forced to close its doors. It is stated that Mr. Emery has property enough to more than offset his liabilities. Mr. Noyes has stated that this personal assignment will not affect the company in any way.

F. E. Parker of Mershon, Schuette, Parker & Co. of Saginaw, Mich., is visiting the trade here. Charles C. Batchelder of the Boston Lumber Company is spending two weeks in Malne.

The Associated Lumber Company, Boston, has been incorporated with a capital stock of \$20,000. The directors are Arthur Lyman, Daniel O'Hara and Michael J. Connolly.

The Washburn & Haywood planing mill, Brockton, has been visited by fire, causing a loss of \$15,000. The insurance is placed at \$1,700.

William E. Litchfield left early this week for a trip to Washington and Virginia. Mr. Litchfield recently acquired large timber holdings in Virginia and has gone there in the interests of this purchase.

The William A. Hall Lumber & Fiber Company has been incorporated under Vermont laws with a capital stock of \$200,000. The main offices of this concern will be at Bellows Falls, Vt.

Alfred Ackerman, who for several years has held the position of state forester in Massachusetts, has resigned and has accepted the Peabody Chair of Forestry in the University of Georgia.

The Somerset Timber Company has been incorporated in Maine with a capital stock of \$300,000. The incorporators are: William J. Lanigan, Waterville; Frank E. Boston, Gardi-

ner, and William T. Haynes and Luther O. Soper of Waterville.

Charles Holyoke, dealer in hardwood lumber, has removed to his new office, room 407, 147 Milk street, Boston.

Frederick Jeffs of Worcester, Mass., died at his home Aug. 28, at the age of 81 years. Mr. Jeffs had the reputation of being the first manufacturer in the country to make solid hardwood doors. He first came into notice in this respect by securing a contract for 700 doors at the time that Wellesley College was built. At that time a contract was given for 700 doors to be made of pine and hardwood veneer. Mr. Jeffs agreed to furnish solid ash doors for less than the veneer doors and in this way secured the contract. Late years the style of the firm has been F. Jeffs & Sons. He is survived by two sons, Orlando A. and Elmer F.

**New York.**

W. M. Ritter, the distinguished hardwood manufacturer of Columbus, Ohio, president of the W. M. Ritter Lumber Company, sailed from this port on August 30 for an extended European trip.

Secretary Lewis Doster of the Hardwood Manufacturers' Association of the United States, with headquarters in Chicago, has been visiting in the city for several days in connection with association affairs, after a visit to his mother at Ridley Park, Pa. While here he conferred with W. M. Ritter, the big hardwood operator of Columbus, previous to the latter's departure for Europe. He reports association matters in excellent shape.

The J. C. Turner Lumber Company, 1123 Broadway, is receiving big cargoes of cypress at its Irvington yards and has piled up in the neighborhood of 40,000,000 feet for the fall and winter trade. The company has also just purchased 325,000,000 feet additional stumpage in the South, bringing its total holdings up to a billion feet.

C. A. Murray, who has been conducting a wholesale business at 18 Broadway for several years, has assumed management of the hardwood department of J. S. Barron & Co., city, effective Sept. 1.

Franklin Greenwood, manager of the Cypress Selling Company, New Orleans, has been in town several days interviewing the various representatives of the company in this territory. He was accompanied by Mrs. Greenwood.

W. M. Crombie of W. M. Crombie & Co., 81 New street, sailed for Europe on Aug. 21 with Mrs. Crombie for a five weeks' trip.

James Green of William Green's Sons, Brooklyn, is back from a stay at Sound Beach, Conn.

L. G. Jones, the venerable wholesaler of Avenue D and Tenth street, is on a European pleasure trip and is expected home on the 15th.

Frank P. McNulty, who has been associated with Price & Hart of this city for some years, has joined forces with the hardwood department of the Stevens-Eaton Company, 1 Madison avenue, and will assist T. S. Miller in the management of that branch.

Gardner L. Jones of the Jones Hardwood Company, Boston, and J. W. Dickson of the J. W. Dickson Lumber Company, Memphis, Tenn., have been here visiting the trade during the fortnight.

**Philadelphia.**

The annual baseball game between teams of the Lumbermen's Exchange of Philadelphia and the Builders' Exchange was played August 30 and resulted in a victory for the lumbermen by a score of 8 to 1. The proceeds of the game were divided between the Children's Country Week Association, the Red Bank Sanitarium and the Sterilized Milk Association. The contest this year yielded over \$500, making the total amount contributed by the games almost \$5,000. John J. Rumbarger, manager of the lumbermen's team, received many congratulations on the good showing made by his side in the game.

On Thursday, August 30, a special meeting of the board of directors of the Lumbermen's Exchange of Philadelphia was held to take action on the seven new candidates proposed for admission. The committee on membership reported favorably on all names and all were elected to membership. The first regular meeting of the board of directors in the new location

took place on September 6. The occasion was made a house warming and a lunch was served to those in attendance almost the full membership of the association. Since the removal of the Exchange up town several innovations looking to the comfort and benefit of the members have been inaugurated. A roster has also been established for the purpose of registering the names of visiting lumbermen, who are invited to make the Exchange their headquarters while in town, meet their friends there, and attend to their mail.

The midsummer statement of the Pennsylvania Lumbermen's Mutual Fire Insurance Company reveals the splendid financial condition of that institution and reflects great credit on the working force and directors. The resources of the company are:

Approved stocks and bonds (cost).....	\$182,147.11
Cash in banks on interest.....	31,979.83
Cash in office.....	170.65
Cash value reinsurance policies.....	951.56
Premiums due.....	11,668.46
	\$227,217.61
Contingent assets.....	431,477.28
	\$658,694.89
Liabilities: Estimated loss.....	200.00
	\$658,494.89
Insurance in force, \$6,608,955.15.	
Premiums in force, \$143,825.76.	

The Philadelphia Hardwood Lumber Company experienced in August one of its best months. H. N. Pattison is now down in Virginia looking after the shipments of the company at the mills.

John Schofield of Schofield Bros. is spending some time in the South looking over a timber tract in which his firm is interested. He will return in two weeks and again take charge of his end of the business.

C. M. Hawkins, one of the buyers for the Rumbarger Lumber Company, is in town conferring with his firm. Mr. Hawkins is being transferred from the Norfolk & Western to the West Virginia and Pittsburg division of the Baltimore & Ohio. He will have his headquarters at Burnsville, W. Va.

J. D. Miller, for a long time in business in Philadelphia but who two months ago took up headquarters at Baker's Mines, Va., was a welcome visitor to the trade during the last week.

Samuel H. Shearer of Samuel H. Shearer & Son is back from his vacation and again at business with his customary energy. The company has had a very prosperous season and looks forward to a greatly increased trade in the fall.

William H. Fritz has returned from an extensive trip through the South, where he spent his vacation, combining business with pleasure. During his absence Mr. Fritz visited mill points and made arrangements for future trade.

Joseph P. Dunwoody has returned from a trip to Boston on business for his firm. S. Y. Warner has lately returned from a short vacation in the South. Business with this firm has been good during the summer and prospects for a brisk fall trade are bright.

**Baltimore.**

There is an animated fight in progress between D. W. and G. H. Thomas, building contractors, on the one hand and Building Inspector Preston on the other. It was caused by a dispute over the maple flooring being put down by the contractors in the new Eastern High School. Mr. Preston contended that the flooring did not come up to specifications, and that it lacked uniformity in color. The contractors protested that the flooring was of the quality called for in the contract, and maintained that inasmuch as the floors were to be stained, the color of the wood made no difference, since after staining all would look alike. The upshot of the matter was that the building inspector has served notice on the firm that its contract was cancelled, which he said he had a right to do under the ordinance providing for the erection of the school, the firm having refused to take up the flooring and relay it, as demanded. The dispute of course will not end here, but will be taken

into the courts. The outcome is awaited with much interest since the decision will go far to determine just what constitutes No. 1 maple flooring.

R. P. Baer & Co., hardwood dealers and manufacturers, have moved from the Knickerbocker Building to the Keyser Building, where they have secured a fine suite of rooms on the tenth floor. The change leaves only Price & Hould in the Knickerbocker Building of all the lumber firms once there. M. S. Baer of R. P. Baer & Co., has gone on another extended southern trip, which will take him as far as Mobile, where the firm is interested in a sawmill.

The Baltimore Lumber Exchange held its quarterly meeting Sept. 3, in the Merchants' Club. A large number of the members were in attendance and considerable routine business was transacted. The exchange considered the ear equipment case, and decided to make a further contribution to the fund to give practical equipment tests.

Word has been received here that A. Temple Dobell, son of Alfred Dobell, and Mr. Ravenscroft of the Liverpool firm of Alfred Dobell & Co., have sailed for New York and will make an extended tour of the United States and Canada. They will first go to the Dominion and afterward visit the states.

J. K. Painter, secretary of the R. E. Wood Lumber Company of this city, was on a tour of Pittsburg and other northern cities recently and placed a considerable number of orders for stocks. Last week he went on a short visit to his mother.

Some of the exporters here have received notice that the Norfolk & Western Railway will issue no more through bills of lading until various points embodied in the new Hepburn rate law have been determined by the Interstate Commerce Commission. The decision of the railroad will cause serious embarrassment to shippers along the line.

Richard W. Price has been appointed co-receiver of the Hiss Company, manufacturer of fine furniture, which got into the bankruptcy court not long ago. The other receivers are Milton R. Williams and Charles D. Fenhagen, the latter of the International Trust Company. The liabilities of the company are placed at \$161,000 and the assets at \$140,000. The latter are expected to undergo an increase, as the company has various profitable contracts in hand.

S. Vold Peterson, son of Laur O. Peterson, a well known lumber importer at Copenhagen, has opened an office in the Carroll Building, this city, and established connections with various hardwood firms here as well as in other cities with a view to making purchases of lumber for his firm. Mr. Peterson first came to Baltimore on a visit and then decided to establish regular headquarters. He is expected to remain here for some time.

**Pittsburg.**

The Nicola Lumber Company is considering several very large timber propositions and may close the purchase of one or more tracts this year. George W. Nicola, president of the lumber company, is enthusiastic in his survey of the field this fall and looks for some record breaking prices for hardwoods before spring.

Willson Brothers are pushing their hardwood business with the kind of vim that means success. Manager E. F. Balsley of the hardwood department has introduced some new methods with striking success, and bids fair to roll up a big total of sales the next four months.

The contest between the planing mill owners and their carpenters is still unsettled, although many of the mills in Allegheny county are working. The carpenters have made one concession in their demands. When they went out in May they asked 84 for eight hours, instead of 83.50 for nine hours, which they then received. Finally they agreed to take 84 for nine hours, but their employers are exercising their right to use the merit system in employing carpenters and do not bind themselves to recognize the carpenters' brotherhood. Some 300 planing mill carpenters in the county are now being carried on the "leaver" of the brotherhood at \$12 a week.

The Kendall Lumber Company has within the last week cleaned up its entire stock of hardwood



at its plant at Crellin, Md. Most of the lumber went into the eastern market. One of the last orders booked by the company was for ten carloads of eight quarter sound wormy chestnut, for which they received \$1 more than the list price. This was for western delivery. J. H. Henderson, secretary of the company, has just returned from an extended trip to the Pacific coast.

W. E. Terhune of the W. E. Terhune Lumber Company is in the East on business.

J. J. T. Penney of J. E. McIlvain & Co. is now in West Virginia replenishing the stocks of the company.

The Ohio Lumber Company, which was formed two years ago with a capital of \$60,000 by the Kendall interests, is making itself felt at Ohio-pyle, Pa., where its big operation is located. It recently bought 1,800 acres more of hardwood timber land, making over 5,000 acres at this point. Its circular mill is now cutting about 40,000 feet a day, most of which is white oak. This lumber is handled at Ohio-pyle by D. H. Horton, secretary of the company, and much of it gets into the Pittsburg market.

The Cheat River Lumber Company is getting its new mill at Burkeville, Va., in good shape and is shipping three cars of hardwood a day from that point. Much of this is hickory which goes chiefly to Ohio towns. Robert Herberston has just returned from the mill, where he went to get his brother, M. L. Herberston, who was confined there with malarial fever.

The C. P. Caughey Lumber Company last week bought a small tract of virgin white oak timber on the Panhandle railroad in Washington county, which it will cut off shortly.

Members of the Flint, Erving & Stoner Company are still absent on their vacations. J. B. Flint's family is still at Lake Simcoe in Ontario, Can.; E. H. Stoner is taking a canoe trip through Canada and R. H. Erving with his family is at his summer home at Lake Baumaris, Ont. Mr. Flint has been at the company's big operation at Dunlevie, W. Va., most of the time for the past two months. Over 200 men are now employed there, many of them on the fifteen miles of railroad which the company is building to connect its big tract with its mills. The tract is said by experts to be the finest in the Mountain state, as it is nearly level, making the cost of stocking the logs fully \$1 less than at most of the plants in that vicinity. The company will shortly build a score or more of houses, as its twenty-six dwellings in the town are not sufficient to care for the help in the winter.

The Paine Lumber Company, Ltd., whose local manager is J. W. Anderson, is forging to the front. It has just opened four new stocks of its famous "Korelock" doors, at Butler, Pa., Altoona, Pa., Charleston, W. Va., and Huntington, W. Va. Three more agencies are to be started shortly.

The American Lumber & Manufacturing Company has just bought 1,500,000 feet of soft yellow cottonwood to be cut under contract in Indian Territory and distributed to its trade generally. The wide boards will go to wagon manufacturers and the common stock to implement makers. The American has lately added to its list of helpers. Charles Crookshank, formerly sales manager for S. F. Minter of New York, who will be assistant hardwood manager. J. G. Darling, manager of the hardwood office of the American at Baxter, Tenn., dropped off in Pittsburg a few hours last week.

### Buffalo.

A. J. Elias visited the city councilmen in their first September meeting, but only in a social sort of way. He came to introduce his friend, Bird S. Coler, president of the borough of Brooklyn.

O. E. Yeager is looking closely to his assortment of birch and maple, as they are found to be the two woods that can be used most readily in place of the others that are getting so scarce.

There is business in plenty on both sides of the specialties of T. Sullivan & Co., ash and elm coming down the lakes and Washington fir coming east from the Pacific coast. Brisk demand is the rule all along the line.

H. A. Stewart is off south again, looking after oak and cherry for his firm of I. N. Stewart & Bro. From Pennsylvania southward he is al-

ways able to find enough to provide a fine yard assortment.

A. W. Kreinheder is still detained here by sickness in his family and is hardly expected to attend the Hoo-Hoo annual at Oklahoma City. He is also booked for the Kentucky mills of the Standard Hardwood Company.

There is always a good lot of lumber coming up from the South for the yard of Beyer, Knox & Co., so that the active sales do not reduce the assortment. Trade has been good all summer.

Manager Hopkins, with his landed interest in the Isle of Pines, is naturally much interested in the Cuban rebellion, but he sticks to his desk and works on the problem of getting oak and selling it for Scatterd & Son.

A. Miller is getting hold of a large amount of elm and basswood from the West, which he finds to be very good sellers again, after some time of slow movement on account of high mill prices, basswood leading as yet.

The Buffalo Hardwood Lumber Company is getting lake cargoes of birch in for yard stock and finds that both inch and five-quarter maple is a good seller. It looks as though the demand for maple was going to be heavy.

The Hugh McLean Lumber Company is still able to report an assortment of ash and chestnut in yard, though it is not as large as it might be, as the demand for both always exceeds the supply unless great effort is made.

H. S. Jones is again in Arkansas looking after the lumber interests of the Empire Lumber Company, which are in fine condition. The plan now is to push southward into Louisiana and extend the company's railroad that way.

The Hardwood Lumber Exchange is preparing to resume its weekly meetings this month, though the business is so nearly social in character that no regular reports of the proceedings are given out. There are a dozen interests in the Exchange and a very solid body is thus made up.

### Saginaw Valley.

The two sawmills of Kneeland-Bigelow Company and the Kneeland, Buell & Bigelow Company at Bay City require fifty-five carloads of logs every twenty-four hours to keep their saws in motion. Bliss & Van Auken are manufacturing 8,000,000 feet of hardwood logs this year, and W. D. Young & Co. consume hardwood logs enough to produce 19,000,000 feet of manufactured lumber. This firm is to install a band resaw in its plant, which is worked day and night. A good portion of the maple is worked up into flooring, the firm having a large business in this commodity, shipping a good portion of the output abroad. It finds the flooring trade satisfactory this year both as to price and demand. The raw material comes from the vicinity of Vanderbilt on the Mackinaw division of the Michigan Central.

The Kneeland-Bigelow Company will operate five logging camps this fall and winter and Frank Buell, who logs for the Kneeland, Buell & Bigelow Company and others, will operate eight camps.

The S. L. Eastman Flooring Company will manufacture 12,000,000 feet of hardwood this year, a good portion of which goes into flooring. Mr. Eastman has disposed of his interest in the Mershon, Schuette, Parker & Co. syndicate and is devoting himself entirely to his own hardwood business, which is remarkably successful.

The Batchelor Timber Company started its sawmill at West Branch last week. The mill was purchased last spring of the Gale Lumber Company, the latter having exhausted its timber holdings tributary to the mill. The purchasers made extensive repairs, amounting almost to a rebuild, and have a ten-year cut for the mill in sight. All of the members of the firm reside in Saginaw and were cradled in the lumber business.

The H. M. Loud's Sons Company of Au Sahle has bought a four-fifths interest in the sawmill property of Paul H. Hoeft at Rogers City, and several thousand acres of hardwood timber in Presque Isle county. The new company to be organized to take on this business will not become effective until September 2, 1907. A logging railroad will be built meantime. The object of the postponement is to enable Mr. Hoeft to clean up a lot of logs and lumber and

odds and ends of timber not included in the deal. The Louds are putting a lot of hardwood lumber on their docks at Au Sahle.

### Grand Rapids.

A new Michigan corporation is the Wisconsin Tie & Pole Company of this city; capital, \$25,000. The officers are as follows: President, C. A. Phelps; vice president, W. A. Phelps; secretary and treasurer, C. C. Tuxbury. The company will operate in northern Wisconsin. Secretary Tuxbury is now at Hackley, Wis. C. A. and W. A. Phelps are respectively manager and president of the Hackley-Phelps-Bonnell Company of this city.

L. L. Skillman of the Skillman Lumber Company left this week on a short buying trip south.

George A. Loud of Au Sahle has been renominated for Congress in the Tenth district.

### Milwaukee.

State Senator Daniel E. Riordan of Eagle River will on October 1 assume the office of secretary-treasurer of the G. F. Sanborn Company of Ashland. The company has a sufficient supply in sight to keep its mills busy for years. It recently completed a deal in timber lands involving upwards of \$400,000. Senator Riordan, to enable him to devote all his time to his new duties, has given up his position as counsel for the North-Western railroad.

The new dry kilns of the John Schroeder Lumber Company, which will increase its output almost 100 per cent, are fast nearing completion. This firm is having a steady run on hardwood flooring this season. Other manufacturers are also reporting increased demands, due to the fact that many building contracts are nearing completion.

### Bristol.

The W. M. Ritter Lumber Company of Columbus, O., which recently purchased the big double band mill of the James Strong Lumber Company in South Bristol, has dismantled same and shipped it to Baum, W. Va., where it will be operated. The mill has a daily capacity of 150,000 feet. The company is preparing to operate extensively in Carter county, and has purchased a large boundary of timber land on Tiger Creek. A big band mill is being put in at Hampton, near Elizabethton, and a railroad from Elizabethton to Hampton, a distance of eight miles, and from Hampton up Tiger Creek to the timber lands, a distance of twelve miles, is being built. W. M. Pryor of Avondale, W. Va.; E. H. Mortimer of Panther, W. Va., and George W. Litz, also of Panther, were in the city this week en route to Hampton to look over the situation. The company now has about five hundred men at work on the mills and railroad and hopes to have same in operation by Jan. 1.

James A. Stone of the Stone-Huling Lumber Company has returned from a business trip in the interest of his company.

B. B. Burns of the Tug River Lumber Company has returned from an important business trip.

H. W. Neily, who has been manager of the Lumbarger Lumber Company of Philadelphia in this section for some years, has resigned his position to become associated with George H. Mell of Kane, Pa. Mr. Neily will have headquarters at Mountain City, Tenn. Mr. Mell is operating extensively in eastern Tennessee and in Mitchell county, North Carolina, and has mills at Swanannoa, N. C.

### St. Louis.

Capt. C. F. Liebke of the C. F. Liebke Hardwood Mill & Lumber Company, who has been slight seeing at Colorado Springs, returned home Aug. 23, much refreshed with his month's tramp over the mountains.

William H. Steele & Hibbard, who has been up in Michigan for a month, returned Aug. 25.

George W. Stoneman, who has been suffering from an attack of malaria, has again taken up the business cares of the Stoneman-Zearing Lumber Company.

E. H. Luehrmann of the Chas. F. Luehrmann Hardwood Lumber Company has returned from Mackinac Island, where he spent his vacation. Thomas W. Fry of the same concern has been



at New Orleans and other southern points during the last month and is expected home in a few days.

R. J. O'Reilly, vice president of the Mosberger-O'Reilly Lumber Company, has returned from quite an extended pleasure trip along the eastern coast of Massachusetts. Mr. O'Reilly also visited at several points in New Jersey.

The Druhe Hardwood Lumber Company reports a rush of trade for July, with a fallback to normal conditions of trade for August. The company's mill at DeKalb, Tex., has been running to its limit this season. They handle ash very largely, but also handle cypress lumber to some extent, and report that they are supplied with nearly a million feet of the Louisiana product.

The Lothman Cypress Company reports that it is quite satisfied with trade conditions in the cypress line. Not only has there been a heavy demand for stock from tank builders, planing mills and sash and door factories, but there has also been a heavy demand from the yard trade.

C. E. Stridler, until recently engaged in the hardwood lumber business in this city, but now of Alhambra, near Los Angeles, Cal., where he is engaged in the real estate business, was in St. Louis the latter part of last month on business connected with the winding up of his affairs here. The company which bore Mr. Stridler's name has been succeeded by the Krug Lumber Company, with Louis C. Krug, formerly vice president of the Stridler concern, as president. The new company continues business at the address of the old company, North Market and Main streets.

W. W. Dings, secretary of the Garetson-Greaseon Lumber Company, reports unusually good trade conditions in the hardwood lumber line this season. There is a "rift within the lute," however, or, more properly speaking, two of them. The first is that the car supply is very inadequate, and the second is that his company's mills are located in the "wet belt," the rains greatly interfering with the company's manufacturing operations. Complaint comes in from several districts in the South, particularly from points in Arkansas.

Theodore Plummer, president of the Plummer Lumber Company, reports that business has increased twenty per cent over that done by the concern last season. The company has found trade conditions unusually good during this season right here in St. Louis, there being a heavy demand for their specialties, cypress and poplar. Mr. Plummer is sanguine concerning the prospects of the trade for the fall, though he, too, looks for a shortage on cars.

A. Hader, whose operations in the hardwood lumber business are confined to the local trade, particularly the box factories, has returned from a trip to Paradise, Mo., where he owns a small saw milling plant, and reports having made contracts with two outside mills for 4,000,000 feet of hardwood stock. Mr. Hader recently filled an order from one of the box factories for 1,000,000 feet.

### Nashville.

E. F. Dodge of the P. G. Dodge Lumber Company of Chicago was here during the past week looking after the opening of a small distributing yard in North Nashville.

Harold Greene, son of M. F. Greene of the Davidson-Benedict Company, and who is in charge of its Vine Hill yard, will be married on September 26 to Miss Marguerite Winsted, a young lady who has a host of friends and is one of the city's most talented musicians.

John Baskette, general manager of the Prewitt-Spurr Manufacturing Company, was one of the prominent business men of the city to attend the exercises held at the Nashville Board of Trade on September 1, when Nashville's annexation bill went into effect. On that occasion a solid mahogany key, two feet long, with silver plates on either side bearing appropriate inscription, was presented by President Hume of the Board of Trade to Mayor Morris. The key was made by the E. & N. Manufacturing Company, Nashville's leading interior finish and woodworking plant, and was the gift of Hillary Howse, a member of the big furniture firm of Howse Bros. on Broadway.

Nashville lumbermen are not much worried over the annexation of new territory by the city. Many big plants which had heretofore not

paid city taxes will now have to come to time. It has been held in Tennessee, however, that lumber itself, being a product of the soil, cannot be taxed before it is manufactured into something. This is why the dealers are not apprehensive about greatly increased tax receipts. The city now embraces seventeen square miles, has a population of about 140,000 and practically every big lumber concern in the county is now in the city limits.

The Bradford Wholesale Furniture Company has been incorporated with a capital stock of \$100,000. The concern has a big salesroom on Broadway, and two factories, one at Baxter, Tenn., and the other at the crossing of the North Carolina & St. Louis railway tracks and Twenty-second street.

John B. Ransom and family have gone for a trip to Denver and the West and returning will go East for about a month.

R. W. Haralson & Son's saw mill at Brownsville, Tenn., says a special to Nashville, was destroyed by fire recently. The origin of the fire is unknown. Loss \$3,500, no insurance.

Samuel A. Epperson, formerly a prominent manufacturer, died recently at his home in Theta, Tenn. He was known as the organizer of the Nashville Spoke & Handle Factory and won an enviable business reputation. He leaves five children.

The John B. Ransom Lumber Company is sawing some hackberry timber now, and using it in place of linn or basswood. Hackberry is plentiful in the South, and formerly was used only for stove wood. It is tough, but not particularly hard.

The Nashville Hardwood Flooring Company recently sold to the Warfelo Cotton Mills 40,000 feet of beech flooring and 20,000 to the hippodrome skating rink. Many of the mills are now using beech in place of maple and the experiment is proving most satisfactory. It takes a pretty polish and of course is cheaper.

John W. Love of Love, Boyd & Co. has quite a party of Nashville visitors at Markland, Nova Scotia, where is located his summer home.

### Minneapolis.

The annual sale of state timber for Minnesota will be held at the state capitol on October 11 at 10 o'clock a. m. It will be conducted by State Auditor Iverson, who will be able to furnish lists of all tracts to be offered for sale after September 17. The selections are now being made.

E. Payson Smith of the Payson Smith Lumber Company has returned from his southern trip much improved in health. The force of the Payson Smith Lumber Company is being expanded by the addition of new buyers, who will provide a larger stock for the company's customers. C. L. Schaab has entered the employ of the company as a southern buyer and will travel through southern hardwood districts picking up stocks. H. L. Le Duke of East Prairie, Mo., has also joined the staff as a buyer and will cover some river territory. W. J. Welsh, an experienced hardwood man, will represent the company in Wisconsin, buying northern hardwood. George S. Agnew will also represent the company in this city and on the road.

The Industrial Lumber Company, which located here in the summer, has closed its offices. The company had stocks of two yellow pine mills in Louisiana to offer the trade, and also had hardwood connections.

C. F. Osborne of Osborne & Clark says they are enjoying a fair trade right along from the retail yards, but factory business is rather quiet. There is demand for everything that is scarce, but birch is rather quiet yet. He looks for a first-class fall business.

I. P. Lennon of I. P. Lennon & Co., wholesalers of hardwood and hemlock, says trade in the manufacturing centers is rather slow just now, but there is a good prospect for fall business and a scarcity in most lines of hardwood.

W. H. Still of the Minneapolis Lumber Company says that nearly all its hardwood output is sold on contract, so it is not rushing business much. He expects to see a good business this fall with rising values.

### Cincinnati.

The list of standing committees for the Cin-

cinnati Lumbermen's Club has been completed by President Moffett and he has made a very wise selection.

The trade is awaiting with interest the outcome of a suit filed at Martha, W. Va., last month by Cole Blankenship & Co. of Cox's Landing, O., against C. Crane & Co. The plaintiffs alleged that the Crane company had the Guyan River obstructed with logs in such a manner that they could not send timber to their mill, only \$300 is involved, but on the court's finding will hinge the right of log men to have logs in the river.

Additions to the plant of the M. B. Farrin Lumber Company will be completed shortly and will give the company a greater capacity. Their present business is in excellent shape, according to Mr. Farrin.

Improvements and additions are being made by the Wilborg & Hanna Company, which will materially facilitate the concern's mammoth business. Several new storage yards have lately been acquired.

The police on Aug. 25 captured a man in the offices of the Bosken Lumber Company in Cumminsville, who had a kit of safeblower's tools in his possession and therefore his capture before he did any damage was fortunate. The Bosken company is experiencing great success with its new veneer mill.

The Evans-Rendig Company has begun business on Reading road, taking over the business conducted by Benjamin Evans. George R. Rendig and Benjamin Evans have charge of the new company.

The J. M. Asher Company, formed several weeks ago by J. M. Asher and others, has opened offices and yards at Bank street and Western avenue. It has excellent railroad facilities and its business is in a healthy state.

A. L. Stone of the Nicola, Stone & Meyers Company of Cleveland, O., visited the local office for several days recently.

The W. H. Perry Lumber Company has been organized in this city by W. J. Perry, William J. Reilly, Walter E. Johns, H. K. Blum and Frank A. McGee.

Thomas J. Moffett, president of the Maley, Thompson & Moffett Company, is back from a fortnight's trip to New York. Mr. Moffett visited the company's New York office.

The H. L. Mickle Company, A. M. Lewin & Co. and Harry Brown, lumber dealers in this city, have filed an involuntary bankruptcy petition in the Federal Court at Covington against the Newport & Dayton Lumber Company of Dayton, Ky., whose plant was destroyed two months ago by fire. Sale of property which the defendant advertised has been prevented by injunction. The assets amount to about \$2,000 and liabilities \$8,000.

The Bacon Lumber Company has removed its offices from Cincinnati to Bastroup, La., where their holdings are located. L. A. Bacon is president of the company.

### Memphis.

The vigorous movement inaugurated by the Lumbermen's Club of Memphis against the new minimum weight basis of the Missouri Pacific system and the earnest cooperation of organizations have resulted in a pronounced victory. Everything was being arranged for a conference between the committees of the lumber organizations and the officials of the Missouri Pacific system, when advices were received from St. Louis that the Missouri Pacific had decided to restore the old basis of minimum weights, effective October 1. The Cotton Belt route has taken similar action, also the Rock Island.

The St. Louis Southwestern (Cotton Belt) railway, Missouri Pacific and Rock Island systems have followed the lead of the Frisco system in the issuance of amendments to their tariffs calling for a charge of \$5 per car for the changing of destination of cars of lumber while in transit, etc. This circular was published in full in the HARDWOOD RECORD immediately after it went into effect June 20. There is still some protest against this circular, but the trade appears to understand it better than at first and it is probable that no official action will be taken thereon, at least for the present.

The export rate situation is in the same position as when the new rate bill went into effect and where export shipments of lumber are being made they are on local bills of lading to the ports and thence on ocean bill of lading. The cotton men are protesting vigorously against the withdrawal of the through bill of lading and a committee has been appointed by the Memphis Cotton Exchange to appear before the Interstate Commerce Commission at Washington September 12, when a ruling will be made by that body in regard to export shipments of this commodity. Lumbermen here are awaiting with interest the outcome of this meeting, because they feel that the ruling of the commission with respect to export rates on cotton will be broad enough to cover shipments of lumber to foreign countries. The plan of shipping on local bill of lading entails considerable delay in drawing against foreign shipments of lumber, because it takes from three to five weeks to get the ocean bill of lading back to Memphis, which will prevent drawing against these shipments for that or a greater length of time.

The Patton-Tully Transportation Company, capitalized at \$100,000, has been granted a charter under the laws of this state. The incorporators are: L. E. Patton, C. J. Tully, S. B. Anderson, C. E. Patton and H. B. Anderson. Mr. Tully is vice-president of the Anderson-Tully Company; S. B. Anderson is president of the same company, and L. E. Patton is a prominent steamboat man of wide experience. The company is already doing business, but will purchase more boats and enlarge its scope of operations. It will handle both freight and passenger business and will make a specialty of purchasing timber and hauling it to various points along the Mississippi. Messrs. Anderson and Tully are the principal stockholders in the Memphis Barge & Towing Company, which has played an important part in the handling of river business of the Anderson-Tully Company.

The Brown-Henderson Improvement & Timber Company of Nashville, Ark., has closed a deal with the Dierks Lumber & Coal Company for all the holdings of that firm east of the Sabine river and south of the Center Point & Lockesburg road, consisting of the timber on 5,000 acres of land, also 500 acres of land and the timber thereon. The consideration was approximately \$27,000. The purchasers announce that they will establish a large plant at Nashville, Ark.

George C. Ehemann of Bennett & Witte returned a few days ago from Cincinnati, where he visited his mother, and the home office of his firm. He has since left for a business trip to Cairo, Ill.

S. C. Major of the S. C. Major Lumber Company returned a few days ago from an extended trip to northern and northwestern lumber consuming centers, and is now looking after the interests of his firm in Arkansas.

J. W. McClure of Thompson & McClure is spending the week in Arkansas.

L. B. Lesh of Lesh & Matthews of Chicago is in the city.

C. W. Stover, who went East some time ago to look after the flotation of the bond issue of the Corner Stone Lumber Company, capitalized at \$200,000, has returned to Memphis.

W. W. Knight of the Long-Knight Lumber Company, Indianapolis, and chairman of the inspection bureau of the National Hardwood Lumber Association, is here looking for lumber for his firm.

### New Orleans.

The first cargo of African mahogany that has ever come through the port of New Orleans will arrive here next week and will be shipped from here to the C. C. Mengel & Bro. Company of Louisville. This announcement was made two or three days ago by H. W. Mengel of this company, who was in the city. The company has been shipping mahogany from Central American points through New Orleans for several years, but has never before brought its African timber through this port. In a short interview regarding the shipment of this mahogany Mr. Mengel said: "We have secured extensive concessions along the gold coast in Africa and as an experiment have chartered a ship carrying over 1,250,000 feet of mahogany to come to this port. If

the experiment is a success we will establish a regular line from Africa to New Orleans. It is also the intention of my company to bring mahogany from the Congo Free State through this port if it is possible to arrange it. In the past the only way in which we have been able to get this lumber has been through the brokers in Belgium, and the Belgian government has taken almost all the profits. We want to branch out and secure all the mahogany lands we can and we expect to ship most of our timber through New Orleans." Besides its African concessions the Mengel company holds titles to extensive mahogany lands in British Honduras, Yucatan and other Central American countries.

One thousand mill employees are out of work and seven big Lake Charles plants are idle as the result of a strike which occurred in that district Sept. 1. The strike immediately followed the refusal of the mill owners and operators to grant to the men a ten-hour day and a weekly pay day. They are now working eleven hours per day. Perfect organization is said to exist among them and it is stated that they will hold to the last for their demands. So far only one of the mill owners has made any concession to the men. C. H. Winterhalter, manager of the L. B. Menefee mill has offered to give the men a weekly pay day if they will withdraw their demand for a ten-hour day. As yet the men have not accepted this proposition.

The Union Manufacturing & Supply Company, which will manufacture sawmill machinery, has filed articles of incorporation in Mississippi and will be domiciled at Hattiesburg. It has a capital stock of \$200,000. The company will have large shops at Hattiesburg, where sawmill machinery of all descriptions will be manufactured. A site has been secured and construction of the buildings will begin at once. The incorporators are W. F. Post, O. R. S. Pool and R. P. Anderson, representative citizens of Hattiesburg, of long experience in the mill supply business. Henry T. Tracey, J. H. Whitehead, Edgar J. Clayton and others are also largely interested.

Advices from Sattartia, Miss., state that between 150,000 and 200,000 staves are now at that place awaiting transportation to New Orleans. This town is in the heart of the stave district of the Yazoo Basin and hundreds of thousands of staves are brought annually from there to New Orleans. The presence of the staves now awaiting transportation has dispelled the belief that Sattartia was about to take its place on the retired list of stave centers. Timber lands which have already been worked over several times are again being worked over for staves. It is admitted, however, that stave timber is becoming very scarce and the time is not far distant when the wine cask manufacturer will have to find some substitute for the stave cask.

A. L. Staples, receiver of the defunct Scranton State Bank, and a number of others have petitioned the United States courts in Mississippi to declare J. T. White & Co., a well known lumber firm of Moss Point, Miss., bankrupt. The petitioners allege that their claims against the company amount to \$57,000 and that the firm is unable to meet its debts. United States Marshal Buckley has taken charge of the assets of the firm.

The Home Lumber Company of Montrose, Miss., has filed an amendment to its charter, increasing its capital stock to \$10,000.

At Marks, Quitman county, Miss., the Riverside Lumber Company has been organized with a capital of \$10,000.

### Ashland, Ky.

Mrs. R. H. Vansant and children are sojourning at Leuce Springs, W. Va.

W. R. Vansant of the W. R. Vansant Lumber Company is very ill with typhoid fever. He has just returned from North Carolina, where he had been on a big timber deal.

A number of damage suits have been instituted by Chapman Fry of Huntington, W. Va., a well known timberman, against G. W. Sutter and L. Merrill, doing business as the L. Merrill Lumber Company. The damages aggregate \$25,000. Three suits are in assumption and one charging trespass on the case. The suits are for alleged breaches of contract and for impairment of credit in lumber deals.

The W. M. Ritter Lumber Company of Columbus, O., has a big force of men at work at the mouth of March Fork of Slab Creek, in Wyoming county, West Virginia, clearing off twenty acres of land upon which a town of sixty commodious dwelling houses will be built.

Hayes & Vansant have cut out all their holdings on East Fork, some 600,000 feet of oak timber and a little poplar.

A large number of ties have been purchased in northeast Kentucky and in West Virginia by the Panhandle and Pennsylvania railroads, and they are being shipped at the rate of three to five cars per day.

Chapman Fry's log and lumber yard and sawmill located on White's Creek, in Wayne county, West Virginia, were washed away in a recent storm, and scarcely a stick of timber was left.

W. E. Berger of the W. H. Dawkins Lumber Company of this city is at Atlantic City, N. J.

### Louisville.

Albert R. Kampf took a week off recently and made a trip to his home in New York. He says the demand for hardwood is active and it is well for millmen not to be too anxious to load up on orders for future delivery. He says he has turned down lots of orders that might have looked good a year ago, but which are not up to his idea of market values today.

Charles Gates of the Turner, Day & Woolworth Company, says the hickory handle business is in good shape and prices on hickory products are advancing. In fact, the only source of worry in the hickory business is to get the raw material, but as this concern has more of this already than any other institution in the country it is not doing much worrying.

W. F. Brown & Sons Lumber Company has been unusually busy getting stock in its yard here as well as shipping out on orders the past two months, and as a result it is now well fixed. The company has in its yard here a heavier stock of lumber than ever before at this time of the year, especially in oak, with a good string of orders ahead to work on.

The Kentucky Hardwood Flooring Company is making good progress with its new plant here and has already gotten in quite a bunch of oak so as to be ready for business as soon as the machinery is installed.

James B. Hall, Clay City, Ky., prominent as a beer stave manufacturer, and vice-president for eastern Kentucky, held an unusually successful concatenation at Winchester Friday night, August 31. There were twenty-five kittens to be initiated from Jackson and Winchester. The twenty-five initiates were hauled to the gardens of Hoo-Hoo in four mammoth cages mounted on four lumber wagons and were then given all that was coming to them in the most approved of bluegrass methods.

The Broadhead-Garrett Lumber Company has been more fortunate than most of the river mills this year and has been able to bring down logs on the summer tides right along, so that it has not only kept running steadily while other mills have had to close for lack of logs, but has in booms now a supply sufficient to last during the fall.

The Capital Lumber Company, Frankfort, Ky., has rebuilt its planing mill recently destroyed by fire on an enlarged scale and is having a prosperous business. This company operates a sawmill, planing mill and lumber yard, the moving spirit being Ed Elliott, a lumberman full of enterprise.

J. W. Clarkson, Boxer, Ky., reports pretty busy times up in the woods these days and says he is expending all his thoughts and energies toward getting out hardwood lumber. Most of the product of his concern is handled by the Linahan Lumber Company, Pittsburg, Pa.

### Wausau.

Hollis and Krueger of Wausau are erecting a mill near Parish. Some years ago the Brooks & Ross Lumber Company cut all the pine timber in that section, but left enough hardwood to supply several mills for years to come.

The largest timber deal consummated in the North in years has been closed. Holland & Graves of Byng Inlet have purchased of the Sarnia Bay Lumber, Timber & Salt Company five townships of land of thirty-six square miles

each for \$1,500,000. The lands are situated in the Georgian Bay district of Canada and are said to be well timbered, largely with hardwood.

W. G. Hinman, one of the stockholders in the Upham Manufacturing Company of Marshfield has purchased of C. F. Dunbar of Wausau ten forties of hardwood lands in Taylor county, said to be covered with 4,000,000 feet of timber. The Upham Manufacturing Company deals largely in hardwood lumber, furniture and hardwood novelties.

The Kiel Woodenware Company of Kiel has decided to build another factory near Marshfield. The company yearly consumes a large amount of elm lumber in making cheese boxes, oil can jackets, etc.

The Kandy Manufacturing Company of Grand Rapids, which lately moved to that city from Neillsville, has started its factory in operation. A large amount of new machinery has been added, which will greatly increase the output of the plant.

Suit has been brought by F. H. Johnson of

Rhineland against the Marshfield Land & Lumber Company and the Upham Manufacturing Company of Marshfield to compel the fulfillment of an option said to have been given the plaintiff by the defendants on hardwood lands owned by them in Lincoln and Taylor counties and recently sold to the Copper River Land Company for a consideration of \$500,000. It is claimed by the plaintiff that in July, 1906, the defendants gave an option on the property to J. S. Crosby of Greenville, Mich., for \$500,000, the term being for one year. F. H. Johnson, the plaintiff, acquired the option and was engaged in looking over the lands when they were sold to the Copper River Company. The suit is brought to compel a specific performance of contract. The complaint alleges that the lands are reasonably worth \$1,000,000 and the plaintiff asks that either they be sold to him on his option price of \$500,000 or that defendants be forced to pay him \$500,000, the difference between his option price and the alleged value of the property.

## Hardwood Market.

(By HARDWOOD RECORD Exclusive Market Reporters.)

### Chicago.

Local conditions in hardwoods remain somewhat "spotted." Those who have well-sorted stocks or good sources of supply are enjoying a very fair trade at good prices. Oak and poplar are the strong sellers. There is a fair call for northern hardwoods, but some items are dragging, notably inch and a half gray elm. The local trade is not at all worried over the situation, as it has had an unusually good summer trade and sees ahead of it a most excellent fall demand.

Owing to the remarkably large quantity of cheap furniture made in this market, there is an unusual call for the sound coarse end of hardwood products in nearly all varieties of wood. These manufacturers are constantly asking for lumber that is cheap. On the whole the demand for hardwoods in the Chicago market runs comparatively light for firsts and seconds and fancy varieties. The present demand is no exception to this general rule.

### Boston.

There has been a slight improvement in the local hardwood market, but the demand is still far from active. In this section there has been considerable building going on this summer, which will naturally call for interior finish during the fall months. The manufacturers of house finish are very busy and have been for two or three weeks past. In some instances orders placed the first of August have not been delivered. Furniture manufacturers are in the market picking up anything that looks like a bargain, but they are not buying freely in anticipation of future requirements, as the majority have very good sized stocks on hand. The local yards are carrying fair stocks but are beginning to make inquiries with the idea of preparing for an active fall business. Prices throughout the market are more firmly held, and in many cases mills are asking higher prices than they did a month ago. Cypress is in moderate call with prices well held. Maple flooring has not been in active call and offerings are not large. Prices are fairly well held under the firm market for rough maple. Quartered oak has begun to show some improvement. There is much more export inquiry for common quartered oak and sales of black walnut are reported for export. Plain oak is firmly held. Whitewood still moves in a moderate way, but prices are firmer and advices from mill points state that holdings of dry stocks are small. Chestnut is in very good demand. Dealers report fair inquiry for thick stock.

### New York.

The general movement of hardwoods continues good, particularly in the manufacturing branch, where the makers of pianos, furniture and novelties are busy with their holiday goods. The general yard trade is fair and there is a little more activity noted in purchase than for the past few weeks. At hardwood manufacturing points, according to returning buyers, there are

no surplus stocks, and there is a little less tendency toward concessions or forcing the market than is usually the case. Wholesalers having any amount of good hardwood stocks are aware of their value and the inability to replace them in time for the fall and early winter trade, and are therefore holding them for the best prices. The excessive rains and the general demand of the country for hardwood lumber have broken stocks considerably, especially in the better grades, and the outlook is in favor of firm prices during the fall and winter trade.

The stocks in most call at the present time are ash, birch and chestnut. They are ruling firm at good prices. Plain oak is not quite so active as it has been, but prices are steady. Poplar is moving fairly well, but there seem to be ample offerings for current wants, and the market fluctuates a little. Quartered oak is in plentiful supply, and is not active. Maple is in much the same position.

### Philadelphia.

Considerable stock is coming into the market, owing probably to the good weather at mill points and the brisk demand from wholesalers. The trade reports prices firmly held and business slightly better than a fortnight ago. Poplar is in demand, as are also chestnut and oak. Cypress is still coming on the market in quantities and finding ready takers, and there have been rather large quantities of basswood sold. Nearly all the firms report that their business has been steadily increasing this year in the aggregate and, although the summer months showed a slight falling off in demand, the general average of sales made during the year is in excess of that of last year.

The retail yards are buying, but not in great quantities, although a resumption of heavy trade is expected in the course of the month. The general feeling is that a prosperous fall trade will occur.

### Baltimore.

Briskness continues to be characteristic of the hardwood trade in this section, and there is prospect of further increase in the volume of business as autumn approaches. It is not easy to see, however, how material additions to the trade can be made since the demand has all along absorbed the output of the mills, though they were run at full capacity. Of course, if the weather improves, manufacturers will be able to increase production. So far the inquiry has been entirely up to the output and much competition for stocks at points of manufacture has been the rule.

Good oak in particular is eagerly sought, bringing satisfactory prices. So large is the consumption of oak on the part of domestic users that exporters find it difficult to obtain lumber for shipment abroad.

Ash is hardly less active than oak, all the mills having orders enough on hand to keep

them going for some time, and prices being attractive. Chestnut and all the other woods in general use are likewise freely called for. Poplar has lost none of its snap. The prevailing prices of walnut serve to bring out lumber and logs in large quantities, and the export trade in this wood is as receptive as usual.

### Pittsburg.

Firmness prevails throughout the entire list of hardwoods. It is safe to say that never before in the history of Pittsburg has the fall market opened with hardwood conditions so uniformly satisfactory. With other dealers, the hardwood men are sharing the disappointment that comes from unsettled conditions in the building world in Greater Pittsburg, due to the carpenters' strike and sympathetic labor agitations. But this is more than offset by the big inquiry from outside points for hardwood for manufacturing purposes.

Prices are uniformly firm, with a steady tendency upward. For oak it is a matter of daily occurrence to hear of premiums being paid for prompt delivery. Poplar is also a banner wood in market. Chestnut is an active seller, and the better grades are now commanding fancy prices. The call for maple continues excellent, and flooring is one of the best sellers in the market the last two weeks. Since August 1 there has been a wonderful increase in the bulk of business done by local firms in southern hardwoods, and there is every prospect that this business will be tremendously increased before January 1.

### Buffalo.

The hardwood lumber trade here is in excellent shape. The general supply is quite as good as could be expected and more, no doubt, than was thought possible last spring.

There is no longer the overstock of maple that there was last year, and there is now considerable movement to elm and basswood. Poplar, being so scarce, it has been necessary to return to basswood, though prices at the mills are still called high.

Birch is quite plentiful and is increasing in use, in place of more expensive hardwoods, especially mahogany and oak. Some very fine birch veneer doors are going into use here at very low prices.

Some very nice white and black ash is now coming down the lakes, but it will be very hard to get enough of either to make a fair stock, as the demand is so great. Washington fir is being substituted for ash and maple is used where great strength is not needed. The oak supply is fair, quartered always being in good assortment. There is not much chestnut unless it be of the low grades.

### Cincinnati.

There was no dullness visible in this market during the summer months, but with the opening of the fall months improvement is noticeable. The only discouraging element is the shortage of cars. Firms ordering ten cars are fortunate in getting two within a day or two, while they have to wait a week for their full quota.

The building situation is in excellent shape. Consumers are becoming anxious regarding their fall and winter requirements and a lively demand is expected to spring up within a short time. Stocks are reported in bad shape, unbroken lots of any size being hard to find. There is general opinion that advances in prices are sure to materialize.

Plain oak within the past two weeks has continued the dominant feature of the market. Stocks are low in both red and white. Quartered white oak finds a free outlet for the better grades, but common is inclined to quietness. Red quartered has been only moderately active, but manufacturers are confident regarding the future and have not urged consumers to come into the market.

Ash has been very strong under a big demand extending to all grades and thicknesses. With stocks at a low price have been maintained on a strong basis.

Cypress has sold well and the same can be said for chestnut.

Firms dealing in mahogany are well pleased with the outlook. The demand is constantly

growing and the market evinces firmness.

Cottonwood in box grades has been active and as supplies are short quotations have been easily sustained. Red gum is a good seller at fine prices.

The poplar movement continues to increase. Offerings are being snapped up at manufacturers' prices.

#### Minneapolis.

There is a temporary lull in the wholesale trade here. The factories are not in the market at present for large stocks. Where they felt any uncertainty as to supply they got orders in and insured themselves against a shortage some time ago. Now they feel comparatively secure, and are only buying for actual needs.

There is a decided scarcity of rock elm, ash and northern oak. There is some northern red oak still offered at good prices, but the white oak is cleaned up. The trade is taking oak right along, and southern mills are being drawn upon heavily. The railroads are buying oak for car shops, for timbers and ties, and this line of business is lively. The quiet is most noticeable in birch and basswood. There is not a big stock of basswood, however, and prices are firm. Culls are moving well at advanced prices, and the upper grades are not over plentiful. Low grade birch is scarce. There are plenty of upper grades in stock, but the prospect is for a good steady demand this fall and winter, and there is no weakness in prices noted here. Maple is in fair supply.

The retail yards are taking hardwood in mixed cars, mainly, and are calling for about the usual amount of oak wagon stock, maple wagon material and flooring.

#### Saginaw Valley.

There has been less activity in hardwood in this location of late than has been manifested in pine and hemlock. This does not signify exceptional dullness in hardwood, but rather more than ordinary activity in the commodities named.

Some hardwoods have been firm and taken as fast as offered during the season, notably ash and oak, but local supplies of these commodities are limited. Even now parties in the valley are scouring the northern portion of the state for oak for piling and bridge work to fill an order for the Michigan Central railroad. Manufacturers state that maple has been dull, they assert due to overproduction. Many if not all of the flooring manufacturers contracted for their maple early in the year and the remainder goes into the hands of dealers who appear to have been loaded up with maple, and this caused an accumulation of stock and falling off in demand. There is a picking up in beech and birch lumber, some lots of the former having been sold recently at \$14. There is more inquiry in fact for all kinds of hardwood stocks and dealers say the market is healthy in tone with prices holding steady and fall prospects good. There is considerable inquiry for basswood, which is bringing good prices, and the fortunate owner of ash can get any price his conscience will permit him to ask. Considerable quantities of beech culls are being cut up into box shooks, two or three firms here using large quantities of them. Elm is steady. While there are no material changes in quotations as yet, it is noted that there is more inquiry and a manifest disposition to buy more freely.

#### Milwaukee.

The market is beginning to assume a firmer tone with increased demands, though prices remain practically at a standstill. It is expected, however, that within a few weeks an advance will make itself noticeable all along the line. The demand for hardwood flooring is very active, but manufacturers are not taking advantage of the situation and quoting higher prices.

#### Bristol.

Market conditions in this section are generally satisfactory, though even better conditions are looked for in the fall and winter. A scarcity of cars is reported on the lines of the Virginia & Southwestern and Norfolk & Western, though the situation has not as yet reached an acute stage.

The mills are all running regularly and some

are running overtime in an effort to get out as much stuff as possible before the bad weather sets in.

#### Nashville.

Cumberland river has enough water in it now for boating or rafting, but little timber is being brought down to market. The supply up the river this fall is said to be considerably short, not more than a third, in fact, of what it generally is. This is one of the contributing causes in keeping the price of lumber up here in all lines. The market is quite firm in all departments and practically nothing is dragging. Both quartered red and quartered white oak are ready sellers. Those who have dry ash are getting most anything they have a mind to ask for it, as the market generally is bare of this wood. Good chestnut, which is fast becoming a popular finishing wood, is also scarce and bringing stiff prices. The best grades of poplar are still being rapidly taken at quotations and quite a demand is noticed for seconds, the box men using the latter. Nashville dealers are full up on orders and business for August, 1906, is nearly double that in August, 1905. Mail orders are coming in and the market is being visited each week by many buyers from a distance. The outlook for fall business is entirely satisfactory, as the lumbermen know they can sell all they can get, and more too. The matter of getting the stuff is the question.

#### Memphis.

There is a very satisfactory demand for southern hardwoods and prices are generally well maintained, with a tendency toward advance. Stocks of dry lumber in this territory are very low and this scarcity is perhaps more largely responsible for the firmness of the market than the extent of the demand. With weather conditions only fair and with production still considerably below normal for this time of the year, there is little prospect for accumulation of holdings before next January. Some of the interior mills are shut down altogether and others are operating only part time, while the shipments of lumber are quite equal to the receipts. The export demand is not particularly active, but there is a very satisfactory movement of plain white oak, red gum and ash, as well as quarter-sawn white oak, into foreign channels at good prices.

Some forward delivery business is being booked, but in such cases sellers are protecting themselves against inability to secure the lumber by making provision for delayed shipment. The scarcity of cars is pronounced and promises to become more so, and this is another reason why it is necessary for lumbermen to protect themselves against possible delay in delivering lumber.

Plain oak is in very satisfactory call, with the market firm and with offerings rather scarce in both red and white. There is some call for quarter-sawn white oak in the higher grades, with the remainder of the list receiving increasing inquiries. Ash is one of the strongest items of the list. All grades and thicknesses find a ready sale at top prices.

Cypress holds up well. It is not as scarce as ash, but the demand takes up what is offered at prices which are considered very good.

Cottonwood and gum are both good sellers in all grades. Cottonwood box boards are very scarce, while the lower grades are hard to secure and are bringing good prices. Firsts and seconds cottonwood are not showing as much snap as the lower grades, and the same is applicable to gum. However, firsts and seconds red gum are commanding good prices, and offerings appear to be scarce. Poplar is still in fair request.

#### New Orleans.

In the last fortnight more of the hardwood mills in this section have resumed operations, and stocks are being added to gradually. However, stocks are not half what they were at this season last year. The foreign trade is slack and exports are not even fair. This is due largely to the increase in ocean freight rates brought about in anticipation of a big foreign cotton movement. The interior demand is good, and the same applies to prices. The big demand from the interior is making up in a large measure for

the poor foreign trade, and the mills are kept busy, notwithstanding the small amount of exports.

#### Knoxville.

A fair amount of hardwood is in sight in local lumber yards and prices are steady, with a very good demand for all grades. The demand is brisk and dealers are behind on shipping orders. The export demand for walnut is especially strong, and the local demand for building woods is improving this month.

#### Louisville.

During the past fortnight the hardwood market in Louisville has improved considerably and at present it looks as though the fall buying will be in full swing about a month earlier than usual. Furniture men and other manufacturers using hardwood who generally come in late in September and October looking for stock are now ready to place orders early in September. Buyers are out earlier than manufacturers expected, so that lumbermen are taken unawares and are a little slow about accepting orders for large quantities. Naturally under these conditions prices are holding firm.

Poplar has scored more advances than any other wood on the list, No. 1 common having advanced \$5 per thousand during the last thirty days. Poplar as a rule is in short supply. Probably there is less excitement in quartered oak than anything else. While quartered oak is good and has been improving right along during the summer, the demand for this stock does not carry with it the same snap as the call for plain oak and other hardwoods. Plain oak is selling briskly with more in sight probably than was expected, but not more by any means than the trade is in need of. The advance in gum predicted in these columns recently is now beginning to be manifest, and some sales have been made recently at figures \$2 above what could be obtained earlier in the summer.

#### Liverpool.

Trade here was quite brisk during the last two weeks. Salesmen all report that they have made large sales. Mahogany continues brisk and in good demand. An incident which happened last week should be taken to heart by buyers of this wood on your side. One large shipper of this wood was busily engaged in chopping the lot numbers off the logs. They could only be doing this for one object—to make a profit on the measure in selling to American buyers. As many of your buyers may know, Liverpool mahogany sale measure gives an advantage to the buyer of at least 20 per cent. Buyers should not only insist on the lot numbers being left on the logs, but should ask the firms from whom they buy that wood for the brokers' cards, which are provided by the auctioneers. Ash and oak logs are in better demand. Ash and oak planks continue strong in price and other woods leave nothing new to report.

#### London.

Although this is generally considered to be the slackest time of the year, being holiday time, it must be acknowledged that there is a fair amount of business doing. Strange to say, while shippers are still asking higher prices for all goods, there is a good deal of stock arriving on consignments that can be picked up at very low prices on the quay.

The Kappahannock has arrived and is the first of the Furness-Leyland line to discharge her cargo in the Greenland docks of the Surrey Commercial Dock and it must be said that considering the facilities offered and the declaration on the dock company's part that they are making a bid for the hardwood trade of the port of London, the trade is to be congratulated upon the fact that this dock company is at last able to give them these facilities.

The best seller at the moment is oak and the parcels arriving are quite equal to the demand, but 3 and 4 inch planks are not coming forward as fast as they are wanted.

Whitewood is not in great demand and buyers are not inclined to face the higher prices asked.

The cheaper grades of satin walnut are in fair demand at the moment, but there is no great call for prime. Hickory and ash are in fair demand at good prices.



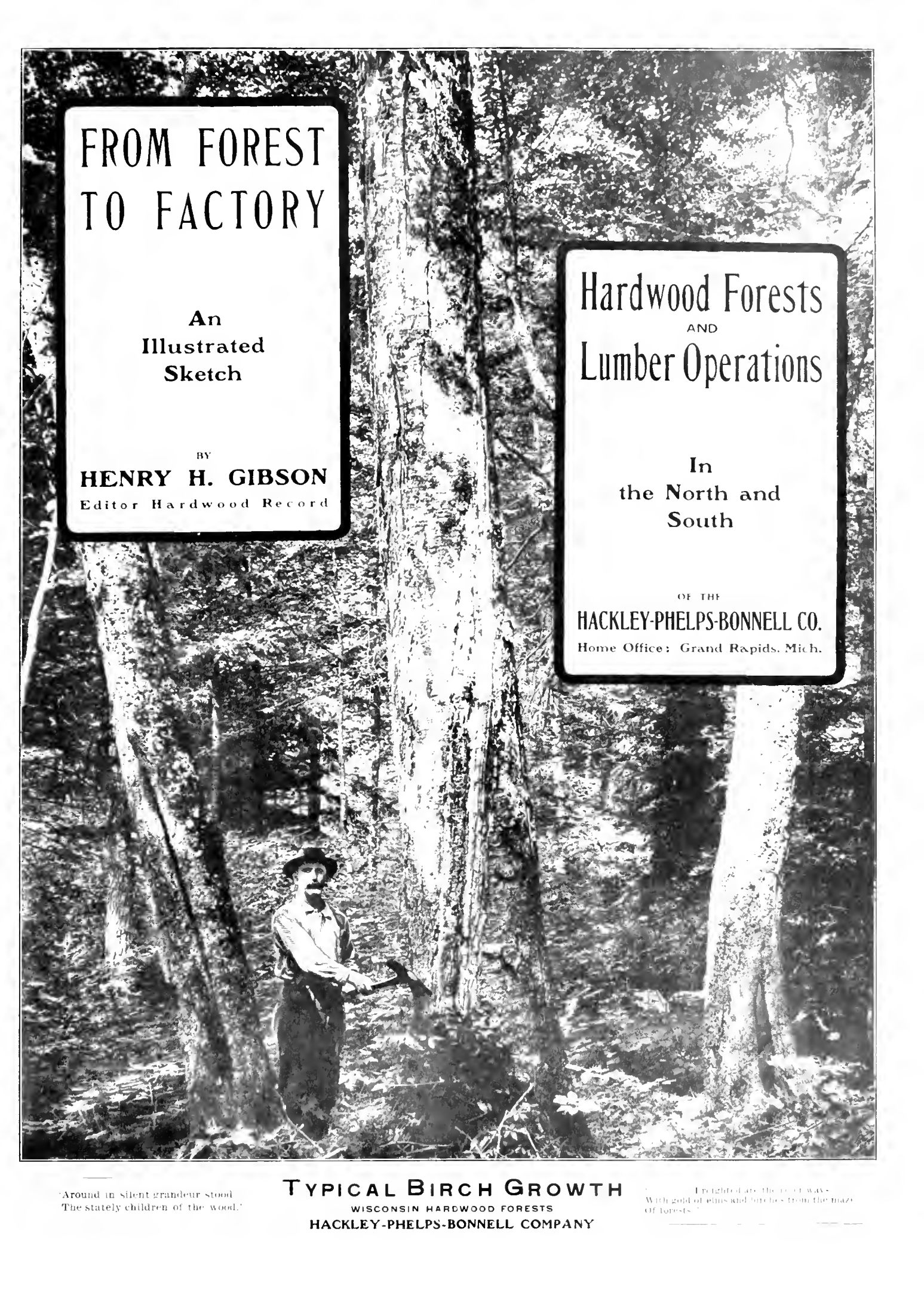

# FROM FOREST TO FACTORY

An  
Illustrated  
Sketch

BY  
**HENRY H. GIBSON**  
Editor Hardwood Record

## Hardwood Forests AND Lumber Operations

In  
the North and  
South

OF THE  
**HACKLEY-PHELPS-BONNELL CO.**  
Home Office: Grand Rapids, Mich.

'Around in silent grandeur stood  
The stately children of the wood.'

### TYPICAL BIRCH GROWTH

WISCONSIN HARDWOOD FORESTS  
HACKLEY-PHELPS-BONNELL COMPANY

'Frightful are the crooked ways  
With gold of pines and birches from the maze  
Of forests.'

**I**T is the privilege of the *HARDWOOD RECORD* to depict by picture and pencil the operations of one of the foremost hardwood lumber producing houses in the United States—the Hackley-Phelps-Bonnell Company, of Grand Rapids, Mich.

This company is a comparatively new institution and was organized in 1904 by the consolidation of the timber and lumber interests of W. A. Phelps, his son C. A. Phelps, and associates, of Grand Rapids, Mich.; of John H. Bonnell and associates, also of Grand Rapids, and of the late Charles H. Hackley, of Muskegon, Mich. While Mr. Hackley never took an active interest aside from a financial one in the concern, his name was placed first in the company's title in deference to his distinguished history in commercial lumber affairs.

The Hackley-Phelps-Bonnell Company has had a history of successful expansion since its inception that has scarcely been equaled by any similar concern in the country. While its financial and general

business headquarters have been maintained at Grand Rapids, Mich., it has expanded in all directions until today it is one of the largest hardwood stumpage owners in Wisconsin, with an immense indus-

try in Indiana, Kentucky, Arkansas and Mississippi. The company maintains a southern branch office and two large yards at Evansville, Ind., where it assembles the cuts of the various mills which it operates in Indiana and Kentucky.

It also has a southwestern branch office at Helena, Ark., where it has two large yards and where a large portion of the Arkansas stock is centralized. The company has an extensive operation in LeFlore county, Mississippi, where it is interested in a large sawmill and a full paraphernalia of logging railroads. Back of this operation is 6,500 acres of fine delta timber land. The company also owns a 4,000 acre tract of cypress and oak in Arkansas county, Arkansas, where it is getting out some of the highest class

cypress and oak found in the Southwest. In addition to its own southern milling operations it controls the cuts of numerous other mills in Kentucky, Indiana, Mississippi and Arkansas.

Altogether the Hackley-Phelps-Bonnell



WOODS HORSES AND HARDWOOD ROLLWAY

trial operation at Hackley, in that state, which, considered from the viewpoint of a complete utilization of the forest, stands first in that part of the lumber producing country. It has some minor mills in the state of Michigan and operates also in In-



BASSWOOD.



GREY ELM.



HARD MAPLE.

Company is one of the most catholic lumber institutions in the United States, manufacturing annually in the North Country upwards of 30,000,000 feet of birch, gray elm, basswood, maple, white pine, Norway, tamarack, hemlock and cedar; in the South Country it is equally prominent in the production of oak, red gum, cypress, ash, cottonwood, hickory and poplar.

This article will treat particularly of the splendid hardwood forests and manufacturing operations of the Hackley-Phelps-Bonnell Company centering at Hackley, Wis. Hackley is the terminus of a ten mile branch of the Chicago & Northwestern Railway, 370 miles north of Chicago. This branch leaves the main line at the little town of Conover.

Hackley is picturesquely situated at the upper end of Big Twin lake. This beautiful body of water, with the timber-clad hills surrounding it, is about five miles in length, and the town of Hackley, with its lumber yards, sawmills, executive and

merchandising buildings, hotel, warehouses and homes, occupies a stretch of lake front more than a mile in length.

The timber holdings of the Hackley-Phelps-Bonnell Company in this section

sent as a whole as fine a body of hardwood timber as grows in the northern country. Vilas county is a part of the picturesque lake country of Wisconsin and abounds in numerous small lakes. The land is of a very high type from an agricultural viewpoint, and eventually the entire section will be transformed into one of the finest farming regions of the state. Of the timber the magnificent red birch predominates. Next in importance is the white basswood, for which northern Wisconsin is so celebrated. Of third importance is the gray elm, which nowhere grows of better quality. In this mixed forest hard maple is found to some extent, and interspersed are a considerable quantity of magnificent white pine, Norway, hemlock, tamarack, balsam and

cedar. The entire area is of a slightly rolling character, thus making logging railroad construction comparatively easy. The company has already built nearly twenty miles of standard gauge railroad, in main line and branches, into its timber holdings.

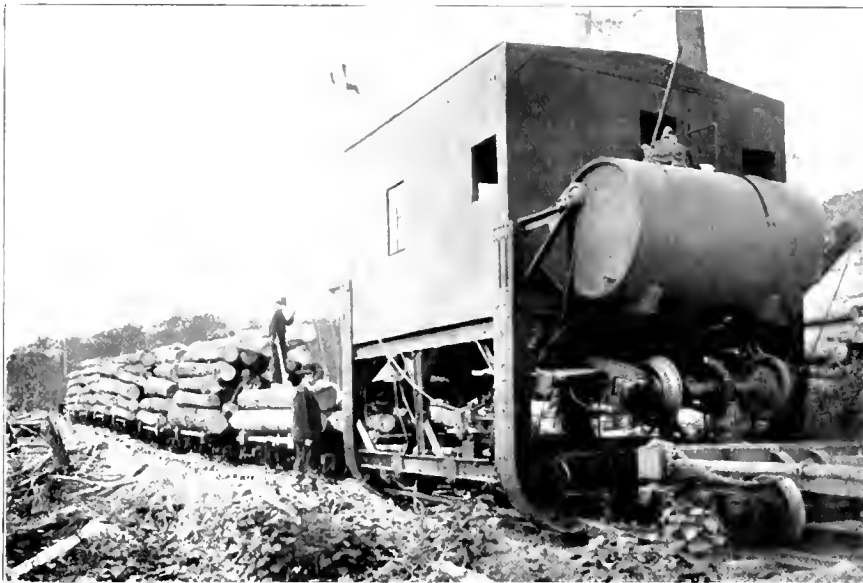

THE McGEFFERT STEAM LOG LOADER.

comprise upwards of 40,000 acres in Vilas county, Wisconsin. The holdings of the company extend over the state line into Iron county, Michigan. These timber properties have been selected with a great deal of care during the past six years and repre-



HACKLEY, WIS., LUMBER YARD AND MILL FROM DOCK FRONT.



The woods work of the Hackley-Phelps-Bonnell Company at Hackley is conducted on superior lines, marked by efficiency in every particular. Its camp is a model, the company recognizing that it pays to house and feed its woodsmen in the best possible manner. The company's equipment of engines, log loaders, etc., is the best that money will buy.

The sawmill is of the double band type, of the most approved construction and equipment. The logs coming from the woods are dumped in a boom at the mill. The yard is one of the best "drying yards" in the country, receiving air from all sides and especially from the wide expanse of lake. It is laid out with geometric accuracy, the lumber is piled with skill, the trams are well and substantially built. In fact, every detail of this great operation impresses the visitor with the quality of good housekeeping. To Delbert Hankin, superintendent of the Hackley operations, is due in no small degree credit for the excellent character of the great Hackley branch.

Between the big lumber yard and the town of Hackley and facing the lake front the company has set aside a few acres of

park, which has been thoroughly shaped up as a pleasure ground. This park abounds in a fine sapling growth of white pine, Norway, spruce, balsam and birch

tures and other articles of virtue. The entire front of this room is lighted with leaded glass windows, beneath which runs a long and comfortable window-seat. Well appointed bath and toilet rooms complete the equipment of this second floor of the mercantile building. The entire structure reflects great credit on Manager Phelps and on his belief that it pays a business man to live comfortably, even if his undertaking is located far from commercial centers. In this general mercantile establishment is kept a stock of goods that in variety almost equals the metropolitan department store, and the trade it enjoys is second to no like establishment in the country. The store is the pet hobby of the company's president,

W. A. Phelps, and distinctly shows his early training in mercantile pursuits. The entire establishment is heated by steam and in every respect is of model character.

Across the street from the general merchandising establishment is a cafe, in the second floor of which is a handsomely appointed amusement hall where very frequently the residents of Hackley are entertained by dramatic performances, lectures, stereopticon shows and kindred amusements.

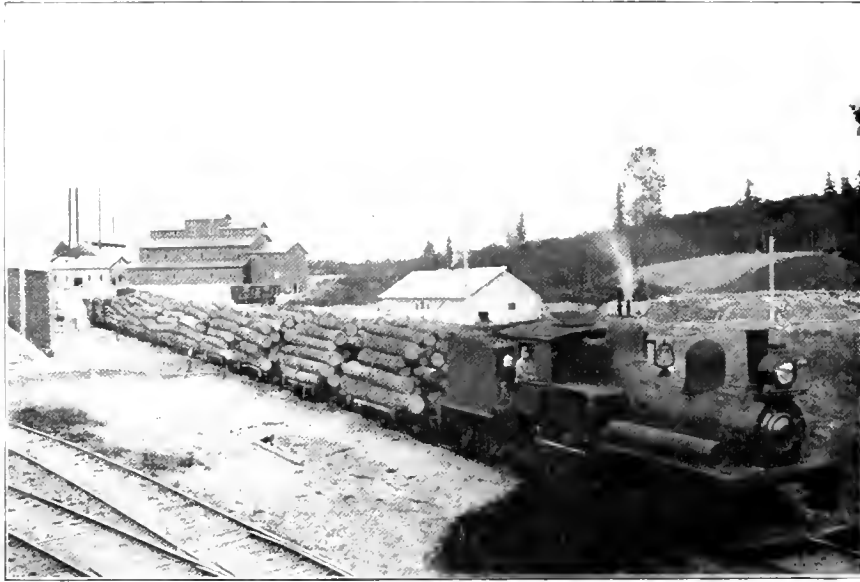

TRAIN OF LOGS IN YARD AT HACKLEY

and is one of the beauty spots of this model lumber town. Beyond the park is the company's big mercantile structure, in the wing of which are located the general offices. The second floor of this building is devoted to a commodious sitting room and a dozen well appointed bedrooms for the use of the managers and principal employees and guests. The sitting room boasts of a great open grate, and is attractively ornamented with trophies of the chase, handsome pic-



BIRD'S-EYE VIEW OF LUMBER YARD AT HACKLEY, WIS.—D.C.

Back of the general store is a large warehouse in which are carried surplus stocks of merchandise and a part of which is occupied as a general freight station. On the main street, a block in the rear of the cafe, is the company's hotel and boarding house, which, like all the other institutions of the village, is handled in a model way. Stretching along beyond this general commercial center of the town and facing the lake are rows of white painted workmen's homes, every one substantially and attractively built and which every employee seems to take pride in maintaining. Of these houses there are 150, all of which are owned by the company and rented at a low rate.

On a rise of ground back of the sawmill is situated an immense chemical plant, owned by an allied company. This is one of the largest wood chemical plants in the United States, the primary product of which is charcoal, and from the gases in the burning of which are produced large quantities of wood alcohol and acetate of lime. Beyond the sawmill is a large structure devoted to the manufacture of barrel heading, where waste mill products are utilized. Nearby is the company's planing mill.

The Hackley-Phelps-Bonnell Company is conducting a big operation and a long lived one, as it owns in northern Wisconsin upwards of 300,000,000 feet of standing tim-

ber where it goes into the retorts on steel cars and is there converted into charcoal. This chemical plant is one of the most interesting features of the entire operation, as it is built quite largely on new and improved plans. The water employed in handling the chemicals is drawn from two immense artesian wells and reaches the coolers at almost freezing point. The charcoal output of the company is sold under a long-time contract to one of the iron furnaces at Ashland, while the wood alcohol and acetate of lime, produced under like contracts, go largely into export.

The timber pictures shown with this article were not selected as remarkable tree types, but simply as specimens typical of the Hackley-Phelps-Bonnell forest,

and only the principal growth is illustrated. Here grows the red birch of the North in its highest perfection, and as this wood constitutes fully 35 per cent of the company's holdings it will perforce be a very important factor in the production of birch for many years to come. The quality of the basswood of this section is too well known to need much comment—it is the highest class timber of this variety existing in the world. The elm is also of high quality,



STORE AND OFFICE BUILDING AT HACKLEY.

ber and is constantly adding to its holdings. The strictest lines of forest and sawmill economy have been adopted. Every form of tree growth is utilized. The saw timber is converted into lumber and the refuse of the sawmill is either made up into dimension stock in the form of heading, etc., or utilized in the chemical plant. The cordwood of the forest is all saved, and after being seasoned is shipped in great rack cars to the chemical plant,



SAWMILL AT RIGHT—STORE, HOTEL, AND RESIDENCES AT LEFT.



HOTEL AND BOARDING HOUSE AT HACKLEY.



OPERA HOUSE AND CAFE AT HACKLEY.

The maple is of a very good type, but constitutes only about 15 per cent of the total. White pine is scattered among the hardwood growth and is of splendid character, and the hemlock, cedar and other woods are likewise excellent.

The illustrations accompanying this article are generally self-explanatory. The titlepage exhibits the magnificent type of red birch in which the Hackley-Phelps-Bonnell Company's forest abounds, and the pictures on the following page are typical of the basswood, gray elm and hard maple growth.

The illustration showing the great roll-way of hardwood logs with the fine teams of horses in the foreground was photographed with particular reference to showing the high class of live stock that the Hackley-Phelps-Bonnell Company employs in its woods work. The picture of the great steam loader handling logs exhibits a standard type of the Mettiffert log loader, manufactured by the Clyde Iron Works of Duluth, Minn. This machine is performing very effective service and materially economizes the cost of log loading. The large illustration on the third page of this article was made in front of the company's gen-

eral store and office building and shows the dock front on Big Twin lake, with the admirable lumber piling in the yard and the big sawmill in the distance. The broadside



INDIAN WOOD CHOPPERS AND WIVES.

view of the plant was taken from the upper floor of the still house of the chemical works, and shows only the sawmill and lumber yard. At the right of the picture are

the cooperage plant and planing mill, while at the extreme left are the numerous houses which make up the village of Hackley. It will be observed by the illustrations of the mercantile and hotel and other structures that the buildings are unusually high class. The picture of the interior of the store at Hackley illustrates fully the possibilities of a modern mercantile establishment located in the woods country. The little picture of the naphtha launch owned by the company, which is utilized on Big Twin lake, and seated in the craft are President W. A. Phelps, General Manager C. A. Phelps, W. E. Barrett of W. E. Barrett & Co., Chicago, and Gen. W. R. Robbins of the C. A. Paltzer Lumber Company of Chicago.

There is quite an Indian settlement in Vilas county and such of them as can be coaxed into working are employed in chopping wood for the chemical plant. These Indians are almost invariably accompanied in the woods by their wives and papooses. The little picture of the group of Indians was made beside the company's store at Hackley. The illustration of the retort house of the chemical plant shows the way



INTERIOR OF STORE AT HACKLEY.



MANAGER'S NAPHTHA LAUNCH ON BIG TWIN LAKE.



RETORT HOUSE OF CHEMICAL PLANT AT HACKLEY.

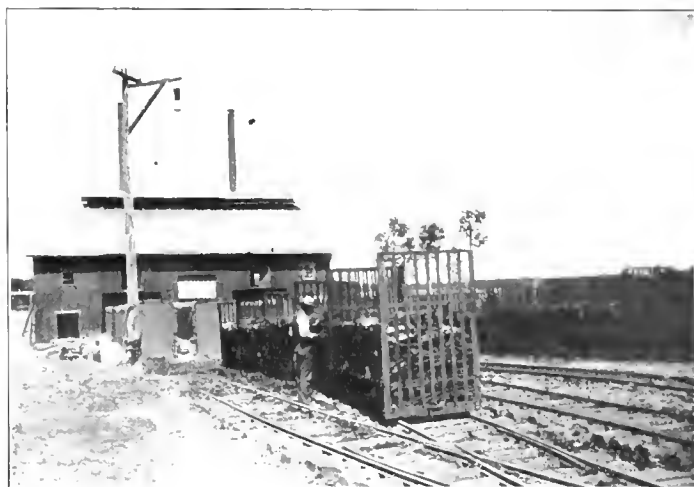

CHARCOAL AS IT COMES FROM THE COOLERS.

in which the cordwood is loaded on steel cars as it is switched into the retorts for reduction into charcoal. The picture alongside shows the cars of charcoal as they are released from the second set of coolers. It will be noted that the bulk of the wood has been reduced about one-half in its charcoal form. The charcoal produced by this company, being exclusively of birch and hard maple, is regarded as the highest class product made anywhere in the United States and is especially esteemed by producers of high grade iron.

The picture of the still house presented will convey some idea of the immense size of this structure, which is devoted to the rectifying of the crude spirits into wood alcohol and the production of acetate of lime. The picture of the cooperage plant shows the modern character of this structure. The little mid-page picture of one of the company's camp cooks was photographed at a tent camp utilized by the company for summer work. This is entirely under canvas—cook shanty, sleeping bunks and stables—and is admirable for summer use. The large picture on the eighth page of this sketch shows the modern office building of the Michigan Trust Company,

at Grand Rapids, Mich., where the general offices of the Hackley Phelps Bonnell Company are located. A very handsome suite of seven rooms, on the fifth floor of this



THE COOK AT A SUMMER CAMP.

building, is occupied by the Hackley Phelps-Bonnell Company, and the interior of the office of Sales Manager Fish, as shown in the illustration, is typical of the entire

suite. The company maintains a yard at Grand Rapids, Mich., to take care of the hurry-up orders of the numerous large furniture plants at Grand Rapids, and here are stored all varieties of furniture woods.

It is pertinent to speak briefly of the people who have brought the great Hackley-Phelps-Bonnell Company's enterprises to such importance in the hardwood industry. The president of the company is William A. Phelps, whose portrait appears as a supplement in this issue of the *Hardwood Record*.

Mr. Phelps was born at Lawrence, Mich., October 10, 1841. He was raised on a farm, and attended the village schools until he was fourteen years old, when he entered the general store of Chadwick Brothers, where he remained five years. The first year he received a salary of \$36 per annum, and the last two years this sum was advanced to \$50 a month and board. He was next employed in the general store of Abbott & Manley at Deatur, Mich., where he stayed for the succeeding two years. At the age of twenty-one he started in the mercantile business on his own account at Lawrence, Mich. Two years later he sold out and located a general store at Hartford, Mich., under the name of Phelps & Goodenough. This establishment was burned out the second year and reorganized under the name of Phelps Brothers, which concern had stores at Hartford and Keeler, Mich. He sold out the Hartford store to his brother



STILL HOUSE OF THE CHEMICAL PLANT.



COOPERAGE PLANT AT HACKLEY

in 1870, and removed the Keeler stock to Montague, Mich. The fire that destroyed the business portion of that town shortly afterward burned up his establishment.

In the spring of 1873 he opened a general store at Whitehall, Mich., under the firm name of Phelps & Parker. In connection with this store he handled hemlock bark, shingles, railroad ties and cordwood. From Whitehall he shipped the first cargo of cedar shingles and ties that was sent to the Chicago market, which were consigned to Goodenow & Hinds. In 1874, Mr. Phelps shipped the first hemlock bark ever handled by railroad in western Michigan. This was forwarded over the Pentwater division of what was then known as the Chicago & Michigan Lake Shore Railroad, now a part of the Pere Marquette system. This bark was transferred from cars to vessel by team at Whitehall and forwarded by lake to Chicago and Milwaukee. He continued in this business until 1882, when he sold out his general store to Blackmarr & Banks and continued to handle lumber and other forest products at Whitehall.

In 1888 Mr. Phelps moved to Grand Rapids, Mich., and, in partnership with N. B. Clark, engaged in the handling of all kinds of lumber and forest products. In 1891 he was one of the organizers of the Michigan Bark & Lumber Company, from which concern he retired in 1894. The same year the Grand Rapids Bark & Lumber Company was organized, with W. A. Phelps as president and C. A. Phelps as secretary and treasurer. In 1902 he was one of the organizers of the Wisconsin Lumber & Bark Company, of which he was president. In 1904 the Grand Rapids Bark & Lumber Company and the Wisconsin Lumber & Bark Company were merged into the Hackley-Phelps-Bonnell Company.

Mr. Phelps is also vice-president of the Wisconsin Chemical Company, president of the Shelby Improvement Company and vice-president of the Wisconsin Tie & Pole Company. He was married in February, 1866, to Miss Nancy T. Andrews of Whitehall, Mich., and has two children, Charles A. Phelps and Maude Phelps Barstow. Mr. Phelps is a man

of high character and ability, who has made a marked success in every enterprise in which he has been engaged.

Charles A. Phelps, chairman of the board and manager of the Hackley-Phelps-Bonnell Company, is a son of William A. Phelps, and was born at Hartford, Mich., March 11, 1869. With his parents he moved to Montague in

1870 and to Whitehall in 1873. He attended the village school at Whitehall, and moved to Grand Rapids in 1888. He took a four years' commercial and literary course at Alldon College, graduating in 1890. At the age of twenty-one he took charge of a lumber interest at Stony Creek, Mich. He was one of the organizers of the Michigan Bark & Lumber Company in 1891, holding the office of secretary and treasurer. He sold out his interest in this company in 1894 and became one of the organizers and secretary and treasurer of the Grand Rapids Bark & Lumber Company. In 1902 he assisted in organizing the Wisconsin Lumber & Bark Company, in which he was interested, and which in 1904 with the Grand Rapids Bark & Lumber Company was merged into the Hackley-Phelps-Bonnell Company.

Charles A. Phelps has other and important interests besides the management of the Hackley-Phelps-Bonnell Company. He is treasurer of the Wisconsin Chemical Company of Hackley, Wis.; president of the Century Fuel Company, Grand Rapids, Mich.; treasurer of the Greulich Company, Grand Rapids, Mich.; secretary and treasurer of the Toomey Lumber & Coal Company of Tennessee; secretary and treasurer of the Hackley Coopersage Company, Hackley, Wis.; president of the Wisconsin Tie & Pole Company; a director of the Grand Rapids National Bank, Grand Rapids, Mich.; a director in the G. F. Sanborn Company, Ashland, Wis., and a director in the Michigan Lithograph Company of Grand Rapids, Mich. He is a member of the Peninsula and Lake Side Clubs of Grand Rapids, and served two years as a member of the Board of Public Works and five years as a member of the Board of Police and Fire Commissioners of Grand Rapids. On July 6, 1901, Mr. Phelps was married to Miss Roslyn Mack of Portland, Ore.

While Mr. Phelps neglects none of the various enterprises in which he is interested, he gives special attention to working out the great problems involved in the handling of the Hackley-Phelps-Bonnell Company's great enterprises at Hackley, Wis. To him more

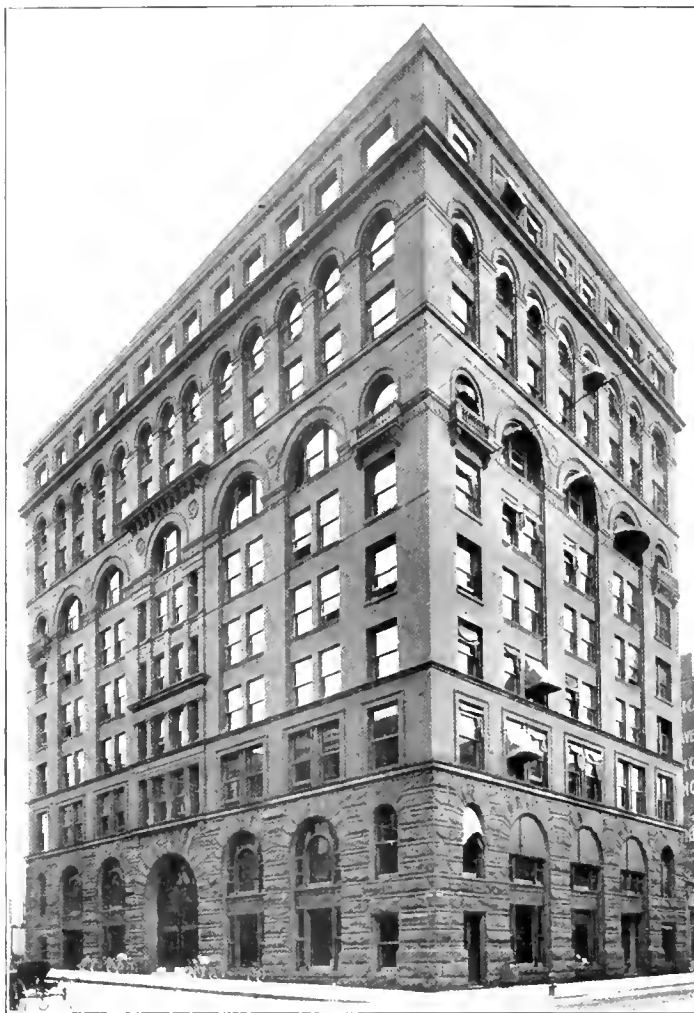

MICHIGAN TRUST COMPANY BUILDING, GRAND RAPIDS, MICH. LOCATION OF GENERAL OFFICE HEAD-QUARTERS HACKLEY-PHELPS-BONNELL COMPANY.



GRAND RAPIDS, MICH., YARD.



OFFICE SALES MANAGER FISH.





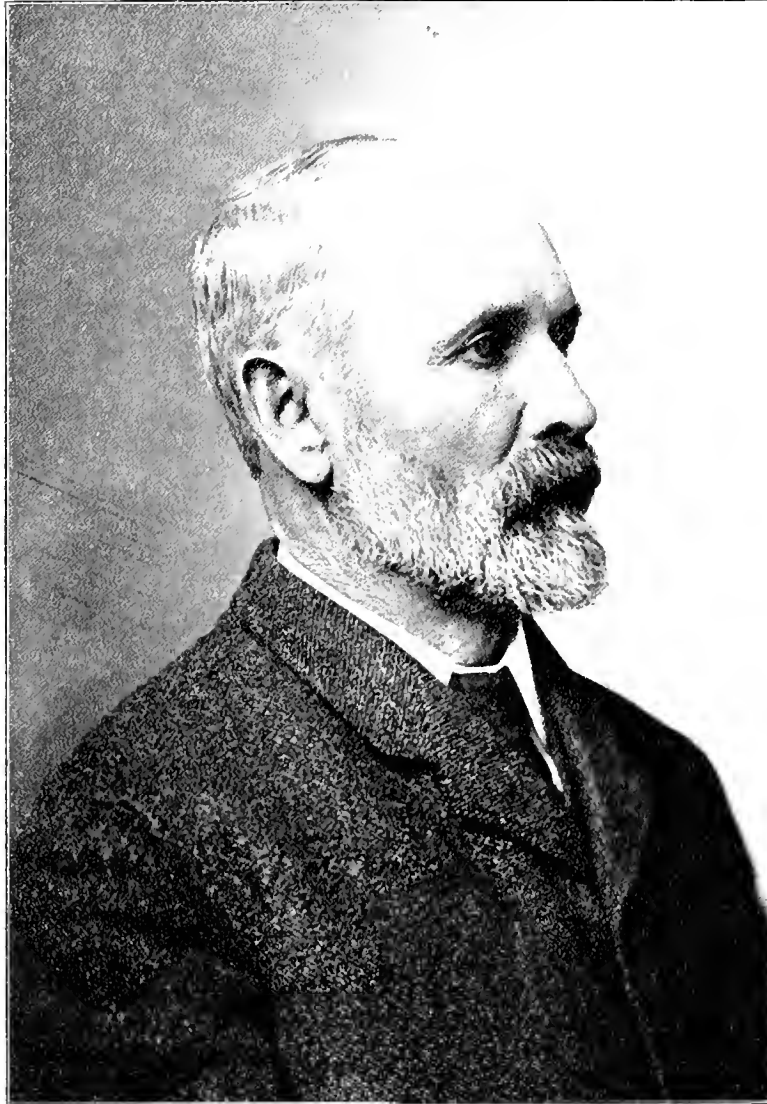

WILLIAM A. PHELPS  
GRAND RAPIDS, MICH.





WILLIAM A. PHELPS, PRESIDENT.



CHAS. A. PHELPS, CHAIRMAN OF BOARD.



HENRY IDEMA, VICE PRESIDENT.

than to any other is due the fine character of the splendid operation which has, within the last few years, been installed in the northern Wisconsin timber field.

The secretary of the Hackley-Phelps-Bonnell Company is Otis A. Felger. Mr. Felger was born in 1865 at Geneseo, Ill., and is of German-American birth. He was valedictorian of the class of 1889 of the Northwestern Normal School. His first employment was as clerk in a general store in Geneseo. At the age of twenty he entered the poultry business. He taught commercial branches during his school life and was a pedagogue for a year after his graduation. He afterward entered the employ of McNeil & Higgins, wholesale grocers of Chicago, and eventually became general clerk and railroad teller of the National Bank of Illinois at Chicago. In 1892 he accepted a position with the Widdicomb Furniture Company of Grand Rapids, Mich., and he added to his lumber experience in the office work of a pine and hardwood operation at Leroy, Mich., for some time afterward. In 1894 he assisted in organizing the Thompson & Bonnell Lumber Company and the Hackley-Bonnell Lumber Company, which succeeded it, acting as secretary and treasurer for both concerns. On the merging of the interests of the Hackley-Bonnell Lum-

ber Company with the Wisconsin Lumber & Bark Company and the Grand Rapids Bark & Lumber Company, Mr. Felger was chosen secretary of the new corporation. Mr. Felger was married in 1889 to Miss Bertha Spickler of Geneseo, Ill., and has three children. He is a member of the Methodist Episcopal church and is identified with various social and business clubs of Grand Rapids. Besides being interested in the Hackley-Phelps-Bonnell Company he is also a stockholder in several furniture manufacturing establishments in Grand Rapids and vicinity. Mr. Felger pays especial attention to the southern operations of the Hackley-Phelps-Bonnell Company.

Portraits of other individuals associated with the Hackley-Phelps-Bonnell Company accompanying this sketch are those of Treasurer John H. Bonnell, who has spent the greater part of his life in Grand Rapids and has been identified with the lumber business for many years; Henry Idema, vice-president of the company, who is a well-known banker and capitalist of the Furniture City; and Dudley E. Waters, a director of the company, who is also a well-known Michigan banker, being president of the Grand Rapids National Bank, Grand Rapids, Mich.

Another portrait is that of W. N. Sayles, a

director of the company, who generally cares for the Michigan interests of the corporation. Mr. Sayles was born in Kalamazoo county, Michigan, in 1858. He spent his boyhood in Oceano county, where as a young man he taught school. He has followed the lumber business practically all his life and has been identified with the enterprises of the Messrs. Phelps for the past fifteen years.

The general sales manager of the Hackley-Phelps-Bonnell Company, whose picture is also presented, is Charles W. Fish. Mr. Fish is a Canadian by birth and parentage and has spent his life in the northern Michigan woods. He commenced his lumber career with the G. W. Jones Lumber Company of Appleton, Wis., at Elcho, and was afterward engaged in business on his own account in the Fish & Mullen Lumber Company, of which he was president. He has been identified with the Hackley-Phelps-Bonnell Company since 1895. He is married and has three children. Mr. Fish is achieving exceptional distinction in his particular field of manager of sales. It is his earnest endeavor to analyze very carefully the special requirements of every one of the numerous customers of his big corporation, and is handling the individual wants in such a painstaking way that once a customer is gained he remains a cus-



CORNER OF HELENA, ARK., YARD.



OTIS A. FELGER, SECRETARY.



J. N. BONNELL, TREASURER



CHARLES W. FISH, SALES MANAGER

tomor for all time to come. Between the intimate acquaintance of Mr. Felger and Mr. Fish with the wants of the furniture and other wood working lines it has become almost axiomatic in the trade that these two people are authority on the subject of the kinds of stock that are best suited to this class of manufacture, and it therefore happens that a large portion of both the northern and southern lumber output of the Hackley-Phelps-Bonnell Company is sold directly to the furniture, interior finish, flooring and kindred trades employing hardwoods in their work.

This sketch is published in the *HARDWOOD RECORD* for the purpose of placing before the wholesale consumers of the country the details of the great and varied lumber enterprises which the Hackley-Phelps-Bonnell Company is operating. It is done with the especial intent that lumber consumers of hardwoods may know that when they deal with the Hackley-Phelps-Bonnell Company they are buying "close up to the stump"; that they are dealing with a concern that is specializing in lumber for their particular requirements; that this concern knows the needs of the consuming trade as well as any house in the country; that it is painstaking in learning the wants of new trade and will attempt to supply practically everything in hardwood lumber needed by any manufacturing institution.



DUDLEY E. WATERS, DIRECTOR.



W. N. SAYLES, DIRECTOR.



DELBERT HANKIN, SUPT. HACKLEY PLANT.



W. A. ARCHER, MANAGER HELENA BRANCH



R. H. HAMILTON, MANAGER EVANSVILLE BRANCH.

# AT COST

IS AN UNCOMMON TERM AS APPLIED TO INSURANCE

But this is the actual price of Indemnity against Fire Loss furnished by the

## Manufacturing Lumbermen's Underwriters

THE STRONGEST INSURANCE ORGANIZATION  
TO-DAY IN AMERICA

The saving is not on a small portion of your insurance but on the entire line.

There are other advantages equally interesting.



Only well built plants with adequate protection and at least five years timber supply are considered eligible.

FOR LIST OF MEMBERS AND FURTHER INFORMATION, ADDRESS

**HARRY RANKIN & CO.      Kansas City, Mo.**

# Wanted and For Sale -SECTION-

Advertisements will be inserted in this section at the following rates:

For one insertion ..... 20 cents a line  
For two insertions ..... 35 cents a line  
For three insertions ..... 50 cents a line  
For four insertions ..... 60 cents a line

Eight words of ordinary length make one line. Headings count as two lines. No display except the headings can be admitted.

Remittances to accompany the order. No extra charges for copies of paper containing the advertisement.

## EMPLOYES WANTED.

### WANTED—EXPERIENCED MILL MAN

Who understands hardwoods, to take an interest in a hand mill in the South, to saw for us and own  $\frac{1}{3}$  or  $\frac{1}{2}$  interest in the mill. This is a good thing for the right party. 5 to 8 years' sawing in a city of 20,000. Must have \$4,000 or a good up-to-date band mill. References required.

J. A. BROWNE & CO., INC.,  
North Manchester, Ind.

### LOGGING CONTRACT TO LET.

We have 150 million feet mixed hemlock, hardwood and pine timber in northern Wisconsin, to be logged at the rate of 12 to 15 million feet per year. Want land cleaned of all timber, including pulpwood, cedar posts, poles, etc. Work to commence fall of 1907. Party must be financially responsible and experienced in logging mixed timber by rail. Send references, stating whom you have logged for before. Address "LOGGING CONTRACT," care HARDWOOD RECORD.

## EMPLOYMENT WANTED

### FIRST CLASS BAND SAWYER,

10 years' experience, Hardwood and Yellow Pine, wants position in modern mill. Strictly temperate. Address

LOCK BOX 22, Farmers, Ky.

## LUMBER WANTED

### WANTED—CRATING.

Cut to dimensioned sizes; 4"x32", 2"x48", etc., inch stuff in basswood or any soft wood. Will order in car lots.

NATIONAL WOODENWARE CO., LTD.,  
Grand Rapids, Mich.

### WANTED.

White Oak logs and White or Gray Ash logs. Write for specifications.  
S. N. BROWN & CO., Dayton, Ohio.

### WANTED—DIMENSION HICKORY.

Hickory Pole and Shaft Strips. Also good man to travel, buying and inspecting same.  
TOLEDO CARRIAGE WOODWORK CO.,  
Toledo, Ohio.

### WANTED—HARDWOOD LOGS.

200 M feet 28-inch and up White Oak logs.  
200 M feet 12-inch and up Walnut logs.  
50 M ft. 12-inch and up Cherry logs.  
C. L. WILLEY,  
Blue Island Av. and Robey St., Chicago.

### OAK.

We are in the market for plain sawed oak, all grades and thicknesses.  
P. G. DODGE & CO., 2116 Lumber St., Chicago.

### LOG RUN ELM WANTED.

Dry or green, mill cuts out, 2x12 standard lengths, and 3x12 standard lengths.  
AMERICAN LBR. & MFG. CO., Pittsburg, Pa.

**DIMENSION STOCK WANTED.**  
5 16" rotary cut basswood. Send for specifications.

DERBY DESK CO., Somerville, Mass.

### WANTED.

5 cars 2 $\frac{1}{2}$ x2 $\frac{1}{2}$ x30 Oak Squares.  
5 cars 4 4" Sound Wormy Chestnut.  
20 cars 4 4" No. 2 Common Gum.  
10 cars 4 4" Log Run Gum.  
6 cars 4 4" No. 2 Common Poplar.

C. H. L. BECKERS,  
429 Victoria Bldg., St. Louis, Mo.

### WANTED—DRY CYPRESS.

2x5" and wider, 8 or 16' firsts and seconds or selects or sound common.

AMERICAN LBR. & MFG. CO., Pittsburg, Pa.

### AXLES AND POLES WANTED.

Hickory axles 5x6—6 ft., and Red and White Oak poles 2 4x4x4—12 ft., to be full in thickness.  
McCLURE LUMBER CO., Detroit, Mich.

### WANTED SOFT MAPLE.

A few cars of 2" Soft Maple, No. 1 C. & B.  
THE WICKS LBR. CO., Battle Creek, Mich.

### OAK WANTED.

3 and 4 inch White Oak; also Mixed Oak; also 12x12 Timbers and Piling of all kinds.

CONTINENTAL LUMBER CO.,  
1213 Monadnock Bldg., Chicago, Ill.

## TIMBER LANDS FOR SALE

### FOR SALE.

3,550 acres of Georgia hardwood, estimated to cut as follows:

8,800,000 feet White Oak.

3,500,000 feet Hickory.

5,500,000 feet Red Oak.

1,750,000 feet White Ash.

High grade stock suitable for wagon and carriage manufacture.

3 $\frac{1}{2}$  miles from railroad; river joins tract.

Ten years to remove timber. Address

"H. H.," care HARDWOOD RECORD.

## LUMBER FOR SALE.

### OAK TIES FOR SALE.

6,000 Red and White Oak Ties, 6x9—6' 8", mostly Red Oak.

McCLURE LUMBER CO., Detroit, Mich.

### RED OAK TIES FOR SALE.

I wish to contract at once with reliable party a large quantity of Red Oak Ties.

Address CHAS. SMITH, Freetown, Ind.

### GUM AND SYCAMORE BOARDS.

200,000 feet of 1-inch boards from 10 to 20 feet long. Apply to

A. ROSENBAUM & SONS, Newport News, Va.

### WALNUT FOR SALE.

One car load of 8 4, 10 4, 12 4, 16 4 firsts and seconds. Exceptionally nice stock, good and dry.

C. J. FRANK,  
2440 N. New Jersey St., Indianapolis, Ind.

### FOR SALE.

One carload Clear Black Walnut Logs, 16" to 25"x8" to 16" long. One carload firsts and seconds Hickory 11 4", 14 4", 2", 2 1/2", 3" and 4"x8" and wider; 10,000 ft. Plain White Oak No. 1 Common 4 4. All choice stock.  
DERING & FRANK LUMBER CO. (Inc.),  
Hopkinsville, Ky.

### FOR SALE.

100,000 feet 5 4 Log Run Plain Red Oak.  
100,000 feet 4 4 Sound Wormy Chestnut.  
SOUTHERN LUMBER CO.,  
312 Keller Bldg., Louisville, Ky.

## TIMBER FOR SALE

### HARDWOOD STUMPAGE FOR SALE.

The timber on a compact tract of over 30,000 acres in Tennessee, largely poplar, oak and chestnut; with other woods of value. For particulars apply to  
"S. 611," care HARDWOOD RECORD.

## BUSINESS OPPORTUNITIES

### DESIRABLE LOCATIONS.

In the territory of splendid timber resources reached by The North-Western Line are several fine locations for new industries, especially in the woodworking lines. A suitable point for a large sawmill having excellent railroad service and a large tributary timber district is one of these. There is also a fine opportunity for securing a well equipped coeprage plant. Reference to these can be obtained upon request to the INDUSTRIAL DEPARTMENT,  
C. & N.-W. Ry., Chicago.

### HARDWOOD TIMBER.

A number of good mill propositions along the Cotton Belt Route. Tracts ranging from five hundred to twenty thousand acres, principally Oak, Hickory, Gum, Cypress, some Aah, Cottonwood and other hardwoods. Can be secured at very reasonable figures now—in some cases at less than \$1 per thousand at stumpage. Choice openings for hardwood lumber mills, handle and spoke factories, slack coeprage plants and other hardwood enterprises.

A number of points on the Cotton Belt offer free sites or will raise cash bonus or take stock in practical propositions. Let us have your wants and see what we can do for you.

E. W. LA BEAUME, G. P. & T. A.,  
COTTON BELT, St. Louis, Mo.

### MODEL LUMBER YARD.

Planing mill or factory location, N. W. corner Brook and "A" streets, on L. & N. R. R., 200x340; switch of 3 cars, shed capacity 1,000,000 ft. lumber, ware room and offices; stable of 7 stalls and loft; electric lights and water. Piling space in open for 3,000,000 ft. lumber. For lease 1 to 4 years. Moderate rent. Apply

STOTZ LUMBER CO.,  
Keller Bldg., Louisville, Ky.

### WANTED.

Party with small capital to take an active interest in well established handle and lumber business. Entire output sold for four years. For further information write or call on  
H. F. CLARKE, Okolona, Miss.

## MACHINERY WANTED

### AT ONCE.

If you are in need of machinery—new or second hand—a few lines in this column will place your wants before those who have such goods for sale. For particulars address  
HARDWOOD RECORD, Chicago, Ill.

## MANUFACTURERS

Contemplating establishing plants in the West should take advantage of a location on



## Chicago & North-Western Ry.

which reaches the famous

**WATER POWERS,  
COAL FIELDS,  
IRON ORE RANGES,  
HARD AND SOFT  
LUMBER DISTRICTS,  
MINING DISTRICTS**

of the West and Northwest, and affords the best means of transportation to the markets of the world.

FOR FURTHER PARTICULARS APPLY TO  
MARVIN HUGHITT, Jr., E. D. BRIGHAM,  
Freight Traffic Manager, Gen'l Freight Agent.

GEO. BONNELL,  
Industrial Agent.

NW513

CHICAGO.

# Advertisers' Directory

## NORTHERN HARDWOODS.

Acock, John L., & Co.	7
Amerlun Lumber & Mfg. Company	56
Apple Hardwood Lumber Company	55
Babeck Lumber Co.	56
Barnaby, C. H.	62
Beyer, Knox & Co.	63
Bliss & Van Auken	12
Boyne City Lumber Company	59
Briggs & Cooper Company	4
Brownlee & Company	58
Buffalo Hardwood Lumber Company	63
Cadillac Handle Company	5
Cheat River Lumber Company	56
Cherry River Boom & Lbr. Company	1
Chivvis, W. K.	5
Cincinnati Hardwood Lumber Co.	61
Cobbs & Mitchell, Inc.	3
Columbia Hardwood Lumber Co.	11
Connor, R., Lumber Company	54
Crosby & Beckley Company, The	6
Crosby, C. P.	55
Cummer, Diglins & Co.	3
Darling, Chas., & Co.	11
Davis, John R., Lumber Company	55
Dells Lumber & Shingle Company	59
Dennis Bros.	58
Dennis & Smith Lumber Company	52
D'Heur & Swain Lumber Company	62
Dixon & Dewey	6
Dubnicher Bros.	60
Dulweber, John, & Co.	61
Elias, G., & Bro.	63
Empire Lumber Company, Buffalo	63
Evans & Rettling Lumber Co.	58
Fall, E. H.	57
Flint, Erving & Stoner Company	56
Froberg Lumber Company, The	61
Fullerton-Powell Hardwood Lumber Company	62
General Lumber Company	60
Gillespie, W. M., Lumber Company	7
Goldie, J. S.	59
Haak Lumber Company	59
Hackley-Phelps-Bonuell Company	59
Hayden, Harvey S.	19
Heath-Witbeck Company	11
Holloway Lumber Company	7
Ingram Lumber Company	53
James & Abbot Company	5
Jenks, Robert H., Lumber Company	57
Jones, G. W., Lumber Company	55
Jones Hardwood Company	5
Kampf, Albert R.	2
Keator, Ben C.	11
Keith Lumber Company	11
Kelley Lumber & Shingle Company	9
Leavitt Lumber Company	12
Lesh & Matthews Lumber Co.	11
Litchman Lumber Company	56
Litchfield, William E.	6
Long-Knight Lumber Company	62
MarBride, Thos., Lumber Company	59
Miley, Thompson & Moffett Company	61
Maley & Wertz	62
Martin-Barriss Company	54
Mason & Donaldson Lumber Company	54
McClure Lumber Company	59
McLivain, J., Gibson, & Co.	7
McLean, Hugh, Lumber Company	63
Miller, Anthony	63
Miller Brothers	11
Mitchell Bros. Company	3
Mowbray & Robinson	61
Napphy & Diglins	5
Nichols & Cox Lumber Company	58
Nicola Lumber Company, The	56
Norman Lumber Company	2
North Shore Lumber Company	58
North Vernon Pump & Lumber Co.	2
North Western Lumber Company	54
O'Brien, John, Land & Lumber Co.	10
Page & Landeck Lumber Company	55
Perrine-Armstrong Company	62
Peters, R. G., Salt & Lumber Co.	59
Preece, E. E.	61
Radina, L. W., & Co.	61
Richmond Park & Co.	10
Rumbarger Lumber Company	10
Ryan & McParland	10
Salling, Hanson & Co.	58
Satcherd & Son	63

Schofield Bros.	7
Schultz Bros. & Cowen	52
Simmons Lumber Company	59
Slimmer, J., & Co.	10
Soble Brothers	7
Southern Oak Lumber Company	9
Standard Hardwood Lumber Co.	63
Stephenson, The L., Company	63
Stewart, Wm. H. & Bro.	12
Stewart, Wm. H. & G. S.	60
Stimson, J. V.	62
Sullivan, T., & Co.	63
Tege Lumber Company	9
Turner, A. M., Lumber Company	56
Upham & Agler	9
Van Keulen & Wilkinson Lumber Co.	59
Vollmar & Below	55
Wagstaff, W. J.	11
Ward Lumber Company	11
Wells, R. A., Lumber Co.	10
Westworth, Chas. S., & Co.	4
White Lumber Company	19
White, W. H., Company	52
Whitmer, Wm., & Sons, Inc.	7
Wilborg & Hanna Company	61
Wiggin, H. D.	6
Willson Bros. Lumber Company	56
Wisconsin Timber & Lumber Co.	11
Wiscarta, Underhill & Co.	7
Yeager, Orson E.	63
Young & Cutsinger	62
Young, W. D., & Co.	12

## SOUTHERN HARDWOODS.

Acock, John L., & Co.	7
Advance Lumber Company	57
American Lumber Company	53
American Lumber & Mfg. Company	56
Anderson-Tully Company	4
Atlantic Lumber Company	4
Bacon-Nolan Hardwood Company	4
Beck, E. E., Lumber Company	61
Beyer, Knox & Co.	63
Briggs & Cooper Company	4
Brown, Geo. C., & Co.	8
Brown, W. P., & Sons, Lumber Co.	2
Buffalo Hardwood Lumber Company	63
Carrier Lbr. & Mfg. Company	12
Cherry River Boom & Lumber Co.	1
Chivvis, W. K.	5
Cincinnati Hardwood Lumber Co.	61
Coleman, J. S., Lumber Company	53
Columbia Hardwood Lumber Co.	11
Crandall & Brown	11
Crane, C., & Co.	61
Crosby & Beckley Company, The	6
Cypress Lumber Company	60
Darling, Chas., & Co.	11
Davidson-Benedict Company	11
Davis, Edw. L., & Co.	2
Dennis & Smith Lumber Company	58
D'Heur & Swain Lumber Company	62
Dixon & Dewey	6
Dubnicher Bros.	60
Dulweber, John, & Co.	61
Elias, G., & Bro.	63
Empire Lumber Company, Buffalo	63
Evans & Rettling Lumber Co.	58
Fall, E. H.	57
Farrin-Korn Lumber Company	60
Flint, Erving & Stoner Company	56
Froberg Lumber Company	61
Fry-Buchanan Lumber Company	53
Fullerton-Powell Hardwood Lumber Company	62
Gareison-Greason Lumber Company	5
Gayoso Lumber Company	4
Gillespie, W. M., Lumber Company	7
Hackley-Phelps-Bonuell Company	59
Hafner Manufacturing Company	5
Heath-Witbeck Company	11
Himmelberger-Harrison Lumber Co.	1
Iediana Lumber Company	8
James & Abbot Company	6
Jenks, Robt. H., Lumber Company	57
Jones, G. W., Lumber Company	55
Jones Hardwood Company	5
Keator, Ben C.	11
Keith Lumber Company	11
Kentucky Lumber Company	61
Lane-White Lumber Company	60

Leavitt Lumber Company	12
Lesh & Matthews Lumber Company	11
Litchman Lumber Company	56
Litchfield, Wm. E.	6
Long-Knight Lumber Company	62
Love, Boyd & Co.	8
Luehrmann, Chas. F., Hardwood Lumber Company	5
McClure Lumber Company	59
Mclivain, J., Gibson, & Co.	7
McLean, Hugh, Lumber Company	63
Maley, Thompson & Moffett Company	61
Martin-Barriss Company	57
Miller, Anthony	63
Miller Brothers	11
Nicola Lumber Company, The	56
Norman Lumber Company	2
O'Brien, John, Land & Lumber Co.	10
Ozark Coopers Company	5
Paepecke-Leicht Lumber Company	8
Page & Landeck Lumber Company	55
Price, E. E.	61
Radina, L. W., & Co.	61
Ranson, J. B., & Co.	8
Rhubesky, E. W.	2
Richmond Park & Co.	10
Ritter, W. M., Lumber Company	64
Roy Lumber Company	42
Rumbarger Lumber Company	10
Ryan & McParland	10
Satcherd & Son	63
Schofield Brothers	7
Slimmer, J., & Co.	10
Smith, W. E., Lumber Company	4
Southern Lumber Company	2
Southern Oak Lumber Company	9
Standard Hardwood Lumber Company	63
Steele & Hibbard	5
Stevens-Eaton Company	7
Stewart, I. N., & Bro.	63
Stewart, Wm. H. & G. S.	60
Stimson, J. V.	62
Stoneman-Zearing Lumber Company	5
Stutz Lumber Company, Inc.	2 & 51
Sullivan, T., & Co.	63
Swann-Day Lumber Company	8
Thomas & Proetz Lumber Company	5
Thompson, J. W., Lumber Company	4
Three States Lumber Company	4
Turner, A. M., Lumber Company	56
Upham & Agler	9
Vestal Lumber & Mfg. Company	53
Ward Lumber Company	11
Wells, R. A., Lumber Co.	10
Westworth, Chas. S., & Co.	7
West Florida Hardwood Company	7
White Lumber Company	10
Whitmer, Wm., & Sons, Inc.	7
Wilborg & Hanna Company	61
Wiggin, H. D.	6
Wilson Bros. Lumber Company	56
Wisconsin Timber & Lumber Co.	11
Wood, R. E., Lumber Co.	6
Yeager, Orson E.	63

Luehrmann, C. F., Hardwood Lumber Company	5
Ozark Coopers Company	5
Paepecke-Leicht Lumber Company	8
Smith, W. E., Lumber Company	4
Stoneman-Zearing Lumber Company	5
Stutz Lumber Company, Inc.	2 & 51
Three States Lumber Company	1

## CYPRESS.

Crandall & Brown	11
Cypress Lumber Company	63
Hafner Manufacturing Company	5
Cobbs & Mitchell, Inc.	12
Lothman Cypress Company	5
Thompson, J. W., Lumber Company	1

## VENEERS

Chicago Veneer Co., Inc.	41
Wisconsin Veneer Company	54

## HARDWOOD FLOORING.

Bliss & Van Auken	12
Carrier Lbr. & Mfg. Company	12
Cobbs & Mitchell, Inc.	3
Cummer, Diglins & Co.	3
Fenn Bros. Company	4
Forman, Thos., Company	7
Haak Lumber Company	59
Kerry & Hanson Flooring Company	58
Mitcheil Bros. Company	3
Nashville Hardwood Flooring Co.	8
Nichols & Cox Lumber Company	58
Pease Company, The	60
Schultz Bros. & Cowen	52
Stephenson, The L., Company	12
Stewart, Wm. H. & G. S.	10
Wood Mosaic Flooring Company	2
Young, W. D., & Co.	12

## SAW MILL MACHINERY.

Mershon, W. B., & Co.	50
Phoenix Manufacturing Company	43

## WOODWORKING MACHINERY

American Wood Working Machinery Company	47
Berlin Machine Works, The	43
Defiance Machine Works	43
Matteson Mfg. Company	44
Nash, J. M., & Co.	43
Ober Mfg. Company, The	44
Schindler, A. J.	44
Smith, H. B., Machine Company	45

## VENEER MACHINERY.

Coe Manufacturing Company	49
---------------------------	----

## LOGGING MACHINERY.

Clyde Iron Works	52
Lidgerwood Manufacturing Company	45
Overpack, S. C.	42
Russel Wheel & Foundry Company	42

## DRY KILNS AND BLOWERS

Grand Rapids Veneer Works	46
Morton Dry Kiln Company	43

## LUMBER INSURANCE.

Adronaack Fire Insurance Company	1
Lumber Insurance Company of New York	1
Lumber Mutual Fire Insurance Company, Boston	12
Lumber Underwriters	12
Pennsylvania Lumbermen's Mutual Fire Insurance Company	1
Runkin, Harry, & Co.	39
Toledo Fire & Marine Insurance Co.	46

## SAWS, KNIVES AND SUPPLIES

Atkins, E. C., & Co.	50
Champion Saw Company	40 & 46
Gillette Roller Bearing Co.	46
Hanchett Swage Works	42
Marshall, Francis	44
Shimer, S. J., & Sons	44

## MISCELLANEOUS.

Barroll, H. C., & Co.	12
Childs, S. H., & Co.	42
Gillette Roller Bearing Co.	46
Lacey, J. D., & Co.	42
Lumbermen's Credit Association	42
Martin & Co.	53
Pense Company, The	60
Schenck, C. A., & Co.	53
Standard Audit Company	9

# A Porch Column "Snap"

☐ In the manufacture of our high-grade veneers, we produce two cars monthly of clear, solid heart, bored Poplar Posts, 8 and 10 inches in diameter, 66 to 96 inches long.

☐ On this product we will make a price that will appeal to every manufacturer of porch columns.

## CHICAGO VENEER COMPANY, Inc.

BURNSIDE, KENTUCKY



**NOVELTIES FOR ADVERTISERS**  
 FOBs, POCKET PIECES  
 BUTTONS,  
 LETTER OPENERS,  
 SCARF PINS, TRAYS,  
 ALUMINUM GOODS,  
 PAPER WEIGHTS.  
**ALL NEW IDEAS.**  
 Send us 50c. and we  
 will send you a  
 Beautiful Watch Fob  
 S. D. CHILDS & CO.  
 200 CLARK ST. CHICAGO.



**ROY LUMBER CO.**  
**LOCS AND LUMBER**  
**Nichols**

**WALNUT.  
 OAK,  
 ASH,  
 POPLAR.**

You want to reach Buyers of  
**FURNITURE LUMBER**  
**The HARDWOOD RECORD**  
 will do it for you.

**Save Your Money**  
 By Using the  
**RED BOOK**  
 Published Semi-Annually  
 in January and July

It contains a carefully prepared list of the buyers of lumber in car lots, both among the dealers and manufacturers.

The book indicates their financial standing and manner of meeting obligations. Covers the UNITED STATES and MANITOBA.

The trade recognizes this book as the authority on the lines it covers.

A well organized Collection Department is also operated and the same is open to you.

**WRITE FOR TERMS.**

**Lumbermen's Credit Association**  
 ESTABLISHED 1878

1405 Great Northern Building, : CHICAGO  
 16 Beaver Street, : NEW YORK CITY

MENTION THIS PAPER

**HARDWOOD  
 TIMBER**

There is no section with so fine and large a supply of hardwood timbers of various kinds left for the lumbermen as that portion of the South in Alabama, Georgia, Kentucky, Mississippi, North Carolina, South Carolina, Tennessee and Virginia served by the lines of the

**Southern Railway  
 and  
 Mobile & Ohio Railroad**

There are oak, poplar, hickory, gum, cypress, ash, elm, buckeye, balsam, spruce, chestnut, and other varieties. There are also available pine lands. These timber resources and many other important features bearing on the cost of manufacture and marketing give special advantages and opportunities for EVERY KIND of WOOD USING INDUSTRY. We have information about the best locations in the country at towns in these States and in Southern Indiana and Southern Illinois, which will be given if requested. All correspondence in regard to timber lands or factory locations will be given prompt and confidential attention. Address your nearest agent.

M. V. RICHARDS,  
 Laud and Industrial Agent,  
 Washington, D. C.

CHAS. S. CHASE, Agent,  
 622 Chemical Building,  
 St. Louis, Mo.

**Locations for  
 Industries**  
 ON  
**THE ERIE, THE COMMERCIAL RAILROAD  
 CHICAGO TO NEW YORK**

The Erie Railroad System's Industrial Department has all the territory traversed by the railroad districted in relation to resources, markets and advantages for manufacturing, can advise with manufacturers of specific products as to suitable locations, and furnish them with current information of a comprehensive nature dealing with the project in its full relation to manufacture and commerce.

The Erie is one of the greatest of trunk lines. Its own rails connect the two largest cities of America. Every section of the System has its particular merits. Profitable locations exist. It has great general and coal, oil and natural gas resources.

It is important in this age of modern facilities for manufacturers to locate where they can obtain side tracks so as to receive from and ship directly into cars at the factory. Information can be promptly furnished in this connection about every point on the system between New York and Chicago.

Manufacturers' inquiries as to locations are treated in strict confidence and absolutely reliable information, so as to promote permanent traffic, is furnished. Address

**LUIS JACKSON**  
 Industrial Commissioner  
 Erie Railroad Company  
 11 Broadway, New York

**RUSSEL WHEEL & FOUNDRY COMPANY**

Builders of  
**Logging Cars**  
 And **Logging  
 Machinery**

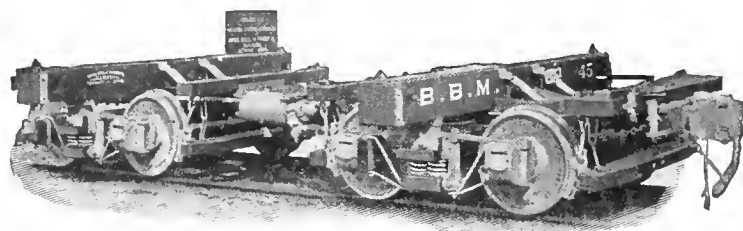

ARE ALWAYS PLEASED TO  
 HAVE OPPORTUNITY OF  
 POINTING OUT ADVAN-  
 TAGES OF THEIR  
 EQUIPMENT.

**Detroit, Mich.**





INSULATOR PIN LATHE

## "DEFIANCE" WOOD-WORKING MACHINERY

COMPLETE EQUIPMENTS OF  
**HIGH GRADE TOOLS**  
\* FOR MAKING \*

Hubs, Spokes, Wheels, Single Trees, Hoops,  
Wagons, Carriages, Handles, Bobbins, Spools,  
Rims, Shalts, Poles, Insulator Pins and  
Neck-Yokes, Oval Wood Dishes.

INVENTED AND BUILT BY  
**The DEFIANCE MACHINE WORKS**  
DEFIANCE, OHIO.

— Send for 500 Page Catalogue —



AUTOMATIC THREADING MACHINE

## The Morton Dry Kiln

MOIST AIR SYSTEM

Recording Thermometers, Transfer Cars.



Trucks, Canvas Doors.

**HOW TO DRY LUMBER**  
As exemplified in our Catalog D. Free on application.

**MORTON DRY KILN CO., Chicago, Ills.**

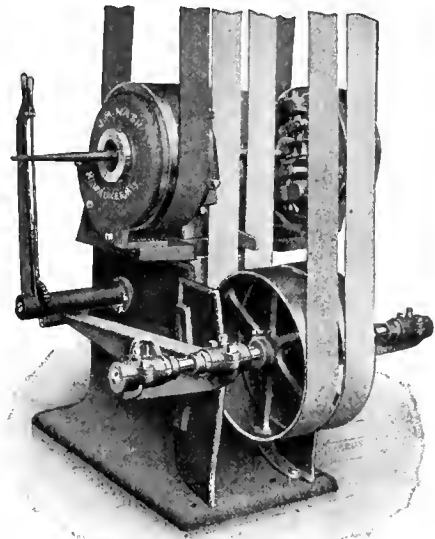

### The Nash Automatic Sander

FOR ALL ROUND STOCK WORK

A wonderful labor-saving machine.  
Pays for itself in a short time. For particulars address

**J. M. Nash** 842-848 Thirtieth St.  
MILWAUKEE, WIS.

Broom, Hoe, Rake, Fork and Shovel Handles, Chair Stock, Dowel Rods, Curtain Poles, Shade Rollers, Whip Stocks, Canes, Veneered Columns, Ten Pins, &c.



### Ten per cent More Profit

The profits of a saw mill can readily be increased ten per cent by using a hand mill instead of a rotary. The price of this mill with six foot wheels for saws eight inches wide is readily within the reach of all. It cuts smooth and perfect lumber and has a capacity of 25,000 feet to 35,000 feet per day. It runs with less expenditure of power than a rotary and puts only half as much of the log into saw dust as does the circular saw.

**PHOENIX MFG. COMPANY,**  
EAU CLAIRE, WIS.

# KNIVES

A man who has been in the presence of angels discloses the fact by his action: Just one reason for our talking good machine knives, good veneer knives or knives of any kind that do good work.

## CHAMPION SAW COMPANY,

BEAVER FALLS, PA.

## A machine that declares saw mill dividends



AUTOMATIC SWING SAW GAUGE.

**FRANCIS MARSHALL, - - Grand Rapids, Mich**

☞ An inexpensive little device that *saves a dollar a day* and upwards.

☞ Stops one of the biggest profit leaks at the mill. Pays for itself several times over during a year.

☞ Isn't it worth investigating?

## Improved Automatic Band Saw Sharpener

All  
Machines  
Fully  
Guaranteed

- ☞ This machine excels all others for single cutting Band Saws from 8 to 14 inches. Its construction is mechanically correct, simple and durable, and does not possess any of the intricate complicated parts that confuse the operator. The head is adjustable so that straight wheels can be used with the same results as concave.
- ☞ This represents just one type of machine. We make in addition a complete line of modern tools for the care of saws. For particulars address

**MATTESON MFG. CO., 120-128 S. Clinton St. CHICAGO, ILLS.**

THE COMBINATION OF MECHANICAL PRINCIPLES  
FOUND IN



## The Shimer Cutter Head

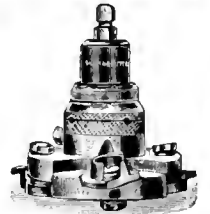

Has forced it to the front as a never failing wood cutting tool to make single tongue and groove Flooring, Ceiling, Siding and Wainscoting.

It applies especially to the various patterns that come within the line of mill work where irregular and square offsets occur. We duplicate Cutters to the nicety and furnish at uniformly low prices. All kinds of knotty and cross-grained lumber is neatly and smoothly finished using faster feeds—reduced costs.

**SAMUEL J. SHIMER & SONS, - - Milton, Penn.**

## New Type of Combined End Matcher

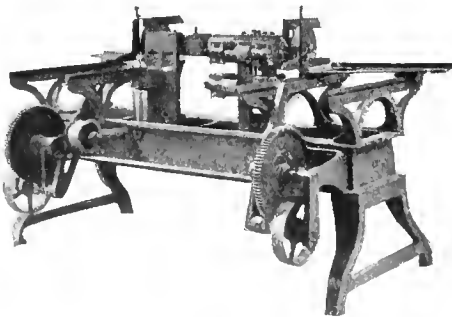

SAVES 20 PER CENT. TIME, COST AND LABOR.  
USED BY THE LARGEST FLOORING CONCERNS.

Write for particulars to

**A. J. SCHINDLER, 441-443 W. 21st Street, CHICAGO**

**Skidders**

**Snakers**

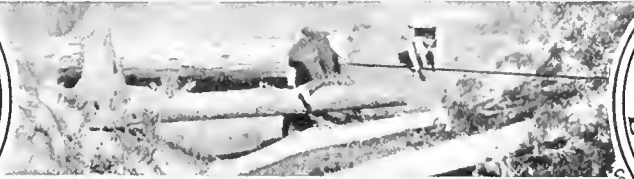

**Lidgerwood Machines  
Will Stock Your Mill**

- Lidgerwood Skidders**
- Lidgerwood Snakers**
- Lidgerwood Yarders**
- Lidgerwood Roaders**
- Lidgerwood Pull Boats**
- Lidgerwood Cableways**

**LIDGERWOOD MFG. CO.**

NEW YORK  
ATLANTA  
SEATTLE  
NEW ORLEANS

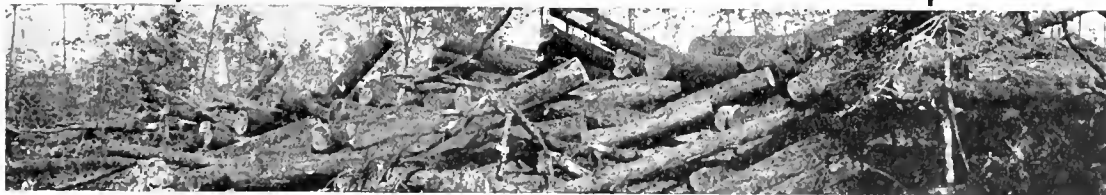

**Loaders**

**Cableways**

# Truck Truths

## 2--Bearing on Bearings

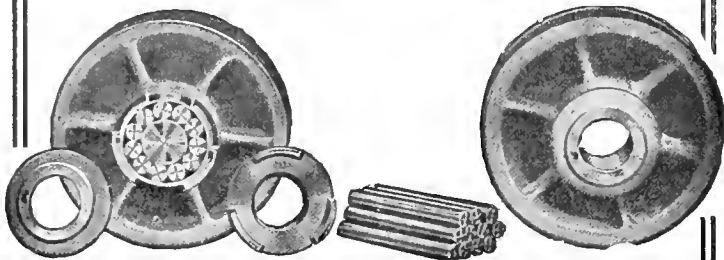

There is but one way to make a perfect truck bearing—the Gillette way.

Take two malleable iron wheels; machine bore and ream them to secure a perfect bearing surface.

Use only the best cold rolled steel for the axles and rollers. When these (Fig. 1) are in place, fit the retaining caps into the notches in the wheels; set the wheels up in the frame; and you have a perfect truck—the Gillette—a truck snugly protected at every point by patents, affording protection both to you and to us.

It will be noticed that the caps (Fig. 1) are interposed between the rollers and the truck frame—move with the wheel—and prevent the rollers from sticking fast or twisting across the axle.

If "anything" will do in trucks, you can buy them "anywhere." If you want the best, they can be had only of the

### Gillette Roller Bearing Co.

Patentees and Sole  
Manufacturers

Grand Rapids, Michigan



Hanchett - Hanchett - Hanchett

# Hanchett Saw Swage

Every one made Perfect

## The Swage with a Name

☐ A poor Swage Ruins a Good Saw, and for that reason the manufacturers of the

### HANCHETT ADJUSTABLE SWAGE

employ only the Best Mechanics and use only the Best Material in their construction.

**It Pays Us  
to make  
The Best**

Send for  
Catalog  
No. 10  
It tells you all  
about them

**It Pays You  
to use  
The Best**

MANUFACTURED BY

## Hanchett Swage Works

Big Rapids, Michigan

Hanchett - Hanchett - Hanchett

# SAWS

I tell you, Mr. Mill Man, there is merit in these saws. Dependable stuff that is made right, will work right, and last the life of good saw material.

## CHAMPION SAW CO.

BEAVER FALLS, PA.

We Guarantee

to

## KILN DRY OAK

IN A WEEK

by the application of a  
new scientific principle

IN YOUR PRESENT  
**Old Kilns**

Grand Rapids Veneer Works

DEPT. ID., GRAND RAPIDS, MICH.

# American 48-inch Band Re-Saw

The ideal machine for Accuracy, Volume, and Conveniences. A few features are Six Rolls, all geared above line of cut. It is the heaviest of its size on the market. Variable BELT Feed, not friction.

For other and more complete information address nearest salesroom

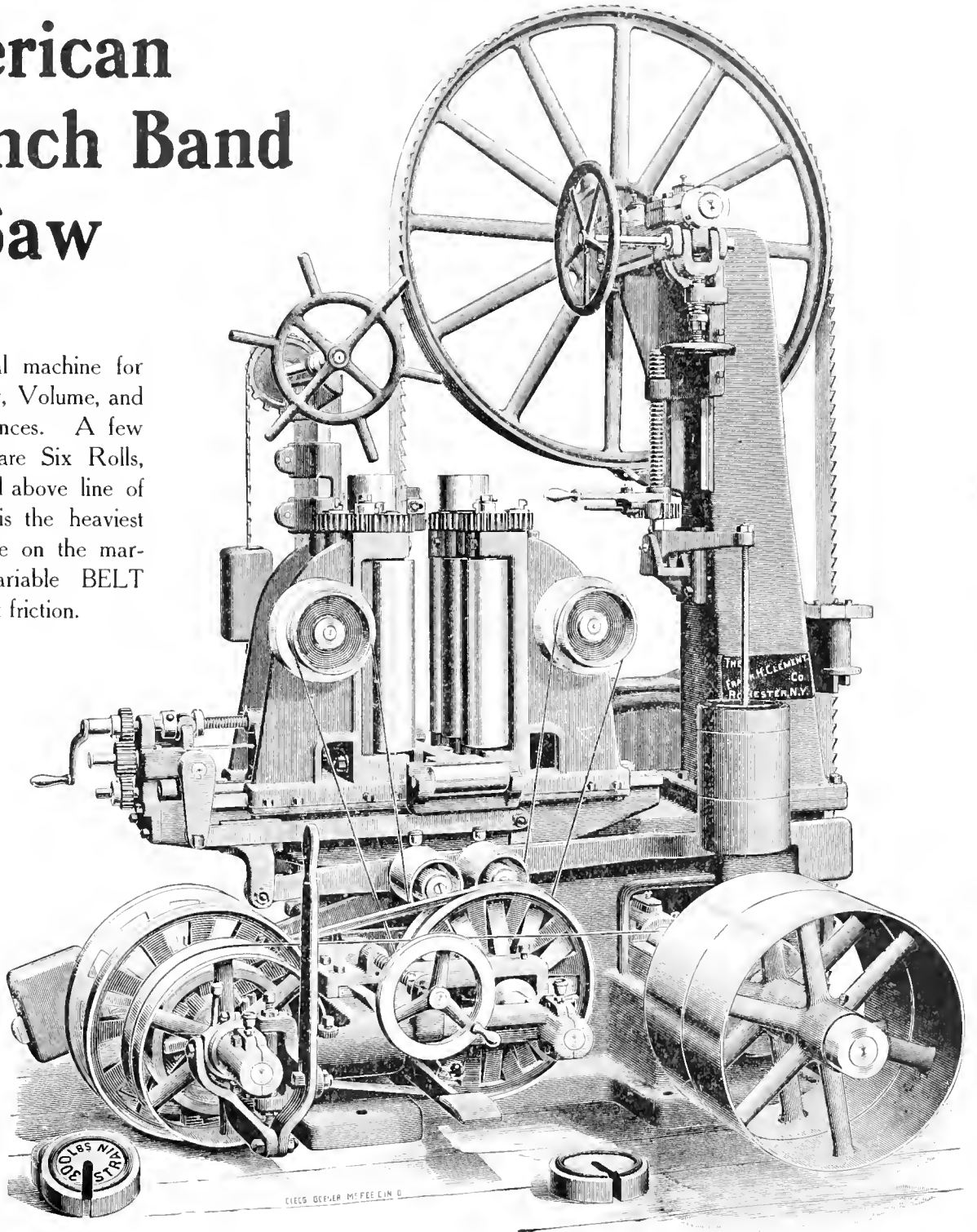

## American Wood Working Machinery Co.

New Orleans

Chicago

New York



**SMITH of  
SMITHVILLE**

**The Profit Builder**

**SMITH of  
SMITHVILLE**

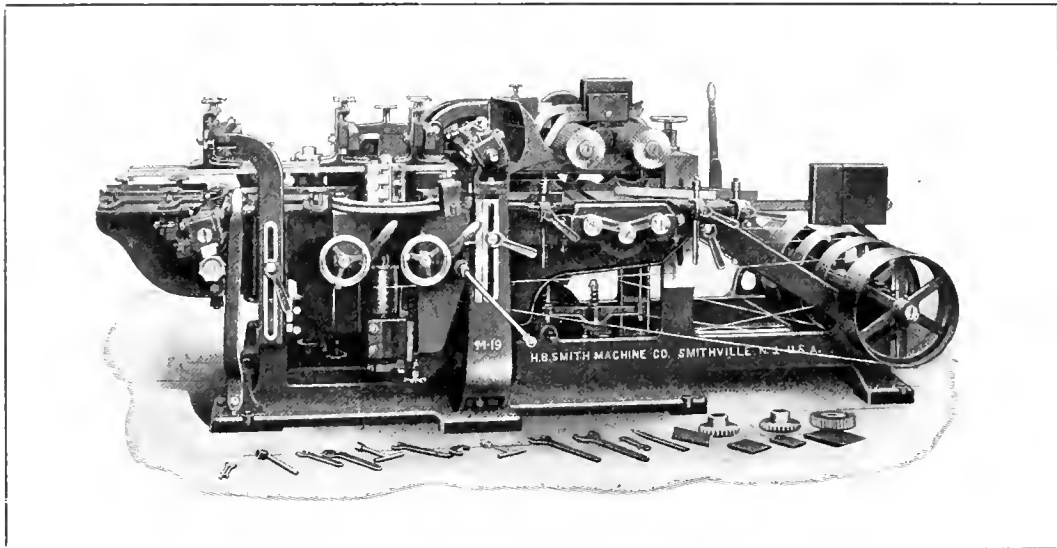

NO. 105-A, EXTRA HEAVY 12-INCH MOULDER



IT HAS been our purpose during the last half century to develop a line of wood working machines containing the best workmanship and material that American skill and wisdom can afford. This fact we are proud to say is well established in the minds of our many patrons. We have, however, now exceeded ourselves by the development of a remarkable Moulder, the excellence of which is due to our obtaining written suggestions from more than a thousand operators throughout America. This machine stands alone as being the composite idea of the thinking operators of this country. One year's test of its work has convinced us that it is impossible for you to compete successfully against the Smith Moulder with any other machine. Can't we send you prices and literature?

**Branches:**  
New York, Chicago,  
Boston

**H. B. SMITH MACHINE CO.**  
SMITHVILLE, N. J., U. S. A.

**Branches:**  
New York, Chicago,  
Boston



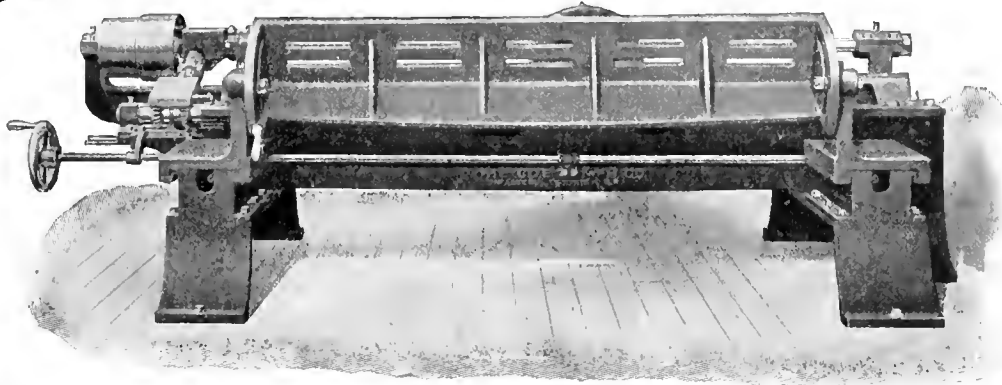

## The Coe Knife Grinder

was designed for the finest grinding and most exacting service. It is built on new lines and has completely overcome the objections to other grinders. The knife is held rigidly while the stone travels back and forth. There is no chance for

vibration, consequently no unevenly ground knives. Entirely automatic in ac-



tion, no ropes or chains. All moving parts operated by cut steel gears, noiseless in operation, will grind straight or hollow bevel. Feeds 1-1000 to 4-1000 for each travel of the stone, very heavy and compact, occupying small floor space. Made in seven sizes to grind up to 168 in.

It is fully described in our catalog No. 5, which we will be glad to send to interested parties.

**The Coe Manufacturing Co.** 105 Bernard Street **Painesville, O.**

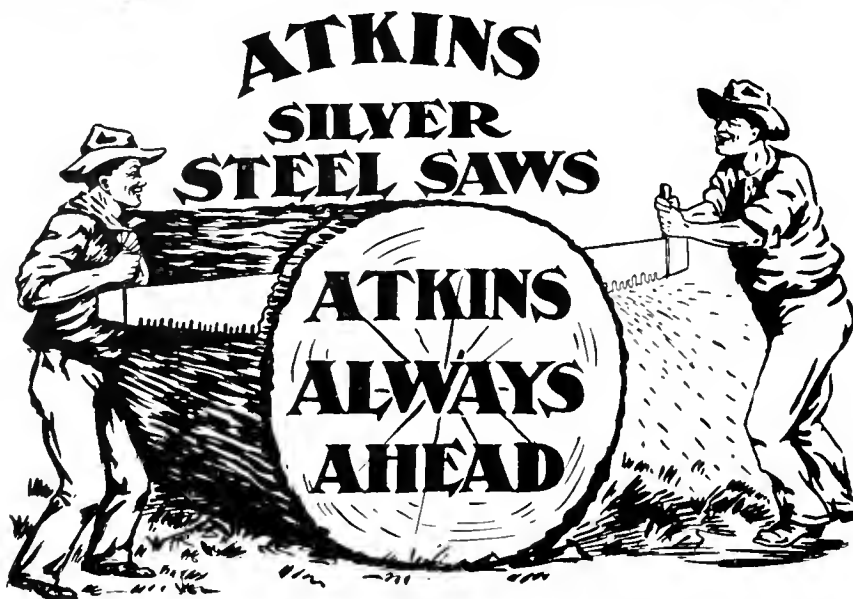

YOU CAN'T KNOW HOW GOOD ATKINS' SILVER STEEL CROSS-CUT SAWS ARE UNTIL YOU TRY THEM. WHY DON'T YOU? ORDER TO-DAY. YOU'LL BE DELIGHTED—CAN'T LOSE MUCH—PERHAPS YOU'LL SAVE THEIR COST—MILLIONS HAVE. IT'S WORTH TRYING. WHY DON'T YOU DO IT?

**E. C. ATKINS & CO.**

INCORPORATED

HOME OFFICE AND FACTORY: INDIANAPOLIS, INDIANA

BRANCHES CARRYING STOCK AT CHICAGO, ATLANTA, MEMPHIS, MINNEAPOLIS AND NEW ORLEANS  
ALSO NEW YORK, PORTLAND, SAN FRANCISCO, SEATTLE AND TORONTO.

# M E R S H O N

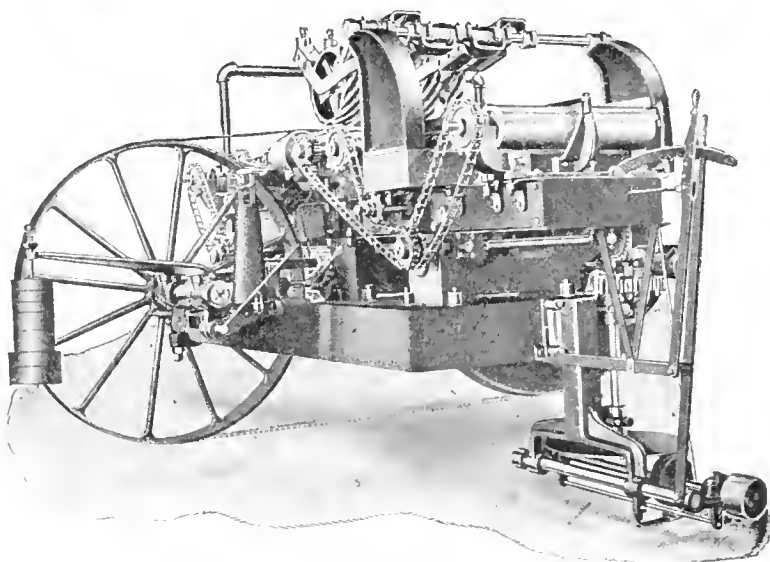

MERSHON NEW HORIZONTAL BAND RESAW FOR SAW MILLS

Band Resawing  
Machinery  
for all requirements

**WM. B. MERSHON  
& CO.,**

Saginaw, = Michigan

ALLIS-CHALMERS COMPANY, Seattle, Wash., Agents for Northern Pacific Territory.

THE EBY MACHINERY CO., San Francisco, Cal., Agents for California and Nevada.

# For shipment October 15th

We have the following stock in pile,  
ready for market about October 15th

## QUARTERED WHITE OAK.

50 M 12/4 1st & 2nd  
10 M 10/4 1st & 2nd  
50 M 8/4 1st & 2nd  
20 M 6/4 1st & 2nd  
10 M 5/4 1st & 2nd  
200 M 4/4 1st & 2nd  
100 M 3/4" 1st & 2nd  
100 M 5/8" 1st & 2nd  
100 M 1/2" 1st & 2nd  
75 M 3/8" 1st & 2nd  
50 M 1/4" 1st & 2nd  
50 M 12/4 No. 1 Com.  
12 M 10/4 No. 1 Com.  
65 M 8/4 No. 1 Com.  
30 M 6/4 No. 1 Com.  
11 M 5/4 No. 1 Com.  
260 M 4/4 No. 1 Com.  
150 M 3/4" No. 1 Com.  
150 M 5/8" No. 1 Com.  
140 M 1/2" No. 1 Com.  
80 M 3/8" No. 1 Com.  
40 M 1/4" No. 1 Com.  
50 M 4/4 No. 2 Com.  
50 M 4/4 1 & 2 Strips  
40 M 4/4 Com. Strips

## QUARTERED RED OAK.

20 M 8/4 1st & 2nd  
10 M 6/4 1st & 2nd  
5 M 5/4 1st & 2nd  
75 M 4/4 1st & 2nd  
40 M 3/4" 1st & 2nd  
35 M 5/8" 1st & 2nd  
20 M 1/2" 1st & 2nd  
10 M 3/8" 1st & 2nd  
10 M 1/4" 1st & 2nd  
60 M 8/4 No. 1 Com.  
30 M 6/4 No. 1 Com.  
15 M 5/4 No. 1 Com.  
130 M 4/4 No. 1 Com.  
40 M 3/4" No. 1 Com.  
20 M 5/8" No. 1 Com.  
20 M 1/2" No. 1 Com.  
15 M 3/8" No. 1 Com.  
15 M 1/4" No. 1 Com.  
50 M 4/4 No. 2 Com.  
20 M 4/4 1 & 2 Strips  
20 M 4/4 Com. Strips

## PLAIN WHITE OAK.

35 M 12/4 1st & 2nd  
20 M 10/4 1st & 2nd  
45 M 8/4 1st & 2nd  
30 M 6/4 1st & 2nd  
20 M 5/4 1st & 2nd  
300 M 4/4 1st & 2nd  
60 M 3/4" 1st & 2nd  
50 M 5/8" 1st & 2nd  
40 M 1/2" 1st & 2nd  
25 M 3/8" 1st & 2nd  
30 M 1/4" 1st & 2nd  
40 M 12/4 No. 1 Com.  
20 M 10/4 No. 1 Com.  
60 M 8/4 No. 1 Com.  
50 M 6/4 No. 1 Com.  
30 M 5/4 No. 1 Com.  
400 M 4/4 No. 1 Com.  
80 M 3/4" No. 1 Com.  
60 M 5/8" No. 1 Com.  
50 M 1/2" No. 1 Com.  
30 M 3/8" No. 1 Com.  
30 M 1/4" No. 1 Com.  
200 M 4/4 No. 2 Com.  
30 M 6/4 No. 2 Com.  
30 M 8/4 No. 2 Com.  
50 M 4/4 1 & 2 Strips

## CHESTNUT.

75 M 4/4 1st & 2nd  
10 M 5/4 1st & 2nd  
15 M 6/4 1st & 2nd  
10 M 8/4 1st & 2nd  
100 M 4/4 No. 1 Com.  
15 M 5/4 No. 1 Com.  
20 M 6/4 No. 1 Com.  
15 M 8/4 No. 1 Com.  
200 M 4/4 No. 2 Com. & S. W.  
20 M 5/4 No. 2 Com. & S. W.  
25 M 6/4 No. 2 Com. & S. W.  
15 M 8/4 No. 2 Com. & S. W.  
20 M 4/4 No. 3 Com.  
500 M 4/4 1 & 2 Bay Poplar  
600 M 4/4 No. 1 Com. Bay Pop.  
800 M 4/4 No. 2 Com. Bay Pop.

If you are interested in any of the  
above, we shall be glad to quote you.  
We are also in position to talk with you  
on Hardwood Flooring, all kinds of Yel-  
low Pine, Cypress and Coast Products.

## PLAIN RED OAK.

10 M 12/4 1st & 2nd  
5 M 10/4 1st & 2nd  
60 M 8/4 1st & 2nd  
50 M 6/4 1st & 2nd  
10 M 5/4 1st & 2nd  
400 M 4/4 1st & 2nd  
75 M 3/4" 1st & 2nd  
60 M 5/8" 1st & 2nd  
45 M 1/2" 1st & 2nd  
30 M 3/8" 1st & 2nd  
30 M 1/4" 1st & 2nd  
15 M 12/4 No. 1 Com.  
5 M 10/4 No. 1 Com.  
75 M 8/4 No. 1 Com.  
70 M 6/4 No. 1 Com.  
15 M 5/4 No. 1 Com.  
560 M 4/4 No. 1 Com.  
80 M 3/4" No. 1 Com.  
80 M 5/8" No. 1 Com.  
60 M 1/2" No. 1 Com.  
30 M 3/8" No. 1 Com.  
20 M 1/4" No. 1 Com.  
200 M 4/4 No. 2 Com.  
30 M 6/4 No. 2 Com.  
30 M 8/4 No. 2 Com.  
50 M 4/4 1st & 2nd Strips

## POPLAR.

30 M 4/4 16 to 18" Wide Box  
50 M 4/4 13 to 15" Wide Box  
25 M 4/4 11 & 12" Box  
50 M 4/4 9 & 10" Box  
50 M 4/4 7 & 8" Box  
125 M 4/4 1st & 2nd 7 to 18"  
25 M 5/4 1st & 2nd 7 to 18"  
25 M 6/4 1st & 2nd 7 to 18"  
25 M 8/4 1st & 2nd 7 to 18"  
30 M 4/4 1 & 2 18 to 40"  
10 M 5/4 1 & 2 18 to 40"  
10 M 6/4 1 & 2 18 to 40"  
15 M 8/4 1 & 2 18 to 40"  
50 M 4/4 Clear Sap  
400 M 4/4 No. 1 Common  
30 M 5/4 No. 1 Common  
40 M 6/4 No. 1 Common  
50 M 8/4 No. 1 Common  
400 M 4/4 No. 2 Common  
40 M 5/4 No. 2 Common  
50 M 6/4 No. 2 Common  
50 M 8/4 No. 2 Common  
50 M 4/4 No. 3 Common

# Stotz Lumber Company

INCORPORATED

Louisville, Kentucky

# Schultz Brothers & Cowen

WE ARE IN THE MARKET TO BUY

**POPLAR—OAK—ASH—CHESTNUT**

AND OTHER HARDWOODS—ALL GRADES AND THICKNESSES

1225 to 1240 OLD COLONY BUILDING, . . . . .

CHICAGO

W. H. WHITE, Pres.  
JAS. A. WHITE, Vice-Pres.

W. L. MARTIN, Secy.  
THOS. WHITE, Treas.

## W. H. WHITE COMPANY

BOYNE CITY, MICHIGAN

**Manufacturers of Hardwood and Hemlock Lumber, Cedar Shingles,  
White Rock Maple Flooring.**

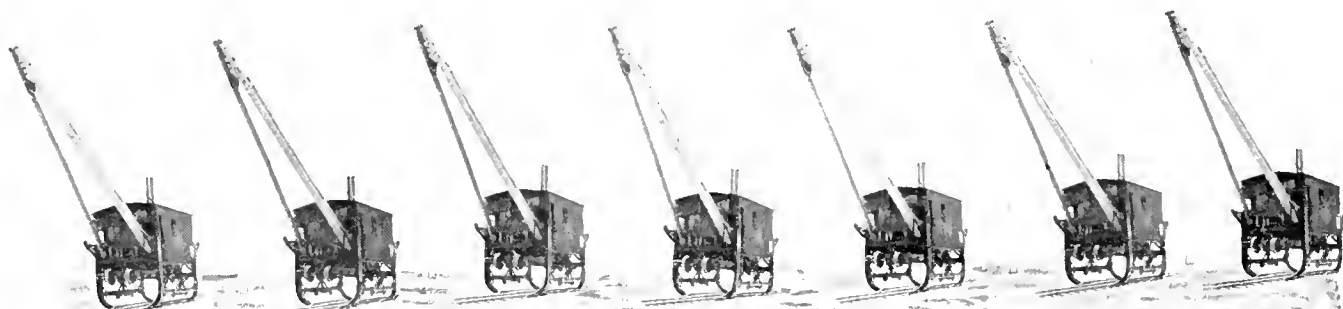

“ALWAYS ON TOP”

**7 McGIFFERT Log Loaders** are now doing the loading for one of the largest operators in the world. He bought the first machine because he *thought* it was the best loader made. He bought the second because, by experience, he *knew* that it was. He bought five more because—well, because he couldn't buy better ones.

Our Booklet Tells You Why.

Manufactured by **GLYDE IRON WORKS, Duluth, Minn.**

**EASTERN TENNESSEE—WESTERN NO. CAROLINA**

ASHEVILLE KNOXVILLE BRISTOL

**Vestal Lumber & Mfg. Co.**

Manufacturers and Wholesalers  
of all kinds of

**HARDWOODS**

BEVELED SIDING A SPECIALTY.  
UNSURPASSED FACILITIES  
FOR DELIVERING.

Knoxville  
Tennessee

**HARDWOODS**

From the famous Asheville district.  
Superior in quality, manufacture and  
gradings. For stock list and prices,  
address

**J. S. COLEMAN LUMBER CO.**  
ASHEVILLE, N. C.

**On the Spot**

We are located right in the heart of this mountain country producing the best hardwoods in existence.

We are headquarters with ample stock, and can interest you both as to assortment and price. Write us.

**American Lumber Company**  
ASHEVILLE, N. C.

**Fry-Buchanan Lumber Co.**

INCORPORATED.

Manufacturers and Wholesalers  
**Hardwood Lumber**

Choicest Varieties. ∴ Full Grades.

POPLAR SQUARES  
A Specialty.

Asheville, N. C.

**All Lumbermen, Attention!**

We do what you can't do.  
We measure your stumpage correctly.  
We make your maps correctly.  
Bank references: Asheville, N. C.

**C. A. Schenck & Co.** Biltmore,  
North Carolina.

**SYMBOLS for GRADE MARKS**

○ Adopted by the Hardwood Manufacturers Association of United States.  
A Every Manufacturer should stamp the grade on his Lumber.  
B Set of 10 Rubber Stamps, 1½"x1¼" in size, Pad, Pint of Ink, and Spreader, packed for shipment \$3.50.  
S

**MARTIN & CO.**  
191 S. Clark St., CHICAGO, or  
**LEWIS DOSTER, Sec'y**

Panel and Wide No. 1  
Wide No. 2  
Box Boards  
FAS or Firsts & Seconds  
Saps

1535 First Nat. Bank Bldg.  
CHICAGO

△  
①  
②  
③  
④  
Selects  
No. 1 Common  
No. 2 Common  
No. 3 Common  
No. 4 Common

**Wood Working Plants**

Manufacturers seeking locations for Saw Mills, Stave and Heading Factories and other Wood Working Plants in the Central Southern States, can secure full and accurate information as to Sites, Timber Tracts, Fuel, Transportation Facilities, etc., by addressing

G. A. PARK, General Immigration and Industrial Agent,  
**Louisville & Nashville Railroad Company**  
LOUISVILLE, KENTUCKY

**Industries are Offered Locations**

WITH SATISFACTORY INDUCEMENTS, FAVORABLE  
FREIGHT RATES, GOOD LABOR CONDITIONS  
HEALTHFUL COMMUNITIES, on the lines of

**The Illinois Central R. R. and the  
Yazoo & Mississippi Valley R. R.**

For full information and descriptive pamphlet address

J. C. CLAIR, Industrial Commissioner, 1 Park Row, Chicago, Ill.

# WISCONSIN

WHERE THE FINEST NORTHERN HARDWOODS GROW

# Mason-Donaldson Lumber Co.

Manufacturers and Wholesalers

## Northern Hardwoods

Birch a specialty

Rhineland, - - - Wisconsin



## R. CONNOR CO.

WHOLESALE MANUFACTURERS

### Wisconsin Hardwood

PINE AND HEM-  
LOCK LUMBER

Mills at  
Auburndale, Wis., on W. C. R. R.  
Stratford, Wis., on C. & N. W. R. R.

**Marshfield, Wis.**

## Wisconsin Veneer Co.

MANUFACTURERS OF

### Rotary Cut Veneers

in Birch, Elm, Ash, Basswood  
Maple and Oak

Rhineland, . . . . Wisconsin

## North Western Lumber Co.

General Offices  
EAU CLAIRE, WIS.

Mills at  
STANLEY, WIS.

Band Sawed

# Wisconsin Hardwoods

Careful Gradings.  
Prompt Shipments.

**SPECIAL OFFERINGS**

- 1 Car 1½ inch No. 1 Common Basswood.
- ½ Car 1¼ inch No. 1 Common Basswood.
- ½ Car 2½ inch 1st and 2nd Clear Basswood.
- 1 Car 1½ inch 1st and 2nd Clear Basswood.
- 1 Car 1¼ inch, 1½ inch and 2 inch No. 3 Soft Elm.

## LOCATIONS FOR NEW INDUSTRIES

can be secured on the lines of the

### Chicago, Milwaukee & St. Paul Railway

in the great middle west. It reaches the Copper Country and the pine and hardwood areas of Northern Michigan, the lead, zinc and iron regions of Wisconsin, the coal fields of Illinois, Iowa and Missouri.

Traverses the great agricultural and manufacturing states of Iowa, Minnesota, North and South Dakota. Operates 7,000 miles of thoroughly equipped railroad.

Correspondence is solicited with eastern manufacturers who desire to move their factories to, or establish branches in the West. Co-operation with Business Men's Associations on the lines of this railway in all matters affecting mutual interests is assured.

Inquiries should be as definite as possible.

*Address*

**Industrial Department**  
**Chicago, Milwaukee & St. Paul Railway,**  
**Room 1327, Railway Exchange**  
**Chicago**



# WISCONSIN

WHERE THE FINEST NORTHERN HARDWOODS GROW

## NORTHERN STOCK

Hemlock  
Birch  
Basswood  
Rock Elm  
Soft Elm  
Ash  
Oak

## SOUTHERN STOCK

Quartered White and Red Oak  
Plain White and Red Oak  
Sycamore  
Poplar  
Cypress  
Gum

## PAGE & LANDECK LUMBER CO.

Wells Building - - - MILWAUKEE, WIS.

## For Sale:

NATIONAL INSPECTION

3,000,000 ft. inch Birch.  
100,000 ft. inch Black Ash.  
50,000 ft. inch Soft Elm.  
All No. 1 Common and Better.  
20,000 ft. 1x4 and wider, 6 ft., 1st & 2nd Birch.

## Dells Lumber & Shingle Co.

EAU CLAIRE, WISCONSIN

## C. P. CROSBY

RHINELANDER : : WISCONSIN

### Wholesale Hardwood Lumber

Hard Maple a Specialty in all thicknesses from 1 inch to 4 inch. Finest Birch in Wisconsin. Black Ash, Rock Elm, Soft Elm, Red and White Oak. : :

DIFFICULT AND MIXED ORDERS A SPECIALTY

## HARDWOOD LUMBER-- NORTHERN AND SOUTHERN

All kinds of Northern and Southern Hardwoods for sale. We call your attention to the following items which we have to offer, to-wit:

50M ft. 1" Curly Birch	30M ft. 1 1/2" No. 2 Com. & Bet. Hickory
50M ft. 2" Com. and Bet. Plain Birch	30M ft. 1 1/2" No. 2 Com. & Bet. Hickory
80M ft. 2 1/2" Com. and Bet. Plain Birch	100M ft. 1" Com. & Bet. Plain Red Oak
150M ft. 1" No. 1 Com. Plain Birch	150M ft. 1" Com. & Bet. Qtd. Red Oak
12M ft. 2" 1sts and 2ods Red Birch	10M ft. 1" No. 3 Com. & Bet. Walnut
200M ft. 1" Com. and Bet. Hard Maple	75M ft. 1 1/2" No. 2 Com. & Bet. Elm
200M ft. 2" Com. and Bet. Hard Maple	150M ft. 1" No. 1 Com. Red Gum
50M ft. 2" Bridge Plank - Oak	

In addition to the foregoing, we have full stocks of Basswood, Birch and Soft Elm and a full selection of Red and Sap Gum. We guarantee our grades to be made strictly in accordance with National Hardwood Association rules of inspection.

### G. W. JONES LUMBER CO., Appleton, Wis.

CHICAGO OFFICE: 1717 RAILWAY EXCHANGE.

## John R. Davis Lumber Company

PHILLIPS, WISCONSIN

The Leading Manufacturers

## Wisconsin Hardwoods

"SHAKELESS" HEMLOCK and WHITE CEDAR PRODUCTS

WE HAVE THE FINEST BLOCK OF

4-4 UNSELECTED BIRCH

ON THE MARKET

Write for our Price Lists and Stock Sheets,

Mixed Cars, Even Grades Prompt Shipments



## BASSWOOD, BIRCH

We cut four million feet of each annually Your inquiries and orders solicited

MILL AND YARDS AT INGRAM, WISCONSIN

## ARPIN HARDWOOD LUMBER CO.

GRAND RAPIDS, WISCONSIN

Saw and Planing Mill at Atlanta, near Bruce, on the Soo Line. Offer

5 cars 1" 1st & 2d Red Birch.	2 cars 3" Clear Plain Birch Flooring.
1 car 1 1/4" 1st & 2d Red Birch.	1 car 3" Clear Red Birch Flooring.
1 car 1 1/4" Common Red Birch.	1 car 3" Factory Birch Flooring.
1 car 1 1/2" 1st & 2d Red Birch.	1 car 3" Red Oak Factory Flooring.
1,000' 1 1/2" Common Red Birch.	1 car 1 1/4 & 1 1/2" quarter sawed Com. and Btr. Red Oak.
2,500' 1 1/2" Com. & Btr. Red Birch.	1/2 car 1 1/4 and 2" Com. & Btr. quarter sawed Red Oak.
5,000' 2" 1st & 2d Red Birch.	1 car 5" Clear quarter sawed Red Oak Flooring.
2 cars 2 1/2 & 3" Plain Birch.	1/2 car each 1 1/2" Com. & Clear Maple Flooring.
2 cars 2 1/2 & 3" Log Run Unselected Birch.	
5 cars 1" Common Red Birch.	
1 car 2" Plain Log Run Birch.	

We make a specialty of high grade Maple, Birch and Oak Flooring, Basswood, Pine Siding, Ceiling and Finish; also Moulding.

## VOLLMAR & BELOW

MARSHFIELD, WISCONSIN

## Basswood, Birch

and Other Wisconsin Hardwoods

LET US KNOW WHAT YOU ARE IN THE MARKET FOR

# PITTSBURG

HARDWOOD DISTRIBUTING CENTER OF PENNSYLVANIA

## The Nicola Lumber Company

One million feet 4-4 Bay Poplar.  
Can be shipped log run, or sold  
on grade. Bone dry; band  
sawed. Send your inquiries.

## Flint, Erving & Stoner Co.

Wholesale Lumber  
Northern and Southern Hardwoods

Beech and Maple Timbers a Specialty

## A. M. Turner Lumber Company

Everything in lumber. We buy hardwoods  
as well as sell them. If you have anything  
to offer, please submit same to us.

## Linehan Lumber Company

PERFECT

## MAPLE FLOORING

SEND US YOUR INQUIRIES

## Willson Bros. Lumber Co.

MANUFACTURERS

## WEST VIRGINIA HARDWOODS

FARMERS BANK BLDG. :: PITTSBURG, PA.

## Hardwoods a Specialty

FOR SALE

POPLAR	CHESTNUT	PLAIN OAK
125,000' 4/4 1s and 2s	200,000' 4/4 Sound Wormy	60,000' 4/4 No. 1 Com.
40,000' 4/4 No. 1 Com.	80,000' 5/4 Sound Wormy	18,000' 4/4 No. 2 Com.
325,000' 4/4 No. 2 Com.	100,000' 6/4 Sound Wormy	<b>QUARTERED OAK</b>
228,000' 4/4 No. 3 Com.	48,000' 8/4 Sound Wormy	2 cars 4/4 No. 1 Com.
150,000' 4/4 Mill Cull		1 car 4/4 No. 2 Com.

OAK TIMBERS SAWED TO ORDER.  
WRITE FOR PRICES.

CHEAT RIVER LUMBER COMPANY, Pittsburg, Penna.

## STOCK LIST

12,500 ft. 4/4 Maple No. 1 Com. & Bet.	192,000 ft. 4/4 Poplar Log Run
8,000 ft. 4/4 Maple No. 1 Common	4,000 ft. 8/4 Poplar Log Run
48,000 ft. 5/4 Maple No. 1 Com. & Bet.	23,500 ft. 12/4 Poplar Good
21,000 ft. 5/4 Maple 1sts and 2nds	2,500 ft. 6/4 Basswood Log Run
12,000 ft. 5/4 Maple No. 1 Common	2,200 ft. 8/4 Basswood Log Run
18,000 ft. 6/4 Maple No. 2 Com. & Bet.	1 Car 4/4 Basswood Log Run
3,000 ft. 6/4 Maple 1sts and 2nds	62,000 ft. 4/4 Cherry Log Run
3,000 ft. 8/4 Maple No. 2 Com. & Bet.	25,000 ft. 5/4 Cherry Log Run
29,000 ft. 8/4 Maple No. 1 Common	23,000 ft. 6/4 Cherry Log Run
13,000 ft. 10/4 Maple 1sts and 2nds	26,000 ft. 8/4 Cherry Log Run
15,000 ft. 12/4 Maple No. 2 Com. & Bet.	1 Car 4/4 White Birch 1sts & 2nds

FAVORABLE FREIGHT RATES TO THE EAST

**Babcock Lumber Co.**  
ASHTOLA, PA.

## Dry Stock for Quick Shipment:

48,492 ft. 4/4 1st & 2ds Qtd. White Oak.	70,812 ft. 4/4 No. 1 Poplar.
124,982 ft. 4/4 No. 1 Com. Qtd. White Oak.	14,182 ft. 6/4 1st & 2ds Poplar.
69,793 ft. 4/4 1st & 2ds Qtd. Red Oak.	118,121 ft. 4/4 Sound Wormy Chestnut.
79,341 ft. 4/4 No. 1 Com. Red Oak.	24,128 ft. 6/4 1st & 2ds Chestnut.
128,402 ft. 4/4 No. 1 Com. Pl. W. O.	21,963 ft. 7/4 No. 1 Com. Chestnut.
119,061 ft. 4/4 No. 1 Com. Pl. R. O.	19,246 ft. 8/4 No. 1 Com. Chestnut.
8,942 ft. 5/4 No. 1 Com. Pl. Red & White Oak.	78,433 ft. 6/4 Sound Wormy Chestnut.
11,312 ft. 6/4 No. 1 Com. Pl. Red & White Oak.	4,284 ft. 8/4 Sound Wormy Chestnut.
41,028 ft. 8/4 No. 1 Com. Pl. Red & White Oak.	126,094 ft. 4/4 1st & 2ds Cottonwood.
38,793 ft. 5/8 1st & 2ds Poplar.	49,021 ft. 4/4 13 to 17" Box Boards, 1st & 2ds.
29,423 ft. 5/8 No. 1 Com. Poplar.	61,975 ft. 4/4 8 to 12" Box Boards, 1st & 2ds.
21,971 ft. 5/8 Saps Poplar.	98,194 ft. 4/4 Sap Gum, 1st & 2ds.
29,824 ft. 5/8 No. 2 Com. Poplar.	129,481 ft. 4/4 Sap Gum No. 1 Com.
21,974 ft. 4/4 1st & 2ds Poplar.	49,200 ft. 4/4 Sap Gum No. 2 Com.
	48,265 ft. 4/4 Red Gum, 1st & 2ds.
	94,589 ft. 4/4 Red Gum, No. 1 Com.
	242,841 ft. 4/4 Bay Poplar, 1st & 2ds.
	181,921 ft. No. 1 Com. Bay Poplar.

**American Lumber & Mfg. Co.** Pittsburg, Pa.

**CLEVELAND**  
HARDWOOD DISTRIBUTING CENTER OF NORTHERN OHIO

**THE  
ROBERT H. JENKS LUMBER  
COMPANY**

**FOR SALE**

60 M feet 1" 1st and 2ds Poplar  
223 M feet 1" No. 1 Common Poplar  
125 M feet 1" No. 2 Common Poplar  
25 M feet 2" 1st and 2nd Poplar, 14" and up  
125 M feet 8 4" Sound Wormy Chestnut  
275 M feet 1" Sound Wormy Chestnut  
153 M feet 1" 1st and 2nd Plain White Oak  
85 M feet 1" 1st and 2nd Plain Red Oak  
125 M feet 1" No. 1 Common Plain Red Oak

**Quartered White and Red Oak.**—We have a good assortment of dry stock,  $\frac{3}{8}$  to 4 inches thick. Your inquiries solicited.

**Plain White and Red Oak.**—A limited amount of nice stock, ready for shipment.

**Do You Want It?  
What?  
Money?**

What have you in lumber to exchange for it? We want particularly Plain Oak, Chestnut, Poplar, Basswood, Ash.

**What Have You?**

**The Advance Lumber Co.**

13th Floor  
Rockefeller Bldg. CLEVELAND, OHIO

Memphis Office, No. 56 Randolph Building.      J. E. MEADOWS, Mgr.

**The Martin-Barriss Company**

Importers and Manufacturers  
**MAHOGANY**

**and Fine Hardwoods**

**E. H. FALL**

EXPORTER  
... OF ...

**WALNUT, POPLAR  
AND  
BIRDSEYE MAPLE LOGS**

Cash paid for Black Walnut Logs at point of shipment. If you have any walnut logs to offer, write me.  
I have some Sycamore, Red Oak, Ash and other hardwood logs which I am prepared to saw to order. Correspondence solicited.  
Can also supply Black Walnut lumber, sawed to any specification required.

**PORT CLINTON : OHIO**

**TO NEW YORK OVER NIGHT**

**The 20th Century Limited**

Via the LAKE SHORE and NEW YORK CENTRAL  
The Route of the Government Fast Mail Trains

**CHICAGO - NEW YORK 18-HOUR TRAIN**  
**IT SAVES A DAY**

<p>FROM LA SALLE ST. STATION CHICAGO</p> <p>Leave Chicago at 2.30 p. m. Arrive New York at 9.30 a. m.</p>	<p>FROM GRAND CENTRAL STATION THE ONLY TERMINAL IN NEW YORK</p> <p>Leave New York at 3.30 p. m. Arrive Chicago at 8.30 a. m.</p>
---	--

W. J. LYNCH, Passenger Traffic Manager, Chicago, Ill.



**M I C H I G A N**  
FAMOUS FOR RED BIRCH AND BASSWOOD

**SOFT ELM AND ROCK ELM**  
FOR SALE BY  
**The R. G. Peters Salt & Lumber Co.**  
EASTLAKE, MICHIGAN

 **J. S. GOLDIE**  
Cadillac, :: Michigan.  
SPECIAL PRICES on 500M pieces  
1" to 3" Maple Squares 16" to 27" long.  
1" to 3" Soft Elm Lumber.  
INQUIRIES SOLICITED FOR MICHIGAN LUMBER.

**BOYNE CITY LUMBER COMPANY**  
BOYNE CITY  
**MICHIGAN ROCK MAPLE and other HARDWOODS**  
LARGE CAPACITY PROMPT SHIPMENTS RAIL OR CARGO

**VAN KEULEN & WILKINSON LUMBER COMPANY**  
Manufacturers and Wholesalers of  
**HARDWOOD LUMBER and CRATING STOCK**  
Complete Stocks of Michigan Hardwoods—Maple, Beech, Birch, Elm,  
Ash and Basswood for sale.  
Grand Rapids, : : : Michigan

**OUR MAPLE FLOORING**  
is as near perfection, in every particular, as it is possible to make it, for we personally supervise every step in its manufacture, from the stump to the shipping of the finished product. Our prices will interest and a trial convince you :  
**HAAK LUMBER COMPANY**  
HAAKWOOD, MICHIGAN

**Hackley-Phelps-Bonnell Co.**  
MANUFACTURERS OF  
**Northern and Southern Hardwood Lumber**  
Main Office, Michigan Trust Company Building  
GRAND RAPIDS : . . . MICHIGAN

**DENNIS BROS.**  
GRAND RAPIDS, : : : MICHIGAN  
**HARDWOOD LUMBER (by water or rail)**  
**"NATIONAL" MAPLE & BIRCH FLOORING**  
SPECIAL BARGAINS IN THE FOLLOWING:  
300M feet 4 4 Log Run Birch  
186M feet 5 4 Log Run Birch  
1 Car 8 4 No. 1 Com. Birch  
1 Car 1 4 Clear Birch  
50M feet 4 4 No. 1 Com. Sap Birch  
40M feet 4 4 No. 1 Com. Red Birch  
All thicknesses and grades Hard Maple  
150M feet 5 4 Log Run Beech  
2 Cars 4 4 No. 3 Com. Cherry  
Main Office :  
205-209 Michigan  
Trust  
Company  
Building

**Thos. MacBride Lumber Company**  
HEADQUARTERS FOR  
**HARDWOODS**  
IN MICHIGAN  
Michigan Trust Building, Grand Rapids, Mich.

**BIRCH**  
This is our specialty. We are in the heart of the best Birch section. Have good stock, Common and better, 4-4, 5-4, 6-4, 8-4, 10-4, 12-4, and 16-4.  
Let us figure with you.  
**Simmons Lumber Company**  
SIMMONS, MICHIGAN

**McCLURE LUMBER COMPANY**  
MANUFACTURERS OF  
**Hardwoods**  
Main Offices, DETROIT, MICH.  
Mills, : EUTAW, ALA.  
SPECIAL OFFERINGS:  
5 cars 1" 1st & 2nds & Com. Qld. White Oak  
2 cars 2 1/2, 3 and 4" White Ash  
2 cars 1" White Ash  
1 car 1 1/2 and 2" No. 1 Com. Brown Ash  
4 cars 2, 3 and 4" 1st and 2nds and No. 1 Com. Green White Oak  
2 cars 2" Log Run Solt Elm  
10 cars 1" Log Run Brown Ash  
10 cars 1" to 4" Dry Hard Maple  
10 cars 1" Log Run Birch  
10 cars 1" Log Run Basswood

# CINCINNATI

THE GATEWAY OF THE SOUTH

## PLAIN OAK—BASSWOOD

Are what we want. All thicknesses and grades. Spot cash. Send us list of your offerings with prices.

**DUHLMEIER BROS., CINCINNATI, O.**

## CYPRESS LUMBER CO.

Manufacturer of Hardwoods and Cypress

Plain and Quartered White and Red Oak, Yellow Poplar, Yellow Pine, Walnut, etc. Mills in Tenn., Ala. and Va.

OFFICE AND YARDS, GEST AND DALTON AVE., CINCINNATI, OHIO.

## OUR AIM is to ship the highest standard of lumber at lowest consistent price

We are manufacturers and ship direct from our band mills

Oak **W.H.&G.S. Stewart** Chestnut  
Poplar Basswood  
Ash Yellow Pine  
Main Office: Cincinnati, Ohio, U. S. A.

## "BUY GUM"

We are in the market to buy Dry Gum Lumber in any quantity, from a single car load to a million feet. Will take all grades and thicknesses. We receive lumber at shipping point, pay cash and are liberal in inspection.



THE FARRIN-KORN LUMBER COMPANY

General Office, Yards, Planing Mills, Dry Kilns, Cincinnati, Ohio  
Purchasing Office, Randolph Building, Memphis, Tenn.  
Cypress Red Gum Oak

FRAMES,  
SASH, DOORS,  
BLINDS, MOULDINGS,  
COLUMNS, GLASS,  
STAIRWORK,  
INTERIOR TRIM.



PAINTS,  
BUILDERS' HARDWARE,  
MANTELS, ETC.  
LARGE CINCINNATI FAC-  
TORIES MAKE PROMPT  
SHIPMENTS POSSIBLE.

THE GENERAL LUMBER COMPANY

**HARDWOODS**  
HEMLOCK, YELLOW PINE.

COLUMBUS OHIO

LANE-WHITE LUMBER CO.

OAK, ASH AND WALNUT OUR SPECIALTY **Hardwoods** ALWAYS IN THE MARKET FOR WALNUT LOGS

MAIN OFFICE AND BAND MILL at FORT SMITH, ARK.

**Q** For items of Hardwood Stock or Hardwood Machinery, you will find it advantageous to write our advertisers. Get in touch!

## The Farmer in the Southwest Prospers

Because he pays from \$8 to \$15 an acre for land that produces as good crops as land in Illinois and Indiana which sells for \$75 to \$100 an acre. The mild climate gives him earlier crops and the short winter makes stock-raising less expensive.

**You** have the same chance to prosper that is being taken by hundreds of the northern and eastern farmers.

Write for free copies of our illustrated books on Texas and Oklahoma.

Low rates to all points in the Southwest on the first and third Tuesdays of each month via



**CHICAGO @ EASTERN ILLINOIS R. R.**  
W. H. RICHARDSON, G. P. A., Chicago, Ill.

# W. H. Dawkins Lumber Co.

Manufacturers of Band Sawn

## Yellow Poplar

ASHLAND, KY.



# CINCINNATI

THE GATEWAY OF THE SOUTH

POPLAR, OAK, ASH, CHESTNUT, BASS-  
WOOD, BUCKEYE, CYPRESS, GUM

WANTED BY

**KENTUCKY LUMBER CO.**

CINCINNATI, OHIO

We will send man to receive stock at shipping point  
when quantity justifies

WE PAY CASH

WRITE US

Poplar, Oak,  
Ash, Chesnut,  
Sycamore,

W. Va. Spruce.  
Pine and Elm

**C. Crane & Co.**

We would like to buy

2,000,000 feet Dry Oak

2,000,000 feet Dry Poplar

Mostly heavy stock. Quotations Solicited.

MILLS AND YARDS  
CINCINNATI, O.

YEARLY CAPACITY  
100,000,000 FT.

LONG BILL STUFF  
A SPECIALTY

**L. W. RADINA & COMPANY**

Correspondence Solicited with Buyers and Sellers of All Kinds of

**HARDWOODS**

Wanted for cash—desirable blocks of 1 inch to 4 inch Poplar, all grades,  
Especially 1 1/2-inch stock, for immediate shipment.

CLARK STREET AND DALTON AVENUE

IN THE MARKET FOR

**OAK—ASH—POPLAR**

ALL GRADES AND THICKNESSES

**MOWBRAY & ROBINSON**

Office:

1219 West Sixth Street

Yards:

Sixth Street, below Harriet

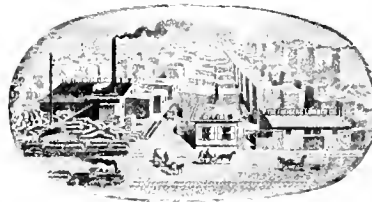

**THE FREIBERG LUMBER CO.**

Manufacturers of

**Tabasco Mahogany  
Walnut, Oak**

Poplar, McLean and Findlay Aves.  
CINCINNATI, O.

WHAT HAVE YOU FOR SALE IN

Red and White **OAK** Qtd. and Plain

ALSO POPLAR, CHESTNUT, WALNUT, ETC

**JOHN DULWEBER & CO., CINCINNATI, OHIO**

**THE WIBORG & HANNA COMPANY**

CINCINNATI, OHIO

PLAIN  
AND  
QUARTER  
SAWED

**White and Red Oak**

CHESTNUT  
POPLAR  
GUM AND  
CYPRESS

Flooring, Siding, Ceiling, Base, Case and Molding. Rough, Dressed and Re-sawed. Mixed Carloads.

**THE  
MALEY, THOMPSON & MOFFETT CO.**

Always in the Market for  
**BLACK WALNUT LOGS,  
SELECTED WHITE OAK LOGS,  
LUMBER OF ALL KINDS.**

CINCINNATI,

:

:

:

OHIO

Cash buyers for stock in our line.

**Cincinnati Hardwood Lumber Co.**

GENT AND SUMNER STREETS

Wholesalers Mahogany, Thin Lumber, Veneers

Finely figured quarter sawed oak veneers a specialty.

**THE E. E. BECK LUMBER COMPANY**

Cash Buyers

**Poplar, Oak, Chestnut**

And Other Southern Hardwoods

ALL GRADES AND THICKNESSES.

WE BUY MILL CUTS.



# INDIANA



WHERE THE BEST HARDWOODS GROW

THE WOODS FOR WHICH INDIANA IS FAMOUS.

- Quart'r'd White Oak
- Plain White Oak
- Quartered Red Oak
- Plain Red Oak
- White Ash
- Poplar
- Black Walnut
- Cherry
- Sycamore
- Red Gum
- Hickory
- Beech
- Maple
- Veneers of
- Indiana Hardwoods

**D'HEUR & SWAIN LUMBER CO.**  
 Manufacturers and Wholesalers  
 Our Specialty Quartered Oak and Sycamore  
 SEYMOUR, IND.

**LONG-KNIGHT LUMBER CO.**  
 MANUFACTURERS AND DEALERS  
 Quarter Sawed White and Red Oak a Specialty  
 INDIANAPOLIS, IND.

**MALEY & WERTZ**  
 Manufacturers, Wholesalers and Exporters of Hardwood Lumber  
 EVANSVILLE, IND.

**FULLERTON-POWELL  
 HARDWOOD LUMBER CO.**  
 SOUTH BEND, IND.

**PERRINE-ARMSTRONG CO.**  
 Long Timber up to 60 feet—Hardwood Specialties  
 The largest Band Mill in Indiana.  
 FORT WAYNE, IND.

**J. V. STIMSON**  
 All Kinds of Hardwood Lumber Manufactured  
 HUNTINGBURG, IND.

**YOUNG & CUTSINGER**  
 Manufacturers and Wholesalers  
 Our Specialty Fine Figured Quartered Oak  
 EVANSVILLE, IND.

**CHARLES H. BARNABY**  
 Manufacturer of Band Sawed Hardwoods  
 Quarter Sawed Indiana White Oak a Specialty  
 GREENCASTLE, IND.

# BUFFALO

THE GREAT WHOLESALE LUMBER CENTER OF THE EAST



Manufacturers and Dealers in

- Ash  
White and Brown
- Basswood
- Birch  
Red and White
- Butternut
- Cherry
- Chestnut
- Cottonwood
- Cypress
- Elm  
Soft and Rock
- Gum  
Red and Tupelo
- Hickory
- Maple  
Hard and Soft
- Red Oak  
Plain and Quartered
- White Oak  
Plain and Quartered
- Black Walnut
- White Wood  
Poplar



## SCATCHERD & SON

HARDWOODS ONLY

Yard, 1555 SENECA STREET

Office, 886 ELLICOTT SQUARE

## STANDARD HARDWOOD LUMBER CO.

OAK, ASH AND CHESTNUT

1075 CLINTON STREET

## I. N. STEWART & BROTHER

Specialties: CHERRY AND OAK

892 ELK STREET

## T. SULLIVAN & COMPANY

Specialties: BROWN ASH, BIRCH, PACIFIC COAST FIR AND SPRUCE

50 ARTHUR STREET

## ORSON E. YEAGER

Specialties: OAK, ASH AND POPLAR

932 ELK STREET

## BEYER, KNOX & COMPANY

ALL KINDS OF HARDWOODS

Office and Yards, 69 LEROY AVENUE

## BUFFALO HARDWOOD LUMBER CO.

We want to buy for cash.

Oak, Ash and other Hardwoods all grades and thicknesses.  
Will receive and inspect stock at shipping point.

518 RANDOLPH BLDG., MEMPHIS, TENN

940 SENECA STREET.

## EMPIRE LUMBER COMPANY

Our specialties are PLAIN and QUARTERED OAK and ASH.

1142 SENECA STREET.

## G. ELIAS & BROTHER

BUY AND CARRY LARGE QUANTITIES OF ALL KINDS OF HARDWOODS

955 TO 1015 ELK STREET

## HUGH McLEAN LUMBER COMPANY

Specialty: INDIANA WHITE OAK

890 ELK STREET

## ANTHONY MILLER

HARDWOODS OF ALL KINDS

893 EAGLE STREET

# YELLOW POPLAR

Manufacturers  
BAND SAWED  
POPLAR LUMBER

ALL GRADES

**DRY** 5-8, 4-4, 5-4, 6-4, 8-4, 10-4, 12-4, 16-4  
Bevel Siding, Lath and Squares  
Specialty, Wide Stock.

# LUMBER CO.

COAL GROVE, OHIO, U. S. A.

## W. M. Ritter Lumber Company

COLUMBUS, OHIO

### 6,000 Car Loads

Sawed and shipped yearly of band-sawed Yellow Poplar, White Pine, White Oak, Basswood, Chestnut, Hemlock and Ash. Planing Mills and Dry Kilns. ☐ If you are in a hurry to get your order placed, call our nearest salesman.

Salesman  
Fred A. Wilson  
E. E. Eaton  
James B. Patton  
A. Wallace Irwin  
Frank B. Pryor  
E. E. Ginn  
A. J. Williams  
L. G. Anderson  
James H. Lang  
W. H. Matthias  
Geo. H. Huganir  
F. H. Browning  
W. T. Baker

Headquarters	Telephone
Portsmouth, Ohio	Bell 4392
New York City, 158 W. 81st St.	Riverside 7390
Buffalo, N. Y., Rockford Hotel	Bryant 1335-R
Baltimore, Md., Eutaw Hotel	
Pittsburgh, Pa., 7th Avenue Hotel	
Jamestown, Ohio	Bell Phone
Cleveland, Ohio, Eastman, Detroit St.	Ridge 593-R
Franklin, Ohio	Bell 482
Detroit, Mich., Hotel Ste. Claire	
Chicago, Ill., 1448 Addison St.	Lakeview 1493
Philadelphia, Pa., 901 N. 50th St.	
Columbus, Ohio	Main 7874
Graham, Va.	

## Vansant, Kitchen & Co.



NEW ASHLAND MILL

Old-Fashioned

### SOFT YELLOW POPLAR

Ashland, Ky.

5-8 AND 4-4 IN WIDE STOCK, SPECIALTY

# Hardwood Record

Eleventh Year.  
Semi-monthly.

CHICAGO, SEPTEMBER 25, 1906.

{ Subscription \$2.  
Single Copies, 10 Cents.

## CHERRY

C. E. LLOYD, JR.  
Manager Sales

## RIVER

GROWS IN  
WEST VIRGINIA

Sold by  
Cherry River Boom &  
Lumber Co.  
Offices: Philadelphia, Pa.

## LUMBER

## Himmelberger-Harrison Lumber Co.

## Red Gum Specialists

Morehouse,

Missouri

## PROFIT-SHARING CONTRACTS

### Our Policies

## PENNA. LUMBERMEN'S MUTUAL FIRE INS. CO.

923 Drexel Bldg., Philadelphia, Pa.

## The Davidson-Benedict Company

NASHVILLE, TENNESSEE

Everything in

## Southern Hardwoods

POPLAR, CHESTNUT, ASH, OAK  
(Plain and Quartered.) Straight or Mixed Cuts.

DRESSED POPLAR ANY  
WAY YOU WANT IT.

YOU GET WHAT YOU BUY FROM  
US. ASK FOR OUR DELIVERED  
PRICES, ANY RAILROAD POINT.

WE WANT TO MOVE

## QUARTERED WHITE OAK

125,000 1 inch No. 1 and No. 2.  
500,000 1 inch No. 1 Common.  
300,000 1 inch No. 2 Common.  
100,000 2 inch No. 1 Common Red Oak.  
400,000 1 inch Sap Cull Poplar

STOCK TWO YEARS DRY.

## THE ATLANTIC LUMBER CO.

2 Kilby Street,

BOSTON, MASS.

The combined facilities of the stock lumber insurance companies

## LUMBER INSURANCE COMPANY OF NEW YORK

## and the ADIRONDACK FIRE INSURANCE COMPANY

and allied organizations, constitute a great insuring opportunity for any owner of a first-class lumber or mill risk.  
Ask for lines and rates.

LUMBER INSURERS GENERAL AGENCY, Underwriting Managers  
66 Broadway, New York

# LOUISVILLE

MANUFACTURING AND DISTRIBUTING CENTER OF KENTUCKY

## The Norman Lumber Co., Inc.

Manufacturers and Wholesalers of

### Hardwood Lumber

FOR SALE

Seasoned Ash, Oak, Poplar, and Walnut Lumber

WANT TO BUY

Walnut, Oak, Ash, Hickory and Poplar Logs and Lumber

Office and Yards: Third Street, H to K Streets  
LOUISVILLE, KY.

## EDWARD L. DAVIS & CO.

OFFER FOLLOWING STOCKS:

<b>POPLAR.</b> 30,000 ft. 4/4 1st & 2d. 50,000 ft. 4/4 Common. 15,000 ft. 5/4 Common. <b>QUARTERED RED OAK.</b> 50,000 ft. 4/4 1st & 2d. 50,000 ft. 4/4 Common. <b>QUARTERED WHITE OAK.</b> 50,000 ft. 4/4 1st & 2d. 10,000 ft. 5/4 1st & 2d. 20,000 ft. 6/4 1st & 2d. 10,000 ft. 8/4 1st & 2d. 50,000 ft. 4/4 Common. 5,000 ft. 5/4 Common. 5,000 ft. 6/4 Common. 20,000 ft. 8/4 Common. 10,000 ft. 2 1/2" Common. 40,000 ft. 3" Common. 1 car Hickory Plank, 1 1/2" to 4" - 8" to 16".	<b>OAK WAGON TONGUES.</b> 12,000 ft. 4x4"x12"-12', 1-6 mos. dry. 800 ft. 3 x4 " -12', 12-18 mos. dry. 400 ft. 3 1/2 x4 1/2 " -12', 12-18 mos. dry. 300 ft. 3 1/2 x4 1/2 " -12', 12-18 mos. dry. 250 ft. 3 1/2 x4 1/2 " -12', 12-18 mos. dry. 800 ft. 3 1/2 x4 1/2 " -12', 12-18 mos. dry. 180 ft. 3x4" & Lgr.-14', 12-18 mos. dry.
--	---

**REACHES.**

1 car 2x4" and larger, dry.

**BOLSTERS.**

2 cars 3x4" and larger, dry.

**HICKORY AXLES.**

1,500-3 x4 "-6', 1-6 mos. dry.

1,500-3 1/2 x4 1/2 "-6', 1-6 mos. dry.

2,000-4 x5 "-6', 1-6 mos. dry.

1,000-4 1/2 x5 1/2 "-6', 1-6 mos. dry.

1,000-5 x6 "-6', 1-6 mos. dry.

## We wish to move and will make close prices on:

- 1 Car 8 4 1st and 2nd Qtd. White Oak
- 2 Cars 8 4 Common Qtd. White Oak
- 1/2 Car 5 4 Common Plain Red Oak
- 1/2 Car 5 4 Common Plain White Oak
- 1 Car 6 4 Common Plain Red Oak
- 1 Car 4 4 Leg Run Ash
- 3 Cars 4 4 No. 3 Common Plain Oak

- 1 Car 8 4 No. 3 Common Plain Oak
- 1 Car 4 4 No. 2 Common Plain Oak
- 3 Cars 8 4 No. 2 Common Plain Oak
- 2 Cars 5 4, 6 4 and 8 4 No. 2 Com. and Sound Wormy Chestnut
- 1 Car 4 4 No. 1 Common Poplar
- 1 Car 5 4 No. 2 Common Poplar
- 1 Car 4 4 Common and Better Bay Poplar

We are moving our local yard and wish to ship this at once.

## Stotz Lumber Company,

Keller Building, Louisville, Kentucky

## Ornamental Hardwood Floors

400 STYLES AND PATTERNS

Illustrated Catalog on Application

### WOOD=MOSAIC FLOORING CO.

Rochester, N. Y. New Albany, Ind.

#### Albert R. Kampf

Manufacturer  
Hardwood Lumber and Timber  
Dimension Stock  
Board of Trade Bldg., Louisville, Ky.

#### E. W. Rhubesky

Wholesale  
Poplar, Rough and Dressed,  
Oak, Chestnut and Other  
Hardwoods

#### North Vernon Pump & Lumber Co.

Band Sawn Plain and Quartered  
Oak and Poplar  
North Vernon, Ind., and  
Louisville, Ky.

#### Southern Lumber Co.

Oak, Poplar and  
Chestnut.  
Louisville, Ky.

## Dry Stock W. P. Brown & Sons Lumber Co. Louisville, Ky.

**PLAIN RED OAK.**  
55,000' 1" 1st & 2nd.  
25,000' 1 1/4" 1st & 2d.  
49,000' 1 1/2" 1st & 2d.  
57,000' 2" 1st & 2d.  
18,000' 2 1/2" 1st & 2d.  
16,000' 3" 1st & 2d.  
131,000' 1" No. 1 Com.  
84,000' 1 1/4" No. 1 Com.  
44,000' 1 1/2" No. 1 Com.  
47,000' 2" No. 1 Com.  
8,000' 2 1/2" No. 1 Com.  
15,000' 3" No. 1 Com.  
**QUARTERED RED OAK.**  
10,000' 1' 1st & 2d.

14,000' 1 1/2" 1st & 2d.  
5,000' 2" 1st & 2d.  
15,000' 1" No. 1 Com.  
7,000' 1 1/2" No. 1 Com.  
13,000' 2" No. 1 Com.

**PLAIN WHITE OAK.**  
80,000' 1" 1st & 2d.  
28,000' 1 1/4" 1st & 2d.  
12,000' 1 1/2" 1st & 2d.  
42,000' 2" 1st & 2d.  
23,500' 2 1/2" 1st & 2d.  
16,000' 3" 1st & 2d.  
227,000' 1" No. 1 Com.  
60,000' 1 1/4" No. 1 Com.  
80,000' 1 1/2" No. 1 Com.

50,000' 2" No. 1 Com.  
17,000' 2 1/2" No. 1 Com.  
22,000' 3" No. 1 Com.  
**QUARTERED WHITE OAK.**  
50,000' 1" 1st & 2d.  
28,000' 1 1/4" 1st & 2d.  
45,000' 1 1/2" 1st & 2d.  
49,000' 2" 1st & 2d.  
19,000' 2 1/2" 1st & 2d.  
18,000' 1" No. 1 Com.  
30,000' 1 1/4" No. 1 Com.  
40,000' 1 1/2" No. 1 Com.  
22,000' 2" No. 1 Com.  
10,000' 3" No. 1 Com.

**ASH.**  
9,000' 1" 1st & 2d.  
65,000' 1 1/4" 1st & 2d.  
16,000' 1 1/2" 1st & 2d.  
10,000' 2" 1st & 2d.  
8,000' 2 1/2" 1st & 2d.  
28,000' 3" 1st & 2d.  
14,000' 3" 1st & 2d.  
6,000' 4" 1st & 2d.  
4,000' 1 1/4" No. 1 Com.  
16,000' 1 1/2" No. 1 Com.  
8,000' 2" No. 1 Com.  
**POPLAR.**  
12,000' 1" 1st & 2d.

12,000' 1 1/4" 1st & 2d.  
11,000' 1 1/2" 1st & 2d.  
12,000' 2" 1st & 2d.  
10,000' 2 1/2" 1st & 2d.  
10,000' 3" 1st & 2d.  
50,000' 1" No. 1 Com.  
28,000' 1 1/4" No. 1 Com.  
10,000' 1 1/2" No. 1 Com.  
10,000' 2" No. 1 Com.  
15,000' 1" 18" & up 1st & 2d.  
8,000' 2" 18" & up 1st & 2d.  
6,000' 2" 24" & up 1st & 2d.  
4,000' 1 1/2" 18" & up 1st & 2d.  
3,000' 1 1/2" 24" & up 1st & 2d.

All thicknesses in cull poplar, ash, chestnut.

Your inquiries will be appreciated.

Prompt delivery guaranteed.



# CADILLAC

CELEBRATED FOR HIGH STANDARD OF QUALITY AND MILL WORK

## MICHIGAN RED OAK

- ☛ As fine stock as was ever cut in the famous Cadillac district.
- ☛ We have some of this choice 4-4 Red Oak which will soon be in shipping condition.
- ☛ If you are in the market, we can please you both in quality and price.
- ☛ We also have some nice Soft Gray Elm in 4-4, 6-4, 8-4 and 12-4. It's Bone Dry.

**Mitchell Brothers Company**

CADILLAC, MICHIGAN

## Cummer, Diggins & Co.

—MANUFACTURERS—

**"CUMMER" MAPLE  
AND BEECH FLOORING**

## MICHIGAN HARDWOODS

Good assortment of dry stock on hand ready for immediate shipment in Hard Maple, Beech, Birch, Soft Elm and Cherry.

SEND US A LIST OF YOUR REQUIREMENTS.

## The Cadillac Handle Co.

. . . Band Sawn . . .  
**Michigan Hardwoods**

<p><b>For Rail Shipment from Cadillac.</b> 2 cars 8-4 Maple, No. 1 Com. &amp; Better 15 cars 4-4 Maple, on Grades, 2 cars 4-4 Basswood, No. 2 Com. &amp; Bet. 2 cars Basswood, No. 2 Com. &amp; Bet.</p>	<p><b>For Water Shipment:</b> 120,000 feet of 4-4 Basswood 160,000 feet of 4-4, 5-4 and 6-4 Birch 100,000 feet of 4-4, 8-4 and 12-4 Soft Elm 10,000 4-4 Ash.</p>
--	--

## MURPHY & DIGGINS

Offer all grades of the following special dry stock

MAPLE—5-4, 6-4, 8-4, 10-4, 12-4, 14-4, 16-4  
GRAY ELM—4-4, 12-4  
BASSWOOD—4-4  
BIRCH—5-4, 6-4

Our own manufacture. Perfect Mill Work. Uniform Grades.

LET US FIGURE ON YOUR HARDWOOD WANTS.

## DRY STOCK

## Northern Michigan Soft Gray Elm

What our old cork pine was to the regular white pine—such is our *Soft Gray Elm* to ordinary soft elm. Buyers who gladly discriminate in favor of something better than the ordinary, will be interested. We have

10 cars 8-4 firsts and seconds.  
1 car 10-4 firsts and seconds.  
2 cars 12-4 firsts and seconds.

Wide, choice stock, our own product, seasoned right, bone dry.

WRITE US ABOUT IT.

**COBBS & MITCHELL**  
(INCORPORATED)  
**GADILLAC, MICHIGAN**

# MEMPHIS

THE HUB OF THE HARDWOOD WORLD

## STOCK LIST Anderson-Tully Co. Memphis Tenn.

**ASH.**  
 9,400 ft. 4 1/4" Clr. Stps., 2 1/2"-5 1/4"  
 5,400 ft. 4 1/4" Com. Stps., 2 1/2"-5 1/4"

**COTTONWOOD.**  
 23M ft. 7 8/9" 1st & 2d 8" & up.  
 100M ft. 4 1/4" 1st & 2d 6" & up.  
 50M ft. 4 1/4" 1st & 2d 12" & up.  
 60M ft. 5 4" 1st & 2d 12" & up.  
 40M ft. 6 4" 1st & 2d 6" & up.  
 20M ft. 4 4" Wg. Box Brds., 9"  
 40M ft. 4 4" Wg. Box Brds., 13"-17"

**CYPRESS.**  
 12M ft. 4 4" Select.  
 35M ft. 4 4" Shops.  
 15M ft. 5 4" Selects.  
 15M ft. 5 4" Shops.

**POPLAR.**  
 60M ft. 4 4" Nos. 1 & 2 Com

**GUM.**  
 50M ft. 4 4" 1st & 2d Red, 6" up.  
 50M ft. 4 4" No. 1 Com. Red.  
 50M ft. 4 4" 1st & 2d Saps, 6"-12"  
 50M ft. 4 4" 1st & 2d Saps, 13"-16"  
 50M ft. 4 4" 1st & 2d Saps, 16" up.  
 150M ft. 4 4" No. 1 Com. Saps  
 150M ft. 4 4" No. 2 Com.  
 50M ft. 5 4" No. 1 Com. Saps  
 50M ft. 4 4" Box Brds., 13"-17"

**RED OAK.**  
 35,000 ft. 4 4" 1st & 2d Plain  
 2,400 ft. 4 4" 1st & 2d Quartered.  
 4,400 ft. 4 4" No. 1 Common.

**WHITE OAK.**  
 10,600 ft. 4 1/4" 1st & 2d Quartered  
 13,900 ft. 4 1/4" No. 1 Com. Quartered.  
 8,700 ft. 4 1/4" 1st & 2d Plain Red & White "wormy."

## FENN BROS. COMPANY

MANUFACTURERS OF

# Oak Flooring

QUARTERED WHITE HOLLOW BACKED  
 QUARTERED RED END MATCHED  
 PLAIN WHITE POLISHED  
 PLAIN RED BORED

Memphis, Tenn.

F. W. GILCHRIST, President  
 W. A. GILCHRIST, Vice President  
 W. E. SMITH, Sec'y and Treasurer

## W. E. SMITH LUMBER CO.

Manufacturers of  
**HARDWOOD LUMBER**

Mills, Tennessee, Arkansas, Mississippi  
 Distributing Yards, Cairo, Illinois  
 General Office, Tennessee Trust Bldg.

MISSISSIPPI VALLEY COTTONWOOD

J. B. Ransom, Prest. A. B. Ransom, V.-Prest. W. A. Ransom, Sec. C. R. Ransom Treas.

## GAYOSO LUMBER CO., Inc.

MANUFACTURERS AND DEALERS IN

# SOUTHERN HARDWOODS

Also make a specialty of Wagon Stock in rough, such as Tongues, Axles, Reaches, Bolsters, and 6-4 to 16-4 Hickory.

## Briggs & Cooper Company, Ltd.

MANUFACTURERS

# NORTHERN SOUTHERN HARDWOODS

GET OUR PRICES ON THESE ITEMS:

1,000,000 feet Soft Grey Elm, 1 to 3".  
 500,000 feet Unselected Birch, 1 to 3".  
 3,000,000 feet Michigan Hard Maple, 1 to 6".  
 350,000 feet Erd Dried White Maple, 1 to 1 1/2".  
 625,000 feet No. 1 Common and Better Winter Sawn Basswood, 1 to 3".  
 150,000 feet Selected White Basswood, 1", 1 1/4" and 1 1/2".  
 210,000 feet Plain and Quartered White and Red Oak, 1 to 2".

YARDS AT

SAGINAW, CHICAGO AND MEMPHIS

F. W. GILCHRIST, Pres. W. A. GILCHRIST, Vice-Pres.  
 W. E. SMITH, Sec'y and Treas.

## Three States Lumber Co.

MANUFACTURERS OF

Mills: Hardwood Lumber Office  
 Cottonwood and Gum Tennessee Trust Building  
 Missouri Arkansas Tennessee

GET OUR PRICES, TRY OUR LUMBER  
 WE SHIP ROUGH, DRESSED, RESAWED

COTTONWOOD GUM

**W**E have in all thicknesses the following kinds and amounts of lumber at places designated. Kindly send us your inquiries.

MEMPHIS YARD:

Ash..... 680,000 feet  
 Quartered White Oak..... 75,000 feet  
 Plain White Oak..... 140,000 feet  
 Quartered Red Oak..... 225,000 feet  
 Plain Red Oak..... 410,000 feet  
 Cypress..... 225,000 feet  
 Cottonwood..... 200,000 feet  
 Poplar..... 308,000 feet

SELMA YARD

Poplar..... 409,000 feet  
 Bay Poplar..... 857,000 feet  
 Red Gum..... 55,000 feet  
 Cypress..... 787,000 feet

BERCLAIR YARD

Bay Poplar..... 100,000 feet  
 Cypress..... 800,000 feet

OTHER YARDS

Plain Red Oak..... 350,000 feet

## J. W. THOMPSON LUMBER COMPANY

Office and Yards: Randolph Road and I. C. R. R. : : MEMPHIS, TENN.

## BACON-NOLAN HARDWOOD CO.

Manufacturers of

# Band Sawn Oak, Ash Gum, Cypress, Etc.

Office,  
 Memphis, Tenn.

Mills,  
 Chancy, Miss.

Address all correspondence to Memphis office.

**ST. LOUIS**

LARGEST OF ALL HARDWOOD MARKETS

**Wanted—Cypress, Ash and Cottonwood**

INSPECTION AT POINT OF SHIPMENT WHEN QUANTITY JUSTIFIES

**Hafner Manufacturing Co.**

CYPRESS, HARDWOODS

Mail orders receive our immediate attention.

YARDS: FOOT OF DOCK STREET

**Garetson-Greaseon Lumber Co.**

MANUFACTURERS OF SOUTHERN HARDWOODS

**GUM LUMBER  
OUR SPECIALTY**

Carload Shipments Direct  
from Our Own Mills

519 Bank of Commerce

**Thomas & Proetz Lumber Co.**

CASH BUYERS OF OAK, ASH, CYPRESS, POPLAR, CHERRY AND ALL

**HARDWOODS**

SEND INSPECTOR WHEN QUANTITY JUSTIFIES

Office and Yards: Hall and Angelrodt Sts.

**CHAS. F. LUEHRMANN HARDWOOD LUMBER COMPANY**

Carry a complete stock of Hardwood and are constantly in the market to purchase large blocks of stock for cash. Are also the largest manufacturers of the famous St. Francis Basin Red Gum.

General Offices: 148 Carroll Street

**LOTHMAN CYPRESS CO.**

AIR DRIED

**Louisiana Red Cypress**

FOOT OF ANGELICA STREET

**Stoneman-Zearing Lumber Co.**

203 Frisco Building

We have the following Dry Stock for sale piled at our mill:

QTD. WHITE OAK:	COTTONWOOD:
3 Cars 4/4 Common.	3 Cars 1" 1 and 2.
2 Cars 4/4 Common and Better Strips.	1 Car 1x13 to 17" Box Boards.
GUM:	ELM:
5 Cars 1" Common Red.	1 Car 6 4 Log Run.
1 Car 1x13 to 17" Box Boards.	4 Cars 4" Log Run.
1 Car 2" 1 and 2 Sap.	
6 Cars 1 1/4 Common and Better Sap.	

This Stock is All Band Sawn and Equalized

**Ozark Cooperage Co.**

WE BUY STOCKS READY CUT OR CONTRACT FUTURE OUTPUT

Four Inspectors in the South

Direct Shipments (COTTONWOOD),  
from mill stocks (CYPRESS, GUM, OAK.)

MAIN OFFICE,  
FRISCO BUILDING

**W. R. CHIVVIS,** Lesperance Street and Iron  
Mountain Railroad.

**WHOLESALE HARDWOODS**

BLACK WALNUT LUMBER MY SPECIALTY. Always in the market to buy Walnut and Cherry Lumber. Pay spot cash and take up at shipping point when amounts justify.

**SIX MILLION FEET**

Ash, Oak, Cypress, Poplar, Etc.

READY FOR PROMPT SHIPMENT

**STEELE & HIBBARD**

NORTH BROADWAY, DOCK AND HALL STREETS

## Are You in the Market ?

Send us your inquiries for prices on the following

# HARDWOODS

100M ft. 1" Com. and Better Quartered Red Oak.  
 100M ft. 1" Com. and Better Quartered White Oak.  
 75M ft. 1 1/4" Com. and Better Quartered Red Oak.  
 25M ft. 1 1/4" Com. Quartered White Oak.  
 25M ft. 1 1/2" 1st and 2nds Quartered Red Oak.  
 50M ft. 3" Com. and Better Quartered White Oak.  
 50M ft. 3" Com. and Better Plain White Oak.  
 100M ft. 1" Com. Plain Birch.  
 50M ft. 1" Com. Red Birch.  
 50M ft. 1 1/4" Com. and Better Plain Birch.  
 100M ft. 1" Com. and Better Hard Maple.  
 100M ft. 1 1/2" Com. and Better Hard Maple.  
 100M ft. 1" Com. and Better Soft Elm.

## UPHAM & AGLER

Distributing Yards: CAIRO, ILL.

Main Offices :: American Trust Building, CHICAGO

## SOUTHERN OAK LUMBER CO.

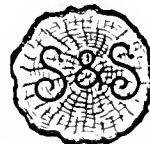

WE WANT TO BUY FOR CASH

# OAK CYPRESS ASH

MILL CUTS OR ROUND LOTS

910 CHAMBER OF COMMERCE 1217 TENNESSEE TRUST BLDG.

CHICAGO MEMPHIS

YARDS: NORTH MEMPHIS

## SEPTEMBER STOCK LIST

MAPLE		BIRCH		BASSWOOD	
1 in.	2,000,000 ft.	1 in.	500,000 ft.	1 in.	300,000 ft.
1 1/4 "	100,000 "	1 1/2 "	100,000 "	1 1/4 "	30,000 "
1 1/2 "	400,000 "	2 "	100,000 "	1 1/2 "	50,000 "
2 "	1,000,000 "	2 1/2 "	50,000 "	2 "	75,000 "
2 1/4 "	200,000 "	3 "	75,000 "	3 "	4,000 "
2 1/2 "	500,000 "	<b>ROCK ELM</b>		<b>GRAY ELM</b>	
3 "	500,000 "	2 in.	25,000 ft.	1 in.	300,000 ft.
4 "	400,000 "	2 1/4 "	50,000 "	1 1/2 "	200,000 "
<b>BEECH</b>		<b>WHITE MAPLE</b>		3 "	200,000 "
1 in.	500,000 ft.	End Piled		<b>ASH</b>	
1 1/4 "	250,000 "	1 in.	100,000 ft.	1 in.	500,000 ft.
1 1/2 "	400,000 "	1 1/2 "	20,000 "		
2 "	100,000 "	2 "	50,000 "		
2 1/2 "	200,000 "				

KELLEY LUMBER & SHINGLE CO., Traverse City, Mich.

## Thomas Forman Company

MANUFACTURERS OF HIGH-GRADE

# Maple and Oak Flooring

New York Branch:  
McGovern & Bowen,  
29 Broadway

And Hardwood Lumber

DETROIT.  
MICHIGAN

Millmen with round lots of well manufactured stock to offer, are sure of a square deal with

# WILLIAM WHITMER & SONS, Inc.

MANUFACTURERS OF

# HARDWOODS

Branches: NEW YORK, BOSTON, PITTSBURG

Girard Trust Bldg. PHILADELPHIA

# THE EAST

BOSTON NEW YORK PHILADELPHIA

## Time To Take A Brace For Good Fall Trade

The country is prosperous—crops are excellent—labor is all employed. Our lumber business never falls behind others at any time. We have good lumber and good service for all customers.

1,680,000 ft. Red and White Oak, 4 4 to 16 4, grades.  
775,000 ft. Yellow Pine, Flooring, Ceiling, Boards and Sizes.  
730,000 ft. Maple, 4 4 to 4 inches, Boards, Plank and Flooring.  
750,000 ft. White Pine, 4 4 to 4 inches, grades.

See September Lumber News—Write to-day.

## J. Gibson McIlvain & Co.

56th to 58th Streets and Woodland Ave., PHILADELPHIA, PA.

## The West Florida Hardwood Co.

MILL ON APALACHICOLA RIVER  
MARYSVILLE, FLA.

Ash Hickory Red and White Oak Yellow Cottonwood Red Gum Tupelo Gum

LET US HAVE YOUR INQUIRIES

BALTIMORE E. E. PRICE BUYER AND EXPORTER OF  
MARYLAND

## Hardwoods, Poplar and Logs

I am always in the market for nice lots of dry and well manufactured lumber. I inspect at point of shipment. Correspondence solicited.

## WM. E. LITCHFIELD

MASON BUILDING, BOSTON, MASS.

### Specialist in Hardwoods

Manufacturers are requested to supply lists of stock for sale

## JOHN L. ALCOCK & CO.

BUYERS OF BLACK WALNUT LOGS  
BOARDS AND PLANKS

Inspection at point of shipment. Spot cash.

Baltimore, Md.

## JONES HARDWOOD CO.

INCORPORATED

WANTS: Poplar, Plain Oak, 147 MILK STREET  
Quartered Oak and Cypress. BOSTON, MASSACHUSETTS

Manufacturers please send stock lists and prices.

## STEVENS-EATON CO.

Buyers of ROUND LOTS of Hardwoods No 1 Madison Avenue, NEW YORK

ESPECIALLY IN MARKET FOR PLAIN RED OAK

## Charles S. Wentworth & Co.

WHOLESALE LUMBER MERCHANTS

147 Milk Street  
BOSTON

We are in the Market for POPLAR, PLAIN OAK, CYPRESS and NORTH CAROLINA PINE LUMBER; also OAK, MAPLE and BIRCH FLOORING, and would appreciate correspondence from manufacturers in position to supply any of the stock named.

## Holloway Lumber Company

WHOLESALE HARDWOODS

In the market for all thicknesses of  
OAK, ASH and CHESTNUT.

312 Arcade Building,  
PHILADELPHIA, PA.

WE MUST MOVE AT ONCE

6 Cars 4-4 1's and 2's Red Oak

High Grade Stock, good widths and lengths  
PRICE RIGHT. Send us your inquiries

SCHOFIELD BROTHERS

1020-22 Pennsylvania Building, PHILADELPHIA

## James & Abbot Company

Lumber and Timber

No. 165 MILK ST., BOSTON, MASS., and GULFPORT, MISS.

## Wistar, Underhill & Co.,

WHOLESALE

HARDWOOD LUMBER

816 Real Estate Trust Building, PHILADELPHIA.

**G** For items of Hardwood Stock or Hardwood Machinery, you will find it advantageous to write our advertisers. Get in touch!

## W. M. GILLESPIE LUMBER

HARDWOODS COMPANY Farmers Bank Bldg.  
Oak a Specialty PITTSBURGH, PA.

# NASHVILLE

HEADQUARTERS FOR ALL SOUTHERN HARDWOODS

## JOHN B. RANSOM & CO.,

NASHVILLE, TENNESSEE

We want to move quickly the following old dry stock. All of it has been on sticks 6 to 18 months. Write us for delivered prices. We are prepared to furnish promptly mixed cars of rough and dressed hardwoods of all kinds:

QUARTERED WHITE OAK	QUARTERED RED OAK
90 M 4 4 first and second	100 M 4 4 first and second
15 M 5 4 first and second	58 M 6 4 first and second
80 M 6 4 first and second	15 M 8 4 first and second
10 M 10 4 first and second	95 M 4 4 No. 1 Common
129 M 4 4 No. 1 Common	84 M 6 4 No. 1 Common
65 M 6 4 No. 1 Common	72 M 8 4 No. 1 Common
58 M 8 4 No. 1 Common	
20 M 10 4 No. 1 Common	<b>PLAIN OAK</b>
70 M 5 8 first and second Poplar	50 M 4 4 1st and 2nd White
80 M 5 8 No. 1 Common Poplar	100 M 4 4 No. 1 Common White
15 M 4 4 1st and 2d Quartered Sycamore	100 M 4 4 first and second Red
10 M 4 4 No. 1 Com. Quart'd Sycamore	100 M 4 4 No. 1 Common Red

## Nashville Hardwood Flooring Co.

Manufacturers of

### "Acorn Brand"

THE FAMOUS FAULTLESS FLOORING  
IN OAK AND BEECH.

Car Lots and Less Than Car Lot  
Orders Solicited. Write for Prices.

Nashville, Tennessee

## GEO. C. BROWN & CO.

MANUFACTURERS AND WHOLESALE DEALERS IN

### Hardwood Lumber

Tennessee Red Cedar Lumber a Specialty.

NASHVILLE, TENNESSEE

## LOVE, BOYD & CO.

Offer:

5,000,000 ft. Quartered White Oak.  
2,000,000 ft. Quartered Red Oak.  
1,000,000 ft. Plain White Oak.  
1,000,000 ft. Plain Red Oak.  
1,000,000 ft. Poplar.  
2,000,000 ft. Chestnut, Ash, Hickory, Red Cedar, Etc.

Our Own Manufacture.  
Prompt Service.  
Dry Stock.

MAIN OFFICE,  
NASHVILLE, TENNESSEE

## INDIANA LUMBER CO.

### Manufacturers Lumber

DIMENSION STOCK A SPECIALTY.

Office and Mills: Corner Oldham  
Street and Cumberland River

NASHVILLE, TENN.

# PAEPCKE-LEICHT LUMBER COMPANY

MANUFACTURERS OF

## COTTONWOOD GUM AND OTHER HARDWOODS

Large stocks of well seasoned Lumber always carried at our yards and mills.

General Offices: 140 W. Chicago Ave., CHICAGO. Mills: Cairo, Ill., Marked Tree, Ark., Greenville, Miss., Arkansas City, Ark., Blytheville, Ark.

# Swann-Day Lumber Company

MANUFACTURERS OF

## POPLAR AND OAK

PLANING MILL STOCK, BOX SHOOKS  
AND HARDWOOD DIMENSION

CLAY CITY, KENTUCKY



# PITTSBURG

HARDWOOD DISTRIBUTING CENTER OF PENNSYLVANIA

## STOCK LIST

12,500 ft. 4 4 Maple No. 1 Com. & Bet.	192,000 ft. 4 4 Poplar Log Run
8,000 ft. 4 4 Maple No. 1 Common	4,000 ft. 8 4 Poplar Log Run
48,000 ft. 5 4 Maple No. 1 Com. & Bet.	23,500 ft. 12 4 Poplar Good
21,000 ft. 5 4 Maple 1sts and 2nds	2,500 ft. 6 4 Basswood Log Run
12,000 ft. 5 4 Maple No. 1 Common	2,200 ft. 8 4 Basswood Log Run
18,000 ft. 6 4 Maple No. 2 Com. & Bet.	1 Car 4 4 Basswood Log Run
3,000 ft. 6 4 Maple 1sts and 2nds	62,000 ft. 4 4 Cherry Log Run
3,000 ft. 8 4 Maple No. 2 Com. & Bet.	25,000 ft. 5 4 Cherry Log Run
29,000 ft. 8 4 Maple No. 1 Common	23,000 ft. 6 4 Cherry Log Run
13,000 ft. 10 4 Maple 1sts and 2nds	26,000 ft. 8 4 Cherry Log Run
15,000 ft. 12 4 Maple No. 2 Com. & Bet.	1 Car 4 4 White Birch 1sts & 2nds

FAVORABLE FREIGHT RATES TO THE EAST

**Babcock Lumber Co.**  
ASHTOLA, PA.

## Dry Stock for Quick Shipment:

48,402 ft. 4/4 1st & 2ds Qtd. White Oak.	70,812 ft. 4/4 No. 1 Poplar.
124,982 ft. 4/4 No. 1 Com. Qtd. White Oak.	14,182 ft. 6/4 1st & 2ds Poplar.
69,793 ft. 4/4 1st & 2ds Qtd. Red Oak.	118,121 ft. 4/4 Sound Wormy Chestnut.
79,341 ft. 4/4 No. 1 Com. Red Oak.	24,128 ft. 6/4 1st & 2ds Chestnut.
128,402 ft. 4/4 No. 1 Com. Pl. W. O.	21,903 ft. 7/4 No. 1 Com. Chestnut.
119,001 ft. 4/4 No. 1 Com. Pl. R. O.	19,246 ft. 8/4 No. 1 Com. Chestnut.
8,942 ft. 5/4 No. 1 Com. Pl. Red & White Oak.	78,433 ft. 6/4 Sound Wormy Chestnut.
11,312 ft. 6/4 No. 1 Com. Pl. Red & White Oak.	4,284 ft. 8/4 Sound Wormy Chestnut.
41,028 ft. 8/4 No. 1 Com. Pl. Red & White Oak.	126,094 ft. 4/4 1st & 2ds Cottonwood.
38,793 ft. 5/8 1st & 2ds Poplar.	49,021 ft. 4/4 13 to 17" Box Boards, 1st & 2ds.
29,423 ft. 5/8 No. 1 Com. Poplar.	61,975 ft. 4 4 8 to 12" Box Boards, 1st & 2ds.
21,971 ft. 5/8 Saps Poplar.	98,194 ft. 4/4 Sap Gum, 1st & 2ds.
21,974 ft. 4/4 1st & 2ds Poplar.	129,481 ft. 4/4 Sap Gum No. 1 Com.
	49,290 ft. 4/4 Sap Gum No. 2 Com.
	48,295 ft. 4/4 Red Gum, 1st & 2ds.
	94,389 ft. 4/4 Red Gum, No. 1 Com.
	242,841 ft. 4/4 Bay Poplar, 1st & 2ds.
	181,921 ft. No. 1 Com. Bay Poplar.

**American Lumber & Mfg Co.** Pittsburg, Pa.

## The Nicola Lumber Company

One million feet 4-4 Bay Poplar. Can be shipped log run, or sold on grade. Bone dry; band sawed. Send your inquiries.

## Flint, Erving & Stoner Co.

Wholesale Lumber  
Northern and Southern Hardwoods

Beech and Maple Timbers a Specialty

## A. M. Turner Lumber Company

Everything in lumber. We buy hardwoods as well as sell them. If you have anything to offer, please submit same to us.

## Linehan Lumber Company

PERFECT

## MAPLE FLOORING

SEND US YOUR INQUIRIES

## Wilson Bros. Lumber Co.

MANUFACTURERS

## WEST VIRGINIA HARDWOODS

FARMERS BANK BLDG. :: PITTSBURG, PA.

## Hardwoods a Specialty

FOR SALE

POPLAR	CHESTNUT	PLAIN OAK
125,000' 4 4 1s and 2s	200,000' 4 4 Sound Wormy	60,000' 4 4 No. 1 Com.
40,000' 4 4 No. 1 Com.	80,000' 5 4 Sound Wormy	18,000' 4 4 No. 2 Com.
325,000' 4 4 No. 2 Com.	100,000' 6 4 Sound Wormy	<b>QUARTERED OAK</b>
228,000' 4 4 No. 3 Com.	48,000' 8 4 Sound Wormy	2 cars 4 4 No. 1 Com.
150,000' 5 4 Mill Cull		1 car 4 4 No. 2 Com.

OAK TIMBERS SAWED TO ORDER.  
WRITE FOR PRICES.

CHEAT RIVER LUMBER COMPANY, Pittsburg, Penna.

# CHICAGO

THE GREATEST HARDWOOD MARKET IN THE WORLD

## PARK RICHMOND & CO.

Wholesale

### Hardwood Lumber

67 West Twentieth Street

Chicago

## R. A. WELLS LUMBER CO.

Manufacturers of All Grades

### HARDWOOD LUMBER

Fine Quartered Oak a Specialty

234 LA SALLE STREET

Yards at Canal and 21st Sts.

CHICAGO, ILL.

—have you anything to offer in hickory, white ash, thick plain oak and wagon stock?

W. W. CASSELL & CO.  
MANUFACTURERS OF ALL GRADES

## Ryan & McParland

Office and Yards  
Knox St. and Blue Island Ave.

Chicago

## White Lumber Company

Dealers in Hardwood Lumber

W. W. CASSELL

W. W. CASSELL



Cherry Lumber a  
Specialty

Lathey @ 22d Sts.  
Chicago

## A floor to adore



## The T. Wilce Company

22nd and LaSalle Sts. CHICAGO, ILL.

## John O'Brien Land & Lumber Co.

### Hardwood Lumber

Ch. A. Smith

22nd and LaSalle Sts.

Chicago

## Harvey S. Hayden

POPULAR

WHITE ASH

511 Railway Exchange. Chicago

## J. Slimmer & Company

### Hardwood Lumber

22nd and LaSalle Sts.

CHICAGO

# CHICAGO

THE GREATEST HARDWOOD MARKET IN THE WORLD

Charles Miller

Milton Miller

MILLER BROS.

## Hardwood Lumber

Main Office, 202 WILLOUGHBY BLDG.,  
616 MADISON STREET.

YARDS:

Loomis St., S. of 22nd St.,  
Chicago, Ill.  
Houston, Miss.  
Mobile, Miss.

CHICAGO, ILL.  
W. W. WILSON, PROP.

## CHAS. DARLING & CO.

Southern  
Hardwoods

22nd Street and Center Avenue - CHICAGO

## Heath-Witbeck Company

Hardwood Lumber

We have for prompt shipment 150,000  
feet DRY WHITE Pine and Spruce  
and Lumber 2, 4, 6 and 8 inch.

Main Office, 6 Madison St. Yards, Loomis and 22nd St.  
CHICAGO

## WISCONSIN TIMBER & LUMBER CO.

Yellow Pine and Hardwood Lumber

Ward Lumber Yard, 22nd Street and Center Avenue  
Manufacturing Bldg., CHICAGO, ILL.

## Lesh & Matthews Lumber Co.

We are offering for sale 100,000 feet of  
dry white pine and spruce lumber  
from the best of the Wisconsin forests.

## The Keith Lumber Company

HARDWOOD, POPLAR & SOUTHERN PINE LUMBER.

MAHOGANY,



CYPRESS,

REDWOOD,

CHESTNUT,

RED CEDAR,

SPRUCE,

MAPLE FLOORING, OAK TIMBERS & WAGON STOCK.

Office and Yards - Loomis and Wood Streets

## The Columbia Hardwood Lumber Co.

Telephone  
NSP 121-222

HARDWOOD LUMBER

## Ben C. Keator—Wholesale Lumber

HARDWOOD AND PINE

1003-4 Manhattan Building CHICAGO

## Hardwood Board Rules

FOR HARDWOOD LUMBERMEN



Best Goods, Prompt Shipment

Send your orders to THE HARDWOOD RECORD, 255 Dearborn St., Chicago

## THE WARD LUMBER COMPANY

MANUFACTURERS OF  
HARDWOODS

22nd Street and Center Avenue - CHICAGO

The only trade paper reaching all classes  
of hardwood consumers

HARDWOOD RECORD  
255 Dearborn St., Chicago

# OAK FLOORING

Kiln Dried  
Bored  
Polished



Hollow  
Backed  
and  
Bundled

# Timber Bonds

SECURED BY FIRST MORTGAGE ON TIMBER LANDS

## H. C. Barroll & Co.

BANKERS, First National Bank Building, CHICAGO.

H. B. LEAVITT, PREST.  
E. H. ADAMS, SECY.

B. F. RICHARDSON, VICE-PREST.  
J. G. LEAVITT, TREAS.

## THE LEAVITT LUMBER CO.

MOST COMPLETE STOCK OF HARDWOODS IN  
CHICAGO

MAKE KNOWN YOUR WANTS AND GET  
IMMEDIATE RESULTS

Mills:  
WISCONSIN  
TENNESSEE  
ARKANSAS  
LOUISIANA  
MISSISSIPPI

General Office and Yard:  
22ND AND LAFLIN STREETS;  
Southern Office:  
808 TENNESSEE TRUST BLDG.  
MEMPHIS, TENN.

## THE "FINEST" MAPLE FLOORING

### W. D. YOUNG & CO. BAY CITY, MICHIGAN.

Producers from TREE to TRADE of the highest type of Michigan Forest Products. Large stock of Maple Flooring and 15,000,000 feet of Hardwoods—1 to 4 inches thick—on hand.

Maple, Birch and Beech Lumber

## "Ideal" Steel Burred Rock Maple Flooring

is the flooring that is manufactured expressly to supply the demand for the best. It is made by modern machinery from carefully-selected stock and every precaution is taken throughout our entire system to make it fulfill in every particular its name—"IDEAL."

Rough or Finished Lumber—All Kinds

Send us Your Inquiries

The I. Stephenson Company  
WELLS, MICHIGAN

## FIRE INSURANCE For Lumbermen and Woodworkers

Lumber Underwriters  
At Mutual Lloyds  
66 Broadway New York

## "Michigan" Maple Flooring

Our model factory is equipped with the highest class tools and appliances made for Flooring production.

We produce our lumber from the best rock Maple area in Michigan and have 20 years' supply.

Our brand "Michigan" is a guaranty of quality. Perfect mill work and excellent grades distinguish our Flooring and our prices are reasonable.

WARD BROS., Big Rapids, Mich.



## Wolverine Brand Maple Flooring.

"THERE IS NONE BETTER."

The same story we have told before. A reminder that now as well as for all time to come Wolverine Brand will be prepared from the tree to the finished product for the especial purpose of filling your orders right. You send the order. We do the rest.

**BLISS & VAN AUKEN**  
900 S. Niagara Street Saginaw, W. S., Mich.

# Hardwood Record

Published in the Interest of Hardwood Lumber, American Hardwood Forests, Wood Veneer Industry, Hardwood Flooring, Hardwood Interior Finish, Wood Chemicals, Saw Mill and Woodworking Machinery.

Vol. XXII.

CHICAGO, SEPTEMBER 25, 1906.

No. 11.

Published on the 10th and 25th of each month by

## THE HARDWOOD COMPANY

HENRY H. GIBSON, President      FRANK W. TUTTLE, Sec-Treas.

### OFFICES

Sixth Floor Ellsworth Bldg., 355 Dearborn St., Chicago, Ill., U.S.A.  
Telephones: Harrison 4960      Automatic 5659

### TERMS OF ANNUAL SUBSCRIPTION

In the United States, Canada, Philippine Islands and Mexico . . . \$2.00  
In all other countries in Universal Postal Union . . . . . 3.00

Subscriptions are payable in advance, and in default of written orders to the contrary are continued at our option.

The entire contents of this publication are covered by the general copyright, and articles must not be reprinted without special permission.  
Entered at Chicago Postoffice as Second Class Matter.

Advertising copy must be received five days in advance of publication date. Advertising rates on application.

## COMING HARDWOOD ASSOCIATION MEETINGS

### Hardwood Manufacturers' Association

A district meeting of this association is scheduled to be held at Cape Girardeau, Mo., Tuesday, October 9.

### National Hardwood Lumber Association

A semi-annual meeting of this association will be held at Hotel Havlin, Cincinnati, on Thursday and Friday, October 25 and 26.

## General Market Conditions.

General reports from all over the country indicate that the hardwood trade is entering on a season of prosperity that will fully equal any of late years. The lack of confidence in the prices ruling during the summer, which had a tendency to prevent buying in some parts of the country, has apparently given way to a belief that prices will remain firm for an indefinite period, and the buying consequent on this state of affairs has given a decided impetus to the market.

The demand for plain oak continues to be strong in all grades, and there seems to be no difficulty in disposing of what stocks there are on hand. Quartered oak seems to be in better shape than it was some time ago, reports from most hardwood centers showing it to have picked up considerably. The veneer and panel business is firm in nearly all markets, good prices and stiff demand prevailing. Ash and hickory continue to be snapped up whenever possible.

The oak and maple flooring business continues very active. The unusually heavy building operations during the summer and the number of buildings of the better class that are now in condition to take flooring stock will continue to render the market steady for a long time to come.

From a review of the conditions prevailing in other lines of business it may be said that the hardwood trade is receiving its share of the general prosperity.

## New Uses for Woods.

There is a constant effort to broaden the uses to which various kinds of woods can be placed. Many products of the forest that were regarded as valueless until within the past few years have now become standard commodities. Twenty years ago maple was regarded as either an incumbrance or useful only for fire-wood. Today it has become the standard flooring material throughout a very large portion of the United States and abroad, being used in many of the highest class structures, as well as for wagon and agricultural machinery building, etc. Hemlock, a wood despised for years as being practically worthless, is a standard building material today. Red gum, but very recently introduced as lumber, was unsalable up to within the last five years. Now the broadened demand is so active that many grades of it show a shortage in the market. The despised tupelo gum has recently become a valuable commercial product, with every prospect that within a few years it will be so appreciated as to command as much money as cypress does today.

It is the constant study of users of wood to find cheaper substitutes for certain standard commodities, by means of which they can turn out their manufactured product at a diminished cost. Some manufacturers have succeeded in substituting other wood for oak. Chestnut and red gum have been the principal kinds used for this substitution. Yellow pine and poplar have largely taken the place of white pine, and now Pacific coast woods are substituting the pines and hemlock. Box makers who formerly used soft woods exclusively have recently learned that they can employ gum, cottonwood and a large variety of other hardwoods advantageously. Substitution is going on constantly, and probably will continue to the end of time.

The tamarack of the North has been a despised wood in the past few years in spite of its strength and lasting qualities, and has even been rejected as a building material. It has been but recently discovered that tamarack makes a most excellent material for tanks, and for this purpose it is coming into quite general use at much higher prices than it ever would have brought in the form of joists and scantling.

Experiments are now being made with maple for car decking. It is strange that this trial was never given the wood before, for it certainly will prove an ideal material for this purpose. It will rot no quicker than yellow pine, Norway or fir, and will stand ten times as much wet and rough usage as any of the woods named. Both northern and southern hardwood manufacturers are creating a considerable demand of late for the coarse end of their hardwood products for sheathing purposes, and some of the woods are being quite generally used in the form of ship lap and bevel siding with good results.

There is a crying need for a substitute for hickory in the wagon and carriage making trade. It seems scarcely possible that any considerable quantity of undiscovered wood suitable for this purpose will ever be located in the United States, but it is logical to prophesy that a vast quantity of material excellent for this purpose can be secured in Mexico, the West Indies and the northern portion of South America. The forests of these countries are all rich in minor hardwoods of very dense character, which are tough and not subject to speedy decay. Undoubtedly the wagon maker who wants to perpetuate a source of supply should cast his eyes in the direction noted.

## Pert, Pertinent and Impertinent.

### The Futility of Wealth.

Money may not make men happy,  
 Money may not make men wise;  
 Money may not, when it's gloomy,  
 Cause the clouds to leave the skies,  
 Money may not bring cool breezes,  
 When the trying days are hot;  
 Money may not give men gladness,  
 But it always helps a lot.

Money may not make us healthy,  
 Money may not make us great;  
 Money may not make them love us  
 Who have cause to cherish hate,  
 Money may not serve to cleanse us  
 When we've smeared ourselves with shame;  
 Money may not bring us glory,  
 But it's helpful, just the same.

Money may not quench our sorrows,  
 Money may not ease our pains;  
 Money may not cause the dampness  
 To diminish when it rains;  
 Money may not bring the maidens  
 Who are fairest to bestow  
 All their sweetest smiles upon us—  
 It is very helpful, though.

### The Old Maid Again.

It was an old maid who said she'd rather be regarded as one, than as the better half of a fool.

### A Potent Argument.

Campaign funds is usually a very good argument for a candidate to put up on election day.

### Inconsistent.

The discovery of a cork screw in the pocket of a prohibitionist might be termed circumstantial evidence.

### Yes, Indeed.

And even the man who is good for nothing is good for something—as a horrible example, for instance.

### Unappreciative.

Though from the beginning of time woman has freely given to man a piece of her mind, the man was never found who appreciated the gift.

### Unsophisticated.

Don't kick at being taken at your word—there are still some people in the world who have faith in humanity.

### Alike.

Water seeks its own level, and so do brains.

## ENTIRELY SATISFIED.



This is the first summer vacation I ever had when prices advanced enough during my absence to pay for it.

### The Only Reason.

The average man spends so much of his time trying to cover up his past that he hasn't a chance to boast of his future.

### True.

It takes a brave man to marry for money, but a braver one to marry without it.

### Appropriate.

Gossips might be very appropriately termed misfortune tellers.

### As Others See Us.

What a miserable crowd of pessimists we would be if we could see ourselves as others see us.

### Poor Show.

All men are created equal, but a boy has only one chance in 40,000,000 of growing up to be President.

### Even More So.

It's always well for the business man not to forget that collections are as essential as sales.

### Overseasoned.

It has been said that human imperfections add spice to life, but too many lives are overseasoned.

### To Which Class Do You Belong?

The world bestows its big prizes in money and in honors for but one thing—initiative. What is initiative? It consists in doing the right thing without being told. The next best thing to doing a thing without being told is to do it when you are told once. Some people never do a thing until they are

told twice; such get no honors and small pay. Then there are those who do the right thing only when necessity kicks them from behind. This class spends most of its time polishing a bench with a hard-luck story. Still lower down in the scale is the fellow who will not do the right thing even when

someone goes along to show him how, and stays to see that he does it; he is always out of a job, and receives only the contempt he deserves, unless he has a rich pa, in which case destiny patiently waits around the corner with a stuffed club.—ELBERT HUBBARD.

# AMERICAN FOREST TREES.

THIRTY-SEVENTH PAPER.

## Mahogany.

*Swietenia mahoganii.*

*Khaya senegalensis.*

*Soymda febrifuga.*

There are three principal species of mahogany: Central American or true mahogany, *Swietenia mahoganii*; African mahogany, *Khaya senegalensis*, and Indian mahogany, *Soymda febrifuga*. These are the mahoganies of commerce. There are a number of minor species called mahogany, but they are of no importance in the trade.

Mahogany is essentially a tropical tree. It reaches its highest development between the latitudes of 11° and 23° 10' north. Trees found nearer the equator are not usually of such fine quality as those in the real mahogany belt. It is one of the most plentiful of the finer hardwoods since it thrives throughout the tropical zone, which is the largest of the zones, and comparatively little of it has as yet been cut off. There are no mahogany forests, and individual trees are often widely scattered, making the cost of logging exceedingly high, especially since it is found in undeveloped regions where transportation facilities are usually lacking.

The tree is one of great beauty, its tall trunk broadening out a few feet from the ground into huge buttresses, much as does the cypress of our own country. It varies in height in the different countries of its growth from fifty to one hundred feet, in diameter from three to even twelve feet.

Central American or true mahogany, *Swietenia mahoganii*, is confined to tropical America—in Cuba, Honduras, Santo Domingo, Jamaica, central and northern South America and Mexico it is found in luxuriant growth and of excellent physics. There is a scattering growth of this species on the Florida keys which is the only mahogany native to the United States. It is known as Madeira and used principally in boat building, but is not of superior quality.

The leaves of *Swietenia mahoganii* are compound, four to six inches long, composed of three or four slender, sharp-pointed leaflets. They are a pale yellowish green above and darker below, smooth and glossy. The bark is a very dark reddish brown. The small white flowers grow in delicate sprays, and appear in July or August. The fruit is a four-valved capsule, as shown in illustration, four to five inches long and two and a half inches broad. It is a dark red-brown in color, has a thick,

hard covering and is full of winged seeds. The generic name of the species is so-called in honor of Baron von Swieten (1700-1772), the distinguished Dutch physician noted as the founder of the Botanic Garden of the Medical School at Vienna.

In all the various classes of mahogany known to the trade, such as Mexican, Cuban, African and Indian, there are various species,

The Mexican wood, as a general rule, is slightly darker than the Cuban, but lighter in color and of a softer texture than the African product. When worked its surface surpasses in figure that of the Cuban wood and it is used where high polish and good markings are required. It is probably the most generally used mahogany in the United States.

There are several different kinds of African mahogany, but the most highly esteemed species is the Lagos wood. The tree is very large and its markings are excellent. It is about as heavy as the Mexican wood and not quite so hard as that of Cuba. It has a rich, dark surface and its figure is more variegated and beautiful than that of other woods.

Indian mahogany, which has been hitherto imported comparatively little into this country, is of a rich, dark color. It is called Vermilion, being of the exact shade of that color, and is very heavy. When made up it has a remarkably fine appearance, the color and finish being of the best.

The mahogany imported into the United States is of course largely of the American varieties, although of late African has come to be quite extensively used. The African field was the last to be entered and wood from this source is rapidly gaining in favor all over the civilized world, most of it being distributed through English markets, of which Liverpool handles the largest quantities. At the periodical auction sales at Liverpool and London it is disposed of to buyers not only from the principal European countries but also to representatives of the large consuming interests of the United States.

Cutting mahogany in any of its native haunts is a laborious and expensive process, but most especially is this true in Africa, where there is not only the usual problem of transportation facilities but also the even more distressing one of insufficiency of labor.

Mahogany has long been the most popular of the expensive woods used in England, where it was introduced the latter part of the seventeenth century by a prominent London physician, Doctor Gibbons. The doctor had a brother who was a captain on a vessel plying between India and England, who on one of his trips took to England several logs of mahogany as ballast. The doctor was then building in Covent Garden and his brother suggested that the wood might be of value as beams. It was experimented with, but the workmen



TYPICAL FOREST GROWTH NICARAGUAN MAHOGANY, CENTRAL AMERICA.

all distinguishable among themselves by slight differences in color, texture and weight. Cuban mahogany is not as highly figured as the African wood, but by many its figure is thought to be finer. It is used where color, strength and good surface are required. It is noted for its hardness and the polish that can be given to it, and when worked up the wood is exceedingly rich under finish.



claimed that it was too hard to be worked with their tools and the logs were rolled into the garden out of the way. Here they lay for a long time, apparently discarded, until one day the physician had need of a candle box and suggested that the mahogany logs might furnish good material. But the cabinetmaker complained as the others had done that he could not work the material with his tools. The doctor then interested himself and ordered that heavier tools be made. The candle box was finally completed and proved to be so handsome after being finished and polished that a bureau was made from another of the logs. Thereafter a craze for mahogany set in which has continued even to the present day.

There are so many qualities that have contributed toward putting mahogany in the exalted position it occupies today that it is almost impossible to state which is the most important. The great beauty of the wood as regards color, figure and texture, its hardness, durability and unusual size, make it the ideal wood for furniture, railway cars, interior finish and a variety of uses requiring the highest class wood. Mahogany seasons readily, warps so little after proper seasoning as to be almost free from that troublesome trait, and is without a peer in the matter of taking glue. For these reasons, together with the unusually large size of the tree, it is especially valued for veneers and panels, and a very large percentage of the mahogany consumed is utilized in this form. For railway car panels, counter tops, store trimmings, pianos, high-class furniture and in fact for every purpose where veneer of large size and excellent quality, beauty of figure and color is required, mahogany is the wood chosen.

Mahogany is a rich red in color, rather light but darkening gradually with age and exposure. This fact has led dealers in furniture to impregnate the new wood with stains and finishes which give the darker tone of the old, much-used wood. This practice was indulged in originally to imitate Colonial furniture, but it has become very common and not only is a vast quantity of mahogany furniture now so finished, but cheaper woods are stained the same dark hue and sold as "real mahogany." During the last two or three years mahogany furniture in the natural finish has come into vogue, and it is probable that this mode of finish, which is really the more beautiful as the wood acquires the darker hue in time and with a mellowness of tone

that cannot be imitated, will eventually take first place.

Considering the heavy cost of cutting and transportation and the high class of the wood, mahogany is sold on the markets of the world



GIANT MAHOGANY TREE, BLUEFIELDS, CENTRAL AMERICA.

today at remarkably low values. In the United States the use of the American species is more general, owing, of course, to the fact that the source of supply is so near our borders, although of late years the African wood is being widely introduced, as is also the beautiful vermilion mahogany of India.

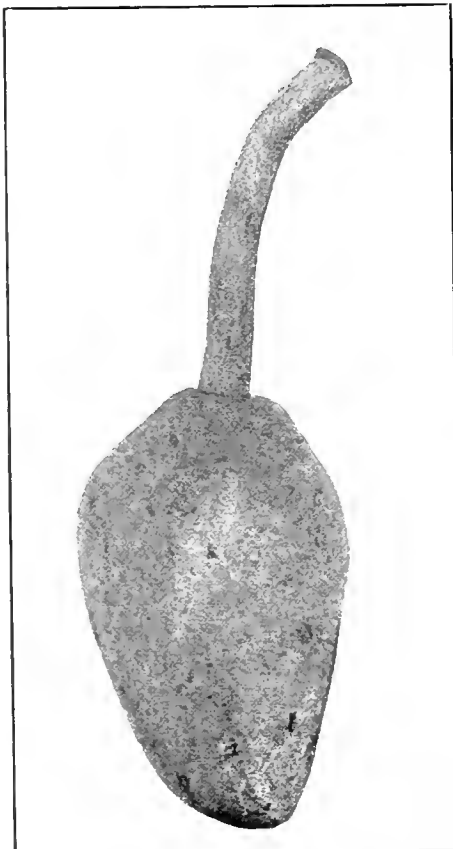

MAHOGANY FRUIT, ONE-THIRD ACTUAL SIZE.

### In the School of Experience.

#### Deflection in Wood.

With 100 pounds placed in the middle of a stick 2x2 inches, 4 feet long, supported at both ends, the stick will deflect about  $\frac{1}{8}$  inch on a medium grade of ash; 200 pounds will bend it  $\frac{1}{4}$  inch; 300 pounds,  $\frac{3}{8}$  inch. This proves that deflection varies according to the weight; however, a point is reached where an additional 100 pounds add more than  $\frac{1}{8}$  inch to the deflection. When this is the case, the limit of elasticity has been reached. Take another piece of the same straight grain, and perfectly plain plank, and the same size as given above, but 8 feet long instead of 4. A load of 100 pounds will deflect this piece 1 inch; double the length reduces the stiffness eightfold; stiffness, therefore, decreases as the cube of the length increases.

Cutting out a piece 2x4 inches, 4 feet long, and placing it flatwise, so that it is double the width of the former stick; then load this with 100 pounds, and it will bend 1-16 inch only. Doubling the width doubles the stiffness.—Carriage Monthly.

#### Inlaying.

A writer in the Practical Carpenter says that everyone has noticed that in ordinary inlaying there is a very ugly glue joint, equal in its width to that of the saw used, which runs around the whole of the inlaid pattern. This, of course, looks bad, and further it involves the use of a very fine saw to reduce the width as much as possible. This again involves the use of comparatively thin wood. To avoid this, tilt up the saw-table a little on one side—say the right; with it in this position cut out the right side of a letter—say the capital I; obviously the uppermost of the two pieces of wood on which we are operating would have its eye slightly broader than the bottom one. Then finish the letter, being always careful to make the cut "sun about," as the phrase is—i. e., in the same direction as the hands of a clock move. We now have an I cut out of the top piece slightly broader and longer than that cut out of the lower one; if we have proportioned the amount of tilt to the table, with due regard to the thickness of the saw and of the wood used, the upper eye will just fit neatly and tightly into the space left in the lower piece. Apply plenty of glue and gently tap the letter or monogram into its place, and we have a glue joint which will be barely visible. The amount of slope required in the table is very slight, and one soon finds out the happy medium.

#### To Clean Hardwood.

Spread paraffin oil on the soiled wood and let it stand for an hour or more to soften the dirt, then wash with soap and warm water and wipe dry.

Next rub on a mixture of paraffin oil and turpentine—one-third turpentine and two-thirds oil. Polish with soft old flannel. Let it rest an hour or two, then polish with soft old linen.

If the surface is very dull, dirty and scratched, instead of washing with soap and water, add more oil and sprinkle powdered rotten stone over it. Rub gently and regularly, first with a circular motion and then with the grain of the wood. When the surface is smooth and bright wipe off the rotten stone and finish as you would after washing with soap and water.—EXCHANGE.





ROBERT E. WOOD  
BALTIMORE, MD.

# Builders of Lumber History.

NUMBER XXXIII.

Robert E. Wood.

(See portrait supplement.)

"Some men are born great, some achieve greatness, and some have greatness thrust upon them." Of the classes thus designated, Americans may be said, as a general rule, to belong to the second. They are the men who achieve greatness. A review of the life histories of the successful business men which have been presented in the *HARDWOOD RECORD* from time to time reveals the fact that these men, in the majority of cases, were of humble origin, and made their way to success by dint of strenuous work—by a combination of brawn and brain.

As another and most worthy example of this type, this sketch will tell something of the early struggles and final success of Robert Elmer Wood, president of the R. E. Wood Lumber Company and the Montvale Lumber Company, of Baltimore, Md. Mr. Wood was born July 30, 1865, at White Pine, Pa., situated eighteen miles north of Williamsport near the Susquehanna river. He is of mixed English and Holland ancestry. His father was a farmer-lumberman at a time and in a place where incessant toil was necessary for existence. He owned a little farm on which he lived and supported his family of seven boys and six girls by carrying on a small business in lumber in conjunction with his farm work.

Under these circumstances it was impossible for the father to give his children more educational advantages than could be gained by an attendance of a few terms at the district school, and Robert early recognized the necessity of work. When he once saw his duty he embraced it with the decision and vigor that have always been characteristic of the man, and at once went to work in the old Beaver mill at Williamsport, pulling lath at fifty cents a day. At the time he was only sixteen years old. Later he secured a place in the W. H. Jenkins sheathing lath factory at Williamsport, where he received a salary of \$35 a month. Always of an inquiring turn of mind and with an insatiable thirst for knowledge he soon became master of whatever work he had in hand, and while still a boy was rewarded with the post of inspector for Kline Bros., of Williamsport, manufacturers of furniture. When he was 20 he set up a business for himself on the mountain side near the old homestead, with a home-made still of the most primitive type, and became a producer of birch extract, made from the limbs and smaller growth of the Black birch and commercially known as the oil of birch, or more commonly, wintergreen oil. For two years he practically lived in the woods in a little shack of his own construction, felling sapling birch, splitting it up into small bits, packing it into his still and making wintergreen oil. The business, although small, was a success. He made good oil and got a good price for it. He rigged up appliances to economize labor, even to

the extent of a tram road and a car to carry the wood and brush to the still. After the distillation was complete, he sold the wood refuse for firewood. The experience was valuable for the work he was to do in after life, for besides early revealing his self-confidence, it developed the qualities of method, economy and grasp of detail which afterward made his leadership in wider lumber affairs pre-eminently a safe one. In January, 1891, when Mr. Wood was between 25 and 26 years old, he went to Lynchburg, Va., to take a position with the West Lynchburg Furniture Company as a buyer and inspector of lumber. He remained with this concern until June, 1893, when he became foreman of Denman & Ritter's little semi-portable saw mill at Welsh, West Virginia. In the fall of 1893 he graduated to a position of log scaler for the Elkhorn & Sandy River Coal & Timber Land Company, and in July, 1894, he entered the service of the Panther Lumber Company at Panther, West Virginia, as grader. For some time after this he made his livelihood and something to spare by estimating timber for various people.

At this time Mr. Wood felt that he was thoroughly equipped for the lumber business and, with the few hundred dollars which he had saved, he began business on his own account. His first venture was on May 6, 1895, when he bought of C. L. Ritter and the estate of W. J. Denman a car of oak lumber which he sold to the Wood & Johnson Furniture Company, of Lynchburg, Va. He continued to trade in lumber in this way for three years. He was his own buyer, his own salesman, his own inspector. During all this time, the personality of the man and his steady application to business, besides winning for him many friends among the more powerful dealers in the lumber world, was steadily widening his trade.

As a lumber manufacturer Mr. Wood's first venture was a small portable saw mill which he hired on Indian Creek, in southern West Virginia. He bought logs from the small operators of that section, had the lumber sawed in the little portable mill and sold the product. Like his previous undertaking, this enterprise was a success and it was not long before he was the owner of a saw mill which he put in at Sandy Huff, West Virginia, in 1898. From this date his operations took in a constantly widening field. He commenced to buy timber and supplemented his original portable mill at Sandy Huff with a band mill at Huff Creek and eventually with a third mill on Lick branch of Cub Creek. This latter organization was known as the Harman Branch Lumber Company. Since that time he has cut over 30,000 acres of the splendid poplar and oak timber of McDowell and Wyoming counties, West Virginia, and has manufactured during the last six years upwards of 150,000,000 feet of lumber.

For the sake of giving some of his employees an interest in his enterprises, Mr.

Wood organized in June, 1902, the R. E. Wood Lumber Company, which has grown to be one of the best and most favorably known of the poplar and oak producing lumber houses in the United States. The company still owns some 25,000 acres of virgin timber in McDowell and Wyoming Counties, besides having valuable holdings in Carter County, Tennessee, equipped with modern mill and railroad facilities.

In November, 1903, Mr. Wood organized the Montvale Lumber Company, and associated with himself in the enterprise are the well-known Williamsport banker, Allen P. Perley, F. L. Winchester, J. K. Painter, G. Leidy Wood, H. L. Bowman, Clarence E. Wood and E. L. Warren. The Montvale Lumber Company, of which Mr. Wood is president, acquired by purchase on the south slope of the Blue Ridge, in the Sapphire country, South Carolina, near the North Carolina line, 53,000 acres of virgin timber land, a new double band saw mill, and a complete equipment of dry kilns and planing mill located at Calhoun, South Carolina. The timber of this extensive property is chiefly poplar, oak and chestnut, but also contains quite a quantity of white and yellow pine. The company also bought extensively in North Carolina, having holdings in Cherokee County, with an estimated cut of 12,000,000 feet and a mill of 30,000 capacity now running. This operation is on the Murphy line of the Southern Railway. At Eagle Creek, in Swain County, on the new line of the Southern Railway, now building, the company has a holding estimated at 140,000,000 feet, on which they are constructing a mill. They have also an extensive property on Bone Valley, a tributary of Hazel Creek, which is a heavily timbered tract located in the line of future railroad construction.

Personally Robert E. Wood is a most interesting man. Although his various enterprises keep him extremely busy, he always has time to greet the stranger or friend who calls upon him, and his hospitality and good fellowship are proverbial among the wide circle of his business and social acquaintances. He is a deep student and a profound and intelligent reader, singularly well versed on the important matters of the day. Always fond of outdoor life, his chief diversions have been a good saddle horse and an automobile.

In business Mr. Wood has met with great success. He is recognized as a progressive lumberman, yet as an example of his safe methods it can be stated that the entire losses of his companies during the past five years have not amounted to one-tenth of one per cent on had sales. Starting with absolutely no capital, his courage, persistence and foresight, combined with a rare talent for making friends and an inflexible honesty, have won him an enviable place among the greater leaders of the lumber trade. It is therefore with pleasure that the *HARDWOOD RECORD* takes this opportunity of presenting to its readers this sketch and portrait of Mr. Wood as a type of man who is honored by his associates in the hardwood lumber field of this country and who is, himself, no less an honor to the business he has selected as his life work.

## Hardwood Record Mail Bag.

[In this department it is proposed to reply to such inquiries as reach this office from the HARDWOOD RECORD clientele as will be of enough general interest to warrant publication. Every patron of the paper is invited to use this department to the fullest extent, and an attempt will be made to answer queries pertaining to all matters of interest to the hardwood trade, in a succinct and intelligent manner.]

### Criticism of New York Inspection Methods.

NEW YORK, Sept. 4. Editor HARDWOOD RECORD: It is not surprising that there are so many firms who refuse to ship lumber to the New York market, for they have realized by sad experience in the past that their stock has been "slaughtered." But few millmen are conversant with the manner of inspection in New York, and when the inside workings are known there doubtless would be fewer who would be willing to ship lumber to New York to be inspected upon arrival. The inside workings are peculiar, to say the least.

There is an organization in New York known as the New York Lumber Trade Association which is about as big a farce as ever existed. A lumber yard having its own inspector has only to apply to the association for a "license" for that particular man and he is duly inaugurated as a "licensed inspector of the New York Lumber Trade Association." He has blanks printed with his name in large letters as a "licensed" inspector. This man only does work for the yard in which he is employed and receives a salary in proportion to the amount of money he can earn for his employer. Some of these men, until they become proficient in grading lumber, receive about \$15 per week and from that up to \$50 per week.

A manufacturer of lumber ships a car to New York; it is inspected by a "licensed inspector" at a cost of 50 cents per thousand and a certificate forwarded by his employer to the shipper. The shipper cannot account for the grade being so very poor, but as the lumber has been inspected, as he supposes, by an impartial inspector, he is forced to "take his medicine." There is hardly a yard in the city of New York which does not have its own private, special inspector duly "licensed" by the association. The jobber who buys lumber from the manufacturer and sells to a New York lumber yard, after receiving an inspection of a car forwards it to the shipper and tells him that this is the inspection of a "licensed inspector." He takes particular care not to mention the fact that the "licensed inspector" is an employee of his customer, and the 50 cents "earned" by inspecting goes to his employer.

The writer of this article is located in New York and has been selling the metropolitan trade for a long while past and is thoroughly conversant with the methods employed for "making money" in grading stock. In nine cases out of ten where his firm is forced to allow deductions they are unjust, but to "keep in" with the trade they allow them, but the shipper knows nothing whatever of the matter. Suppose the shipper wants to have the car which has been inspected by the "licensed inspector" (employed by his customer) reinspected by an unprejudiced person, how can he have this done? He calls upon the secretary of the New York Lumber Trade Association, explains the matter to him and is advised that as soon as an inspector who is not engaged can be found he will be glad to have the lumber reinspected. In Greater New York there is but one public inspector, who, in the opinion of the writer, is unprejudiced and will give the shipper "a square deal." In talking with this inspector recently about the farce of the New York inspection, he stated that this thing could never be remedied because the lumber yards wanted their own inspectors and would have them. This man is so busy that it is necessary to file an application with him about a month before you can get a car inspected. There are a number of men who have licenses from the association and who are not employed by the lumber yards, principally because of their habits.

The National Hardwood Lumber Association is hardly known in New York. It is true, however, that they have one inspector here to do the work for a place having a population of approximately five millions of people. We recently received an inspection of four cars of lumber which we shipped to a large concern in this city, the inspection having been made by their employee, a "licensed" inspector of the New York

Lumber Trade Association. We were not satisfied with this inspection and called for a re-inspection. The work of inspecting 42,000 feet of lumber was done in less than two hours, the inspection certificates made out and the 50 cents per thousand collected from our customer, which was deducted from our invoice. This charge is in addition to the one paid our customer's "licensed" inspector. The inspection was identically the same to the foot and grade as the licensed inspector who was an employee of our customer. We venture to say that the first man who inspected the lumber, if he should reinspect the cars every day for two weeks (without the lumber having been marked to designate his former grades) that in every single car there would have been some difference.

Let us compare the farce of the New York inspection with the inspection in Boston. No yard in the city of Boston has or could have, if desired, a licensed inspector on a salary basis. In Boston there is a surveyor general, an appointee of the governor of the commonwealth, who is an up-to-date lumberman and who has an office at 88 Broad street. This surveyor general has nineteen deputies who are experienced lumbermen and impartial. We venture to say that if a lumber dealer in Boston who had had a car of lumber rejected should request the surveyor general to send a certain man to inspect the car, that his suggestion would be spurned, and the man who was most familiar with that particular kind of lumber and best qualified in the judgment of the surveyor general would be sent to do the work. In Boston it is only necessary to call the surveyor general by telephone and request him to send an inspector to survey a certain car of lumber; within twenty-four hours a certificate is delivered to your office. This is the way business is done in Boston. In New York you chase around at night to the inspector's home, climb three, four or five flights of stairs and are informed by the wife of the inspector that he is not at home, but will probably be found at the saloon on the corner. Imagine the surveyor general in Boston having a deputy whose business address was at some saloon! We contend that the New York Lumber Trade Association should refuse to issue a license to employees of any lumber concern.

We recently had a car of lumber rejected and the yard to whom we sold the stock insisted upon having their paid inspector go over the lumber, but we would not agree to this and, owing to our being unable to locate a public inspector, finally agreed that we would leave the matter of inspection in the hands of a certain inspector who was an employee of another yard. We then applied to his employer and asked if he would accommodate us in the matter and he replied that he was so busy with his own lumber that he could not spare him. This is the way things are done in the Great Metropolis.—NEW YORK JOBBER.

The foregoing letter is from a well-known New York jobber of lumber. The Lord knows there is enough to criticize in the method in which New York Lumber Trade Association inspection rules are applied in the Metropolis, but the arraignment made by our correspondent must be regarded considerably in the light of ex parte evidence, as he has evidently been the victim of particularly irregular methods in the application of the New York system of inspection. In New York, as in all large commercial centers, there is a deal of business transacted in lumber that is "on the level," while there are of course other methods that are open to criticism.

The statement made that the National Hardwood Lumber Association is hardly known in New York and that they have only one inspector there to do the work, is not borne out by the facts, as, during the month of August, two licensed, salaried inspectors, viz., F. P. Southgate, 472A Greene avenue, Brooklyn; W. T. Holahan and two extra inspectors, were employed by the Na-

tional Association to handle New York hardwood inspection. Suffice it to say that hardwood inspection conditions in New York City are gradually improving, and in the course of time it will be possible to ship hardwood lumber to all buyers in that market with the assurance of a square deal. Today it is the part of wisdom on the part of lumbermen to know the purchaser pretty thoroughly before shipments are made.

The favorable comment the correspondent makes about the method of application of inspection rules in Boston is just, but it must further be recalled that the inspection rules themselves, known as "Boston Survey," are extremely severe. Shippers to either market are advised to make, as a part of their selling bargain, a specification not only of the system of grades contemplated in the sale, but also who shall apply the grading rules in the event of a dispute.—EDITOR.

### Concerning Laurel.

LOUISVILLE, KY., Sept. 6. Editor HARDWOOD RECORD: We should like very much to know where laurel wood grows, and where we can obtain some of it. If you can give us this information we shall appreciate it very much.—COMPANY.

Without naming the botany of the wood referred to, it is difficult to tell what particular variety is meant by the common name laurel. There are half a dozen varieties of American tree growth which might answer to this name. The best known of the laurels of course is the mountain laurel (*Kalmia latifolia*, Linn.). This is the great flowering underbrush growth of the lower Appalachian region which bears the great masses of beautiful blossoms in early June. The wood is reddish brown, heavy and fine grained, but so far has not been adapted to commercial use. The roots of this growth are employed quite extensively in the manufacture of "French" briar pipes. It is found in greatest profusion in southern West Virginia, eastern Tennessee and western North Carolina.

Or it may be that the great flowered magnolia or "ball bay" (*Magnolia foetida*, Sargent), which in some sections is known as "big laurel" and in others as "laurel-leaved magnolia," is meant. The range of growth of this variety of magnolia is along the coast region of North Carolina, south of the Cape Fear river, to Florida and as far south as Tampa bay, westward in the gulf coast region to Texas and through western Louisiana and southern Arkansas. The wood of this magnolia is more valuable than that of any other of its genus. It is strong, somewhat fibrous in its nature and very light in color, and is worthy a place as a cabinet wood.

The address of the above correspondent will be supplied upon request to anyone interested in the class of material sought.—EDITOR.

### Wants Beech Lumber for Plane Stock.

NEW YORK, N. Y., Sept. 13. Editor HARDWOOD RECORD: Please give us the names of a few firms handling beech lumber for plane stock (manufacturing planes). Thanking you in anticipation of your courtesy, etc.—

The above inquirer has been supplied with the names of several concerns manufacturing beech lumber; on application the address of this correspondent will be furnished to firms making a specialty of beech lumber for plane stock.—EDITOR.

## Veneer Department in the Sawmill.

Although all admit the veneer business has come to be an important branch of the hardwood industry, it is generally looked upon as something aside from sawmilling, when in reality the cutting of veneer, and especially the sawing of quarter-sawed oak veneer, really belongs to and could be advantageously carried on in connection with sawmilling.

Oak flooring, especially quartered oak, and veneer fit together nicely and make a close clean-up of timber. The best plan is to work the narrow stock into flooring, since in flooring wide stock is not needed, leaving the wide stock for veneer flitches where it is not practical to use the narrow. Thus it will be seen that the two work together remarkably well, and it is strange that the plan has not been adopted more extensively. Probably one reason is that flooring stock must be thoroughly dried before it is worked, and it is preferable on account of weight in shipping to dry it considerably even before shipping it from the mills to the flooring plant when the mill man is not a manufacturer of flooring, as is quite frequently the case. In such instances the sawmill man might pile the narrow stock for flooring and load up the veneer flitches while they are green and ship them to the veneer plant. This is especially good advice for small portable mills which would hardly find it practical to install a veneer saw, and which might profit by this same idea by getting out stock or flitches for veneer mills in connection with oak flooring stock. But in an oak mill of any pretensions, especially if it is cutting quartered oak, it would certainly be worth while to investigate thoroughly the possibilities of adding a veneer department where the wide quartered stock could be immediately cut into veneer. The future use of oak in cabinet work will of necessity be more and more in the form of veneer since oak is getting so scarce, and consequently high in price, that there is no other way to make the supply meet the enormous demand upon it for any length of time. Moreover, built-up work with a fine veneer face for cabinet work or any purpose where it is protected from the elements really has qualities not to be found in the solid wood. But what more directly interests the sawmill operator is that the chances are decidedly in favor of getting more money out of this fine quartered oak by cutting it into veneer than by cutting it into lumber, and especially if the practice heretofore has been to cut it into thick quartered lumber. The demand for thick quartered oak probably will never again be what it once was, as steel has replaced wood quite extensively in the manufacture of numerous lines, such as tanks and casks for breweries, where large quantities of this oak were formerly used, and two, three or more plied veneer stock is also being substituted for thick oak for a great many

uses. This deterioration of the thick oak market is not to be seriously regretted, as this same stock can be manufactured into a product that will bring better returns than the thick oak ever offered. It is a little difficult to give exact prices on sawed veneer, as so much depends on figure, grain and general quality as well as thickness, but as a rule quartered oak stock cut into veneer will bring better returns than when made into solid lumber, and hence if the process of manufacturing and handling does not cost too much or lead to excessive waste, it should offer an inviting field to the sawmill man making oak lumber.

Generally speaking, the oak that has the best figure is the trash oak, and it also works easier than some of the tougher varieties, so that where it can be handled right it is sometimes best to work the tough butts into some line of stock requiring strength rather than figure. On the other hand, there is a chance of taking on a confusing variety of lines, and in some cases it will undoubtedly be found best not to try to assort for figure, but to take all the clear quartered stock where it runs wide, say 8 inches and up, and put it into veneer. One can frequently find a sale for the veneer mill-run so that the user of the veneer will himself do the sorting for special figure, and thus save the millman considerable tedious detail that requires expert knowledge. The people who study the fine arts in veneer make good money by carefully sorting veneer and selling that of fine figure for fancy prices, the prices being largely influenced by figure. However, unless the sawmill operator has some special talent and inclination in this direction it is advisable for him to figure on selling the mill run for a given price, without making any attempt at sorting out and passing expert opinion on each sheet of veneer.

With the idea of assorting for special figure eliminated, the process of manufacturing quarter-sawed veneer is really very simple and requires only a small crew. Two men handle the veneer saw, and while the work may seem slow and tedious as compared to sawing lumber, they turn out quite a large quantity of stock, depending of course on the width of the flitches, the condition of the mill, etc.

After the veneer is sawed for flitches, which must be done while it is green, not only because it is easier to do the sawing then, but because thick lumber checks more or less in drying, which spoils some of the veneer, the only thing that remains is to dry the stock and tie it up into bundles convenient for handling.

The usual method of drying veneer is to edge-pile it in racks, and practically the same method is followed whether the stock is dried in the open air or in a kiln. A kiln or hothouse for drying veneer can be made very easily without a great deal of expense

by simply making an enclosed room with an open floor and steam pipe coils underneath to give heat and providing some method of ventilating. In a room of this kind the same piling racks may be utilized as are used in open-air processes and drying done regardless of the weather. Some manufacturers expose the veneers to the direct rays of the sun and others protect it in sheds. It is probably better to have the drying racks under sheds where air drying is adopted, because this thin stock dries out very quickly and the intense heat of the sun in the summertime is often found to be injurious. Big veneer concerns of course have special kilns and special methods for drying veneer, all of which are worthy of consideration to those going into the business on an extensive scale, but the average sawmill putting in a veneer cutting department may, without great expense, provide means for drying stock as indicated above.

In addition to means for drying there must, of course, be provided warehouse room for storing veneer, which should be a clean, dry place with the floor enough above ground to keep it free from moisture. The veneer after being dried should be tied up securely in bundles of a size convenient for handling, as this not only facilitates loading and unloading, but serves in a measure to protect the veneer, which being thin and frail is subject to damage in handling.

In connection with this subject it is in order to say that quarter-sawed oak veneer is not by any means the cheapest, is not to be compared in price to veneer in general and is, in fact, the most expensive veneer made from the same wood. This is partly due to the fact that veneer sawing is a much slower process than veneer cutting, and necessarily cuts away and wastes generally as much in sawdust as is made in veneer. Notwithstanding this, however, the demand for quarter-sawed veneer is growing rapidly, since in quality there is absolutely no comparison between that and cut stock. Sawed veneer when faced up shows a surface exactly like that of solid lumber. It has qualities that no cut veneer possesses, and this point should be remembered when selling it, so as not to make prices on a basis of those obtained for cut veneer.

The usual thickness for quarter-sawed veneer is 1/20, 1/8 and 1/16 of an inch for thin stock, and 1/8 and 1/4 of an inch for heavy stock, such as is used for doors and various kinds of planing mill work. Before beginning to cut anything of this kind, of course, it is best to find a prospective market and see just what it uses and what quantity and widths in the various thicknesses. At the present time there is not much demand for narrow widths, say 6 inches and under, notwithstanding the fact that large quantities are used by the furniture trade, they evidently figuring on getting the narrow stock out of working the wide. This is another reason why, as stated above, veneer and flooring may be worked in combination to great advantage in making the most economical utilization of timber.



## In Northern Wisconsin and Michigan.



LOGGING SCENE AT STANLEY, WIS., OPERATIONS, NORTH WESTERN LUMBER COMPANY.

Probably there is no other place in the United States where the rugged battle with nature has been waged more successfully, or where men of finer mold have been engaged in the work of converting vast stretches of virgin timberland into wealth than in the great woods of the north. The opportunities of the region and the obstacles to be overcome seemed to have called out the best qualities of those who have made the marketing of timber their profession. In the old days when the forests were first invaded the men who laid ax to the trees were of a sturdy pioneer type, full of courage and perseverance. During these latter days it takes men of no less resourcefulness and business capacity to push on to a successful conclusion the operations whose foundations were laid a generation ago.

### North Western Lumber Company.

The North Western Lumber Company of Eau Claire and Stanley, Wis., is one of the largest concerns in the state. It had its origin some thirty years ago when D. R. Moon, S. T. McKnight and Gilbert E. Porter formed a partnership and purchased what was then known as the Porter mills, located some four miles from Eau Claire on the Chippewa River. At that time it was only a small circular mill, but under the

wise management of these two veteran lumbermen it steadily grew until it became one of the largest plants in that section of the country. Of the original founders of the company, Mr. Moon and Mr. Porter have passed away, but Mr. McKnight still lives,

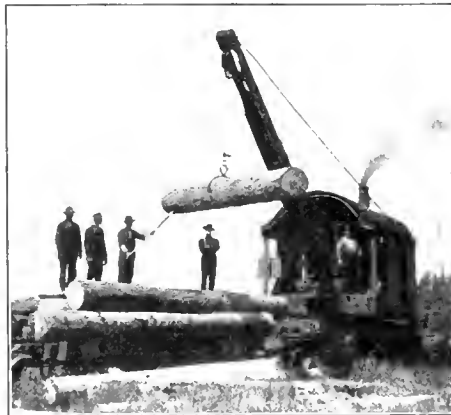

LOG LOADER IN OPERATION, NORTH WESTERN LUMBER COMPANY.

is hale and vigorous, in Minneapolis, where he is enjoying a well-earned retirement from active business life.

The progressive traditions of the firm are still maintained under the direction of the

now active management. The officers, G. T. Barber, president; S. V. Moon, vice-president and treasurer; C. D. Moon, secretary, and George H. Chapman, manager, are all well known in the business life of the state. From its inception until the present time the company has enjoyed a rapid and deserved progress. When the old Porter mills were closed down, the plant had been enlarged to several times its original capacity. The single circular sawmill had grown into two modern mills and a planing mill, all equipped with the most modern and efficient machinery. When the timber adjacent to the first plant had been depleted, the company bought a mill at Eau Claire, operating a two hand gang mill. Later it purchased a plant at Sterling, twenty miles from Stanley, known as the Sterling Lumber Company, which consists of two band mills and gang with a capacity of 50,000 feet every ten hours. The operation has also a planing mill and dry kilns.

The North Western Lumber Company is one of the largest operators in the state. It owns large tracts of standing timber and stumpage in the upper part of Wisconsin, and owns and operates a logging road with a main line forty-five miles long, besides various branches, known as the Stanley,



MILL AND LOG POND, NORTH WESTERN LUMBER COMPANY.



MILL AND YARD, INGRAM LUMBER COMPANY, INGRAM, WIS.



LOG TRAIN, INGRAM LUMBER COMPANY, INGRAM,



Merrill & Phillips Railroad. Besides its purely lumber activities, the company operates a daily schedule of passenger trains which pass through one of the wildest and most beautiful routes in the northern woods.

**Mason-Donaldson Lumber Company.**

The criterion of every man's ability is the quality of work he does. A fallow field

lumber trade of the state. In 1905 the company handled over 35,000,000 feet, and in 1906 will probably handle 60,000,000 feet. It also manufactures lumber, and last year acquired the high capacity mill of the Wilbur Lumber Company, at State Line, Wis., where it owns 9,000 acres of hemlock and hardwood timber. Connected with the operation is a narrow gauge railroad, fully equipped for logging purposes, by which the logs are hauled to the mill. Besides the holdings mentioned, the company has an additional stumpage in the same locality, which brings the total acreage up to 20,000, and is expected to furnish work for the mill for the next twenty years.

Both Geo. W. Mason, president of the company, and Carl H. Donaldson, secretary and treasurer, know the business from the ground up. Their dominant characteristic is energy. Geo. W. Mason entered the employ of Brown Brothers when he was sixteen years old and remained with them for seventeen years, working both in the office and on the road, and in both positions acquiring knowledge that afterward became invaluable to him. Carl H. Donaldson also worked for Brown Brothers, beginning in the yards and working through all the details of the business up to the position of sales manager. It is characteristic of both men that in the highest as well as in the more subordinate positions they showed qualities of foresight and resourcefulness.

Besides the general offices of the company at Rhinelander, a branch office is maintained in Chicago, in charge of A. C. Quixley.

**The R. Connor Company.**

No statement of lumber operations in Wisconsin is complete without mentioning the R. Connor Company, which is at once one of the oldest and largest concerns in the state. The firm owes its origin to Robert Connor, father of W. D. Connor and Robert Connor, Jr., the men who are now the active spirits in charge of the enterprise. The father was born in Scotland, but early in life came to America and settled in the Wisconsin woods, at that time only thinly settled by white men, where he adopted the profession of farming. In those early days there was practically no market

for the valuable hardwoods of the country and the majority of the settlers burned timber to secure farming lands. Robert Connor, however, with rare foresight, invested in tract after tract and ultimately when the needs of the market warranted it, erected a sawmill at Anburndale, ten miles east of Marshfield, Wis. His work was not unre-

C. H. DONALDSON, SEC. TREAS. MASON DONALDSON LUMBER COMPANY, RHINELANDER, WIS.

warded, for the business grew to proportions unheard of in those days, and when the sons, W. D. and Robert, Jr., were growing to manhood they received an education as lumbermen that included every detail of the business.

The company successfully weathered the panic of 1893 and when the recurrent years of prosperity swept over the country, was in position, from its extensive holdings in hardwoods, to supply the most exacting needs of the trade. From that time the history of the firm has been one of continual progress. During 1894 and 1895 the activities of the R. Connor Company included, in addition to the plants at Anburndale and Stratford, two mills in Clark county and seven other mills, with a total yearly output approximating 50,000,000 feet. The hold-



GEORGE W. MASON, PRES. MASON DONALDSON LUMBER COMPANY, RHINELANDER, WIS.



may contain the possibilities of a rich harvest, but unless the labor is expended to render it productive, it will remain barren to the end. So with men. There may, perhaps, be characters of great ability hidden in obscure positions, but, as a general rule, it will be found that the reason of their failure to rise is because of the lack of some distinguishing characteristic of initiative or readiness to grasp an occasion that in a country so pregnant with opportunities as ours almost invariably marks the successful man.

The reward that comes from thorough preparedness and hard work is illustrated in the career of the Mason-Donaldson Lumber Company of Rhinelander, Wis. A little more than three years old, it has achieved a position of commanding importance in the

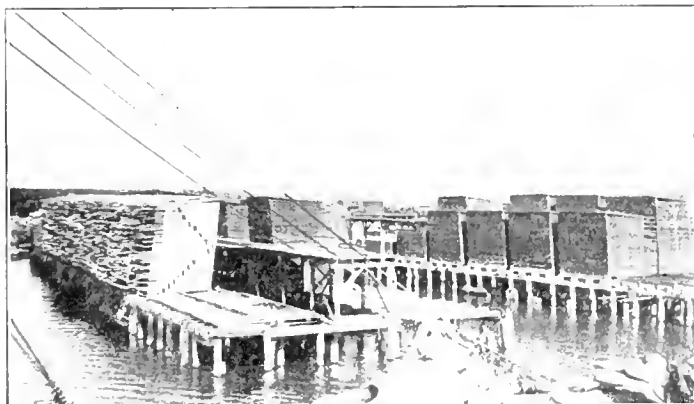

LUMBER READY FOR SHIPMENT, NORTH SHORE LUMBER COMPANY, THOMPSON, MICH.

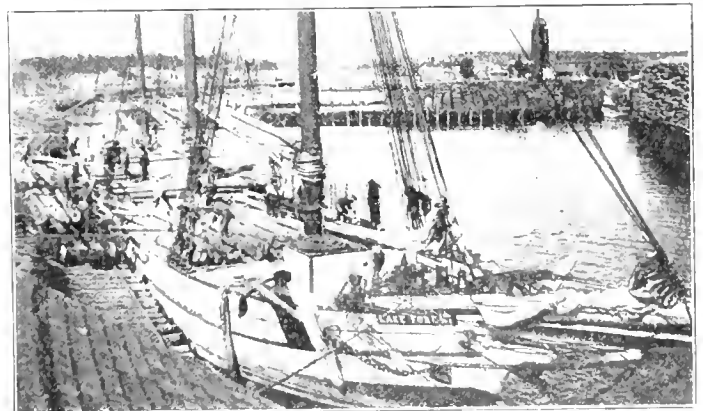

LOADING VESSEL AT DOCKS OF NORTH SHORE LUMBER COMPANY, THOMPSON, MICH.

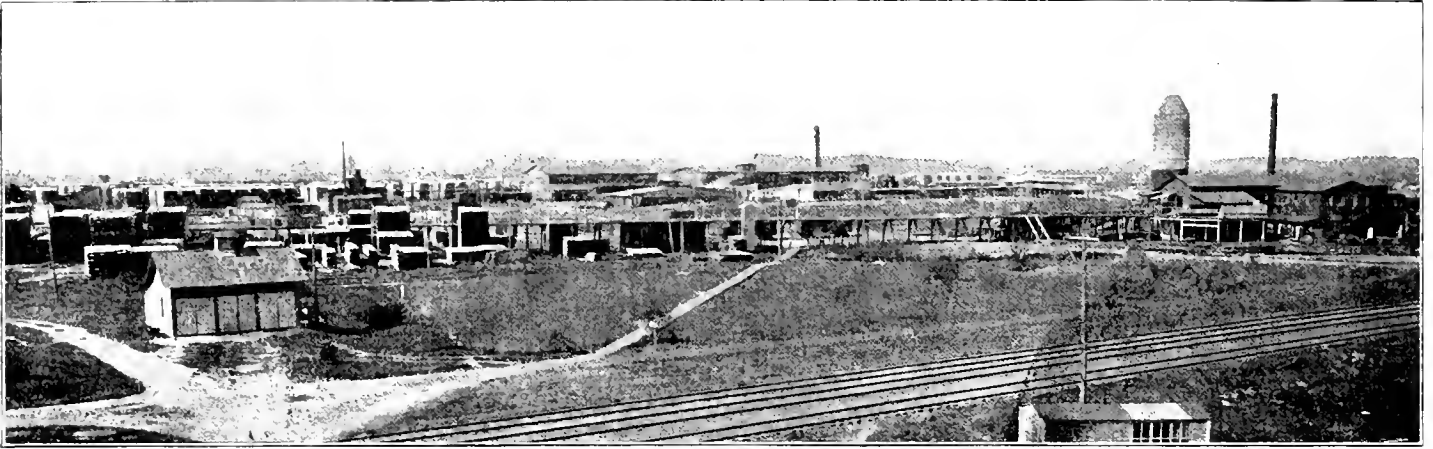

PANORAMIC VIEW PLANT WISCONSIN LAND & LUMBER COMPANY, HERMANSVILLE, MICH.

ings of the company in that section are still sufficient to keep it busy for several years. At Stratford, in Marathon county, there is enough timber to keep the mill of 20,000,000 feet yearly capacity running fifteen years longer, and the holdings of the company at Laona, where the concern has lately acquired extensive tracts, will supply the mill for probably thirty years to come. The operations here, which began in 1901, consist of a double band mill and a shingle and lath mill, besides a planing mill. It has twelve miles of logging road and an annual capacity of 20,000,000 feet. The company also controls extensive holdings in Iron, Ashland and Oneida counties and many thousands of acres in the northern peninsula of Michigan.

W. D. Connor has become well known not only through his successful business operations, but also because of the services he rendered the state in the recent stormy political times. His devotion to the cause of the people has won him many friends throughout the entire commonwealth, and as a result of his good work he has been made the candidate of the Republican party in his state for lieutenant-governor.

Robert Connor, Jr., was born on the farm at Auburndale in 1878. He attended the district schools and later entered Hanover College, at Madison, Ind. His experience in lumbering was gained, like that of his brother, by actual work at the mill and yard, and then by passing through the various subordinate grades in the executive end of the business.

The R. Connor Company is conceded one of the most powerful factors in the lumber life of the state. The men at its head are thorough masters of the business. They have an intimate knowledge of the work and control holdings of such an extent that the future will see their influence augmented rather than decreased.

#### Ingram Lumber Company.

At Wausau, Wis., are the main offices of the Ingram Lumber Company, a concern which, during its comparatively short life, has made a notable impression in hardwood lumber circles. C. S. Curtis, president; E.

H. Parloe, vice-president, and A. H. Clark, secretary and treasurer, are all splendidly equipped for their work. They are men of such experience in the business that there can be no doubt of the important part their company will play in the lumber markets of the country.

Their main timber holdings are located just outside the town of Ingram and consist of a tract of some 76,000 acres, bearing basswood, birch, elm, ash, oak and hemlock. The operation includes a modern saw and planing mill, having a capacity of 14,000,000 feet of mixed stock annually, with eight miles of logging road and every modern device for handling the stock from the tree to the market. The future of the business is bright, not only because of the valuable holdings of the company, but also because the men in charge of the work are conversant with market conditions and can be trusted to make the most possible out of their holdings.

#### Wisconsin Land & Lumber Company.

The offices of the Wisconsin Land & Lumber Company are located at Hermansville, Mich., at the junction of the Soo and Chicago & Northwestern Railways. Here also are the two large sawmills, shingle mills and hardwood flooring factory of the concern. The village is practically owned by the company, nearly all the inhabitants being employed at the works, and all the industries of the town being under the superintendence of the owners of the lumber operations. The company conducts a general merchandise store, meat market and machine shop, besides the mills that are engaged in producing lumber products. It also operates a logging railroad with locomotives and rolling stock.

Dr. George W. Earle, of Hermansville, is president of the company, and the history of the operation is largely the story of his progressiveness and ability. Dr. Earle was graduated from the Buffalo Medical College in 1872 and took up the practice of his profession in Onondago county, New York, where he speedily secured a large clientele. Through his father-in-law he made a heavy investment in the operation of the Wisconsin

Land & Lumber Company and, believing that his health could be benefited by the change, he removed to Hermansville. While there he also took occasion to study the lumber business. The company was in financial difficulties, with a heavy load of debts to care for, bonds having been issued from time to time in settlement of its obligations. Matters became so serious that Dr. Earle was invited, on the reorganization of the company, to become vice-president and assistant manager. He took up the work, but the associated management, after struggling for some years, gave up the task as hopeless. Foreclosure being threatened on several mortgages, the principal stockholder determined to turn his interests over to the creditors and advised Dr. Earle to do the same. The latter, however, against all advice shouldered the responsibilities of the company and began an up-hill battle against the accumulated indebtedness. He was so successful that he not only discharged the liabilities, but the second mortgage bonds, before considered worthless, were paid, dollar for dollar. The company was then reorganized under Michigan laws and since that time has had a successful career. Dr. Earle occupies a high place among his contemporaries and his worth as a business man was recognized when his associates of the Maple Flooring Association elected him to the office of president of that organization.

#### An Opportunity in Southern Hardwoods.

Good hardwood timber lands are now scarce and every year is adding to the difficulty in locating hardwood timber accessible to railroad or other transportation facilities. The Western National Bank, of Louisville, Ky., offers an excellent opportunity for the hardwood manufacturer who wishes to procure a location with these advantages for manufacturing. The bank has a tract of oak timber land which is located within a short distance of three railroads. The tract is rich bottom land and would be valuable for cotton raising after the timber has been removed.

# Meeting of Wisconsin Hardwood Lumbermen's Assn.

The eleventh annual meeting of the Wisconsin Hardwood Lumbermen's Association was held on Tuesday, September 18, at the Hotel Pfister, Milwaukee, Wis., with a fair number of members in attendance. President E. P. Arpin called the meeting to order



PRESIDENT E. P. ARPIN, ARPIN HARDWOOD LUMBER COMPANY, GRAND RAPIDS.

This committee showed remarkable energy in securing the passage of a resolution before the National Lumber Manufacturers' Association, thereby securing the cooperation of the thirteen affiliated associations in this matter. The committee appointed by President William Irvine of the National Lumber Manufacturers' Association to meet with the Transcontinental Freight Bureau consisted of John B. Ransom, of Nashville, Tenn., Eugene Shaw of Eau Claire, Wis., and your president. The committee met at two different times in Chicago in connection with a similar committee appointed by the National Hardwood Lumber Association, viz., O. O. Agler of Chicago, J. M. Pritchard of Indianapolis and G. J. Landeck of Milwaukee; also Lewis Doster, secretary of the Hardwood Manufacturers' Association of the United States.

At the first meeting they ascertained that the Transcontinental Freight Bureau had postponed its meeting until July 16. Our committee secured a hearing on July 18, at which time the subject was entered into fully, and we were in hopes from what encouragement we had obtained through interviews with the traffic managers of the different roads that we would be successful. Later on, however, we were advised that our petition for lower rates had been rejected.

Our committee afterward met for the third time in Chicago to draw up a plan of action and make a report to our respective associations

those below should go into the next lower one, thereby establishing the give and take principle on this question of measurement.

They appointed a committee to confer with the National Hardwood Lumber Association to take up the question of rules and, as this question is bound to come up before long, think it would be advisable to have a committee from this association prepared to consider this important question when the proper time arrives.

I feel that I have received hearty cooperation from all the members in the work required, for which I am duly thankful.

The lumber press has always been active and diligent in furthering the interests of our association work and has given us valuable aid, for which it is entitled to a vote of thanks.

The report of the secretary being next in the order of business, the president called on Mr. Beebe, who submitted the following:

### Report of the Secretary.

After the thorough manner in which President Arpin has taken up the several matters of interest to the association, it barely seems necessary for the secretary to make a report on the same questions, therefore such matters as car stake equipment, etc., will be omitted from this report.

During the last year this association has lost five members on account of the firms going out of business. During the same period we have gained nine new members, and our present roll of membership now consists of the names of sixty firms. Recently the secretary sent out blanks for collecting statistics in regard to dry and green lumber and logs in the hands of members of the association September 1, 1906. We have received thirty-four replies, and the following is a summary of the various reports.

	Mill Run, No. 3 Common and Better.		Logs.	Totals.
	Dry Lumber.	Green Lumber.		
Ash	2,057,000	747,000	31,000	2,835,000
Basswood	16,883,000	4,247,000	625,000	21,755,000
Birch	32,509,000	6,029,000	1,823,000	40,361,000
Butternut	50,000	174,000	18,000	242,000
Rock Elm	1,769,000	471,000	61,000	2,295,000
Soft Elm	7,541,000	1,145,000	622,000	9,308,000
Maple	8,976,000	4,188,000	2,351,000	15,515,000
Red Oak	1,680,000	906,000	136,000	2,722,000
White Oak	658,000	391,000	138,000	887,000
Total	72,195,000	18,397,000	5,807,000	96,399,000

at 10 o'clock and, after the minutes of the last meeting at Marshfield had been read and approved, made a short talk on the progress of the work of the association.

### President Arpin's Address.

The past year has been one of exceptional prosperity for the entire country, and the hardwood lumber industry prospered fully as well as most of the other industries. The demand has constantly kept ahead of the supply, and the result has been in some cases that there has been a lack of supply, especially in ash, while the supply of dry, plain oak has never been up to requirements.

When we consider the fast diminishing source of supply and the immense demands on it through the natural growth of this country, it can readily be seen that the situation will always be strong. Those who are fortunate enough to have timber holdings have become alive to the fact that the supply is being narrowed down yearly and will always prefer to hold their timber rather than to sacrifice it.

The value of the association work has been manifested in many different ways during the past season. The committee appointed by the National Lumber Manufacturers' Association to take up the subject of equipment of flat and gondola cars have already been offered a concession by the railroads of an allowance of 500 pounds on each car. This allowance is now being made by most all the leading lines. As you all know, the committee having this in hand will endeavor to secure an order from the Interstate Commerce Commission requiring the railroads to equip the cars with permanent stakes or pay for such equipment when furnished by the manufacturers.

A meeting before the Interstate Commerce Commission will be held in Chicago tomorrow, September 19. Your committee, appointed by this association to secure the cooperation of the National Lumber Manufacturers' Association and the National Hardwood Lumber Association on west coast rate matters, was successful in securing the cooperation of these associations. I attach herewith a report signed by F. H. Pardoe, George E. Foster and E. R. Week, members of the association, who attended the meeting of the National Lumber Manufacturers' Association at St. Louis on May 8 and 9.



VICE PRESIDENT B. W. DAVIS, JOHN R. DAVIS LUMBER COMPANY, PHILLIPS.

This time new developments occurred which seemed to warrant the postponement of drawing up a special report, and it was left to a special committee consisting of your president and O. O. Agler.

We are now informed by the traffic managers of the Great Northern, Northern Pacific and Canadian Pacific that they are about to grant a rate of 60 cents per hundred from Chicago and common points, based on a minimum weight of 50,000 pounds. We believe that the other lines will also make concession at this rate, and that it will eventually result in our securing the reduction we are asking for.

William H. White, president of our newly organized Michigan Hardwood Manufacturers' Association, requested your president to attend their meeting held at Mackinac Island on August 8. There was a good attendance at this meeting, and the result will no doubt be that the Michigan association will soon be permanently and strongly organized and the result will be beneficial to the entire trade.

The most important subjects that came up at this meeting were those of grading and inspection rules. The manufacturers were strong in the opinion that common and better lumber should be graded from the best side of the board and that a board measuring one-half inch in width should go into the higher unit, and



SECRETARY A. E. BEEBE, B. F. McMILLAN & BRO., McMILLAN.

It may be of interest at this time to state that a stock report gathered March 10, 1905, in which thirty-seven members reported, showed a total stock on hand of 230,129,000 feet.

After a motion had been made and passed that the report of the secretary be received

and filed the report of E. H. Pardoe, George E. Foster and A. R. Week, the committee appointed to attend the meeting of the National Lumber Manufacturers' Association at St. Louis, May 8 and 9, was submitted.

WAUSAU, WIS., May 16, 1905.  
Wisconsin Hardwood Lumbermen's Association,  
E. P. Arpin, President, Grand Rapids, Wis.

Gentlemen:—Your committee, appointed to attend the National Lumber Manufacturers' Association at St. Louis, Mo., May 8 and 9, submit the following report for your worthy consideration:

The meeting was most pleasant and profitable and was attended by about fifty delegates representing the various allied associations from all sections of the United States, whose combined production aggregates 12,000,000,000 feet annually.

Mr. Kellogg of the Government Forestry Department had prepared for the occasion statistical tables showing the annual production of the different kinds of woods by states, together with the supply of each kind of woods by states, together with the supply of each kind on hand January 1, 1905, which showed the annual production in board feet to be about 27,000,000,000, and estimates that his figures represented between 80 per cent and 90 per cent of the total amount produced in the United States annually.

A committee consisting of one member from each association was appointed to report on the credit rating department inaugurated some time

Your committee also secured the adoption of a resolution protesting against the present west bound freight rates on hardwood lumber from Chicago and common points to the Pacific coast territory, and the appointment of a committee consisting of E. P. Arpin, Grand Rapids, Wis., chairman; John B. Ransom, Nashville, Tenn.; Eugene Shaw, Eau Claire, Wis., to take this matter up with the Transcontinental Freight Bureau and its allied lines and secure a reduction of west bound freight rates. We were ably assisted in this movement by the delegates representing the Hardwood Manufacturers' Association of the United States, as the committee on resolutions had declined to report our resolution and we were obliged to place the matter before the open meeting. It was introduced on the floor by R. H. Vansant of Ashland, Ky., and supported by the members of your committee, and was finally adopted.

Your committee is also indebted to J. E. DeFebaugh, editor of the American Lumberman, for his active support of this resolution, and also to many others present whose influence was favorable to our resolution.

We are also pleased to state that William Irvine of Chippewa Falls, Wis., was elected president, and George E. Foster of Mellen, Wis., was chosen to represent this association on the board of governors for the ensuing year.

Respectfully submitted,

F. H. PARDOE,  
GEORGE E. FOSTER,  
A. R. WEEK.

After the reading of the report of the committee it was ordered filed, on motion, and the treasurer's report was then presented. The statement of receipts and disbursements was as follows:

**Treasurer's Report.**

RECEIPTS.	
From W. J. Colby, Treasurer	\$231.46
From left over, 1905	25.00
From members	24.00
From sale of books of grading rules	3.00
From 1906 dues	307.50
<b>Total</b>	<b>\$590.96</b>
DISBURSEMENTS.	
For stamps	\$ 46.30
For printing, stationery, office supplies, etc.	112.65
For National Lumber Manufacturers' assessment	100.00
For assessment to car stake and equipment committee	100.00
For secretary's salary for one year	120.00
For balance on hand	112.01
<b>Total</b>	<b>\$590.96</b>

After the secretary's report had been read and filed Mr. Beebe congratulated the members on the fact that all dues had been paid up.

This being the annual meeting of the association and the election of new officers being in order, President Arpin then appointed a nominating committee, consisting of Eugene Shaw, Geo. H. Chapman and Geo. E. Foster.

**Remarks of Lewis Doster.**

Lewis Doster, secretary of the Hardwood Manufacturers' Association of the United States, was called on for a speech and replied, stating the objects of his organization and the progress lately made in their work. He called special attention to the value of the information bureau established and the means taken to protect the members from unjust dealings, stating that in this last effort the association had been especially successful. He closed by assuring the Wisconsin organization that his association stood ready to work together with them on any points that might benefit the hardwood trade at large.

**O. O. Agler Talks.**

O. O. Agler, first vice-president of the National Hardwood Lumber Association, also responded to an invitation to address the meeting and made a short reply, stating

that, although he did not come to the meeting as a representative of the National Association, he was glad to call attention to what that body was doing to perfect an inspection department. In regard to the strength of the association he stated that it has now over 600 members. He closed by stating that, although not of that state, he had always been interested in Wisconsin woods and believed that whatever the Wisconsin Association would do would be for the best interests of all concerned.

On motion the meeting adjourned until 2 o'clock.

**AFTERNOON SESSION.**

**Officers Elected.**

When the meeting was called to order the report of the nominating committee was presented, recommending that all the old officers be retained in their positions, and a motion to that effect was made and passed. President Arpin was called upon to say a few words in regard to his reelection and in reply thanked the association for the honor it had conferred upon him, recalling to them that when he accepted the post last year he realized that



GEORGE E. FOSTER, FOSTER LATHAM LUMBER COMPANY, MELLEN.

ago by the National association (George E. Foster of this committee represented your association in that capacity.) That committee reported the credit rating department in a most satisfactory condition, it having cost about \$27,000 up to date, and that it could without doubt be disposed of to competitive credit corporations for a sum considerably in excess of the actual cost. They further recommended that the outstanding indebtedness be retired by an issue of five year 6 per cent interest bearing bonds to the amount of \$30,000, and the establishing of branch agencies through several different secretaries of allied associations for the convenience of members who cannot communicate with the St. Louis office readily. The committee's resolution was adopted by the association and the secretary was instructed to carry this work forward. The amount allotted to the Wisconsin Hardwood Lumbermen's Association was \$500, of which \$200 has now been subscribed. The delegates present representing other associations pledged the full amount of their respective associations, and at first your committee was doubtful as to the advisability of pledging this amount, as no such authority had been delegated to it, but upon further consideration it was the unanimous opinion of the committee that this association could not afford to be behind in this important work, and pledged the amount allotted to this association and respectfully asks your support of their position.



GEORGE H. CHAPMAN, NORTH WESTERN LUMBER COMPANY, STANLEY.

there was considerable work to be done. He stated that the work was even more than he anticipated and thought it would be a good thing if the association would take into consideration the appointment of a secretary who could devote his whole attention to the work, getting information, making statistics and otherwise providing data for the association.

**Expense Accounts of Committees.**

In the course of the consideration of the work of the various committees who have been going from place to place attending to the business of the association, the question arose as to the expense account of the various members when looking after the interests of the organization, and it was finally moved by H. C. Humphrey that the association pay all the necessary expenses of such committees in attendance on the work of the association, the expenses to be passed upon by the Board of Directors. The motion was passed, and the meeting proceeded to the consideration of grading and inspection.

**Grading and Inspection.**

President Arpin called the attention of the meeting to the importance of the question and stated that he would be glad to hear from any of the members who had anything to say on grading from the better side of the board. In response to a question as to what the Michigan people are doing, he stated that as far as he could learn they are in favor of grading from the better side of the board, but that they had taken no official action and thought that they would take none until their association was better organized.

In regard to inspection an animated discussion was carried on, many of the speakers favoring a system of inspection under the Wisconsin Association itself. President Arpin called attention to the fact that the question had arisen last year and that after the meeting inquiries had been sent to the various members of the association and that the replies received showed that most of the members were opposed to it, but that he would be glad to hear any further discussion on the subject.

- W. W. Heinemann, Wausau, B. Heinemann Lumber Co.
- F. J. Byrne, HARDWOOD RECORD, Chicago.
- Eugene Shaw, Eau Claire, Daniel Shaw Lumber Co.
- A. E. Beebe, McMillan, B. F. McMillan & Bro.
- L. H. Wheeler, Wausau, Wheeler-Timlin Lumber Co.
- George Maxson, Dunbar, Girard Lumber Co.
- C. H. Donaldson, Rhinelander, Mason Donaldson Lumber Co.
- F. H. Pardoe, Wausau, Fenwood Lumber Co.
- George H. Chapman, Stanley, North Western Lumber Co.
- B. W. Davis, Phillips, John R. Davis Lumber Co.
- William C. Klann, Milwaukee, Rietbrock Land & Lumber Co.
- C. J. Aburg, Milwaukee, Rietbrock Land & Lumber Co.
- W. E. McGraw, Soperton, Menominee Bay Shore Lumber Co.
- J. D. R. Stevens, Eau Claire, William J. Starr.
- J. F. Hughes, Owen, John S. Owen Lumber Co.
- E. P. Arpin, Grand Rapids, Arpin Hardwood Lumber Co.
- L. E. Fuller, Chicago, American Lumberman.
- J. P. Hayman, Minneapolis, Mississippi Valley Lumberman.
- O. O. Agler, Chicago, Upham & Agler.
- Lewis Foster, Chicago, Hardwood Manufacturers' Association.

**A. R. Owen on New Price List Adopted by His Firm.**

In discussing conditions after the meeting

had adjourned, A. R. Owen of the John S. Owen Lumber Company, of Owen, Wis., called attention to the prosperous condition of the hardwood trade during the past year and in particular to the bright outlook for the trade of the Wisconsin lumbermen. In speaking of prices he stated that his firm would advance ash in log run and firsts and seconds and No. 1 common \$1. In birch a reduction of \$1 would be made on log run, \$2 reduction on firsts and seconds and No. 1 common. Butternut will remain unchanged. In basswood log run will be advanced 50 cents, making it \$21, and in firsts and seconds and No. 1 common there will be an advance of \$1. In rock elm they will add \$1 to the price of log run and also advance firsts and seconds and No. 1 common \$1. Bridge plank also takes an advance of \$1.

In all the other items the price will remain about the same. Mr. Owen stated that he thought the condition of trade warranted the advance and felt that his firm could get it, although he could not say what the other firms would do in the matter. The prices, however, he said were fair and might be taken as an average of what the lumber was worth. The changes suggested by Mr. Owen are embodied in the following schedule, prices being f. o. b. Wausaw, Wis., freight rate:

			1st and 2nd. Com.	No. 1 Com.	No. 2 Com.	No. 3 Com.
	1 in. log run (No. 3 Common out)	\$26.00				
ASH	1 in.	\$39.00	\$26.00	\$14.00	\$11.00	
	1 1/4 in. and 1 1/2 in.	41.00	28.00	16.00	11.00	
	2 in.	42.00	29.00	16.00	11.00	
	2 1/2 in. and thicker	47.00	31.00	16.00	11.00	
BIRCH	1 in. log run (mixed color, No. 3 Common out)	18.00				
	1 in. (red out)	29.00	16.00	12.00	10.00	
	1 1/4 in. and 1 1/2 in.	31.00	18.00	12.00	10.00	
	2 in.	32.00	20.00	13.00	10.00	
	1 in. red	38.00	26.00	15.00		
	1 1/4 in. and 1 1/2 in.	40.00	28.00	15.00		
BUTTERNUT	1 in.	40.00	28.00	15.00		
	2 in.	42.00	30.00	15.00		
	2 1/2 in. and thicker	42.00	30.00	15.00		
	Curly birch, red and white mixed	75.00	50.00	25.00		
BASSWOOD	1 in. log run (No. 3 Common out)	25.00				
	1 in.	35.00	25.00	15.00	12.00	
	1 1/4 in. and 1 1/2 in.	40.00	30.00	20.00	13.00	
SOFT ELM	1 in.	42.00	32.00	22.00	12.00	
	2 in. log run (No. 3 Common out)	21.00				
	1 in., 5 in. to 11 in., 8 ft. to 16 ft.	38.00	30.00	21.00	14.00	
	12 in. and wider	34.00	25.00	17.00	15.00	
ROCK ELM	1 1/4 in. and 1 1/2 in.	36.00	25.00	16.00	14.00	
	2 in.	36.00	25.00	16.00	14.00	
	1 in. Box Common (Nos. 2 and 3 Com. mixed)	15.00				
For sorting basswood to lengths of 10 and 12 ft. add \$2 per M ft.						
WHITE OAK	1 in. log run (No. 3 Common out)	20.00				
	1 1/4 in., 1 1/2 in. and 2 in. log run (No. 3 Com. out)	21.00				
	1 in.	29.00	19.00	13.00	11.00	
	1 1/4 in., 1 1/2 in. and 2 in.	32.00	21.00	13.00	11.00	
HARD MAPLE	2 1/2 in. and thicker	35.00	24.00	13.00	11.00	
	1 in. log run (No. 3 Common out)	24.00				
	1 1/4 in., 1 1/2 in. and 2 in. log run (No. 3 Com. out)	27.00				
	1 in.	36.00	24.00	15.00	10.00	
	1 1/4 in. and 1 1/2 in.	40.00	26.00	17.00	10.00	
	2 in.	40.00	28.00	19.00	10.00	
SOFT MAPLE	2 1/2 in. and thicker	43.00	33.00	22.00	10.00	
	Bridge Plank, 2 in., all lengths	17.00				
	Bridge Plank, 3 in. and thicker, all lengths	19.00				
	Of one length add \$2.					
HARD MAPLE	1 in.	50.00	38.00	27.00	9.00	
	1 1/4 in. and 1 1/2 in.	52.00	41.00	30.00	10.00	
	2 in.	55.00	43.00	32.00	10.00	
	2 1/2 in. and thicker	60.00	48.00	37.00	10.00	
WHITE OAK	1 in. wormy Common and better	15.00				
	1 1/4 in., 1 1/2 in. and 2 in. wormy Common and better	17.00				
	1 in.	45.00	35.00	23.00	9.00	
	1 1/4 in. and 1 1/2 in.	49.00	39.00	27.00	10.00	
HARD MAPLE	2 in.	51.00	41.00	29.00	10.00	
	2 1/2 in. and thicker	55.00	45.00			
	Bridge Plank, 2 in., all lengths	17.00				
	Bridge Plank, 2 1/2 in. and 3 in., all lengths	21.00				
Of one length add \$2.						
SOFT MAPLE	1 in. to 2 in. log run (No. 3 Common out)	14.00				
	1 in.	24.00	14.00	11.00	9.00	
	1 1/4 in. and 1 1/2 in.	26.00	16.00	11.00	9.00	
	2 in. and thicker	30.00	20.00	16.00	12.00	
SOFT MAPLE	1 to 2 in. log run (No. 3 Common out)	16.00				
	1 to 2 in.				9.00	



HOWELL C. HUMPHREY, G. W. JONES LUMBER COMPANY, APPLETON.

After a discussion in which the merits of the different kinds of inspection were passed upon, it was moved by Mr. Pardoe that a committee of three be appointed to go over the matter carefully and formulate a plan if, in their judgment, it is advisable to establish some plan of inspection in conjunction with the National Association. The motion was seconded and carried, and F. H. Pardoe, Geo. H. Chapman and Geo. E. Foster were appointed a committee.

There being no further business, the body adjourned.

**Attendance.**

- Ed. J. Young, Madison, Wis., Brittingham & Young Co.
- George E. Foster, Mellen, Foster-Latimer Lumber Co.
- J. E. Gillett, Eau Claire, Dells Lumber & Shingle Co.
- H. C. Humphrey, Appleton, G. W. Jones Lumber Co.
- A. H. Ruth, Chicago, G. W. Jones Lumber Co.
- R. T. Doud, Winona, Minn., Doud, Sons & Co.
- A. H. Barnard, Minneapolis, Minn., A. H. Barnard.
- A. R. Owen, Owen, John S. Owen Lumber Co.



## News Miscellany.

### Cape Girardeau Meeting.

The previously announced district meeting of the Hardwood Manufacturers' Association, about the date of which there has been considerable confusion, has been officially set for October 9.

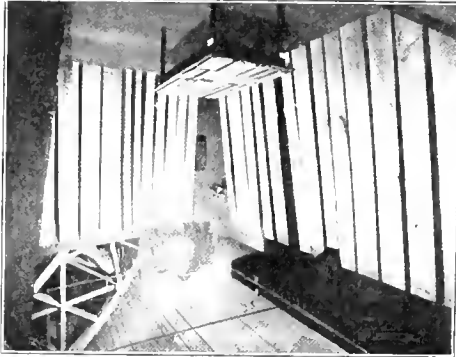

A CORNER OF THE INTERIOR.

The conference will assemble on that date in the rooms of the Commercial Club, Cape Girardeau, Mo., at 2:30 p. m. In view of the fact that there are several questions of more than passing interest to be discussed the attendance will probably be large.

### The "Lumber Yard" at the Cincinnati Fall Festival.

The members of the Lumbermen's Club of Cincinnati are proverbially hospitable to the stranger within the gates of their city. The recent Fall Festival, from August 28 to September 22, an event held almost every year by Cincinnati merchants and manufacturers for the

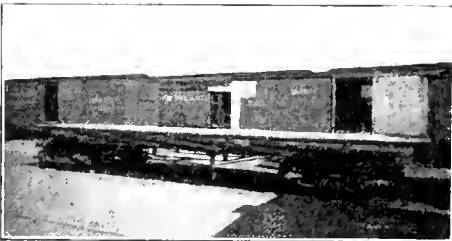

FLAT CAR WITH HARVEY STAKE COLLAPSED.

purpose of bringing out-of-town visitors to the city, they made the occasion of special interest to visiting lumbermen both in a social and business way. Invitations were extended the trade to visit the headquarters of the club during their stay in the city and an attractive little booklet, bound in imitation veneer, was gotten

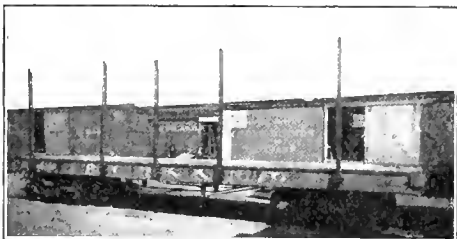

FLAT CAR WITH HARVEY STAKE IN POSITION.

up, containing the names of the members of the club and citing the advantages of Cincinnati as a lumber center.

As an exhibit they erected a "lumber yard" at the festival. It appeared to be simply a row of lumber piles, but, on approaching, entrances were found on both sides leading to a hollow square where were displayed all kinds of woods handled in that market. The exhibition was not only interesting from a layman's

point of view but was of such trade advantage that the technical schools of the city asked for the privilege of giving object lessons from the display and begged the donation of the materials at the end of the festival. The "yard" was a point of great interest to visitors and the progressiveness of the Lumbermen's Club was commented upon not only by lumbermen but by merchants in other lines of business.

### The Hoo-Hoo Annual.

The fifteenth annual meeting of the Order of Hoo-Hoo began at Oklahoma City, Okla., on September 9, with an attendance of nearly a thousand members. The local arrangements for the entertainment of the visitors were perfect, the various games and theatrical representations being especially enjoyable. The officers elected for the coming year were: Snark of the Universe, A. C. Ramsey, St. Louis, Mo.; Senior

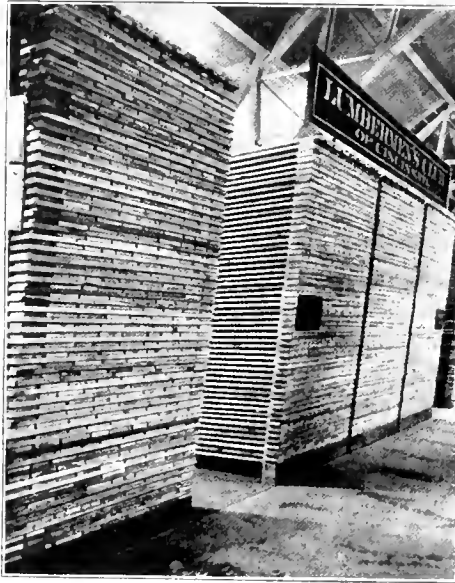

EXTERIOR VIEW LUMBERMEN'S EXHIBIT AT CINCINNATI FALL FESTIVAL.

Hoo-Hoo, T. H. Rogers, Oklahoma City, Okla.; Junior Hoo-Hoo, W. W. Everett, San Francisco, Cal.; Bojum, George M. Duncan, Houston, Tex.; Scrivenoter, J. H. Baird, Nashville, Tenn.; Jabberwock, Charles Wollin, Evansville, Ind.; Custocatian, George E. Youle, Seattle, Wash.; Arcanoper, John L. Alcock, Baltimore, Md.; Gurdon, R. W. Polk, Little Rock, Ark.

Atlantic City was chosen as the next meeting place of the annual.

### Five Hundred Pounds Conceded by Western Roads.

When the Pacific Coast Lumber Manufacturers' Association opened its case against the western railroads before the Interstate Commerce Commission in Chicago, September 19, the railroads asked for time on the ground that they were not yet prepared to bring witnesses to prove their side of the case. While the question was being argued, counsel for the railroads professed their clients' wish to meet the lumbermen fair-mindedly, and it was arranged to postpone the case and appoint a committee from the railroads and one from the lumbermen to meet and devise some means of securing a satisfactory equipment for the cars, as was done in the cases against the eastern and southern roads. The railroads, through their attorneys, also stated that they were willing to allow 500 pounds to be deducted from the total weight of the shipment as the weight of the equipment. This concession was agreed to by all the railroads but the Union Pacific, which had no representation at the meeting. Chairman Knapp of the commission stated, however, that they would take it for granted that the Union Pacific would agree to the concession and adjourned the case to some day to be hereafter fixed.

It was announced on the part of the railroads

that there will probably be a joint conference of all the traffic managers at an early date, when a committee will be appointed to meet the committee of lumbermen.

After the adjournment of the commission the railroad men were taken to view the equipments designed by George Harvey and John Toomey, engineers employed on behalf of the lumbermen. The Toomey stake has been thoroughly tested



ANOTHER INTERIOR VIEW OF THE EXHIBIT.

and has successfully carried four loads. The Harvey stake has not as yet been put to a thorough test. On Sept. 22 a party consisting of L. L. Barth of the Edward Hines Lumber Company of Chicago, John Toomey and George Harvey, engineers, and Walter Ross, counsel for the various lumber associations, representing the lumbermen, and M. K. Barnum, assistant to second vice president of the C., B. & Q.; C. A. Schroyer, superintendent car department, C. & N. W.; J. E. De Voy, mechanical engineer, C. & N. W.; R. H. Ashton, general manager C. & N. W.; C. F. Rice, superintendent train service, C., B. & Q.; D. L. Bush, general superintendent, C. & N. W. & St. P., representing the rail-



GONDOLA CAR WITH HARVEY STAKE COLLAPSED.

roads, went to the Rock Island railroad yards and viewed the Harvey equipment. The general opinion was that the stakes were entirely practicable, and tests will be made in the near future on various railroad lines. In the course of the next few days a committee of one from each of the complainant lumber associations will be ap-



GONDOLA CAR WITH HARVEY STAKE IN POSITION.

pointed to meet the railroad men and both sides will select a sub or working committee of probably four men who will take charge of the actual experimental work to be done.

### New Tenoning Machine.

The single end tenoner shown in the accompanying cut is made by the H. B. Smith Machine Company of Smithville, N. J., and is the result of nearly sixty years' successful experience in

the manufacture and construction of thousands of machines of the same class. It displaces the previous widely copied No. 2 tenoning machine made by this company, and, while retaining all the valuable features of its predecessors, has

metal; those for the tenon-head spindles are six inches long next to the heads and five inches long on the outer ends. The belt compensating tightener of the spindles is also self-adjusting to all positions of the belt. The copes

The special advantages in the line of new construction and improvement are certain to make the present machine as great a favorite with the trade as have been its predecessors.

#### Concerning the Atlas Engine Works.

Perhaps the foremost builder of high-class power plants in the United States is the Atlas Engine Works of Indianapolis. It is said that this company builds the most complete line of engines and boilers made by any one manufacturer in the world.

The Hardwood Record is in receipt of the company's latest bulletin, No. 131, on the Atlas single valve engines, which is now ready for distribution. It will be found a very interesting and instructive document for all users of engines, and can be had from the company on application.

Incidentally, there have been several changes in the executive force of the Atlas Engine Works of late. Death has overtaken E. T. Hannan, the inventor of the Atlas water tube boiler, one of the best known of the company's power plant equipments. Mr. Hannan died on Saturday, Aug. 18, at Chicago, of heart disease, and at the time of his death was assistant manager of sales of the water tube boiler department.

J. P. Johnston, recently sales manager for the Weber Steel Concrete Chimney Company of Chicago, has become sales manager of the water tube boiler department of the Atlas Engine Works, with headquarters at Indianapolis.

The company's Chicago sales offices which, for several years have been located in Suite 900-902 Fischer Building will, upon the completion of the new addition to this structure in November, be increased by the addition of several large offices. Frank H. Baker will continue as the manager of the Chicago office and will be assisted by J. F. Davis, formerly located at the company's Pittsburg office.

Howard E. Troutman, for several years manager of the Chicago office of the Buckeye Engine Company, has become the sales manager of the Corliss and high-speed engine department of the Atlas Engine Works, with headquarters at Indianapolis, and J. M. Broncher of the Brownell Company, Dayton, O., goes to the big Indianapolis concern as assistant general manager of sales.

#### New One-Knife Shavings Grinder.

In the cut below is shown the new one-knife shavings grinder or hog, designed for cutting up shavings from hardwood flooring scrapers. The machine has been put on the market by A. F. Bartlett & Co. of Saginaw, Mich., manufacturers of the well-known sawmill hog or edgings grinder and other sawmill machinery. The machine is attached to the scraper by a hood and connected directly with the blower system. As the shavings pass through the hog, they are cut up in such a manner that they can be easily

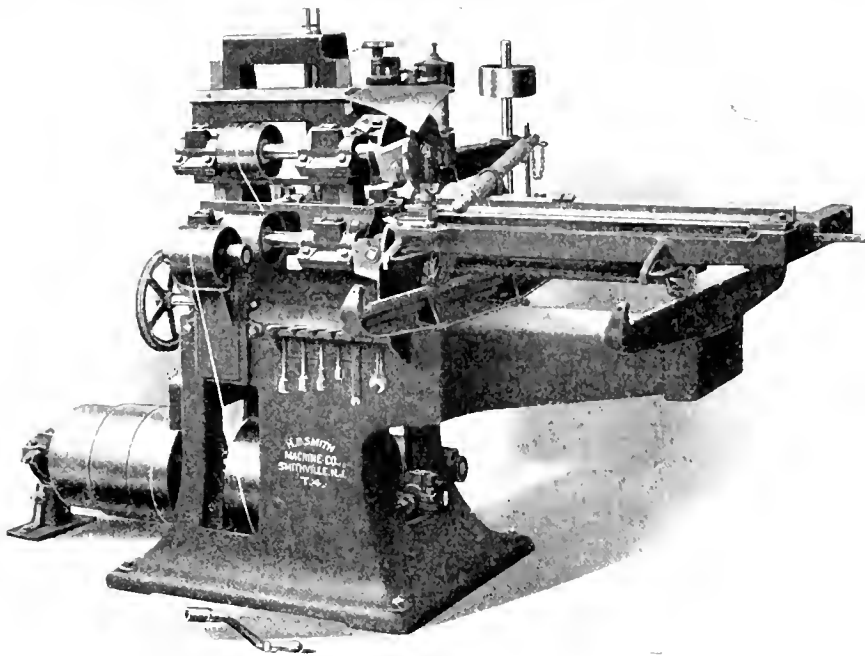

NEW TENONING MACHINE MANUFACTURED BY THE H. B. SMITH MACHINE CO., SMITHVILLE, N. J.

added many hitherto unanticipated improvements. It is especially suited for tenoning sash, door and blind work, for use in the cabinet departments of car shops and for all general cabinet and joinery framing. The frame is of iron, massive and pedestal in form, with base 30x34, wide enough to support all projecting parts. The extension for supporting the table is curved from the operator so as to admit of following the work through the cutters, and a chute is cast within the frame for directing the shavings to the outside.

The table is the chief advantage, being an improvement over any hitherto made, and is the feature which gives superiority to the machine. The principal advance in construction is the application of the roller bearing. The table must always move square across the ways because the rollers are connected together and kept square or parallel by a guiding or riding frame. Therefore, if the rolls move at one end they must also move at the other, and hence the whole carriage must move, no matter where it is taken hold of or how much weight is upon it. A man could sit upon the table and the operator could take hold of the outer end of the gauge bar, and with two fingers move the table in either direction, perfectly square the entire length of the ways. The rolls next to the cutter head are grooved to prevent end motion, and all are protected perfectly from shavings. They are also provided with leather scrapers for removing any accumulating dust. The table is quite heavy, so that it cannot spring when clamping the work on, and has a traverse movement of thirty-three inches, the roller bearing moving only slightly more than one-half that distance. The end of the table or carriage next to the cutters is provided with a covering that extends below and adjusts to a projection on the ways, so that the table cannot lift up when operating. The table is provided with the usual clamp for holding the material and also with a gauge bar of usual dimensions.

The headstocks are substantial and movable up and down by two screws so arranged that they may be moved in either direction, both at one time or separately, thus perfectly controlling the size and position of the tenon. The cutter spindles are all made of high carbon steel, turned and ground accurately to perfect roundness. The bearings are all compensating and self-lubricating and lined with the best Babbitt

are attached to the main headstocks and adjust with them, but they have both vertical and lateral adjustments controlled by suitable screws with hand wheels. The tenon-heads may be used double or single and have 7½-inch cutting circle. When the machine is fitted with double heads it will cut tenons as long as six inches; when fitted with single heads it will cut tenons only as long as 3½ inches. The upper and lower heads expand or separate to take in stock as thick as five inches, and the table movement will admit to cut tenons on stock as wide as 20 inches by 1 inch thick. By passing material through twice tenons may be cut as long as eight inches. The knives are placed on the heads so as to make a smooth drawing cut, and are readily ground to the required shape. A cut-off saw may be applied to the rear. The usual equipment is supplied with this machine, consisting of wrenches, cutter heads and cutters,

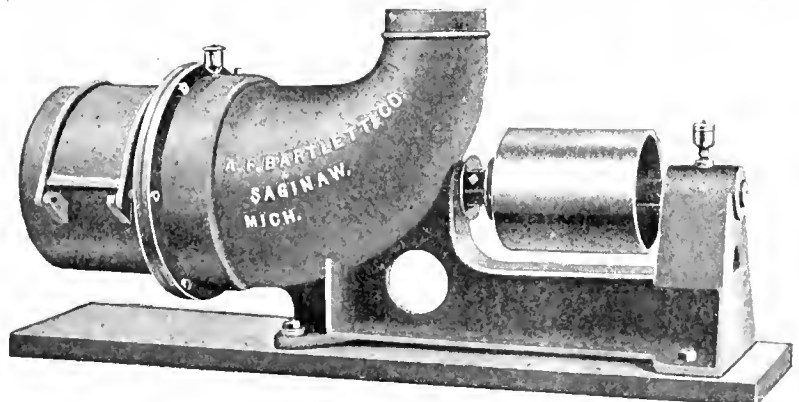

NEW ONE KNIFE SHAVINGS GRINDER, MANUFACTURED BY A. F. BARTLETT & CO., SAGINAW, MICH.

together with a countershaft, with tight and loose pulleys.

The machine shown in the illustration is known as No. 225C. The style is double heads with two copes and the weight 2,000 pounds. The floor space required is 6 feet 8 inches by 5 feet, and the average horsepower is from 2½ to 6

blown to the dust collector or directly to the boilers. The machine is built in one piece, allowing a free delivery to the blower pipe. It has a hinged door on top which allows the operator to get a good view of the working parts and to make any necessary adjustments, and has an outside bearing which makes it a very smooth running machine.



### Death of Aaron T. Bliss.

EX Governor Aaron T. Bliss of Saginaw, Mich., died in a sanitarium at Milwaukee, Wis., Sept. 16. For a long time he was one of the most prominent lumbermen in the state, but for two years prior to his death had not been actively identified with the trade because of poor health. Aaron T. Bliss was born on a farm at Smith



EX GOVERNOR AARON T. BLISS OF SAGINAW MICH., WHO DIED SEPT. 16, 1906.

field, Madison county, N. Y., May 22, 1837. He received the common school education that the district afforded and at the age of seventeen devoted himself to mercantile pursuits, taking a position with a business house at Benkville, N. Y. At the outbreak of the Civil War he enlisted in the Tenth New York Cavalry and served throughout the war with distinction, finally rising to the rank of captain.

After the war he went to Saginaw and identified himself with the lumber business, becoming one of the best known men in the trade. His operations were extensive. Between 1886 and 1900 the timber holdings of the concerns in which he was the chief figure amounted to 150,000,000 feet. Some years ago he acquired 36,000 acres of timber land in Arkansas and founded the Chicot Lumber Company and a saw and planing mill were erected at Blissville, where a lumbering town was started and a logging railroad constructed. When his health began to fail two years ago his interest in the concern was bought out by Bliss & Van Anken, A. P. Bliss of that firm being his nephew, and the company was reorganized, becoming the Bliss Cook Oak Company, now one of the largest operators in Arkansas.

Governor Bliss was a republican and active in politics, being successively state senator, congressman and governor. It was to the overwork incident to the duties of this latter office that the physical breakdown was due that resulted in his death.

Governor Bliss was a benefactor to many worthy charitable enterprises and by the terms of his will, which was made public on Sept. 21, gave bequests aggregating \$50,000 to educational and other institutions.

The funeral occurred on Wednesday, Sept. 19, and was attended by Governor Warner and staff, the Knights Templar and other Masonic bodies of which he was a member, the past commanders of the G. A. R. and men prominent throughout the state.

### The Coe Manufacturing Company.

The year 1906 marks an epoch in the veneer business. The organization of the trade into a

harmonious and aggressive association has done much toward the advancement of the industry.

The large number of mills recently started has severely taxed the capacity of the Coe Manufacturing Company of Painesville, O., one of the largest manufacturers of this class of machinery in the world. Only by adding several large buildings to its plant and running twenty-four hours a day has it been possible to keep abreast of orders.

The company recently furnished complete outfits for the Asheville Veneer Company, Biltmore, N. C., and the Pittsburg & Southern Veneer Company of Narrows, Va., two concerns recently organized which bid fair to become among the foremost in the country. Money has been spent freely by both companies on machinery and buildings, and they are in position to turn out orders in first-class shape. The entire machinery outfit for the new mill of the Virginia Veneer Company at Keezletown, Va., was also supplied by the company, as well as countless orders for single machines all over the country.

Evidence of the widespread popularity of Coe veneer machinery is shown in the order just received for a veneer saw to be shipped to the Kinshin Railway Company at Moji, Japan. Without doubt this is the first veneer saw ever ordered for shipment to Japan.

The Coe Manufacturing Company has been gradually building up a foreign trade until its machinery is now well known in many parts of the world.

Among the recent export shipments are two veneer lathes to Paris; box board machine and veneer clipper to Reval, Russia; veneer lathe to Moscow; 100-inch veneer lathe, clipper and grinder to London, England; veneer clipper to Cologne, Germany, and a complete outfit of veneer machinery to the Island of Ceylon.

The new catalog issued by the Coe Manufacturing Company, Painesville, O., is interesting and instructive reading and may be had upon request.

### The Robert W. Higbie Company.

The Robert W. Higbie Company, incorporated by Robert W. Higbie and others of New York City some months ago to develop a tract of 32,000 acres of timber lands in St. Lawrence county, in the Adirondack region, has begun sawing lumber. It is not expected, however, that deliveries of dry stock can be made before early spring. The tract is covered with a heavy growth of virgin hardwoods and hemlock and a modern mill, 48x120 feet, fitted with a band saw equipment, has just been completed. The power house is detached from the main building, is of brick and equipped with three boilers aggregating 250 horsepower and one engine of about 200 horsepower. The company is now at work on the construction of ten miles of new railroad to tap this timber, and a modern planing mill is to be built at once, equipped with a full complement of flooring machines, as the company proposes to turn out a line of maple, beech and birch lumber, a portion of which will be worked up into flooring. A post-office has been established near the operation which has been officially designated "New Bridge," St. Lawrence county, New York.

The officers of the company are: Robert W. Higbie, president and treasurer, and J. E. Bickers, secretary. The output of the mill will be handled entirely through the office of Robert W. Higbie, 45 Broadway, New York City.

### Marriage of James Cooper.

The *Hardwood Record* takes pleasure in acknowledging the announcement of the marriage of Miss Laura Catherine Myers of McVeytown, Pa., and James Cooper of Saginaw, Mich. The ceremony took place at the home of the bride's parents and was performed by Rev. J. Allen Myers of Juniata College, a cousin of the

bride. Mrs. Cooper is well known in Philadelphia and the East as a Christian Settlement worker. She is a graduate of the Moody Bible Training School and has been prominent in settlement work in Hartford, Conn., and New York, and while deaconess of a Presbyterian church in Saginaw became acquainted with Mr. Cooper.

The groom is one of the best known lumbermen in Michigan, being president and general manager of the Briggs & Cooper Company, Limited, with general offices in Saginaw and branch yards and offices in Chicago and Memphis. He is very prominent in association work, having been twice president of the Saginaw Valley Lumber Dealers' Association, and is a member of both the National Wholesale Lumber Dealers' Association and of the National Hardwood Lumber Association.

The *Hardwood Record* extends its heartiest congratulations to Mr. Cooper and his bride and wishes them a most happy future.

### Death of Ferdinand C. Fischer.

Ferdinand C. Fischer, president of the Yellow Poplar Lumber Company of Coal Grove, O., who died September 10 at Baltimore, was one of the most widely known and influential men in the hardwood industry of the country and an important factor in lumber association work.

He was a thorough lumberman. He had not only the minute grasp of affairs that made it easy for him to keep informed on all the details of his various enterprises, but he had the wider comprehension and foresight that made him invaluable as a leader and organizer when projects of great importance were under consideration.

His entire life was given to the lumber business from the time he left the University of West Virginia in 1876 and took a position as bookkeeper for the firm of Lay & Moore, lumber dealers in Oil City, Pa., until he attracted the attention of the trade by his masterly handling of the problems that grew out of the financial difficulties of M. T. Greene of the Chicago Lumber Company some years later. At the time of the Greene failure, the First National bank of



THE LATE FERDINAND C. FISCHER, PRESIDENT YELLOW POPLAR LUMBER CO., COAL GROVE, O.

Chicago, as trustee, took over the Yellow Poplar Lumber Company of Coal Grove, O. The affairs of the company were in a deplorable condition, law suits and entanglements of various kinds threatened its disruption. Mr. Fischer, as manager and treasurer, took up the task of

straightening out conditions, and in a remarkably short time succeeded in putting the affairs of the concern on a sound basis.

After the indebtedness to the bank had been cancelled, Mr. Fischer took over the company himself, becoming president and chief stockholder, and under his leadership the concern attained the reputation of being one of the strongest lumber companies in the country. He enlarged and extended its business and made it one of the most successful manufacturing concerns in the United States.

Mr. Fischer was prominent in the formation of the Hardwood Manufacturers' Association of the United States, and at the time of his death was treasurer of that organization. The funeral took place on September 11 from the home of his brother-in-law, L. N. Davis, at Ashland, Ky., and was attended by prominent citizens of Ashland and Ironton and by many well-known lumbermen.

#### Miscellaneous Notes.

The Great Lakes Veneer Company has been incorporated, with \$100,000 capital stock, to manufacture veneers at Munising, Mich.

A new concern at Lyons, Mich., is the Herriek Casket Company; capital \$10,000.

The three-story brick factory building at 510 518 West Twenty-fourth street, New York City, occupied by the piano wood manufactory of Joseph W. Courtard, was badly damaged by fire recently. Mr. Courtard's loss on machinery and lumber will approximate \$5,000.

The Consumers' Lumber & Veneer Company of Apopka, Fla., by the recent installation of new machinery has doubled its daily capacity of lumber and crate material. Additional timber supplies have been secured by the purchase of a large tract of land in the vicinity of Bay Ridge, and the company has a force of men

now at work constructing a road from Bay Ridge to Apopka, a distance of ten miles.

D. S. Hood of Crowson, Okla., has taken the contract sublet to him by C. H. Drinker of Beggs, to cut 100,000 feet of oak lumber for export to England. The work is to be rushed to completion and the lumber stacked for ninety days before shipment.

Fire in the factory of the Athens Veneered Door Company of Athens, O., damaged building, lumber and machinery valued at between \$12,000 and \$15,000. The loss is said to be well covered by insurance, and it is likely that the company will rebuild very soon. The buildings were erected only last spring, when they were completely equipped with new machinery, the heaviest loss in this fire being on the machinery. The origin of the fire is unknown.

The firm of Mohr & Ziemer of Wausau, Wis., which recently moved into more commodious quarters, will continue its old line, manufacturing fine wood finishings and cabinets on a more extensive scale and branching out on new lines.

R. F. Pool of Cameron, Tex., is building a hardwood sawmill on the Jones farm, about six miles from Marlin. Timber rights on a large tract of land, rich in elm, ash, cotton wood and other hardwoods, have been secured. Machinery is now being delivered at the plant and the manufacture of boxes and crates for fruit and vegetable shippers will begin shortly.

D. M. Hartman of San Diego, Cal., who recently retired from the general contracting business, has decided to enter the lumber trade and will handle hardwoods exclusively. He has already made several big sales. He lately bought two lots in San Diego on which he has erected a warehouse for storing hardwood flooring and veneered doors.

## Hardwood News.

(By HARDWOOD RECORD Special Correspondents.)

### Chicago.

Leopold Mayer-Dinkel, son of Gustav Mayer-Dinkel of the firm of Mayer-Dinkel & Dreyfus, Mannheim, Germany, was a recent caller at the office of the HARDWOOD RECORD. The firm of which the young man is a representative is well known as an importer of American woods, and it is to obtain accurate information regarding the hardwoods and yellow pine of the United States that Mr. Mayer-Dinkel is now making a visit to this country. The firm is contemplating going into the business of handling hardwoods, principally plain oak and gum, on an extensive scale and if the results of Mr. Mayer-Dinkel's investigations are satisfactory it is probable that his company will establish an agency in this country to facilitate the handling of these woods.

J. V. Stimson of Huntington, Ind., while in Chicago last week paid the RECORD office a very welcome call. Mr. Stimson expresses entire satisfaction concerning the 1906 lumber operations, both past and prospective.

An unique card is being distributed among the trade by the Nashville Hardwood Flooring Company, Nashville, Tenn., in the form of a polished metal sign for hanging. The color decoration is a rich green which sets out in strong relief the "Acorn Brand" trade mark and other wording. The company is to be congratulated upon the production of this choice bit of advertising.

The death was announced last week from Germany of Peter Schuttler, president of the Peter Schuttler Wagon Company of Chicago, well known as one of the important figures in the vehicle manufacturing world. The company of which Mr. Schuttler was president was founded by his father in 1843, and gradually grew to mammoth proportions. After the death of his father Peter Schuttler continued the business along the same lines and in 1903 greatly extended the activities of the firm, building a factory at Twenty-second and Rockwell streets, which is said to be the largest wagon works in the United States. The body will be brought to this country and the funeral will take place in Chicago from the late residence of the deceased at 66 Lake Shore Drive.

The well known hardwood lumber manufacturer, Samuel Burkholder of Crawfordsville, Ind., found opportunity to call at the RECORD office while on a hasty business trip through Chicago. While Mr. Burkholder reports business as very good, he is to be congratulated upon his ability to retain the same patronage year after year regardless of high or low prices. Mr. Burkholder knows his trade thoroughly and therein lies the secret of his success.

The G. W. Jones Lumber Company has had an exceptionally good season, the average of the year's business to date surpassing that of last year. The mills at Nettleton and Forrest City, Ark., are running full time and the cut is all that could be desired.

James C. Cowen of Schultz Bros. & Cowen is spending some time in Mississippi looking after some matters that need his attention. Trade with the firm has been excellent and shipments good. Prospects for a future fall trade indicate that the amount of business done this year will surpass that of last season.

Lewis Doser returned from the East recently, where he had been visiting his mother. On his way home he stopped in Kentucky on the occasion of the death of Ferdinand C. Fischer, president of the Yellow Poplar Lumber Company of Coalgrove, O.

The car equipment suit brought to Chicago many well known lumbermen, among them Lewis Hill, Baltimore, Md.; R. H. Downman, New Orleans; Samuel R. Ely, New Orleans; William MacKenzie, Beaumont, Tex.; C. I. Millard, St. Louis; Edgar Dalzell, Minneapolis, Minn.; E. F. Perry, New York; M. S. Tomaine, Buffalo, N. Y.; Willard L. Church, Kansas City, Mo.; W. W. Knight, Indianapolis, Ind.

### Boston.

Owing to the death of Mrs. Harry Wiggin's mother, the office of Lawrence & Wiggin, hardwood dealers, was closed Friday, September 14.

Warren C. B. Robbins, manager of the Suncook Valley Lumber Company and secretary of the Massachusetts Lumber Dealers' Association, has returned from a vacation spent in the Prov-  
inces.

Appleton P. Williams of Upton, Mass., is a candidate for the Republican nomination for state senator. Mr. Williams is well known in the lumber industry, being treasurer of the Upton Manufacturing Company. The plant of this woodworking company is one of the best in the east.

Frank William Rame has been proposed as the successor to Alfred Ackerman as state forester of Massachusetts. Mr. Rame is well fitted for the position. He is an honorary member of the New Hampshire Lumbermen's Association. Ralph C. Hawley, who has been assistant state forester under Mr. Ackerman, has resigned to accept a position in the Yale faculty in the department of forestry.

Wholesale lumber dealers are complaining of slow shipments from the hardwood centers of the country, due to a shortage of cars. Several shippers write in response to calls for more prompt delivery that it is impossible to get cars enough from the railroads. One road is reported as being in receipt of a demand for about 400 cars a day at one point and cannot supply half the number.

Charles S. Wentworth of Charles S. Wentworth & Co., one of the most popular hardwood dealers in this city, is taking his first real vacation in seven years. He is making a trip through in White Mountains with his wife.

J. C. Walton of J. R. Walton & Co., Anderson, Ind., manufacturers of hardwood lumber, has been visiting the eastern trade.

Gardiner L. Jones of the Jones Hardwood Company of this city has been on a business trip to New York.

William E. Litchfield, who has recently acquired large hardwood timber lands in Virginia, returned about ten days ago from a trip to his property.

A. M. Moore, with William E. Litchfield of this city, recently spent a week visiting Washington and New York. He also spent a short time in Philadelphia.

Walter G. Jenness has started in the wholesale lumber business and is at present making his headquarters in Somerville. For several years he was in the employ of Edwin H. Buzzell.

The Northeastern Lumber Company of this city has moved to larger quarters at 88 Broad street. It was formerly located in the Old South building.

The woodworking plant and machinery of L. A. Hayden, South Carver, Mass., has been purchased by Harrison Shurtleff of Middleboro, Mass.

The Nashua Lumber Company of Nashua, N. H., has purchased a large tract of timber in the vicinity of Milford, N. H.

The Perham Lumber Company has been organized at Portland, Me., with a capital stock of \$20,000.

The woodworking plant of A. C. Leonard & Co., Providence, R. I., has been destroyed by fire, causing a loss of about \$20,000.

### New York.

R. W. Higgin, the hardwood manufacturer of 45 Broadway, is just back from a lengthy stay at his new hardwood operation at Newton Falls, in the Adirondacks, and states that the plant has started up, cutting about 10,000 feet of birch, beech, maple and hemlock per day from the 30,000 acres of fine timber land back of it. The ten miles of railroad which have been under course of construction will be completed about October 1, assuring the plant a steady and permanent supply of logs. It is also his intention to install a flooring plant and dry kiln in a short time. The product of this mill will be distributed through Mr. Higgin's local office.

C. W. Manning of 66 Broad street has just returned from a lengthy vacation in Maine and is planning a business trip into the southern hardwood belt next month.

The annual meeting of the New York Lumber Trade Association will occur at the association rooms, 18 Broadway, on October 10. This is the twentieth anniversary of the organization of the association and a large and representative attendance is expected. The business session will be preceded by a Delmonico lunch, and the reports to be rendered will cover one of the most active and successful years in the history of the association.

Secretary E. M. Terry of the National Lumber Exporters' Association left here September 14 after a lengthy stay in this vicinity, combining vacation and business. Just before leaving he attended a hearing of the Interstate Commerce Commission on export cotton and lumber rates under the new law, and expressed himself as very well satisfied with the prospects of benefit to the export trade under the new railroad law.

There was much rejoicing among local Hoo-Hoo last week when it became known that the recent annual convention at Oklahoma City had chosen Atlantic City, N. J., for the Hoo-Hoo annual in 1907, with the eastern members of the order as a collective host. Steps will be taken immediately to organize a general reception committee from Boston, Philadelphia, Norfolk, etc., to give the members a right royal welcome next year.

E. A. Philig, nephew of Louis Rossert, the well-known Brooklyn retailer, has joined the selling staff of the Holcomb & Caskey Lumber Company, wholesalers, 12 Broadway, Manhattan.

H. C. Kane, who is prominently associated with the wholesale house of Dixon & Dewey, Flatiron building, was united in marriage on September 5 at Elizabethton, Tenn., to Miss Hattie Clark, daughter of Mr. and Mrs. M. E. Clark. Mr. and Mrs. Kane have returned to this city, which they will make their future home.

F. P. McNulty, formerly with Price & Hart, 18 Broadway, has joined the selling staff of the Stevens-Eaton Company, 1 Madison avenue, where he will assist T. S. Miller, manager of the hardwood department, in the selling end.

There has been an organized plan of lumber theft going on in the West Side which has just been brought to light with the arrest of three drivers in the employ of the S. E. Kellar Lumber Company, and one Hess. It seems that the drivers in making deliveries would drop a few pieces off of each load and on the way back would pick them up and deliver them to a yard kept by Hess, where they would be paid for it. Late information seems to indicate that the Kellar Lumber Company was not the only sufferer and that it has been a regular organized plan to mulct a number of dealers.

W. R. Eddy of the firm of Eddy Bros., Stapleton, S. I., died at his residence in that place September 15.

R. H. Downman, prominent cypress manufacturer of New Orleans, La., passed through the city last week on his way home after an outing with his family at Loon Lake, N. Y.

John F. Cronin, eastern representative of the Yellow Poplar Lumber Company, Coal Grove, O., has been spending several days in town during the fortnight on business.

L. G. Jones, the veneer wholesaler of Avenue D and Tenth street, Manhattan, has just returned from a lengthy trip abroad.

During his recent visit here, Secretary Lewis Doster of the Hardwood Manufacturers' Association of the United States, spent considerable time in consultation with J. V. Hill, chief inspector of the association, during which plans were gone over looking to an expansion of the eastern inspection work of the organization.

W. W. Lockwood, head of the Rice & Lockwood Lumber Company, 11 Broadway, announces the appointment of a sales representative for Boston and vicinity. J. L. Barney has been appointed to that position.

Dixon & Dewey, Flatiron building, are enjoying a good volume of trade both in hardwoods and their Pacific coast product. They report a very fair movement of all kinds of stock at firm prices.

William Wilms, president of the Hardwood Manufacturers' Association of the United States and principal in the extensive hardwood interests of the Paepcke-Leicht Lumber Company, Chicago, is here this week to meet his brother from abroad, whom he has not seen for sixteen years. Mr. Wilms spoke most favorably of hardwood trade and conditions.

A petition in bankruptcy has been filed against Lynn P. Hollowell, dealer in lumber and veneers at 540 First avenue, by the Astoria Veneer Mills, a creditor to the extent of \$1,106. It was alleged that he is insolvent and on August 27 transferred all his stock, valued at \$10,000, to the Indiana Lumber & Veneer Company, a credi-

tor, to prefer it. Mr. Hollowell was formerly vice president of the Indiana Lumber & Veneer Company of Indianapolis, became manager of the New York branch in 1901, and has been in business on his own account for about a year.

### Philadelphia.

H. I. Soble lately returned from a trip to the South where he spent some time inspecting the progress being made at the new plant of the Oketa Planing Mill Company at Honaker, Va. The operation is expected to be in working order in a short time.

The Righter-Parry Lumber Company experienced one of its best months during August. Conditions have been such that the firm is contemplating an extension of its business, and during the next month or so will probably make arrangements at shipping points that will enable it to offer considerably more stock to the trade.

A committee consisting of President George F. Craig, Emil Guenther, Edward F. Henson, W. L. Rice and Robert C. Lippincott was appointed at the last meeting of the Lumbermen's Exchange of Philadelphia to confer with the commissioners of the president of the United States during their visit to Philadelphia, the latter part of September, on the advisability of the proposed routes for the canal between the Delaware and Chesapeake bays. The committee was also authorized to expend such sums as it thought proper for the entertainment of the commissioners during their stay in the city. At the first annual fall meeting of the exchange Emil Guenther, who had just returned from a seven months' trip to Europe and the Holy Land, presented the exchange with a gavel made from the wood of an olive tree from Jerusalem. The gift was accepted and the thanks of the body rendered Mr. Guenther by President Craig.

The end of the summer season sees many of the well-known lumbermen returned from their vacations. George F. Craig is back from a two months' stay at his mills at Winterburn; W. M. McCormick is back to his office again after a vacation spent in Maine; George W. Kugler has returned from a four weeks' trip to Newfoundland.

Henry Whelpton of the Owen M. Bruner Company is making an extensive trip through Canada and northeastern points. During his stay there he will buy considerable timber. The company will also make arrangements in a short time to supplement its hardwood stocks and place itself in position to supply the needs of its growing trade.

The Coppock-Warner Lumber Company has removed its office to 1018 Land Title building. The business of the company during August surpassed expectations and the volume done during the first part of September, if continued throughout the month, will make it the banner month in the history of the company.

F. S. Underhill of Wistar, Underhill & Co. reports that the business of the firm during the summer was all that could be desired. The company notes a decided quickening in trade during the last few weeks and have no doubt but that the fall season will be fully equal to the trade experienced here in other years. Mr. Underhill lately took an end of the summer vacation at Ocean City, where he created consternation among the finny tribes by his determined and successful assault on them.

Mr. Lukenbach of Frank C. Gillingham & Son Company left a week ago for a five weeks' trip to Maine. S. B. Vrooman returned ten days ago from a two months' trip to Europe, where he went in the interests of his firm. While abroad he looked up foreign woods. Among the visitors to the trade during the last two weeks have been: J. Edward Libbey of Georgetown, Washington, D. C.; Jerome Moltz of Williamsport, Pa., and Ralph Bush of Royersford, Pa.

The Philadelphia Veneer & Lumber Company had an exceptionally good month during August. Francis Goodhue, Jr., secretary and treasurer of the company, took an extended trip through the New England states some weeks ago and in discussing conditions there stated that he found all the trade very busy. The Philadelphia Veneer & Lumber Company does a big business with the furniture factories of the East, and Mr. Goodhue is making arrangements to extend the business considerably during the coming year.

### Baltimore.

The Oakland Planing Mill, at Oakland, Garrett county, Maryland, was destroyed by fire September 14, together with all machinery and a quantity of lumber in the yard. The loss is estimated at \$3,000, fully covered by insurance. The destruction of the plant will interfere materially with building operations at Oakland, as the mill supplied much of the material, being owned by a number of prominent residents of the town.

E. B. Beckley of the Crosby-Beckley Company, New Haven, Conn., was here recently and paid his respects to various hardwood firms. He was on a trip down the coast and also visited a number of cities in the interior.

The controversy between D. W. & G. H. Thomas, contractors for the erection of the Eastern High School, and Building Inspector Preston over the quality of the maple flooring put into the building, which for a time gave every promise of having to be fought out in the courts, has been satisfactorily adjusted by reference to the board of awards, which gave out the contract.

John L. Alcock and George E. Waters, the latter vicegerent snark for Maryland, the two representatives of Baltimore Hoo-Hoo who attended the concatenation in Oklahoma, have returned and express themselves as delighted with the reception accorded them out West. While they regret the fact that Baltimore did not get the concatenation next year, they feel comforted by the reflection that Atlantic City, being only a few hours' run from Baltimore, will offer an opportunity for nearly every member of the order here to attend.

W. D. Young of W. D. Young & Co., Bay City, Mich., one of the largest maple flooring firms in the country, was in the city during the past fortnight, being on an extended trip East, and called on various firms here. He spoke most encouragingly of the business outlook and expressed the belief that values will remain strong with a brisk demand.

### Pittsburg.

The American Lumber & Manufacturing Company has filed a petition in bankruptcy against the Knickerbocker Contracting Company of Philadelphia in the United States courts, which is the sequel to the failure of the Real Estate Trust Company of Philadelphia and the suicide of President Dipple. Adolph C. Segal, the promoter, is treasurer of the Knickerbocker Contracting Company. This company, through Segal, it is said, sold the Real Estate Trust Company of Philadelphia \$500,000 worth of mortgages on property in South Altoona, Pa., where another of Segal's enterprises was developed. The American Lumber & Manufacturing Company claims the Knickerbocker company is insolvent and wants it declared a bankrupt. C. H. Hamor of Altoona and other eastern people joined in the petition. The total claims are said to be large, but those filed by the American and its allies amount to only \$10,000.

The Hart Planing Mill Company of Pittsburg has applied for a Pennsylvania charter. Its incorporators are: A. B. Manberz, H. J. Bort, J. A. Meyers, William Weitzel and A. C. Defebaugh. The company will manufacture hardwoods to a considerable extent.

The C. P. Caughey Lumber Company has been one of the busiest hardwood firms in the city all summer. Its contracts for oak and beech to be used in the four new dams being constructed on the Ohio and the Monongahela rivers near Pittsburg have taken all the oak it could get out of its plant in Washington county, Pennsylvania, on the Panhandle. Last week it bought an additional 100,000 feet of oak in this county and will cut it off at once.

The A. M. Turner Lumber Company looks for a good fall in lumber dealing. Its inquiry is keeping its office force busy, and all lines of hardwood lumber seem to be in good call on its books. The company's operations in the South are progressing finely and from present prospects, with the improved machinery that has been installed, a record breaking cut will be made this fall and winter.

Dry stocks are low is the report that comes from the Flint, Erving & Stoner Company. This concern's cut of spruce and hardwoods at its West Virginia plants, and especially at its new plant at Dunlevie, will be much the largest in its history.

The L. L. Sattler Lumber Company, which recently bought 9,000 acres of timber land at Blackstone, Va., put out 1,200,000 feet of lumber in August and expects to make a larger showing from this time forward. Mr. Sattler has been at Blackstone much of the summer, but operations there are now being watched by J. S. McNaugher while Mr. Sattler is at the home office. Seven mills are now in operation, including three planing mills at Blackstone, Crew and Dunwiddie, where the product is centered. The mills at Blackstone are shortly to be greatly improved and new machinery will be installed in two of the other plants. The company's operations in this territory are under the personal supervision of Benham Morris, who was formerly secretary of the Blackstone Lumber Company, and who is regarded as one of the most thoroughly posted men on timber and lumber operations in the country.

The Linehan Lumber Company is booking some fine orders for oak and poplar. Hardwood values in general are better than last fall. The company reports a special scarcity of hickory, every car of which is taken before it is loaded by wholesalers at the mills. The firm's call for maple flooring is also indicative of a very healthy tone in the hardwood market.

The James I. M. Wilson Co. have secured the order for all the hard maple flooring to be used in the skyscraper of the Union National bank, now going up at Fourth avenue and Wood street. The building is twenty stories high, and the order calls for about 125,000 feet of lumber.

The Cheat River Lumber Company, to replenish its timber supplies, is now figuring on buying a large amount of land adjoining its operation at Burkeville, Va.

The American Lumber & Manufacturing Company, through its sales manager, J. N. Wollett, booked an order last week for 750,000 feet of car sills for eastern delivery. Its sales of oak car stuff are larger this fall than last, and during the last three weeks Mr. Wollett has booked orders for over 1,000,000 feet of oak, mostly square stuff.

The hub factories of northern Ohio are getting active again. There is an unusually large inquiry this fall from the manufacturers for hubs. Concerns in Michigan and Indiana are ordering from 30 to 50 per cent more stock than in former years. The supply of good hub timber on the Western Reserve of Ohio is getting well nigh exhausted, but the few tracts that are left are being cut down rapidly. One of the most active men in this line is S. C. Reid, of Warren, Trumbull county, Ohio, whose big mill on the main line of the Erie railroad is a target for shippers for forty miles in all directions, and is now filling up with a fine lot of second-growth elm.

The Stoval Lumber Company, with a capital of \$50,000, has been formed at Connellsville, Pa., by the following officers. President, H. M. Kerr; vice president, James W. Buttermore; secretary and treasurer, J. R. Davidson, all of Connellsville. The manager is N. M. Cupp of Addison, Pa. The company has taken over 50,000,000 feet of oak and yellow pine timber in Granville county, North Carolina, and proposes to push the development of the operations there with all speed.

### Buffalo.

I. N. Stewart has been looking over the ground with regard to attendance at the Cincinnati meeting of the National Hardwood Lumber Association and finds that a large delegation will go, including himself. H. A. Stewart is in West Virginia completing some oak and chestnut deals.

A. Miller agrees that there is considerable oak in yard here, but it will all be needed. He finds the demand for all hardwoods good and is getting a large stock in to make good his sales.

A return to the lake trade, but mostly as handlers of ash and birch, makes T. Sullivan & Co. very active on the docks this fall. These woods are among the best sellers in hardwood and one is lucky to get a supply, especially of ash.

The Buffalo Hardwood Lumber Company has been making all haste to get in a stock of oak and now feel that the right thing has been done when the report comes in from the Southwest that business is held up by car shortage.

The yard of O. E. Yeager has been very busy

of late, especially in shipping out stock, though receipts have been good, both by lake and rail, so that the yard assortment is as good as ever.

Angus McLean is back from his jaunt to the Pacific coast. He did not go for business, but naturally saw lumber when it was in sight and noted the fact that the mills on that coast ship lumber close to the saw.

J. N. Scatcherd is now able to get about after the automobile accident that injured him so severely some time ago. It will be some time before he will be able to look after business regularly.

Beyer, Knox & Co. are still able to report a full yard on account of their good southern and Pennsylvania connections. They will be ready for more lines on that country when these are off.

The sympathy of all goes out to A. W. Kreinleder of the Standard Hardwood Lumber Company, continued sickness in his family this season having culminated in the death of a little daughter, the result of whooping cough.

F. W. Vetter is bringing lumber in by lake, mostly birch and ash. He is expecting to take a trip to North Carolina to look after the lumber cutting there for the Empire Lumber Company.

### Saginaw Valley.

E. E. Koch of Sandusky, O., who is engaged in the wholesale trade, was in the valley Saturday on his way home, having been up in the northern part of the state buying lumber. He complained of the lethargy which to some extent characterizes the trade and said he bought some maple firsts and seconds at a marked reduction compared with last year's quotations. He said there was more inquiry for birch, but nothing tempting in the way of prices to prices to the seller. There are manufacturers who sold their output for the year months ago who are not affected or particularly interested in this, as are the dealers who are endeavoring to turn their stocks over.

John J. Flood's mill at Bay City, which has been idle six weeks, is about to start up on a hardwood contract for Salling, Hanson & Co. of Grayling.

The S. G. M. Gates mill at Bay City has been sawing hardwood steadily through the season. The logs are brought down on the railroad.

Bliss & Van Auken are having a successful run at their Saginaw mill and their flooring factory is busily employed. They have also added a flooring mill at the plant at Blissville, Ark., where they will manufacture oak flooring.

The H. M. Lund's Sons Company of An Sable last week shipped a cargo of maple lumber to Tonawanda. This concern has cut out a number of million feet of maple building material this season for eastern concerns. The lumbering operations tributary to the An Sable plant, the building of a new railroad and the preparation of a stock of logs for the mill recently bought at Rogers City, will give the concern about all the business it will be able to handle during the winter and spring.

It has been excessively dry and warm for many weeks and fires in the forests have done considerable damage. C. F. Bach had a camp destroyed near Sebawaing and eighteen hundred acres of hardwood timber swept away by fire Friday, involving a loss of several thousand dollars. Many small timber owners have suffered material loss.

Peters & Son of Saginaw are moving their small sawmill from Bridgeport to Smith's Siding, near Gladwin. They have let a contract for cutting and hauling timber to the mill and it will be in operation in a few weeks. It has a long cut ahead.

At Alpena extensive repairs are being made to the Bradford flooring and planing mill and in the meantime the Gilchrist flooring factory, which obtained its power from the Bradford plant, is idle.

Miss Laura Catherine Myers of McVeytown, Pa., and James Cooper were married at the home of the bride last Saturday. The bride is well known in Philadelphia and Wilmington as a Christian settlement worker and is a graduate of the Moody Bible Training School. While deaconess of the Presbyterian church in Saginaw she met Mr. Cooper. The latter is president of the Briggs & Cooper Company, Ltd., of Saginaw, one of the most extensive hardwood lumber concerns in the West, and operating a

yard also at Memphis. They will reside at Saginaw and will be at home after Dec. 1.

The car famine is becoming acute and affects the lumber shippers quite seriously already, and there is every reason to expect that it will handicap business for months. Great difficulty is being experienced in getting cars to load and even after they are loaded and sent east it is almost impossible to get the empty cars back, the tendency being to take them on west.

Mershon, Schmette, Parker & Co. are operating a box factory in connection with their planing mill at Bay City and manufacturing box shooks from beech culls, having a contract with the Kneeland, Buell & Bigelow Company for the raw material.

### Grand Rapids.

A number of prominent table manufacturers of Michigan met in this city Sept. 19 for a conference with G. M. Petrie of the St. Johns Table Company, Cadillac, president of the National Association of Table Manufacturers. Trade conditions were reported excellent in the state, and in some cases the factories have about all the orders they can take care of until the opening of the spring season in January.

The town of Buckley, formerly known as New Wexford, though only fifteen months old, has two sawmills, a factory, salting station and several stores in different lines. At present six business buildings are in course of construction, brick and cement blocks being used. The town has sprung up through the enterprise of the Thomas MacBride Lumber Company of this city, whose mills are located there.

The new factory buildings erected at Muskegon by the Chamber of Commerce of that city for the Brunswick-Balke-Collender Company have been turned over to the Chicago concern and the machinery is being installed. Close to \$60,000 was paid by the city of Muskegon to secure the big woodworking concern.

A dispatch from Iron Mountain says: "The hardwood forests of the Menominee iron range are being drawn on to supply the fuel markets of Chicago and Milwaukee and during the past two years one firm alone, operating in the Granite Bluff and Sagola districts, has filled contracts for 25,000 cords of maple wood. The Cleveland-Cliffs Iron Company maintains three camps the year round to supply cord wood for its blast furnaces at Marquette and Gladstone, these plants requiring about 650 cords a day, 216,000 per year, or the cutting over of about 7,000 acres. Although the scars left annually in the forests are growing larger, there is hardwood enough in sight to last for some decades to come."

The Lumbermen's Association of Grand Rapids will hold its regular monthly meeting Tuesday evening, Sept. 25, at the Lakeside Club. It is planned to have the ladies in attendance at this gathering.

George S. Wilkinson of the Van Keulen & Wilkinson Lumber Company returned Sept. 22 from an extended business trip through northern Michigan and Wisconsin.

### Indianapolis.

W. W. Knight, secretary of the Long Knight Lumber Company of Indianapolis, has returned from a trip to Memphis, Tenn., and other southern points which he visited in the interest of his company.

The Newcastle Casket Company of Newcastle has just been formed with a capital stock of \$50,000 to manufacture caskets. Harry Borris of Newcastle and W. D. Williams and Arthur Kennedy of Richmond are the stockholders. The new company will give employment to 100 men.

The Cardwell Lumber Company of Decatur has been incorporated with a capital stock of \$10,000 with the following directors: Rufus K. Allison, John W. Vail, Joseph E. Thomas, Aaron T. Vail, Charles S. Niblack, French Quinn and Don L. Quinn.

The Island saw and planing mill plant at Jasper, Ind., was burned on the night of Sept. 19 and several thousand feet of lumber consumed. Much of it was valuable finishing lumber waiting to be planed. The total loss is estimated at \$3,000. Hamilton Glezen and Walter Cooper operated the plant.

A called meeting of the National Veneer Manufacturers' Association was held at the Grand Hotel in Indianapolis September 29. The meet-

ing was held simply for the discussion of the conditions of trade. It was announced by one of the members that the meeting had nothing to do with the fixing of prices. The officers are as follows: President, O. M. Pruitt, Indianapolis; vice president, C. H. Barnaby, Greencastle, Ind.; secretary, H. B. Millikan, Indianapolis; and treasurer, C. C. Boyd, Cincinnati.

The Montgomery Hardwood Lumber Company of Crawfordsville has filed articles of incorporation with a capital stock of \$15,000. The directors are Thomas Hill, Edward A. Sterzick, Harry M. Scholter, Walter L. Neible, Charles Hammond and Robert G. Porter. The incorporators are all from Flat Rock, Ind., and recently purchased the Everson sawmill at Crawfordsville.

#### Milwaukee.

A. C. McComb of Oshkosh has secured a tract of about 8,000 acres of pine and oak lands in Texas county, Missouri, which he purchased from A. J. Johnson, the Champion Land & Timber Company and others. It is estimated that it will cut 50,000,000 feet of yellow pine and 20,000,000 feet of white and black oak. A branch of the Frisco line is now building past this tract from Winona, Mo., northward.

Dealers are looking forward to a stiffening of prices as the demand for hardwoods is constantly increasing. Hardwood is being put to more uses than in former years, but the supply is not increasing in the same ratio. Manufacturers of hardwood flooring are finding ready sales for their waste material at \$4 a load, many people preferring this wood to coal, claiming that it gives the same amount of heat for less money.

#### Nashville.

A disastrous fire occurred Sept. 23 in the yards of Lieberman, Loveman & O'Brien, which destroyed 5,000,000 feet of quartered oak and poplar, a dry kiln and three drying sheds, entailing a loss estimated to be between \$125,000 and \$150,000, covered by insurance.

Two Nashville lumbermen who have been taking extensive vacations and have returned home ready for the fall business are John B. Ransom and John W. Love.

Henry E. Sanford of the firm of Sanford & Treadway of New Haven, Conn., was in the city during the past week looking over stocks. His company has a yard at Elizabethton, Tenn.

W. M. Hopkins of the Theo. Fathauer Company of Chicago was in Nashville last week visiting local dealers.

A. T. Haas of the Williams & Haas Lumber Company of Fayetteville, Tenn., was in the city Friday. His company has recently inaugurated a big interior finishing plant and is equipped to handle large contracts.

Down on Cumberland River things look like old times for the lumbermen and the boatmen. There is a rise of several feet and the tow boats are hustling to get down every stick of timber they can reach. The Chauncy Lamb, one of the tow boats of the Nashville Transportation Company, of which John B. Ransom is president, came down last week with a million and a half feet of lumber and staves. The boating season will hardly be on in full blast, however, until about November, as the present rise is temporary and does not extend all the way up, the water being reported as falling at Burnside.

The furniture establishment of G. M. Dame at Jasper, Tenn., has been destroyed by fire, entailing a loss of about \$25,000, with \$1,000 in insurance.

A syndicate of gentlemen of Gainesboro, Tenn., in Jackson county, have purchased a timber reservation in Van Buren county, Arkansas, paying about \$10,000 for their holdings. The syndicate is headed by J. E. Stafford, a well-known Gainesboro merchant.

John B. Ransom & Co. report the biggest month in their history during August. It is understood that the business done by this influential firm for the one month was considerably over \$100,000.

Hamilton Love is building a pretty home on West End avenue, not many blocks from the handsome residence of his older brother, John W. Love, both of the firm of Love, Boyd & Co.

Capitalists from Chicago, comprising what is known as the Alabama Coal, Iron & Railroad

Company, have closed a deal purchasing 30,000 acres of timber lands in Jackson county, Alabama, says a special from Scottsboro, Ala. George E. McNeil and Jesse L. Austin, both of Chicago, are respectively president and secretary and treasurer of the company. The land is timbered with oak, gum, hickory, poplar, walnut and chestnut. A nine-mile branch railroad is to be built to the tract from the Southern Railway at Gurley.

The Kentucky Stave Company of Louisville is putting in a stave mill at Clarksville, Tenn. Several timber tracts have been acquired near that place. For the present the timber will be worked in the rough and a finishing plant will be built later.

A factory to manufacture scrubbing brushes is being established at Oliver Springs, Tenn. Vann & Gardner are the proprietors.

Charles S. Hunnan, formerly a traveling salesman for Love, Boyd & Co., but now in the lumber business for himself at Homer, N. Y., was a recent visitor to the Nashville market.

#### Memphis.

The ruling of the Interstate Commerce Commission in connection with export shipments of cotton, which was looked forward to by lumber exporters as throwing some light on their exports of lumber, has not served to materially clarify the atmosphere. However, the statement of the commission, that it concerns itself only with the inland rate and that through bills of lading can be issued on the joint rate, including the inland and ocean rates, has been received with much interest, because, under this ruling, those roads which run via New Orleans can issue through bills of lading and are doing so right along on both lumber and cotton exports. The roads running to the eastern ports, however, are, with one probable exception, refusing to handle either lumber or cotton for export shipment, pending further developments. The official order of the commission, setting forth the position of this body, has not been received here and this is the cause of much uncertainty and is the occasion of the unwillingness of some roads to handle export shipments of any kind.

James S. Davant, commissioner of the Memphis Freight Bureau, who went to Washington with the Memphis cotton committee, was authorized by the Lumbermen's Club of Memphis to enter its protest against the enforcement of the thirty-day notice required under the Hepburn rate bill on export lumber shipments. E. M. Terry, secretary of the National Lumber Exporters' Association, appeared before the Interstate Commerce Commission also, and this is probably responsible for the statement contained in press dispatches from Washington to the effect that "the petition of lumber and cotton seed products interests is denied." In speaking of this matter this afternoon, a prominent exporter made the statement that the Washington meeting was peculiarly one for the cotton people and that the lumber interests of the country did not voice their sentiments. He holds therefore that the commission, before handing down such a sweeping denial of the so-called petition of the lumber interests, should call a meeting at which the lumbermen of the country could enter their protests. He further expresses the belief that the National Hardwood Lumber Association, the National Lumber Exporters' Association and the other large organizations would take part in such a conference, and he is of the opinion that the lumbermen will make such a protest against the stand the commission is alleged to have taken without giving the lumbermen a proper hearing.

Feeling here regarding the reconsigning charge of 85 per cent which has been made effective on the Frisco system, St. Louis, Iron Mountain & Southern, St. Louis Southwestern (Cotton Belt) Railway and the Rock Island system has become more friendly, largely because of a better understanding of the meaning of the ruling. The following explanation, which has been made by officials of the interested roads, is largely responsible for the changed sentiment: "When a car is shipped to a junction point or other point and ordered delivered to any railroad for purposes of reconsigning and forwarding instructions are given to the agent of the road in whose care the car is billed, the charge does not apply; nor does it apply when cars are billed to any point and ordered delivered to a consignee other than the one to whom originally billed. The

only place it applies is in cases where the shipper, after having originally shipped a car to one point, decides for some reason to change the destination and requests the railroad company to divert the shipment and protect the through rate from original shipping point to final destination."

The Lumber Exchange of St. Louis has written a letter to the Lumbermen's Club of Memphis protesting against this reconsigning charge of 85 and asking that the local organization join with it in fighting the proposition. If it should be discovered that the new ruling is working a hardship on lumber interests in St. Louis, the local organization will undoubtedly fall in line and render whatever aid it may be able to give. The additional charge, as outlined above, is regarded here as justifiable because the railroads are performing an additional service and are entitled to compensation therefor. And further, it is pointed out by a member, there are very few cases in which the additional charge will apply because there are very few times when the destination of lumber has to be ordered changed.

There will be a meeting of the Lumbermen's Club of Memphis next Saturday evening at the Hotel Gayoso, the first regular meeting of the fall season. The communication from the Lumber Exchange of St. Louis will be laid before the body, and it will then decide what action shall be taken in connection therewith. The Lumbermen's Club enters the new business year with the largest membership in its history.

Secretary E. M. Terry of the National Lumber Exporters' Association, who left Memphis several weeks ago, has returned after an extended trip including Cincinnati, Buffalo, New York, Philadelphia, Baltimore, Norfolk, Washington, Knoxville and Chattanooga. He met many members of the association and reports that he found everything in splendid shape and learned that members of the organization are much pleased with the manner in which the association is handling the various problems which have arisen from time to time.

Rapid progress is being made on the enlargement of the plant of the Memphis Saw Mill Company, successor to Hugart & Kendal, New South Memphis. The company hopes to be in operation by Oct. 1. The plant has been closed down for improvement work for about five or six weeks.

Russe & Burgess resumed operations this week after a shut-down of about ten days resulting from the installation of new machinery. During the shut down the firm received heavy shipments of logs and now has enough timber on its yards to insure steady operation for some time.

The Alabama Coal, Iron & Lumber Company of Scottsboro, Ala., has purchased 30,000 acres of timber, coal and mineral lands in Paint Rock Valley, near the Alabama-Tennessee state line. A railroad, nine miles long, is being built through the valley. It is estimated that the tract contains three-quarters of a billion feet of hardwood lumber. The company is organized under the laws of South Dakota and has strong financial backing.

The Nashville, Chattanooga & St. Louis Railroad Company has employed P. J. Denison and Thomas A. Enochs of Lexington, Tenn., to get out a large quantity of ties to be used on the western portion of its line. The contract calls for an annual output of 125,000 ties, which are to be delivered at various stations in West Tennessee. The employes are empowered to purchase the necessary timber lands and employ persons to get out the ties in the woods.

The Tennessee Stave & Box Company, which is capitalized at \$200,000, has purchased a large tract of land in South Memphis on which it proposes to erect one of the largest stave and box factories in the city. There will be two principal buildings, one 80x100 feet and the other 30x80 feet, and the cost will be approximately \$75,000. The company is backed largely by Chicago capital. A. H. Kersting, E. J. Hastings and others are the incorporators.

S. B. Anderson, C. J. Tully and W. B. Morgan of the Anderson-Tully Company have purchased the Memphis Stave Company, including its plant in North Memphis, from George M. Brasfield, and have taken over the operation of the factory. George P. Markham, who was with Mr. Brasfield for some years, will be one of the managers of the company under the new regime.



This purchase virtually gives stockholders in the Anderson-Tully Company control of the slack coeage industry of this city.

The Chapman-Dewey Lumber Company has purchased a circular sawmill at Marked Tree, Ark., and will convert this into a band sawmill with a daily capacity of about 60,000 feet. The machinery has not yet been purchased but the company is now securing estimates thereon and bids will soon be asked for.

Angus McNeil of the Corning Handle Company, Corning, Ark., has purchased the old box factory of the Marked Tree Lumber Company at Marked Tree and is now making preparations for operating this at an early date. Considerable ash stumpage was secured at the time the plant was purchased.

The Chicago Mill & Lumber Company, which is putting in a planing mill, sawmill, veneer plant and box factory at or near Blytheville, Ark., is making rapid progress thereon and some parts of the plant will be in readiness for operation within the next few weeks.

Harold Petri of Quintet & Petri, Antwerp, Belgium, has arrived in Memphis, and it is understood that he will remain here for some time. Mr. Petri is well known to the local trade, having had headquarters here for some years prior to his return to Europe, two or more years ago.

Max Sondheimer, president and general manager of the E. Sondheimer Company, has been east for some time. Rudolf Sondheimer, who recently returned from a trip to Europe, is looking after the business of the firm during his brother's absence.

### New Orleans.

That New Orleans will receive large quantities of the lumber manufactured by the new Mexican Chicle & Mahogany Company of Mexico, and that two ships will be chartered in the near future to handle the lumber, was recently given out here by Dr. Lorenzo B. Spyer, a wealthy Mexican banker who is heavily interested in the new firm. He stated that the Mexican Chicle & Mahogany Company is capitalized at \$1,000,000 and has a very large timber acreage in Quintana Roo territory, Yucatan, covered mostly with oak and chicle growth and some mahogany. J. S. Codifer and a number of other New Orleans people are interested, and local headquarters will be established with Mr. Codifer in charge. This is the same company that proposes to introduce the chicle rail road tie into the American market. This tie is said to be much more durable than the cypress tie; the average life of a chicle tie is said to be more than thirty years. Dr. Spyer stated that within the next week or so the company would start a big sawmill on its property and that it would shortly prepare a shipload of chicle ties to be sent to the United States for use on the railroads.

John Koper has been appointed as receiver for the Southwestern Lumber & Export Company of New Orleans. Mr. Koper's bond has been fixed at \$10,000 and he has taken charge of the affairs of the concern. The appointment of a receiver was brought about by the suit of Charles E. & W. F. Peck, Ltd., who sued for premiums alleged to be due on insurance policies and who charged that the defendant company was insolvent and unable to fulfill its contracts and meet its debts. The president of the company, George Jurgens, admitted to the court that the company could not fulfill its contracts and the receiver was appointed.

A serious car shortage prevails throughout this territory and advices received from points in Louisiana and Mississippi state that the car shortage is becoming alarming. It is stated that unless conditions improve a number of failures in the lumber mills may result from the fact that the mills are unable to market their output. The Gulf & Ship Island road, one of the principal lumber carrying roads in Mississippi, was short more than 400 cars one day recently.

The new plant of the Brinker Wagon Manufacturing Company, at Washington avenue and Claiborne street, this city, will begin operations October 1. The company is capitalized at \$50,000 and its officers are: Frank Brinker, president; Henry Steffeldt, vice president; Ed. Miller, secretary and treasurer.

Plans are now being laid by the Deemer Manufacturing Company of Wolfshoro, Pa., to

develop its 41,000 acres of oak and hardwood timber land in Neshoba county, Mississippi. This company is one of the largest timber holding corporations in the state of Mississippi and has close on to 400,000,000 feet of hardwood timber on its big tract. It is proposed to erect and equip on the tract a mill of large capacity, that will cost complete \$100,000. The tract is near Philadelphia, the county seat of Neshoba county. One of the principal owners is J. L. Snyder of Tioga county, Pennsylvania, and he will take entire charge of the development of the lands. He expects to begin work on the big mill in a short time.

Recent advices from the Angola State Convict Farm at Angola state that quite a success has been made there in manufacturing lumber. The mill at Angola is cutting about 80,000 feet per day and the convicts are proving excellent saw mill hands. It costs comparatively little for the state to manufacture this lumber and, incidentally, it is not bothered by labor questions.

R. V. Turner and John J. Herlihy, lumbermen of prominence at Taylorsville and Fenton, Miss., respectively, were in New Orleans last week.

H. H. Welbe, Jr., of Mobile, and Hampton D. Ewing of Northport, L. I., recently purchased at Mobile, from Jim Hand of the Hand Lumber Company, 50,000 acres of fine timber land located in the vicinity of Bay Minette, Ala. They paid \$147,000 for the land, which contains a great deal of valuable hardwood timber.

D. W. Walker, manager of the American Hardwood Lumber Company, has returned from his vacation and again taken charge of the company's big plant at Southport.

The Mexican steamship Oaxaca, Captain Ybarreto, consigned to the OGI Manufacturing Company, arrived here yesterday with 800 mahogany logs.

### Ashland.

The funeral of Ferdinand C. Fischer, president of the Yellow Poplar Lumber Company, Coal Grove, O., brought to Ashland many men prominent in the lumber industry of the country. The funeral was held from the home of his brother-in-law, L. D. Davis, and the honorary pallbearers were J. E. Dofbaugh, editor of the American Lumberman; C. Crane of Cincinnati; W. H. Nigh, Ironton; W. A. Smith, Catsburg; R. H. Vansant, Ashland; Clinton Green, Cincinnati, and J. W. Mayhew, Columbus.

The Baker & Spidler planing mill at Huntington, W. Va., has been transferred to the C. M. Calloway Lumber Company. The new company incorporates at \$25,000, of which \$15,000 is paid up stock. The change in management has already begun. Mr. Calloway has been engaged in the lumber business in Raleigh county for some time, and has two large lumber yards in that county as well as something like 8,000,000 feet of merchant timber to operate on, besides options on several thousand acres of valuable timber land. The large timbers which Mr. Calloway has been holding from lack of proper means to reach the market will be shipped to Huntington and put into shape for use by local builders in the big buildings now in construction in that city. The mill will make a large addition to the force of men already employed at the planing mill.

Michael Foley, a leading citizen of Cork, Ireland, and having timber interests in Logan county, West Virginia, has been a local visitor.

Lloyd Queensberry of the C. M. Calloway Lumber Company will remove soon to Central City, W. Va., to take charge of the lumber plant recently purchased from Baker & Spidler.

The Giles Wright Lumber Company has purchased the Mahan sawmill at Chaffee, which will be rebuilt and enlarged. The Ashland office will be removed to the mill about October 1.

The Lock Haven Development Company of Lock Haven, Wayne county, West Virginia, has been chartered to manufacture timber, operate railways and conduct stores. The capital stock is \$100,000. The incorporators are: J. W. M. Stewart, M. F. Fleming, S. S. Willis, Lou Wilson and Thomas Roggess of Ashland.

The Front street sawmill at Gallipolis, O., operated by William Mills, was burned down and valuable lumber destroyed. It was used as a dimension mill, cutting up stock for chairs, tables and a variety of stuff of that kind. The

machinery and stock are estimated to have been worth from \$2,500 to \$3,000.

C. Crane & Co., Ashland, Ky., lost several thousand logs by a recent sudden flood in the Guyandotte river. The greater part of them were caught at Huntington, and the remainder nearly all caught before they reached Ironton, O.

### Louisville.

J. N. Struck & Bro., prominent planing mill men here, who make a specialty of hardwood trim, are now making a feature of the red gum door, which they call the "Struck-it." It is a built-up veneered door, furnished either in the natural finish or stained, and seems to be meeting with favor.

E. M. Platter, who was in town from North Vernon, Ind., last week looking after affairs at the mill of the Platter-Powell Company here, says the company has all the orders for hardwood it can take care of.

The Stotz Lumber Company says it has completed the grading on its new yard and expects the architect to have plans completed for the new flooring plant in a few days. The demands in hardwoods have been very active and the company has its hands full taking care of orders.

Albert R. Kampff had the misfortune to lose his Auburn sawmill by fire Thursday, September 15. The loss is about \$5,000, with no insurance, and at this writing Mr. Kampff has not decided whether he will rebuild the mill at Auburn or go out into the country nearer the timber when he sets it to work again.

Will McLean has just returned from a trip up among his Canada timber holdings. He was accompanied by Edward L. Davis and a few others. While in the woods the party enjoyed several days' fishing and all report a very enjoyable time. In regard to business, Mr. McLean says they have lots of orders for lumber, flooring and everything else and are kept busy all the time.

Edward L. Davis reports they are building another sawmill down in the country about twenty miles from Glasgow, Ky., where they have bought several million feet of timber, mostly white oak. He says the demand for hardwood is excellent, and they are up to their eyes in work. The Berry Davis Saw Mill Company has been making some extensive improvements to their power plant here.

### Minneapolis.

Minneapolis lumbermen are the incorporators of the Hawkins Lumber & Land Company, which has just been organized with \$50,000 capital, and will build a mill to manufacture its timber at Hawkins, Wis. The mill will be in operation this winter and by next spring will have on the market a stock of maple, elm, birch and basswood lumber. The company has extensive hardwood holdings tributary to the mill. It is incorporated by W. F. Meader, M. C. Meader, George F. Meader and George C. Farnham.

C. P. Cook, the well known manufacturer of Glen Flora, Wis., was in Minneapolis on business a few days ago. He says many woodsmen have left the Wisconsin camps to find what they think will be better conditions on the Pacific coast. Men will be scarce in the hardwood camps this winter, and wages will be higher than ever.

The Radford Sash & Door Company of Chicago and the allied interests at Oshkosh, Wis., and Duluth, Minn., have opened a sales office in this city in charge of L. B. Craven, an experienced traveling salesman for sash and door products.

Albert La Berge, a manufacturer of hardwood and hemlock lumber at Stetsonville, Wis., was a business visitor in Minneapolis a few days ago.

D. F. Clark, of Osborne & Clark, the Minneapolis wholesalers, says that business with them is not above the average for this time of year, but is satisfactory. There is an ample supply of birch on the market, but beyond a doubt there will be a market between now and spring for all the hardwood now on hand. There seems to be an increased use of oak for finish and in veneer work, and practically all of it is coming from the South.

E. Payson Smith of the Payson Smith Lumber Company has returned from a trip to Chi-

ago and other large consuming points. A. S. Bliss of the same company says their September business has been excellent, and that it has been good in the Northwest as well as in the East. They have made some excellent sales of maple, and find that wood not abundant and firm in price. Birch is also rather diminishing, and not many stocks remain unsold. They find a steady demand for southern oak from the northern factory trade.

#### Wausau.

W. Wilson of Rhineland has purchased a large tract of hardwood lands from the Paine Lumber Company of Oshkosh. The lands are located in the vicinity of Stella and he will erect a mill at that place. He has enough timber to keep the mill in operation for several years.

T. C. Nehrass of the Nehrass Casket Company, Fond du Lac, died recently.

The Upson Lumber Company is a new corporation formed to do business in Iron county. The incorporators are Martin Erecke, Andrew Erecke and Elmer Stone. They reside at Stetsonville and have bought the mill and timber holdings of the Star Lumber Company at Upson.

The Roldis Veneer Company of Marshfield has already placed crews of men in the woods to cut next year's supply of logs, but is greatly hampered for lack of hands. It will furnish employment for 300 men this winter, if they can be secured. Its plans call for 12,000,000 feet of lumber, an increase of 3,000,000 feet over last year. About 750,000 feet of grades of hardwood heretofore not cut at the mill will this year be worked up into veneer for new styles of furniture.

This is the season when lumbermen of north-

ern Wisconsin begin preparing for their winter's work and the greatest difficulty facing them this year is the scarcity of labor. Perhaps not since the civil war has the "lumberjack" been as scarce in this section as at present. Employment agencies have booked many orders for woodsmen, but this source of supply will avail the lumbering interests but little. Logging operations are paying better wages than they have for years, with transportation and excellent board and accommodations, but they no doubt will be compelled to draw on the Italian and other foreign labor of the big cities. In fact, even at the present time whole camps in logging districts often consist of laborers speaking a foreign tongue, with the camp boss, the cook and the scaler as the only Americans. Crews such as these do not give satisfaction. It requires weeks, often months, for the men to become accustomed to the work and the effect as concerns the season's cut is plainly apparent. Since lumbermen have entered so largely into the cutting of hardwood there is almost as much work in the woods as when pine was supreme, but the old-time "lumberjack," who in years past was the lumberman's reliance, has disappeared and has been partially succeeded by men less skillful with logging tools. It is claimed that the large lumbering operations that are opening up in the South and West have taken him from Wisconsin.

A. E. Beebe of McMillan, Wis., secretary of the Wisconsin Hardwood Lumbermen's Association, is the republican candidate for member of the assembly from the first district of Marathon county. His qualifications and record are a guarantee that he will be an excellent addition to the legislative body of the state, if elected, and the *Hardwood Record* wishes him success in his candidacy.

## Hardwood Market.

(By *HARDWOOD RECORD* Exclusive Market Reporters.)

#### Chicago.

The last few weeks has seen the rush of fall business actually begun. Most of the firms are busy getting out their orders with more speed than usual this year on account of the car shortage, which is beginning to be felt, and which will undoubtedly increase as the season progresses. In almost all items the market is strong. There are complaints about the slowness of quartered oak, although there is no evidence of the prices being anything but sound, and it is thought that the active trading of the next few weeks will serve to put the article on a better footing. Plain oak is firm and a considerable number of concerns that are making the stuff in heavy quantities have no difficulty whatever in disposing of their product. The general opinion among the local trade and their experience thus far with the state of trade is that the coming season will be a remarkably good one.

#### Boston.

While the local hardwood market lacks that snap needed to make an active market, the demand shows an improvement in many lines as compared with a month ago. There has been a general hardening of values due largely, it is reported, to a short supply of desirable stock at mill points, available for prompt shipment. Dealers express more encouragement regarding the future than for several weeks. The yards in this vicinity are not overstocked, although many of them have a fair supply on hand. Manufacturers of house finish are very busy at present and have been for several weeks past. Some are behind with deliveries. There has been quite a little building going on this summer that has about reached a stage where the interior finish is wanted. Furniture manufacturers are busy and the outlook is that they will run full during the remainder of the year at least.

A very fair demand for mahogany is reported. Imports at Boston during the past month have amounted to about two hundred logs. A steady market is found for plain oak, although the demand at present is not brisk. No lower quotations are expected. Quartered oak has been in a little better demand of late and prices are firmly held in most instances. Birch is in moderate inquiry. In some places this wood is being used

as a substitute for mahogany. A good demand is reported for brown ash. Whitewood is very firmly held. The demand is not brisk, but dealers have but little trouble in getting full asking quotations, as offerings of desirable stock are not large. Cypress is held in strong hands, but the call is not brisk. Maple flooring moves in a moderate way. No large orders are reported in the market this week. Chestnut is in very good demand.

#### New York.

The salient feature of the market during the past fortnight has been the money question, due to the building trade requiring funds to complete structures in hand, a condition which is always prevalent at this time of year. The stringency in the money market, coming as it does toward the end of a very active building period, has made itself strongly felt in the large number of mechanics' liens filed with the county clerk. At this writing the money market is not high and it is believed that within a very short time this undesirable feature of trading will pass away.

As to the hardwood market itself, the situation during the fortnight just closed has revealed no weakness, both demand and prices being steady. The wholesale trade reports stocks in hand and at mill points very much broken and holdings of first-class, well-manufactured stock in the better grades are being held very strongly as a general thing. Of course here and there will be found small offerings from small mills at slightly shaded prices, but a majority of the trade who are conversant with conditions at supply points are perfectly satisfied to keep their stock off the market rather than to make any concessions. Taking the buying trade as a whole, however, purchasing is quite free and every indication points to a good fall and winter trade. There is a little weakness shown in maple and quartered oak, and there seems to be more than enough stock to go round. In birch, the demand is strong, with good stock in desirable sizes very scarce. The demand has been unprecedented for this stock for a good many months and the current situation shows no change in that respect. Ash is in fair call and some inquiries are hard to fill in the better grades, owing to the scar-

city of available supplies. Beech is having a very good run, especially in thick plank for temporary work. Plain oak is firm, but stocks in the hands of buyers seem ample for early fall demands and the market is a little easy. Poplar is holding its own, with the better grades in good demand and the lower grades moving quite freely. Prices are firm and the general outlook indicates that it will enjoy a very fair movement during the balance of the year.

#### Philadelphia.

During the past fortnight sales have materially increased, especially in oak and chestnut. Good prices are being obtained for all woods, the lists being strong in all items. Basswood is again becoming a factor after the quiet period of sales experienced in the wood during the past month, and poplar especially good dry stock is in active demand. The outlook for a busy season is favorable and the trade as a unit feel confident that the brisk demand that is beginning to usher in the fall business is the forerunner of a prosperous, steady season. The stocks in the yards are at a comparatively low ebb, and orders from them are beginning to be received in larger volume.

#### Baltimore.

The favorable conditions that have distinguished the Baltimore hardwood trade all summer still prevail. There is a brisk demand for practically all items of stock, and the mills apparently find a ready market for their entire output, though some of the dealers incline to the view that production has gained somewhat on consumption and that stocks are more plentiful than they have been for some time. For the present the inquiry is brisk at figures that are perhaps a shade easier, but that do not depart materially from the range of values which has prevailed during the whole summer. The competition at the mills for stocks is still very active, though the offerings are said by some lumbermen to be more liberal. Oak, ash and other woods in general use are eagerly sought and the distribution is large, though in the southern states the car shortage is causing more or less trouble. Poplar has lost none of its snap, being in strong demand at figures that yield a satisfactory profit. Large quantities of lumber are going abroad, though the quotations there are not relatively as high as on this side. The prevailing prices for walnut serve to bring out lumber and logs in fairly large quantities, the supplies being taken up in part for domestic consumption, as the home revival in the use of the wood is still in evidence. The local requirements in mahogany are fairly satisfactory.

#### Pittsburg.

In the midst of sultry summer weather the fall market for hardwoods shows a very encouraging aspect. It is doubtful, in fact, if there has been a fall for ten years when the hardwood dealers of Pittsburg had reason to hope for a better trade than just now. Inquiry is broadening and prices are stiffening. Furthermore, stocks of dry hardwood are too small to be counted on to furnish a supply for any considerable period. This augurs well for the quick sale of the entire output of the hardwood mills this fall and winter. Pittsburg firms are exerting themselves to get their mills and mill connections in the best possible shape before winter sets in.

Prices of all hardwoods are firm with a constant tendency to higher quotations. There is not a break in the list, except, perhaps, sound wormy chestnut, which is offering rather more freely than the market demands just now. Oak is a strong leader, all grades being in excellent call. The best grades of chestnut are bringing better prices than a month ago. The small stocks of hickory that are occasionally located about Pennsylvania and Ohio are grabbed up eagerly by local dealers and as quickly resold at prices that are usually named by the seller. Maple flooring is one of the best sellers on the hardwood list. Considerable beech is being sold through Pittsburg agencies, chiefly for construction work on the local rivers. Birch is wanted from eastern points, but its scarcity makes sales small. Both elm and ash are com-



ing to the front this month since the mills of Ohio and western Pennsylvania have resumed operations, and large quantities are being sold to the wagon and buggy trade and the handle manufactories.

#### Buffalo.

Sales in all lines are increasing in spite of the large amount of lumber sold during the summer. Hardwoods have been in good demand all during the past season. Hardwood dealers here are very active and they appear to work to good purpose, for the supply of lumber they obtain and pass on to the retailer and consumer is much greater than would be supposed possible, with all hardwood lumber so scarce. Prices do not change to any extent, nothing but poplar going up, and that still lower than the prices that were put on it some years ago by the producers.

Everybody is still looking to birch for helping out in most directions. It takes the place of any wood used for inside finish and seems to grow more plentiful with its increasing use. Washington fir is coming into much the same use, while its strength puts it into the ash trade, which is disappearing on account of scarcity.

Chestnut is not more plentiful and sells about on a par with plain oak. There is a good report from cherry, and walnut is still an occasional seller. Maple sells well, good reports coming from the flooring mills. There is some increase in the demand for basswood, with elm still rather quiet. They will both be wanted in good time and would never have been laid aside but for the high price asked for them at the sawmills.

The great point in the entire trade is the rapid consumption. The eastern retailer is not stocking up. This is shown by the hurry-up orders given with purchases. He wants the stock for the consumer. Buffalo was never building so generally all over the city as now and though extra competition is cutting down the earnings of the door mills the work is heavy.

#### Saginaw Valley.

Trade is a little brighter as regards orders and inquiries than it has been for some time, but quotations show no perceptible appreciation in the matter of values. There is some call for beech and birch, a number of sales being reported in this last week. Maple is weak. It can be bought, so buyers assert, at interior mills at a figure less than was asked last spring. On the other hand, it is claimed that this is only small scattered lots, but that the general market is holding up well and at fair prices. No. 2 common and better being firm at \$16 and \$18. Elm is still sold around the \$22 to \$26 mark, and basswood at \$23. The demand for basswood mills by box manufacturers has helped that commodity. Beech is moving better at \$14 and birch at \$20 to \$25.50. Ash is strong at \$27 and \$28 and not much offering. There is ample stock to meet the requirements of the trade and timber owners are making preparations for the usual output this fall and winter in the woods.

#### Indianapolis.

The hardwood lumber situation here is entirely satisfactory to dealers. Indeed, the volume of business done during the summer season was larger than was anticipated and all Indianapolis firms have apparently prospered. There is considerable building done here now and as a result demand for all grades of hardwoods is good. Prices are steady. The fall buying by manufacturers is now on and numerous orders of this nature have been placed with local dealers. Plain and quartered oak are both in good demand.

#### Nashville.

A strong market, stiff prices, good demand and no surplus of stocks are the characteristics of the local market at this writing. Orders by mail and from salesmen on the ground are plentiful and are from all parts of the country. The only question is that of being able to get the stuff. For some time chestnut has been in great demand in this market. This wood has proved to be useful for interior finish, as it does not cost as much to work as it does oak, and at the same time good widths and grades are obtainable. Good black locust poles are in heavy de-

mand, having replaced cedar as telephone and telegraph poles and as railway and highway piling. The ends are being crosscut and the wood is found to last comparatively well. Poplar is bringing the full list price and all the dry stock, firsts and seconds, is being accepted by ready buyers. The heavy building that has characterized this section as well as the entire country has made quartered oak flooring in great demand, both in firsts and seconds and strips and common. All grades of ash and hickory are being bought wherever obtainable. A tide is on now and a good deal of badly needed timber is coming down the river. Every tow of it is welcomed eagerly and enthusiastically too, as the supply this fall and winter is said to be about one-third of what was expected and is usual. September trade is holding up about as briskly as did the remarkable business scored during the month of August, which was a record breaker for Nashville lumbermen.

#### Memphis.

The demand for hardwoods in Memphis and vicinity continues excellent and the market is in a very healthy position from a price standpoint. Stocks continue rather light in shipping and bone dry. Although weather conditions during the past fortnight have been more favorable for production, there is not as much lumber on sticks as there should be at this season. The domestic demand is better than the foreign, but there is a very satisfactory business reported in export circles. There are more mills operating in this territory than there have been for some time, owing to the more favorable weather, but nothing like all of them are in operation and almost everybody in the trade admits that there will not be any accumulation of lumber this winter unless it results from something that affects the demand.

The car shortage is perhaps not quite so pronounced as was expected by this time, but it is bad enough and lumber from interior points is rather slow in moving. In Memphis proper there is very little trouble so far.

Plain oak is a very ready seller in all grades and thicknesses of both red and white. Prices have been maintained with comparative ease, and there is not enough stock to prove a weight on the market for some time. Quarter sawed white oak is selling more readily, especially in the higher grades, but quartered red is easily the dullest item on the list. Ash is a very ready seller. There is not much of this available and those who have any for sale are disposing of it at as high prices as have prevailed at any time during the past twelve months. Cypress moves without difficulty at very full figures and in all grades. Cottonwood is in excellent demand in both box boards and Nos. 1, 2 and 3 common. The supply is very light. The box manufacturers, who are the largest consumers, state that they do not know where 500,000 feet of dry low grade cottonwood could be found in this section. The box men are doing a phenomenal business, the largest in their history, and this is one of the stimulating factors in the cottonwood situation. Gum is a splendid seller in the lower grades, deriving part of its strength from the scarcity of low grade cottonwood. Firsts and seconds red are also in good demand, with a large movement in thin stock and inch lumber. Clear saps are dull, however, and prices on these are low compared to the upper and lower grades of this wood.

#### New Orleans.

Excepting that more lumber is being cut by reason of the fact that more mills are in operation, there has been little change in the condition of the hardwood market in the last fortnight. Exports are improving slightly and the interior demand remains about the same as it was two weeks ago. Like all the other mills throughout this territory, the hardwood plants are experiencing some difficulty in moving their cut because of the shortage of cars. This is affecting in some degree the supply to the interior. Prices are a little higher and it is expected they will continue to go up.

#### Louisville.

Manufacturers and dealers here report that there are lots of buyers in the hardwood market now, and it is practically no trouble to dispose of anything in the hardwood line at fair prices.

The furniture men, as noted heretofore, started in buying earlier than usual this year, and car stock people are scouring the country for stock right along. It is also noted that the demand from the building trades for structural work of various kinds is taking more oak than usual this year, so that the manufacturers are able to find a ready market for rough stock in framing and timbers. There also appears to be a very active demand for small dimension stock, especially for chair stock of one kind or another, though of course the prices attached to these inquiries are not always as inviting as manufacturers think they ought to be. It all indicates plainly, however, that the buyers are much more anxious for stock these days than the millmen are to sell. There is a fair supply of plain oak among the yards here which will unquestionably come in handy since the car shortage has become general, and the yard men who have put forth unusual energies toward accumulating stock the latter half of the summer feel justified in their action. Poplar dry stock is bringing some fancy prices and there is probably not a man here but what could sell twice as much as he can get.

#### Minneapolis.

For some reason which hardwood dealers are not able to explain, the demand for hardwood lumber from the sash and door plants and other manufacturing concerns has not been in proportion to the amount of business they have done this summer. Apparently a large proportion of their product has gone into pine and western lumber. The factories have all had a good season, and are running at full tilt with an excellent outlook for fall and winter business. They still buy hardwood, however, on a light scale, and mostly in small lots to fill immediate needs. Business is fairly good and prices are firm. In fact, most of the manufacturers are holding off with the idea that prices will advance after the holidays, so there is little eagerness on the part of either buyer or seller. There is no real abundance in any kind of hardwood. The most plentiful thing is birch, and the trade is beginning to realize that unsold birch stocks are not very large and numerous. In all probability the birch now manufactured will be well cleaned up by next spring. There is a fair call for basswood, which is firm in price and in smaller quantity than usual at this season of the year. The supply of rock elm, ash and northern oak is extremely limited, and for all practical purposes they are about wiped off the slate. Maple in most sizes is also getting scarce. There is a good demand for flooring, and the country trade is taking a fair proportion of wagon stock with its regular fall stock orders.

#### Liverpool.

Three mahogany auction sales have taken place during the last fortnight. They were well attended and higher prices ruled generally. However, the top has undoubtedly been reached and lower prices may be expected toward the end of the year.

It is well to again refer to the practice of merchants here of obliterating the lot numbers of logs bought by American buyers, who should take it to heart that where this is done in almost every case it means that they are being "had." They should insist on lot numbers being left on the logs, and to ask for the brokers' measurement cards, as was stated in this department in the last issue of the *Hardwood Record*.

Ash and oak planks are in active demand and are commanding high prices.

Several large orders have been placed for prime quartered oak boards, but low prices only have been obtained. A very curious position is to be found in this wood. We have a very large stock bought at much lower figures than they could be replaced for, but in spite of this if one is to obtain orders one has great difficulty in finding a profit. This, however, will undoubtedly right itself in due course.

Ash logs are selling at a figure which is altogether too low. Suffering from the excessive import on consignment wagon oak planks in suitable lengths are absolutely unobtainable and will bring high prices.

Oak and ash dimension timber is also in much request and any cutters of this could obtain large orders.

# AT COST

IS AN UNCOMMON TERM AS APPLIED TO INSURANCE

But this is the actual price of Indemnity against Fire Loss furnished by the

## Manufacturing Lumbermen's Underwriters

THE STRONGEST INSURANCE ORGANIZATION  
TO-DAY IN AMERICA

The saving is not on a small portion of your insurance but on the entire line.

There are other advantages equally interesting.



Only well built plants with adequate protection and at least five years timber supply are considered eligible.

FOR LIST OF MEMBERS AND FURTHER INFORMATION, ADDRESS

**HARRY RANKIN & CO.      Kansas City, Mo.**

# Wanted and For Sale -SECTION-

Advertisements will be inserted in this section at the following rates:

For one insertion ..... 20 cents a line  
For two insertions ..... 35 cents a line  
For three insertions ..... 50 cents a line  
For four insertions ..... 60 cents a line

Eight words of ordinary length make one line. Heading counts as two lines. No display except the headings can be admitted.

Remittances to accompany the order. No extra charges for copies of paper containing the advertisement.

## EMPLOYES WANTED.

### SALESMAN WANTED.

A Bangor Hardwood Salesman, one acquainted with the mills in West Virginia, Kentucky and Tennessee. Good wages for good man. Answer fully.

W. M. GILLESPIE LUMBER CO.,  
Farmers' Bank Bldg., Pittsburg, Pa.

### TALLYMEN WANTED.

Two tallymen who understand grading hardwoods. Good wages and steady work.

W. O. KING & CO.,  
Loomis Street Bridge, Chicago.

### LOGGING CONTRACT TO LET.

We have 150 million feet mixed hemlock, hardwood and pine timber in northern Wisconsin, to be logged at the rate of 12 to 15 million feet per year. Want land cleaned of all timber, including pulpwood, cedar posts, poles, etc. Work to commence fall of 1907. Party must be financially responsible and experienced in logging mixed timber by rail. Send references, stating whom you have logged for before. Address "LOGGING CONTRACT," care HARDWOOD RECORD.

## LUMBER WANTED

### WANTED.

Basswood, 200,000 ft. 1" firsts and seconds, 7" and up wide. Hard Maple Axles, 4x5 and 4½x5½—6 ft.  
McCLURE LUMBER CO., Detroit, Mich.

### WANTED—HANDLE BILLETS.

Hickory for hammer, hatchet, ax, pick and sledge handles. Maple and hickory for miners' pick handles. White ash for shovel handles.  
THE PITTSBURG SHOVEL CO., Leechburg, Pa.

### OAK AND ASH BALUSTER STOCK.

Wanted, any quantity 1¾x1¾—2¼ long, for cash.  
G. GANS, 200 Diamond St.,  
Brooklyn, N. Y.

### WHITE OAK CAR FRAMING.

And timbers wanted for cash, from reliable mills located in Louisiana, Alabama and Mississippi.  
AMERICAN LBR. & MFG. CO.,  
Pittsburg, Pa.

### WANTED.

White Oak logs and White or Gray Ash logs. Write for specifications.  
S. N. BROWN & CO., Dayton, Ohio.

### WANTED—DIMENSION HICKORY.

Hickory Pole and Shaft Strips. Also good man to travel, buying and inspecting same.  
TOLEDO CARRIAGE WOODWORK CO.,  
Toledo, Ohio.

### WANTED—HARDWOOD LOGS.

200 M feet 28-inch and up White Oak logs.  
200 M feet 12-inch and up Walnut logs.  
50 M ft. 12-inch and up Cherry logs.  
C. L. WILLEY,  
Blue Island Av. and Robey St., Chicago.

### OAK.

We are in the market for plain sawed oak, all grades and thicknesses.  
P. G. DODGE & CO., 2116 Lumber-St., Chicago.

### OAK WANTED.

3 and 4 inch White Oak; also Mixed Oak; also 12x12 Timbers and Piling of all kinds.  
CONTINENTAL LUMBER CO.,  
1213 Monadnock Bldg., Chicago, Ill.

## TIMBER LANDS FOR SALE

### HARDWOOD TIMBER.

20,000 acres Southwest Louisiana hardwoods—White Oak, Hickory, Ash, Yellow Pine—on railroad and navigable stream. Saw mill of 30,000 capacity—new. Town site. One of the finest tracts to be had in the Southwest. Write us for price. CHAVANNE INSURANCE AGENCY. Established 1899. General Insurance—Real Estate—Rentals—Loans—Investments.

No. 316 Broad Street, Lake Charles, La.

### FOR SALE.

10,800 acres Arkansas virgin oak timberland. Railroad runs through the property. Rare opportunity to purchase one of the best tracts of timber in the Southwest. Fine cotton land when cleared. Write us promptly, as we are going to sell.  
WESTERN NATIONAL BANK, Louisville, Ky.

### FOR SALE.

3,550 acres of Georgia hardwood, estimated to cut as follows:  
8,800,000 feet White Oak.  
3,500,000 feet Hickory.  
5,500,000 feet Red Oak.  
1,750,000 feet White Ash.  
High grade stock suitable for wagon and carriage manufacture.  
3½ miles from railroad; river joins tract. Ten years to remove timber. Address "H. H.," care HARDWOOD RECORD.

## LUMBER FOR SALE.

### ORDERS WANTED.

For short leaf pine and white oak car framing, bridge timbers, switch ties, etc. Mill in Miss.  
D. B. MURPHY & CO., London, Ky.

### WALNUT FOR SALE.

One car load of 8/4, 10/4, 12/4, 16/4 firsts and seconds. Exceptionally nice stock, good and dry.  
C. J. FRANK,  
2440 N. New Jersey St., Indianapolis, Ind.

### FOR SALE.

100,000 feet 5 4 Log Run Plain Red Oak.  
100,000 feet 4/4 Sound Wormy Chestnut.  
SOUTHERN LUMBER CO.,  
312 Keller Bldg., Louisville, Ky.

## TIMBER FOR SALE

### HARDWOOD STUMPAGE FOR SALE.

The timber on a compact tract of over 20,000 acres in Tennessee, largely poplar, oak and chestnut; with other woods of value. For particulars apply to  
"S. 611," care HARDWOOD RECORD.

## BUSINESS OPPORTUNITIES

### HICKORY.

If you want a good location for a Hickory mill write us for further information.  
STONEMAN-ZEARING LUMBER CO.,  
203 Frisco Bldg., St. Louis, Mo.

### DESIRABLE LOCATIONS.

In the territory of splendid timber resources reached by The North-Western Line are several fine locations for new industries, especially in the woodworking lines. A suitable point for a large sawmill having excellent railroad service and a large tributary timber district is one of these. There is also a fine opportunity for securing a well equipped cooage plant. Reference to these can be obtained upon request to the INDUSTRIAL DEPARTMENT,  
C. & N.-W. Ry., Chicago.

### HARDWOOD TIMBER.

A number of good mill propositions along the Cotton Belt Route. Tracts ranging from five hundred to twenty thousand acres, principally Oak, Hickory, Gum, Cypress, some Ash, Cottonwood and other hardwoods. Can be secured at very reasonable figures now—in some cases at less than \$1 per thousand stumpage. Choice openings for hardwood lumber mills, handle and spoke factories, slack cooage plants and other hardwood enterprises.

A number of points on the Cotton Belt offer free sites or will raise cash bonus or take stock in practical propositions. Let us have your wants and see what we can do for you.

E. W. LA BEAUME, G. P. & T. A.,  
COTTON BELT, St. Louis, Mo.

### WANTED.

Party with small capital to take an active interest in well established handle and lumber business. Entire output sold for four years. For further information write or call on  
H. F. CLARKE, Okolona, Miss.

## MACHINERY FOR SALE

### FOR SALE.

Six foot Band Mill, steam feed, entire plant complete with equipment, filing machinery, saws, rip saws, etc. Plant can be conveniently seen now in running condition. Address "BAND MILL," care HARDWOOD RECORD.

## MISCELLANEOUS

### FACTS FROM PRACTICAL MEN.

The HARDWOOD RECORD is always in the market for articles on any and every feature of the hardwood industry. It wants practical statements of fact from practical men who know how certain things can be done in the best way. Literary quality not essential. Liberal pay for acceptable articles. Address Editor HARDWOOD RECORD.

## MANUFACTURERS

Contemplating establishing plants in the West should take advantage of a location on



## Chicago & North-Western Ry.

which reaches the famous

**WATER POWERS,  
COAL FIELDS,  
IRON ORE RANGES,  
HARD AND SOFT  
LUMBER DISTRICTS,  
MINING DISTRICTS**

of the West and Northwest, and affords the best means of transportation to the markets of the world.

FOR FURTHER PARTICULARS APPLY TO  
MARVIN HUGHITT, Jr., E. D. BRIGHAM,  
Freight Traffic Manager, Gen'l Freight Agent,

Geo. BONNELL,  
Industrial Agent,

NW513

CHICAGO.

# Advertisers' Directory

## NORTHERN HARDWOODS.

American Lumber & Mfg. Company	7
Alpin Hardwood Lumber Company	49
Barlow Lumber Company	54
Barnaby, C. H.	54
Becker, Knox & Co.	55
Bliss & Van Anken	12
Boyer, J. H.	54
Boyer, Knox & Co.	55
Briggs & Cooper Company	1
Brownlee & Co.	51
Buffalo Hardwood Lumber Company	55
Cadillac Handle Company	3
Chest River Lumber Company	9
Cherry River Boom & Lbr. Company	1
Chivvis, W. R.	55
Cincinnati Hardwood Lbr. Company	55
Cobbs & Mitchell, Inc.	3
Columbia Hardwood Lumber Company	11
Conner, R. Lumber Company	48
Crosby & Beckley Company, The	19
Crosby, C. P.	19
Cummer, Diggins & Co.	3
Darling, Chas. & Co.	11
Davis, John R. Lumber Company	49
Dells Lumber & Shingle Company	49
Dennis Bros.	51
Dennis & Smith Lumber Company	50
D'Hour & Swain Lumber Company	51
Dixon & Dewey	52
Duhlmeier Bros.	52
Dulweber, John, & Co.	53
Elias, G., & Bro.	55
Empire Lumber Company, Buffalo	55
Evans & Retting Lumber Co.	59
Fall, E. H.	54
Flint, Erving & Stoner Company	9
Freiberg Lumber Company, The	53
Fullerton-Powell Hardwood Lumber Company	54
General Lumber Company	52
Gillespie, W. M., Lumber Company	51
Goldie, J. S.	51
Hank Lumber Company	51
Hackley-Phelps-Bunnell Company	51
Hayden, Harvey S.	10
Heath-Whitlock Company	11
Holloway Lumber Company	7
Ingram Lumber Company	49
James & Abbot Company	7
Jenks, Robert H., Lumber Company	47
Jones, G. W., Lumber Company	49
James Hardwood Company	2
Kampf, Albert R.	7
Keator, Ben C.	11
Keith Lumber Company	11
Kelley Lumber & Shingle Company	6
Leavitt Lumber Company	12
Lesh & Matthews Lumber Company	11
Lieban Lumber Company	9
Litchfield, William E.	7
Long Knight Lumber Company	54
MacBride, Thos., Lumber Company	51
Malley, Thompson & Moffett Company	53
Malley & Weritz	54
Martin Barriss Company	47
Mason & Donaldson Lumber Company	48
McClure Lumber Company	54
McHvain, J. Gibson, & Co.	55
McLean, Hugh, Lumber Company	55
Miller, Anthony	55
Miller Brothers	11
Mitchell Bros. Company	3
Mowbray & Robinson	53
Murphy & Diggins	3
Nichols & Cox Lumber Company	59
Nicola Lumber Company, The	9
Norman Lumber Company	2
North Shore Lumber Company	50
North Vernon Pump & Lumber Co.	2
North Western Lumber Company	18
O'Brien, John, Land & Lumber Co.	10
Perrine-Armstrong Company	54
Peters, R. G., Salt & Lumber Co.	51
Price, E. E.	7
Radhna, L. W., & Co.	55
Richardson Park & Co.	10
Rimbarger Lumber Company	10
Ryan & McParland	10
Salling, Hanson & Co.	50
Scatfield & Son	55
Schofield Bros.	7

Schultz Bros. & Cowen	45
Shimmens Lumber Company	51
Shimmer, J., & Co.	19
Soble Bros.	5
Southern Oak Lumber Company	6
Standard Hardwood Lumber Company	55
Stephenson, The T., Company	12
Stewart, I. N., & Bro.	55
Stewart, Wm. H. & G. S.	52
Stinson, J. V.	54
Stone, T. B., Lumber Company	52
Sullivan, T., & Co.	55
Tegge Lumber Company	9
Turner, A. M., Lumber Company	9
Upham & Azler	6
Van Kenlen & Wilkinson Lumber Co.	51
Vollmar & Below	49
Wagstaff, W. J.	49
Ward Lumber Company	11
Wells, R. A., Lumber Company	10
Wentworth, Chas. S., & Co.	7
White Lumber Company	19
White, W. H., Company	45
Whitmer, Wm. & Sons, Inc.	6
Wilberg & Hanna Company	53
Wilson Bros. Lumber Company	9
Wisconsin Timber & Lumber Company	11
Wistar, Underhill & Co.	7
Yeager, Orson E.	55
Young, W. D., & Co.	52
Young & Outshiner	54

## SOUTHERN HARDWOODS.

Advance Lumber Company	47
Abeok, John L., & Co.	7
American Lumber Company	46
American Lumber & Mfg. Company	9
Anderson-Tully Company	1
Atlantic Lumber Company	1
Bacon-Nolan Hardwood Company	1
Beck, E. E., Lumber Company	55
Becker, Knox & Co.	55
Briggs & Cooper Company	51
Brown, Geo. C., & Co.	8
Brown, W. P., & Sons, Lumber Co.	2
Buffalo Hardwood Lumber Company	55
Carrier Lbr. & Mfg. Company	12
Cherry River Boom & Lumber Co.	1
Chivvis, W. R.	55
Cincinnati Hardwood Lumber Co.	55
Coleman, J. S., Lumber Company	16
Columbia Hardwood Lumber Company	11
Craig, C., & Co.	53
Crosby & Beckley Company, The	19
Cypress Lumber Company	52
Darling, Chas. & Co.	11
Davidson-Benedict Company	6
Davis, Edw. L., & Co.	2
Dennis & Smith Lumber Company	50
D'Hour & Swain Lumber Company	54
Dixon & Dewey	52
Duhlmeier Bros.	52
Dulweber, John, & Co.	53
Elias, G., & Bro.	55
Empire Lumber Company, Buffalo	55
Evans & Retting Lumber Company	59
Fall, E. H.	54
Farrin-Korn Lumber Company	52
Flint, Erving & Stoner Company	9
Freiberg Lumber Company	53
Fry-Buchanan Lumber Company	46
Fullerton-Powell Hardwood Lumber Company	54
Garrison-Greason Lumber Company	5
Gavoso Lumber Company	1
Gillespie, W. M., Lumber Company	51
Hackley-Phelps-Bunnell Company	51
Hafner Manufacturing Company	5
Norman Lumber Company	2
North Shore Lumber Company	50
North Western Lumber Company	18
Indiana Lumber Company	7
Jones & Abbot Company	47
Jenks, Robt. H., Lumber Company	47
Jones, G. W., Lumber Company	49
Jones Hardwood Company	2
Kampf, Albert R.	7
Keator, Ben C.	11
Keith Lumber Company	11
Kentucky Lumber Company	32
Lane-White Lumber Company	52
Leavitt Lumber Company	12
Lesh & Matthews Lumber Company	11

Lieban Lumber Company	9
Litchfield, Wm. E.	7
Long-Knight Lumber Company	54
Love, Boyd & Co.	8
Luehrmann, Chas. F., Hardwood Lumber Company	5
McClure Lumber Company	54
McHvain, J. Gibson, & Co.	55
McLean, Hugh, Lumber Company	55
Malley, Thompson & Moffett Company	53
Martin-Barriss Company	47
Miller, Anthony	55
Miller Bros.	11
Nicola Lumber Company, The	9
Norman Lumber Company	2
O'Brien, John, Land & Lumber Co.	10
Ozark Cooperae Company	5
Paapeke-Leicht Lumber Company	8
Price, E. E.	7
Radhna, L. W., & Co.	55
Ransom, J. B., & Co.	8
Rhubesky, E. W.	2
Richmond Park & Co.	10
Ritter, W. M., Lumber Company	56
Roy Lumber Company	39
Rimbarger Lumber Company	9
Ryan & McParland	10
Scatfield & Son	55
Schofield Bros.	7
Shimmer, J., & Co.	19
Smith, W. F., Lumber Company	4
Southern Lumber Company	9
Southern Oak Lumber Company	6
Standard Hardwood Lumber Company	55
Steele & Hibbard	5
Stevens-Eaton Company	7
Stewart, I. N., & Bro.	55
Stewart, Wm. H. & G. S.	52
Stinson, J. V.	54
Stone, T. B., Lumber Company	52
Stoneman-Zearing Lumber Company	5
Stolz Lumber Company, Inc.	2
Sullivan, T., & Co.	55
Swain-Day Lumber Company	46
Thomas & Proetz Lumber Company	7
Thompson, J. W., Lumber Company	1
Three States Lumber Company	4
Turner, A. M., Lumber Company	9
Upham & Azler	6
Vestal Lumber & Mfg. Company	46
Ward Lumber Company	11
Wells, R. A., Lumber Company	10
West Florida Hardwood Company	7
White Lumber Company	10
Whitmer, Wm. & Sons, Inc.	6
Wilberg & Hanna Company	53
Wilson Bros. Lumber Company	9
Wisconsin Timber & Lumber Co.	11
Wood, R. E., Lumber Company	45
Yeager, Orson E.	55

## POPLAR.

Advance Lumber Company	47
Athletic Lumber Company	1
Brown, W. P., & Sons, Lumber Co.	2
Chest River Lumber Company	9
Chicago Veneer Company	38
Craig, C., & Co.	53
Davidson-Benedict Company	1
Davis, Edw. L., & Co.	2
Dawkins, Harry H., Lumber Company	52
Hayden, Harvey S.	10
Kentucky Lumber Company	53
Rhubesky, E. W.	2
Ritter, W. M., Lumber Company	56
Roy Lumber Company	39
Southern Lumber Company	9
Stevens-Eaton Company	7
Swain-Day Lumber Company	46
Thomas & Proetz Lumber Company	7
Vaillant, Kitchen & Co.	5
Wood, R. E., Lumber Company	45
Yellow Poplar Lumber Company	56

## COTTONWOOD AND GUM.

Anderson-Tully Company	4
Bacon-Nolan Hardwood Company	1
Farrin-Korn Lumber Company	52
Himmelberger-Harrison Lumber Co.	11
Luehrmann, C. F., Hardwood Lumber Company	5

Ozark Cooperae Company	5
Paapeke-Leicht Lumber Company	8
Smith, W. E., Lumber Company	4
Stoneman-Zearing Lumber Company	5
Stolz Lumber Company, Inc.	2
Three States Lumber Company	4

## CYPRESS.

Cypress Lumber Company	52
Hafner Manufacturing Company	5
Lothman Cypress Company	5
Thompson, J. W., Lumber Company	4

## VENEERS.

Chicago Veneer Company, Inc.	38
Wisconsin Veneer Company	48

## HARDWOOD FLOORING.

Bliss & Van Anken	12
Carrier Lbr. & Mfg. Company	12
Cobbs & Mitchell, Inc.	3
Cummer, Diggins & Co.	3
Fenn Bros. Company	4
Forman, Thos., Company	6
Hank Lumber Company	50
Kerry & Hanson Flooring Company	50
Mitchell Bros. Company	3
Nashville Hardwood Flooring Co.	8
Nichols & Cox Lumber Company	50
Pease Company, The	52
Schultz Bros. & Cowen	45
Stephenson, The T., Company	12
Ward Bros.	12
Whee, The T., Company	10
Wood Mosaic Flooring Company	2
Young, W. D., & Co.	12

## SAW MILL MACHINERY.

Mershon, W. B., & Co.	40
Phoenix Manufacturing Company	40

## WOODWORKING MACHINERY.

American Wood Working Machinery Company	41
Berlin Machine Works, The	40
Dehance Machine Works	40
Matteson Mfg. Company	4
Nash, J. M.	9
Over Mfg. Company, The	47
Schmuller, A. J.	40
Smith, H. B., Machine Company	4

## VENEER MACHINERY.

Coe Manufacturing Company	43
---------------------------	----

## LOGGING MACHINERY.

Clyde Iron Works	41
Lidgerwood Manufacturing Company	45
Overpack, S. C.	50
Russel Wheel & Foundry Company	30

## DRY KILNS AND BLOWERS.

Grand Rapids Veneer Works	42
Morton Dry Kiln Company	40

## LUMBER INSURANCE.

Adirondack Fire Insurance Company	1
Lumber Insurance Company of New York	1
Lumber Mutual Fire Insurance Company, Boston	1
Lumber Underwriters	12
Pennsylvania Lumbermen's Mutual Fire Insurance Company	5
Rankin, Harry & Co.	36
Toledo Fire & Marine Insurance Co.	1

## SAWS, KNIVES AND SUPPLIES.

Atkins, E. C., & Co.	44
Champion Saw Company	42 & 52
Gillette Roller Bearing Company	42
Hanchett Swage Works	42
Marshall, Francis	40
Shimer, S. J., & Sons	40

## MISCELLANEOUS.

Barroll, H. C., & Co.	12
Childs, S. D., & Co.	39
Gillette Roller Bearing Company	42
Lacey, J. D., & Co.	39
Lumbermen's Credit Association	46
Martin & Co.	46
Pruse Company, The	52
Schenck, C. A., & Co.	46
Standard Audit Company	5

# A Porch Column "Snap"

☞ In the manufacture of our high-grade veneers, we produce two cars monthly of clear, solid heart, bored Poplar Posts, 8 and 10 inches in diameter, 66 to 96 inches long.

☞ On this product we will make a price that will appeal to every manufacturer of porch columns.

# CHICAGO VENEER COMPANY, Inc.

BURNSIDE, KENTUCKY

**NOVELTIES FOR ADVERTISERS**

FOBS, POCKET PIECES  
BUTTONS,  
LETTER OPENERS,  
SCARF PINS, TRAYS,  
ALUMINUM GOODS,  
PAPER WEIGHTS.

*ALL NEW IDEAS.*

Send us 50c. and we  
will send you a  
Beautiful Watch Fob  
S. D. CHILDS & CO.  
200 CLARK ST. CHICAGO.



THERE IS NO BETTER WAY  
BETWEEN

**CHICAGO  
INDIANAPOLIS  
AND  
CINCINNATI**

THAN THE

**Monon Route**

**4 TRAINS A DAY 4**

Standard and Compartment Sleepers on Night Trains, Parlor and Dining Cars on Day Train.

CHAS. H. ROCKWELL, FRANK J. REED,  
Traffic Manager, Genl. Pass. Agent,  
CHICAGO

You want to reach Buyers of  
**FURNITURE LUMBER**  
**The HARDWOOD RECORD**  
will do it for you.

**ROY LUMBER CO.**  
**LOGS AND LUMBER**  
Nicholasville, KY

**WALNUT,  
OAK,  
ASH,  
POPLAR.**

You read this--others  
will, too. They would  
read your ad. Try it.

**RUSSEL WHEEL & FOUNDRY COMPANY**

Builders of  
**Logging Cars**  
And **Logging  
Machinery**

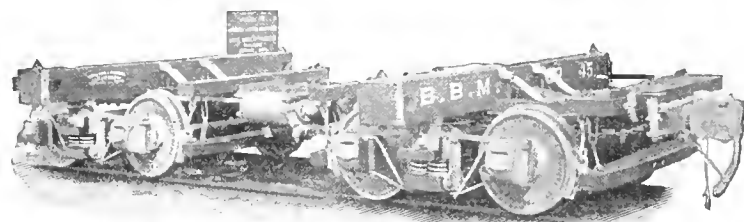

ARE ALWAYS PLEASSED TO  
HAVE OPPORTUNITY OF  
POINTING OUT ADVAN-  
TAGES OF THEIR  
EQUIPMENT.

**Detroit, Mich.**

**HARDWOOD  
TIMBER**

There is no section with so fine and large a supply of hardwood timbers of various kinds left for the lumbermen as that portion of the South in Alabama, Georgia, Kentucky, Mississippi, North Carolina, South Carolina, Tennessee and Virginia served by the lines of the

**Southern Railway  
and  
Mobile & Ohio Railroad**

There are oak, poplar, hickory, gum, cypress, ash, elm, buckeye, balsam, spruce, chestnut, and other varieties. There are also available pine lands. These timber resources and many other important features bearing on the cost of manufacture and marketing give special advantages and opportunities for EVERY KIND of WOOD USING INDUSTRY. We have information about the best locations in the country at towns in these States and in Southern Indiana and Southern Illinois, which will be given if requested. All correspondence in regard to timber lands or factory locations will be given prompt and confidential attention. Address your nearest agent.

M. V. RICHARDS,  
Land and Industrial Agent,  
Washington, D. C.

CHAS. S. CHASE, Agent,  
622 Chemical Building,  
St. Louis, Mo.

**Locations for  
Industries**  
ON  
**THE ERIE, THE COMMERCIAL RAILROAD  
CHICAGO TO NEW YORK**

The Erie Railroad System's Industrial Department has all the territory traversed by the railroad districted in relation to resources, markets and advantages for manufacturing, can advise with manufacturers of specific products as to suitable locations, and furnish them with current information of a comprehensive nature dealing with the project in its full relation to manufacture and commerce.

The Erie is one of the greatest of trunk lines. Its own rails connect the two largest cities of America. Every section of the System has its particular merits. Profitable locations exist. It has great general and coal, oil and natural gas resources.

It is important in this age of modern facilities for manufacturers to locate where they can obtain side tracks so as to receive from and ship directly into cars at the factory. Information can be promptly furnished in this connection about every point on the system between New York and Chicago.

Manufacturers' inquiries as to locations are treated in strict confidence and absolutely reliable information, so as to promote permanent traffic, is furnished.

**LUIS JACKSON**  
Industrial Commissioner  
Erie Railroad Company  
11 Broadway, New York

**Save Your Money**  
By Using the  
**RED BOOK**

Published Semi-Annually  
in January and July

It contains a carefully prepared list of the buyers of lumber in car lots, both among the dealers and manufacturers.

The book indicates their financial standing and manner of meeting obligations. Covers the UNITED STATES and MANITOBA.

The trade recognizes this book as the authority on the lines it covers.

A well organized Collection Department is also operated and the same is open to you.

**WRITE FOR TERMS.**

**Lumbermen's Credit Association**  
ESTABLISHED 1878

1405 Great Northern Building, : CHICAGO  
16 Beaver Street, : NEW YORK CITY

MENTION THIS PAPER

# "DEFIANCE" WOOD-WORKING MACHINERY

COMPLETE EQUIPMENTS OF  
**HIGH GRADE TOOLS**

FOR MAKING

Hubs, Spokes, Wheels,  
Wagons, Carriages,  
Rims, Shafts, Poles,  
Neck-Yokes,

Single Trees, Hoops,  
Handles, Bobbins, Spools,  
Insulator Pins and  
Oval Wood Dishes.

INVENTED AND BUILT BY

The **DEFIANCE MACHINE WORKS**  
DEFIANCE, OHIO.

Send for 500 Page Catalogue

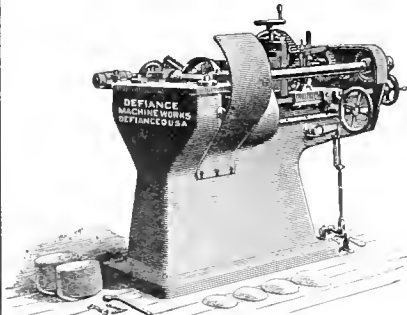

PATENT OVAL WOOD DISH MACHINE

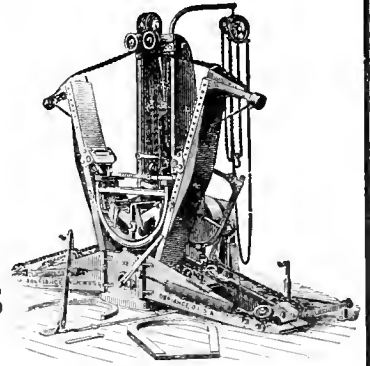

12" RIM, HOUND AND BOW BENDER.

## New Type of Combined End Matcher

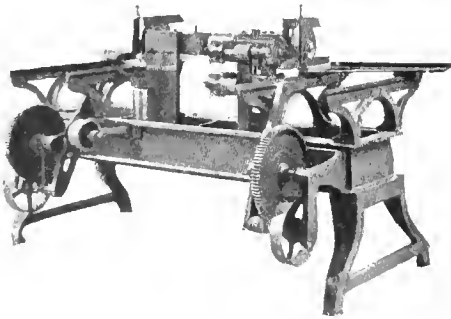

SAVES 20 PER CENT. TIME, COST AND LABOR.  
USED BY THE LARGEST FLOORING CONCERNS.

Write for particulars to

**A. J. SCHINDLER, 441-443 W. 21st Street, CHICAGO**

### STRONG, SAFE AND RELIABLE

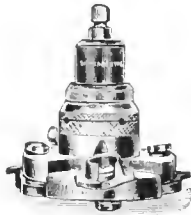

## The Shimer Cutter Heads

ARE BUILT FROM  
FORGINGS OF STEEL

and are finished throughout in the solid metal. This insures accuracy, durability and perfect mechanical adjustments.

They are appreciated by the user because they hold up under the severest tests. They cut easily all kinds of hard, knotty and cross-grained lumber. If you make single tongue and groove Flooring, Ceiling and Wainscoting, buy THE SHIMER CUTTER HEADS and you will have no disappointment.

We make Heads for every class of work. A copy of our catalogue giving the uses to which they are put and the best styles for certain classes of work, will be sent free on request.

**SAMUEL J. SHIMER & SONS,**  
MILTON, PENNSYLVANIA

### Ten per cent More Profit

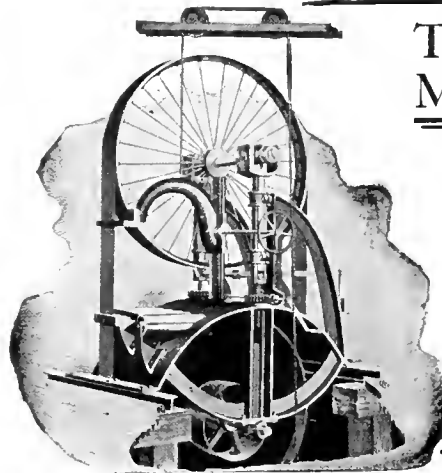

The profits of a saw mill can readily be increased ten per cent by using a hand mill instead of a rotary. The price of this mill with six foot wheels for saws eight inches wide is readily within the reach of all. It cuts smooth and perfect lumber and has a capacity of 25,000 feet to 35,000 feet per day. It runs with less expenditure of power than a rotary and puts only half as much of the log into saw dust as does the circular saw.

**PHOENIX MFG. COMPANY,**  
EAU CLAIRE, WIS.

## The Morton Dry Kiln

MOIST AIR SYSTEM

Recording  
Ther-  
mometers.  
Transfer  
Cars.



Trucks.  
Canvas  
Doors.

**HOW TO DRY LUMBER**  
As exemplified in our Catalog D. Free on application.  
**MORTON DRY KILN CO., Chicago, Ills.**



# American Improved 4-Sided Moulders

8 in., 9 in., 10 in. and 12 in. machines.

**A Houston!**

Known, used and praised for over  
33 years.

(The 8' and 9' machines differ slightly from cut.)

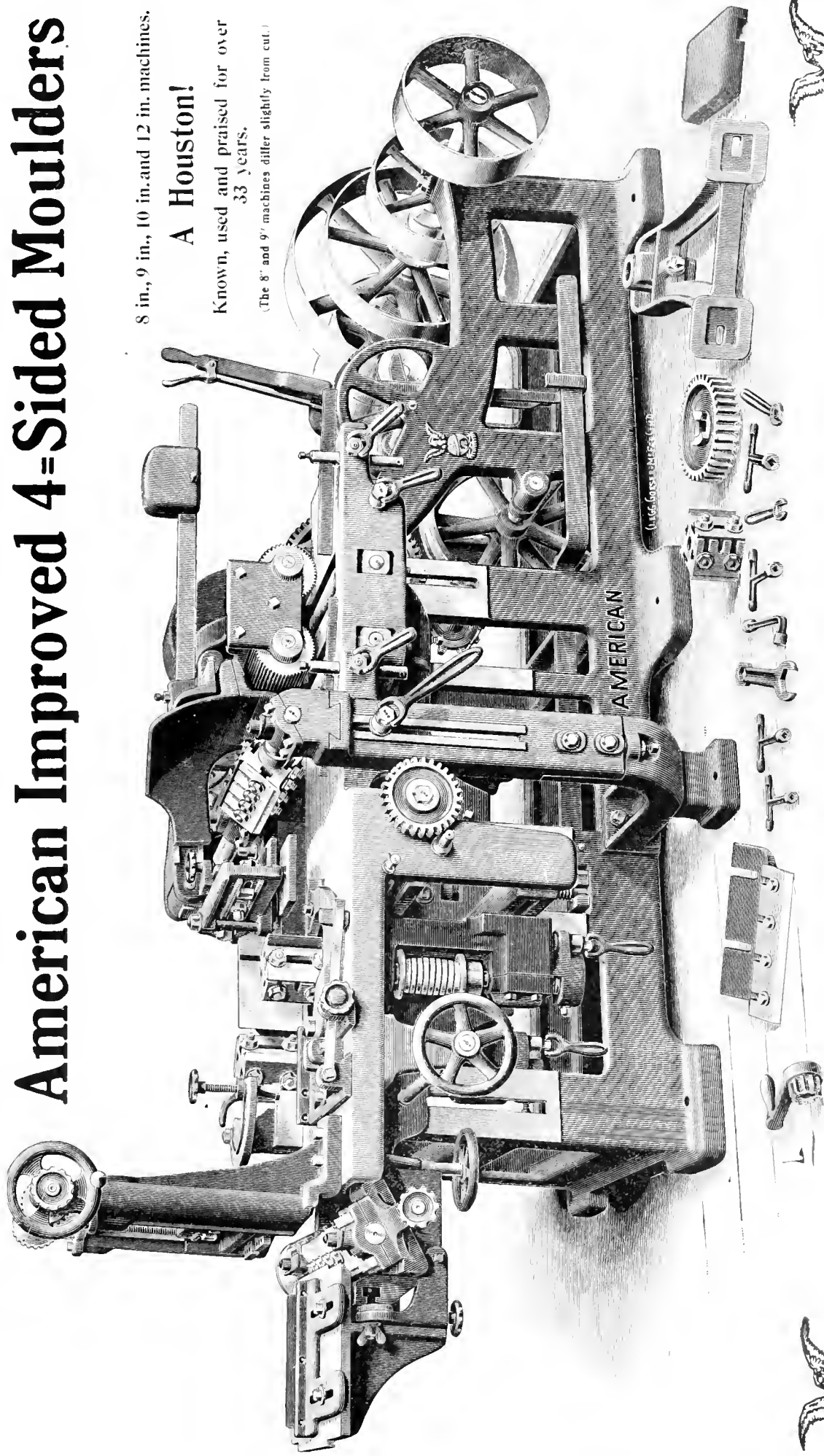

## American Wood Working Machinery Company

New Orleans

Chicago

New York

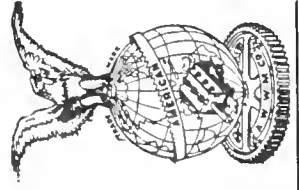
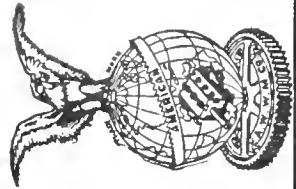



We Guarantee  
to  
**KILN DRY OAK**

IN A WEEK

by the application of a  
new scientific principle

IN YOUR PRESENT  
**Old Kilns**

Grand Rapids Veneer Works  
DEPT. ID., GRAND RAPIDS, MICH.

**"Burn your old trucks"**

was the advice given by one of Michigan's greatest lumbermen—"burn them and buy Gillette's." He had used both and knew that the Gillette Roller Bearing Lumber Cart lasted so long and moved so easily as to make it the cheapest cart on earth. The reason why for the asking.

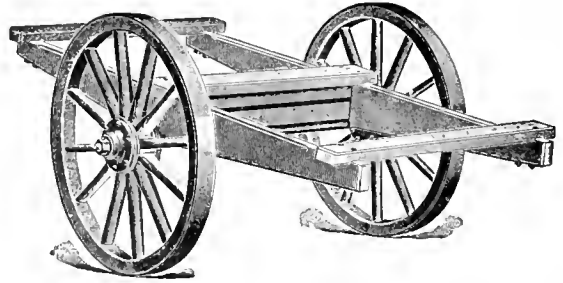

**The Gillette Roller Bearing Co.**



Patentees and Sole  
Manufacturers

Grand Rapids, Michigan

**SAWS**

I tell you, Mr. Mill Man, there is merit in these saws. Dependable stuff that is made right, will work right, and last the life of good saw material.

**CHAMPION SAW CO.**

BEAVER FALLS, PA.

**Hanchett - Hanchett - Hanchett**

**Hanchett Saw Swage**

Every one made Perfect

**The Swage with a Name**

☞ A poor Swage Ruins a Good Saw, and for that reason the manufacturers of the **HANCHETT ADJUSTABLE SWAGE** employ only the Best Mechanics and use only the Best Material in their construction.

<b>It Pays Us to make The Best</b>	Send for Catalog No. 10 It tells you all about them	<b>It Pays You to use The Best</b>
------------------------------------	---	------------------------------------

{ MANUFACTURED BY }

**Hanchett Swage Works**  
Big Rapids, Michigan

**Hanchett - Hanchett - Hanchett**



## The Coe Knife Grinder

was designed for the finest grinding and most exacting service. It is built on new lines and has completely overcome the objections to other grinders. The knife is held rigidly while the stone travels back and forth. There is no chance for

vibration, consequently no unevenly ground knives. Entirely automatic in ac-

tion, no ropes or chains. All moving parts operated by cut steel gears, noiseless in operation, will grind straight or hollow bevel. Feeds 1-1000 to 4-1000 for each travel of the stone, very heavy and compact, occupying small floor space. Made in seven sizes to grind up to 168 in.

It is fully described in our catalog No. 5, which we will be glad to send to interested parties.



The Coe Manufacturing Co. <sup>105</sup> Bernard Street Painesville, O.



"ALWAYS ON TOP"

**7 McGIFFERT Log Loaders** are now doing the loading for one of the largest operators in the world. He bought the first machine because he *thought* it was the best loader made. He bought the second because, by experience, he *knew* that it was. He bought five more because—well, because he couldn't buy better ones.

Our Booklet Tells You Why.

Manufactured by **CLYDE IRON WORKS, Duluth, Minn.**

C62

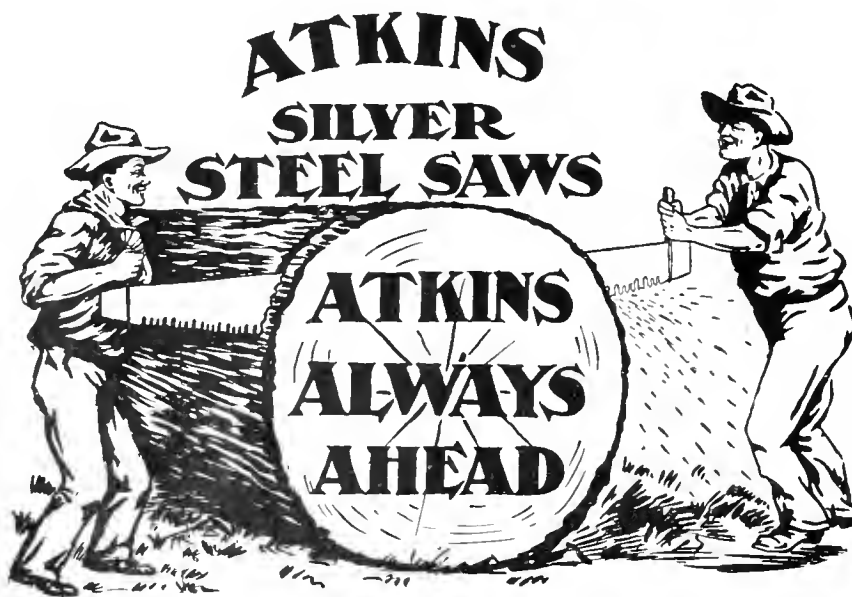

YOU DON'T KNOW HOW GOOD ATKINS' SILVER STEEL CROSS-CUT SAWS ARE UNTIL YOU TRY THEM. WHY DON'T YOU? ORDER TO-DAY. YOU'LL BE DELIGHTED—CAN'T LOSE MUCH—PERHAPS YOU'LL SAVE THEIR COST—MILLIONS HAVE. IT'S WORTH TRYING. WHY DON'T YOU DO IT?

**E. C. ATKINS & CO.**

INCORPORATED

HOME OFFICE AND FACTORY: INDIANAPOLIS, INDIANA

BRANCHES CARRYING STOCK AT CHICAGO, ATLANTA, MEMPHIS, MINNEAPOLIS AND NEW ORLEANS  
ALSO NEW YORK, PORTLAND, SAN FRANCISCO, SEATTLE AND TORONTO.

# R. E. Wood Lumber Company

☞ We own nearly a thousand million feet of virgin poplar, oak, chestnut and other hardwood timber, and operate our own band mills in West Virginia, Tennessee, North Carolina and South Carolina.  
 ☞ Let us figure on your hardwood requirements.

**GENERAL OFFICES:  
 CONTINENTAL BUILDING.**

**Baltimore, Maryland**

# Schultz Brothers & Cowen

WE ARE IN THE MARKET TO BUY

**POPLAR—OAK—ASH—CHESTNUT**

AND OTHER HARDWOODS—ALL GRADES AND THICKNESSES

1225 to 1240 OLD COLONY BUILDING,

CHICAGO

W. H. WHITE, Pres.  
 JAS. A. WHITE, Vice-Pres.

W. L. MARTIN, Secy.  
 THOS. WHITE, Treas.

# W. H. WHITE COMPANY

BOYNE CITY, MICHIGAN

**Manufacturers of Hardwood and Hemlock Lumber, Cedar Shingles,  
 White Rock Maple Flooring.**

# LIDGERWOOD MACHINES

WILL STOCK YOUR MILL

SKIDDERS  
 SNAKERS  
 YARDERS

LOADERS  
 PULL BOATS  
 CABLEWAYS

**LIDGERWOOD MFG. CO.**

96 Liberty St., New York.

NEW ORLEANS

ATLANTA

SEATTLE

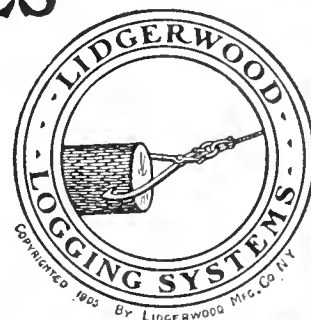

**EASTERN TENNESSEE—WESTERN NO. CAROLINA**

ASHEVILLE KNOXVILLE BRISTOL

**On the Spot**

We are located right in the heart of this mountain country producing the best hardwoods in existence.

We are headquarters with ample stock, and can interest you both as to assortment and price. Write us.

**American Lumber Company**  
ASHEVILLE, N. C.

**Vestal Lumber & Mfg. Co.**

Manufacturers and Wholesalers  
of all kinds of

**HARDWOODS**

BEVELED SIDING A SPECIALTY.  
UNSURPASSED FACILITIES  
FOR DELIVERING.

Knoxville  
Tennessee

**Fry-Buchanan Lumber Co.**

INCORPORATED.

Manufacturers and Wholesalers  
**Hardwood Lumber**

Choicest Varieties. ∴ Full Grades.

POPLAR SQUARES  
A Specialty.

Asheville, N. C.

**HARDWOODS**

From the famous Asheville district.  
Superior in quality, manufacture and gradings. For stock list and prices, address

**J. S. COLEMAN LUMBER CO.**  
ASHEVILLE, N. C.

**All Lumbermen, Attention!**

We do what you can't do.  
We measure your stumpage correctly.  
We make your maps correctly.  
Bank references: Asheville, N. C.

**C. A. Schenck & Co.** Biltmore, North Carolina.

**SYMBOLS for GRADE MARKS**

○ Adopted by the Hardwood Manufacturers Association of United States.

△ Every Manufacturer should stamp the grade on his Lumber.

Ⓚ Set of 10 Rubber Stamps, 1 1/2" x 1 1/4" in size, Pad, Pint of Ink, and Spreader, packed for shipment \$3.50.

**MARTIN & CO.**  
191 S. Clark St., CHICAGO, or  
**LEWIS DOSTER, Sec'y**

Panel and Wide No. 1  
Wide No. 2  
Box Boards  
FAS or Firsts & Seconds  
Saps

1535 First Nat. Bank Bldg.  
CHICAGO

Selects  
No. 1 Common  
No. 2 Common  
No. 3 Common  
No. 4 Common

**Wood Working Plants**

Manufacturers seeking locations for Saw Mills, Stave and Heading Factories and other Wood Working Plants in the Central Southern States, can secure full and accurate information as to Sites, Timber Tracts, Fuel, Transportation Facilities, etc., by addressing

G. A. PARK, General Immigration and Industrial Agent,  
**Louisville & Nashville Railroad Company**  
LOUISVILLE, KENTUCKY

**Industries are Offered Locations**

WITH SATISFACTORY INDUCEMENTS, FAVORABLE  
FREIGHT RATES, GOOD LABOR CONDITIONS  
HEALTHFUL COMMUNITIES, on the lines of

**The Illinois Central R. R. and the  
Yazoo & Mississippi Valley R. R.**

For full information and descriptive pamphlet address  
J. C. CLAIR, Industrial Commissioner, 1 Park Row, Chicago, Ill.

**CLEVELAND**

HARDWOOD DISTRIBUTING CENTER OF NORTHERN OHIO

**Do You Want It?  
What?  
Money?**

What have you in lumber to exchange for it? We want particularly Plain Oak, Chestnut, Poplar, Basswood, Ash.

**What Have You?**

**The Advance Lumber Co.**

13th Floor  
Rockefeller Bldg. CLEVELAND, OHIO

Memphis Office, No. 56 Randolph Building.

J. E. MEADOWS, Mgr.

**THE  
ROBERT H. JENKS LUMBER  
COMPANY**

**FOR SALE**

60 M feet 1" 1st and 2ds Poplar  
223 M feet 1" No. 1 Common Poplar  
125 M feet 1" No. 2 Common Poplar  
25 M feet 2" 1st and 2nd Poplar, 14" and up  
125 M feet 8 4" Sound Wormy Chestnut  
275 M feet 1" Sound Wormy Chestnut  
153 M feet 1" 1st and 2nd Plain White Oak  
85 M feet 1" 1st and 2nd Plain Red Oak  
125 M feet 1" No. 1 Common Plain Red Oak

**Quartered White and Red Oak.**—We have a good assortment of dry stock,  $\frac{3}{8}$  to  $\frac{1}{2}$  inches thick. Your inquiries solicited.

**Plain White and Red Oak.**—A limited amount of nice stock, ready for shipment.

**FRAMES FOR HARDWOOD RECORD SUPPLEMENTS**

Complete with backing, but without the glass, made from Flemish Oak, are to be had delivered by express, charges prepaid to any point east of the Missouri river, at 50 cents each; or at the HARDWOOD RECORD office, at 30 cents each. Prepay orders with two-cent stamps or postal notes, addressed

Hardwood Record, 355 Dearborn Street, Chicago

**The Martin-Barriss Company**

Importers and Manufacturers

**MAHOGANY**

**and Fine Hardwoods**

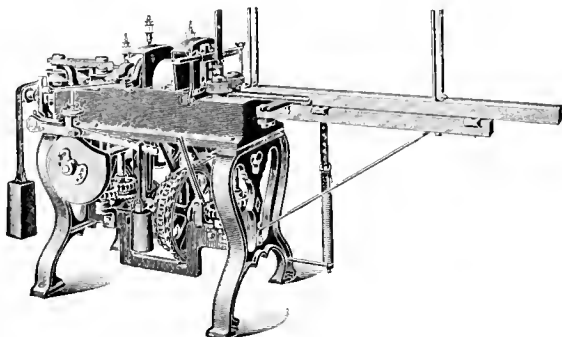

This is a cut of the **No. 10 OBER LATHE** for Turning Fork, Hoe, Rake, Mop, Broom and Ice Hook Handles, Pike Poles, Trolley Poles, Tent Poles, Curtain Poles, Chair Bows, Dowels, Rods and similar work.

**Simple, Strong, Durable,  
Economical**

We also manufacture other Lathes for making Spokes, Handles, and Variety Work, Sanders, Shapers, Boring and Chucking Machines, etc., etc. Complete Catalogue and Price List Free.

**THE OBER MFG. CO., No. 28 Bell St., CHAGRIN FALLS, O., U. S. A.**



# WISCONSIN

WHERE THE FINEST NORTHERN HARDWOODS GROW



## R. CONNOR CO.

WHOLESALE MANUFACTURERS

**Wisconsin  
Hardwood**

PINE AND HEM-  
LOCK LUMBER

Mills at  
Auburndale, Wis., on W. C. R. R.  
Stratford, Wis., on C. & N. W. R. R.

**Marshfield, Wis.**

## Wisconsin Veneer Co.

RHINELANDER, WIS.

Largest and best equipped Veneer  
cutting plant in the country. High-  
grade product from Birch, Maple,  
Elm, Basswood, Ash and other na-  
tive woods.

**Veneers for Door Work a Specialty.**

# Mason-Donaldson Lumber Co.

Manufacturers and Wholesalers

## Northern Hardwoods

Birch a specialty

Rhineland, - - - Wisconsin

## North Western Lumber Co.

General Offices  
EAU CLAIRE, WIS.

Mills at  
STANLEY, WIS.

Band Sawed

# Wisconsin Hardwoods

Careful Gradings,  
Prompt Shipments.

**SPECIAL OFFERINGS**

- 1 Car 1½ inch No. 1 Common Basswood.
- ½ Car 1¼ inch No. 1 Common Basswood.
- ½ Car 2½ inch 1st and 2nd Clear Basswood.
- 1 Car 1½ inch 1st and 2nd Clear Basswood.
- 1 Car 1¼ inch, 1½ inch and 2 inch No. 3 Soft Elm.

## LOCATIONS FOR NEW INDUSTRIES

can be secured on the lines of the

### Chicago, Milwaukee & St. Paul Railway

in the great middle west. It reaches the Copper Country and the  
pine and hardwood areas of Northern Michigan, the lead, zinc and  
iron regions of Wisconsin, the coal fields of Illinois, Iowa and  
Missouri.

Traverses the great agricultural and manufacturing states of  
Iowa, Minnesota, North and South Dakota. Operates 7,000 miles of  
thoroughly equipped railroad.

Correspondence is solicited with eastern manufacturers who de-  
sire to move their factories to, or establish branches in the West.  
Co-operation with Business Men's Associations on the lines of this  
railway in all matters affecting mutual interests is assured.

Inquiries should be as definite as possible.

*Address*

**Industrial Department**  
**Chicago, Milwaukee & St. Paul Railway,**  
**Room 1327, Railway Exchange**  
**Chicago**

# WISCONSIN

WHERE THE FINEST NORTHERN HARDWOODS GROW

## ARPIN HARDWOOD LUMBER CO.

GRAND RAPIDS, WISCONSIN

Saw and Planing Mill at Atlanta, near Bruce, on the Soo Line. Offer

- |                                      |   |
|--------------------------------------|---|
| 5 cars 1" 1st & 2d Red Birch.        | 2 cars 3" Clear Plain Birch Flooring.   |
| 1 car 1 1/2" 1st & 2d Red Birch.     | 1 car 3" Clear Red Birch Flooring.      |
| 1 car 1 1/2" Common Red Birch.       | 1 car 3" Factory Birch Flooring.        |
| 1 car 1 1/2" 1st & 2d Red Birch.     | 1 car 3" Red Oak Factory Flooring.      |
| 1,000' 1 1/2" Common Red Birch.      | 1 car 1 1/4 & 1 1/2" quarter sawed Com. |
| 2,500' 1 1/2" Com. & Btr. Red Birch. | and Btr. Red Oak.                       |
| 5,000' 2" 1st & 2d Red Birch.        | 1/2 car 1 3/4 and 2" Com. & Btr. quar-  |
| 2 cars 2 1/2 & 3" Plain Birch.       | ter sawed Red Oak.                      |
| 2 cars 2 1/2 & 3" Log Run Unselected | 1 car 5" Clear quarter sawed Red        |
| Birch.                               | Oak Flooring.                           |
| 5 cars 1" Common Red Birch.          | 1/2 car each 1 1/2" Com. & Clear Maple  |
| 1 car 2" Plain Log Run Birch.        | Flooring.                               |

We make a specialty of high grade Maple, Birch and Oak Flooring, Basswood, Pine Siding, Ceiling and Finish; also Moulding.

## VOLLMAR & BELOW

MARSHFIELD, WISCONSIN

### Basswood, Birch

and Other Wisconsin Hardwoods

LET US KNOW WHAT YOU ARE IN THE MARKET FOR

## Wagstaff Lumber Oshkosh

### WISCONSIN BASSWOOD

Early sawed; good color; choice stock; log run or on grade

### WISCONSIN BIRCH

All grades

Ask for my prices on any other Wisconsin hardwoods before placing your orders.

## For Sale:

NATIONAL INSPECTION

- 3,000,000 ft. inch Birch.
- 100,000 ft. inch Black Ash.
- 50,000 ft. inch Soft Elm.
- All No. 1 Common and Better.
- 20,000 ft. 1x4 and wider, 6 ft., 1st & 2nd Birch.

## Dells Lumber & Shingle Co.

EAU CLAIRE, WISCONSIN

## C. P. CROSBY

RHINELANDER : : WISCONSIN

### Wholesale Hardwood Lumber

Hard Maple a Specialty in all thicknesses from 1 inch to 4 inch. Finest Birch in Wisconsin. Black Ash, Rock Elm, Soft Elm, Red and White Oak. : :

DIFFICULT AND MIXED ORDERS A SPECIALTY

## HARDWOOD LUMBER--NORTHERN AND SOUTHERN

All kinds of Northern and Southern Hardwoods for sale.

We call your attention to the following items which we have to offer, to-wit:

- |  |  |
|--|--|
| 50M ft. 1" Curly Birch                   | 30M ft. 1 1/2" No. 2 Com. & Bet. Hickory |
| 50M ft. 2" Com. and Bet. Plain Birch     | 30M ft. 1 1/2" No. 2 Com. & Bet. Hickory |
| 80M ft. 2 1/2" Com. and Bet. Plain Birch | 100M ft. 1" Com. & Bet. Plain Red Oak    |
| 150M ft. 1" No. 1 Com. Plain Birch       | 150M ft. 1" Com. & Bet. Qtd. Red Oak     |
| 12M ft. 2" 1sts and 2nds Red Birch       | 10M ft. 1" No. 3 Com. & Bet. Walnut      |
| 200M ft. 1" Com. and Bet. Hard Maple     | 75M ft. 1 1/2" No. 2 Com. & Bet. Elm     |
| 200M ft. 2" Com. and Bet. Hard Maple     | 150M ft. 1" No. 1 Com. Red Gum           |
| 50M ft. 2" Bridge Plank - Oak            |  |

In addition to the foregoing, we have full stocks of Basswood, Birch and Soft Elm and a full selection of Red and Sap Gum. We guarantee our grades to be made strictly in accordance with National Hardwood Association rules of inspection.

**G. W. JONES LUMBER CO., Appleton, Wis.**

CHICAGO OFFICE: 1717 RAILWAY EXCHANGE.

## John R. Davis Lumber Company

PHILLIPS, WISCONSIN

The Leading Manufacturers

## Wisconsin Hardwoods

"SHAKELESS" HEMLOCK and WHITE CEDAR PRODUCTS

WE HAVE THE FINEST BLOCK OF

4-4 UNSELECTED BIRCH

ON THE MARKET

Write for our Price Lists and Stock Sheets



Mixed Cars, Even Grades Prompt Shipments



WAUSAU, WIS.

## BASSWOOD, BIRCH

We cut four million feet of each annually  
Your inquiries and orders solicited

MILL AND YARDS AT INGRAM, WISCONSIN

# MICHIGAN

FAMOUS FOR HARD MAPLE AND GREY ELM

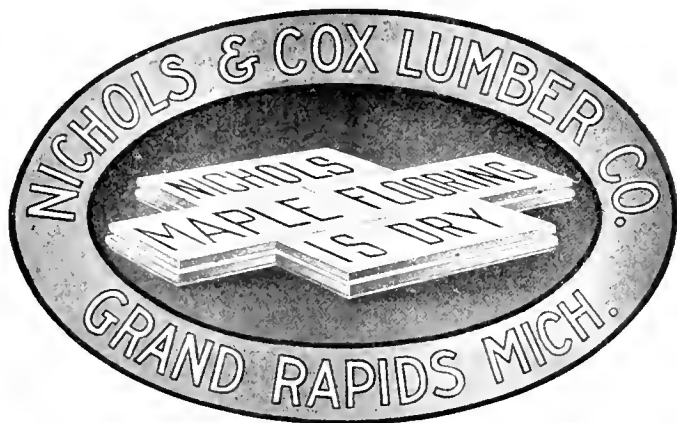

## BROWNLEE & COMPANY

DETROIT MICHIGAN

Some "snaps" we are offering:

<b>BASSWOOD</b>	4 4 1sts and 2nds, including one car 1x12 and wider.
<b>BIRCH</b>	4 4 Log Run; also No. 1 and No. 2 Common.
<b>HARD MAPLE</b>	3-inch No. 1 Common; 6 4 and 8 4 1sts and 2nds.
<b>WHITE ASH</b>	4 4 No. 1 Common and better; rather narrow, but very cheap.

All Bone Dry and at Bargain Prices to Close Out.

### Special bargains in the following:

200 M 4-4 No. 2 C & B Birch  
 50 M 8-4 No. 1 C & B Birch  
 100 M 4-4 No. 2 C & B Grey Elm  
 50 M 8-4 No. 1 C & B Grey Elm  
 140 M 4-4 No. 2 C & B Beech  
 500 M 4-4 No. 2 C & B Maple  
 50 M 8-4 No. 2 C & B Maple

Above piled for water shipment, but the 4-4 Beech and 8-4 Maple can be shipped by rail. Write us for prices.

The North Shore Lumber Co. THOMPSON, MICHIGAN

## DENNIS & SMITH LUMBER CO.

Wholesale Hardwood Lumber

Office and Yards, FOURTH AND HOLDEN AVENUES,  
 DETROIT, MICH.

MILLS AT: Heaters, W. Va. Valley Bend, W. Va. Diana, W. Va. Parkersburg, W. Va. McNutt Siding, W. Va.

## SALLING, HANSON & CO.

MANUFACTURERS OF

### Michigan Hardwoods

GRAYLING, MICHIGAN

## "Chief Brand" Maple Flooring

Will commend itself to you and your trade on its merits alone. \* Comprises all the features desirable in good flooring. \* Made by the latest, most approved machinery methods and best skilled labor. \* We believe we can make it to your interest to handle our "Chief Brand" and will appreciate your inquiries.

Kerry & Hanson Flooring Co.  
 GRAYLING, MICHIGAN

## Michigan Logging Wheels

Have Made More Than 1,000 and Know How.



Standard for a Quarter Century

Cheap and easy logging. Write for circular & prices.

S. C. OVERPACK

MANISTEE, MICH.

## Evans & Retting Lumber Co.

Manufacturers and Wholesale Dealers

### Hardwood Lumber

RAILROAD TIMBERS, TIES AND SWITCH TIES

541 and 543 Michigan Trust Building Grand Rapids, Mich.

**M I C H I G A N**  
FAMOUS FOR RED BIRCH AND BASSWOOD

**BIRCH**

WE WANT YOUR ORDERS FOR  
**4-4 and 5-4 No. 1 Common Birch**  
A No. 1 STOCK

**Simmons Lumber Company**  
SIMMONS, MICHIGAN

**McCLURE LUMBER COMPANY**

MANUFACTURERS OF  
**Hardwoods**

Main Offices, : DETROIT, MICH.  
Mills, : EUTAW, ALA.

SPECIAL OFFERINGS:

5 cars 1" 1st & 2nds & Com. Qtd. White Oak	10 cars 1" Log Run Brown Ash
2 cars 2 1/2, 3 and 4" White Ash	10 cars 1" to 4" Dry Hard Maple
2 cars 1" White Ash	10 cars 1" Log Run Birch
1 car 1 1/2 and 2" No. 1 Com. Brown Ash	10 cars 1" Log Run Basswood
4 cars 2, 3 and 4" 1st and 2nds and No. 1 Com. Green White Oak	
2 cars 2" Log Run Soft Elm	

**SOFT ELM AND ROCK ELM**  
FOR SALE BY  
**The R. G. Peters Salt & Lumber Co.**  
EASTLAKE, MICHIGAN

 **J. S. GOLDIE**  
Cadillac, : : Michigan.

SPECIAL PRICES on 500M pieces  
1" to 3" Maple Squares 16" to 27" long.  
1" to 3" Soft Elm Lumber.

INQUIRIES SOLICITED FOR MICHIGAN LUMBER.

**BOYNE CITY LUMBER COMPANY**  
BOYNE CITY  
**MICHIGAN ROCK MAPLE and other HARDWOODS**  
LARGE CAPACITY    PROMPT SHIPMENTS    RAIL OR CARGO

**VAN KEULEN & WILKINSON LUMBER COMPANY**  
Manufacturers and Wholesalers of  
**HARDWOOD LUMBER and CRATING STOCK**  
Complete Stocks of Michigan Hardwoods—Maple, Beech, Birch, Elm,  
Ash and Basswood for sale.

Grand Rapids, : : : Michigan

**Do You Need Maple Flooring?**

Then send us your order and you will receive  
a product that is not excelled.

We manufacture by  
**A SPECIAL PROCESS**

This costs us more but our prices are as low as of  
any other first-class manufacturer.

We also have a stock of firsts and seconds Maple 4-4, 5-4, 6-4,  
8-4 and 10-4, which is bone dry and very fine.

**Haak Lumber Co., Haakwood, Mich.**

**Hackley-Phelps-Bonnell Co.**

MANUFACTURERS OF

**Northern and Southern  
Hardwood Lumber**

Main Office, Michigan Trust Company Building  
GRAND RAPIDS : : : MICHIGAN

**DENNIS BROS.**  
GRAND RAPIDS, : : : MICHIGAN

**HARDWOOD LUMBER (by water or rail)**  
**"NATIONAL" MAPLE & BIRCH FLOORING**

SPECIAL BARGAINS IN THE FOLLOWING:

300M feet 4 4 Log Run Birch	Main Office : 205-209 Michigan Trust Company Building
186M feet 5 4 Log Run Birch	
1 Car 8 4 No. 1 Com. Birch	
1 Car 1 4 Clear Birch	
50M feet 4 4 No. 1 Com. Sap Birch	
40M feet 4 4 No. 1 Com. Red Birch	
All thicknesses and grades Hard Maple	
150M feet 5 4 Log Run Beech	
2 Cars 4 4 No. 3 Com. Cherry	

**Thos. MacBride Lumber Company**

HEADQUARTERS FOR  
**HARDWOODS**  
IN MICHIGAN

Michigan Trust Building, Grand Rapids, Mich.

# CINCINNATI

THE GATEWAY OF THE SOUTH

## THE HOUSE OF STONE

The One of Good Grades and Prompt Shipments  
Solicits Your Inquiries for  
Yellow Poplar, Oak, Chestnut, Cottonwood, Ash, Basswood,  
Cherry and Gum

T. B. STONE LUMBER CO. Mfrs. and Wholesalers  
CINCINNATI, O.

## "BUY GUM"

We are in the market to buy  
Dry Gum Lumber in any  
quantity, from a single car  
load to a million feet. Will  
take all grades and thick-  
nesses. We receive lumber  
at shipping point, pay cash  
and are liberal in inspection.



## THE FARRIN-KORN LUMBER COMPANY

General Office, Yards,  
Planing Mills, Dry Kilns,  
Cincinnati, Ohio  
Purchasing Office,  
Randolph Building,  
Memphis, Tenn.

Cypress Red Gum Oak

## PLAIN OAK—BASSWOOD

Are what we want. All thicknesses and grades. Spot  
cash. Send us list of your offerings with prices.

DUHLMEIER BROS., CINCINNATI, O.

## CYPRESS LUMBER CO.

Manufacturer of Hardwoods and Cypress

Main and Quartered White and Red Oak, Yellow Poplar,  
Yellow Pine, Walnut, etc. Mills in Tenn., Ala. and Va.

OFFICE AND YARDS, GEST AND DALTON AVE., CINCINNATI, OHIO.

## OUR AIM is to ship the highest standard of lumber at lowest consistent price

We are manufacturers and ship direct from our band mills

Oak Chestnut  
Poplar Basswood  
Ash Yellow Pine  
**W. H. & G. S. Stewart**  
Main Office: Cincinnati, Ohio, U. S. A.

FRAMES,  
SASH, DOORS,  
BLINDS, MOULDINGS,  
COLUMNS, GLASS,  
STAIRWORK,  
INTERIOR TRIM.



PAINTS,  
BUILDERS' HARDWARE,  
MANTELS, ETC.  
LARGE CINCINNATI FAC-  
TORIES MAKE PROMPT  
SHIPMENTS POSSIBLE.

## LANE-WHITE LUMBER CO.

OAK, ASH AND WALNUT **Hardwoods** ALWAYS IN THE MARKET  
OUR SPECIALTY FOR WALNUT LOGS

MAIN OFFICE AND BAND MILL at FORT SMITH, ARK.

## THE GENERAL LUMBER COMPANY

**HARDWOODS**

HEMLOCK, YELLOW PINE.

COLUMBUS

OHIO

# W. H. Dawkins Lumber Co.

Manufacturers of Band Sawed

## Yellow Poplar

ASHLAND, KY.

## KNIVES

A man who has been in the presence of angels discloses the fact  
by his action: Just one reason for our talking good machine  
knives, good veneer knives or knives of any kind that do good work.

CHAMPION SAW COMPANY,

BEAVER FALLS, PA.

**CINCINNATI**

THE GATEWAY OF THE SOUTH

**THE  
MALEY, THOMPSON & MOFFETT CO.**

Always in the Market for  
**BLACK WALNUT LOGS,  
SELECTED WHITE OAK LOGS,  
LUMBER OF ALL KINDS.**

CINCINNATI, : : : OHIO

**THE E. E. BECK LUMBER COMPANY**

Cash Buyers

**Poplar, Oak, Chestnut**

And Other Southern Hardwoods

ALL GRADES AND THICKNESSES.

WE BUY MILL CUTS.

Poplar, Oak,  
Ash, Chestnut,  
Sycamore,

**C. Crane & Co.**

We would like to buy

**2,000,000 feet Dry Oak  
2,000,000 feet Dry Poplar**

W. Va. Spruce,  
Pine and Elm

Mostly heavy stock. Quotations Solicited.

MILLS AND YARDS  
CINCINNATI, O.

YEARLY CAPACITY  
100,000,000 FT.

LONG BILL STUFF  
A SPECIALTY

IF YOU HAVE IT TO SELL, WRITE US

**POPLAR**

ROUGH AND DRESSED

Will take any quantity, from a carload to ten million feet.  
Will receive at shipping point when quantity justifies.

**KENTUCKY LUMBER CO.**

CINCINNATI, OHIO

**L. W. RADINA & COMPANY**

Correspondence Solicited with Buyers and Sellers of All Kinds of

**HARDWOODS**

Wanted for cash—desirable blocks of 1 inch to 4 inch Poplar, all grades,  
Especially 1½-inch stock, for immediate shipment.

CLARK STREET AND DALTON AVENUE

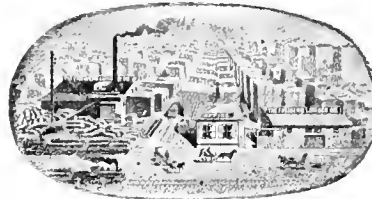

**THE FREIBERG LUMBER CO.**

Manufacturers of

**Tabasco Mahogany  
Walnut, Oak**

Poplar, McLean and Findlay Aves.  
CINCINNATI, O.

IN THE MARKET FOR

**OAK—ASH—POPLAR**

ALL GRADES AND THICKNESSES

**MOWBRAY & ROBINSON**

Office:  
1219 West Sixth Street

Yards:  
Sixth Street, below Harriet

WHAT HAVE YOU FOR SALE IN

Red and White **OAK** Qtd. and Plain

ALSO POPLAR, CHESTNUT, WALNUT, ETC.

**JOHN DULWEBER & CO., CINCINNATI, OHIO**

Cash buyers for stock in our line.

**Cincinnati Hardwood Lumber Co.**

GEST AND SUMMER STREETS

Wholesalers Mahogany, Thin Lumber, Veneers

Finely figured quarter sawed oak veneers a specialty.

**THE WIBORG & HANNA COMPANY**

CINCINNATI, OHIO

PLAIN  
AND  
QUARTER  
SAWED

**White and Red Oak**

CHESTNUT  
POPLAR  
GUM AND  
CYPRESS

Flooring, Siding, Ceiling, Base, Case and Molding. Rough, Dressed and Re-sawed. Mixed Carloads.





# INDIANA



WHERE THE BEST HARDWOODS GROW

THE WOODS FOR  
WHICH INDIANA  
IS FAMOUS.

Quart'r'd White Oak

Plain White Oak

Quartered Red Oak

Plain Red Oak

White Ash

Poplar

Black Walnut

Cherry

Sycamore

Red Gum

Hickory

Beech

Maple

Veneers of

Indiana Hardwoods

## CHARLES H. BARNABY

Manufacturer of Band Sawed Hardwoods

Quarter Sawed Indiana White Oak a Specialty

GREENCASTLE, IND.

## D'HEUR & SWAIN LUMBER CO.

Manufacturers and Wholesalers

Our Specialty Quartered Oak and Sycamore

SEYMOUR, IND.

## LONG-KNIGHT LUMBER CO.

MANUFACTURERS AND DEALERS

Quarter Sawed White and Red Oak a Specialty

INDIANAPOLIS, IND.

## MALEY & WERTZ

Manufacturers, Wholesalers and Exporters of Hardwood Lumber

EVANSVILLE, IND.

## FULLERTON-POWELL HARDWOOD LUMBER CO.

SOUTH BEND, IND.

## PERRINE-ARMSTRONG CO.

Long Timber up to 60 feet—Hardwood Specialties

The largest Band Mill in Indiana.

FORT WAYNE, IND.

## J. V. STIMSON

All Kinds of Hardwood Lumber Manufactured

HUNTINGBURG, IND.

## YOUNG & CUTSINGER

Manufacturers and Wholesalers

Our Specialty Fine Figured Quartered Oak

EVANSVILLE, IND.

# BUFFALO

THE GREAT WHOLESALE LUMBER CENTER OF THE EAST



Manufacturers and Dealers in

Ash

White and Brown

Basswood

Birch

Red and White

Butternut

Cherry

Chestnut

Cottonwood

Cypress

Elm

Soft and Rock

Gum

Red and Tupelo

Hickory

Maple

Hard and Soft

Red Oak

Plain and Quartered

White Oak

Plain and Quartered

Black Walnut

White Wood

Poplar



## ANTHONY MILLER

HARDWOODS OF ALL KINDS

893 EAGLE STREET

## SCATCHERD & SON

HARDWOODS ONLY

Yard, 1555 SENECA STREET

Office, 886 ELLICOTT SQUARE

## STANDARD HARDWOOD LUMBER CO.

OAK, ASH AND CHESTNUT

1075 CLINTON STREET

## I. N. STEWART & BROTHER

Specialties: CHERRY AND OAK

892 ELK STREET

## T. SULLIVAN & COMPANY

Specialties: BROWN ASH, BIRCH, PACIFIC COAST FIR AND SPRUCE

50 ARTHUR STREET

## ORSON E. YEAGER

Specialties: OAK, ASH AND POPLAR

932 ELK STREET

## BEYER, KNOX & COMPANY

ALL KINDS OF HARDWOODS

Office and Yards, 69 LEROY AVENUE

## BUFFALO HARDWOOD LUMBER CO.

We want to buy for cash:

Oak, Ash and other Hardwoods, all grades and thicknesses.

Will receive and inspect stock at shipping point.

518 RANDOLPH BLDG., MEMPHIS, TENN.

940 SENECA STREET.

## EMPIRE LUMBER COMPANY

Our specialties are PLAIN and QUARTERED OAK and ASH.

1142 SENECA STREET.

## G. ELIAS & BROTHER

BUY AND CARRY LARGE QUANTITIES OF ALL KINDS OF HARDWOODS

955 TO 1015 ELK STREET

## HUGH McLEAN LUMBER COMPANY

Specialty: INDIANA WHITE OAK

940 ELK STREET

# Vansant, Kitchen & Co.

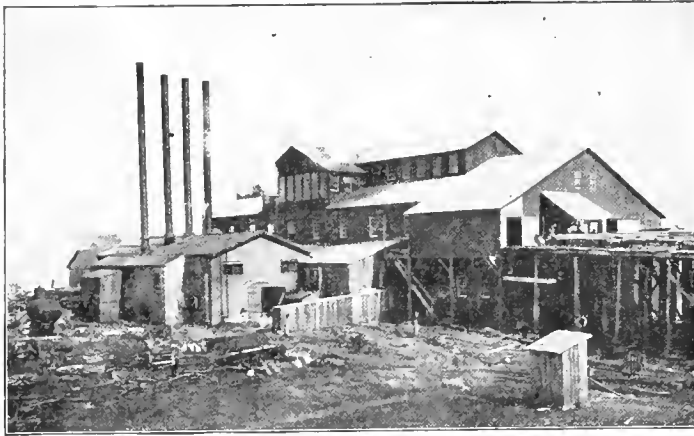

NEW ASHLAND MILL

Old-Fashioned

## SOFT YELLOW POPLAR

Ashland, Ky.

5-8 AND 4-4 IN WIDE STOCK, SPECIALTY

# YELLOW POPLAR

Manufacturers  
BAND SAWED  
POPLAR LUMBER

ALL GRADES

**DRY** 5-8, 4-4, 5-4, 6-4, 8-4, 10-4, 12-4, 16-4  
Bevel Siding, Lath and Squares  
Specialty, Wide Stock.

# LUMBER CO.

COAL GROVE, OHIO, U. S. A.

## W. M. Ritter Lumber Company

COLUMBUS, OHIO

### 6,000 Car Loads

Sawed and shipped yearly of band-sawed Yellow Poplar, White Pine, White Oak, Basswood, Chestnut, Hemlock and Ash. Planing Mills and Dry Kilns. ☞ If you are in a hurry to get your order placed, call our nearest salesman.

Salesman	Headquarters	Telephone
Fred A. Wilson.....	Portsmouth, Ohio.....	Bell 4392
E. E. Eaton.....	New York City, 158 W. 81st St.....	Riverside 7390
James B. Patton.....	Buffalo, N. Y., Rockford Hotel.....	Bryant 1335-R
A. Wallace Irwin.....	Baltimore, Md., Eutaw Hotel.....	
Frank B. Pryor.....	Pittsburgh, Pa., 7th Avenue Hotel.....	
E. E. Ginn.....	Jamestown, Ohio.....	Bell Phone
A. J. Williams.....	Cleveland, Ohio, Eastman, Detroit St.....	Ridge 593-R
L. G. Anderson.....	Franklin, Ohio.....	Bell 482
James H. Lang.....	Detroit, Mich., Hotel Ste. Claire.....	
W. H. Matthias.....	Chicago, Ill., 1448 Addison St.....	Lakeview 1493
Geo. H. Haganir.....	Philadelphia, Pa., 901 N. 50th St.....	
F. H. Browning.....	Columbus, Ohio.....	Main 7874
W. T. Baker.....	Graham, Va.....	

# Hardwood Record

Eleventh Year.  
Semi-monthly.

CHICAGO, OCTOBER 10, 1906.

{ Subscription \$2.  
{ Single Copies, 10 Cents.

## CHERRY

C. E. LLOYD, JR.  
Manager Sales

## RIVER

GROWS IN  
WEST VIRGINIA

Sold by  
Cherry River Boom &  
Lumber Co.  
Offices: Philadelphia, Pa.

## LUMBER

## Himmelberger-Harrison Lumber Co.

## Red Gum Specialists

Morehouse.

Missouri

Why not grasp the opportunity for saving in cost of your insurance? Make a trial and be convinced.

## The Lumber Mutual Fire Insurance Company

Of Boston, Mass., 141 Milk Street.

CASH DIVIDENDS TO POLICY HOLDERS NOW 33 1/3 PER CENT.

## RUMBARGER LUMBER COMPANY

<p><b>Ash.</b> 1 car 4/4, F'tle 5/4, some 8/4, Nos. 1 &amp; 2 &amp; No. 1 Common.</p> <p><b>Basewood.</b> 30 cars 4/4, log run. 1/3 car 5/4, log run.</p> <p><b>Beech.</b> 5 cars 4/4, log run; choice stock. 17 cars 4/4, log run; wormy stock.</p> <p><b>Birch.</b> 71 cars 4/4, log run. 4 cars 5/4, log run. 3 cars 6/4, log run. 12 cars 8/4, log run.</p> <p><b>Cherry.</b> 20 cars 4/4, log run. 1/2 car 8/4, log run. Choice wide stock. Will sell on grades.</p> <p><b>Cucumber.</b> 3 cars 4/4, log run.</p> <p><b>Maple.</b> 5 cars 5/4, log run. 10 cars 6/4, log run. 33 cars 4/4, log run. 11 cars 8/4, log run.</p> <p><b>Chestnut.</b> 5 cars 4/4, Nos. 1 &amp; 2 &amp; No. 1 Common. 1 car 4/4 &amp; 8/4, Nos. 1 &amp; 2 and No. 1 common; half 8/4.</p>	<p>7 cars 4/4, sound wormy. 2 cars 6/4, sound wormy.</p> <p><b>Plain Red Oak.</b> 1 1/2 cars 4/4, Nos. 1 &amp; 2. 3 cars 4/4, Nos. 1 &amp; 2 &amp; No. 1 Com. 3 cars 6/4, Nos. 1 &amp; 2 &amp; No. 1 Com. 1 car 4 1/4 &amp; 5/4, Nos. 1 &amp; 2 and No. 1 common; half each thickness.</p> <p>1 1/2 cars 4/4, No. 1 Common. 1 car 4/4, No. 2 Common. 8 cars 4/4, log run.</p> <p><b>Plain Red and White Oak.</b> 1 car 4/4, Nos. 1 &amp; 2. 3 cars 4/4, No. 1 Common. Mostly red oak, only small percent white oak.</p> <p><b>Plain White Oak.</b> 1 car 4/4, Nos. 1 &amp; 2 &amp; No. 1 Common. 1/2 car 4/4, No. 1 Common. 2 cars 4/4, No. 2 Common. 2 cars 4/4, log run.</p> <p><b>Plain White and Red Oak.</b> 1 car 5/4, 6/4 &amp; 8/4, Nos. 1 &amp; 2 &amp; No. 1</p>	<p>Common; mostly W. O. only small percent R. O.</p> <p>1 car 8/4, Nos. 1 &amp; 2 &amp; No. 1 Common; mostly W. O., only small percent R. O.</p> <p>3 cars 4/4, log run; mostly W. O., only small percent R. O.</p> <p>4 cars 4/4, No. 2 common, 1/2 each white oak and red oak.</p> <p><b>Quartered Red Oak.</b> 1 car 4/4, Nos. 1 &amp; 2. 1 car 4/4, clear strips (narrow). 4 cars 4/4, No. 1 Common.</p> <p><b>Quartered White Oak.</b> 1 car 4/4, Nos. 1 &amp; 2. 2 cars 4/4, clear strips (narrow). 9 cars 4/4, No. 1 Common.</p> <p><b>White Pine.</b> 230,000 ft. 4/4, log run. 46,000 ft. 6/4, log run. 46,000 ft. 8/4, log run. 1,000,000 ft. 4/4 to 8/4 sorted as to grades and widths; rough or worked.</p>	<p><b>Poplar.</b> 2 cars 5/8, Nos. 1 &amp; 2. 4 cars 4/4, Nos. 1 &amp; 2. 1/2 car 5/4, Nos. 1 &amp; 2. 1 car 8/4, Nos. 1 &amp; 2. 9 cars 4/4, clear saps. 1/2 car 5/4, clear saps. 7 cars 4/4, No. 1 Common. 3 cars 5/4, No. 1 Common. 1 1/2 cars 6/4, No. 1 Common. 2 cars 8/4, No. 1 Common. 7 cars 4/4, No. 2 Common. 4 cars 6/4, No. 2 Common. 1 car 16/4, Nos. 1 &amp; 2 &amp; No. 1 Common. 11 cars 4/4, log run. 1 car 4/4, Nos. 1 &amp; 2, 24" to 36" wide. Clear Spruce. 1/3 car 7/8. 1 car 8/4. 1 car 4/4.</p> <p><b>Spruce Box.</b> 30 cars 4/4, rough. 10 cars 4/4, S 2 S. 5 cars 4/4, S 1 S.</p>
---	--	---	---

Main Office: 808 Harrison Bldg., 15th and Market Sts., Philadelphia, Pa.      New York Office: 8018 Metropolitan Bldg., 1 Madison Av.      Pittsburgh Office, 701 Keystone Bldg.

The combined facilities of the stock lumber insurance companies

## LUMBER INSURANCE COMPANY OF NEW YORK

## and the ADIRONDACK FIRE INSURANCE COMPANY

and allied organizations, constitute a great insuring opportunity for any owner of a first-class lumber or mill risk. Ask for lines and rates.

LUMBER INSURERS GENERAL AGENCY, Underwriting Managers

66 Broadway, New York

# LOUISVILLE

MANUFACTURING AND DISTRIBUTING CENTER OF KENTUCKY

## Dry Stock **W. P. Brown & Sons Lumber Co.** Louisville, Ky.

<b>PLAIN RED OAK.</b>	14,000' 1½" 1st & 2d.	50,000' 2" No. 1 Com.	<b>ASH.</b>	12,000' 1¼" 1st & 2d.
55,000' 1" 1st & 2d.	5,000' 2" 1st & 2d.	17,000' 2½" No. 1 Com.	9,000' 1" 1st & 2d.	11,000' 1½" 1st & 2d.
25,000' 1¼" 1st & 2d.	15,000' 1" No. 1 Com.	22,000' 3" No. 1 Com.	65,000' 1¼" 1st & 2d.	12,000' 2" 1st & 2d.
49,000' 1½" 1st & 2d.	7,000' 1½" No. 1 Com.		16,000' 1½" 1st & 2d.	10,000' 2½" 1st & 2d.
57,000' 2" 1st & 2d.	13,000' 2" No. 1 Com.	<b>QUARTERED WHITE OAK.</b>	10,000' 2" 1st & 2d.	10,000' 3" 1st & 2d.
18,000' 2½" 1st & 2d.		50,000' 1" 1st & 2d.	8,000' 2½" 1st & 2d.	50,000' 1" No. 1 Com.
16,000' 3" 1st & 2d.	<b>PLAIN WHITE OAK.</b>	28,000' 1¼" 1st & 2d.	14,000' 3" 1st & 2d.	28,000' 1¼" No. 1 Com.
131,000' 1" No. 1 Com.	80,000' 1" 1st & 2d.	45,000' 1½" 1st & 2d.	6,000' 4" 1st & 2d.	10,000' 1½" No. 1 Com.
84,000' 1¼" No. 1 Com.	28,000' 1¼" 1st & 2d.	49,000' 2" 1st & 2d.	4,000' 1¼" No. 1 Com.	10,000' 2" No. 1 Com.
44,000' 1½" No. 1 Com.	12,000' 1½" 1st & 2d.	10,000' 2½" 1st & 2d.	16,000' 1½" No. 1 Com.	15,000' 1" 18" & up 1st & 2d.
47,000' 2" No. 1 Com.	42,000' 2" 1st & 2d.	18,000' 1" No. 1 Com.	8,000' 2" No. 1 Com.	8,000' 2" 18" & up 1st & 2d.
8,000' 2½" No. 1 Com.	23,800' 2½" 1st & 2d.	30,000' 1¼" No. 1 Com.	<b>POPLAR.</b>	6,000' 2" 24" & up 1st & 2d.
15,000' 3" No. 1 Com.	16,000' 3" 1st & 2d.	40,000' 1½" No. 1 Com.	12,000' 1" 1st & 2d.	4,000' 1½" 18" & up 1st & 2d.
<b>QUARTERED RED OAK.</b>	227,000' 1" No. 1 Com.	22,000' 2" No. 1 Com.		3,000' 1½" 24" & up 1st & 2d.
10,000' 1" 1st & 2d.	50,000' 1¼" No. 1 Com.	10,000' 3" No. 1 Com.		
	80,000' 1½" No. 1 Com.			

All thicknesses in cull poplar, ash, chestnut.

Your inquiries will be appreciated.

Prompt delivery guaranteed.

## The Norman Lumber Co., Inc.

Manufacturers and Wholesalers of

### Hardwood Lumber

FOR SALE

Seasoned Ash, Oak, Poplar, and Walnut Lumber

WANT TO BUY

Walnut, Oak, Ash, Hickory and Poplar Logs and Lumber

Office and Yards: Third Street, H to K Streets  
LOUISVILLE, KY.

## E. L. DAVIS LUMBER CO.

OFFER FOLLOWING STOCKS:

<b>POPLAR.</b>	<b>OAK WAGON TONGUES.</b>
30,000 ft. 4/4 1st & 2d.	12,000 ft. 4x4"x12"—12', 1—6 mos. dry.
50,000 ft. 4/4 Common.	800 ft. 3 x4"—12', 12—18 mos. dry.
15,000 ft. 5/4 Common.	400 ft. 3¼x4¼"—12', 12—18 mos. dry.
<b>QUARTERED RED OAK.</b>	300 ft. 3½x4½"—12', 12—18 mos. dry.
50,000 ft. 4/4 1st & 2d.	250 ft. 3½x4½"—12', 12—18 mos. dry.
50,000 ft. 4/4 Common.	800 ft. 3¼x4¼"—12', 12—18 mos. dry.
<b>QUARTERED WHITE OAK.</b>	180 ft. 3x4" & Lgr.—14', 12—18 mos. dry.
50,000 ft. 4/4 1st & 2d.	<b>REACHES.</b>
10,000 ft. 5/4 1st & 2d.	1 car 2x4" and larger, dry.
20,000 ft. 6/4 1st & 2d.	<b>BOLSTERS.</b>
10,000 ft. 8/4 1st & 2d.	2 cars 3x4" and larger, dry.
50,000 ft. 4/4 Common.	<b>HICKORY AXLES.</b>
5,000 ft. 5/4 Common.	1,500—3 x4"—6', 1—6 mos. dry.
5,000 ft. 6/4 Common.	1,500—3½x4½"—6', 1—6 mos. dry.
20,000 ft. 8/4 Common.	2,000—4 x5"—5', 1—8 mos. dry.
10,000 ft. 2½" Common.	1,000—4½x5½"—6', 1—6 mos. dry.
40,000 ft. 3" Common.	1,000—5 x6"—6', 1—6 mos. dry.
1 car Hickory Plank, 1½ to 4"—8' to 16'.	

## We wish to move and will make close prices on:

1 Car 8 4 1st and 2nd Qtd. White Oak  
2 Cars 8 4 Common Qtd. White Oak  
½ Car 5 4 Common Plain Red Oak  
½ Car 5 4 Common Plain White Oak  
1 Car 6 4 Common Plain Red Oak  
1 Car 4 4 Log Run Ash  
3 Cars 4 4 No. 3 Common Plain Oak

1 Car 8 4 No. 3 Common Plain Oak  
1 Car 4 4 No. 2 Common Plain Oak  
3 Cars 8 4 No. 2 Common Plain Oak  
2 Cars 5 4, 6 4 and 8 4 No. 2 Com. and Sound Wormy Chestnut  
1 Car 4 4 No. 1 Common Poplar  
1 Car 5 4 No. 2 Common Poplar  
1 Car 4 4 Common and Better Bay Poplar

We are moving our local yard and wish to ship this at once.

### Stotz Lumber Company,

Keller Building,  
Louisville, Kentucky

## Ornamental Hardwood Floors

400 STYLES AND PATTERNS

Illustrated Catalog on Application

### WOOD=MOSAIC FLOORING CO.

Rochester, N. Y. New Albany, Ind.

### Albert R. Kampf

Manufacturer  
Hardwood Lumber and Timber  
Dimension Stock  
Board of Trade Bldg., Louisville, Ky.

### E. W. Rhubesky

Wholesale  
Poplar, Rough and Dressed.  
Oak, Chestnut and Other  
Hardwoods

### North Vernon Pump & Lumber Co.

Band Sawn Plain and Quartered  
Oak and Poplar.  
North Vernon, Ind. and  
Louisville, Ky.

### Southern Lumber Co.

Oak, Poplar and  
Chestnut.  
Louisville, Ky.

# CADILLAC

CELEBRATED FOR HIGH STANDARD OF QUALITY AND MILL WORK

## MICHIGAN RED OAK

- ☞ As fine stock as was ever cut in the famous Cadillac district.
- ☞ We have some of this choice 4-4 Red Oak which will soon be in shipping condition.
- ☞ If you are in the market, we can please you both in quality and price.
- ☞ We also have some nice Soft Gray Elm in 4-4, 6-4, 8-4 and 12-4. It's Bone Dry.

**Mitchell Brothers Company**

CADILLAC, MICHIGAN

## Cummer, Diggins & Co.

MANUFACTURERS  
"CUMMER" MAPLE  
AND BEECH FLOORING

## MICHIGAN HARDWOODS

Good assortment of dry stock on hand ready for immediate shipment in Hard Maple, Beech, Birch, Soft Elm and Cherry.

SEND US A LIST OF YOUR REQUIREMENTS.

## The Cadillac Handle Co.

. . . Band Sawn . . .  
Michigan Hardwoods

For Rail Shipment from Cadillac.	For Water Shipment:
2 cars 8 4 Maple, No. 1 Com. & Better	120,000 feet of 4 4 Basswood
15 cars 4 4 Maple, on Grades.	160,000 feet of 4 4, 5 4 and 6 4 Birch
2 cars 4 4 Basswood, No 2 Com & Bet.	100,000 feet of 4 4, 8 4 and 12 4 Soft Elm
2 cars Basswood, No. 2 Com. & Bet.	10,000 4 4 Ash.

## MURPHY & DIGGINS

Offer all grades of the following special dry stock

MAPLE—5/4, 6/4, 8/4, 10/4, 12/4, 14/4, 16/4  
GRAY ELM—4/4, 12/4  
BASSWOOD—4/4  
BIRCH—5/4, 6/4

Our own manufacture. Perfect Mill Work. Uniform Grades.

LET US FIGURE ON YOUR HARDWOOD WANTS.

## DRY STOCK

## Northern Michigan Soft Gray Elm

What our old cork pine was to the regular white pine—such is our *Soft Gray Elm* to ordinary soft elm. Buyers who gladly discriminate in favor of something better than the ordinary, will be interested. We have

10 cars 8-4 firsts and seconds.  
1 car 10-4 firsts and seconds.  
2 cars 12-4 firsts and seconds.

Wide, choice stock, our own product, seasoned right, bone dry.

WRITE US ABOUT IT.



**COBBS & MITCHELL**  
(INCORPORATED)  
CADILLAC, MICHIGAN





# MEMPHIS

THE HUB OF THE HARDWOOD WORLD

**W**E have in all thicknesses the following kinds and amounts of lumber at places designated. Kindly send us your inquiries.

<b>MEMPHIS YARD:</b>		<b>SELMA YARD</b>	
Ash.....	680,000 feet	Poplar.....	409,000 feet
Quartered White Oak.....	75,000 feet	Bay Poplar.....	857,000 feet
Plain White Oak.....	140,000 feet	Red Gum.....	55,000 feet
Quartered Red Oak.....	225,000 feet	Cypress.....	787,000 feet
Plain Red Oak.....	410,000 feet	<b>BERCLAIR YARD</b>	
Cypress.....	225,000 feet	Bay Poplar.....	100,000 feet
Cottonwood.....	200,000 feet	Cypress.....	800,000 feet
Poplar.....	308,000 feet	<b>OTHER YARDS</b>	
		Plain Red Oak.....	350,000 feet

## J. W. THOMPSON LUMBER COMPANY

Office and Yards: Randolph Road and I. C. R. R. : : MEMPHIS, TENN.

## BACON-NOLAN HARDWOOD CO.

Manufacturers of

### Band Sawn Oak, Ash Gum, Cypress, Etc.

Office,  
Memphis, Tenn.

Mills,  
Chancy, Miss.

Address all correspondence to Memphis office.

## STOCK LIST Anderson-Tully Co. Memphis Tenn.

<b>ASH.</b>		<b>GUM.</b>	
9,400 ft. 4/4" Clr. Stps., 2 1/2"-5 1/2".		50M ft. 4/4" 1st & 2d Red, 6" up.	
5,400 ft. 4/4" Com. Stps., 2 1/2"-5 1/2".		50M ft. 4/4" No. 1 Com. Red.	
<b>COTTONWOOD.</b>		50M ft. 4/4" 1st & 2d Saps, 6"-12".	
23M ft. 7/8" 1st & 2d 8" & up.		50M ft. 4/4" 1st & 2d Saps, 13"-16".	
100M ft. 4/4" 1st & 2d 6" & up.		50M ft. 4/4" 1st & 2d Saps, 16" up.	
50M ft. 4/4" 1st & 2d 12" & up.		150M ft. 4/4" No. 1 Com. Saps.	
60M ft. 5/4" 1st & 2d 12" & up.		150M ft. 4/4" No. 2 Com.	
40M ft. 6/4" 1st & 2d 6" & up.		50M ft. 5/4" No. 1 Com. Saps.	
20M ft. 4/4" Wag. Box Brds., 9".		50M ft. 4/4" Box Brds., 13"-17".	
10M ft. 4/4" Wg. Box Brds., 13"-17".		<b>RED OAK.</b>	
<b>CYPRESS.</b>		35,000 ft. 4/4" 1st & 2d Plain.	
12M ft. 4/4" Select.		2,400 ft. 4/4" 1st & 2d Quartered	
35M ft. 4/4" Shops.		4,400 ft. 4/4" No. 1 Common.	
15M ft. 5/4" Selects.		<b>WHITE OAK.</b>	
15M ft. 5/4" Shops.		10,000 ft. 4/1" 1st & 2d Quartered.	
<b>POPLAR.</b>		15,900 ft. 3/4" No. 1 Com. Quartered.	
50M ft. 4/4" Nos. 1 & 2 Com.		8,700 ft. 4/1" 1st & 2d Plain Red & White "wormy."	

## FENN BROS. COMPANY

MANUFACTURERS OF

### Oak Flooring

QUARTERED WHITE	HOLLOW BACKED
QUARTERED RED	END MATCHED
PLAIN WHITE	POLISHED
PLAIN RED	BORED

Memphis, Tenn.

F. W. GILCHRIST, President  
W. A. GILCHRIST, Vice President  
W. E. SMITH, Sec'y and Treasurer

## W. E. SMITH LUMBER CO.

Manufacturers of  
**HARDWOOD LUMBER**

Mills, Tennessee, Arkansas, Mississippi  
Distributing Yards, Cairo, Illinois  
General Office. Tennessee Trust Bldg.

MISSISSIPPI VALLEY COTTONWOOD

J. B. Ransom, Prest. A. B. Ransom, V.-Prest. W. A. Ransom, Sec. C. R. Ransom Treas.

## GAYOSO LUMBER CO., Inc.

MANUFACTURERS AND DEALERS IN

### SOUTHERN HARDWOODS

Also make a specialty of Wagon Stock in rough, such as Tongues, Axles, Reaches, Bolsters, and 6-4 to 16-4 Hickory.

## Briggs & Cooper Company, Ltd.

MANUFACTURERS

### NORTHERN SOUTHERN HARDWOODS

GET OUR PRICES ON THESE ITEMS:

1,000,000 feet Soft Grey Elm, 1 to 3".
500,000 feet Unselected Birch, 1 to 3".
3,000,000 feet Michigan Hard Maple, 1 to 6".
350,000 feet End Dried White Maple, 1 to 1 1/2".
525,000 feet No. 1 Common and Better Winter Sawm Basswood, 1 to 3".
150,000 feet Selected White Basswood, 1", 1 1/4" and 1 1/2".
210,000 feet Plain and Quartered White and Red Oak, 1 to 2".

YARDS AT

SAGINAW, CHICAGO AND MEMPHIS

F. W. GILCHRIST, Pres. W. A. GILCHRIST, Vice-Pres.  
W. E. SMITH, Sec'y and Treas.

## Three States Lumber Co.

MANUFACTURERS OF

Mills: Missouri Arkansas Tennessee	<b>Hardwood Lumber Cottonwood and Gum</b>	Office Tennessee Trust Building
---	---	--

GET OUR PRICES. TRY OUR LUMBER  
WE SHIP ROUGH, DRESSED, RESAWED

COTTONWOOD GUM

**ST. LOUIS**

LARGEST OF ALL HARDWOOD MARKETS

Roland T. Krebs **Ozark Cooperage Co.** Hardwood Department  
 Manager

**WE BUY STOCKS READY CUT OR CONTRACT FUTURE OUTPUT**

Four Inspectors in the South

Direct Shipments from mill stocks { COTTONWOOD, CYPRESS, GUM, OAK. } MAIN OFFICE, FRISCO BUILDING

**Stoneman-Zearing Lumber Co.**

203 Frisco Building

We have the following Dry Stock for sale piled at our mill:

<b>QTD. WHITE OAK :</b>	<b>COTTONWOOD :</b>
3 Cars 4/4 Common.	3 Cars 1" 1 and 2.
2 Cars 4/4 Common and Better Strips.	1 Car 1x13 to 17" Box Boards.
<b>GUM :</b>	<b>ELM :</b>
5 Cars 1" Common Red.	1 Car 6 4 Log Run.
1 Car 1x13 to 17" Box Boards.	4 Cars 4" Log Run.
1 Car 2" 1 and 2 Sap.	
6 Cars 1 1/2 Common and Better Sap.	

This Stock is All Band Sawed and Equalized

**W. R. CHIVVIS,** Lesperance Street and Iron Mountain Railroad.  
**WHOLESALE HARDWOODS**

**BLACK WALNUT LUMBER MY SPECIALTY.** Always in the market to buy Walnut and Cherry Lumber. Pay spot cash and take up at shipping point when amounts justify.

**Wanted—Cypress, Ash and Cottonwood**

INSPECTION AT POINT OF SHIPMENT WHEN QUANTITY JUSTIFIES

**Hafner Manufacturing Co.**

CYPRESS, HARDWOODS  
 Mail orders receive our immediate attention.

YARDS: FOOT OF DOCK STREET

**Garetson-Greaseon Lumber Co.**

MANUFACTURERS OF SOUTHERN HARDWOODS

**GUM LUMBER  
 OUR SPECIALTY**

Carload Shipments Direct from Our Own Mills

519 Bank of Commerce

**Thomas & Proetz Lumber Co.**

CASH BUYERS OF OAK, ASH, CYPRESS, POPLAR, CHERRY AND ALL

**HARDWOODS**

SEND INSPECTOR WHEN QUANTITY JUSTIFIES

Office and Yards: Hall and Angelrodt Sts.

**CHAS. F. LUEHRMANN HARDWOOD LUMBER COMPANY**

Carry a complete stock of Hardwood and are constantly in the market to purchase large blocks of stock for cash. Are also the largest manufacturers of the famous St. Francis Basin Red Gum.

General Offices: 148 Carroll Street

**LOTHMAN CYPRESS CO.**

AIR DRIED

**Louisiana Red Cypress**

FOOT OF ANGELICA STREET

**SIX MILLION FEET**

Ash, Oak, Cypress, Poplar, Etc.

READY FOR PROMPT SHIPMENT

**STEELE & HIBBARD**

NORTH BROADWAY, DOCK AND HALL STREETS

# THE EAST

BOSTON NEW YORK PHILADELPHIA

JOHN T. DIXON

HARRY S. DEWEY



We are not **Wizards** in making new grades to fit a price. No tricks in our methods of making shipments. The straight grades are good enough for us.

If you will give us a trial order for **POPLAR, OAK, ASH, CHESTNUT** or **OAK, MAPLE** and **YELLOW PINE FLOORING**, we believe we can demonstrate our ability to please you.

## DIXON & DEWEY

716 and 716 A, Flatiron Building,

NEW YORK

## The Crosby & Beckley Company

### HARDWOODS

We are  
In the Market for Choice Stock  
WRITE US

No. 1 Madison Ave.,  
New York, N. Y.

New Haven,  
Connecticut.

## Thomas Forman Company

MANUFACTURERS OF HIGH-GRADE

### Maple and Oak Flooring

New York Branch:  
McGovern & Bowen,  
29 Broadway

And Hardwood Lumber

**DETROIT.**  
**MICHIGAN**

Millmen with round lots of well manufactured stock to offer,  
are sure of a square deal with

## WILLIAM WHITMER & SONS, Inc.

MANUFACTURERS OF

### HARDWOODS

Branches: NEW YORK, BOSTON, PITTSBURG

Girard Trust Bldg. PHILADELPHIA

# R. E. Wood Lumber Company

☐ We own nearly a thousand million feet of virgin poplar, oak, chestnut and other hardwood timber, and operate our own band mills in West Virginia, Tennessee, North Carolina and South Carolina.

☐ Let us figure on your hardwood requirements.

**GENERAL OFFICES:**  
**CONTINENTAL BUILDING.**

**Baltimore, Maryland**

**THE EAST**  
 BOSTON      NEW YORK      PHILADELPHIA

J. J. SOBLE      H. I. SOBLE  
**SOBLE BROTHERS**  
 Wholesale Hardwoods  
 911-912 Land Title Bldg.      PHILADELPHIA  
 WANTED: 20 cars Common and Better Chestnut, all thicknesses.

**W. M. GILLESPIE LUMBER**  
 HARDWOODS COMPANY      Farmers Bank Bldg.  
 Oak a Specialty      PITTSBURGH, PA.

**James & Abbot Company**  
 Lumber and Timber  
 No. 165 MILK ST., BOSTON, MASS., and GULFPORT, MISS.

**The West Florida Hardwood Co.**  
 MILL ON APALACHICOLA RIVER  
 MARYSVILLE, FLA.  
**Ash      Red and White Oak      Red Gum**  
**Hickory      Yellow Cottonwood      Tupelo Gum**  
 LET US HAVE YOUR INQUIRIES

**Always Looking for Business  
 Good Things for Fall Trade**  
 We want your orders for lumber because we have the stocks and can give you good service. Our rail and water connections are favorable to customers.  
 3,920,000 ft. Chestnut, 4 4 to 8 4, Sound, Wormy - Com. and Bet.  
 216,000 ft. Ash, 4 4 to 6 inches, mostly 1 and 2 - Com. and Bet.  
 1,560,000 ft. Poplar, 4 4 to 4 inches, 1 and 2 - Com. and Better.  
 156,600 ft. White Birch, 4 4 to 4 inches, mostly 1 and 2 and Com.  
 See October Lumber News—Write us to-day.  
**J. Gibson McIlvain & Co.**  
 56th and 58th Streets and Woodland Ave., PHILADELPHIA, PA.

BALTIMORE      E. E. PRICE      BUYER AND  
 MARYLAND      EXPORTER OF  
**Hardwoods, Poplar and Logs**  
 I am always in the market for nice lots of dry and well manufactured lumber. I inspect at point of shipment. Correspondence solicited.

**JOHN L. ALCOCK & CO.**  
 BUYERS OF BLACK WALNUT LOGS  
 BOARDS AND PLANKS  
 Inspection at point of shipment. Spot cash.      Baltimore, Md.

**WM. E. LITCHFIELD**  
 MASON BUILDING, BOSTON, MASS.  
**Specialist in Hardwoods**  
 Manufacturers are requested to supply lists of stock for sale

**STEVENS-EATON CO.**  
 Buyers of ROUND LOTS of **Hardwoods**      No 1 Madison Avenue, NEW YORK  
 ESPECIALLY IN MARKET FOR PLAIN RED OAK

**JONES HARDWOOD CO.**  
 INCORPORATED  
 WANTS: Poplar, Plain Oak,      147 MILK STREET  
 Quartered Oak and Cypress.      BOSTON, MASSACHUSETTS  
 Manufacturers please send stock lists and prices.

**Holloway Lumber Company**  
**WHOLESALE HARDWOODS**  
 In the market for all thicknesses of OAK, ASH and CHESTNUT.      312 Arcade Building, PHILADELPHIA, PA.

**Charles S. Wentworth & Co.**  
**WHOLESALE LUMBER MERCHANTS**  
 147 Milk Street  
**BOSTON**  
 We are in the Market for POPLAR, PLAIN OAK, CYPRESS and NORTH CAROLINA PINE LUMBER; also OAK, MAPLE and BIRCH FLOORING, and would appreciate correspondence from manufacturers in position to supply any of the stock named.

J. H. SCHOFIELD      R. W. SCHOFIELD  
**SCHOFIELD BROTHERS**  
**LUMBER**  
 WHITE PINE AND HARDWOODS      1019-1020 PENNSYLVANIA BLDG., PHILADELPHIA

**Wistar, Underhill & Co.,**  
**WHOLESALE**  
**HARDWOOD LUMBER**  
 816 Real Estate Trust Building,      PHILADELPHIA.

# NASHVILLE

HEADQUARTERS FOR ALL SOUTHERN HARDWOODS

## INDIANA LUMBER CO.

Manufacturers Lumber  
DIMENSION STOCK A SPECIALTY.

Office and Mills: Corner Oldham  
Street and Cumberland River

NASHVILLE, TENN.

## GEO. C. BROWN & CO.

MANUFACTURERS AND WHOLESALE DEALERS IN

Hardwood Lumber

Tennessee Red Cedar Lumber a Specialty.

NASHVILLE, TENNESSEE

## JOHN B. RANSOM & CO.,

NASHVILLE, TENNESSEE

We want to move quickly the following old dry stock. All of it has been on sticks 6 to 18 months. Write us for delivered prices. We are prepared to furnish promptly mixed cars of rough and dressed hardwoods of all kinds:

QUARTERED WHITE OAK	QUARTERED RED OAK
90 M 4/4 first and second	100 M 4/4 first and second
15 M 5/4 first and second	58 M 6/4 first and second
80 M 6/4 first and second	15 M 8/4 first and second
10 M 10/4 first and second	95 M 4/4 No. 1 Common
120 M 4/4 No. 1 Common	84 M 6/4 No. 1 Common
65 M 6/4 No. 1 Common	72 M 8/4 No. 1 Common
58 M 8/4 No. 1 Common	
20 M 10/4 No. 1 Common	PLAIN OAK
70 M 5/8 first and second Poplar	50 M 4/4 1st and 2nd White
80 M 5/8 No. 1 Common Poplar	100 M 4/4 No. 1 Common White
15 M 4/4 1st and 2d Quartered Sycamore	100 M 4/4 first and second Red
10 M 4/4 No. 1 Com. Quart'd Sycamore	100 M 4/4 No. 1 Common Red

## LOVE, BOYD & CO.

Offer:

5,000,000 ft. Quartered White Oak.  
2,000,000 ft. Quartered Red Oak.  
1,000,000 ft. Plain White Oak.  
1,000,000 ft. Plain Red Oak.  
1,000,000 ft. Poplar.  
2,000,000 ft. Chestnut, Ash, Hickory, Red Cedar, Etc.

Our Own Manufacture.  
Prompt Service.  
Dry Stock.

MAIN OFFICE,  
NASHVILLE, TENNESSEE

## Nashville Hardwood Flooring Co.

Manufacturers of

### "Acorn Brand"

THE FAMOUS FAULTLESS FLOORING  
IN OAK AND BEECH.

Car Lots and Less Than Car Lot  
Orders Solicited. Write for Prices.

Nashville, Tennessee

# Swann-Day Lumber Company

MANUFACTURERS OF

## POPLAR AND OAK

PLANING MILL STOCK, BOX SHOOKS  
AND HARDWOOD DIMENSION

CLAY CITY, KENTUCKY

# PAEPCKE-LEICHT LUMBER COMPANY

MANUFACTURERS OF

## COTTONWOOD GUM AND OTHER HARDWOODS

Large stocks of well seasoned Lumber always carried at our yards and mills.

General Offices: 140 W. Chicago Ave., CHICAGO. Mills: Cairo, Ill., Marked Tree, Ark., Greenville, Miss., Arkansas City, Ark., Blytheville, Ark.

JOHN C. SPRY

JOHN D. SPAULDING

# SOUTHERN OAK LUMBER CO.

IN THE MARKET FOR MILL CUTS OR ROUND LOTS, FOR CASH

## POPLAR **HARDWOODS** CYPRESS

INSPECTION AT MILL

910 Chamber of Commerce  
**CHICAGO**

YARDS: NORTH MEMPHIS

1217 Tennessee Trust Bldg.  
**MEMPHIS**

### The Tegge Lumber Co.

MILWAUKEE  
WISCONSIN

BUYERS OF  
ALL KINDS OF

**HARDWOOD LUMBER**

### Are You in the Market ?

Send us your inquiries for prices on  
the following

## HARDWOODS

- 100M ft. 1" Com. and Better Quartered Red Oak.
- 100M ft. 1" Com. and Better Quartered White Oak.
- 75M ft. 1 1/4" Com. and Better Quartered Red Oak.
- 25M ft. 1 1/2" Com. Quartered White Oak.
- 25M ft. 1 1/2" 1st and 2nds Quartered Red Oak.
- 50M ft. 3" Com. and Better Quartered White Oak.
- 50M ft. 3" Com. and Better Plain White Oak.
- 100M ft. 1" Com. Plain Birch.
- 50M ft. 1" Com. Red Birch.
- 50M ft. 1 1/2" Com. and Better Plain Birch.
- 100M ft. 1" Com. and Better Hard Maple.
- 100M ft. 1 1/2" Com. and Better Hard Maple.
- 100M ft. 1" Com. and Better Soft Elm.

## UPHAM & AGLER

Distributing Yards: CAIRO, ILL.

Main Offices :: American Trust Building, CHICAGO

### OCTOBER STOCK LIST

MAPLE		BEECH		BASSWOOD	
1 in.	2,000,000 ft.	1 in.	500,000 ft.	1 in.	300,000 ft.
1 1/4 "	100,000 "	1 1/2 "	400,000 "	2 "	75,000 "
1 1/2 "	400,000 "	2 "	100,000 "		
2 "	1,000,000 "				
2 1/4 "	200,000 "				
2 1/2 "	500,000 "				
3 "	500,000 "				
4 "	400,000 "				
WHITE MAPLE		BIRCH		GRAY ELM	
1 in.	100,000 ft.	1 in.	100,000 ft.	1 in.	300,000 ft.
End Piled	1 1/2 "	1 1/2 "	50,000 "	1 1/2 "	30,000 "
1 1/2 in.	20,000 ft.	2 "	20,000 "	3 "	200,000 "

**KELLEY LUMBER & SHINGLE CO., Traverse City, Mich.**

# Schultz Brothers & Cowen

WE ARE IN THE MARKET TO BUY

## POPLAR—OAK—ASH—CHESTNUT

AND OTHER HARDWOODS—ALL GRADES AND THICKNESSES

1225 to 1240 OLD COLONY BUILDING,

CHICAGO



**C H I C A G O**  
THE GREATEST HARDWOOD MARKET IN THE WORLD

**Harvey S. Hayden**  
IN THE MARKET FOR  
**POPLAR**  
25 M ft. 1 1/2" No. 1 Common, standard widths and lengths.  
40 M ft. 2" No. 1 Common, standard widths and lengths.  
25 M ft. 2 1/2" No. 1 Common, standard widths and lengths.  
60 M ft. 3" No. 1 Common, standard widths and lengths.

**WHITE ASH**  
30 M ft. 1" 1s and 2s, standard widths and lengths.  
75 M ft. 5 4" 1s and 2s, standard widths and lengths.  
50 M ft. 6 4" 1s and 2s, standard widths and lengths.  
50 M ft. 8 4" 1s and 2s, standard widths and lengths.  
25 M ft. 10 1" 1s and 2s, standard widths and lengths.  
50 M ft. 16 4" 1s and 2s, standard widths and lengths.  
(We can use a small percentage of No. 1 Common.)

**511 Railway Exchange, - Chicago**

**J. Slimmer & Company**

**Hardwood  
Lumber**

Office and Yard :  
65 W. Twenty-second St. **CHICAGO**

**PARK RICHMOND & CO.**  
Wholesale  
**Hardwood Lumber**  
67 West Twenty-second St.  
**Chicago**

**R. A. WELLS LUMBER CO.**  
Manufacturers of All Kinds of  
**HARDWOOD LUMBER**  
Fine Quartered Oak a Specialty  
234 LA SALLE STREET  
Yards at Canal and 21st Sts. **CHICAGO, ILL.**

—have you anything to offer in  
hickory, white ash, thick plain  
oak and wagon stock?

WE ARE CASH BUYERS  
PLEASE SEND US YOUR STOCK LISTS

**Ryan & McParland**  
Office and Yards  
Robey St. and Blue Island Ave. **Chicago**

**White Lumber Company**  
Dealers in Hardwood Lumber

ALL KINDS  ALL GRADES

Cherry Lumber a  
Specialty Laflin @ 22d Sts.  
Chicago

 **A floor to adore**

For thirty-three years Wilce's Hardwood Flooring has been among the foremost on the market and because it stands today "unequaled" is the best evidence that its manufacturer has kept abreast of modern methods and the advanced demands of the trade. To convince yourself of the above statements, try our polished surface flooring, tongued and grooved, hollow backed, with matched ends and holes for blind nailing—you'll find it reduces the expense of laying and polishing. Our Booklet tells all about Hardwood Flooring and how to care for it—also prices—and is free.

**The T. Wilce Company**  
22nd and Throop Sts. **CHICAGO, ILL.**

**John O'Brien Land & Lumber Co.**  
MANUFACTURERS AND DEALERS IN  
**Hardwood Lumber**  
Of All Kinds  
OFFICE AND YARDS :  
873 to 881 So. Laflin Street **Chicago**  
MILL : PHILIPP, MISS.

**CHICAGO**

THE GREATEST HARDWOOD MARKET IN THE WORLD

**The Keith Lumber Company**  
 HARDWOOD, POPLAR & SOUTHERN PINE LUMBER,

MAHOGANY,

REDWOOD,

RED CEDAR,



CYPRESS,

CHESTNUT,

SPRUCE.

MAPLE FLOORING, OAK TIMBERS & WAGON STOCK.

Office and Yards: Fourteenth and Wood Streets.

**CHAS. DARLING & CO.**

Southern  
 Hardwoods

22nd Street and Center Avenue - CHICAGO

Chas. Miller

Milton Miller

MILLER BROS.

**Hardwood Lumber**

Main Office, 208 WILLOUGHBY BLDG.,  
 6 E. MADISON STREET,

YARDS:

Loomis St., S. of 22nd St.,  
 Chicago, Ill.  
 Houston, Miss.  
 Macon, Miss.

CHICAGO, ILL.

Phone CENTRAL 1363

**THE WARD LUMBER COMPANY**

MANUFACTURERS OF  
**HARDWOODS**

CHAMBER OF COMMERCE BUILDING :: CHICAGO

**WISCONSIN TIMBER & LUMBER CO.**

— BUY AND SELL —

Yellow Pine and Hardwood Lumber

Want thick hardwoods and wagon box boards.

Monadnock Bldg.,

CHICAGO, ILL.

**Heath-Witbeck Company**

**Hardwood Lumber**

We have for quick shipment 170,000  
 feet DRY BIRCH, First and Seconds  
 and Common 2, 2½, 3 and 4 inch.

Main Office, 6 Madison St. Yards, Loomis and 22nd St.  
 CHICAGO

**Lesh & Matthews Lumber Co.**

1649-50 MARQUETTE BUILDING

Are now offering bone dry BIRCH, ROCK ELM, BLACK ASH, etc., Wis-  
 consin stock. Also PLAIN AND QUARTERED OAK, POPLAR, etc.,  
 from our Memphis yard. We are constant buyers.

**The Columbia Hardwood Lumber Co.**

Wholesale and Retail

Telephone  
 NORTH 223

**HARDWOOD LUMBER**

47 Dominick St.  
 CHICAGO

**Undoubtedly  
 you are interested in**

Audits of the condition and operation of  
 your business.

Modern accounting methods:  
 Mill cost systems:

If so, may we have a talk  
 with you?

**Standard Audit Company**

Suite 335

Marquette Building, CHICAGO

**Ben C. Keator—Wholesale Lumber**

**HARDWOOD AND PINE**

1003-4 Manhattan Building, CHICAGO

The only trade paper reaching all classes  
 of hardwood consumers

HARDWOOD RECORD  
 355 Dearborn St., Chicago

## "Michigan" Maple Flooring

Our model factory is equipped with the highest class tools and appliances made for Flooring production.

We produce our lumber from the best rock Maple area in Michigan and have 20 years' supply.

Our brand "Michigan" is a guaranty of quality. Perfect mill work and excellent grades distinguish our Flooring and our prices are reasonable.

**WARD BROS., Big Rapids, Mich.**

# FLOORING



## The Celebrated Wolverine Brand...

We claim nothing new or original in point of manufacture on Wolverine Brand Hard Maple Flooring, but do claim by our method, we can produce a finer floor than by ordinary methods. It is bored, butted and end matched, and lays with all joints even.

**BLISS & VAN AUKEN**  
900 S. Niagara St., Saginaw, West Side, Michigan

## OAK FLOORING

Kiln Dried  
Bored  
Polished



Hollow Backed and Bundled

## Timber Bonds

SECURED BY FIRST MORTGAGE ON TIMBER LANDS

## H. C. Barroll & Co.

BANKERS, First National Bank Building, CHICAGO

H. B. LEAVITT, PREST.  
E. H. ADAMS, SECY.

B. F. RICHARDSON, VICE-PREST.  
J. G. LEAVITT, TREAS.

## THE LEAVITT LUMBER CO.

MOST COMPLETE STOCK OF HARDWOODS IN CHICAGO

MAKE KNOWN YOUR WANTS AND GET IMMEDIATE RESULTS

Mills:  
WISCONSIN  
TENNESSEE  
ARKANSAS  
LOUISIANA  
MISSISSIPPI

General Office and Yard:  
22ND AND LAFLIN STREETS.  
Southern Office:  
808 TENNESSEE TRUST BLDG.  
MEMPHIS, TENN.

## THE "FINEST" MAPLE FLOORING

## W. D. YOUNG & CO.

BAY CITY, MICHIGAN.

Producers from TREE to TRADE of the highest type of Michigan Forest Products. Large stock of Maple Flooring and 15,000,000 feet of Hardwoods—1 to 4 inches thick—on hand.

## Maple, Birch and Beech Lumber

## "Ideal" Steel Burnished Rock Maple Flooring

is the flooring that is manufactured expressly to supply the demand for the best. It is made by modern machinery from carefully-selected stock and every precaution is taken throughout our entire system to make it fulfill in every particular its name—"IDEAL."

Rough or Finished Lumber—All Kinds

Send us Your Inquiries

**The I. Stephenson Company**  
WELLS, MICHIGAN

## FIRE INSURANCE

We Stand Between You and High Rates

## Lumber Underwriters

66 Broadway New York

# Hardwood Record

Published in the Interest of Hardwood Lumber, American Hardwood Forests, Wood Veneer Industry, Hardwood Flooring, Hardwood Interior Finish, Wood Chemicals, Saw Mill and Woodworking Machinery.

Vol. XXII.

CHICAGO, OCTOBER 10, 1906.

No. 12.

Published on the 10th and 25th of each month by

## THE HARDWOOD COMPANY

HENRY H. GIBSON, President      FRANK W. TUTTLE, Sec.-Treas.

### OFFICES

Sixth Floor Ellsworth Bldg., 355 Dearborn St. Chicago, Ill., U.S.A.  
Telephones: Harrison 4960      Automatic 5659

### TERMS OF ANNUAL SUBSCRIPTION

In the United States, Canada, Philippine Islands and Mexico . . . \$2.00  
In all other countries in Universal Postal Union . . . . . 3.00

Subscriptions are payable in advance, and in default of written orders to the contrary are continued at our option.

The entire contents of this publication are covered by the general copyright, and articles must not be reprinted without special permission.  
Entered at Chicago Postoffice as Second Class Matter.

Advertising copy must be received five days in advance of publication date. Advertising rates on application.

## COMING HARDWOOD ASSOCIATION MEETINGS

### National Hardwood Lumber Association

A semi-annual meeting of this association will be held at Hotel Havlin, Cincinnati, on Thursday and Friday, October 25 and 26.

### Michigan Hardwood Manufacturers' Association

An important meeting of this association will be held at the Park Place Hotel, Traverse City, Mich., commencing at 10 a. m. on Wednesday, October 31.

## General Market Conditions.

An analysis of the hardwood market conditions prevailing in all the hardwood consuming centers of the country reveals that the general demand is strong, with prices firm. The weather conditions prevailing in the South during the last two weeks, which have varied from a heavy rainfall to a hurricane, have practically shut off lumber production over a large area of hardwood territory. Conditions in northern hardwood production and demand remain about normal.

The Editor of the HARDWOOD RECORD has just returned from a month's cruise in the hardwood producing sections of Pennsylvania, West Virginia, Virginia, western Kentucky, western Tennessee, eastern North Carolina and northern South Carolina, and has paid especial attention to the condition of stocks in the hands of producers in the various sections named.

There never has been a time in the history of the hardwood industry when there was such a manifest shortage in all of the standard hardwoods in those sections as there is at the present time. In the great trammed yard of the Burt & Brably Lumber Company at Ford, Ky., there are acres of bare foundations and the stock of poplar is of the most meager description. The same condition prevails in the yards of the Swann-Day Lumber Company at Clay City, Ky., in the several yards at Coal Grove, Ashland and Ironton, and in the entire lumber producing section of the Appalachian range, which naturally at this time of the year would show many millions of feet of poplar, oak and

chestnut. In stock unsold there appears to be but a paucity of lumber in pile, and even a large proportion of these small stocks is marked up as having been sold.

Reports coming from Nashville, Cairo, Memphis and southwestern districts producing oak, cottonwood and gum would indicate about the same condition of affairs prevailing in that region. Buyers can therefore be assured that there is no possible chance of an overstock of any variety of hardwoods for the remainder of this year, and can make their purchases with the assurance that the demand is already in excess of supply and with every indication that values will strengthen as the year advances.

## A Heart to Heart Talk by the Editor.

Nearly all the sharps of the lumber press have had their say on hardwood inspection. To be sure they do not know much about the subject, but then it is an interesting topic. While I spent a good many years of my life with a board rule in one hand and a marking stick in the other, I am not sure that I know very much more than some other people about the just way to grade hardwoods. However, I feel constrained to discuss the subject.

A couple of years ago Billy Bennett, who is the most generous man in the world—with advice—told me how to run a lumber newspaper. "Primarily," he said, "let associations alone. Let inspection systems alone—entirely alone. The whole scheme doesn't amount to much anyhow. You go ahead and attend to your own business. Spend mighty little money on your paper—get profit out of it." Up to date I have pretty nearly followed Bennett's advice, save that I have spent a lot of money on my newspaper and have not made much money out of it.

I have a letter from an esteemed friend at Detroit, who is insistent upon knowing how manufacturers of hardwood lumber can benefit consumers. The answer to this inquiry gets me deep into the inspection problem. The inquiry, which is undeniably made in good faith, is from a man who has spent his lifetime in manufacturing and jobbing lumber. He is a mighty clean man commercially and if he ever shipped a "salted" carload of lumber I never heard of it—but more about his letter later.

I was talking with a small furniture manufacturer in Chicago a few days ago and asked him what he was paying for oak. He told me that he was buying firsts and seconds delivered at his factory at \$42 a thousand.

"You are not buying straight firsts and seconds at that price, are you?"

"I certainly am, and I know the grade is right because I inspected the lumber myself."

I looked over the shipment carefully. The stock did not show twenty-five per cent of firsts and seconds by any standard of grading in use.

The man was paying fully five dollars more a thousand than if he had bought the relative proportion of grades which the shipment contained at current market prices.

What are you going to do with a case like this?

A Pittsburg jobber showed me something of the ins and outs of the hardwood trade a few weeks ago by exhibiting an invoice from a West Virginia manufacturer for a little less than 2,000 feet of firsts and seconds, plain red and white oak, and 12,000 feet of No. 1 common,

plain red and white oak, mixed, and shipped in one car. He also displayed a copy of his invoice to a furniture manufacturer of this same car of approximately 14,000 feet, billed as firsts and seconds, and then exhibited to me the returns on the shipment. The consignee regretted that he had to make a complaint, but he failed to find but about 12,000 feet of firsts and seconds in the car, and alleged that it also contained 1,600 feet of No. 1 common and 100 feet of No. 2 common.

"Are you going to let a man get away with a kick like this?" I asked.

"Well," he replied, "there's a couple of hundred dollars in the sale and I guess I will let it go."

"What about the shipper? Are you going to let him soak you with 100 feet of No. 2 common?"

"He is a pretty good fellow and I guess I will also let him off." "What's to be done in a case like this?"

In discussing the matter of uniform inspection a foremost Memphis jobber told me a while ago that during that day he had sold three lots of firsts and seconds white oak to three different people, at three different prices, and that each man would get a different inspection. He is a good National association man and "hollers" louder than anyone in the bunch about the good work of his association in establishing uniform inspection.

What's to be done in a case like this?

A good Buffalo National association man, whom I esteem as highly as I do any man in the hardwood industry, said to me some months ago that the buyer of a prominent consuming house was in his office recently and said to him that he was ready to place his order for his season's requirements of quarter-sawed oak. He said he knew the stock was worth \$78 a thousand, but he wanted to place his order at \$73. He concluded by observing, "You know what I can use."

My Buffalo friend said to him, "Why don't you buy a straight grade and pay the price?" The buyer said to him, "Back of me is a board of directors and they know what the price of quarter-sawed oak is just as well as you do. I want to hold down my job, and I can best hold it down by demonstrating to them that I am smart enough to buy standard grades of oak lumber at five dollars a thousand less than the market price."

My Buffalo friend made the sale. "What's to be done in a case like this?"

A friend of mine in East Tennessee, who is a large manufacturer and merchant in hardwoods, tells me that he deals almost exclusively with eastern jobbers. He says that ninety-five orders out of one hundred come to him specifying a certain proportion of one grade of lumber, and another proportion of a lower grade, with the invariable injunction attached, "thoroughly mixed in the car."

What are you going to do in a case like this?

I was in the office of a well-known Chicago jobbing house about three months ago when the ruling price of four quarter first and second white oak was \$15 a thousand on this delivery. A sale was made of a car of this alleged grade of lumber at \$43 a thousand. I asked how it could be done, and it was explained to me that the car sold was an "old purchase" and contained 7,000 feet of firsts and seconds on straight National association inspection, for which they paid \$43 a thousand, and 7,000 feet of No. 1 common, for which they paid \$29 a thousand. It was shown to me that the profit on this transaction was seven times the difference between \$43 and \$29.

What are you going to do in a case like this?

These citations are not exceptional cases. They are the every day transactions of a big majority of the hardwood trade. They are discussed as openly as a man invites a friend to step in next door and have a high-ball. It would seem that the smartest man in the business is the one who is able to work in the largest proportion of lower grades in the sale of an alleged higher one. This way of doing things may be good "business"—may be good hardwood ethics, but I must confess that I am old-fashioned enough not to be-

lieve it. It is possibly because I was educated in the lumber trade to deliver one thousand feet for every ten hundred sold, and to give a man uppers when I sold him uppers that I cannot be accounted a distinct success as a lumberman.

My esteemed contemporary, The Lumber Trade Journal, gives credit to the allegation that "fully seventy-five per cent of the hardwood lumber sold throughout the country is on National inspection." If it can be demonstrated to me that seven and one-half per cent of the hardwood lumber sold throughout the country is inspected and shipped on straight National hardwood inspection, I will guarantee to go to New Orleans and jump across the Mississippi River—or, at least, I will stand on the bank and jump as far as I can.

Now about the letter. Here it is:

DETROIT, MICH., Sept. 14.—Editor HARDWOOD RECORD: In your issue of Sept. 10 you make the editorial prediction that "within the year" the new Michigan Hardwood Manufacturers' Association "will have achieved more for the benefit of the manufacturing element of the state and for the consumers of Michigan hardwood products than has been accomplished in all the years of the past."

The italics are my own.

The manufacturers can benefit themselves only by raising the price or lowering the grade, or both.

Where does the consumer come in?—SQUARE DEAL.

The observation was made advisedly. I was brought up in the state of Michigan and I know the character and temper of Michigan hardwood manufacturers, and I know they are in deadly earnest to reform their sales system and to correct the evils of it. I assert that they will speedily do more "for the consumers of Michigan hardwood products than has been accomplished in all the years of the past."

These people have spent a lot of time and intelligent work in preparing a system of just and equitable grading to be applied to their product, and from this time forward it is absolutely safe to prophesy that the larger proportion of Michigan hardwoods will be inspected on a uniform basis, and in grades that will be best suited to the requirements of the consuming trade; that hereafter "salted" or manipulated cars will not be loaded out of that state; and if need be, consumers will be educated to know what constitutes just grades of hardwoods.

The manufacturers of Michigan can benefit themselves and the consumer by making fair grades and asking fair prices for them, and seeing to it that their product goes into the hands of the consumer without being manipulated.

Now about the jobbers of hardwood lumber. There always has been and always will be room in the commercial world for the merchant. He has always made a good living for himself and always will. The merchants who have made money in this world, however, have been the men who have done business on the level. The scalawag merchant has never made a success and never will. There is room and always will be for the hardwood merchant who buys mill cuts and round lots of lumber and resells the product to the consuming trade, but there is not room in the hardwood trade for the scalper who manipulates and "salts" lumber and by misleading representations succeeds in grafting profits out of irregular transactions. Even the honest scalper is all right, his calling is legitimate, but for the fakir, the grafter, the thief of the hardwood lumber trade, I have no use.

Hanging up in the private office of my esteemed friend Gardner I. Jones of Boston is one of those impertinent legends which reads:

.....  
: DON'T TAKE YOURSELF TOO DAM SERIOUSLY. :  
:.....

That sign of Jones' has kept me from speaking my mind about hardwood inspection and hardwood methods for a good while, and I am truly glad that I am far enough away from Boston so that for once I have eased my conscience.—H. H. G.

# Pert, Pertinent and Impertinent.

**The Whole Trouble.**

Some folks can't mind their business  
The reason is, you'll find,  
They either have no business  
Or else they have no mind.  
Catholic Standard and Times.

**And That's So.**

There are no birds in last year's nests  
No fun in last year's jokes;  
And weep for him who pays the bills  
No wives in last year's cloaks.  
Houston Post

**Only Two Classes.**

Two men there are who never  
Forget themselves, I wist  
And one's the perfect gentleman  
And one's the egotist.  
Philadelphian Ledger

**Giving.**

A charitable man gives according to his means, a miser according to his meanness.

**Pessimistic View.**

To the pessimist, whatever isn't is right; whatever is is wrong.

**'Close.'**

A close friend is one who refuses to lend.

**Silence.**

There are times when it isn't necessary to speak the truth—but at such times it isn't necessary to speak at all.

**Good Plan.**

Advice is very much like opportunities, the capable provide their own.

**Pride and Vanity.**

Pride is the knowledge that no one can do you a favor; vanity is the belief that no one can do you an injury.

**True.**

There are a good many noughts in the sum total of the world's inhabitants.

**Well Known.**

Fortune knocks often at the door of the man who keeps his name and address in the advertising column.

## IS HISTORY TO BE REPEATED?

[The question of admitting wholesale hardwood consumers to membership will come up for discussion and action. News Item.]

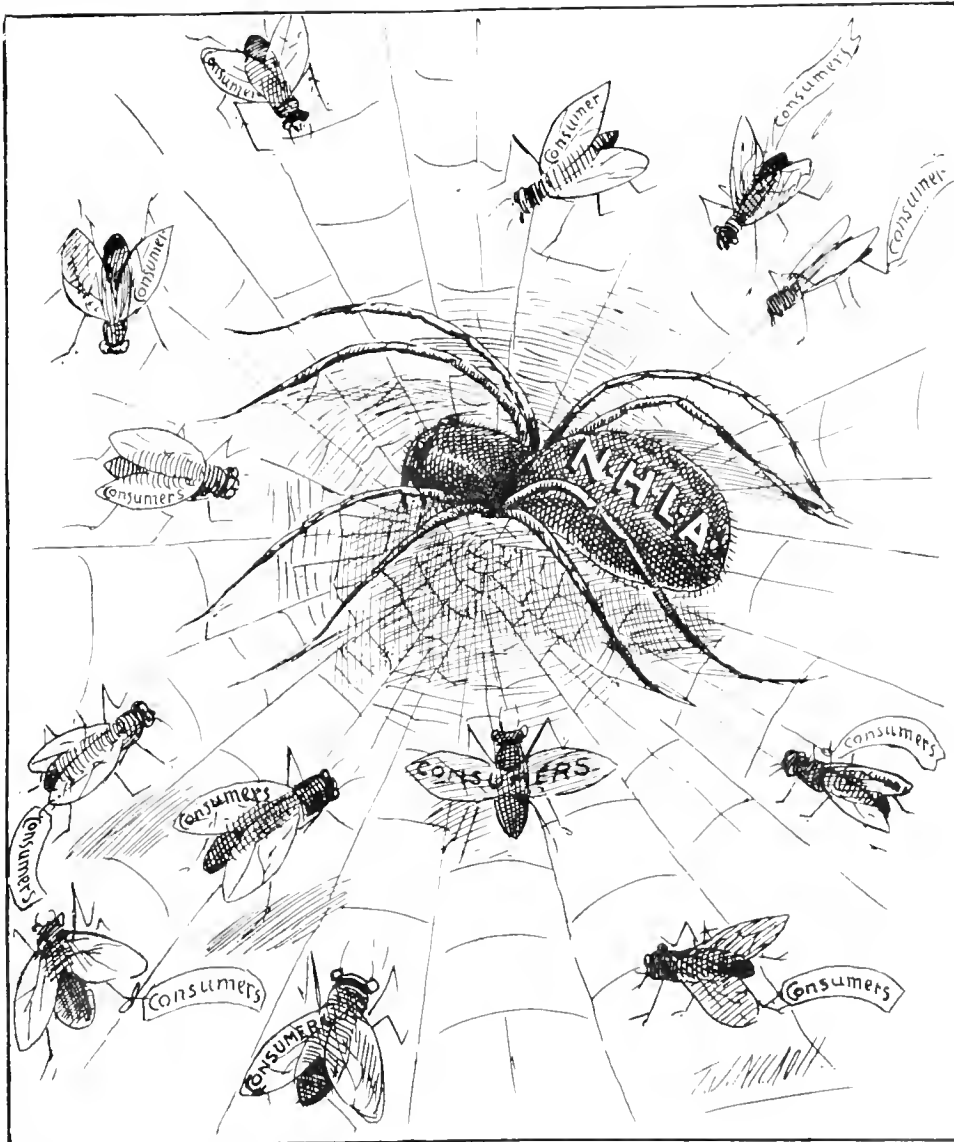

"Will you walk into my parlor says the spider to the fly?"

**Secret of Success.**

Instead of trying to dodge your work, try and devise some easier method of doing it—that's one of the secrets of success.

**Doubtful.**

Some people seem to think that speculation in futures is equivalent to buying experience.

**Drinking.**

The philosophy of drinking consists in knowing when to treat and when to retreat.

**Real Difficulties.**

Two things which are equally hard to do in this life are to keep up appearances and to keep down expenses.

**Always.**

The fellow who intends to succeed works without a time table.

**Hosts of Them.**

There are plenty of people who would be proud of being arrested for exceeding the speed limit in an automobile.

**The Way.**

If you must argue, choose a subject you know something about and then keep your mouth shut and listen.

**IDEAL.**

I wonder how a man would feel  
To have no cause at all to worry,  
To sit down to a three-course meal  
And know he didn't have to hurry;  
To smoke thereafter at his ease  
And tell the world to go to thunder—  
To do exactly what he'd please.  
I wonder!

I wonder how a man would feel  
To have the debts all paid he's owing,  
To fear no creditor's appeal,  
To have a bank account that's growing,  
To know that he was right on top  
Of all he had been squirming under  
And had no chance to slip and drop.  
I wonder!

I wonder how a man would feel  
I think it would seem mighty funny  
To know I had for once a deal  
Of leisure time and lots of money,  
That pleasant state of things and I  
Just now are pretty far asunder,  
So I can only wish and sigh  
"I wonder!"



# AMERICAN FOREST TREES.

THIRTY-EIGHTH PAPER.

## Chestnut Oak.

*Quercus Prinus*, Linn.

The distribution of chestnut oak ranges from the coast of southern Maine and the Blue Hills of eastern Massachusetts southward to Delaware and the District of Columbia; along the Appalachian mountains to northern Georgia and Alabama; westward to the shores of Lake Champlain and the valley of the Genesee river, New York, along the northern shores of Lake Erie and to central Kentucky and Tennessee. It is rare and local in New England and Ontario, but plentiful on the banks of the lower Hudson river and on the Appalachian hills from southern New York to Alabama.

It is known as rock oak in New York; as rock chestnut oak in Massachusetts and Rhode Island; as rock oak and rock chestnut oak in Pennsylvania and Delaware; as tan bark oak and swampy chestnut oak in North Carolina and as rock chestnut oak and mountain oak in Alabama.

The chestnut oak is a type of a group of white oaks whose leaves are very much like those of the chestnut tree, as may be seen in the accompanying illustration. The leaves are alternate, five to nine inches long, and obovate, with coarse teeth rounded at the top. At maturity, they are thick and firm or subcoriaceous; yellow-green and rather lustrous on the upper surface, paler and usually pubescent beneath. In the autumn before falling, they turn a dull orange color or rusty brown.

The flowers appear in May and are solitary or paired; staminate yellow; pistillate on short spurs; with short, dark-red stigmas. The fruit or acorn is solitary or in pairs, one to two and one-half inches long, very lustrous and of a bright chestnut-brown color. The acorn cup is thin, downy-lined and covered with small tubercular scales. The kernel is sweet and edible. The bark of the chestnut oak is thin, smooth, purplish-brown and often lustrous on young stems and small branches, becoming a thick, dark, reddish brown, or nearly black on old trunks, and divided into broad rounded ridges, separating on the surface into small, closely appressed scales. The bark of the tree is so dark in color and so deeply furrowed that it has often been mistaken for one of the black oak group, although its wavy leaf margins and annual fruit clearly differentiate it from that species. The bark of the chestnut oak is one

of the highest valued tanning materials and is used extensively in the manufacture of high-grade leather. The bark is also incorporated with that of some other varieties of oak, hemlock and chestnut wood in the preparation of tannic acid extract.

The chestnut oak is a vigorous tree and grows rapidly in dry soil, finding its most abundant growth and largest size in the

in its field growth it sometimes splits into two or more larger limbs, fifteen to twenty feet from the ground and shows a broad spread of foliage. The wood is heavy, hard, strong, rather tough, close-grained and durable in contact with the soil. In color it is dark, reddish-brown, with conspicuous medullary rays. The sapwood, as is the case in most other trees, is much lighter. A cubic foot of the seasoned wood weighs about forty-six pounds.

From its comparative cheapness and hard, strong and rather tough character, chestnut oak lumber at the present time is attracting the attention of the leading wagon makers of the country and they are employing it very extensively in vehicle building. In many respects it is even better than the highest type of white oak for this purpose, the only drawback to its use being its somewhat refractory character in seasoning. Care must be used in air-drying it, and special caution be taken in dry-kiln operations to avoid season checking.

Chestnut oak has become quite a favorite in the markets of Great Britain and continental Europe for wagon-making purposes and is there classed, as it is in the home trade, as a variety of white oak. It is probable that its use for wagon material will constantly broaden, as it undeniably is the best substitute that this country affords for oak used in the construction of wagons, save the very highest type of white oak.

Some furniture manufacturers are also interesting themselves to a considerable extent in using chestnut oak for furniture making and there is one large concern at Connersville, Ind., that employs the wood exclusively in a large line of chiffoniers.

The large remaining area of timber growth in which chestnut oak appears is the Appalachian range through eastern Tennessee and western North Carolina, and the fact that it is comparatively plentiful in the forests of the Appalachian range will tend to bring it

more and more into prominence as a factor in the building of wagons as the other oaks become scarcer.

The beautiful specimen of forest growth with which this article is illustrated was photographed recently by the editor of the *Hardwood Record* on Eagle Creek, in Swain county, North Carolina, on the timber holdings of the Montvale Lumber Company of Baltimore, Md.



TYPICAL FOREST GROWTH CHESTNUT OAK, SWAIN COUNTY, NORTH CAROLINA.

lower slopes of the mountains of the Carolinas and Tennessee, where it often forms a great part of the forest. It is not as large in size as the white oak or red oak, but is a splendid tree, its bole being very symmetrical and holding its size well. It grows usually to a height of from sixty to seventy feet and sometimes 100 feet, with a diameter of from two to five feet and occasionally as large as seven feet,



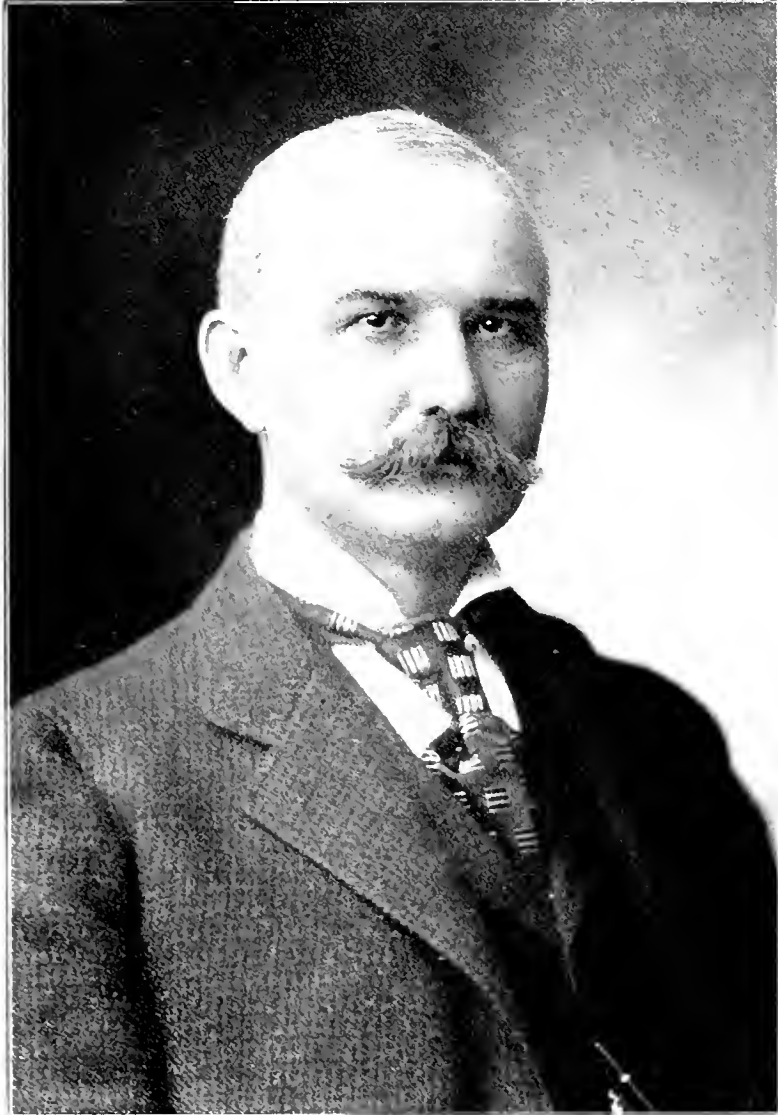

PORTER B. YATES  
BELOIT, WIS.

# Makers of Machinery History.

NUMBER V.

Porter B. Yates.

(See *Portrait Supplement*.)

Wherever woodworking machinery is used the trademark "Berlin" is invariably known as marking high-class tools. Closely associated with this word is the name of the town in which these appliances are manufactured—Beloit, Wis. In this issue of the *HARDWOOD RECORD* are published a number of half-tone engravings and a sketch telling something of the woodworking machine manufacturing house of that city, which will prove interesting to many thousands of users.

In connection with this article it is pertinent and timely that a brief sketch be given of the master mind of the institution, who has brought into such universal prominence the Berlin woodworking tools, for, in spite of the fact that a very great measure of success has attended their making, there are few people who know anything about the man who is responsible for their prestige. This is because he has always been reticent when his own achievements were under discussion. He has avoided publicity, and it is doubtful if ever before the picture of Porter B. Yates, president of the Berlin Machine Works, has been seen in print.

Mr. Yates was born in Schenectady, N. Y., in 1856, his parents being Joseph and Jane E. Yates. While Porter was still a child the family removed to Berlin, Wis., where as a boy he attended the common schools of the district, finally passing through the high school, from which he was graduated at the age of seventeen. This ended his school days, for immediately after graduation he became clerk in a retail hardware store owned by his father and a partner named Foote. In 1877 he became his father's partner, Mr. Foote selling out his interests.

In 1884 Mr. Yates bought a small machine shop at Berlin, known as the Berlin Machine Works, which manufactured a single drum sanding machine. In 1887 the business was organized as a stock company capitalized at \$100,000. In 1888 the company removed to Beloit and established its plant in a small two and one story stone building. The floor space occupied by the factory was only 60x140 feet, with a wing 40x100 feet, but the little shop was practically the beginning of the Berlin Machine Works, which now covers two large city blocks and has a cash paid-up capital of \$2,500,000. The plant is equipped with hundreds of the highest class and most modern iron and steel working tools, which turn out annually thousands of the finest woodworking appliances.

Physically, Mr. Yates is a squarely built man who invariably gives the impression of being extremely alert and forceful. He is typical of the keen, accurately minded American business man, and the success which has attended the making and marketing of the products of his factory has been largely due

to his work primarily in the careful making of the machines, and afterwards in the vigorous exploitation of their merits. He is easily the first citizen of his own town, and



PRINT OF CHESTNUT OAK LEAF.

as a manufacturer of woodworking tools, ranks foremost in the country.

By training and inclination Mr. Yates is pre-eminently a business man rather than a mechanic, but he has surrounded himself

with the best men that money and merited promotion can attract, and as a consequence he has a staff of workers that includes the most skillful men in every detail of the production of woodworking tools.

Mr. Yates talks very little, and that modestly, about himself. His life has been devoted to making high-grade tools for woodworkers, and in the constant effort to better his product and extend its market he has found ample scope for his energies. The fact that he has succeeded in building up a vast and profitable business and forced a world-wide recognition for his machinery, is a better tribute to his personality, and a more enduring monument to his business sagacity than any that could be conceived. His success is the more commendable when it is considered that the wide market for his products was won against a number of veteran houses that had occupied and covered the field for years. In order to make any progress with his machinery he recognized that his tools would have to be better than any then being produced. He devoted his energies to this end, with the result that the products of his factory have become remarkable for their excellence.

One of the most striking features of Mr. Yates' personality is his ability to infuse his employes with his own energy and enthusiasm. Every man of the great corps of workers is a firm believer in Berlin tools, and every one knows the details of their construction and can talk about them intelligently.

Mr. Yates is married and lives at Beloit in a modest way. He is entirely domestic in his tastes, but to his friends is a host par excellence. He travels extensively both on business and pleasure, and he has branch houses scattered all over the United States and agencies in many foreign countries. He is a member of the Union League Club of Chicago, and has the respect of his competitors and the esteem of his patrons.

## A Lumberman's Letters to His Son.

CHICAGO, OCT. 6, 1906.

MY DEAR SON: It occurs to me, bright and blessed, that the longer you are in the hardwood game the less sense you have about the business. Our swamp oak is none too good at best, and what I want you to do is to have it shipped out on just as high a standard of grade as can be made. Don't you do any more "salting" of cars at your end of the line. This Arkansas mill proposition has got to stand on its own bottom. I am perfectly competent to manipulate grades after they reach me. You need not butt into that at all.

I am just home from a little selling trip over in Michigan and Ohio. The furniture people are putting up a lot of loud noise over the price of oak and, as a consequence, are buying at their own prices—but on the shipper's grade. The wholesale consumer who gets a shipment of first and second with less than fifteen per cent of No. 1 in it is tickled to death.

Your report indicates that you are away in the soup on the woods end of the operation. I have told you for months to keep ahead with your log supply. You ought to know that we are going to have weather in Arkan-

sas for some months to come that will have burrs on it. If you keep the mill running steady for the next thirty days you will do better than I expect you will.

Let me again impress on you that the only secret of successfully running a sawmill in the swamp or mountain country is to keep your mill stocked. This is the place where nine operators out of ten fall down. Next spring you will fully realize the force of this observation.

Get on to another thing. When you get a little short of labor, don't go to raising the scale. You will get more work down in Arkansas with low-priced labor than you will with high-priced. All they want is money enough to live on, anyhow, and if they can support themselves by four days' work you can bet your life they won't work six. Cut wages.

Your affectionate FATHER.

P. S.—No, I shall not suggest to your mother to buy you that pigeon-blood ruby scarf pin at Peacock's. A chicken-blood garnet is good enough for Arkansas. You can buy that at Memphis.

## Hardwood Record Mail Bag.

[In this department it is proposed to reply to such inquiries as reach this office from the HARDWOOD RECORD clientele as will be of enough general interest to warrant publication. Every patron of the paper is invited to use this department to the fullest extent, and an attempt will be made to answer queries pertaining to all matters of interest to the hardwood trade, in a succinct and intelligent manner.]

### Wants Information About Veneers.

CHINA GROVE, N. C., Sept. 10. Editor HARDWOOD RECORD: Will you kindly advise me if the veneer workers prefer a sawed veneer in quartered stock to a sliced cut veneer? Kindly state what advantage if any the sawed veneer has over the sliced and why it is better. Does it give a better finish to furniture? Do manufacturers of high grade goods prefer the sawed veneer to sliced cut? What thicknesses of sawed veneer are more generally used by the furniture trade? What is conceded a good average width for quartered veneer? Can you advise me where I can get the market prices on all widths of sawed quartered veneer, 1 20" and 1 16" thick? — COMPANY.

Veneer workers prefer sawed veneer to sliced or rotary cut stock, because there is no break in the grain of the wood in the manufacture, as is always more or less the case in sliced or rotary cut. Some woods are susceptible of production into very handsome veneers under rotary cut processes, and of course the only way to produce quarter-sawed veneers is by sawing or slicing. Sliced veneer invariably has one "weak" side, while the sawed always has two "strong" sides, which enables the veneer maker to open out his corresponding sheets and produce a "figure."

Again, sliced or rotary cut veneers are made from stock that has been steamed or boiled, which disintegrates and distributes the tannic acid and other coloring matter contained in the wood, which often results in deteriorating effects. Sawed veneers are in all respects better than sliced veneers, and command a much higher price. They are therefore preferred by producers of high class furniture, interior finish, piano work and railroad cars. Sawed veneers are used in thicknesses varying from one-eighth to one-twentieth of an inch, and thinner. Eight inches is a good average width for quartered veneers.

I think if you will write to D. E. Kline, Louisville, Ky., president of the National Veneer & Panel Association, that he can give you the information about market prices. — EDITOR.

### Suggestion for a Substitute for Hickory.

FORT SCOTT, KAN., Sept. 24. Editor HARDWOOD RECORD: I notice in the last issue of your paper the article entitled "A Pressing Need," which I have read carefully and have given considerable thought. I would like to say for the benefit of the National Hickory Consumers' Association that I believe sapodilla, which grows abundantly in the Central American countries, would be a good substitute for hickory, and for the manufacturing of all kinds of handles, better, if anything, than the real thing. The texture, or grain, of sapodilla is about the same as hickory, and is fully its equal in strength and durability. It is dark red in color and susceptible of polish, and handles made from this wood, in contrast with white and black handles, would make an attractive display in the show-case or window of any dealer. I have seen ax handles made by the natives in Honduras that had been in use for years and were still in good condition.

Generally speaking, sapodilla is a large,

straight tree sometimes 60 feet to the first limb, and could be brought to this country at less expense than to pick up small and scattered lots of hickory at home. It is a heavy timber, however, and could not be floated down the rivers as mahogany is, but could be brought down with floaters or in short blocks corded in cribs, as the natives bring down logwood. These methods, however, I think, would be unnecessary for some time, as there has been little or none of that variety of timber shipped out of the country, and for this reason it could be secured in large quantities in localities where the transportation question is practical. I have specimens of this wood which I will send for inspection, and would be pleased to correspond with anyone interested.—J. V. HAMILTON.

The foregoing is worthy of consideration on the part of the hickory interests, coming as it does from Mr. Hamilton, who should be quite an authority on the subject, since he spent several years in timber research in Central America.—EDITOR.

### In Market for Wagon Stock.

HARRINGTON, WASH., Sept. 27.—Editor HARDWOOD RECORD: Can you place us in communication with dealers from whom we can purchase wagon stock in car lots? Following is a list of what we use:

Second growth hickory spokes, B grade, 2 1/2", 2 3/4" and 2 5/8".

Wood hubs in oak or birch, 8 1/2"x11", 9"x11" and 9 1/2"x12".

Sawed felloes in oak, 3" face, 2 1/2" deep x 3' and 3 7/8" high.

Sawed felloes in oak, 3" face, 2 1/2" deep x 3 1/2' x 4" high.

Axle stock, hickory, 4"x5"x6".

Pole plank, 4"; also 4"x5" rough poles.

Plank in hickory and oak not over 6" wide.

2 1/2" any length, any width, not under 6"

3" any length, any width, not under 6"

3 1/2" any length, any width, not under 6"

4" any length, any width, not under 6"

This company has already been supplied with the names of several manufacturers of wagon dimension, but any one interested, on application will be put into communication with this buyer.—EDITOR.

### Wants White Ash.

CORNWALL, ONT., Sept. 24. Editor HARDWOOD RECORD: We would be greatly obliged to you if you could supply us with the names of dealers from whom we could buy white ash suitable for the manufacture of baseball bats.—COMPANY.

The above correspondent has been furnished the names of several concerns which handle this class of material. Readers of the HARDWOOD RECORD who are interested in this inquiry will be put into communication with this buyer on application to this office.—EDITOR.

### Wants Information About Hickory Growth.

PITTSBURG, PA., Sept. 10. Editor HARDWOOD RECORD: Can you give me an idea where the best tracts of hickory timber may be found? If you can give me some information on this subject I will be greatly obliged to you.—

You doubtless know that hickory does not grow in a pure stand, but is found intermingled with other hardwood growth. Arkansas probably contains more hickory than any other state. In that locality it sometimes shows a stand of fifteen to even twenty-five per cent with oak, cottonwood, yew, ash, gum and other woods. In other sections

of the country, notably the lower Appalachian range in eastern Tennessee and western North Carolina, there is a scattering growth of hickory intermingled with poplar, chestnut and oak, but which will rarely show more than fifteen per cent of the total stand. There are some properties of considerable size timbered with this character of woods that can still be had at reasonable prices.—EDITOR.

### Who Knows About These Concerns?

ASHESVILLE, N. C., Oct. 3. Editor HARDWOOD RECORD: One of our representatives has an inquiry for lumber from H. J. Smith & Co., Easton, Pa. H. J. Smith of this concern claims to have been associated with Lawrence Fiske & Co. of Washington, D. C., and refers to them as to his financial responsibility. Can you give us information about the standing of either one of these institutions? We have been caught several times by smooth letters from unknown parties and do not want to get caught again.

Diligent inquiry through commercial agency sources fails to reveal anything very definite about either of the concerns named, but the HARDWOOD RECORD would suggest to its correspondent that the disposal of hardwood lumber at a good price is so easy nowadays that it is not necessary to take chances with unknown concerns unless the commercial agencies are able to give very satisfactory information concerning them.—EDITOR.

### The Delaware Hardwood Lumber Co.

ST. LOUIS, MO., Oct. 4.—Editor HARDWOOD RECORD: We would be very glad if you could give us any supplementary information other than that you have printed concerning either the Pittsburg Fuel Company, formerly of Pittsburg, Pa., or the Delaware Hardwood Lumber Company, the probable successor of this institution of Wilmington, Del. We made a hard some loss with the Pittsburg institution and now have an attorney on the case at Wilmington and are trying to establish the fact that J. C. Harris is a member of both firms.—

Any additional information that the RECORD has concerning this Inel-Harris bunch and their doings is the fact that it is still flooding the mails with inquiries for lumber, and during the last few weeks has sent out numerous inquiries for coal in carload lots. From the fact that the Delaware Hardwood Lumber Company makes no denial of its interests being formerly identified with the Pittsburg Fuel Company, it is safe to say that it is an institution with which lumbermen should become well acquainted before doing business with it.—EDITOR.

### Weight of Lumber From Given Quantity of Logs.

OSAKA, VA., Oct. 3. Editor HARDWOOD RECORD: Suppose you get a carload of logs and they weigh 45,000 pounds and saw them into inch boards, what would the lumber you get from them weigh?—J. R. LEGG, Superintendent Stoneza Coke & Coal Company.

The best test and only absolutely certain rule to determine the question of this correspondent is to take 45,000 pounds of logs, saw them to inch boards, and weigh the resultant product. Seriously, 45,000 pounds of logs will result in approximately 30,000 pounds of inch lumber if well manufactured. Of course, the result is entirely determinable by the thickness of the saw and the accuracy with which the stock is edged and trimmed, having reference, of course, to the quality of the logs and to the proportion of worthless heart.—EDITOR.

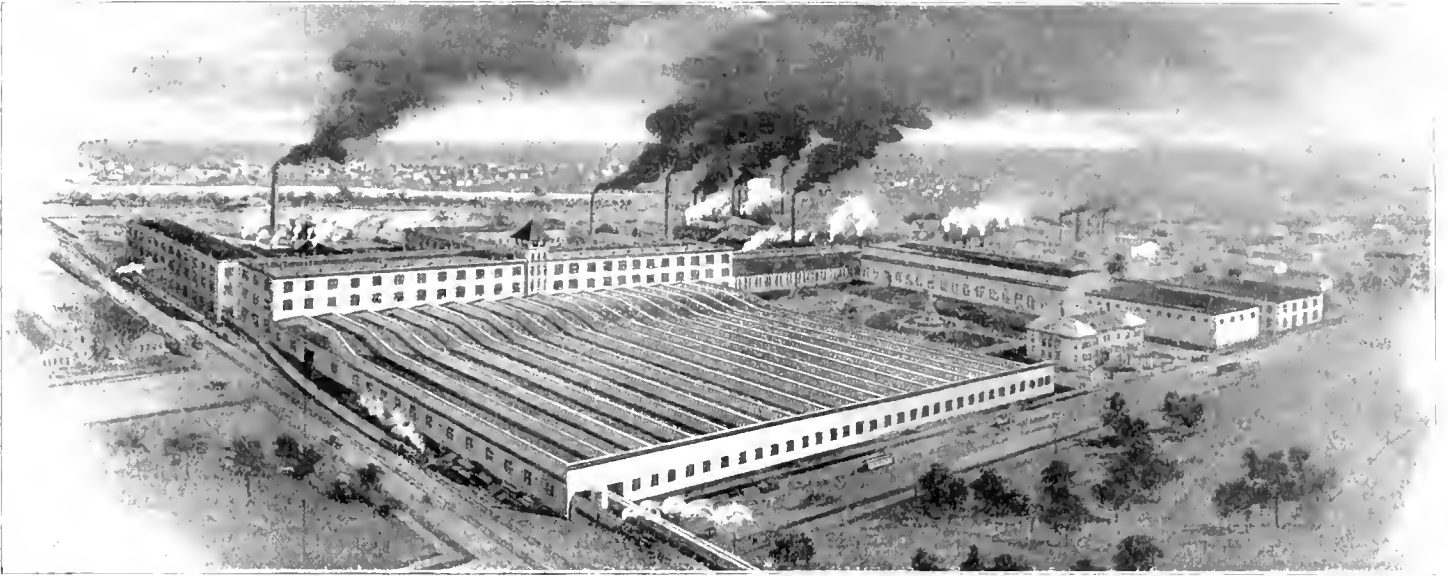

GENERAL VIEW PLANT BERLIN MACHINE WORKS, BELOIT, WIS.

## *Where Berlin Wood Working Tools Are Made.*

TEXT AND PHOTOGRAPHS BY EDITOR HARDWOOD RECORD

About ninety miles northwest of Chicago, on the Chicago & Northwestern and the Chicago, Milwaukee & St. Paul, is the cleanly, thriving and energetic manufacturing town of Beloit, Wis. It is a city in which things are done in which things are done well. One of the chief industries is the Berlin Machine Works, which manufactures a great variety of woodworking tools. The monster plant of this institution covers an area of two large city squares and from its several entrances there pour forth each night more than a thousand workmen.

It is with pleasure that the *HARDWOOD RECORD* takes this opportunity of depicting with camera and pen some of the salient features of this great institution. The accompanying illustrations will convey an excellent idea of the model character of the plant. While it has been erected section by section, a general plan was outlined at its inception according to which each succeeding structure was builded, contributing its special functions to the whole, harmonizing with it, and adding increased conveniences and efficiency. The great works stands as a monument to the

mechanism, forethoughtfulness and commercial sagacity of its projector, Porter B. Yates, the president and managerial genius of the enterprise.

The Berlin Machine Works had its inception in a little machine shop at Berlin, Wis., which was purchased in 1881 by Mr. Yates. In this plant was built the first power feed sanding machine ever made. It was the invention of two cabinet makers who were employed in a burial case factory at that place. About 1876 they conceived the idea of making a machine for finishing the curved sides of burial cases. The owners of the coffin factory bore the expense of having a tool made for this purpose and a small local machine shop executed the ideas of the mechanics in the form of a single drum sanding machine. Naturally, it was crude, but after a fashion it did the work for which it was designed. The inventors of the machine secured a little financial assistance from a local banker, took out a patent and built two more machines. These tools were sold to other manufacturers and at once a demand was created for them, especially among the furniture trade. In 1880 the

machine was improved by the addition of a second drum carrying a different grade of paper, and a few more machines were made and installed. By this time wood workers generally began to realize that no plant was complete without a power sander. The business of manufacturing these tools was continued until 1884, when the works were taken over by the financial backers and sold to Mr. Yates, who incorporated under the name of The Berlin Machine Works. This, then, was the inception of the present great business at Beloit, to which point the plant was moved in 1888.

The little one-story stone structure pictured herewith was a wing of the building in which The Berlin Machine Works was installed, and is now used as one of the shipping rooms. The main shop was two stories and had a floor space of only 60x140 feet. Less than two score of workmen were originally employed. In 1891 The Berlin Machine Works increased its line by adding the manufacture of cabinet planers, glue jointers and other minor tools used largely by furniture makers, and as time passed, constantly added to its line

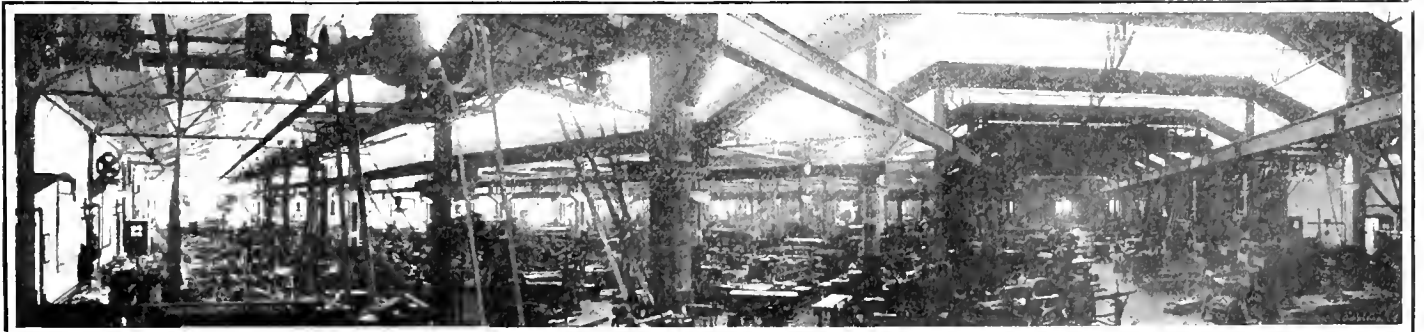

ERECTING ROOM, BERLIN MACHINE WORKS, BELOIT, WIS.



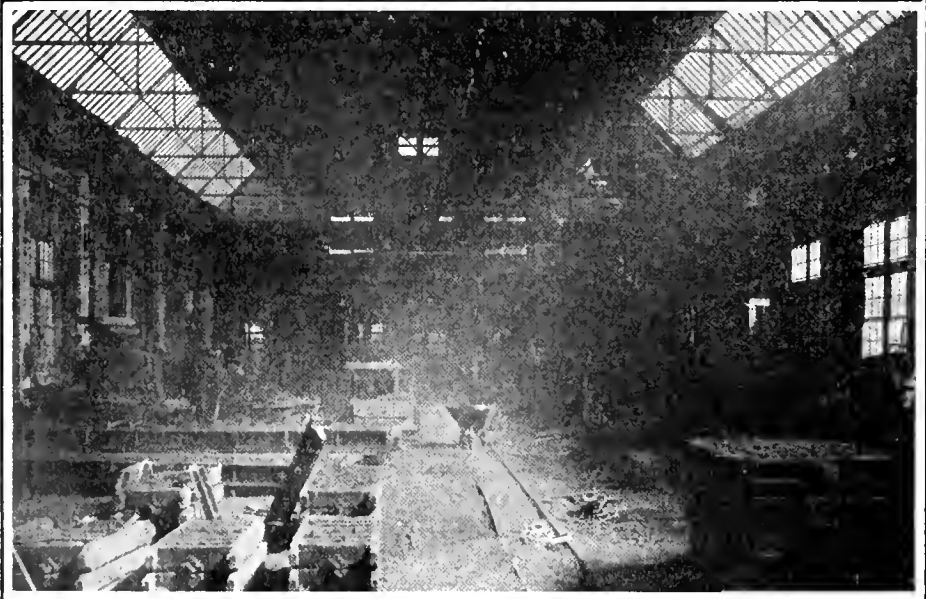
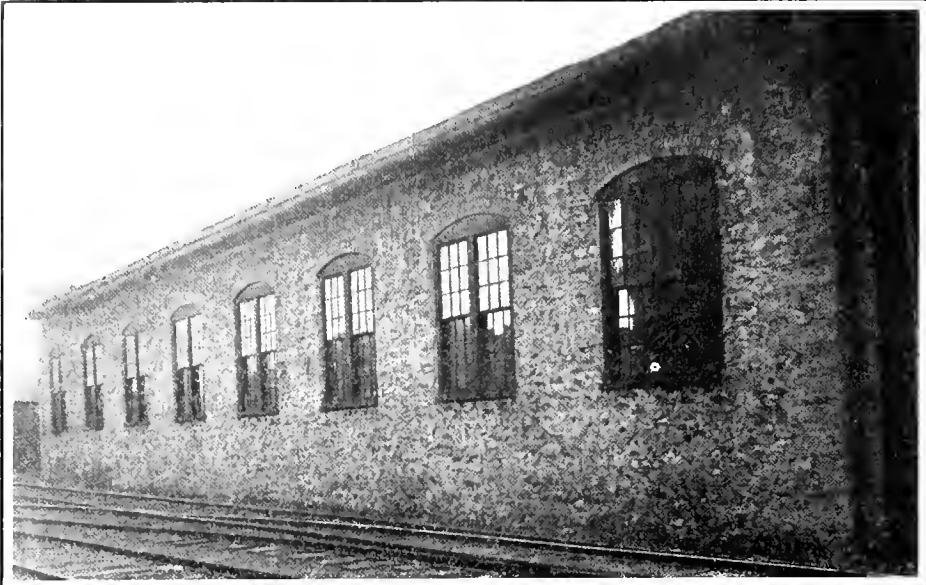

SCENES ABOUT THE PLANT.

(1) THE ORIGINAL BUILDING. (2) FIREPROOF PATTERN VAULTS. (3) THE MAIN FOUNDRY.

of output until today it has become one of the foremost producers of planing mill machinery in the country.

Some details of the great Beloit industry are worthy of special mention. The general plan of construction is in the form of a hollow square. As before noted the plant occupies an area of two large city squares, a street having been closed to accommodate it. One of the accompanying pictures shows a corner of the fireproof pattern vault building, which has an area of 72x136 feet. This structure is three stories in height, is built entirely of steel, cement and brick and is divided into twenty-four fireproof vaults. Communication with this building is had only through an elevator and from the iron balconies and staircases on the outside. In the unlucky event of a conflagration in one room, the patterns in that room might be destroyed with no possibility of endangering the contents of the remaining vaults. Thus the company has provided that no contingency covering the destruction of patterns shall interrupt its business.

Another picture shows the main foundry of the institution, a single well-lighted steel building with a floor area of 72x300 feet. It is equipped with two electric cranes, one having a capacity of ten tons and the other fifteen tons, which greatly expedite the work of handling the large one-piece castings, flasks, patterns and crane ladders. This building has a wing, 10x60 feet, and there is also a second foundry structure, 66x250 feet in size, in which the smaller castings are made. This great foundry space is rendered necessary by the fact that The Berlin Machine Works produces all its own castings. An especial feature of its work in this line is that many of the frames of its tools from the minor one weighing 1,000 pounds to the gigantic frame for a sizer which weighs 1,000 pounds, are cast in one piece. This method of construction has such manifest advantage over sectional framework bolted together that it scarcely needs comment. It makes a machine that is absolutely rigid and which may be successfully operated with or without a substantial foundation. In carrying castings or entire machines from one part of the plant to another, a system of electric cranes is used, as shown in the illustrations, which can deposit the iron and steel not only in any room of the building but in any part of a room.

A striking feature in connection with the foundry is the thoroughly equipped chemical laboratory which is under the supervision of an expert metallurgist. Here are analyzed all materials used in the construction of Berlin machines. Any consignment of iron, steel, coke or other material, which does not test up to standard is rejected. This is a feature which



cannot be too carefully considered by users of woodworking machinery.

Sections of the three floors of the great machine shop are shown in a series of pictures in connection with this article. This building is three stories in height and 66x200 feet in size. On the ground floor are long lines of monster planers capable of finishing the framework of the largest woodworking tool manufactured by the company. On the next floor are located lines of lathes and other tools essential in boring and fitting shaftings, pulleys, gears, etc., while on the top floor are located the lighter tools producing the minor parts of the machines.

To illustrate the genius in molding employed by The Berlin Machine Works an engraving is shown of a single-piece casting of the framework of a giant horizontal band resaw. In a tool of this character the manifest advantage of the rigidity secured by this form of construction is readily appreciated. A pile of single-piece frame castings for planers and matchers is depicted in another illustration.

Perhaps the feature of The Berlin Machine Works that most forcefully impresses the visitor is the vast erecting room pictured on the first page of this sketch. It covers an area of 300x100 feet, equal in size to an ordinary city square, and from wall to wall in close array are long lines of various types of woodworking machinery in process of erection. It is a splendidly lighted room, being of the saw-tooth roof style and most admirably answers the purpose for which it was constructed.

The Berlin Machine Works at this time produces eighty sizes and kinds of two and four side planing machines, from the moderate-sized furniture planer to the immense timber sizer, and from a small moulder to the heavily constructed hardwood flooring machine; fourteen kinds of band resaws and band ripping machines, ranging from the tool utilized in a furniture factory to pony band mills and the mammoth resaws designed for sawmill use, and ten sizes of triple drum sanders, all built on the spiral drum design, ranging in width from 30 to 102 inches. In addition to this the company manufactures cut-off saws, rip saws, buzz planers and a variety of other small tools.

As before noted, P. B. Yates, president of The Berlin Machine Works, is the managerial genius of the institution. He is an incisive, forceful, typical American business man, and his accomplishments are fully manifested in the success he has achieved for his company, and from the fact that the Berlin tools are well and favorably known through all parts of the civilized world. The secretary and treasurer of the institution is L. D. Forbes, who ably handles the financial end of the business. The practical man in charge of designing is H. B. Ross, the vice president of the company. Under his direction are

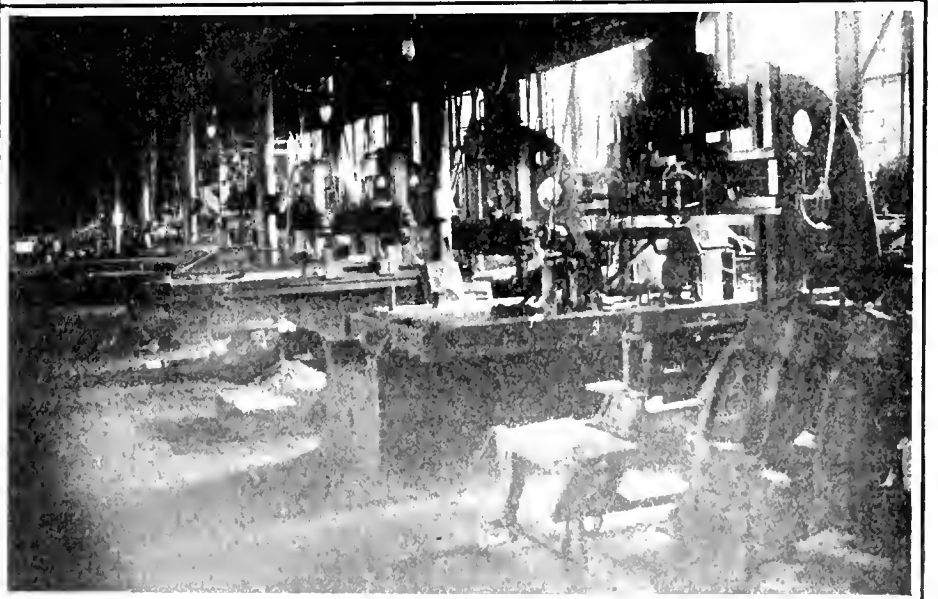
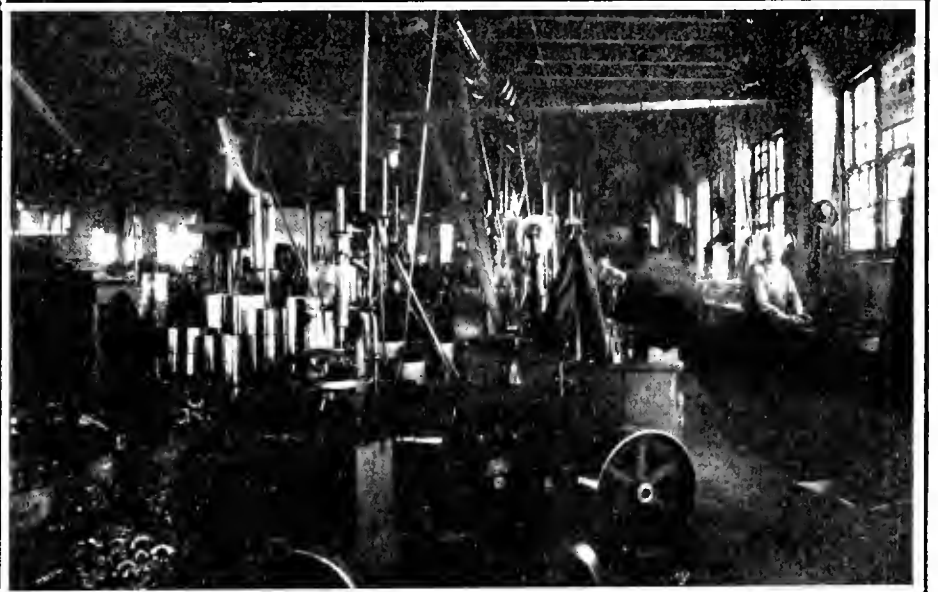
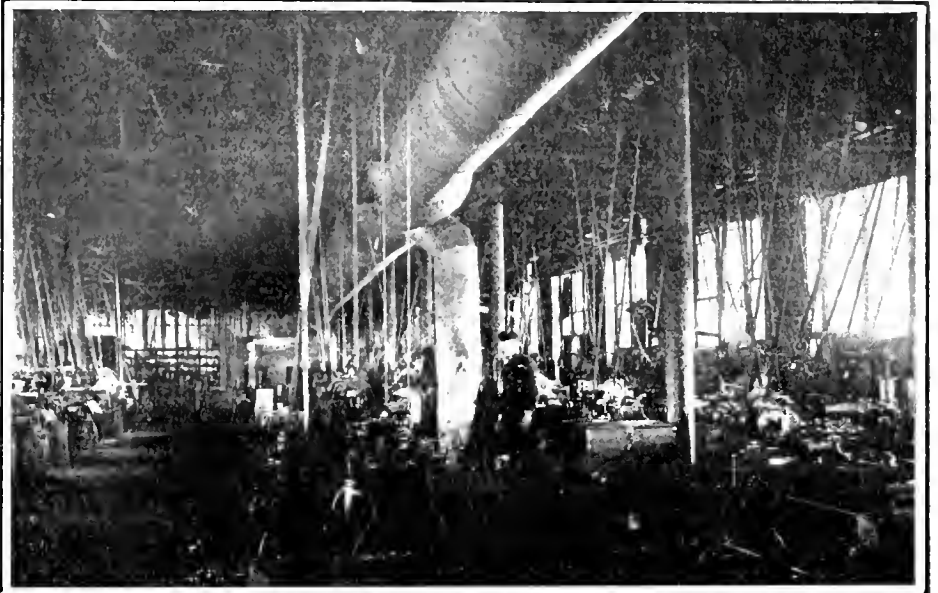

MACHINE ROOM BUILDING.

(1) PART OF THE THIRD FLOOR. (2) PART OF THE SECOND FLOOR.  
(3) PART OF THE FIRST FLOOR, SHOWING LONG LINE OF GIANT IRON  
PLANERS.

four expert designers with their corps of subordinates; one whose specialty is planning machines; a second, hand-sawing machinery; a third, sanders, and another small tools. The construction of all machinery is in charge of F. L. Lane, general superintendent.

It has never been the good fortune of the writer to visit and inspect a better organized, more orderly, and a more fully equipped machine manufacturing house than that of The Berlin Machine Works. The systematic manner in which every part of the business is conducted is manifest to even the casual visitor. In construction, an analysis of the tools of the Berlin Machine Works is also a particularly noticeable feature. Primarily every tool seems to be built for strength and rigidity. It seems to be in the mind of the designer that if a 3,000-pound frame, bolted together on lugs will stand the strain of a fast running machine, a 3,500-pound solid cast frame will do it better, therefore the better plan is adopted. It

seems to be in his mind that if an eight-inch narrow gear will carry the load of driving a feed-roll, that a twelve-inch wide gear will do the work better and

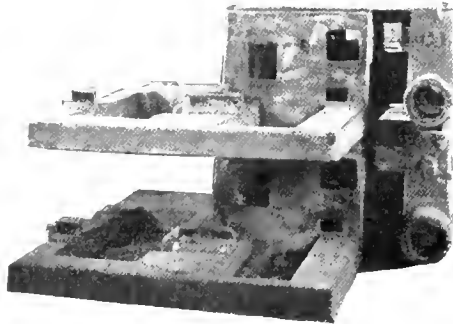

FRAME OF HORIZONTAL BAND RESAW CAST IN A SINGLE PIECE.

safer, and the better plan is therefore adopted.

Simplicity is another feature of the tools. Wherever one piece, even at a higher cost, will take the place of two, the one piece is used. One could go on

without end in discussing the details of the construction of Berlin tools. He could tell of the self-hardening steel employed in its knives, the avoidance of objectionable gears in band resawing construction, the simplicity and strength of parts in a hundred other tools and yet could not finish the story in the brief scope of a newspaper article. In short, The Berlin Machine Works is a well-ordered, well equipped and mammoth plant which produces wood-working tools of quality.

The Berlin Machine Works maintains branch stores and offices at Seattle and San Francisco; branch offices at Chicago, New York, Boston, New Orleans, Spokane and Macon, Ga. Traveling representatives are located at Columbus, Norfolk, Minneapolis, St. Louis and Little Rock, Ark. An allied house is The Berlin Machine Works of Canada, which is about to erect a large plant at Hamilton, Ontario, which will manufacture a line in duplicate of that of the parent institution.

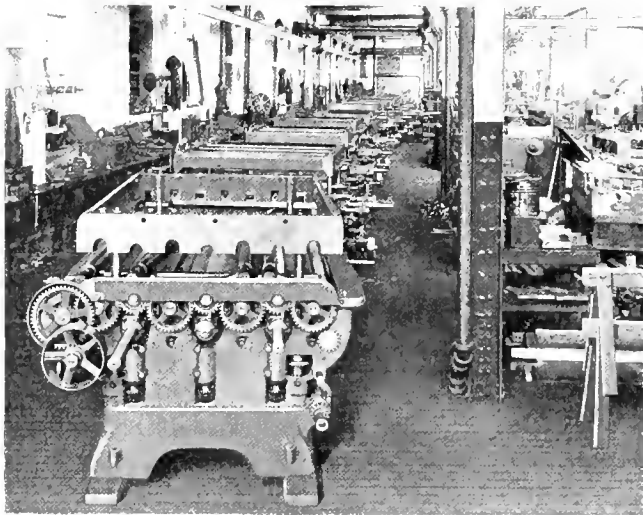

LONG LINE OF SANDERS READY FOR SHIPMENT.



PILE OF SOLID SINGLE CASTING FRAMES FOR PLANING MACHINES.

## News Miscellany.

### Brazil Market for Office Fittings.

The American consul stationed at Rio Janeiro states that American manufacturers of office fittings should have little difficulty in introducing their goods, and once recognized there would undoubtedly be a constant demand for them. He writes as follows:

"There is a wave of improvement on in Brazil generally and especially in Rio de Janeiro. A large number of modern office buildings are being constructed, creating a demand for new office appliances, which will be mostly made in Brazil, but an aggressive campaign in behalf of American roll-top desks and similar conveniences would probably be successful. Manufacturers of patent files, especially metal files, and other office appliances should do a good business. The tariff is high. On an office desk, for instance, the duty would be \$6 to \$40 gold, specific, and an additional 50 to 60 per cent ad valorem, depending upon the nature of the article. However, high prices are common on everything. The business men of Rio de Janeiro will buy American office fittings when once they are led to appreciate

their merits, high prices or not. In a community where business affairs are dominated largely by conservative foreigners, however, the introduction of modern American conveniences will not be accomplished without effort. [American manufacturers desiring to enter the market in such goods should write to some of the firms named by Mr. Anderson, the addresses of which are obtainable from the Bureau of Manufactures.] Correspondence should be in Portuguese, if possible, otherwise in French, and in English only as a last resort."

### German Discrimination Against American Lumber.

Henry W. Diederich, formerly American consul at Bremen, called the attention of American lumber and timber shippers to the fact that under the rules of the Prussian railways a special and higher rate of freight was collected on American pitch pine, yellow pine, hickory and black walnut for inland transportation than was charged for wood coming into Germany from European countries. In this report it was further stated that inasmuch as nearly all the

railroads engaged in this transportation were owned and managed by the government this special freight tariff was in reality a discrimination against American lumber. As the new German tariff law went into effect on March 1, 1906, it may be of interest to lumber shippers to know that, although the import duty on hardwoods has been increased considerably, no change has been made in regard to this special freight tariff.

Vice-Consul Frederick Hoyerann writes that by the terms of the new German tariff the import duty on hardwoods has been raised from \$1.14 to \$1.37 per cubic meter (35.314 cubic feet).

### Reforestation in China.

China has been destitute of tree growth for so many years that the action of the Germans at Tsingtau, where they maintain a fortified garrison, in providing for the reforestation of the district under their control is to be most heartily commended. The authorities have been conducting a department of forestry since their occupation, with the result that the barren hills of a few years ago are now covered with young forests. Millions of young trees have been set out and the work has been taken up by the Chinese, who are planting trees themselves under the supervision of the German authorities.

### Some Historic Trees of Tennessee.

Tennessee can boast of having some historic old trees that bear testimony of events of the long ago. Near Reelfoot Lake still stands the black oak where Davy Crockett had a fight with a bear. In Sumner county near Tyrone Springs is a spreading elm under which President Andrew Jackson, Felix Grundy and other notables established a mock court, after a notable political campaign, and by the fines imposed on all in the "jurisdiction" of the tribunal, kept themselves and the ladies supplied with the choicest fruits and melons. Near Nashville stands the large oak under which the famous Judge John Haywood of the Tennessee Supreme Court was accustomed to lie on a bull hide and examine applicants for law licenses. Just out of Gallatin is a huge hollow sycamore known as "Spencer's tree." This trunk was for years the home and retreat of Spencer, a noted trapper and Indian fighter. He was a man of gigantic size and many wonderful stories are related of his feats. An old beech tree standing on Boone's Creek in East Tennessee is known today as "Boone's tree." On it is carved the quaint inscription: "D. Boone Called A. Bar On Tree in the Year 1760." In the Watauga valley in East Tennessee also stands an old locust tree that marks the site of the old fort of the Watauga settlers, the first distinctive landmark in the history of the state.

### American Pianos in Brazil.

In a recent report Consul General G. E. Anderson of Rio de Janeiro calls attention to the fact that the twenty per cent reduction in tariff duties on pianos entering that country from the United States ought to prove beneficial to the American exporter. This is a preferential reduction and does not apply to instruments coming from other countries. American pianos here before have not suited the Brazilians in size, shape, finish or decoration. A small and light piano can be more easily sold because of the difficulty of transportation, the instrument frequently going into interior villages and towns where means of carrying are primitive, while the natives also like a more ornate decoration than is usually found in the American stock. According to Mr. Anderson there is at present a decidedly favorable opportunity for the introduction of the American product into the country because of the high price and uniformly poor instrument that is being sent there from other countries, and because the American manufacturers, besides making a better instrument, have the benefit of a preference in tariff. A list of Rio de Janeiro dealers can be secured from the Bureau of Manufacturers.

### Hardwoods in Santo Domingo.

In speaking of the various hardwoods to be found on the Island of Santo Domingo, Vice-Consul A. W. Lithgow, writing from Puerto Plata, says that those chiefly exported besides mahogany are lignum vitae, lancewood, fustic, greenheart and mora. The largest diameters procurable are, in cedar, sixty inches; in mahogany, thirty-five inches, and in lignum vitae, ten inches. On the northern side of the island quantities of large timber can be procured about ten miles from the railroad. It is expensive to draw out the wood, and as there are no roads, paths have to be cleared through the forests. The people usually drag the logs with bulls, but the more intelligent use two large wheels on an axle, on which they hang the timber. Roads could be made in the woods for wagons, but as this would be expensive it would all depend on the extent of the enterprise.

In some sections there are rivers on which the logs may be floated, but one has to wait for a freshet, which often delays for years. The facilities and price of getting out the wood depends entirely on the location. Where one owns the trees, the medium cost of felling, squaring, hauling from forest, railroad freight and delivering alongside ship is about thirty dollars, American money, for 1,000 feet of mahogany or

cedar. Trees can be bought standing at from twenty-five cents to one dollar per tree, depending on the size, condition and location. It is preferable to purchase the right to fell over an extent of land, first going over same to estimate the amount of timber that can be gotten out, or one can buy it at the rate of \$5 per thousand feet.

### Establishment of New Mahogany Trim Plant.

The Mahogany Interior Trim Company of Indianapolis, Ind., has established a new manufacturing plant at that place for the purpose of making high grade quarter-sawed oak and mahogany interior trim as well as to do work in other precious woods.

The new mill is especially well supplied with veneer machinery and intends to make a specialty of furnishing interiors for high class residences, office and public buildings. The company has a branch office at 132 La Salle street, Chicago.

### New Veneer Department.

The Buffalo Hardwood Lumber Company of Buffalo, N. Y., has lately added to its business by establishing a veneer department and is carrying a large and complete stock of sawed and sliced veneers in quartered oak and mahogany. The veneers, which are of various thicknesses, have been especially selected for figure and quality by the company's own experts, and they are cut from squareditches so that stock in each ditch runs in uniform width, giving an advantage and saving that cannot fail to be appreciated.

The company also has mills with a daily capacity of upwards of 200,000 feet, manufacturing rotary cut oak, poplar, ash, elm, gum, basswood, maple, beech, and in fact all domestic woods, in thicknesses from 1/32" to 3/4".

### New Secretary American Forestry Association.

Owing to pressure of personal business, H. M. Suter, formerly secretary of the American Forestry Association, found it impossible to devote sufficient time to the work incident to that office, and some time ago signified his desire to resign as soon as a successor could be chosen. On Sept. 1 Dr. Thomas E. Will took up the secretaryship of the association as successor to Mr. Suter.

Dr. Will has spent the greater part of his life in teaching, lecturing, writing and administrative work, having held professorships in various schools and colleges all over the country. In July, 1905, he entered the Civil Service at Washington in the Bureau of the Census. He was soon transferred, however, to the editorial department of the Forest Service, where he remained until his recent appointment. The past summer he lectured on forestry, under the auspices of the Forest Service, in North Carolina, Indiana, Missouri, Oklahoma and Kansas. He is an enthusiast on forestry, of which subject he has made a close study, and as secretary of the American Forestry Association should accomplish much for that organization. Dr. Will's headquarters will be the offices of the association, 519 Twelfth street, N. W., Washington, D. C.

### Recent Timber Purchases of D'Heur & Swain Lumber Co.

The D'Heur & Swain Lumber Company of Seymour, Ind., always on the lookout for the best timber that grows in the far-famed Indiana section, has concluded the purchase of the Bailey farm, located about seven miles northeast of Bedford. This timber property runs very heavily to poplar and walnut, and is reputed to be the finest tract left now in Indiana. It is virgin timber and has been held out of the market for many years. The poplar runs as high as sixty inches in diameter and the walnut thirty-four, averaging from four to six logs to the tree. The timber will be shipped to the D'Heur & Swain Lumber Company's mill at Seymour for sawing.

### Walnut Timber Purchase in Ohio.

The Miami Lumber & Veneer Company of Dayton, O., has just concluded the purchase of a tract of timber land near that city in which walnut largely predominates. It is regarded as the largest and best walnut timber tract standing in the United States. The trees run from twenty-eight to forty-four inches in diameter with a few larger specimens, and, of course, it is the old-fashioned, rich-toned, mature, black walnut that has become so scarce in this country during the last twenty years. The Miami Lumber & Veneer Company has for many years made specialties of both oak and walnut, and ships quite a portion of its output to Great Britain, the Continent and to Canada, besides enjoying a large domestic trade. It has a finely equipped band sawmill and veneer plant at Dayton.

### Meeting of Michigan Hardwood Manufacturers' Association.

The Hardwood Record is advised by Bruce Odell of Cadillac, secretary of the Michigan Hardwood Manufacturers' Association, that its next meeting will be held at the Park Place Hotel, Traverse City, on Wednesday, Oct. 31. The first session will be called at 10 a. m. At this meeting the grading committee will submit a set of grading rules for discussion and probable adoption, which will cover every variety of Michigan hardwood growth.

There will also be submitted by the secretary a report of stocks on hand Oct. 1, 1906, and a comparison made with the stocks of July 1.

There will also be a discussion on the subject of values and an effort will be made to establish a basis commensurate with existing conditions.

A general invitation is extended to every manufacturer and stumpage owner of hardwoods in Michigan to be present at this meeting. Undoubtedly it will be the most important meeting of this association that has yet been held, as the legislation forwarded will be of vital importance to every hardwood producer of the state. From the manifest interest shown by the larger proportion of the hardwood people of Michigan a very large attendance is already assured.

Traverse City at this time of year is a most delightful place for a gathering of this sort and the Park Place Hotel is a particularly excellent hostelry at which to hold the meeting.

### The North Shore Lumber Company.

One of the strongest hardwood concerns of northern Michigan, with important and extensive operations, is the North Shore Lumber Company, formed some eighteen months ago to cut out a timber tract at Thompson, Mich. The tract, which is a large one, consisting of hardwoods and hemlock, was purchased in 1905 by Paul Johnson and included a sawmill and logging railroad. After the property had been secured by Mr. Johnson, the mill was entirely rebuilt, the railroad was improved and the holdings were turned over to the new company, which began the work with a capitalization of \$150,000, of which \$100,000 was paid in.

The officers of the company are Paul Johnson of Thompson, Mich., president; A. M. Chesbrough of Toledo, O., secretary and treasurer, and D. D. Flanner of Toledo, vice president.

Mr. Johnson is widely known in Michigan, where he has had a long and successful career in the management of hardwood and hemlock operations. A. M. Chesbrough is vice president of the National Bank of Commerce of Toledo, O., and is splendidly equipped to handle successfully the finances of the company. He was also familiar with lumber operations before the present venture, having large sawmill interests at Emerson, Mich., where he operates in connection with his brother under the firm name of Chesbrough Brothers. D. D. Flanner of Toledo, O., has a wide reputation in the hardwood trade as president of the Big River Lumber Company

Wood, and is the senior partner of the firm Plummer & Reeves.

The company both in its personal equipment and financially constitutes one of the strongest factors in the Michigan trade. It has an annual output of approximately 20,000,000 feet, which is shipped to market by both rail and water.

In the last issue of the *Hardwood Record* were shown photographs illustrating lumber ready for shipment and vessels loading at the docks of the North Shore Lumber Company at Thompson, Mich.

#### Removal Case Lumber Co.'s Headquarters.

The headquarters of the Case Lumber Company, which, since its inception three years ago, have been at Chattanooga, Tenn., have been removed to Birmingham, Ala. The change was made so as to be nearer the chief source of supply. A little over a year ago the company completed a fine band mill at Birmingham, where it owns a large boundary of hardwood timber lands. This mill is operated under the style of the Fowler-Personett Lumber Company and is said to be one of the finest hardwood mills in the state.

The Case Lumber Company has been one of Tennessee's most successful lumber firms. The president of the company is J. D. Case of Indiana; M. M. Erb is vice president and sales manager; A. B. Irwin, secretary, and William Fowler, treasurer and general manager.

#### Purchase of Hardwood Timberland.

The Henry Maley Lumber Company of Evansville, Ind., has just completed the purchase of a valuable tract of hardwood in Mississippi, containing approximately 8,000 acres, and it is understood that the price paid for the property was \$140,000. The company, which includes Henry Maley, Claude Maley, Daniel Wertz, Frank Outlinger and Bedna Young of Evansville and Messrs. Barney and Hines of Memphis, Tenn., already has extensive interest at Evansville, Memphis and at Grenada, Miss. Arrangements are being completed by the Illinois Central Railroad to run a line into the timber and open up the tract so that the company can ship the logs to their various sawmill points, where it is intended to cut up the stock.

Claude Maley spent some time in the South recently before buying the present tract and while there looked over other timber lands, with a view to extending the holdings of the company.

#### The Government Recovers Walnut Logs.

The suit instituted at Tecumseh, Okla., some time ago by the United States government to recover walnut logs alleged to have been illegally cut on the reservation of the Kaw and Ponca Indians has been decided in favor of the federal authorities. Two carloads of logs had already been shipped from the reservation and sixty-five more were in process of being hauled out when the business was stopped by the United States marshal. For some time there had been a steady business in the cutting of walnut logs on the reservations for shipment to Germany, selling the less valuable ones on the home market. The federal department in charge of the reservations has positively forbidden anything of the kind and there is nothing to be cut or sold on the reservation for such purposes. A suit at Oklahoma City is still pending to recover the remainder of the logs, and, as the issues are just the same as in the one concluded, it is expected that the government will ultimately gain possession of the entire quantity.

#### Consolidation of Memphis Hardwood Interests.

The Lamb Hardwood Lumber Company, the Bacon Nolan Hardwood Company, and the Guirel-Stoyer Lumber Company have announced in a circular letter that they have consolidated their various businesses, including timber lands, mills, stocks on hand, etc., under the name of the

Lamb-Fish Lumber Co. The three companies have been operated together recently under a working agreement established some time ago, and the new corporation announces that the management will be the same, and that, on completion of the large 100,000 feet capacity band mill at Charleston, Miss., it will have four mills in operation. The headquarters of the new concern will remain in the Memphis Trust Building, Memphis.

LaFayette Lamb, president of the consolidated interests, accompanied by his son, C. R. Lamb, together with a number of friends, reached Memphis early this week, after a tour of inspection which included the mill at Lambertville, about twenty-five miles above Memphis. They also spent some time in Charleston, Miss., in company with H. E. Pacon, general manager of the Lamb-Fish Lumber Company, where the company is erecting its new hardwood plant.

#### Temporary Discontinuance of Box Factory.

The new box and shuck factory, together with the engine and boiler houses, of the Garetson-Greason Lumber Company at Fisk, Mo., was destroyed by fire on Sept. 23. Owing to the fact that it would require several months to rebuild and a great length of time to secure the special machinery necessary for operation, the company has decided to discontinue that branch of its business, and has notified its customers of the cancellation of all existing contracts for boxes and shucks.

#### New Maple Flooring Factory.

The Manistee Planing Mill Company of Manistee, Mich., is erecting a maple flooring factory in connection with its planing mill, which will be in operation about Nov. 1. The new plant will have a capacity of about 4,000,000 feet a year and will be equipped with the latest improvements in kilns and machinery. The company has already employed a force of thoroughly experienced men and expects to manufacture a superior product from the start.

#### Miscellaneous Notes.

The McKinnle Veneer Package Company of Mechanicsburg, Ky., sustained a loss of over \$15,000 by fire recently. The factory, which was a frame structure 200x250 feet in dimensions, was badly damaged and considerable finished stock destroyed. The company was not insured.

Hugh Murphy, James A. Lewis, D. B. Scott and L. J. Gregor are the incorporators of the Alabama Hardwood Lumber Company of Mobile, Ala., recently organized with a capital stock of \$20,000.

The Smith-Snyder Company of Sandusky, O., and the Akron Woodworking Company of Akron have merged their interests and filed articles of incorporation at Columbus a few days ago, with a capital stock of \$150,000. The machinery of the Akron concern will be removed to Sandusky and installed in the present plant of the Smith-Snyder Company. The new concern, for which a name has not yet been chosen, will manufacture sash, doors, screens, grille work, hardwood flooring and engage in a general woodworking business.

The Mitchell Hardwood Lumber Company of Mitchell, Ind., has been incorporated with \$15,000 capital stock to manufacture lumber, buy and sell timber, lumber, etc. F. G. Cline, F. X. Newman and Morton J. Traub are the promoters of the enterprise.

Fire, entailing an estimated loss of \$30,000, destroyed the factory of the Anderson Veneer Door Company at Jamestown, N. Y.

The Union Hickory & Lumber Company is a new concern at Corning, Ark., capitalized at \$3,000. T. W. Fry is president of the company; H. C. Dow, vice president and secretary, and J. W. McKee, treasurer.

The plant of Parker & Barnes at Lowville, N. Y., was partially destroyed by fire on Sept. 7.

The sawmill, planing mill, broom handle factory pulp mill and boiler house were badly damaged. The loss is estimated at \$20,000, with only \$5,000 insurance.

The Clarksville Hardwood Lumber Company, Clarksville, Tenn., will rebuild at once its plant which was damaged by fire late in August.

The style of the Great Lakes Veneer & Panel Company of Grand Marais and Munising, Mich., has been changed to the Great Lakes Veneer Company, operations to be continued at both places as heretofore. The concern has an authorized capital stock of \$100,000.

The Ohio Manufacturing Company of Ashville, N. C., has been incorporated with \$25,000 capital stock and the following officers: A. F. Hall, president; F. Littleford, secretary, and S. J. Taylor, general manager. The company has for some time been operating mills at Whittier, N. C., and Morristown, Tenn., manufacturing oak and hickory wagon dimension stock, and is contemplating the increase of the capacity of both plants in the near future.

George Strable, whose maple flooring factory at Reed City, Mich., was destroyed by fire in July last, is building a large maple flooring and crate plant at Saginaw, Mich., which he expects will be ready for occupancy by December 1. The plant will be modern in every respect and will have a capacity of 30,000 feet of maple flooring and 20,000 feet of crating a day.

The Ford Brenner Lumber Company, formerly of Chattanooga, Tenn., but now of Norfolk, Va., has recently established a branch yard at Salisbury, N. C. In addition to its regular export trade, which has grown to such enormous proportions, the company is fast building up a profitable business in supplying material to the furniture factories along the Atlantic seaboard.

The Nashville, Chattanooga & St. Louis Railway Company has employed P. J. Dennison and Thomas A. Enochs of Lexington, Tenn., under a yearly contract to buy ties for that system from Hollow Rock Junction to Memphis and from Lexington to Perryville. The contract calls for an annual output of 125,000 ties.

The contract to log 4,000,000 feet of hardwoods was recently taken by Mark Hessey of Iron River, Wis. The timber in question lies about ten miles northeast of that city on the Washburn branch of the Northern Pacific railway, and will be shipped via that line to the Webster Manufacturing Company of Superior, Wis.

The Turner, Day & Woodworth Handle Company of Louisville, Ky., recently purchased a tract of land at Paragould, Ark., on which it will erect a new handle factory.

The firm of Pritchett & McDonald is a new concern which will handle hardwoods on commission, with offices in the Machea building, New Orleans, La. F. M. Pritchett, formerly with the Forest Lumber Company of Jackson, Ala., and more recently with McDonald Bros. of Helena, Ark., and Charles McDonald, a hardwood lumberman with a lifelong experience who has lately been engaged in logging operations near Washington, La., are the organizers of the firm.

The Montgomery Hardwood Lumber Company has been incorporated at Crawfordsville, Ind., to manufacture and buy and sell hardwood lumber. It is capitalized at \$45,000 and Thomas Hill, Edward A. Sterzick, Charles Hammond, Walter J. Neible, Harry M. Schooler and Robert G. Porter are the directors.

Work has been started on the erection of a sawmill at Richmond, Tex., for Dr. Ziegler. The plant will be equipped for the manufacture of hardwoods, and it is probable that a planer will be installed later.

The Grace Furniture Company is the name of a new concern at Salisbury, N. C., which will operate a large factory there in the manufacture of furniture. The capital stock is \$100,000.

An investment of \$10,000 will be made by

S. R. Lownd of Norfolk, Va., in the erection of a sawmill 26x100 feet, a planing mill 50x80 feet and a dry kiln 22x100 feet and their equipment.

The Advance Lumber Company of Cleveland, O., has increased its capital stock from \$250,000 to \$500,000.

The Forbes Manufacturing Company of Hopkinsville, Ky., is erecting a new wagon factory 316x160 feet in dimensions, of brick and two stories high, which will be equipped with new machinery, giving the company an annual output of 10,000 wagons.

The National Lumber & Manufacturing Company of Walnut Ridge, Ark., has purchased the plant of J. J. Moore at that place, on which it will make extensive improvements. The company also contemplates the erection of a woodworking factory.

The Hoffman Heading & Stave Company has

been incorporated with \$150,000 capital stock at Mount Pleasant, Tex. The company has decided on the erection of a factory at Mount Pleasant and the building of a tram road sixteen miles long to its timber holdings, which are rich in white oak growth. The addition of a barrel and wagon factory is a future possibility. Frank Goodrich of Dexter, Mo., is president of the company, and John V. Moore of Mount Pleasant is manager and superintendent of the rail road.

Work on the hardwood mills of the Sanford Sullivan Lumber Company at Naples, Tex., is progressing rapidly, and what will undoubtedly be the largest hardwood plant in the state will soon be in commission. The establishment of this operation at Naples has given building an impetus and Naples bids fair to become quite a business center.

## Hardwood News.

(By HARDWOOD RECORD Special Correspondents.)

### Chicago.

R. J. Clark, president of the Peninsular Bark & Lumber Company of Sault Ste. Marie, Mich., was a welcome visitor at the HARDWOOD RECORD offices on Sept. 28.

C. E. Lloyd, Jr., second vice president of the National Hardwood Lumber Association and sales manager of the Cherry River Boom & Lumber Company of Philadelphia, Pa., was a Chicago visitor on the 30th ult., en route to St. Louis, and dropped into the RECORD offices for a friendly call. Mr. Lloyd reports business excellent in the East, with prices advancing, especially on the coarse end of the pile.

Frank W. Vetter, the popular president of the Empire Lumber Company, Buffalo, N. Y., was a Chicago visitor on Monday.

Henry E. Bacon of the Bacon-Nolan Hardwood Company of Memphis, Tenn., stopped in Chicago a few days on his way home to Memphis the latter part of the month, and found time to run into the RECORD office for a little chat.

W. A. Gilchrist of the Three States Lumber Company, Memphis, Tenn., was among the prominent Chicago visitors during the past fortnight.

The manufacturer of the automatic swing saw gauge, Francis Marshall of Grand Rapids, Mich., was in Chicago Sept. 29, and called on the RECORD. As the desirable features of Mr. Marshall's valuable appliance become known to the trade, his sales increase with surprising rapidity.

That trade in hardwoods is active not only in his home state but all over the country is the report which genial Jesse Thompson of the J. W. Thompson Lumber Company of Memphis gave out on a recent trip to Chicago.

W. Hollis of the Pine Plume Lumber Company of Montgomery, Ala., was in Chicago and paid a welcome visit to this office a few days ago.

The irresistible "Wagstaff of Oshkosh" was a Chicago visitor on Oct. 2 and honored the RECORD offices with a call.

James C. Cowen of Schultz Bros. & Cowen, Old Colony Building, has just returned from a three weeks' southern buying trip.

The warehouse of the Morgan Sash & Door factory, at Twenty-second and Halsted streets, was destroyed on Oct. 7, causing a loss estimated at \$100,000. The fire is thought to have originated from a fault in the electric wire installation.

F. J. Roys, sales manager of the Fullerton Powell Hardwood Lumber Company of South Bend, Ind., was in town on Oct. 4, in consultation with the local manager of the house, F. B. McMullen of the Chamber of Commerce Building.

John D. Spaulding of the Southern Oak Lum-

ber Company is home from a southern trip during which he visited his company's plant at Memphis.

John H. Jenks, vice-president of the Robert H. Jenks Lumber Company of Cleveland, O., was a Chicago visitor on Oct. 3. Mr. Jenks reports general lumber conditions in excellent shape and is especially well pleased with the hardwood end of his enterprise.

The HARDWOOD RECORD received a call a few days ago from C. D. Boynton of St. Louis, manager of the Boynton Lumber Company of Boynton, Ark., and incidentally litterateur, bon vivant, raconteur, royal entertainer and good lumberman of the northeast corner of Arkansas. Mr. Boynton's company owns a solid township of virgin oak, gum, cottonwood, ash, and hickory in Washington county, which it is turning into lumber at the rate of upwards of 40,000 feet a day. He reports sales clear up to green lumber at the present time and, while he has a large stock of logs in sight for his mill, he anticipates that the weather for the remainder of the season will preclude any but the most moderate log output in his section. He looks for a manifest shortage of all varieties of hardwoods in the southwest for months to come.

The HARDWOOD RECORD desires to present its compliments and apologies to Southwest of Houston, Texas, for purloining and publishing without credit an article on the subject of black walnut in its issue of July 25 last, which was printed in the publication named in its following August issue. However, the blunder is happily corrected by Forestry and Irrigation in its September issue, which reprints the article, and credits it to our more or less esteemed southwestern contemporary.

C. E. Le Crone, representing the J. W. Thompson Lumber Company, Memphis, Tenn., was a caller at the RECORD office Oct. 8. Mr. Le Crone has just returned from an extended sales trip through the Mississippi valley and reports an unusually good business with a notable call for oak.

Among the recent lumbermen visiting Chicago, were, D. J. Peterson of Toledo and H. W. Reeves of Detroit.

C. D. Danaher, the well-known timberman of Chicago, who has acquired large interests on the Pacific Coast during the last few years, has closed his office in the Title & Trust Building in this city and will make his future headquarters at Tacoma, Wash.

J. N. Woodbury, recently of St. Louis, formerly in the hardwood business on his own account and, at one time, manager of the Ozark Coöperage Company, has joined forces with E. B. Lombard in the wholesale hardwood trade at 213 Railway Exchange. Mr. Woodbury will be manager of the business. He has had a long experience and his success with Mr. Lombard should be assured.

Fred. W. Black of the Fred. W. Black Lumber Company has recently returned from a trip among the Tennessee mills. Mr. Black has accumulated a nice stock of hardwoods at his Blue Island and Robey streets yards and has secured a fine source of supply for the fall trade.

I. L. Lane of the Lane-White Lumber Company, Fort Smith, Ark., who has been ill for some time has returned to his Chicago office for a protracted stay.

Wood Deal of J. D. Lacey & Co. has just returned from an outing to the Pacific Coast and Yellowstone Park, in which he was accompanied by his wife and mother.

C. L. Willey, the well-known Chicago veneer and tany wood man, is just back from a trip to Great Britain, where he made extensive mahogany log purchases.

Secretary Fish of the National Hardwood Lumber Association spent last week in Memphis on association business, and this week is visiting St. Louis, Evansville and Louisville.

Lewis Hoster, secretary of the Hardwood Manufacturers' Association, is out of town on a southwestern trip among the sawmills.

AS the HARDWOOD RECORD goes to press the thirteenth annual convention of the National Association of Agricultural Implement & Vehicle Manufacturers is in session at the Auditorium hotel. The delegates number about 250 and represent twenty-two states.

### Boston.

The C. W. Leatherbee Lumber Company has removed its wholesale office from 70 Kilby street to 107 Atkinson street, Roxbury, in order to consolidate the office force. The retail yard and mill of the company is located on Southampton street, Roxbury.

Charles S. Wentworth of Charles S. Wentworth & Co. made a trip through the White Mountains late in September.

William E. Litchfield, hardwood manufacturer and dealer and president of the Massachusetts Wholesale Lumber Dealers' Association, is visiting his mill at North Vernon, Ind.

Hugh McLean of the Hugh McLean Lumber Company, Buffalo, N. Y., visited this market early in the month.

Henry E. Sanford of Sanford & Tredway, New Haven, Conn., made a trip through the South-west early in the month.

A circular letter has been sent out by the creditors of the Vergennes School Seat Company of Vergennes, Vt., stating that the affairs of the company have been in an unsettled condition for several months. They also make an offer to settle their indebtedness on a basis of 50 cents on the dollar.

C. H. Annable, who has conducted a lumber business in Springfield, Mass., for several years, has incorporated his company under the name of the C. H. Annable Lumber Company with a capital stock of \$25,000. In addition to their present property a retail yard will be established. Mr. Annable is treasurer and manager of the new company.

The woodworking establishment and warehouses of Silliker & Co., Amherst, N. S., have been destroyed by fire.

Knott & Sampson of Boston have incorporated a company under the name of the Knott-Sampson Lumber Company with a capital stock of \$10,000.

William Edgar Lawton, who has been in the employ of Burrows & Kenyon, Providence, R. I., for many years, as salesman and deputy surveyor of lumber, died at the home of his brother in Orange, Mass., Sept. 22.

Edward C. Hammond was married Sept. 20 to Miss Daisy G. Dutcher, Worcester, Mass. Mr. Hammond is the son of Edward J. Hammond, prominent in Boston lumber circles, and is associated with his father in business.

The W. A. Hall Lumber Company has been incorporated at Bellows Falls, Vt., with a capital stock of \$200,000.



The Boston & Maine Railroad Company has filed with the Interstate Commerce Commission note of a tariff of \$1 per net ton on southern lumber from Boston to Rockland, Me. The same rate is made also on lumber from Boston to intermediate points where there is water competition.

Frank Lawrence of Lawrence & Wiggin, Lindsay H. Shepard and Willis C. Bates, Boston lumber dealers and members of the Ancient and Honorable Artillery Company, Boston, attended the regular fall outing of the latter company, which was held in Atlantic City last week. Mr. Lawrence on his way home stopped off in New York for a few days.

J. L. Barney, formerly connected with the Northern Lumber Company of Boston, has entered the employ of the Rice & Lockwood Lumber Company of Springfield, Mass. Mr. Barney will represent this company in eastern Massachusetts, Maine, New Hampshire and Rhode Island.

Howard L. Platt, secretary of the New Britain Lumber Company, New Britain, Conn., and secretary and treasurer of the Naugatuck Lumber Company, has been elected director of the Connecticut Lumber Dealers' Association.

The yard of the E. P. Reed Lumber Company, North Abington, Mass., was damaged by fire, causing a loss of about \$10,000. Two of the buildings filled with lumber were destroyed. The loss is covered by insurance.

William Bacon of Davenport, Peters & Co., Boston, who has been spending three weeks' vacation in Nova Scotia, has returned.

Horace Barse of Owen Barse & Son, who has been absent in Europe for about five months, returned this week.

#### New York.

Earl Palmer of the Ferguson & Palmer Company of Paducah, Ky., and ex-president of the National Hardwood Lumber Association, was a visitor in town last week accompanied by Mrs. Palmer.

A petition in bankruptcy has been filed against the Keables & Bayer Piano Company, manufacturers at 1901-1905 Park avenue, Manhattan. The company was organized in March, 1904, with a capital of \$10,000, succeeding the Milton Piano Company. The liabilities are said to be \$20,000 and the assets \$4,000. J. C. Coleman has been appointed receiver of the assets.

H. A. Savage, who for several years past has been associated with the Cypress Lumber Company of Boston, has engaged with Gouverneur E. Smith, hardwood wholesaler at 17 Battery place, this city, to represent him in the New England territory and to that end has opened an office at 810 Broad Exchange Building, Boston.

All efforts to find heirs to the estate of John W. Russell, for many years a prominent wholesaler of this city, who died recently, leaving no will and an estate of \$100,000, have proved without avail and as a result the estate will go to the state of New Jersey and the Dominion of Canada unless some relatives come forward to claim the same.

John B. Ransom, the prominent Nashville hardwood lumberman, and head of the extensive interests of John B. Ransom & Co., was in town for several days last week in the interest of business.

Charles F. Hofferberth of the hardwood firm of Charles Hofferberth, 502 West Twenty-second street, is one of the incorporators of the Hofferberth-Troy Company, incorporated last week with a capital of \$500,000, to conduct a general lumber business. The directors are Charles F. Hofferberth, F. W. Troy and F. R. Wood of New York. The headquarters will be at Troy, N. Y.

R. H. Downman, the prominent New Orleans cypress manufacturer, was a recent New York visitor in the interest of business. He reports business in cypress very satisfactory.

Horace F. Taylor of Taylor & Crate, Buffalo, N. Y., spent several days here during the fortnight in the interest of business and insurance

affairs. Mr. Taylor is vice president of the Lumber Insurance Company and the Adirondack Fire Insurance Company, 66 Broadway, city.

The Rubin Grau Company has been incorporated at Brooklyn with a capital of \$40,000 to succeed to the large trim business previously conducted by Rubin Grau in that city. Mr. Grau recently filed a petition in bankruptcy personally and it was arranged by the creditors to make a settlement on the basis of notes in a new corporation for their debts and the new corporation has now been organized with that end in view.

Charles H. Finch, head of Charles H. Finch & Co., Brooklyn, died at his residence, 326 Stratford road, on September 26, in the 31st year of his age. He had been associated with the Brooklyn lumber trade since 1887 with various firms, and organized Charles H. Finch & Co. three years ago. Much regret is expressed in whole-sale circles at his untimely death. The firm is a member of the New York Lumber Trade Association and in accordance with the usual custom a prominent committee attended the funeral representing that body.

The twentieth annual meeting of the New York Lumber Trade Association will be held at the association rooms, this city, on Oct. 10, preceded by a Delmonico luncheon. Indications point to the largest attendance in the history of the organization.

Franklin Greenwood of the Cypress Selling Company, Ltd., New Orleans, was a recent visitor in the interest of business and while here met the various representatives of the company in this territory. He reports conditions in the Louisiana cypress belt very satisfactory, with the demand constantly increasing.

E. C. Mershon of W. B. Mershon & Co., band saw manufacturers of Saginaw, Mich., arrived in port Sept. 25 after an extended European trip. While abroad he enjoyed the sights of France and Switzerland and had a generally fine time, and returns much benefited.

William E. Marsh of Marsh & McClellan arrived last week after a lengthy stay at the California operations of his firm.

Benjamin G. Hitchings, the Brooklyn manufacturer, has just installed a fine new twelve-inch S. A. Woods molding machine, which is an important addition to his mill.

S. F. Minter, the hardwood wholesaler of 1 Madison avenue, was married Sept. 20 to Mrs. Jennie M. Morten in this city. They have just returned from a wedding journey in Maine and will take up their residence in this city.

Moses Hatch of Kornthal & Co., extensive casket manufacturers of this city, died suddenly Oct. 3, while attending a theater in Buffalo. He was a prominent figure in that branch of the local hardwood trade and well known there.

The Charles F. Fischer Lumber Company expanded their hardwood yards in Manhattan by the opening up of a new storage yard at the north side of 134th street, between Madison and Park avenues, whereon they are accumulating additional choice stock of hardwoods.

#### Philadelphia.

With a few exceptions the local lumbermen are all back from their vacations and regard the outlook for fall and winter business favorably.

J. Gibson Melvain & Co. are busy. Hardwoods are active and prices stiff. The mills of this firm, on account of a general demand from all quarters for good hardwoods, have been unable to accumulate stock but are looking forward to more rapid shipments as the season opens up.

Miller & Miller, who are now thoroughly settled in their new quarters, regard the outlook bright. Orders are coming in in good shape. J. Clark Miller of this firm has just returned from South Carolina, where he has been making new connections, which will place his company in a position to meet the increase in business.

C. E. Lloyd, Jr., Philadelphia manager of the Cherry River Boom & Lumber Company, has been

spending a few days at the main office in Scranton, Pa., and is now on a business trip through the western territory.

B. C. Currie, Jr., Philadelphia manager of R. M. Smith & Co., is touring Pennsylvania in the interest of the firm, whose headquarters is in Parkersburg, W. Va. Reports emanating from this office show a prosperous season.

T. N. Nixon of Wistar, Underhill & Co. is traveling through West Virginia and North Carolina buying for his firm. H. E. Bates of this company spent two weeks in New York state visiting the trade and has now gone to Canada looking up stock. Orders are coming in and indications are very favorable for the fall and winter business.

William H. Fritz & Co. report a steady increase in business, their hardwood department progressing favorably and general conditions encouraging. E. B. Hayman of this firm is taking his usual trip through the state.

R. W. Schofield of Schofield Bros. is indulging in a short rest at Atlantic City, N. J. His firm is anticipating a steady demand for good hardwoods during the coming season.

The Philadelphia Hardwood Lumber Company is coming to the front. It reports a considerable number of new orders and that the volume of business will far exceed the previous year.

Francis Goodhue, Jr., of the Philadelphia Veneer & Lumber Company is enjoying a pleasure trip through the state of Massachusetts. The company is rushed in cigar box lumber, which wood, however, is scarce and prices stiff.

Franklin A. Smith, president of the Producers Lumber Company, is taking a trip through the state of Maine. He will be gone two or three weeks.

J. H. Garing of the Weston-Garing Company, Jacksonville, Fla., has been visiting the local trade during the last week.

Frank Buck of the Daniel Buck Estate has recently returned from a three months' tour of Europe.

The Keystone Casket Company called a meeting of creditors for Oct. 3 in the office of William H. Peace, attorney. The company showed the following statement of its affairs: Liabilities, \$25,266.78, and assets, \$17,350.96. An offer was made of forty per cent in cash, to be paid in thirty days, to the merchandise creditors, and twenty-five per cent in cash, to be paid in thirty days, to the borrowed-money creditors. This offer comes from an outsider, whose name was not given. He proposes to take over the business and the old company will be dissolved. A committee was appointed to examine the books and report at a meeting adjourned to Oct. 5. The company is only a few years old, was chartered under Pennsylvania laws; authorized capital, \$30,000, of which \$12,500 was paid in.

The Henry H. Sheip Manufacturing Company suffered a disastrous fire on Sept. 24, when one of the smaller buildings was destroyed. The conflagration occurred at an unfortunate time, for the building was stocked with finished work to be sent to the varnishing department and made ready for shipment. This will cause a delay of a week or more, and as all departments are working full force the company will undoubtedly receive a setback when they come to get out their orders. It is difficult to obtain any definite figures as to the fire loss, but a careful estimate gives over \$100,000 as approximating the mark. The company makes it a rule to carry full insurance, therefore it is thoroughly protected.

Jerome H. Sheip of Sheip & Vandegrift has just returned from a business trip to Knoxville, Tenn., where his firm has extensive interests in band and veneer mills.

The Rumbarger Lumber Company has recently added some 8,000 acres of timber lands in western North Carolina to their already extensive holdings in this state, making a total in this immediate locality of 30,000 acres. Frank T. Rumbarger of this company is traveling through

western North Carolina and eastern Tennessee looking after the various interests of his company in these sections.

Max L. Pease of the Galloway-Pease Company of Johnson City, Tenn., is calling upon the Philadelphia trade. F. E. Fish of the Alton Lumber Company of Buckhannon, W. Va., is here also for a few days. Charles Carroll Cross, sales manager of the Santee River Cypress Lumber Company of Ferguson, S. C., is making a round of the trade.

The removal of the Lumbermen's Exchange to its present quarters is much appreciated by out-of-town as well as local lumbermen. This is evident from the many callers. During the last few weeks the following out-of-town visitors paid their respects to the exchange: R. S. Cohn of the Roanoke Lumber Company, Norfolk, Va.; Julius Dietz of the Builders' Planing Mills Company, Buffalo, N. Y.; W. G. Underwood of the Albemarle Lumber Company, Hartford, N. C.; Horace Smedley of Smedley & Mehl, Ardmore, Pa.; and Mr. Kimball of Kimball, Prince & Co., Vineland, N. J. The regular monthly meeting was held on Oct. 4 with a very fair attendance. President George F. Craig presided. Routine business only was transacted. The committee previously appointed to draft a new set of by-laws handed in their report. Each item was thoroughly discussed, several amendments added and the matter was continued for further action at the next meeting. Horace Smedley of Smedley & Mehl, Ardmore, Pa., was elected a member of the exchange. The appointment of two boards, one for sales and the other for wants, is an innovation in the work of the exchange, and that it is a success is shown by the appearance already of sales of special cargoes and the listing of wants in certain lines.

Christopher J. Heppe, the widely known organizer and president of the Heppe Piano Company, died on Oct. 4 of heart disease. The Heppe instruments, organ and piano, have a far and wide celebrity for superiority of construction. This fact in connection with the distinction of Mr. Heppe as a leader of music and a large benefactor of organized charity has kept him for long in the public eye.

#### Baltimore.

The hurricane which swept the Gulf and South Atlantic coasts last week was particularly damaging to the lumber interests. A number of mills were completely destroyed, while others sustained serious losses in lumber, logs and buildings. Structures were blown over and stocks washed away, while at sea a small fleet of lumber laden vessels was lost. Baltimore interests suffered in common with others. At the plant of R. P. Baer & Co., Keyser Building, this city, at Mobile, Ala., considerable damage was done. There was only a trifling loss on lumber, while the damage to the mill amounts to about \$500. The shut-down necessitated comes at an opportune time, as the firm intended to change the equipment from a circular saw to a band saw, and operations would have been suspended to permit of the alteration. R. P. Baer of the firm left Baltimore last Tuesday on a southern trip, visiting mills in various states and gradually extending his journey as far as Mobile.

A number of the other plants in the vicinity of that city fared far worse, those of the Queen & Crescent Company and of the Vaughn Company, among others, being almost entirely destroyed. Their loss includes the wrecking of mills and the drifting away of many thousands of feet of lumber and logs. The Eddy Lake Cypress Company at Eddy Lake, on the Little Pee Dee River, South Carolina, sustained some damage, the smoke stack being blown down and a tank wrecked. William M. Burgan and Norman James of this city, both of whom are largely interested in the company, left last Monday for Eddy Lake to see for themselves what the situation is and how the plant fared.

The Iron Mountain Lumber Company, owned by the same interests which control the hardwood firm of Carter, Hughes & Co., this city, and

which has been for some time past operating a mill at Troutdale, Va., under the personal supervision of David T. Carter, has begun the operation of another plant at Jothuada, Grayson county, Va., about six miles from the older plant. The new mill has a circular saw equipment and has a capacity of about 20,000 feet of hardwoods a day. It connects with the Virginia Southern Railroad and has three miles of wooden tram road. Philip Littig, formerly of Baltimore, is superintendent of the mill.

Gen. G. W. Curtin of the Curtin Lumber Company of Curtin, W. Va., was in town last week and called on a number of local firms. He spoke in most enthusiastic terms of existing trade conditions as well as of the outlook, but added that trade is much handicapped by a scarcity of cars, which makes delivery subject to vexatious delays. The new mill which the company built to take the place of the one destroyed by fire last January is about ready for active operations and will start up in the next few days.

The firm of Kimball, Tyler & Co., manufacturers of barrels, with a large factory at High Landtown, a Baltimore suburb, has been succeeded by the Kimball-Tyler Company, a corporation. The same interests, however, will continue in control and the business will be conducted as before.

Among visiting lumbermen in this city recently were George L. Fish of the Alton Lumber Company, Buckhannon, W. Va., and F. S. Paddock of Wise, Va.

Henry S. Hiss, president of the Hiss Manufacturing Company, maker of fine furniture, which went into the hands of receivers on July 30 last, on September 29 applied for the benefit of the bankruptcy law. His liabilities are placed at \$179,554.92 and his assets at \$18,275.

G. L. Wood, general manager of the R. E. Wood Lumber Company, with headquarters at Ashville, N. C., was here last week for the transaction of important business matters.

The managing committee of the Baltimore Lumber Exchange held its monthly meeting last Monday; only routine business was transacted.

The J. I. Gilbert & Bro. Lumber Company has purchased the property at the northwest corner of Eastern and East Falls avenues and will use it for a lumber yard, the old place at Aliceanna street and East Falls avenue having been preempted by the city for a pumping station.

#### Pittsburg.

The Mendelssohn Planing Mill Company of Mendelssohn, Pa., is going to stop operations, its proprietor going into business in the West.

The Jacob Herbst Lumber Company has been formed by Jacob and John Herbst, Peter Yonker and Magdaline Yonker and will be organized under a Pennsylvania charter to operate in Pittsburg.

The Pittsburg Retail Lumber Dealers' Association banqueted the Pittsburg Wholesale Lumber Dealers' Association at the Nixon cafe, Thursday, October 4. E. M. Hill of the Retailers presided and A. M. Turner officiated for the Wholesalers. The banquet was given as a result of a ball game lost by the Retailers in the summer. To show their further esteem the Retailers gave their guests a handsome loving cup decorated with baseball emblems.

The Nicola Lumber Company is having a very active fall trade in hardwoods. E. C. Brauer, formerly sales manager for the old Nicola Brothers Company, is now hunting customers for the beautiful sites of the Schenley Farms Company in which F. T. and O. E. Nicola are largely interested.

The Linchan Lumber Company finds no time for complaint at its Kentucky plants. Both the Linchan brothers are on the road much of the time and find hardwood conditions more favorable to the wholesaler than a month ago. The one drawback in this respect is the car shortage which they in common with many of the large firms are feeling seriously on the Southern railroads.

T. F. Balsley, hardwood manager for Willson Brothers, lately bought 2,000,000 feet of hardwood on sticks and 15,000,000 feet to cut under contract at a mill on the Coal & Coke railroad in West Virginia. Mr. Balsley reports trade in common oak a little slow but finds other lines of hardwood especially strong. Sound worn chestnut is coming to the front and recent orders have been looked at 81 advance over list. Ash is also in good demand and Hickory is badly wanted but is handled but little by Pittsburg dealers owing to the small profit there is in the scattering car load lots they are able to secure at the country mills. Alex. Willson of Willson Brothers is the recipient of general sympathy this week owing to the death of his wife Mrs. Elmore Hamilton Willson who passed away very suddenly Saturday evening, September 29. The couple had been married less than two years, and resided in a beautiful home on Squirrel Hill.

The Flint, Eaving & Stoner Company has its mills in operation in Cambria and Clearfield counties, Pennsylvania, Patton, Millport, Ebensburg and Tunnel Sidling. In addition the company has just bought a tract of timber near Ligonier, Pa., which will also be cut off. These mills are supplying the company's Pittsburg trade in hemlock and hardwood.

George W. Haynar of the Reliance Lumber Company, is back from an extended trip through Wisconsin and Minnesota. The company is in good shape for a busy season in hardwood and has stended its sources of supply by making some good purchases in West Virginia. Its lake trade is increasing at a most satisfactory rate.

The A. M. Turner Lumber Company by O. H. Reetanus reports a much better general demand for all kinds of lumber this month. Hardwood is sharing liberally in this increase and the company looks for a prosperous six months ahead. Its southern operations are progressing finely barring the extreme inconvenience from car shortage on all southern roads.

W. E. Hammer who has charge of the Buckhannon, West Virginia, plant of James L. M. Wilson & Co., reports a big cut of oak and poplar in that section. Stocks are fair, he says, but are not increasing at too fast a rate. Both basswood and chestnut have taken quite a spurt in demand lately and the former is increasing in price.

William Whitmer & Sons, Incorporated, are pushing operations at their four mills and will make this month a record period. The following changes have been made lately: M. L. Woodliffen has been made manager at a new branch office at Mobile, Alabama. W. F. Wagner, who was connected with the Whitmers for some time, is with them again doing the Pennsylvania trade. M. C. Morgan, formerly of the American Lumber & Manufacturing Company, has been working up orders in Ohio and West Virginia.

The L. L. Sattler Lumber Company now has eight sawmills, three planing mills and 100 men bustling day and night on the old Blackstone operation at Blackstone, Va. It is getting out 1,500,000 feet a month, and practically all this lumber goes to manufacturers.

W. E. Penfield of the Pine Tree Lumber Company of Little Falls, Minnesota, visited the Pittsburg trade last week. He says that the logs are running fairly well at the Minnesota plants but that there is no overproduction of lumber. Moving the enormous wheat crop has caused a severe car shortage and firms in the northwest find it extremely difficult to fill mixed car orders.

Perhaps the most encouraging feature of the hardwood situation in Pittsburg just now is the steady increase and the determined spirit manifested in the inquiry from manufacturers. Firms that enter largely to the furniture trade say that the prospects for heavy winter sales in this direction were never so good. Traveling salesmen who reach the thriving towns of Ohio,



Indiana and Michigan are confident that the demand for hardwood from carriage, wagon and implement manufacturers is going to be exceptionally hard to fill during the next six months. The effect of this is already showing in a slight but gradual stiffening of price on the minor hardwoods which have to be secured largely from the smaller country mills.

#### Buffalo.

Messrs. J. S. and M. M. Wall spent some time in New York last week. Their yard is very busy with hardwood lumber, with oak leading.

A. W. Kyndehder has gone south to look after Kentucky and Tennessee lumber. He intends to be at the Cincinnati meeting and hopes to get as far west as Memphis.

J. N. Stewart & Bro. are including in their yard stock a lot of good walnut lumber, which came up from Alabama. It sells well, especially along with cherry, with which the yard is always well supplied.

E. W. Vetter is among those who are looking to the lake route for filling up the Empire company's yard here. He is spending some time on the Lake Huron shore shipping some cargoes of birch, black ash and maple.

G. Elias & Bro. find that it is not much use to depend on timber orders from the South. As a consequence they have a big yard stock on hand.

O. E. Yeager is showing his usual full stock, having a lot of birch coming in to swell the former assortment.

Hugh McLean is making the round of the southern sawmills of the McLean interest.

Scatcherd & Son are dealing heavily in oak, often having large consignments of it on the road. The Memphis mills are doing as well as could be expected. Mr. Scatcherd will soon be back to business.

A. Miller is finding more sales for basswood than he did awhile ago and looks for it to return to full favor if the prices do not run too high. He is stocking up with a good supply of southern hardwoods.

J. F. Knox has returned from a trip to Pennsylvania, where he bought considerable maple. Meyer, Knox & Co. expect a heavy trade in maple and are preparing for it.

#### Detroit.

George L. McClure of McClure Brothers reports that over \$1,000,000 worth of building is being done in Detroit every month. The boom is general. Even the manufacturing branch is benefiting by the rush. The wagon trade is especially active.

Under date of Oct. 4, the Detroit News prints a highly colored story of the life of Rasmus Hanson, the millionaire member of the famous hardwood firm of Salling & Hanson of Grayling, Mich. A four-column article at the head of the story reads: "Hardheaded Dane, Piling Up Millions When Most Men Are Ostracized, Is Hanson, of Grayling, Michigan's King of Hardwood."

Local manufacturers report plain and quarter-sawn white and red oak are scarce.

Detroit boxmakers, who maintain a protective association among themselves, are planning to better divide the demand for shucks, by combining two firms. A big sale is expected this month. It is expected the Vinton interests are branching out.

#### Saginaw Valley.

A good deal of maple has recently gone into lumber for buildings and bridge work and the government has taken a number of million feet from the valley for harbor work. One concern supplied over 3,000,000 feet for Lake Erie government purposes. Within two weeks the H. M. Loud's Sons Company of Au Sable has shipped 1,300,000 feet of maple to Tonawanda. Thus it will be seen this wood is selling, even if manufacturers are objecting to the demand and price. There has been less activity and vim also to the flooring market though the plants are all doing a steady business.

The repairs on the W. D. Young & Co. saw mill which include a band resaw, will increase the capacity of the mill one-third. The sawmill has been shut down while these repairs were being made but the flooring mill has been operated without interruption.

The Flood sawmill at Bay City has taken a contract to cut out a lot of hardwood logs for Salling, Hanson & Co., of Grayling, and is expected to run during the greater part of the winter.

Southern Michigan parties have arranged for the purchase of the Willis hardwood mill plant on the east branch of the Au Gres on the bay shore, and will make extensive improvements, increasing the capacity of the plant.

The demand for box material is calling for all the beech and basswood mills manufactured in this locality. The Kneeland, Buell & Bigelow plant has a contract for five years to furnish beech and basswood culls to the box factory operated by Mershon, Schmette, Parker & Co. at Bay City, and the latter firm sold a lot of basswood culls to other box firms at \$15 a thousand.

The Bliss & Van Auken plant has been steadily employed day and night during the entire season manufacturing hardwood and flooring and the firm has had a very satisfactory business.

The Batchelor Timber Company is installing a complete electric lighting plant in its sawmill and mill premises at West Branch.

The H. M. Loud's Sons Company at Au Sable recently purchased a four-fifth interest in the sawmill at Rogers City and timber in Presque Isle county of Herman Hoeft, Paul Hoeft retaining a one-fifth interest. The new concern, however, will not begin operations under the contract for about a year. Meantime Paul H. Hoeft is starting nine camps to keep the mill in operation until next fall.

The scarcity of labor will affect the matter of putting in logs this winter. It is almost impossible to get men at \$26 to \$32 a month and north of the straits \$35 and \$37 is being offered for good men. They are scarce at that figure even. It is so everywhere in the lumbering districts.

Some exceptionally fine hardwood logs are being brought down the Mackinaw division of the Michigan Central for mills on this river. Something like 200 cars are brought down every 24 hours.

Ground has been broken on Holland avenue, Saginaw, for a new maple flooring plant for George Strable, formerly of Reed City. There will be four principal buildings in addition to the dry kilns, sheds, etc. The main building is to be 56x250 feet, constructed of brick and concrete, one story high and basement. Three dry kilns each 75 feet long are in progress of erection, each to be provided with solid concrete floors. The boiler house is to be 32x64 feet, and no wood will be used in its construction. It will be equipped with two Wickes Bros. water tube boilers of 200 horse power each and motive power will be a 350 horse power Harris-Corliss engine. The warehouse will be 56x200 feet with steel sides and concrete floors.

The Detroit & Mackinac Railway has just received and placed in service three high-powered freight locomotives built by the Rogers Locomotive Works, Paterson, N. J. They have a series of eight driving wheels, fifty-seven inches in diameter, a firebox heating surface of 218 square feet and a boiler diameter of eighty-one and one-half inches. The capacity of the tender is fifteen tons of coal and 7,000 gallons of water. The immense weight of the locomotive, which together with its tender is 178 tons, and the unusually large heating surface which provides an ample supply of steam at all times, makes it possible to haul trains of from eighty-five to ninety loaded freight cars. The fact that the Detroit & Mackinac roadbed is unsurpassed by any in the state, being laid with

eighty-five and ninety-pound steel rails, with practically no curves or grades, makes it certain that the maximum of efficiency can be obtained from the new locomotives.

#### Grand Rapids.

William H. White and wife of Boyne City were in Grand Rapids Oct. 4.

Rush Culver, president of the Northern Lumber Company of Marquette, called on his friend and business associate, W. F. McKnight in this city Oct. 3.

Fox & Mason, furniture manufacturers of Corunna, Mich., announce their intention to build a new factory costing \$30,000 at Arcadia, Benzie county, for making cheap and medium grade dressers, chiffoniers and sideboards. Work on the new plant will begin at once. The officers of the concern are as follows: President, John Mount, Arcadia; secretary, George D. Mason, Corunna; treasurer, Adolph Hasse, Arcadia; superintendent, S. I. Fox, Corunna.

Muskegon now hopes to secure the removal of another branch of the Brunswick-Ralke-Collender Company to that city, the branch devoted to the manufacture of bar-room fixtures and bowling alleys.

E. G. Shortley of Kalamazoo, Vicegerent Snark for Michigan, announces a Hood-Hoo concatenation for Grand Rapids on Oct. 26. This is a postponement from Sept. 28 and a double dose of pleasure is coming to the members.

George Engel, president of the Engel Lumber Company, will leave Oct. 10 for Englewood, where the company's mill is located. He will be accompanied by E. F. Miller, who has had charge of the offices in this city. Mr. Miller goes south to spend the winter at the Englewood office.

The Stearns Salt & Lumber Company has transferred its new camp outfit on wheels from Ludington to the scene of its logging operations on the Klondike branch of the Pere Marquette, in Kalkaska county. This logging outfit is unique in Michigan lumbering operations. The train was fitted up at Ludington, ordinary flat cars being made over into dining room, kitchen, blacksmith shop, sleeping room, hospital, office and steam heating plant, the latter being placed in the center of the train and supplying heat to all the cars. The car platforms are extended four feet on either side and the camp is well equipped with modern conveniences. The train is sidetracked, of course, and moved as the logging progresses. The company has a tract of fine hardwood timber in that section, the cut being estimated at ten years. The logs will be shipped to Ludington for cutting.

N. J. G. Van Keulen of the Van Keulen & Wilkinson Lumber Company reports early fall business exceptionally good. Trade is especially brisk in crating stock at this time.

J. L. Retting of the Evans & Retting Lumber Company reports an unusual scarcity of cars, so that their business out of Vanceburg, Ky., over the Chesapeake & Ohio, is greatly restricted.

A number of Grand Rapids lumbermen are planning to attend the semiannual meeting of the National Hardwood Lumber Association to be held at Cincinnati Oct. 25 and 26. They leave this city Oct. 24.

The Gibbs, Hall & Allen Company of this city is operating three portable mills and will start two more soon, cutting the scattering tracts of hardwood that remain in northern Michigan.

R. J. Clark, president of the Peninsula Bark & Lumber Company, Sault Ste. Marie, was in the city a few days ago. He was on his way to Buffalo and eastern points.

H. R. Blacker of Chicago and Patrick Noud of Manistee were in Grand Rapids, Oct. 4.

M. F. Bitters of Ludington, president of the Mason & Oceana Railway Company, states that prospects are now bright for extension of the road to Grand Rapids. The road will be standard gauge; surveyors will begin work on the right of way within a few days.

*Continued on page 15.*



LUMBERING ALONG THE APPALACHIANS  
 FROM THE COAL FIELDS TO THE COTTON COUNTRY

The Poplar is one of the most valuable trees in the South. It is found in the coal fields and the cotton country. It is a hard wood and is used for many purposes.

**TYPICAL POPLAR GROWTH**  
 Hardwood Forests  
 R. E. Wood Lumber Company

The Poplar is one of the most valuable trees in the South. It is found in the coal fields and the cotton country. It is a hard wood and is used for many purposes.

# Hardwood Lumbering Along the Appalachians

FROM THE COAL FIELDS TO THE COTTON COUNTRY

A PEN AND PICTURE SKETCH OF THE OPERATIONS OF

*The R. E. Wood Lumber Company and The Montvale Lumber Company of Baltimore, Md.*

**I**N THE last issue of the HARDWOOD RECORD was published a brief biographical sketch of Robert E. Wood, president of the R. E. Wood Lumber Company and the Montvale Lumber Company of Baltimore, Md.

Mr. Wood made a friendly call at the office of the HARDWOOD RECORD some two months ago. I have known him about ten years, but so little did I know of his affairs that I was surprised when, by dint of questioning, I discovered that instead of being a comparatively small poplar and hardwood operator in West Virginia, his commercial affairs have grown by leaps and bounds until he has become one of the foremost timber owners and hardwood lumber producers in the United States. It was only after vigorous persuasion that I prevailed upon him to permit me to print a brief biographical sketch and his portrait. When I further appealed to Mr. Wood to permit me to visit his timber properties and sawmill operations lying along the lower Appalachian Range in West Virginia, Tennessee, North Carolina and South Carolina, with a view of telling the lumber purchasing public of his gigantic enterprise, he balked at the publicity and said:

"I have always done business in a very unostentatious way. I am not a man who seeks the limelight. I am not seeking distinction for my achievements. I have always lived in the woods. I have earned my way in the world by hard and strenuous endeavor. Every piece of timber property that I ever operated I have bought only after a thorough and systematic examination, and my judgment of timber values has been based on the experience that has arisen from previous purchases and their operation. My business has been one of gradual and steady growth. I started for myself by the purchase of a single carload of lumber, and made a profit on the transaction. A little portable sawmill that I leased was a succeeding venture. I first bought a few trees, then a small area of timber. I bought a small mill and then others; then more tim-

ber. I eventually arose to the dignity of owning a band mill and bought more timber. All during my business career I have kept myself poor—lumber poor, timber poor. Today myself and the young men who are associated with me in the R. E. Wood Lumber Company and the Montvale Lumber Company have tracts of timber in the mountain districts of almost all the

of from thirty to forty thousand feet, and are about to put in a fourth operation to convert another timber tract into lumber. We are marketing lumber all over the eastern part of the United States and shipping large quantities abroad."

"Give me the privilege," I urged, "to visit these properties, to picture and describe the qualities of your forest, to photograph your sawmills, to tell something of the work involved in producing lumber from the country in which you operate, and to inform the lumber buying public of what you have and how you do things."

The small, wiry man winced at this idea of publicity and deprecated the fact that either he or his affairs were a matter of public interest. I eventually persuaded him that he was wrong in his assumption, and that the exploitation of his timber properties and lumber operations would be a matter of more than passing interest to the great lumber buying public. Thus I have been permitted to visit not only his sawmills—which is about as far as the average lumber newspaper writer or lumber buyer ever goes—but also to cruise his forests in a general way from the coal fields of West Virginia to the cotton country of South Carolina.

My trip lasted nearly a month, and veteran timber cruiser though I am, I must say that I have seen more magnificent poplar, oak and chestnut timber than I ever saw before in my life within the holdings of the Wood corporations.

## The West Virginia Operation.

I landed with my camera from the Norfolk & Western train at Jaeger, McDowell county, W. Va.,

and was welcomed by G. Leidy Wood and Clarence E. Wood, brothers of R. E. Wood, and respectively general manager and assistant general manager of the R. E. Wood Lumber Company. We took the morning train out of Jaeger, and shortly after noon, after traversing twenty-five miles of the Jaeger & Southern branch of the Norfolk & Western Railroad, carved most of the way out of the rocky sides of Dry Fork creek,



QUILL ROSE AND HIS "MOWING MACHINE"—FAMOUS BEAR HUNTER OF EAGLE CREEK—TYPICAL HOME NORTH CAROLINA BACKWOODSMAN.

southern states. We have nearly 125,000 acres of as fine poplar, oak and chestnut forests as grow in the country. Every acre of it is virgin timber, carefully selected, for its quality, its undepredated nature and its availability to lines of transportation, and hence the ready and economical means by which the lumber can be placed upon the market. We are at present operating three sawmills, each with a daily capacity



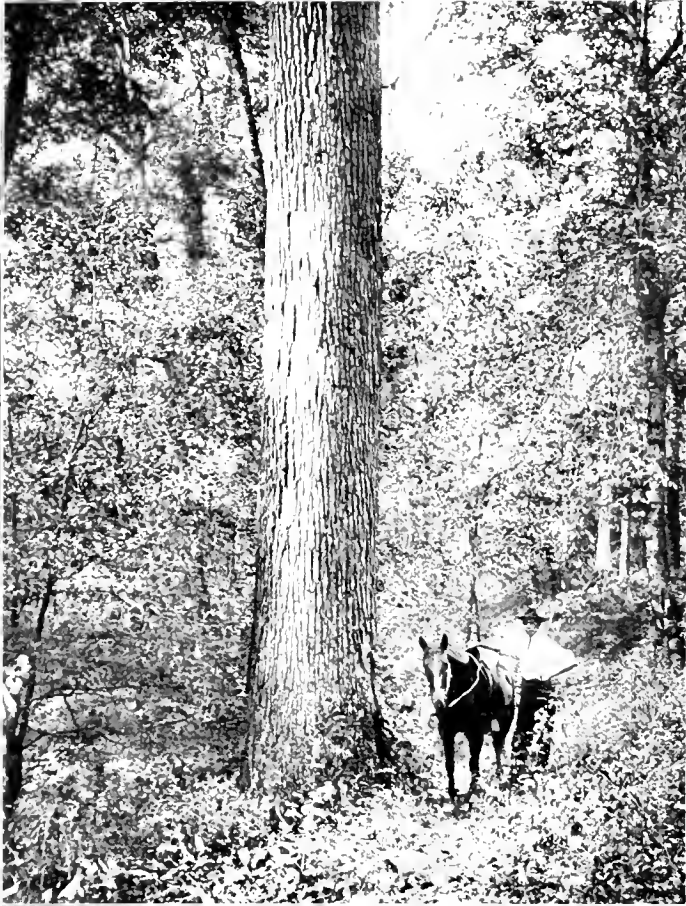

POPULAR



WHITE OAK



MOUNTAIN RED OAK



CHESTNUT

*Characteristic Timber Growth on the Wood Appalachian Properties*

reached Rift station, from which point the R. E. Wood Lumber Company has a railroad to its mill site at Keno, some two miles distant. This larger & Southern division of the Norfolk & Western road was built at large expense to open up not only the timber properties lying along the upper reaches of the Dry Fork and its branches, but also to make an outlet for the magnificent coal which underlies that portion of West Virginia.

The Dry Fork timber property of the R. E. Wood Lumber Company was purchased from the Pocahontas Coal & Coke Company in September, 1902. It comprises about 50,000,000 feet of counted and branded poplar trees. The purchasers have thirteen years in which to remove the timber. In addition to these timber rights the company is constantly adding outlying and smaller timber tracts, which will afford a source of timber supply for its Keno mill for many years. The coal land of this section is leased by the Illinois Steel Company, the Berwin-White Company and other large mining concerns. A group of pictures printed with this article reveals the model character of the Keno sawmill operation. The central picture shows the Clark band mill, fully equipped with all labor-saving devices; at the left may be seen the well-arranged yard, stocked up to this date entirely with poplar lumber, and the right-hand picture shows the well-equipped machine shop and commissary, the boarding house and the railroad leading up the valley to the timber property. It was at this operation that I had my first view of the splendid poplar holdings owned by the Wood corporations.

Under the guidance of G. L. and C. E. Wood, I spent the greater part of two days, mounted on the latter's favorite saddler, in prowling along the company's new tram road and up various coves rich with splendid poplar timber. The tree pictures herewith shown are typical of the character of this growth. In these photographs no attempt was made to select and picture trees of unusual size; only those indicative of the general character of the growth of whatever section was traversed were chosen. In these upper reaches and creek coves of McDowell county, embraced within the property, is found poplar timber that is unsurpassed in maturity, size, texture and character by any poplar that ever grew in the United States. It is absolutely virgin forest, undepredated in any way. As a logging proposition, as mountain logging goes, it is a very easy one—the slopes are gentle and there are no rocky promontories

to obstruct in any way economical operating. Opening into the main valley on both sides are "draws" which contain the rich poplar timber in profusion, all readily accessible to practically one main line of tram road.

The mill at Keno has been in operation since midsummer of this year, and the company has just commenced filling orders from the accumulated stock. The poplar lumber is wide, soft and of the peculiarly rich yellow variety known and valued the world over.

#### The Tennessee Operation.

To the plant of the R. E. Wood Lumber Company at Buladeen, Carter county, Ten-

nessee, that the mill and yards of the company are located. A panoramic view of this plant is shown in connection with this article. From scenic considerations it is most beautiful and its selection as a mill site, from a utilitarian viewpoint, is equally fortunate. Up the creek from the Buladeen plant is run a forty-pound steel narrow-gauge road some two miles, and then penetrating the various timber coves are projected wood-rail tram roads.

This Carter county property of the R. E. Wood Lumber Company is about thirty-five miles from Bristol, and the timber rights were purchased from the Boston Iron & Timber Company in January, 1905. The mill has been in operation since August, 1905, and the company has already shipped considerable lumber from it. The boundary consists of 6,700 acres, with an estimated yield of 40,000,000 feet of merchantable timber, of which about 5,000,000 feet have already been manufactured. This timber is of mixed growth, running quite heavily to poplar of splendid physiques, but interspersed with it are mountain (red) oak, white oak, chestnut, white pine and hemlock. The quality of this growth is well illustrated by the timber pictures accompanying this article, which are distinctive of the general character of the forest.

The equipment of the plant at Buladeen is a 9-foot Sinker-Davis band mill, with a full complement of lath machinery, and all labor-saving appliances that go to make up a first-class single band mill. The standard gauge railroad runs up to the lumber yards, and switches penetrate between each row of piles.

Incidentally, in all the operations of the Wood corporations, Climax locomotives, American Car & Foundry Company logging cars and Decker log loaders are employed. In the Carter county proposition the company has fifteen years to remove the timber, ties and tan bark. The topography of this property varies materially from that of all the other timber holdings of the Wood companies, as the valleys are narrow and the slopes of the mountain sides quite steep. Timber felling is commenced at the top of the slopes, and almost of their own weight logs slide down the incline to within reaching distance of the log loader on the tram road, thus making unnecessary the use of live stock. This method leaves the accumulation of tree tops and other debris clear of the timber located lower on the hillsides, and makes a comparatively clean operation until the last trees are cut along the tram roads. One of the pictures accompanying this article



UPPER WHITEWATER FALLS, JACKSON COUNTY, N. C.

mussee, was the next step. G. L. Wood and myself left Bristol, Va. Tenn., on the morning freight of the Virginia & Southwestern Railroad (which line, by the way, has just been absorbed by the Southern Railway), found for Elizabethton and up the Stony Creek Branch of the railroad to the picturesque milling town of Buladeen. The journey through the valleys of eastern Tennessee was alluring—we rode in the cupola of the caboose—and all the way was spread out beside us the beautiful little valleys and sparkling streams, the farms and the timber-clad slopes of the Holston mountains. Buladeen is the terminus of the branch line, and it is here, in the bottom lands of upper



WHITE PINE



SHORT LEAF YELLOW PINE



HEMLOCK



CLEMMER

*Characteristic Timber Growth on the Wood Appalachian Properties.*



shows the log loader at work in one of these deep coves, and another illustrates the comparatively cheap way in which the grade is made for extensions of the logging railroad. It will be seen that a three-cornered cut is made in the lower angle of the hillside, thus making a roadbed for the ties and rails.

This Carter county property, it is figured, will develop fully 10,000,000 feet of a remarkably high-class southern white pine, which is of exactly the same botany as the white pine of the North. To a great extent the white pine of the South produces but a small proportion of good lumber, but at this operation the many piles of uppers, selects and fine common and shop lumber of excellent quality in the yard proves that this is one of the best tracts of southern white pine in the country. None of the timber on this property is of unusual girth, but as the coves are deep the length of the tree bodies is remarkable. Tree after tree of poplar, white pine, white oak and red oak show a clean hole of from eighty to a hundred feet before the branching of a limb. The chestnut and hemlock is also of most excellent type, and from the bark of these two varieties, and from the chestnut wood a large source of revenue is derived.

#### The North Carolina Operation.

G. Leidy Wood accompanied me as far as Asheville, where the Wood corporations' general southern office is located, and there turned me over to F. L. Winchester, superintendent of the North Carolina and South Carolina operations of the Montvale Lumber Company, an institution allied to the R. E. Wood Lumber Company. At this writing the Montvale Lumber Company has but one timber tract in operation, as it is chiefly a timber holding company.

Under the guidance of Mr. Winchester, I visited the sawmill and timber holdings of the Montvale Lumber Company at Tomotla, Cherokee county, North Carolina, on the Murphy branch of the Southern Railway, 118 miles west of Asheville. This is a comparatively small timber area, embracing rights on about 3,500 acres of land and an additional fee simple purchase of an adjoining property of about 1,500 acres, making a total boundary of 5,000 acres. This property is estimated to have upwards of 12,000,000 feet of merchantable poplar, oak, chestnut, hemlock and short-leaved yellow pine, exclusive of the tan bark, crossties, chestnut acid wood, etc., which the company has a period of ten years to remove. The sawmill at Tomotla is the only circular mill

operated by the Wood corporations, and was built with especial reference to speedily clearing the tract. Mr. Wood deeming a circular rig more economical in handling the general class of timber on this holding than a band equipment. This operation is carried on in the same general way as the others, with tram roads, Climax engines and logging cars. A small portion of the poplar timber on this tract was logged some years ago and it is the only timber owned by the Wood corporations that has been depredated. This applies only to that portion of the boundary in which the company has timber rights; the property owned in fee simple is virgin timber, but has not yet been reached by the tram road. This



LOWER WHITEWATER FALLS, 350 FEET IN HEIGHT, MAGNIFICENT WATER POWER ON THE WOOD PROPERTIES, OCONEE COUNTY, S. C.

operation will probably be cleaned up within five years at a very handsome profit to its owners.

#### Swain County Timber Holdings.

The Southern Railway has about completed the grade and cement abutment work for bridges and culverts for a double-track low-grade line from Marysville, Tenn., up the Little Tennessee River to Bushnell, N. C., on the Murphy branch of its system. This section of the new line of the Southern Railway is now practically ready for the ties and rails, and active work is in progress over every mile of the way to put it speedily in operation. It is

designed as the company's future through line on an excellent grade from Knoxville via Marysville (to which point it has had a road in operation for many years) to its main line running between Atlanta, Ga., and Charlotte, N. C. This road will shorten the distance greatly and improve the grades for the immense through traffic of the company from Memphis, Nashville, St. Louis, Louisville and Cincinnati to the Southeast and East. There is positive assurance that trains will be running over the new line by January first next. It is on this new extension of the Southern road, from ten to sixteen miles from Bushnell and less than seventy-five miles from Knoxville, that the Montvale Lumber Company has two magnificent holdings of virgin timber. The one is known as the Eagle Creek property, and is a boundary of 19,500 acres purchased in fee in July, 1905. In anticipation of the early operation of the Southern Railway's new division, the company has already made surveys for a logging railroad up Eagle Creek, which, with comparatively few branch lines, will penetrate the entire area of timber on the property. The mill site has been selected and plans are already well under way for the erection of a model band sawmill, with a daily capacity of 50,000 feet, about one and one-half miles from the mouth of Eagle creek. From the mill to the main line of the Southern road a standard gauge railroad will be built. This boundary of timber is one of the finest holdings of the Montvale Lumber Company, as it is absolutely virgin, there being but eleven settlers in the entire valley. The poplar is of a particularly fine quality and the white oak, red oak, chestnut oak, chestnut and hemlock is not surpassed in quality or quantity per acre by any similar property in the entire Appalachian range. This tract is estimated to cut 152,000,000 feet of merchantable timber, exclusive of tan bark, ties and extract wood.

Adjoining this property, the company owns a boundary of about 5,000 acres known as the Bone Valley tract, which was purchased in fee in June, 1905. This property is timbered in much the same varieties of woods as the Eagle Creek holdings, except that in growth it is even more prolific, as the estimates show upward of 50,000,000 feet of merchantable timber. This product will come down the valley of Hazel Creek, which is parallel to Eagle Creek, and seven miles distant from the new extension of the Southern Railway. There is a large boundary of timber up Hazel Creek, above the Bone Valley property of the Montvale





CHESTNUT OAK



WATER BIRCH



BEECH



BLACK LOCUST

*Characteristic Timber Growth on the Wood Appalachian Properties.*



PICTURESQUE AND WELL-ORDERED BAND SAWMILL PLANT OF R. E. WOOD LUMBER COMPANY.

Lumber Company, and a charter for a standard gauge road up this valley has already been issued and the road will probably be constructed within the next year. Another feature of the Eagle Creek and Bone Valley properties of the Montvale Lumber Company which promises eventual returns of value is the fact that copper in paying quantities has been discovered at several points upon them and many thousands of dollars have already been expended by copper people in opening some of these mines. The location is a very favorable one for the establishment of a tannin extract plant and one is already projected. Altogether the prospects seem very favorable for the speedy opening up of the Bone Valley holdings of the company without the necessity of its constructing a railroad to the mouth of Hazel Creek on its own account.

Outside of comparatively little rock work that will be necessary in railroad construc-

tion at the mouths of Hazel and Eagle creeks, the railroad proposition into both these holdings is a very good one. After the first mile of the creek mouths is passed the slopes of the mountains are very favorable for both railroad construction and logging operations at low cost. The slopes of the mountains are not severe in any place and show little or no rock protruding over any of the property itself. In fact, Mr. Winchester and myself on horseback traversed a large portion of both tracts over Hind trails with the necessity of dismounting on account of obstructions less than a half-dozen times in a three-days' journey. The forest is a remarkably clean one and I do not recall, outside of an occasional small tree on some of the ridge trails, having encountered during the entire journey a single fallen tree by reason of hypermaturity or windstorms.

The country is delightfully alluring and the illustrations of several phases of the



SAWMILL OF THE MONTVALE LUMBER COMPANY.



THE POPLAR LUMBER YARD.



FINE SAWMILL AND POPLAR OPERATION OF R. E. WOOD LUMBER COMPANY.



LUMBER COMPANY AT BELLEPLAINS, CARTER COUNTY, TENNESSEE

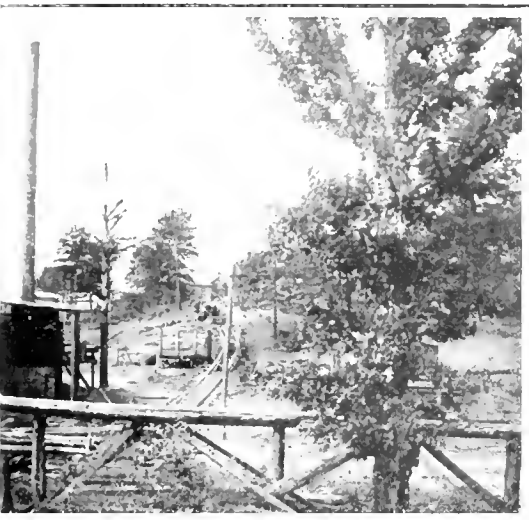

AT TOMOTLA, CHEROKEE COUNTY, N. C.

picturesque beauty of the land will be fully appreciated by the readers of the *HARDWOOD RECORD*. Every foot of the way it is virgin timber, unspoiled by squatters, fire "scalds" or overproduction. It is doubtful if there ever existed a timber area in the United States of a higher type or of more intrinsic worth than Eagle Creek and Bone Valley. I sat on my horse on one slope in Eagle Creek and within the range of vision counted more than fifty majestic poplar trees, ranging from three to six feet in diameter, the great boles towering straight up to the sky to such a height that the shape of the leaves could not be distinguished by the naked eye. The average length of bole was more than ninety feet. This scene was well nigh duplicated so many times on the journey that great poplars, oaks and chestnuts seemed almost unlimited in number, and had I not known how fast timber areas are actually being depleted, I would almost have said that

there was timber enough in those two valleys to stock a big sawmill for a century.

Higher up along the ridges I found a magnificent growth of mountain oak—the splendid red oak of the lower Appalachians—chestnut oak and locust, and along other mountain sides were beautiful oases of white pine of excellent character, while lower down in some of the coves, intermingled with the poplar, chestnut, white oak and birches, were monster hemlocks. Altogether these two valleys contained the finest timber I have ever seen in size, quality and physics, and I have traversed a good deal of timber land in my time.

I returned to Asheville with Mr. Winchester after having traversed the Cherokee and Swain county properties of the Montvale Lumber Company and there laid good eye to one of the best posted timbermen and cruisers with whom I ever had the pleasure of making a journey.



MILL COMPANY AT RENO, McDOWELL COUNTY, WEST VIRGINIA

MACHINE SHOPS, STORE AND BOARDING HOUSE



### The Lower Blue Ridge Properties.

About sixty miles south of Asheville, on the Transylvania branch of the Southern Railway, is Lake Toxaway, a mountain pleasure resort situated on a lake of irregular contour some fifteen miles in diameter, and in a pass of the lower Blue Ridge of the Appalachians. At Lake Toxaway and in the vicinity are some half-dozen resort hotels. The railroad has been completed to this point only a short time, but the Toxaway district, located in Transylvania county, one of the great southwestern counties of North Carolina, has already become a famous resort for pleasure and health seekers. At this point is the source of the Toxaway and the Whitewater rivers, which run southward across the state line into Oconee county and eventually join, forming the Keowee river, which is a main stem of the Seneca river. The two streams first named, from the Lake Toxaway country to their mouths form really one main valley situated in Transylvania county, North Carolina, and in Oconee and Pickens counties, South Carolina. Oconee county is the northwestern county of South Carolina and Pickens county joins it on the east. North of Oconee county and joining it is Transylvania county, North Carolina.

I reached Lake Toxaway at noon and, in company with George T. Reid, custodian of the Montvale Lumber Company's South Carolina properties, dined at the mountain home of Joseph McGuire, in charge of the North Carolina holdings of the company. In June, 1903, the Wood corporations purchased in fee 5,810 acres of timber land, with a contract from the seller to deliver an additional 5,703 acres, or a total of 11,513 acres in Transylvania county immediately south and adjoining Lake Toxaway and extending to the state line of South Carolina. This property lies within one and a half miles of the terminus of the Transylvania branch of the Southern Railway. In February of the same year the company purchased from the Benedict-Love Company 23,000 acres in fee and the timber rights on 17,000 acres in Oconee and Pickens counties, South Carolina, which join the North Carolina purchase. These several tracts embrace practically the totality of the southern timber area of the upper valleys of the Toxaway and Whitewater rivers, save some small holdings amounting to about 5,000 acres which the company has since acquired. The total acreage of this boundary is nearly 55,000, and it presents a surprising area of a great variety of timber growth. The deep coves

are prolific in poplar, oak, hemlock and chestnut, while higher up in the range white pine and mountain oak abound in various sections. Lower down on the very edge of the cotton country there is an extensive mixed growth of oak and short-leaf yellow pine. Again, on the higher levels there is no inconsiderable quantity of white pine. The altitude of Lake Toxaway, the source of the streams that penetrate this, as it is sometimes known, Jocassee Valley, is only a little above 3,000 feet, and it is therefore surprising to see woods of far northern habitat growing here in profusion and of excellent quality, intermingled lower down with timber that ordinarily exists only in southern latitudes. The richest and most

county area of the Montvale Lumber Company.

On the higher levels of the tract is an extensive growth of hickory which a conservative estimate would place at nearly fifteen per cent of the total forest. It is apparently of young, thrifty trees and does not show a single specimen of what is commercially known as "shellbark." The short-leaved yellow pine, which abounds generally in the western portion of Oconee county, is intermingled with oak, is of a very good type and covers a range of well toward 15,000 acres of the total. Intermingled with the poplar in the deep drains are scattering specimens of magnificent beech, often showing a bole of upwards of three feet in diameter and from seventy to eighty feet to a limb. The timber over this entire tract, notably the poplar, chestnut and oak, is ordinarily of good size, thirty inches to four feet, but there are occasional specimens of poplar which are more than six feet in diameter at the stump line. Several specimens of this timber growth are pictured in this article and are typical of the whole.

The original owners of the South Carolina property erected a fine double land mill, complete with dry kiln and planing mills, at Calhoun, where the river draining the property crosses the main line of the Southern Railway between Atlanta and Charlotte, and there started to utilize the lower streams as log waterways to stock the mill. They cut out of the property some 2,000,000 feet, largely poplar. When the holdings fell into the hands of the Wood corporations the principals did not deem it wise to continue this form of operation and therefore closed the mill, after sawing and marketing the remainder of the logs in the river. This mill has since remained closed and will soon be removed to a location in near proximity to timber.

Mr. Wood is not a believer in attempting to use mountain streams for logging purposes. He can see no economy in it, as he figures that the only way to thoroughly and economically utilize a forest is to take out of it all the merchantable timber it contains. Hence he is by training a railroad operator, and uses to the last limit tram roads. He invariably places his mills at the very closest consistent point to his timber holdings, being well aware that lumber can be moved to main lines of transportation much cheaper than can logs. By this method of operation he is enabled to handle all his valuable hardwoods out of a timber property and thus handsomely increase earnings over an operation where

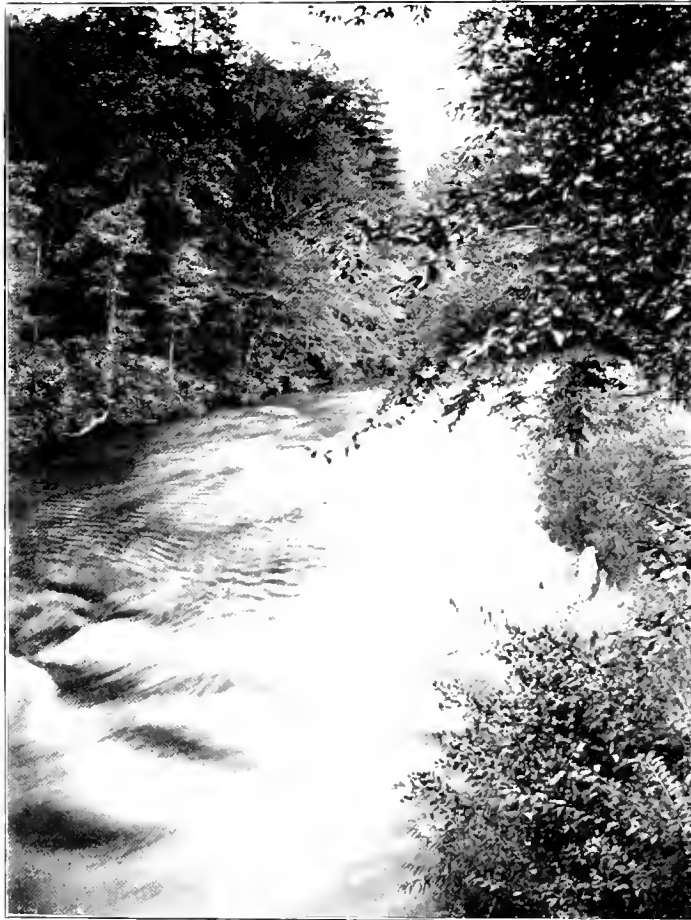

LOWER REACHES OF WHITEWATER RIVER, OCONEE COUNTY, SOUTH CAROLINA.

valued of the timber in this great section is poplar, which of course grows in the upper and deeper draws of the small streams.

Incidentally, a word about poplar: Unlike nearly all other wood growth, poplar seems never to get too old to be high-class merchantable timber. The poplar veterans of the forest, ranging from 800 to 1,000 years old, may become somewhat hollow luffed close to the stump, but all around this hollow luff is most excellent wood, and a short luff log almost invariably removes the defect. The remainder of the tree is sound, rich, yellow wood. This describes the general character of the poplar of this Transylvania, Oconee and Pickens



"PROCTOR'S," THE LAST HABITATION UP BONE VALLEY

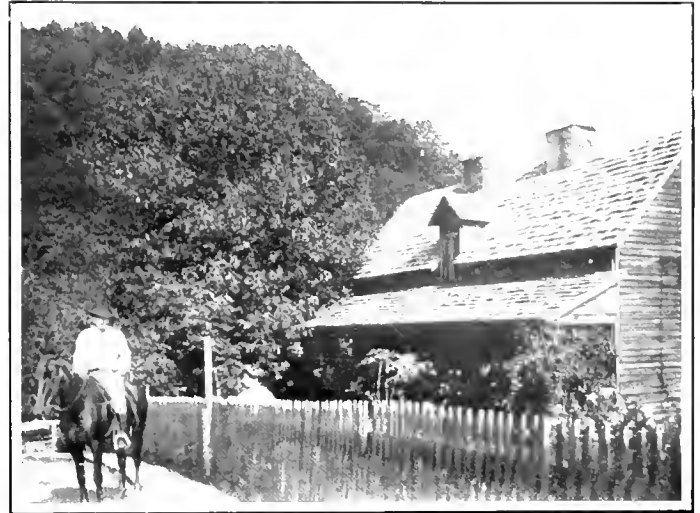

LACK COBURN, TIMBERMAN, HIS HOME ON HAZEL CREEK

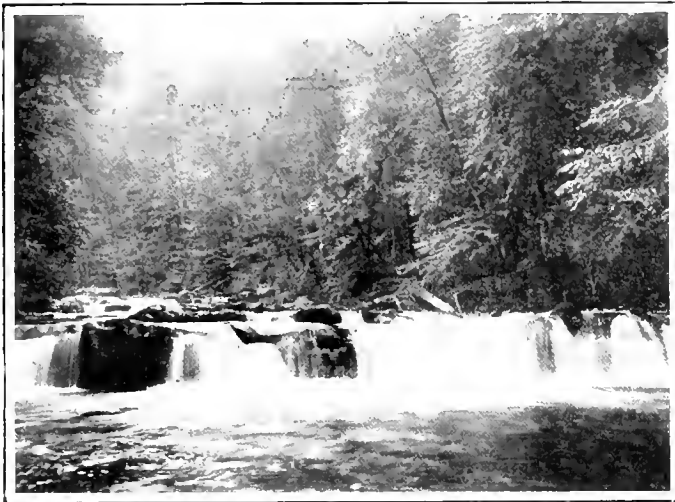

CASCADE IN HAZEL CREEK, BELOW BONE VALLEY



BONE VALLEY, SHOWING TIMBER CLAD MOUNTAINS.



CALHOUN'S ISLAND AND FORD, LITTLE TENNESSEE RIVER



BEAUTIFUL VIEW ALONG LITTLE TENNESSEE RIVER.

*Picturesque Features of the Wood Appalachian Properties.*

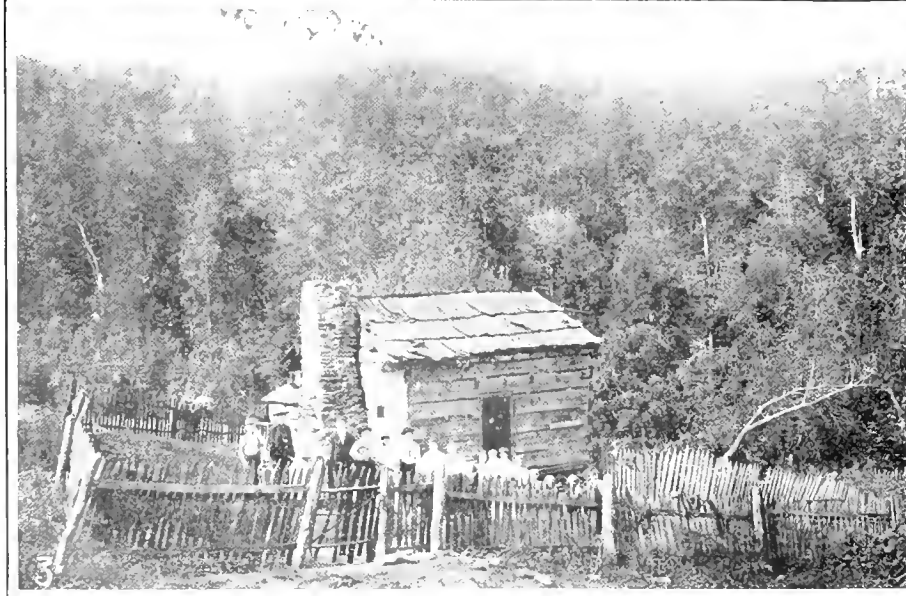

*West Virginia Scenes.*

LOOKING UP TIMBER COVE, LONG CREEK VALLEY, W. VA.

SOLID MOUNTAIN SIDE OF TIMBER, UPPER DRY FORK, W. VA.

HOME AND FAMILY OF WEST VIRGINIA SQUATTER

only the floatable woods are taken from the forest.

This great lower Blue Ridge timber holding of the Montvale Lumber Company is not designed by the Wood companies for immediate operation, but rather as a reserve source of timber supply for some years hence. However, the opening up of the Jocassee Valley appears to be imminent. The great trend of visitors to the Toxaway and Sapphire country of Transylvania county, North Carolina, which southerners from New Orleans to Charleston are making a sort of summer Mecca, demands that a shorter route from the South and Southwest shall be afforded them to reach this mountain fastness. At the present time visitors must go by way of Asheville or Hendersonville by a very circuitous route to get to Lake Toxaway. The Southern road has already surveyed a line on a very good grade from Walhalla, Oconee county, a terminus of one of the Southern's branch lines, to Lake Toxaway, which will give it a direct route only 150 miles long from Atlanta through the center of the Wood timber holdings. This extension from Walhalla to Lake Toxaway will be about thirty-five miles long and will connect the terminus of the Transylvania road at Lake Toxaway with the main line of the Southern at Seneca. The road will also develop a large freight tonnage from its very inception in timber, lumber, bark and tannic acid wood. It is estimated that the timber holdings of the Wood companies in Transylvania, Oconee and Pickens counties will cut upwards of 315,000,000 feet.

**Valuable Water Power.**

Pictured in this article are views of two magnificent waterfalls on the Whitewater river. The one inscribed "The Upper Falls" is in Jackson county, North Carolina, and is not located on the property of the Montvale Lumber Company. The other and larger one, showing a sheer descent of more than 350 feet, is in Oconee county, South Carolina, and is owned by the Wood interests. Recently Mr. Wood has had hydraulic engineers make a survey and estimate of this great water power and they place it at the lowest water stage at upwards of 32,000 H. P. The break in the mountains where these falls are located is the only really "rough" spot on the entire Wood timber holdings. The parallel Toxaway river, a few miles distant from the Whitewater, shows no such cascades in its entire course. It is figured by the engineers passing on the water power of the lower Whitewater falls that it will produce an electric power delivered at Atlanta, about 190 miles distant, of sufficient capacity to run the entire street car and electric light system of that city. Financial interests are already at work contemplating the organization of a company to transfer this splendid power to Atlanta. Mr. Wood has thus far declined to make any price on this power, but it promises to become a valuable asset.



**The Wood Methods.**

One feature about the Wood timber holdings is especially commendable. Mr. Wood has apparently sought to buy timber on streams where it has not been pillaged and where the growth is of a thrifty character and best fitted for the manufacture of high class lumber. The thing particularly noticeable about the lumber operations of his companies is a maximum of efficiency with a minimum of cost. There is no concern in the hardwood industry that makes and cares for its lumber any better than the Wood institutions, and there is none that figures its cost of equipment and production any cheaper. At all times mills and logging equipment seem to be regarded as temporary affairs and they are built just substantially enough to complete the clearing of the forest without having a mass of valueless railroad and saw mill machinery to charge to profit and loss when the operation is ended. Good house-keeping marks every detail of all the operations; everything is orderly, everything is systematic. Each detail of operations is carefully analyzed and goes forward to the head office at Baltimore in the form of daily reports. A labor report shows the daily cost of skidding, cutting, tramming, tram building, sawing and piling, loading dry lumber, building construction and planing mill work, while a second mill report shows the number of hours run, the number of men on duty and their cost in the cutting, skidding, tramming, sawing and piling, building and repairing trams, loading mill orders, mill repairs and planing mill work, all of which is totalled. The same sheet shows the log scale of various kinds of lumber; it shows the shipments of dry rough lumber, of bill lumber and dressed lumber; it shows the total of dry lumber for shipment; it shows store sales. It further exhibits the mill cuts by thicknesses and grades of the various kinds of lumber and the totals of each kind and thickness in stock. These daily reports go into every detail, even including the infinitesimal items of lumber delivered for local building operations, mill culls and tram roads; and shows in final, the total daily cost per thousand feet of lumber production delivered ready for shipment. No less complete is the statistical work by means of which cost and profit are figured at the general offices of the company at Baltimore. Here every item of sales is as carefully analyzed as is its cost of production. It is a comprehensive and accurate system of business and reflects credit on both Mr. Wood and his efficient corps of subordinates.

To the marketing of lumber the principals have given a most analytic study. In oak lumber the company enters to the furniture and car trade very largely. Its basswood, of which it has a considerable quantity, is sold chiefly to the picture frame manufacturers. The chestnut goes to the coffin making, house finishing and furniture trade. The poplar is sold direct to the automobile maker, the wagon maker, the furniture trade and to retail lumber yards; the white and yellow pine



*In the Timber Operations.*

MAKING GRADE FOR EXTENSION OF LOGGING ROAD  
 BECKER STEAM LOG LOADER AT WORK IN A COVE  
 PART OF TRAIN LOAD OF BIG POPLAR LOGS

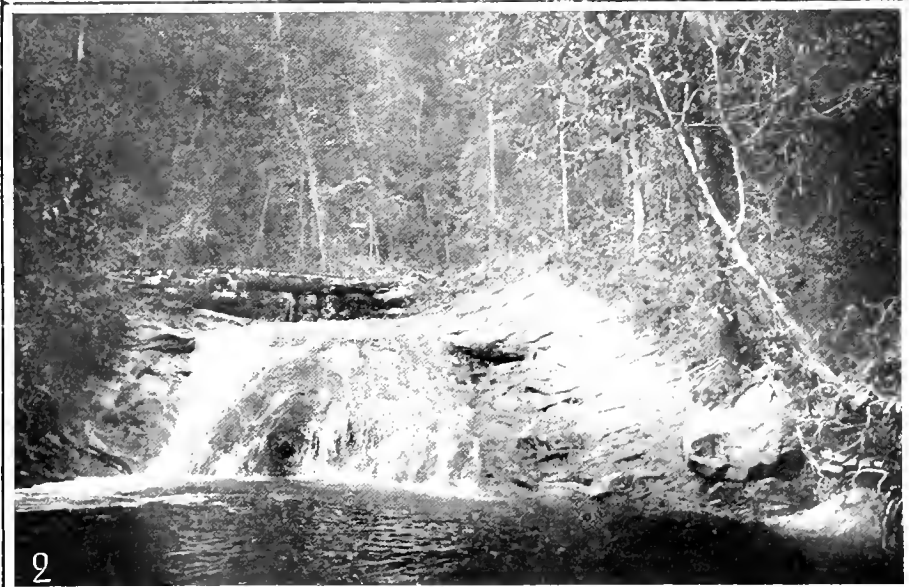

*In the North Carolina Country.*

CORNER OF THE LUMBER YARD AT TOMOTLA.  
 CONNER'S CASCADE, CROSSED BY LOGGING ROAD.  
 LOGGING RAILROAD BRIDGE ACROSS CREEK NEAR TOMOTLA.

and hemlock are sold almost exclusively to retail yards, with which the company has a trade from Boston to Cincinnati. Beyond this from 30 to 45 per cent of the company's oak and poplar is marketed abroad in such principal trade centers as Liverpool, London, Hamburg and Rotterdam. So carefully has the sales department been conducted that its total losses from bad debts during the past five years have amounted to less than one-tenth of 1 per cent.

Incidentally every detail of operation of the Wood enterprises is handled by machinery, and manual labor is minimized wherever possible. Steam skidders and log loaders, logging engines, log turning devices, log haul-ups, five rolls and all steam mechanism that can be employed is utilized to economize on the number of men employed. All the company's mills are equipped with lath and cut-up machinery, where all woods and sawmill waste is utilized. The bark from the oaks, chestnut and hemlock is all carefully peeled and sold to tanners in the vicinity of the plants. The refuse chestnut wood is harvested and sold to tannic acid plants, and the tie timber is also taken out and converted into railway ties. Waste timber in the Wood operations is practically nil. The several structures, local office buildings, boarding houses, store buildings and houses for the employees, are cheaply but substantially built of cull lumber and building paper. Neither on the exterior nor interior of any of these structures is seen either the result of the planing machine or painter's brush. They may be called crude, but they answer the purpose and are cheap. On the whole, it is my opinion that from the point of cost in equipment and operation the R. E. Wood lumber enterprises are the peer of any in the United States.

**Personnel.**

In connection with this article it is pertinent that something be said concerning the principals and subordinates of the R. E. Wood Lumber Company and the Montvale Lumber Company.

**ROBERT E. WOOD.**

The biographical sketch giving Mr. Wood's commercial history presented in the last issue of the *HARDWOOD RECORD* covered his career quite fully. Little need be added save that he is a careful, painstaking man, thoroughly trained in his calling of timber expert and lumber manufacturer. He is the embodiment of dynamic force. His woodsmen tell me that in cruising he can fire out the huskiest landlooker in his employ. He is insured to hardships and spends a great portion of his time in looking timber properties. He has a reputation for fairness in all his transactions. The fact that has most impressed itself upon me during my visits to his various operations and in my talks with his subordinates has been the loyal friendship manifested by every employe. From woods foreman to "tote boy" I gathered expression of fidelity to the "boss." By them he is looked upon as an exacting but kindly employer, and everyone loves him.



A. P. PERLEY, VICE PRESIDENT MONTVALE LUMBER COMPANY

G. L. Wood.

Mr. Wood is the next younger brother of Robert E. Wood, and has grown up with him in the timber and lumber business. On "Leidy," as he is affectionately called, has devolved the railway building, logging, sawmilling and shipping of lumber; in fact, a general supervision over the entire operations of the Wood corporations. He is a young man of physical activity and mental alertness and to him falls a large share of the credit due to the surpassing manner in which this department of the business is conducted.

CLARENCE E. Wood.

Clarence E. Wood, the third brother of the Wood family, acts as chief assistant to G. L. Wood, but devotes his time and especial attention to executing the work at the Keno, Dry Fork operation. Mr. Wood is as industrious and forceful as his two elder brothers and the admirable way in which his work is conducted bespeaks volumes for his future in the hardwood industry.

F. L. WINCHESTER.

F. L. Winchester is a veteran in the timber and lumber business of the Appalachian range. For many years he was a stockholder and general manager of the Loomis & Hart Manufacturing Company at Chattanooga, Tenn., a concern that has made no inconsiderable lumber history. He retired from this house some years ago on account of ill health induced by overwork and it is only within the last few years that he has again taken up active life in woods work. Although of a very quiet disposition and gentlemanly manner, he is a genuine "mixer" with the people living in the great Smoky and Blue Ridge country of the lower Appalachians. He has the confidence and respect of every land owner and settler in the entire region and the timber deals that would be impossible to the



G. L. WOOD, GENERAL MANAGER R. E. WOOD LUMBER COMPANY

s ranger are carried out by him with diplomacy and finesse. I have never had the pleasure of trailing the forest with a more competent and agreeable woodsman than F. L. Winchester. He has immediate charge of the North Carolina and South Carolina timber and lumber operations of the Montvale Lumber Company.

OTHER EMPLOYEES IN THE WOODS WORK.

Incidentally I met and was very favorably impressed with the personality and the manner in which they conduct their share of the work of the Wood enterprises, W. L. Leitzell, superintendent of the Keno manufacturing operation; W. W. Pruet, superintendent of the Buladea plant, and W. J. Wright, chief accountant at the same operation; J. A. Robertson, superintendent of the Tomolia plant, and Kyle Conner, the logger at the same operation; George T. Reid of Joanssee, S. C., the stalwart custodian of the South Carolina properties of the Montvale Lumber Company, and Joseph McGuire, who occupies the same position in the Transylvania, N. C., property of the company. To those named above and many others who contributed to my comfort, pleasure and information I wish to return sincere thanks.

THE EXECUTIVE FORCE.

While the Wood companies are thoroughly organized in the woods and operating end of the business, it is no less true that the executive staff is equally well organized into an efficient corps that reflects credit on the sagacity of R. E. Wood, in selecting assistants.

A. P. PERLEY.

A man to whom R. E. Wood owes no little debt of gratitude is the vice president of the Montvale Lumber Company, A. P. Perley, of Williamsport, Pa. Mr. Perley is the well known banker of eastern Pennsylvania, being president of the West Branch National Bank of Williams-



C. E. WOOD ASSISTANT GENERAL MANAGER R. E. WOOD LUMBER COMPANY

port. He is an able financier and a banker of repute, as no banking institution in eastern Pennsylvania stands higher or has had a better record than his institution.

Mr. Perley began his lumber career in Williamsport, Pa., as a bookkeeper for one of the large lumber companies of that city. Later he entered the business on his own account as partner in the firm of Howard & Perley, which concern acquired valuable timber holdings on the Susquehanna river and its tributaries, and engaged extensively in the manufacture of lumber.

At the time of the organization of the Montvale Lumber Company of Baltimore, February 2, 1904, Mr. Perley was elected vice president of this company and still acts in this capacity.

Mr. Perley has had a wide lumber experience, which together with his position as head of such an enterprising institution as the West Branch National Bank, which is very favorably known throughout Pennsylvania, merits for him the appreciation he enjoys of being a good adviser in commercial enterprises.

H. L. BOWMAN.

Ambition to succeed, coupled with untiring energy and thorough honesty, are the dominant traits of character of the man now at the head of the sales department of the Wood corporations. Mr. Bowman was born and reared at Lynchburg, Va. After reaching manhood he became interested in the iron industry, which business he followed for a number of years. In November, 1891, he entered a new field of endeavor and became engaged with the West Lynchburg Furniture Company as secretary and treasurer, retaining that position until the year 1902, when he accepted the position of sales manager with Mr. Wood, continuing in that capacity until the organization of the R. E. Wood Lumber Company, at which time he was made general sales manager for that com-



HOW POPLAR SAPS ARE "RICKED" TO PREVENT STAINING



PRIMITIVE WATER POWER SAWMILL NEAR BULADEEN, TENN.



F. L. WINCHESTER, SUPERINTENDENT NORTH AND SOUTH CAROLINA OPERATIONS, MONTVALE LUMBER COMPANY

pany and later for the Montvale Lumber Company.

J. K. PAINTER.

J. K. Painter, secretary and treasurer of the Wood corporations, was born in 1871 in Wythe county, Virginia. Here he grew to manhood, acquiring the sterling qualities so often developed in men of that mountainous portion of the Old Dominion.

In the spring of 1899 Mr. Painter accepted a responsible position with the Pittsburg Plate Glass Company at its plant at Ford City, Pa., where he remained until forced by ill health to seek a change of climate. In the fall of 1900 he entered upon the duties of bookkeeper and general office man for R. E. Wood while the headquarters of his business were still located in West Virginia. In this work Mr. Painter continued, proving by his character and business integrity to be well deserving of the trust reposed in him by the promotion to the office of secretary and treasurer of the R. E. Wood Lumber Company at the time of its organization and later to the same office in the Montvale Lumber Company.

E. L. WARREN.

E. L. Warren, purchasing agent for the Wood companies, was born at Emory, Va., in 1874. He was educated at Emory and Henry Colleges and launched on his business career at an early age. He sought for and found a field for his untiring energy in southern West Virginia, which was just then being opened by the building of



J. K. PAINTER, SECRETARY AND TREASURER R. E. WOOD LUMBER COMPANY AND MONTVALE LUMBER COMPANY

the Pocahontas division of the Norfolk & Western Railway. Here he received his first training in the lumber industry, gaining rapidly by dint of hard work an experience and knowledge of the practical manufacture of lumber which promptly recommended him to Mr. Wood, with whom a warm personal friendship had begun during the first months of their acquaintance.

Early in 1903 Mr. Warren was made purchasing agent for the Wood corporations, which department he conducted ably, buying lumber and superintending the shipping in the Tennessee and North Carolina territory, until the recent addition of new plants required his attention. He is not only energetic and hard working, but, better still, is versatile and has greatly assisted the general management in the many different fields of the company's operations.

Mr. Warren is a member of the executive board of the R. E. Wood Lumber Company and the Montvale Lumber Company.

J. H. YOST.

Mr. Yost was born in Wythe county, Virginia, in 1875, his parents moving to Washington county in the same state when he was but two years of age. He obtained his education at Weaverville College, North Carolina.

In 1899 he entered the employ of R. E. Wood at Sandy Hill, W. Va., as clerk in the commissary. By his strict attention to business and his mastery of detail in that department, he was soon promoted to the position of general store manager.



H. L. BOWMAN, SALES MANAGER R. E. WOOD LUMBER COMPANY AND MONTVALE LUMBER COMPANY

In June, 1903, shortly after the organization of the R. E. Wood Lumber Company, Mr. Yost was appointed to the important post of general accountant for the company and transferred from West Virginia to Baltimore, to the general offices of the company. This position he still retains, filling it with the same degree of efficiency which has characterized all his work for the Wood interests.

W. L. TAYLOR.

At the head of the legal department is one of those earnest and energetic workers whose habits of life were formed under the strenuous conditions natural to development in the rural mountainous regions of south-western Virginia.

At the age of twenty-four W. L. Taylor began the practice of law at Perryville, the county seat of Mingo county, West Virginia. Two years later, when the court house was removed to Welch, he followed this center of interest, becoming thereby a pioneer in the section in which R. E. Wood began the moulding of the great business which is the subject of this story.

Mr. Taylor has been legal adviser and general attorney for R. E. Wood and the companies under his control since the beginning of operations in West Virginia. Because of his thorough familiarity with that country and his excellent attainments as a lawyer and man of business his labors in the upbuilding of these interests have ever been marked by most successful accomplishing.



E. L. WARREN, PURCHASING AGENT FOR THE WOOD COMPANIES.



W. L. TAYLOR, ATTORNEY FOR THE WOOD COMPANIES.



J. H. YOST, CHIEF ACCOUNTANT FOR THE WOOD COMPANIES.



HARDWOOD NEWS.

Continued from page 28.

The Imperial Furniture Company of this city, manufacturing tables, is operating its plant thirteen hours a day. Some of the other factories are also running overtime.

Bristol, Va.-Tenn.

E. L. Edwards of Dayton, O., is spending some days in this section. Mr. Edwards handles the output of a number of mills throughout East Tennessee and Western North Carolina.

The W. M. Ritter Lumber Company is working hard in an effort to have their new band mill at Hampton, Carter County, Tennessee, completed and ready for operation by January 1st. A railroad (standard gauge) is being built from Elizabethton to Hampton, a distance of about eight miles, and a narrow gauge railroad is under course of construction from the company's mill site at Hampton, up Tiger's Creek to its timber lands, a distance of some twelve miles.

A charter has been granted to the White Top Railway Company, which is being built through Washington, Smyth and Grayson counties, Virginia, by the Hassinger Lumber Company, of Lamona, Pa. This company has purchased one of the biggest tracts of timber in southwest Virginia and is preparing to develop same. The incorporators of the new concern held a meeting at Abingdon, Va., on September 25, and elected the following officers: President, W. A. Hassinger, Abingdon, Va.; vice president, J. H. Hassinger, Lamona, Pa.; secretary, J. Hy Hurt, Abingdon, Va.; treasurer, L. C. Hassinger, Azen, Va. The principal offices of the company will be at Hazen, Va. The company will construct a large band mill and will begin cutting timber as quickly as possible.

W. S. Feagin, of Bristol, has closed a deal for 4,000,000 feet of lumber in the lower end of Sullivan county, about seventeen miles from Bristol. This stock will be manufactured at Bristol, and shipped from there.

R. F. Clapp, of Panther, West Virginia, O. C. Hathaway, of Hampton, Tenn.; H. H. Andrews, of Panther, and R. G. Page, of Hampton, officials of the W. M. Ritter Lumber Company, of Columbus, Ohio, spent part of last week in Bristol on important business.

W. O. Price, of the W. O. Price Lumber Company, of Baltimore, Md., was a visitor in the city last week. Mr. Price is buying hardwood stock in large quantities in this section.

L. R. Byler, purchasing agent of the Pennsylvania railroad, was a recent visitor to the local market. Mr. Byler has bought 200,000 feet of fine oak at Gate City, and is making numerous other purchases in this district. The lumber is being shipped to Altoona, Pennsylvania, for use in the construction of Pennsylvania railroad equipment.

The Douglas Lumber Company has constructed a twelve-mile line of railroad extending from the company's mill near Laureldale, Va., into a richly timbered section of southwest Virginia.

The Came-Wyman Lumber Company is constructing seven miles of standard gauge railroad from Swastika, near Bluff City, ten miles south of Bristol, into its timber properties. The company has purchased a 3,000 acre tract of timber near Elkannah and the logs will be brought out over the new road to the V. & S. W., and thence direct to Bristol, where they will be cut at the band mill of the Bristol Door & Lumber Company. The company has already purchased the larger part of its railroad equipment, and is contemplating the erection of a band mill on their timber tract.

The Collins Lumber Company has purchased the property of the Elkhurst Planing Mill Company, at Elkhurst, W. Va. The company now has one of the best equipped wood working plants in West Virginia.

Franklin P. Pishon, of the Tug River Lumber Company, leaves this week for an important business trip to Philadelphia and New York.

Paul W. Fleck of Philadelphia was a recent visitor to the city.

Cincinnati.

The proposed belt railroad and the transportation question in general were discussed at the meeting of the Cincinnati Lumbermen's Club held Monday night, Oct. 1, at the Business Men's Club. James T. McHugh, who is chairman of the Terminal Committee of the Business Men's Club, spoke on the belt road, and E. E. Williamson, commissioner of the Receivers' and Shippers' Association, spoke on general transportation.

The following new members were admitted: The Sterritt Lumber Company, the Riemer Lumber Company, the U. S. Timber Company and Wildberg Lumber Company.

President Moffett appointed R. E. Dulweber, Chester F. Korn and W. W. Stone delegates to the Ohio State Railroad Commission meeting at Columbus on Oct. 18. At this meeting the re-consignment charge case against the B & O S. W. Railroad will be heard. Other questions in which lumbermen are vitally interested will also be discussed.

The lumber movement for September was as follows: Receipts, 6,124 cars; shipments, 4,734 cars. For the same months last year receipts aggregated 6,292 cars and shipments 4,905 cars.

The exhibit of the Lumbermen's Club at the fall festival which ended Sept. 28 was donated to the Cincinnati University of Cincinnati for the instruction of students. The exhibit attracted more than 200 lumbermen from other cities during the month's run of the festival and club members secured much business. George Littleford was chairman of the committee in charge of the exhibit.

C. Crane & Co. have 200,000 logs along the Kanawha River and part of them will be floated down as soon as the tide reaches a suitable stage. "Fortunately we do not need the logs right now," said C. Crane. "General lumber business is in excellent shape with us."

The Wildberg Lumber Company, a new corporation at Arlington Heights, a suburb, is enjoying a fine business at present. Horace Wildberg and brothers are at the head of the firm.

The Freiberger Lumber Company, with mills at Poplar, Findlay and McLean avenue, has resumed operations after a shut down because of no logs. They have a fine assortment now and will be kept busy for some time. The firm is specializing in mahogany.

The Baldwin Piano Company has acquired considerable additional property and will establish yards where lumber can be kept for years. They will also build new woodworking shops.

O. P. Hurd of O. J. Hurd, Jr. & Co., Cairo, Ill., spent his vacation here last month. The Hurd company was located in this city until a year ago.

Nashville.

The skating rink fad has resulted in a heavy demand for beech and other hardwood flooring. Orders for new rinks are reported to be coming in all the time and the demand for beech, which is used for the flooring, has resulted in advanced prices. Beech makes excellent flooring, takes a high polish and is hard and durable.

John B. Ransom of John B. Ransom & Co., returned Saturday night from a stay of several days in New York, where he attended a meeting of the special committee of the Methodist Episcopal Church, South.

Arthur B. Ransom is attending the annual session of the Tennessee Conference at Lebanon, Tenn., thirty miles from Nashville.

Richard Wilson of the Nashville Hardwood Flooring Company, accompanied by Mrs. Wilson, is making an extended stay in New York.

John W. Love of Love, Boyd & Co. reports

business very good, with an exceptional demand for plain oak.

W. J. Cude of Kimmins, Tenn., is in Louisville attending a meeting of the creditors of the Stokes Lumber Company.

W. A. Ransom, head of the Gayoso Lumber Company of Memphis, was a recent visitor to the city, accompanied by John Lasky, one of the salesmen for that concern.

J. R. Russell of Bowling Green, Ky., was a recent visitor to the local market. He is looking around for beech flooring for a skating rink to be built there.

One of the most attractive booths and exhibits at the big Tennessee State Fair, which took place on Monday and continued for a week, is that of the Nashville Hardwood Flooring Company. In a space 10 by 12 feet square the company has laid a lot of fancy flooring in squares and strips, with plain and fancy borders, all highly polished. Wax and felt brooms, floor wax and other items incident to floor keeping, are included in the exhibit.

A special from Cloyd's Landing, Ky., states that E. E. Turner & Co. have bought a tract of timber lands near there containing several million feet. They have erected a saw mill on it and will market the timber at an early date.

Frank Kyle, son of Hugh Kyle, a prominent lumberman of Celina, Tenn., at the mouth of the famous Obed river, was in the city Saturday.

In the recent heavy rains around Middle Tennessee a large quantity of staves were lost near White Bluff, Tenn., Joseph Brown at that place losing a quantity valued at \$14,000. Not only were the staves washed away, but the factory was badly damaged by water and mud.

Lieberman, Loveman & O'Brien, who recently sustained a severe loss by fire, are handling their usual big business as though nothing had happened, drawing from their five other yards in this section.

The Abbott Lumber Company of St. Louis has bought the planing mill of the O. G. Gardner Lumber Company of Jackson, Tenn., and will enlarge the capacity of the same. The firm has contracted for 100,000,000 feet of hardwood lumber for delivery at Jackson.

Joseph Whited has sold his stave mill at White Bluff to George Gilliland of Nashville.

The Lamb Fish Lumber Company of New Jersey, capitalized at \$1,500,000, has registered its charter at the state capital for the purpose of engaging in business in Tennessee.

Owing to the excessive rains of the past two or three weeks there is a good tide on in the Cumberland river and quite a quantity of logs have come down.

Memphis.

Secretary E. M. Terry, of the National Lumber Exporters' association, is back from an Eastern trip on which he combined business and pleasure. He visited Cincinnati, Buffalo, Niagara Falls, New York, Philadelphia, Baltimore, Norfolk, Washington, Knoxville and Chattanooga. He met nearly all the members of the association and got much closer in touch with them and their work than he had been previously. While at Norfolk he took up with the United Shipping Company the question of restoring gum to the hardwood list and today he received official advices from that concern to the effect that it had taken this action. All the southern steamship lines with the exception of those operated by the United States Shipping Company out of Norfolk have been classifying gum as a hardwood and giving it the hardwood rate and this fact was used with telling effect on the management of the company. Mr. Terry also during his trip appeared before the interstate commerce commission at Washington Sept. 12, when the question of export rates was under advisement. He represented the association before that body, and

though the meeting was called explicitly for the purpose of considering rates on cotton exports.

At a recent meeting of the Lumbermen's Club of Memphis President W. H. Russe, of the National Hardwood Lumber Association, called the attention of the membership to the fact that the semi-annual meeting of that organization would be held in Cincinnati Oct. 25-26 and urged that there be a good representation from the local club, which now seems assured. Three new members were received, W. C. Palmer, of the Wiborg & Hanna Company, a branch of the Cincinnati firm of the same name; A. L. Foster, of the J. W. Thompson Lumber Company, and W. A. Stark, of James E. Stark & Company. The committee which had charge of the minimum weight contest with the Missouri Pacific system, consisting of George C. Ehemann, chairman, E. E. Goodlander, James E. Stark, S. C. Major and J. W. McClure, was given a vote of thanks for the able manner in which it had performed its duties and discharged.

Rapid progress is reported on the grading of the Memphis, Paris & Gulf Railroad which was incorporated some time ago for the purpose of building a line from Nashville to Ashdown, both Arkansas points, a distance of 28 miles. Nine miles have been completed and rail laying has begun, while the remainder of the grading is under contract. The road runs through a splendid timber section and will prove a factor in the development of it.

The Illinois Central has given notice to shippers that it will not accept shipments in its cars for points which are not reached by its own lines. The only exceptions are the Baltimore & Ohio and the Pennsylvania system, exclusive of the Vandalia lines of the latter. This move is made because the Illinois Central fears a decided shortage of cars and desires to conserve its own rolling stock as far as possible, but lumber shippers are very much handicapped by this action and there is some discussion of taking the matter before the interstate commerce commission. Lumbermen fear that other roads will follow the course of the Illinois Central and in that event it would be almost impossible to make shipments of lumber at all.

Harold Petri, of Quinet & Petri, Antwerp, Belgium, who was located in Memphis for several years, has opened headquarters at the Hotel Gayoso for a while. He has come over to this country to buy lumber and says he will remain until he has secured his requirements. He has been south of Memphis during the past few days.

Stockholders in the Merchant's Trust Company, which closed its doors here during Christmas week last year, have been officially notified by the receiver of that institution that he is ready to declare a dividend of between 40 and 50 cents on the dollar in their favor. This is a rather better showing than anticipated some time ago. A number of lumbermen held stock in the bank and were also large depositors. All deposits were fully met a few months ago.

Max Sondheimer, president and general manager of the E. Sondheimer Company, has returned from an extended eastern trip. He also passed through Chicago. While he was away Rudolf Sondheimer looked after the interests of the company here. Mr. Sondheimer reports an excellent demand for hardwood lumber and predicts the greatest shortage in the supply of southern hardwoods for the late winter and early spring trade witnessed in recent years.

Clay & Elliott, of Henderson, Ky., have purchased the hardwood timber holdings of Russell Gardner, of the Banner Buggy Company of St. Louis, in Saline, Cleveland, Dallas and adjoining counties in southeastern Arkansas. The price is not known. The purchasers propose to put in a large spoke factory and band saw mill at Rison, Ark., a few miles from Pine Bluff, Ark.

The property of the C. B. Kelly Lumber Company of Homan, Ark., which passed into the hands of a receiver some time ago, consisting of timber land holdings, a hardwood mill and a tram-road, has been sold, under order of the federal court for the western district of Arkansas, to William F. Wood, of Chicago, for \$40,000. The estimated value of the holdings at the time of the failure was \$150,000. The failure of the lumber company resulted in the suspension of the Bank of Newport at Newport, Ark., this firm being the largest creditor of that institution.

The Fee-Creighton Company of Newark, O., has decided to establish a hardwood specialty manufacturing plant at Newport, Ark., which is to have a monthly payroll of between \$5,000 and \$10,000. A representative of the company has been south for some time looking over the field and was so impressed with Newport and its facilities that he made a proposition to locate there in the event business men donated a site. This was immediately accepted, fifteen acres being given the firm. Work on the plant is to be begun at once. Mr. Creighton, a member of the firm, will make his permanent residence at Newport and will be in charge of the plant.

Eastern capitalists have sent agents into the Mississippi valley for the purpose of investigating and making an exhaustive report on the gum forests of that section. These gentlemen are connected with the lumber industry and the statement is made that if the investigation proves satisfactory they will establish plants for the manufacture of gum lumber and various products made therefrom. Their plans are said to contemplate also the erection of vulcanizing and crosscutting plants for the treatment of gum to be used as cross ties, the claim being made that their process will give gum ties as long life as those made of oak.

A meeting of the Lumbermen's Club was held at the Hotel Gayoso Oct. 6. A communication from the Lumber Exchange of St. Louis, asking the local organization to join with that body in a protest to the railroads against the enforcement of the reconsigning charge of \$5 per car, was brought to the attention of the meeting. There was considerable discussion of the matter, and a committee consisting of James E. Stark, chairman, A. L. Foster and George C. Ehemann, was appointed to investigate the bearing of the charge on the lumber industry of Memphis and to confer with the committee appointed by the Lumber Exchange of St. Louis.

Secretary E. M. Terry of the National Lumber Exporters' Association attended this meeting and was called upon for a talk on the subject. It was resolved that the Lumbermen's Club put itself on record as in favor of the restoration of the basis which prevailed before the new rate law became effective, and the president was authorized to appoint a committee to go to Washington on Oct. 10 to attend the hearing of the interstate commerce commission.

It was also decided to extend an invitation to the National Lumber Exporters' Association to hold its next annual meeting here in January, 1907, as the guest of this body.

Besides Secretary Terry there were two other visitors present, Harold Petri, of Quinet & Petri, Antwerp, Belgium, and W. A. Bennett, of Bennett & Witte, Cincinnati.

R. J. Darnell of R. J. Darnell, Inc., has just returned from an extended business trip to Europe.

The National Lumber Exporters' Association, owing to the short notice it had in reference to the meeting of the interstate commerce commission and the consequent difficulty of communicating with its widely scattered membership, decided to present its case regarding the equalization of lumber export rates before the commission through a written statement instead of through personal representation. This action was taken in response to a

telegram received by Secretary Terry, informing him that the association could take up the matter either through personal appearance before that body or through a statement filed with it. If the statement is not effective, it is highly probable that all the lumber organizations will get together and make a strong effort to obtain the equalization of export rates on lumber because they realize that, unless there is equalization, all the business from this territory will have to go through New Orleans, thus causing congestion which will prove exceedingly costly to the exporters of lumber.

Visiting lumbermen to Memphis recently included: W. E. Douglass, of Douglass & Walkley of Columbus, O.; Allen Vinneedge, of A. R. Vinneedge & Company, Chicago; H. S. Janes, of the Empire Lumber Company, Buffalo, N. Y.; F. F. Fish, secretary of the National Hardwood Lumber Association, Chicago; C. F. Korn, of the Farris-Korn Lumber Company, Cincinnati; W. A. Bennett, of Bennett & Witte, Cincinnati; W. Dixon Smith, of Parkersburg, W. Va., representing Alfred Dobell & Co. of London, Eng.; M. Neely, of McDonald Brothers, Helena, Ark.

F. E. Gary, vice-president and general manager of the Baker Lumber Company, has gone to Chicago to look after plans connected with the rebuilding of its big band sawmill at Turrell, Ark., which was destroyed by fire Sept. 30. The loss is estimated at about \$50,000, covered by insurance. There were about 6,000,000 feet of lumber on the yards which was saved through the heroic efforts of the employees.

J. W. McClure of Thompson & McClure has returned to Memphis from an extended business trip "down East." He came back via Chicago.

#### New Orleans.

The timber interests in Louisiana and Mississippi suffered heavy losses in the hurricane which swept over Mobile, Pensacola and other places in this territory last Wednesday and Thursday. The yellow pine operators in Mississippi were the heaviest losers, the damage to hardwoods throughout that state and Louisiana being comparatively slight. In some sections of Alabama and Florida the destruction of hardwoods was considerable. In most cases lumbermen are erecting small portable sawmills on the devastated property to cut the fallen timber.

With the charge that the action of the Illinois Central Railroad in deciding to use its cars on its own lines and there only was unfair, lumber manufacturers of Mississippi recently met and resolved to take steps to have the railroad company set aside this order. Probably fifty manufacturers were present at the meeting, which was held in Hattiesburg, and these denounced the action of the railroad company. The car shortage problem was discussed, and it was generally agreed that the lumbermen of the South were facing a serious situation. It was finally resolved to protest to the traffic manager of the Illinois Central and to call upon him for aid in the matter.

One of the largest timber deals consummated in Louisiana in some time was closed at Monroe, La., Oct. 1, when the Standard Lumber Company in Catahoula parish sold its 60,000-foot capacity sawmill, 52,000 acres of land and six miles of railroad to the Louisiana Central Lumber Company of Clarks, receiving something over \$1,000,000 for its properties. It is understood that the Louisiana Lumber Company at Rochelle is interested in the deal to the extent of one-fourth of the purchase price. The timber is in one of the hardwood sections of the state, though there is considerable shortleaf pine on the property. The purchasers will enlarge the plant to double its capacity.

Advices from Meridian, Miss., state that a \$100,000 furniture manufacturing company will probably succeed the Meridian Coffin Factory. Among those interested in the movement are B. V. White, W. Meeds, E. Cahn, S. A. Gray, F. J. Burke, Sam Greenwald and W. A. Gough.



It is purposed to liquidate the affairs of the Meridian Coffin Factory.

Dispatches from Macon, Ga., state that the big plant of the Central City Planing Mill & Lumber Company, the largest in that section, with all its machinery and a large amount of lumber, was destroyed by fire recently, entailing a loss of \$100,000.

George Long, a Vicksburg real estate dealer, recently sold for Campbell, Brennan & Allen 2,100 acres of timber on the Big Black and Yazoo rivers to Ed M. Maxwell and E. L. Powell of Milwaukee. There is considerable hardwood on the tract.

Fritchett & McDonald, a new hardwood firm, have opened offices in the Machee building and will handle hardwood lumber on commission. The firm is composed of F. M. Fritchett, formerly with McDonald Bros. of Helena, Ark., and Charles McDonald, an experienced hardwood man.

The C. H. Wright Stave Company, Inc., which operates a big plant at Hollow Rock, Tenn., is removing to New Albany, Miss., where it will continue operations. New machinery will be purchased and the capacity of the plant will be one carload of staves per day.

The Robert Nixon Lumber Company has been organized in New Orleans with a capital of \$200,000 to buy, sell and develop timber lands and to manufacture lumber of all kinds.

Another new company here is the Welch Schneide Company, Ltd., which has been organized with a capital of \$25,000. It will deal in timber lands and also manufacture staves and lumber. Rudolph U. Schneide, Delos A. Welch and Joseph R. Schneide are the principal stockholders.

Other new corporations organized in this vicinity recently are:

Sunflower Delta Land Improvement Company, domiciled at New Orleans, capital stock \$500,000, to do a general timber and land business; incorporators, Albert DeMore, Edward E. Carrier and Frank A. Daniels.

Roberts Lumber Company, capitalized at \$50,000 and domiciled at Allis, a new town on the Santa Fe, near Leesville. The officers and directors are B. H. Lyons, president; J. S. Roberts, vice president; C. T. Allis, secretary and treasurer; G. R. Ferguson and Frank Miller.

Jackson Lumber Company, domiciled at Bayou Seie, Sabine parish, La. Capital \$10,000, to do a general lumber manufacturing business. Officers, J. P. Towery, president; W. M. Jackson, vice president; R. T. Crow, secretary.

Lena Lumber Company, domiciled at Lena, Rapides parish, La., to do a general lumber business; capital, \$10,000. Officers, John Brogan, president; Thomas Cleveland, vice president; David W. Love, secretary, and William E. Brogan, treasurer.

### Louisville.

Railroad matters are pretty troublesome in this section of the country. Besides the usual annual battle for cars this year there is an added difficulty that comes from the new railway rate bill.

Among the Point mills, Kirwan Bros. sawed out their logs a few days ago and are now waiting until they get more from up the Big Sandy River, which they hope to do in a short time. The Ohio Valley Sawmill Company and the Louisville Point Lumber Company have good supplies of logs yet, the latter firm especially, which has all it can possibly handle this winter. All the mills report a good demand for hardwood lumber and have no trouble in finding a market for everything cut.

The Kentucky Hardwood Flooring Company has secured a contract to furnish oak flooring for the Stewart Building, one of the big downtown buildings now in course of erection. This furnishes the new company a nice bit of work to start its plant with, and it is now installing machinery and dry kiln equipment so as to get started as soon as possible.

Albert R. Kempt has put a new mill down in the woods near Auburn, Ky., to take the place of the one he recently lost at that place by fire.

H. M. McCracken of the Kentucky Veneer Mills says the veneer business is coming along very nicely, both for rotary cut stock and quarter sawed.

George N. Welch of the Welch Stave & Heading Company, Monterey, Tenn., who was a visitor in town a few days ago, says his company is not doing much with its sawmill right now, giving most of its attention to getting out staves. Some lumber is being shipped out now on contracts which were on hand, but the company is not at present operating the mill.

Z. Clark Thwing of the Grand Rapids (Mich.) Veneer Company was in town recently. As well as being big factors in the line face veneer business, these people are promoting a new system of kiln drying hardwoods. The new Kentucky Hardwood Flooring Company is putting in one of the company's kilns here. Mr. Thwing advances some startling ideas on kiln drying lumber, and says he is ready to stand back of them with a guarantee that if the kiln is not as represented it will not have to be paid for. He is very enthusiastic over the new kiln, but that does not keep him from doing a big business in line face veneers. He says the veneer trade is in very good shape and the outlook bright.

### Ashland.

A charter has been issued to the Dana Lumber Company, a big enterprise just established by well-known Charleston, W. Va., men; its chief works to be located in the Malden district. The capital is \$880,000, all of which has been subscribed and \$65,000 paid. The incorporators are all prominent business men.

The Tygart's River Lumber Company of Mill Creek, W. Va., has acquired the rights to 60,000 acres of valuable timber land near Huttonsville, closing a deal with Col. Elihu Hutton and Wirt C. Ward, both of Huttonsville. The amount paid for the timber rights was \$100,000.

The Kentucky Land, Timber & Coal Company was recently organized with headquarters in this city. T. N. Fannin is president, J. B. Wilhoit, vice president and attorney, and J. W. Perry, secretary and manager.

M. A. Hayward, vice president and manager of the Kenova Poplar Manufacturing Company, has resigned and removed his family from Kenova to Columbus.

W. E. Berger of the W. H. Dawkins Lumber Company is on a business trip to New York.

F. O. Clapp of Scituate, Mass., was among recent callers to this market.

### Minneapolis.

E. Payson Smith of the Payson Smith Lumber Company is absent on a business trip in northern Minnesota, looking after some stocks. George S. Agnew of the same company has returned

from a vacation spent at Lincoln and Denver, where he visited relatives. A. S. Bliss of the same company reports that they are rapidly acquiring new stocks to supply their growing trade, and that their new buyer in Wisconsin has bought some good stocks of pine for them, which will be something of a new departure. They have also acquired a stock of butternut, for which they expect to find a ready sale. They have had an excellent run of fall business in hardwood, and that while birch is inclined to be weak there is not much unsold stock in the country.

C. E. LeCrone of the J. W. Thompson Lumber Company of Memphis, Tenn., has been in Minneapolis on business this week.

L. C. Nolan of the Bacon-Nolan Hardwood Company, Memphis, Tenn., has been visiting his former home in St. Paul for a few days and looking after some business matters. He reports that they are having a prosperous season with their new property.

Damage of \$30,000 was done to the plant of the North St. Paul Table Company on Oct. 3 by fire, which destroyed the building used as a warehouse for the finished product and for oiling and finishing. The factory building itself was saved, and the loss on the other section of the works is covered by insurance. The plant is owned by John Joseph and Frank Luger, who have operated it for the past twenty years.

Minneapolis building permits for September showed a temporary falling off. They came to an estimated value of \$711,525. Last year in September they were valued at \$797,225. The total for the nine months is still half a million larger than last year. St. Paul is also running stronger than last year, and the September total was one of the best of the year, \$887,021, against \$482,180 last year.

A. F. Hein of the John Hein Lumber Company, Tony, Wis., one of the leading hardwood producers of this section, was a business visitor in Minneapolis this week.

H. Boorem of the firm of Halsted & Boorem, hardwood wholesalers, with offices at St. Anthony Park, St. Paul, has gone to New York to take charge of an eastern office they have opened at 160 Broadway. The firm has developed such a large market for its stocks in eastern centers that it was deemed advisable for one of the partners to be near this trade and give it close attention. Mr. Halsted remains in charge of the main office here.

C. F. Osborne of Osborne & Clark, the local wholesalers, returned this week from a visit to the retail lumber yards of the company in Illinois.

A. E. Beebe of McMillan, Wis., secretary of the Wisconsin Hardwood Lumbermen's Association, has been honored with a nomination to the Wisconsin assembly. This action is a guarantee of election.

## Hardwood Market.

(By HARDWOOD RECORD Exclusive Market Reporters.)

### Chicago.

Hardwood affairs locally are in very good shape. While trade is fair there is no rushing demand. Prices are very well maintained, although there is some concession in price apparent owing to manipulated grades. This is notably true in oak, which wood is still in short supply. A good many jobbers have secured stocks enough at manufacturing centers to provide for a normal fall trade, while others are still scurrying for lumber. Poplar is in good call, very few dealers having any of this wood to offer. Northern hardwoods are in reasonable demand, with maple as perhaps the slowest seller of the list.

### Boston.

During the past two weeks there has been a slight improvement in the market for hardwoods.

This better feeling has not been confined to any one wood but is shared by all. A moderate export business is in progress, one of the large exporters stating that the demand is not quite as active as it was last month. Several lots of oak have been taken for export. The furniture manufacturers are all busy and in the market for good sized blocks of hardwoods. In many instances they ask for prompt shipment, showing that their stocks have been allowed to run down. Manufacturers of interior finish are all well filled up with orders and in some cases are obliged to work their plants at nights in order to get orders off when promised.

Quartered oak remains in rather quiet demand with prices steady, while the demand for plain oak is active. The inquiry for brown ash is of moderate proportions only. Maple flooring is in fair demand. Whitewood is very firmly

held in most instances at outside figures, and offerings of desirable grades are not large. Cypress is firm with the call moderate. No one is trying to increase his business by offering lumber at concessions. Dry stock is not plentiful. Mahogany is in fair call and firm.

#### New York.

The general tone of the local market for the past fortnight has shown improvement and reports throughout the district indicate a very fair volume of both present and prospective business, with prices well maintained. There is less complaint heard regarding concessions in prices and a forcing of the market than is usually the case. The yards are in possession of a very fair assortment of stock, but buying is active and good stock is rapidly snapped up. All reports received from those who have made recent visits to producing points are along the same lines, namely, a scarcity of good, well manufactured hardwoods in shipping condition. In the manufacturing fields a large percentage of the mills are behind on their orders and those having any accumulation of stocks have all sold out weeks ago, with the result that those wholesale houses having at the present time any amount of good hardwood stocks in hand realize their value and are holding out for the best price possible. The hardwood situation is certainly in very fair shape as regards this part of the country.

The stocks enjoying the most activity at this writing are ash, birch, chestnut, poplar and plain oak. Stocks are only in nominal supply and prices are very firm. Quartered oak, while showing some improvement over its midsummer condition is still not up to the mark, although prices are tending to more firmness. Maple seems to be more plentiful than demand and prices are a little off. Red gum is moving in larger quantities right along, and cottonwood is also active in this part of the country. Beech is enjoying a good run particularly in thick stock for temporary planking or construction work. The rise which this latter wood had had in popular favor is really remarkable.

#### Philadelphia.

As the fall season advances, a decided improvement is noted in the general market. Yards which have been somewhat backward are beginning to buy more actively. Good hardwoods are in demand, with prices stiff and climbing upwards. Prices are better on all but red cherry, birch and ash, while quartered oak has been slightly lowered. Chestnut and number one oak are somewhat scarce, while plain oak is more plentiful. Gratifying reports are coming in from the eastern Pennsylvania furniture factories, which are all busy and buying more freely; conditions in this line having consequently a bright outlook. As was feared, the shortage of cars is already being felt here, shippers receiving but one-half their allotment, and being anxious to get out back orders. In the Pennsylvania district a great many cars were leased to the coal mining companies until October 1, and after this date the tension should be relieved. It is, however, up to the railroad companies, who are allowing loaded cars to remain standing in yards, with no certainty as to when they will be moved.

The terrific gales passing along the southern coast during the last few weeks, wrecking some of the mills located upon the coast line and sinking lumber vessels, have given rise to new, unexpected, and unavoidable conditions. No general report has been received as yet as to the extent of damage, but local lumbermen interested in mills exposed to coast storms, have become uneasy and await anxiously definite tidings, which they fear will prove detrimental to speedy shipments. Building operations are active, and a better grade of hardwood finishings is used than has been the case for some years. Though September shows a decrease in the value of building permits of \$198,965, compared with

the same month of 1905, the Bureau of Building Inspection reports that the last nine months show an increase of over \$2,000,000 over the corresponding period of last year.

#### Baltimore.

No decided change has taken place in the hardwood situation. All the leading woods continue in good demand, while the range of values is very satisfactory. Heavy rains in many of the hardwood producing states have interfered materially with the operation of mills, so that the output has not exceeded moderate figures, while the requirements of the trade have been unabated. This has served to keep the market in fine shape and has contributed not a little to keeping up prices. The large needs of the railroads and other heavy consumers have done the rest. Some lumbermen maintain that values are quite certain to ease off in consequence of an accumulation of stocks, but the great majority incline to the view that the quotations will be sustained and that even an advance is not among the improbabilities. During recent weeks the feeling has been a shade easier, though no decided decline in prices has taken place. In some directions an advance is to be noted, such being the case with poplar. It was possible during the summer to buy mill cuts for \$19 or thereabouts per 1,000 feet, but lately the holders of stocks have received as high as \$21 and \$22. Furniture manufacturers and other users of hardwoods are in the market buying with comparative freedom, and the outlook is very promising.

Oak is moving freely. Nearly all the mills have plenty of orders on hand, and the tendency in values is upward. Stocks in the hands of local dealers suffice to meet current wants, but no great surplussage is reported and the receipts are not gaining on the distribution. Ash is a strong second to oak, being in urgent request and bringing remunerative returns. Chestnut and other woods are likewise buoyant, the movement keeping up with the production. The export business is without any special features. Quiet continues to prevail as to oak and some of the other woods, while poplar is being shipped in fairly large quantities, though at prices that are relatively lower than those in the domestic market. Walnut is still in active demand at home as well as abroad, the revival in the use of this wood among American consumers having so far shown no abatement.

#### Pittsburg.

As the fall market opens Pittsburg hardwood men see further indications of a brisk business ahead for the coming year.

Since September 15 the most noticeable improvement in market conditions has been the inquiry from manufacturers. Every hardwood firm in the city reports a better trade, larger orders from the furniture, handle, spoke, carriage, wagon and implement factories throughout the Central West as well as in the Eastern cities. In the Pittsburg district the glass factories whose fires started September 1, are also active buyers chiefly of box and crating stuff. The trade in heavy timbers and ties has not fallen off to any appreciable extent, but it has been sidetracked temporarily by the more urgent business from the factories.

Prices are firm throughout the list. Oak continues to be the favorite seller and all grades with the possible exception of No. 2 common are in first class demand. Chestnut is showing up better on the books and judging from inquiry spruce and poplar are going to be big sellers this month. Among the minor hardwoods there is noted, a scarcity of hickory and a conspicuous increase in inquiry for ash and basswood.

#### Buffalo.

Hardwood lumbermen are very busy this fall and will be until there is some change in the state of general business to shut off the demand.

There is very little trouble with prices, for they have not changed much of late and do not promise to change much right away. It is all a question of how to get a supply of stock.

There are some special drawbacks just now. Dealers with southern interests are afraid that the late storms there will cut down the supply of oak and possibly of some other hardwoods, at least for a while. At the same time they are speculating over the chances of lumber being plentiful and perhaps lower when the forests that have been thrown down by the late hurricane are worked into lumber to save them.

Another difficulty is the scarcity of men and cars. It is almost impossible to get the men needed to keep the yard business in shape and the cars are growing more and more uncertain.

The dealer who can get his lumber in by lake is very fortunate. He may have to pay a good freight, for lake rates are going up, but the cargoes come in promptly when loaded and they turn out stock fast. Shipments from Canada are also pretty prompt, as compared with other directions. The supply of birch comes from that direction as well as others, but not much else now in hardwoods.

Poplar is scarce, but may be helped by the southern rains. Basswood is doing better, but elm remains quiet.

#### Saginaw Valley.

No fluctuations of note are recorded in the hardwood list. Beech and birch are in greater demand and a little firmer in price. Maple is steady and basswood is doing very well. Elm is in fair call. There is enough stock coming forward to take care of the demand and not much complaint is being heard as to trade in hardwood, which is generally regarded as healthy. The great handicap just now that confronts the trade is the famine in cars. It is impossible for shippers to get even one-third of the cars wanted.

#### Asheville.

Trade conditions in western North Carolina continue to improve and the lumbermen in this section are looking forward to another prosperous season. Business shows marked improvement but dealers in this city and on the Murphy branch of the Southern Railway are hard put for cars, and many shipments are in arrears. The Asheville Lumber Exchange has taken up in serious manner the question of car supply, and is making efforts toward a solution of the problem. A meeting of the exchange was held late in September, when reports of committees were presented and accepted and resolutions concerning the situation passed. Just what action was taken relative to the car supply question has not been made public. The officials of the exchange deem it wise to withhold this information until definite action is taken.

The failure of the railway company to give adequate car service in this territory has been a source of continual annoyance this year. It is a fact that the lumber business in western North Carolina has grown beyond even the expectations of the lumbermen and the railroad officials. While this is true lumbermen take the position that three years is a sufficient length of time to enable the railroad company to place its shipping facilities on a par with the requirements of the traffic and believe that the time has come when it is expedient to force the railroad to provide better service. Lumbermen say that it is impossible to secure a regular and dependable supply of cars. When they ask for 125 or 150 cars they are given 25. Though they have complained bitterly for a long time that they have been given no relief or even promise of relief. Under the present conditions it is not unusual for loaded cars of lumber filled and ready for shipment to remain on the sidetracks unmoved for days. In many instances more than a week's time has been lost in this manner. The lumbermen of this section of the state have become tired of the

many inconveniences and loss of prestige and trade caused by the poor service granted them by the Southern railway and are preparing to act now in a concerted manner.

#### Bristol, Va.-Tenn.

The lumbermen in this section are generally pleased with trade conditions and entertain a rosy view of the prospects for winter business. Demand is holding up and prices are firm. The bad weather has not set in as yet and the country mills are busy getting their stock to the railroads before the heavy fall rains make the roads impassable.

The car supply is by no means what it should be and, while it has not yet assumed a serious aspect, it is feared that business generally will be handicapped by the usual car famine this fall and winter. The Southern Railway is doing everything possible to relieve the situation and an order for 4,000 cars was placed some months ago in contemplation of a shortage this fall. The shortage on the Norfolk & Western and Virginia & Southwestern is causing much delay.

#### Cincinnati.

Lumbermen who have been indulging in vacations have returned and fall business is on in earnest. Inquiries are being received from big consumers and many heavy orders will be placed before the end of the month, according to indications. Weather conditions continue favorable and building operations are going on uninteruptedly. Nearly all firms are carrying fair-sized stocks at this time and it is probable that many logs will be received before the end of September.

Prices have been firm in all directions during the past fortnight and plain oak has continued the best seller, and quartered oak has not dragged by any means. Ash and chestnut are moving well. Red gum has met with brisk inquiry. In fact, all the hardwoods have maintained excellent positions.

#### Nashville.

After a rainy spell of almost unprecedented duration renewed activity prevails in all directions. There has never been any dearth of orders and all the dealers have their books full, but the delay in shipments will cause considerable trouble. Little change is noted in the market. Plain white oak is bringing good prices and is in most excellent demand, with quartered white oak commanding higher prices than has been the case recently. Quartered red oak is moving well and there is a noticeable demand for all low grades of oak, the furniture dealers taking readily all they can get. Poplar is both scarce and high, and there is plenty of demand for it. It is hard to get it in all thicknesses, and what there is of it in the Nashville market is in the hands of comparatively few people. Some ash has been coming down the river on the recent tide and the local supply is said to be larger than usual, which, however, does not make it large at that, as ash is always high and scarce in this market and in great demand.

#### Memphis.

There is a very satisfactory demand for southern hardwoods, and the market is firm with a higher tendency to prices following the interruption of logging due to the recent heavy rainfall throughout the Mississippi valley. The scarcity of available stock, both actual and prospective, gives the real strength to the market, and promises to remain a feature for at least the next six months. The export demand is reported to be somewhat slow, but there is a good call from domestic sources. Yard stocks here are much broken and receipts within the next few weeks will be very light. The interruption to milling and logging operations here is bad enough in its effect on the market, but the situation is further complicated by the knowledge that there has been remarkably heavy precipitation throughout the Ohio river valley and well

down into the Virginias. A shortage of lumber has been apparent for some time but it is now conceded on almost every hand that it will be more pronounced than at first anticipated.

There is no difficulty in selling plain oak in any grade or thickness at excellent prices. The demand is active, while offerings are comparatively light. There is no large demand for quarter-sawn oak, but there is some improvement noted in the call for quartered white in both the higher and lower grades. Quarter-sawn red is dull and rather neglected, but there is no great quantity of this available.

Ash is a very ready seller in all grades and thicknesses and is commanding fancy prices. This lumber is particularly scarce. Cypress sells with ease at well maintained figures. There is no great amount of it to be had. All grades are in request.

Cottonwood shows an upward tendency. Stocks are light, while there is an excellent demand. Prices are being advanced by most manufacturers, and they are hardly able to supply the demand. The cottonwood mills are now nearly all closed down on account of the rainfall. The demand is good for all grades, but, if anything, the lower are relatively stronger than the higher because of the phenomenally large demand for box material. There are very few box boards to be had and prices on these have reached a pretty high level.

The gum situation is very healthy. The demand for the upper grades as well as for the lower is splendid, though there is apparently little interest manifested in clear saps. Low-grade stock is gradually gaining ground, owing to the increasing consumption of this class of material in box factories and the whole gum list is being sustained by the fact that new uses are being found almost every day for this lumber which was once regarded as almost worthless from a commercial standpoint. There is very little poplar for sale here and the demand for the limited offerings is quite satisfactory. Prices are well maintained.

#### New Orleans.

There is little change to note in the condition of the hardwood market during the last fortnight. The interior demand is still active, exports have improved a very little and prices are good. Many of the mills are busy cutting timber, and stocks are being increased.

#### Louisville.

The call for hardwood in this territory continues unabated. The main source of worry for the manufacturers comes from unsatisfactory weather conditions. Rains continue to interfere with operations in the woods and make hauling very difficult among the country mills. Some of the river mills here have a supply of logs on hand, but others are sawed out and are waiting for a tide up in the mountain streams to get another supply started. General market conditions are unchanged, with more buyers in sight than sellers for practically everything on the hardwood list. The most plentiful items are in quarter-sawn lumber and quarter-sawn veneer. Manufacturers do not manifest any special anxiety to dispose of these items unless they can do so at good prices. This is especially true of veneer, where the cost of quartered ditches is so extremely high that it makes the veneer man's margin rather close, unless he can get a pretty stiff price for his stock. The nature of the poplar market is too well known generally to require further comment at the present time. The plain oak market is in good shape, and the demand for railway stock is very active both in the domestic and in the foreign trade.

#### Minneapolis.

The only weak spot to be detected in the market is in birch. There is a good demand, larger probably than last year, but the supply has been heavier and has come from a wider territory. It is believed by well posted hard-

wood men that dry birch will all be needed before the next spring cut is available, and it birch stocks were all in strong hands prices would be maintained. A canvass of the mills shows that there is not much stock unsold, but the trouble is that a good deal has been bought or contracted for by small jobbers who are in a hurry to make sales, and are eager to close out at small margin. All other stocks are strong, and are being picked up rapidly by the factory trade. Basswood is firmer than in years, and advances in price are noted. Culls are a dollar higher than in the summer, and sell readily. The upper grades are also somewhat higher in price. The closest search of Wisconsin fails to reveal any unsold stocks of either red or white oak in large quantities. Black ash is off the market and customers have orders placed with every jobber, asking for a chance at the first stock that may turn up. Rock elm is also cleaned up by the implement factories. Maple is in fair supply and is moving briskly. The factory trade is better now than that from the country yards, but the country trade when it buys is anxious for quick delivery. Shortage of cars is holding back shipment, and is making it hard to get stock out of the mills in small towns.

#### Liverpool.

Mahogany sales were held on the 27th and 28th ult., and despite all the "bullish" talk of merchants and auctioneers here that the prices were going higher they barely held their own.

Good advice to American buyers would be to cover themselves for immediate wants, and buying at present prices until the end of the year is undoubtedly advisable. With the turn of the year prices will doubtless take a downward course.

All hardwoods are firm. Oak is in as strong demand as ever and commands very high prices, but large quantities remain to be delivered on contract, and until these deliveries are made few orders can be expected.

Rock elm is in active call and large orders could be obtained for dimension stock; also for logs.

Birch is firmer and will be back at its old price before the month is out.

Maple logs, after being slow for some time, are now in active demand again. This is a trade in itself, and shippers should be careful not to ship logs until they are certain as to what this market requires both as regards quality and size. Maple manufactured boards are firm in price and some large lines have recently been placed.

#### London.

The demand shows slight improvement and accumulated stocks are becoming light at the docks, as most of the goods arriving are going direct to the consumers, and buyers are becoming more inclined to pay the advancing prices asked by shippers.

There is a good demand for plain oak boards and planks in No. 1 common, but low priced goods are neglected. Shipments are light in walnut, but prices are firm, and there is more call for this wood.

There is fair business in whitewood passing for prime dressed stocks and the market is now bare of planks, but no shipments should be made unless previously sold. Culls are in good demand at high prices, but there is not much of this stock arriving. Satin walnut in all grades is in good demand at fair prices.

Mahogany prices are well maintained and stocks are light.

Robert M. Turner has commenced business as a timber importer and agent on his own account under the name of R. M. Turner & Co., and intends to make a specialty of teak and American hardwoods. Mr. Turner is well known in the timber trade of Great Britain and fitted through long experience to conduct his new business successfully.

# AT COST

IS AN UNCOMMON TERM AS APPLIED TO INSURANCE

But this is the actual price of Indemnity against Fire Loss furnished by the

## Manufacturing Lumbermen's Underwriters

THE STRONGEST INSURANCE ORGANIZATION  
TO-DAY IN AMERICA

The saving is not on a small portion of your insurance but on the entire line. There are other advantages equally interesting.



Only well built plants with adequate protection and at least five years timber supply are considered eligible.

FOR LIST OF MEMBERS AND FURTHER INFORMATION, ADDRESS

**HARRY RANKIN & CO.      Kansas City, Mo.**

# Wanted and For Sale -SECTION-

Advertisements will be inserted in this section at the following rates:

For one insertion ..... 20 cents a line  
For two insertions ..... 35 cents a line  
For three insertions ..... 50 cents a line  
For four insertions ..... 60 cents a line

Eight words of ordinary length make one line. Heading counts as two lines. No display except the headings can be admitted.

Remittances to accompany the order. No extra charges for copies of paper containing the advertisement.

## EMPLOYES WANTED.

### SALESMAN WANTED.

A Bangup Hardwood Salesman, one acquainted with the mills in West Virginia, Kentucky and Tennessee. Good wages for good man. Answer fully.

W. M. GILLESPIE LUMBER CO.,  
Farmers' Bank Bldg., Pittsburg, Pa.

### LOGGING CONTRACT TO LET.

We have 150 million feet mixed hemlock, hardwood and pine timber in northern Wisconsin, to be logged at the rate of 12 to 15 million feet per year. Want land cleaned of all timber, including pulpwood, cedar posts, poles, etc. Work to commence fall of 1907. Party must be financially responsible and experienced in logging mixed timber by rail. Send references, stating whom you have logged for before. Address "LOGGING CONTRACT," care Hardwood Record.

## EMPLOYMENT WANTED

### WANTED—CONTRACT.

Of sawing with heavy portable mill.  
A. L. BUCHER, Morenci, Mich.

## LUMBER WANTED

### YELLOW PINE POLE STOCK.

Wanted, from reliable mills in Florida, Georgia, Alabama, Louisiana and Texas, No. 1 pole stock, clear and straight grain quality for prompt cash.  
AMERICAN LBR. & MFG. Co., Pittsburg, Pa.

### WANTED.

Basswood, 200,000 ft. 1" firsts and seconds, 7" and up wide. Hard Maple Axles, 4x5 and 4½x5½—6 ft.  
McCLURE LUMBER CO., Detroit, Mich.

### WANTED—HANDLE BILLETS.

Hickory for hammer, hatchet, ax, pick and sledge handles. Maple and hickory for miners' pick handles. White ash for shovel handles.  
THE PITTSBURG SHOVEL CO., Leechburg, Pa.

### WANTED.

White Oak logs and White or Gray Ash logs. Write for specifications.  
S. N. BROWN & CO., Dayton, Ohio.

### WANTED—DIMENSION HICKORY.

Hickory Pole and Shaft Strips. Also good man to travel, buying and inspecting same.  
TOLEDO CARRIAGE WOODWORK CO., Toledo, Ohio.

### WANTED—HARDWOOD LOGS.

200 M feet 28-inch and up White Oak logs.  
200 M feet 12-inch and up Walnut logs.  
50 M ft. 12-inch and up Cherry logs.  
C. L. WILLEY,  
Blue Island Av. and Robey St., Chicago.

### OAK.

We are in the market for plain sawed oak, all grades and thicknesses.  
P. G. DODGE & CO., 2116 Lumber St., Chicago.

### OAK WANTED.

3 and 4 inch White Oak; also Mixed Oak; also 12x12 Timbers and Piling of all kinds.  
CONTINENTAL LUMBER CO.,  
1213 Monadnock Bldg., Chicago, Ill.

## TIMBER LANDS FOR SALE

### ALL TIMBER ON 12,800 ACRES

In Citrus county, Florida. On river, and six miles to railroad. Experts estimate fifteen million feet Cypress; twenty million Pine. Tract also contains Oak, Gum and Ash, not estimated. Twenty years for removal. For further particulars write

FINLEY & RALEY, Cheraw, S. C.

### FOR SALE.

10,500 acres Arkansas virgin oak timberland. Railroad runs through the property. Rare opportunity to purchase one of the best tracts of timber in the Southwest. Fine cotton land when cleared. Write us promptly, as we are going to sell.

WESTERN NATIONAL BANK, Louisville, Ky.

### FOR SALE.

3,550 acres of Georgia hardwood, estimated to cut as follows:  
8,500,000 feet White Oak.  
3,500,000 feet Hickory.  
5,500,000 feet Red Oak.  
1,750,000 feet White Ash.  
High grade stock suitable for wagon and carriage manufacture.  
3½ miles from railroad; river joins tract. Ten years to remove timber. Address "H. H.," care Hardwood Record.

## LUMBER FOR SALE.

### FOR SALE.

- 10 M ft. 1", 1st and 2nd Soft Elm.
  - 10 M ft. 2", 3" and 1" Hard Maple, Com. & Bet.
  - 10 M ft. 1" Hard Maple, Com. & Bet.
  - 20 M ft. 4/4, 5/4, 6/4, 5/4 1st & 2nd Red Oak.
  - 10 M ft. 1" 1st and 2nd Basswood.
  - 10 M ft. 1", 1st and 2nd White Oak.
  - 10 M ft. 2", 3" and 4" 1st and 2nd White Oak.
  - 10 M ft. 1", 2", 3", 4" Black & White Ash, 1st & 2nd.
  - 10 M ft. 1" Com. Quarter-sawed White Oak.
  - 10 M ft. 1" Common White Oak.
  - 5 M ft. 2", 3", 4" 1st & 2nd Hickory.
  - 10 M ft. 2½" and 3"x30" Wh. Oak squares.
- SMITH & RANDALL LUMBER CO.,  
Fort Wayne, Ind.

### ORDERS WANTED.

For short leaf pine and white oak car framing, bridge timbers, switch ties, etc. Mill in Miss. D. B. MURPHY & CO., London, Ky.

## BUSINESS OPPORTUNITIES

### HICKORY.

If you want a good location for a Hickory mill write us for further information.  
STONEMAN-PEARSON LUMBER CO.,  
203 Frisco Bldg., St. Louis, Mo.

### HARDWOOD TIMBER.

A number of good mill propositions along the Cotton Belt Route. Tracts ranging from five hundred to twenty thousand acres, principally Oak, Hickory, Gum, Cypress, some Ash, Cottonwood and other hardwoods. Can be secured at very reasonable figures now—in some cases at less than \$1 per thousand stumpage. Choice openings for hardwood lumber mills, handle and spoke factories, slack cooperative plants and other hardwood enterprises.

A number of points on the Cotton Belt offer free sites or will raise cash bonus or take stock in practical propositions. Let us have your wants and see what we can do for you.

E. W. LA BEAUME, G. P. & T. A.,  
COTTON BELT, St. Louis, Mo.

### WANTED.

Party with small capital to take an active interest in well established handle and lumber business. Entire output sold for four years. For further information write or call on

H. F. CLARKE, Okolona, Miss.

## MACHINERY FOR SALE

### A SNAP IN 2D HAND MACHINERY.

One Stearns Saw Husk and Mandrel, with Top Saw, two 40" Top Saws, one 56" Circular Saw, two 62" Circular Saws, Automatic Grind er, Emery Wheel, Saw Swage, Hammering Anvil and Hammer. Within 100 miles of Memphis. Will sell for cash or exchange for lumber.  
BACON LUMBER CO., Grand Rapids, Mich.

### VENEER MACHINERY FOR SALE.

Owing to changes being made in our Veneer Mill, we offer for sale—

- One 50"x61" Coe Veneer Machine.
- One 61" Power Feed Clipper.
- One 60" Giant Wringer.

The above are practically new and in first-class condition and to dispose of them promptly that the space can be utilized, we will sell at a substantial sacrifice. For further particulars address "VENEER MACHINERY,"

Care Hardwood Record.

### FOR SALE.

Six foot Band Mill, steam feed, entire plant complete with equipment, filing machinery, saws, rip saws, etc. Plant can be conveniently seen now in running condition. Address "RAND MILL," care Hardwood Record.

THERE IS NO BETTER WAY

BETWEEN

**CHICAGO  
INDIANAPOLIS  
AND  
CINCINNATI**

THAN THE

**Monon Route**

**4 TRAINS A DAY 4**

Standard and Compartment Sleepers on Night Trains. Parlor and Dining Cars on Day Train.

CHAS. H. ROCKWELL, FRANK J. REED,  
Traffic Manager, Gen. Pass. Agent,  
CHICAGO

Advertisers' Directory

Table with multiple columns listing various lumber and hardware companies, categorized by sections such as POPLAR, LUMBER INSURANCE, SAWS, KNIVES AND SUPPLIES, MISCELLANEOUS, SOUTHERN HARDWOODS, and NORTHERN HARDWOODS. Each entry includes a company name and a corresponding number.

A Porch Column "Snap"

In the manufacture of our high-grade veneers, we produce two cars monthly of clear, solid heart, bored Poplar Posts, 8 and 10 inches in diameter, 66 to 96 inches long.

On this product we will make a price that will appeal to every manufacturer of porch columns.

CHICAGO VENEER COMPANY, Inc.

BURNSIDE, KENTUCKY



# HARDWOOD TIMBER

There is no section with so fine and large a supply of hardwood timbers of various kinds left for the lumbermen as that portion of the South in Alabama, Georgia, Kentucky, Mississippi, North Carolina, South Carolina, Tennessee and Virginia served by the lines of the

Southern Railway  
and  
Mobile & Ohio Railroad

There are oak, poplar, hickory, gum, cypress, ash, elm, buckeye, balsam, spruce, chestnut, and other varieties. There are also available pine lands.

These timber resources and many other important features bearing on the cost of manufacture and marketing give special advantages and opportunities for EVERY KIND of WOOD USING INDUSTRY. We have information about the best locations in the country at towns in these States and in Southern Indiana and Southern Illinois, which will be given if requested. All correspondence in regard to timber lands or factory locations will be given prompt and confidential attention. Address your nearest agent

M. V. RICHARDS,  
Land and Industrial Agent,  
Washington, D. C.  
CHAS. S. CHASE, Agent,  
622 Chemical Building,  
St. Louis, Mo.

## Locations for Industries

ON  
THE ERIE, THE COMMERCIAL RAILROAD  
CHICAGO TO NEW YORK

The Erie Railroad System's Industrial Department has all the territory traversed by the railroad districted in relation to resources, markets and advantages for manufacturing, can advise with manufacturers of specific products as to suitable locations, and furnish them with current information of a comprehensive nature dealing with the project in its full relation to manufacture and commerce.

The Erie is one of the greatest of trunk lines. Its own rails connect the two largest cities of America. Every section of the System has its particular merits. Profitable locations exist. It has great general and coal, oil and natural gas resources.

It is important in this age of modern facilities for manufacturers to locate where they can obtain side tracks so as to receive from and ship directly into cars at the factory. Information can be promptly furnished in this connection about every point on the system between New York and Chicago.

Manufacturers' inquiries as to locations are treated in strict confidence and absolutely reliable information, so as to promote permanent traffic, is furnished. Address

**LUIS JACKSON**  
Industrial Commissioner  
Erie Railroad Company  
11 Broadway, New York



**WALNUT,  
OAK,  
ASH,  
POPLAR.**

### NOVELTIES FOR ADVERTISERS

FOBS, POCKET PIECES  
BUTTONS,  
LETTER OPENERS,  
SCARF PINS, TRAYS,  
ALUMINUM GOODS,  
PAPER WEIGHTS.



**ALL NEW IDEAS.**  
Send us 50c. and we will send you a Beautiful Watch Fob  
S. D. CHILDS & CO.  
200 CLARK ST. CHICAGO.

You want to reach Buyers of

## FURNITURE LUMBER

The **HARDWOOD RECORD**

will do it for you.

## MANUFACTURERS

Contemplating establishing plants  
in the West should take advantage  
of a location on



**Chicago & North-Western Ry.**

which reaches the famous

**WATER POWERS,  
COAL FIELDS,  
IRON ORE RANGES,  
HARD AND SOFT  
LUMBER DISTRICTS,  
MINING DISTRICTS**

of the West and Northwest, and  
affords the best means of transportation to the markets of the world.

FOR FURTHER PARTICULARS APPLY TO  
**MARVIN HUGHITT, Jr.,** E. O. BRIGHAM,  
Freight Traffic Manager, Gen'l Freight Agent,

**GEO. BONNELL,**  
Industrial Agent,

NW513

CHICAGO.

## Do You Need Maple Flooring?

Then send us your order and you will receive a product that is not excelled. We manufacture by

### A Special Process

This costs us more, but our prices are as low as of any other first-class manufacturer. We also have a stock of firsts and seconds Maple 1-4, 5-4, 6-4, 8-1 and 10-4, which is bone dry and very fine.

## Haak Lumber Co.

Haakwood, Michigan

You read this==others will, too. They would read your ad. Try it.

## Save Your Money

By Using the

## RED BOOK

Published Semi-Annually  
in January and July

It contains a carefully prepared list of the buyers of lumber in car lots, both among the dealers and manufacturers.

The book indicates their financial standing and manner of meeting obligations. Covers the UNITED STATES and MANTOBA.

The trade recognizes this book as the authority on the lines it covers.

A well organized Collection Department is also operated and the same is open to you.

WRITE FOR TERMS.

## Lumbermen's Credit Association

ESTABLISHED 1878

1405 Great Northern Building, CHICAGO  
16 Beaver Street, NEW YORK CITY

MENTION THIS PAPER

# "DEFIANCE" WOOD-WORKING MACHINERY

COMPLETE EQUIPMENTS OF  
HIGH GRADE TOOLS

✻ FOR MAKING ✻

Hubs, Spokes, Wheels,  
Wagons, Carriages,  
Rims, Shafts, Poles,  
Neck-Yokes,

Single Trees, Hoops,  
Handles, Bobbins, Spools,  
Insulator Pins and  
Oval Wood Dishes.

INVENTED AND BUILT BY

The **DEFIANCE MACHINE WORKS**  
DEFIANCE, OHIO.

— Send for 500 Page Catalogue —

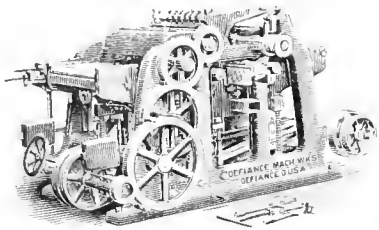

**26" DOUBLE SURFACE PLANER.**  
Planes 26" wide x 12" deep.  
Has Cut Gears throughout.  
Has Sectional Feed Roll and 12" Ring  
Oiling Bearings.

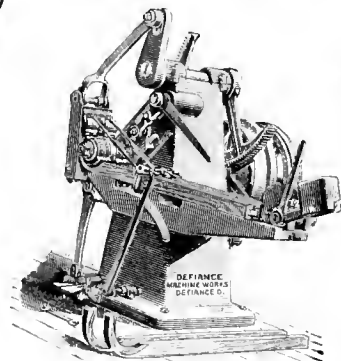

PATENT PLOW HANDLE BENDER.

## The Shimer Cutter Head Expansion

Is a Mechanism of Beauty, Completeness and Accuracy, registering  
by stops and figures and automatically locking the  
head sections at every stop.



You turn the adjusting nut encircling the hub to the right to enlarge, or to the left to reduce, the tongue and groove thicknesses. The Reliable Expansion Device is not only a desirable feature in The Shimer Cutter Head, but it is also a great convenience and time saver. It takes you away from the practice of putting washers under the Bits for making the tongue and groove variations. It permits of greater accuracy in the adjustments than can possibly be obtained by means of washers. All this for a song—only \$2.00 extra for each head. Can you afford to do without it? Full information given in our Catalogue.

ADDRESS

**SAMUEL J. SHIMER & SONS, Milton, Pa.**

## New Type of Combined End Matcher

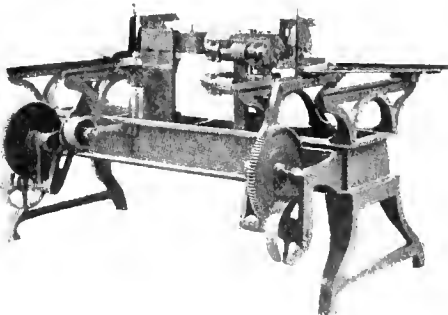

SAVES 20 PER CENT. TIME, COST AND LABOR.  
USED BY THE LARGEST FLOORING CONCERNS.

Write for particulars to

**A. J. SCHINDLER, 441-443 W. 21st Street, CHICAGO**

## Improved Automatic Band Saw Sharpener

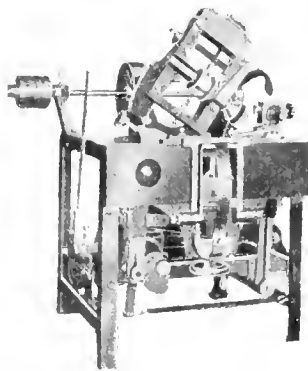

All  
Machines  
Fully  
Guaranteed

- ☞ This machine excels all others for single cutting Band Saws from 8 to 14 inches. Its construction is mechanically correct, simple and durable, and does not possess any of the intricate complicated parts that confuse the operator. The head is adjustable so that straight wheels can be used with the same results as concave.
- ☞ This represents just one type of machine. We make in addition a complete line of modern tools for the care of saws. For particulars address

**MATTESON MFG. CO., 120-128 S. Clinton St. CHICAGO, ILLS.**

IF YOU ARE INTERESTED IN

# APPALACHIAN TIMBER

---

---

VIRGIN POPLAR, OAK, CHEST-  
NUT AND OTHER HARDWOODS

---

---

In boundaries of from 10,000 to 50,000 acres, either for investment or operation, would be pleased to have you consult us. A few tracts of Pacific Coast Fir, Pine, Cedar and Spruce for Sale.

## James D. Lacey & Co.

James D. Lacey    Wood Beal    Victor Thrane

608 Hennen Bldg., NEW ORLEANS

507 Lumber Exchange, SEATTLE

1200 Old Colony Building, CHICAGO

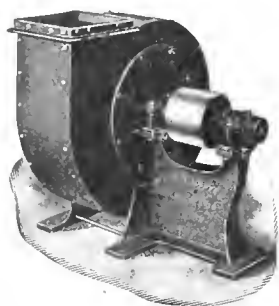

FACTORY:  
BUCYRUS, OHIO

**Power  
Money**



**Saved  
Saved**

Heating, Vent-lating, Mechanical Draft,  
Shavings and Conveying

**FANS AND EXHAUSTERS**

of every description.

**New York Blower Company**

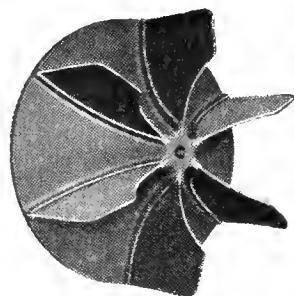

CHICAGO OFFICE:  
25th Place and Stewart Avenue

**A machine that declares saw mill dividends**



AUTOMATIC SWING SAW GAUGE

☐ An inexpensive little device that *saves a dollar a day* and upwards.

☐ Stops one of the biggest profit leaks at the mill. Pays for itself several times over during a year.

☐ Isn't it worth investigating?

**FRANCIS MARSHALL, - - Grand Rapids, Mich.**

**M E R S H O N**

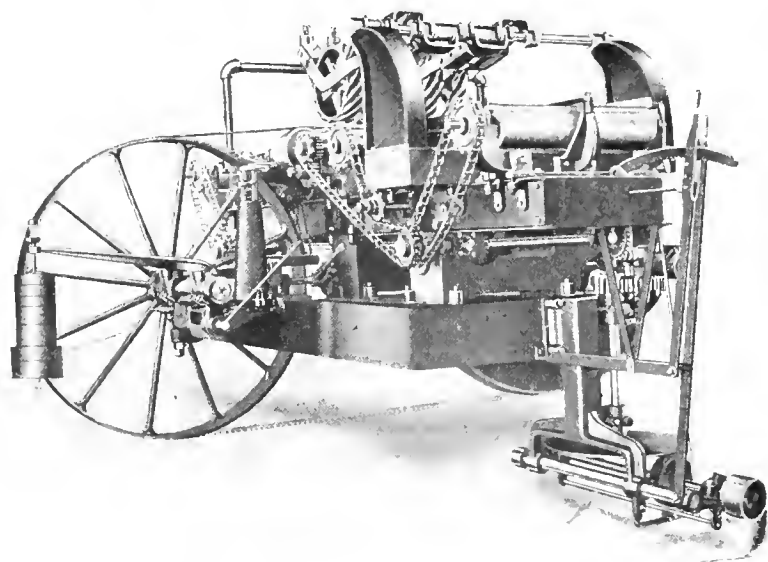

MERSON NEW HORIZONTAL (BAND) RESAW FOR SAW MILLS

Band Resawing  
Machinery  
for all requirements

**WM. B. MERSON  
& CO.,**

**Saginaw, = Michigan**

ALLIS-CHALMERS COMPANY, Seattle, Wash., Agents for Northern Pacific Territory.

THE EBY MACHINERY CO., San Francisco, Cal., Agents for California and Nevada.

# American Improved 4-Sided Moulders

8 in., 9 in., 10 in. and 12 in. machines.

## A Houston!

Known, used and praised for over 33 years.

The 8' and 9' machines differ slightly from cut

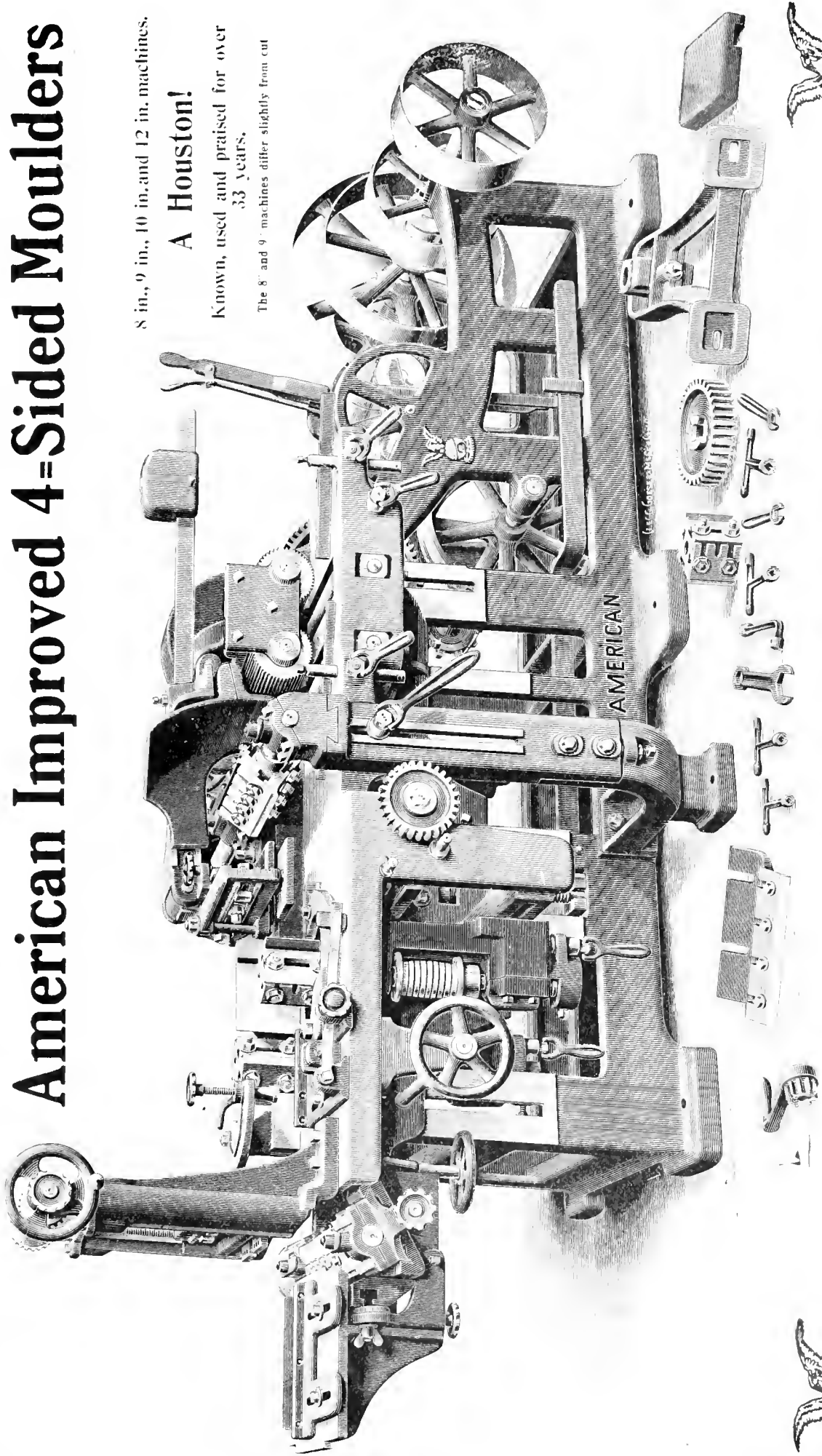

# American Wood Working Machinery Company

New Orleans      Chicago      New York

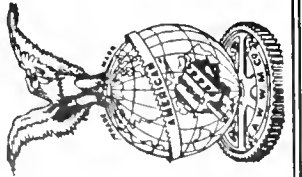
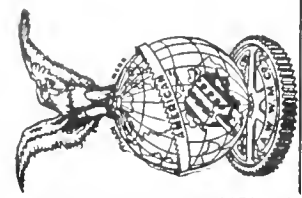

We Guarantee  
to  
**KILN DRY OAK**

IN A WEEK  
by the application of a  
new scientific principle

IN YOUR PRESENT  
**Old Kilns**

Grand Rapids Veneer Works  
DEPT. ID., GRAND RAPIDS, MICH.

**Hanchett - Hanchett - Hanchett**

**Hanchett  
Saw Swage**

Every one made Perfect  
**The Swage with a Name**

¶ A poor Swage Ruins a Good Saw, and for that reason the manufacturers of the  
**HANCHETT ADJUSTABLE SWAGE**  
employ only the Best Mechanics and use only the Best Material in their construction.

**It Pays Us** Send for **It Pays You**  
**to make** Catalog **to use**  
**The Best** No. 10 **The Best**  
It tells you all about them

MANUFACTURED BY  
**Hanchett Swage Works**  
Big Rapids, Michigan

**Hanchett - Hanchett - Hanchett**

**SAWS**

I tell you, Mr. Mill Man, there is merit in these saws. Dependable stuff that is made right, will work right, and last the life of good saw material.

**CHAMPION SAW CO.**  
BEAVER FALLS, PA.

**®** **\$\$ The Pocketbook Test \$\$**

The average man who buys largely, buys carefully. Manufacturers who have expended \$4,000.00 to \$5,000.00 each on Gillette Roller Bearing Lumber Carts know why they did it. So do we. They are the highest running, longest lasting carts made. Likewise they are marketed at honest, money-saving prices.



INVEST in Gillette Carts—Don't WASTE money on others. What's your address?

**The Gillette Roller Bearing Co.**  
Patentees and Sole  
Manufacturers  
**Grand Rapids, Michigan**

**®**





## The Coe Knife Grinder

was designed for the finest grinding and most exacting service. It is built on new lines and has completely overcome the objections to other grinders. The knife is held rigidly while the stone travels back and forth. There is no chance for

vibration, consequently no unevenly ground knives. Entirely automatic in ac-

tion, no ropes or chains. All moving parts operated by cut steel gears, noiseless in operation, will grind straight or hollow bevel. Feeds 1-1000 to 4-1000 for each travel of the stone, very heavy and compact, occupying small floor space. Made in seven sizes to grind up to 168 in.

It is fully described in our catalog No. 5, which we will be glad to send to interested parties.



The Coe Manufacturing Co. <sup>105</sup> Bernard Street Painesville, O.

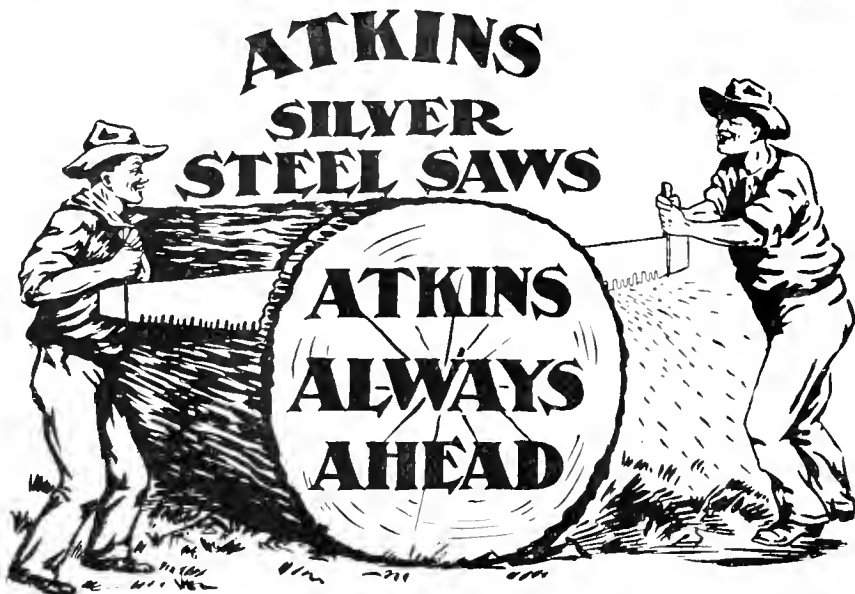

YOU DON'T KNOW HOW GOOD ATKINS' SILVER STEEL CROSS-CUT SAWS ARE UNTIL YOU TRY THEM. WHY DON'T YOU? ORDER TO-DAY YOU'LL BE DELIGHTED CAN'T LOSE MUCH PERHAPS YOU'LL SAVE THEIR COST MILLIONS HAVE. IT'S WORTH TRYING. WHY DON'T YOU DO IT?

## E. C. ATKINS & CO.

INCORPORATED

HOME OFFICE AND FACTORY: INDIANAPOLIS, INDIANA

BRANCHES CARRYING STOCK AT CHICAGO, ATLANTA, MEMPHIS, MINNEAPOLIS AND NEW ORLEANS  
ALSO NEW YORK, PORTLAND, SAN FRANCISCO, SEATTLE AND TORONTO.

The real "meat" in any production depends largely on the cost the method of producing and especially is this true in logging. The

## McGIFFERT Log Loader

gets out the most "meat" with the fewest "shells." Propelling itself, it rushes the work and reduces switching delays. Being very powerful yet simple to operate the average engineer soon becomes an expert and with few helpers can load as high as 100 to 150,000 feet in 8 hours, in fact 200,000 has been accomplished. Cut your cost-- (rather let a McGiffert do it) form your methods of handling logs is the real secret in a nut shell.

First send for booklet and look into this  
**CLYDE IRON WORKS**  
DULUTH, MINN.

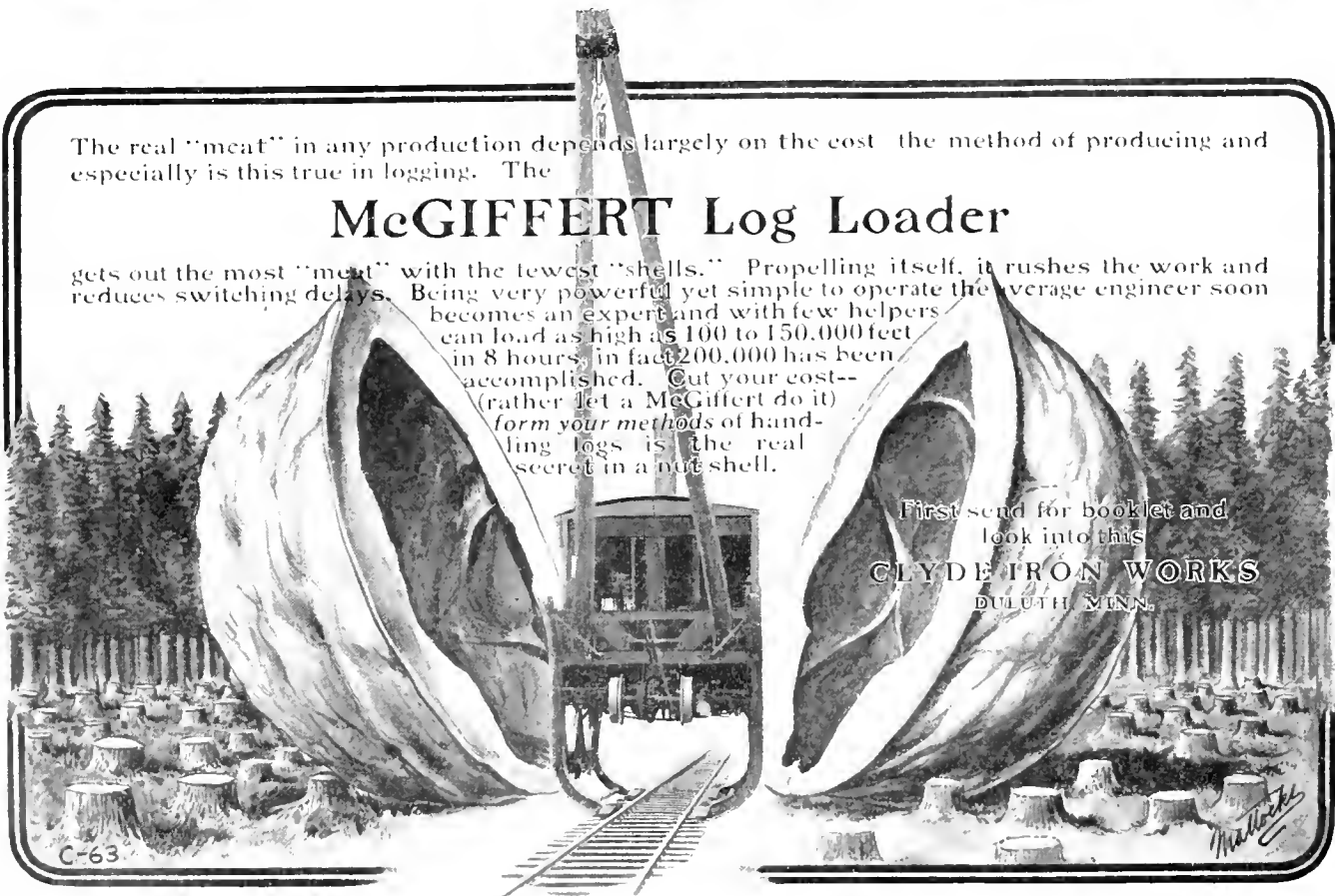

**SMITH of  
SMITHVILLE**

**The Profit Builder**

**SMITH of  
SMITHVILLE**

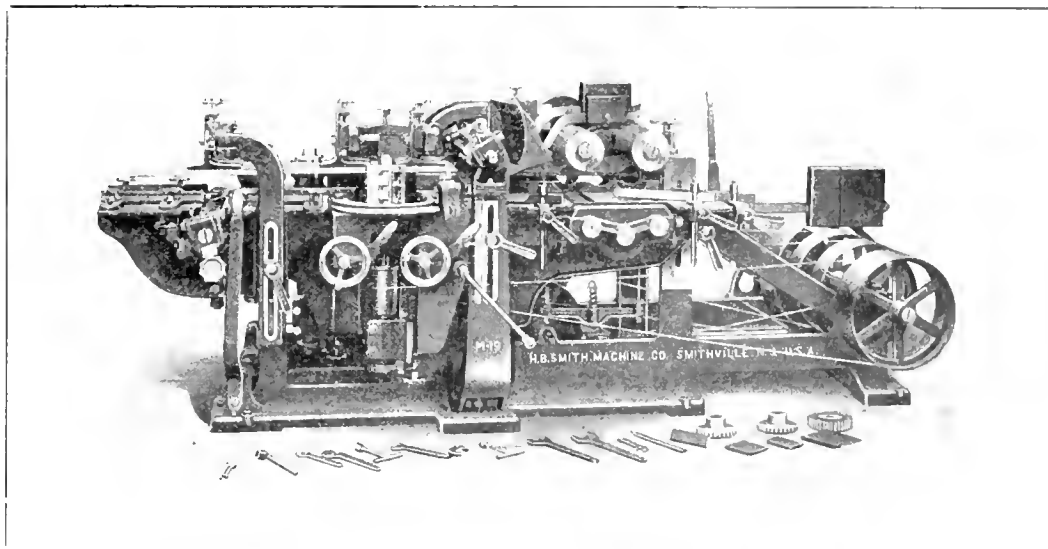

NO. 105-A, EXTRA HEAVY 12-INCH MOULDER



IT HAS been our purpose during the last half century to develop a line of wood working machines containing the best workmanship and material that American skill and wisdom can afford. This fact we are proud to say is well established in the minds of our many patrons. We have, however, now exceeded ourselves by the development of a remarkable Moulder, the excellence of which is due to our obtaining written suggestions from more than a thousand operators throughout America. This machine stands alone as being the composite idea of the thinking operators of this country. One year's test of its work has convinced us that it is impossible for you to compete successfully against the Smith Moulder with any other machine. Can't we send you prices and literature?

**Branches:**  
New York, Chicago,  
Boston

**H. B. SMITH MACHINE CO.**  
SMITHVILLE, N. J., U. S. A.

**Branches:**  
New York, Chicago,  
Boston

# Berlin No. 182

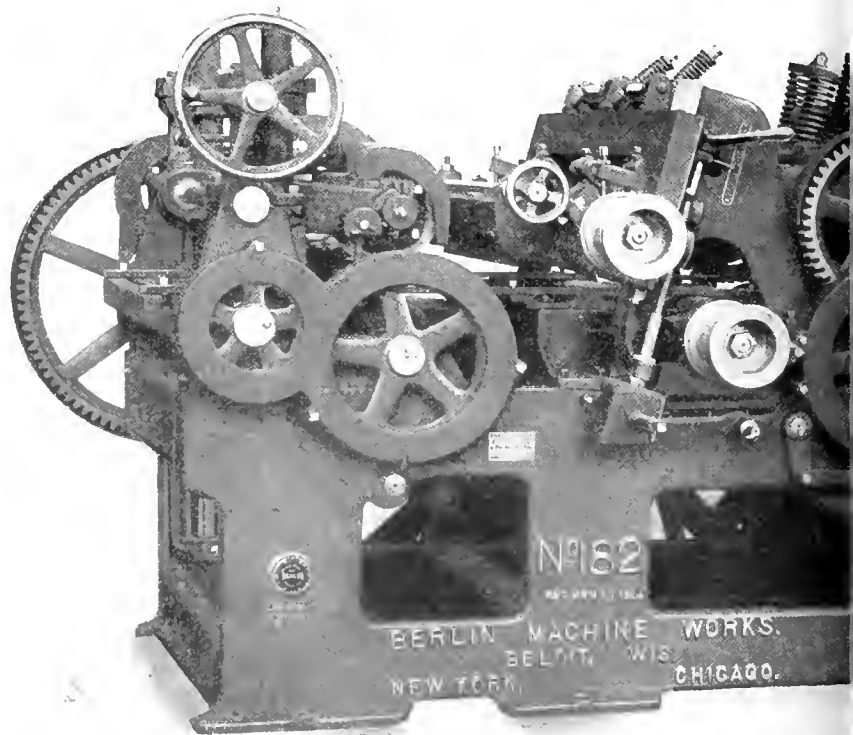

The most powerful Double Surfacer made!

That sounds like a pretty strong statement, but the machine backs it up with results.

To begin at the bottom — the frame is cast in one piece, like our No. 94 Matcher, which is one of the principal reasons why the working parts do their work so well.

They have a solid foundation, which prevents vibration and insures perfect alignment.

The feed works are similar in general construction to those used on the No. 94.

The rolls are 10 inches in diameter and each one is driven by a gear almost twice as large. This reduces the pressure on the teeth of the gears to about one-half what it is on other machines.

**BRANCH OFFICES**

*New York, Chicago, Boston, Seattle,  
San Francisco, New Orleans, Macon, Ga.*

## The Berlin M

# Double Surfacers

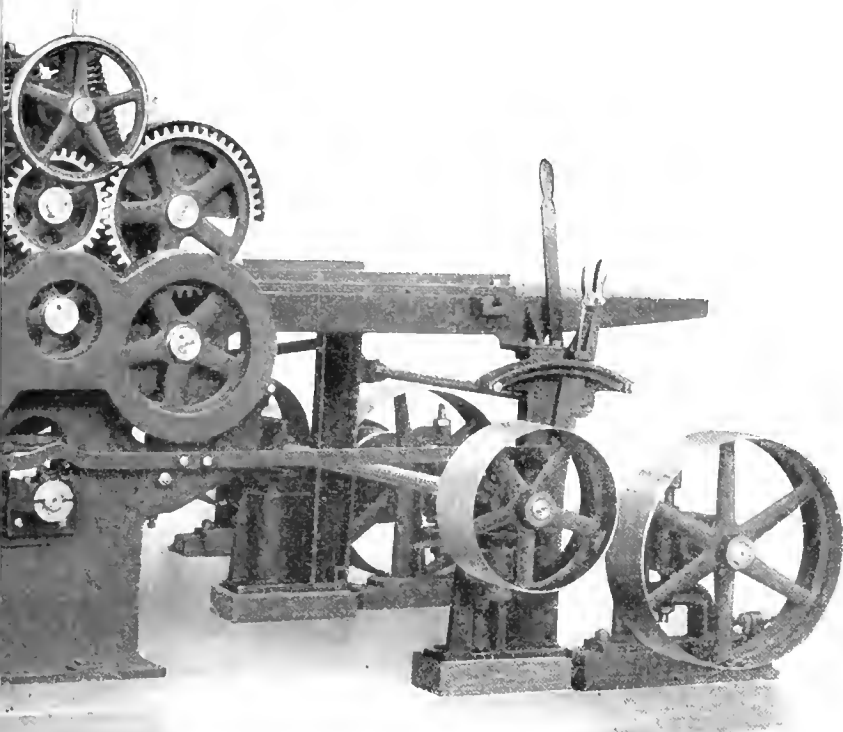

Result—the gears wear about twice as long.

In no case is the power to drive one roll transmitted through another.

Compare this with any other machine made and you will find that their double-driven rolls are in reality only half-driven.

The bottom head cuts first, making it possible to accurately thickness stock, as the sizing is all done by the top head.

The sectional pressure bar over the bottom head helps materially to take stock out of wind.

The working parts are all on top of the machine, easy to get at and simple in construction.

We will gladly send you a large picture and more complete description of this machine for the asking. What is your address?

## Machine Works

**BELOIT, WISCONSIN**  
**U. S. A.**

**Skidders**

**Snakers**

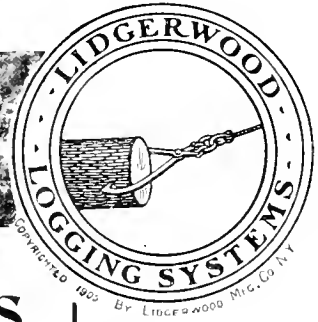
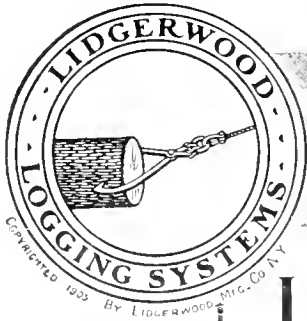

**Lidgerwood Machines  
Will Stock Your Mill**

- Lidgerwood Skidders
- Lidgerwood Snakers
- Lidgerwood Yarders
- Lidgerwood Roaders
- Lidgerwood Pull Boats
- Lidgerwood Cableways

**LIDGERWOOD MFG. CO.**

NEW YORK  
ATLANTA  
SEATTLE  
NEW ORLEANS



**Loaders**

**Cableways**



# PITTSBURG

HARDWOOD DISTRIBUTING CENTER OF PENNSYLVANIA

## Willson Bros. Lumber Co.

MANUFACTURERS

### WEST VIRGINIA HARDWOODS

FARMERS BANK BLDG. :: PITTSBURG, PA.

## Hardwoods a Specialty

FOR SALE

POPLAR	CHESTNUT	PLAIN OAK
125,000' 4 4 1s and 2s	200,000' 4 4 Sound Wormy	60,000' 4 4 No. 1 Com.
40,000' 4 4 No. 1 Com.	80,000' 5 4 Sound Wormy	18,000' 4 4 No. 2 Com.
325,000' 4 4 No. 2 Com.	100,000' 6 4 Sound Wormy	<b>QUARTERED OAK</b>
228,000' 4 4 No. 3 Com.	48,000' 8 4 Sound Wormy	2 cars 4 4 No. 1 Com.
150,000' 4 4 Mill Cull		1 car 4 4 No. 2 Com.

OAK TIMBERS SAWED TO ORDER.  
WRITE FOR PRICES.

CHEAT RIVER LUMBER COMPANY, Pittsburg, Penna.

## STOCK LIST

12,500 ft. 4 4 Maple No. 1 Com. & Bet.	192,000 ft. 4 4 Poplar Log Run
8,000 ft. 4 4 Maple No. 1 Common	4,000 ft. 8 4 Poplar Log Run
48,000 ft. 5 4 Maple No. 1 Com. & Bet.	23,500 ft. 12 4 Poplar Good
21,000 ft. 5 4 Maple 1sts and 2nds	2,500 ft. 6 4 Basswood Log Run
12,000 ft. 5 4 Maple No. 1 Common	2,200 ft. 8 4 Basswood Log Run
18,000 ft. 6 4 Maple No. 2 Com. & Bet.	1 Car 4 4 Basswood Log Run
3,000 ft. 6 4 Maple 1sts and 2nds	62,000 ft. 4 4 Cherry Log Run
3,000 ft. 8 4 Maple No. 2 Com. & Bet.	25,000 ft. 5 4 Cherry Log Run
29,000 ft. 8 4 Maple No. 1 Common	23,000 ft. 6 4 Cherry Log Run
13,000 ft. 10 4 Maple 1sts and 2nds	26,000 ft. 8 4 Cherry Log Run
15,000 ft. 12 4 Maple No. 2 Com. & Bet.	1 Car 4 4 White Birch 1sts & 2nds

FAVORABLE FREIGHT RATES TO THE EAST

**Babcock Lumber Co.**  
ASHTOLA, PA.

## Dry Stock for Quick Shipment:

48,492 ft. 4/4 1st & 2ds Qtd. White Oak.	70,812 ft. 4/4 No. 1 Poplar.
124,982 ft. 4/4 No. 1 Com. Qtd. White Oak.	14,182 ft. 8/4 1st & 2ds Poplar.
69,793 ft. 4/4 1st & 2ds Qtd. Red Oak.	118,121 ft. 4/4 Sound Wormy Chestnut.
79,341 ft. 4/4 No. 1 Com. Red Oak.	24,128 ft. 8/4 1st & 2ds Chestnut.
128,402 ft. 4/4 No. 1 Com. Pl. W. O.	21,903 ft. 7/4 No. 1 Com. Chestnut.
119,001 ft. 4/4 No. 1 Com. Pl. R. O.	19,246 ft. 8/4 No. 1 Com. Chestnut.
8,942 ft. 5/4 No. 1 Com. Pl. Red & White Oak.	78,433 ft. 6/4 Sound Wormy Chestnut.
11,312 ft. 6/4 No. 1 Com. Pl. Red & White Oak.	4,284 ft. 8/4 Sound Wormy Chestnut.
41,028 ft. 8/4 No. 1 Com. Pl. Red & White Oak.	126,094 ft. 4/4 1st & 2ds Cottonwood.
38,793 ft. 5/8 1st & 2ds Poplar.	49,021 ft. 4/4 13 to 17" Box Boards, 1st & 2ds.
29,423 ft. 5/8 No. 1 Com. Poplar.	61,975 ft. 4/4 8 to 12" Box Boards, 1st & 2ds.
21,971 ft. 5/8 Sapa Poplar.	98,194 ft. 4/4 Sap Gum, 1st & 2da.
29,824 ft. 5/8 No. 2 Com. Poplar.	129,481 ft. 4/4 Sap Gum No. 1 Com.
21,974 ft. 4/4 1st & 2ds Poplar.	49,200 ft. 4/4 Sap Gum No. 2 Com.
	48,205 ft. 4/4 Red Gum, 1st & 2da.
	94,389 ft. 4/4 Red Gum, No. 1 Com.
	242,841 ft. 4/4 Bay Poplar, 1st & 2da.
	181,921 ft. No. 1 Com. Bay Poplar.

**American Lumber & Mfg Co.** *Pittsburg, Pa.*

## The Nicola Lumber Company

One million feet 4-4 Bay Poplar.  
Can be shipped log run, or sold on grade. Bone dry; band sawed. Send your inquiries.

## Flint, Erving & Stoner Co.

**Wholesale Lumber**  
Northern and Southern Hardwoods

Beech and Maple Timbers a Specialty

## A. M. Turner Lumber Company

Everything in lumber. We buy hardwoods as well as sell them. If you have anything to offer, please submit same to us.

## Linehan Lumber Company

PERFECT

## MAPLE FLOORING

SEND US YOUR INQUIRIES

**EASTERN TENNESSEE—WESTERN NO. CAROLINA**

ASHEVILLE KNOXVILLE BRISTOL

**Fry-Buchanan Lumber Co.**

INCORPORATED.

Manufacturers and Wholesalers

**Hardwood Lumber**

Choicest Varieties. Full Grades.

POPLAR SQUARES  
A Specialty.

Asheville, N. C.

**On the Spot**

We are located right in the heart of this mountain country producing the best hardwoods in existence.

We are headquarters with ample stock, and can interest you both as to assortment and price. Write us.

**American Lumber Company**

ASHEVILLE, N. C.

**HARDWOODS**

From the famous Asheville district. Superior in quality, manufacture and gradings. For stock list and prices, address

**J. S. COLEMAN LUMBER CO.**

ASHEVILLE, N. C.

**Vestal Lumber & Mfg. Co.**

Manufacturers and Wholesalers  
of all kinds of

**HARDWOODS**

BEVELED SIDING A SPECIALTY.  
UNSURPASSED FACILITIES  
FOR DELIVERING.

Knoxville  
Tennessee

**The Morton Dry Kiln**

MOIST AIR SYSTEM

Recording  
Ther-  
mometers.  
Transfer  
Cars.

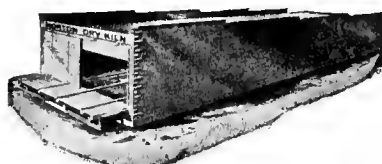

Trucks.  
Canvas  
Doors.

**HOW TO DRY LUMBER**

As exemplified in our Catalog D. Free on application.

**MORTON DRY KILN CO., Chicago, Ills.**

**All Lumbermen, Attention!**

We do what you can't do.  
We measure your stumpage correctly.  
We make your maps correctly.  
Bank references: Asheville, N. C.

**C. A. Schenck & Co.** Biltmore,  
North Carolina.

**Wood Working Plants**

Manufacturers seeking locations for Saw Mills, Stave and Heading Factories and other Wood Working Plants in the Central Southern States, can secure full and accurate information as to Sites, Timber Tracts, Fuel, Transportation Facilities, etc., by addressing

G. A. PARK, General Immigration and Industrial Agent,

**Louisville & Nashville Railroad Company**

LOUISVILLE, KENTUCKY

**Industries are Offered Locations**

WITH SATISFACTORY INDUCEMENTS, FAVORABLE  
FREIGHT RATES, GOOD LABOR CONDITIONS  
HEALTHFUL COMMUNITIES, on the lines of

**The Illinois Central R. R. and the  
Yazoo & Mississippi Valley R. R.**

For full information and descriptive pamphlet address

J. C. CLAIR, Industrial Commissioner, 1 Park Row, Chicago, Ill.

# CLEVELAND

HARDWOOD DISTRIBUTING CENTER OF NORTHERN OHIO

## THE ROBERT H. JENKS LUMBER COMPANY

### FOR SALE

- 60 M feet 1" 1st and 2ds Poplar
- 223 M feet 1" No. 1 Common Poplar
- 125 M feet 1" No. 2 Common Poplar
- 25 M feet 2" 1st and 2nd Poplar, 14" and up
- 125 M feet 8 4" Sound Wormy Chestnut
- 275 M feet 1" Sound Wormy Chestnut
- 153 M feet 1" 1st and 2nd Plain White Oak
- 85 M feet 1" 1st and 2nd Plain Red Oak
- 125 M feet 1" No. 1 Common Plain Red Oak

**Quartered White and Red Oak.**—We have a good assortment of dry stock,  $\frac{3}{8}$  to 4 inches thick. Your inquiries solicited.

**Plain White and Red Oak.**—A limited amount of nice stock, ready for shipment.

## The Martin-Barriss Company

Importers and Manufacturers

# MAHOGANY

and Fine Hardwoods

## Do You Want It? What? Money?

What have you in lumber to exchange for it? We want particularly Plain Oak, Chestnut, Poplar, Basswood, Ash.

What Have You?

## The Advance Lumber Co.

13th Floor  
Rockefeller Bldg. CLEVELAND, OHIO

Memphis Office, No. 56 Randolph Building.

J. E. MEADOWS, Mgr.

## SYMBOLS FOR GRADE MARKS

Adopted by the Hardwood Manufacturers Association of United States

- |                             |                |
|-----------------------------|----------------|
| ○ Panel and Wide No. 1      | △ Selects      |
| △ Wide No. 2                | ① No. 1 Common |
| B Box Boards                | ② No. 2 Common |
| ② FAS or Firsts and Seconds | ③ No. 3 Common |
| S Saps                      | ④ No. 4 Common |

Every Manufacturer should stamp the grade on his Lumber. Set of 10 Rubber Stamps, 1 1/4"x1 1/4" in size, Pad, Pint of Ink, and Spreader, packed for shipment \$3.50.

**MARTIN & CO.** 191 S. Clark St., CHICAGO, or  
**LEWIS DOSTER, Sec'y** 1535 First Nat. Bank Bldg. CHICAGO

## E. H. FALL

EXPORTER  
OF ...

### WALNUT, POPLAR AND BIRDSEYE MAPLE LOGS

Cash paid for Black Walnut Logs at point of shipment. If you have any walnut logs to offer, write me. I have some Sycamore, Red Oak, Ash and other hardwood logs which I am prepared to saw to order. Correspondence solicited. Can also supply Black Walnut lumber, sawed to any specification required.

PORT CLINTON : OHIO

## A HANDY THING

TO HAVE IN YOUR DESK AND IN YOUR TRAVELING BAG IS A TIME TABLE FOLDER OF THE

# MICHIGAN CENTRAL

The Direct Line to All Important Points of Michigan and Between

CHICAGO, DETROIT, NIAGARA FALLS, BUFFALO, NEW YORK, BOSTON and NEW ENGLAND POINTS.

SEND FOR A COPY NOW

W. J. LYNCH,  
Pass. Traffic Mgr.,



CHICAGO

O. W. RUGGLES,  
Gen'l Pass. Agt.,

**WISCONSIN**

WHERE THE FINEST NORTHERN HARDWOODS GROW

**John R. Davis Lumber Company**

PHILLIPS, WISCONSIN  
The Leading Manufacturers

**Wisconsin Hardwoods**

"SHAK ELESS" HEMLOCK and WHITE CEDAR PRODUCTS

WE HAVE THE FINEST BLOCK OF  
**4-4 UNSELECTED BIRCH**  
ON THE MARKET

Write for our Price Lists and Stock Sheets Mixed Cars, Even Grades  
Prompt Shipmen s



**BASSWOOD, BIRCH**

*We cut four million feet of each annually  
Your inquiries and orders solicited*

MILL AND YARDS AT INGRAM, WISCONSIN

**ARPIN HARDWOOD LUMBER CO.**

GRAND RAPIDS, WISCONSIN

Saw and Planing Mill at Atlanta, near Bruce, on the Soo Line. Offer

- |  |  |
|--|--|
| 5 cars 1" 1st & 2d Red Birch.                | 2 cars 3" Clear Plain Birch Flooring.                      |
| 1 car 1 1/4" 1st & 2d Red Birch.             | 1 car 3" Clear Red Birch Flooring.                         |
| 1 car 1 1/4" Common Red Birch.               | 1 car 3" Factory Birch Flooring.                           |
| 1 car 1 1/2" 1st & 2d Red Birch.             | 1 car 3" Red Oak Factory Flooring.                         |
| 1,000' 1 1/2" Common Red Birch.              | 1 car 1 1/4" & 1 1/2" quarter sawed Com. and Btr. Red Oak. |
| 2,500' 1 1/2" Com. & Btr. Red Birch.         | 1/2 car 1 1/4" and 2" Com. & Btr. quarter sawed Red Oak.   |
| 5,000' 2" 1st & 2d Red Birch.                | 1 car 5" Clear quarter sawed Red Oak Flooring.             |
| 2 cars 2 1/2" & 3" Plain Birch.              | 1/2 car each 1 1/2" Com. & Clear Maple Flooring.           |
| 2 cars 2 1/2" & 3" Log Rnn Unselected Birch. |  |
| 5 cars 1" Common Red Birch.                  |  |
| 1 car 2" Plain Log Rnn Birch.                |  |

We make a specialty of high grade Maple, Birch and Oak Flooring, Basswood, Pine Siding, Ceiling and Finish; also Moulding.

**VOLLMAR & BELOW**

MARSHFIELD, WISCONSIN

**Basswood, Birch**

and Other Wisconsin Hardwoods

LET US KNOW WHAT YOU ARE IN THE MARKET FOR

**C. P. CROSBY**

RHINELANDER : : WISCONSIN

**Wholesale Hardwood Lumber**

Hard Maple a Specialty in all thicknesses from 1 inch to 4 inch. Finest Birch in Wisconsin. Black Ash, Rock Elm, Soft Elm, Red and White Oak. : :

DIFFICULT AND MIXED ORDERS A SPECIALTY

**For Sale:**

**NATIONAL INSPECTION**

- 3,000,000 ft. inch Birch.
- 100,000 ft. inch Black Ash.
- 50,000 ft. inch Soft Elm.
- All No. 1 Common and Better.
- 20,000 ft. 1x4 and wider, 6 ft., 1st & 2nd Birch.

**Dells Lumber & Shingle Co.**

EAU CLAIRE, WISCONSIN

**Mason-Donaldson Lumber Co.**

Manufacturers and Wholesalers

**Northern Hardwoods**

Birch a specialty

Rhinelanders.

Wisconsin

# WISCONSIN

WHERE THE FINEST NORTHERN HARDWOODS GROW

## North Western Lumber Co.

General Offices  
EAU CLAIRE, WIS.

Mills at  
STANLEY, WIS.

Band Sawed

# Wisconsin Hardwoods

Careful Gradings  
Prompt Shipments.

### SPECIAL OFFERINGS

- 1 Car 1½ inch No. 1 Common Basswood.
- ½ Car 1¼ inch No. 1 Common Basswood.
- ½ Car 2½ inch 1st and 2nd Clear Basswood.
- 1 Car 1½ inch 1st and 2nd Clear Basswood.
- 1 Car 1¼ inch, 1½ inch and 2 inch No. 3 Soft Elm.

## HARDWOOD LUMBER-- NORTHERN AND SOUTHERN

All kinds of Northern and Southern Hardwoods for sale.

We call your attention to the following items which we have to offer, to-wit:

- |                                       |                                       |
|---------------------------------------|---------------------------------------|
| 50M It. 1" Curly Birch                | 30M It. 1¼" No. 2 Com. & Bet. Hickory |
| 50M It. 2" Com. and Bet. Plain Birch  | 30M It. 1½" No. 2 Com. & Bet. Hickory |
| 80M It. 2½" Com. and Bet. Plain Birch | 100M It. 1" Com. & Bet. Plain Red Oak |
| 150M It. 1" No. 1 Com. Plain Birch    | 150M It. 1" Com. & Bet. Qld. Red Oak  |
| 12M It. 2" 1sts and 2nds Red Birch    | 10M It. 1" No. 3 Com. & Bet. Walnut   |
| 200M It. 1" Com. and Bet. Hard Maple  | 75M It. 1½" No. 2 Com. & Bet. Elm     |
| 200M It. 2" Com. and Bet. Hard Maple  | 150M It. 1" No. 1 Com. Red Gum        |
| 50M It. 2" Bridge Plank—Oak           |                                       |

In addition to the foregoing, we have full stocks of Basswood, Birch and Soft Elm and a full selection of Red and Sap Gum. We guarantee our grades to be made strictly in accordance with National Hardwood Association rules of inspection.

**G. W. JONES LUMBER CO., Appleton, Wis.**

CHICAGO OFFICE: 1717 RAILWAY EXCHANGE.

## Ten per cent More Profit

The profits of a saw mill can readily be increased ten per cent by using a band mill instead of a rotary. The price of this mill with six foot wheels for saws eight inches wide is readily within the reach of all. It cuts smooth and perfect lumber and has a capacity of 25,000 feet to 35,000 feet per day. It runs with less expenditure of power than a rotary and puts only half as much of the log into saw dust as does the circular saw.

PHOENIX MFG. COMPANY,  
EAU CLAIRE, WIS.

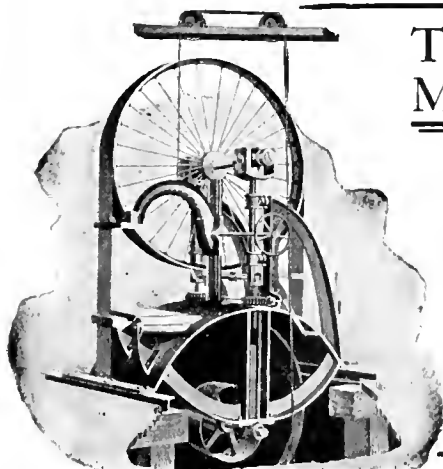

## R. CONNOR CO.

WHOLESALE MANUFACTURERS

### Wisconsin Hardwood

PINE AND HEM-LOCK LUMBER

Mills at  
Auburndale, Wis., on W. C. R. R.  
Stratford, Wis., on C. & N. W. R. R.

Marshfield, Wis.

## Wisconsin Veneer Co.

RHINELANDER, WIS.

Largest and best equipped Veneer cutting plant in the country. High-grade product from Birch, Maple, Elm, Basswood, Ash and other native woods.

Veneers for Door Work a Specialty.

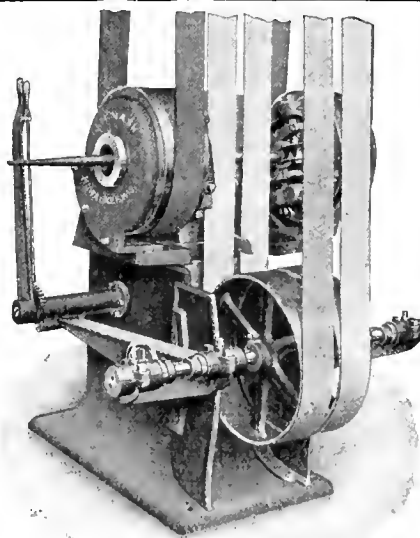

Broom,  
Hoe, Rake,  
Fork and  
Shovel  
Handles,  
Chair Stock,  
Dowel Rods,  
Curtain  
Poles,  
Shade  
Rollers,  
Whip Stocks,  
Canes,  
Veneered  
Columns,  
Ten Pins, &c.

## The Nash Automatic Sander

FOR ALL ROUND STOCK WORK

A wonderful labor-saving machine.  
Pays for itself in a short time. For particulars address

**J. M. Nash** 842-848 Thirtieth St.  
MILWAUKEE, WIS.

**M I C H I G A N**  
FAMOUS FOR HARD MAPLE AND GREY ELM

**SALLING, HANSON & CO.**  
MANUFACTURERS OF  
**Michigan Hardwoods**  
GRAYLING, MICHIGAN

**Evans & Retting Lumber Co.**  
Manufacturers and Wholesale Dealers  
**Hardwood Lumber**  
RAILROAD TIMBERS, TIES AND SWITCH TIES  
541 and 543 Michigan Trust Building Grand Rapids, Mich.

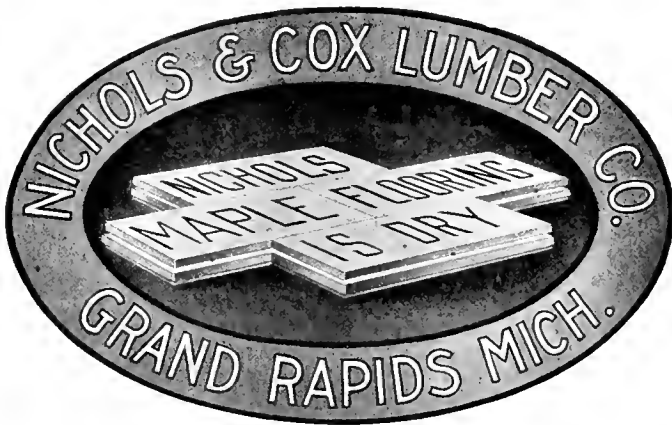

**BROWNLEE & COMPANY**  
DETROIT MICHIGAN  
Some "snaps" we are offering:  
**BASSWOOD** 4 4 1sts and 2nds, including one car 1x12 and wider.  
**BIRCH** 4 4 Log Run; also No. 1 and No. 2 Common.  
**HARD MAPLE** 3-inch No. 1 Common; 6 4 and 8 4 1sts and 2nds.  
**WHITE ASH** 4 4 No. 1 Common and better; rather narrow, but very cheap.  
All Bone Dry and at Bargain Prices to Close Out.

**DUDLEY LUMBER COMPANY**  
HAS FOR SALE  
Memphis Yard—Plain and Qtd. Oak  
Grand Rapids Yard—Michigan Hardwoods  
HEMLOCK LUMBER ALSO A SPECIALTY  
OFFICES: GRAND RAPIDS, MICHIGAN

**DENNIS & SMITH LUMBER CO.**  
Wholesale Hardwood Lumber  
Office and Yards, FOURTH AND HOLDEN AVENUES,  
**DETROIT, MICH.**  
MILLS AT: Heaters, W. Va. Valley Bend, W. Va. Diana, W. Va. Parkersburg, W. Va. McNutt Siding, W. Va.

**Q** For items of Hardwood Stock or Hardwood Machinery, you will find it advantageous to write our advertisers. Get in touch!

W. H. WHITE, Pres.  
JAS. A. WHITE, Vice-Pres.  
W. L. MARTIN, Secy.  
THOS. WHITE, Treas.

**W. H. WHITE COMPANY**  
BOYNE CITY, MICHIGAN  
Manufacturers of Hardwood and Hemlock Lumber, Cedar Shingles,  
White Rock Maple Flooring.



# MICHIGAN

FAMOUS FOR RED BIRCH AND BASSWOOD

## DENNIS BROS.

GRAND RAPIDS, MICHIGAN

**HARDWOOD LUMBER (by water or rail)  
"NATIONAL" MAPLE & BIRCH FLOORING**

**SPECIAL BARGAINS IN THE FOLLOWING:**

120M feet 4 4 Log Run Birch  
125M feet 5 4 Log Run Birch  
2 Cars 8 4 Common and Better Birch  
1 Car 1x4 Clear Birch  
2 Cars 1x7 and Wider No. 1 Common Birch  
140M feet 5 4 Log Run Beech  
150M feet 4 4 Log Run Soft Elm  
Hard Maple—All grades and thicknesses

Main Office :  
205-209 Michigan  
Trust  
Company  
Building

## Thos. MacBride Lumber Company

HEADQUARTERS FOR

### HARDWOODS

IN MICHIGAN

Michigan Trust Building, Grand Rapids, Mich.

## BIRCH

WE WANT YOUR ORDERS FOR

**4-4 and 5-4 No. 1 Common Birch**

A No. 1 STOCK

**Simmons Lumber Company**

SIMMONS, MICHIGAN

## McCLURE LUMBER COMPANY

MANUFACTURERS OF

### Hardwoods

Main Offices, DETROIT, MICH.  
Mills, EUTAW, ALA.

**SPECIAL OFFERINGS:**

5 cars 1" 1st & 2nds & Com. Qtd. White Oak	10 cars 1" Log Run Brown Ash
2 cars 2 1/2, 3 and 4" White Ash	10 cars 1" to 4" Dry Hard Maple
2 cars 1" White Ash	10 cars 1" Log Run Birch
1 car 1 1/2 and 2" No. 1 Com. Brown Ash	10 cars 1" Log Run Basswood
4 cars 2, 3 and 4" 1st and 2nds and No. 1 Com. Green White Oak	
2 cars 2" Log Run Soft Elm	

## SOFT ELM AND ROCK ELM

FOR SALE BY

**The R. G. Peters Salt & Lumber Co.**

EASTLAKE, MICHIGAN



## J. S. GOLDIE

Cadillac, Michigan.

SPECIAL PRICES on 500M pieces  
1" to 3" Maple Squares 16" to 27" long.  
1" to 3" Soft Elm Lumber.

INQUIRIES SOLICITED FOR MICHIGAN LUMBER.

## BOYNE CITY LUMBER COMPANY

BOYNE CITY

**MICHIGAN ROCK MAPLE and other HARDWOODS**

LARGE CAPACITY PROMPT SHIPMENTS RAIL OR CARGO

## VAN KEULEN & WILKINSON LUMBER COMPANY

Manufacturers and Wholesalers of

### HARDWOOD LUMBER and CRATING STOCK

Complete Stocks of Michigan Hardwoods—Maple, Beech, Birch, Elm,  
Ash and Basswood for sale.

Grand Rapids, Michigan

## "Chief Brand" Maple Flooring

Will commend itself to you and your trade on its merits alone. \* Comprises all the features desirable in good flooring. \* Made by the latest, most approved machinery methods and best skilled labor. \* We believe we can make it to your interest to handle our "Chief Brand" and will appreciate your inquiries.

**Kerry & Hanson Flooring Co.**

GRAYLING, MICHIGAN

## Hackley-Phelps-Bonnell Co.

MANUFACTURERS OF

### Northern and Southern Hardwood Lumber

Main Office, Michigan Trust Company Building

GRAND RAPIDS MICHIGAN

# CINCINNATI

THE GATEWAY OF THE SOUTH

**OUR AIM** is to ship the highest standard of lumber at lowest consistent price

We are manufacturers and ship direct from our band mills

Oak **W. H. & G. S. Stewart** Chestnut  
Poplar Basswood  
Ash Yellow Pine

Main Office: Cincinnati, Ohio, U. S. A.

FRAMES,  
SASH, DOORS,  
BLINDS, MOULDINGS,  
COLUMNS, GLASS,  
STAIRWORK,  
INTERIOR TRIM.



PAINTS,  
BUILDERS' HARDWARE,  
MANTELS, ETC.  
LARGO CINCINNATI FAC-  
TORIES MAKE PROMPT  
SHIPMENTS POSSIBLE.

## THE HOUSE OF STONE

The One of Good Grades and Prompt Shipments  
Solicits Your Inquiries for

Yellow Poplar, Oak, Chestnut, Cottonwood, Ash, Basswood,  
Cherry and Gum

T. B. STONE LUMBER CO. Mfrs. and Wholesalers  
CINCINNATI, O.

## "BUY GUM"

We are in the market to buy  
Dry Gum Lumber in any  
quantity, from a single car  
load to a million feet. Will  
take all grades and thick-  
nesses. We receive lumber  
at shipping point, pay cash  
and are liberal in inspection.



## THE FARRIN-KORN LUMBER COMPANY

General Office, Yards,  
Planing Mills, Dry Kilns,  
Cincinnati, Ohio  
Purchasing Office,  
Randolph Building,  
Memphis, Tenn.

Cypress Red Gum Oak

## PLAIN OAK—BASSWOOD

Are what we want. All thicknesses and grades. Spot  
cash. Send us list of your offerings with prices.

DUHLMAYER BROS., CINCINNATI, O.

## CYPRESS LUMBER CO.

Manufacturer of Hardwoods and Cypress

Plain and Quartered White and Red Oak, Yellow Poplar,  
Yellow Pine, Walnut, etc. Mills in Tenn., Ala. and Va.

OFFICE AND YARDS, GEST AND DALTON AVE., CINCINNATI, OHIO.

## THE GENERAL LUMBER COMPANY

**HARDWOODS**  
HEMLOCK, YELLOW PINE.

COLUMBUS OHIO

## LANE-WHITE LUMBER CO.

OAK, ASH AND WALNUT **Hardwoods** ALWAYS IN THE MARKET  
OUR SPECIALTY FOR WALNUT LOGS

MAIN OFFICE AND BAND MILL at FORT SMITH, ARK.

# W. H. Dawkins Lumber Co.

Manufacturers of Band Sawed

## Yellow Poplar

ASHLAND, KY.

## KNIVES

A man who has been in the presence of angels discloses the fact  
by his action: Just one reason for our talking good machine  
knives, good veneer knives or knives of any kind that do good work.

CHAMPION SAW COMPANY,

BEAVER FALLS, PA.

**CINCINNATI**

THE GATEWAY OF THE SOUTH

**THE WIBORG & HANNA COMPANY**

CINCINNATI, OHIO

PLAIN  
AND  
QUARTER  
SAWED

**White and Red Oak**

CHESTNUT  
POPLAR  
GUM AND  
CYPRESS

Flooring, Siding, Ceiling, Base, Case and Molding. Rough, Dressed and Re-sawed. Mixed Carloads.

**THE  
MALEY, THOMPSON & MOFFETT CO.**

Always in the Market for  
**BLACK WALNUT LOGS,  
SELECTED WHITE OAK LOGS,  
LUMBER OF ALL KINDS.**

CINCINNATI, : : : OHIO

**THE E. E. BECK LUMBER COMPANY**  
Cash Buyers

**Poplar, Oak, Chestnut**

And Other Southern Hardwoods

ALL GRADES AND THICKNESSES. WE BUY MILL CUTS.

Poplar, Oak,  
Ash, Chestnut,  
Sycamore,

**C. Crane & Co.**

We would like to buy

**2,000,000 feet Dry Oak**

**2,000,000 feet Dry Poplar**

W. Va. Spruce,  
Pine and Elm

Mostly heavy stock. Quotations Solicited.

MILLS AND YARDS  
CINCINNATI, O.  
YEARLY CAPACITY  
100,000,000 FT.  
LONG BILL STUFF  
A SPECIALTY

WE WANT  
**HARDWOODS**

ALL THICKNESSES, ALL KINDS, ALL GRADES.

Write for Prices

**KENTUCKY LUMBER CO.**

SUITE 507, FIRST NATIONAL BANK

Cincinnati, O.

**L. W. RADINA & COMPANY**

Correspondence Solicited with Buyers and Sellers of All Kinds of

**HARDWOODS**

Wanted for cash—desirable blocks of 1 inch to 4 inch Poplar, all grades,  
Especially 1½-inch stock, for immediate shipment.

CLARK STREET AND DALTON AVENUE



**THE FREIBERG LUMBER CO.**

Manufacturers of

**Tabasco Mahogany  
Walnut, Oak**

Poplar, McLean and Findlay Aves.  
CINCINNATI, O.

IN THE MARKET FOR

**OAK—ASH—POPLAR**

ALL GRADES AND THICKNESSES

**MOWBRAY & ROBINSON**

Office:  
1219 West Sixth Street

Yards:  
Sixth Street, below Harriet

WHAT HAVE YOU FOR SALE IN

**Red and White OAK Qtd. and Plain**

ALSO POPLAR, CHESTNUT, WALNUT, ETC

JOHN DULWEBER & CO., CINCINNATI, OHIO

Cash buyers for stock in our line.

**Cincinnati Hardwood Lumber Co.**

GEST AND SUMMITT STREETS

Wholesalers Mahogany, Thin Lumber, Veneers

Finely figured quarter sawed oak veneers a specialty.



# INDIANA



WHERE THE BEST HARDWOODS GROW

THE WOODS FOR  
WHICH INDIANA  
IS FAMOUS.

Quart'r'd White Oak

Plain White Oak

Quartered Red Oak

Plain Red Oak

White Ash

Poplar

Black Walnut

Cherry

Sycamore

Red Gum

Hickory

Beech

Maple

Veneers of

Indiana Hardwoods

## YOUNG & CUTSINGER

Manufacturers and Wholesalers

Our Specialty Fine Figured Quartered Oak

EVANSVILLE, IND.

## CHARLES H. BARNABY

Manufacturer of Band Sawed Hardwoods

Quarter Sawed Indiana White Oak a Specialty

GREENCASTLE, IND.

## D'HEUR & SWAIN LUMBER CO.

Manufacturers and Wholesalers

Our Specialty Quartered Oak and Sycamore

SEYMOUR, IND.

## LONG-KNIGHT LUMBER CO.

MANUFACTURERS AND DEALERS

Quarter Sawed White and Red Oak a Specialty

INDIANAPOLIS, IND.

## MALEY & WERTZ

Manufacturers, Wholesalers and Exporters of Hardwood Lumber

EVANSVILLE, IND.

## FULLERTON-POWELL HARDWOOD LUMBER CO.

SOUTH BEND, IND.

## PERRINE-ARMSTRONG CO.

Long Timber up to 60 feet—Hardwood Specialties

The largest Band Mill in Indiana.

FORT WAYNE, IND.

## J. V. STIMSON

All Kinds of Hardwood Lumber Manufactured

HUNTINGBURG, IND.

# BUFFALO

THE GREAT WHOLESALE LUMBER CENTER OF THE EAST



Manufacturers and Dealers in

- Ash  
White and Brown
- Basswood
- Birch  
Red and White
- Butternut
- Cherry
- Chestnut
- Cottonwood
- Cypress
- Elm  
Soft and Rock
- Gum  
Red and Tupelo
- Hickory
- Maple  
Hard and Soft
- Red Oak  
Plain and Quartered
- White Oak  
Plain and Quartered
- Black Walnut
- White Wood  
Poplar



## HUGH McLEAN LUMBER COMPANY

Specialty: INDIANA WHITE OAK

940 ELK STREET

## ANTHONY MILLER

HARDWOODS OF ALL KINDS

893 EAGLE STREET

## SCATCHERD & SON

HARDWOODS ONLY

Yard, 1555 SENECA STREET

Office, 886 ELLICOTT SQUARE

## STANDARD HARDWOOD LUMBER CO.

OAK, ASH AND CHESTNUT

1075 CLINTON STREET

## I. N. STEWART & BROTHER

Specialties: CHERRY AND OAK

892 ELK STREET

## T. SULLIVAN & COMPANY

Specialties: BROWN ASH, BIRCH, PACIFIC COAST FIR AND SPRUCE

50 ARTHUR STREET

## ORSON E. YEAGER

Specialties: OAK, ASH AND POPLAR

932 ELK STREET

## BEYER, KNOX & COMPANY

ALL KINDS OF HARDWOODS

Office and Yards, 69 LEROY AVENUE

## BUFFALO HARDWOOD LUMBER CO.

We want to buy for cash:  
Oak, Ash and other Hardwoods, all grades and thicknesses.  
Will receive and inspect stock at shipping point.

P. O. Box 312, MEMPHIS, TENN.

940 SENECA STREET

## EMPIRE LUMBER COMPANY

Our specialties are PLAIN and QUARTERED OAK and ASH.

1142 SENECA STREET.

## G. ELIAS & BROTHER

BUY AND CARRY LARGE QUANTITIES OF ALL KINDS OF HARDWOODS

955 TO 1015 ELK STREET

# W. M. RITTER LUMBER COMPANY

COLUMBUS, OHIO

Although our Stocks, generally, are lower than for several years past, we still have the following DRY and ready for PROMPT shipment.

## POPLAR

4-4, 6-4, 8-4, 1 and 2  
4-4 Saps.  
4-4 No. 1 Common.  
4-4 No. 3 Common.

## POPLAR BEVEL SIDING

4 inch, No. 1.  
6 inch Selects.  
4 inch Selects.

## BASSWOOD

4-4, 1 and 2, 10 and 12 feet.  
4-4, 1 and 2, 14 and 16 feet.  
5-4, 1 and 2, 10 to 16 feet.  
5-4, No. 1 Common, 10 and 12 ft.  
5-4, No. 1 Common, 14 and 16 ft.

## PLAIN WHITE OAK

4-4, 1 and 2.  
4-4, No. 2 Common.  
4-4, No. 3 Common.

## PLAIN RED OAK

4-4, 1 and 2.  
4-4, No. 1 Common.

## QUARTERED WHITE OAK

4-4, 1 and 2.  
4-4, No. 1 Common.

## WHITE PINE

5-4, 6-4, 8-4 B and Better.  
4-4, 5-4, 6-4 "C" Selects.

WRITE US TODAY FOR PRICES.

# Vansant, Kitchen & Co.

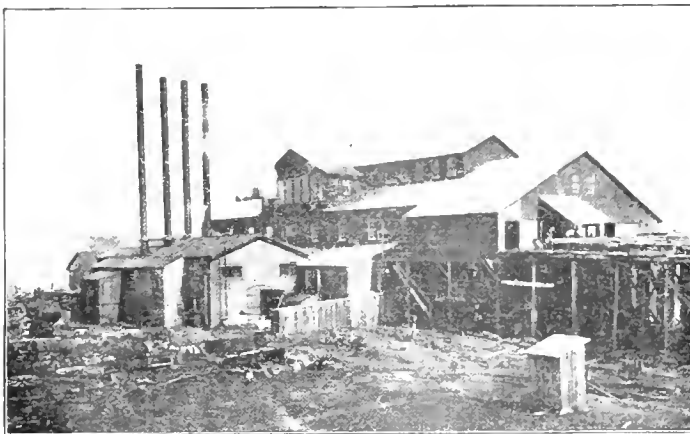

NEW ASHLAND MILL

Old-Fashioned

## SOFT YELLOW POPLAR

Ashland, Ky.

5-8 AND 4-4 IN WIDE STOCK, SPECIALTY

# YELLOW POPLAR

Manufacturers  
BAND SAWED  
POPLAR LUMBER

ALL GRADES

**DRY** 5-8, 4-4, 5-4, 6-4, 8-4, 10-4, 12-4, 16-4  
Bevel Siding, Lath and Squares  
Specialty, Wide Stock.

# LUMBER CO.

COAL GROVE, OHIO, U. S. A.



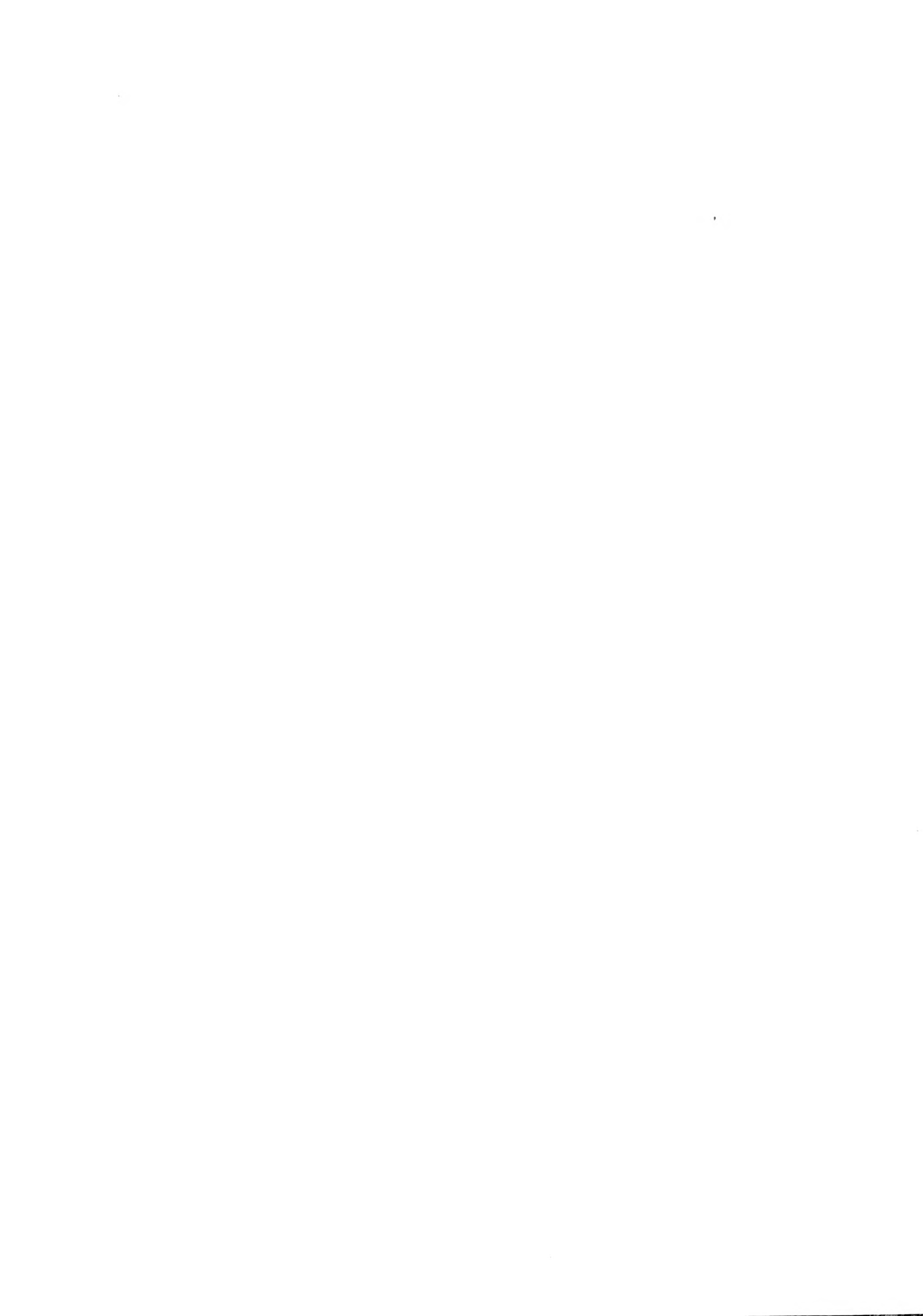









3 5185 00256 3037

