



HISTOIRE
DE
L'ACADEMIE
ROYALE
DES SCIENCES.

ANNÉE M. DCCXXXVIII.

Avec les Mémoires de Mathématique & de Physique,
pour la même Année, .

Tirés des Registres de cette Académie.

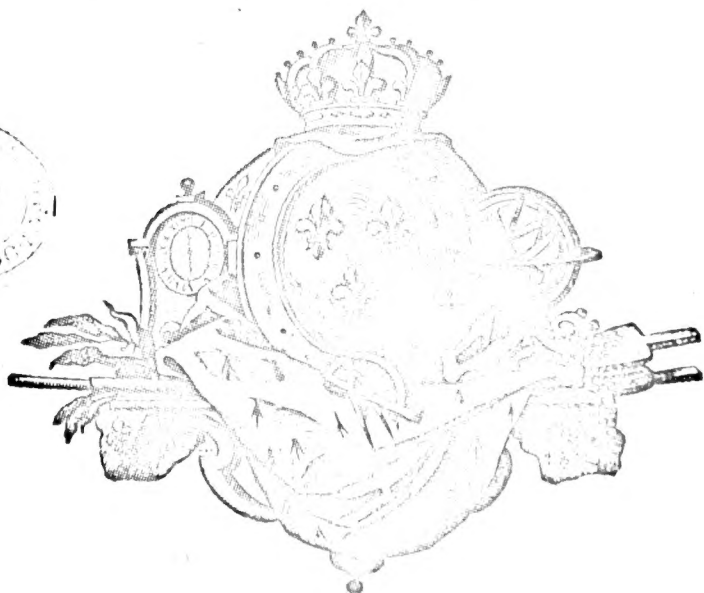

A PARIS,
DE L'IMPRIMERIE ROYALE.

M. DCCXL.

21

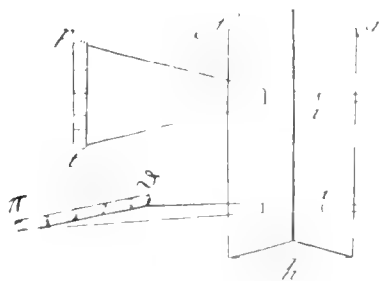

20

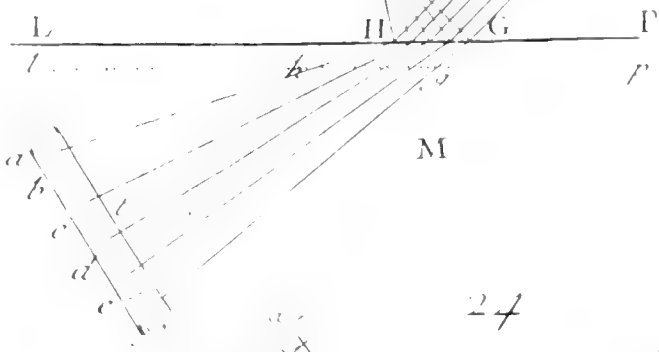
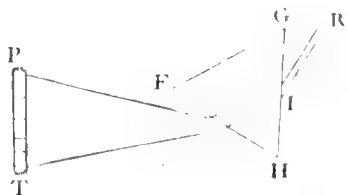

22

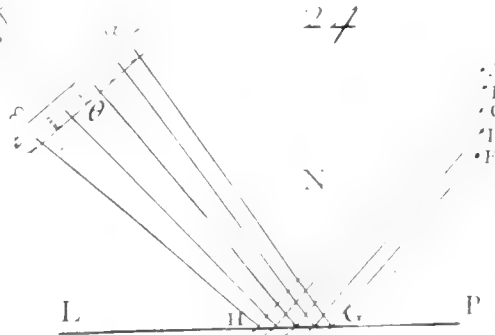
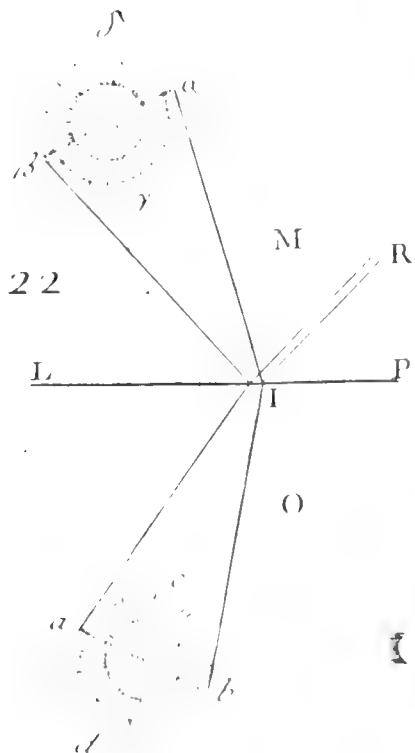

25

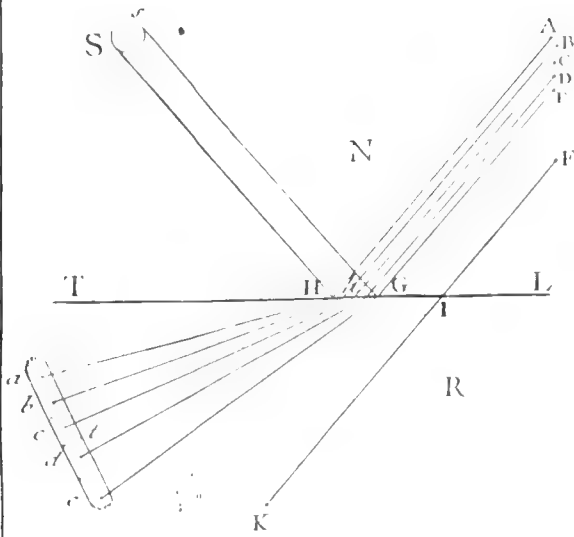

27

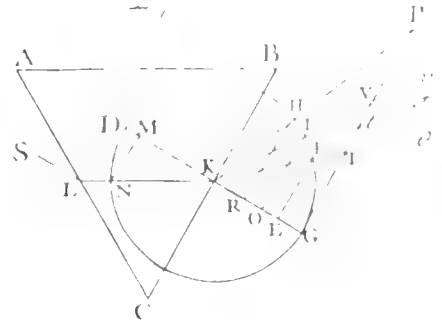

28

Vitesse Sinus

$\frac{1}{3}$ --- 8

$\frac{1}{5}$ --- $\frac{2}{5}$

$\frac{1}{2}$ --- $\frac{2}{3}$

$\frac{1}{2}$ --- $\frac{1}{2}$

$\frac{1}{3}$ --- $\frac{1}{3}$

$\frac{1}{5}$ --- $\frac{1}{5}$

$\frac{1}{5}$ --- $\frac{1}{5}$

$\frac{1}{5}$ ---

P

	Gr. 1/2	Gr. 1/2
Violet	8	8
Indigo	5	5
Bleu	4	4
Vert	3	3
Jaune	2	2
Orange	1	1
Rouge	1	1

26

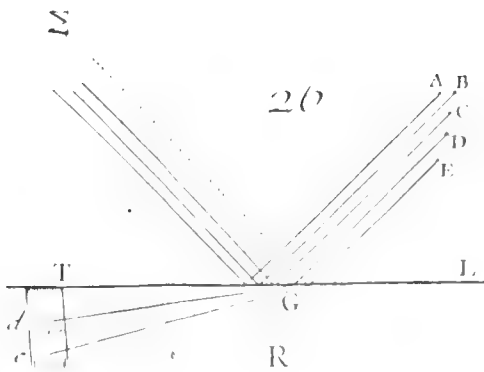

I

30

29

31

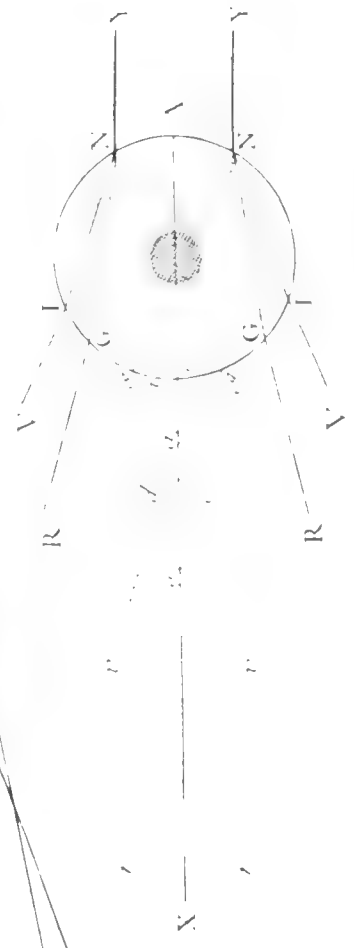
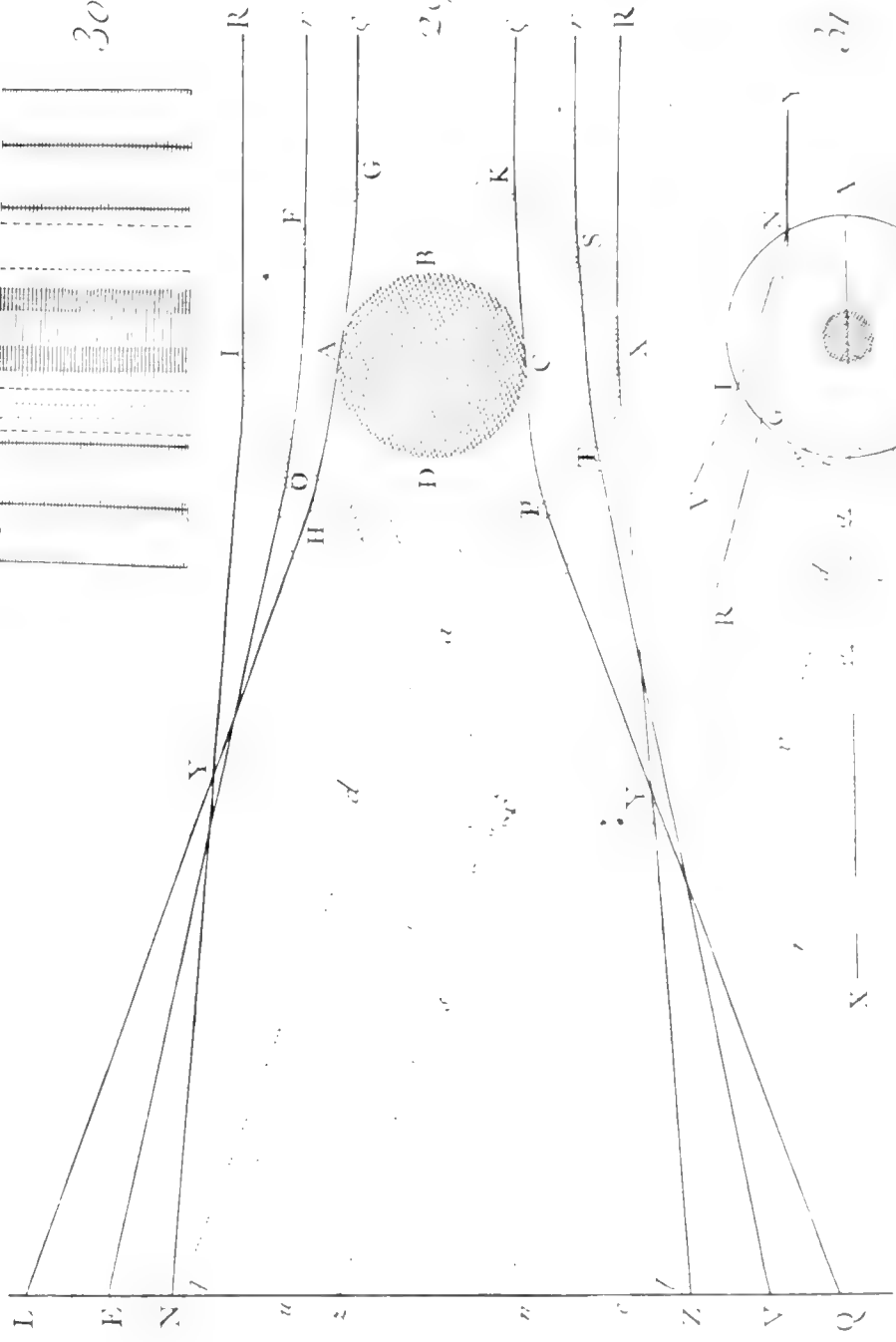
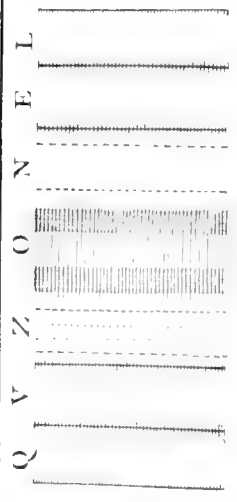





Fig 1



Fig 3

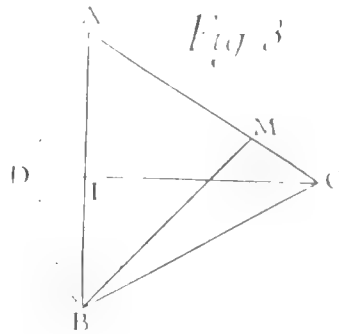

Fig 2

