

SE DEFENDENDO

*Ex Libris*

*James Arthur Beck*



JOHN A. SEAVERNS

1137 5

Veterinary Medicine  
Comparative and Clinical Medicine  
College of Veterinary Medicine at  
Tufts University  
200 Westboro Road  
North Grafton, MA 01536

TUFTS UNIVERSITY LIBRARIES



3 9090 014 532 523

THE HORSE.

LONDON : PRINTED BY  
SPOTTISWOODE AND CO., NEW-STREET SQUARE  
AND PARLIAMENT STREET

# THE HORSE.

BY

WILLIAM YOUATT.



HEAD OF THE BLACK ARABIAN.

WITH A TREATISE ON DRAUGHT.

REVISED AND ENLARGED BY WALKER WATSON, M.R.C.V.S.

LONDON:

LONGMANS, GREEN, AND CO.

1880

Searched

CF

025

162

102



# PREFACE

TO

THE FOURTH EDITION.



THE AUTHOR'S first edition of this work was published in the year 1831, at the request of the 'Society for the Diffusion of Useful Knowledge,' with a view of supplying a work of reference in connection with the natural history, general management, and treatment of the horse, in health and disease. Since then it has passed through two other editions, the last of which, by the late Mr. Gabriel, appeared in the year 1861.

In undertaking the preparation of a fourth edition, the Editor has endeavoured as much as possible to carry out the original intentions of the author in accordance with the rapid advancement which veterinary science has of late years made. In doing this, considerable alterations have been made. The remarks on the 'early history and the different breeds of horses,' and the 'treatise on draught,' are nearly unaltered. The illustrations of the age of the horse, and some remarks on Mr. Rarey's method of 'breaking in the horse' from Captain Richardson's work, also remain as in the last edition. In other respects the present edition will be found to have undergone a thorough revision and arrangement, many fresh diseases have been introduced, and the nature and treatment of others considered in accordance with the principles of veterinary science at the present day.

The great object of the Editor has been to make the work as practical as possible for all classes of readers, by avoiding as much as circumstances would permit those technical details which none but the scientific reader would comprehend. It will therefore necessarily follow that any lengthened anatomical details must be omitted, although it is believed sufficient have been retained to enable the general reader to understand the more important parts of the frame. The same remark applies to the chapters on medicines and poisons.

In conclusion, the Editor trusts that the alterations and additions which have been made will tend to enhance the value of the work, and render this the fourth edition equally worthy of the public esteem and patronage which have been accorded to its predecessors.

# CONTENTS.

CHAP.	PAGE
I. THE EARLY HISTORY OF THE HORSE . . . . .	i
II. THE FOREIGN BREEDS OF HORSES . . . . .	17
III. THE HISTORY OF THE ENGLISH HORSE . . . . .	54
IV. THE DIFFERENT BREEDS OF ENGLISH HORSES . . . . .	66
V. BREEDING AND BREAKING IN . . . . .	107
VI. THE GENERAL MANAGEMENT OF THE HORSE . . . . .	122
VII. THE ZOOLOGICAL CLASSIFICATION OF THE HORSE . . . . .	139
VIII. THE SENSORIAL FUNCTION . . . . .	144
IX. INJURIES AND DISEASES OF THE SKULL—THE BRAIN— THE EARS—AND THE EYES . . . . .	167
X. THE ANATOMY AND DISEASES OF THE NOSE AND MOUTH . . . . .	196
XI. THE ANATOMY AND DISEASES OF THE NECK AND NEIGH- BOURING PARTS . . . . .	236
XII. THE CHEST . . . . .	243
XIII. THE ANATOMY AND DISEASES OF THE RESPIRATORY ORGANS . . . . .	254
XIV. THE ANATOMY AND DISEASES OF THE DIGESTIVE ORGANS . . . . .	311
XV. THE SKIN AND ITS DISEASES . . . . .	342
XVI. THE FORE LEGS . . . . .	358
XVII. THE HIND LEGS . . . . .	381
XVIII. THE FOOT . . . . .	395
XIX. THE DISEASES OF THE FOOT . . . . .	403
XX. ON SHOEING . . . . .	429
XXI. FRACTURES . . . . .	441
XXII. OPERATIONS . . . . .	456
XXIII. A LIST OF THE MEDICINES USED IN THE TREATMENT OF THE DISEASES OF THE HORSE . . . . .	474
XXIV. POISONS . . . . .	498
XXV. THE VICIES AND DISAGREEABLE OR DANGEROUS HABITS OF THE HORSE . . . . .	502
XXVI. ON SOUNDNESS, AND THE PURCHASE AND SALE OF HORSES. . . . .	517
—————	
A TREATISE ON DRAUGHT . . . . .	527
—————	
INDEX . . . . .	575

# LIST

OF

## ILLUSTRATIONS.

	PAGE		PAGE
Frieze from the Temple of Minerva . . . . .	4	Nasal Cavity . . . . .	197
The Godolphin Arabian . . . . .	19	Muscles, Nerves, and Blood-vessels	
Arab Mare and Foal . . . . .	23	of the Head and Upper Part of	
Bay Arabian . . . . .	24	Neck . . . . .	199, 237
Cossack Soldier accounted for his		The Palate . . . . .	218
Journey . . . . .	50	Glenoid Cavity . . . . .	220
The Colonel . . . . .	67	The Teeth . . . . .	221—229
Flying Childers . . . . .	68	Spine and Ribs . . . . .	244
Eclipse . . . . .	69	Œsophagus . . . . .	312
Fleur-de-Lis . . . . .	78	Stomach . . . . .	313
The Hunter . . . . .	82	Intestines . . . . .	315, 317
The Hackney . . . . .	89	Bots . . . . .	322
The Coach Horse . . . . .	95	Worms . . . . .	331
The Suffolk Punch . . . . .	99	Catheter . . . . .	341
The Dray Horse . . . . .	102	Pasterns . . . . .	378
The Shetland Pony . . . . .	106	Hock . . . . .	385
Gag-bit . . . . .	119	Foot . . . . .	395, 397
Spring Buckle . . . . .	121	Shoe . . . . .	434, 436
Skeleton of the Horse . . . . .	140, 360	Sandal . . . . .	440, 441
Muscles of the Horse . . . . .	142	Slings, mode of fixing . . . . .	443
Head of the Horse . . . . .	145	Firing, method of . . . . .	463
Spinal Cord . . . . .	153	Hobbles, method of fixing . . . . .	463
The Eye . . . . .	160	Nerve on the Inside of the Leg . . . . .	470
Muscles of the Eye . . . . .	166	Diagrams illustrating the Principle	
Tetanus or Locked Jaw . . . . .	179	of Draught . . . . .	534—571

# THE HORSE.



## CHAPTER I.

### THE EARLY HISTORY.

THAT this animal existed before the Flood, the researches of geologists afford abundant proof. There is not a portion of Europe, nor scarcely any part of the globe, from the tropical plains of India to the frozen regions of Siberia—from the northern extremities of the New World to the very southern point of America, in which the fossil remains of the horse have not been found mingled with the bones of the hippopotamus, the elephant, the rhinoceros, the bear, the tiger, the deer, and various other animals, some of which, like the mastodon, have passed away.

There is scarcely a district in Great Britain in which the fossil remains of this animal have not been discovered. In the majority of cases the bones are of nearly the same size with those of the common breed of horses at the present day; but in South America the bones of horses of a gigantic size have been dug up.

Whether the horse had then become the servant of man, or for what purpose he was used, we know not. Every record of him was swept away by the general inundation, except that the ark of Noah preserved a remnant of the race for the future use of man.

An interesting and valuable account of the history of the horse from the earliest period is given by that learned and indefatigable naturalist, Col. Hamilton Smith, in the 12th volume of the 'Naturalist's Library.' This work, from the extent of its investigations, the largeness of its views, and its careful series of inductions, render it one of the most comprehensive and authoritative that has been produced. In allusion to these more remote data, he says, 'We know so little of the primitive seat of civilisation, the original centre, perhaps in Bactria, in the higher valleys of the Oxus, or in Cashmere, whence knowledge radiated to China, India, and Egypt, that it may be surmised that the first domestication of the *post-diluvian* horse was achieved in Central Asia, or commenced nearly simultaneously in several regions where the wild animals of the horse form existed.'

In the sacred volume, which, besides its higher claims to stand at the head of 'The Farmer's Library,' contains the oldest authentic history of past transactions, an enumeration is made of certain valuable gifts that were presented to Abraham by Pharaoh, the monarch of Egypt. They consisted of sheep, oxen, asses male and female, camels, men-servants and maid-servants; but the horse is not mentioned. This can scarcely be

accounted for, except on the supposition that this noble animal was not then found in Egypt, or, at least, had not been domesticated there.

The first allusion to the horse, after the period of the Flood, is a perfectly incidental one. It is said, in Genesis xxxvi. 24, of Anah, the son of Zibeon, a contemporary of Isaac, who was born about the year before Christ, 1590, that he found the mules in the wilderness—the progeny of the ass and the horse—as he fed the asses of his father. The wilderness referred to was that of Idumea or Seir. Whether these were wild horses that inhabited the deserts of Idumea, or had been subjugated by man, we know not. History is altogether silent as to the period when the connexion commenced or was renewed between the human being and this his most valuable servant.

‘Fossil remains,’ says the Colonel, ‘of the horse have been found in nearly every part of the world. His teeth lie in the polar ice along with the bones of the Siberian mammoth; in the Himalaya Mountains with lost, and but recently ascertained, genera; in the caverns of Torquay, Ireland, and, in one instance, from Barbary, completely fossilised. His bones, accompanied by those of the elephant, rhinoceros, tiger, and hyæna, rest by thousands in the caves in Constadt,—in Sevron, at Argenteuil,—with those of the mastodon, in Val d’Arno, and on the borders of the Rhine, with colossal urns. All the remains hitherto discovered appear so perfectly similar in their conformation to the domesticated horse, that they can scarcely be ascribed to other species of the genus. From the commixture of their remains, there cannot be a doubt that they have existed together with several great pachydermata; but what is most deserving of attention is, that while all the other genera and species, found under the same conditions, have ceased to exist, or have removed to higher temperatures, the horse alone has remained to the present time in the same regions without, it would appear, any protracted interruption, since from the circumstances which manifest deposits to be of the earliest era, fragments of its skeleton continue to be traced upwards in successive formations to the present superficial mould.’

Nearly a century after this, when Jacob departed from Laban, a singular account is given, in Gen. xxxii., of the number of goats and sheep, and camels, and oxen, and asses which he possessed; but no mention is made of the horse. This also would lead to the conclusion that the horse was either not known or was not used in Canaan at that early period.

Another century or more passed on, and waggons—conveyances drawn by animals—were sent to Canaan to bring Joseph’s father into Egypt. No mention is made of the kind of animals by which these vehicles were drawn; but there are many fragments of the architecture of the early ages, and particularly of the Egyptian architecture, in which the chariots, even on state occasions, were drawn by oxen. We cannot, however, come to any certain conclusion from this; but, at no distant period, while Joseph and his father were still living, a famine, preceded by several years of plenty, occurred in Egypt. Joseph, who had arrived at the chief office in the state under Pharaoh, had availed himself of the cheapness of the corn during the plentiful years, and had accumulated great quantities of it in the royal granaries, which he afterwards sold to the starving people for money, as long as it lasted, and then for their cattle and horses.

This is the first certain mention of the horse in sacred or profane history; but it affords no clue as to the purposes to which this animal was then devoted. In a few years, however, after the cessation of this famine, some elucidation of this interesting point is obtained. When Jacob lay on his deathbed, he called his sons around him, and, under the influence of that inspiration which has been withheld in later times, prophesied what

would be the character and fate of their descendants. Of Dan he says, 'Dan shall be a serpent by the way, an adder in the path that biteth the horse's heels, so that *his rider* shall fall backward.' We have nothing here to do with the fulfilment of this prediction. That which principally concerns the reader is the office which is, for the first time, assigned to the horse. He is ridden.

We hear no more of the horse until the time of Job, who lived about twenty years before the Israelites were brought out of Egypt by Moses. He was well acquainted with the horse, and admired him on account of his unrivalled beauty and the purposes to which he was devoted. Job's description of the horse is quoted in almost every work on the subject, and Dr. Blair cites it as an instance of the sublimity of the inspired writers. 'Hast thou'—the Divine Being is supposed to inquire of Job—'given the horse his strength? Hast thou clothed his neck with his beautiful mane? The glory of his nostrils is terrible. He paweth in the valley, and rejoiceth in his strength. He hurries on to meet the armed men—he mocketh at fear—he turneth not his back from the sword. The quiver rattleth against him—the glittering spear and the shield—he swalloweth the ground with fierceness and rage; neither believeth he that it is the sound of the trumpet (ordering a retreat). He saith among the trumpets, Ha! ha!—and he smelleth the battle afar off, and heareth the thunder of the captains and the shouting.' The Hebrew word, which is translated 'thunder' in the 19th verse, also signifies the mane of a horse. Whoever has observed how much the mane of a thorough-bred perfect horse, and under some momentary excitement, contributes to the nobleness of his appearance, will enter into the sublimity of the question, 'Hast thou clothed his neck with his beautiful mane?' To 'clothing the neck with thunder' no meaning can be attached.

It appears from this that the horse, nearly 1500 years before the birth of Christ, was used for the purposes of war. The noble animal which Job described belonged to the cavalry service of that time.

The same author assigns to him another task. Job had been previously speaking of the ostrich and of the hunting of that bird, and he says, 'What time she lifteth herself on high,'—springs from the ground as she runs,—'she scorneth the horse and his rider.'

In less than twenty years after this, we are told that Pharaoh 'took 600 chosen chariots and all the horses and chariots of Egypt, and all the horsemen, and pursued the Israelites to the Red Sea.' Here we seem to have three distinct classes of horses, the chosen chariot horse, the more ordinary chariots, and the cavalry. In fact, the power and value of the horse were now fully appreciated. Buxtorff says that the word 'parash,' or 'horseman,' is derived from the Hebrew root to prick or spur, and that the *rider* derived his name from the use of the spur. It would seem from Berenger that riding was at this period not only a familiar exercise, but had attained a degree of perfection not generally imagined.

In what country the horse was first domesticated there are no records certainly to determine. The most ancient of all histories is silent as to his existence in the time of Abraham; although it can hardly be imagined that this noble animal was not used when Nimrod founded the Babylonish monarchy, full 200 years before the birth of Abraham—or Semiramis, 150 years afterwards, reigned over the same country—or the Shepherd Kings, a little while before that period, conquered Egypt. It is natural to imagine that the domestication of the horse was coeval with the establishment of civilisation.

The author was disposed, in a former edition of this work, to trace the first domestication of the horse to Egypt; but farther consideration has

induced him to adopt the opinion of Colonel Hamilton Smith, that it took place in Central Asia, and perhaps nearly simultaneously in the several regions where the wild animals of the horse form existed. From the higher valleys of the Oxus and from Cashmere the knowledge of his usefulness seems to have radiated to China, India, and Egypt.

The original horse of the southern and western countries came from the north-eastern part of Asia, the domicile of those who escaped from the ravages of the Flood. Indeed, without the aid of the horse, the advancement of colonisation would have been exceedingly slow.

Colonel Smith is perfectly correct when he says that 'to ancient Egypt we appear to be indebted for the first systematic attention to reviving and improving the breeds of horses; numerous carved or outlined pictures represent steeds whose symmetry, beauty, and colour, attest that they are designed from high-bred types.' Grooms also are represented as 'rubbing their joints, and sedulously attending to their comfort on every proper occasion.' The horses, in all those tasteful works of art, are represented as either being loose or harnessed to chariots; no *mounted cavalry* are to be seen until a comparatively late period. It is the same with the bas-reliefs of Persepolis. On the frieze, however, of the temple of Minerva, in the Acropolis of Athens, built many years before the destruction of Persepolis, there were numerous figures of men on horseback, but not one of a horse harnessed to a chariot. The following cut was faithfully copied



from the frieze of that temple. This is a singular fact, that might lead to a very wrong conclusion—namely, that the chariot was in common use in Persia, and not known in Greece: whereas the Persians were far more decidedly a nation of horsemen than the Greeks, but chariots were occasionally used by them in their solemn festivals in honour of their divinities, and therefore naturally found on the frieze of their temples. Among the Greeks, however, chariots were never used for the purposes of war, but only in their public games. It may not be useless to pause for a moment, and study the form and character of these horses and their riders.

There is considerable difference in the form and action of the two horses.



The right-hand one, and the foremost of the two, is sadly defective in the portions of the fore-arms which we are permitted to see. The near one is poorly supplied with muscle.

The off-horse is out of all keeping. The large ears placed so low; the clumsy swelling of the lower part of the neck; the bad union of it with the breast; the length and thinness of the barrel compared with the bulk of the fore parts, notwithstanding the natural and graceful position of the hind legs, show no little want of skill in the statuary.

The more animated head of the left and hinder horse, the inflated nostril, the opening of the mouth, the form and prominence of the eye, and the laying of the ears, sufficiently confirm the accounts which we have of the spirit—sometimes untameable—of the primitive horses. The neck, however, is too short even for one with these immense forehands; it springs badly out of the chest; the shoulder is very defective; but the fore-arms, their expression and their position, are exceedingly good; the long fore-arms and short leg are excellent, and so are the off-letlock and foot, but the barrel is deficient, the carcass is lengthy, and the hind-quarters are weak compared with the fore-arms.

The beautiful execution of the riders cannot escape observation. The perfect Grecian face, the admirable expression of the countenance, the rounding and perfection of every limb, are sufficient proofs that the riders were portraits, as probably the horses were to a very considerable extent.

These animals remind us of some of the heavy ones of the present day particularly; they have the beauties and the defects of many of the modern Holstein horses; they are high, but perhaps heavy actioned; courageous, spirited, possibly fierce. They exhibit the germs of many future improvements, and, taken all together, may be examined with considerable pleasure, remembering that they are horses of nearly 2300 years ago. Art has done much for the horse since that period, but the countenance and figure of the human being were at that time perfect. These horsemen have not even the switch to guide the animal; but they are holding by the mane with the left hand, and are evidently directing the horse by pulling the mane, or pressing the neck with the right hand a little higher up.

The breeding of the horse, and his employment for pleasure and in war, were forbidden to the Israelites. They were commanded to *hough* or *hamstring* those that were taken in war. The sheep yielded them their wool, and the cattle their milk, and both of them their flesh. By the latter of these animals, the land was tilled and the corn trodden out; while the rulers and the judges, and even the kings of Israel, are carried by asses.

The horse is occasionally mentioned in the early period of the Israelitish commonwealth. No definite duty, however, is assigned to him; and it is said of the then monarch that 'He shall not multiply horses to himself.' There were two reasons for this: they were destined to be a peculiar people, preserving in the narrow confines of their country the knowledge and worship of the true God: therefore they were forbidden the means of wandering to other lands. The nature of their country likewise forbade the extensive breeding of the horse. It consisted, in a great measure, of mountains, and was bounded on the west by the sea, and on three other sides by deserts. It was not until the time of Solomon, 500 years after the Israelites had left Egypt, that the horse was domesticated among them; and then so rapidly did he increase, that Solomon had 1,400 chariots and 12,000 cavalry, and stabling for 40,000 horses. The greater part of these horses were imported from Egypt.

The sacred historian gives the price both of the chariots and the horses. It is the oldest document of the kind on record. The horse, including probably the expense of the journey, cost 150 shekels of silver, or rather

more than 17*l*. The chariot cost 600 shekels, or little more than 68*l*. Of the comparative value of money at that period it is impossible to speak; but it was probably many times greater than at present.

It is a question yet disputed, whether the use of chariots or the art of riding was first cultivated. According to Colonel Hamilton Smith, the northern nations were exclusively riders. At Nineveh, in Asia Minor, and India, they were both charioteers and riders. In Greece, Palestine, and Egypt, they were originally charioteers only. The probability, however, is, that although one might prevail in particular eras and countries, the other would not long remain unpractised.

Before a sketch of the history of the European horse is attempted, it may be interesting to collect the accounts given by historians of the character and management of the horse in earlier periods.

Upper Egypt and Ethiopia were inhabited by horsemen, of wild and predatory habits; plundering those who fell into their power, or hiring themselves to increase the army of any foreign potentate. Many troops of them attended Xerxes in his expedition into Greece.

In Libya, Numidia, Mauritania, and the settlements on the northern coast of Africa, comprising Morocco, Barbary, Tunis, and Tripoli of the present day, and the northern part of the Sahara, or Great Desert, the horses were numerous and fleet. *Ælian* describes them as being somewhat slenderly made, and seldom carrying much flesh; requiring little care and attendance from their owners: content with the common pasture which the country afforded, and on which they were turned, without further care or notice, as soon as their work was done. Their present treatment is not a great deal better.

They were at first ridden, as they are represented on the fresco of the Parthenon, without either bridle or saddle; and the rider had nothing but a switch or stick by which to guide them. This is said to have given them an ungraceful and awkward appearance; their necks being straight and extended, and their noses pointing somewhat upwards. 'It may, in some degree,' says *Berenger*, 'be difficult to conceive how a wand or stick could be sufficient to guide or control a spirited or obstinate horse in the violence of his course, or the tumult of battle; but the attention, docility, and memory of this animal are such, that it is hard to say to what a degree of obedience he may not be reduced. There is no reason why these horses should not be brought to understand the intention and obey the will of their riders with as much certainty and readiness as our cart-horses in our crowded streets attend to the voice of their driver, by which they are almost solely governed.' The older writers say that the horse was touched on the right of the face to make him go forward—on the left, to direct him to the right—on the muzzle, when he was required to stop: while the heel was used to urge him forward. The guidance of the horse by the gentle touch of the fingers is well represented in the engraving given at page 4.

Passing the Isthmus of Suez, ancient writers say not a word of the horses of Arabia. These deserts were not then inhabited by this noble animal, or there was nothing about him worthy of record.

Palestine, during the later periods of the Jewish monarchy, contained numerous horses. Mention has been made of the forty thousand stalls for horses built by Solomon; but they were all brought from Egypt, and a very little portion of the Holy Land was ever devoted to the breeding of horses after the settlement of the Israelites in it.

Syria acquired little reputation, on this account, nor did Asia Minor generally, with the exception of the country around Colophon, between Smyrna and Ephesus, whose cavalry was so numerous and well trained

that they were always in request as mercenaries, and deemed to be invincible. In all long and tedious wars the assistance of the Colophonian troops was courted, and the party that obtained supplies from them were so certain of success, that *Κολοφῶνα τιθέται*, and afterwards among the Romans, 'Colophonem imponere,' were used proverbially for putting a conclusion to any affair. Strabo, lib. xiv.

We must now travel to ARMENIA, on the west of Media, before we meet with anything to arrest our steps. A beautiful breed of horses was cultivated in this district. The chariot of Xerxes was drawn by Armenian horses, being the stateliest and the noblest which his extensive empire could produce.

Some writers, describing the horse at a later period, mention the great care that was taken of the dressing and adorning of the mane. Vegetius gives a long account of this. It was cut into the form of an arch or bow; or it was parted in the middle, that the hair might fall down on either side; or, more generally, it was left long and flowing on the right side—a custom which has been retained to the present day.

Many old sculptures prove that the horsemen of almost every country mounted on the right side of the animal. There are a few exceptions to this. The mane hanging on that side would assist the rider in getting on the horse. There were not any stirrups in those days. The modern horseman always mounts on the left side, yet the mane is turned to the right.

MEDIA produced numerous horses of the same character as those from Armenia.

CAPPADOCIA stood highest of all the eastern countries for its breed of horses; not perhaps so speedy as those from some other districts, but distinguished for their stately appearance and lofty action. Old Blundeville, from the inspection of many of the ancient sculptures, says that these were more heavy-headed than the heroes of the Parthians. Perhaps they were so; but no one can dispute the stateliness of their figure, and their proud and high and equal step. Although often ridden, they were better calculated for the chariot. This kind of horse seems to have pleased the ancients; and their painters and statuaries are fond of exhibiting them in their most striking attitudes. The horses in the cut at the commencement of this chapter are illustrative of the remark. Oppian says of them, what is true at the present day of many horses of this character, 'when young, they are delicate and weak; but strength comes with years, and, contrary to other horses, they are better and more powerful when advanced in age.'

The PARTHIANS fought on foot in the army of Xerxes. Either they had not begun to be celebrated as horsemen, or there were reasons which no author states for their being dismounted at that time. No very long period, however, passed before they became some of the most expert riders that the world could produce, and were reckoned, and justly so, almost invincible. They are described as being exceedingly active and dexterous in the management of their horses. They were as formidable in flight as in attack, and would often turn on the back of the animal, and pour on their pursuers a cloud of arrows that at once changed the fortune of the day.

Vegetius gives a singular account of the manner of their breaking in their horses, and rendering them sure-footed when galloping over the most irregular, and dangerous grounds; for they were lighter and hardier horses than those of the Cappadocians or Medes, and better for their peculiar pace and manner of fighting. A spot of dry and level ground was selected, on which various troughs or boxes, filled with chalk or clay, were placed at irregular distances, and with much irregularity of surface

ard of height. Here the horses were taken for exercise ; and they had many a stumble and many a fall as they galloped over this strangely uneven course ; but they gradually learned to lift their feet higher, and to bend their knees better, and to deal their steps sometimes shorter and sometimes longer, as the ground required, until they could carry their riders with ease and safety over the most irregular and dangerous places. Then it was that the Parthians could fully put into practice their favourite manœuvre, and turn upon and destroy their unsuspecting foes. They could also travel an almost incredible distance without food or rest.

To the Scythians, the Medes, and the Parthians, in after times, and in rapid succession (if, indeed, they were not different names for hordes of one common origin), succeeded the Ostraces, the Urals, the Monguls, the Calmucks, the Nogays, the Visigoths, the Ostrogoths, and the Huns—all people of the vast plains of Central Asia, which has been well denominated the nursery of nations. These were all horsemen. Some of their leaders could bring from two to three hundred thousand horsemen into the field. The speed of their marches ; their attacks and their retreats ; the hardihood to which they inured themselves and the animals by which they were carried ; the incursion, and often settlement, of horde after horde, each as numerous as that to which it succeeded ;—these are circumstances that must not be forgotten in our rapid sketch of the horse.

At the end of the eighth century, when the Saracens overran a great part of Europe, they brought with them a force of 200,000 cavalry, in a much higher state of discipline than the Goths and Huns of former ages.

Of the horses in the south of Asia and the east of the Indus little mention occurs, except that both chariots and cavalry were summoned from this distant region to swell the army of Xerxes.

Celebrated as the horses of Persia afterwards became, they were few, and of an inferior kind, until the reign of Cyrus. That monarch, whose life was devoted to the amelioration and happiness of his people, saw how admirably Persia was adapted for the breeding of horses, and how necessary was their introduction to the maintenance of the independence of his country. He therefore devoted himself to the encouragement and improvement of the breed of horses. He granted peculiar privileges to those who possessed a certain number of these animals ; so that at length it was deemed ignominious in a Persian to be seen in public, except on horseback. At first the Persians vied with each other in the beauty of their horses, and the splendour of their clothing ; and incurred the censure of the historian Athenæus that they were more desirous of sitting at their ease than of approving themselves dexterous and bold horsemen ; but under such a monarch as Cyrus they were soon inspired with a nobler ambition, and became the best cavalry of the East. The native Persian horse was so highly prized, that Alexander considered one of them the noblest gift he could bestow ; and when the kings of Parthia would propitiate their divinities by the most costly sacrifice, a Persian horse was offered on the altar.

Vegetius has preserved a description of the Persian horse, which proves him to have been a valuable animal, according to the notions of those times ; but capable of much improvement, according to the standard of a more modern period. He says that ‘they surpassed other horses in the pride and gracefulness of their paces, which were so soft and easy as to please and relieve, rather than fatigue the rider, and that the pace was as safe as it was pleasant ; and that, when they were bred on a large scale, they constituted a considerable part of their owners’ revenue.’ He adds, as a commendation, ‘the graceful arching of their necks, so that their chins leaned upon their breasts, while their pace was something between

a gallop and an amble.' The horsemen of the present day would decidedly object to both of these things, and that which follows would be a still more serious cause of objection:—'They were subject to tire upon a long march or journey, and then were of a temper which, unless awed and subdued by discipline and exercise, inclined them to obstinacy and rebellion; yet, with all their heat and anger, they were not difficult to be pacified.'

Both the soldier and the horse were often covered with armour from head to foot. They adopted much of the tactics of the Parthians in their pretended flight. Even when retreating in earnest, they annoyed their pursuers by the continual discharge of their arrows. Arrian gives a curious account of their manner of riding. They had no bridles, like the Greeks; but they governed their horses by means of a thong or strap, cut from the raw hide of a bull, and which they bound across their noses. On the inside of this noseband were little pointed pieces of iron, or brass, or ivory, moderately sharp. In the mouth was a small piece of iron, in the form of a small bar, to which the reins were tied, and with which the noseband was connected. When the reins were pulled, the small teeth on the noseband pinched the horse, and compelled him to obey the will of the rider. The modern cavesson was probably derived from this invention.

It is time to proceed to the early history of the horse in Europe. Many colonies of Egyptians emigrated to Greece. They carried with them the love of the horse, and as many of these noble animals as their ships would contain. It would appear that the first colony, about the time of the birth of Moses, landed in Thessaly, in the north of Greece. Their appearance, mounted on horseback, according to the old fable, terrified the native inhabitants, and they fled in all directions, imagining that their country was attacked by a set of monsters, half horse and half man, and they called them Centaurs. Such was the origin of the figures which are not unfrequent among the remains of ancient sculpture.

Another and a more natural interpretation offers itself to the mind of the horseman. The Thessalians were the pride of the Grecian cavalry. Before the other provinces of Greece were scarcely acquainted with the name of the horse their subjugation of him was so complete, that, in the language of another poet of far later days, but not inferior to any that Greece ever knew, (Shakspeare, in his exquisite tragedy of 'Hamlet,')

These gallants  
Had witchcraft in 't—they grew unto their seat,  
And to such wondrous doing brought their horse  
As they had been incorpsed, and demi-natured  
With the brave beast.

Hence the origin of the fable and of all the expressive sculptures. Buccephalus, the favourite war-horse of Alexander, was probably of this breed. We are told by Plutarch that he would permit no one to mount him but his master, and he always knelt down to receive him on his back. Alexander rode him at the battle of the Hydaspes, in which the noble steed received his death-wound. For once he was disobedient to the commands of his master: he hastened from the heat of the fight; he brought Alexander to a place where he was secure from danger; he knelt for him to alight, and then dropped down and died.

Sixty years afterwards, another colony of Egyptians landed in the southern part of Greece, and they introduced the knowledge of the horse in the neighbourhood of Athens. Their leader was called Erichthonius, or the horse-breaker; and after his death, like the first Centaur, he found a place in the Zodiac under the name of 'The Archer.' Erichthonius likewise occupied a situation among the constellations, and was termed *Auriga*, or the Charioteer.

The Thessalians always maintained their character as the first and the choicest of the Grecian cavalry. In point of fact, it was the only part of the country in which horses could with decided advantage be bred. It abounded in rich pastures, whereas the rest of Greece was comparatively dry and barren. Blundeville, who was an excellent classic as well as horseman, says:—‘The horses of Greece have good legges, great bodyes, comely heads, and are of a high stature, and very well made forward, butt not backward, because they are *pyn-buttocked*. Notwithstanding, they are very swift, and of a bolde courage. But of all the races in Greece, both the horses and mares of Thessaly for their bewtie, bignesse, bountie and courage, of all authors are most celebrated. For which cause Xerxes, on his coming into Greece, made a running of horses in chariots to be proclaymed only in Thessalia, because he woulde have his owne horses to runne wythe the best horses in Greece. Julius Cæsar, also, beyng Dictator of Rome, knowyng the courage of these horses, was the first that ordeyned them as a spectacle before the people to fyghte wythe wyld bulls, and to kyll them.’

From various of the Greek authors we can very satisfactorily trace the rapid improvement which about this time took place in the character and management of the horse. It has been stated that the soil and produce of Greece were not favourable for the breeding of horses, and that it could be a matter of profit only in Thessaly. They soon, however, became necessary in almost every part of the country, both for offence and defence: therefore, in most of the cities, and particularly in Athens and in Sparta, in order to induce the inhabitants to keep the requisite number, a new order of citizens was instituted, deemed the second in rank in the commonwealth, and distinguished by certain honours and privileges. The equites, or knights in the Roman republic, were formed on the same model.

It is in some of the first Grecian sculptures that we first see the bit in the horse's mouth, but it is not always that we do see it; on the contrary there is frequently neither bridle, saddle, nor stirrup. It however was frequently necessary to make use of cords or thongs, in order to confine the horse to the place at which it suited the rider for a while to leave him. These cords were fastened round the animal's neck, and may be seen in several of the ancient figures. According to some writers, the occasional struggles of the animal to escape from these trammels, and the strength which he exerted in order to accomplish his purpose, first suggested the idea of harnessing him to certain machines for the purpose of drawing them; and it is very evident that soon after this it must have occurred to the horseman, that if this rope were put over the head, and over the muzzle or perhaps into the mouth of the animal, he would be more easily fastened and led from place to place, and more securely guided and managed whether the man be off or on his back. Hence arose the bridle. It probably was at first nothing more than a halter or cord by which the horse was usually confined. An improvement on this was a detached cord or rope, with prolongations coming up on both sides of the mouth, and giving the rider much greater power over the animal; and after that, for the sake of cleanliness, and to prevent the wear and tear of the rope, and also giving yet more command over the animal, an iron bit was fitted to the mouth, and rested on the tongue, and the bridle was attached to each end of it. *It was the common snaffle bridle of the present day, the iron being jointed and flexible, or often composed of a chain.* There were, however, no cross pieces to these bits at the mouth, but simple knobs or bulbs, to the inside of which the bits were attached.

Bits and bridles of this kind occur frequently in the Athenian sculptures

of the time of Pericles, about 430 years before the Christian era; but the head-gear of the bridle had not been long introduced, the bit being supported, in some figures, by the buckling or tying of the bridle about the nose, a little above the muzzle. These, however, soon disappear, and we have the present snaffle, with very little alteration except a straight leather or cord from the head to the noseband, and that not always found. The chain under the chin is occasionally observed, probably for the sake of keeping the bit steady in the month.

In no period of Grecian history, so far as the author is aware, was the severe and often cruel curbed-bit known. This was an invention of after-times. The only instrument of punishment which was then attached to the bit was found in the knobs at the corners of the mouth; they had sharp or rough points on their inner surface, which by a turn or twist of the bridle might easily be brought to bear painfully on the cheeks and angles of the month. A bit so constructed was termed a *lupatum*, from the supposed resemblance of these sharp projections to the teeth of a wolf. It would seem that this was, among the Romans, almost coeval with the introduction of the bit, for the poet attributes it to Neptune, the fabulous parent of the horse.

Neptunus equo, si certa priorum,  
Fama patet, primus teneris læsisse lupatis  
Ora, et littoreo domuisse in pulvere fertur.  
Neptune, if we may credit give to fame,  
First taught with bits the generous horse to tame.

No mention is made of saddles, such as are used in modern times; but by way of ornament, and partly of convenience too, the horses are often covered with beautiful cloths, or with skins of wild beasts, secured by a girth or surcingle. Thus the horse of Parthenopius was covered with the skin of a lynx, and that of Æneas with a lion's skin. In their religious or triumphal processions the housings of the horse were particularly magnificent, being frequently adorned with gold and silver and diamonds. Rich collars were also hung round their necks, and bells adorned their crests. The trappings of the young knight in the days of chivalry did not exceed those of the Grecian warrior on days of ceremony.

The stirrup was likewise unknown. The adoption of that convenient assistance in mounting the horse was of singularly late date. The first mention of it occurs in the works of Eustathius, about the 1158th year of the Christian era; but it was used in the time of William the Conqueror, nearly a century before that. Berenger gives the figure of a horse saddled, bridled, and with stirrups, copied from the Bayeux tapestry, which was embroidered in the time of the Conqueror by his wife, and describes the circumstances preceding and attending his descent into England. The heroes of ancient times trusted chiefly to their own agility in leaping on their horses' backs, and that whether standing on the right side or the left.

They who fought on horseback with the spear or lance had a projection on the spear, or sometimes a loop of cord, about two feet from the bottom of it, which served at once for a firmer grasp of the weapon, and a step on which the right or the left foot might be placed, according to the side on which the warrior intended to mount, and from which he could easily vault on his courser's back. The horse was sometimes taught to assist the rider in mounting by bending his neck or kneeling down. The magnates always had their slaves by their horse's side to assist them in mounting and dismounting. Some made use of a short ladder; and it was the duty of the local magistracy, both in Rome and Greece, to see that convenient stepping-stones were placed at short distances along all the roads.

The boot for the defence of the leg from the dangers to which it was

exposed was very early adopted, and the heel of it was, occasionally at least, armed with a spur.

The horses' feet were unshod, the paved or flinty roads, which are now so destructive to the feet, being in a manner unknown. Occasionally, however, from natural weakness of the foot, or from travelling too far or too fast over the causeways, lameness then, as now, occurred. In order to prevent this, the Greeks and the Romans were accustomed to fasten a sort of sandal or stocking, made of sedges twisted together like a mat, or else of leather, and where the owner could afford it, strengthened with plates of iron, and sometimes adorned with silver and even with gold, as was the case with the horses of Poppæa and Nero.

There was a peculiarity in the Greek mode of riding, at least with regard to the cavalry horses, and, sometimes, those used for pleasure. Two or three of them were tied together by their bridles, and the horseman, at full speed, leaped from one to another at his pleasure. This might occasionally be useful; when one horse was tired or wounded, the warrior might leap upon another; but he would be so hampered by the management of all of them, and the attention which he was compelled to pay to them all, that it never became the general way of riding or fighting; nor was it practised in any other country. Homer, in his 15th Iliad, alludes to it as a feat of skill attempted in sport. The following is a translation of the passage:—'Just as a skilful horseman riding four chosen horses along a public road to some great city, where his course is to terminate, the whole town assembles to behold him, and gaze upon him with wonder and applause; while he leaps with ease from the back of one horse to another, and flies along with them.'

The Greeks must have carried their management of the horse to a very high state of perfection; and the Grecian horse must have been exceedingly docile, when exhibitions of this kind could take place.

It was, however, to the draught of the chariot that this animal was principally devoted in some other countries, and among the Greeks in the early period of their history. No mention is made of a single horseman on either side, during the ten years' siege of Troy; but the warriors all fought on foot or in chariots.

The chariots were simple in their structure, open at the back, and partly on the sides; and containing the driver in the front, and the warrior standing on a platform, usually somewhat elevated. These vehicles seem to have been rarely brought into collision with each other; but they were driven rapidly over the field, the warrior hurling his lances on either side, or alighting when he met with a foe worthy of his attack. These chariots were not only contrived for service, but were often most splendidly and expensively ornamented. They were the prize of the conqueror. Sometimes they were drawn by three horses; but the third was a spare one, in case either of the others should be tired or wounded. Some had four horses yoked abreast; such was the chariot of Hector.

The charioteer, although at the time inferior to, or under the command of the warrior, was seldom or never a menial. He was often the intimate friend of the warrior; thus Nestor, and even Hector, are found acting as charioteers. When not the personal friend of the warrior, he was usually a charioteer by profession; and drove where he was directed.

Occasional mention is made of the *currus fuleati*, chariots with armed instruments in the form of scythes, projecting from the axles of the wheels, by means of which whole ranks might be mown down at once. They were confined, however, to the more barbarous nations, and were used neither by the Greeks nor the Romans. They were advantageous only on tolerably open or level ground; and it not unfrequently happened



that, affrighted by the clamour of the battle, or by wounds, the horses became ungovernable, and, turning on the ranks of their friends, threw them into complete disorder. They were on this account laid aside, even by the barbarians themselves.

In process of time, war-chariots of every kind fell into disuse, and the higher classes of warriors were content to fight on horseback, where their personal strength and courage might be as well displayed, and discipline could be better preserved.

Still, almost to the period of the Christian era, and long after that in many countries, the use of the horse was confined to war, to the chase, and to public pageants. The first employment of the Egyptian colonists, when they landed in Thessaly, was to rid the forests of the wild cattle, and other dangerous animals, with which they were then peopled. In the central and southern parts of Greece, the country was more open and the wilder animals were scarcely known; but in Assyria and Persia, and every country in which the legitimate prey of the hunter was found, the horse was employed in its pursuit.

In process of time, in order to decide the comparative value of different horses, or to gratify the vanity of their owners, and also to give more effect to certain religious rites and public spectacles, horse-races were introduced. The most celebrated of these exhibitions was that at Olympia, in Peloponnesus, held every fourth year, in honour of Jupiter. The young men flocked thither from every district of Greece, to contend in every manly exercise—hurling the javelin, leaping, running, wrestling and boxing. The candidates were persons of unblemished reputation—the contest fairly and honourably conducted, and the conqueror, crowned with a laurel, or with gold, was received in his native town with acclamations of joy. A breach was made in the wall of the town for one who had so distinguished himself to pass. He was, for life, entitled to precedence at every public exhibition; he was exempted from all taxes and inferior civil offices; his name was enrolled in the archives of his country, and statues were erected to his memory. This was the source of the noble spirit of emulation and the ardent love of country by which the Greek was distinguished.

Nearly a century, however, passed before the attraction of the exhibition was increased by the labours of the horse. The first colonists could bring with them only a few of these noble animals. In several of the wars in which they were engaged, their deficiency in cavalry was lamentably apparent. It was not until the 23rd Olympiad that the horse mingled in the contest.

During the first two Olympiads after this, horsemen alone appeared. Of these races the accounts are exceedingly imperfect. Each horse was ridden by his owner, who was obliged to undergo preparatory trials for the space of thirty days. The horses were divided into full and under-aged; but no explanation is given by any writer of the precise meaning of these terms, nor is anything said of the weight of the riders. We only know the space to be run over, which somewhat exceeded four miles. There was one race called *Colne*, in which mares alone were permitted to run. Towards the end of the course the riders were compelled to leap from their backs, and, keeping the bridle in their hands, to run alongside of them to the winning-post.

In the 25th Olympiad, chariot-races were introduced. The chariots were arranged abreast of each other at the starting-post; the places—for it will appear that these gave some important advantages—having been previously decided by lot. An altar was erected on one side, upon which stood a brazen eagle, dedicated to Jupiter, and a dolphin, sacred to

Neptune. At a signal from the presiding officer, the eagle, by some mechanism, sprang into the air, the dolphin sank under ground; and away the horses started. The hippodrome, or course, was about one-third of a mile in length; and at the farther end was a pillar, round which the chariots were to be driven and back again to the starting-place six times, making rather more than four miles.

The rounding of this pillar was the first test of the skill of the driver and the docility of the horses, and many an accident happened there.

This dangerous spot was no sooner passed, than the competitors came at once upon a strange figure placed to try the courage and nerve of the horses. It was an enormous statue, called Taraxippus, the terrifier of horses; and, according to old writers, well worthy of the name. None of them describe this strange deity, but all agree that he used sadly to frighten the steeds, and often to endanger their lives, and that of the drivers.

A little further on was a lofty rock, in the very centre of the course, leaving only a very narrow defile, in the passing through which the skill of the charioteer was severely tried; while several men, placed on the rock, increased the confusion and the terror of the horses, by the continual braying of their trumpets.

As may be well supposed, the number of the competitors was much diminished ere the conclusion of the race. Some ran against the pillar, others were frightened out of the course by the horrible statue, and not a few were wrecked on that fearful rock. Some were destroyed on the spot; others, who escaped without serious injury, were derided by the spectators, on account of their want of skill; and the fragments with which the course was covered rendered almost every step perilous. 'The conqueror in such a race,' says Pausanias, 'well deserved the crown which he received, and the honours that were bestowed on him.'

What were the opinions which prevailed at this early period respecting the proper form—the points of the horse? Let that master horseman, Xenophon, declare:—'The first thing that ought to be looked to is the foot; for as a horse would be of no use, though all the upper parts of it were beautiful, if the lower parts of it had not a proper foundation, so a horse would not be of any use in war if he had tender feet, even though he should have all other good qualities; for his good qualities could not be made any valuable use of.' This maxim, more than 2,200 years old, bespeaks at once the horseman.

'Thick hoofs make a horse's feet better than thin ones.' This must be self-evident, where there was no artificial protection of the foot. The force with which the foot will come in contact with the ground at every step will produce sufficient expansion of the heel; but it is only a strong foot that can long endure the concussion, without being worn away.

'It likewise must not be forgotten to see whether the hoofs are high or low; and near the ground, both before and behind.' Few things are of greater importance than this. If the *inclination* of the foot in front is less than its usual angle (forty-five degrees), it indicates a contracted foot, and a morbidly hollow sole, and inflammation of the laminae, and speedy and incurable lameness. If the inclination is greater, and the angle acuter than it should be, there is flatness of the sole, and liability to serious bruise of it, or, perhaps, pumiced feet.

'The pasterns, or bones immediately above the hoofs and below the fetlocks, ought not to be straight like those of a goat, for this would shake the rider, and such legs are more subject to inflammation; nor ought these bones to be too low, for the fetlock would be chafed and ulcerated if the horse was ridden over ploughed grounds, or among stones.' If he had added

that the oblique pastern was sadly liable to sprain, and there would often be injury through the whole course of the flexor tendon, nothing could have been added to the force of his observation.

‘The bones of the legs ought to be large, since they are supporters of the body; not, however, thick with veins or cellular matter.’ He is speaking of the war-horse and the hunter; and what can be more correct?

‘If the colt in walking bends his knees freely, you may judge, when he comes to be ridden, that his legs will be supple; and supple joints are justly commended, as they make a horse less liable to stumble, and not tire so soon as when his joints are stiff.’

‘The thighs under the shoulders (the fore-arms), when they are large, are both powerful and graceful; and the chest being large, contributes not only to beauty and strength, but to a horse’s being able to continue a long time in one pace.’

‘The neck should proceed from the chest, rising upwards, and it should be loose about the bend of the head; the head too, being bony, should have a small cheek. The eye should be standing out, and not sunk in the cheek. The nostrils that are wide, are not only better adapted for breathing than those that are compressed, but likewise cause the horse to appear more terrible in battle. The top of the head being large, and the ears small, makes the head appear more elegant. The point of the shoulder likewise, being high, renders that part of the body more compact.’ The author was evidently aware of the advantage of this form, but he did not know the principles on which it was founded.

‘The sides, being deep and swelling towards the belly, make a horse in general more commodious to be seated on, and better able to digest his food. The broader and shorter his loins are, the more readily will he throw his fore feet out; and the belly that appears small, being large, not only disfigures a horse, but makes him weaker and less able to carry his rider.’ How beautifully again he seizes the point, although we of the present day smile a little at his illustration!

‘The haunches should be large and full of flesh, that they may correspond with the sides and the chest; and when all these are firm, they make a horse lighter for the course and fuller of animation.’

Another work of Xenophon, *Περὶ Ἱππικῆς*,—on the management of the horse,—exhibits equal proof of a knowledge of the points and proper treatment of this animal, mixed with the same ignorance of the principles on which these things are founded. He was an acute observer, and the facts made their due impression, but no one had yet taught the anatomy and physiology of the horse.

The Romans, from the very building of their cities, paid much attention to the breeding and management of the horse; but this was more than 700 years after this animal had been imported into Greece, and his value and importance had begun to be almost universally acknowledged.

Horse and chariot races were early introduced at Rome. The chariot races fell gradually into disrepute, but the horse races were continued to the times of the Cæsars, and the young men of the equestrian order were enthusiastically devoted to this exercise. There were not, however, any of the difficulties or dangers that attended the Grecian races. They were chiefly trials of speed or of dexterity in the performance of certain circles, now properly confined to our theatrical exhibitions. The rider would stand upright on his steed, lie along his back, pick up things from the ground at full speed, and leap from horse to horse in the swiftest gallop.

A singular circumstance in the management of this animal by the Romans was the superior value which they attributed to the mare. Their natural historians, agriculturists, and poets unite in this opinion. Perhaps

this might in part arise from the custom of the Romans to castrate all the horses that were employed in mercantile and agricultural pursuits. The horse, however, was not degraded by the operation or the labour, but rather he was made to occupy the situation for which nature designed him; and from this time, and gradually over every part of Europe, he has become one of the most useful of the servants of man.

To the Romans may be attributed the invention of the curb bit. The Emperor Theodosius is represented in one of the ancient sculptures as using a bit with a tremendously long lever, and which could inflict dreadful punishment if the rider were so inclined.

It may readily be supposed that a knowledge of the horse now became more perfect and more diffused. Terrentius Varro, who flourished about the year 70 before Christ, and during the existence of the commonwealth, has given a description of the horse, which has scarcely been excelled in modern times. 'We may prognosticate great things of a colt,' says he, 'if, when running in the pastures, he is ambitious to get before his companions, and if, in coming to a river, he strives to be the first to plunge into it. *His head should be small*, his limbs clean and compact, his eyes bright and sparkling, his nostrils open and large, his ears placed near each other, his mane strong and full, his chest broad, his shoulders flat and sloping backward, his barrel round and compact, his loins broad and strong, his tail full and bushy, his legs straight and even, his knees broad and well knit, his hoofs hard and tough, and his veins large and swelling over all his body.'

Virgil, eighty or ninety years afterwards, gives some interesting accounts of the horse, and particularly when taken from the pursuits of war and employed in the peaceful service of agriculture.

A few years after him followed Columella, who, in a work devoted exclusively to agriculture, treats at length of the management of the horse and of many of his diseases.

To him succeeded Palladius on agriculture, the management of the vineyard, and the apiary, &c.; and he also describes at considerable length the treatment and the diseases of the horse.

About the same time, or somewhat before, the Roman emperors being continually engaged in foreign wars, and in many of these expeditions the cavalry forming a most effective division of the army, veterinary surgeons were appointed to each of the legions. The horse and his management and diseases were then for the first time systematically studied. The works, or extracts from the works, of a few of them are preserved. There is, however, little in them that is valuable.

About the middle of the fourth century a volume of a different character on the veterinary art was written by Vegetius, who appears to have been attached to the army, but in what situation is unknown. His work, with all its errors, is truly valuable as a collection of the best remarks that had been written on veterinary matters, from the earliest age to his day and including extracts from the works of Chiron and Hippocrates, which would otherwise have been lost. The history of the symptoms of various diseases is singularly correct, but the mode of treatment reflects little credit on the veterinary acquirements of the author or the age in which he lived.

Almost in his time the irruptions of the Goths commenced, and shortly after every record of science was swept away in both the eastern and the western empires.

## CHAPTER II.

## THE FOREIGN BREEDS OF HORSES.

WE commence again with that country connected with which we have the earliest history of the horse.

## THE EGYPTIAN HORSES.

Notwithstanding the flattering reports of travellers, and the assertion of Dr. Shaw that the Egyptian horses are preferable to the Barbary ones in size, beauty, and goodness, the modern horse of this country had little to recommend him. The despotism under which the inhabitants groaned altogether discouraged the rearing of a valuable breed, for their possession was completely at the mercy of their Turkish oppressors, and the choicest of their animals were often taken from them without the slightest remuneration for the wrong. It was therefore a common practice with the owners of superior or good horses to blemish or to lame them, in order that they might not be robbed of them by order of the Bey.

Of the state to which the native horses were reduced, and even many in the corps of the Mamelukes—the body-guard of the Bey—the following evidence from a competent observer will determine. Wilson, in his ‘Expedition to Egypt,’ tells us—‘Although the horses there seldom pass out of a foot pace except for a gallop of 100 yards, most of them are foundered, and none, if quickly trotted ten miles, would be able, from want of wind and stamina, to go farther.’

The testimony of Burekhardt is to the same effect:—‘The Egyptian horse is ugly, of coarse shape, and looking more like a cart-horse than a racer. Thin legs and knees and short and thick necks are frequent defects among them. The head is sometimes fine, but I never saw good legs in an Egyptian horse. They are not able to bear any great fatigue, but when well fed, their action occasionally is more brilliant than that of the Arabian. Their impetuosity, however, renders them peculiarly desirable for heavy cavalry, and it is upon this quality alone that their celebrity has ever been founded.’

Since the accession of Mehemet Ali to the government of Egypt, a beneficial change has been effected in the internal management and prosperity of the country, and the improvement of the breed of horses has especially engaged his attention. He has even gone so far as to establish a veterinary school at Abou-Zabel, and, as should be the case with every institution of this kind, he has not only identified it with the cavalry service, but with the agricultural interests of the country. The happy consequences of this are neither doubtful nor distant.

There is a long but narrow tract of desert between the Nile and the Red Sea, on which some Arabian horses of the choicest breed are reared.

## THE DONGOLA OR NUBIAN HORSE.

The kingdom of Dongola, the modern Nubia, lying between Egypt and Abyssinia, contains a breed of horses different from any other that either Arabia or Africa produces. Mr. Bruce speaks of it in the following strong terms of approbation:—‘What figure the Nubian breed of horses would make in point of swiftness is very doubtful, their form being so entirely different from that of the Arabian; but if beautiful and symmetrical parts, great size and strength, the most agile, nervous, and elastic

movements, great endurance of fatigue, docility of temper, and, beyond any other domestic animal, seeming attachment to man, can promise anything for a stallion, the Nubian is, above all comparison, the most eligible in the world. Few of them are less than sixteen hands high.'

Bosman, whose descriptions prove him to be no bad horseman, thus speaks of them:—'The Dongola horses are the most perfect in the world, being beautiful, symmetrical in their parts, nervous and elastic in their movements, and docile and affectionate in their manners. One of these horses was sold in 1816, at Grand Cairo, for a sum equivalent to 1,000*l.*' The Dongola horses are usually of a black colour, but there are some bright bays and sorrels. When their exercise is over, the usual bridle is taken away, and a lighter one put upon them; for the inhabitants tell of many battles that were lost, from their being attacked when their horses were unbridled.

The slender yet finely set on neck, the noble crest, the elevated withers, the beautiful action and bearing of the animal were admirable; but the long and slender legs, the weakness of the fore-arm, the narrowness and want of depth of the chest, and even a deficiency of substance about the flank and quarters, could not escape observation. Such an animal might have speed, but his endurance must be doubtful, and it is difficult to suppose that any breed of English horses could be materially improved by it.

Some of these horses have lately reached England: and one of them was recently in London, and belonged to an officer of the Life Guards.

#### THE HORSE OF ETHIOPIA OR ABYSSINIA.

Ludolph, in his history of this country, says that the horses are strong, nimble, mettlesome, and mostly black. They are used only for war and in the chase; they travel no long and fatiguing journeys, and all the drudgery of every kind is performed by the mule.

An Abyssinian who accompanied Ludolph to Europe expressed a great deal of pity for the horses when he saw them drawing heavy carts, and loudly exclaimed at the cruelty of putting so noble a creature to such base and servile employment. He said that he wondered at the patience of the animals, and was every moment in expectation that they would rebel against such unheard-of tyranny.

The number of horses in Ethiopia must have considerably decreased, for Cyrtacus, a former king of that country, entered Egypt at the head of 100,000 cavalry.

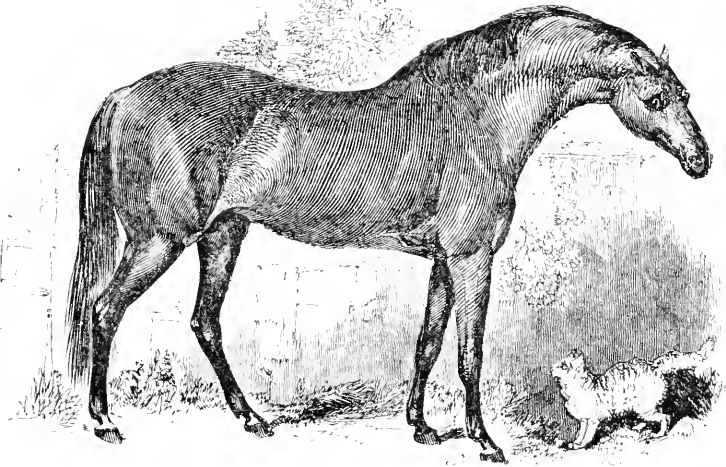
The art of shoeing had not in Ludolph's time (the middle of the seventeenth century) reached Abyssinia; and consequently, when the natives had to travel over rough and stony ground, they dismounted and got upon mules, and led their horses in hand, that by having no burden to carry, they might tread the lighter.

Bruce says little of the Ethiopian horses; but Mr. Salt, an enterprising traveller, says that the horses are generally strong, well-made, and kept in good condition; that their accoutrements are also good, and the men themselves are excellent horsemen.

#### THE BARB.

By the term Barbary is understood the northern part of Africa, extending along the coast, and as far inland as the Great Desert, from the frontiers of Egypt to the Mediterranean. The Arabs that are found in this extensive district are mostly the descendants of those who emigrated or were driven from eastern Arabia. The horses are likewise all of Arab stock, considerably modified by change of climate, food, and manage-

ment. Mr. Bruce relates, that 'the best African horses are said to be descended from one of the five on which Mahomet and his four immediate



THE GODOLPHIN ARABIAN.

successors fled from Mecca to Medina, on the night of the Hegira.' This must be received with very considerable allowance. The inhabitants of almost the whole of these countries are as cruelly oppressed as the Fellahs of Egypt, and the consequence of that oppression is the same. The Arabs will scarcely be induced to cultivate a breed of horses of much value, when, without scruple or compensation, they may be deprived of every colt by the first man in power that chooses to take a fancy to it. It is only among the tribes of the Desert, who are beyond the reach of the tyrants of their country, that the Barb of superior breed, form, and power, is to be found.

The common horse of Barbary is a very inferior animal—just such a one as many years of supineness and neglect would produce; but the following are the characteristic points of a true Barb, and especially from Morocco, Fez, and the interior of Tripoli, as described by Berenger:— 'The forehead is long, slender, and ill-furnished with hair, but rising distinctly and boldly out of their withers; the head is small and lean; the ears well-formed and well-placed; the shoulders light, sloping backward, and flat; the withers fine and high; the loins straight and short; the flanks and ribs round and full, and with not too much band; the haunches strong; the croup, perhaps, a little too long; the quarters muscular and well developed; the legs clean, with the tendons boldly detached from the bone; the pastern somewhat too long and oblique; and the foot sound and good. They are rather lower than the Arabian, seldom exceeding fourteen hands and an inch, and have not his spirit, or speed, or continuance, although in general form they are probably his superior.'

The Barb has chiefly contributed to the excellence of the Spanish horse; and, when the improvement of the breed of horses began to be systematically pursued in Great Britain, the Barb was very early introduced. The Godolphin Arabian, as he is called, and who was the

origin of some of our best racing blood, was a Barb; and others of our most celebrated turf-horses trace their descent from African mares. They are generally first mounted at two years old. They are never castrated, for a 'Massulman would not mutilate or sell the skin of the beast of the Prophet.' The horses alone are used for the saddle, and the mares are kept for breeding. No Arab ever mounts a stallion; on the contrary, in Africa they never ride mares. The reason is plain. The Arabs are constantly at war with their neighbours, and always endeavour to take their enemies by surprise in the grey of the evening or the dawn of day. A stallion no sooner smells the stale of the mare in the enemy's quarters, than he begins to neigh, and that would give the alarm to the party intended to be surprised. No such thing can ever happen when they ride mares only. On the contrary, the African trusts only to superior force. They are in an open plain country, must be discovered at many miles' distance, and all such surprises and stratagems are useless to them. The cavalry exercise to which their horses are exposed is exceedingly severe. The Moorish method of fighting principally consists in galloping at the very height of their horses' speed for the distance of a quarter of a mile or more, then suddenly stopping while the rider throws his spear or discharges his musket. By way of exercise, they will sometimes continue to do this without a moment's intermission to change or to breathe their horse. All that is required of the best-taught and most valuable Barbary horse is thus to gallop and to stop, and to stand still, all the day if it is necessary, when his rider quits him. As for trotting, cantering, or ambling, it would be an unpardonable fault were he ever to be guilty of it. A Barbary horse is generally broken in in a far severer way, and much earlier than he ought to be, and therefore he usually becomes unfit for service long before the Arabian. The usual food for the Barb is barley and chopped straw, and grass while it is to be found, but of the provision for winter food in the form of hay they are altogether ignorant.

Captain Brown, in his 'Biographical Sketches of Horses,' gives the following interesting account of a Barb and his rider, at the Cape of Good Hope:—'In one of the violent storms which often occur there, a vessel in the road dragged her anchors, and was forced on the rocks, and beaten to pieces. The greater part of the crew perished immediately, but some few were seen from the shore clinging to different pieces of the wreck. No boat could venture to their assistance. Meanwhile a planter came from his farm to see the shipwreck, and perceiving no other chance of escape for the survivors, and knowing the spirit of his horse and his excellence as a swimmer, he determined to make one desperate effort for their deliverance, and pushed into the midst of the breakers. At first both disappeared, but they were soon seen on the surface. Nearing the wreck, he induced two of the poor fellows to quit their hold and to cling to his boots, and so he brought them safe ashore. He repeated this perilous expedition seven times, and saved fourteen lives; but on his return, the eighth time, his horse being much fatigued, and meeting with a formidable wave, the rider lost his balance and was overwhelmed in a moment. The horse swam safely to land, but his gallant rider was seen no more. The Cape was then a colony of the Dutch. The directors christened one of their new vessels after him, and ordered a pillar to be erected to his memory, but the local authorities refused to the son a trifling place which his father filled.'

The Barb improves towards the Western coast of Africa, both in his form and graceful action.

Deep in the Sahara Desert is a noble breed of Barbs, known by the



name of the 'Wind-sucker or the Desert-horse.' Jackson says of him that the Desert-horse is to the common Barbary horse what the Desert-camel is to the usual camel of burden; but that he can only be induced to eat barley or wheat—oats are never given to horses in Africa; but that, supplied with a little camel's milk, he will travel almost incredible distances across the Desert. He is principally employed in hunting the antelope and the ostrich.

There is some little exaggeration, however, about this, for when he is brought towards the coast, and can no longer get his camel's milk, he will eat the barley and the straw which are given to him, and will thrive and get fat upon them. If he chances to die, it is from being suffered to gorge too much of his new food; or if he loses a portion of his speed and wind, it is because he has been taken out of his exercise, and permitted to accumulate flesh and fat too fast.

More in the centre of Africa, in the kingdom of Bournou, is a breed, which Mr. Tully, in his almost romantic history of Tripoli, reckons superior even to those of Arabia or Barbary; it possesses, according to him, the best qualities of both those breeds, being as serviceable as that of Arabia, and as beautiful as that of Barbary.

On the south of the Great Sahara Desert we find again the Arabian or the Barbary horse in the possession of some of the chiefs of the Foulahs and the Jalofs; but the general character of the animal is in those torrid regions much deteriorated. These horses are small, weak, unsafe, and untractable. The Foulahs, however, can bring into the field no fewer than 16,000 cavalry. Some writers have asserted, that in the kingdom of Benin a much larger number could be collected.

In the country lying between that of the Foulahs and the kingdom of Benin, there are few horses immediately on the coast, but they are more numerous in the inland districts. Bosman, however, says of them that they are very ill-shaped; that they carry their heads and necks more projecting and depressed than even the ass; that they are slow and obstinate, and only to be forced on by dint of blows; and that they are so low, that a tall man sitting on their backs could touch the ground with his feet. He adds that at Fida, on the Slave-coast, whence he journeyed inland to Elmina, he bought five or six of them, each of which cost him somewhat less than 4*l.*, but they did him no manner of service, and he was compelled to leave them behind. Neither horses, nor any other produce of value, can be looked for in these unhappy countries, so long as they are desolated by the abominable slave-trade, under the sanction of the more civilised but truly unchristian nations of Europe.

#### THE CAPE OF GOOD HOPE HORSE.

Nothing is certainly known of the western coast of Africa, descending towards the south: but arriving at the Cape of Good Hope, we find that the horse, if a native of that country, is only occasionally seen in its wild state. The horses that were introduced by the first colonists, the Dutch, were mostly procured from Batavia, Java, and South America. At the very commencement of the colony, many horses were imported from Persia. These were mingled together, and crossed in every possible way, except that not one notion of scientific improvement seems to have entered the head of the Dutch boor. They were a small hardy race, capable of enduring a great deal of fatigue, but in every way sadly neglected; never dressed, and often ill-fed.

When the Cape was ceded to the English, both the colonists and the government set earnestly to work to improve these undersized animals, and with very considerable success. The British light regiments of dragoons,

in their passage to the East, can now frequently draw considerable supplies of horses from this colony, and some regiments have been entirely mounted here. This is sufficient proof of the degree of improvement which they have reached. It is, however, said, by Percival, in his 'Cape of Good Hope,' that the riding-masters have occasionally much trouble in breaking in the Cape horses, which are naturally vicious, and especially when put beyond the pace to which they had been accustomed. They rarely stand above fourteen hands high; they are hardy, and when thoroughly broken in, are capable of enduring great privations and fatigue. They are rarely shod while they remain in the colony, or if they are, it is only on the fore feet. Their principal food is carrots, with a small quantity of corn. No hay is grown near Cape Town, nor are there any pastures on which the horses can be turned.

The wild horses have long disappeared near to the colony, and we have no authentic record that any of them were ever taken and attempted to be domesticated.

The horse is rarely seen in any part of the eastern coast of Africa. It is not a native of Madagascar, but is again found in Ajan and Adel, on the southern frontiers of Abyssinia.

#### THE ARABIAN HORSE.

Although modern Europe owes so much to Arabia for the improvement in her breed of horses, it may be doubted whether these animals were found in that country as a matter of merchandise, or indeed existed there at all in large numbers in very early times. The author of the book of Job, in describing the wealth of that patriarch, who was a native of Arabia, and the richest man of his time, makes no mention of horses, although the writer shows himself very conversant with that animal. Five hundred years after that, Solomon imported spices, gold, and silver, from Arabia; but we are told in Chronicles, all the horses for his own cavalry and chariots, and those with which he supplied the Phœnician monarchs, he procured from Egypt.

There is a curious record of the commerce of different countries at the close of the second century. Among the articles exported from Egypt to Arabia, and particularly as presents to reigning monarchs, were horses.

In the fourth century, two hundred Cappadocian horses were sent by the Roman emperor as the most acceptable present he could offer a powerful prince of Arabia.

So late as the seventh century the Arabs had few horses, and those of little value; for when Mahomet attacked the Koreish near Mecca, he had but two horses in his whole army; and at the close of his murderous campaign, although he drove off twenty-four thousand camels and forty thousand sheep, and carried away twenty-four thousand ounces of silver, not one horse appears in the list of plunder.

These circumstances sufficiently prove that, however superior may be the present breed, it is comparatively lately that the horse was naturalised in Arabia. Indeed the Arabs do not deny this; for until within the last century, when their horses began to be so deservedly valued, they were content to limit their pedigree to one of the five on which Mahomet and his four immediate successors fled from Mecca to Medina on the night of the Hegira.

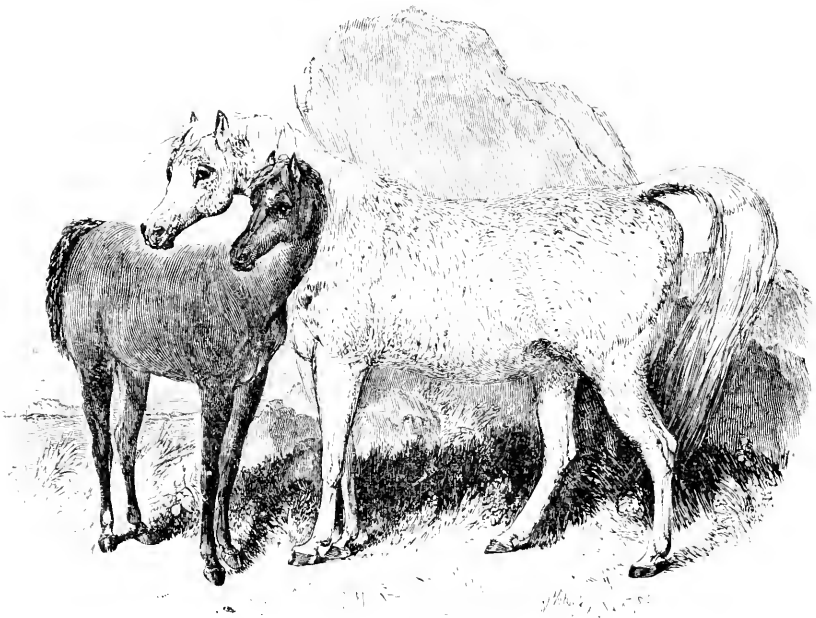
Although in the seventh century the Arabs had no horses of value, yet those which they had derived from their neighbours began then to be preserved with so much care, and propagated so uniformly and strictly from the finest of the breed, that in the thirteenth century the Arabian horse began to assume a just and unrivalled celebrity.

There are now said to be three breeds or varieties of Arabian horses :

the *Attechi*, or inferior breed, on which the natives set little value, and which are found wild on some parts of the deserts; the *Kadischi*, literally horses of an unknown race, answering to our half-bred horses—a mixed breed; and the *Kochlani*, horses whose genealogy, according to the modern exaggerated accounts, has been cultivated during two thousand years. Many written and attested pedigrees extend, with true Eastern exaggeration, to the stud of Solomon. The *Kochlani* are principally reared by the Bedouin Arabs in the remote deserts. A stallion may be procured without much difficulty, although at a great price. The Arabs imagine that the female is more concerned than the male in the excellence and value of the produce, and the genealogies of their horses are always traced through the dam.

The Arab horse would not be acknowledged by every judge to possess a perfect form. The head, however (like that which is delineated in the title-page), is inimitable. The broadness and squareness of the forehead; the smallness of the ears; the prominence and brilliancy of the eye; the shortness and fineness of the muzzle; the width of the nostril; the thinness of the lower jaw, and the beautifully developed course of the veins,—will always characterise the head of the Arabian horse. The cut in the title-page is the portrait of the head of a black Arabian presented to William IV. by the Imam of Muscat. It is a close and honest likeness. The muzzle, the nostrils, and the eye, are inimitable. In the sale of the Hampton Court stud, in 1837, this animal realised 580 guineas; it was bought for the King of Würtemberg, and was highly prized in Germany.

The body of the Arab may, perhaps, be considered as too light, and his chest too narrow; but behind the arms the barrel generally swells out,



ARAB MARE AND FOAL.

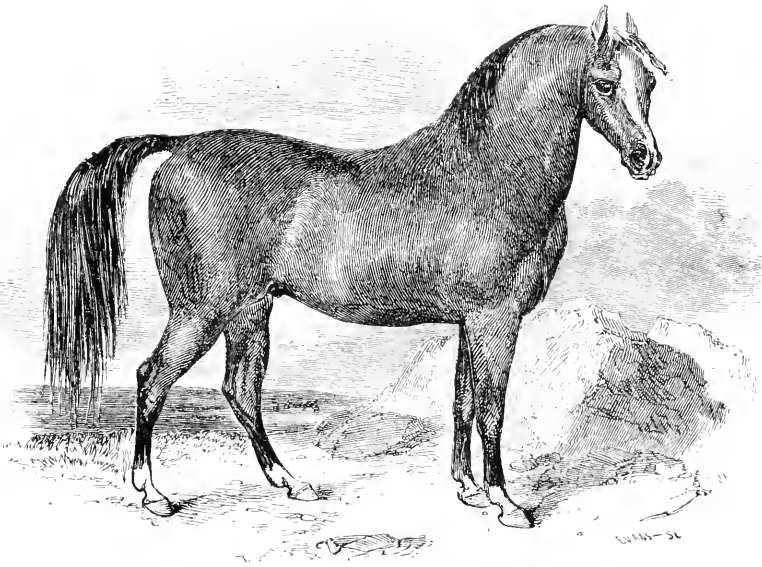
and leaves sufficient room for the play of the lungs. This is well exhibited in the cut of the grey Arabian mare, whose portrait is here given.

She is far inferior to the black one in the peculiar development of the head and neck, but in other respects affords a more faithful specimen of the true form of the Arabian horse. She is of the purest caste, and was a present from the same potentate by whom the black Arabian was given. The foal at her foot was by Acteon. She was sold for 100 guineas only. Perhaps her colour was against her. Her flea-bitten appearance would not please every one. The foal, which had more than the usual clumsiness belonging to the youngster, sold for 58 guineas.

The neck of the Arabian is long and arched, and beautifully joined to the chest. The black horse in the frontispiece afforded a perfect specimen of this. In the formation of the shoulder, next to that of the head, the Arab is superior to any other breed. The withers are high, and the shoulder-blade has its proper inclination backwards. It is also thickly clothed with muscle, but without the slightest appearance of heaviness.

The fineness of his legs and the oblique position of the pasterns might be supposed by the uninitiated to lessen his apparent strength, but the leg, although small is deep, and composed of bone of the densest character. The tendons are sufficiently distinct from the bone, and the starting muscles of the fore-arm and the thigh indicate that he is fully capable of accomplishing many of the feats that are recorded of him.

As a faithful specimen of the general form of these horses, with perhaps a little deficiency in the head and neck, we refer once more to the following portrait of a bay Arabian—an animal of the purest cast, presented also by the Imam of Muscat. It was sold for 410 guineas. The higher price that was given for the black Arabian proves that he was the general favourite; but the bay one, although not so striking in his figure was a stronger, a speedier, and a better horse.



BAY ARABIAN.

The Barb alone excels the Arabian in noble and spirited action; but if there is a defect about the latter, he is perfect for that which he was designed. He presents the true combination of speed and bottom:

strength enough to carry more than a light weight, and courage that would cause him to die rather than yield.

Mr. Burekhardt, in a letter to Professor Sewell, says that 'the tribes richest in horses are those who dwell, during the spring of the year at least, in the fertile plains of Mesopotamia; for, notwithstanding all that is said of the desert horse, plenty of nutritious food is absolutely requisite for its reaching its full vigour and growth. The numerous tribes on the Red Sea, between Akaba and Mecca, and especially those to the south of Mecca, and as far as Yemen, have very few horses; but the Curdes and Bedouins in the east, and especially in Mesopotamia, possess more horses, and more valuable ones, than all of the Arabian Bedouins; for the richness of their pastures easily nourishes the colts, and fills their studs.' These observations are very important, and are evidently founded on truth. He adds, that 'the number of horses in Arabia is not more than 50,000; a number far inferior to that found in any part of Europe, or Asia, on an equal extent of ground.'

'During the Wahabee government, horses became scarcer every year among the Arabs. They were sold by their masters to foreign purchasers, who carried them to Yemen, Syria, and Bassora; which latter place supplies India with Arabian horses, because they were afraid of having them seized upon by their chiefs—it having become the custom, upon every slight pretext of disobedience or crime, to declare the most valuable Bedouin mare forfeit to the public treasury.'

Syria is the best place to purchase true Arabian blood-horses; and no district is superior to the Naurau, where the horse may be purchased from the first hand, and chosen in the very encampments of the Arabs themselves, who fill these plains in the spring. The horses bought at Bassora for the Indian markets are purchased second-hand from Bedouin dealers. These procure them from the Montifell Arabs, who are not careful in maintaining a pure breed. Damascus would be the best residence for a person constantly employed in this trade.

While the number of horses generally is much smaller than had been supposed, there are comparatively fewer of those of perfect quality and beauty,—perhaps not more than five of six in a whole tribe; probably not two hundred in the whole desert. Each of these in the desert itself may be worth from one hundred and fifty to two hundred pounds; but very few, if any, of these have ever found their way to Europe.

There has, however, been much exaggeration with regard to these pedigrees. Burekhardt says, that in the interior of the desert, the Bedouins never make use of any, because, among themselves, they know the genealogy of their horse almost as well as that of their own families; but if they carry their horses to any distance, as to Bassora, Bagdat, or Damascus, they take care to have a written pedigree made out, in order to present it to the purchaser. In that case only would a Bedouin be found possessed of his horse's pedigree. He would laugh at it in the desert.

The Kochilani are principally reared by the Bedouin Arabs in the remoter deserts. One of them was sold at Acre for the sum of fifteen thousand piastres.

It is an error into which almost every writer on the history of the horse has fallen, that the Arabian is bred in the arid deserts, and owes the power of endurance which he possesses in his adult state to the hardships which he endured while he was a colt. The real fact is, that the Arabs select for their breeding-places some of those delightful spots, known only in countries like these, where, though all may be dry and barren around, there is pasture unrivalled for its succulence and its nutritious or aromatic properties. The powers of the young animal are afterwards developed, as

they alone could be, by the mingled influence of plentiful and healthy food, and sufficient, but not, except in one day of trial, cruel exercise.

The most extraordinary care is taken to preserve the purity of the breed. Burekhardt states that the favourite mare of Savud the Wahabee, which he constantly rode in all his expeditions, and was known in every part of Arabia, produced a colt of very superior beauty and promise, and it grew to be the finest stallion of his day. Savud, however, would never permit him to be used for the purposes of breeding, because his mother was not of pure blood; and not knowing what to do with him, as the Bedouins never ride stallions, he sent him as a present to the scherriff.

The parentage and birth of the foal are carefully recorded by competent witnesses, whose certificate includes the marks of the colt, and the names of the sire and dam.

The colt is never allowed to fall on the ground at the period of birth, but is caught in the arms of those who stand by, and washed and caressed as though it was an infant. The mare and her foal inhabit the same tent with the Bedouin and his children. The neck of the mare is often the pillow of the rider, and more frequently, of the children, who are rolling about upon her and the foal. No accident ever occurs, and the animal acquires that friendship and love for man which occasional ill-treatment will not cause her for a moment to forget.

At the end of a month the foal is weaned, and is fed on camel's milk for one hundred days. At the expiration of that period, a little wheat is allowed; and by degrees that quantity is increased, the milk continuing to be the principal food. This mode of feeding continues another hundred days, when the foal is permitted to graze in the neighbourhood of the tent. Barley is also given; and to this some camel's milk is added in the evening, if the Arab can afford it. By these means the Arab horse becomes as decidedly characterised for his docility and good temper, as for his speed and courage. The kindness with which he is treated from the time of his being foaled, gives him an affection for his master, a wish to please, a pride in exerting every energy in obedience to his commands, and, consequently, an apparent sagacity which is seldom found in other breeds. In that delightful book, Bishop Heber's 'Narrative of a Journey through the Upper Provinces of India,' the following interesting character is given of him:—'My morning rides are very pleasant. My horse is a nice, quiet, good-tempered little Arab, who is so fearless, that he goes without starting close to an elephant, and so gentle and docile that he eats bread out of my hand, and has almost as much attachment and coaxing ways as a dog. This seems the general character of the Arab horses, to judge from what I have seen in this country. It is not the fiery dashing animal I had supposed, but with more rationality about him, and more apparent confidence in his rider than the majority of English horses.'

When the Arab falls from his mare, and is unable to rise, she will immediately stand still, and neigh until assistance arrives. If he lies down to sleep, as fatigue sometimes compels him in the midst of the desert, she stands watchful over him, and neighs and arouses him if either man or beast approaches. The Arab horses are taught to rest occasionally in a standing position; and a great many of them never lie down.

The Arab loves his horse as truly and as much as the horse loves him; and no little portion of his time is often spent in talking to him and caressing him.

An old Arab had a valuable mare that had carried him for fifteen years in many a rapid weary march, and many a hard-fought battle; at length, eighty years old, and unable longer to ride her, he gave her, and a scimitar that had been his father's, to his eldest son, and told him to appreciate their

value, and never lie down to rest until he had rubbed them both as bright as a mirror. In the first skirmish in which the young man was engaged, he was killed, and the mare fell into the hands of the enemy. When the news reached the old man, he exclaimed, that 'life was no longer worth preserving, for he had lost both his son and his mare, and he grieved for one as much as the other.' He immediately sickened and soon afterwards died.

The following anecdote of the attachment of an Arab to his mare has often been told:—"The whole stock of an Arab of the desert consisted of a mare. The French consul offered to purchase her in order to send her to his sovereign, Louis XIV. The Arab would have rejected the proposal, but he was miserably poor; he had scarcely a rag to cover him, and his wife and his children were starving. The sum offered was great,—it would provide him and his family with food for life. At length, and reluctantly, he yielded. He brought the mare to the dwelling of the consul, dismounted and stood leaning upon her; he looked now at the gold, and then at his favourite. "To whom is it," said he, "I am going to yield thee up? To Europeans, who will tie thee close,—who will beat thee,—who will render thee miserable. Return with me, my beauty, my jewel, and rejoice the hearts of my children." As he pronounced the last words, he sprung upon her back, and was presently out of sight.'

One of our own countrymen, the enterprising traveller, Major Denham, affords us a pleasing instance of the attachment with which the docility and sagacity of this animal may inspire the owner. He thus relates the death of his favourite Arabian, in one of the most desert spots of Central Africa. His feelings needed no apology: we naturally honour the man in whom true sensibility and undaunted courage, exerted for useful purposes, were thus united:—

'There are a few situations in a man's life in which losses of this nature are felt most keenly; and this was one of them. It was not grief, but it was something very nearly approaching to it; and though I felt ashamed of the degree of derangement I suffered from it, yet it was several days before I could get over the loss. Let it, however, be remembered, that the poor animal had been my support and comfort,—nay, I may say, companion, through many a dreary day and night;—had endured both hunger and thirst in my service; and was so docile, that he would stand still for hours in the desert while I slept between his legs, his body affording me the only shelter that could be obtained from the powerful influence of a noon-day sun: he was yet the fleetest of the fleet, and ever foremost in the chase.'

Man, however, is an inconsistent being. The Arab who thus lives with and loves his horses, regarding them as his most valuable treasure, sometimes treats them with a cruelty scarcely to be credited. The severest treatment which the English race-horse endures is gentleness compared with *the trial* of the young Arabian. Probably the filly has never before been mounted. Her owner springs on her back, and goads her over the sands and rocks of the desert for fifty or sixty miles without one moment's respite. She is then forced, steaming and panting, into water deep enough for her to swim. If, immediately after this, she will eat as if nothing had occurred, her character is established, and she is acknowledged to be a genuine descendant of the *Kochlam* breed. The Arab does not think of the cruelty which he thus inflicts; he only follows an invariable custom.

We may not perhaps believe all that is told us of the speed and endurance of the Arabian. It has been remarked, that there are on the deserts which this horse traverses no mile-stones to mark the distance, or watches

to calculate the time; and that the Bedouin is naturally given to exaggeration, and most of all, when relating the prowess of the animal that he loves as dearly as his children: yet it cannot be denied that, at the introduction of the Arabian into the European stables, there was no horse comparable to him. The mare in her native deserts, will travel fifty miles without stopping; she has been urged to the almost incredible distance of one hundred and twenty miles, and, occasionally, neither she nor her rider has tasted food for three whole days.

Our horses would fare badly on the scanty nourishment afforded the Arabian. The mare usually has but two meals in twenty-four hours. During the day she is tied to the door of the tent, ready for the Bedouin to spring, at a moment's warning, into the saddle; or she is turned out before the tent ready saddled, the bridle being merely taken off, and she is so trained that she immediately gallops up at her master's call. At night she receives a little water; and with her scanty provender of five or six pounds of barley or beans, and sometimes a little straw, she lies down content, if she is accustomed to lie down at all, in the midst of her master's family.

Burekhardt relates a story of the speed and endurance of one of them, and shows with what feelings an Arab regards his quadruped friend:— 'A troop of Druses on horseback attacked, in the summer of 1815, a party of Bedouins, and pursued them to their encampment; the Bedouins were then assisted by a superior force, and becoming the assailants in their turn, killed all the Druses excepting one who fled. He was pursued by some of the best mounted Bedouins, but his mare, although fatigued, could not be overtaken. Before his pursuers gave up the chase, they called to him, and begged to be permitted to kiss his excellent mare, promising him safe conduct for her sake. He might have taken them at their word, for the pledge of an Arab, in such circumstances, might have been relied on: he however refused. They immediately left the pursuit, and blessing the noble beast, cried out to the fugitive, "Go and wash the feet of your mare and drink off the water." This expression is often used by the Bedouins to show the regard they have for their mares.'

A periodical writer in the 'Sportsman,' on what authority is not stated, but he is right in most of the particulars if not in all of them, says, that 'taking the comparative excellence of the different races, *Nejed*, between the desert of Syria and Yemen, and now in the possession of the Wahabis, is generally reckoned to produce the grandest, noblest horses. *Hejaz* (extending along the Red Sea, from Mount Sinai to Yemen, and including in it Medina and Mecca) the handsomest; Yemen (on the coast of the Red Sea and the Indian Ocean, and the most fertile part of Arabia) the most durable; Syria the richest in colour; Mesopotamia the most quiet; Egypt the swiftest; Barbary the most prolific; and Persia and Koordistan the most warlike.'

The introduction of the Arabian into England, and the concern which he has had in the improvement of the English horse, will be treated of in the next chapter.

#### THE PERSIAN HORSE.

Next in the route which has been pursued along the south of Asia, towards the east, and yielding only to the Arabian in beauty and value, stands the Persian horse. He is of larger growth than the Arabian,—purposely bred so,—and on that account some foreign—still east country, but not pure Arabian blood, being introduced. A larger animal, one more adapted for modern war, is the result, but with some diminution of speed and endurance. The Persian is a nobler-looking animal at the first glance,



but he will not bear the accurate examination that only increases our admiration of the other. Berenger thus describes their principal points:—‘They are in general small headed; they have long and somewhat too fine foreheads, and they are rather too narrow chested; their legs are a little small, but their croups are well fashioned, and their hoofs good and firm. They are docile, quick, light, bold, full of spirit, capable of enduring much fatigue, swift, sure-footed, hardy in constitution, and contented with almost any provender.’ They have, since his time, lost somewhat of the beauty, elasticity, docility, speed, and almost never-failing endurance.

The Persian Horses constituted in ancient times the best cavalry of the East. The improved, incomparable Arabian breed was not then in existence.

An entertaining traveller (Sir R. Kerr-Porter) gives the following account of them:—‘The Persian horses seldom exceed fourteen or fourteen and a half hands high, yet certainly, in the whole, are taller than the Arabs. Those of the desert and country about Hillah run very small, but are full of bone and of good speed. General custom feeds and waters them only at sunrise and sunset, when they are cleaned. Their usual provender is barley and chopped straw, which, if the animals are picketed, is put into a nose-bag and hung from their heads; but if stabled it is thrown into a small lozenge-shaped hole left in the thickness of the mud-wall for that purpose, but much higher up than the line of our mangers, and there the animal eats at his leisure. Hay is a kind of food not known here. The bedding of the horse consists of his dung. After being exposed to the drying influence of the sun during the day, it becomes pulverised, and, in that state, is nightly spread under him. It is the usual flooring of the stable and the tent. The united influence of the sun and air deprives it of all unpleasant odour, and when from use it becomes a second time offensive, it is again exposed to the sun, and all unpleasant smell once more taken away. Little of it touches his body, that being covered by his clothing, a large *mummud* from the ears to the tail, and bound firmly round his body by a very long surcingle. But this apparel is only for cold weather; in the warmer season the night-clothes are of a lighter substance, and during the heat of the day the animal is kept entirely under shade.

‘At night he is tied in the court-yard. The horses’ heads are attached to the place of security by double ropes from their halters, and the heels of their hinder legs are confined by cords of twisted hair, fastened to iron rings and pegs driven into the earth. The same custom prevailed in the time of Xenophon, and for the same reason: to secure them from being able to attack and maim each other, the whole stud generally consisting of stallions. Their keepers, however, always sleep on their rugs amongst them to prevent accident; and sometimes, notwithstanding all this care, they manage to break loose, and then the combat ensues. A general neighing, screaming, kicking, and snorting, soon rouses the grooms, and the scene for a while is terrible. Indeed no one can conceive the sudden uproar of such a moment who has not been in Eastern countries to hear it, and then all who have, must bear me witness that the noise is tremendous. They seize, bite, and kick each other with the most determined fury, and frequently cannot be separated before their heads and haunches stream with blood. Even in skirmishes with the natives, the horses take part in the fray, tearing each other with their teeth, while their masters are in similar close quarters on their backs.’

His description of a Persian race does not altogether remind us of Newmarket or Doneaster.

‘My curiosity was fully on the spur to see the racers, which I could

not doubt must have been chosen from the best in the nation to exhibit the perfection of its breed before the sovereign. The rival horses were divided into three sets, in order to lengthen the amusement. They had been in training for several weeks, going over the ground very often during that time; and when I did see them, I found so much pains had been taken to sweat and reduce their weight, that their bones were nearly cutting the skin. The distance marked for the race was a stretch of a four-and-twenty miles, and, that his majesty might not have to wait when he had reached the field, the horses had set forward long before, by three divisions, from the starting point, (a short interval of time passing between each set,) so that they might begin to come in a few minutes after the king had taken his seat. The different divisions arrived in regular order at the goal, but all so fatigued and exhausted that their former boasted fleetness hardly exceeded a moderate canter when they passed before the royal eyes.

The plains of Persepolis, Media, Ardebil and Derbane, rear annually a great number of valuable horses, but those bred in Kurdistan are accounted the best both in beauty and strength.

#### THE CIRCASSIAN HORSE.

The Circassian horse, although inferior to the Persian, does not often find his equal among the predatory hordes with which this part of Asia abounds. Vast numbers of horses and sheep are reared in the plains of Circassia, and they and the slaves which are made in the excursions form the principal articles of the commerce of the natives. Almost every family of distinction aims at possessing a peculiar breed of horses, excelling, in their estimation, that of any other tribe. Each breed is distinguished by its peculiar mark, to forge or to place which on an inferior breed would be punished with death. The most valuable breed of all is in the possession of the reigning family, and its distinguishing mark is a full horse-shoe. These horses possess considerable strength and speed.

#### THE EAST INDIAN HORSE.

We will now travel further eastward, and examine the breeds of horses in our Indian possessions. They are small, and, although some have considerable endurance and courage, they wear the general character of degeneracy from a nobler stock. First in value is the *Toorky*, originally from a Toorkoman and a Persian, beautiful in his form, graceful in his action, and docile in his temper. When skilfully managed his carriage is stately and grand. His spirit rising as his exertions are required, he exhibits to his beholders an appearance of fury in the performance of his task, yet preserving to his rider the utmost playfulness and gentleness. They are usually from fourteen to fifteen hands high, and have the common defect of the East India horse—smallness and length of bone below the knees and about the hocks.

Next comes the *Iranee*, well limbed, and his joints closely knit, and particularly powerful in the quarters, but with large head, and hanging ears, and deficiency of spirit.

The gentle and docile *Cozakee* is deep in the girth, powerful in the fore-arm, but with large head and cat-hammed; hardy, and calculated for long journeys and severe service.

The *Mojinniss* have spirit, beauty, speed, and perseverance.

The *Tuzsee* is slight, hollow-backed, and, for that reason perhaps, deficient in strength. His hind-legs are ill placed, and dragged as it were behind him, and he is stubborn and irritable; yet this horse is sought after on account of the peculiar easiness of his paces, a matter of no

small consideration where the heat is so great and the slightest exertion fatiguing.

A sale of horses near the Company's stud, at Hissar, is thus described by an excellent judge:—'Not less than one thousand horses were shown. They were all above fourteen hands and a half in height, high-crested, and showy-looking animals. The great defect seemed a want of bone below the knee, which is general to all the native horses throughout India; and also so great a tendency to fulness in the hocks, that, in England, it would be thought half of them had blood spavins.'

There are other studs in different parts of the country, in which some valuable stallions are kept for the purpose of improving the various Indian breeds. Almost all of them have a greater or lesser portion of Arabian blood in them, which gives them the appearance of good cavalry horses, but renders them inferior to the Arabians generally in swiftness and always in endurance. For this reason the native cavalry are principally mounted on Arabian horses, which are brought in great numbers, but of no considerable value, from Arabia and Syria.

It may be readily supposed that it was not long before races were established in the East Indies, and that they were properly patronised by the government. They were, however, confined almost entirely to the Arabian horses, for those of half-blood were manifestly inferior to them.

In 1828, *Recruit*, by *Whalebone*, a horse of some celebrity at the time, was sent out to Calcutta. This was deemed a proper opportunity to decide the question of superiority between the pure Arab and the true English racing blood, and he was matched against *Pyramus*, the best Arabian in Bengal. The distance was two miles, with give and take weights, fourteen hands to carry nine stone, and the Arabian to be allowed seven pounds; *Recruit* carried ten stones twelve pounds, and *Pyramus* only eight stones three pounds. They started well together, and ran the first part of the distance neck and neck, but at about half the distance *Recruit* took the lead, and the Arabian was beaten easily by several lengths. The distance was run in three minutes and fifty-seven seconds. Another trial took place between *Champion*, a first-rate Arabian, and *Constance*, a moderately good thoroughbred English horse. The Arabian won in a canter; the question, therefore, is thought by some persons to be yet undecided.

There is an East Indian pony, called the *Tattoo*, varying from ten to twelve hands in height. This is a serviceable and hardy animal for carrying baggage or any light weight. Tavernier describes one which he saw ridden by a young Mogul prince, of seven or eight years of age, and which was not much larger than a greyhound.

In 1765 one, not more than seven hands, or twenty-eight inches in height, was sent from India as a present to the queen of George III. It was taken from the ship to the palace in a hackney-coach. It was of a dun colour; and its hair resembled that of a young fawn. It was four years old, well proportioned, had fine ears, a quick eye, with a handsome long tail, and was thoroughly good natured and manageable.

The Mahrattas were two powerful tribes or nations, inhabiting the central part of Hindoostan, and their territory extending from sea to sea, across the south of the Deccan. Their wars among themselves, or in union with the British against Tippoo Saib, and afterwards against their former protectors and allies, are prominent objects in the modern history of India. Their troops consisted almost entirely of cavalry, composed of one of the best varieties of the half-blood Arabian and native horse. The Mahratta, when not on horseback, may be said to be almost constantly employed in shampooing his horse. It is properly so called, for he rubs him violently

with his wrists and elbows, as well as his hands, and moulds and bends his limbs in every direction. The Mahrattan way of riding is a singular and, according to European notions, a very ungraceful one. His knees are as high as his horse's back; he holds on with his heels, and clings with his hands either to the mane or the peak of the saddle. With such aids, his seat is more secure than at first sight it would appear to be. The peak of the saddle rises in the form of a crane's neck, and is said to have been borrowed from the Moguls. A crupper and a martingale are almost indispensable accompaniments of the Mahratta horse-furniture. It is a singular kind of crupper, however, not projecting from the centre of the saddle, but attached to both sides. The *tobsa*, or leathern vessel out of which the horse eats his corn, is also attached to the crupper, and this part of the trappings is generally ornamented with silver knobs, or with silk tassels or embroidery.

Their horses, like most of those in the East, are picketed, not only during the day, but very frequently in the night. A rope is carried from the head-stall on each side to a peg driven into the ground. A rope, or thong, is also tied round the fetlocks behind, and carried backwards twenty or thirty feet, and fastened to a peg. This pulls the horse back, and keeps him, when standing, on the stretch, but does not prevent him from lying down. When they are thus tethered, their eyes are covered, that they may not be alarmed by any object that passes. They are also clothed, in order that the beautiful, glossy appearance of their coat may be preserved.

They use the snaffle-bridle, but it is so jagged and pointed that the animal may be punished to the full content of any barbarian that may ride him. The headstall is usually ornamented, and from the rein a thong descends by which the horse may be occasionally reminded of his duty. The horseman has neither whip, switch, nor spur, but the horse is controlled, if he is disposed to rebel, by the cruel argument of the bit.

The breast of the Mahratta horse is more splendidly ornamented than any other part. Numerous coins, of different size and value—rupees and double rupees—are formed into plates more or less highly ornamented, and which in time of war form a rich booty for the conqueror. The mane, too, is generally plaited with silk-braids, and silver knobs attached to them, with a beautiful top-knot between the ears. If the rider has distinguished himself in war, some curious tails, said to be taken from the wild cow, dangle on either side.

#### THE BIRMAN AND CHINESE HORSE.

The Birman horses are small, but spirited and strong. There was one in 1842 in the menagerie belonging to the Zoological Society of London. He did not stand more than twelve hands high, but was a beautiful little fellow, and a picture of strength.

In SIAM the horses are few, and inferior to those of the Birman empire.

In COCHIN-CHINA, on the eastern coast of the peninsula, the horses are still small, but they are better formed, and more active and strong, than they are at Siam. In SUMATRA and JAVA the horses have not increased in size, but in form and usefulness they scarcely yield to any in the south-west of Asia. In BORNEO they are few, and scarcely deserving of notice. The horses of CHINA are, generally speaking, small, ill-formed, weak, and without spirit; indeed they have little occasion for the horse in the greater part of that immense empire.

#### THE AUSTRALIAN HORSE.

The new colonies of the British in Australia and its dependencies will present something more satisfactory. The greater part of the horses in

New South Wales, the eastern coast of Australia, were derived from the Cape of Good Hope and from India. Very little judgment was employed in the selection, and indeed very few horses of good quality could have been procured from either place. The consequence was, that a writer so late as 1824 says of them, that 'they are principally of the nag kind, and bred without much care. They are not very slightly in appearance, being narrow-chested and sharp-backed, and sadly deficient in the quarters. They have an incurable habit of shying, and they are not very sure-footed.' The New South Wales horses are seldom stabled, but are supposed to be healthier, and better able to endure fatigue, when kept in the open air. This, however, is probably only an excuse for neglect.

The sheep, however, prospering so well, and the cattle rapidly increasing and improving, the colonist began to be a little ashamed of his horses. Several of a better kind, cart and blood, were consequently imported from the mother-country—an Arabian was procured from India—and the Australian horse soon began to be a very different sort of animal. A writer of a few years' later date says: 'We have few thorough-bred cart-horses, almost all of them having a spice of blood about them, which makes them unsteady at draught, restive, and given to jibbing when put to a hard pull.' This was a very erroneous charge, and the writer seems to be aware of it, for he adds, 'this may arise in a great measure from their being badly broken in.' It was the faulty management and education of the horse, and not the portion of pure blood which he had acquired, that produced vices like these. The writer proceeds: 'We have many fine gig, carriage, and saddle horses, and even some that have pretensions to rank in the list of racers.' In fact, races were instituted at Sydney. A turf-club was formed, and horses of no despicable qualities entered the lists.

An excellent stallion, named Bay Cameron, was imported from England, and the owner netted by him, for the first season or two, more than 600*l.* per annum. Horses generally rose more than fifteen per cent. in value. Even at Sydney, 200*l.* and more were given for a horse of extraordinary figure and powers; and no good saddle, gig, or cart horse could be purchased for less than 40*l.*

These horses were found to be remarkably hardy, and could undergo considerable fatigue. The greatest fault was a heaviness of the head, with a considerable degree of obstinacy and sulkiness—as much, however, the fault of education as of natural disposition.

A still later writer says: 'that the breed is rapidly improving, and particularly the draught horses, from the importation of some of the Cleveland breed from England.' The true dray-horse, however, was yet to be found, and could not be procured from any of the native horses, not even with the assistance of the Cleveland. The mixture of English blood has not lessened the endurance of the native breed; for at the hottest time of the year, with the thermometer at times as high as ninety-six degrees in the shade, the writer says that he has ridden the same animal fifty miles a day for three successive days. They will all go through a vast deal of work, but they would have more endurance, if they were not broken in for the saddle and for harness so young. It is no unusual thing to ride them sixty miles in less than seven hours, and immediately turn them out, to pick up what scanty herbage they can find. The number of good horses was so rapidly increased, that their price had materially diminished, and scarcely more than 35*l.* could be got for the best of them.

The traveller adds, that there are some diseases to which the horse is subject in England, which are as yet unknown in New South Wales. Glanders has never made its appearance there. Greasy heels, the almost peculiar disease of Britain, have not been seen there. Strangles, however,

are prevalent, and, the author of the present work learns from another source, unusually severe.

In Van Diemen's Land the breed of horses, originally derived from India, is very good. A valuable breed of cart-horses is beginning to be formed. The riding-horses are small, but they are hardy. Horses of every kind are sixty per cent. dearer in Van Diemen's Land than in New South Wales; because the colony is smaller, and the number of horses that are bred is comparatively small. Their treatment is not so good as in the larger colony. Many of them know not the taste of corn, and, when it is given to them, it is usually in the straw.

#### THE TARTARIAN HORSE.

Tartary comprehends a vast extent of country, reaching from the Eastern Ocean, to the European dominions of Russia, through the central part of Asia and Europe. Eastern Tartary belongs chiefly to China—the Western has been subjected by Russia, but a small portion of it about the Caspian Sea claims to be independent. The tribes which inhabit this immense space are dissimilar in their appearance, manners, and customs; but, with a few exceptions, the character of the horse is nearly the same.

The WILD HORSE is found in various parts of Tartary; but nowhere can it be considered as a remnant of an original race that has never been domesticated. The horses of the Ukraine, and those of South America, are equally the descendants of those that had escaped from the slavery of man. The origin of the horses of Tartary has been clearly traced to those that were employed in the siege of Azof in 1657. Being suffered, from want of forage, to penetrate into the desert in order to find subsistence, they strayed to too great a distance to be pursued or recalled, and became wild and created a new breed. They are generally of a red colour, with a black stripe along the back. They are divided into numerous herds, at the head of each of which is an old stallion, who has fought his way to the crown, and whose pre-eminence is acknowledged by the rest. On the approach of apparent danger, the mares and their foals are driven into a close body, in front of which the males are ranged. There are frequent contests between the different herds. The domesticated horse, if he falls in their way unprotected by his master, is instantly attacked and speedily destroyed; but at the sight of a human being, and especially mounted, they all take to flight, and gallop into the recesses of the desert. The young stallions as they grow up are driven from the herd, and are seen straggling about at a distance, until they are strong enough to form herds of wild mares for themselves.

The Cossacks are accustomed to hunt the wild horses, partly to keep up their own stock, and partly for food. A species of vulture is sometimes made use of in this affair. The bird pounces upon the poor animal, and fastens itself on his head or neck, fluttering his wings, and perplexing, and half-blinding him, so that he becomes an easy prey to the Tartar. The young horses are generally tamed without much difficulty; they are, after a little while, coupled with a tame horse, and grow gentle and obedient. The wild horses thus reclaimed are usually found to be stronger and more serviceable than any which can be bred at home.

In the great deserts of Tartary, the herds of wild horses are much larger. Many thousands, as on the Pampas of South America, are often collected together. The Kirghise Tartars either capture them for use, or spear them for food.

The flesh of the horse is a frequent article of food among the Tartars; and although they do not, like the Indians of the Pampas, eat it raw, their

mode of cookery would not be very inviting to the European epicure. They cut the muscular part into slices, and place them under their saddles, and after they have galloped thirty or forty miles, the meat becomes tender and sodden, and fit for their table. At all their feasts, the first and last and most favourite dish is a horse's head, unless they have a roasted foal, which is the greatest delicacy that can be procured.

When water was not at hand, the Scythians used to draw blood from their horses, and drink it; and the Dukes of Muscovy, for nearly two hundred and sixty years, presented the Tartar ambassadors with the milk of mares. Most of the Tartars manufacture a liquor called *koumiss*, from the milk of the mare. It has a very pleasant taste of mingled sweet and sour, and is considerably nutritious. The Tartars say that it is an excellent medicine, and almost a specific in consumption and some diseases of debility. It is thus made:—To a certain quantity of fresh mare's milk, a sixth part of water, and an eighth part of very sour milk, or of old *koumiss*, is added. The vessel is covered with a thick cloth, and set in a place of moderate warmth. It is thus left at rest twenty-four hours, when the whole of it will have become sour, and a thick substance will have gathered on the top. The whole is then beaten with a stick in the form of a churn-staff, until it becomes blended into one homogeneous mass. Twenty-four hours after this the beating is repeated, or the liquor is agitated in a churn, until the whole is again mingled together. The process is now complete and the *koumiss* is formed, but it must be always well shaken before it is used.

The Tartars have discovered a method of obtaining an ardent spirit from this *koumiss*, which they call *rack*, or *racky*, from the name given to the spirit manufactured in the East Indies.

Some of the Tartar and Kalmuck women ride fully as well as the men. When a courtship is taking place between two of the young ones, the answer of the lady is thus obtained. She is mounted on one of the best horses, and off she gallops at full speed. Her lover pursues, and if he overtakes her, she becomes his wife; but it is seldom or never that a Kalmuck girl once on horseback is caught, unless she has a partiality for her pursuer.

The domesticated horses belonging to the Tartars that wander over the immense plains of Central Asia are little removed from a wild state. They are small and badly made, but capable of supporting the longest and most rapid journeys on the scantiest fare.

One well-known circumstance will go far to account for their general hardiness. The Tartars live much on the flesh of horses; and the animals that are unable to support the labour of their frequent and rapid emigrations are first destroyed; the most vigorous are alone preserved.

Berenger gives the following account of the Tartar horses:—‘Although but of a moderate size, they are strong, nervous, proud, full of spirit, bold, and active. They have good feet, but somewhat narrow; their heads are well-shaped and lean, but too small; the forehead long and stiff; and the legs over long; yet with all these imperfections they are good and serviceable horses, being unconquerable by labour, and endowed with considerable speed. The Tartars live with them almost in the same manner that the Arabs do with their horses. When they are six or eight months old, they make their children ride them, who exercise them in small excursions, dressing and forming them by degrees, and bringing them into gentle and early discipline, and after a while, making them undergo hunger and thirst, and many other hardships. The men, however, do not ride them until they are five or six years old, when they exact from them the severest service, and inure them to almost incredible fatigue, travelling two or three days almost without resting, and passing four or five days

with no more or better nourishment than a handful of grass, and with nothing to quench their thirst.' This discipline as much exceeds that of the Arabs in severity and horrible barbarity, as the Arabs excel the Tartars in civilisation.

The horses of the Nogais Tartars are some of the best of the roving tribes. They are stronger and taller than the others; and some of them are trained to draw carriages. It is from them that the Khan of Tartary derives the principal part of his supplies. It is said that in case of necessity they could furnish a hundred thousand men. Each of the Nogais commonly has with him four horses; one is for his own riding; a second to mount if the first should be tired; and the other two to carry his provisions, his slaves, and his booty.

#### THE TOORKOMAN HORSE.

Turkistan is that part of South Tartary north-east of the Caspian sea, and has been celebrated from very early times for producing a pure and valuable breed of horses. They are called *Toorkomans*. They are said to be preferable even to the pure Persians for actual service. They are large, from fifteen to sixteen hands high, swift, and inexhaustible under fatigue. Some of them have travelled nine hundred miles in eleven successive days. They are, however, somewhat too small in the barrel, too long on the legs, occasionally ewe-necked, and always having a head out of proportion large: yet such are the good qualities of the horse, that one of the pure blood is worth two or three hundred pounds even in that country.

Captain Fraser, who is evidently a good judge of the horse, thus relates the impression which they made on him, in his 'Journey to Khorasan':— 'They are deficient in compactness. Their bodies are long in proportion to their bulk. They are not well-ribbed up. They are long on the legs, deficient in muscle, falling off below the knee; narrow-chested; long-necked; head large, uncouth, and seldom well put on. Such was the impression I received from the first sight of them, and it was not for some time that their superior valuable qualities were apparent to me.'

The Toorkomans trace their breed of horses to Arabian sires; and, most anxious that a sufficient proportion of the pure blood shall be retained, they have frequent recourse to the best Arabians they can procure.

Before a Toorkoman starts on an expedition, he provides himself with a few hard balls of barley-meal, which are to serve both him and his horse for subsistence until his return; but sometimes when, crossing the desert, he is unusually faint and weary, he opens the jugular vein of his horse, and drinks a little of the blood, by which he is undoubtedly refreshed, and, he thinks, his horse is relieved. According to Sir John Malcolm, the Toorkoman will think little of pushing the same horse one hundred miles a day for some successive days; and he adds, that a horseman mounted on a Toorkoman horse brought a packet of letters from Shiraz to Teheran, a distance of five hundred miles, in six days.

#### THE TURKISH HORSE.

The Turkish horses are descended principally from the Arab, crossed by the Persian and other kindred varieties. They possess all the gentleness and tractability of the parent race, but they have lost some of their vigour and speed. They have contributed materially to the improvement of the English breed. The Byerley and the Helmsley Turk are names familiar to every one conversant with horses, and connected with our best blood.

The learned and benevolent Busbequius, who was ambassador at Con-



stantinople in the seventeenth century, gives the following account of the Turkish horses. Our grooms, and their masters too, may learn a lesson of wisdom and humanity from his words.

‘There is no creature so gentle as a Turkish horse, nor more respectful to his master, or the groom that dresses him. The reason is, because they treat their horses with great lenity. I myself saw, when I was in Pontus, passing through a part of Bithynia called Axilos, towards Cappadocia, how indulgent the countrymen were to young colts, and how kindly they used them soon after they were foaled. They would stroke them, bring them into their houses, and almost to their tables, and use them even like children. They hung something like a jewel about their necks, and a garter which was full of amulets against poison, which they are most afraid of. The grooms that dress them are as indulgent as their masters; they frequently sleek them down with their hands, and never use a cudgel to bang their sides, but in cases of necessity. This makes their horses great lovers of mankind; and they are so far from kicking, wincing, or growing untractable by this gentle usage, that you will hardly find an ill-tempered horse amongst them.

‘But, alas! our Christian grooms’ horses go on at another rate. They never think them rightly carried till they thunder at them with their voices, and let their clubs or horse-whips, as it were, dwell on their sides. This makes some horses even tremble when their keepers come into their stable; so that they hate and fear them too. But the Turks love to have their horses so gentle, that at the word of command they may fall on their knees, and in this position receive their riders.

‘They will take up a staff or club upon the road with their teeth, which their rider has let fall, and hold it up to him again; and when they are perfect in this lesson, then, as a reward, they have rings of silver hung on their nostrils as a badge of honour and good discipline. I saw some horses, when their master was fallen from the saddle, stand stock still without wagging a foot till he got up again. Another time I saw a groom standing at a distance in the midst of a whole ring of horses, and at the word of command they would either go round or stand still. Once I saw some horses, when their master was at dinner with me in an upper room, prick up their ears to hear his voice, and when they did so they neighed for joy.’

#### THE AMERICAN HORSES.

Before we can advance eastward into Europe, it will be convenient to dispose of the horses of the American continents. In South America, although constant warfare is carried on against them, there are innumerable herds of wild horses; and in the back settlements of the southwestern States of North America there is a horse resembling the wild horse of the Pampas; but both are evidently the descendants of those who have escaped from the slavery of man.

#### THE WILD HORSE OF SOUTH AMERICA.

All travellers who have crossed the plains extending from the shores of La Plata to Patagonia have spoken of numerous droves of wild horses. Some affirm that they have seen ten thousand in one troop. They appear to be under the command of a leader, the strongest and boldest of the herd, and whom they implicitly obey. A secret instinct teaches them that their safety consists in their union, and in a principle of subordination. The lion, the tiger, and the leopard are their principal enemies. At some signal, intelligible to them all, they either close into a dense mass and trample their enemy to death, or placing the mares and foals in

the centre, they form themselves into a circle and welcome him with their heels. In the attack, their leader is the first to face the danger, and when prudence demands a retreat, they follow his rapid flight.

In the thinly inhabited parts of South America it is dangerous to fall in with any of these troops. The wild horses approach as near as they dare; they call to the loaded horse with the greatest eagerness, and if the rider is not on the alert, and has not considerable strength of arm and sharpness of spur, his beast will divest himself of his burden, take to his heels, and be gone for ever. Byron beautifully describes this in his *Mazeppa* :—

A trampling troop: I see them come:  
 In one vast squadron they advance!  
 I strove to cry--my lips were dumb.  
 The steeds rush on in plunging pride,  
 But where are they the reins who guide?  
 A thousand horse and none to ride!  
 With flowing tail and flying mane,  
 Wide nostrils--never stretch'd by pain--  
 Mouths bloodless to the bit or rein,  
 And feet that iron never shod,  
 And flanks unscarr'd by spur or rod--  
 A thousand horse, the wild, the free,  
 Like waves that follow o'er the sea.  
 On came the troop . . . .  
 They stop--they start--they snuff the air,  
 Gallop a moment here and there,  
 Approach, retire, wheel round and round,  
 Then plunging back with sudden bound;  
 They snort, they foam, neigh, swerve aside,  
 And backward to the forest fly.

Captain Head gives the following account of a meeting with a troop of wild horses, where the country is more thickly inhabited. Some poor captured animals are supposed to be forced along by their riders at their very utmost speed:—‘As they are thus galloping along, urged by the spur, it is interesting to see the groups of wild horses one passes. The mares, which are never ridden in South America, seem not to understand what makes the poor horse carry his head so low and look so weary. The little innocent colts come running to meet him, and then start away frightened; while the old horses, whose white marks on the flanks and backs betray their acquaintance with the spur and saddle, walk slowly away for some distance, then breaking into a trot as they seek their safety, snort and look behind them, first with one eye and then with the other, turning their noses from right to left, and carrying their long tails high in the air.’

The same pleasing writer describes the system of horse-management among the rude inhabitants of the plains of South America. They have no stables, no fenced pastures. One horse is usually kept tied at the door of the hut, fed scantily at night on maize; or at other times several may be enclosed in the *corral*, which is a circular space surrounded by rough posts, driven firmly into the ground. The mares are never ridden, or attempted to be tamed, but wander with their foals wherever they please.

When the *Gaucha*, the native inhabitant of the plains, wants horses for himself or for the supply of a traveller, he either goes gith his *lasso* to the *corral*, and selects those possibly who on the preceding day had for the first time been backed, or he scampers across the plain, and presently returns with an unwilling, struggling, or subdued captive. When the services of the animals have been exacted, he either takes them to the *corral* and feeds them with a small quantity of maize, if he thinks he

shall presently need them again, or he once more turns them loose on the plains.

Travellers give some amusing accounts of the manner in which all this is effected. Miers thus describes the *lasso*, simple in its construction, but all-powerful in the hands of the Gaucho :—

‘The *lasso* is a missile weapon used by every native of the United Provinces and Chili. It is a very strong plaited thong of equal thickness, half an inch in diameter and forty feet long, made of many strips of green hide plaited like a whipthong, and rendered supple by grease. It has at one end an iron ring, above an inch and a half in diameter, through which the thong is passed, and this forms a running-noose. The Gaucho, or native Peon, is generally mounted on horseback when he uses the *lasso*. One end of the thong is affixed to his saddle girth : the remainder he coils carefully in his left hand, leaving about twelve feet belonging to the noose-end in a coil, and a half of which he holds in his right hand. He then swings this long noose horizontally round his head, the weight of the iron ring at the end of the noose assisting in giving to it, by a continued circular motion, a sufficient force to project it the whole length of the line.’

When the Gauchos wish to have a grand breaking-in, they drive a whole herd of wild horses into the corral :—‘The corral was quite full of horses, most of which were young ones about two or three years old. The *capitán* (chief Gaucho), mounted on a strong steady horse, rode into the corral, and threw his *lasso* over the neck of a young horse, and dragged him to the gate. For some time he was very unwilling to lose his comrades ; but the moment he was forced out of the corral, his first idea was to gallop away : however, a timely jerk of the *lasso* checked him in the most effectual way. The peons now ran after him on foot, and threw a *lasso* over his fore-legs just above the fetlock, and twitching it, they pulled his legs from under him so suddenly, that I really thought the fall he got had killed him. In an instant a Gaucho was seated on his head, and with his long knife, in a few seconds, cut off the whole of the horse’s mane, while another cut the hair from the end of his tail : this, they told me, was a mark that the horse had been once mounted. They then put a piece of hide into his mouth to serve for a bit, and a strong hide halter on his head. The Gaucho who was to mount arranged his spurs, which were unusually long and sharp, and while two men held the horse by the ears, he put on the saddle, which he girthed extremely tight. He then caught hold of the horse’s ear, and in an instant vaulted into the saddle ; upon which the man who held the horse by the halter threw the end to the rider, and from that moment no one seemed to take any further notice of him.

‘The horse instantly began to jump in a manner which made it very difficult for the rider to keep his seat, and quite different from the kick or plunge of an English horse : however, the Gaucho’s spurs soon set him going, and off he galloped, doing everything in his power to throw his rider.

‘Another horse was immediately brought from the corral ; and so quick was the operation, that twelve Gauchos were mounted in a space which I think hardly exceeded an hour. It was wonderful to see the different manner in which different horses behaved. Some would actually scream while the Gauchos were girding the saddle upon their backs ; some would instantly lie down and roll upon it ; while some would stand without being held, their legs stiff and in unnatural positions, their necks half bent towards their tails, and looking vicious and obstinate : and I could not help thinking that I would not have mounted one of those for any

reward that could be offered me, for they were invariably the most difficult to subdue.

‘It was now curious to look around and see the Gauchos on the horizon in different directions, trying to bring their horses back to the corral, which is the most difficult part of their work, for the poor creatures had been so scared there that they were unwilling to return to the place. It was amusing to see the antics of the horses; they were jumping and dancing in different ways, while the right arm of the Gauchos was seen flogging them. At last they brought the horses back, apparently subdued and broken in. The saddles and bridles were taken off, and the young horses trotted off towards the corral, neighing to one another.’

The manufacture of the Gaucho’s boots is somewhat singular:—‘The boots of the Gauchos are formed of the ham and part of the leg-skin of a colt taken reeking from the mother, which is said to be sacrificed for the sole purpose, just at the time of bearing, when the hair has not begun to grow. At this stage, the skin strips off easily, and is very white and beautiful in texture and appearance. The ham forms the calf of the boot; the hock easily adapts itself to the heel, and the leg above the fetlock constitutes the foot; the whole making a neat and elegant half-boot, with an aperture sufficient for the great toe to project through.’

When the Gaucho wishes to take a wild horse, he mounts one that has been used to the sport, and gallops over the plain. As soon as he comes sufficiently near his prey, ‘the lasso is thrown round the two hind legs, and as the Gaucho rides a little on one side, the jerk pulls the entangled horse’s feet laterally, so as to throw him on his side, without endangering his knees or his face. Before the horse can recover the shock, the rider dismounts, and snatching his *poncho* or cloak from his shoulders, wraps it round the prostrate animal’s head. He then forces into his mouth one of the powerful bridles of the country, straps a saddle on his back, and bestriding him, removes the poncho; upon which the astonished horse springs on his legs, and endeavours by a thousand vain efforts to disencumber himself of his new master, who sits quite composedly on his back, and, by a discipline which never fails, reduces the horse to such complete obedience, that he is soon trained to lend his whole speed and strength to the capture of his companions.’

These animals possess much of the form of the Spanish horse, from which they sprang; they are tamed, as has been seen, with far less difficulty than could be thought possible; and although theirs is the obedience of fear, and enforced at first by the whip and spur, there are no horses who so soon and so perfectly exert their sagacity and their power in the service of man. They are possessed of no extraordinary speed, but they are capable of enduring immense fatigue. They are frequently ridden sixty or seventy miles without drawing bit, and have been urged on by the cruel spur of the Gaucho more than a hundred miles, and at the rate of twelve miles in the hour.

Like the Arab horses, they know no intermediate pace between the walk and the gallop. Although at the end of a day so hard, their sides are horribly mangled, and they completely exhausted, there is this consolation for them,—they are immediately turned loose on the plains, and it will be their own fault if they are speedily caught again. The mare is occasionally killed for food, and especially on occasions of unusual festivity. General San Martin, during the war for independence, gave a feast to the Indian allies attached to his army in which mares’ flesh, and the blood mixed with gin, formed the whole of the entertainment.

On such dry and sultry plains the supply of water is often scanty, and then a species of madness seizes on the horses, and their generous and

docile qualities are no longer recognised. They rush violently into every pond and lake, savagely mangling and trampling upon one another; and the carcasses of many thousands of them, destroyed by their fellows, have occasionally been seen in and around a considerable pool. That is one of the means by which the too rapid increase of this quadruped is, by the ordinance of nature, there prevented. Humboldt says that during the periodical swellings of the large rivers, immense numbers of wild horses are drowned, particularly when the river Apure is swollen, and these animals are attempting to reach the rising grounds of the Llanos. The mares may be seen, during the season of high water, swimming about followed by their colts, and feeding on the tall grass, of which the tops alone wave above the waters. In this state they are pursued by crocodiles, and their thighs frequently bear the prints of the teeth of these carnivorous reptiles. They lead for a time an amphibious life, surrounded by crocodiles, water-serpents, and marsetees. When the rivers return again into their beds, they roam in the savannah, which is then spread over with a fine odoriferous grass, and seem to enjoy the renewed vegetation of spring.

Numerous herds of wild horses abound in the west of Louisiana, and of all colours. They are like those on the Pampas, the remains of the Spanish horses, and are hunted, caught, and sometimes destroyed for food by the savage inhabitants of the back settlements.

Mr. Low, in his beautiful delineations of the British quadrupeds, gives the following account of the horses of North America:—

‘North America seems as well adapted to the temperament of the horse as any similar countries in the old continent. The Mexican horses are derived from, but somewhat deteriorated by, a less careful management. Mexican horses have likewise escaped into the woods and savannahs, and although they have not multiplied, as in the plains of the Plata, thence they have descended northward to the Rocky Mountains, and the sources of the Columbia. The Indians of the country have learned to pursue and capture them, employing them in hunting and transporting their families from place to place—the first great change that has taken place for ages in the condition of the Red Man of the North American woods. The highest ambition of the young Indian of these northern tribes, is to possess a good horse for the chase of the buffalo. The Osages form large hunting-parties for the chase of horses in the country of the Red Canadian River, using relays of fresh horses, until they have run down the wild herds. To steal the horse of an adverse tribe is considered as an exploit almost as heroic as the killing of an enemy, and the distances that they will travel and the privations they will undergo in these predatory excursions are scarcely to be believed.’

The Anglo-Americans, the Canadians, and the colonists of the West India Islands, have all acquired the domesticated horse. The *Canadian* is found principally in Canada and the Northern States. He is supposed to be of French descent, and many of the celebrated trotters are of this breed. Mention will be made of some of these when the paces of the horse are described.

These horses are much used for winter travelling in Canada and in the Northern States. One of them has drawn a light cabriolet over the ice ninety miles in twelve hours. Their shoes are roughened by the insertion of two or three steel screws, instead of the common European method. The curry-comb is never used upon them in the winter, for a thick fur has grown over them to protect them from the inclemency of the season. They are animals never refusing the collar, yet they are accustomed to bad usage. Those of the United States are of every variety, but crossed

by the modern English race or the Arab. The improvement of the horse, at this time, occupies much of their attention. Horse-races are established in many places, and particularly in the Southern States; and they have adopted, to a very considerable degree, the usages of the English turf. They have different varieties of useful horses for riding, and for their public and private carriages. Habit, arising from some cause or whim now not known, has made them partial to the trotting-horse; and the fastest trotting-horses in the world are to be found in the United States. The breeds of the West India Islands are those of the parent states. The horses of Cuba are derived from Spain, and retain the distinctive characters of the parent stock; and those of the English colonies have been improved by continued intercourse with the mother country.

A much-valued correspondent, Mr. Rotch, of Louisville, in the State of New York, thus addresses the author:—‘From my own personal experience, I should say that all our stock in America seem to possess a harder constitution and are much less liable to disease than in England; and that animals, but a few generations removed from those actually imported, acquired much stronger constitutions than their ancestors; and it has been a question with me, and acceded to by the late Rev. H. Berry, whether importations of some of our pure-bred animals might not sometimes be made into your country with advantage. I am sure that our hacks and roadsters will endure a great deal more fatigue and hardship than the same description of horse in England. I speak with confidence in these matters, because I have been a breeder in both countries.’

That the greater hardship and labour to which the American horse of this description is exposed would produce a greater development of animal power, there can be no doubt, and a cross from the best of such a breed could not fail of being advantageous; but we must adopt and perpetuate the circumstances that produced this superior power, or we should not long retain the advantage of the cross.

In the extensive territory and varied climate of the United States several breeds of horses are found.

The *Conestoga* horse is found in Pennsylvania and the middle States; long in the leg and light in the carcass; sometimes rising seventeen hands; used principally for the carriage; but, when not too high, and with sufficient substance, useful for hunting and the saddle.

The *English* horse, with a good deal of blood, prevails in Virginia and Kentucky, and is found to a greater or less degree in all the States. The Americans have at different times imported some of the best English blood. It has been most diligently and purely preserved in the Southern States. The celebrated Shark, the best horse of his day, and equalled by few at any time, was the sire of the best Virginian horses; and Tally-ho, a son of Highflyer, peopled the Jerseys.

## THE MODERN EUROPEAN HORSES.

The limits of our work compel us to be exceedingly brief in our account of the breeds of the different countries of Europe. We start from the south-west of this quarter of the world.

### THE SPANISH HORSE.

The Spanish horses for many a century ranked next to those of Barbary and Arabia. They descended from the Barbs, or rather they were the Barbs transplanted to a European soil, and somewhat altered, but not materially injured, by the change. Solleysel, the *parfait mareschal*, gives an eloquent description of them:—‘I have seen many Spanish horses;

they are extremely beautiful, and the most proper of all to be drawn by a curious pencil or to be mounted by a king, when he intends to show himself in his majestic glory to the people.'

The common breed of Spanish horses have nothing extraordinary about them. The legs and feet are good, but the head is rather large, the forehead heavy, and yet the posterior part of the chest deficient, the crupper also having too much the appearance of a mule. The horses of Estremadura and Granada, and particularly of Andalusia, are most valued. Berenger, whose judgment can be fully depended on, thus enumerates their excellences and their defects:—'The neck is long and arched, perhaps somewhat thick, but clothed with a full and flowing mane; the head may be a little too coarse; the ears long, but well placed; the eyes large, bold, and full of fire. Their carriage lofty, proud, and noble. The breast large; the shoulders sometimes thick; the belly frequently too full, and swelling; and the loin a little too low; but the ribs round, and the croup round and full, and the legs well formed and clear of hair, and the sinews at a distance from the bone—active and ready in their paces—of quick apprehension; a memory singularly faithful; obedient to the utmost proof; docile and affectionate to man, yet full of spirit and courage.' The Parfait Mareschal shall take up the story again:—'There will not be found any kind of horses more noble than they, and of their courage! why I have seen their entrails hanging from them, through the number of wounds that they have received; yet they have carried off their rider safe and sound with the same pride with which they brought him to the field, and after that they have died, having less life than courage.' It is delightful to read accounts like these, and we know not which to admire most, the noble horse or the man who could so well appreciate his excellence.

The modern Spanish horses are fed upon chopped straw and a little barley. When the French and English cavalry were there, during the Peninsular war, and were without preparation put upon this mode of living, so different from that to which they had been accustomed, they began to be much debilitated, and a considerable mortality broke out among them; but, after a while, they who were left regained their strength and spirits, and the mortality entirely ceased.

#### THE PORTUGUESE HORSE.

There was a time when the Lusitanian or Portuguese horses were highly celebrated. The Roman historian Justin compares their swiftness to that of the winds, and adds, that many of them might be said to be born of the winds; while, on the other hand, Berenger, who lived at a time when the glory of the Spanish horse had not quite faded away, says, that 'the Portugal horses are in no repute, and differ as much from their neighbours, the Spaniards, as crabs from apples, or sloes from grapes.' He thus accounts for it. When Portugal was annexed to Spain, the latter country was preferred for the establishment of the studs for breeding, and the few districts in Portugal which were sufficiently supplied with herbage and water to fit them for a breeding country were devoted to the rearing of horned cattle for the shambles and the plough, and mules and asses for draught. Hence, the natives regarded the horse as connected more with pomp and pleasure than with utility, and drew the comparatively few horses that they wanted from Spain. The present government, however, seems disposed to effect a reform in this, and there are still a sufficient number of Andalusian horses in Portugal, and Barbs in Africa, fully to accomplish the purpose.

## THE FRENCH HORSE.

According to the survey of 1829, France contained 2,400,000 horses including those of every description. The number of mares was 1,227,781. The greater part of these were employed in the breeding of mules, and perhaps not more than a fourth part were used for keeping up the number of horses. Besides these, nearly 27,000 horses are annually imported into France, either on speculation of immediate sale, or for the express purpose of improving the breed.

Two-thirds of the French horses are devoted to purposes of light work, and possess a certain degree, and that gradually increasing, of Eastern blood. There is room, however, for a great deal more than the French horse usually possesses. One-third of the horses are employed in heavy work; 70,000 in post work; and about the same number are registered as fit for military use, although not more than half of them are on actual service. The ascertained number of deaths is about one in 12 or 13, or leaving the average age of the horse at 12. This speaks strongly in favour of the humanity of the French, or the hardihood of the horses, for it exceeds the average duration of the life of the horse in England by more than two years. Calculating the average value of the French horse at 400 francs, or 1*l.* 13*s.* 4*d.*, there results a sum of 960,000,000 francs, or 40,000,000 pounds sterling, as the gross value of this species of national property.

It must be supposed that so extensive a country as France possesses various breeds of horses. Auvergne and Poitou produce good ponies and galloways; but the best French horses are bred in Limousin and Normandy. From the former district come excellent saddle-horses and hunters, and from the latter a stronger species for the road, the cavalry service, and the carriage.

M. Hoüel has recently published an interesting work on the varieties of the horse in France. He states that in the time of the Romans there were but two kinds of horses,—the war-horse, and the sumpter or pack-horse. The carriage, or draught-horse, was comparatively or quite unknown; and even men of the highest station suffered themselves to be indolently drawn by oxen. Great care was taken to preserve or to renew the strength and speed of the war-horse, and African or Arab blood was diligently sought. An animal, the type of the English Cleveland breed, the handsomest and strongest description of the coach-horse, was thus procured. By degrees, this horse was found too valuable for a hackney, and too high-trotting for a long journey, and a more smoothly-moving animal was gradually introduced. Still the charger did not grow quite out of fashion, and in Normandy the rearing of this animal became an object of much attention to the farmer. At first they were bred too slow and ponderous, but by degrees a horse was obtained of somewhat lighter action and considerable speed without much sacrifice of strength, and they now constitute a most valuable breed. 'I have not elsewhere,' says M. Hoüel, 'seen such horses at the collar, under the diligence, or the post-carriage, or the farm-cart. They are enduring and energetic beyond description. At the voice of the brutal driver, or at the dreaded sound of his never-ceasing whip, they put forth all their strength, and they keep their condition when other horses would die of neglect and hard treatment.' The little Norman cart-horse is perhaps the best for farm-work. The Norman horses—and the same observation applies to all the northern provinces of France—are very gentle and docile. A kicking or vicious one is almost unknown there; but they are, with few exceptions, treated with tyranny and cruelty from first to last. The reign of terror may to a certain degree be



necessary where there are many perfect horses; but the principle of cruelty should not extend, as it too often does, to the treatment of every kind of horse.

Something must be attributed to both causes. There is more humanity among the French than the English peasantry; but, on the other hand, there are horrible scenes of cruelty to the horse hourly taking place in the streets of Paris, that would not be tolerated for a moment in the British metropolis.

The breeding of horses has more decidedly become a branch of agricultural attention and speculation than it used to be; for it has been proved to the farmer that, with the proper kind of pasture, and within a fair distance of a proper market, instead of being one of the most uncertain and unprofitable modes of using the land, it yields more than an average return.

The establishment of races in almost every part of France has given a spirit to the breeding and improvement of the horse which cannot fail of being exceedingly beneficial throughout the whole of the French empire. In fact, it may be stated without exaggeration, that the rapid improvement which is taking place is attributable principally to this cause. In order to effect the desired improvement, the French, and with much judgment, have had recourse to the English thorough-bred horse far more than to the native Arabian. A great many of the best English stallions have been purchased for the French studs, and have been beneficially employed in improving, and often creating, the hunter, the racer, and almost all of the better class of horses used for purposes of luxury.

It has been stated that the most valuable native horses are those of Normandy; perhaps they have been improved by the English hunter, and occasionally by the English thorough-bred horse; and, on the other hand, the English roadster and the light draught-horse have derived considerable advantage from a mixture with the Norman, not only in early times when William the Conqueror was so eager to improve the horses of his new subjects by means of those of Norman blood, but at many succeeding periods.

A certain number of Normandy horses used to be purchased every year by the French Government for the use of the other departments. This led occasionally to considerable trickery and evil. None of the Norman horses were castrated until they were three, or sometimes four years old; and then it frequently happened that horses of superior appearance, but with no pure blood in them, were sold as belonging to the improved breed, and it was only in their offspring that the cheat could be discovered. The government now purchases the greater part of the Normandy horses in their first year, and brings them up in the public studs. They cost more money, it is true; but they are better bred, and become finer animals. There is no deception with regard to these horses, and the amelioration of the other breeds is secured.

Every country that has occupied itself with the amelioration of its breed of horses, has deemed it necessary to have a public register of the names and progeny of those of an acknowledged race. England has had its stud-book nearly half a century, containing a list of all the horses of pure blood that have existed in the country. France, in the year 1837, had her first stud-book, in which are inscribed the names of 215 stallions, of pure English blood, imported into France or born there; 266 Arabs, Barbs, Persian, or Turkish horses; 274 English mares of true blood, and 41 Eastern mares. Their progeny is also traced, so far as it was practicable. This work will form an epoch in the equestrian annals of that country.

## THE SARDINIAN AND CORSICAN HORSES.

They are small, well-made, and capable of enduring much fatigue; as for their other qualities (and they are not much changed at the present day from what they formerly were), Blundeville shall speak of them:—‘The horses that come out of the Isle of Sardygnia and Corsica have short bodies and be verye bolde and courageous, and unquiet in their pace, for they be so fierce and hote cholericke complexion, and therewith so much used to running in their countrie as they will stand still on no ground. And, therefore, this kynde of horse requireth a discrete and pacient ryder, who must not be over hastie in correcting him for feare of marring him altogether.’

## THE ITALIAN HORSE

Was once celebrated for the beauty of his form and his paces; but, like everything else in that degraded country, he has sadly degenerated. The Neapolitan horses were particularly remarkable for their size and majestic action; there was, however, a degree of clumsiness about the heads, and forehead, and general appearance, which the seeming grandeur of their action would not always conceal, and they were occasionally untractable and vicious to an alarming degree. They are now much deteriorated, and, in fact, with but few exceptions, scarcely of any value.

Some of the Italian races are a disgraceful burlesque on those of other countries. At Rome they have become a necessary appendage to the annual carnival, and there is no other of the pastimes of that gay season in which the people take an equal delight. Some of the horse-races resemble those in other countries, and are fairly contested; but much oftener the Roman course presents nothing but the horse running without any rider, and not from his own spirit and emulation, but startled by noises and goaded on by ridiculous and barbarous contrivances.

The horses termed *Barberi*—because the race was at first contested by *Barbs*—are brought to the starting-post, their heads and their necks gaily ornamented: while to a girth which goes round the body of each are attached several loose straps, having at their ends small balls of lead thickly set with sharp steel points. At every motion these are brought in contact with the flanks and bellies of the horses, and the more violent the motion, the more dreadful the incessant torture. On their backs are placed sheets of thin tin, or stiff paper, which, when agitated, will make a rustling, rattling noise.

It is difficult to conceive of the rearing, kicking, pawing, and snorting which occurs at the starting-place. A rope placed across the street prevents them from getting away, and a stout peasant is employed with each horse in a struggle of downright strength, and, at the hazard of limb and of life, to restrain him. Occasionally some of them do break away and pass the rope before the street—the race-course—is cleared, and then many serious accidents are sure to happen.

When all is ready for starting, a troop of dragoons gallop through the street in order to clear the way. A trumpet sounds—the rope drops—the grooms let go their hold, and the horses start away like arrows from a bow. The harder they run, the more they are pricked; the cause of this they seem scarcely able to comprehend, for they bite and plunge at each other, and a terrible fight is sometimes commenced. Others, from mere fright or sulkiness, stand stock-still, and it is by brute force alone that they can again be induced to move.

A strong canvas screen is passed along the bottom of the street. This is the goal. It has the appearance of a wall; but some of the horses, in

the excess of their agony and terror, dart full against it, tear through it, or carry it away.

After all, the prize is nothing more than an ornamental flag; but it is presented by the governor of Rome, and it is supposed to be a pledge of the speed and value of the horse which will descend as an heir-loom from generation to generation among the peasantry, to whom many of these horses belong. The decision of such a race, however, can have little to do with the speed or strength or value of the horses in any respect. The Italians, however, enter into the affair with all their characteristic eagerness of feeling, and are guilty of every kind of extravagance. During the first six days of the carnival, the horses are fairly classed according to the age, height, degree of breeding, &c.; but on the last two days—the choice days—they run altogether, and some in the manner that I have described, and thus increase the confusion, the riot, and the danger of the exhibition.

The Corso is very nearly a mile, and it has occasionally been run in two minutes and twenty-one seconds: a very quick pace for small horses, many of them not more than fourteen hands high. Races of a similar character take place at Florence, of which Mrs. Piozzi gives the following description:—‘The street is covered with saw-dust, and made fast at both ends. Near the starting-post are elegant booths, lined with red velvet, for the court and first nobility. At the other end a piece of tapestry is hung, to prevent the creatures from dashing their brains out when they reach the goal. Thousands and tens of thousands of people on foot fill the course, so that it is a great wonder to me still that numbers are not killed. The prizes are exhibited to view in quite the old classical style—a piece of crimson damask for the winner; a small silver basin and ewer for the second; and so on, leaving no performer unrewarded.

‘At last come out the horses, without riders, but with a narrow leathern strap hung across their bodies, which has a lump of ivory fixed to the end of it, all set full of sharp spikes like a hedgehog, and this goads them along while galloping, worse than any spur could do, because the faster they run the more this old machine keeps jumping up and down, and pricking their sides ridiculously enough; and it makes one laugh to see that some of them are so tickled by it as not to run at all, but set about plunging in order to rid themselves of the inconvenience, instead of driving forward to divert the mob, who leap, and caper, and shout with delight, and lash the laggards along with great indignation indeed, and with the most comical gestures.’

Before we quit the neighbourhood of Italy, we may perhaps notice another curious mode of horse-racing, practised in Malta. The horses here are indeed mounted, but they have neither saddle nor bridle. The riders sit on the bare back, and have nothing to guide or to spur on their horses, but a small pointed instrument, not unlike a cobbler’s awl. These horses are small barbs, well tempered, or they would resist this mode of management, and they certainly are not swift. By pricking the horse on one side or the other of the neck, the rider can guide him a little in the way he should go, and certainly he may urge him to his fullest speed; but still, although it affords a novel and amusing sight to the stranger, the horse and the spectators are degraded by such an exhibition.

#### THE AUSTRIAN HORSE.

The following account is given by the Duke of Ragusa of the imperial establishment for the breeding of horses at Mesohagyés, near Carlsburg, in Austria:—‘This is the finest establishment in the Austrian monarchy for the breeding and improvement of horses. It stands on 40,000 acres of

land of the best quality, and is surrounded in its whole extent, which is 15 leagues, by a broad and deep ditch, and by a broad plantation 60 feet wide. It was formerly designed to supply horses to recruit the cavalry; at present its object is to obtain stallions of a good breed, which are sent to certain dépôts for the supply of the various provinces. To produce these, 1,000 brood mares and 48 stallions are kept; 200 additional mares, and 600 oxen are employed in cultivating the ground. The plain is divided into four equal parts, and each of these subdivided into portions, resembling so many farms. At the age of four years the young horses are all collected in the centre of the establishment. A selection is first made of the best animals to supply the deficiencies in the establishment, in order always to keep it on the same footing. A second selection is then made for the use of the other: none of these, however, are sent away until they are five years old; but the horses that are not of sufficient value to be selected are sold by auction, or sent to the army to remount the cavalry, as circumstances may require.

'The whole number of horses at present here, including the stallions, brood-mares, colts, and fillies, is 3,000. The persons employed in the cultivation of the ground, the care of the animals, and the management of the establishment generally, are a major-director, 12 subaltern officers, and 1,170 soldiers.

'The Imperial treasury advances to the establishment every year 118,000 florins (the half rix-dollar or florin is in value about 2s. 1*d.* English money), and is reimbursed by the sale of 150 stallions, which are sent every year to the provinces at the price of 1,000 florins each, and by the value of the horses supplied to the cavalry. The other expenses of every description are paid for by the produce of the establishment, which is required to defray, and does defray all. This is, therefore, an immense estate—a farm on a colossal scale—with a stud in proportion managed on account of the sovereign, and which produces a considerable revenue, independently of the principal object which is attained, the propagation and multiplication of the best breeds of horses. He can always supply the wants of his army at a price almost incredibly small. For a horse of the light cavalry he pays only 110 florins, for the dragoons 120, for the cuirassiers 140, for the train 160, and for the artillery 180. It is a great element of power to possess at home such an immense resource against a time of war, at an expense so far below that which the powers of the west and south of Europe are compelled to incur.'

So early as 1790, a very superior Arabian, named Turkmainath, was imported into Germany, and his stock became celebrated, not only in Hungary, but throughout most of the German provinces. In 1819 the Archduke Maximilian, brother to the emperor, purchased some valuable racers and hunters in England, and sent them to Austria. Some of them went to the Imperial establishment of which mention has just been made, and the others contributed materially to the improvement of the horses wherever they were distributed. Races have been established in various parts of the Austrian dominions, and particularly at Buda and at Pest, in Hungary. Of the good effect which this will have on the breed of horses, there can be no dispute, provided the race do not degenerate into a mere contest of superiority of speed, and exhibited in an animal that from his youth must inevitably be injured or ruined in the struggle.

The gipsies used to be the principal horse-dealers in Hungary, but they have been getting into comparative disrepute since the establishment of the noble studs scattered through this district. He who wants a horse, or to speculate in horses, may now go to head-quarters and choose for himself.

## THE RUSSIAN HORSE.

It may be well supposed that this animal will be of a very different character in various parts of this immense empire. The heavy cavalry and the greater part of the horses for pleasure are descended originally from Cossack blood, but improved by stallions from Poland, Prussia, Holstein, and England; and the studs are now found on an immense scale in various parts of Russia. The lighter cavalry, and the commoner horses, are, as these have ever been, Cossacks, without any attempted improvement, and are hardy and better suited to the duties required from them.

It has been supposed that no horse, except the Arab, could endure privation like the Cossack, or had combined speed and endurance equal to him. The Cossack, however, was beaten, and that not by horses of the first-rate English blood, in a race which fairly put to the test both qualities. It was a cruel affair; yet nothing short of such a contest would have settled the question.

On the 4th of August, 1825, a race of forty-seven miles was run between two Cossack and two English horses. The English horses were Sharper and Mina, well known, yet not ranking with the first of their class. The Cossacks were selected from the best horses of the Don, the Black Sea, and the Ural.

On starting, the Cossacks took the lead at a moderate pace; but before they had gone half a mile, the stirrup-leather of Sharper broke, and he ran away with his rider, followed by Mina, and they went more than a mile, and up a steep hill, before they could be held in.

Half the distance was run in an hour and fourteen minutes. Both the English horses were then fresh, and one of the Cossacks. On their return, Mina fell lame, and was taken away, and Sharper began to show the effects of the pace at which he had gone in running away, and was much distressed. The Calmuck was completely knocked up, his rider was dismounted, a mere child was put on his back, and a Cossack on horseback on either side dragged him on by ropes attached to his bridle, while others at the side supported him from falling. Ultimately Sharper performed the whole distance in two hours and forty-eight minutes—sixteen miles an hour for three successive hours—and the Cossack horse was brought in eight minutes after him. At starting, the English horses carried full three stone more than the Cossacks; and during the latter part of the race a mere child had ridden the Cossack.

The Emperor Nicholas established races in different parts of his vast empire, for the improvement of the Cossack and other horses. On the 20th of September, 1836, the races at Ouralsk took place. The distance to be run was 18 wersts, or about  $4\frac{1}{2}$  French leagues—rather more than 10 miles. Twenty-one horses of the military stud of the Cossacks of Oural started for the first heat, and which was won in 25 minutes and 19 seconds by a horse belonging to the Cossack Bourteche-Tchourunief. The second race was disputed by twenty-three horses of the Kergheese Cossacks, and which was won in 25 minutes and 5 seconds by the horse of the Cossack Siboka-Isterlaie. On the following day the winners of the two first heats strove for the point of honour. The course was now 12 wersts—3 French leagues, or about  $6\frac{3}{4}$  miles. It was won in 15 minutes by the horse of the Cossack Bourteche-Tchourunief. The Russian noblemen who were present, admiring the speed and stoutness of the horse, were anxious to purchase him; but the Cossack replied that 'All the gold in the world should not separate him from his friend, his brother.'

In Southern and Western Russia, and also in Poland, the breeding of

horses and cattle has lately occupied the attention of the great land proprietors, and has constituted a very considerable part of their annual



[This cut represents a Cossack soldier, accoutred for his journey, and having all that is necessary for him or for his horse. It gives a faithful but somewhat flattering representation both of the soldier and his steed.]

income. There is scarcely now a signorial residence to which there is not attached a vast court, in four large divisions, and surrounded by stables. In each of the angles of this court is a passage leading to beautiful and extensive pasture-grounds, divided into equal compartments, and all of them having convenient sheds, under which the horses may shelter themselves from the rain or the sun. From these studs a larger kind of horse than that of the Cossacks is principally supplied, and more fit for the regular cavalry troops, and also for pleasure and parade, than common use. The remnants of the principal houses in Germany are derived hence; and from the same source the great fairs in the different states of the German empire are supplied. The breeding of cattle is also zealously and profitably pursued. The cow-houses form the greater portion of the other buildings attached to the mansion. The largest of these is destined for the milch cows, and another square building serves for a milking house. These dairies are disposed and fitted up like those in Switzerland. In the

middle is a jet of water. Slabs or tables of marble occupy every side, and a slight inclination of the floor permits the observance of the greatest possible cleanliness. An upper story serves for the manufacture of different kinds of cheese, which are made in imitation of, and sometimes equal those which are most esteemed in other parts of Europe.

There is another space or court inclosed with walls, and with little buildings closed with iron bars. This is destined to be a menagerie for bears of the rarest and most beautiful colours, and yielding the choicest furs. This speculation is a very profitable one. A cub of six months old, with black hair pointed with silver white, yields a very light skin and fur, and which will obtain a considerable price, especially if there are others of the same fineness and variegated colour sufficient to make a pelisse. A garment of this kind will sometimes be sold for 600*l.* or 1000*l.* The skins of the old bears are employed for carpets, or linings of carriages, and the most supple of them form the clothing of the coachmen.

The stud of the Russian Countess Orloff Tshesmensky in the province of Walonese contains 1320 horses, Arabs, English, natives and others. The ground attached to it amounts to nearly 1100 acres; and the number of grooms, labourers, and others is more than 4000. The sum realised by the sale of horses is of considerable annual amount; and they are disposed of not only on the spot itself, but in the regular markets, both of St. Petersburg and Moscow.

#### THE ICELAND HORSE.

There are numerous troops of horses in this cold and inhospitable country, descended, according to Mr. Anderson, from the Norwegian horse, but, according to Mr. Horrebow, being of Scottish origin. They are very small, strong, and swift. There are thousands of them in the mountains which never enter a stable: but instinct or habit has taught them to scrape away the snow, or break the ice, in search of their scanty food. A few are usually kept in the stable; but when the peasant wants more he catches as many as he needs, and shoes them himself, and that sometimes with a sheep's horn.

#### THE LAPLAND HORSE.

This animal, according to Berenger, is small, but active and willing—somewhat eager and impatient, but free from vice. He is used only in the winter season, when he is employed in drawing sledges over the snow, and transporting wood, forage, and other necessaries, which in the summer are all conveyed in boats. During the summer these horses are turned into the forests, where they form themselves into distinct troops, and select certain districts from which they rarely wander. They return of their own accord when the season begins to change, and the forests no longer supply them with food.

#### THE SWEDISH HORSE

Is small, but nimble and willing. He is almost entirely fed on bread, composed of equal parts of rye and oatmeal. To this is added a considerable quantity of salt, and, if he is about to start on a long journey, a little brandy. 'While changing horses,' writes Sir A. Brooke in his *Travels in Sweden*, 'we were not a little entertained at the curious group formed by the peasants and their steeds breakfasting together; both cordially partaking of a large hard rye cake. The horses sometimes belong to three or even more proprietors; it is then highly amusing to observe the frequent altercations between them, each endeavouring to spare his own horse. Their affection for their horses is so great that I have seen them shed tears when they have been driven beyond their strength.'

expedition, however, with which these little animals proceed is surprising, when we consider the smallness of their size, which hardly exceeds that of a pony. The road being universally good throughout Sweden, they frequently do not relax from a gallop from one post-house to another.'

#### THE FINLAND HORSES

Are yet smaller than the Swedes, and not more than twelve hands high. They are beautifully formed and very fleet. They, like the Swedes, are turned into the forests in the summer, and must be fetched thence when they are wanted by the traveller. Although apparently wild, they are under perfect control, and can trot along with ease at the rate of twelve miles in the hour.

Fish is much used, both in Finland and Lapland, for the winter food of horses and cattle.

#### THE NORWEGIAN HORSE

Is larger than the Swedish or Finland, but is equally hardy and manageable, and attached to its owner, and its owner to it. The roads in Norway are the reverse of what they are in Sweden: they are rough and almost impassable for carriages, but the sure-footed Norwegian seldom stumbles upon them. Pontoppidan speaks of their occasional contests with bears and wolves, and chiefly the latter. These occurrences are now more matter of story than of actual fact, but they do sometimes occur at the present day. When the horse perceives any of these animals, and has a mare or foal with him, he puts them behind him, and then furiously attacks his enemy with his fore-legs, which he uses so expertly as generally to prove the conqueror; but if he turns round in order to strike with his hind-legs, the bear closes upon him immediately, and he is lost.

Of the horses of the islands of FERØE, still belonging to the Danish crown, Berenger speaks in terms of much praise. He says that 'they are small of growth, but strong, swift, and sure of foot, going over the roughest places with such certainty that a man may more surely rely upon them than trust to his own feet. In Suderoe, one of these islands, they have a lighter and swifter breed than in any of the rest. On their backs the inhabitants pursue the sheep, which are wild in this island; the pony carries the man over places that would be otherwise inaccessible to him—follows his rider over others—enters into the full spirit of the chase, and even knocks down and holds the prey under his feet until the rider can take possession of it.'

#### THE HOLSTEIN AND MECKLENBURG HORSES.

Returning to the Continent, and having crossed the Baltic, we meet with a horse as different from those which have just been described as it is possible to imagine. The horses of Holstein and Mecklenburg, and some of the neighbouring districts, are on the largest scale. Their usual height is sixteen, or seventeen, or eighteen hands. They are heavily made; the neck is too thick; the shoulders are heavy; the backs are too long, and the croups are narrow compared with their fore-parts: but their appearance is so noble and commanding, their action so high and brilliant, and their strength and spirit are so evident in every motion, that their faults are pardoned and forgotten, and they are selected for every occasion of peculiar state and ceremony.

Before, however, we arrive at the native country of these magnificent horses, we must glance at the attempt of one noble individual to improve the general breed of horses. In the island of Alsen, separated from the duchy of Sleswick by a narrow channel, is the noble habitation of the Duke of Augustenbourg. His stud is attached to it, and under the im-



mediate management of the noble owner. It contains thirty mares of pure blood, and fifteen or sixteen stallions of the same grade; and all of them selected with care from the best thorough-bred studs in England. Notwithstanding this selection of pure blood, or rather in its peculiar selection, it has been the object of the duke to produce a horse that shall be useful for the purpose of pleasure, commerce, and agriculture. Some of the stallions are reserved for his own stud; but with regard to the others, such is the spirit with which this noble establishment is conducted, and his desire to improve the race of horses in Sleswick, that he allows more than 600 mares every year, belonging to the peasants of the isle of Alsen, to be covered gratuitously. He keeps a register of them, and in the majority of cases he examines the mares himself, and chooses the horse which will best suit her form, her beauties, her defects, or the purpose for which the progeny is intended. It is not therefore surprising that there should be so many good horses in this part of Denmark, and that the improvement in Sleswick, and in Holstein, and also in Meeklenburg, should be so rapid, and so universally acknowledged.

There is another circumstance which should not be forgotten—it is that by which alone the preservation of a valuable breed can be secured—it is that to the neglect of which the deterioration of every breed must be partly, at least, and, in many cases, chiefly traced. The duke in his stud, and the peasants in the surrounding country, preserve the good breeding mares, and will not part with one that has not some evident or secret fault about her.

How much have the breeders of Great Britain to answer for in the deterioration of some of our best breeds from this cause alone!

There is, however, nothing perfect under the sun. This determination to breed only from horses of pure blood, although care is taken that these horses shall be the stoutest of their kind, has lessened the size and somewhat altered the peculiar character of the horse in the immediate districts; and we must go somewhat more southward for the large and stately animal of which frequent mention has been made. The practice of the country is likewise to a certain degree unfriendly to the full development of the Augustenbourg horse. The pasturage is sufficiently good to develop the powers of the colt, and few things contribute more to his subsequent hardihood than his living on these pastures, and becoming accustomed to the vicissitudes of the seasons: yet this may be carried too far. The Sleswick colt is left out of doors all the year round, and, except when the snow renders it impossible for him to graze, he is, day and night, exposed to the cold, and the wind, and the rain. We are no advocates for a system of nursing laborious to the owner and injurious to the animal, but a full development of form and of power can never be acquired amidst outrageous neglect and privation.

#### THE PRUSSIAN HORSE.

Prussia has not been backward in the race of improvement—or rather, with her characteristic policy, she has taken the lead, where her influence and her power were concerned. The government has established some extensive and well-regulated studs in various parts of the kingdom; and many of the Prussian noblemen have establishments of their own. In some of the marshy districts, and about the mouth of the Vistula, there is a breed of large and strong horses suited to agricultural purposes. The studs produce others for pleasure or for war. In the royal studs particular attention has been paid to the improvement of the Prussian cavalry-horse. He has acquired considerably more fire and spirit, and strength and endurance, without any sacrifice either of form or action.

## THE FLEMISH AND DUTCH HORSE.

The *Flemish and Dutch* horses are large, and are strongly formed. We are indebted to them for some of the best blood of our draught-horses, and we still have frequent recourse to them for keeping up and improving the breed. They will be more particularly described when the cart-horse is spoken of.

## CHAPTER III.

## HISTORY OF THE ENGLISH HORSE.

THE earliest record of the horse in Great Britain is contained in the history given by Julius Cæsar of his invasion of our island. The British army was accompanied by numerous war-chariots, drawn by horses. Short scythes were fastened to the ends of the axle-trees, sweeping down everything before them, and carrying terror and devastation into the ranks of the enemy. The conqueror gives an animated description of the dexterity with which these horses were managed.

What kind of horse the Britons then possessed, it would be useless to inquire; but, from the cumbrous structure of the car, and the fury with which it was driven, and the badness of the roads, and the almost non-existence of those that were passable, it must have been both active and powerful in an extraordinary degree. It is absurd to suppose, as some naturalists have done, that the ponies of Cornwall and of Devon, or of Wales, or of Shetland, are types of what the British horse was in early times. He was then as ever the creature of the country in which he lived. With short fare and exposed to the rigour of the seasons, he was probably the little hardy thing which we yet see him; but in the marshes of the Nen and the Witham, and on the borders of the Tees and the Clyde, there would be as much proportionate development of frame and of strength as we find at the present day.

Cæsar deemed these horses so valuable, that he carried many of them to Rome; and they were, for a considerable period afterwards, in great request in various parts of the Roman empire.

Horses must at that time have been exceedingly numerous in Britain, for we are told that when the British king, Cassivellaunus, dismissed the main body of his army, he retained four thousand of his war-chariots for the purpose of harassing the Romans, when they attempted to forage.

The British horse now received its first cross; but whether the breed was thereby improved cannot be ascertained. The Romans having established themselves in Britain, found it necessary to send over a numerous body of cavalry, in order effectually to check the frequent insurrections of the natives. The Roman horses would breed with those of the country and, to a greater or less extent, change their character; and from this time, the English horse would consist of a compound of the native animal and those from Gaul, Italy, Spain, and every province from which the Roman cavalry was supplied.

Many centuries afterwards passed by without leaving any record of the character or value, improvement or deterioration, of the horse. About the year 630, however, according to Bede, the English were accustomed to

use the saddle. He says, that 'the bishops and others rode on horseback, who until then were wont to go on foot; and that even then it was only on urgent occasions that they thus rode. They used mares only, as a mark of humility, the mare generally not being so handsome or so much valued as the horse.'

About 920 years after the first landing of Caesar, we find the various British kingdoms united, and Alfred on the throne. Nothing that concerned the welfare of his kingdom was neglected by this patriotic monarch, and some of the chronicles relate the attention which he paid to the breeding and improvement of the horse. An officer was appointed for this especial purpose, who was entitled the *Hors-Than* or *Horse-Thane*, or, as the historian renders it, *Equorum Magister*, Master of the Horse. In every succeeding reign, this officer was always near the royal person, especially on every state occasion.

Athelstan, the natural son of Alfred, having subdued the rebellious portions of the Heptarchy, was congratulated on his success by some of the Continental princes, and received from Hugh Capet of France, who solicited his sister in marriage, several *German running horses*. Hence our breed received another cross, and probably an improvement. We are not, however, certain of the precise breed of these horses, or how far they resembled the beautiful state horses, whether black or cream-coloured, which we obtain from Germany at the present day. Athelstan seems to have placed peculiar value on these horses or their descendants, or the result of their intercourse with the native breed; for he soon afterwards (A.D. 930) decreed, that no horses should be sent abroad for sale, or on any account, except as royal presents. This proves his anxiety to preserve the breed, and likewise renders it probable that that breed was beginning to be esteemed by our neighbours.

It is not unlikely that, even at this early period, the beautiful effect of the English soil and climate, and care in the improvement of the horse, began to be evident. This will be a subject for pleasing inquiry by and by: but the experience of every age has proved that there are few countries in which the native breed has been rendered so much more valuable by the importation of a foreign stock, and every good quality of a foreign race so certainly retained, as in England.

In a document bearing date A.D. 1000, we have an interesting account of the relative value of the horse. If a horse was destroyed, or negligently lost, the compensation to be demanded was thirty shillings; for a mare or colt, twenty shillings; a mule or young ass, twelve shillings; an ox, thirty pence; a cow, twenty-four pence; a pig, eight pence; and, it strangely follows, a man, one pound. According to the Anglo-Saxon computation, forty-eight shillings made a pound, equal in silver to about three pounds of our present money. Five pence made one shilling: the actual value of these coins, however, strangely varied in different times and circumstances.

In the laws of Howell Dha, Howell the Good, Prince of Wales, enacted a little before this time, there are some curious particulars respecting the value and sale of horses. The value of a foal not fourteen days old is fixed at four pence; at one year and a day it is estimated at forty-eight pence; and at three years, sixty pence. It was then to be tamed with the bridle, and brought up either as a *palfrey* or a *serving horse*, when its value became one hundred and twenty pence. That of a *wild* or unbroken mare was sixty pence.

Even in those early days, the frauds of dealers were too notorious, and the following singular regulations were established. The buyer was allowed time to ascertain whether the horse was free from three diseases. He had

three nights to prove him for the staggers; three months to prove the soundness of his lungs; and one year to ascertain whether he was infected with glanders. For every blemish discovered after the purchase, one-third of the money was to be returned, except it should be a blemish of the ears or tail, which it was supposed to be his own fault if the purchaser did not discover. The seller also warranted that the horse would not tire when on a journey with others, or refuse his food from hard work, and that he would carry a load or draw a carriage up or down hill, and not be *resty*.

The practice of letting horses for hire then existed; and then, as now, the services of the poor hack were too brutally exacted. The benevolent Howell disdains not to legislate for the protection of this abused and valuable servant. 'Whoever shall borrow a horse, and rub the hair so as to gull the back, shall pay four pence; if the skin is forced into the flesh, eight pence; if the flesh be forced to the bone, sixteen pence.' If a person lamed a horse, he was to forfeit the value of the animal; and if he was supposed to have killed a horse, he was to purge himself by the oaths of twenty-four compurgators.

Then, as now, it would appear that some young men were a little too fond of unwarrantable mischief, or perhaps there were thieves in the country, even so soon after Alfred's days, showing also the estimation in which this portion of the animal was held, and the manner in which the hair was suffered to grow, for it was decreed that he who cut off the hair from a horse's tail was to maintain him until it was grown again, and in the mean time to furnish the owner with another horse. If the tail was cut off with the hair, the miscreant who inflicted the outrage was mulcted in the value of the animal, and the horse was deemed unfit for future service.

Athelstan seems to have placed considerable value on some of his horses; for he bequeaths, in his will, the horses given him by Thurbrand, and the white horses presented to him by Lisbrand. These are apparently Saxon names, but the memory of them is now lost.

With William the Conqueror came a marked improvement in the British horse. To his superiority in cavalry this prince was chiefly indebted for the victory of Hastings. The favourite charger of William was a Spaniard. His followers, both the barons and the common soldiers, principally came from a country in which agriculture had made more rapid progress than in England. A very considerable portion of the kingdom was divided among these men; and it cannot be doubted that, however unjust was the usurpation of the Norman, England benefited in its husbandry, and particularly in its horses, by the change of masters. Some of the barons, and particularly Roger de Boulogne, earl of Shrewsbury, introduced the Spanish horse on their newly-acquired estates. The historians of these times, however—principally monks, and knowing nothing about horses—give us very little information on the subject.

The Spanish horse was then highly and deservedly valued for his stately figure and noble action, and was in much request in the tilts and tournaments that were then in fashion. The Spanish horse was the war-horse of every one who could afford to purchase and properly accoutre so noble an animal. The courage and the skill of the rider were most perfectly displayed when united with the strength and activity, and spirit and beauty, of the steed.

One circumstance deserves to be remarked, namely, that in none of the earliest historical records of the Anglo-Saxons or the Welsh is there any allusion to the use of the horse for the plough. Until a comparatively recent period, oxen alone were employed in England, as in other countries, for this purpose; but about this period—the latter part of the tenth century—some innovation on this point was commencing, and a Welsh

law forbade the farmer to plough with horses, mares, or cows, but with oxen alone. On one of the pieces of the Bayeux tapestry woven in the time of William the Conqueror (A.D. 1066), there is the figure of a man driving a horse attached to a harrow. This is the earliest notice that we have of the use of this animal in field-labour.

In the reign of Henry I. (A.D. 1121), the first Arabian horse, or at least the first on record, was introduced. Alexander I., king of Scotland, presented to the church of St. Andrew's an Arabian horse, with costly furniture, Turkish armour, many valuable trinkets, and a considerable estate.

There have been some pretensions to the existence of a breed derived from or improved by this horse, but no certain proof of it can be adduced.

In the reign of Henry II. several foreign horses were imported, but of what kind is not mentioned. Maddox speaks of 'the increased allowance that was made for the subsistence of the King's horses that were lately brought from beyond sea.'

Smithfield is also now first spoken of as a horse-market, a field for tournaments, and a race-course. Fitzstephen, who lived at that time, gives the following animated account of the scene:—'Without one of the gates of the city is a certain field, plain or *smooth*, both in *name* and *situation*. Every Friday, except some festival intervene, there is a fine sight of horses brought to be sold. Many come out of the city to buy or look on—to wit, earls, barons, knights, and citizens. It is a pleasant thing to behold the horses there, all gay and sleek, moving up and down, some on the *amble* and some on the *trot*, which latter pace, although rougher to the rider, is better suited to men who bear arms. Here also are colts, yet ignorant of the bridle, who prance and bound, and give early signs of spirit and courage. Here also are *managed* or war-horses, of elegant shape, full of fire, and giving every proof of a generous and noble temper. Horses also for the cart, dray, and plough, are to be found here; mares, big with foal, and others with their colts wantonly running by their sides.

'Every Sunday in Lent, after dinner, a company of young men ride out into the fields, on horses that are fit for war, and excellent for their speed. Every one among them is taught to run the rounds with his horse. The citizens' sons issue out through the gates by troops, furnished with lances and shields. The younger sort have their pikes not headed with iron; and they make representation of battle, and exercise a skirmish. To this performance many courtiers resort, when the court is near; and young striplings, yet uninitiated in arms, from the families of barons and great persons to train and practise.

'They begin by dividing themselves into troops. Some labour to outstrip their leaders, without being able to reach them; others unhorse their antagonists, yet are not able to get beyond them. A race is to be run by this sort of horses, and perhaps by others, which also in their kind are strong and fleet, a shout is immediately raised, and the common horses are ordered to withdraw out of the way. Three jockeys, or sometimes only two, as the match is made, prepare themselves for the contest. The horses on their part are not without emulation: they tremble and are impatient, and are continually in motion. At last, the signal once given, they start, devour the course, and hurry along with unremitting swiftness. The jockeys, inspired with the thought of applause and the hope of victory, clap spurs to their willing horses, brandish their whips, and cheer them with their cries.' This animated description reminds us of the more lengthened races of the present day, and proves the blood of the English horse, even before the Eastern breed was tried.

Close on this followed the Crusades. The champions of the Cross

certainly had it in their power to enrich their native country with some of the choicest specimens of the Eastern horse, but they were completely under the influence of superstition and fanaticism, and common sense and usefulness were forgotten.

An old metrical romance, however, records the excellence of two horses belonging to Richard Cœur de Lion, which he purchased at Cyprus, and were, therefore, probably of Eastern origin:—

Yn this worlde they hadde no pere,  
 Dromedary nor destriere,  
 Stede, Rabyte, ne Cammele,  
 Goeth none so swifte, without fayle:  
 For a thousand pownd of golde,  
 Ne should the one be solde.

The head of the war-steed was ornamented with a crest, and together with his chest and flanks, was wholly or partially protected. Sometimes he was clad in complete steel, with the arms of his master engraved or embossed on his *bardings*. The bridle of the horse was always as splendid as the circumstances of the knight allowed, and thus a horse was often called *brigliadore*, from *briglia d'oro*, a bridle of gold. Bells were a very favourite addition to the equipment of the horse. The old troubadour, Arnold of Marston, says that 'nothing is so proper to inspire confidence in a knight and terror in an enemy.'

The price of horses at this period was singularly uncertain. In 1185, fifteen breeding mares sold for two pounds twelve shillings and sixpence; They were purchased by the monarch, and distributed among his tenants; and in order to get something by the bargain, he charged them the great sum of four shillings each. Twenty years afterwards, ten capital horses brought no less than twenty pounds each; and twelve years later, a pair of horses were imported from Lombardy, for which the extravagant price of thirty-eight pounds thirteen shillings and fourpence was given. The usual price of good handsome horses was ten pounds, and the hire of a car or cart with two horses was tenpence a-day.

To King John, hateful as he was in all other respects, we are much indebted for the attention which he paid to agriculture generally, and particularly to the improvement of the breed of horses. He imported one hundred chosen stallions of the Flanders breed, and thus mainly contributed to prepare our noble species of draught-horses, as unrivalled in their way as the horses of the turf.

John accumulated a very numerous and valuable stud. He was eager to possess himself of every horse of more than usual power; and at all times gladly received from the tenants of the crown, horses of a superior quality instead of money for the renewal of grants, or the payment of forfeitures belonging to the crown. It was his pride to render his cavalry, and the horses for the tournament and for pleasure, as perfect as he could. It was not to be expected that so haughty and overbearing a tyrant would concern himself much with the inferior kinds; yet while the superior kinds were rapidly becoming more valuable, the others would, in an indirect manner, partake of the improvement.

One hundred years afterwards, Edward II. purchased thirty Lombardy *war-horses*, and twelve heavy draught-horses. Lombardy, Italy, and Spain were the countries whence the greater part of Europe was then supplied with the most valuable cavalry or parade horses. Those for agricultural purposes were chiefly procured from Flanders.

Edward III. devoted one thousand marks to the purchase of fifty Spanish horses; and of such importance did he consider this addition to the English, or rather, mingled blood then existing, that formal application was made

to the kings of France and Spain to grant safe conduct to the troop. When they had safely arrived at the royal stud, it was computed that they had cost the monarch no less than thirteen pounds six shillings and eight-pence per horse, equal in value to one hundred and sixty pounds of our present money.

These horses were bought in order to enable him successfully to prosecute a war against Scotland, and to prepare for a splendid tournament which he was about to hold.

Entire horses were alone used for this mimic contest, and generally so in the duties and dangers of the field. It was rarely the custom to castrate the colts; and the introduction of the female among so many perfect horses might occasionally be productive of confusion. The mare was at this period comparatively despised. It was deemed disgraceful for any one above the common rank to ride her, and she was employed only in the most servile offices. This feeling and practice was then prevalent in every part of the world. When, however, it began to be the custom to castrate the young horses, the worth and value of the mare was soon appreciated; and it is now acknowledged that usually she is not much, if at all, inferior to the perfect horse in many respects, while she has far more strength, proportionate courage, and endurance than the gelding.

This monarch had many *running-horses*. The precise meaning of the term is not, however, clear. They might be light and speedy animals in opposition to those destined for the cavalry service, or horses that were literally used for the purpose of racing. The average price of these running-horses was twenty marks, or thirteen pounds six shillings and eightpence.

Edward was devoted to the sports of the turf and the field, or he began to see the propriety of crossing our stately and heavy breed with those of a lighter structure and greater speed. There was, however, one impediment to this, which was not for a very long period removed. The soldier was cased in heavy armour, and the knight, with all his accoutrements, often rode more than twenty-five stones. No little bulk and strength were required in the animal destined to carry this back-breaking weight. When the musket was substituted for the cross-bow and battle-axe, and this iron defence, cumbrous to the wearer and destructive to the horse, became useless, and was laid aside, the improvement of the British horse in reality commenced.

While Edward was thus eager to avail himself of foreign blood, he, with the too frequent selfishness of the sportsman, would let no neighbour share in the advantage. The exportation of horses was forbidden under heavy penalties. One case in which he relaxed from his severity is recorded. He permitted a German merchant to re-export some Flanders horses which he had brought on speculation; but he strictly forbade him to send them to Scotland. Nay, so jealous were these sister-kingdoms of each other's prosperity, that so late as the time of Elizabeth, it was deemed felony to export horses from England to Scotland.

The English horse was advancing, although slowly, to an equality with, or even superiority over, those of neighbouring countries. His value began to be more generally and highly estimated, and his price rapidly increased—so much so, that the breeders and the dealers, then, as now, skilful in imposing on the inexperienced, obtained from many of the young grandees enormous prices for their cattle. This evil increased to such an extent, that Richard II. (1386) interfered to regulate and determine the price. The proclamation which he issued is interesting, not only as proving the increased value of the horse, but showing what were, four hundred and seventy years ago, the chief breeding districts, as they still

continue to be. It was ordered to be published in the counties of Lincoln and Cambridge, and the East and North Ridings of Yorkshire; and the price of the horse was restricted to that which had been determined by former monarchs. A more enlightened policy has at length banished all such absurd interferences with agriculture and commerce.

We can now collect but little of the history of the horse until the reign of Henry VII., at the close of the fifteenth century. He continued to prohibit the exportation of stallions, but allowed that of mares when more than two years old; and under the value of six shillings and eightpence. This regulation was, however, easily evaded; for if a mare could be found worth more than six shillings and eightpence, she might be freely exported on the payment of that sum.

The intention of this was to put an end to the exportation of perfect horses; for it is recited in the preamble 'that not only a smaller number of good horses were left within the realm for the defence thereof, but also that great and good plenty of the same were in parts beyond the sea, which in times past were wont to be within this land, whereby the price of horses was greatly enhanced,' &c. The exception of the mare, and the small sum for which she might be exported, shows the unjust contempt in which she was held. Another act of the same monarch, however unwillingly on his part, restored her to her proper rank among her kind.

It had been the custom to keep large herds of horses in the pastures and common fields, and when the harvest was gathered in, the cattle of a great many owners fed promiscuously together. The consequence of this was that the progeny presented a strange admixture, and there was often a great deterioration of the favourite and best breed. On this account an act was passed prohibiting stallions from being turned out into any common pasture. This, at no great distance of time, necessarily led to the castrating of all but a very few of the best stallions, and then, on comparing the powers and work of the mare with that of the gelding, she soon began to be accounted more valuable—more service was exacted from her—she was taken more care of, and the general breed of horses was materially improved.

Polydore Virgil, who flourished in this reign, confirms the statements already made, that 'the English horses were seldom accustomed to trot, but excelled in the softer pace of the *amble*.'

Henry VII. was an arbitrary monarch, and seemed to be too fond of prohibitory acts of parliament; but so far as the horse was concerned they were most of them politic, although tyrannical.

Succeeding monarchs acted on the same principle, and by prohibiting exportation, and encouraging a numerous and good breed of horses, by public rewards and recompenses, every necessary incitement was afforded rapidly to improve the breed.

Henry VIII., a tyrannical and cruel prince, but fond of show and splendour, was very anxious to produce a valuable breed of horses; and the means which he adopted were perfectly in unison with his arbitrary disposition, although certainly calculated to effect his object. He affixed a certain standard, below which no horse should be kept. The lowest height for the stallion was fifteen hands, and for the mare thirteen hands. Those whose local interests were injured loudly complained of this arbitrary proceeding. The small breed of Cornish horses was in a manner extinguished. The dwarfish but active and useful inhabitants of the Welsh mountains rapidly diminished, the Exmoors and the Dartmoors were compelled to add an inch to their stature, and a more uniformly stout and useful breed of horses was produced.

The monarch was determined to effect and to secure his object. At



'Michaelmastide' the neighbouring magistrates were ordered to 'drive' all forests and commons, and not only destroy such stallions, but all 'unlikely tits,' whether mares, or geldings, or foals, which they might deem not calculated to produce a valuable breed.

He next had recourse to a sumptuary law in order more fully to accomplish his object; and, appealing to the pride of those who were concerned, he had no difficulty in this matter. Every archbishop and duke was compelled, under certain penalties, to keep seven trotting stallions for the saddle, each of which was to be fourteen hands high at the age of three years.

There were very minute directions with regard to the number of the same kind of horses to be kept by the other ranks of the clergy and nobility, and the statute concludes by enacting, that every person having benefices to the amount of one hundred pounds yearly, and 'every layman, whose wife shall wear any French hood or bonnet of velvet,' shall keep one such *trotting* stallion for the saddle.

These enactments, tyrannical as they appear to us, were quietly submitted to in those days, and produced the kind of horse which was then alone comparatively useful, and whose strength and noble bearing and good action were the foundation of something better in after days.

The civil dissensions were at an end, there was no fear of foreign invasions—no numerous cavalry were needed—the labours of agriculture were performed chiefly by oxen, or by the smaller and inferior breeds of horses—races were not established—the chase had not begun to be pursued with the ardour and speed of modern days—nothing, in fact, was now wanted or sought for, but an animal more for occasional exhibition than for sterling use, or if useful, principally or solely with reference to the heavy carriages and bad roads and tedious travelling through the country. If this is rightly considered, it will be acknowledged that, with all his faults, and with the confession that he was ever more actuated by the determinations of his own un governable passions than the advantage of his people or of posterity, we still owe him thanks for the preservation of that breed of horses from which in after times sprung those that were the glory of our country and the envy of every other.

The following extract from a manuscript dated 1512, in the third year of the reign of Henry VIII., and entitled the Regulations and Establishment of the Household of Algernon Percy, the fifth Earl of Northumberland, may give the reader a sufficient knowledge of the different kinds of horses then in use.

'This is the ordre of the chequir rool of the nombre of all the horsys of my lordis and my ladys that are apoynted to be in the charge of the hous yerely, as to say, gentil hors [one of the superior breed, in distinction from the ordinary race—the same term is at present applied to Italian horses of the best breeds]; palfreys [smaller horses of an inferior breed, —the best of them, distinguished for their gentleness, and pleasant paces, were set apart for the females of the family:—"The bard that tells of *palfried* dames."] Others of inferior value were ridden by the domesties or servants of every kind. Thus Dryden says,

The smiths and armourers on palfreys ride.]

Hobys [strong and active horses of rather small size, and said to have been originally of Irish extraction. Thus Davies, in his account of Ireland, says:—"For twenty *hobblers* armed—Irish horse-soldiers—so called because they served on hobbies; they had 6*l.* per diem"]; naggis, [or nags, so called from their supposed propensity to neigh, *kuugga*. They

were small, and not much valued, but active horses :—"Thy nags," says Prior,

The leanest things alive,  
So very hard thou lov'st to drive.]

Cloth-sek hors, [that carried the cloak-bag.]; male-hors, [or mail, was equivalent to portmanteau. Thus, in Chaucer, "I have relics and pardons in my *male*."] First, gentil-hors, to stand in my lordis stable, six. *Item*. Palfreys of my lady's, to wit, one for my lady, and two for her gentilwomen, and oone for her chamberer. Four hobys and naggis for my lordis oone saddill, viz. oone for my lorde to ride, oone to lede for my lorde, and oone to stay at home for my lorde. *Item*. Chariot hors to stound in my lorde's stable yerely. Seven great trottynge hors to draw in the chariott [or car; was the vehicle in various forms, but far inferior to the chariot or coach in common use, in which the furniture or moveables were conveyed, or, perchance, the inferior females of the family. The lord and the lady usually rode on horseback. They were slow-paced, heavy horses, perhaps not much unlike the carriage-horses a century ago, which ploughed all the week, and took the family to church on Sunday. It must not be forgotten, as marking the character of the vehicle and its contents, that the chariot-man, or coachman, rode by the side of the horses, and so conducted them and the carriage], and a nagg for the chariott-man to ride; eight. Again, hors for lorde Percy, his lordship's son and heir. A grete doble trottynge horse [a large and broad-backed horse, the depression along whose back gives almost the appearance of two horses joined together. Thus the French speak of *le double bidet*; and Virgil, referring to the horse, says, "At duplex agitur per lumbos spina"] for my lorde Percy to travel on in winter. *Item*. A grete doble trottynge hors, called a curtal, [one with a docked tail. Thus, Ben Jonson :—"Hold my stirrup, my one lacquey, and look to my *curtal* the other,"] for his lordship to ride on out of townes. Another trottynge gambaldyng [gambald was the old word for gambol, and it means a horse that was fond of playing and prancing about] hors, for his lordship to ride upon when he comes into townes. An ambling hors for his lordship to journey on dayly. A proper ambyng little nagg for his lordship when he goeth on hunting or hawking. A gret ambyng gelding or trottynge gelding to carry his male.—*Berenger on Horsemanship*.

Sir Thomas Chaloner, who wrote in the early part of the reign of Elizabeth, and whose praise of the departed monarch may be supposed to be sincere, speaks in the highest terms of his labour to introduce into his kingdom every variety of breed, and his selection of the finest animals which Turkey, or Naples, or Spain, or Flanders could produce. Sir Thomas was now ambassador at the court of Spain, and had an opportunity of seeing the valuable horses which that country could produce; and he says that 'England could furnish more beautiful and useful breeds than any which foreign kingdoms could supply.' The fact was, that except for pageantry or war, and the slow travelling of those times, there was no motive to cultivate any new or valuable breed. The most powerful stimulus had not yet been applied.

Berenger, who would be good authority in such a case, provided experienced and skilful persons to preside in his stables, and to spread by these means the rules and elements of horsemanship through the nation. He invited two Italians, pupils of Pignatelli the riding master of Naples, and placed them in his service; and he likewise had an Italian farrier named Hannibale, who, Berenger quaintly remarks, 'did not discover any great mysteries to his English brethren, but yet taught them more than they knew before.'

There is nothing worthy of remark in the short reign of Edward VI., except the constituting the stealing of horses a felony without benefit of clergy.

In the twenty-second year of Elizabeth, the use of coaches was introduced. It has been already remarked that the heads of noble houses travelled almost from one end of the kingdom to the other on horseback, unless occasionally they took refuge in the ears that were generally appropriated to their household. Even the Queen rode behind her master of the horse when she went in state to St. Paul's. The convenience of this new mode of carriage caused it to be immediately adopted by all who had the means; and the horses were so rapidly bought up for this purpose, and became so exorbitantly dear, that it was agitated in Parliament whether the use of carriages should not be confined to the higher classes.

This fashion would have produced an injurious effect on the character of the English horse. It would have too much encouraged the breed of the heavy and slow horse, to the comparative or almost total neglect of the lighter framed and speedy one; but, gunpowder having been invented, and heavy armour beginning to be disused, or, at this period, having fallen into almost perfect neglect, a lighter kind of horse was necessary in order to give effect to many of the manœuvres of the cavalry. Hence arose the light cavalry—light compared with the horsemen of former days—heavy compared with those of modern times; and hence, too, arose the lighter horse, which, except for a few particular purposes, gradually superseded the old heavy war and draught horse.

An account has already been given of the occasional races at Smithfield. They were mostly accidental trials of strength and speed, and there were no *running-horses*, properly speaking—none that were kept for the purpose of displaying their speed, and dedicated to this particular purpose alone. Regular races, however, were now established in various parts of England, first at Garterly in Yorkshire, then at Croydon, at Theobald's on Enfield-chase, and at Stamford. Boucher, in his History of Stamford, says, that the first valuable public prize was run for at that place in the time of Charles I. It was a silver-gilt cup and cover, of the value of 5*l.*, provided by the corporation. There was no acknowledged system as now—no breed of racing-horses; but hackneys and hunters mingled together, and no description of horse was excluded.

There was at first no course marked out for the race, but the contest generally consisted in the running of *train-scent* across the country, and sometimes the most difficult and dangerous part of the country was selected for the exhibition. Occasionally our present steeple-chase was adopted with all its dangers, and more than its present barbarity; for persons were appointed cruelly to flog along the jaded and exhausted horse. This perhaps requires a little explanation. A match was formed called the 'Wild-Goose Chase,' between two horses, and a tolerably sure trial it was of the speed and hunting properties of the horse. Whichever horse obtained the lead at twelve score yards from the starting post, the other was compelled to follow him wherever he went, and to keep within a certain distance of him, as twice or thrice his length, or else to be 'beaten up,' whipped up to the mark by the judges who rode to see fair play. If one horse got before the other twelve score yards, or any *certain* distance, according as the match was made, he was accounted to be the winner; but if the horse which at the beginning was behind, could get before him that first led, then the other was bound to follow, and so on, until one got 240 yards, the eighth part of a mile, before the other, or refused some break-neck leap which the other had taken.

By degrees, however, certain horses were devoted to these exhibitions,

and were prepared for the race, as far as the mystery of the training stable could then be explored, somewhat in the same way as at present. The weight of the rider, however, was not always adjusted to the age or performances of the horse; but no rider could start who weighed less than 10 st.

The races of that period were not disgraced by the system of gambling and fraud which in later times seems to have become almost inseparable from the amusements of the turf. No heavy stakes were run for, and no betting system had been established. The prize was usually a wooden bell adorned with flowers. This was afterwards exchanged for a silver bell, and 'given to him who should run the best and farthest on horseback, and especially on Shrove Tuesday.' Hence the common phrase of 'bearing away the bell.'

Horse-racing became gradually more cultivated; but it was not until the last year of the reign of James I. that rules were promulgated and generally subscribed to for their regulation. That prince was fond of field-sports. He had encouraged, if he did not establish, horse-racing in Scotland, and he brought with him to England his predilection for it; but his races were often matches against time, or trials of speed and bottom for absurdly and cruelly long distances. His favourite courses were at Croydon and on Enfield-chase.

Although the Turkish and Barbary horses had been freely used to produce with the English mare the breed that was best suited to this exercise, little improvement had been effected. James, with great judgment, determined to try the Arab breed. Probably he had not forgotten the story of the Arabian that had been presented to one of his Scottish churches, five centuries before. He purchased from a merchant, named Markham, a celebrated Arabian horse, for which he gave the extravagant sum of five hundred pounds. Kings, however, like their subjects, are often thwarted and governed by their servants, and the Duke of Newcastle took a dislike to this foreign animal. He wrote a book, and a very good one, on horsemanship; but he described this Arabian as a little bony horse, of ordinary shape; setting him down as almost worthless, because, after being regularly trained, he seemed to be deficient in speed. The opinion of the duke, probably altogether erroneous, had for nearly a century great weight; and the Arabian horse lost its reputation among the English breeders.

A south-eastern horse was afterwards brought into England, and purchased by James, of Mr. Place, who afterwards became stud-master or groom to Oliver Cromwell. This beautiful animal was called the White Turk; and his name and that of his keeper will long be remembered. Shortly after this appeared the Helmsley Turk, introduced by Villiers, the first duke of Buckingham. He was followed by Fairfax's Morocco barb. These horses speedily effected a considerable change in the character of our breed, so that Lord Harleigh, one of the old school, complained that the great horse was fast disappearing, and that horses were now bred light and fine for the sake of speed only.

Charles I., however, ardently pursued this favourite object of English gentlemen; and, a little before his rupture with the parliament, established races in Hyde Park and at Newmarket.

We owe to Charles I. the introduction of the bit into universal use in the cavalry service, and generally out of it. The invention of the bit has been traced to as early as the time of the Roman emperors, but for some inexplicable reason it had not been adopted by the English. Charles I., however, in the third year of his reign, issued a proclamation stating that such horses as are employed in the service, being more easily managed

by means of the bit than the snaffle, he strictly charged and commanded that, except in times of *disport*—racing and hunting—no person engaged in the cavalry service should, in riding, use any *snaffles*, but *bites* only.

It was feared by some that the love of hunting and racing was making somewhat too rapid progress; for there is on record a memorial presented to Charles, 'touching the state of the kingdom, and the deficiency of good and stout horses for its defence, on account of the strong addiction which the nation had to racing and hunting horses, which, for the sake of swiftness, were of a lighter and weaker mould.'

The civil wars somewhat suspended the inquiry into this, and also the improvement of the breed; yet the advantage which was derived by both parties from a light and active cavalry sufficiently proved the importance of the change that had been effected. Cromwell, perceiving with his wonted sagacity how much these pursuits were connected with the prosperity of the country, had his stud of race-horses.

At the Restoration a new impulse was given to the cultivation of the horse by the inclination of the court to patronise gaiety and dissipation. The races at Newmarket, which had been for a while suspended, were restored; and, as an additional spur to emulation, royal plates were given at each of the principal courses. Charles II. sent his master of the horse to the Levant, to purchase brood mares and stallions. These were principally Barbs and Turks.

James II. lived in too unquiet a period to be enabled to bestow much time on the sports of the turf or the field. He has, however, been represented as being exceedingly fond of hunting, and showing so decided a preference for the English horse as, after his abdication, to have several of them in his stables in France. Berenger speaks of this with much feeling:—'He expressed a peculiar satisfaction in having them, and that at a time, and in a situation in which it is natural to think that they were rather likely to have given him uneasiness and mortification than to have afforded him pleasure.'

William III., and Anne, principally at the instigation of her consort, George, Prince of Denmark, were zealous patrons of the turf, and the system of improvement was zealously pursued; every variety of Eastern blood was occasionally engrafted on our own, and the superiority of the newly-introduced breed above the best of the original stock began to be evident.

Some persons imagined that this speed and stoutness might possibly be further increased; and Mr. Darley, in the latter part of the reign of Queen Anne, had recourse to the discarded and despised Arabian. He had much prejudice to contend with, and it was some time before the horse which he selected, and which was afterwards known by the name of the Darley Arabian, attracted much notice. At length the value of his produce began to be recognised, and to him we are mainly indebted for a breed of horses of unequalled beauty, speed, and strength.

The last improvement furnished all that could be desired: nor was this true only of the thorough-bred or turf-horse—it was to a very material degree the case with every description of horse. By a judicious admixture and proportion of blood, we have rendered our hunters, our hackneys, our coach—nay, even our cart-horses, stronger, more active, and more enduring, than they were before the introduction of the race-horse.

The history of the horse in England is a very interesting one. The original breed—that of which mention is first made in history—seems to have been a valuable one. The Conqueror carried away many specimens of it, and they were long held in repute in every country subjugated by the Romans. The insular situation of Britain, and its comparatively little

need of the war-horse, led under several monarchs to a culpable degree of negligence; and although, perhaps, on the whole the English were not far behind their Continental neighbours, yet at no period, until within the last century and a half, has Great Britain been at all distinguished on this account: but from that time, and especially during the latter part of it, the British horse has been sought after in every part of the world. There is nothing in our climate that can account for this—nothing in our soil, or this superior excellence would have been acknowledged long ago. ‘The grand first cause,’ says Mr. Wm. Percivall, in his introductory lecture at University College, in 1834, ‘—that, by the steady prosecution and scientific management of which this success has been brought about, appears to me to be breeding; by which I do not only mean the procurement of original stock of a good description, but the continual progressive cultivation of that stock in the progeny by the greatest care in rearing and feeding, and by the most careful selection. On these two circumstances, and particularly on the latter, a great deal more depends than on the original characters or attributes of the parents. By these means we have progressed from good to better, losing sight of no subsidiary help, until we have attained a perfection in horse-flesh unknown in the whole world beside.’

The love of the turf, and the anxious desire to possess horses of unrivalled excellence, have within the last twenty years spread over the European continent. Everywhere stud-houses have been built and periodical races established, and sporting societies formed of persons of the greatest weight in the community, and, everywhere, zealous attempts have been made to improve the native stock. The coursers of the East might have been easily procured—a new supply of Arabian blood might have been obtained from the native country of the Barb: but French, and Italians, Germans, Russians, and Flemings, have flocked to the British Isles. The pure blood of the present Barb and Arabian has been postponed, and all have deeply drawn from that of the thorough-bred English horse. This is a circumstance with regard to which there is no dispute. It is a matter of history—and it is highly creditable to our sporting men and breeders. Mr. Percivall has rightly stated the cause, but there are some circumstances connected with this pre-eminence that may give occasion for serious reflection, and which will be best considered as the respective breeds of horses pass in review.

---

## CHAPTER IV.

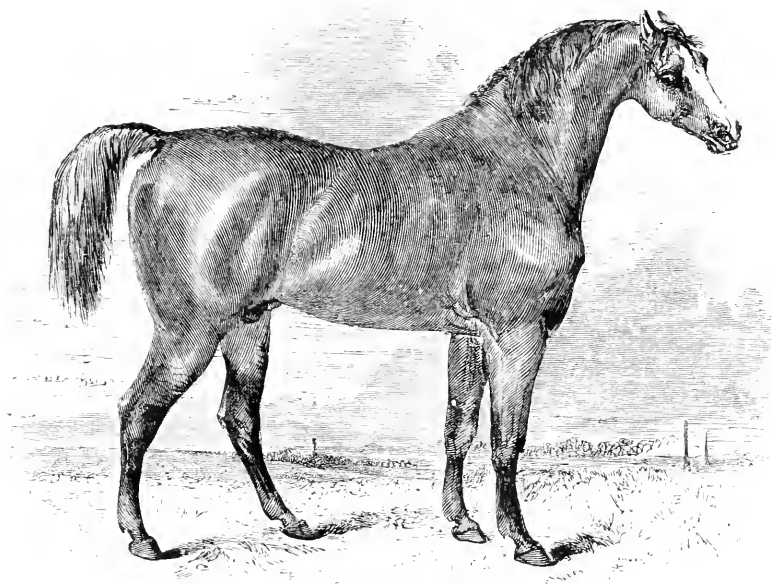
### THE DIFFERENT BREEDS OF ENGLISH HORSES.

#### THE RACE-HORSE.

THERE was much dispute with regard to the origin of the *thorough-bred horse*. By some he was traced through both sire and dam to Eastern parentage; while others believed him to be the native horse, improved and perfected by judicious crossing with the Barb, the Turk, or the Arabian. ‘The Stud-Book,’ which is an authority acknowledged by every English breeder, traces all the old racers to some Eastern origin, or at least until the pedigree is lost in the uncertainty of an early period of breeding. If the pedigree of a racer of the present day is required, it is traced back to a certain extent, and ends with a well-known racer; or if an

earlier derivation is required, that ends either with an Eastern horse or in obscurity.

It is now admitted that the present English thorough-bred horse is of



THE COLONEL.

foreign extraction, improved and perfected by the influence of climate and diligent cultivation. There are some exceptions, as in the cases of Sampson and Bay Malton, in each of which, although the best horses of their day, there was a cross of vulgar blood; but they are only deviations from a general rule. In our best racing-stables this is an acknowledged principle; and it is not, when properly considered, in the slightest degree derogatory to the credit of our country. The British climate and British skill made the thorough-bred horse what he is.

The beautiful tales of Eastern countries and somewhat remote days may lead us to imagine that the Arabian horse possesses marvellous powers: but it cannot admit of a doubt that the English-trained horse is more beautiful and far swifter and stouter than the justly-famed coursers of the desert. In the burning plains of the East and the frozen climate of Russia, he has invariably beaten every antagonist on his native ground. It has been already stated that, a few years ago, Recruit, an English horse of moderate reputation, easily beat Pyramus, the best Arabian on the Bengal side of India.

It must not be objected that the number of Eastern horses imported is far too small to produce so numerous a progeny. It will be recollected that the thousands of wild horses on the plains of South America descended from only two stallions and four mares, which the early Spanish adventurers left behind them.

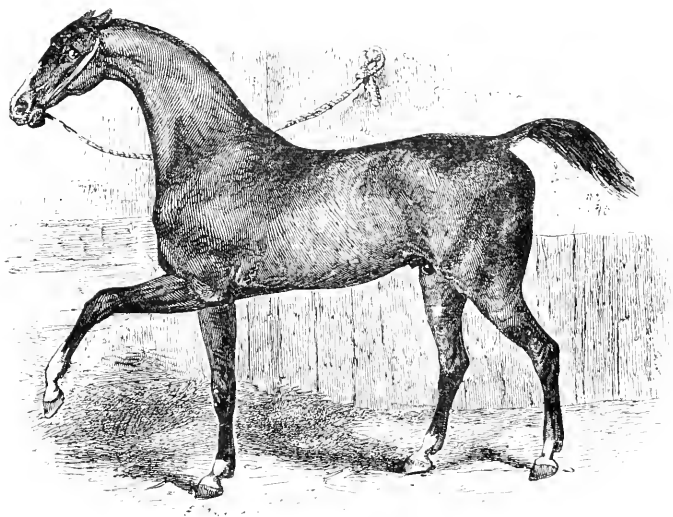
Whatever may be the truth as to the origin of the race-horse, the

strictest attention has for the last hundred years been paid to his pedigree. In the descent of almost every modern racer, not the slightest flaw can be discovered: or when, with the splendid exceptions of Sampson and Bay Malton, one drop of common blood has mingled with the pure stream, it has been immediately detected in the inferiority of form and deficiency of stamina, and it has required two or three generations to wipe away the stain and get rid of its consequences.

The racer is generally distinguished by his beautiful Arabian head: tapering and finely-set-on neck; oblique lengthened shoulders; well-bent hinder legs; ample, muscular quarters; flat legs, rather short from the knee downward, although not always so deep as they should be; and his long and elastic pastern. These will be separately considered when the structure of the horse is treated of.

The Darley Arabian was the parent of our best racing stock. He was purchased by Mr. Darley's brother at Aleppo, and was bred in the neighbouring desert of Palmyra. His figure contained every point, without much show, that could be desired in a turf-horse.

The immediate descendants of this invaluable horse were the Devonshire or Flying Childers; the Bleeding or Bartlett's Childers, who was never trained; Almanzor, and others.



FLYING CHILDERS.

The two Childers were the means through which the blood and fame of their sire were widely circulated; and from them descended another Childers, Blaze, Snap, Sampson, Eelipse, and a host of excellent horses.

The Devonshire or Flying Childers, so called from the name of his breeder, Mr. Childers, of Carr House, and the sale of him to the Duke of Devonshire, was the fleetest horse of his day. He was at first trained as a hunter, but the superior speed and courage which he discovered caused him to be soon transferred to the turf. Common report affirms that he could run a mile in a minute; but there is no authentic record of this. Childers ran over the round course at Newmarket (three miles, six furlongs and ninety-three yards) in six minutes and forty seconds, and the



Beacon course (four miles, one furlong, and one hundred and thirty-eight yards) in seven minutes and thirty seconds. In 1772, a mile was run by Firetail in one minute and four seconds.

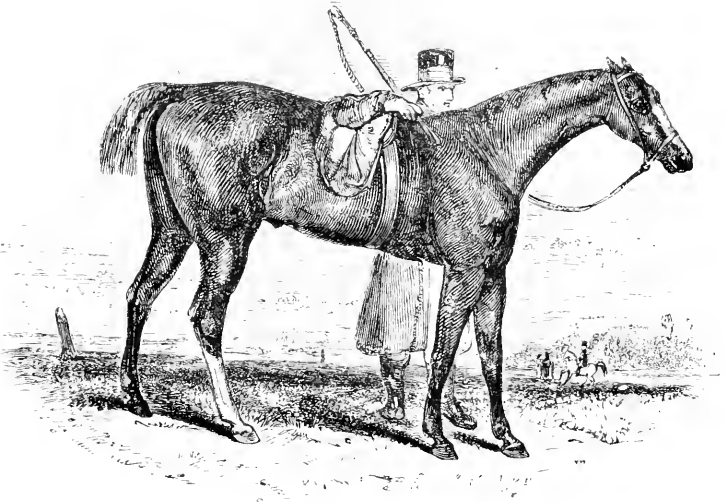
In 1755, Bay Malton, the property of the Marquis of Rockingham, ran the four-mile course at York in seven minutes and forty-three seconds, this being seven seconds less time than it had ever been accomplished in before. Some of these old ones could run fast as well as stoutly. Twenty years afterwards there was a beautiful horse, the son of Eclipse, and inheriting a great portion of his speed without his stoutness. He won almost every mile-race for which he ran, but he never could accomplish a four-mile one. He broke down, in 1779, running over the Beacon course.

One of the most *really* severe races that ever was run took place at Carlisle in 1761. There was no less than six heats, and two of them dead heats. Each of the six was honestly contested by the winning horse: therefore he ran in good earnest twenty-four miles: yet there was no breaking down, nor any account of the slightest injury received.

The following are some additional instances of the mingled speed and endurance of these horses, and deserve to be placed on record:—

In October, 1741, at the Curragh meeting in Ireland, Mr. Wilde engaged to ride one hundred and twenty-seven miles in nine hours. He performed it in six hours and twenty-one minutes. He employed ten horses, and, allowing for mounting and dismounting, and a moment for refreshment, he rode during six hours at the rate of twenty miles an hour.

Mr. Thornhill, in 1745, exceeded this; for he rode from Stilton to



ECLIPSE.

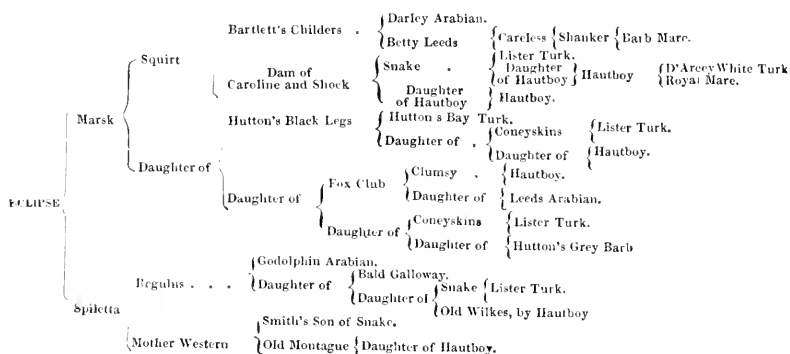
London and back, and again to London, being two hundred and thirteen miles, in eleven hours and thirty-four minutes. This amounts, after allowing the least possible time for changing horses, to twenty miles an hour for eleven hours, and on the turnpike-road and uneven ground.

Mr. Shaftoe, in 1762, with ten horses, and five of them ridden twice,

accomplished fifty miles and a quarter in one hour and forty-nine minutes. In 1763, he won a still more extraordinary match. He engaged to procure a person to ride one hundred miles a day for twenty-nine days, having any number of horses not exceeding twenty-nine from which to make his selection. He accomplished it on fourteen horses; but on one day he was compelled to ride a hundred and sixty miles, on account of the tiring of his first horse.

Mr. Hull's Quibbler, however, afforded the most extraordinary instance on record, of the stoutness as well as speed of the race-horse. In December, 1786, he ran twenty-three miles round the flat at Newmarket, in fifty-seven minutes and ten seconds.

Eclipse was got by Marsk, a grandson of Bartlett's Childers, and his pedigree affords a singular illustration of the descent of our thorough-bred horses from pure Eastern blood :—



The pedigree of Eclipse will likewise afford another curious illustration of the uncertainty which attends thorough-bred horses. Marsk was sold at the sale of the Duke of Cumberland's stud for a mere trifle, and was suffered to run almost wild on the New Forest. He was afterwards purchased for one thousand guineas, and before his death covered for one hundred guineas. Squirt, when the property of Sir Harry Harpur, was ordered to be shot; and while he was actually being led to the dog-kennel, he was spared at the intercession of one of Sir Harry's grooms. Neither Bartlett's Childers, nor Snake, were ever trained. On the side of the dam, Spiletta never started but once and was beaten; and the Godolphin Arabian was purchased from a water cart in Paris.

Eclipse was bred by the Duke of Cumberland, and sold at his death to Mr. Wildman, a sheep salesman, for seventy-five guineas. Colonel O'Kelly purchased a share of him from Wildman. In the spring of the following year, when the reputation of this wonderful animal was at its height, O'Kelly wished to become sole owner of him, and bought the remaining share for eleven hundred guineas.

Eclipse was what was termed a thick-winded horse, and puffed and roared so as to be heard at a considerable distance. For this or some other cause, he was not brought on the turf until he was five years old.

O'Kelly, aware of his horse's powers, had backed him freely on his first race, in May 1769. This excited curiosity, or, perhaps, roused suspicion, and some persons attempted to watch one of his trials. Mr. John Lawrence says, that, 'they were a little too late; but they found an old woman who gave them all the information they wanted. On inquiring whether she had seen a race, she replied she could not tell whether it was a race or

not, but that she had just seen a horse, with a white leg, running away at a monstrous rate, and another horse a great way behind, trying to run after him; but she was sure he would never catch the white-legged horse if he ran to the world's end.'

The first heat was easily won, when O'Kelly, observing that the rider had been pulling at Eclipse during the whole of the race, offered a wager that he placed the horses in the next heat. This seemed a thing so highly improbable, that he immediately had bets to a large amount. Being called on to declare, he replied, 'Eclipse first, and the rest nowhere!' The event justified his prediction, for all the others were distanced by Eclipse with the greatest ease, and thus, in the language of the turf, they had no place.

In the spring of the following year, he beat Mr. Wentworth's Bucephalus, who had never before met with his equal. Two days afterwards, he distanced Mr. Strode's Pensioner, a very good horse; and in the August of the same year, he won the great subscription at York. No horse daring to enter against him, he closed his short career, of seventeen months, by walking over the Newmarket course for the King's plate, on October the 18th, 1770. He was never beaten, nor ever paid forfeit, and won for his owner more than twenty-five thousand pounds.

Eclipse was afterwards employed as a stallion, and produced the extraordinary number of three hundred and thirty-four winners, and these netted to their owners more than 160,000*l.* exclusive of plates and cups. The produce of King Herod, a descendant of Flying Childers, was even more numerous. He got no less than four hundred and ninety-seven winners, who gained for their proprietors upwards of two hundred thousand pounds. Highflyer was a son of King Herod.

The profit brought to the owner of Eclipse by his services as a stallion must have been immense. It is said that ten years after he was withdrawn from the turf, O'Kelly was asked at what price he would sell him. At first he peremptorily refused to sell him at any price, but after some reflection, he said that he would take 25,000*l.*, with an annuity of 500*l.* a year on his own life, and the annual privilege of sending six mares to him. The seeming extravagance of the sum excited considerable remark; but O'Kelly declared that he had already cleared more than 25,000*l.* by him, and that he was young enough still to earn double that sum. In fact, he did live nearly ten years afterwards, covering at 50 guineas a mare, for some part of the time; but his feet having been carelessly and cruelly neglected, he became foundered. His feet rapidly grew worse and worse until he was a very uncertain foal-getter; and the value of his progeny was more than suspected. He died in February 1789, at the age of twenty-five years. Of the beauty and yet the peculiarity of his form there has been much dispute. His lowness before was evident enough, and was a matter of objection and reproach among those who could not see how abundantly this was redeemed by the extent and obliquity of the shoulder, the broadness of the loins, the ample and finely-proportioned quarters, and the swelling and the extent—the sloping and the power of the muscles of the fore-arm, and of the thighs.

A little before the death of Eclipse, M. St. Bel, the founder of the Veterinary College in St. Pancras, had arrived from France. In teaching the French pupils the general conformation of the horse, and the just proportions of his various parts, it had been necessary that reference should be made to some horse of acknowledged excellence. It occurred to St. Bel that this extraordinary and unbeaten horse would be the proper standard to which the English student might be referred for a similar purpose, and,

with considerable trouble, he formed an accurate scale of the proportions of this noble animal. It is as follows:—

PROPORTIONS OF ECLIPSE.

Although it is perfectly true, as stated by Mr. Blaine, in his 'Outlines of the Veterinary Art,' that 'for *racing*, we require that the greatest possible quantity of bone, and muscle, and sinew, should be got into the smallest bulk, and that, in addition to great flexibility and some length, the limbs must be strongly united, the chest deep and capacious, and the hinder extremities furnished with powerful muscles; for *hunting*, we must have a similar yet somewhat bulkier horse, with powerful loins, and more powerful quarters, and for the *hackney*, while we undervalue not the strength of the loins and the quarters, we look more to the elevated withers, and the deep and muscular shoulders, and the straight and well-formed leg;' yet there is a nearer and a truer proportion between the several parts of these kindred animals than many persons are disposed to allow; and this sketch of them in Eclipse, will not only be interesting, but useful, to the general horseman.

The length of the head of the horse is supposed to be divided into twenty-two equal parts, which are the common measure for every part of the body.

Three heads and thirteen parts will give the height of the horse from the foretop to the ground.

Three heads from the withers to the ground.

Three heads from the rump to the ground.

Three heads and three parts the whole length of the body, from the most prominent part of the chest to the extremity of the buttocks.

Two heads and twenty parts the height of the body, through the middle of the centre of gravity.

Two heads and seven parts, the height of the highest part of the chest from the ground.

Two heads and five parts, the height of the perpendicular line which falls from the articulation of the arm with the shoulder, directly to the hoof.

One head and twenty parts, the height of the perpendicular line which falls from the top of the fore-leg, dividing equally all its parts to the fetlock.

One head and nineteen parts, the height of the perpendicular line from the elbow to the ground.

One head and nineteen parts, the distance from the top of the withers to the stifle.

The same measure also gives the distance from the top of the rump to the elbow.

One and a half head, the length of the neck from the withers to the top of the head.

The same measure also gives the length of the neck from the top of the head to its insertion into the chest.

One head, the width of the neck at its union with the chest.

Twelve parts of a head, the width of the neck in its narrowest part.

The same measure gives the breadth of the head taken below the eyes.

One head and four parts, the thickness of the body from the middle of the back to the middle of the belly.

The same measure gives the breadth of the body.

Also the rump from its summit to the extremity of the buttocks.

Also the distance from the root of the tail to the stifle.

Also the length from the stifle to the hock.

Also the height from the extremity of the hoof to the hock.

Twenty parts of a head, the distance from the extremity of the buttocks to the stifle.

Also the breadth of the rump or group.

Ten parts of a head, the breadth of the fore-legs from their anterior part to the elbow.

Ten parts of a head, the breadth of one of the hind-legs taken beneath the fold of the buttocks.

Eight parts of a head, the breadth of the ham taken from the bend.

Also the breadth of the head above the nostrils.

Seven parts of a head, the distance of the eyes from one great angle to the other.

Also the distance between the fore-legs.

Five parts of a head, the thickness of the knees.

Also the breadth of the fore-legs above the knees.

Also the thickness of the hams.

Four parts of a head, the breadth of the pastern, or fetlock joint.

Also the thickness of the coronet.

Four and a half parts of the head, the breadth of the coronet.

Three parts of a head, the thickness of the legs at their narrowest part.

Also the breadth of the hinder legs or shanks.

Two and three-quarter parts of a head, the thickness of the hind-pasterns.

Also the breadth of the shanks of the fore-legs.

Two and a quarter parts of a head, the thickness of the fore-pasterns.

Also the breadth of the hind-pasterns.

One and three-quarter parts of a head, the thickness of the fore and hind shanks.

More than twenty years after the Darley Arabian, and when the value of the Arabian blood was fully established, Lord Godolphin possessed a beautiful but singularly-shaped horse, which he called an Arabian, but which was really a Barb. His crest, lofty and arched almost to a fault, will distinguish him from every other horse.

It will likewise be seen from the cut (p. 19), that he had a sinking behind his shoulders, almost as peculiar, and a corresponding elevation of the spine towards the loins. His muzzle was uncommonly fine, his head beautifully set on, his shoulders capacious, and his quarters well spread out. He was bought in France, where he was actually employed in drawing a cart; and when he was afterwards presented to Lord Godolphin, he was in that nobleman's stud a considerable time before his value was discovered. It was not until the birth of Lath, one of the first horses of that period, that his excellence began to be appreciated. He was then styled an Arabian, and became, in even a greater degree than the Darley, the founder of the modern thorough-bred horses. He died in 1753, at the age of twenty-nine.

An intimate friendship subsisted between him and a cat, which either sat on his back when he was in the stable, or nestled as closely to him as she could. At his death, she began to refuse her food, and pined away, and died.—Mr. Holcroft gives a similar relation of the attachment between a race-horse and a cat, which the courser would take in his mouth and place in his manger and upon his back without hurting her. Chillaby, called from his great ferocity the Mad Arabian, whom one only of the grooms dared to approach, and who savagely tore to pieces the image of a man that was purposely placed in his way, had his peculiar attachment to a lamb, who used to employ himself for many an hour in butting away the flies from his friend.

Another foreign horse, was the Wellesley Arabian; the very picture of a beautiful wild horse of the desert. His precise country was never determined. He is evidently neither a perfect Barb, nor a perfect Arabian, but from some neighbouring province, where both the Barb and Arabian would expand to a more perfect fulness of form. This horse has been erroneously selected as the pattern of a superior Arabian, and therefore we have introduced him: few, however, of his produce were trained who can add much to his reputation.

At the commencement of the last century, when public races had been established in the neighbourhood of almost every large town, and when many of them were especially patronised by royalty, although there was sufficient opportunity given for the value of the young stock to be exhibited, or at least guessed at, the contest principally lay among the adults.—The kind of contest which was best calculated to try the worth of the horse, and to promote the actual improvement of the breed, was one of mingled speed and endurance. They were mostly heats for distances of three or four miles. Occasionally they were for greater lengths, even extending to six or eight miles; and in one case, when the Duke of Queensberry's Dash beat Lord Barrymore's Highlander, twelve miles. This, however, was cruel and absurd, and never established itself among the best supporters of the turf.

Four miles constituted the average distance, not only for king's plates, but for simple matches; and the horses did not sleep on their way. There were occasionally as extraordinary bursts of speed as are now witnessed in our mile and a half races.

Did the horses of those days come to any extraordinary harm? Did they ruin themselves by the exertion of one day and appear no more? The anonymous writer of a most interesting and valuable work—'A

Comparative view of the English Racer and Saddle Horse during the Last and Present Centuries'—mentions a horse called Exotic, that was on the turf eleven years. 'We do not know,' says our author, 'how many times he started during this period, but in the course of it he won eighteen times. In his seventh year on the turf he won a race at Peterborough consisting of four heats of four miles each.'

'Four horses were handicapped by Dr. Bellyse at Newcastle-under-Lyne—Sir John Egerton's Astbury, Mr. Milton's Handel, Sir W. Wynne's Tarragon, and Sir Thomas Stanley's Cedric. The following was the result:—Of the first three heats there was no winner, Tarragon and Handel being each time nose and nose, and, although Astbury was stated to have been third in the first heat, yet he was so nearly on a level with the others, that there was a difficulty of placing him as such. After the second heat, the steward requested two other gentlemen to look with him steadily as they came, to try to decide in favour of one of them, but it was impossible to do so. In the third dead heat Tarragon and Handel had struggled with each other until they reeled about as if they were drunk, and could scarcely carry their riders to the scales. Astbury, who had laid by after the first heat, then came out and won. The annals of the turf cannot produce another such contest, founded on a thorough knowledge of the horses, their ages, and their previous running.'

'In 1737, Black Chance, at five years old, won a plate at Durham, carrying 10 st. With the same weight he won the Ladies' plate at York, in that year. In 1738, he won the king's plate at Guildford, beating several horses. He won the plate also at Salisbury, at Winchester, at Lewes, and at Lincoln—five king's plates in one season, and every race four miles and contested. The same horse was in the field in 1744, and he walked over for the annual plate at Farnden.'

What are our racers now? They are speedier. That it would be folly to deny.

They are longer, lighter, but still muscular, although shorn of much of their pride in this respect. They are as beautiful creatures as the eye would wish to gaze on, but the greater part of them give in before half the race is run; and out of a field of fifteen, or even twenty, not more than two or three of them live, in the exertion of their best energies, far within the ropes.

And what becomes of them when the struggle is over? After the *severe* racing, as it is now called, of former times, the horse came again to the starting-post with not a single power impaired; and year after year he was ready to meet any and every rival. A single race, however, like that of the Derby, now occasionally disables the winner from ever running again; yet the distance is only a mile and a half. The St. Leger is more destructive to the winner, although the distance is less than two miles. The race of the day has been run; some heavy stakes have been won by the owner; the animal by whose exertions they were gained is led away, and it is sometimes an even chance whether he is ever heard of, or, perhaps, thought of again. He has answered the purpose for which he was bred, and he has passed away.

And by what witchery has all this been accomplished? How came it that skilful and honourable men should have conspired together to deteriorate the character of the racer, and with him that of the English horse generally? Why, there was no conspiracy in the matter. It was the natural course of things. The race-horses of the beginning, and even of the middle, of the last century were fine powerful animals; they had almost as much fleetness as could be desired, and they had strength that would never tire. He who bred for the turf might in his moments of reflection

be pleased by the conviction that, while he was accomplishing his own purpose, he was breeding an animal valuable to his country. He might be gratified by this reflection, yet it would not influence the system which he pursued. *He would breed to win*; and he would naturally try to add a little more speed to the acknowledged power. Thence came the Mambrino and the Sweet Briar, and others who had lost but little of their compactness of form—who had got rid of a portion of that which an enemy might call coarseness, but none of the capacity of the chest, or the substance or the power of the muscular system—whose speed was certainly increased, and whose vigour was not impaired.

It is not in human nature to be satisfied even with perfection; and it was tried whether a little more fleetness could not be obtained. It was so—and, some thought, with a slight impairment of stoutness. There were those, and they were not altogether wrong, who saw in Shark and Gimcrack an evident increase of speed, and little diminution of strength.

It was easy to imagine what would now be the result. The grand principle was speed. It was taken for granted that stoutness would follow—or rather, in the selection of the stock, stoutness was a minor consideration. The result of this was a horse with an elongated frame—as beautiful as his predecessors, or more so, but to the eye of the scientific man displaying diminished muscles and less prominent sinews, and sharper and less powerful withers. The fleetness was all that heart could desire, but the endurance was fearfully diminished. Irresistible proof was soon given of this. They could not run the distances that their predecessors did with ease. Heats became unfashionable—they were esteemed, and with too much truth, severe and cruel. We might refer to the disgraceful exhibitions of Chateau Margaux, and Mortgage, and Lamplighter. The necessary consequence was that the ground run over in the ordinary matches was lessened a full half.

And was not this sufficient to convince the man of the turf—the breeder of horses for his own use—was not this sufficient to convince him of the error which he had committed? Perhaps it was, with regard to those who would give themselves the trouble to think. But the error had been committed. The all-important question was, how could it be repaired? Were they to breed back again to their former stoutness? There were *individuals* stout and speedy, but *the breed* was gone. Beside, the short race had become fashionable. It was determined in two or three minutes. There was not the lengthened suspense of seven or eight rotations of the second-hand of the watch; and who could resist the omnipotence of fashion? some harsh expressions have been used with regard to the leading sporting characters of that time; but what power had they of resistance? They had bred for speed. They had obtained it. They had obtained that kind of race that would be popular, for it was short. They had no alternative, except with regard to the king's plates. There they should have made a stand. The interests and honour of the country should not have been sacrificed because they had erred. There should have been something left to encourage the continuance of the old and unrivalled blood—something to fall back upon when the fashionable leaders of the sporting world had discovered their error. This battle, however, must yet be fought. Additional reasons for it will appear when the present state of the hunter and the road-horse are considered.

There is one circumstance connected with these short races which perhaps has not been sufficiently appreciated. On the old system, the truthness and the stoutness of the horse would generally insure the prize to him that best deserved it; but with the present young horses and short

courses, the actual race being sometimes little more than two or three hundred yards, a great deal depends on the rider. If the cattle are tolerably fairly matched, *all* depends upon him. If he has confidence in the stoutness of his horse, he may distance all his competitors; or he may nurse the fleet but weedy thing to almost the last stride, and dart by the winning post before his rival has been able to gather himself up for the last effort.

One thing cannot be denied, that the consciousness in the jockeys of their power, and the account which they will probably be called upon to render of the manner in which they have used it, has led to far more cruelty in the management of these races than ever disgraced the records of former times. Habit had given to the older horses of those days a principle of emulation and of obedience. When the race in reality began, the horse understood the meaning of his rider, and it seldom required any cruel application of the whip or the spur to bring him through if he could win.

Forrester will afford sufficient illustration of this. He had won many hardly-contested races; but on an unfortunate day he was matched against an extraordinary horse, Elephant, belonging to Sir Jennison Shaftoe. It was a four-mile heat over the straight course. They passed the flat—they ascended the hill as far as the distance post—they were nose to nose. Between this and the chair, Elephant got a little ahead. Forrester made every possible effort to recover this lost ground, until, finding all his efforts ineffectual, he made one, desperate plunge—he seized his antagonist by the jaw to hold him back, and could scarcely be forced to quit his hold. In like manner, a horse belonging to Mr. Quin, in 1753, finding his adversary gradually passing him, seized him by the leg; and both riders were obliged to dismount, in order to separate the animals.

The youngsters may not have felt all this emulation, nor be disposed painfully to exert their energies to the very utmost; and it may be necessary—necessary, in order to accomplish the purpose of the owner by winning the race—that the poor animal should be brutally urged on, until the powers of nature fail, and he retires from the course a cripple for life.

This is a necessary part of the system. It is accounted the duty of the rider—it is a duty on the skilful discharge of which a few of them plume themselves; but it is that which should not be tolerated, and the system of which it is a necessary part should undergo a speedy and effectual reformation. We entirely agree with the remarks of Nimrod on this subject. ‘There are many jockeys employed by the inferior black-leg species of sportsmen, and even some of a higher class, who will not be convinced that a rider has acted honestly, unless his horse is nearly dissected alive; but, in the strongest probability, every drop of blood drawn is utterly unnecessary, as it is barbarous and contrary to the very idea of sport, in which even the horse himself ought to share. Such an opinion was given from the heart, as well as from the mature judgment of the late Sir Thomas Charles Bunbury, within a few months of his decease, after five-and-fifty years of experience on the most extensive scale. Although the stout and game horse will run to the whip, the excess of it must necessarily *shorten his stride*, and, in course, detract from his speed. Many a race has been lost by a foul cut, or a brutal use of the spur—either by damping the spirit and enfeebling the nerve of the horse, or inducing a sullen disgust and desperation. An example, much talked of at the time, and through which a vast sum of money was lost, occurred in the case of a horse of old Duke William, which was nearly home and winning. He received a foul



out with the whip on a tender part, and instantly hung back and lost the race. With respect to the hot-spirited and washy horses, if they cannot win without the aid of the whip, they will seldom win with it.

We have been enabled to place at the head of our chapter a portrait of 'The Colonel,' taken for this work by Mr. Harvey; and Mr. Goodwin, veterinary surgeon to the Queen, has kindly furnished us with a considerable part of the following account of him and of Fleur-de-Lis:—

He was a chesnut horse, fifteen hands three inches high, with good substance, capital legs and feet, and true action, bred by Mr. Petre, in 1825. He was got by Whisker out of a Delphini mare—her dam, Tipple Cider, by King Fergus—the grandam was Sylvia, by Young Marsk, out of Ferret, by a brother to Sylvio-Regulus, &c.

He came out in 1827, when he won the two-years stakes, beating Kitty, a colt by Trump, and a black colt by Whisker.

In the same year he carried off the two-years old stakes at Pontefract, beating Vanish; and the Champagne stakes at Doncaster, beating a filly by Blackleg.

In 1828 he ran a dead heat with Cadland for the Derby, beating Zinganee and twelve others, but he lost the second heat. He won, however, the St. Leger at Doncaster, beating Belinda, Velocipede, and seventeen others; and walked over for the 200 sovereigns stakes at the same place. At the latter end of 1828 he was sold by Mr. Petre to George IV. for 4,000 guineas. He continued, however, on the turf, and won many races.

In 1829 he was beaten at the York Spring Meeting, by Bessie Bedlam, in a match for 300 sovereigns each—the St. Leger course. He started, but was not placed, for the gold cup at Ascot, being beaten by Zinganee and Mameluke.

In 1830 he won the Craven stakes of ten sovereigns each, beating Harold, Clio, and eight others. He ran second for the gold cup at Ascot, being beaten by Lucetta, but beating Greenmantle and Zinganee. In the same year he won a sweepstake at Stockbridge; and ran third for the gold cup at Goodwood, but was beaten by Fleur-de-lis and Zinganee.

In 1831 he won the Craven stakes at Epsom; and ran a dead heat with Mouch for the Oatlands at Ascot; but running the second heat with her, he broke down—the suspensory ligaments failing in both hind legs. He did not continue lame; but the enlargement of the fetlock, and the traces of the iron, plainly indicated that he could no longer be depended upon as a racer.

The Colonel was not successful as a stallion; he was sent to Germany by the Messrs. Tattersall, where he met with no better success, and was brought back to this country to finish a career that scarcely left an animal behind him of the smallest notoriety.

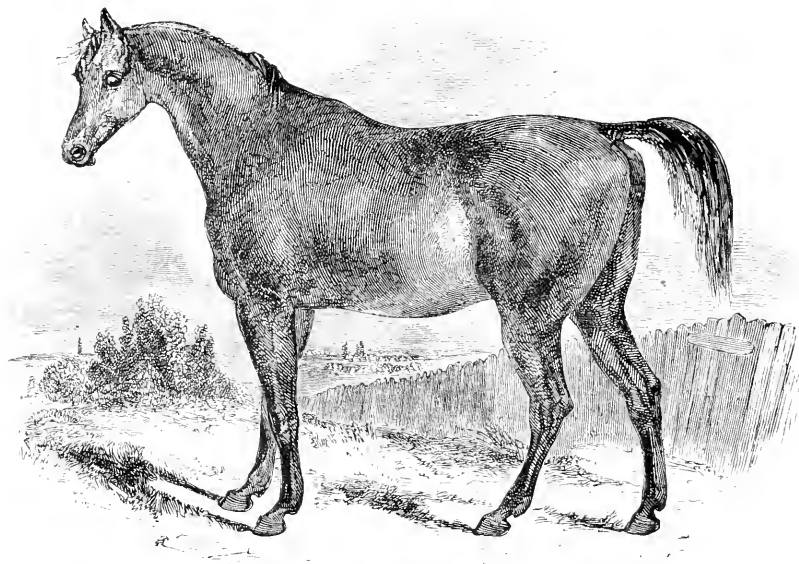
We are also gratified in being enabled to present our readers with a portrait of that beautiful and almost unrivalled mare, Fleur-de-Lis, by the same artist.

She was bred by Sir M. W. Ridley, in 1822, and was got by Bourbon, the son of Sorcerer, out of Lady Rachel, by Stamford—her dam, Young Rachel, by Volunteer, out of Rachel, sister to Maid of All Work, and by both the sire and the dam was descended from Highflyer. Bourbon started twenty-three times, out of which he was successful seventeen times; and carried off two classes of the Newmarket October Oatland stakes, the Claret, the Craven, and the Trial, besides 4,130 guineas in specie.

She was the finest mare in form and size ever produced in England. She stood fully sixteen hands, and had extraordinary good legs, and feet that never failed. Her speed was good, but her forte was distance. Independent of her being so fine a mare in every other respect, her chest was

one of extraordinary capacity in an animal of such unusual depth in the girthing place.

She first appeared on the turf at three years old, at Newcastle-upon-Tyne,



FLEUR-DE LIS.

for the twenty-five guineas sweepstakes—one mile—and beat her four competitors.

On September 8, she won a sweepstake of twenty guineas, and twenty added—six subscribers—at Pontefract.

On the 20th of the same month, she started for the Great St. Leger, and would probably have won it had she not been thrown down in the running by Actæon, as she beat Memnon afterwards, and all the best horses of that description. On the 23rd of September, however, she won a sweepstake of twenty sovereigns each, with twenty added—nineteen subscribers.

On May 20, 1826, she was in the sweepstakes of twenty sovereigns each—two miles—seven subscribers, at the York Spring Meeting. Lottery, Actæon, and Catterick were among her opponents. After the first 100 yards, Lottery got in front, closely followed by the others at strong running. He kept ahead until nearly the distance post, when Fleur-de-Lis shot ahead, Actæon and Catterick letting loose at the same time. The filly, however, kept in front, and won in gallant style by half a length.

On the next day, she won the gold cup, opposed again by Actæon, and also by the Alderman and six others. The betting was seven to four on the Alderman, and four to one against the winner. The Alderman took the lead, and made all the running up to the distance-post. They were in a cluster at the stand, when Actæon and Fleur-de-Lis came out. A severe struggle took place, the mare winning by a length.

July 6, she won the gold cup at Newcastle-upon-Tyne—ten subscribers. The betting was fifteen to eight in favour of the winner.

On the next day she won the first heat for the town-plate, and walked over the course for the second heat.

On September 19, she won the Doncaster stakes of ten sovereigns each, with twenty added by the corporation—twenty-nine subscribers. She was opposed by Actæon, Lottery, Jerry, and others; but the bets were five to four on Fleur-de-lis.

On the 21st she won the gold cup, beating Mulatto, Helenus, and others. The betting was five to four on her.

On the 29th she won the gold cup at Lincoln, walking over the course.

May the 12th, 1827, she won the Constitution stakes at the York Spring Meeting—fifteen subscribers, at twenty guineas each, among which were Jerry, Humphrey Clinker, and Sirius; the betting six to five against Fleur-de-Lis. During most of the way Fleur-de-Lis was in front, Jerry second, Humphrey Clinker third, and Sirius fourth. When between the rails, Jerry looked as if he would win, but suddenly swerving, Fleur-de-Lis won easily by two lengths.

On the 27th she ran at Manchester, for a tureen, value 100 guineas, with twenty-four subscribers of ten sovereigns each: betting, five to four on her. On making the last turn she slipped, and nearly came on her side. She, however, recovered; but, after a severely-contested race, lost by half a head.

On July the 13th, she won the gold cup, and sweepstakes of ten guineas each, at Preston; twenty subscribers. The course was three miles and a distance. It was doubted whether any horse could be found to compete with Fleur-de-Lis; but at length Mr. Milton's old grey horse Euphrates, and Sir W. Wynn's Signorina, entered the lists. The old horse looked as well and appeared as gay as ever, and Signorina was ever a well-known good mare; but the odds were three to one on Fleur-de-Lis. After the usual preparations the competitors were brought to the post, and away they went. Euphrates made play, dashing off at score, and at about half a mile had got so far ahead, that Fleur-de-Lis, who evidently was waiting on Signorina, found it necessary to creep rather nearer, lest the old gelding should steal the race. Euphrates kept the lead, and seemed determined to do so as long as he could; and he was allowed to do this until within about a distance from home, when both the mares shot ahead, and the gallant old horse gave it up. The contest now became highly interesting. Signorina ran well in, and was beaten only by a neck.

She likewise won a Goodwood cup, beating the Colonel and Zinganee, both out of the same stables with herself, and nearly distancing a field of others.

This is a continuance of success that is scarcely equalled in the annals of the turf. The loss of the Manchester cup was solely attributable to the accident that occurred while she was running. She likewise failed in the St. Leger; but there she was thrown down by another horse during the race. She was never beaten in a fair struggle. Her owner, however, was perhaps justified in selling her, as he did, for 1,500 guineas, when he knew that he was consigning her to the royal stud; for he thus rendered it impossible that the laurels that she had won could ever be torn from her.

She possessed the points and form of a racer to a degree of perfection which has been rarely met with. It is true that she stood nearly sixteen hands; but the depth of her chest, her length, her quarters, her pasterns, marked her as equally framed for motion and for endurance. Her colour was bay, with black legs and feet, and a small stroke on her forehead. The slouched ear has been found fault with by some; others, and perhaps with more truth, have considered it as an indication of pure blood. It has been hereditary in some of our stables, as in the Orville family.

She was bought of Sir M. W. Ridley, for George IV., for 1,500 guineas.

Her produce, after having been put into the stud, was eagerly sought

for by foreigners, and sent out of the country. Fleur-de-Lis was in 1842 in the possession of Monsieur Lupin, in France, who bought her at the Hampton Court sale for the inadequate sum of 550 guineas. Her end was disgraceful: she is said to have finished her days in a street cab in Paris, where some charitable Englishmen, shocked at seeing her in such a miserable plight, bought her for a few pounds, and had her shot. She was the dam of Sovereign, an American stallion of celebrity, who is the sire of Charleston, now advertised to cover at 20 guineas a mare in this country as the property of Mr. Tenbroek.

The valuable mare Wings, the dam of Caravan, was sold to the same person for 600 guineas; and Young Mouse, the dam of Rat Trap, for 360 guineas.

Since the days of the animals we have been describing, important alterations have taken place upon the turf; heats have been entirely done away with, except in a few country places, and this alone, it is supposed, has tended much to diminish the size and strength of the race-horse; and there are those who, if they could, would take away the 5000 guineas granted by act of parliament as Queen's Plates annually, and apply the money to the purchase of what they deem more likely stallions. But if these more likely stallions are to be selected solely for their appearance and the opinions formed thereon, instead of their merits, as proved by facts, who is there among us can judge, either of speed or endurance, by looking to the size of animals, whether it be horse or greyhound? Take, for instance, the best horse that has been on the turf for the last forty years—Bay Middleton, by Sultan out of Cobweb, the property of the Earl of Jersey. This horse never was beaten: he won the 2000 guineas, beating Elis, the same year that Elis won the St. Leger; and then won the Derby, beating Gladiator, Venison, Slane, and a field of good horses. Yet, such was the shape of this horse, that the late Mr. Thornhill, who was a great breeder and authority in those days, promised, if such a rail as this horse was, should win the Derby, he would eat him and his shoes afterwards. Yet Bay Middleton was not only a long way the best horse of his year, but he was the best of stallions also; he was the sire of the Earl of Eglinton's Flying Dutchman, winner of both the Derby and St. Leger, and other races of great value, who has recently been sold to the French Government for 4000 guineas, which says but little for the kind feeling of his owner, who profited so much by his performances, nor for the patriotic feeling of the turf men of this country, to let such a horse go out of it.

There are more race-horses now than were kept in former years, and there always will be, among the 1,400 mares and 400 stallions which are kept to supply the breed, sufficient to keep up the superiority of the English thoroughbred horse. Racing, like other pastimes, may have its abuses; still the race tells us which is the best horse, and the stud confirms or contradicts the opinion which has been formed upon shape and qualifications only.

In former days a flaw in a pedigree was a serious affair, but now there are numerous instances where horses with (h. b.), half bred, attached to their pedigrees, are found beating fields of our best-bred horses, and the definition of thoroughbred is more difficult than ever to define; for instance, Hotspur and Marlborough Buck, h. b., running second for the Derby; Lady Superior, h. b., second in the Oaks; Cawronch, Mrs. Taft, and Mr. Sykes winning the Cæzarewitch; Mongrel winning the Nursery Stakes, and beating large fields of the best thoroughbred horses: so that there will soon be a necessity for placing these and their numerous progeny in the stud book.

The facility of sending horses from one part of the kingdom, by railroad, to another in the present day, has not improved the condition of our race-horses, and their strength and chances of keeping sound are hazarded more than ever, and it is nothing uncommon now to find two-year-olds running fifteen races, more or less, in a year, three-year-olds some twenty or thirty races, and old horses running an unconscionable number. As an instance of the number of races a horse may run for, Fisherman, five years old in 1858, ran in thirty-two races, and won twenty-one of the number; he ran at York, in 1857, one day, and was beaten by Warlock for the Queen's Plate; and the day after, after having travelled in his own van on a railway all night and day, he beat a field of horses at Abingdon, in Oxfordshire. Now it is quite impossible for horses to be in condition so many times in the year; it tries the strength and ruins many young horses before they arrive at maturity, and it is almost impossible to find a sound old race-horse in the kingdom.

The breed of race-horses has kept up its superiority in this country to a surprising extent, considering that in all others the governments spend large sums towards thoroughbred stock, while in *this* nothing but individual enterprise has sustained it and made it flourish above all others. There is no doubt, however, but that more might be done by breeding on a large scale, with experience and judicious management; and although it must be admitted that our best horses have descended, as shown by Mr. Goodwin, in his valuable table of the pedigree of the thoroughbred horse, from the Darley Arabian, the Godolphin Arabian, and the Byerly Turk, it would be a great mistake to think of going back to Arabian or other blood, to improve that which is in every way so much its superior.

#### THE HUNTER.

There are few agriculturists who have not a little liking for the sports of the field, and who do not fancy rich music in the cry of the hounds. To what extent it may be prudent for them to indulge in these sports circumstances must decide, and they deserve the most serious consideration. Few can, or, if they could, ought to keep a hunter. There are temptations to expense in the field, and to expense after the chase, which it may be difficult to withstand. The hunter, however, or the hunting horse,—i.e. the horse on which a farmer, if he is not a professed sportsman, may occasionally with pleasure, and without disgrace, follow the hounds,—is in value and beauty next to the racer.

Fashion and an improved state of the agriculture of the country have materially increased the speed of the chase. The altered character of the fox-hounds, and the additional speed which they have lately acquired, compel the farmer to ride a better horse, or he will not live among his companions after the first burst. Stoutness is still required, but blood has become an essential quality.

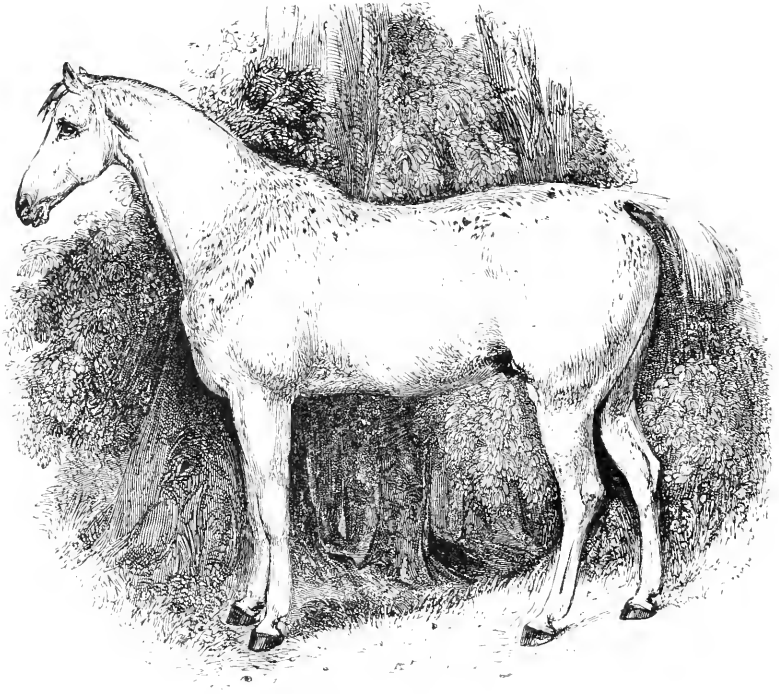
In strong, thickly-inclosed countries, the half-bred horse may get tolerably well along; but for general use the hunter should be at least three-quarters, or perhaps seven-eighths bred. When he can be obtained with bone enough, a *thoroughbred horse* will form the best of all hunters; especially if he has been taught to carry himself sufficiently high to be aware of and to clear his fences.

He should seldom be under fifteen or more than sixteen hands high; below this standard he cannot always measure the object before him, and above it he is apt to be leggy and awkward at his work.

The first property of a good hunter is, that he should be *light in hand*. For this purpose his head must be small; his neck thin and especially thin beneath; his crest firm and arched, and his jaws wide. The head will

then be well set on. It will form that angle with the neck which gives a light and pleasant mouth.

The forehead should be loftier than that of the racer. A turf horse may be forgiven if his hind quarters rise an inch or even two above his fore ones. His principal power is wanted from behind, and the very lowness of the forehead may throw more weight in front, and cause the whole machine to be more easily and speedily moved. A lofty forehead, however, is indispensable in the hunter; and a shoulder as extensive as in the racer and as oblique, and somewhat thicker. The saddle will then be in its proper place, and will continue so, however long may be the run.



THE HUNTER.

The barrel should be rounder, in order to give greater room for the heart and lungs to play, and to send more and purer blood to the larger frame of this horse, especially when the run continues unchecked for a time that begins to be distressing. A broad chest is always an excellence in a hunter. In the violent and long-continued exertion of the chase the respiration is exceedingly quickened, and abundantly more blood is hurried through the lungs in a given time than when the animal is at rest. There must be sufficient room for this, or he will not only be distressed, but possibly destroyed. The majority of the horses that perish in the field are narrow-chested.

The arm should be as muscular as that of the racer, or even more so, for both strength and endurance are wanted.

The leg should be deeper than that of the race-horse—broader as we stand at the side of the horse—and especially beneath the knee. In proportion to the distance of the tendon from the cannon or shank-bone, and

more particularly a little below the knee, is the mechanical advantage with which it acts.

The leg should be shorter. Higher action is required than in the racer, in order that the legs may be clearly and safely lifted over many an obstacle, and, particularly, that they may be well doubled up in the leap.

The pastern should be shorter, and less slanting, yet retaining considerable obliquity. The long pastern is useful, by the yielding resistance which its elasticity affords to break the concussion with which the race-horse from his immense stride and speed must come on the ground: and the oblique direction of the different bones beautifully contributes to effect the same purpose. With this elasticity, however, a considerable degree of weakness is necessarily connected, and the race-horse occasionally breaks down in the middle of his course. The hunter, from his different action, takes not this length of stride, and therefore wants not all this elastic mechanism. He more needs strength to support his own heavier carcase, and the greater weight of his rider, and to undergo the fatigue of a long day. Some obliquity, however, he requires, otherwise the concussion even of his shorter gallop, and more particularly of his frequently tremendous leaps, would inevitably lame him.

The foot of the hunter is a most material point. The narrow contracted foot is the curse of much of the racing blood. The work of the racer, however, is all performed on the turf: but the foot of the hunter is battered over many a flinty road and stony field, and, if not particularly good, will soon be disabled and ruined.

The position of the feet in the hunter requires some attention. They should if possible stand straight. If they turn a little outward, there is no serious objection; but if they turn inward, his action cannot be safe, particularly when he is fatigued or over-weighted.

The body should be short and compact, compared with that of the race-horse, that he may not in his gallop take too extended a stride. This would be a serious disadvantage in a long day and with a heavy rider, from the stress on the pasterns; and more serious when going over clayey poached ground during the winter months. The compact short-strided horse will almost skim the surface, while the feet of the longer-reached animal will sink deep, and he will wear himself out by efforts to disengage himself.

Every sporting man knows how much more enduring is a short-bodied horse in climbing hills, although perhaps not quite so much in descending them. This is the secret of suiting the *race-horse* to his course: and unfolds the apparent mystery of a horse decidedly superior on a flat and straight course, being often beaten by a little horse with far shorter stride on uneven ground and with several turnings.

The loins should be broad;—the quarters long;—the thighs muscular;—the hocks well bent, and well under the horse.

The reader needs not to be told how essential temper and courage are. A hot irritable brute is a perfect nuisance, and the coward that will scarcely face the slightest fence exposes his owner to ridicule.

The *principle* of preparing both the race-horse and the hunter for their work is the same, and can have no mystery about it. It consists in getting rid of all superfluous flesh and fat, by physic and exercise, yet without too much lowering the animal; and, particularly in bringing him by dint of exercise into good wind, and accustoming him to the full trial of his powers without overstraining or injuring him. Two or three doses of physic as the season approaches, and these not too strong; plenty of good hard meat; and a daily gallop of a couple of miles—at a pace not too quick—will be nearly all that can be required. Physic must not indeed

be omitted; but the three words, *air, exercise, food*, contain the grand secret and art of training.

The old hunter may be fairly ridden twice, or, if not with any very hard days, three times in the week; but, after a thoroughly trying day, and evident distress, three or four days' rest should be allowed. They who are merciful to their horses, allow about thirty days' work in the course of the season, with gentle exercise on each of the intermediate days, and particularly a sweat on the day before hunting. There is an account, however, of one horse who followed the fox-hounds seventy-five times in one season. This feat has never been exceeded.

We recollect to have seen the last Duke of Richmond but one, although an old man, and when he had the gout in his hands so severely that he was obliged to be lifted on horseback, and both arms being passed through the reins, were crossed on his breast, galloping down the steepest part of Bow Hill, in the neighbourhood of Goodwood, almost as abrupt as the ridge of an ordinary house, and cheering on the hounds with all the ardour of a youth.

Sir John Malcolm (in his *Sketches of Persia*) gives an amusing account of the impression which a fox-hunt in the English style made on an Arab.

'I was entertained by listening to an Arab peasant, who, with animated gestures, was narrating to a group of his countrymen all he had seen of this noble hunt. "There came the fox," said he, pointing with a crooked stick to a clump of date-trees, "there he came at a great rate. I hallooed, but nobody heard me, and I thought he must get away; but when he got quite out of sight, up came a large spotted dog, and then another and another. They all had their noses to the ground, and gave tongue—whow, whow, whow, so loud, I was frightened. Away went these devils, who soon found the poor animal. After them galloped the Foringees (a corruption of Frank, the name given to a European over all Asia), shouting and trying to make a noise louder than the dogs. No wonder they killed the fox among them.'"

The Treasurer Burleigh, the sage councillor of Queen Elizabeth, could not enter into the pleasures of the chase. Old Andrew Fuller relates a quaint story of him:—

'When some noblemen had gotten William Cecil, Lord Burleigh, to ride with them a hunting, and the sport began to be cold, "What call you this?" said the treasurer. "Oh! now the dogs are at fault," was the reply. "Yea," quoth the treasurer, "take me again in such a fault, and I'll give you leave to punish me.'"

In former times it was the fashion for women to hunt almost as often and as keenly as the men. Queen Elizabeth was extremely fond of the chase. Rowland Whyte, in a letter to Sir Robert Sidney, says, 'Her Majesty is well, and excellently disposed to hunting; for every second day she is on horseback, and continues the sport long.'

This custom soon afterwards began to decline, and the jokes and sarcasms of the witty court of Charles II. contributed to discountenance it.

It is a curious circumstance, that the first work on hunting that proceeded from the press was from the pen of a female, Juliana Barnes, or Berners, the sister of Lord Berners, and prioress of the nunnery of Sope-well, about the year 1481.

The difference in the pace, and the consequent difference in the breed of the horse, have effected a considerable alteration in the usage of the hunter. It is the almost invariable practice for each sportsman to have two, or sometimes three horses in the field, and after a moderate day's sport the horse has his three or four days' rest, and no fewer than five or six after a severe run. When a little more speed was introduced into the



turf horse, the half-bred or three-parts-bred horse, which constituted the racer of thirty-years ago, soon acquired a portion of the increase of speed, and in consequence of this began to be inconveniently or annoyingly close to the hounds.—A change then took place in the breed of the hound. This, however, as might be expected, was carried a little too far, and they soon began to run at a rate to which the far greater proportion of the half-breds were altogether unequal. The thoroughbred horse then began to find his way into the field. The prejudice was strong against him at first. It was said that he could not take his leaps like the old hunter: but, after a little training, he became equal in this respect to the very best of his predecessors, and superior to the greater part of them. This is well treated of by Nimrod in his work on 'The Chase.'

The horse fully shares in the enthusiasm of his rider. It is beautiful to watch the old hunter who, after many a winter's hard work, is turned into the park to enjoy himself for life. His attitude and his countenance when, perchance, he hears the distant cry of the dogs, are a study. If he can, he will break his fence, and, over hedge, and lane, and brook, follow the chase, and come in first at the death.

A horse that had, a short time before, been severely fired on three legs, and was placed in a loose box, with the door, four feet high, closed, and an aperture over it little more than three feet square, and standing himself nearly sixteen hands, and master of fifteen stone, hearing the cheering of the huntsman, and the cry of the dogs at no great distance, sprung through the aperture without leaving a single mark on the bottom, the top, or the sides.

Then, if the horse is thus ready to exert himself for our pleasure—and pleasure alone is here the object—it is indefensible and brutal to urge him beyond his own natural ardour so severely as we sometimes do, and even until nature is quite exhausted. We do not often hear of a 'hard day,' without being likewise informed, that one or more horses either died in the field, or scarcely reached home before they expired. Some riders have been thoughtless and cruel enough to kill two horses in one day. One of the severest chases on record was by the king's stag-hounds. There was an uninterrupted burst of four hours and twenty minutes. One horse dropped dead in the field; another died before he could reach the stable, and seven more within the week ensuing.

It is very conceivable, and does occasionally happen, that, entering as fully as his master into the sports of the day, the horse disdains to yield to fatigue, and voluntarily presses on, until, nature being exhausted, he falls and dies: but much oftener, the poor animal has, intelligibly enough, hinted his distress; unwilling to give in, yet painfully and falteringly holding on, while the merciless rider occasionally, rather than give up one hour's enjoyment, tortures him with whip and spur, until he drops and dies,—that man is a brute.

Although the hunter may not willingly relinquish the chase, he who 'is merciful to his beast,' will soon recognise the symptoms of excessive and dangerous distress. To the drooping pace and staggering gait, and heaving flank, and heavy bearing on the hand, will be added a very peculiar sound. The inexperienced person will fancy it to be the beating of the heart; but that has almost ceased to pulsate, and the lungs are becoming gorged with blood. It is the convulsive motion of the diaphragm, called into violent action to assist in the now laborious office of breathing. The man who proceeds a single step after this, ought to suffer the punishment he is inflicting.

Let the rider instantly dismount. If he has a lancet and skill to use it, let him subtract five or six quarts of blood; or, if he has no lancet, let

him deeply cut the bars of the palate with a knife. The lungs will be thus relieved, and the horse may be able to crawl home. Then, or before, if possible, let some powerful cordial be administered. Cordials are, generally speaking, the disgrace and bane of the stable; but here, and almost here alone, they are truly valuable. They may rouse the exhausted powers of nature. They may prevent what the medical man would call the re-action of inflammation, although they are the veriest poison when inflammation has commenced.

A favourite hunter fell after a long burst, and lay stretched out, convulsed, and apparently dying. His master procured a bottle of good sherry from the house of a neighbouring friend, and poured it down the animal's throat. The patient immediately began to revive: soon afterwards, he got up, walked home, and gradually recovered. The sportsman may not always be able to get this, but he may obtain a cordial-ball from the nearest veterinary surgeon; or, such aid not being at hand, he may beg a little ginger from some good housewife, and mix it with warm ale; or he may give the ale alone, or even strengthened with a little ardent spirit. When he gets home, or if he stops at the first stable he finds, let the horse be put into *the coolest place*, and then well clothed, and diligently rubbed about the legs and belly. The practice of putting the animal, thus distressed, into 'a comfortable warm stable,' and excluding every breath of air, has destroyed many valuable horses.

We are now describing the very earliest treatment to be adopted, and before it may be possible to call in an experienced practitioner. This stimulating plan would be fatal twelve hours afterwards. It will, however, be the wisest course to commit the animal, the first moment it is practicable, to the care of the veterinary surgeon, if such a one resides in the neighbourhood, and in whom confidence can be placed.

The labours and pleasures of the hunting season being passed, the farmer makes little or no difference in the management of his untrained horse; but the wealthier sportsman is somewhat at a loss what to do with his. It used to be thought, that when the animal had so long contributed, sometimes voluntarily, and sometimes with a little compulsion, to the enjoyment of his owner, he ought for a few months to be permitted to seek his own amusement, in his own way; and he was turned out for a summer's run at grass. Fashion, which governs everything, and now and then most cruelly and absurdly, has exercised her tyranny in the case of the hunter. His field, where he could wander and gambol as he liked, is changed to a loose box; and the liberty in which he so evidently exulted, to an hour's walking exercise daily. He is allowed vetches, or grass occasionally; but from his box he stirs not, except for his dull morning's round, until he is taken into training for the next winter's business.

In this, however, as in most other things, there is a medium. There are few horses who have not materially suffered in their legs and feet, before the close of the hunting season. There is nothing so refreshing to their feet as the damp coolness of the grass into which they are turned in April or May; and nothing so calculated to remove every enlargement and sprain, as the gentle exercise which the animal voluntarily takes while his legs are exposed to the cooling process of evaporation that is taking place from the herbage on which he treads. The experience of ages has shown that it is superior to all the embrocations and bandages of the most skilful veterinarian. It is the renovating process of nature, where the art of man fails; let him therefore have his paddock as well as his loose box.

The spring grass is the best physic that can possibly be administered to the horse. To a degree, which no artificial aperient or diuretic can reach, it carries off every humour that may be lurking about the animal. It fines

down the roundness of the legs; and, except there is some bony enlargement, restores them almost to their original form and strength. When, however, the summer has thoroughly set in, the grass ceases to be succulent, aperient, or medicinal. The ground is no longer cool and moist, at least during the day; and a host of tormentors, in the shape of flies, are, from sunrise to sunset, persecuting the poor animal. Running and stamping to rid himself of his plagues, his feet are battered by the hard ground, and he newly, and perhaps more severely, injures his legs. Kept in a constant state of irritation and fever, he rapidly loses his condition, and sometimes comes up in August little better than a skeleton.

Let the horse be turned out as soon as possible after the hunting season is over. Let him have the whole of May, and the greater part, or possibly the whole of June; but when the grass fails, and the ground gets hard, and the flies torment, let him be taken up. All the benefits of turning out, and that which a loose box and artificial physic can never give, will have been obtained, without the inconvenience and injury that attend an injudiciously protracted run at grass, and which, arguing against the use of a thing from the abuse of it, have been improperly urged against turning out at all.

The *Steeple Chase* is a relic of ancient foolhardiness and cruelty. It was the form under which the horse race, at its first establishment, was frequently decided. It is a race across the country, of two, or four, or even a greater number of miles, and it is generally contrived that there shall be some deep lane, or wide brook, and many a stiff and dangerous fence between. It is ridden at the imminent hazard of the life of the sportsman; and it likewise endangers the life or enjoyment of the horse. Many serious accidents have happened both to the horse and his rider, and the practice must ere long get into disuse; for, while it can have no possible recommendation but its foolhardiness, it has on many occasions been disgraced by barefaced dishonesty. It has all the severest punishment of the severest chase, without any of the pleasure and excitement which enables this noble animal so unflinchingly to struggle through it.

#### THE HACKNEY.

The perfect HACKNEY is more difficult to find than even the hunter or the courser. There are several faults that may be overlooked in the hunter, but which the road-horse must not have. The former may start; may be awkward in his walk, or even his trot; he may have thrushes or corns; but if he can go a good slapping pace, and has wind and bottom, we can put up with him and prize him: but the hackney, if he is worth having, must have good fore-legs, and good hinder ones too; he must be sound on his feet; even-tempered; no starter; quiet, in whatever situation he may be placed; not heavy in hand; and never disposed to fall on his knees.

If there is one thing more than any other, in which the possessor, and, in his own estimation at least, the tolerable judge of the horse, is in error, it is the *action* of the road-horse: 'Let him lift his legs well,' it is said, 'and he will never come down.'

In proportion, however, as he lifts his legs well, will be the force with which he puts them down again; the jar and concussion to the rider; and the battering and wear and tear of the feet. A horse with too great 'knee action' will not always be speedy; he will rarely be pleasant to ride, and he will not, in the long-run, be safer than others. The careless *daisy-cutter*, however pleasant on the turf, should indeed be avoided; but it is a rule, not often understood, and sometimes disputed, but which experience will fully confirm—that the safety of the horse depends a great

deal more on the manner in which he puts his feet down, than on that in which he lifts them up:—more on the foot being placed at once flat on the ground, or perhaps the heel coming first in contact with it, than on the highest and most splendid action.

When the toe first touches the ground, it may be readily supposed that the horse will occasionally be in danger. An unexpected obstacle will throw the centre of gravity forward. If the toe digs into the ground before the foot is firmly placed, a little thing will cause a trip and a fall.

For pleasant riding and for safety also, a hackney *should not carry his legs too high*. His going a little *too* near to the ground is not always to be considered as an insuperable objection. The question is, does he dig his toe into the ground?

He should be mounted and put to the test. Let his feet be taken up and examined. If the shoe, after having been on a week, or a fortnight, is not unnecessarily worn at the toe, and he is felt to put his foot flat on the ground, he may be bought without scruple, although he may not have the lofty action which some have erroneously thought so important.

Every horse, however, is liable to fall; and hence comes the golden rule of riding, '*Never trust to your horse,*' but always feel his mouth lightly. He does wrong who constantly pulls might and main; he will soon spoil the animal's mouth. He does worse who carelessly throws the reins on the neck of the horse. *Always feel the mouth lightly*, with a simultaneous gentle pressure of both legs. By these means the rider will insure a regularity of pace, and command the safety and speed of his horse. If he depends entirely upon the feeling of the hand, the mouth may become too sensitive, and refuse to have the proper bearing upon the bit. The action of the horse may also be uncollected, so that the hind feet may strike against or overreach the fore feet. Again, if the horseman neglects the elasticity and fine feeling of the hand, and makes too much use of his legs alone, a callous mouth and boring upon the bit will most likely result from the practice. By this uniformity of feeling, the horse may thus have occasional and immediate assistance before he is too much off the centre of gravity, and when a little check will save him. By this constant gentle *feeling* he will likewise be induced to carry his head well, than which few things are more conducive to the easy, beautiful, and safe going of the horse. There is one merring criterion by which a good hack may be known: if he can walk well he can do no other pace ill.

The road-horse may, and should, like the hunter, possess different degrees of breeding, according to the nature of the country, and the work required of him. When approaching to thoroughbred, he may be a splendid animal, but he will be scarcely fitted for his duty. His legs will be too slender; his feet too small; his stride too long; and he will rarely be able to trot. Three parts of blood, or even half, for the horse of all-work, will make a good and useful animal.

The hackney should be a hunter in miniature, with these exceptions. His height should rarely exceed fifteen hands and an inch. He will be sufficiently strong and more pleasant for general work below that standard. Some will imagine, and perhaps with justice, that the portrait which we give of the road-horse represents him as somewhat too tall. He certainly should be of a more compact form than the hunter, and have more bulk according to his height; for he has not merely to stand an occasional and perhaps severe burst in the field, but a great deal of every-day work.

It is of essential consequence that the bones beneath the knee should be deep and flat, and the tendon not *tied in*.

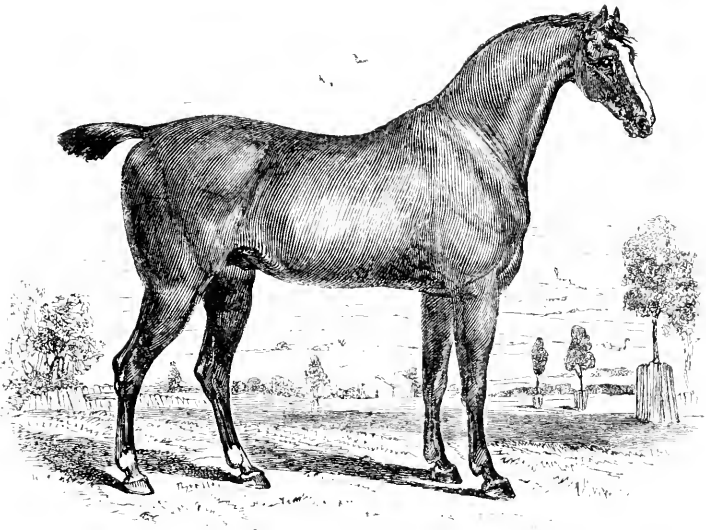
The pastern should be short, and although oblique or slanting, yet far less so than that of the race-horse or the hunter. There should be obliquity

enough to give pleasant action, but not to render the horse incapable of the wear and tear of constant, and, sometimes, hard work.

The foot is a matter of the greatest consequence in a hackney. It should be of a size corresponding with the bulk of the animal, neither too hollow nor too flat; open at the heels; and free from corns and thrushes.

The fore-legs should be perfectly straight. There needs not a moment's consideration with the public to be convinced that a horse with his knees bent, will, from a slight cause, and especially if he is over-weighted, come down. The fact however is, that a horse with bent fore-legs has rarely broken knees.

The back should be straight and short, yet sufficiently long to leave comfortable room for the saddle between the shoulders and the haunch without pressing on either. Some persons prefer a hollow-backed horse. He is generally an easy one to go. He will canter well with a lady; he may not carry so heavy a weight, nor stand such very hard work, but it is a great luxury to ride him.



THE HACKNEY.

The road-horse should be high in the forehead; round in the barrel; and deep in the chest: the saddle will not then press too forward, but the girths will remain firmly fixed in their proper place.

A hackney is far more valuable for the pleasantness of his paces, and his safety, good temper, and endurance, than for his speed. We rarely want to go more than eight or ten miles in an hour; and, on a journey, not more than six or seven. The fast horses, and especially the fast trotters, are not often easy in their paces, and although they may perform very extraordinary feats, are disabled and worthless when the slower horse is in his prime.

The above is the portrait of one that belonged to an old friend of the author. He was no beauty, and yet he was full of good points. He was never out of temper—he never stumbled—he never showed that he was tired—most certainly was never off his feed—but, being a strange fellow to eat, he one day, although the groom had a thousand times been

cautioned, gorged himself, and was immediately taken out by his owner, ignorant of this, in order to be ridden somewhat far and fast. At about the middle of the intended journey he almost stopped;—he would after this have gone on at his usual pace, but it was evident that something unusual was the matter with him, and his master stopped at the first convenient place. The stomach was ruptured, and, two days afterward, he died.

Most of our readers probably are horsemen. Their memories will supply them with many instances of intelligence and fidelity in the horse, and particularly in the hackney—the every-day companion of man. A friend rode his horse thirty miles from home into a country that was perfectly new to him. The road was difficult to find, but by dint of inquiry he at length reached the place he sought. Two years passed away, and he again had occasion to take the same journey. No one rode this horse but himself, and he was perfectly assured that the animal had not, since his first excursion, been in that direction. Three or four miles before he reached his journey's end he was benighted. He had to traverse moor and common, and he could scarcely see his horse's head. The rain began to pelt. 'Well,' thought he, 'here I am, apparently far from any house, and I know not nor can I see an inch of my road. I have heard much of the memory of the horse,—it is my only hope now,—so there,' throwing the reins on his horse's neck, 'go on.' In half an hour he was safe at his friend's gate.

The following anecdote, given on the authority of Professor Kruger of Halle, proves both the sagacity and fidelity of the horse:—A friend of his, riding home through a wood in a dark night, struck his head against the branch of a tree and fell from his horse stunned. The steed immediately returned to the house that they had lately left, and which was now closed, and the family in bed, and he pawed at the door until some one rose and opened it. He turned about, and the man, wondering at the affair, followed him. The faithful and intelligent animal led him to the place where his master lay senseless.

A few instances are selected of the speed and endurance of the hackney.

On May 13, 1793, a hackney named Sloven, *walked* twenty-two miles in three hours and fifty-two minutes. In November, 1791, she had beaten the then celebrated pedestrian, James Cotterel, by walking twenty miles in three hours and forty-one minutes. It had been previously imagined that no horse could, in fair walking, contend with a man who had accustomed himself to this kind of exercise.

As for the *trotting* performances of the hackney, they are so numerous, and yet apparently so extraordinary, that some difficulty attends the selection.

In 1822, there was a match of nine miles between Mr. Bernard's mare and Captain Colston's horse, near Gerrard's Cross, for 500 guineas. It was won easily by the mare, who performed the distance in twenty-seven minutes and forty-six seconds. The horse went the same distance in twenty-seven minutes, forty-nine seconds—which is nearly at the rate of nineteen and a half miles an hour.

This, however, had been equalled or excelled some years before. Sir Edward Astley's Phenomenon mare, when twelve years old, trotted seventeen miles in fifty-six minutes. There being some difference about the fairness of the trotting, she performed the same distance a month afterwards in less than fifty-three minutes, which was rather more than nineteen miles an hour. Her owner then offered to trot her nineteen and a half miles an hour; but, it being proved that in the last match she did one four miles in eleven minutes, or at the rate of more than twenty-one and

a half miles an hour, the betting men would have nothing more to do with her.

After this, with shame be it spoken, she lived a life of drudgery and starvation, and, occasionally, of cruel exertion, until, at twenty-three years old, she became so changed as to be offered for sale at 7*l*. Even in that state she trotted nine miles in twenty-eight minutes and a half—being, as nearly as possible, nineteen miles an hour. Within six months afterwards, it is said that she won four extraordinary matches in one day, the particulars of which are not recorded. In her twenty-sixth year she became the property of the late Sir R. C. Daniel, by whom she was well fed, and had no disgraceful tasks imposed upon her; and in a few months she looked as fresh and clean upon her legs as in her best days. So far as speed was concerned, there was nothing in the annals of trotting comparable to her performances.

Of stoutness, whether confined to this pace, or the accomplishment of great distances with little or no rest, there are too many instances; and the greater number of them were accompanied by circumstances of disgraceful barbarity.

Mr. Osbaldestone had a celebrated American trotting-horse, called Tom Thumb. He matched him to trot 100 miles in ten hours and a half. It seemed to be an amazing distance, and impossible to be accomplished: but the horse had done wonders as a trotter; he was in the highest condition; the vehicle did not weigh more than 100 lbs., nor the driver more than 10 st. 3 lbs. He accomplished his task in ten hours and seven minutes; his stoppages to bait, &c., occupied thirty-seven minutes—so that, in fact, the 100 miles were done in nine hours and a half. He was not at any time distressed; and was so fresh at the end of the ninetieth mile, that his owner offered to take six to four that he did fourteen miles in the next hour.

An English-bred mare was afterwards matched to accomplish the same task. She was one of those animals rare to be met with, that could do almost anything as a hack, a hunter, or in harness. On one occasion, after having, in following the hounds, and travelling to and from cover, gone through at least sixty miles of country, she fairly ran away with her rider over several ploughed fields. She accomplished the match in ten hours and fourteen minutes—or, deducting thirteen minutes for stoppages, in ten hours and a minute's actual work; and thus gained the victory. She was a little tired, and, being turned into a loose box, lost no time in taking her rest. On the following day she was as full of life and spirit as ever. These are matches which it is pleasant to record—and particularly the latter; for the owner had given positive orders to the driver to stop at once, on her showing decided symptoms of distress, as he valued her more than anything he could gain by her enduring actual suffering.

Others, however, are of a different character, and excite indignation and disgust. Rattler, an American horse, was, in 1829, matched to trot ten miles with a Welsh mare, giving her a minute's start. He completed the distance in thirty minutes and forty seconds—being at the rate of rather more than nineteen miles an hour—and beating the mare by sixty yards. All this is fair; but when the same horse was, some time afterward, matched to trot thirty-four miles against another, and is distressed, and *dies* in the following night—when two hackneys are matched against each other, from London to York, 196 miles, and one of them runs 182 of these miles and dies, and the other accomplishes the dreadful feat in forty hours and thirty-five minutes, being kept for more than half the distance under the influence of wine—when two brutes in human shape match their horses, the one a tall and bony animal, and the other a mere pony, against each

other for a distance of sixty-two miles, and both are run to a complete standstill, the one at thirty and the other at eighty yards from the winning point, and, both being still urged on, they drop down and die—when we peruse records like these, we envy not the feelings of the owners, if indeed they are not debased below all feeling. We should not have felt satisfied in riding an animal, that had done much and good service, seventy miles when he was thirty-six years old; nor can we sufficiently reprobate the man, who, in 1827, could ride a small gelding from Dublin to Nenagh, ninety-five miles, in company with the Limerick coach; or that greater delinquent who started with the Exeter mail, on a galloway, under fourteen hands high, and reached that city a quarter of an hour before the mail, being 172 miles, and performed at the rate of rather more than seven miles an hour. The author saw this pony, a few months afterwards, strained, ringboned, and foundered—a lamentable picture of the ingratitude of some human brutes towards a willing and faithful servant.

#### THE FARMER'S HORSE.

The FARMER'S HORSE is an animal of *all work*: to be ridden occasionally to market or for pleasure, but to be principally employed for draught. He should be higher than the road-horse, about fifteen hands and two inches may be taken as the best standard. A horse with a shoulder thicker, lower, and less slanting than would be chosen in a hackney, will better suit the collar; and collar work will be chiefly required of him. A stout compact animal should be selected, yet not a heavy cloddy one. Some blood will be desirable; but the half-bred horse will generally best suit the farmer's purpose. He should have weight enough to throw into the collar, and sufficient activity to get over the ground.

Farmers are now beginning to be aware of the superiority of the moderately-sized, strong, active horse, over the bulkier and slower animal of former days. It is not only in harvest, and when a frosty morning must be seized to cart manure, that this is perceived, but in the every-day work of the farm the saving of time, and the saving of provender too, will be very considerable in the course of a year.

It has often been said, that a horse used much for draught, is neither pleasant nor safe for the saddle. The little farmer does not want a showy, complete hackney. He should be content if he is tolerably well carried; and—if he has taken a little care in the choice of his horse—if he has selected one with sound feet, shoulders not too thick, and legs not too much under him; and if he keeps him in good condition, and does not scandalously overweight him, the five days' carting or harrow-work will not, to any material degree, unfit him for the saddle; especially if the rider bears in mind what we have termed the golden rule of horsemanship, always *a little to feel* the mouth of the animal he is upon.

A farmer, and more particularly a small farmer, will prefer a mare to a gelding, both for riding or driving. She will not cost him so much at first; and he will get a great deal more work out of her. There can be no doubt that, taking bulk for bulk, a mare is stronger and more lasting than a gelding; and in addition to this, the farmer has her to breed from. This, and the profit which is attached to it, is well known in the breeding counties; but why the breeding of horses for sale should be almost exclusively confined to a few northern districts, it is not easy to explain. Wherever there are good horses, with convenience for rearing the colts, the farmer may start as a breeder with a fair chance of success.

If he has a few useful cart mares, and crosses them with a well-knit half-bred horse, he will certainly have colts useful for every purpose of agriculture, and some of them sufficiently light for the van, post-chaise,



or coach. If he has a superior mare, one of the old Cleveland breed, and puts her to a bony, three-fourths-bred horse, or, if he can find one stout and compact enough, a seven-eighths or a thoroughbred one, he will have a fair chance to rear a colt that will amply repay him as a hunter or carriage-horse.

The mare needs not to be idle while she is breeding. She may be worked moderately almost to the period of her foaling, and with benefit rather than otherwise; nor is there occasion that much of her time should be lost, even while she is suckling. If she is put to horse in June, the foaling time will fall, and the loss of labour will occur, in the most leisure time of the year.

There are two rocks on which the farmer often strikes—he pays little attention to the kind of mare, and less to the proper nourishment of the foal. It may be laid down as a maxim in breeding, however general may be the prejudice against it, that the value of the foal depends as much on the dam as on the sire. The Arabs go farther than this, for no price will buy from them a likely mare of the highest blood; and they trace back the pedigree of their horses, not through the sire, but the dam. The Greek sporting men held the same opinion, long before the Arab horse was known. ‘What chance of winning have I?’ inquired a youth whose horse was about to start on the Olympic course. ‘Ask the *dam* of your horse,’ was the reply, founded on experience. Bishop Hall, who wrote in the time of James I., intimates that such was the opinion of horsemen at that period. He asks in one of his satires (Lib. iv.),

——— dost thou prize  
Thy brute beasts' worth by their dams' qualities?  
Say'st thou this colt shall prove a swift-paced steed,  
Onely because a Jennet did him breed?  
Or say'st thou this same horse shall win the prize,  
Because his dam was swiftest Tranchevie?

The farmer, however, too frequently thinks that any mare will do to breed from. If he can find a great prancing stallion, with a high sounding name, and loaded with fat, he reckons on having a valuable colt; and should he fail he attributes the fault to the horse, and not to his own want of judgment. Far more depends on the mare than is dreamed of in his philosophy.

If he has an undersized, or a blemished, or unsound mare, let him continue to use her on his farm. She probably did not cost him much, and she will beat any gelding; but let him not think of breeding from her. A sound mare, with some blood in her, and with most of the good points, will alone answer his purpose. She may bear about her the marks of honest work (the fewer of these, however, the better), but she must not have any disease. There is scarcely a malady to which the horse is subject that is not hereditary. Contracted feet, curb, spavin, roaring, thick wind, blindness, notoriously descend from the sire or dam to the foal. Mr. Roberts, in ‘*The Veterinarian*,’ says:—‘Last summer I was asked my opinion of a horse. I approved of his formation with the exception of the hocks, where there happened to be two curbs. I was then told his sister was in the same stable: she also had two curbs. Knowing the sire to be free from these defects, I enquired about the dam: she likewise had two confirmed curbs. She was at this time running with a foal of hers, two years old, by another horse, and he also had two curbs.’

The foal should be well taken care of for the first two years. It is bad policy to stint or half-starve the growing colt.

The colt, whether intended for a hunter or carriage-horse, may be

early handled, but should not be broken in until three years old; and then, the very best breaking-in for the carriage-horse is to make him earn a little of his living. Let him be put to harrow or light plough. Going over the rough ground will teach him to lift his feet well, and give him that high and showy action, excusable in a carriage-horse, but not in any other. In the succeeding winter he will be perfectly ready for the town or country market.

#### THE CAVALRY HORSE.

This is the proper place to speak of the *Cavalry Horse*. That noble animal whose varieties we are describing, and who is so admirably adapted to contribute to our pleasure and our use, was, in the earliest period of which we have any account of him, devoted to the destructive purposes of war; and the cavalry is, at the present day, an indispensable and a most effective branch of the service.

The cavalry horses contain a different proportion of blood, according to the nature of the service required, or the caprice of the commanding officer. Those of the household troops are from half to three-fourths bred. Some of the lighter regiments have more blood in them. Our cavalry horses were formerly large and heavy. To their imposing size was added action as imposing. The horse was trained to a peculiar, and grand, yet beautiful method of going; but he was often found deficient in real service, for this very action diminished his speed, and added to his labour and fatigue.

A considerable change has taken place in the character of our troop horses. This necessarily followed from the change that has occurred in the thoroughbred horse. If he has lost much of his muscular form and actual power of endurance, a similar alteration will take place in the offspring; lightness and activity will succeed to bulk and strength, and for skirmishing and sudden attack the change will be an improvement. But if the horse be improved, there still requires to be a great change effected in the bulk of the accoutrements which is carried by the Light Dragoon. When the men are of equal weights, the accoutrements of the Light Horseman are, when on active service, quite as ponderous as those of the Heavy Dragoon. Hence the want of judgment shown in those commanding officers of Hussars who continue to mount their regiments with thoroughbred horses of little power, to carry weights of 15, 16, or 17 stones. It was proved that in the engagements previous to and at the battle of Waterloo, our heavy household troops alone were able to repulse the formidable charge of the French guard.

There are few things that more imperiously demand the attention of government. If from the habit of running short distances, and at the very early ages of one and two years, with light weights, there is a deterioration in the strength and stoutness of our thoroughbred horses, they will become every year less and less fitted for getting stock sufficiently hardy and powerful to do credit to the courage and discipline of our cavalry.

The following anecdote of the memory and discipline of the troop-horse is related on good authority. The Tyrolese, in one of their insurrections in 1809, took fifteen Bavarian horses, and mounted them with so many of their own men; but in a skirmish with a squadron of the same regiment, no sooner did these horses hear the trumpet and recognise the uniform of their old masters, than they set off at full gallop, and carried their riders, in spite of all their efforts, into the Bavarian ranks, where they were made prisoners.

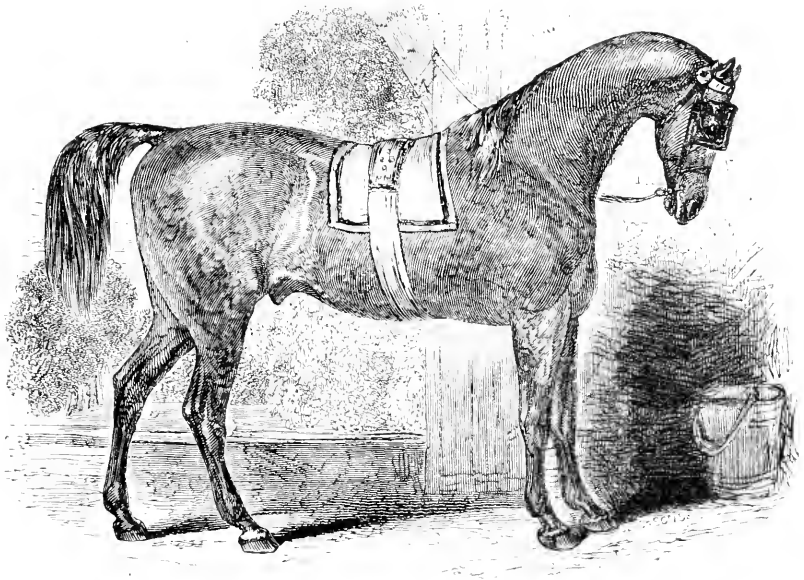
The wounds of a soldier are honourable. The old war-horse can some-

times exhibit his share of scars. One of them, twenty-seven years old, lately died at Stangleton Lodge, near Bedford, that had belonged to one of the regiments of lancers, and was in the battle of Waterloo, and the engagements of the two days that preceded it. No fewer than eight musket-balls were discovered in him after his death, and the scars of several wounds by the sabre and the lance.

A horse died at Snowhill, near Gainsford, in 1753, that had been in General Carpenter's regiment at the battle of Shirreff-Muir, in 1715, being at that time seven years old. He was wounded by a bullet in his neck in that engagement, and this bullet was extracted after his death.

#### THE COACH-HORSE.

This animal in external appearance is as different from what he was fifty years ago as it is possible to conceive. The clumsy-barrelled, cloddy-shouldered, round-legged, black family horse—neither a coach nor a dray-horse, but something between both—as fat as an ox—but, with all his pride and prancing when he first starts, not equal to more than six miles an hour, and knocking-up with one hard day's work, is no more seen



THE COACH-HORSE.

He indeed was quite in keeping with the vehicle he had to draw in olden times. Wheel carriages, bearing any resemblance to *chariots*, first came into use in the reign of Richard II., about the year 1388; they were called *whirlcotes*, and were little better than litters or *cots* (*cots*) placed on wheels. We are told by Master John Stowe, that 'Richard II. being threatened by the rebels of Kent, rode from the Tower of London to the Miles End, and with him his mother, because she was sick and weak, in a whirlcote;' and this is described as an ugly vehicle of four boards put together in a clumsy manner.

*Coaches* were not used until the time of Elizabeth, when we were told (Stowe's Survey of London and Westminster, book i.) 'divers great ladies

made them coaches, and rode in them up and down the countries, to the great admiration of all the beholders.' The fashion soon spread; and he adds, what is often too true in the present day, 'the world runs on wheels with many whose parents were glad to go on foot.'

These coaches were heavy and unwieldy, and probably bore some rough resemblance to the state-coaches now used occasionally in court processions.

Now we have, instead of him, an animal tall, deep-chested, rising in the withers, slanting in the shoulders, flat in the legs, with far more strength, and with treble the speed.

There is a great deal of deception, however, even in the best of these improved coach-horses. They prance it nobly through the streets, and they have more work in them than the old, clumsy, sluggish breed; but they have not the endurance that could be wished, and a pair of poor post-horses would, at the end of the second day, beat them hollow.

The knee-action and high lifting of the feet in the carriage-horse is deemed an excellence, because it adds to the grandeur of his appearance; but, as has already been stated, it is necessarily accompanied by much wear and tear of the legs and feet, and this is very soon apparent.

The principal points in the coach-horse are, substance well-placed, a deep and well-proportioned body, bone under the knee, and sound, open, tough feet.

The CLEVELAND BAY is the origin of the better kind of coach-horse, and is confined principally to Yorkshire and Durham, with, perhaps, Lincolnshire on one side, and Northumberland on the other, but difficult to find pure in either county. The Cleveland mare is crossed by a three-fourth or thoroughbred horse, of sufficient substance and height, and the produce is the coach-horse most in repute, with his arched crest and high action. From the thoroughbred of sufficient height, but not of so much substance, we obtain the four-in-hand and superior curriole horse.

Professor Low, in his superb work 'Illustrations of the Breeds of the Domestic Animals of the British Islands,' which should adorn the library of every sportsman and agriculturist, gives the following account of the Cleveland Bay:—

'It is the progressive mixture of the blood of horses of higher breeding with those of the common race, that has produced the variety of coach-horse usually termed the Cleveland Bay; so called from its colour and the fertile district of that name in the North Riding of Yorkshire, on the banks of the Tees. About the middle of the last century this district became known for the breeding of a superior class of powerful horses, which, with the gradual disuse of the heavy old coach-horse, became in request for coaches, chariots, and similar carriages. The breed, however, is not confined to Cleveland, but is cultivated through all the great breeding district of this part of England. It has been formed by the progressive mixture of the blood of the race-horse with the original breeds of the country. To rear this class of horses, the same principles of breeding should be applied as to the rearing of the race-horse himself. A class of mares, as well as stallions, should also be used having the properties sought for. The district of Cleveland owes its superiority in the production of this beautiful race of horses to the possession of a definite breed, formed not by accidental mixture, but by continued cultivation.'

'Although the Cleveland Bay appears to unite the blood of the finer with that of the larger horses of the country, to combine action with strength, yet many have sought a farther infusion of blood nearer to the race-horse. They are accordingly crossed by hunters or thoroughbred horses, and thus another variety of coach-horse is produced, of lighter

form and higher breeding; and many of the superior Cleveland carriage and four-in-hand horses are now nearly thoroughbred. The bay colour is in the most general estimation, but the grey are not unfrequently used.'

From less height and more substance we have the hunter and better sort of hackney; and, from the half-bred, we derive the machinist, the poster, and the common carriage-horse: indeed, Cleveland, and the vale of Pickering in the East Riding of Yorkshire, may be considered as the most decided breeding countries in England for coach-horses, hunters, and hackneys. The coach-horse is nothing more than a tall, strong, over-sized hunter.

Whether we are carrying supposed improvement too far, and sacrificing strength and usefulness to speed, is a question not difficult to resolve. The rage for rapid travelling was introduced by the improvement in the speed of the racer, and for a while it became the bane of the postmaster, the destruction of the horse, and a disgrace to the English character.

The stages were then twelve, sixteen, or even twenty miles; the horses stout and true, but formed for, and habituated to, a much slower pace; and the increase of two, and even four, miles an hour, rendered every stage a scene of continuous barbarity, and speedily thinned the stables of the post and stage master. The post-horse has not to the present moment altogether escaped from the system of barbarity to which he was subjected. He is not expressly bred for his work—that work is irregular—the pace is irregular—the feeding and the time of rest uncertain—and the horse himself, destined to be the victim of all these means of annoyance and suffering and impairment of natural power, is not always or often either speedy or stout. The coachmaster, on a large scale, has, however, learned, and, generally speaking, follows up, a system at once conducive to his own profit, and the health and comfort and prolonged labour of his horse. He buys a good horse, says Nimrod, 'one that has,' in the language of the highest authority in these matters, 'action, sound feet and legs, power and breeding equal to the nature and length of the ground he will have to work upon, and good wind, without which no other qualification will long avail in fast work.' He feeds him well—he works him but little more than two or three hours out of the four-and-twenty—he rests him one day out of every five—he has everything comfortable about him in his stable—and by these means, that which was once a life of torture is one of comparative enjoyment. This is now the case in large and well-conducted concerns, and where the eye of the master or the confidential manager overlooks and directs all.

In other establishments, and in too many of them, there is yet much animal suffering. The public has to a very considerable extent the power to distinguish between the two, and to uphold the cause of humanity.

Reference has been made to the dreadful operations which the new system of horse management has introduced. The cautery lesions are more numerous and severe than they used to be, in too many of our establishments. The injuries of the feet and legs are severe in proportion to the increased pace and labour; for where the animal machine is urged beyond its power, and the torture continues until the limb or the whole constitution utterly fails, the lesions must be deep, and the torture must be severe, by means of which the poor slave is rendered capable of returning to renewed exertion.

There is no truth so easily proved, or so painfully felt by the postmaster, at least in his pocket, as that *it is the pace that kills*. A horse at a dead pull, or at the beginning of his exertion, is enabled, by the force of his muscles, to throw a certain weight into the collar. If he walks four miles in the hour, some part of that muscular energy must be expended in the

act of walking; and, consequently, the power of drawing must be proportionably diminished. If he trots ten miles in the hour, more animal power is expended in the trot, and less remains for the draught; but the draught continues the same, and, to enable him to accomplish his work, he must tax his energies to a serious degree; and this taxing, this exhaustion, this suffering, must be increased to a most merciless extent in the poor beast that, with all his powers required to draw the load behind him, has to carry the extra weight of the post-boy. Skilful breeding, and high health, and stimulating food, and a very limited time of work, can alone enable him to endure the labour long, on the supposition that the system which has just been described is resorted to. But the coach proprietor is not always sufficiently enlightened, or good-hearted, to see on which side his interest lies; and then the work is accomplished by the overstrained exertion — the injury — the torture — the destruction of the team. That which is true of the coach-horse is equally so of every other. Let the reader apply it to his own animal, and act as humanity and interest dictate.

Many a horse used on the public roads is unable to throw all his natural power or weight into the collar. He is tender-footed — lame; but he is bought at little price, and he is worked on the brutal and abominable principle, that he may be ‘whipped sound.’ And so, apparently, he is. At first he sadly halts; but urged by the torture of the lash, he acquires a peculiar habit of going. The faulty limb appears to keep pace with the others, but no stress or labour is thrown upon it, and he gradually contrives to make the sound limbs perform among them all the duties of the unsound one; and thus he is barbarously ‘whipped sound,’ and cruelty is undeservedly rewarded.

After all, however, what has been done? Three legs are made to do that which was almost too hard a task for four. Then they must be most injuriously strained, and soon worn out, and the general power of the animal must be rapidly exhausted, and, at no great distance of time disease and death release him from his merciless persecutors. Fortunately, for the sake of humanity, this cruel and painful era has passed away, and even could the incalculable advantages of the rail to mankind alone be overlooked or undervalued, its introduction and use must be hailed with delight as superseding the suffering and torture inevitably accompanying the later years of posting, stage coaching, and the conveying of the mails.

It is said, that between Glasgow and Edinburgh, a carrier in a single-horse cart, weighing about seven hundredweight, will take a load of a ton, and at the rate of twenty-two miles in a day. The Normandy carriers travel with a team of four horses, and from fourteen to twenty-two miles in a day, with a load of ninety hundred weight.

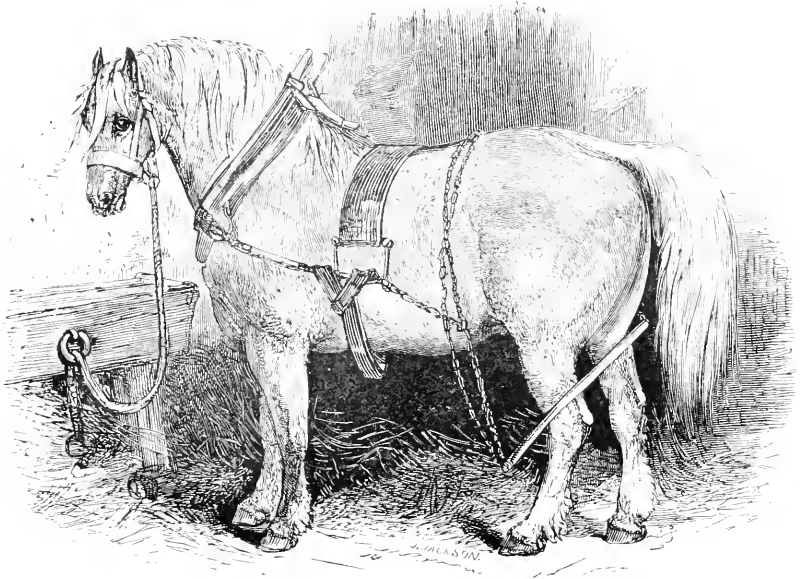
An unparalleled instance of the power of a horse when assisted by art, was shown near Croydon. The Surrey iron railway being completed, a wager was laid between two gentlemen, that a moderate-sized horse could draw thirty-six tons six miles along the road — that he should draw the weight from a dead pull, as well as turn it round the occasional windings of the road. A numerous party of gentlemen assembled near Merstham to see this extraordinary triumph of art. Twelve waggons laden with stones, each waggon weighing above three tons, were chained together, and a horse, taken promiscuously from the timber carts of Mr. Harwood, was yoked to the train. He started from the Fox public-house, near Merstham, and drew the immense chain of waggons, with apparent ease, almost to the turnpike at Croydon, a distance of six miles, in one hour and forty-one minutes, which is nearly at the rate of four miles an hour. In the course of the journey he was stopped four times, to show that it was not by any advantage of descent that this power was acquired;

and after each stoppage he again drew off the chain of waggons with perfect ease. Mr. Banks, who had wagered on the power of the horse, then desired that four other loaded waggons should be added to the cavalcade, with which the same horse again started and with undiminished pace. Still further to show the effect of the railway in facilitating motion, he directed the attending workmen, to the number of fifty, to mount on the waggons, and the horse proceeded without the least distress; and, in truth, there appeared to be scarcely any limitation to the power of his draught. After the trial the waggons were taken to the weighing machine, and it appeared that the whole weight was as follows:—

	TON.	CWT.	QR.
Twelve waggons first linked together . . . . .	38	4	2
Four ditto afterwards attached . . . . .	13	2	0
Supposed weight of fifty labourers . . . . .	4	0	0
	55	6	2

## HEAVY DRAUGHT HORSES.

The Cleveland horses have been known to *carry* more than seven hundred pounds sixty miles in twenty-four hours, and to perform this journey four times in a week; and mill-horses have carried nine hundred and ten pounds two or three miles.



THE SUFFOLK PUNCH.

Horses for slower draught, and sometimes even for the carriage, are produced from the SUFFOLK PUNCH, so called on account of his round punchy form. He is descended from the Norman stallion and the Suffolk cart mare. The true Suffolk, like the Cleveland, is now nearly extinct. It stood from fifteen to sixteen hands high, of a sorrel colour; was large headed; low shouldered, and thick on the withers; deep and round chested; long backed; high in the croup; large and strong in the quarters; full in the flanks; round in the legs; and short in the pasterns.

It was the very horse to throw his whole weight into the collar, with sufficient activity to do it effectually and hardihood to stand a long day's work.

The present breed possesses many of the peculiarities and good qualities of its ancestors. It is more or less inclined to a sorrel colour; it is a taller horse; higher and finer in the shoulders; and is a cross with the Yorkshire half or three-fourths bred.

The excellence, and a rare one, of the old Suffolk—the new breed has not quite lost it—consisted in nimbleness of action, and the honesty and continuance with which he would exert himself at a dead pull. Many a good draught horse knows well what he can effect; and, after he has attempted it and failed, no torture of the whip will induce him to strain his powers beyond their natural extent. The Suffolk, however, would tug at a dead pull until he dropped. It was beautiful to see a team of true Suffolks, at a signal from the driver, and without the whip, down on their knees in a moment, and drag everything before them. Brutal wagers were frequently laid as to their power in this respect, and many a good team was injured and ruined. The immense power of the Suffolk is accounted for by the low position of the shoulder, which enables him to throw so much of his weight into the collar.

Although the Punch is not what he was, and the Suffolk and Norfolk farmer can no longer boast of ploughing more land in a day than any one else, this is undoubtedly a valuable breed.

The Duke of Richmond obtained many excellent carriage horses, with strength, activity, and figure, by crossing the Suffolk with one of his best hunters.

The Suffolk breed is in great request in the neighbouring counties of Norfolk and Essex. Mr. Wakefield, of Barnham in Essex, had a stallion for which he was offered four hundred guineas.

The CLYDESDALE is a good kind of draught horse, and particularly for farming business and in a hilly country. It derives its name from the district on the Clyde, in Scotland, where it is principally bred. The Clydesdale horse owes its origin to one of the Dukes of Hamilton, who crossed some of the best Lanark mares with stallions that he had brought from Flanders. The Clydesdale is larger than the Suffolk, and has a better head, a longer neck, a lighter carcass, and deeper legs; he is strong, hardy, pulling true, and rarely restive. The southern parts of Scotland are principally supplied from this district; and many Clydesdales, not only for agricultural purposes, but for the coach and the saddle, find their way to the central, and even southern counties of England. Dealers from almost every part of the United Kingdom attend the markets of Glasgow and Rutherglen.

Mr. Low says that 'the Clydesdale horse as it is now bred is usually sixteen hands high. The prevailing colour is black, but the brown or bay is common, and is continually gaining upon the other, and the grey is not unfrequently produced. They are longer in the body than the English black horse, and less weighty, compact and muscular, but they step out more freely, and have a more useful action for ordinary labour. They draw steadily, and are usually free from vice. The long stride, characteristic of the breed, is partly the result of conformation, and partly of habit and training; but, however produced, it adds greatly to the usefulness of the horse, both on the road and in the fields. No such loads are known to be drawn, at the same pace, by any horses in the kingdom, as in the single-horse carts of carriers and others in the west of Scotland.'

In the opinion of this gentleman, 'the Clydesdale horses, although inferior in weight and physical strength to the black horse, and in figure



and showy action to the better class of the draught horses of Northumberland and Durham, yet possess properties which render them exceedingly valuable for all ordinary uses. On the road they perform tasks that can scarcely be surpassed, and in the fields they are found steady, docile, and safe.'

THE HEAVY BLACK HORSE is the last variety it may be necessary to notice. It is bred chiefly in the midland counties from Lincolnshire to Staffordshire. Many are bought up by the Surrey and Berkshire farmers at two years old,—and, being worked moderately until they are four, earning their keep all the while, they are sent to the London market, and sold at a profit of ten or twelve per cent.

It would not answer the *breeder's* purpose to keep them until they are fit for town work. He has plenty of fillies and mares on his farm for every purpose that he can require: he therefore sells them to a person nearer the metropolis, by whom they are gradually trained and prepared. The traveller has probably wondered to see four of these enormous animals in a line before a plough, on no very heavy soil, and where two lighter horses would have been quite sufficient. The farmer is training them for their future destiny, and he does right in not requiring the exertion of all their strength, for their bones are not yet perfectly formed, nor their joints knit; and were he to urge them too severely, he would probably injure and deform them. By the gentle and constant exercise of the plough, he is preparing them for that *continued and equable* pull at the collar, which is afterwards so necessary. These horses are adapted more for parade and show, and to gratify the desire which one brewer has to outvie his neighbour, than for any peculiar utility. They are certainly noble-looking animals, with their round fat carcasses, and their sleek coats, and the evident pride which they take in themselves; but they eat a great deal of hay and corn, and, at hard and long-continued work, they would be completely beaten by a team of active muscular horses an inch and a half lower.

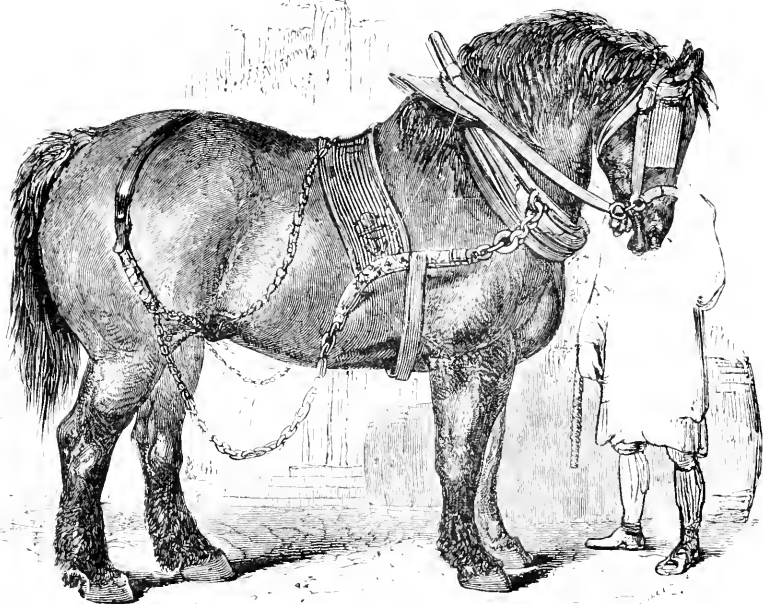
The only plea which can be urged in their favour, beside their noble appearance, is, that as shaft-horses, over the badly-paved streets of the metropolis, and with the immense loads they often have behind them, great bulk and weight are necessary to stand the unavoidable battering and shaking. Weight must be opposed to weight, or the horse would sometimes be quite thrown off his legs. A large heavy horse must be in the shafts, and then little ones before him would not look well.

Certainly no one has walked the streets of London without pitying the poor thill-horse, jolted from side to side, and exposed to many a bruise, unless, with admirable cleverness, he accommodates himself to every motion; but, at the same time, it must be evident, that bulk and fat do not always constitute strength, and that a compact muscular horse, approaching to sixteen hands high, would acquit himself far better in such a situation. The dray-horse, in the mere act of ascending from the wharf, may display a powerful effort, but he afterwards makes little exertion, much of his force being expended in transporting his own overgrown carcass.

This horse (see engraving in next page) was selected from the noble stock of dray-horses belonging to Messrs. Barclay, Perkins, and Co., London, by the author's friend, Mr. E. Braby. While he is a fine specimen of this breed, he affords a singular illustration of the mode of breeding often practised with respect to these horses and the education which they undergo. He was bred in Leicestershire,—his grand-sire was a Flanders-bred horse, and his grand-dam a Wiltshire mare,—his sire was a Wiltshire horse, and his dam a Berkshire mare. At two and a half years old he

was sold to a farmer and dealer in Berkshire, on whose grounds he was worked until he was four and a half years old. He was then sold at Abingdon fair to the dealer from whom Messrs. Barclay purchased him.

These heavy horses, however, are bred in the highest perfection, *as to size*, in the fens of Lincolnshire, and few of them are less than seventeen hands high at two and a half years old. Neither the soil, nor the produce of the soil, is better than in other counties; on the contrary, much of the lower part of Lincolnshire is a cold, hungry clay. The true explanation of the matter is, that there are certain situations better suited than others to different kinds of farming, and the breeding of different animals; and, that not altogether depending on richness of soil or pasture. The principal art of the farmer is, to find out what will best suit his soil, and make the produce of it most valuable.



The Lincolnshire colts are also sold to the Wiltshire and Berkshire dealers, as are those that are bred in Warwickshire and Berkshire, at two years, or sometimes only one year old, and worked until the age of four or five years.

A dray-horse should have a broad breast, and thick and upright shoulders, (the more upright the collar stands on him the better,) a low forehead, deep and round barrel, loins broad and high, ample quarters, thick fore-arms and thighs, short legs, round hoofs broad at the heels, and soles not too flat. The great fault of the large dray-horse is his slowness. This is so much in the breed, that even the discipline of the ploughman, who would be better pleased to get through an additional rood in the day, cannot permanently quicken him. Surely the breeder might obviate this. Let a dray-mare be selected, as perfect as can be obtained. Let her be put to the strongest, largest, most compact, thorough-bred horse. If the produce is a filly, let her be covered by a superior dray-horse, and the result of this cross, if a colt, will be precisely the animal required to breed from.

The largest of this heavy breed of black horses are used as *dray-horses*.

The next in size are sold as *waggon-horses*; and a smaller variety, and with more blood, constitutes a considerable part of our *cavalry*, and is likewise devoted to undertakers' work.

All our heavy draught horses, and some even of the lighter kind, have been lately much crossed by the Flanders breed, and with evident improvement. Little has been lost in depth and bulk of carcase; but the forehead has been raised, the legs have been flattened and deepened, and very much has been gained in activity. The slow heavy black, with his two miles and a half an hour, has been changed into a lighter, but yet exceedingly powerful horse, that will step four miles in the same time, with perfect ease, and has considerably more endurance.

This is the very system, as already described, which has been adopted, and with so much success, in the blood horse, and has made the English racer and hunter, and the English horse generally, what they are. As the racer is principally or purely of Eastern origin, so has the English draught horse sprung chiefly from Flemish blood, and to that blood the agriculturist has recourse for the perfection of the breed. For the dray, the spirit waggon, and not too heavy loads, and for road work generally, a cross with the Flanders will be advantageous; but if the enormous heavy horse must be used in the coal-waggon, or the dray, we must leave our midland black, with all his unwieldy bulk untouched.

As an ordinary beast of lighter draught, and particularly in the neighbourhood of London, the worn-out hackney, and the refuse of the coach, and even of the hackney-coach, is used. In the hay-markets of Whitechapel and Camden Town are continually seen wretched teams that would disgrace the poorest district of the poorest country. They who are unacquainted with this part of the country, would scarcely think it possible, that on the forests and commons within a few miles of London, as many ragged, wild, mongrel horses are to be found as in any district of the United Kingdom, and a good horse is scarcely by any chance bred there.

#### GALLOWAYS AND PONIES.

A horse between thirteen and fourteen hands in height is called a GALLOWAY, from a beautiful breed of little horses once found in the south of Scotland, on the shore of the Solway Firth, but now sadly degenerated, and almost lost, through the attempts of the farmer to obtain a larger kind, and better adapted for the purposes of agriculture. There is a tradition in that country, that the breed is of Spanish extraction, some horses having escaped from one of the vessels of the Grand Armada, that was wrecked on the neighbouring coast. This district, however, so early as the time of Edward I., supplied that monarch with a great number of horses.

The pure galloway was said to be nearly fourteen hands high, and sometimes more; of a bright bay, or brown, with black legs, small head and neck, and peculiarly deep and clean legs. Its qualities were speed, stoutness, and sure-footedness over a very rugged and mountainous country.

Some remains of the old galloways are still to be met with in the Isle of Mull; but they are altogether neglected, and fast degenerating from admixture with inferior breeds.

Dr. Anderson thus describes the galloway:—'There was once a breed of small elegant horses in Scotland, similar to those of Iceland and Sweden, and which were known by the name of galloways; the best of which sometimes reached the height of fourteen hands and a half. One of this description I possessed, it having been bought for my use when a boy. In point of elegance of shape it was a perfect picture; and in

disposition was gentle and compliant. It moved almost with a wish, and never tired. I rode this little creature for twenty-five years, and twice in that time I rode a hundred and fifty miles at a stretch, without stopping, except to bait, and that not for above an hour at a time. It came in at the last stage with as much ease and alacrity as it travelled the first. I could have undertaken to have performed on this beast, when it was in its prime, sixty miles a day for a twelvemonth running, without any extraordinary exertion.'

In 1754, Mr. Corker's galloway went one hundred miles a day, for three successive days, over the Newmarket Course, and without the slightest distress.

A galloway, belonging to Mr. Sinclair, of Kirby-Lonsdale, performed at Carlisle the extraordinary feat of a thousand miles in a thousand hours.

Many of the galloways now in use are procured either from Wales or the New Forest; but they have materially diminished in number.

Old Marsk, before his value was known, contributed to the improvement of the Hampshire breed; and the Welsh ponies are said to be indebted to the celebrated Merlin for much of their form and qualities.

The modern *New-foresters*, notwithstanding their Marsk blood, are generally ill-made, large-headed, short-necked, and ragged-hipped; but hardy, safe, and useful, with much of their ancient spirit and speed, and all their old paces. The catching of these ponies is as great a trial of skill as the hunting of the wild horse on the Pampas of South America, and a greater one of patience.

The *Welsh pony* is one of the most beautiful little animals that can be imagined. He has a small head, high withers, deep yet round barrel, short joints, flat legs, and good round feet. He will live on any fare, and will never tire.

Pony-hunting used to be one of the favourite amusements of the Welsh farmers and peasantry, a century and a half ago, and it has not, even now, fallen altogether into disuse. The following story of one of these expeditions, narrated in the *Cambrian Quarterly Magazine*, is founded on fact:—

'A farmer, named Hugo Garonwy, lived in the neighbourhood of Llweyn Georie. Although he handled the small tilt plough, and other farming tools in their due season, yet the catching of the merlyn, the fox, and the hare, were more congenial pursuits; and the tumbles and thumps which he received, and from which no pony-hunter was exempt, served but to attach him to the sport. Rugged, however, as the Merioneddshire coast and its environs were, and abounding with precipices and morasses, worse mishaps were sometimes experienced—and so it happened with Garonwy.

'He set out one morning with his lasso coiled round his waist, and attended by two hardy dependents and their greyhounds. The lasso was then familiar to the Welshman, and as adroitly managed by him as by any guaco on the plains of South America. As the hunters climbed the mountain's brow, the distant herd of ponies took alarm—sometimes galloping onwards, and then suddenly halting and wheeling round, snorting, as if in defiance of the intruders, and furiously pawing the ground. Garonwy, with the assistance of his servants and the greyhounds, contrived to coop them up in a corner of the hills, where perpendicular rocks prevented their escape.

'Already had he captured three of the most beautiful little fellows in the world, which he expected to sell for 4*l.* or 5*l.* each at the next Bala fair—to him a considerable sum, and amounting to a fourth of the annual rent which he paid for his sheep-walk. There remained, however, one most untameable creature, whose crested mane, and flowing tail, and wild

eye, and distended nostril, showed that he was a perfect *Bucephalus* of the hills; nor, indeed, was it safe to attack him in the ordinary way. Many of the three-year-olds had been known to break the legs of their pursuers, and some had been dismounted and trampled to death.

'Garonwy was determined to give the noble fellow a chase over the hills, and so overcome him by fatigue before the lasso was flung. The dogs were unslipped, and off they went, swift as the winds, Garonwy following, and the two assistants posted on a neighbouring eminence. Vain was the effort to tire the merlyn. Hugo, naturally impatient, and without waiting to ascertain that the coils were all clear, flung the lasso over the head of the wild horse. The extremity of the cord was twisted round his own body, and tightening as the animal struggled, the compression became unsupportable, and, at length, in spite of every effort to disengage himself, Garonwy was dragged from his horse.

'The affrighted merlyn finding himself manacled by the rope, darted off with all the speed of which he was capable, dragging poor Garonwy over the rocky ground and stunted brushwood. This occurred at some distance from the men. They called in their dogs that the speed of the merlyn might not be increased, but, ere they could arrive at the spot at which the accident happened, the horse and the man had vanished. Whether the sufferings of the hunter were protracted, or he was dashed against some friendly rock at the commencement of this horrible race, was never known; but the wild animal, frenzied and blinded by terror, rushed over a beetling cliff, at a considerable distance, overhanging the sea-shore, and the hunter and the horse were found at the bottom, a mis-shapen semblance of what they had been when living.'

A great many ponies of little value used to be reared on the Wildmoor fens, in the neighbourhood of Boston, in Lincolnshire. They seldom reached thirteen hands; the head was large, and the forehead low, the back straight, the leg flat and good; but the foot, even for a Lincolnshire pony, unnaturally large. They were applied to very inferior purposes even on the fens, and were unequal to hard and flinty and hilly roads. The breed became generally neglected, and, at no very distant time, will be probably extinct.

The *Exmoor ponies*, although generally ugly enough, are hardy and useful. A well-known sportsman says, that he rode one of them half-a-dozen miles, and never felt such power and action in so small a compass before. To show his accomplishments, he was turned over a gate at least eight inches higher than his back; and his owner, who rides fourteen stone, travelled on him from Bristol to South Molton, eighty-six miles, beating the coach which runs the same road.

The horses which were once used in Devonshire, and particularly in the western and southern districts, under the denomination of *PACK-HORSES*, are a larger variety of the Exmoor or Dartmoor breed. The saddle-horses of Devonshire are mostly procured from the more eastern counties.

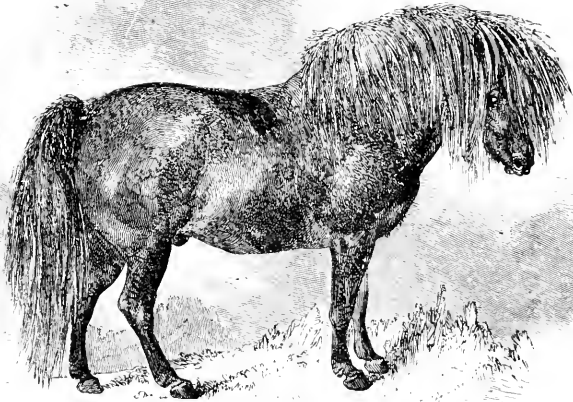
There are still some farms in the secluded districts in that beautiful part of the kingdom on which there is not a pair of wheels. Hay, corn, straw, fuel, stones, dung, lime, are carried on horseback; and in harvest, sledges drawn by oxen and horses are employed. This was probably, in early times, the mode of conveyance throughout the kingdom; but it is now rapidly getting into disuse even in Devonshire.

There is on Dartmoor a race of ponies much in request in that vicinity, being sure-footed and hardy, and admirably calculated to scramble over the rough roads and dreary wilds of that mountainous district. The Dartmoor pony is larger than the Exmoor, and, if possible, uglier. He exists there almost in a state of nature. The late Captain Colgrave,

governor of the prison, had a great desire to possess one of them of somewhat superior figure to its fellows; and having several men to assist him, they separated it from the herd. They drove it on some rocks by the side of a tor (an abrupt pointed hill). A man followed on horseback, while the captain stood below watching the chase. The little animal being driven into a corner, leaped completely over the man and horse, and escaped.

The *Highland pony* is far inferior to the galloway. The head is large; he is low before, long in the back, short in the legs, upright in the pasterns, rather slow in his paces, and not pleasant to ride, except in the canter. His habits make him hardy; for he is rarely housed in the summer or the winter. The Rev. Mr. Hall, in his 'Travels in Scotland,' says, 'that when these animals come to any boggy piece of ground, they first put their nose to it, and then pat on it in a peculiar way with one of their fore-feet; and from the sound and feel of the ground, they know whether it will bear them. They do the same with ice, and determine in a minute whether they will proceed.'

The *Shetland pony*, called in Scotland *sheltie*, an inhabitant of the extremest northern Scottish isles, is a very diminutive animal—sometimes not more than seven hands and a half in height, and rarely exceeding nine and a half.



THE SHETLAND PONY.

He is often exceedingly beautiful, with a small head, good-tempered countenance, a short neck, fine towards the throttle, shoulders low and thick,—in so little a creature far from being a blemish,—back short, quarters expanded and powerful, legs flat and fine, and pretty round feet. These ponies possess immense strength for their size; will fatten upon almost anything; and are perfectly docile. One of them, nine hands (or three feet) in height, carried a man of twelve stone forty miles in one day.

A friend of the author was, not long ago, presented with one of these elegant little animals. He was several miles from home, and puzzled how

to convey his newly-acquired property. The Shetlander was scarcely more than seven hands high, and as docile as he was beautiful. 'Can we not carry him in your chaise?' said his friend. The strange experiment was tried. The sheltie was placed in the bottom of the gig, and covered up as well as could be managed with the apron; a few bits of bread kept him quiet; and thus he was safely conveyed away, and exhibited the curious spectacle of a horse riding in a gig.

In the southern parts of the kingdom the Shetlanders have a very pleasing appearance harnessed to a light garden-chair, or carrying an almost baby-rider. There are several of them now running in Windsor Park.

### THE IRISH HORSE.

In some of the rich grazing counties, as Meath and Roscommon, a large, long blood-horse is reared, of considerable value. He seldom has the elegance of the English horse; he is larger-headed, more leggy, ragged-hipped, angular, yet with great power in the quarters, much depth beneath the knee, stout and hardy, full of fire and courage, and an excellent leaper. It is not, however, the leaping of the English horse, striding as it were over a low fence, and stretched at his full length over a higher one: it is the proper *jump* of the deer, beautiful to look at, difficult to sit, and, both in height and extent, unequalled by the English horse.

In the last forty years, immense improvements have been made in Ireland in all kinds of agricultural stock. The Irish hunter is now one of the most valuable of his class, with abundance of bone and breeding. Ireland is the nursery for re-mounting our cavalry, and should a regiment leave the country with inferior horses, it only proves the great want of judgment in the officer who has had the selection of them.

There are very few horses in the agricultural districts of Ireland exclusively devoted to draught. The minute division of the farms renders it impossible for them to be kept. The occupier even of a good Irish farm wants a horse that shall carry him to market, and draw his small car, and perform every kind of drudgery—a horse of all-work; therefore the thorough draught-horse, whether Leicester or Suffolk, is rarely found.

If we look to the commerce of Ireland, there are few stage-waggons, or drays with large cattle belonging to them, but almost everything is done by one-horse carts. In the north of Ireland some stout horses are employed in the carriage of linen; but the majority of the *garrons* used in agriculture or commercial pursuits are miserable and half-starved animals. In the north it is somewhat better. There is a native breed in Ulster, hardy, and sure-footed, but with little pretension to beauty or speed.

---

## CHAPTER V.

### BREEDING AND BREAKING IN.

A VOLUME of itself would be required to do justice to a subject possessing so many features of interest and importance as the effects of breeding on our different classes of the horse. Our observations, therefore, on it will necessarily be brief and of a general nature. That breeding has a

considerable influence on the value of our different class of horses will be readily admitted, and the great attention which has been given to this subject by breeders during the last twenty years, has been rewarded with the most successful results. However much may have been said or written of late respecting the deterioration of our breed of horses, we are inclined to believe that this country never possessed such numbers of valuable animals in every class, as at the present. The general axiom laid down is that 'like will produce like,' and that the progeny will inherit the general or mingled qualities of the parents. This fact should not only be taken into consideration with regard to the general conformation, temper, &c., of the animal, but also in regard to the transmission of disease. That disease is transmissible from the parents to the offspring, there cannot be a doubt; and such is the hereditary nature of certain diseases, that, although they may not show themselves in the immediate progeny, they frequently do so in the next and even more distant generation. There is abundant proof that blindness, roaring, broken wind, sidebones, spavins, ringbones, laminitis and navicular disease, have been bequeathed to their offspring both by sire and dam. Nor is this all, for although the freedom from disease of some particular organ on the part of one of the parents may counteract, and to a certain extent obliterate a palpable defect in that organ in the other, there will still remain a peculiar weakness, or tendency in the part, which requires but some slight exciting cause to bring about its full development. To illustrate this, we will suppose a mare perfectly sound in her wind is sent to a horse afflicted with roaring: although the produce may be free from roaring, and may continue so for some time without giving any evidence of the disease, nevertheless, how often does it happen that an attack of influenza is succeeded by the animal becoming a confirmed roarer? Again, send a mare with curbs on her hocks, to a horse with perfectly sound ones, and what is frequently the result on the produce? The young animal may not possess the great defects observable in the dam—in short, may not have curbs at all; he will, nevertheless, in all probability have weak and badly-shaped hocks, what are commonly called curby hocks, which will require but slight stress upon the part to develop the disease inherited from the dam. Hence the necessity of a thorough knowledge of both sire and dam. One of the first principles we would therefore impress upon the breeders of all animals, and the horse in particular, is that both parents should be free from disease. This has been too much lost sight of, especially in country districts, where stud-horses are kept for getting hunters, many of which are nothing better than cast-offs from the racing stable, in consequence of some disease (not unfrequently of the respiratory organs), which makes them valueless for the purposes for which they have been reared. The result in the course of a few years will be manifest in the young produce exhibiting in a greater or less degree the infirmities of the sire. There cannot be a doubt that the employment of such animals for breeding purposes is calculated to produce the greatest evil amongst all classes of horses; and the best course that could be adopted would be to consign them to an operation, which, while it would allow of their being made useful for some purposes, would prevent the spread of their deleterious influence. Peculiarity of form and constitution will also be inherited. This is a most important but neglected consideration, for however desirable or even perfect may have been the conformation of the sire, every good point may be neutralised, or lost, by the defective structure of the mare. The essential points should be good in both parents, or some minor defect in either, be met and got rid of by excellence in that particular point in the other. The unskillful or careless breeder too often so badly pairs the animals, that



the good points of each are almost lost, the defects of both increased, and the produce far inferior to both sire and dam.

That the constitution and endurance of the horse are inherited, no sporting man ever doubted. The qualities of the sire or the dam descend from generation to generation, and the excellences or defects of certain horses are often traced, and justly so, to some peculiarity in a far-distant ancestor.

It may, perhaps, be justly affirmed, that there is more difficulty in selecting a good mare to breed from than a good horse, because she should possess somewhat opposite qualities. Her carcass should be long, in order to give room for the growth of the fœtus; and yet with this there should be compactness of form and shortness of leg. What can they expect whose practice it is to purchase worn-out, spavined, foundered mares, about whom they fancy there have been some good points, and send them far in the country to breed from, and, with all their variety of shape, to be covered by the same horse? In a lottery like this there may be now and then a prize, but there must be many blanks. If horse-breeders, possessed of good judgment, would pay the same attention to breed and shape as Mr. Bakewell did with his sheep, they would probably attain their wishes in an equal degree, and greatly to their advantage, whether for racing or hunting, for the collar, or the road.

As to the shape of the stallion, little satisfactory can be said. It must depend on that of the mare, and the kind of horse wished to be bred; but if there is one point absolutely essential, it is 'compactness'—as much goodness and strength as possible condensed into a little space.

On the subject of *breeding in and in*, that is, persevering in the same breed, and selecting the best on either side, much has been said. The system of crossing requires more judgment and experience than breeders usually possess. The bad qualities of the cross are too soon engrafted on the original stock, and, once engrafted there, are not, for many generations, eradicated. The good qualities of both are occasionally neutralised to a most mortifying degree. On the other hand, it is the fact, however some may deny it, that strict confinement to one breed, however valuable or perfect, produces gradual deterioration. Crossing should be attempted, but with great caution. The valuable points of the old *breed* should be retained, but varied or improved by the introduction of some new and valuable quality, with reference to beauty, strength, or speed. This is the secret of the turf. The pure south-eastern blood is never left, but the stock is often changed with manifest advantage.

Considerable discussion has recently taken place with regard to the influence of weight and the distance required to be run, upon the breed of our race-horses. It has been said that the present system of placing light weights on animals, and allowing them to run but short distances, has already much diminished the capabilities and endurance of our race-horses. The following, amongst other remarks upon the subject, contained in a letter to the *Times* newspaper, June 29th, 1864, by one so thoroughly acquainted with it as Admiral Rous, will sufficiently indicate our views on the point. He says, 'There can be but one opinion among all persons who are interested in the turf, that the grand object in breeding is to combine good size, great strength, and power of endurance with superior speed. This has never been lost sight of. Our motto is "*Fortes creantur fortibus et bonis.*" We have succeeded in establishing a breed with one-fifth more speed and strength than the original stock—an increased average stature from fourteen hands to fifteen and a half—in thirteen generations, from the first imported stallions, Darley Arabian, Bryerley Turk, without a drop of mixed blood, and we have a firm convic-

tion, with ready proof, that no horses in the world can be compared to them. On the authority of Abd-el-Kader and my Indian friends, the race of Zad-el-Rakeb, the gift of Solomon to the tribe of Azed, has not degenerated since 1720, when the calibre of the English race-horse was probably on a par with the Barbs which now adorn the Gibraltar meeting. Admit this fact, and it is patent to every racing man that the best of these "divine horses" which, according to Eastern history, descended as a heavenly gift from Adam to Ishmael, Ishmael to Solomon, from Solomon to Mahomet, and from Mahomet to our own times, cannot compete with the Anglo-Arabian at a difference of five stone; a thoroughbred butcher's hack will beat the Flower of the Desert any distance under 100 miles. If there is a depreciation, why ascribe it to the abolition of heavy weights, or to the substitution of shorter courses? The natural solution would be that it is owing to the sale of our most valuable stock to every country in Europe, to China, to Australia, New Zealand. But we have enough left to challenge all the world. In 1843, the total amount of stakes, plates, and matches, was 199,000*l.*; in 1863, it was above 250,000*l.*, without including the royal plates. The deterioration of horses is a pure fiction. Stockwell, King Tom, Young Melbourne (Nabob, sold to France), and many other stallions are framed to gallop under twenty stone; the first charges 100*l.*, King Tom 75*l.*, next season for the chance of a foal. You may see in Lord Glasgow's and Baron Rothschild's stables, twenty horses up to eighteen stone; sixty years ago you could not have found five thoroughbred horses of this description in the United Kingdom. Fine yearling colts fetch at auction from 450 to 800 guineas, if they appear likely to stay a distance and to carry heavy weights. That ought to be a sufficient answer to those persons who imagine that light weights and short courses are detrimental to the breed, and encourage "leggy weeds." The following table of the length of the different courses at Newmarket will give some general idea of the distance usually required to be run

## NEWMARKET.

	mi.	fur.	yds.
The Beacon Course . . . . .	4	1	173
Round Course . . . . .	3	4	139
Summer Course (last 2 miles of R. C.) . . . . .	2	0	0
Last three miles of B. C. . . . .	3	0	74
Ditch in (from the running-gap to the end of B. C.) . . . . .	2	0	119
The last mile and a distance of B. C. . . . .	1	0	240
Ancaster Mile (last mile straight) . . . . .	1	0	18
Criterion, Rutland, and Granby Courses (from the turn of the Lands in) . . . . .	0	5	182
Audley End Course (from the starting-post of the T. Y. C. to end of B. C.) . . . . .	1	7	56
Across the Flat . . . . .	1	2	73
Rowley Mile (last mile of A. F.) . . . . .	1	0	17
Ditch Mile (first mile of A. F.) . . . . .	0	7	210
Abingdon Mile (on the Flat) . . . . .	0	7	212
First half of Ab. M. . . . .	0	3	215
Last half of Ab. M. . . . .	0	3	217
Two middle miles of B. C. . . . .	1	7	158
Last mile and a half of T. M. M. . . . .	1	4	29
Two Year Old Course (on the Flat) . . . . .	0	5	140
New Two Year Old Course (on the B. M.) . . . . .	0	5	136
Last half mile of New T. Y. C. . . . .	0	4	0
Yearling Course (on the Flat) . . . . .	0	2	52
Yearling Course (from starting-post of last half Ab. M. to winning-post of D. M.) . . . . .	0	2	138
Bunbury Mile (a straight mile, finishing at the end of R. C.) . . . . .	0	7	196
Chesterfield Course (last half of B. M.) . . . . .	0	3	212
Brethby Stakes Course (last six fur. of R. M.) . . . . .	0	6	0

	mi.	fr.	yds.
Cesarewitch Course (from the starting post of T. M. M. to the end of the Flat)	2	2	58
Cambridgeshire Course (last mile and a distance, straight)	1	0	240
Suffolk Stakes Course (last mile and a half R. C.)	1	4	2
Bedford Stakes Course (last 5 fur. of A. F.)	0	5	0
From Starting-Post of last half of Ab. M. to T. X. C. winning-post	0	1	143½
From Old Betting-Post on Criterion Course to the end of B. C.	0	3	53

From the above it will be seen that great variety of distances is adopted ranging from 1 furlong 143 yards to 4 miles 1 furlong 173 yards, well calculated to test the general speed and endurance of every class of race-horse.

A mare is capable of breeding at two years old, but should not be allowed to do so before three or four years old. Some have injudiciously commenced at two years old, before her form and strength are sufficiently developed, and with the development of which this early breeding will materially interfere. If a mare does little more than farm-work, she may continue to be bred from until she is nearly twenty; but if she has been hardly worked and bears the marks of it, let her have been what she may in her youth, she will deceive the expectation of the breeder in her old age. The mare usually comes into heat in the early part of the spring. She is said to go with foal eleven months, but there is sometimes a strange irregularity about this. Some have been known to foal five weeks earlier, while the time of others has been extended six weeks beyond the eleven months. We may, however, take eleven months as the average time.

From the time of covering, to within a few days of the expected period of foaling, the cart-mare may be kept at moderate labour, not only without injury, but with decided advantage. It will then be prudent to release her from work, and keep her near home, and under the frequent inspection of some careful person.

When nearly half the time of pregnancy has elapsed, the mare should have a little better food. She should be allowed one or two feeds of corn in the day. This is about the period when they are accustomed to slink their foals, or when abortion occurs: the eye of the owner should, therefore, be frequently upon them. Good feeding and moderate exercise will be the best preventives of this mishap. The mare that has once aborted is liable to a repetition of the accident, and therefore should never be suffered to be with other mares between the fourth and fifth months; for such is the power of imagination or of sympathy in the mare, that if one suffers abortion, others in the same pasture will too often share the same fate. Farmers wash, and paint, and tar their stables, to prevent some supposed infection;—the infection lies in the imagination.

The thorough-bred mare—the stock being intended for sporting purposes—should be kept quiet and apart from other horses, after the first four or five months. When the period of parturition is drawing near, she should be watched, and shut up during the night in a safe yard or loose box.

If the mare, whether of the pure or common breed, be thus taken care of and be in good health while in foal, little danger will attend the act of parturition. If there is false presentation of the fœtus, or difficulty in producing it, it will be better to have recourse to a well-informed practitioner, than to injure the mother by the violent and injurious attempts that are often made to relieve her.

The parturition being over, the mare should be turned into some well-sheltered pasture, with a hovel or shed to run into when she pleases; and as, supposing that she has foaled in April, the grass is scanty, she should

have a couple of feeds of corn daily. By the present rules of the jockey-club the age of turf horses is reckoned from the 1st of January, but this has not by any common consent extended to the half-breds.

The 1st of May being nearest the general time of foaling, the age of all but thorough-bred stock is usually dated from that period. The breeder may depend upon it that nothing is gained by starving the mother and stinting the foal at this time. It is the most important period of the life of the horse; and if from false economy his growth is arrested, his puny form and want of endurance will ever after testify the error that has been committed. The corn should be given in a trough on the ground, that the foal may partake of it with the mother. When grass is plentiful, the quantity of corn may be diminished. The mare will usually be found at heat from the eighth to the tenth day after foaling, which is the best time for her to be put to the horse again, and if this period be allowed to pass without her taking the horse, three weeks will generally be found to elapse before she will be again found to be at heat, and every precaution should be adopted by again bringing her to the horse, at the expiration of another three weeks, to ensure her being in foal. If used for agricultural purposes, she may now be again put to work. The foal is at first shut in the stable during the hours of work; but as soon as it acquires sufficient strength to toddle after the mare, and especially when she is at slow work, it will be better for the foal and the dam that they should be together. The work will contribute to the health of the mother; the foal will more frequently draw the milk, and thrive better; and will be hardy and tractable, and gradually familiarised with the objects among which it is afterwards to live. While the mother, however, is thus worked, she and the foal should be well fed; and two feeds of corn, at least, should be added to the green food which they get when turned out after their work, and at night.

In five or six months, according to the growth of the foal, it may be weaned. It should then be housed for three weeks or a month, or turned into some distant rick-yard. There can be no better place for the foal than the latter, as affording, and that without trouble, both food and shelter. The mother should be put to harder work, and have drier meat. One or two urine-balls, or a physic-ball, will be useful if the milk should be troublesome, or she should pine after her foal.

There is no principle of greater importance than the liberal feeding of the foal during the whole of his growth, and at this time in particular. Bruised oats and bran should form a considerable part of his daily provender, and if the advantage of a dairy is available, a liberal supply of new milk will accelerate his development to a most extraordinary extent. The farmer may be assured that the money is well laid out which is expended on the liberal nourishment of the growing colt; yet while he is well fed, he should not be rendered delicate by excess of care.

A racing colt is often stabled; but one that is destined to be a hunter, a hackney, or an agricultural horse, should have a square rick, under the leeward side of which he may shelter himself; or a hovel, into which he may run at night, and out of the rain. Too often, however, the foal after weaning is left to struggle on as he can, and becomes poor and dispirited. He is seen shrinking under a hedge, his head hanging down, cold and almost shivering, and when made to move, listlessly drags his limbs along, evidently weak and generally in pain, a sad specimen of poverty and misery; such treatment generally results either in the death of the animal during the winter or following spring, or lays the foundation for a variety of debilitating diseases which may more or less affect the animal for life. The process of breaking-in should commence from the very period of weaning.

The foal should be daily handled, accustomed to the halter, led about, and even tied up. The tractability, good temper, and value of the horse depend a great deal more upon this than breeders are aware; this should be done as much as possible by the man by whom they are fed, and whose management of them should be always kind and gentle. There is no fault for which a breeder should so invariably discharge his servant as cruelty, or even harshness, towards the rising stock; for the principle on which their after usefulness is founded is attachment to, and confidence in man, and obedience, implicit obedience, resulting principally from these. With the horse used for agricultural purposes, after the second winter, the work of breaking-in may commence in good earnest. He may first be bitted, and a bit carefully selected that will not hurt his mouth, and much smaller than those in common use; with this he may be suffered to amuse himself, and to play, and to champ for an hour, on a few successive days. Having become a little tractable, portions of the harness may be put upon him, and, last of all, the blind winkers; and a few days after he may go into the team. It would be better if there could be one before and one behind him, beside the shaft horse. Let there be first the mere empty waggon. Let nothing be done to him except that he may have an occasional pat or kind word. The other horses will keep him moving and in his place: and no great time will pass, sometimes not even the first day, before he will begin to pull with the rest; then the load may be gradually increased.

The agricultural horse is wanted to ride as well as to draw. Let this first lesson be given when he is in the team. Let his feeder, if possible, be first put upon him: he will be too much hampered by his harness, and by the other horses, to make much resistance; and, in the majority of cases, will quietly and at once submit. We need not repeat that no whip or spur should be used in giving the first lessons in riding. When he begins a little to understand his business, backing, the most difficult part of his work, may be taught him; first, to back well without anything behind him, then with a light cart, and afterwards with some serious load; and taking the greatest care not to hurt his mouth. If the first lesson causes much soreness of the gums, the colt will not readily submit to a second. If he has been rendered tractable before by kind usage, time and patience will do all that can be wished here. Some carters are in the habit of blinding the colt when teaching him to back; it may be necessary with the restive and obstinate one, and should be used only as a last resort. The colt having been thus partially broken-in, the necessity of implicit obedience may be taught him, and that not by severity, but by firmness and steadiness; the voice will go a great way, but the whip or the spur is sometimes indispensable—not so cruelly applied as to excite the animal to resistance, but to convince him that we have the power to enforce submission. Few, we would almost say, no horses, are naturally vicious. It is cruel usage which has first provoked resistance; that resistance has been followed by greater severity, and the stubbornness of the animal has increased; open warfare has ensued, in which the man seldom gained an advantage, and the horse was frequently rendered unserviceable. Correction may or must be used to enforce implicit obedience after the education has proceeded to a certain extent, but the early lessons should be inculcated with kindness alone. Young colts are sometimes very perverse; many days will occasionally pass before they will permit the bridle to be put on, or the saddle to be worn; one act of harshness will double or treble this time. Patience and kindness will, after a while, prevail. On some morning, of better humour than usual, the bridle will be put on, and the saddle will be worn; and this compliance being followed by kindness and soothing on the part of the breaker, and no inconvenience or pain being suffered by the animal, all

resistance will be at an end. The same principles will apply to the breaking-in of the horse for the road or the chase. The handling and some portion of instruction should commence from the time of weaning. The future tractability of the horse will much depend on this. At two years and a half, or three years, the regular process of breaking-in should come on. If it be delayed until the animal is four years old, his strength and obstinacy will be more difficult to overcome. We cannot much improve on the plan usually pursued by the breaker, except that there should be much more kindness and patience, and far less harshness and cruelty, than these persons are accustomed to exhibit, and a great deal more attention to the form and natural action of the horse. A headstall is put on the colt, and a cavesson (or apparatus to confine and pinch the nose) affixed to it, with long reins. He is first accustomed to the rein, then led round a ring on soft ground, and at length mounted and taught his paces. Next to preserving the temper and docility of the horse, there is nothing of so much importance as to teach him every pace, and every part of his duty, distinctly and thoroughly. Each must constitute a separate and sometimes long-continued lesson, and that taught by a man who will never suffer his passion to get the better of his discretion.

After the cavesson has been attached to the headstall, and the long rein put on, the first lesson is, to be quietly led about by the breaker, a steady boy following behind, by occasional threatening with the whip, but never by an actual blow, to keep the colt up. When the animal follows readily and quietly, he may be taken to the ring, and walked round, right and left, in a very small circle. Care should be taken to teach him this pace thoroughly, never suffering him to break into a trot. The boy with his whip may here again be necessary, but not a single blow should actually fall.

Becoming tolerably perfect in the walk, he should be quickened to a trot, and kept steadily at it; the whip of the boy, if needful, urging him on, and the cavesson restraining him. These lessons should be short. The pace should be kept perfect and distinct in each; and docility and improvement rewarded with frequent caresses, and handfuls of corn. The length of the rein may now be gradually increased, and the pace quickened, and the time extended, until the animal becomes tractable in this his first lessons, towards the conclusion of which, crupper-straps, or something similar, may be attached to the clothing. These, playing about the sides and flanks, accustom him to the flapping of the coat of the rider. The annoyance which they occasion will pass over in a day or two; for when the animal finds that no harm comes to him on account of these straps, he will cease to regard them.

Next comes the biting. The bit should be large and smooth, and the reins should be buckled to a ring on either side of the pad. There are many curious and expensive machines for this purpose, but the simple rein will be quite sufficient. The reins should at first be slack, and very gradually tightened. This will prepare for the more perfect manner in which the head will be afterwards got into its proper position, when the colt is accustomed to the saddle. Occasionally the breaker should stand in front of the colt, and take hold of each side rein near to the mouth, and press upon it, and thus begin to teach him to stop and to back at the pressure of the rein, rewarding every act of docility, and not being too eager to punish occasional carelessness or waywardness.

The colt may now be taken into the road or street to be gradually accustomed to the objects among which his services will be required. Here, from fear or playfulness, a considerable degree of starting and shying may be exhibited. As little notice as possible should be taken of it. The same or a similar object should be soon passed again, but at a greater dis-

tance. If the colt still shies, let the distance be farther increased, until he takes no notice of the object ; then he may be gradually brought nearer to it, and this will be usually effected without the slightest difficulty ; whereas, had there been an attempt to force the animal close to it in the first instance, the remembrance of the contest would have been associated with the object, and the habit of shying would have been established.

Hitherto, with a cool and patient breaker, the whip may have been shown, but will scarcely have been used ; the colt must now, however, be accustomed to this necessary instrument of authority. Let the breaker walk by the side of the animal, and throw his right arm over his back, holding the reins in his left ; and occasionally quicken his pace, and, at the moment of doing this, tap the horse with the whip in his right hand, and at first very gently. The tap of the whip and the quickening of the pace will soon become associated together in the mind of the animal. If necessary, the taps may gradually fall a little heavier, and the feeling of pain be the monitor of the necessity of increased exertion. The lessons of reining in and stopping, and backing on the pressure of the bit may continue to be practised at the same time. He may now be taught to bear the saddle. Some little caution will be necessary at the first putting of it on. The breaker should stand at the head of the colt, patting him, and engaging his attention, while one assistant, on the off-side, slowly tightens the girths. If he submits quietly to this, as he generally will when the previous process of breaking-in has been properly conducted, the ceremony of mounting may be attempted on the following or on the third day. The breaker will need two assistants to accomplish this operation. He will remain at the head of the colt, patting and making much of him. The rider will put his foot into the stirrup, and bear a little weight upon it, while the man on the off-side presses equally on the other stirrup-leather, and according to the docility of the animal he will gradually increase the weight, until he balances himself on the stirrup. If the colt be uneasy or fearful, he should be spoken kindly to and patted, or a mouthful of corn be given him ; but if he offers serious resistance, the lessons must terminate for that day ; he may probably be in better humour on the morrow. When the rider has balanced himself for a minute or two, he may gently throw his leg over, and quietly seat himself in the saddle. The breaker will then lead the animal round the ring, the rider sitting perfectly still. After a few minutes he will take the reins, and handle them as gently as possible, and guide the horse by the pressure of them ; patting him frequently, and especially when he thinks of dismounting—and after having dismounted, offering him a little corn or green meat. The use of the rein in checking him, and of the pressure of the leg and the touch of the heel in quickening his pace, will soon be taught, and the education will be nearly completed. The horse having thus far submitted himself to the breaker, these pittings and rewards must be gradually diminished, and implicit obedience mildly but firmly enforced. Severity will not often be necessary : in the great majority of cases it will be altogether uncalled for ; but should the animal, in a moment of waywardness, dispute the command of the breaker, he must at once be taught that he is the slave of man, and that we have the power, by other means than that of kindness, to bend him to our will. The education of the horse is that of the child. Pleasure is as much as possible associated with the early lessons ; but firmness, or if need be coercion, must confirm the habit of obedience. Tyranny and cruelty will, more speedily in the horse than even in the child, provoke the wish to disobey, and on every practicable occasion, the resistance to command. The restive and vicious horse is, in ninety-nine cases out of a hundred, made so by ill-usage, and not by nature. None but those who will take

the trouble to try the experiment, are aware how absolute a command the due admixture of firmness and kindness will soon give us over any horse.

A somewhat new system of breaking-in horses was introduced into this country by Mr. Rarey, of Ohio, in 1858, which at the time attracted considerable attention, and was thought would supersede the old system of horse-breaking. But the complications and other difficulties attendant upon its being fully carried out have prevented its general adoption, and the above system is that now generally employed. The following is a description of Mr. Rarey's method.

Mr. Rarey commences his acquaintance with the colt when at pasture; and by the gentlest means, and almost without gesticulation, he will entice or urge the colt to enter into the precincts of a barn, stable, or outhouse in the immediate neighbourhood. The colt is very quietly surrounded, or an old horse is first led in. When the colt has entered he is left alone with the operator, every one and every thing having life being excluded, so that the attention of the colt may be entirely absorbed in the person of the man who has to train and subdue him. After a short pause, the man advances very slowly, holding out either hand and speaking to the colt with the gentlest tone of voice. Eventually the colt will also approach, smell the hand, when occasion must be taken to stroke the nose, then the front of the face, cheeks, and neck. So soon as the colt remains perfectly passive and content with this treatment, then a leathern halter is very gently passed up and on to his head. Rope halters, from their coarseness, are highly objectionable, and should only be employed upon emergency. When the halter is secured, a plain smooth snaffle bridle with a moderate sized snaffle bit is passed into the mouth and fitted to the head. Should the colt resist the introduction of the snaffle, then the left hand having the iron bit in it is placed immediately behind the lower lip, and the finger and thumb feeling the bars of the mouth within the lips, instantly induces the colt to move the tongue and open the mouth. At that moment the snaffle is inserted within the front teeth, and is drawn well into the mouth by the headstall in the right hand. This must be effected without hurry or in any manner to disturb the feelings of the animal. When the bridle is secured with the reins in the left hand, the person proceeds with his training by handling, with the utmost gentleness, the neck, shoulder, and near fore-leg. This operation may require some time to effect by continued and oft-repeated pattings and coaxings, since the nervousness or perverseness of some leads them to strike with the near hind-foot, and follow with rapidity the hand of the operator. When the colt permits the handling of the leg and fetlock, the front of the shank is taken in the palm of the hand, and the foot raised from the ground. Sometimes a pressure of the back sinew with the finger and thumb will conduce to lift the leg, at others, turning the colt's head and neck well to the left will assist the movement. When the foot has been once stirred, the operation must be repeated until the colt will allow the foot to be bent near to the elbow joint, and to be retained for a time in that position. The gentle feeling of the hand then proceeds along the body near the hind quarter and leg. The hind-leg should be lifted in the quietest manner and raised as high as possible. The tail is then well handled, and the off-side of the colt finishes the process of handling or gentling. Should the colt evince any unevenness of temper, the speedier method of training consists in strapping up both of the fore-legs, and bringing the colt to the ground upon his knees.

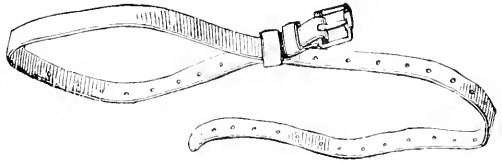
When this process is determined upon, the stable, loose box, or barn should be covered with straw or litter to the depth of a foot; and if the



foundation be of stone or brick, the knees of the colt must be protected by knee-caps.

The strap for the near fore-leg must be about three feet in length, and an inch in breadth. It has a buckle at the end with a metal D or a loop

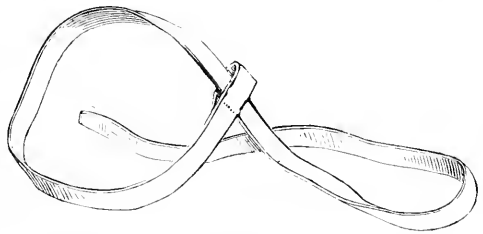
on the inside, about two inches from the buckle. The strap is perforated with holes from the point to the half of its length. The point of the strap is passed between the arms close to the chest, and run



through the D. The strap is then allowed to slide down the near fore-leg and clip the pastern, the operator standing upright, and holding on by the point of the strap. Strain is then made on the pastern to lift the foot, and a movement to the left will effectually do so. When the colt remains quiescent with the foot well up, the point of the strap is carried over the arm or radius through the buckle; and the limb is thus fastened up and bent together. The colt is then incited to move about on three legs, either by bending him round by aid of the bridle to the near or to the off-side, or by reining him backwards—the latter process is objectionable, as in the convulsive spring, he may rear and fall backwards. When the animal is in a great measure reconciled to his crippled state, the handling of the body and hind-legs must be again proceeded with. Except in very vicious dispositions, the confinement of the near fore-leg will be a sufficient means to enable the most nervous operator to carry through the process of handling the colt. Some horses will attempt to kick when upon three legs, and the zebra will kick and bite in any position, even when lying upon his back; but such instances of vice in general are rare. As soon as the colt will permit his body to be handled, let a surcingle or roller be fastened round it.

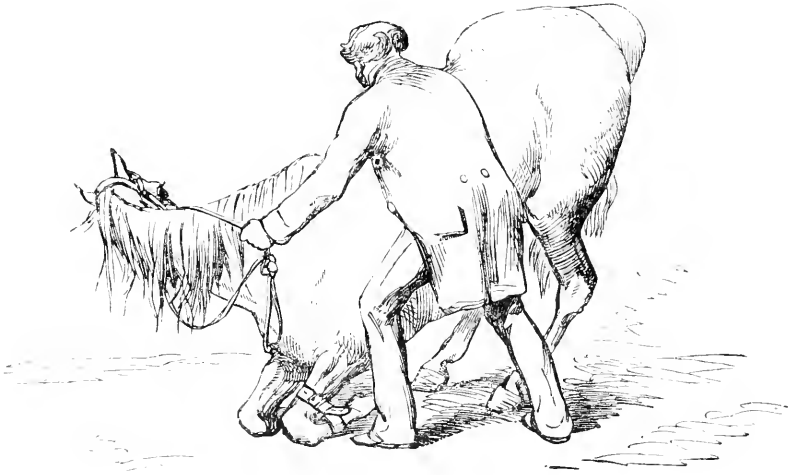
Should the colt not remain quiet with the bending up of the near fore-leg alone, then proceed with strapping up the off fore-leg also. The strap for this purpose must be about six feet in length, an inch or an inch and a

quarter in width, and of the thickness of strong rein or light stirrup leather. It has a loop of three inches, or a metal D at one end. The loop or D is passed round the pastern of the off fore-leg, the point of the strap taken through it, and the strap drawn tight to the

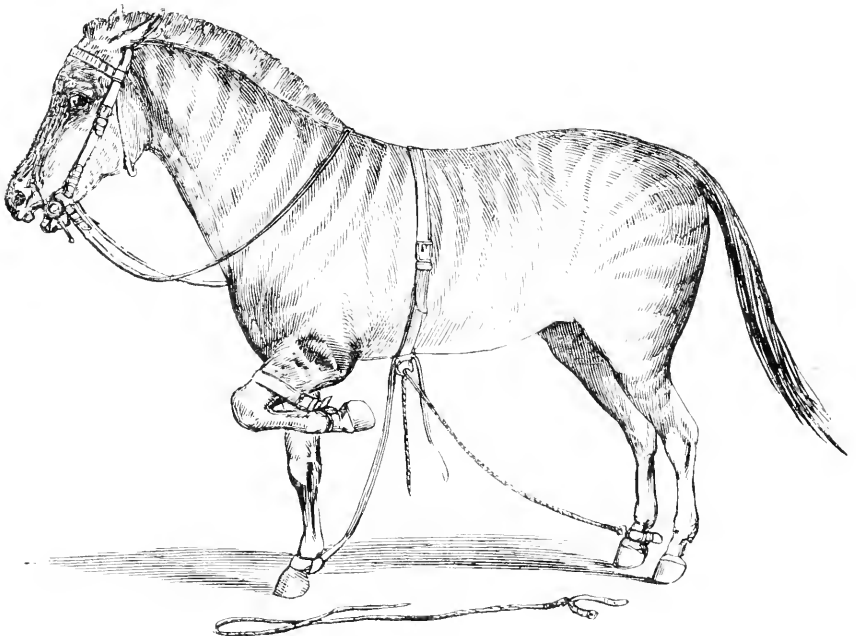


pastern. The point of the strap is then carried within the surcingle or roller and held tightly in the right hand. When the operator is desirous to raise the off fore-leg, he inclines the head of the colt by the aid of the bridle to the right or left hand; and the instant the foot is removed, it is drawn up to the surcingle with force, and retained in that position, if possible. Generally speaking, a succession of violent plunges will succeed the fall, during the whole of which the person must retain his hold upon the leg, and by placing his shoulder to the near forehead of the horse with a strong bearing upon the off rein to bend the head and neck outwards, so that the animal cannot collect with advantage his muscular force, he soon compels the colt to yield up the contest. This part of the process must, on no account, be hurried over or

anticipated. The plunges may continue for five, ten, or fifteen minutes, seldom longer. But the colt must be allowed his own time to lie down

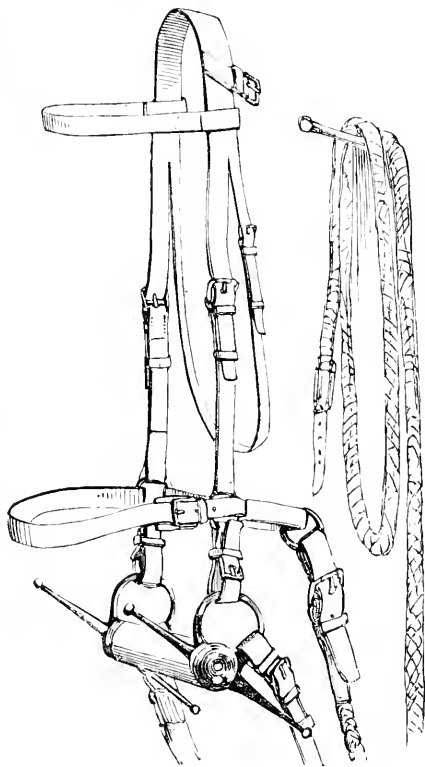


and succumb. Eventually he falls to either side, generally on the near side. When down, extend the head and neck to the full extent hori-



zontally. Handle the head, neck, body, limbs, and tail in succession until the colt remains completely passive under the treatment, taking several opportunities to sit down upon the forehead, the body, and the hind

quarters. At this period, the saddle without girths or stirrups may be temporarily placed upon the body, or the harness may be laid upon the hind quarters. The hobble and strap represented as attached to the hind-leg of the zebra are only used when an animal is a violent, savage, and confirmed kicker, and in subduing horses that will not allow their feet to be touched or shod. When you have to deal with a horse as savage and wicked as 'Cruizer,' or the zebra, a horse that can kick from one leg as fiercely as others can from two: in that case, to subdue and



compel him to lie down, have a leather surcingle with a ring fastened on the belly part, buckle the hobbles on the hind-legs, and pass the ropes through the ring: when the horse is thrown down by the strapping up of the fore-legs, the hind-legs must be drawn close up to the ring in the surcingle.

If the horse has any propensity to indulge in the vice of biting, the head must be drawn up forcibly to the operator, as he sits upon the forehead, and taking the front and back part of the mouth in both hands, the jaws are opened and shut with frequency so that the teeth are made to clash against each other very palpably. But for conquering a vicious, biting horse, there is nothing equal to the large wooden gag-bit which Mr. Rarey first exhibited in public on the zebra. A muzzle only prevents a horse from biting, a gag properly used, cures: for, when he finds he cannot bite, he by degrees abandons this most dangerous vice. Colts inclined to crib-bite, should be dressed with one on. This

will prove to the horse his utter impotency, and may be considered by frequent repetition to be the most perfect specific for a vice otherwise and hitherto deemed to be incurable. When the colt is perfectly quiet, the fore-legs are freed from the straps which are then drawn out to their full extent, and the surcingle removed from the body.

Thus the horse lies in the horizontal position thoroughly subdued, and for the moment may be said to be quite tamed. He has now to be raised by gentle means, and without disturbing the equanimity of his feelings by the use of stick or whip.

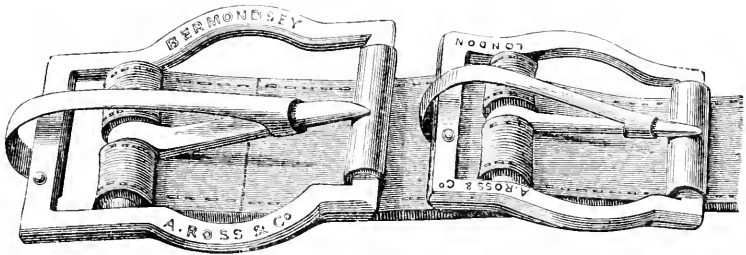
Take hold of the mane with both hands, and raise the head and neck to the upright position. In the course of this movement the colt will double up the fore-legs, and remain in the natural position of lying at ease. The fore-legs are then drawn out straight to the front, as the first natural movement to rise, and by inciting the colt by means of the bridle and the voice, he will instantly rise to his feet. If the saddle has not been removed at the same time with the straps, it must now be girthed, and the stirrups

added also. But should it have been removed, it must now be offered to the attention of the horse, who as soon as he has smelt at and touched it with his nose, will immediately permit it to be quietly put upon his back. The saddle must be placed a full hand's breadth from the shoulder blade, and the girths fastened without tightness or causing disturbance. The trainer then attempts to mount by putting the ball of the left foot in the stirrup, pressing the knee well against the saddle to prevent the point of the toe from irritating the side of the colt; taking hold of the off-side of the pommel with the right hand, or the cantle of the saddle as most convenient, a lock of the mane in the left hand, and springing very gently and effectually into the seat.

If the horse will not remain completely at rest during the above operation, strap up the near fore-leg, and proceed to mount him as he stands upon three legs, or begin the whole process of throwing down, handling, and taming throughout afresh. Every colt should be thrown and tamed two, three, four or five times in succession, and without intermission, according to the nature of its disposition, before the trainer commences upon any system of movements subsequent to the act of mounting, because by such processes the horse will become thoroughly familiarised, and obedient to the sound of the human voice, and tractable to every part of teaching that may follow. Moreover, by repeating the operations consecutively, the mind of the animal will become impressed with the sense of that which will be required from him, and by anticipation and a conviction of the uselessness of resistance, readily yield to the directions of the trainer. Thus every fall will be attended by fewer and lesser struggles, and eventually, or in the course of two or three days' close schooling, the most refractory colt will kneel and lie down at the word of command.

But the operation of throwing down, though exceedingly simple in itself, requires a certain amount of dexterity, fearlessness, and physical energy only possessed by a very limited number of individuals. The exertion necessary to tire the animal will, in warm weather, and in a very confined atmosphere, also exhaust the energies of a strong man. Therefore, in order to render the process more simple and attainable by the most timid practitioner, a self-acting or spring buckle has been invented, which has the power of retaining the off fore-leg in its bent up position without further assistance or interference on the part of the employer. The buckle is attached to the end of the strap, which in this case is an inch and a quarter wide, seven feet six inches long, and perforated with holes throughout. Another spring buckle of smaller size is fixed on the inside of the strap, at three inches' distance from the larger one. The strap is fastened round the pastern of the off fore-leg by drawing the strap round it and through the smaller buckle. The point of the strap is then taken within the surcingle, and drawn through the larger buckle, and the instant the foot is raised from the ground, it is rapidly drawn up to the surcingle, and fixed in position by the power of the spring. The surplus end of the strap is then hitched within the surcingle, and the operator looks quietly on during the struggles of the horse, or leisurely guides his head to the near or off-side, as the fancy may direct. Thus, the whole of the physical power requisite to carry through the operation to a successful issue, will be just so much as will enable the practitioner to pull up the off fore-leg, and to raise the head and neck from the horizontal position when on the ground. If a large metal D be placed upon the surcingle, and the end of the strap be passed within the roller of it, then a stable boy may be enabled to raise the fore-leg with facility, since with one hand an adult can raise to the surcingle without great effort a 56 lb. weight, and the power of the spring buckle will retain it at any given height. The strap is released by draw-

ing it to either side of the interior of the buckle. So soon as the tongue of the buckle is withdrawn from the hole, and presses upon the solid leather, the strap is made to slide away with the utmost ease.



Spring buckles can be readily made by any whitesmith, gunsmith, or even blacksmith, who professes to be an ingenious mechanic. The opening of the frame must be the exact width of the strap; one inch and a quarter. The depth of the buckle from the roller to the cross bar, upon which are fastened the tongue and the strap, about one inch and three quarters, having bent cheeks to admit the points of the finger and thumb, and the distance from the base to the cross bar is entirely optional, say half an inch. The spring must be sprung from the under side of the base, because experience has proved that if it be fastened to the upper side, it cannot be made to resist effectually the violent concussions in the plunging of the horse. The point of the spring must clip with exactness the tongue, and be made to reach within half an inch from its point. The spring itself must be strong, and of the finest temper, otherwise it will be thrown out of gear in a very short time. It is made to screw on to the base, so that it can be readily removed to be repaired or exchanged. The strength of the frame may be about a quarter of an inch, or even less in thickness. The smaller buckle must just admit the strap to be slanted to either side when required to be released.

By these means, we will conclude the operator to be quietly and securely fixed in the saddle. He is now placed upon a timid creature, that has felt neither whip nor spur, and in whose mouth the mucous membrane is as fine in the fibre, and as sensitive to the touch, as is the interior covering of his own organisation. Moreover, he now has attained a moral sway over the animal, hitherto unknown to the horse himself, and perfectly unappreciated by the man also. Therefore the rider must feel his own way with gentleness, and not destroy that fine feeling, which is thus certain to result, by the exhibition of brute force, guided by the spirit of wayward tyranny.

In attempting to urge the colt into motion, the readiest method is to bend the head and neck to either side, and thus induce him to move in a circuitous course. So soon as he does so with facility, the process of moving in any direction will be rendered extremely simple. The walk must be the only pace of exercise for the colt, until his bones, sinews, and constitution are thoroughly accustomed to the weight of the rider, and the periods of time required for exertion. The quiet pressure of the legs, simultaneous with gentle feelings on the mouth, must gradually tend to collect the colt in his walk, and assist to perfect his method of carriage and correct regularity of pace. There are very few of the present race of horse-breakers who practically know the difference between the amble and the true walk, and if bad habits are taught in the first instance, the shuffling gait may continue through life.

Should the colt be required exclusively and immediately for the purposes

of harness, then the different parts of the harness must be quietly presented to its notice and sense of smell, before they are applied to the body of the animal. If it be inclined to be restive, then the near fore-leg must be immediately strapped up, or the colt must be thrown down, tamed, and partially harnessed in the horizontal position. If upon rising, there still continues a disposition to kick, the near fore-leg must be again strapped up, and the colt fastened up in the break upon three legs only. The colt is then moved to the right or left, to induce him to bear well upon the collar, and thus take a circular direction. When he has gone quietly for some distance upon three legs, the near fore-leg may be released from its confinement. In a very inveterate kicker, it will be fully necessary to retain a purchase upon the pastern of the near fore-leg by a strap which shall be made to pass from the pastern through the rings of the harness into the hand of the driver, so that upon the first intimation of restiveness, the leg may be instantly drawn up and retained in position for a considerable time. If the colt be intended for slow and heavy draught, the very best education it can receive will be to be placed as the centre of a team of three, so that it cannot recede or progress without the concurrence of the remaining two.

---

## CHAPTER VI.

### THE GENERAL MANAGEMENT OF THE HORSE.

THIS is a most important part of our subject, and deserving the careful attention of all parties interested in the health and condition of the horse. We will arrange the most important points of general management under the following heads:—

#### AIR.

There cannot be a doubt that the proper ventilation of our stables has very great influence in determining the health and vigour of the animals confined in them. But although attention has of late years been directed to this subject, and considerable improvements carried out in the management of some of our best stables, as a general rule the ventilation of the majority of stables, and especially those in which agricultural horses are confined, will be found very deficient, and in many instances utterly devoid of any special arrangement by which this very important process can be carried on.

Mr. Clarke, of Edinburgh, was the first who advocated the use of well-ventilated stables. After him Professor Coleman established them in the quarters of the cavalry troops, and there cannot be a doubt that he saved the Government many thousand pounds every year. His system of ventilation, however, like many other salutary innovations, was at first strongly resisted. Much evil was predicted; but after a time, diseases that used to dismount whole troops almost entirely disappeared from the army.

It should always be borne in mind that the breathing of pure air is necessary to the existence and the health of man and beast, and in proportion to the purity of the air in which an animal is kept, will be found the greater or less vigour and health with which all the functions of the body will be performed. There are two chief sources from which the impurities of the stable are derived, viz.: the changes produced in the air by the process of respiration, and the gaseous matters which are formed by the decomposition of excrementitious and other matters from the want

of proper drainage or neglect. To make the subject clearly understood, we will briefly describe the composition of the atmosphere and the changes which are brought about in it, by the function of respiration. The air which surrounds us, in its ordinary state, consists of two principal gases named oxygen and nitrogen, in the proportions of about a fifth by bulk of the former to nearly four-fifths of the latter; besides these there are also very small quantities of carbonic acid and some watery vapour. Either oxygen or nitrogen gas, in a separate state, or combined in any other proportions, would prove destructive or otherwise injurious to life, but by a beautiful arrangement, they are blended together in such proportions that the destructive properties of each are neutralised and made one of the chief means by which the life of men and animals is sustained. The function of respiration consists of two distinct parts, viz. inspiration and expiration. At each inspiration made by the animal a considerable quantity of air passes into the lungs, and having penetrated to the remotest parts of the bronchial tubes, enters what are called the air-cells. Around these cells ramify great numbers of very minute blood-vessels called capillaries, containing the blood which has been rendered impure in its passage through the system of the animal. A peculiar change here takes place between the air and the blood. The oxygen of the air combines with the blood, and uniting with the carbon contained in it, and which renders it impure, forms carbonic acid, thus rendering it again fit to pass on and supply the wants of the system, while the carbonic acid and nitrogen (both in their present state destructive poisons) are expelled from the lungs by the process of expiration into the surrounding atmosphere. From the above it will be seen that an abundant supply of pure air is necessary for the maintenance of the health and life of the animal. The effect of several horses being shut up in the same stable is completely to empoison the air; and yet, even in the present day, there are too many who carefully close every aperture by which a breath of fresh air can by possibility gain admission. In effecting this, even the key-hole and the threshold are not forgotten. What, of necessity, must be the consequence of this? The breathing of every animal contaminates the air, and when in the course of the night, with every aperture stopped, it passes again and again through the lungs, the blood cannot undergo its proper and healthy change, digestion will not be so perfectly performed, the brain and nervous system will suffer, and all the functions of life be more or less injured, and one need not feel surprised at finding sore throat, inflamed lungs, diseased eyes, grease, mange, and glanders, at times making their appearance in such stables. One other chief source of impurity to the air in stables, is the presence of certain deleterious gases resulting from the decomposition of the urine and dung of the animal, and also of other vegetable substances, caused either by defective drainage or neglect. The principal gases evolved are the compounds of sulphur and carbon with hydrogen and ammonia, all more or less injurious to health. When a person first enters an ill-managed stable, and especially early in the morning, he is annoyed, not only by the heat of the confined air, but by a pungent smell, resembling hartshorn. It has been ascertained by chemical experiments that the urine of the horse contains in it exceedingly large quantities of compounds easily converted by decomposition into ammonia; and not only so, but that influenced by the heat of a crowded stable, and possibly by other decompositions that are going forward at the same time, this ammoniacal vapour begins to be rapidly given out almost immediately after the urine is voided. When disease begins to appear among the inhabitants of these ill-ventilated places, is it wonderful that it should rapidly spread among them, and that the plague-spot should be, as it were, placed on the door of such a

stable? When influenza appears in spring or in autumn, it is, in very many cases, to be traced to such a pest-house. It is peculiarly fatal there. The horses belonging to a small establishment, and rationally treated, have it comparatively seldom, or have it lightly; but among the inmates of a crowded stable it is sure to display itself, and there it is most fatal. The experience of every veterinary surgeon, and of every large proprietor of horses, will corroborate this statement. Agriculturists should bring to their stables the common sense which directs them in the usual concerns of life, and should begin, when their pleasures and their property are so much at stake, to assume that authority, and to enforce that obedience, to the lack of which is to be attributed the greater part of bad stable-management and horse-disease. Of nothing are we more certain than that the majority of the maladies of the horse, and those of the worst and most fatal character, are directly or indirectly to be attributed to a deficient supply of air, cruel exaction of work, and insufficient or bad fare. Each of these evils is to be dreaded—each is, in a manner, watching for its prey; and when they are combined, more than half of the inmates of the stable are often swept away.

The temperature of the stable is also another important consideration. This should seldom exceed  $70^{\circ}$  in the summer, or fall below  $40^{\circ}$  or  $50^{\circ}$  in the winter. It may be readily ascertained by a thermometer, which no establishment where large numbers of horses are kept should be without. A hot stable has, in the mind of the groom, been long connected with a glossy coat. The latter, it is thought, cannot be obtained without the former.

To this we should reply that, in winter, a thin, glossy coat is not desirable. Nature gives to every animal a warmer clothing when the cold weather approaches. The horse—the agricultural horse especially—acquires a thicker and a lengthened coat, in order to defend him from the surrounding cold. Man puts on an additional and a warmer covering, and his comfort is increased and his health preserved by it. He who knows anything of the farmer's horse, or cares about his enjoyment, will not object to a coat a little longer and a little roughened when the wintry wind blows bleak. The coat, however, needs not to be so long as to be unsightly; and warm clothing, even in a cool stable, will, with plenty of honest grooming, keep the hair sufficiently smooth and glossy to satisfy the most fastidious. The over-heated air of a close stable saves much of this grooming, and therefore the idle attendant unscrupulously sacrifices the health and safety of the horse.

Let this be considered in another point of view. The horse stands twenty or two-and-twenty hours in this unnatural vapour bath, and then he is suddenly stripped of all his clothing, he is led into the open air, and there he is kept a couple of hours or more in a temperature fifteen or twenty degrees below that of the stable. Putting the inhumanity of this out of the question, must not the animal, thus unnaturally and absurdly treated, be subjected to rheumatism, catarrh, and various other complaints?

It is not so generally known as it ought to be, that the return to a hot stable is quite as dangerous as the change from a heated atmosphere to a cold and biting air. Many a horse that has travelled without harm over a bleak country, has been suddenly seized with inflammation and fever when he has, immediately at the end of his journey, been surrounded with heated and foul air. It is the sudden change of temperature, whether from heat to cold, or from cold to heat, that does the mischief, and yearly destroys thousands of horses.

The stable should be large in proportion to the number of horses which it is destined to contain. It usually consists of loose boxes, each to hold



one horse, or divided into stalls in which a number of horses can be kept secured by the head. Boxes are preferable to stalls, inasmuch as they allow considerable space for the animal to move in and exercise himself, and also enable him to lie down and rest after a hard day's work, with less chance of being disturbed. Boxes are also essentially necessary for sick horses, and especially when suffering from any contagious disease. Each box should be about fifteen feet in length by ten in width, with the side walls from nine to twelve feet high, and where space will admit, the opening above should extend to the roof. A stable for six horses divided into stalls should not be less than forty feet in length, and fifteen or sixteen feet wide. If there be no loft above, the inside of the roof should always be plastered, to prevent direct currents of air, and occasional droppings from broken tiles; and the heated and foul air should escape, and cool and pure air be admitted by elevation of the central tiles, or other opening in the roof sufficiently protected to prevent the beating in of the rain; or by gratings placed high up in the walls. These latter apertures should be as far above the horses as they can conveniently be placed, by which means all injurious draught will be prevented.

If there is a loft above the stable, the ceiling should be plastered, in order to prevent the foul air from penetrating to the hay above, and injuring both its taste and its wholesomeness; and no openings should be allowed above the racks, through which the hay may be thrown into them; for they will permit the foul air to ascend to the provender, and also in the act of filling the rack, and while the horse is eagerly gazing upward for his food, a grass seed may fall into the eye, and produce considerable inflammation. At other times, when the careless groom has left open the trap-door, a stream of cold air beats down on the head of the horse.

The stable with a loft over it should never be less than twelve feet high, and proper ventilation should be secured, either by tubes carried through the loft to the roof, or by gratings close to the ceiling. These gratings or openings should be enlarged or contracted by means of a covering or shutter, so that during spring, summer, and autumn the stable may possess nearly the same temperature with the open air, and in winter a temperature of not more than ten or fifteen degrees above that of the external atmosphere.

#### LITTER.

Having spoken of the vapour of ammonia, which is so rapidly and so plentifully given out from the urine of a horse in a heated stable, we next take into consideration the subject of litter. The first caution is frequently to remove it. The early evolution of gas shows the rapid putrefaction of the urine; and the consequence of which will be the rapid putrefaction of the litter that has been moistened by it. Everything hastening to decomposition should be carefully removed where life and health are to be preserved. The litter that has been much wetted or at all softened by the urine, and is beginning to decay, should be swept away every morning; the greater part of the remainder may then be piled under the manger, a little being left on the hard pavement during the day. The soiled and macerated portion of that which was left should be removed at night. In the better kind of stables, however, the stall should be completely emptied every morning.

No heap of fermenting dung should be suffered to remain during the day in the corner or in any part of the stable. With regard to this the directions of the master should be peremptory.

The stable should be so contrived that the urine shall quickly run off, and the offensive and injurious vapour from the decomposing fluid and the

litter will thus be materially lessened: if, however, the urine is carried away by means of a gutter running along the stable, the floor of the stalls must slant towards that gutter, and the declivity must not be so great as to strain the back sinews, and become an occasional, although unsuspected, cause of lameness. Mr. R. Lawrence well observes, that, 'if the reader will stand for a few minutes with his toes higher than his heels, the pain he will feel in the calves of his legs will soon convince him of the truth of this remark. Hence, when a horse is not eating, he always endeavours to find his level, either by standing across the stall or else as far back as his halter will permit, so that his hind-legs may meet the ascent of the other side of the channel.'

This inclination of the stall is also at times the cause of contraction of the heels of the foot, by throwing too great a proportion of the weight upon the toe, and removing that pressure on the heels which tends most to keep them open. Care, therefore, must be taken that the slanting of the floor of the stalls shall be no more than is sufficient to drain off the urine with tolerable rapidity. Stalls of this kind certainly do best for mares; but for horses we much prefer those with a grating in the centre, and a slight inclination of the floor on every side towards the middle. A short branch may communicate with a larger drain, by means of which the urine may be carried off to a reservoir outside the stable. Traps are now contrived, and may be procured at little expense, by means of which neither any offensive smell nor current of air can pass through the grating.

The farmer should not lose any of the urine. It is from the dung of the horse that he derives a principal and the most valuable part of his manure. It is that which earliest takes on the process of putrefaction, and forms one of the strongest and most durable dressings. That which is most of all concerned with the rapidity and the perfection of the decomposition is the urine.

Humanity and interest, as well as the appearance of the stable, should induce the proprietor of the horse to place a moderate quantity of litter under him during the day. The farmer who wants to convert every otherwise useless substance into manure, will have additional reason for adopting this practice: especially as he does not confine himself to that to which in towns and in gentlemen's stables custom seems to have limited the bed of the horse, viz. wheat and oat straw, and sometimes, during the summer months, tan or sawdust. Pea and bean haulm, and heath, occupy in the stable of the farmer, during a part of the year, the place of wheaten and oaten straw. It should, however, be remembered that these substances are disposed more easily to ferment and putrefy than straw, and therefore should be more carefully examined and oftener removed. It is the faulty custom of some farmers to let the bed accumulate until it reaches almost to the horse's belly, and the bottom of it is a mass of dung. If there were not often many a hole and cranny through which the wind can enter and disperse the foul air, the health of the animal would materially suffer.

#### LIGHT.

This neglected branch of stable management is of far more consequence than is generally imagined; and it is particularly neglected by those for whom these treatises are principally designed. The farmer's stable is frequently destitute of any glazed window, and has only a shutter, which is raised in warm weather, and closed when the weather becomes cold. When the horse is in the stable only during a few hours in the day, this is not of so much consequence, nor of so much, probably, with regard to horses of slow work; but to carriage horses and hackneys, so far, at least,

as the eyes are concerned, a dark stable is little less injurious than a foul and heated one. Comfort, cleanliness, and health, are all connected with this question; and why stables are not as well lighted as any of the rooms in dwelling-houses, it is not easy to say—the idea of too much light being in any way injurious is ridiculous; horses, as well as men, in a state of nature, live in clear open daylight; and there is no reason why, in a state of domesticity, one should not do so as well as the other. A great proportion of stables are dark, foul, and unhealthy; the two latter states often depending, to a considerable extent, on the former; for, was sufficient light admitted, the causes of the latter would be more evident and their accumulation would be prevented; but, as it is, both in town and the country, darkness covers a multitude of sins, even, in many respects, in otherwise well-ordered establishments. In order to illustrate this, reference may be made to the unpleasant feeling, and the utter impossibility of seeing distinctly, when a man suddenly emerges from a dark place into the full blaze of day. The sensation of mingled pain and giddiness is not soon forgotten; and some minutes pass before the eye can accommodate itself to the increased light. If this were to happen every day, or several times in the day, the sight would be irreparably injured, or possibly blindness would ensue. Can we wonder, then, that the horse, taken from a dark stable into a glare of light, feeling, probably, as we should do under similar circumstances, and unable for a considerable time to see anything around him distinctly, should become a starter, or that the frequently repeated violent effect of sudden light should induce inflammation of the eye so intense as to terminate in blindness? There is, indeed, no doubt that horses kept in dark stables are frequently notorious starters, and that abominable habit has been properly traced to this cause.

Farmers know, and should profit by the knowledge, that the darkness of the stable is not unfrequently a cover for great uncleanness. A glazed window, with leaden divisions between the small panes, would not cost much, and would admit a degree of light somewhat more approaching to that of day, and at the same time would render the concealment of gross inattention and want of cleanliness impossible.

If plenty of light is admitted, the walls of the stable, and especially that portion of them which is before the horse's head, must not be of too glaring a colour. The constant reflection from a white wall, and especially if the sun shines into the stable, will be as injurious to the eye as the sudden changes from darkness to light. The perpetual slight excess of stimulus will do as much mischief as the occasional but more violent one when the animal is taken from a kind of twilight to the blaze of day. The colour of the stable, therefore, should depend on the quantity of light. Where much can be admitted, the walls should be of a grey hue. Where darkness would otherwise prevail, frequent whitewashing may in some degree dissipate the gloom.

For another reason, it will be evident that the stable should not possess too glaring a light: it is the resting-place of the horse. In the quietness of a dimly-lighted stable he obtains repose, and accumulates flesh and fat. Dealers are perfectly aware of this. They have their darkened stables, in which the young horse, with little or no exercise, and fed upon mashes and ground corn, is made up for sale. The round and plump appearance, however, which may delude the unwary, soon vanishes with altered treatment, and the animal is found to be unfit for hard work, and predisposed to many an inflammatory disease. The circumstances, then, under which a stable somewhat darkened may be allowed, will be easily determined by the owner of the horse; but, as a general rule, dark stables are unfriendly

to cleanliness, and the frequent cause of the vice of starting, and of the most serious diseases of the eye.

#### GROOMING.

Of this much need not be said to the agriculturist, since custom, and apparently without ill effect, has allotted so little of the comb and brush to the farmer's horse. The animal that is worked all day, and turned out at night, requires little more to be done to him than to have the dirt brushed off his limbs. Regular grooming, by rendering his skin more sensible to the alteration of temperature, and the inclemency of the weather, would be prejudicial. The horse that is altogether turned out needs no grooming. The dandriff or scurf which accumulates at the roots of the hair, is a provision of nature to defend him from the wind and the cold.

It is to the stabled horse, highly fed, and little or irregularly worked, that grooming is of so much consequence. Good rubbing with the brush or the currycomb opens the pores of the skin, circulates the blood to the extremities of the body, produces free and healthy perspiration, and stands in the room of exercise. No horse will carry a fine coat without either unnatural heat or dressing. They both effect the same purpose; they both increase the insensible perspiration: but the first does it at the expense of health and strength, while the second, at the same time that it produces a glow on the skin, and a determination of blood to it, rouses all the energies of the frame. It would be well for the proprietor of the horse if he were to insist—and to see that his orders are really obeyed—that the fine coat in which he and his groom so much delight, is produced by honest rubbing, and not by a heated stable and thick clothing, and most of all, not by stimulating or injurious spices. The horse should be regularly dressed every day, in addition to the grooming that is necessary after work.

There is no necessity, however, for half the punishment which many a groom inflicts upon the horse in the act of dressing; and particularly on one whose skin is thin and sensitive. The curry-comb should at all times be lightly applied. With many horses its use may be almost dispensed with; and even the brush needs not to be so hard, nor the points of the bristles so irregular as they often are. A soft brush, with a little more weight of the hand, will be equally effectual, and a great deal more pleasant to the horse. A hair-cloth, while it will seldom irritate and tease, will be almost sufficient with horses that have a thin skin, and that have not been neglected; the hay whisp and the linen rubber are the means by which the coat is kept in the most perfect order, and they cannot too generally be had recourse to, for their effect on the skin is most soothing, and to no part of his dressing does the horse, particularly the well-bred one, so willingly submit himself as to this. After all, it is no slight task to dress a horse as it ought to be done. It occupies no little time, and demands considerable patience, as well as dexterity. It will be readily ascertained whether a horse has been well dressed by rubbing him with one of the fingers. A greasy stain will detect the idleness of the groom. When, however, the horse is changing his coat, both the curry-comb and the brush should be used as lightly as possible.

Whoever would be convinced of the benefit of friction to the horse's skin, and to the horse generally, needs only to observe the effects produced by well hand-rubbing the legs of a tired horse. While every enlargement subsides, and the painful stiffness disappears, and the legs attain their natural warmth, and become fine, the animal is evidently and rapidly reviving; he attacks his food with appetite, and then quietly lies down to rest.

## EXERCISE.

Our observations on this important branch of stable-management must have only a slight reference to the agricultural horse. His work is usually regular and not exhausting. He is neither predisposed to disease by idleness, nor worn out by excessive exertion. He, like his master, has enough to do to keep him in health, and not enough to distress or injure him: on the contrary, the regularity of his work prolongs life to an extent rarely witnessed in the stable of the gentleman. Our remarks on exercise, then, must have a general bearing, or have principal reference to those persons who are in the middle stations of life, and who contrive to keep a horse for business or pleasure, but cannot afford to maintain a servant for the express purpose of looking after it. The first rule we would lay down is, that every horse should have daily exercise. The animal that, with the usual stable feeding, stands idle for three or four days, as is the case in many establishments, must suffer. He is predisposed to fever, or to grease, or, most of all, to diseases of the foot; and if, after three or four days of inactivity, he is ridden far and fast, he is liable to have inflammation of the lungs or of the feet.

A gentleman or tradesman's horse suffers a great deal more from idleness than he does from work. A stable-fed horse should have two hours' exercise every day, if he is to be kept free from disease. Nothing of extraordinary or even of ordinary labour can be effected on the road or in the field without sufficient and regular exercise. It is this alone which can give energy to the system, or develop the powers of any animal.

How then is this exercise to be given? As much as possible by, or under the superintendence of, the owner. The exercise given by the groom is rarely to be depended upon. It is inefficient or it is extreme. It is in many cases both irregular and injurious. It is dependent upon the caprice of him who is performing a task, and who will render that task subservient to his own pleasure or purpose.

In training the hunter and the race-horse, regular exercise is the most important of all considerations, however it may be forgotten in the usual management of the stable. The exercised horse will discharge his task, and sometimes a severe one, with ease and pleasure; while the idle and neglected one will be fatigued ere half his labour is accomplished, and, if he is pushed a little too far, dangerous inflammation will ensue. How often, nevertheless, does it happen, that the horse which has stood inactive in the stable three or four days, is ridden or driven thirty or forty miles in the course of a single day! This rest is often purposely given to prepare for extra-exertion:—to lay in a stock of strength for the performance of the task required of him: and then the owner is surprised, and dissatisfied if the animal is fairly knocked up, or possibly becomes seriously ill. Nothing is so common and so preposterous, as for a person to buy a horse from a dealer's stable, where he has been idly fattening for sale for many a day, and immediately to give him a long run after the hounds, and then to complain bitterly, and think that he has been imposed upon, if the animal is exhausted before the end of the chase, or is compelled to be led home suffering from violent inflammation. Regular and gradually increasing exercise would have made the same horse appear a treasure to his owner.

Exercise should be somewhat proportioned to the age of the horse. A young horse requires more than an old one. Nature has given to young animals of every kind a disposition to activity; but the exercise must not be violent. A great deal depends upon the manner in which it is given. To preserve the temper, and to promote health, it should be moderate, at

least at the beginning and the termination. The rapid trot, or even the gallop, may be resorted to in the middle of the exercise, but the horse should be brought in cool. If the owner would seldom intrust his horse to boys, and would insist on the exercise being taken within sight, or in the neighbourhood of his residence, many an accident and irreparable injury would be avoided. It should be the owner's pleasure, and it is his interest, personally to attend to all these things. He manages every other part of his concerns, and he may depend on it that he suffers when he neglects, or is in a manner excluded from, his stables.

#### FOOD.

The system of manger-feeding is becoming general among farmers. There are few horses that do not habitually waste a portion of their hay; and by some the greater part is pulled down and trampled under foot, in order first to call the sweetest and best locks, and which could not be done while the hay was inclosed in the rack. A good feeder will afterwards pick up much of that which was thrown down; but some of it must be soiled and rendered disgusting, and, in many cases, one-third of this division of their food is wasted. Some of the oats and beans are imperfectly chewed by all horses, and scarcely at all by hungry and greedy ones. The appearance of the dung will sufficiently evince this.

The observation of this induced the adoption of manger-feeding, or of mixing a portion of chaff with the corn. By this means the animal is compelled to chew his food; he cannot, to any great degree, waste the straw or hay; the chaff is too hard and too sharp to be swallowed without considerable mastication, and, while he is forced to grind that down, the oats and beans are ground with it, and yield more nourishment; the stomach is more slowly filled, and therefore acts better on its contents, and is not so likely to be overloaded; and the increased quantity of saliva thrown out in the lengthened mastication of the food, softens it, and makes it more fit for digestion.

As Professor Stewart very properly remarks, 'Many horses swallow their corn in great haste, and when much is eaten, that habit is exceedingly dangerous. The stomach is filled—it is overloaded before it has time to make preparation for acting on its contents—the food ferments, and painful or dangerous colic ensues. By adding chaff to his corn, the horse must take more time to eat it, and time is given for the commencement of digestion, before fermentation can occur. In this way chaff is very useful, especially after long fasts.'

If, when considerable provender was wasted, the horse maintained his condition, and was able to do his work, it was evident that much might be saved to the farmer, when he adopted a system by which the horse ate all that was set before him; and by degrees it was found out, that even food somewhat less nutritious, but a great deal cheaper, and which the horse either would not eat, or would not properly grind down in its natural state, might be added, while the animal would be in quite as good plight, and always ready for work.

Chaff may be composed of equal quantities of clover or meadow hay, and wheaten, oat, or barley straw, cut into pieces of a quarter or half an inch in length, and mingled well together; the allowance of oats or beans is afterwards added, and mixed with the chaff. Many farmers very properly bruise the oats or beans. The whole oat is apt to slip out of the chaff and be lost; but when it is bruised, and especially if the chaff is a little wetted, it will not readily separate; or, should a portion of it escape the grinders, it will be partly prepared for digestion by the act of bruising. The prejudice against bruising the oats is, so far as the farmer's horse,

and the waggon horse, and every horse of slow draught, are concerned, altogether unfounded. The quantity of straw in the chaff will always counteract any supposed purgative quality in the bruised oats. Horses of quicker draught, except they are naturally disposed to scour, will thrive better with bruised than with whole oats; for a greater quantity of nutriment will be extracted from the food, and it will always be easy to apportion the quantity of straw or beans to the effect of the mixture on the bowels of the horse. The principal alteration that should be made in the horse of harder and more rapid work, such as the post-horse, is to increase the quantity of hay, and diminish that of straw. Two trusses of hay may be cut with one of straw.

Some gentlemen, in defiance of the prejudice and opposition of the coachman or the groom, have introduced this mode of feeding into the stables of their carriage horses and hackneys, and with manifest advantage. There has been no loss of condition or power, and considerable saving of provender. This system is not, however, calculated for the hunter or the race-horse. Their food must lie in smaller bulk, in order that the action of the lungs may not be impeded by the distension of the stomach; yet many hunters have gone well over the field who have been manger-fed, the proportion of corn, however, being materially increased.

For the agricultural and cart horse, eight pounds of oats and two of beans should be added to every twenty pounds of chaff. Thirty-four or thirty-six pounds of the mixture will be sufficient for any moderate-sized horse, with fair, or even hard work. The dray and waggon horse may require forty pounds. Hay in the rack at night is, in this case, supposed to be omitted altogether. The rack, however, may remain, as occasionally useful for the sick horse, or to contain tares or other green meat.

Horses are very fond of this provender. The majority of them, after having been accustomed to it, will leave the best oats given to them alone, for the sake of the mingled chaff and corn. We would, however, caution the farmer not to set apart damaged hay for the manufacture of the chaff. The horse may be thus induced to eat that which he would otherwise refuse; but if the nourishing property of the hay has been impaired, or it has acquired an injurious principle, the animal will either lose condition, or become diseased. Much more injury is done by eating damaged hay or musty oats than is generally imagined. There will be sufficient saving in the diminished cost of the provender by the introduction of the straw, and the improved condition of the horse, without poisoning him with the refuse of the farm. For old horses, and for those with defective teeth, chaff is peculiarly useful, and for them the grain should be broken down as well as the fodder.

While the mixture of chaff with the corn prevents it from being too rapidly devoured and a portion of it swallowed whole, and therefore the stomach is not too loaded with that on which, as containing the most nutriment, its chief digestive power should be exerted, yet, on the whole, a great deal of time is gained by this mode of feeding, and more is left for rest. When a horse comes in wearied at the close of the day, it occupies, after he has eaten his corn, two or three hours to clear his rack. On the system of manger-feeding, the chaff being already cut into small pieces, and the beans and oats bruised, he is able fully to satisfy his appetite in an hour and a half. Two additional hours are therefore devoted to rest. This is a circumstance deserving of much consideration even in the farmer's stable, and of immense consequence to the postmaster, and the owner of every hard-worked horse.

Manger food will be the usual support of the farmer's horse during the winter, and while at constant or occasional hard work; but from the

middle of April to the end of July, he may be fed with this mixture in the day and turned out at night, or he may remain out during every rest-day. A team in constant employ should not, however, be suffered to be out at night after the end of August.

The farmer should take care that the pasture is thick and good; and that the distance from the yard is not too great, or the fields too large, otherwise a very considerable portion of time will be occupied in catching the horses in the morning. He will likewise have to take into consideration the sale he would have for his hay, and the necessity for sweet and untrodden pasture for his cattle. On the whole, however, turning out in this way, when circumstances will admit of it, will be found to be more beneficial for the horse, and cheaper than soiling in the yard.

The horse of the inferior farmer is sometimes fed on hay or grass alone, and the animal, although he rarely gets a feed of corn, maintains himself in tolerable condition, and does the work that is required of him: but hay and grass alone, however good in quality, or in whatever quantity allowed, will not support a horse under hard work. Other substances containing a larger proportion of nutriment in a smaller compass, have been added. They shall be briefly enumerated, and an estimate formed of their comparative value.

In almost every part of Great Britain, OATS have been selected as that portion of the food which is to afford the principal nourishment. They contain seven hundred and forty-three parts out of a thousand of nutritive matter. They should be about or somewhat less than a year old, heavy, dry, and sweet, plump, bright in colour, and free from unpleasant taste or smell. New oats will weigh ten or fifteen per cent. more than old ones; but the difference consists principally in watery matter, which is gradually evaporated. New oats are not so readily ground down by the teeth as old ones. They form a more glutinous mass, difficult to digest, and, when eaten in considerable quantities, are apt to occasion colic and even staggers. If they are to be used before they are from three to five months old, they would be materially improved by a little kiln-drying. There is no fear for the horses from simple drying, if the corn was good when it was put in the kiln. The old oat forms, when chewed, a smooth and uniform mass, which readily dissolves in the stomach, and yields the nourishment which it contains. Perhaps some chemical change may have been slowly effected in the old oat, disposing it to be more readily assimilated. The musty smell of wetted or damaged corn is produced by fungus which grows upon the seed, and the deep red (foxy) colour which some oats possess, is produced by excessive fermentation in the rick, and in both these conditions they will have an injurious effect on the urinary organs, and often on the intestines, producing profuse staling, inflammation of the kidneys, colic, and inflammation of the bowels.

This musty smell is removed by kiln-drying the oat; but care is here requisite that too great a degree of heat is not employed. It should be sufficient to destroy the fungus without injuring the life of the seed. Many persons, but without just cause, have considerable fear of the kiln-burnt oat. It is said to produce inflammation of the bladder, and of the eyes, and many affections of the skin. The fact is, that many of the kiln-dried oats that are given to horses were damaged before they were dried, and thus became unhealthy. A considerable improvement would be effected, by cutting the unthreshed oat-straw into chaff, and the expense of threshing would be saved. Oat-straw is better than that of barley, but does not contain so much nutriment as that of wheat.

When the horse is fed on hay and oats, the quantity of the oats must vary with his size and the work to be performed. In winter, four feeds, or from



ten to fourteen pounds of oats in the day, will be a fair allowance for a horse of fifteen hands one or two inches high, and that has moderate work. In summer, half the quantity, with green food, will be sufficient. Those who work on the farm have from ten to fourteen pounds, and the hunter from twelve to sixteen. There are no efficient and safe substitutes for good oats; but, on the contrary, we are much inclined to believe that they possess an invigorating property which is not found in other food.

Oatmeal, in the form of gruel, constitutes one of the most important articles of diet for the sick horse — not, indeed, forced upon him, but a pail containing it being slung in his box, and of which he will soon begin to drink when water is denied. Few grooms make good gruel; it is either not boiled long enough, or a sufficient quantity of oatmeal has not been used. The proportions should be, a pound of meal thrown into a gallon of water, and kept constantly stirred until it boils, and five minutes afterwards.

White-water, made by stirring a pint of oatmeal in a pail of water, the chill being taken from it, is an excellent beverage for the thirsty and tired horse.

BARLEY is a common food of the horse on various parts of the Continent, and, until the introduction of the oat, seems to have constituted almost his only food. It is more nutritious than oats, containing nine hundred and twenty parts of nutritive matter in every thousand. There seems, however, to be something necessary besides a great proportion of nutritive matter, in order to render any substance wholesome, strengthening, or fattening; therefore it is that, in many horses that are hardly worked, and, indeed, in horses generally, barley does not agree with them so well as oats. They are occasionally subject to inflammatory complaints, and particularly to surfeit and mange.

When barley is given, the quantity should not exceed a peck daily. It should always be bruised, and the chaff should consist of equal quantities of hay and barley-straw, and not cut too short. If the farmer has a quantity of spotted or unsaleable barley that he wishes thus to get rid of, he must very gradually accustom his horses to it, or he will probably produce serious illness among them. For horses that are recovering from illness, barley, in the form of malt, is often serviceable, as tempting the appetite and recruiting the strength. It is best given in mashes—water, considerably below the boiling heat, being poured upon it, and the vessel or pail kept covered for half an hour.

Grains fresh from the mash-tub, either alone, or mixed with oats or chaff, or both, may be occasionally given to horses of slow draught; they would, however, afford very insufficient nourishment for horses of quicker or harder work.

WHEAT is, in Great Britain, more rarely given than barley. It contains nine hundred and fifty-five parts of nutritive matter. When farmers have a damaged or unmarketable sample of wheat, they sometimes give it to their horses, and, being at first used in small quantities, they become accustomed to it, and thrive and work well; it must, however, always be bruised and given in chaff. Wheat contains a greater portion of *gluten*, or sticky adhesive matter, than any other kind of grain. It is difficult of digestion, and apt to cake and form obstructions in the bowels. This will often be the case if the horse is suffered to drink much water soon after feeding upon wheat.

Inflammation of the bowels and feet, colic, and death, are occasionally the consequence of eating any great quantity of wheat. A horse that is fed on wheat should have very little hay. The proportion should not be more than one truss of hay to two of straw. Wheaten flour, boiled in

water to the thickness of starch, is given with good effect in over-purging, and especially if combined with chalk and opium.

BRAN, or the ground husk of the wheat, used to be frequently given to sick horses on account of the supposed advantage derived from its relaxing the bowels. There is no doubt that it does operate gently on the intestinal canal, and assists in quickening the passage of its contents, when it is occasionally given; but it must not be a constant, or even frequent food. Mr. Ernes attended three mills at which many horses were kept, and there were always two or three cases of indigestion from the accumulation of bran or pollard in the large intestines. Bran may, however, be useful as an occasional aperient in the form of a mash, but never should become a regular article of food.

BEANS.—These form a striking illustration of the principle, that the nourishing or strengthening effects of the different articles of food depend more on some peculiar property which they possess, or some combination which they form, than on the actual quantity of nutritive matter. Beans contain but five hundred and seventy parts of nutritive matter, yet they add materially to the vigour of the horse. There are many horses that will not stand hard work without beans being mingled with their food, and these not horses whose tendency to purge it may be necessary to restrain by the astringency of the bean. There is no traveller who is not aware of the difference in the spirit and continuance of his horse whether he allows or denies him beans on his journey. They afford not merely a temporary stimulus, but they may be daily used without losing their power, or producing exhaustion. They are indispensable to the hard-worked coach horse. Washy horses could never get through their work without them; and old horses would often sink under the task imposed upon them. They should not be given to the horses whole or split, but crushed. This will make a material difference in the quantity of nutriment that will be extracted. They are sometimes given to turf horses, but only as an occasional stimulant. Two pounds of beans may, with advantage, be mixed with the chaff of the agricultural horse, during the winter. In summer the quantity of beans should be lessened, or they should be altogether discontinued. Beans are generally given whole. This is very absurd; for the young horse, whose teeth are strong, seldom requires them; while the old horse, to whom they are in a manner necessary, is scarcely able to masticate them, swallows many of them whole which he is unable to break, and drops much corn from his mouth in the ineffectual attempt to crush them. Beans should not be merely split, but crushed; they will even then give sufficient employment to the grinders of the animal. Some post-masters use chaff with beans instead of oats. With hardly-worked horses they may possibly be allowed; but, in general cases, beans, without oats, would be too binding and stimulating, and would produce costiveness, and probably megrims or staggers.

Beans should be at least a twelvemonth old before they are given to the horse, and should be plump, and carefully preserved from damp and mouldiness, which at least disgust the horse if they do no other harm, and harbour an insect that destroys the inner part of the bean.

The straw of the bean is nutritive and wholesome, and is usually given to the horses. Its nutritive properties are supposed to be little inferior to those of oats.

PEAS are occasionally given. They appear to be in a slight degree more nourishing than beans, and not so heating. They contain five hundred and seventy-four parts of nutritive matter. For horses of slow work they may be used; but the quantity of chaff should be increased, and a few oats added. They have not been found to answer with horses of quick

draught. It is essential that they should be crushed; otherwise, on account of their globular form, they are apt to escape from the teeth, and many are swallowed whole. Exposed to warmth and moisture in the stomach, they swell considerably, and may painfully and injuriously distend it. The peas that are given to horses should be sound, and at least a twelvemonth old.

In some northern countries pea-meal is frequently used, not only as an excellent food for the horse, but as a remedy for diabetes.

LINSEED is sometimes given to sick horses—raw, ground, and boiled. It is supposed to be useful in cases of catarrh. Mr. Black, veterinary surgeon of the 14th Dragoons, says, that sugar was tried as an article of food during the Peninsular War. Ten horses were selected, each of which got 8 lbs. a day at four rations. They took it very readily, and their coats became fine, smooth, and glossy. They got no corn, and only 7 lbs. of hay, instead of the ordinary allowance, which is 12 lbs. The sugar seemed to supply the place of the corn so well, that it would have been probably given abroad; but peace came, and the circumstances that rendered the use of sugar for corn desirable ceased, and the horses returned to their usual diet. That the sugar might not be appropriated to other purposes it was slightly scented with assafœtida, which did not produce any apparent effect upon them.

Herbage, green and dry, constitutes a principal part of the food of the horse. There are few things with regard to which the farmer is so careless as the mixture of grasses on both his upland and meadow pasture. Hence we find, in the same field, the ray-grass, coming to perfection only in a loamy soil, not fit to cut until the middle or latter part of July, and yielding little aftermath; the meadow fox-tail, best cultivated in a clayey soil, fit for the scythe in the beginning of June, and yielding a plentiful aftermath; the glaucous fescue-grass, ready at the middle of June, and rapidly deteriorating in value as its seeds ripen; and the fertile meadow-grass, increasing in value until the end of July. These are circumstances the importance of which will, at no distant period, be recognised. In the meantime, Sinclair's account of the different grasses, or the condensation of the most important part of his work in Sir Humphry Davy's *Agricultural Chemistry*, or Low's *Elements of Practical Agriculture*, are well deserving of the diligent perusal of the farmer.

Hay is most in perfection when it is about a twelvemonth old. The horse perhaps would prefer it earlier, but it is neither so wholesome nor so nutritive, and often has a purgative quality. When it is about a year old, it retains, or should retain, somewhat of its green colour, its agreeable smell, and its pleasant taste. It has undergone the slow process of fermentation, by which the sugar which it contains is developed, and its nutritive quality is fully exercised. Old hay becomes dry and tasteless, and innutritive and unwholesome. After the grass is cut, and the hay stacked, a slight degree of fermentation takes place in it. This is necessary for the development of the saccharine principle; but occasionally it proceeds too far and the hay becomes *mourburut*, in which state it is injurious, or even poisonous. The horse soon shows the effect which it has upon him. He has diabetes to a considerable degree—he becomes hidebound—his strength is wasted—his thirst is excessive, and he is almost worthless.

Where the system of manger-feeding is not adopted, or where hay is still allowed at night, and chaff and corn in the day, there is no error into which the farmer is so apt to fall as to give an undue quantity of hay, and that generally of the worst kind. If the manger-system is good, there can be no necessity for hay, or only for a small quantity of it; but if the rack is overloaded, the greedy horse will be eating all night, instead of taking

his rest—when the time for the morning feed arrives, his stomach will be already filled, and he will be less capable of work from the want of sleep, and from the long-continued distension of the stomach rendering it impossible for the food to be properly digested.

Of the value of TARES, as forming a portion of the late spring and summer food of the stabled and agricultural horse, there can be no doubt. They are cut after the pods are formed, but a considerable time before the seeds are ripe. They supply a larger quantity of food for a limited time than almost any other forage-crop. The *Vicia sativa* is the most profitable variety of the tare. It is very nutritive, and acts as a gentle aperient. When surfeit-lumps appear on the skin, and the horse begins to rub himself against the divisions of the stall, and the legs swell, and the heels threaten to crack, a few tares, cut up with the chaff, or given instead of a portion of the hay, will afford considerable relief. Ten or twelve pounds may be allowed daily, and half that weight of hay subtracted. It is an erroneous notion, that, given in moderate quantities, they either roughen the coat or lessen the capability for hard work.

RYE GRASS affords a valuable article of food, but is inferior to the tare. It is not so nutritive. It is apt to scour and, occasionally, and late in the spring, it has appeared to be injurious to the horse.

CLOVER, for soiling the horse, is inferior to the tare and the rye grass, but nevertheless is useful when they cannot be obtained. Clover hay is, perhaps, preferable to meadow hay for chaff. It will sometimes tempt the sick horse, and may be given with advantage to those of slow and heavy work; but custom seems properly to have forbidden it to the hunter and the hackney.

LUCERN, where it can be obtained, is preferable even to tares, and SAINFOIN superior to lucern. Although they contain but a small quantity of nutritive matter, it is easily digested, and perfectly assimilated. They speedily put both muscle and fat on the horse that is worn down by labour, and they are almost a specific for hide-bound. Some farmers have thought so highly of lucern as to substitute it for oats. This may be allowable for the agricultural horse of slow and not severe work, but he from whom speedier action is sometimes required, and the horse of all work, must have a proportion of hard meat within him.

THE SWEDISH TURNIP is an article of food the value of which has not been sufficiently appreciated, and particularly for agricultural horses. Although it is far from containing the quantity of nutritive matter which has been supposed, that which it has seems to be capable of easy and complete digestion. It should be sliced with chopped straw, and without hay. It quickly fattens the horse, and produces a smooth glossy coat and a loose skin. It will be good practice to give it once in the day, and that at night when the work is done.

CARROTS.—The virtues of this root are not sufficiently known, whether as contributing to the strength and endurance of the sound horse, or the rapid recovery of the sick one. To the healthy horse they should be given sliced in his chaff. Half a bushel will be a large daily allowance. There is little provender of which the horse is fonder. The following account of the value of the carrot is not exaggerated by Stewart in his *Stable Economy*. ‘This root is held in much esteem. There is none better, nor perhaps so good. When first given it is slightly diuretic and laxative; but as the horse becomes accustomed to it these effects cease to be produced. They also improve the state of the skin. They form a good substitute for grass, and an excellent alterative for horses out of condition. To sick and idle horses they render corn unnecessary. They are beneficial in all chronic diseases connected with breathing, and have a marked

influence upon chronic cough and broken wind. They are serviceable in diseases of the skin, and in combination with oats they restore a work horse much sooner than oats alone.'

POTATOES have been given, and with advantage, in their raw state, sliced with the chaff; but, where it has been convenient to boil or steam them, the benefit has been far more evident. Purging has then rarely ensued. Some have given boiled potatoes alone, and horses, instead of rejecting them, have soon preferred them even to the oat; but it is better to mix them with the usual manger feed, in the proportion of one pound of potatoes, to two and a half pounds of the other ingredients. The use of the potatoe must depend on its cheapness, and the facility for boiling it. Half a dozen horses would soon repay the expense of a steaming boiler in the saving of provender, without taking into the account their improved condition and capability for work. Professor Low says that 15 lbs. of potatoes yield as much nourishment as four pounds and a half of oats. Von Thayer asserts that three bushels are equal to 112 lbs. of hay; and Curwen, who tried potatoes extensively in the feeding of horses, says that an acre goes as far as four acres of hay. A horse fed on potatoes should have his quantity of water materially curtailed.

FURZE has sometimes been given during the winter months. There is considerable trouble attending the preparation of it, although its plentifulness and little value for other purposes would, on a large farm, well repay that trouble. The furze is cut down at about three or four years' growth; the green branches of that and the preceding year are bruised in a mill, and then given to the horses in the state in which they come from the mill, or cut up with the chaff. Horses are very fond of it. If twenty pounds of the furze are given, five pounds of straw, the beans, and three pounds of the oats, may be withdrawn.

It may not be uninteresting to conclude this catalogue of the different articles of horse-food with a list of the quantities of nutritive matter contained in each of them; for although these quantities cannot be considered as expressing the actual value of each, because other circumstances besides the simple quantity of nutriment seem to influence their effect in supporting the strength and condition of the horse, yet many a useful hint may be derived when the farmer looks over the produce of his soil, and inquires what other grasses or vegetables might suit his land. The list is partly taken from Sir Humphry Davy's *Agricultural Chemistry*:—1,000 parts of wheat contain 955 parts of nutritive matter; barley, 920; oats, 743; peas, 574; beans, 570; potatoes, 230; red beet, 148; parsnips, 99; carrots, 98. Of the grasses, 1,000 parts of the meadow cat's-tail contain, at the time of seeding, 98 parts of nutritive matter; narrow-leaved meadow grass in seed, and sweet-scented soft grass in flower, 95; narrow-leaved and flat-stalked meadow grass in flower, fertile meadow grass in seed, and tall fescue in flower, 93; fertile meadow grass, meadow fescue, reed-like fescue, and creeping soft grass in flower, 78; sweet-scented soft grass in flower, and the aftermath, 77; fiorin, cut in the winter, 76; tall fescue, in the aftermath, and meadow soft grass in flower, 74; cabbage, 73; crested dog's-tail and brome when flowering, 71; yellow oat, in flower, 66; Swedish turnips, 64; narrow-leaved meadow grass, creeping beet, round-headed cocksfoot, and spiked fescue, 59; roughish and fertile meadow grass, flowering, 56; fiorin, in summer, 54; common turnips, 42; sainfoin, and broad-leaved and long-rooted clover, 39; white clover, 32; and lucern, 23.

The times of feeding should be as equally divided as convenience will permit; and when it is likely that the horse will be kept longer than usual from home, the nose-bag should invariably be taken. The small stomach

of the horse is emptied in a few hours; and if he is suffered to remain hungry much beyond his accustomed time, he will afterwards devour his food so voraciously as to distend the stomach and endanger an attack of staggers. When this disease appears in the farmer's stable, he may attribute it to various causes; the true one, in the majority of instances, is irregularity in feeding. When extra work is required from the animal, the system of management is often injudicious, for a double feed is put before him, and as soon as he has swallowed it he is started. It would be far better to give him a double feed on the previous evening, which would be digested before he is wanted, and then he might set out in the morning after a very small portion of corn has been given to him, or perhaps only a little hay. One of the most successful methods of enabling a horse to get well through a long journey is to give him only a little at a time while on the road, and at night to indulge him with a double feed of corn and a full allowance of beans.

**WATER.**—This is a part of stable management little regarded by the farmer. He lets his horses loose morning and night, and they go to the nearest pond or brook and drink their fill, and no harm results, for they obtain that kind of water which nature designed them to have, in a manner prepared for them by some unknown influence of the atmosphere, as well as by the deposition of many saline admixtures. The difference between *hard* and *soft* water is known to everyone. In hard water soap will curdle, vegetables will not boil soft, and the saccharine matter of the malt cannot be fully obtained in the process of brewing. There is nothing in which the different effect of hard and soft water is so evident as in the stomach and digestive organs of the horse. Hard water, drawn fresh from the well, will assuredly make the coat of a horse unaccustomed to it stare, and it will not unfrequently gripe and otherwise injure him. Instinct or experience has made even the horse himself conscious of this, for he will never drink hard water if he has access to soft, and he will leave the most transparent and pure water of the well for a river, although the stream may be turbid, and even for the muddiest pool.

Some trainers have so much fear of hard or strange water, that they carry with them to the different courses the water that the animal has been accustomed to drink, and that which they know agrees with it.

He is injured, however, not so much by the hardness of the well-water as by its coldness—particularly by its coldness in summer, and when it is many degrees below the temperature of the atmosphere. The water in the brook and the pond being warmed by long exposure to the air, as well as having become soft, the horse drinks freely of it without danger.

If the horse were watered three times a day, and especially in summer, he would often be saved from the sad torture of thirst, and from many a disease. Whoever has observed the eagerness with which the over-worked horse, hot and tired, plunges his muzzle into the pail, and the difficulty of stopping him until he has drained the last drop, may form some idea of what he had previously suffered, and will not wonder at the violent spasms, and inflammation, and sudden death, that often result.

There is a prejudice in the minds of many persons against the horse being fairly supplied with water. They think that it injures his wind, and disables him for quick and hard work. If he is galloped, as he too often is, immediately after drinking, his wind may be irreparably injured; but if he were oftener suffered to satiate his thirst at the intervals of rest, he would be happier and better. It is a fact unsuspected by those who have not carefully observed the horse, that if he has frequent access to water he will not drink so much in the course of the day, as another will do, who, to cool his parched mouth, swallows as fast as he can, and knows not when to stop.

On a journey, a horse should be liberally supplied with water. When he is a little cooled, two or three quarts may be given to him, and after that, his feed. Before he has finished his corn two or three quarts more may be offered. He will take no harm if this is repeated three or four times during a long and hot day.

It is a judicious rule with travellers, that when a horse begins to refuse his food, he should be pushed no farther that day. It may, however, be worth while to try whether this does not proceed from thirst, as much as from exhaustion, for in many instances his appetite and his spirits will return soon after he has partaken of the refreshing draught.

## CHAPTER VII.

### THE ZOOLOGICAL CLASSIFICATION OF THE HORSE.

THERE are so many thousand species of living beings, some so much resembling each other, and others so strangely and altogether different, that it would have been impossible to have arranged them in any order, or to have given any description that could be understood, had not naturalists agreed on certain peculiarities of form which should characterise certain classes, and other lesser peculiarities again subdividing these classes.

The first division of animals is into *vertebrated* and *invertebrated*.

*Vertebrated* animals are those which have a *cranium*, or bony cavity containing the brain, and a succession of bones called the *spine*, and the divisions of it named *vertebræ*, proceeding from the cranium, and containing a prolongation of the brain, denominated the *spinal marrow*.

*Invertebrated* animals are those which have no *vertebræ*.

The horse, then, belongs to the *division vertebrated*, because he has a cranium or skull, and a spine or range of *vertebræ* proceeding from it.

The *vertebrated* animals are exceedingly numerous. They include man, quadrupeds of all kinds, birds, fishes, and many reptiles. We naturally look for some subdivision, and a very simple line of distinction is soon presented. Certain of these *vertebrated* animals have *mammæ* or teats, with which the female suckle their young. The human female has two, the mare has two, the cow four, the bitch ten or twelve, and the sow more than twelve.

This *class* of *vertebrated* animals having *mammæ* or teats is called *mammalia*; and the horse belongs to the *division vertebrata*, and the *class mammalia*.

The *class mammalia* is still exceedingly large, and we must again subdivide it. It is stated (Library of Entertaining Knowledge, vol. i. p. 13) that 'this class of quadrupeds, or mammiferous quadrupeds, admits of a division into two *Tribes*.

'I. Those whose extremities are divided into fingers or toes, scientifically called *unguiculata*, from the Latin word for *nail*; and II. Those whose extremities are hoofed, scientifically called *ungulata*, from the Latin word for *hoof*.

'The extremities of the first are armed with claws or nails, which enable them to grasp, to climb, or to burrow. The extremities of the second tribe are employed merely to support and move the body.'

The extremities of the horse are covered with a hoof by which the body is supported, and with which he cannot grasp anything, and therefore he belongs to the *tribe unguolata* or *hoofed*.

But there is a great variety of hoofed animals. The elephant, the

rhinoceros, the hippopotamus, the swine, the horse, the sheep, the deer, and many others, are *ungulated* or *hoofed*; they admit, however, of an easy division. Some of them masticate, or chew their food, and it is immediately received into the stomach and digested; but in others the food, previous to digestion, undergoes a very singular process. It is returned to the mouth to be remasticated, or chewed again. These are called *ruminantia*, or *ruminants*, from the food being returned from one of the stomachs (for they have four), called the *rumen* or paunch, for the purpose of remastication.

The *ungulata* that do not ruminate are, somewhat improperly, called *pachydermata*, from the thickness of their skins. The horse does not ruminate, and therefore belongs to the *order pachydermata*.

The *pachydermata* who have only one toe belong to the *family solipeda*—*single-footed*. Therefore the horse ranks under the division *vertebrata*—the class *mammalia*—the tribe *ungulata*—the order *pachydermata*—and the family *solipeda*.

The *solipeda* consist of several *species*, as the horse, the ass, the mule, and the quagga.

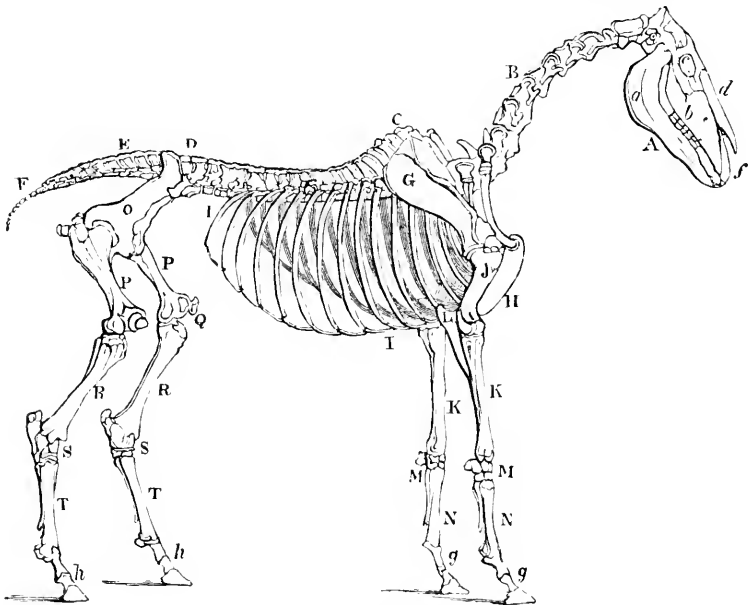
First stands the *EQUUS CABALLUS*, or COMMON HORSE.

Animals are likewise distinguished according to the number, description, and situation of their teeth. The horse has six *incisors* or *cutting* teeth in the front of each jaw; and one *canine* tooth or *tusk*.

On each side, above and below—at some distance from the incisors, and behind the canines, and with some intervening space—are six *molar* teeth, or *grinders*; and these molar teeth have flat crowns, with ridges of enamel, and that enamel penetrating into the substance of the tooth.

The whole is thus represented by natural historians:—

Horse.—Incisors  $\frac{6}{6}$ , canines  $\frac{1-1}{1-1}$ , molar  $\frac{6-6}{6-6}$ . Total, forty teeth.



THE SKELETON OF THE HORSE.

A The Head.

a The posterior maxillary or under jaw.



- b* The superior maxillary or upper jaw. A little lower down than the letter is a foramen, through which pass the nerves and blood-vessels which chiefly supply the lower part of the face.
- c* The orbit, or cavity containing the eye.
- d* The nasal bones, or bones of the nose.
- e* The suture dividing the parietal bones below from the occipital bones above.
- f* The inferior maxillary bone, containing the upper incisor teeth.
- B** The Seven Cervical Vertebrae, or bones of the neck.
- C** The Eighteen Dorsal Vertebrae, or bones of the back.
- D** The Six Lumbar Vertebrae, or bones of the loins.
- E** The Five Sacral Vertebrae, or bones of the haunch.
- F** The Caudal Vertebrae, or bones of the tail, generally about fifteen.
- G** The Scapula, or shoulder-blade.
- H** The Sternum, or forepart of the chest.
- I** The Costae or ribs, eight articulating with the sternum, and called the *true ribs*, and ten united together by cartilage, called the *false ribs*.
- J** The Humerus, or upper bone of the arm.
- K** The Radius, or bone of the fore-arm.
- L** The Ulna, or elbow. The point of the elbow is called the Olecranon.
- M** The Carpus or knee, consisting of seven bones.
- N** The metacarpal bones. The larger metacarpal or cannon or shank in front, and the smaller metacarpal or splint bone behind.
- g* The pastern, consisting of the Os Suffraginis, or the upper and larger pastern bone, with the sesamoid bones behind, articulating with the cannon and greater pastern; *h*, the Os Coronae, or lesser pastern; *i*, the Os Pedis or coffin bone, and the Os Navicular, or navicular, or shuttle-bone, not seen, and articulating with the smaller pastern and coffin bones.
- g h i* The corresponding bones of the hind-feet.
- O** The Haunch, consisting of three portions, the Ilium, the Ischium, and the Pubis.
- P** The Femur or thigh.
- Q** The stifle joint with the Patella.
- R** The Tibia or proper leg-bone—behind is a small bone called the fibula.
- S** The Tarsus or hock, composed of six bones. The prominent part is the Os Calcis, or point of the hock.
- T** The Metatarsals of the hind leg.

#### THE MUSCLES OF THE HORSE.

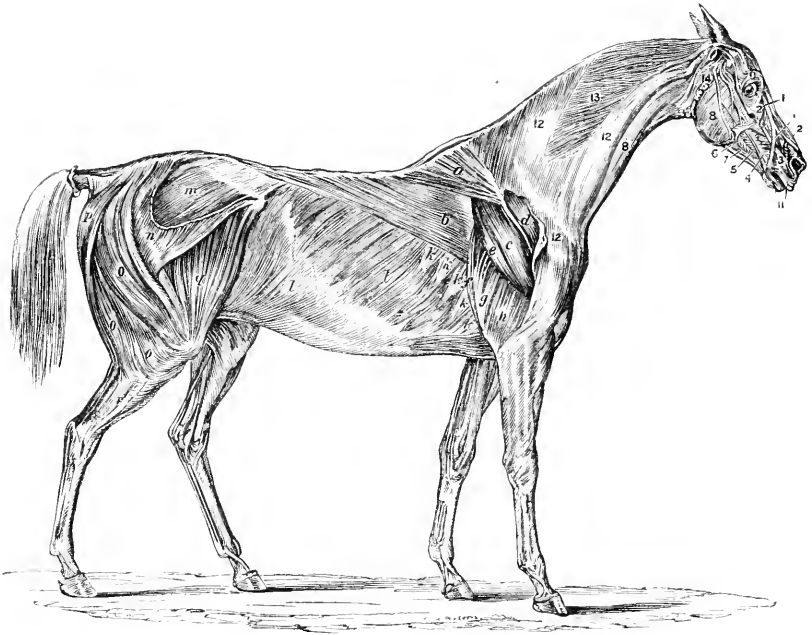
Having finished the description of the skeleton, it may now be desirable to give the more important of the muscles by which they are acted on; this description, however, must be a very general one, and will be limited to the first layer of muscles, or those found immediately under the skin, on which, however, the shape and power of the animal, to a very considerable degree, depends; one plate will be sufficient to delineate these, and its description will include all that is necessary for the general reader to be acquainted with.

1. *Levator Angliosis*, is a portion of the *panculus carnosus* converging towards the angle of the mouth, which it retracts or draws back. 2. *Retractor Labii Superioris*, arises from the superior portion of the maxillary bone, and is inserted into the upper part of the angle of the mouth, which it draws on one side. 3. *Levator Labii Superioris atque Nasi*, arises from the junction of the lachrymal, nasal, and superior maxillary bones, and divides into two parts, one inserted in the lateral part of the nostril, and the other into the upper and lateral part of the lip; its action is to raise the lip and dilate the nostril.

4. *Zygomaticus*, arises from the zygomatic ridge, and is also inserted into the angle of the mouth, which it retracts. 5. *Caninus* is a penniform muscle; the superior portion arises from the superior maxillary bone, a little above the upper canine tooth; the lower from the posterior maxillary, just below the lower canine tooth; the two meet each other in the space between the upper and lower jaw; its use is to compress the cheeks. 6. *Buccinator* arises from the superior and inferior maxillary bones, from just above and below the edges of the alveolar sockets, a little posterior to

the last molar tooth—is inserted in the corner of the mouth, and assists the tongue in moving about the pellet of food in the act of mastication.

7. *Retractor Labii Inferioris* arises from the lower jaw, as far back as



the last molar tooth, where it becomes blended with the orbicularis oris, and is inserted into the inferior part of the lower lip, which it retracts. 8. *Panniculus Carnosus*, a portion of a thin muscle spread over the head, neck, and body, to corrugate the skin when irritated, as a compensation for the want of hands. 9. *Orbicularis Palpebrarum*, surrounds the surface of the eyelids. 10. *Temporalis* arises from the occiput, frontal, parietal, squamous, temporal, and sphenoid bones, and is inserted in the caracoid process of the lower jaw; its office is to close the mouth. 11. *Orbicularis Oris* surrounds the mouth, is more developed in the upper than in the lower lip; its action is to close the lips.

12. *Levator Humeri*, arises from the mastoid process of the petrous temporal bone, the wing of the atlas, from the second, third, and fourth cervical vertebrae, and from the lower portion of the ligamentum nuchae; it is inserted into the anterior and inferior part of the humerus, and its action, when the head is fixed, is to advance the foreleg, or when the legs are fixed, one muscle will pull the head on one side, or both will curve the head downwards. 13. The *Splenius* arises from the mastoid process of the petrous temporal bone, the spines of the second, third, and fourth dorsal vertebrae, and is inserted into the five first cervical vertebrae and wing of the atlas; it curves the head on one side or, both acting, raise it. 14. The *Parotid Gland*, which secretes the most considerable portion of the saliva.

A. *Trapezius* arises from the second to the eleventh dorsal, and from the ligamentum nuchae, as far forward as the third cervical vertebrae; it is inserted into the spine of the scapula, and its action is to draw the shoulder upwards and backwards.

B. *Latissimus Dorsi* arises from the fascia of the loins, and the superior spinal ligament; it is inserted into the inner side of the humerus; it aids in retracting the arm and bracing the muscles of the back.

C. *Posteus Spinatus* is attached to the whole surface of the posterior fossa of the scapula; it is inserted into the humerus a little behind the outer tubercle, and also to the upper part of the ridge, on the upper and outer part of this bone. It flexes the arm on the shoulder.

D. *Anteus Spinatus* is attached superiorly to the surface of the anterior fossa, and two-thirds of the anterior *costa* of the scapula, inferiorly to the greater and lesser tubercle of the humerus. It straightens the humerus on the scapula and throws the shoulder outwards.

E. *Teres Externus* arises from a tubercle on the posterior angle of the scapula, and is inserted into the upper and outer surface of the humerus; it aids in flexing the shoulder on the arm.

F. *Scapulo Ulnaris* arises from the upper part of the superior and posterior angle of the scapula, inserted into the inner and upper part of the ulna, which it flexes on the scapula, and draws the elbow inwards.

G and H. *Caput Magnum* and *Medium* of the *triceps extensor brachii*, arises from the posterior margin of the scapula, from a ridge on its neck; from the outer side, and from the body of the humerus, and is inserted into the olecranon or point of the elbow. It is of great use in draught, in pushing the body against the collar, or in forcing the forelegs under the body.

I. *Pectoralis Magnus* arises from the fascia of the external oblique muscles, the ensiform cartilage and from the three last bones of the sternum, and is inserted into the inferior part of the inner tubercle of the humerus; it aids the muscles of the haunch in the propulsion of the trunk, and assists in respiration.

K K K. *Serratus Magnus* arises from the four last cervical vertebræ, from the whole length of the first four ribs, and from portions of the four next; it is inserted into the concavity of the scapula. It moves the shoulders in progression, and when at rest enlarges the chest and assists in laboured respiration.

L L. *Obliquus Externus Abdominis* arises by fleshy digitations from the fourteen posterior ribs, from two-thirds of the crest of the ilium, and its anterior spinous process; it passes over the lateral and inferior portions of the belly to meet its fellow from the opposite side, and form the *linea alba*, posteriorly, into the symphysis pubis; it assists in expelling the feces and urine.

M. *Gluteus Maximus* arises from the crista and the dorsum of the ilium, and from the sacro-sciatic ligament; it is inserted into the great trochanter and also along the body of the femur, as far as the small external trochanter; its use when the hindlegs are fixed, is in raising the anterior part of the body; when in action, it abducts and retracts the femur, and is actively engaged in kicking.

N. *Gluteus Externus* arises from the spines of the ilium and sacrum and is inserted into the small trochanter of the femur and the fascia of the thigh; it advances the femur.

O O O. *Triceps Abductor Femoris* arises from the spines and transverse processes of the sacrum—from the sacro-sciatic ligament, from the great trochanter of the femur and the tuberosity of the ischium; it is inserted into the outer side of the patella and the superior portion of the tibia; its action is to steady the body, and to raise it when the feet are firmly fixed, as in leaping; it is a most important organ of progression, and is not inactive in kicking.

P. *Biceps Rotator Tibialis* arises from the last sacral and two first

coccygeal bones, the posterior part of the tuberosity of the ischium ; inserted into the inner, upper, and anterior part of the tibia : rotates and abducts the thigh.

Q. *Tensor Vagina* arises from the anterior spine of the ilium, and is inserted into the trochanter minor externus of the femur, the fascia of the haunch and the patella ; it advances the leg and tightens the fascia of the haunch.

---

## CHAPTER VIII.

### THE SENSORIAL FUNCTION.

BEAUTIFUL as is the horse, and identified so much with our pleasure and our profit, he has been the object of almost universal regard ; and there are few persons who do not pretend to be somewhat competent judges of his form, qualities, and worth. From the nobleman with his numerous and valuable stud, to the meanest helper in the stable, there is scarcely a man who would not be offended if he were thought altogether ignorant of horse-flesh. There is no subject on which he is so positive ; there is no subject on which, generally speaking, he is so deficient ; and there are few horses, on some points of which these pretended and self-sufficient judges would not give a totally opposite opinion.

The truth is, that this supposed knowledge is rarely founded on principle—or is the result of the slightest acquaintance with the actual structure of the animal, the form and connection of parts on which strength, or fleetness, or stoutness must necessarily depend.

In speaking of the structure of this animal, and the points which guide the opinion of real judges of him, we shall, as briefly and as simply as we are able, explain those fundamental principles on which his usefulness and beauty must depend. We require one kind of horse for slow and heavy draught, and another for lighter and quicker work ; one as a pleasant and safe roadster—another, with more speed and equal continuance, as a hunter—and another still is wanted for the race-course. What is the peculiarity of structure—what are the particular points that will fit each for his proper business, and, to a certain degree, unfit him for everything else ? The farmer will require a horse of *all-work*, that can carry him to market and take him round his farm—on which he can occasionally ride for pleasure, and which he must sometimes degrade to the dung-cart or the harrow. What combination of powers will enable the animal to discharge most of these duties well, and all of them to a certain extent profitably ?

Much time spent among horses, an acquired love of them, and a little, sometimes possibly too dearly-bought, experience, may give the agriculturist some insight into these matters. We will try whether we cannot assist him in this affair—whether we cannot explain to him the reason why certain points must be good, and why a horse without them must of necessity be good for nothing. Perhaps some useful rules may thus be more deeply impressed upon his memory, or some common but dangerous prejudices may be discarded, and considerable degree of error, disappointment, and expense avoided.

If we treat of this at considerable length, let it be remembered that the horse is our noblest servant, and that, in describing the structure and economy of his frame, we are in a great measure describing that of other domestic quadrupeds, and shall hereafter have to speak only of points of

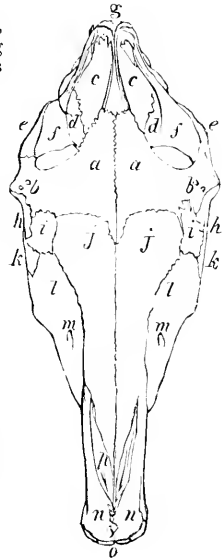
difference required by the different services and uses for which they were destined. And further, let it be remembered, that it is only by being well acquainted with the structure and anatomy of the horse that we can appreciate his shape and uses, or understand the different diseases to which he is liable. It is from the want of this that much of the mass of ignorance and prejudice which exists as to the diseases to which he is subject is to be referred.

We begin with the head, containing the brain and the most important organs of sense.

The following cut represents the head of the horse divided into the numerous bones of which it is composed, and the boundaries of each bone clearly marked by the sutures which connect it with those around.

The upper and broadest part is the cranium or skull in which the brain is contained and by which it is protected. It is composed of twelve bones, four pairs and four single ones: the four pairs are the two frontal, two parietal, two squamous temporal, and two petrous temporal; the single are, the occipital bone, the sphenoid, the ethmoid, and the os triquetrum; of these, the ones sketched in the plate are:—

- a a* The frontal bones, or bones of the forehead.  
*b b* The supra-orbital foramina or holes above the orbit, through which the nerves and blood-vessels supplying the forehead pass out. The small hole beneath the vessels which dip into and supply the bone.  
*c c* The parietal bones, or walls of the skull.  
*d d* The temporal bones, or bones of the temples.  
*e e* The zygomatic, or yoke-shaped arch.  
*f f* The temporal fossa, or pit above the eye.  
*g* The occipital bone, or bone of the hinder part of the head.  
*h h* The orbits containing and defending the eye.  
*i i* The lachrymal bones belonging to the conveyance of the tears from the eyes.  
*j j* The nasal bones, or bones of the nose.  
*k k* The malar, or cheek-bones.  
*l l* The superior maxillary, or that portion of the upper jaw containing the molar teeth or grinders.  
*m m* The infra-orbital foramen—a hole below the orbit, through which pass branches of nerves and blood-vessels to supply the lower part of the face.  
*n n* The inferior maxillary, the lower part of the upper jaw-bone—a separate bone in quadrupeds, containing the incisor or cutting teeth, and the upper tusches at the point of union between the superior and inferior maxillaries.  
*o* The upper incisor or cutting teeth.  
*p p* The openings into the nose, with the bones forming the palate.



There is an evident intention in this division of the head into so many bones. When the fœtus—the unborn foal—first begins to have life, that which afterwards becomes bone, is a mere jelly-like substance. This is gradually changed into a harder material—cartilage; and, before the birth of the animal, much of the cartilage is taken away by vessels called absorbents, and bone deposited in its stead. In flat bones, like those of the head, this deposit takes place in the centre, and rays or radiations of bone extend thence in every direction. Then, by having so many bones, there are so many centres of radiation; and, consequently, the formation of bone is carried on so much the more rapidly, and perfected at the time when the necessities of the animal require it. At the period of birth, however, this process is not completed, but the edges of the bones remain somewhat soft and pliant, and therefore, in parturition, they yield a little

and overlap each other, and thus, by rendering the birth more easy, they save the mother much pain, and contribute to the safety of the foal.

The first of these bones, or the first pair of them, occupying the broad expanse of the forehead, are called the *frontal bones, a a*. They are united together by a most curious and intricate dove-tailing, to defend the brain which lies beneath the upper part of them. Lower down, and where the cavity of the nose is to be defended, their union is sufficient, but far less complicated. Thus, at first starting, there is an evident proof of design, an illustration of that adaptation to circumstances which will again and again present itself in the most interesting points of view. Peculiar strength of union is given where a most important organ is to be defended—the suture is there intricate and laboured. Where less important parts are covered, it is of a far simpler character. The inner plate of the frontal bone covers a considerable portion of the anterior part of the brain, and it is studded with depressions corresponding with irregularities on the surface of the brain.

Few things more clearly indicate the breed or blood of the horse than the form of the frontal bones. Who has not remarked the broad angular forehead of the blood horse, giving him a beautiful expression of intelligence and fire, and the face gradually tapering from the forehead to the muzzle, contrasted with the large face of the cart or dray horse, and the forehead scarcely wider than the face?

At *f*, between the frontal bones, is the pit or cavity above the eye, and by the depth of which we form some idea of the age of the horse. There is placed at the back of the eye a considerable quantity of fatty substance, on which it may revolve easily and without friction. In aged horses, and in diseases attended with general loss of condition, much of this disappears; the eye becomes sunken, and the pit above it deepens. It is said that some of the lower class of horse-dealers puncture the skin, and, with a tobacco pipe or small tube blow into the orifice, until the depression is almost filled up. This, with the aid of a bishopped tooth, may give a false appearance of youth, that will remain during some hours, and may deceive the unwary, but the trickery may easily be detected by pressing on the part.

These bones, however, are not solid, but a considerable portion of them is composed of two plates receding from each other, and leaving numerous and large vacuities or cells. These vacuities are called *the frontal sinuses*.

The sinns on the different sides of the forehead do not communicate with each other, but with other sinuses in the ethmoid, and sphenoid, and upper jaw-bones, and also with the cavities of the nose on their respective sides. These sinuses afford a somewhat increased protection to the brain beneath; and by the continuous and slightly projecting line which they form, afford lightness, while they give beauty to the forehead; but their principal use probably is, like the windings of the French horn, to increase the clearness and loudness of the neighing. It will be remarked that they are very irregular in depth, which at one place is an inch or more.

Immediately above the frontal, and extending from the frontal to the poll, are the *parietal bones, c c*. They are two, united together by a suture when the animal is young, but that suture soon becoming obliterated. They have the *occipital, g*, (p. 145) above, the *frontals, a a*, below, and the *temporals, d d*, on either side. They are of a closer and harder texture than the frontals, because they are more exposed to injury, and more concerned in defending the brain.

A very small portion only of the *parietals* is naked, and that is composed of bone even harder than the other part, and with an additional layer of bone rising in the form of a crest or ridge externally. Every

other part of these bones is covered by a thick mass of muscle, the *temporal* muscle, which is principally concerned in chewing the food, but which likewise, by its yielding resistance, speedily and effectually breaks the force of the most violent blow. A woolpack hung over the wall of a fortress, when the enemy is battering to effect a breach, renders the heaviest artillery almost harmless. So the yielding resistance of the *temporal* muscles affords a sure defence to the brain, however sudden or violent may be the blow which falls on the parietal. These benevolent provisions will not be disregarded by the reflecting mind.

On the side of the head, and under the parietals (*d d*, p. 145) are the *temporal bones*, one on each side, *f f*. These again are divided into two parts, or consist of two distinct bones; the *petrous* portion, so called from its great or *stony* hardness, and containing the wonderful mechanism of the ear, and the *squamous* portion from the appearance of its union with the parietal, overlapping it like a great *scale*.

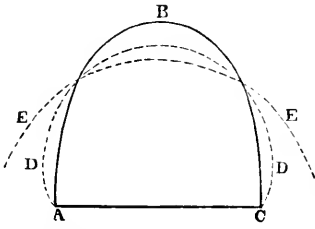
From the latter there projects a portion of bone, *e*, which unites with the frontal, and forms a strong arch—the zygomatic—distinctly to be felt at the side of the head immediately above the eye. This arch is designed to protect the upper part of the lower jaw, the motion of which may very plainly be seen beneath it when the horse is feeding. It is very strong, and it ought to be, for if it were depressed or forced inward, the horse would starve. There is one species of violence which causes this arch to require no common strength; and that is, the brutal manner in which the collar is often forced over the head.

At the base of the arch is an important cavity not visible in the cut, receiving into it, and forming a joint with, the head of the lower jaw—it will be presently described.

Having reached the base of the temporal bone, it is found united to the parietal, not by a simple suture, as the lower part of the frontals, or the bones of the nose (see fig. *a* and *j*, p. 145), nor by a dove-tailed suture, as the upper part of the frontals (see the same cut), but it is spread over the parietal in the form of a large scale, and hence, as before observed, called the *squamous* portion of the temporal bone. In fact, there are two plates of bone instead of one. Was there design in this? Yes, evidently so. In the first place, to increase the strength of the base of the *zygomatic* arch. This extensive union between the temporal and parietal bones resembles the buttress or mass of masonry attached to the base of every arch, in order to counteract its lateral pressure. The concussion, likewise, which might be communicated by a blow on the top of the arch, is thus spread over a large surface, and consequently weakened and rendered comparatively harmless; and that surface is composed of the union of two bones of dissimilar construction. The hard *stony* structure of the parietal is very different from the tougher material of the temporal; and thus as a finger acts on a sounding glass, the vibration communicated to the temporal is at once stopped, and the brain receives no injury.

There is another proof of admirable design. Where is this *squamous* portion of the temporal bone situated? On the side of the head. And what is the figure of the cranium or skull, and principally that part of it which contains the cerebrum or brain? It is an elliptical or oval arch. If pressure is made on the crown of that arch—if a blow is received on the suture between the parietals sufficient to cause the elastic materials of which the skull is composed to yield—the seat of danger and injury is at the side. If a man receives a violent blow on the crown or back part of the head, the fracture, if there is any, is generally about the temple, and the extravasation of blood is oftenest found there. The following figure will explain this:—

Let the line *A B C* represent an elliptical arch, composed of elastic materials. Some force shall be applied at *B* sufficient to cause it to yield. We



cannot compress it into smaller compass; but just in proportion as it yields at *B* will it spur or bulge out at *D*, and give way sometimes as represented at *E*. In a dome the weight of the materials constantly acting may be considered as representing the force applied at *B*; and so great is the lateral pressure, or tendency to bulge out (*vide D and E*), that it is necessary either to dove-tail the materials into one another,

or to pass strong iron chains round them. For want of sufficient attention to this, 'the dome of St. Sophia, in Constantinople, built in the time of the Emperor Justinian, fell three times during its erection; and the dome of the cathedral of Florence stood unfinished a hundred and twenty years, for want of an architect.'

Nature, in the construction of the horse's head, has taken away the pressure, or removed the probability of injury, by giving an additional layer of bone, or a mass of muscle, where alone there was danger, and has dove-tailed all the materials. Farther than this, in order to make assurance doubly sure, she has placed this effectual girder at the base, in the overlapping of the squamous portion of the temporal bone.

Above the *parietals*, and separated from them by a suture (fig. *g*, p. 145), is the *occipital* bone. Superiorly it covers and protects the smaller portion of the brain, the cerebellum; and as it there constitutes the summit or crest of the head, and is particularly exposed to danger, and not protected by muscles, it is interesting to see what thickness it assumes. The head of the horse does not, like that of the human being, ride upright on the neck, with all its weight supported on the spinal column, the only office of the muscles of the neck being to move the head forward, or backward, or horizontally on its pivot; but it hangs in a slanting position from the extremity of the neck, and the neck itself projects a considerable distance from the chest, and thus the whole weight of the head and neck are suspended from the chest, and require very great power in order to support them. In addition to the simple weight of the head and neck, the latter projecting from the chest, and the head hanging from the extremity of the neck, act with enormous mechanical force, and increase more than a hundredfold the power necessary to support them.

The head and neck of the horse, and particularly of some horses of a coarse breed, are of no little bulk and weight. It will hereafter be shown in what breeds and for what purposes a light or heavy head and neck are advantageous; but it may be safely affirmed that, projecting so far from the chest, and being consequently at so great a distance from the fulcrum or support, the lightest head will act or bear upon the joint between the last bone of the neck and the first rib with a force equal to many thousand pounds.

How is this weight to be supported? Is muscular power equal to the task? The muscles of the animal frame can act for a certain time with extraordinary force; but as the exertion of this power is attended with the consumption of vital energy, the period soon arrives when their action is remitted or altogether suspended. A provision, however, is made for the purpose, simple and complete.

From the back of the occipital bone, and immediately below the crest, proceeds a round cord of considerable bulk, and composed of a ligamentous



substance, which reaches down and is securely attached to the spines of the vertebræ, or bones of the back; and by this ligament—the *ligamentum colli*, ligament of the neck, commonly called the *packwax*—the head is supported.

There are, however, some admirable contrivances connected with the arrangements of the *ligamentum colli*. As it proceeds from the head, it is in the form of a round cord. It is connected with the *atlas*, or first bone of the neck, and then, attaching itself strongly to the second bone, principally supports the head by its union with this bone. The mechanical disadvantage is increased; but the head is turned more freely on the first and second bones. The principal stress is on the *dentata*, or second bone, so much so, that, in poll-evil, this ligament may be divided without serious inconvenience to the horse. It then suddenly sinks deeper, and communicates with all the other vertebræ. Each of these communications becomes a separate point of support, and as they approach nearer to the base, the mechanical disadvantage, or the force with which the weight of the head and neck presses and acts, is materially lessened.

The head, then, while the animal is in a state of rest, is supported by this ligament, without any aid from muscular energy.

There is, however, something yet wanting. The head must not be always elevated. The animal has his food to seek. In a state of nature this food lies principally on the ground, and the head must be lowered to enable the horse to get at it. How is this effected? This ligament, as it has been called, because it resembles in appearance the other ligaments of the body, possesses a property which they have not, and which they must not have, or they would be useless. No well-knit joint could exist if it had this property. It is *elastic*. It will yield to a force impressed upon it, and will resume its natural dimensions when that force is removed. It sustains perfectly the weight of the head. That portion of tenacity or strength is given to it which will not give way to the simple weight of the head, but which will yield to a very little additional weight. Its resisting power is so admirably adjusted to that which it has to sustain, that when certain muscles, whose action is to depress or lower the head, begin to act, and add their power to the previous weight it had to bear, the ligament stretches, and when the horse is browsing, it is full two inches longer than when the head is erect.

When the animal has satisfied himself, these depressing muscles cease to act, and other muscles which are designed to assist in raising the head, begin to exert themselves; and by their aid—but more by the inherent elasticity of the ligament—the head is once more elevated, and remains so without the slightest exertion of muscular power. This is one of the many applications of the principle of elasticity which will be discovered and admired in the construction of the animal frame.

The ligament of the neck is inserted into the centre of the back part of the occipital bone, and immediately below the vertex or crest of the bone; and therefore the bone is so thick at this part.

Many large and powerful muscles are necessary to turn the head in various directions, as well as to assist in raising it when depressed. The occipital bone presents a spine running down the centre, and a large roughened surface for the attachment of muscles.

Lower down, and still at the back of the occipital bone, are two rounded protuberances, by which the head is connected with the *atlas*, or upper or first vertebra, or bone of the neck; and these are called the *condyloid* processes of the occipital bone. All the perpendicular motions of the head are performed by this joint.

Between them is a large hole, the *foramen magnum*, or great aperture.

through which the continuation of the brain, termed the spinal cord or marrow, passes out of the skull.

As an additional contrivance to support the enormous weight of the head, are two other projections of the occipital bone, peculiar to animals whose heads are set on in a slanting direction, and to which powerful muscles are inserted. They are called the *coracoid*, beak-like, processes or prolongations of the occipital bone.

Running forward, and forming outwardly a part of the base, and inwardly a portion of the floor of the skull, is what, from its wedge-like shape, is called the *basilar* process of the occipital bone. It is thick, strong, and solid, and placed at the bottom of the skull, not only to be a proper foundation for, and to give additional strength to the arch on either side, but speedily to stop all vibration and concussion.

At the base of the skull, and anterior to or below the *occipital*, lies the *sphenoid*, wedge-like bone. This bone branches out into four irregular bodies or plates, two of which are called the *wings*, and two running to the palate, the *legs*. There is nothing important belonging to them, so far as this work is concerned. Internally the sphenoid forms a portion of the cavity of the skull.

Of the *ethmoid*—sieve-like—bone, little can be seen outwardly. A small portion is found in the back part of the orbit and in the cavity of the cranium: but the most important part of it is that which is composed of a great number of thin convoluted plates, forming numerous cavities or cells lined with the mucous membrane of the nose, and entering into its cavity. The upper portion is called the cribriform or sieve-shape plate, from its being perforated by a multitude of little holes, through which the nerve connected with smelling passes and spreads over the nose.

Altogether these bones form a cavity of an irregular oval shape, but the tentorium stretching across it, gives it the appearance of being divided into two.

The cavity of the skull may be said to be arched all round. The builder knows the strength which is connected with the form of an arch. If properly constructed, it is equal to a solid mass of masonry. The arch of the horse's skull has not much weight to support, but it is exposed to many injuries from the brutality of those by whom he should be protected, and from accidental causes.

The roof of the skull is composed of two plates of bone: the outer one hard and tough, and the different parts dove-tailed together, so as not to be easily fractured; the inner plate being elastic. By the union of these two substances of different construction, the vibration is lessened or destroyed, so far as safety requires.

On raising any part of the skull of the horse, the dense and strong membrane which is at once the lining of the cranium and the covering of the brain—the *dura mater*—presents itself. Between this membrane, common to the cranium and the brain, and the proper investing tunic of that organ, is found that delicate gossamers' web appropriately called the *arachnoid*—the spider's membrane—and which is seen in other animals, designed either to secrete the fluid which is interposed, for the purpose of obviating injurious concussion, or, perhaps, to prevent the brain from readily sympathising with any inflammatory action produced by injury of the skull.

Beneath is the proper investing membrane of the brain—the *pia mater*—it is indeed the vascular membrane of the brain, being that through the medium of which the arteries convey the blood to the brain—which not only covers the external surface of the brain, but penetrates into every depression, and clothes every irregularity and part and portion of the brain.

We now arrive at the brain itself. The brain of the horse corresponds with the cavity in which it is placed. It is a flattened oval. It is divided into two parts, one much larger than the other—the *cerebrum* or brain, and the *cerebellum* or little brain. In the human being the cerebrum is above the cerebellum, in the quadruped it is below; and yet in both they retain the same relative situation. The cerebellum is nearer to the foramen through which the brain passes out of the skull, than the cerebrum, but portions from each unite to form the medulla oblongata, which passing out of the cavity of the cranium into the spinal canal, becomes the spinal cord. In the human head this foramen is at the base of the skull; but in the quadruped, in whom the head is placed slanting, it is necessarily elevated.

He who for the first time examines the brain of the horse will be struck with its comparative diminutive size. The human being is not, generally speaking, more than one-sixth of the size and weight of the horse; yet the brain of the biped is twice as large and as heavy as that of the quadruped. If it had been the brain of the ox that had been here exposed, it would have been but two-thirds of that of the horse. If the dog had been the subject, it would have been very considerably larger, comparing the general bulk of each animal. This is singular. The human brain largest in comparative bulk; then the brain of the dog, the horse, the ox. *Thus would they be classed in the scale of intelligence.*

If the brain is more closely examined, it will be observed that there is not that roundness and broadness found in the human being; it is comparatively level and flat. There is, however, sufficient irregularity of surface—there are projections and depressions to remind us that the phrenological development of the brain of the horse should not be lost sight of—his pride and love of approbation, his acute remembrance of persons and places, his perception of music and time are extraordinary. After the dog, there is no animal endowed with more intelligence than the horse. Were the brain of the beaver, of the hare, or the rabbit, or of almost any bird, substituted for it, there would be no convolutions or irregularities at all.

The irregularities on the surface of the brain are not so bold and so deep in the ox as in the horse, nor in the horse as in the dog. We do not know enough, as yet, of the functions of the particular portions of the brain to associate those convolutions, accurately, with any particular powers of mind, or good or bad propensities; though, doubtless, such knowledge will ultimately be obtained. It would occupy too much space fully to enter into these questions; but there are some diseases to which the horse is subject, for which a very useful operation—the division of some of the nerves—is had recourse to, the effect of which operation could not be understood without a previous slight account of this important organ.

When the brain is cut, it is found to be composed of two substances very unlike in appearance; one, principally on the outside, grey, or ash-coloured, and therefore called the *cortical* (*bark-like*) from its situation, and *cineritious* (*ashen*) from its colour; and the other lying deeper in the brain, and from its pulpy nature called the *medullary* substance. Although placed in apposition with each other, and seemingly mingling, they never run into the same mass, or change by degrees into one another, but are essentially distinct in construction as well as in function. We are told by Mr. Solly, in his most valuable work on the brain, that the cineritious or dark portion of the brain is the source of mental power—that is, it is the portion of the brain by means of which the mind or instinct develops itself; that it is collected in masses of variable form and shape, both within and without the brain, called ganglia, and that these ganglia are the immediate means of mental demonstration, while the medullary or white portion

of the brain, has the secondary office of being the conductor of that demonstration to every part of the body, it is not developed in the form of irregular masses or ganglia, but is moulded into the more symmetrical form of nerves.

The *medullary* portion is connected with the nervous system. The nerves are prolongations of it, and are concerned in the discharge of all the offices of life. They give motion and energy to the limbs, the heart, the lungs, the stomach, and every part connected with life. They are the medium through which sensation is conveyed; and they supply the mind with materials to think and work upon.

The *cineritious* part has a different appearance, and is differently constituted. Some have supposed, and with much appearance of truth, that it is the residence of the mind—receiving the impressions that are conveyed to the brain by the sensitive nerves, and directing the operation and action of those which give motion to the limbs. In accordance with this, it happens that, where superior intelligence is found, the cineritious portion prevails, and where little beside brute strength and animal appetite exists, the medullary portion is enlarged. There is, comparing bulk with bulk, less of the medullary substance in the horse than in the ox, and in the dog than in the horse. The additional bulk of brain is composed of cineritious matter; and how different is the character of these animals?—the sluggish, stupid ox, and the intelligent horse; the silly sheep, and the intellectual companionable dog!

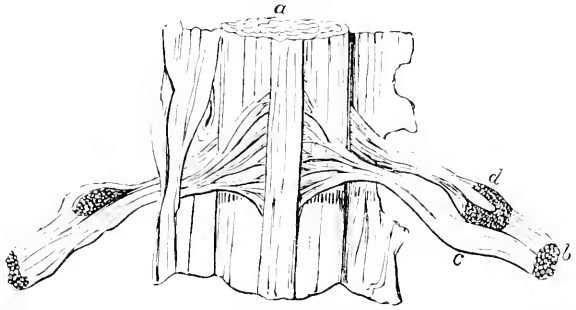
In a work like this, it would be somewhat out of place to enter deeply into any metaphysical speculation; but the connexion between the cineritious part of the brain and the intellectual principle, and that between the medullary portion and the mere animal principle, do seem highly probable. The latter is the medium through which the impression is conveyed, or the motion is effected; the former is the substance to which that impression is referred—where it is received, registered, and compared, and by which the operation of the motor nerves is influenced and governed.

The *cortical* substance is small in the quadruped; for in their wild state brutes have no concern and no idea beyond their food and reproduction; and in their domesticated state they are destined to be the servants of man. The acuteness of their senses, and the preponderance of animal power, qualify them for these purposes; but were proportionate intellectual capacity added to this—were they made conscious of their strength, they would burst their bonds, and man would, in his turn, be the victim and the slave. The cortical part is found in each in the proportion in which it would seem to be needed for our purpose, in order that intelligence should be added to animal power. Almost every mental faculty, and almost every virtue, too, may be traced in the brute. The difference is in degree, and not in kind. The one being improved by circumstances and the other contaminated, the quadruped is decidedly the superior.

From the medullary substance—as already stated—proceed certain cords or prolongations, termed *nerves*, by which the animal is enabled to receive impressions from surrounding objects, and to connect himself with them; and also to possess many pleasurable or painful sensations. One of them is spread over the membrane of the nose, and gives the sense of smell; another expands on the back of the eye, and the faculty of sight is gained; and a third goes to the internal structure of the ear, and the animal is conscious of sound. Other nerves, proceeding to different parts, give the faculty of motion, while equally important ones bestow the power of feeling.

One division of nerves springing from a prolongation of the brain, wanders to different parts of the frame, for important purposes connected

with respiration or breathing. The act of breathing is essential to life, and were it to cease, the animal would die. These are nerves of *involuntary* motion; so that, whether he is awake or asleep, conscious of it or not, the lungs heave and life is supported. Lastly, extending from the medulla oblongata is the spinal cord—a further prolongation of the brain,



running through a cavity in the bones of the neck, back, and loins, and extending to the sacral canal—from which other nerves are given off at certain intervals. This cut delineates a pair of them. The portion of spinal cord represented, is supposed to be placed with its inner or lower surface towards us. The spinal cord, *a*, is composed of six distinct divisions or rods, running through its whole length—three on either side. The two upper divisions proceed from those tracks of the brain devoted to sensation. Numerous distinct fibres spring abruptly from the column, and which collect together, and, developing a little ganglion or enlargement, *d*—an enlargement of a nervous cord is called a ganglion—become a nerve of sensation. From the lower or inner side—a prolongation of the track devoted to motion—proceed other fibres, which also collect gradually together, and form a nervous cord, *c*, giving the power of motion. Beyond the ganglion the two unite, and form a perfect spinal nerve, *b*, possessing the power both of sensation and motion; and the fibres of the two columns proceed to their destination, enveloped in the same sheath, and apparently one nerve. Each portion, however, continues to be wrapped in its own membrane. They are united, yet distinct; they constitute one nerve, yet neither their substance nor their office is confounded. Our cut, closely examined, will give at *b* some idea of the manner in which these distinct fibres are continued;—each covered by its own membrane but all enveloped in a common envelope. The difference of action in the sentient and motive portions of the nerves must not be lost sight of; in the sentient, the impression commences in the minute ramifications of the nerve, and is carried on through the trunk to the sensorium: while, on the contrary, in the motor, the volition originates in the brain itself, and is communicated to the muscles; the impression in the sentient nerves traversing from the tissues to the brain, and in the motor from the brain to the tissues.

All these nerves are organs of sensation and motion alone; but there are others whose origin seems to be outside of and below the brain. These are the *sympathetic*, so called from their union and sympathy with all the others, and identified with life itself. They arise from a small enlargement, called the anterior cervical ganglia, in the upper part of the neck, and are more or less distributed over every part of the body. They go to the heart, and its beats; and to the stomach, and it digests. They form a network round each blood-vessel, and the current flows on. They surround the very minutest vessels, and the frame is nourished and built up. They are destitute of sensation, and they are perfectly beyond the control of the will.

The reader, we trust, will now comprehend this wonderful yet simple machinery, and be able, by-and-by, to refer to it the explanation of several diseases, and particularly of the operation to which we have referred.

They who know anything of the horse pay much attention to the size, setting on, and motion of the ear. Ears rather small than large—placed not too far apart—erect and quick in motion, indicate both breeding and spirit; and if a horse is frequently in the habit of carrying one ear forward and the other backward, and especially if he does so on a journey, he will generally possess both spirit and continuance. The stretching of the ears in contrary directions shows that he is attentive to everything that is taking place around him, and, while he is doing this, he cannot be much fatigued, or likely soon to become so. It has been remarked that few horses sleep without pointing one ear forward and the other backward, in order that they may receive notice of the approach of objects in every direction. ‘When horses or mules,’ says Dr. Arnott, in his ‘Elements of Physic,’ ‘march in company at night, those in front direct their ears forwards; those in the rear direct them backwards; and those in the centre turn them laterally or across; the whole troop seeming thus to be actuated by one feeling, which watches the general safety.’

The ear of the horse is one of the most beautiful parts about him, and by few things is the temper more surely indicated than by its motion. The ear is more intelligible even than the eye; and a person accustomed to the horse, and an observer of him, can tell by the expressive motion of that organ almost all that he thinks or means. It is a common saying, that when a horse lays his ears flat back upon his neck, and keeps them so, he most assuredly is meditating mischief, and the stander by should beware of his heels or his teeth. In play, the ears will be laid back, but not so decidedly or so long. A quick change in their position, and more particularly the expression of the eye at the time, will distinguish between playfulness and vice.

The external ear is formed by a cartilage of an oval or cone-like shape, flexible, yet firm, and terminating in a point. It has, directed towards the side, yet somewhat pointing forward, a large opening extending from the top to the bottom. The intention of this is to collect the sound, and convey it to the interior part of the ear.

The hearing of the horse is remarkably acute. A thousand vibrations of the air, too slight to make any impression on the human ear, are readily perceived by him. It is well known to every hunting man, that the cry of the hounds will be recognised by the horse, and his ears will be erect, and he will be all spirit and impatience a considerable time before the rider is conscious of the least sound.

This custom of cutting the ears of the horse originated, to its shame, in Great Britain, and for many years was a practice not only cruel to the animal, but depriving him also of much of his beauty; and was so obstinately pursued, that at length the deformity became in some hereditary, and a breed of horses born without ears was produced. Fortunately for this too-often abused animal, cropping is not now the fashion. Some thoughtless or unfeeling young men endeavoured, a little while ago, again to introduce it, but the voice of reason and humanity prevailed.

This cartilage, the *conch* or shell, is attached to the head by ligaments, and sustained by muscles, on which its action depends. It rests upon another cartilage, round without and irregular within, called the *annular*, ring-like, cartilage, and conducting to the interior of the ear; and it is likewise supported and moved by a third small cartilage, placed at the fore part of the base of the conch, and into which several muscles are inserted.

The ear is covered by skin thinner than in most other parts of the body, and altogether destitute of fat, in order that it may not be too bulky and heavy, and may be more easily moved. Under the skin lining the inside

of the cartilage are numerous glands that secrete or throw out a scaly white greasy matter, which may be rubbed off by the finger, and is destined to supply this part of the ear, and to keep it soft and smooth. Below this are other glands, which pour out a peculiar, sticky, bitter fluid—the wax—probably displeasing to insects, and therefore deterring them from crawling down the ear and annoying the animal, or by its stickiness arresting their progress.

The internal part of the cochlea is covered with long hair, which stands across the passage in every direction. This likewise is to protect the ear from insects, that can with difficulty penetrate through this thick defence. The cold air is likewise prevented from reaching the interior of the ear, and the sound is moderated, not arrested—penetrating readily but not violently—and not striking injuriously on the membrane covering the drum of the ear. Can these purposes be accomplished when it is the custom of so many carters and grooms to cut out the hair of the ear so closely and industriously as they do? The groom who sings it to the root with a candle must either be very ignorant or very brutal. It can scarcely be accomplished without singeing the ear as well as the hair. Many a troublesome sore is occasioned by this; and many a horse that was perfectly quiet before rendered difficult to handle or to halter, and even disposed to be otherwise vicious, from a recollection of the pain which he suffered during the absurd and barbarous operation.

The sound collected by the outer ear passes through the lower or *annular*, ring-shaped cartilage, and through irregularities which, while they break and modify it, convey it on to another canal, partly cartilaginous and partly bony, conducting immediately to the internal mechanism of the ear. This canal or passage is called the external auditory passage, and at the base of it is placed, stretching across it, and closing it, a thick and elastic membrane, *membrana tympani*, called the membrane of the drum. This membrane is supplied with numerous fibres, from the fifth pair, or sensitive nerve of the head, for it is necessary that it should possess extreme sensibility.

Between this membrane and a smaller one almost opposite, leading to the still interior part of the ear, and on which the nerve of hearing is expanded, are four little bones, united to these membranes and to each other. Their office is to convey, more perfectly than it could be done through the mere air of the cavity, the vibrations that have reached the *membrana tympani*.

These bones are connected together, and are covered by a cartilaginous substance, elastic in the greatest degree, by means of which the force of the vibration is much increased.

It is conveyed to a strangely irregular cavity, filled with an aqueous fluid, and the substance or pulp of the *portio mollis* or soft portion of the seventh pair of nerves, the *auditory* nerve, expands on the membrane that lines the walls of this cavity.

Sound is propagated far more intensely through water than through air, and therefore it is that an aqueous fluid occupies those chambers of the ear on the walls on which the auditory nerve is expanded. By this contrivance, and by others, which we have not space now to narrate, the sense of hearing is fully equal to every possible want of the animal.

The *Eye* is a most important organ, and comes next under consideration, as enclosed in the bones of the skull. The eye of the horse should be large, somewhat but not too prominent, and the eyelid fine and thin. If the eye is sunk in the head, and *apparently* little—for there is actually a very trifling difference in the size of the eye in animals of the same species

and bulk, and that seeming difference arises from the larger or smaller opening between the lids—and the lid is thick, and especially if there is any puckering towards the inner corner of the lids, that eye either is diseased, or has lately been subject to disease; and, particularly, if one eye is smaller than the other, it has at no great distance of time been inflamed.

The eye of the horse enables us with tolerable accuracy to guess at his temper. If much of the white is seen, the buyer should pause ere he completes his bargain; because, although it may, yet very rarely, happen that the *cornea* or transparent part is unnaturally small, and therefore an unusual portion of the white of the eye is seen, experience has shown that this display of white is dangerous. The mischievous horse is slyly on the look out for opportunities to do mischief, and the frequent backward direction of the eye, when the white is most perceptible, is only to give surer effect to the blow which he is about to aim.

A cursory description of the eye, and the uses of its different parts, must be given.

The eyes are placed at the side of the head, but the direction of the conoid cavity which they occupy, and of the sheath by which they are surrounded within the orbit, gives them a prevailing direction forwards, so that the animal has a very extended field of vision. We must not assert that the eye of the horse commands a whole sphere of vision; but it cannot be denied that his eyes are placed more forward than those of cattle, sheep, or swine. He requires an extensive field of vision to warn him of the approach of his enemies in his wild state, and a direction of the orbits considerably forward, in order to enable him to pursue with safety the headlong course to which we sometimes urge him.

The eyeball is placed in the anterior and most capacious part of the orbit, nearer to the frontal than the temporal side, with a degree of prominence varying with different individuals and the will of the animal. It is protected by a bony socket beneath and on the inside, but is partially exposed on the roof and on the outside. It is, however, covered and secured by thick and powerful muscles—by a mass of adipose matter which is distributed to various parts of the orbit, upon which the eye may be readily moved without friction, and by a sheath of considerable density and firmness, and especially where it is most needed, on the external and superior portions.

The adipose matter exists in a considerable quantity in the orbit of the eye of the horse, and enables that organ readily to revolve by the slightest contraction of the muscles. By the absorption of this fatty matter in sickness or old age, the eye is not only to a certain degree sunk in the orbit, but the roof of the orbit posterior to the frontal bone, being deprived of its support, is considerably depressed.

In front the eye is covered and protected by the lids, which, closing rapidly, secure it from many an injury that threatens—diffuse over it that moisture which is necessary to preserve its transparency—in the momentary act of closing give a certain and sufficient respite to a delicate organ, which would otherwise be fatigued and worn out by the constant glare of day—defend it when the eye labours under inflammation from the stimulus of light—and, gradually drooping, permit the animal to enjoy that repose which nature requires.

Extending round both lids, and, it may be almost said, having neither origin nor insertion, is a muscle called the *orbicularis palpebrarum*, or circular muscle. Its office is to close the lids in the act of winking or otherwise, but only while the animal is awake. When he sleeps this is effected by another and very ingenious mechanism. The natural state of



the eyelids is that of being closed, and they are kept open by the energy of the muscles whose office it is to raise the upper lid. As sleep steals upon the animal, these muscles cease to act, and the lids close by the inherent elasticity of the membrane of which they are composed.

The skin of the lid is, like that of the ear, exceedingly fine, in order to prevent unnecessary weight and pressure on such a part, and to give more easy and extensive motion. The lids close accurately when drawn over the eye, and this is effected by a little strip of cartilage at the edge of each of them, which may be easily felt with the finger, and preserves them in a hooplike form, and adapts them closely to the eye and to each other. The lower cartilage, however, does not present, towards the inner corner of the eye, the whole of its flat surface to the upper, but it evidently slopes inward, and only the outer edge of the under lid touches the upper. By this means a little gutter is formed, through which the superfluous moisture of the eye flows to the inner corner, where there is a canal to convey it away. By this contrivance it neither accumulates in the eye nor unpleasantly runs down the cheek.

Along the edges of the lids are placed numerous little hollows, which can be plainly distinguished even in the living horse by slightly turning down the lid. These are the openings from the meibomian or ciliary glands containing a thick and unctuous fluid, by means of which the eyes are more accurately closed, and the edges of the lids defended from the acrimony of the tears.

The horse has no *eyebrows*, and the *eyelashes* are very peculiarly arranged. The rows of hair are longest and most numerous on the upper lid, and especially towards the outer or temporal corner, because the light comes from above; and, as the animal stands, particularly when he is grazing, and from the lateral situation of his eyes, the greater portion of the light, and the attacks of insects, and the rolling down of moisture, would chiefly be from the outside or temples. Towards the inner corner of the upper lid there is little or no eyelash, because there is no probable danger or nuisance in that direction. Only a small quantity of light can enter from below, and therefore the lashes are thin and short; but as, in the act of grazing, insects may more readily climb up and be troublesome to the eye, towards the inner angle, there the principal or only hair is found on the lower lid. These apparently trifling circumstances will not be overlooked by the careful observer.

They who are unacquainted with the absurdities of stable management, or who have not carefully examined the abuses that may exist in their own establishments, can scarcely believe the foolish and cruel practices of some carters and grooms. When the groom is anxious that his horse should be as trim and neat all over as art can make him, the very eyelashes are generally sacrificed. What has the poor animal suffered, when, travelling in the noon of day, the full blaze of the sun has fallen upon his eyes; and how many accidents have probably happened from his being dazzled by the light, which have been attributed to other causes!

If the horse has no eyebrow, there are several hairs or bristles scattered on the upper eyelid, and there is a projecting fold of the lid which discharges nearly the same office. It is more conspicuous in old horses than in young ones. Some horsemen do not like to see it, and associate the idea of it with weakness or disease of the eye. This is perfectly erroneous. It is a provision of nature to accomplish a certain purpose, and has nothing to do either with health or disease.

On the lower lid is a useful provision to warn the horse of the near approach of any object that might incommode or injure him, in the form of long projecting hairs or bristles, which are plentifully imbued with

nervous influence, so that the slightest touch should put the animal on his guard. We would request our readers to touch very slightly the extremity of one of these hairs. They will be surprised to observe the sudden convulsive twitching of the lid, rendering the attack of the insect absolutely impossible. The grooms, however, who cut away the eyelashes, do not spare these useful feelers.

The eye is exposed to the action of the atmospheric air, and the process of evaporation, destructive of its transparency, is continually going on. The eye of the horse, or the visible part of the eye, is, likewise, more prominent and larger than in the human being, and the animal is often subject to extreme annoyance from dust and insects, while he has no hands or other guard to defend himself from the torture which they occasion. What is the provision of nature against this? Under, and a little within, the outer corner of the upper lid, is an irregular body, the *lachrymal gland*, comparatively larger than in the human being, secreting an aqueous fluid, which, slowly issuing from the gland, or occasionally pressed out of it in the act of winking, flows over the eye, supplies it with moisture, and cleanses it from all impurities. Human ingenuity could not have selected a situation from which the fluid could be conveyed over the eye with more advantage for this purpose.

When this fluid is secreted in an undue quantity and flows over the eye, it is called *tears*. An increased flow of tears is produced by anything that irritates the eye, and, therefore, a constant accompaniment and symptom of inflammation. A horse with any degree of weeping should be regarded with much suspicion. In the human being an unusual secretion of tears is often caused by bodily pain, and emotions of the mind; and so it is occasionally in the horse. We have seen it repeatedly under acute pain or brutal usage. John Lawrence, speaking of the cruelty exercised by some dealers in what they call 'firing' a horse before he is led out for sale, in order to rouse every spark of mettle, says, 'more than fifty years have passed away, and I have before my eyes a poor mare stone blind, exquisitely shaped, and showing all the marks of high blood, whom I saw numerically cut with the whip a quarter of an hour before the sale, to bring her to the use of her stiffened limbs, *while the tears were trickling down her cheeks.*'

Having passed over the eye, the fluid is conveyed by the little canal to which we have alluded, formed by the sloping of the under lid, towards the corner of the eye; and there are two little orifices that conduct it to a small reservoir within, and at the upper part of the lachrymal bone (fig *i*, p. 145). A little protuberance of a black or pied colour, called the *caruncle*, placed in the very corner of the eye, and to be seen without opening the lids, is situated between these orifices, and guides the fluid into them. From this reservoir the tears are conveyed by a long canal, the *lachrymal duct*, partly bony, and partly membranous, to the lower part of the nose. A little within the nostril, and on the division between the nostrils, is seen the lower opening of this canal; the situation of which should be carefully observed, and its real use borne in mind, for not only horsemen, but even some careless veterinary surgeons, have mistaken it for a glandular ulcer, and have condemned a useful and valuable animal. It is found just before the skin of the muzzle terminates, and the more delicate membrane of the nostril commences. The opening of the canal is placed thus low because the membrane of the nose is exceedingly delicate, and would be irritated and made sore by the frequent or constant running down of the tears.

There is, however, something yet wanting. We have a provision for supplying the eye with requisite moisture, and for washing from off the

transparent part of it insects or dust that may annoy the animal. What becomes of these impurities when thus washed off? Are they carried by the tears to the corner of the eye, and so pass down this duct, and irritate and obstruct it; or do they accumulate at the inner angle of the eye? There is a beautiful contrivance for disposing of them as fast as they accumulate. Concealed within the inner corner of the eye, or just at the margin of it, black or pied, is visible a triangular-shaped cartilage, the *haw*, with its broad part forwards. It is concave within, exactly to suit the globe of the eye; it is convex without, accurately to adapt itself to the membrane lining the lid; and the base of it is reduced to a thin or almost sharp edge. At the will of the animal this is suddenly protruded from its hiding-place. It passes rapidly over the eye, and shovels up every nuisance mixed with the tears, and then being speedily drawn back, the dust or insect is wiped away as the cartilage again passes under the corner of the eye.

How is this managed? The cartilage has no muscle attached to it; and the limbs and the different parts of the body, when put into motion by the influence of the will, are moved invariably by muscles. The mechanism, however, is simple and effectual. There is a considerable mass of fatty matter at the back of the eye, in order that this organ may be easily moved; and this fat is particularly accumulated about the inner corner of the eye, and beneath, and at the point of this cartilage. The eye of the horse has likewise very strong muscles attached to it, and one, peculiar to quadrupeds, of extraordinary power, by whose aid, if the animal has not hands to ward off a danger that threatens, he is at least enabled to draw the eye back almost out of the reach of that danger.

Dust, or gravel, or insects, may have entered the eye, and annoy the horse. This muscle suddenly acts: the eye is forcibly drawn back, and presses upon the fatty matter. That may be displaced, but cannot be reduced into less compass. It is forced violently towards the inner corner of the eye, and it drives before it the haw; and the haw, having likewise some fat about its point, and being placed between the eye and an exceedingly smooth and polished bone, and being pressed upon by the eye as it is violently drawn back, shoots out with the rapidity of lightning, and, guided by the eyelids, projects over the eye, and thus carries off the offending matter.

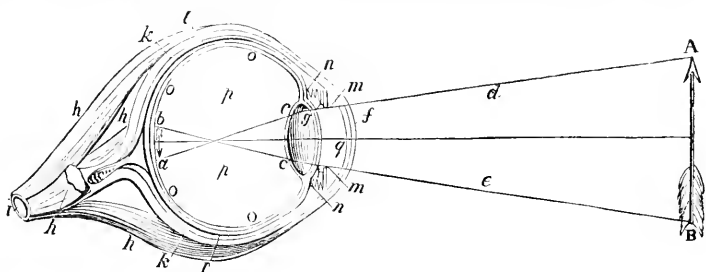
In what way shall we draw the haw back again without muscular action? Another principle is called into play, of which mention has already been made, and of which we shall have much to say—elasticity. It is that principle by which a body yields to a certain force impressed upon it, and returns to its former state as soon as that force is removed. It is that by which the ligament of the neck (p. 153), while it supports the head, enables the horse to graze—by which the heart expands after closing on and propelling forward the blood in its ventricles and the artery contracts on the blood that has distended it, and many of the most important functions of life are influenced or governed. This muscle ceases to act, and the eye resumes its natural situation in the orbit. There is room for the fatty matter to return to its place, and it immediately returns by the elasticity of the membrane by which it is covered, and draws after it this cartilage with which it is connected, and whose return is as rapid as was the projection.

The old farriers strangely misunderstood the nature and design of the haw, and many at the present day do not seem to be much better informed. When, from sympathy with other parts of the eye labouring under inflammation, and becoming itself inflamed and increased in bulk, and the neighbouring parts likewise thickened, it is either forced out of its place,

or voluntarily protruded to defend the eye from the action of light, and cannot return, they mistake it for some injurious exerescence or tumour, and proceed to cut it out. The 'haw in the eye' is a disease well known to the majority of grooms, and this sad remedy for it is deemed the only cure. It is a barbarous practice, and if they were compelled to walk half a dozen miles in a thick dust, without being permitted to wipe or to cleanse the eye, they would feel the torture to which they doom this noble animal. A little patience having been exercised, and a few cooling applications made to the eye while the inflammation lasted, and afterwards some mild astringent ones, and other proper means being employed, the tumour would have disappeared, the haw would have returned to its place, and the animal would have discharged the duties required of him without inconvenience to himself, instead of the agony to which an unguarded and unprotected eye must now expose him.

The loss of blood occasioned by the excision of the haw may frequently relieve the inflammation of the eye; and the evident amendment which follows induces these wise men to believe that they have performed an excellent operation; but the same loss of blood by scarification of the overloaded vessels of the conjunctiva, would be equally beneficial, and the animal would not be deprived of an instrument of admirable use to him.

The eye is of a globular figure, yet not a perfect globe. It is rather composed of parts of two globes; the half of one of them smaller and transparent in front, and of the other larger, and the coat of it opaque, behind. We shall most conveniently begin with the coats of the eye.



- A B a supposed object viewed by the animal, and an inverted image of which, *a, b*, is thrown on the retina at the back of the eye.
- d e* The rays proceeding from the extremities of the object to the eye.
- c c* The points where the rays, having passed the cornea and lens, converge by the refractive power of the lens.
- f* The *cornea*, or horny and transparent part of the eye, covered by the *conjunctiva*, uniting different parts together.
- g* The crystalline (crystal or glassy) lens, behind the pupil, and in front of the vitreous humour.
- h h* Muscles of the eye.
- i* The optic nerve, or nerve of sight.
- k* The *sclerotica* (hard firm coat) covering the whole of the eye except the portion occupied by the cornea, and being a seeming prolongation of the covering of the optic nerve.
- l* The *choroids* (receptacle or covering), or choroid coat, covered with a black secretion or paint.
- m m* The *iris* or rainbow-coloured circular membrane under the cornea, in front of the eye, and on which the colour of the eye depends. The duplicature behind is the *uvula*, from being coloured like a grape. The opening in the centre is the pupil.
- n n* The ciliary (hair-like) processes.
- o* The *retina*, or net-like expansion of the optic nerve, spread over the whole of the choroides as far as the lens.
- p p* The vitreous (glass-like) humour filling the whole of the cavity of the eye behind the lens.
- The aqueous (water-like) humour filling the space between the cornea and the lens.

The *conjunctiva, f*, is that membrane which lines the lids, and covers the fore part of the eye. It spreads over all that we can see or feel of the eye, even its transparent part, and is then reflected over the internal surface of the lid. It is itself transparent, and transmits the colour of the parts beneath. It is very susceptible of inflammation, during which the lining of the lids will become intensely red, and the white of the eye will be first *streaked* with red vessels, and then covered with a complete mesh of them, and the cornea will become cloudy and opaque. It is the seat of various diseases, and, particularly, it first announces that sad inflammation of the horse's eye, which bids defiance to the veterinary surgeon's skill and almost invariably terminates in blindness.

The examination of the conjunctiva, by turning down the lid, will enable us to form an accurate judgment of the degree of inflammation which exists in the eye.

Covering the back part of the eye, and indeed four-fifths of the globe of it, is the *sclerotica, k*. It is an exceedingly strong membrane, composed of fibres interweaving with each other, and almost defying the possibility of separation. An organ so delicate and so important as the eye, requires secure protection.

It is to a certain extent comparatively inelastic. It is necessary that it should be so, when it is considered that the eye is surrounded by several very powerful muscles, which must temporarily, and even for the purposes of vision, alter its form. The slight elasticity of the sclerotica is usefully developed in causing the globe of the eye to resume its former and natural shape, as soon as the action of the muscle ceases.

The sclerotica has very few blood vessels—is scarcely sensible—and its diseases, except when it participates in general disturbance or disorganisation, are rarely brought under our notice.

The *cornea* is, or we should wish it to be, the only visible part of the horse's eye, for the exhibition of much white around it is a frequent symptom of wickedness. The cornea fills up the vacuity which is left by the sclerotica in the fore part of the eye, and, although closely united to the sclerotica, may be separated from it, and will drop out like a watch-glass. It is not round, but wider from side to side than from the top to the bottom; and the curve rather broader towards the inner than the outer corner of the eye, so that the near eye may be known from the off one after it is taken from the head.

The convexity or projection of the cornea is a point of considerable importance. The prominence of the eye certainly adds much to the beauty of the animal, but we shall see presently, when we consider the eye as the organ of sight, that by being too prominent, the rays of light may be rendered too convergent, and the vision indistinct; or, if the cornea is small and flat, the rays may not be convergent enough, and perfect vision destroyed. In either case the horse may unpleasantly start, or suddenly and dangerously turn round. An eye neither too prominent nor too flat will be nearest to perfection.

It should be perfectly transparent. Any cloudiness or opacity is the consequence of disease. It is an exceedingly firm and dense membrane, and can scarcely be pierced by the sharpest instrument. The cornea is composed of many different plates, laid over one another; and between each, at least in a state of health, is a fluid that is the cause of its transparency, and the evaporation of which, after death, produces the leaden or glazed appearance of the eye. When it appears to be opaque, it is not often, and never at first, that the cornea has undergone any change.

Within the sclerotica, and connected with it by innumerable minute fibres and vessels, is the *choroid coat, l*. It is a very delicate membrane,

and extends over nearly the whole of the internal part of the eye, from the optic nerve to the cornea. It secretes a dark-coloured substance or paint, by which it is covered; the intention of which, like the inside of our telescopes and microscopes, is probably to absorb any wandering rays of light which might dazzle and confuse. The black paint, *pigmentum nigrum*, seems perfectly to discharge this function in the human eye. It is placed immediately outside the retina or expansion of the optic nerve. The rays of light fall on the retina, and penetrating its delicate substance, are immediately absorbed or destroyed by the black covering of the choroides underneath. For the perfection of many of his best pleasures, and particularly of his intellectual powers, man wants the vivid impression which will be caused by the admission of the rays of light into a perfectly dark chamber; and when the light of the sun begins to fail, his superior intelligence has enabled him to discover various methods of substituting an artificial day, after the natural one has closed. Other animals, without this power of kindling another, although inferior light, have far more to do with the night than we have. Many of them sleep through the glare of day, and are awake and busy during the period of darkness. The ox occupies some hours of the night in grazing; the sheep does so when not folded in his pen; and the horse, worked during the day for our convenience and profit, has often little more than the period of night allotted to him for nourishment and repose. It is necessary then that, by some peculiar and adequate contrivance, these hours of comparative or total darkness to us should be partially yet sufficiently illuminated for them; and therefore, in the horse, the dark-brown or black coat of the choroides does not extend over the whole of the internal part of the eye, or rather it is not found on any part on which the rays proceeding from the objects could fall. It does not occupy the smallest portion of what may be called the field of vision; but, in its place, a bright variegated green is spread, called the *tapetum lucidum*, and more over the upper part than the lower, because the animal's food, and the objects which it is of consequence for him to notice, are usually below the level of his head—thus, by suffering the impression to remain longer on the retina, or by some portion of light reflected from this variegated bed on which the retina reposes, or in some other inexplicable but efficient way, enabling the animal, even in comparative darkness, to possess a power of vision equal to his wants.

The reader may see in the dusk, or even when duskiness is fast yielding to utter darkness, the beautiful sea-green reflection from the eye of the horse. It is that lucid variegated carpet of which we are now speaking.

Who is unaware that in the fading glimmering of the evening, and even in the darker shades of night, his horse can see surrounding objects much better than his rider: and who, resigning himself to the guidance of that sagacious and faithful animal, has not been carried in safety to his journey's end, when he would otherwise have been utterly bewildered?

If the reader has not examined this beautiful pigment in the eye of the horse, he should take the earliest opportunity of doing so. He will have a beautiful illustration of the care which that Being who gave all things life has taken that each shall be fitted for his situation. The horse has not the intelligence of man, and may not want for any purpose of pleasure or improvement the vivid picture of surrounding objects which the retina of the human being presents. A thousand minute but exquisite beauties would be lost upon him. If, therefore, his sense of vision may not be so strong during the day, it is made up to him by the increased power of vision in the night.

Perfectly white and cream-coloured horses have a peculiar appearance of the eyes. The pupil is red instead of black. There is no black paint or

brilliant carpet. It is the choroid coat itself which we see in them, and not its covering; and the red appearance is caused by the numerous blood-vessels which are found on every part of that coat.

When we have to treat of other domestic animals, we shall see how this carpet is varied in colour to suit the situation and necessity of each. In the ox it is of a dark green. He has not many enemies to fear, or much difficulty in searching for nourishment, and the colour of the eye is adapted to his food. In the cat and all his varieties it is yellow. We have heard of the eyes of the lion appearing like two flaming torches in the night. There are few of our readers who have not seen the same singular glare from the eyes of the domestic cat. In the wolf, and likewise in the dog, who, in his wild state, prowls chiefly at night, it is grey. In the poor unjustly-persecuted badger, who scarcely dares to crawl forth at night, although sheltered by the thickest darkness, it is white; and the ferret, who is destined to hunt his prey through all its winding retreats, and in what would be to us absolute darkness, has no paint on the choroides.

Tracing the choroides towards the fore part of the eye, we perceive that it is reflected from the side to the edge of the lens, *n*, and has the appearance of several plaits or folds. They are actually foldings of the membrane. It is not diminished in size, but it has less space to cover, and there must be duplicatures or plaits. They are usefully employed in the place in which we find them. They prevent the passage of any rays of light on the outside of the lens, and which, proceeding forward in various directions, and uncondensed by the power of the lens, would render vision confused or imperfect. These folds of the choroides are called the *ciliary processes*.

Occupying the fore part of the eye, is the *aqueous humour*, *q*, so termed from its resemblance to pure water. It is that by which the cornea is preserved in its protuberant and rounded form. It extends to the crystalline lens, *g*, and therefore a portion of it, although a very small one, is behind the iris. Floating in this fluid is a membrane, with an oblong aperture, called the *Iris* (*m*, p. 160). It is that which gives colour to the eye. The human eye is said to be black, or hazel, or blue, according to the colour of this membrane or curtain; and it is denominated the iris, or rainbow, from its beautiful, intermingling hues. The colour varies little in the horse, except that it always bears some analogy to that of the skin. We rarely see it lighter than a hazel, or darker than a brown. Horses perfectly white, or cream-coloured, have the iris white and the pupil red. When horses of other colours, and that are usually pied, have a white iris and a black pupil, they are said to be *wall-eyed*. Vulgar opinion has decided that a wall-eyed horse is never subject to blindness, but this is altogether erroneous. There is no difference of structure that can produce this exemption; but the wall-eyed horse, from this singular and unpleasant appearance, and his frequent want of breeding, may not be so much used and exposed to many of the usual causes of inflammation.

The aperture in the iris is termed the *pupil*, and through it light passes to the inner chamber of the eye. The pupil is oblong, and variable in size. It differs with the intensity or degree of light that falls upon the eye. In a dark stable the pupil is expanded to admit a great proportion of the light that falls upon the cornea; but when the horse is brought towards the door of the stable and more light is thrown upon the eye, the pupil contracts in order to keep out that extra quantity which would be painful to the animal, and injurious to vision. When opposed directly to the sun, the aperture will almost close.

This alteration of form in the pupil is effected by the muscular fibres that enter into the composition of the iris. There are two orders of these fibres, the circular and the straight or radiating. When the circular fibres

act, the pupillary opening is closely contracted, having the appearance of a single line; when, on the contrary, the radiating fibres are brought into action, the pupil is dilated to its greatest extent. A strong light induces the action of the former, to lessen its effect, and a dim light the latter, to admit the greatest possible quantity of it. The light, however, does not act on the iris itself, but on the optic nerve, and it is from a reflected action from the brain that the muscular power of the iris is influenced. The motions of the iris are not at all under the control of the will, nor is the animal sensible of them. They are produced by sympathy with the state of the retina. When, however, a deficient portion of light reaches the retina, and vision is indistinct, we are conscious of an apparent effort to bring the object more clearly into view, and the fibres then contract, and the aperture enlarges, and more light is admitted.

This dilatation or contraction of the pupil gives a useful method of ascertaining the existence of blindness in one eye or in both. The cornea and crystalline lens remain perfectly transparent, but the retina is palsied, and is not affected by light; and many persons have been deceived when blindness of this description has been confined to one eye. A horse blind in both eyes will usually have his ears in constant and rapid motion, directing them in quick succession to every quarter. He will likewise hang back in his halter in a peculiar way, and will lift his feet high as if he were stepping over some obstacle, when there is actually nothing to obstruct his passage, and there will be an evident uncertainty in the putting down of his feet. In blindness of one eye little or nothing of this characteristic gait and manner can be perceived. Although a one-eyed horse may not be absolutely condemned for the common business of the carriage or the road, he is generally deteriorated as a hunter, for he cannot measure his distances, and will run into his leaps. Many a sportsman, puzzled and angry at the sudden blundering of his horse, or injured by one or more stunning falls, has found a very natural although unexpected explanation of it in the blindness of one eye, and that perhaps produced through his own fault, by over riding his willing and excellent servant and causing a determination of blood to the eye, which proved fatal to the delicate texture of the retina. Even for the carriage or the road he is considerably deteriorated, for his field of observation must be materially lessened.

Let the size of both pupils be carefully noticed before the horse is removed from the stable, and, as he is led to the door, observe whether they both contract, and equally so, with the increase of light. If the horse should be first seen in the open air, let it be observed whether the pupils are precisely of the same size; and let the hand be placed over each eye alternately and held there for a little while, and let it be observed whether the pupil dilates with the abstraction of light, and equally in each eye.

Hanging from the upper edge of the pupil of the horse, are two or three round black substances, as large as millet seeds, called the *corpora nigra*. When the horse is suddenly brought into an intense light, and the pupil is closed, they present a singular appearance, as they are pressed out from between the edges of the iris. An equal number, but much smaller, are attached to the edge of the lower portion of the iris. Their general use is probably to intercept rays of light which would be troublesome or injurious, and their principal function is accomplished during the act of grazing. They are larger on the upper edge of the iris, and are placed on the outer side of the pupil, evidently to discharge the same function which we have attributed to the eyelashes, viz., to obstruct the light in those directions in which it would come with greatest force, both from above and even from



below, while, at the same time, the field of view is perfectly open, so far as it regards the pasture on which the horse is grazing.

In our cut *m* gives a duplicature of the iris, or the back surface of it. This is called the *uvea*, and it is covered with a thick coat of black mucus, to arrest the rays of light, and to prevent them from entering the eye in any other way than through the pupil. The colour of the iris is, in some unknown way, connected with this black paint behind. Wall-eyed horses, whose iris is white, have no uvea.

We now arrive at a body on which all the important uses of the eye mainly depend, the *crystalline lens*, *g*, p. 160, so called from its resemblance to a piece of crystal, or transparent glass. It is of a yielding jelly-like consistence, thicker and firmer towards the centre, and convex on each side, but more convex on the posterior than the anterior side. It is enclosed in a delicate transparent bag or *capsule*, and is placed between the aqueous and the vitreous humours, and received into a hollow in the vitreous humour, with which it exactly corresponds. It has, from its density and its double convexity, the chief concern in converging the rays of light which pass into the pupil.

Behind the lens, and occupying four-fifths of the cavity of the eye, is the *vitreous humour* (glassy, or resembling glass). It seems, when first taken from the eye, to be of the consistence of a jelly, and of beautiful transparency; but if it is punctured a fluid escapes from it as limpid and as thin as water, and when this has been suffered completely to ooze out, a tissue of thin transparent membranous bags or cells remains. The *vitreous humour* consists of a watery fluid contained in these cells; but the fluid and the cells form a body of considerably greater density than the aqueous fluid in the front of the eye.

Last of all, between the *vitreous humour* and the *choroid coat*, is the *retina*, *o*, p. 160, or net-like membrane. It is an expansion of the substance, *i*, of the optic nerve. When that nerve has reached the back of the eye, and penetrated through the sclerotic and choroid coats, it first enlarges into a little white prominence, from which radiations or expansions of nervous matter proceed, which spread over the whole of the choroid coat, and form the third investment of the eye. The membrane by which this nervous pulp is supported, is so exceedingly thin and delicate, that it will tear with the slightest touch, and break even with its own weight. The membrane and the pulp are perfectly transparent in the living animal. The pupil appears to be black, because in the daytime it imperfectly reflects the colour of the choroid coat beneath. In the dusk it is greenish, because, the glare of day being removed, the actual green of the paint appears.

On this expansion of nervous pulp, the rays of light from surrounding objects, condensed by the lens and the humours, fall, and producing a certain image corresponding with these objects, the animal is conscious of their existence and presence.

It may, however, so happen that from the too great or too little convexity of the eye or a portion of it, the place of most distinct vision may not be immediately on the retina, but a little before or behind it. In proportion as this is the case, the sight will be indistinct and imperfect; nor shall we be able to offer any remedy for this defect of sight. There is a *shying*, often the result of cowardice or playfulness, or want of work, but at other times proving, beyond contradiction, a defect of sight even more dangerous than blindness. A blind horse will resign himself to the guidance of his rider or driver; but against the misconception and starting of a shying horse there is no defence. That horses grow shy as they grow old no one accustomed to them will deny; and no intelligent person will be slow in attributing it to the right cause—a decay in the organ of vision,

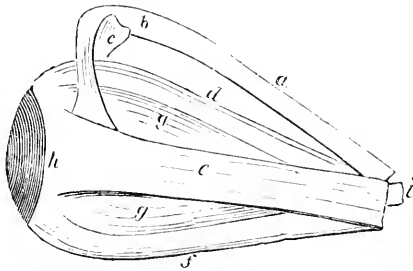
—a loss of convexity in the eye, lessening the convergency of the rays, and throwing the perfect image beyond, and not on the retina. There is a striking difference in the convexity of the cornea in the colt and the old horse; and both of them, probably, may shy from opposite causes—the one from a cornea too prominent, and the other from one too flat. In the usual examination of the horse previously to purchase, sufficient attention is not always paid to the convexity of the cornea.

The remedy for shying will be considered when we speak of the *vices* of horses.

There is a provision yet wanting. The horse has a very extended field of view, but many persons are not perhaps aware how little of it he can command at a time. There is not one of our readers who can make out a single line of our treatise without changing the direction of the eye. It is curious to follow the motion of the eyes of a rapid reader. Nature has given no less than seven muscles to the horse, in order to turn this little but important organ; and that they may act with sufficient power and quickness, no fewer than six nerves are directed to the muscles of the eye generally, or to particular ones—while the eye rests on a mass of fat, that it may be turned with little exertion of power, and without friction.

#### MUSCLES OF THE EYE.

There are four straight muscles, three of which, *d*, *e*, and *f*, are represented in our cut, rising from the back of the orbit, and inserted into the



ball of the eye, opposite to and at equal distances from each other. One, *d*, runs to the upper part of the eye, just behind the transparent and visible portion of it, and its office is clearly to raise the eye. When it contracts, the eye must be drawn upward. Another, *f*, is inserted exactly opposite, at the bottom of the eye; and its office is as clearly to depress the eye, or enable the

animal to look downwards. A third, *e*, is inserted at the outer corner, and by means of it the eye is turned outward, and from the situation of the eye of the horse, considerably backward; and the fourth is inserted at the inner corner, turning the eye inward. They can thus rotate or turn the eye in any direction the animal wishes, and by the action of one, or the combined power of any two of them, the eye can be immediately and accurately directed to every point.

These muscles, however, have another duty to discharge. They support the eye in its place. In the usual position of the head of the horse, they must be to a certain degree employed for this purpose; but when he is grazing or feeding, the principal weight of the eye rests upon them. Another muscle is therefore added, peculiar to quadrupeds, called the *retractor* (*drawer-back*), or the *suspensorius* (*suspensory*) muscle, *g*. It arises from the edge of the foramen through which the optic nerve enters the orbit—surrounds the nerve as it proceeds forward, and then, partially dividing into four portions, is attached to the back part of the eye. Its office is evidently to support the eye generally, or, when suddenly called into powerful action, and assisted by the straight muscles, it draws the eye back out of the reach of threatening danger, and in the act of drawing it back causes the hawk to protrude, as an additional defence.

The power of this muscle is very great. It renders some operations on the eye almost impossible. It is an admirable substitute for the want of hands, to defend the eye from many things that would injure it; and, being partially separated into four divisions, it assists the straight muscles in turning the eye.

These muscles discharge another and a most important office. If we examine near and distant objects through a telescope, we must *alter the focus*; i. e. we must increase or diminish the length of the tube. We must shorten it a little when we examine distant objects, because the rays, coming to us from them in a less divergent direction, are sooner brought to a point by the power of the lens. Thus the straight and retractor muscles drawing back the eye, and forcing it upon the substance behind, and in a slight degree flattening it, bring the lens nearer to the retina, and adapt the eye to the observation of distant objects.

Still, however, being constantly employed in supporting the weight of the eye, these muscles may not be able to turn it so rapidly and so extensively as the wishes or wants of the animal require; therefore two others are superadded which are used solely in turning the eye. They are called oblique muscles, because their course is obliquely across the eye. The upper one is most curiously constructed, *a, b*. It comes from the back part of the orbit, and takes a direction upwards and towards the inner side, and there, just under the ridge of the orbit, it passes through a perfect mechanical pulley, and turning round, proceeds across the eye, under the tendon of the upper straight muscle, and is inserted rather beyond the middle of the eye, towards the outer side. Thus the globe of the eye is evidently directed downwards and outwards. Something more, however, is accomplished by this singular mechanism. The eye is naturally deep in its orbit, that it may be more perfectly defended; but it may be necessary occasionally to bring it forward, and enlarge the field of vision. The eye is actually protruded under the influence of fear. Not only are the lids opened more widely, but the eye is brought more forward. How is this accomplished? There are no muscles anterior to or before the eye—there is no place for their insertion. The object is readily effected by this singular pulley, *c*. By the power of this muscle,—the *trochlearis*, or pulley-muscle—and the straight muscles at the same time not opposing it, or only regulating the direction of the eye, it is really brought somewhat forward. The lower oblique muscle rises just within the lachrymal bone (*i*, p. 166), and, proceeding across the eye, is fixed into the part of the sclerótica opposite to the other oblique muscle, and it turns the eye in a contrary direction, assisting, however, the upper oblique in bringing the eye forward from its socket.

---

## CHAPTER IX

### INJURIES AND DISEASES OF THE SKULL — THE BRAIN — THE EARS—AND THE EYES.

WE have now arrived at a convenient resting-place in our somewhat dry but necessary description of the structure of the horse, and we willingly turn to more practical matter. We will consider the injuries and diseases of the parts we have surveyed. In entering, however, on this division of our work we would premise, that it is impossible for us to give the farmer such an account of the nature and treatment of the diseases of horses as will enable him with safety to practise for himself, except in the com-

monest cases. The causes of most diseases are so obscure, their symptoms so variable, and their connection with other maladies so complicated and mysterious, that a life devoted to professional study will alone qualify a man to become a judicious and successful practitioner on the diseases of the horse and other domestic animals. Our object will be to communicate sufficient instruction to the farmer to enable him to act with promptness and judgment when he cannot obtain professional assistance, to qualify him to form a satisfactory opinion of the skill of the veterinary surgeon whom he may employ, and, more especially, to divest him of those strange and absurd prejudices which in a variety of cases not only produce and prolong disease, but bring it to a fatal termination.

#### CONCUSSION OF THE BRAIN.

This consists of a sudden interruption of the functions of the brain, caused by some mechanical injury to the head, such as a fall or violent blow, not necessarily accompanied by structural injury to the brain itself. It is frequently produced by the horse rearing and falling backwards, bringing the head with great violence to the ground, or by the animal running away and the head coming in contact with a wall or some hard substance. After the injury, the animal generally lies motionless and insensible, and may continue so from a few minutes to half an hour. When in this state, he should be allowed to remain for a time without being disturbed, and, in most cases, sensibility will quickly return. The animal having risen, should be removed into a well ventilated but somewhat dark stable. He should be kept for a few days perfectly quiet; a dose of purgative medicine should be given, and his diet consist of soft foods, such as bran-mash—when, if no other symptoms show themselves, he may be considered convalescent. The most serious results which sometimes follow this injury of the brain, are fracture of the bones of the skull, or rupture of some large vessel connected with the brain.

#### PRESSURE ON THE BRAIN.

Hydatids are often found within the cranial cavity, and lying upon or imbedded in the brain of oxen and sheep. Their existence is usually fatal to the animal. There is no well-authenticated account of the existence of an hydatid in the cranial cavity of the horse; but cysts, containing a serous or viscid fluid, are occasionally observed. The following is the history of one:—A horse exhibited symptoms of vertigo, or staggers, which disappeared after copious bleeding and purgatives. About twelve months afterwards the same complaint was evident. He carried his head low and inclined to the right side. He staggered as he walked, and the motion of his limbs was marked by a peculiar action, confined to the fore extremities. He moved by a succession of spasmodic boundings. He was completely deaf; and rapidly lost flesh, although he ate and drank voraciously. He remained in this state, to the shame of the owner and the practitioner, several months, and then he had a fresh attack of vertigo, and died suddenly. On examination of the brain, its membranes were found to be completely reddened; and between the two lobes of the brain was a round cyst as large as a pullet's egg. The pressure of this was the manifest cause of the mischief.

This may also be produced by some fluid thrown out between the membranes, or occupying and distending the ventricles of the brain. In the full-grown horse it rarely occurs; but it is well known to breeders as an occasional disease of the foal, under the name of 'water in the head'—hydrocephalus. The head is either much enlarged, or strangely deformed,

or both ; and the animal dies, either in the birth, or a few days after it. A much more common cause of pressure on the brain arises from fracture, with depression of the bone; when an accident occurs either from a fall or a blow, and it is followed by an immediate state of stupor or insensibility, this will be found to be the case, and a careful examination of the cranium will at once detect it; or very nearly as rapid a state of stupor may supervene when, from the accident, a blood-vessel is ruptured, and effusion of blood on the surface of the brain follows.

#### STAGGERS.

Under this head three varieties are familiarly known: viz., Stomach Staggers, Sleepy Staggers, and Mad Staggers. They all more or less resemble each other, differing only in their degree of violence, and the causes in operation to produce them.

#### STOMACH STAGGERS,

As the name indicates, is generally produced by some derangement of the digestive organs, consequent upon some mismanagement either in the feeding of the animal or in the nature of the food upon which he has been fed. When the horse has been kept for some hours without eating, and has been worked hard, and become thoroughly hungry, he feeds ravenously on every kind of food he can get at, swallowing it faster than his small stomach can digest it, and no water being given to soften and hasten its passage, the stomach becomes crammed, and having been previously exhausted by long fasting, is unable to contract upon its contents. The food soon begins to ferment and to swell, causing great distension; the brain sympathises with this overloaded organ, and staggers are produced. We can easily imagine this, when we remember the sad head-aches occasionally arising from an overfilled and disordered stomach.

This disease is found more frequently in the stable of the postmaster and the farmer than anywhere else. Thirty years ago it was the very pest of these stables, and the loss sustained by some persons was enormous; but, as veterinary science progressed, the nature and the causes of the disease were better understood, and there is not now one case of staggers where twenty used to occur.

The system of horse management is now essentially changed. Shorter stages, a division of the labour of the day, and a sufficient interval for rest, and for feeding, have, comparatively speaking, banished *stomach staggers* from the stables of the postmaster. The division of the morning and afternoon labour of the farmer's horse, with the introduction of that simple but invaluable contrivance, *the nose-bag*, having rendered this disease comparatively rare in the establishment of the agriculturist. To the late Professor Coleman we are indebted for some of these most important improvements.

Old horses are more subject to staggers than young ones, for the stomach has become weak by the repetition of the abuses just described. It has not power to digest and expel the food, and thus becomes a source of general, and particularly of cerebral, disturbance.

Horses at grass are occasionally attacked by this disease; but they are generally poor, hard-worked, half-starved animals, turned on richer pasture than their impaired digestive organs are equal to. Perhaps the weather is hot, and the sympathy of the brain with the undue labour of the stomach is more easily excited, and a determination of blood to the brain more readily effected.

Mr. Percivall gives a very satisfactory illustration of the production of staggers in this way. He says that 'when his father first entered the

service of the Ordnance, it was the custom to turn horses which had become low in condition, but were still well upon their legs, into the marshes, in order to recruit their strength. During the months of July, August, and September, nothing was more common than an attack of staggers among these horses, and which was naturally attributed to the luxuriant pasture they were turned into, combined with the dependent posture of the head, and the sultry heat to which they were exposed.'

When the horse is attacked with stomach staggers, he generally appears dull and sleepy, standing with his head hanging down, and supported by the manger, or pushed forward against the wall, breathing heavily, with a slow, oppressed pulse, bowels constipated and abdomen frequently distended. He sleeps or seems to do so, as he stands, being partly unconscious of surrounding objects. When aroused he will look vacantly around, perhaps seize a lock of hay, and doze again with it in his mouth. He may continue in this state for several days, and will either begin slowly to recover, or the symptoms will take a more violent form and terminate either in apoplexy or phrenitis. In regard to the treatment, it will be necessary for the owner or the veterinary attendant to institute very careful inquiry, or he will not detect the real causes of the disease. Does it arise from improper management, to which the horse has been in a manner habituated? Had he been subjected to long labour and fasting, and had then the opportunity of gorging to excess? Did it proceed from accidental repletion—from the animal having got loose in the night, and found out the corn or the chaff bin, and filled himself almost to bursting? There is nothing in the appearance of the animal which will lead to a discovery of the cause—no yellowness or twitchings of the skin, no local swellings, as some have described; but the practitioner or the owner must get at the truth of the matter as well as he can, and then proceed accordingly.

Our first object, then, should be to remove if possible the causes in operation producing this disease, and with this view large doses of oleaginous purgatives should be administered, and repeated every six hours, and during the interval a stimulant, such as the aromatic spirit of ammonia, given in large quantities of water; clysters also of soap and warm water should be frequently administered, and all food removed from the animal. Should this treatment have the desired effect and the horse begin to exhibit signs of returning consciousness, he should be kept quiet for a time, care being taken to keep the bowels freely open, and nothing but soft and easily digestible food allowed him. If any staggering remains, a blister should be applied at the back of his head. When sufficiently recovered he may be turned out with advantage on rather bare pasture. One circumstance, however, should never be forgotten, that the horse who has once been attacked with staggers is liable to a return of the complaint from causes that would not otherwise affect him. Let no farmer delude himself with the idea that stomach staggers is contagious. If his horses have occasionally slight fits of staggers, or if the disease carries off several of them, he may be sure there is something wrong in his management. One horse may get at the corn-bin and cram himself to bursting, but if several are attacked, it is time for the owner to look about him.

#### SLEEPY STAGGERS.

Although this disease much resembles stomach staggers in its general characters, it cannot be traced to the same cause, viz., derangement of the digestive organs, but is generally considered to be a primary disease of the brain. The symptoms are much the same as in stomach staggers, the animal appearing dull and sleepy, pushing his head forward in a peculiar manner against the wall or manger, not however with so much force as in

that disease. When aroused by some sudden noise, he starts up in a state of alarm, appearing frightened, looks up, and perhaps recognises those near him, and then relapses into his former state of stupor. The pulse is slow and oppressed, with the respiration laboured. The stomach frequently contains but little food, and no distension of the abdomen is present. By way of treatment a full dose of aloes, in combination with calomel, should be given, and a blister at once applied to the upper and back part of the head. The animal in the meantime should be kept perfectly quiet, and allowed nothing but soft food, such as bran-mash, &c. to eat. Should the symptoms not pass off in a few days, an attack of phrenitis will generally follow.

#### APOPLEXY.

Although apoplexy is a disease somewhat rare in the horse compared with man, it much resembles it in its generally fatal termination. It depends upon some undue pressure on the substance of the brain, and may result from several causes, such as tumours pressing on the brain, fracture and depression of bone, or rupture of some blood-vessel, and extravasation of blood, either the result of injury, such as concussion, or as a termination of a congested state of the vessels of the brain. Apoplexy as resulting from the last-named cause is the form in which we most commonly meet with the disease in the horse, being generally a termination of stomach staggers. The symptoms will depend upon the cause in operation. When apoplexy is produced by fracture and depression of bone or the sudden rupture of some blood-vessel, the result of violence, the symptoms will immediately follow the injury, but when it is produced by the giving way of the previously congested blood-vessels, we have usually some premonitory symptoms. These will be found described under stomach staggers, and may continue for some days, when they suddenly assume a more serious character.

The animal, which has hitherto been only in a partly unconscious state, will now be found perfectly insensible; the eye opens, but it has an unmeaning glare; the hand is moved before him, but the eye closes not; he is spoken to, but he hears not.

He now begins to foam at the mouth. His breathing is laborious and loud. It is performed by the influence of the organic nerves, and those of animal life no longer lend their aid. The pulse is slow and oppressed—the muzzle is cold, and the discharge of the fæces involuntary. He grinds his teeth—twitchings steal over his face and attack his limbs—they sometimes proceed to convulsions, and dreadful ones too, in which the horse beats himself about in a terrible manner; but there is rarely disposition to do mischief. In the greater number of cases these convulsions last not long. The last act of voluntary motion which he will attempt is usually to drink: but he has little power over the muscles of deglutition, and the fluid returns through the nostrils. All the powers of life are oppressed, and death speedily closes the scene.

Little can be hoped from the treatment of apoplexy, as in most cases all our efforts will fail in affording relief. If there be time for medical treatment, our first effort should be to prevent inflammation, and procure absorption of the extravasated blood. Copious bleeding, therefore, from the jugular vein, to the extent of seven or eight quarts, should be at once had resort to, and a full dose of purgative medicine, from eight to ten drachms of aloes, administered; clysters also of warm water and soap, should be frequently thrown up the rectum. The animal should be allowed plenty of cool air, and be kept perfectly quiet. Should the more active symptoms abate, which there is too much fear will rarely be the case, care

should be taken to keep the bowels freely relaxed, and a blister may now be applied to the back of the head, or a seton inserted. For some time the horse should be kept on a restricted diet; mashies should be given; green meat in no great quantity; a moderate allowance of hay, and very little corn until sufficiently recovered, when he may be allowed a more generous diet.

#### PHRENITIS—INFLAMMATION OF THE BRAIN—MAD STAGGERS.

Inflammation of the brain or its membranes, or both, sometimes occurs, and of the membranes oftenest when both are not involved. It may be produced by several causes, such as from a tumour pressing on the brain, or fracture and depression of bone, inflammation supervening after the comatose stage has passed off. It may also be produced by metastasis, but we most commonly meet with phrenitis in the horse, as a termination of either stomach or sleepy staggers, most frequently the latter. Whatever be the origin of phrenitis, its early symptoms are scarcely different from those of stomach or sleepy staggers. The horse is drowsy, stupid; his eye closes; he sleeps while he is in the act of eating, and dozes until he falls. The pulse is slow and creeping, and the breathing oppressed and laborious. The symptoms may differ a little in intensity and continuance, but not much in kind.

The phrenitic horse, however, is not so perfectly comatose as another that labours under apoplexy. The eye will respond a little to the action of light, and the animal is somewhat more manageable, or at least more susceptible, for he will shrink when he is struck, while the other frequently cares not for the whip.

If remedial measures have not become effectual in the early stage, the scene all at once changes, and the most violent reaction succeeds. The eye brightens—strangely so; the membrane of the eye becomes suddenly reddened, and forms a frightful contrast with the transparency of the cornea; the pupil is dilated to the utmost: the nostril, before scarcely moving, expands, and quivers, and labours; the respiration becomes short and quick; the pulse hard and frequent; the ears are erect, or bent forward to catch the slightest sound; and the horse becoming more irritable every instant, trembles at the slightest motion. The irritability of the patient increases—it may be said to change to ferocity—but the animal has no aim or object in what he does. He dashes himself violently about, plunges in every direction, rears on his hind legs, whirls round and round, and then falls backward with dreadful force. He lies for a while exhausted—there is a remission of the symptoms, but perhaps only for a minute or two, or possibly for a quarter of an hour.

Now is the surgeon's time, and his courage and adroitness will be put to the test. He must open, if he can, one or both jugulars: but let him be on his guard, for the paroxysm will return with its former violence and without the slightest warning. This is a case, and the only case, in which a ligature should be placed round the neck previously to the vein being opened; for this being done, however soon the paroxysm of violence may return, a full abstraction of blood may confidently be relied on.

The second attack is more dreadful than the first. Again the animal whirls round and round, and plunges and falls. He seizes his clothing and rends it in pieces; perhaps, destitute of feeling and of consciousness, he bites and tears himself. He darts furiously at everything within his reach; but no mind, no design, seems to mingle with or govern his fury.

Another and another remission and a return of the exacerbation follow, and then, wearied out, he becomes quiet; but it is not the quietness of returning reason—it is mere stupor. This continues for an uncertain



period, and then he begins to struggle again; but he is now probably unable to rise. He pants—he foams—at length, completely exhausted, he dies.

There are but two diseases with which phrenitis can be confounded, and they are colic and rabies. In colic, the horse rises and falls; he rolls about and kicks at his belly; but his struggles are tame compared with those of the phrenitic horse. There is no involuntary spasm of any of the limbs; the animal is perfectly sensible, and, looking piteously at his flanks, seems designedly to indicate the seat of pain. The beautiful yet fearfully excited countenance of the one, and the piteous, anxious gaze of the other, are sufficiently distinct; and if it can be got at, the rapid bounding pulse of the one, and that of the other scarcely losing its natural character in the early stage, cannot be mistaken.

In rabies, when it does assume the ferocious form, there is even more violence than in phrenitis; but there is method, and treachery too, in that violence. There is the desire of mischief for its own sake, and there is frequently the artful stratagem to allure the victim within the reach of destruction. There is not a motion of which the rabid horse is not conscious, nor a person whom he does not recognise; but he labours under one all-absorbing feeling—the intense longing to devastate and destroy.

The post-mortem appearances are altogether uncertain. There is usually very great injection and inflammation of the membranes of the brain, and even of portions of the substance of the brain; but in other cases there is scarcely any trace of inflammation, or even of increased vascularity.

The treatment of phrenitis has been very shortly hinted at. The first—the indispensable proceeding—is to bleed; to abstract as much blood as can be obtained; to let the animal bleed on after he is down; and indeed not to pin up the vein of the phrenitic horse at all. The patient will never be lost by this decisive proceeding, but the inflammation may be subdued, and here the first blow is the whole of the battle. The physic should be that which is most readily given and will most speedily act. The farina of the croton will, perhaps, have the preference. Half a drachm or two scruples of it may be fearlessly administered. The intense inflammation of the brain gives sufficient assurance that no dangerous inflammation will be easily set up in the intestinal canal. This medicine can be formed into a very little ball or drink, and in some momentary remission of the symptoms, administered by means of the probang, or a stick, or the horn. Sometimes the phrenitic horse, when he will take nothing else, and is unconscious of everything else, will drink with avidity gruel or water. Repeated doses of purgative medicine may perhaps be thus given, and they must be continued until the bowels respond. The bleeding and physis having been energetically had recourse to, these must be followed up by the uninterrupted application of cold in any and every form;—ice, if it can be procured, the coldest water dashed freely against the head, or poured on it from a considerable height, and for a considerable length of time, is the only adjunct that offers a chance of relief;—continue it unremittingly for hours;—blisters are not only useless but absolutely injurious, and in this active, rapid, and fatal disease should never be had recourse to. The bowels having been well opened, emetic tartar, with calomel or nitre, should be given. The animal should be kept as quiet as possible in a somewhat dark but well-ventilated stable.

While the disease continues, no attempt must be made to induce the horse to feed; and even when appetite returns with the abatement of inflammation, great caution must be exercised both with regard to the quantity and quality of the food.

## MEGRIMS.

There are but few diseases in the horse, respecting the nature of which so many different views have been entertained, and of which, nevertheless, even at the present day, so little is understood, as megrims. By some it has been considered as a mild form of apoplexy, depending upon an undue supply of blood to the brain, and by others upon just the opposite state, viz. some obstruction to the natural supply of blood to that organ. Mr. Percivall treats of it as a species of vertigo, but probably the more general opinion at the present time inclines to the belief that it is a disease analogous to that termed epilepsy in the human subject. It is occasionally met with in all classes of horses and under a variety of circumstances, when both at rest and at work, but much more frequently amongst horses that are used for harness purposes, especially when used for that purpose, on the bright, sunny days of spring and summer.

It comparatively rarely happens when the horse is ridden; but should he be driven, and perhaps rather quickly, he may perform a part of his journey with his usual cheerfulness and ease; he will then suddenly stop, shake his head, and exhibit evident giddiness and half-unconsciousness. In a minute or two this will pass over, and he will go on again as if nothing had happened.

Occasionally, however, the attack will be of a more serious nature. He will fall without the slightest warning, or suddenly run round once or twice, and then fall. He will either lie in a state of complete insensibility, or struggle with the utmost violence. In five or ten minutes he will begin gradually to come to himself; he will get up and proceed on his journey, yet somewhat dull, and evidently affected and exhausted by what had happened, although not seriously or permanently ill.

This is a very dangerous disease—dangerous to the horse, which will occasionally die on the spot, and particularly dangerous to those who drive him, for there will be no warning or opportunity to escape. When the horse is attacked with megrims, the first object of the driver should be to control the violence of the animal as much as possible; he should loosen the curb-rein, ease the collar, and, if at hand, dash some cold water over the animal's head, and pursue his journey as slowly as circumstances will permit. When the horse gets home a dose of purgative medicine should be given to him, and be kept on bran-mash for three or four days, great attention being afterwards paid to the state of the digestive organs. Is all this necessary because a horse has happened to have a fit of the megrims? Yes, and more too, in the mind of the prudent man; for it is seldom that the horse has the megrims without the predisposition to a second attack remaining. The testimony of experience is uniform in regard to this, and he would not do justice to himself or his family who trusted himself behind a horse that had a second attack of megrims. The numbers of horses that in London are constantly being sold and resold on account of this malady, is perfectly astonishing. There are a set of men about town, known by the name of 'touters,' who either personally, or through the medium of the common sale yards, dispose of an animal with this affection at prices varying from 15*l.* to 30*l.* In a short time the unfortunate purchaser discovers his mistake, and is too happy to get rid of him for a few pounds, to be resold to a fresh victim. So notoriously is this the case, that some horses are so well known to be subject to these attacks, that a roar of laughter announces their arrival in the yard.

## RABIES, OR MADNESS.

This is another and fearful disease of the nervous system. It results from the bite of a rabid animal, and most commonly of the companion and friend of the horse, the coach-dog. The account now given of this malady is extracted from lectures which the author of the present work delivered to his class. There is occasional warning of the approach of this disease in the horse, or rather of the existence of some unusual malady, the real nature of which is probably mistaken. A mare, belonging to Mr. Karslake, had, ten days before the recognition of the disease, been drooping, refusing her food, heaving at the flanks, and pawing occasionally. It was plain enough that she was indisposed, but at length the furious fit came upon her, and she destroyed almost everything in the stable in the course of an hour. The late Mr. Moneyment had a two-years-old colt brought to his establishment. It was taken ill in the afternoon of the preceding day, when it first attracted attention by refusing its food, and throwing itself down and getting up again immediately. From such a description, Mr. Moneyment concluded that it was a case of cholera; but, when he went into the yard, and saw the pony, and observed his wild and anxious countenance, and his excessive nervous sensibility, he was convinced that something uncommon was amiss with him, although he did not at first suspect the real nature of the case.

The early symptoms of rabies in the horse have not been carefully observed or well recorded; but, in the majority of cases, so far as our records go, there will not often be premonitory symptoms sufficiently decisive to be noticed by the groom.

The horse goes out to his usual work, and, for a certain time and distance, performs it as well as he had been accustomed to do: then he stops all at once—trembles, heaves, paws, staggers, and falls. Almost immediately he rises, drags his load a little further, and again stops, looks about him, backs, staggers, and falls once more. This is not a fit of merrims—it is not a sudden determination of blood to the brain, for the horse is not for a single moment insensible. The sooner he is led home the better, for the progress of the disease is as rapid as the first attack is sudden; and, possibly, he will fall twice or thrice before he reaches his stable.

In the great majority of cases—or, rather, with very few exceptions—a state of excitation ensues, which is not exceeded by that of the dog under the most fearful form of the malady; but there are intervals when, if he had been naturally good-tempered and had been attached to his rider or his groom, he will recognise his former friend and seek his caresses, and bend on him one of those piteous, searching looks, which, once observed, will never be forgotten: but there is danger about this. Presently succeeds another paroxysm, without warning and without control; and there is no safety for him who had previously the most complete mastery over the animal.

I was once attending a rabid horse. The owner would not have him destroyed, under the vain hope that I had mistaken a case of phrenitis for one of rabies, and that the disease might yield to the profuse abstraction of blood that I had been prevailed on to effect, and the purgative influence of the farina of the croton-nut, with which he had been abundantly supplied in an early stage of the malady. I insisted on his being slung, so that we were protected from injury from his kicking or plunging. He would bend his gaze upon me as if he would search me through and through, and would prevail on me, if I could, to relieve him from some dreadful evil by which he was threatened. He would then press his head against my bosom, and keep it there a minute or more. All at once,

however, the paroxysm would return. He did not attempt to bite me; but, had it not been for the sling, he would have plunged furiously about, and I might have found it difficult to escape.

I had previously attended another horse, which the owner refused to have destroyed, and to which attendance I only consented on condition of the animal being slung. He had been bitten in the near hind leg. When I approached him on that side he did not attempt to bite, and he could not otherwise injure me; but he was agitated and trembled, and struggled as well as he could; and if I merely touched him with my finger, the pulsations were quickened full ten beats in a minute. When, however, I went round to the off-side, he permitted me to pat him, and I had to encounter his imploring gaze, and his head was pressed against me—and then presently would come the paroxysm; but it came on almost before I could touch him, when I approached him on the other side.

These mild cases, however, are exceptions to a general rule. They are few and far between. The horse is the servant, and not the friend of man; and if his companion, yet an oppressed one. In proportion to his bulk, he has far less of that portion of the brain with which intelligence is connected—less attachment—less gratitude. He is, nevertheless, a noble animal. I am not speaking disparagingly of him; but I am comparing him with—next to man—the most intellectual of all quadrupeds. There is neither the motive for, nor the capability of, that attachment which the dog feels for his master, and, therefore, under the influence of this disease, he abandons himself to all its dreadful excitement.

The mare of Mr. Karslake, when the disease was fully developed, forgot her former drooping, dispirited state: her respiration was accelerated—her mouth was covered with foam—a violent perspiration covered every part of her, and her screams would cow the stoutest heart. She presently demolished all the wood-work of the stable, and then she employed herself in beating to pieces the fragments, no human being daring to expose himself to her fury.

The symptoms of the malady of Mr. Moneymet's pony rapidly increased—he bit everything within his reach, even different parts of his own body—he breathed laboriously—his tail erect—screaming dreadfully at short intervals, striking the ground with his fore-feet, and perspiring most profusely. At length he broke the top of his manger, and rushed out of the stall with it hanging to his halter. He made immediately towards the medical attendant, and the spectators who were standing by. They fortunately succeeded in getting out of his way, and he turned into the next stall, and dropped and died.

A young veterinary friend of mine very incautiously and fool-hardily attempted to ball a rabid horse. The animal had previously shown himself to be dangerous, and had slightly bitten a person who gave him a ball on the preceding evening: he now seized the young student's hand, and lifted him from the ground, and shook him, as a terrier would shake a rat. It was with the greatest difficulty, and not until the grooms had attacked the ferocious animal with their pitchforks, that they could compel him to relinquish his hold; and, even then, not before he had bitten his victim to the bone, and nearly torn away the whole of the flesh from the upper and lower surfaces of the hand. In the Museum of the Veterinary School, at Alfort, is the lower jaw of a rabid horse, which was fractured in the violent efforts of the animal to do mischief.

There is also in the horse, whose attachment to his owner is often comparatively small, a degree of treachery which we rarely meet with in the nobler and more intellectual dog. A horse that had shown symptoms of great ferocity was standing in the corner of his box, with a heaving flank,

and every muscle quivering from the degree of excitement under which he laboured. A groom, presuming on the former obedience of the animal, ventured in, and endeavoured to put a headstall upon him. Neither the master nor myself could persuade him to forbear. I was sure of mischief, for I had observed the ear lying flat upon the neck, and I could see the backward glance of the eye; I therefore armed myself with a heavy twitch stick that was at hand, and climbed into the manger of the next box. The man had not advanced two steps into the box before I could see the shifting position of the fore feet, and the preparation to spring upon his victim; and he would have sprung upon him, but my weapon fell with all the force I could urge upon his head, and he dropped. The man escaped, but the brute was up again in an instant, and we trembled lest the partition of the box should yield to his violence, and he would realise the graphic description of Mr. Blaine, when he speaks of the rabid horse as 'levelling everything before him, himself sweating, and snorting, and foaming amidst the ruins.'

I have had occasion more than once to witness the evident pain of the bitten part, and the manner in which the horse in the intervals of his paroxysms employs himself in licking and gnawing the cicatrix. One animal had been bitten in the chest, and he, not in the intervals between the exacerbations, but when the paroxysm was most violent, would bite and tear himself until his breast was shockingly mangled, and the blood flowed from it in a stream.

The most interesting and satisfactory symptom is the evident dread of water which exists in the decided majority of cases, and the impossibility of swallowing any considerable quantity. Professor Dupuy gives an account of this circumstance:—'A rabid horse was confined in one of the sick-boxes. His food was given to him through an opening over the door, and a bucket was suspended from the door, and supplied with water by means of a copper tube. As soon as he heard the water falling into the pail, he fell into violent convulsions, seized the tube, and crushed it to pieces. When the water in his bucket was agitated, the convulsions were renewed. He would occasionally approach the bucket as if he wished to drink, and then, after agitating the water for an instant, he would fall on his litter, uttering a hoarse cry; but he would rise again almost immediately. These symptoms were dreadfully increased if water was thrown upon his head. He would then endeavour to seize it as it fell, and bite with fury at everything within his reach, his whole frame being dreadfully convulsed.'

As the disease progresses, not only is the animal rapidly debilitated, but there is the peculiar staggering gait which is observable in the dog—referable to evident loss of power in the muscles of the lumbar region. I once saw a mare sitting on her haunches, and unable to rise; yet using her fore feet with the utmost fury, and suffering no one to come within her reach. She, too, would sometimes plunge her muzzle into the offered pail; and immediately withdraw it in evident terror, while every limb trembled. At other times the lowering of the pail would affright her, and she would fall on her side and struggle furiously. Although this symptom is not often observed in the dog, it is a satisfactory identification of the disease, when it is so frequently seen in the horse, and so invariably in the human being.

The earliest, and perhaps the most decisive, symptom of the near approach of rabies in the horse, is a spasmodic movement of the upper lip, particularly of the angles of the lip. Close following on this, or contemporaneous with it, are the depressed and anxious countenance, and inquiring gaze, suddenly however lighted up and becoming fierce and menacing, from

some unknown cause, or at the approach of a stranger. From time to time different parts of the frame—the eyes—the jaws—particular limbs—will be convulsed. The eye will occasionally wander after some imaginary object, and the horse will snap again and again at that which has no real existence. Then will come the irrepressible desire to bite the attendants or the animals within its reach. To this will succeed the demolition of the rack, the manger, and the whole furniture of the stable, accompanied by the peculiar dread of water which has been already described.

Towards the close of the disease there is generally paralysis, usually confined to the loins and the hinder extremities, or involving those organs which derive their nervous influence from this portion of the spinal cord;—hence the distressing tenesmus which is occasionally seen.

The disease rarely extends beyond the third day.

After death, there is uniformly found inflammation at the back part of the mouth, and at the top of the windpipe, and likewise in the stomach, and on the membrane covering the lungs, and where the spinal marrow first issues from the brain.

When the disease can be clearly connected with a previous bite, the sooner the animal is destroyed the better, *for there is no cure*. If the symptoms bear considerable resemblance to rabies, although no bite is suspected, the horse should at least be slung, and the medicine, if any is administered, given in the form of a drink, and with the hand well protected; for if it should be scratched in balling the horse, or the skin should have been previously broken, the saliva of the animal is capable of communicating the disease. Several farriers have lost their lives from being bitten or scratched in the act of administering medicine to a rabid horse.

It is always dangerous to encourage any dogs about the stable, and especially if they become fond of the horses, and are in the habit of jumping up and licking them. The corners of the mouth of the horse are often sore from the pressure of the bit; and when a coach-dog in a gentleman's stable—and it is likely to happen in every stable, and with every dog—becomes rabid and dies, the horse too frequently follows him at no great distance of time.

If a horse is bitten by a dog under suspicious circumstances, he should be carefully examined, and every wound, and even the slightest scratch, well burned with the lunar caustic (nitrate of silver). The scab should be removed and the operation repeated on the third day. The hot iron does not answer so well, and other caustics are not so manageable. In the spring of 1827, four horses were bitten, near Hyde Park, by a mad dog. To one of them the lunar caustic was twice severely applied—he lived. The red-hot iron was unsparingly used on the others, and they died. The caustic must reach every part of the wound. At the expiration of the fourth month, the horse may be considered to be safe.

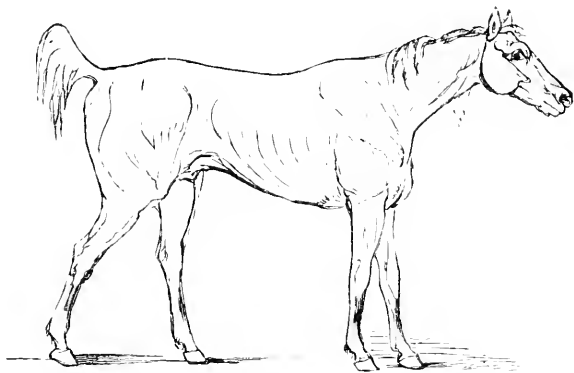
#### TETANUS, OR LOCKED JAW.

Tetanus is one of the most dreadful and fatal diseases to which the horse is subject. It is called LOCKED JAW, because the muscles of the jaw are earliest affected, and the mouth is obstinately and immovably closed. It is a permanent spasm of all the voluntary muscles, and particularly of those of the neck, the spine, and the head. It is sometimes slow and treacherous in its attack. The horse, for a day or two, does not appear to be quite well; he does not feed as usual; he partly chews his food, and drops it; and he gulps his water. The owner at length finds that the motion of the jaws is considerably limited, and some saliva is drivelling from the mouth.

If he tries he can only open the mouth a very little way or the jaws are perfectly and rigidly closed; and thus the only period at which the disease could have been successfully combated is lost. A cut of a horse labouring under this disease is here given, which the reader will do well to examine carefully.

The first thing that strikes the observer is a protrusion of the muzzle, and stiffness of the neck; and, on passing the hand down it, the muscles will be found singularly prominent, distinct, hard, knotty, and unyielding.—

There is difficulty in bringing the head round, and still greater difficulty in bending it. The eye is drawn deep within the socket on the slightest excite-



ment, and, in consequence of this, the fatty matter behind the eye is pressed forward; the haw is protruded, and there is an appearance of strabismus, or squinting, in an outward direction.

The ears are erect, pointed forward, and immoveable; if the horse is spoken to, or threatened to be struck, they change not their position. Considering the beautiful play of the ear in the horse when in health, and the kind of conversation which he maintains by the motion of it, there is not a more characteristic symptom of tetanus than this immobility of the ear. The nostril is expanded to the utmost, and there is little or no play of it, as in hurried or even natural breathing. The respiration is usually accelerated, yet not always so; but it is uniformly laborious. The pulse gives little indication of the severity of the disease. It is sometimes scarcely affected. It will be rapidly accelerated when any one approaches the animal and offers to touch him, but it presently quiets down again almost to its natural standard. After a while, however, the heart begins to sympathise with the general excitation of the system, and the pulse increases in frequency and force until the animal becomes debilitated, when it beats yet quicker and quicker, but diminishes in power, and gradually flutters and dies away.

The countenance is eager, anxious, haggard, and tells plainly enough what the animal suffers. The stiffness gradually extends to the back. If the horse is in a narrow stall, it is impossible to turn him; and, even with room and scope enough, he turns altogether like a deal-board. The extremities begin to participate in the spasm—the hinder ones generally first, but never to the extent to which it exists in the neck and back. The horse stands with his hind legs straddling apart in a singular way. The whole of the limb moves, or rather is dragged on together, and anxious care is taken that no joint shall be flexed more than can possibly be helped. The fore limbs have a singular appearance; they are as stiff as they can possibly be, but stretched forward and straddling. They have not unaptly been compared to the legs of a form.

The abdominal muscles gradually become involved. They seem to

The stiffness gradually extends to the back. If the horse is in a narrow stall, it is impossible to turn him; and, even with room and scope enough, he turns altogether like a deal-board.

The extremities begin to participate in the spasm—the hinder ones generally first, but never to the extent to which it exists in the neck and back. The horse stands with his hind legs straddling apart in a singular way. The whole of the limb moves, or rather is dragged on together, and anxious care is taken that no joint shall be flexed more than can possibly be helped. The fore limbs have a singular appearance; they are as stiff as they can possibly be, but stretched forward and straddling. They have not unaptly been compared to the legs of a form.

The abdominal muscles gradually become involved. They seem to

contract with all the power they possess, and there is a degree of 'hide-bound' appearance and rigidity, and of tucking up of the belly, which is seen under no other complaint. The tail becomes in constant motion from the alternate and violent action of the muscles that elevate and depress it.

Constipation, and to an almost insurmountable degree, now appears. The abdominal muscles are so powerfully contracted, that no portion of the contents of the abdomen can pass on and be discharged.

By degrees the spasm extends and becomes everywhere more violent. The motion of the whole frame is lost, and the horse stands fixed in the unnatural posture which he has assumed. The countenance becomes wilder and more haggard—its expression can never be effaced from the memory of him who cares about the feelings of a brute; the tail is now permanently raised, and, if depressed for a moment by the hand, instantly resumes its elevation. The violent cramp of a single muscle or set of muscles makes the stoutest heart quail, and draws forth the most piteous cries—what, then, must it be for this torture to pervade the whole frame, and to continue, with little respite, from day to day, and from week to week. When his attendant approaches and touches him, he scarcely moves; but the despairing gaze, and the sudden acceleration of the pulse, indicate what he feels and fears.

Tetanus, then, is evidently an affection of the nerves. A small fibre of some nerve has been injured, and the effect of that injury has spread to the origin of the nerve—the brain then becomes affected—and universal diseased action follows. Tetanus is a spasm of the whole frame—not merely of one set of muscles, but of their antagonists also. The fixidity of the animal is the effect of opposed and violent muscular contraction. It belongs to the lower column of nerves only. The sensibility is unimpaired—perhaps it is heightened. The horse would eat if he could; he tries to suck up some moisture from his mash; and the avidity with which he lends himself to assist in the administering of a little gruel, shows that the feelings of hunger and thirst remain unimpaired.

The disease may terminate fatally in forty-eight hours, but as a rule death takes place from the third to the sixth day; if the horse should survive till the seventh or eighth day, a favourable termination may be expected, although in some cases they will die a month after the attack. If from strength of constitution or medical treatment, he should recover, the first favourable symptom is a slight and short remission of the spasm; the time of the remission gradually lengthening, and the jaws a little relaxing; but the progress of cure is exceedingly slow, and the horse is left very weak.

On *post-mortem* examination the muscular fibre will exhibit sufficient proof of the labour which has been exacted from it. The muscles will appear as if they had been macerated—their texture will be softened, and they will be torn with the greatest ease. The lungs will, in the majority of cases, be highly inflamed, for they have been labouring long and painfully to furnish arterial blood in sufficient quantity to support this great expenditure of animal power. The stomach will contain patches of inflammation, but the intestines, in most cases, will not exhibit much departure from the hue of health. The examination of the brain will be altogether unsatisfactory. There may be slight injection of some of the membranes, but, in the majority of cases, there will not be any morbid change worthy of record.

Tetanus is usually the result of the injury of some nervous fibre, and the effect of that lesion propagated to the brain. It occurs at all ages, from the foal a fortnight old, and amongst all classes of the horse; but



high-bred, irritable animals are the most liable to it. It may result from almost every variety of wound, no matter what its situation. It would appear, however, that wounds in some parts have a much greater tendency to produce this disease than in others. The foot is a very frequent source or focus of tetanic injury. The horse becomes lame—the injury may have been carefully treated, carelessly treated, or not treated at all—the lameness, however, disappears, but the wound has not healed. There is an unhealthiness about it, and at the expiration of eight or ten days, tetanus appears. Some nervous fibre has been irritated or inflamed by the accident, slight as it was.

Docking, nicking, overreach, suppurating corns, castration and injuries, especially about the orbit, are frequent causes of tetanus. In all these cases the attack is termed Traumatic Tetanus as arising from, or depending on, some injury received, but unquestionably it may be set up without any external injury whatever. The records of veterinary proceedings contain accounts of tetanus following labour, brutally exacted beyond the animal's natural strength, in the draught of heavy loads. Horses that have been matched against time have too frequently died of tetanus a little while afterwards. Sudden exposure to cold after being heated by exercise has produced this dreadful state of nervous action, and especially if the horse has stood in a partial draught, or cold water has been dripping on the loins. These cases are called Idiopathic Tetanus, that is, arising, like any other severe malady, from some peculiar susceptibility to derangement of the constitution itself.

Traumatic Tetanus is much the most dangerous kind, and will generally prove fatal; on the other hand, from Idiopathic Tetanus the animal not unfrequently recovers. Other terms are also applied to distinguish when certain parts only are affected. When the spasm is confined to the muscles of the jaws it is named Trismus; when the muscles of the neck and back are chiefly affected, it is called Opisthotonos; the reverse of this, when the inferior muscles are affected, is Emprosthotonos; when the body is drawn to one side, that of Pleurosthotonos. Although these different states may exist in the human subject, we shall rarely meet with them in the horse, and then only in the form of Trismus or Opisthotonos.

The treatment of tetanus is simple, and would be oftener successful if carried to its full extent. The indication of cure is plain enough—the *system must be tranquillised*.

Eight or ten drachms of aloes, with  $\zeta i.$  to  $\zeta ij.$  calomel, should be administered. If the remission of the spasm is slight, there is another purgative—not so certain in its action, but more powerful when it does act—the farina of the croton nut. There is little or no danger of exciting inflammation of the mucous membrane of the intestines by this prompt and energetic administration of purgative medicine, for there is too much determination of vital power towards the nervous system—too much irritation there—to leave cause for dreading the possibility of metastasis elsewhere. It would be desirable if a certain degree of inflammation could be excited, because to that extent the irritation of the nervous system might be allayed. There is another reason, and a very powerful one—time is rapidly passing. The tetanic action may extend to the intestines, and the co-operation of the abdominal muscles in keeping up the peristaltic motion of the bowels, and expelling their contents, may be lost. We have, indeed, more faith in the effect of physic, as a remedy for this dreadful disease, than any other; if active purgation can be set up—and a chance of recovery is left—that purgation will insure it. Use the balling probang, a cone, a stick, anything, to introduce a full dose of physic into his throat; if not into his throat, leave it on the tongue; if that is impossible, insert

it between the lips and the grinders—this may always be done—and to a certainty a greater portion of it will gradually be swallowed. This should be followed by the administration of  $\zeta$ ij. of powdered opium frequently repeated. Opium is not only a valuable drug, but it is that on which alone dependence can be placed in this disease. Clysters may also be employed to assist in promoting the action of the bowels. Bleeding, blistering, friction to the back, and the application of cold water are calculated to do no good, and suchlike remedies should not be had resort to. The one great object in the treatment of tetanus should be to keep the animal as quiet as possible, and free from those attentions assuming the shape of remedial measures which are too apt to increase the already excited state of the nervous system. The horse should be placed in a warm, somewhat dark, but well-ventilated stable, selected as free as possible from all external noises. Both the floor of the stable and also for some distance outside should be covered with short litter. The stable should be locked, and no one allowed to see the animal but the attendant or professional man, and when this is rendered necessary for the administration of food or medicine, great caution should be used in preventing any sudden noise or movement which may disturb the animal.

One thing should not be forgotten, namely, that a horse with locked jaw is as hungry as when in health, and every possible contrivance should be adopted to furnish him with that nutriment which will support him under his torture, and possibly enable him to weather the storm. If a pail of good gruel is placed within his reach, how will he nuzzle in it, and contrive to drink some of it too! If a thoroughly wet mash is placed before him in a pail, he will bury his nose in it, and manage to extract no small portion of nutriment. By means of a small horn, or a bottle with a very narrow neck, it will often be possible to give him a small quantity of gruel; but the flexible pipe that accompanies Read's patent pump will render this of easier accomplishment, for the nutriment may be administered without elevating the head of the horse, or inflicting on him the extreme torture which used to accompany the act of drenching. If the jaw is ever so closely clenched, the pipe may be introduced between the tushes and the grinders, and carried tolerably far back into the mouth, and any quantity of gruel or medicine introduced into the stomach. Nor is this the only way in which this valuable instrument may be made available in this fearful disease; for with an enema pipe attached to the end of the tube, considerable quantities of good beef tea, strong infusions of oats or malt, combined with thick well-boiled gruel, may be injected into the intestines, and the animal's strength supported to a considerable extent.

It will also be good practice to let a small portion of food be in the manger. The horse will not at first be able to take up the slightest quantity, but he will attempt to do so. Small portions may be placed between his grinders, and they will presently drop from his mouth scarcely or at all masticated: but some good will be done—there is the attempt to put the muscles of the jaw to their proper use. On the following day he will succeed a little better, and make some trifling advance towards breaking the chain of spasmodic action. Experience will teach the careful groom the value of these minutiae of practice; and the successful termination of many a case may be traced to the careful nursing of the patient.

When the horse is getting decidedly better, and the weather will permit, there can be no better practice than to turn him out for a few hours in the middle of the day. His toddling about will regain to him the use of his limbs; the attempt to stoop in order to graze will diminish the spasm in his neck; the act of grazing will relax the muscles of the jaws; and he can have no better food than the fresh grass.

## CRAMP.

This is a sudden, involuntary, and painful contraction of a particular muscle or set of muscles. It differs from tetanus in its shorter duration, and in its occasionally attacking the muscles of organic life. It may be termed a species of transitory tetanus, affecting mostly the hind extremities. It is generally observed when the horse is first brought out of the stable, and especially if he has been hardy worked. One of the legs appears stiff, inflexible, and is, to a slight degree, dragged after the animal. After he has proceeded a few steps, the stiffness nearly or quite disappears, or only a slight degree of lameness remains during the greater part of the day.

Cramp may be brought on by exposure either to a high or low temperature.

If a certain degree of lameness remains, the attendant on the horse should endeavour to find out the muscle chiefly affected, which he may easily do by a feeling of hardness, or an expression of pain, when he presses on the part affected. Friction with the hand will very frequently be all that is necessary to remove cramp, but should this not be effectual, hot fomentations to the part, and the administration of laxative medicines, must be had resort to.

## STRINGHALT.

This is a sudden and spasmodic action of some of the muscles of the thigh, observable when the horse is first led from the stable. One or both legs are caught up at every step with great rapidity and violence, so that the fetlock sometimes touches the belly. In the great majority of cases it does not disappear after exercise, but the horse continues to be afflicted with this peculiar gait. In a few cases, however, after the horse has been out a little while, it partially goes off, and the normal action of the limb, to a certain extent, returns.

Stringhalt is not a perfectly involuntary action of a certain muscle, or a certain set of muscles. The limb is flexed at the command of the will, but it acts to a greater extent and with more violence than the will had prompted. There is an accumulation of excitability in the muscle, and the impulse which should have called it into natural and moderate action causes it to take on a spasmodic one.

But although the peculiar action constituting stringhalt is developed through the muscles, it must not be taken for granted that the cause of the affection lies in the muscles themselves, but rather in the tissues through which the muscular action is exerted, namely, the nerves; and, as a general rule, it may be stated that disease of the nerves themselves, more particularly of the great Ischiatic nerve, or of the canal through which they pass from the spinal cord, will be found to exist. Either the nerve at its origin is softened and discoloured, or its egress from the vertebral canal is through a roughened and irritating foramen instead of a smooth and polished one.

Many ingenious but contradictory theories have been advanced in order to account for this peculiarity of gait. What muscles are concerned? Clearly those by which the thigh is brought under the belly, and the hock is flexed, and the pasterns are first flexed and then extended. But by which of them is the effect principally produced? What muscle, or, more properly, what nerve is concerned? Instead of entering into any useless controversy on this point, a case shall be related, and one of the most interesting there is on record: the author was personally cognisant of every particular.

*Guildford*, first called Roundhead, and then Landlord, was foaled in

1826. He was got by Hampden out of a Sir Harry Dimsdale mare. In 1828, and being two years old, and the property of the Duke of Richmond, he won a 50*l.* plate at Goodwood. In 1829, and belonging to Lord W. Lennox, he won 55 guineas at Hampton. Being then transferred to Mr. Coleman, he won 50 guineas at Guildford; and in the same year, having been purchased by Mr. Pearce, he won 60 guineas at Basingstoke.

In the course of this year stringhalt began to appear in a slight degree, and it evidently, although slowly, increased. There soon began to be a little difficulty in getting him off; but when he had once started, neither his speed nor his stoutness appeared to be in the slightest degree impaired. He continued on the turf until 1836, and won for his different owners seventeen races, the produce of which, exclusive of bets, amounted to 1,435*l.*

The difficulty and loss of advantage in starting had now increased to a degree which rendered it prudent to withdraw him from the turf, and he came into the possession of Dockeray, who used him for the purpose of leading the young horses that he had under training. This is well known to be hard work, and his rider was a man of some weight. In addition to this, he was generally hunted twice in the week. His first starting into a gallop had something singular about it. It was a horrible kind of convulsive action, and so violent, that he frequently knocked off his shoes on the very day that they were put on; but when he got a little warmed, all this disappeared. He galloped beautifully, and was a very sure fencer. The sport, however, being over, and he returning to a slow pace, the stringhalt was as bad as ever.

At length the old horse became artful, and it was with great difficulty that he could be made to lead. Sometimes he refused it altogether. In consequence of this, he was sent to St. Martin's Lane to be sold. The highest bidding for him was 3*l.* 14*s.*, and the hero of the turf and the field was doomed to the omnibus. There he was cruelly used, and this spasmodic convulsion of his hind legs sadly aggravated his torture. The skin was presently rubbed from his shoulders, his hips and haunches were bruised in every part, and his stifles were continually and painfully coming in contact with the pole.

In this situation he was seen by the veterinary surgeon to 'The Society for the Prevention of Cruelty to Animals.' There is a fund at the disposal of that society for the purchase of worn-out horses, who are immediately released from their misery by the pole-axe of the knacker. The horse was bought for this purpose, another and laudable motive influencing the purchase—the wish to ascertain what light the dissection of an animal that had had stringhalt to such an aggravated extent, and for so long a period, would cast on the nature of this disease.

The author of this work saw him a little while before he was slaughtered. He was still a noble-looking animal, and seemed to possess all his former strength and spirit unimpaired; but he was sadly scared all over, in consequence of his being put to a kind of work for which his spasmodic complaint so entirely incapacitated him. So aggravated a case of stringhalt had rarely been seen. Both hind legs were affected, and both in an equal degree; and the belly was forcibly struck by the pastern joints every time the hind feet were lifted. The belly and the pastern joint were both denuded of hair in consequence of this constant battering.

He was destroyed by the injection of prussic acid into the jugular vein, and the dissection of him was conducted by Professor Spooner, of the Royal Veterinary College.

On taking off the skin, all the muscles presented their perfect healthy character. There was not the slightest enlargement or discoloration of

the fasciæ. The muscles of both extremities were dissected from their origins to their tendinous terminations, and their fibrous structure carefully examined. They were all beautifully developed, presenting no inequality or irregularity of structure, nor aught that would warrant the suspicion that any one of them possessed an undue power or influence beyond the others. The only abnormal circumstance about them was that they were of a rather darker yellow in colour than is usually found. This referred to them generally, and not to any particular muscle or sets of muscles.

The lumbar, crural, and sciatic nerves were examined from the spot at which they emerge from the spinal cord to their ultimate distributions. The crural and lumbar nerves were perfectly healthy. The sciatic nerve, at the aperture through which it escapes from the spine, was darker in colour than is usual, being of a yellowish-brown hue. Its texture was softened, and its fibrillæ somewhat loosely connected together. The nerve was of its usual size; but, on tracing it in its course through the muscles of the haunch, several spots of ecchymosis presented themselves, and were more particularly marked on that part of the nerve which is connected with the sacrosciatic ligament. As the nerve approached the hock, it assumed its natural colour and tone; and the fibres given off from it to the muscles situated inferior to the stifle-joint were of a perfectly healthy character.

On dissecting out a portion of the nerve where it appeared to be in a diseased state, it was found that this ecchymosis was confined to the membranous investiture of the nerve, and that its substance, when pressed from its sheath, presented a perfectly natural character.

The cavity of the cranium, and the whole extent of the spinal canal, were next laid open. The brain and spinal marrow were deprived of their membranous coverings, and both the thecæ and their contents diligently examined. There was no lesion in any part of them, not even at the lumbar region.

The articulations of every joint of the hind extremities then underwent inspection, and no disease could be detected in either of them.

Professor Spooner was of opinion that this peculiar affection was not referable to any diseased state of the brain or spinal cord, nor to any local affection of the muscles of the limbs, but simply to a morbid affection of the sciatic nerve. He had not dissected a single case of stringhalt in which he had not found disease of this nerve, which mainly contributes to supply the hind extremities with sensation and the power of voluntary motion.

As a proof that stringhalt may come on suddenly the following is a case in point. A race-horse called 'Warwick' fell out of a horse-box, when travelling at the rate of twenty miles per hour by rail between Holywell and Flint, and when he got up he was affected with stringhalt; he won many races afterwards. The cause of the accident was this: the horse-box was standing against a wall, and, while loading, the porters forgot to fasten the door next the wall. Shortly after the train was in motion, the flap or door of the box fell down, letting the horse's hind parts out; being tied up with a small race-horse head-collar, fortunately it broke, and the animal fell out on the rails. Being a cold morning he was wrapt up in extra rugs, which so enveloped him as to prevent the rails cutting him. The train was stopped, and the horse was found lying quite unnerved: the instant he was spoken to he got up, and the stable-boy led him away home. The only injury he received was stringhalt in both legs, and he had never shown the least symptoms of it before: he was five years old at the time of the accident.

Now comes a very important question. What connection is there between stringhalt and the supposed value or deterioration of the horse? Some experienced practitioners have maintained that it is a pledge of more than usual muscular power. It is a common saying that 'there never was a horse with stringhalt that was incapable of doing the work required of him.' Most certainly we continually meet with horses having stringhalt that pleasantly discharge all ordinary, and even extraordinary, service; and although stringhalt is excess or irregular distribution of nervous power, it at least shows the existence of that power, and the capability in the muscular system of being acted upon by it. Irregular distributions of vital energy are not, however, things to be desired. They argue disease and derangement of the system, and a predisposition to greater derangement. They materially interfere with the speed of the horse. This was decidedly the case with regard to the poor fellow whose history has been related.

Stringhalt is decided unsoundness. It is an irregular supply of the nervous influence, or a diseased state of the nervous or muscular system, or both. It prevents us from suddenly and at once calling upon the horse for the full exercise of his speed and power, and therefore it is *unsoundness*; but, generally speaking, it so little interferes with the services of the animal, that, although an unsoundness, it would not weigh a great deal against other manifest valuable qualities.

#### PARALYSIS, OR PALSY.

The stream of nervous influence is sometimes stopped, and thence results palsy. In the human being general palsy sometimes occurs. The whole body—every organ of motion and of sense—is paralysed. The records of our practice, however, do not afford us a single instance of this; but of partial paralysis there are several cases, and most untractable ones they were. The cause of them may be altogether unknown. In the human being there is yet another distinction, Hemiplegia and Paraplegia. In the former the affection is confined to one side of the patient; in the latter the posterior extremity on both sides is affected. Few cases of hemiplegia occur in the horse, and they are more manageable than those of paraplegia; but if the affection is not removed, they usually degenerate into paraplegia before the death of the animal. It would appear singular that this should be the most common form of palsy in the human being, and so rarely seen in the quadruped. There are some considerations, however, that will partly account for this. Palsy in the horse usually proceeds from injury of the spinal cord; and that cord is more developed and far larger than in the human being. It is more exposed to injury, and to injury that will affect not one side only, but the whole of the cord.

Palsy in the horse, although sometimes attacking the fore extremities, is far more frequently met with in the hind ones. The reason of this is plain. The fore limbs are attached to the trunk by a dense mass of highly elastic substance. This was placed between the shoulder-blade and the ribs for the purpose of preventing that concussion, which would be annoying and even dangerous to the horse or his rider. Except in consequence of a fall, there is scarcely the possibility of any serious injury to the anterior portion of the spine. The case is very different with regard to the hind limbs and their attachment to the trunk; they are necessarily liable to many a shock and sprain injurious to the spine and its contents. The loins and the back oftenest exhibit the lesions of palsy, because there are some of the most violent muscular efforts, and there is the greatest movement and the least support. It may, consequently, be taken as an

axiom to guide the judgment of the practitioner, that palsy in the horse almost invariably proceeds from disease or injury of the spine.

We most frequently meet with complete paraplegia in the horse, as the result of some injury to the spine. It sometimes ensues when the animal has been cast for the performance of some operation: he struggles violently at first, but after a time ceases. The operation being concluded the hobbles are removed, and attempts are made to cause the animal to arise; but these are fruitless, and to the great annoyance of the operator, his hind extremities are found to be totally paralysed. It is also met with in the hunting-field, as a consequence of the animal dropping the hind extremities into a fence, or when galloping across a field, suddenly placing the hind legs into a drain or hidden trench; when this happens the animal generally drags his hind extremities a short distance and falls; he will then make frequent efforts to get up again, but will only succeed in raising his fore extremities; the hind ones are paralysed: in short, his 'back is broken.' It may also be produced by getting cast in the stable, and slipping up, &c. In most of these cases the posterior dorsal or lumbar vertebræ will be found to be either displaced or fractured, and the symptoms will appear immediately after the injury. Other causes of paralysis are—exposure to cold and moisture, and disease affecting the spinal cord itself, or its membranes. When this is the case, we sometimes get premonitory symptoms. The first symptoms generally noticed will be a peculiar reeling unsteadiness in the animal's walk, which will be increased when he is made to trot, the hind legs being to a certain extent dragged after him. This may continue for an uncertain length of time, but in most cases, the animal will get gradually worse in a few days, until he falls and is unable to rise again. Paralysis may also be confined to certain parts only, such as the face, ear, and lips; another frequent instance of this will be found in paralysis of the muscles on one side of the larynx, producing roaring.

The treatment of paralysis will not generally prove very successful. If it results from a violent injury, and we have reason to believe from the circumstances connected with it, and the total loss of both motive and sentient power in the hind extremities, that some fracture or dislocation of the vertebra has taken place, the animal should be at once destroyed. If we have premonitory symptoms sufficient to indicate the approach of an attack of paralysis, a strong dose of purgative medicine should be at once administered, and this should be assisted by frequent injections of warm water. The loins should be covered with a mustard poultice, frequently renewed. The patient should be placed in a well-ventilated stable, kept warmly clothed, and his food consist for the first few days of nothing but bran-mash. If the horse be down, the better plan to adopt will be to make him as comfortable as possible, taking care to turn him on the other side occasionally, so that the muscles may not become cramped. This will be better than placing him in slings. If favourable symptoms appear, and the animal begins to regain the use of his limbs, he must not be in the slightest degree neglected, nor medical treatment suspended. There are few diseases in which the animal is more liable to a relapse, or where a relapse would be so fatal. The bowels should be kept relaxed, counter-irritation continued over the loins, and great attention paid to the animal's diet. Strychnine, and many other medicines, have been strongly recommended in attacks of paralysis, but they are doubtful and powerfully dangerous remedies. If the disease assumes a somewhat chronic form, an extensive and stimulating charge over the loins should be applied. It will accomplish three purposes—there will be the principle of counter-irritation, a defence against the cold, and a useful support of the limbs.

When paralysis is confined to certain parts alone, such as the ear, lips, and larynx, any apparent cause should be at once removed, and then treated by counter-irritants, such as blisters and setons.

#### DISEASES OF THE EYE.

The diseases of the eye constitute a very important, but a most unsatisfactory division of our work, for the maladies of this organ, although few in number, are frequent in their appearance. They are sadly obstinate, and often baffle all skill.

Occasionally a wound is inflicted by a passionate or careless servant. The eye itself is rarely injured. It is placed on a mass of fat, and it turns most readily, and the prong of the fork glances off; but the substance round the eye may be deeply wounded, and very considerable inflammation may ensue. This should be abated by poultices, and bleeding, and physic; but no probe should be used under the foolish idea of ascertaining the depth of the wound in the lid, supposing that there should be one, for, from the constant motion of the eye, it is almost impossible to pass the probe into the original wound, and the effort to accomplish it would give a great deal of pain, and increase the inflammation.

The eyelids are subject to occasional inflammation from blows or other injuries. Fomentation with warm water will be serviceable here.

The horse has occasionally a scaly eruption on the edges of the eyelids, attended with great itching, in the effort to allay which, by rubbing the part, the eye may be blemished. The nitrated ointment of mercury, mixed with an equal quantity of lard, may be slightly rubbed on the edges of the lids with considerable good effect.

The eyelids will sometimes become œdematous. Horses that are fed in low and humid pastures are subject to this. It is also the consequence of inflammation badly treated. The eyelids are composed of a lax structure, and the tissue is somewhat deficient in vitality—hence this disposition to infiltration. Sometimes the collection of fluid accumulates so rapidly, and so extensively, that the eyes are closed. They should be well bathed with warm water mingled with an aromatic tincture. The cellular substance of the lids will thus be disposed to contract on their contents and cause their absorption.

Old carriage-horses are subject to this œdema; and it frequently accompanies both chronic and common ophthalmia.

Weakness and dropping of the upper lid is caused by diminution or loss of power in its muscles. Dry frictions and astringent lotions will frequently restore the tone of the parts.

The eyelids are subject to occasional injury from their situation and office. In small incised wounds of them great care should be taken that the divided edges unite by the first intention. This will hasten the cure and prevent deformity. If any of the muscles are divided, it is usually the ciliary or orbicularis palpebrarum. This lesion must be healed, if possible, by the first intention, and either by means of adhesive plaster or the suture. The suture is probably the preferable agent.

If the accident has occurred many hours before being noticed, and a portion of the upper lid hangs over the eye, it should on no account be removed without attempts being made to cause it to unite by taking a sharp scalpel, and removing a small portion from the lacerated edges and afterwards bringing them together with metallic sutures. Great care should be afterwards taken to secure the animal's head in such a position that he cannot rub the wound against the manger or wall of the stable.

Suppurating wounds in the eyelids may be the consequence of the ne-



cessary abstraction of a considerable surface of the skin in the removal of warts or tumours. The principal thing to be attended to is the frequent removal of the pus by means of tow or cotton wool. The rest may generally be left to nature.

Inversion of the lid is of very rare occurrence in the horse.

Warts are sometimes attached to the edges of the lids, and are a source of great irritation. When rubbed they bleed, and the common opinion is true—that they are propagated by the blood. They should be taken off with a sharp pair of scissors, and their roots touched with the lunar caustic.

The membrane which covers the haw is subject to inflammation. It is, indeed, a continuation of the conjunctiva, the inflammation of which constitutes ophthalmia. An account of this inflammation will be better postponed until the nature and treatment of ophthalmia comes under particular notice.

The Haw, or *Membrana Nictitans*, is subject to inflammation peculiar to itself, arising from the introduction of foreign bodies, or from blows or other accidents. The entire substance of the haw becomes inflamed. It swells and protrudes from the inner angle of the eye. The heat and redness gradually disappear, but the membrane often continues to protrude. The inflammation of this organ assumes a chronic character in a very short time, on account of the structure of the parts, which are in general little susceptible of reaction.

The ordinary causes of this disease in the horse are repeated and periodical attacks of ophthalmia, and blows on the part. Young and old horses are most subject to it.

Emollient applications, bleeding, and restricted diet will be proper at the commencement of the disease, and, the inflammation being abated, slight astringents will be useful in preventing the engorgement of the part. Rose-water with subacetate of lead will form a proper collyrium. If the protruding body does not diminish after proper means have been tried, and for a sufficient period, it must be removed with a curved pair of scissors. No danger will attend this operation if it is performed in time.

Ulceration and caries of the cartilage will sometimes be accompanied by ulceration of the conjunctiva. This will frequently prove a very serious affair.

The *Caruncula Lachrymalis*, or Tubercle, by means of which the tears are directed into the canal through which they are to escape from the nostril, is sometimes enlarged in consequence of inflammation, and the *Puncta Lachrymalia*, or conduits into which the tears pass from the eye, are partially or completely closed. The application of warm and emollient lotions will generally remove the collected mucus or the inflammation of the parts; but if the passage of a stylet or other more complicated means are required, the assistance of a veterinary surgeon should be immediately obtained. The lachrymal sac into which the tears pass from the puncta has occasionally participated in the inflammation, and been distended and ruptured by the tears and mucus. This lesion is termed *Fistula Lachrymalis*. It has occasionally existed in colts, and will require immediate and peculiar treatment.

#### SIMPLE OPHTHALMIA, OR COMMON INFLAMMATION OF THE EYE.

The indications of common inflammation of the eye are so clear, that it never ought to be confounded with specific, for in it the external coverings of the eye alone are implicated; we have engorgement of the conjunctival membrane, accompanied with a marked circumscribed opacity of the transparent cornea, and that is all; there is no effusion in the anterior chamber, giving that discoloured muddy appearance so charac-

teristic in specific ophthalmia; the iris remains clear and bright, and the lens is unaffected.

This common inflammation is generally sudden in its attack. It is occasionally connected with an attack of catarrh or cold; but it is as often unaccompanied by this, and depends on external irritation, as a blow, or the presence of a bit of hay-seed or oat-husk within the lid, and towards the outer corner where the hawk cannot reach it: therefore the lids should always be carefully examined as to this possible source of the complaint. The lids will be found swollen, and the eyes partially closed, with more or less weeping, the inner surface of the eyelids red and tumid, and the cornea will either appear bright or cloudy, according to the extent of the injury. It not unfrequently happens when the injury has resulted from the lash of a whip, or a thorn, that the conjunctival membrane becomes lacerated; and sometimes the injury extends to the cornea.

Our first object by way of treatment should be to ascertain the cause of the mischief by carefully examining the eye and the removal of any offending object. The animal should be placed in a cool but somewhat dark box, the eye should be bathed with warm water, laxative medicine given, and the animal kept on soft diet. If the inflammation be very acute, blood may be taken from the facial vein. In a few days the inflammation will generally subside, and then a weak solution of sulphate of zinc may be applied. When the acute inflammation has passed away, the cornea is sometimes left very tense and cloudy: we may now apply stimulants to its surface in the form of solution nitrate of silver (gr. viii to ℥j aqua distillata), at first injected for twenty-four hours, and then ceasing for two or three days, and again employing it if necessary. When we get granulations on the cornea as the result of lesions, nitrate of silver must be applied in its pure state.

#### SPECIFIC OPHTHALMIA, OR MOON-BLINDNESS.

In this we have a far more formidable and destructive disease than the one just described; it is, indeed, one of the opprobria of veterinary science, utterly baffling all its resources and running its course erratically, indeed, but most surely and destructively. The aqueous humour often loses its transparency—even the iris changes its colour, and the pupil is exceedingly contracted. Indeed the term Iritis, or inflammation of the iris, will convey a much more intelligible idea of the disease than any other, for it is this, with the other internal tissues of the eye, that especially suffer from its devastations. The external parts of the eye are comparatively but little implicated, and suffer only in a comparative degree; but see its effects on the iris, which gives the colouring and beauty to the eye,—its brilliancy is lost, its texture is broken down, it is a dark, discoloured curtain; look at the symmetrical pupil with its full rounded edge,—it is lacerated and torn, jagged and disfigured, as if mechanical destruction had torn it; then its centre ornament, the beautiful lens, transparent as a crystal, clear as a diamond, is become disorganised, crushed, discoloured, a shapeless opaque lump, instead of the bright transparent conductor,—the light of heaven can no longer permeate it, and total blindness is the result.

The veterinary surgeon has now an obstinate disease to combat, and one that will generally maintain its ground in spite of all his efforts. For three, or four, or five weeks, the inflammation will remain undiminished; or if it appears to yield on one day, it will return in redoubled violence on the next. At length, and often unconnected with any of the means that have been used, the eye begins to bear the light, the redness of the membrane of the lid disappears, the cornea clears up, and the only vestige of disease which remains is a slight thickening of the lids, and apparent uneasiness when exposed to a very strong light.

If the owner imagines that he has got rid of the disease, he will be sadly disappointed, for, in the course of three weeks or a month, either the same eye undergoes a second and similar attack, or the other one becomes affected. All again seems to pass over, except that the eye is not so perfectly restored, and a slight, deeply-seated cloudiness begins to appear; and after repeated attacks, and alternations of disease from eye to eye, the affair terminates in opacity of the lens or its capsule, attended with perfect blindness either of one eye or both. This affection was formerly known by the name of moon-blindness, from its periodical return, and some supposed influence of the moon. That body, however, has not, and cannot have anything to do with it.

What is the practitioner doing all this while? He is an anxious and busy, but almost powerless spectator. He foment the eyes with warm water, or applies cold lotions; he bleeds, not from the temporal artery, for that does not supply the orbit of the eye, but from the facial vein, or he scarifies the lining of the lid, or subtracts a considerable quantity of blood from the jugular vein. The scarifying of the conjunctiva, which may be easily accomplished without a twitch, by exposing the inside of the lids, and drawing a keen lancet slightly over them, is the most effectual of all ways to abate inflammation, for we are then immediately unloading the distended vessels. He places his setons in the cheek, or his rowels under the jaw; and he keeps the animal low, and gives physic or fever medicine. The disease, however, ebbs and flows, retreats and attacks, until it reaches its natural termination, blindness of one or both eyes.

Cart-horses are the most subject to this disease, and the period at which it generally appears is from the age of three to five years. He has then completed his growth. He is full of blood, and liable to inflammatory complaints, and the eye is the organ attacked from a peculiar predisposition in it to inflammation, the nature and cause of which cannot always be explained. Every affection of the eye appearing about this age must be regarded with much suspicion.

As this malady so frequently destroys the sight, and there are certain periods when the inflammation has seemingly subsided and the inexperienced person would be deceived into the belief that all danger is at an end, the eye should be most carefully observed at the time of purchase, and the examiner should be fully aware of all the minute indications of previous or approaching disease.

There is nothing which deserves so much attention from the purchaser of a horse, as the perfect transparency of the cornea over the whole of its surface. The eye should be examined for this purpose, both in front, and with the face of the examiner close to the check of the horse, under and behind the eye. The latter method of looking through the cornea is the most satisfactory, so far as the transparency of that part of the eye is concerned. During this examination, the horse should not be in the open air, but in the stable, standing in the door-way and a little within the door. If there be thickening of the lids, or puckering towards the inner corner of the eye; a difference in the apparent size of the eyes; a cloudiness, although perhaps scarcely perceptible, of the surface of the cornea or more deeply seated, or a hazy circle round its edge; a gloominess of eye generally, and dullness of the iris; with the surface of the corpora nigra ragged and hanging down, or a minute, faint, dusky spot in the centre, with or without minute fibres or lines diverging from it, we may feel assured that inflammation has occurred at no very distant period, and there will be every probability of its return. There is one little caution to be added. The cornea in its natural state is not only a beautiful transparent body, but it reflects, even in proportion to its transparency, many of the rays which fall upon it, and

if there be a white object immediately before the eye, as a very light waistcoat, or much display of a white neckcloth, the reflection may puzzle an experienced observer, and has misled the careless one. The coat should be buttoned up, and the white cravat carefully concealed. The cause of this inflammation is undoubtedly a strong predisposition to it in the eye of the horse, but assisted by over exertion and the heated and empoisoned air of many stables. The heated air has much to do with the production of the disease; the empoisoned air a great deal more; for every one must have observed, on entering a close stable early in the morning, strong fumes of ammonia, which were painful to his eyes, and caused the tears to flow. What must be the constant action of this on the eyes of the horse? The dung of the horse, and the litter of the stables, when becoming putrid, emit fumes of volatile alkali or ammonia. Often, very soon after the evacuations are voided, they begin to yield an immense quantity of this pungent gas. If we are scarcely able to bear this when we stand in the stable for only a few minutes, we need not wonder at the prevalence of inflammation in the eye of the stabled horse, nor at the difficulty of abating inflammation while this organ continues to be exposed to such painful excitement. Stables are now much better ventilated than they used to be, and ophthalmia is far from being so prevalent as it was fifty years ago. This disease generally commences during the night, and is usually detected in the morning, as soon as the horse is turned in his stable to have his head and neck dressed. In many cases one eye only suffers, the attack lasting ten days or a fortnight, then subsiding, and returning periodically every three weeks or a month. When this is the case, the other eye entirely escapes, receiving additional value from its comparison with its unfortunate fellow. But unfortunately this too often is not the case; but on the subsidation of the attack in one eye, the mischief is brewing in the other; it has to go through the same devastating process, and the result to both is derangement, worse almost in its effects than complete disorganisation.

The propagation of various diseases, and this more than any other, from the sire to his progeny, has not been sufficiently considered by breeders. Let a stallion that is blind, or whose sight is defective, possess every other point and quality that can be wished, yet he is worse than useless; for a very considerable proportion of his offspring will most assuredly inherit weak eyes or become totally blind. There is no fact better established than this, there is no more positive proof of the existence of hereditary disease than this: in many instances the entire progeny of the blind sire or dam have been implicated in the destructive disease.

The most frequent consequences of this disease are cloudiness of the eye, and cataract. The cloudiness is singular in its nature. It will change in twenty-four hours from the thinnest film to the thickest opacity, and, as suddenly, the eye will nearly regain its perfect transparency, but only to lose it, and as rapidly, a second time.

The most barbarous methods have been resorted to for the purpose of removing this cloudiness. Chalk, and salt, and sugar, and even pounded glass have been introduced into the eye mechanically to rub off the film. It was forgotten that the cloudiness was the effect of inflammation; that means so harsh and cruel were very likely to recall that inflammation; that these rough and sharp substances must of necessity inflict excruciating pain; and that, after all, it generally was not a film on the surface of the cornea, but a dimness pervading its substance, and even sinking deep within it, and therefore not capable of being removed. Where the cloudiness can be removed, it will be best effected by first abating inflammation, and then exciting the absorbents to take up the grey deposit by

washing the eye with a very weak solution of nitrate of silver or sulphate of zinc.

Opacity of the lens is another consequence of specific inflammation. A white speck appears on the centre of the lens, which gradually spreads over it, and completely covers it. It is generally so white and pearly as not to be mistaken; at other times it is more hazy, deceiving the inexperienced, and occasioning doubt in the mind of the professional man. We have seen many instances in which the sight has been considerably affected, or almost lost, and yet the horse has been pronounced sound by very fair judges. The eye must be exposed to the light, and yet under the kind of shelter which has been already described, in order to discover the defect. The pupil of the horse is seldom black, like that of the human being, and its greyish hue conceals the recent or thin film that may be spreading over the lens.

Confirmed cataract in the eye of the horse admits of no remedy, for two obvious reasons: the retractor muscle draws the eye back so powerfully and so deeply into the socket, that it would be difficult to perform any operation; and should an operation be performed, and the opaque lens removed, the sight would be so imperfect, from the rays of light not being sufficiently converged, that the horse would be worse to us than a blind one. The man who has undergone the operation of couching may put a new lens before his eye, in the form of a convex spectacle; but we cannot adapt spectacles to the eye of the horse, or fix them there.

Since the publication of the first edition of 'The Horse,' some communications have been made in the seventh volume of the 'Veterinarian' with regard to the occasional appearance and disappearance of cataract without any connection with the common moon-blindness. It is there stated, that cataracts might be formed in a fortnight or three weeks; that many instances had been known in which they had been completed in less time, and without any previous apparent disease of the eyes; and that they had been detected on examination, when the owners had not the slightest suspicion of disease in the eye. These cataracts, however, were very minute, and occasionally were found after a time to have disappeared. They differ entirely from the cataracts produced by the repeated attacks of specific ophthalmia, in being small and temporary, and in the other tissues of the eye remaining intact.

That excellent veterinarian, Mr. Percivall, had a case of this description. A gentleman brought a horse one morning to the hospital, in consequence of its having fallen in his way to town, and grazed his eye-brow. On examining him carefully, the cornea was partially nebulous, and a cataract was plainly visible. Neither of these defects was sufficient to attract the notice of any unprofessional observer, and both were unconnected with the slight bruise produced by the fall. The owner was told that the corneal opacity might possibly be removed; but as for the cataract he might regard this as beyond the reach of medicine. He returned with his horse on the fifth day, saying that the physic had operated well, and that he thought the eye was as clear as ever. Mr. Percivall examined the eye, and could discover no relic either of the corneal opacity or of the cataract.

The opinion respecting cataract is therefore essentially modified. It may not of necessity be the result of previous inflammation, although in the great majority of cases it is so, nor does it always lead to blindness. Still it is a serious thing at all times, and, although existing in the minutest degree, it is *unsoundness*, and very materially lessens the value of the horse.

'Were I asked,' says Mr. Percivall, 'how the practitioner could best distinguish a cataract of the above description from that which is of ordi-

nary occurrence, and known by us all to constitute the common termination of periodical ophthalmia, I should say that the unusually lucid and healthy aspect which every other part of the eye presents is our best diagnostic sign; the slightest indication, however, or the slightest suspicion of prior or present inflammation, being a reason for coming to a different conclusion. As to the period of time a cataract of this species, supposing it to be membranous, would require for its formation, I should apprehend that its production might be, as its disappearance often would seem to be, the work of a very short interval, perhaps not more than five or six days.' As to the cause and treatment of it, we are at present completely in the dark. If it does not soon disappear, the hydriodate of potash administered internally might offer the best prospect of success.

#### AMAUROSIS, OR GUTTA SERENA.

Another species of blindness, and of which mention was made when describing the retina, is Gutta Serena, commonly called *glass eye*. The pupil is more than usually dilated: it is immovable, bright, and glassy, and the animal is totally blind. This is palsy of the optic nerve, or its expansion, the retina. It may be produced by several causes, such as from a blow on the head, internal hæmorrhage, pressure, the result of tumours, or effusion upon that particular part of the brain from whence the optic nerves arise, from some disease of the retina itself, or as the result of debilitating diseases. The treatment of Gutta Serena is quite as difficult as that of cataract. We have heard of successful cases, but we never saw one; nor should we be disposed to incur much expense in endeavouring to accomplish impossibilities. If it proceed from injuries such as blows, &c., warm fomentations should be employed and setons inserted, laxative medicines being given; if from debility we should allow nutritious food, and give vegetable and mineral tonics. If we succeed it must be by constitutional treatment. As to local treatment, the seat of disease is out of our reach.

#### GLAUCOMA.

This is a disease occasionally met with as a termination of ophthalmia, and known by the name of green cataract; but it is much more frequently met with as a result of age in very old horses. On examination the pupil will be found dilated, and the interior of the eye presenting a peculiar sea-green appearance, the animal being blind. It is a diseased condition of the vitreous humour, and admits of no relief.

#### DISEASES OF THE EAR.

Wounds of the ear are usually the consequence of careless or brutal treatment. The twitch may be applied to it, when absolute necessity requires this degree of coercion; but troublesome ulcers and bruises have been the consequence of the abuse of this species of punishment, and more especially has the farrier done irreparable mischief when he has brutally made use of his plyers.

These bruises or wounds will generally—fortunately for the animal, and fortunately, perhaps, for the brute that inflicted the injury—speedily heal; but occasionally sinuses and abscesses will result that bid defiance to the most skilful treatment. A simple laceration of the cartilage is easily remedied. The divided edges are brought into apposition, and the head is tied up closely for a few days, and all is well; but, occasionally, ulceration of the integument and cellular substance, and caries of the cartilage, will take place—deep sinuses will be formed, and the wound will bid defiance

to the most skilful treatment. The writer of this work had once a case of this kind under his care more than two months, and he was at length compelled to cut off the ear, the other ear following it, for the sake of uniformity of appearance. The lunar caustic, or the muriate of antimony, or the heated iron, must be early employed, or the labour of the practitioner will be in vain.

It has been the misfortune of the same person to witness two cases in which the auditory passage was closed and the faculty of hearing destroyed, by blows on the ear violently inflicted. No punishment can be too severe for these brutes in human shape. Whenever there is considerable swelling about the root of the ear, and the fluctuation of a fluid within can be detected, it should be immediately opened with a lancet, and the purulent fluid liberated.

The abscess usually begins to form about the middle of the conch, or rather nearer the base than the point. The incision should be of considerable length, or the opening will close again in four-and-twenty hours. The purulent matter having been evacuated, the incision should not be permitted to close until the edges of the ulcer have adhered to each other, and the abscess is obliterated.

The size and the carriage of the ear do not always please. The ears may be larger and more dependent than fashion requires them to be, and this is remedied by an operation. On either side of the projection of the occipital bone, and in a straight line forward and backward, a fold of the skin is pinched up and cut away. The divided edges on either side are then brought together, and confined by two or three stitches—they presently unite, and the owner has a better-looking horse, and soon forgets or cares not about the punishment which he has inflicted on him.

The ears of other horses may be supposed to be too close to each other. This fault is corrected by another piece of cruelty. Similar slips of skin are cut away on the outside of the base of the ear, and in the same direction. The edges of the wound are then brought together, confined by sutures, and the ears are drawn further apart from each other, and have different directions given to them. A very slight examination of either of the horses will readily detect the imposition.

#### DEAFNESS.

Of the occasional existence of this in the horse, there is no doubt. The beautiful play of the ears has ceased, and the horse hears not the voice of his master, or the sound of the whip. Much of the apparent stupidity of a few horses is attributable to their imperfect hearing. It occasionally appears to follow the decline of various diseases, and especially of those that affect the head and the respiratory passages. It has been the consequence of brutal treatment closing the conduit of the ear, or rupturing the tympanum; and it is certainly, as in other domesticated animals, the accompaniment of old age.

In the present state of veterinary knowledge it is an incurable complaint; the only thing that can be done is not to punish the poor slave for his apparent stupidity, produced perhaps by over-exertion in our service, or, at least, the natural attendant of the close of a life devoted to us.

## CHAPTER X.

## THE ANATOMY AND DISEASES OF THE NOSE AND MOUTH.

WE now proceed to a description of the *face*, or lower part of the head of the Horse. The *nasal bones*, or bones of the nose (*j j*, p. 145), are connected with the frontal bones above, and with the lachrymal, *i i*, and the bones of the upper jaw, *l l*, on either side. They are united together by a plain suture, which is a continuation of the frontal, and they terminate in a point at the nostril (*p*, p. 145). They are rounded and arched above, because they are exposed to occasional violence and injury, which the arch-form will enable them best to resist; and at the base of the arch, where the main strength should be, they are overlapped by the upper jaw-bone, as the temporal bone overlaps the base of the parietal. These bones form a principal part of the face; and the length or shortness, and the character of the face, depend upon them. Sometimes there is an appearance of two little arches, with a depression between them along the sutures. This is often found in the blood-horse, with his comparatively broad head and face. The single elevated arch is found in the long and narrow face of the heavy draught-horse.

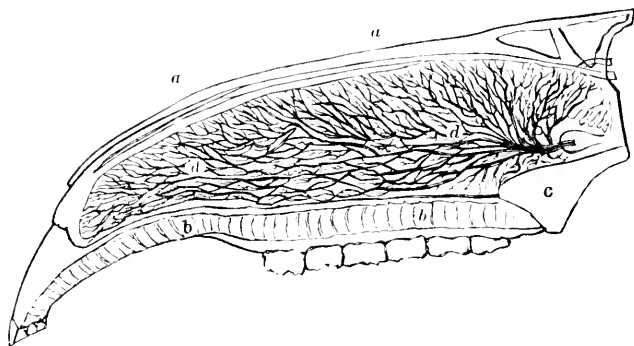
The nasal bones pursue their course down the face, in some horses in a straight line—in others, there is a slight prominence towards the upper part, while in a considerable number, a depression is observed a little lower down. Some persons have imagined that this deviation in the line of the face affords an indication of the temper of the animal, and there may be a little truth in this. The horse with a straight profile may be good or bad tempered, but not often either to any great excess. The one with the prominent Roman nose will generally be an easy, good-tempered kind of beast—hardy—ready enough to feed, not always, perhaps, so ready to work, but may be made to do his duty without any cruel urging, and having no extraordinary pretension to speed or blood. On the other hand, a depression across the centre of the nose generally indicates some breeding, especially if the head is small, but occasionally accompanied by a vicious, uncontrollable disposition.

There is another way, however, in which the nasal bones do more certainly indicate the breed, viz., by their comparative length or shortness. There is no surer criterion of a well-bred horse, than a broad angular forehead, prominent features, and a short face; nor of a horse with little breeding, than a narrow forehead, small features, and lengthened nose. The comparative development of the head and face indicates, with little error, the preponderance of the animal or intellectual principle.

These bones form the roof of an important cavity—the nasal cavity, as shown in the cut (*a, a*, p. 197). The sides are constituted above by the nasal bones, and, lower down, by the upper jawbones (*superior maxillaries*), while plates from these latter bones project and compose the palate, which is both the floor of the nose and the roof of the mouth (*b, b*). Above is a bone called the *palatine* (*c*), although it contributes very little to the formation of the palate. It is the termination of the palate, or the border of the opening where the cavities of the mouth and nose meet. The frontal sinuses and large vacuities in the upper jaw-bone, and in the æthmoid and sphenoid bones, communicate with and enlarge the cavity of the nose.



This cavity is divided into two parts by a cartilage called the *Septum* (*d, d*). It is of considerable thickness and strength, and divides the



cavity of the nose into two equal parts. It is placed in the centre for the purpose of strength, and it is formed of cartilage, in order that, by its gradually yielding resistance, it may neutralise almost any force that may be applied to it.

When we open the nostril, we see the membrane by which the cartilage, and the whole of the cavity of the nose, is lined, and by the colour of which, much more than by that of the lining of the eyelids, we judge of the degree of fever, and particularly of inflammation of the lungs, or any of the air-passages. The above cut shows the ramifications of the blood-vessels, both arterial and venous, on the membrane of the nose. It beautifully accounts for the accurate connection which we trace between the colour of the nasal membrane, and various diseases or states of the circulation. By the sore places or ulcerations discovered on this membrane, we likewise determine respecting the existence of glanders: and the interposition of the septum is a wise and benevolent provision to hinder the spread of the mischief, by cutting off all communication with the neighbouring parts, and also to preserve one nostril pervious, when the other is diseased or obstructed. The nasal cavity is, on either side, occupied by two bones, which, from their being rolled up somewhat in the form of a turban, are called the *turbinated* or *turban-shaped* bones. They are as thin as gauze, and perforated like gauze, with a thousand holes. Between them are left sufficient passages for the air.

If they were unrolled, they would present a very considerable surface; and on every part of them is spread the substance or pulp of the *olfactory* or first pair of nerves. These bones, lined with delicate membranes and covered by the olfactory nerves, are the *seat of smell*; and they are thus expanded, because the sense of smell in the horse must, to a very considerable degree, supply the place of the sense of touch and the lessons of experience in the human being. By this alone he is enabled to select, amongst the nutritive and poisonous herbage of the meadow, that which would support and not destroy him. The troops of wild horses are said to smell the approach of an enemy at a very considerable distance. In his domestic state, the horse does not examine the different food which is placed before him with his eye, but with his nose: and if the smell displeases him no coaxing will induce him to eat. He examines a stranger by the smell, and, by very intelligible signs, expresses the opinion which he forms of him by this inquisition. The horse will evidently recognise his favourite groom when he has nothing else to indicate his approach but the sense of smell. These cavities are likewise organs of voice. The sound reverberates

through them, and increases in loudness, as through the windings of a French horn.

The extension of the nostril at the lower part of these cavities is an important part of the face, and intimately connected with breeding, courage, and speed. The horse can breathe only through the nose. All the air which goes to and returns from the lungs must pass through the nostrils. In the common act of breathing, these are sufficiently large; but when the animal is put on his speed, and the respiration is quickened, these passages must dilate, or he will be much distressed. The expanded nostril is a striking feature in the blood-horse, especially when he has been excited and not over-blown. The sporting man will not forget the sudden effect which is given to the countenance of the hunter, when his ears become erect, and his nostrils dilate as he first listens to the cry of the hounds, and snorts, and scents them afar off. The painful and spasmed stretching of this part, in the poor over-driven post-horse, will show how necessary it is that the passage to the lungs should be free and open. The nostrils should not only be large, but the membranous substance which covers the entrance into the nose should be thin and elastic, that it may more readily yield when the necessity of the animal requires a greater supply of air, and afterwards return to its natural dimensions. Therefore, nature, which adapts the animal to his situation and use, has given to the cart-horse, that is seldom blown, a confined nostril, and surrounded by much cellular substance, and a thick skin; and to the horse of more breeding, whose use consists in his speed and his continuance, a wider nostril, and one much more flexible.

The inhabitants of some countries were accustomed to slit the nostrils of their horses that they might be less distressed in the severe and long-continued exertion of their speed. The Icelanders do so to the present day. There is no necessity for this, for nature has made ample provision for all the ordinary and even extraordinary exertion we can require from the horse.

Some very powerful muscles proceed from different parts of the face to the neighbourhood of the nostrils, in order to draw them back and dilate them. Four of these are given in the next cut, which is introduced to complete our present subject, and which will be often referred to in the course of our work; *l*, *m*, *o*, and *p*, are muscles employed for this purpose.

There are also four distinct cartilages, attached to the nostrils, which, by their elasticity, bring back the nostrils to their former dimensions, as soon as the muscles cease to act. The bones of the nose (*p*, p. 145) are also sharpened off to a point, to give wider range for the action of the muscles; while the cartilages are so contrived, as not only to discharge the office we have mentioned, but to protect this projection of bone from injury.

There are two circumstances, which, more than any others, will enable not only the veterinary surgeon, but the owner of a horse also, accurately to judge of the character and degree of many diseases, and to which very few persons pay sufficient attention; these are the pulse, of which we shall presently speak, and the colour of the membrane of the nose. It is the custom of most veterinary surgeons and horse-men to lift the upper eyelid, and to form their opinion by the colour which its lining presents. If it is very red, there is considerable fever; if it is of a pale pinkish hue, there is little danger. The nose, however, is more easily got at;—the surface presented to the view is more extensive;—its sympathy with almost all the important organs is greater;—and the changes produced by disease are more striking and more conclusive. Let the reader first make himself well acquainted with the uniform pale pink appearance of that portion of the membrane

which covers the lower part of the cartilaginous partition between the nostrils, when the horse is in health and quiet; then the increased blush of red, betokening some excitement of the system—the streaked appearance of inflammation commenced, and threatening to increase—the intense florid red, of acute inflammation—the pale ground with patches of vivid red, showing the half subdued, but still existing fever—the uniform colour although somewhat redder than natural, predicting a return to healthy circulation—the paleness approaching to white, marking the stage of debility, and sometimes intermingled with radiations of crimson, inducing the suspicion of lurking mischief; and the dark livid colour of approaching stagnation of the vital current. These, with all their shades of difference, will be guides to his opinion and treatment, which every one who has studied them will highly appreciate.

THE MUSCLES, NERVES, AND BLOOD-VESSELS OF THE HEAD AND UPPER PART OF THE NECK.



- a The upper part of the ligament of the neck.
- b The *levator humeri* (elevator of the shoulder), arising from the tubercle of the occiput, the mastoid (nipple-shaped) process of the petrose temporal bone, the transverse processes (cross projections) of the four first bones of the neck, and the ligament of the neck, and going to the muscles of the shoulders, and the upper bone of the arm: to draw forward the shoulder and arm; or turn the head and neck; and, when the two levators act, to depress the head.
- c The tendon common to the *trachelo mastoideus*, and *splenius* (splint-like): to the mastoid process of the petrose temporal bone, to raise the head, or the muscles on one side alone acting, to turn it.
- d The *sterno-maxillaris* (belonging to the breast-bone and lower jaw), from the cartilage in front of the chest to the angle of the lower jaw: to assist in opening the mouth.
- e The *stylo-maxillaris*, from the styloid (pencil-shaped) or coracoid (beak-shaped) process of the occiput, to the angle of the jaw: to pull the jaw backward and open it.
- f The *subscapulo hyoides*, from the *fascia of subscapularis* to the body of the *os hyoides* (the bone at the root of the tongue formed like a Greek  $\nu$ ): to draw back that bone.
- g The *masseter* (chewing); a most powerful muscle, constituting the cheek of the horse: from the upper jaw-bone into the rough surface round the angle of the lower: to assist in closing the mouth and chewing the food.
- h The *orbicularis palpebrarum* (circular), surrounding the eye and closing the lids.
- i The *zygomaticeus*, from the zygomatic arch and masseter to the corner of the mouth, to draw back the angle of the mouth.

- k* The *buccinator* (trumpeter), from the inside of the mouth and cheeks, to the angle of the mouth, to draw it back.
- l* The *nasalis longus labii superioris* (belonging to the nose and upper lip), from a depression at the junction of the superior maxillary, lachrymal, and malar bones to the upper lip: to raise the lip and dilate the nostrils.
- m n* *Levator labii superioris alaeque nasi*, from the junction of the lachrymal, nasal, and superior maxillary bones, to the upper lip and false nostril: to raise the lip and dilate the nostril.
- o* *Retractor labii inferioris* (puller back of the under lip), to the sides of the inferior maxilla and under lip: to draw it back.
- p* *Orbicularis oris* (circular muscle of the mouth), surrounding the mouth: to close the lips.
- q* The upper portion of the parotid gland (gland near the ear) reversed, to show the blood-vessels and nerves beneath it.
- r* The parotid duct piercing the cheek, to discharge the saliva into the mouth.
- s* The maxillary gland (gland of the lower jaw) with its duct.
- t* The jugular (neck) vein, after the two branches have united.
- u* At this letter, the submaxillary artery, a branch of the jugular, and the parotid duct pass under and within the angle of the lower jaw; they come out again at *w*, and climb up the cheek.
- v* The temporal vein and artery, passing under the zygomatic arch.
- x y* The motor nerves of the face, emerging from under the parotid gland.
- z* Branches of both nerves, with small blood-vessels.

### NASAL POLYPUS.

By a polypus is meant an excrescence or tumour, varying in size, structure, and consistence, and attached by a pedicle to a mucous surface. The true polypus is attached to mucous membranes, and is usually found in the nostrils, the pharynx, the uterus, or the vagina. Tumours have been seen hanging loose in the veins and ventricles of the heart; and in the larger blood-vessels there have been accumulations of the fibrine of the blood, with peduncular attachments.

The nasal polypus usually adheres to some portion of the superior turbinated bone, or it has come from some of the sinuses connected with that cavity. It escaped, while small, through the valvular opening under the superior turbinated bone into the cavity of the nose, and there attained its full growth.

No better account, however, can be given of the cause of their appearance than that of tumours in other parts of the body. They evidently have a constitutional origin: they are frequently hereditary, and the animal in which they have once appeared is subject to a return of them.

By some means, probably the increasing weight of the tumour, and being in a dependent situation, the polypus is gradually detached from its base, and forces with it the soft and easily distensible membrane of the nose. As it continues to descend, this portion of membrane is farther elongated, and forms the pedicle or root of the tumour;—if that may be termed a root which is a mere duplicate of its investing membrane.

The polypus, when it hangs free in the nasal cavity, is usually of a pyriform or pear-like shape; and it varies in weight, from a few drachms to three or four pounds.

How is the surgeon to proceed? Can he lay hold of the polypus by the finger, or the forceps, or (for these tumours do not possess much sensibility) the tenaculum? To ascertain this, he will cast the horse, and fix the head in a position to take the greatest advantage of the light. If he cannot fairly get at the tumour by any of these means, he will let it alone. It will continue to grow—the membrane constituting the pedicle will be lengthened—and the polypus will at length descend, and be easily got at. Time and patience will effect wonders in this and many similar cases.

Supposing it to have grown, and the surgeon is endeavouring to extract it, he must not use any great force. It must not be torn out by the root; the tumour must be gently brought down, and a ligature passed round the pedicle, as high up as it can conveniently be placed. If the polypus can then be returned to the nose, the animal will suffer very little inconvenience; and in a few days it will slough off, and the pedicle will contract, and gradually disappear.

If the polypus is so large that it cannot be well returned after it has been brought down, we must, notwithstanding, use the ligature, passing it round the pedicle sufficiently tightly to cut off the supply of blood to the tumour. We may then immediately excise it. Except the pedicle is exceedingly thick, there will be little or no hæmorrhage. Should some bleeding occur, it will probably soon stop, or may be stopped by the caутery, which should, however, be avoided if possible, for our object is to produce as little irritation as may be in the membrane, and the actual caутery will be applied with considerable difficulty in the cavity of the nose.

In very bad cases, when the tumour cannot be drawn out of the nose, it may be necessary to slit up the ala or side of the nostril. It will be better, however, not to cut through the false nostril, for that consists of a duplication of such thin integument, that the stitches can hardly be retained in it, when the horse will be continually snorting at the least inconvenience. It will also be difficult to bring the edges of this thin membrane accurately together again, or, if this be effected, there is scarcely life enough in it for the parts readily to unite. The false nostril should be avoided, and the incision made along the lateral edge of the nasal bone, beginning at its apex or point. The flap will then conveniently turn down, so as to expose the cavity beneath; and there will be sufficient muscular substance to secure an almost certain union by the first intention. The nostril being opened, the pedicle will probably be displayed, and a ligature may be passed round it, as already recommended; or if it is not actually in sight, it may probably gradually be brought within reach.

#### NASAL GLEET, OR DISCHARGE FROM THE NOSE.

There is a constant secretion of fluid to lubricate and moisten the membrane that lines the cavity of the nose, and which, under catarrh or cold, is increased in quantity, and altered in appearance and consistence. This will properly belong to the account of catarrh or cold; but that which is immediately under consideration is a continued and oftentimes profuse discharge of thickened mucus, when every symptom of catarrh and fever has passed away. If the horse is at grass, the discharge is almost as green as the food on which he lives;—or if he is stabled, it is white, or straw-coloured, or brown, or even bloody, and sometimes purulent. It is either constantly running, or snorted out in masses many times a day; teasing the horse, and becoming a perfect nuisance in the stable, and to the rider. This has been known to continue several months, and eventually to destroy the horse.

The discharge is sometimes confined to one nostril, and there may exist considerable tumefaction of the submaxillary glands, which has caused this disease to be mistaken for glanders. Should any doubt exist, no time should be lost in obtaining the opinion of a veterinary surgeon respecting its nature.

If the discharge is not offensive to the smell, nor mixed with purulent matter, it is probably merely an increased and somewhat vitiated secretion from the cavities of the nose; and all fever having disappeared, will frequently yield to small doses of blue vitriol, given twice in the day. If

the discharge is considerable and mingled with pus, we may conclude, that the disease has extended to the sinuses of the head, and that abscesses have formed, most likely, in the frontal sinus. The discharge being very offensive, will indicate that the disease has extended to the bones and cartilage. The treatment should consist of the internal administration of sulphate of copper, either mingled with the animal's corn, or in combination with ginger and gentian, continued for a considerable time, for this is a disease which will not very quickly yield to treatment. The animal should be kept on the most nutritious diet, great attention being paid to cleanliness. If the discharge does not yield to this treatment, the next course to adopt will be to open the sinuses of the head with the trephine (the method of doing this will be described under 'Operations'), and after having well syringed the parts with warm water, inject some astringent solution, such as the sulphate of zinc or copper. The injection should be at first weak, but gradually increased in strength. If the discharge continue for a length of time, without yielding to treatment, there is danger of its terminating in glanders.

#### OZENA.

OZENA is ulceration of the membrane of the nose not always or often visible, but recognised by the discharge of muco-purulent matter, of a peculiar fetor, from which the disease derives its name. It resembles glanders in being confined in most instances to one nostril, and the sub-maxillary gland on the same side being enlarged; but differs from it, in the gland not being adherent, and the discharge, from its earliest stage, being purulent and stinking.

There is sometimes a fœtid discharge from the nostril in consequence of inflammation of the lungs, or produced by some of the sequelæ of pneumonia; distinguished, however, from ozena by its usually flowing irregularly, being coughed up in great quantities, more decidedly purulent, and the gland or glands seldom affected. The discharge from ozena is constant, muco-purulent, and attended by enlargement of the glands. It is of immense consequence that we should be enabled to distinguish the one from the other; for while ozena may, sometimes at least, be manageable, the other is too frequently the precursor of death.

The cause of ozena cannot always be discovered. Chronic inflammation of the membrane may assume another and malignant character. In severe catarrh the membrane may become abraded, and the abrasions may degenerate into foul and fœtid ulcers. It is not an unfrequent consequence of epidemic catarrh. It has been produced by caustic applications to the lining membrane of the nose. It has followed hæmorrhage, spontaneous, or the consequence of injury.

In some cases, and those as obstinate as any, it cannot perhaps be traced to any probable cause, and the health of the animal has not appeared to be in the slightest degree affected.

The membrane of the nose is highly sensitive and irritable, and an ulcer, in whatever way formed on it, does not readily heal. It often runs on to gangrene, and destroys not only the membrane, but the bone beneath and even the cartilaginous septum. This is rarely the case in glanders; and the ravages of the chancrous ulcers are usually confined to the membrane. The ulceration proceeds to a certain point—its progress is then arrested, usually by nature alone—the discharge gradually lessens—it loses its offensive character, and at length ceases.

Local applications are seldom available in the treatment of this disease; for we know not the situation of the ulcer, and if we did, we probably

could not get at it. Some have recommended setons. Where are they to be applied? If the seat of ulceration is unknown, the seton may only give useless pain. Several *post-mortem* examinations have shown that the frontal sinuses are a frequent seat of the disease. Yet what injection could we use? An emollient one would be thrown away. A stimulating injection might convert ozena into glanders. Other examinations have shown that the superior portion of the central meatus was diseased. What instrument can be contrived to reach that? Internal medicines are almost thrown away in this complaint: yet something, perhaps, may be done under the form of a local application. The discarded nose-bag (undervalued at least by too many practitioners) will afford the means of employing an emollient fomentation. The steam from a bran-mash, scalding hot, will probably reach every part of the nasal cavity, and so afford some chance of being beneficially applied to the ulcer. It will, at least, thoroughly cleanse the part. By means of the nose-bag and the warm mash, the chloride of lime may be introduced into the cavity, not only combining with the extricated gases, and removing the fœtor, but arresting the tendency to decomposition.

Then there is a digestive—a gentle stimulus to abraded and ulcerated surfaces, rousing them to healthy action, and without too much irritating them—turpentine. This may be applied in the form of vapour, and in the best of all ways, by using the best yellow deal shavings instead of bran. This digestive may be brought into contact with every part of the Schneiderian membrane, and has been serviceable.

There is another resource, and one that bids fairer to be successful than any other with which we are acquainted—the spring grass. It is the finest alterative, depurative, and restorative in our whole materia medica; and if it is accessible in the form of a salt marsh, there is no better chance of doing good.

#### GLANDERS.

The most formidable of all the diseases to which the horse is subject is GLANDERS. It has been recognised from the time of Hippocrates of Cos; and few modern veterinary writers have given a more accurate or complete account of its symptoms than is to be found in the works of the father of medicine. Three-and-twenty hundred years have rolled on since then, and veterinary practitioners are not yet agreed as to the tissue primarily affected, nor the actual nature of the disease: we only know that it is at the present day, what it was then, a loathsome and an incurable malady.

We shall therefore, in treating of this disease, pursue our course slowly and cautiously.

The earliest symptom of Glanders is an increased discharge from the nostril, small in quantity, constantly flowing, of an aqueous character and a little mucus mingling with it.

Connected with this is an error too general, and highly mischievous, with regard to the character of this discharge in the earliest stage of the disease, when, if ever, a cure might be effected, and when, too, the mischief from contagion is most frequently produced. The discharge of glanders is not sticky when it may be first recognised. It is an aqueous or mucous, but small and constant discharge, and is thus distinguished from catarrh, or nasal gleet, or any other defluxion from the nostril. It should be impressed on the mind of every horseman that this small and constant defluxion, overlooked by the groom and by the owner, and too often by the veterinary surgeon, is a most suspicious circumstance.

Mr. James Turner deserves much credit for having first or chiefly

directed the attention of horsemen to this important but disregarded symptom. If a horse is in the highest condition, yet has this small aqueous constant discharge, and especially from one nostril, no time should be lost in separating him from his companions. No harm will be done by this, although the defluxion should not ultimately betray lurking mischief of a worse character.

Mr. Turner relates a case very much in point. A farmer asked his opinion respecting a mare in excellent condition, with a sleek coat, and in full work. He had had her seven or eight months, and during the whole of that time there had been a discharge from the right nostril, but in so slight a degree as scarcely to be deemed worthy of notice. He now wanted to sell her, but, like an honest man, he wished to know whether he might warrant her. Mr. Turner very properly gave it as his opinion, that the discharge having existed for so long a time, he would not be justified in sending her into the market. A farrier, however, whose ideas of glanders had always been connected with a sticky discharge and an adherent gland, bought her, and led her away.

Three months passed on, when Mr. Turner examining the post-horses of a neighbouring inn, discovered that two of them were glandered, and two more farcied, while, standing next to the first that was attacked, and his partner in work, was his old acquaintance the farmer's mare, with the same discharge from her nostril, and who had, beyond question, been the cause of all the mischief.

The peculiar viscosity and guiness which is generally supposed to distinguish the discharge of glanders from all other mucous and prevalent secretions belongs to the second stage of the disease, and, for many months before this, glanders may have existed in an insidious and highly contagious form. It must be acknowledged, however, that, in the majority of cases, some degree of stickiness does characterise the discharge of glanders from a very early period.

It is a singular circumstance, for which no satisfactory account has yet been given, that when one nostril alone is attacked, it is, in a great majority of cases, the near, or left. M. Dupuy, the director of the veterinary school at Toulouse, gives a very singular account of this. He says that, out of eighty cases of glanders that came under his notice, only one was affected in the right nostril. The difference in the affected nostril does not exist to so great an extent in Great Britain; but in two horses out of three, or three out of four, the discharge is from the left nostril alone. We might account for the left leg failing oftener than the right, for we mount and dismount on the left side; the horse generally leads with it, and there is more wear and tear of that limb: but we cannot satisfactorily account for this usual affection of the left nostril. It is true that the reins are held in the left hand, and there may be a little more bearing and pressure on the left side of the mouth; but this applies only to saddle-horses, and even with them does not sufficiently explain the result.

This discharge, in cases of contagion, may continue, and in so slight a degree as to be scarcely perceptible, for many months, or even two or three years, unattended by any other disease, even ulceration of the nostril, and yet the horse being decidedly glandered from the beginning and capable of propagating the malady. In process of time, however, pus mingles with the discharge, and then another and a characteristic symptom appears. Some of this is absorbed, and the neighbouring glands become affected. If there is a discharge from both nostrils, the glands within the under jaw will be on both sides enlarged. If the discharge is from one nostril only, the swelled gland will be found on that side alone. Glanders, however, will frequently exist at an early age without these swelled glands, and some



other diseases, as catarrh, will produce them. Then we must look out for some peculiarity about these glands, and we shall readily find it. The swelling may be at first somewhat large and diffused, but the surrounding enlargement soon goes off, and one or two small distinct glands remain; and they are not in the centre of the channel, but *adhere closely to the jaw on the affected side.*

The membrane of the nose should now be examined, and will materially guide our opinion. It will either be of a dark purplish hue, or almost of a leaden colour, or of any shade between the two; or if there is some of the redness of inflammation, it will have a purple tinge: but there will never be the faint pink blush of health, or the intense and vivid red of usual inflammation. Spots of ulceration will probably appear on the membrane covering the cartilage of the nose—not mere sore places, or streaks of abrasion, and quite superficial, but small ulcers, usually approaching to a circular form, deep, and with the edges abrupt and prominent. When these appearances are observed, there can be no doubt about the matter. Care should be taken, however, to ascertain that these ulcers do actually exist, for spots of mucus adhering to the membrane have been more than once taken for them. The finger should, if possible, be passed over the supposed ulcer, in order to determine whether it can be wiped away; and it should be recollected, as was hinted when describing the duct that conveys the tears to the nose, that the orifice of that duct, just within the nostril, and on the inner side of it, has been mistaken for a chancrous ulcer. This orifice is on the continuation of the common skin of the muzzle which runs a little way up the nostril, while the ulcer of glanders is on the proper membrane of the nose above. The line of separation between the two is evident on the slightest inspection.

When ulcers begin to appear on the membrane of the nose, the constitution of the horse is soon evidently affected. The patient loses flesh—his belly is tucked up—his coat unthrifty, and readily coming off—the appetite is impaired—the strength fails—cough, more or less urgent, may be heard—the discharge from the nose will increase in quantity; it will be discoloured, bloody, offensive to the smell—the ulcers in the nose will become larger and more numerous, and the air-passages being obstructed, a grating, choking noise will be heard at every act of breathing. There is now a peculiar tenderness about the forehead. The membrane lining the frontal sinuses is inflamed and ulcerated, and the integument of the forehead becomes thickened and somewhat swelled. Farcy is now super-added to glanders, and more of the absorbents are involved.

At or before this time little tumours appear about the muscles, and face, and neck, following the course of the veins and the absorbents, for they run side by side; and these tumours soon ulcerate. Tumours or buds, still pursuing the path of the absorbents, soon appear on the inside of the thighs. They are connected together by a corded substance. This is the inflamed and enlarged lymphatic; and ulceration quickly follows the appearance of these buds. The deeper-seated absorbents are next affected; and one or both of the hind-legs swell to a great size, and become stiff, and hot, and tender. The loss of flesh and strength is more marked every day. The membrane of the nose becomes of a dirty livid colour. The membrane of the mouth is strangely pallid. The eye is infiltrated with a yellow fluid; and the discharge from the nose becomes more profuse, and insufferably offensive. The animal presents one mass of putrefaction, and at last dies exhausted.

The enlargement of the submaxillary glands, as connected with this disease, may, perhaps, require a little farther consideration. A portion of the fluid secreted by the membrane of the nose, and altered in character

by the peculiar inflammation there existing, is absorbed; and as it is conveyed along the lymphatics, in order to arrive at the place of its destination, it inflames them, and causes them to enlarge and suppurate. There is, however, a peculiarity accompanying the inflammation which they take from the absorption of the virus of glanders. They are rarely large, except at first, or hot, or tender; but they are characterised by a singular hardness, a proximity to the jaw-bone, and, frequently, actual adhesion to it. The adhesion is produced by the inflammatory action going forward in the gland, and the effusion of coagulable lymph. This hardness and adhesion accompanying discharge from the nostril, and being on the same side with the nostril whence the discharge proceeds, afford proof not to be controverted that the horse is glandered. Notwithstanding this, however, there are cases in which the glands are neither adherent nor much enlarged, and yet there is constant discharge from one or both nostrils. The veterinary surgeon would have little hesitation in pronouncing them to be cases of glanders. He will trust to the adhesion of the gland, but he will not be misled by its looseness, nor even by its absence altogether.

*Glanders* has often been confounded with *strangles*, and by those who ought to have known better. *Strangles* are peculiar to young horses. The early stage resembles common cold, with some degree of fever and sore throat—generally with distressing cough, or at least frequent wheezing; and when the enlargement appears beneath the jaw, it is not a single small gland, but a swelling of the whole of the substance between the jaws, growing harder towards the centre, and, after a while, appearing to contain a fluid, and breaking. In *strangles* the membrane of the nose will be intensely red, and the discharge from the nose profuse and purulent, or mixed with matter almost from the first. When the tumour has burst, the fever will abate, and the horse will speedily get well.

Should the discharge from the nose continue, as it sometimes does, for a considerable time after the horse has recovered from *strangles*, there is no cause for fear. Simple *strangles* need never degenerate into glanders. Good keep, and small doses of tonic medicine, will gradually perfect the cure.

*Glanders* has been confounded with catarrh or cold; but the distinction between them is plain enough. Fever, and loss of appetite and sore throat, accompanying cold—the quidding of the food and gulping of the water are sufficient indications of the latter of these; the discharge from the nose is profuse, and perhaps purulent; the glands under the jaw, if swelled, are moveable, there is a thickening around them, and they are tender and hot. With proper treatment the fever abates; the cough disappears; the swellings under the throat subside; and the discharge from the nose gradually ceases, or, if it remains, it is usually very different from that which characterises glanders. In glanders there is seldom cough of any consequence, and generally no cough at all.

A running from the nose, small in quantity, and, from the smallness of its quantity, drying about the edges of the nostril, and presenting some appearance of stickiness, will, in a few cases, remain after severe catarrh, and especially after the influenza of spring; and these have gradually assumed the character of glanders, and more particularly when they have been accompanied by enlarged glands and ulceration in the nose. Here the aid of a judicious veterinary surgeon is indispensable; and he will sometimes experience considerable difficulty in deciding the case. One circumstance will principally guide him. No disease will run on to glanders which has not, to a considerable and palpable degree, impaired and broken down the constitution; and *every disease that does this will run on to glanders*. He will look then to the general state and condition

of the horse, as well as to the situation of the glands, the nature of the discharge, and the character of the ulceration.

If, after all, he is in doubt, an experiment may be resorted to, which wears indeed the appearance of cruelty, and which only the safety of a valuable animal, or of a whole team, can justify. He will inoculate an ass, or a horse already condemned to the hounds, with the matter discharged from the nose. If the horse is glandered, the symptoms of glanders or farcy will appear in the inoculated animal in the course of a few days.

The *post-mortem* examination of the horse will remove every doubt as to the character of the disease. The nostril is generally more or less blanched, with spots or lines of inflammation of considerable intensity. Ulceration is almost invariably found, and of a chancreous character, on the septum, and also on the æthmoid and turbinated bones. The ulcers evidently follow the course of the absorbents, sometimes almost confined to the track of the main vessel, or, if scattered over the membrane generally, thickest over the path of the lymphatic. The æthmoid and turbinated bones are often filled with pus, and sometimes eaten through and carious; but, in the majority of cases, the ulceration is confined to the external membrane, although there may be pus within. In aggravated cases the disease extends through all the cells of the face and head.

The path of the disease down the larynx and windpipe is easily traced, and the ulcers follow one line—that of the absorbents. In aggravated cases, this can generally be traced on to the lungs. It produces inflammation in these organs, characterised in some cases by congestion; but in other cases, the congestion has gone on to hepatisation, in which the cellular texture of the lungs is obliterated. Most frequently, when the lungs are affected at all, tubercles are found—miliary tubercles—minute granulated spots on the surface, or in the substance of the lungs, and not accompanied by much inflammation. In a few cases there are larger tubercles, which soften and burst, and terminate in cavities of varying size; they are then called vomicæ.

In some cases, and showing that glanders is not essentially or necessarily a disease of the lungs, there is no morbid affection whatever in those organs.

The history thus given of the symptoms of glanders will clearly point out its nature. It is an affection of the membrane of the nose. Some say, and at their head is Professor Dupuy, that it is the production of tubercles, or minute tumours in the upper cells of the nose, which may long exist undetected, except by a scarcely perceptible running from the nostril, caused by the irritation which they occasion. These tubercles gradually become more numerous; they cluster together, suppurate and break, and small ulcerations are formed. The ulcers discharge a poisonous matter, which is absorbed and taken up by the neighbouring glands, and this, with greater or less rapidity, vitiates the constitution of the animal, and is capable of communicating the disease to others. Some content themselves with saying that it is an inflammation of the membrane of the nose, which may assume an acute or chronic form, or in a very short time, or exceedingly slowly, run on to ulceration.

It is inflammation, whether specific or common, of the lining membrane of the nose—possibly for months, and even for years, confined to that membrane, and even to a portion of it—the health and the usefulness of the animal not being in the slightest degree impaired. Then, from some unknown cause, not a new but an intenser action is set up, the inflammation more speedily runs its course and the membrane becomes ulcerated. The inflammation spreads on either side down the septum, and the ulceration at length assumes that peculiar chancreous form which characterises

inflammation of the absorbents. Even then, when the discharge becomes gluey, and sometimes after chancres have appeared, the horse is apparently well. There are hundreds of glandered horses about the country with not a sick one among them. For months or years this disease may do no injury to the general health. The inflammation is purely local, and is only recognised by the invariable accompaniment of inflammation and increased secretion. Its neighbours fall around, but the disease affects not the animal whence it came. At length a constitutional inflammation appears; farcy is established in its most horrible form, and death speedily closes the scene.

What, then, is the cause of this insidious dreadful disease? Although we may be in a manner powerless as to the removal of the malady, yet if we can trace its cause and manner of action, we may at least be able to do something in the way of prevention. Much has been accomplished in this way. Glanders does not commit one-tenth part of the ravages which it did thirty or forty years ago, and, generally speaking, it is now only found as a frequent and prevalent disease where neglect, and filth, and want of ventilation exist.

Glanders may be either bred in the horse, or communicated by contagion. What we have farther to remark on this malady will be arranged under these two heads.

Improper stable management we believe to be a far more frequent cause of glanders than contagion. The air which is necessary to respiration is changed and poisoned in its passage through the lungs, and a fresh supply is necessary for the support of life. That supply may be sufficient barely to support life, but not to prevent the vitiated air from again and again passing to the lungs, and producing irritation and disease. The membrane of the nose, possessed of extreme sensibility for the purposes of smell, is easily irritated by this poison, and close and ill-ventilated stables oftenest witness the ravages of glanders. Professor Coleman relates a case which proves to demonstration the rapid and fatal agency of this cause. 'In the expedition to Quiberon, the horses had not been long on board the transports before it became necessary to shut down the hatchways for a few hours; the consequence of this was, that some of them were suffocated, and that all the rest were disembarked either glandered or farcied.'

In a close stable, the air is not only poisoned by being repeatedly breathed, but there are other and more powerful sources of mischief. The dung and the urine are suffered to remain fermenting, and giving out injurious gases. In many dark and ill-managed stables, a portion of the dung may be swept away, but the urine lies for days at the bottom of the bed, the disgusting and putrefying nature of which is ill-concealed by a little fresh straw which the lazy horsekeeper scatters over the top.

The stables of the gentleman are generally kept hot enough, and far too hot, although, in many of them, a more rational mode of treatment is beginning to be adopted; but they are lofty and roomy, and the horses are not too much crowded together, and a most scrupulous regard is paid to cleanliness. Glanders seldom prevails there. The stables of the farmer are ill-managed and filthy enough, and the ordure and urine sometimes remain from week to week, until the horse lies on a perfect dunghill. Glanders seldom prevails there; for the same carelessness which permits the filth to accumulate leaves many a cranny for the wind to enter and sweep away the deleterious fumes from this badly-roofed and unceiled place.

The stables of the horse-dealer are hot enough; but a principle of strict cleanliness is enforced, for there must be nothing to offend the eye or the

nose of the customer, and there glanders is seldom found; but if the stables of many of our post and omnibus horses, and of those employed on our canals, are examined, almost too low for a tall horse to stand upright in them,—too dark for the accumulation of filth to be perceived,—too far from the eye of the master,—ill-drained and ill-paved,—and governed by a false principle of economy, which begrudges the labour of the man, and the cleanliness and comfort of the animal; these will be the very hotbeds of the disease, and in many of these establishments it is an almost constant resident.

Glanders may be produced by anything that injures, or for a length of time acts upon and weakens, the vital energy of this membrane. It has been known to follow a fracture of the bones of the nose. It has been the consequence of violent catarrh, and particularly the long-continued discharge from the nostrils, of which we have spoken. It has been produced by the injection of stimulating and acrid substances up the nostril. Everything that weakens the constitution generally will lead to glanders. It is not only from bad stable management, but from the hardships which they endure, and the exhausted state of their constitution, that post and machine horses are so subject to glanders; and there is scarcely an inflammatory disease to which the horse is subject that is not occasionally wound up and terminated by the appearance of glanders.

Among the causes of glanders is want of regular exercise. The connection, although not evident at first glance, is too certain. When a horse has been worked with peculiar severity, and is become out of spirits, and falls away in flesh, and refuses to eat, a little rest and a few mashes would make all right again; but the groom plies him with cordials, and adds fuel to fire, and aggravates the state of fever that has commenced. What is the necessary consequence of this? The weakest goes to the wall, and either the lungs or the feet, or this membrane—that of the nose—the weakest of all, exposed day after day to the stimulating, debilitating influences that have been described, becomes the principal seat of inflammation that terminates in glanders.

It is in this way that glanders has so frequently been known to follow a hard day's chase. The seeds of the disease may have previously existed, but its progress will be hastened by the general and febrile action excited—the absurd measures which are adopted not being calculated to subdue the fever, but to increase the stimulus.

Every exciting cause of disease exerts its chief and its worst influence on this membrane. At the close of a severe campaign the horses are more than decimated by this pest. At the termination of the Peninsular war the ravages of this disease were dreadful. Every disease will predispose the membrane of the nose to take on the inflammation of glanders, and with many, as strangles, catarrh, bronchitis, and pneumonia, there is a continuity of membrane, an association of function, and a thousand sympathies.

There is not a disease which may not lay the foundation for glanders. Weeks, and months, and years may intervene between the predisposing cause and the actual evil; but at length the whole frame may become excited or debilitated in many a way, and then this debilitated portion of it is the first to yield to the attack. Atmospheric influence has somewhat to do with the prevalence of glanders. It is not so frequent in the summer as in the winter, partly attributable, perhaps, to the different state of the stable in the summer months, neither the air so close or so foul, nor the alternations of temperature so great.

There are some remarkable cases of the connection of moisture, or moist exhalations, that deserve record. When new stabling was built for the

troops at Hythe, and inhabited before the walls were perfectly dry, many of the horses that had been removed from an open, dry, and healthy situation, became affected with glanders; but, some time having passed over, the horses in these stables were as healthy as the others, and glanders ceased to appear. An innkeeper at Wakefield built some extensive stabling for his horses, and inhabiting them too soon, lost a great proportion of his cattle from glanders. There are not now more healthy stables in the place. The immense range of stables under the Adelphi, in the Strand, where light never enters, and the supply of fresh air is not too abundant, were for a long time notoriously unhealthy, and many valuable horses were destroyed by glanders; but now they are filled with the finest waggon and dray-horses that the metropolis or the country contains, and they are fully as healthy as in the majority of stables above-ground.

There is one more cause to be slightly mentioned—hereditary predisposition. This has not been sufficiently estimated, with regard to the question now under consideration, as well as with respect to everything connected with the breeding of the horse. There is scarcely a disease that does not run in the stock. There is that in the structure of various parts, or their disposition to be affected by certain influences, which perpetuates in the offspring the diseases of the sire; and thus contraction, ophthalmia, roaring, are decidedly hereditary, and so is glanders. M. Dupuy relates some decisive cases. A mare, on dissection, exhibited every appearance of glanders; her filly, who resembled her in form and in her vicious propensities, died glandered at six years old. A second and a third mare and their foals presented the same fatal proof that glanders is hereditary.

Glanders is highly contagious. The farmer cannot be too deeply impressed with the certainty of this. Considering the degree to which this disease, even at the present day, often prevails, the legislature would be justified in interfering by some severe enactments, as it has done in the case of the small-pox in the human subject.

The early and marked symptom of glanders is a discharge from the nostrils of a peculiar character; and if that, even before it becomes purulent, is rubbed on a wound, or on a mucus surface, as the nostrils, it will produce a similar disease. If the division between two horses were sufficiently high to prevent all smelling and snorting at each other and contact of every kind, and they drank not out of the same pail, a sound horse might live for years, uninfected, by the side of a glandered one. The matter of glanders has been mixed up into a ball, and given to a healthy horse, without effect. Some horses have eaten the hay left by those that were glandered, and no bad consequence has followed; but others have been speedily infected. The glanderous matter must come in contact with a wound, or fall on some membrane, thin and delicate like that of the nose, and through which it may be absorbed. It is easy, then, accustomed as horses are to be crowded together, and to recognise each other by the smell—eating out of the same manger, and drinking from the same pail—to imagine that the disease may be very readily communicated. One horse has passed another when he was in the act of snorting, and has become glandered. Some fillies have received the contagion from the matter blown by the wind across a lane, when a glandered horse, in the opposite field, has claimed acquaintance by neighing or snorting. It is almost impossible for a glandered horse to remain long in a stable with others without irreparable mischief.

If some persons underrate the danger, it is because the disease may remain unrecognised in the infected horse for some months, or even years,

and therefore, when it appears, it is attributed to other causes or to after inoculation. No glandered horse should be employed on any farm, nor should a glandered horse be permitted to work on any road, or even to pasture on any field. Mischief may be so easily and extensively effected, that the public interest demands that every infected animal should be summarily destroyed, or given over for experiment to a veterinary surgeon, or recognised veterinary establishment.

There are a few instances of the spontaneous cure of chronic glanders. The discharge has existed for a considerable time. At length it has gradually diminished, and has ceased; and this has occurred under every kind of treatment, and without any medical treatment: but in the majority of these supposed cases, the matter was only pent up for a while, and then, bursting from its confinement, it flowed again in double quantity: or, if glanders has not reappeared, the horse, in eighteen or twenty-four months, has become farcied, or consumptive, and died. These supposed cures are few and far between, and are to be regarded with much suspicion.

As for medicine, there is scarcely a drug to which a fair trial has not been given, and many of them have had a temporary reputation; but they have passed away, one after the other, and are no longer heard of. The blue vitriol and the Spanish-fly have held out longest; and in a few cases, either nature or these medicines have done wonders, but in the majority of instances they have palpably failed. The diiodide of copper has lately acquired some reputation. It has been of great service in cases of farcy, but is not to be depended upon in glanders.

Where the life of a valuable animal is at stake, and the owner adopts every precaution to prevent infection, he may subject the horse to medical treatment; but every humane man will indignantly object to the slitting of the nostril, and the scraping of the cartilage, and searing of the gland, and firing of the frontal and nasal bones, and to those injections of mustard and capsicum, corrosive sublimate and vitriol, by which the horse has been tortured, and the practitioner disgraced. At the veterinary school, and by veterinary surgeons, it will be most desirable that every experiment should be tried to discover a remedy for this pest; but, in ordinary instances, he is not faithful to his own interest or that of his neighbours who does not remove the possibility of danger in the most summary way.

If, however, remedial measures are resorted to, a pure atmosphere is that which should first be tried. Glanders is the peculiar disease of the stabled horse, and the preparation for, or the foundation of, a cure must consist in the perfect removal of every exciting cause of the malady. The horse must breathe a cool and pure atmosphere, and he must be turned out, or placed in a situation equivalent to it.

A salt marsh is, above all others, the situation for this experiment; but there is much caution required. No sound horse must be in the same pasture, or a neighbouring one. The palings or the gates may receive a portion of the matter, which may harden upon them, and, many a month afterwards, be a source of mischief—nay, the virus may cling about the very herbage and empoison it. Cattle and sheep should not be trusted with a glandered horse, for the experiments are not sufficiently numerous or decided as to the exemption of these animals from the contagion of glanders.

Supposing that glanders has made its appearance in the stables of a farmer, is there any danger after he has removed or destroyed the infected horse?—Certainly there is, but not to the extent that is commonly supposed. There is no necessity for pulling down the racks and mangers, or even the stable itself, as some have done. The poison resides not in the breath of the animal, but in the nasal discharge, and that can

only reach certain parts of the stable. If the mangers, and racks, and bales, and partitions, are first well scraped, and scoured with soap and water, and then thoroughly washed with a solution of the chloride of lime (one pint of the chloride to a pailful of water), and the walls are lime-washed, and the head-gear burned, and the clothing baked or washed, and the pails newly painted, and the iron-work exposed to a red heat, all danger will cease.

Little that is satisfactory can be said of the *prevention* of glanders.

The first and most effectual mode of prevention will be to keep the stables cool and well ventilated, for the hot and poisoned air of low and confined stables is one of the most prevalent causes of glanders.

Next to ventilation comes good and efficient drainage. The urine should never be allowed to lie on the surface, but have ready means of escape through ample and well-arranged drains; for the foul air from the fermenting litter, and urine, and dung, must not only be highly injurious to health generally, but irritate and predispose to inflammation that delicate membrane which is the primary seat of the disease. If to this be added regular exercise, and occasional green meat during the summer, and carrots in the winter, we shall have stated all that can be done in the way of prevention.

*Glanders in the human being.*—It cannot be too often repeated, that a glandered horse can rarely remain among sound ones without serious mischief ensuing; and, worse than all, the man who attends on that horse is in danger. The cases are now becoming far too numerous in which the groom or the veterinary surgeon attending on glandered horses becomes infected, and in the majority of cases dies. It is, however, somewhat more manageable in the human being than in the quadruped. Some cases of recovery from farcy and glanders stand on record with regard to the human being, but they are few and far between.

#### FARCY.

Farcy is intimately connected with glanders; they will run into each other, or their symptoms will mingle together, and before either arrives at its fatal termination the other will generally appear. An animal inoculated with the matter of farcy will often be afflicted with glanders, while the matter of glanders will frequently produce farcy. They are different types of the same disease. There is, however, a very material difference in their symptoms and progress, and this most important one of all, that while glanders is incurable, farcy, in its early stage and mild form, may be successfully treated.

While the capillary vessels of the arteries are everywhere employed in building up the frame, the absorbents are no less diligently at work in selecting and carrying away every useless or worn-out portion or part of it. There is no surface—there is no assignable spot on which thousands of these little mouths do not open. In the discharge of their duty, they not only remove that which is become useless, and often that which is healthy, but that which is poisonous and destructive. They open upon the surface of every glanderous chancre. They absorb a portion of the virus which is secreted by the ulcer, and as it passes along these little tubes, they suffer from its acrimonious quality; hence the *corded veins*, as they are called by the farrier, or, more properly, the thickened and inflamed absorbents following the course of the veins.

At certain distances in the course of the absorbents are loose duplicatures of the lining membrane, forming valves, which are pressed against the side of the vessel and permit the fluid to pass in a direction towards the chest, but belly out and impede or arrest its progress from the chest.



The virus at these places, and the additional inflammation there excited, is to a greater or less degree evident to the eye and to the feeling. They are usually first observed about the lips, the nose, the neck, the axillary spaces of the chest, and the thighs. They are very hard—even of a scirrhous hardness, more or less tender, and with perceptible heat about them.

The poisonous matter being thus confined and pressing on the part, supuration and ulceration ensue. The ulcers have the same characters as the glanderous ones on the membrane of the nose. They are rounded, with an elevated edge and a pale surface. They are true chancre, and they discharge a virus as infectious and as dangerous as the matter of glanders. While they remain in their hard prominent state, they are called *buttons* or *farcy buds*; and they are connected together by the inflamed and *corded* absorbents.

In some cases the horse will droop for many a day before the appearance of the corded veins or buds—his appetite will be impaired—his coat will stare—he will lose flesh. The poison is evidently at work, but has not gained sufficient power to cause the absorbents to enlarge. In a few cases these buds do not ulcerate, but become hard and difficult to disperse. The progress of the disease is then suspended, and possibly for some months the horse will appear to be restored to health; but he bears the seeds of the malady about him, and in due time the farcy assumes its virulent form, and hurries him off. These buds have sometimes been confounded with the little tumours or lumps termed *surfeit*. They are generally higher than these tumours, and not so broad. They have a more knotty character, and are principally found on the inside of the limbs, instead of the outside.

Few things are more unlike, or more perplexing, than the different forms which farcy assumes at different times. One of the legs, and particularly one of the hinder legs, will suddenly swell to an enormous size. At night the horse will appear to be perfectly well, and in the morning one leg will be three times the size of the other, with considerable fever and scarcely the power of moving the limb.

At other times the head will be subject to this enlargement, the muzzle particularly will swell, and an offensive discharge will proceed from the nose. Sometimes the horse will gradually lose flesh and strength; he will be hide-bound; mangy eruptions will appear in different parts; the legs will swell; cracks will be seen at the heels, and an inexperienced person may conceive it to be a mere want of condition, combined with grease.

By degrees the affection becomes general. The virus has reached the termination of the absorbents, and mingles with the general circulating fluid, and is conveyed with the blood to every part of the frame. There are no longer any valves to impede its progress, and consequently no knots or *buds*, but the myriads of capillary absorbents that penetrate every part become inflamed, and thickened, and enlarged, and cease to discharge their function. Hence arises enlargement of the substance of various parts, swellings of the legs, and chest, and head—sudden, painful, enormous, and distinguished by a heat and tenderness, which do not accompany other enlargements.

It is a question considered somewhat difficult to answer, whether farcy can exist without previous glanders. Certainly it can; there are numerous instances of cases of farcy running their course purely as such, and ultimately arriving at a complete recovery, without a single symptom of glanders intervening. Farcy is a curable form of the disease, glanders the incurable; and this most important distinction between them at once

proves, that although they may be, and most probably are, types of one and the same disease, they are not identical with each other. There is the long-continued insidious progress of glanders—the time which may elapse, and often does, before the owner is aware or the veterinary surgeon sure of it—the possibility that minute ulceration may have for a long while existed in some of the recesses of the nose—or that the slight discharge, undreaded and unrecognised, yet vitiated, poisoned, and capable of communicating the disease, may have been long travelling through the frame, and affecting the absorbents, and preparing for the sudden display of farcy.

One thing, however, is undeniable, that farcy does not long and extensively prevail without being accompanied by glanders, and that it never destroys the animal without plainly associating itself with glanders. They are, in fact, types of the same disease.

Glanders is inflammation of the membrane of the nose, producing an altered and poisonous secretion, and when sufficient of this vitiated secretion has been taken up to produce inflammation and ulceration of the absorbents, farcy is established. Its progress is occasionally very capricious, continuing in a few cases for months and years, the vigour of the horse remaining unimpaired; and at other times, running on to its fatal termination with a rapidity perfectly astonishing.

Farcy has been confounded with other diseases; but he must be careless or ignorant who mistook sprain for it. The inflammation is too circumscribed and too plainly connected with the joint or the tendon.

It may be readily distinguished from grease or swelled legs. In grease there is usually some crack or scurfiness, a peculiar tenseness and redness and glossiness of the skin, some ichorous discharge, and a singular spasmodic catching up of the leg.

In farcy the engorgement is even more sudden than that of grease. The horse is well to-day, and to-morrow he is gorged from the fetlock to the haunch, and although there is not the same redness or glossiness, there is great tenderness, a burning heat in the limb, and much general fever. It is simultaneous inflammation of all the absorbents of the limb.

Surfeit can scarcely be confounded with farcy or glanders. It is a pustular eruption—*surfeit bumps*, as they are called, and terminating in desquamation, not in ulceration, although numerous, yet irregularly placed, and never following the course of the absorbents, but scattered over the skin.

Local dropsy of the cellular membrane, and particularly that enlargement beneath the thorax which has the strange appellation of *water-farcy*, have none of the characters of real farcy. It is general debility to a greater or less degree, and not inflammation of the absorbents. If properly treated, it soon disappears, except that, occasionally, at the close of some serious disease, it indicates a breaking up of the constitution.

Farcy, like glanders, springs from contagion and from bad stable management. It is produced by all the causes which give rise to glanders, with this difference, that it is more frequently generated, and sometimes strangely prevalent in particular districts. It will attack, at the same time, several horses in the same ill-conducted stable, and others in the neighbourhood who have been exposed to the same predisposing causes. Some have denied that it is a contagious disease. They must have had little experience. It is true that the matter of farcy must come in contact with a wound or sore, in order to communicate the disease; but accustomed as horses are to nibble and play with each other, and sore as the corners of the mouth are frequently rendered by the bit, it is easy to imagine that this may be easily effected; and experience tells us, that a horse having farcy ulcers cannot be suffered to remain with others without extreme risk.

The treatment of farcy differs with the form that it assumes. As a general rule, and especially when the buttons or buds are beginning to appear, a mild dose of physic should first be administered. The buds should then be carefully examined, and if any of them have broken, the budding-iron, at a dull red heat, should be applied. If pus should be felt in them, showing that they are disposed to break, they should be penetrated with the iron. These wounds should be daily inspected, and if, when the slough of the cauterly comes off, they look pale, and foul, and spongy, and discharge a thin matter, they should be frequently washed with a strong lotion of corrosive sublimate, dissolved in rectified spirit. When the wounds begin to look red, and the bottom of them is even and firm, and they discharge a thick white or yellow matter, the Friar's balsam will usually dispose them to heal.

As, however, the constitution is now tainted, local applications will not be sufficient, and the disease must be attacked by internal medicine as soon as the physic has ceased to operate.

*Corrosive sublimate* used to be a favourite medicine, combined with tonics, and repeated morning and night until the ulcers disappeared, unless the mouth became sore or the horse was violently purged, when the sulphate of copper was substituted for the corrosive sublimate. During this treatment the animal was placed, if possible, in a large box, with a free circulation of air; and green meat or carrots, and particularly the latter, were given, with a full allowance of corn. If he could be turned out in the day, it was deemed highly advantageous. It is related by Mr. Blaine, that a horse, so reduced as not to be able to stand, was drawn into a field of tares, and suffered to take his chance. The consequence was that, when he had eaten all within his reach, he contrived to move about and search for more, and eventually recovered. Many horses recover under the use of the sublimate, but the great majority of them die.

Mr. Vines introduced a more effective medicine—*cantharides*, in combination likewise with the vegetable bitters — as a cure for farcy and glanders. It cannot be denied, that many animals labouring under the former, and a few under the latter, were to all appearance radically cured. The medicine was suspended for awhile if affection of the kidneys supervened.

A still more effectual medicine has been introduced by Professor Morton, namely, *the diiodide of copper*, and it has been found of essential service in farcy and in diseases simulating glanders. He says that its action is that of a stimulant to the absorbent vessels, and a tonic. The gentian root is usually combined with it. *Cantharides*, in small quantities, may be advantageously added. An indication of its influence is a soreness of the diseased parts arising from the absorbent vessels being roused into increased action: the agent should then be for a time withheld.

WATER-FARCY, confounded by name with the common farcy, and by which much confusion has been caused, and a great deal of mischief done, is a dropsical affection of the skin, either of the chest or of the limbs, and belongs to another part of the subject.

#### THE LIPS.

The *lips* of the horse are far more important organs than many suppose. They are the hands of the animal; and if any one will take the trouble to observe the manner in which he gathers up his corn with them, and collects together the grass before he divides it with his nippers, he will be satisfied that the horse would be no more able to convey the food to his mouth without them, than the human being could without his hands. This has even been put to the test of experiment. The nerves which

supply the lips were divided in a poor ass, to illustrate some point of physiology. The sensibility of the lips was lost, and he knew not when he touched his food with them. The motion of the lips was lost, and he could not get the oats between his teeth, although the manger was full of them: at length, driven by hunger, he contrived to lick up a few of them with his tongue; but when they were on his tongue, the greater part of them were rubbed off before he could get them into his mouth.

It is on account of this use of the lips, that they may be brought into contact with the food without inconvenience or injury to other parts of the face, that the heads of most quadrupeds are so lengthened. Several muscles go to the lips from different parts of the jaw and face. Some of them are shown in the cut, p. 199. The orbicularis or circular muscle, *p*, employed in pushing out the lips and closing them, and enabling the horse to seize and hold his food, is particularly evident; and in the explanation of the cut, the action of other muscles, *i*, *k*, *m*, and *o*, was described. The nerves likewise, *y*, taking their course along the cheek, and principally supplying the lips with the power of motion, and those, *z*, proceeding from the foramen, or hole in the upper jaw, deserve attention.

The lips are composed of a muscular substance for the sake of strength, and a multitude of small glands, which secrete a fluid that covers the inside of the lips and the gums, in order to prevent friction, and likewise furnish a portion of the moisture so necessary for the proper chewing of the food. The skin covering the lips is exceedingly thin, in order that their peculiar sensibility may be preserved, and for the same purpose they are scantily covered with hair, and that hair is fine and short. Long hairs or feelers, termed the beard, are superadded with the same intention. The horse is guided and governed principally by the mouth, and therefore the lips are endowed with very great sensibility, so that the animal feels the slightest motion of the hand of the rider or driver, and seems to anticipate his very thoughts. The *fineness* or *goodness of the mouth* consists in its exquisite feeling, and that depends on the thinness of this membrane.

The lips of the horse should be thin, if the beauty of the head is regarded; yet, although thin, they should evidently possess power, and be strongly and regularly closed. A firm, compressed mouth gives a favourable and no deceptive idea of the muscular power of the animal. Lips apart from each other and hanging down, indicate weakness or old age, or dulness and sluggishness.

The depth of the mouth, or the distance from the fore-part to the angle of the lips, should be considerable. A short protuberant mouth would be a bad finish to the tapering face of the blood-horse. More room is likewise given for the opening of the nostril, which has been shown to be an important consideration. The bridle will not be carried well, and the horse will hang heavy on hand, if there is not considerable depth of mouth.

The corners or angles of the lips are frequently made sore or wounded by the smallness, or shortness, or peculiar twisting of the snaffle, and the unnecessary and cruel tightness of the bearing rein. This rein was introduced as giving the horse a grander appearance in harness, and placing the head in that position in which the bit most effectually presses upon the jaw. It is an useful adjunct to driving safely, for, deprived of this control, many horses would hang their heads low, and be disposed every moment to stumble, and would defy all pulling, if they tried to run away. There is, and can be no necessity, however, for using a bearing-rein so tight as to cramp the muscles of the head, or to injure and excoriate the angles of the lips.

The following is the opinion of Nimrod, and to a more competent judge

we could not appeal:—‘As to the universal disuse of the bearing-rein with English horses, *it can never take place*. The charge against it of cruelty at once falls to the ground, because to make a team work together in fast work, every horse’s head must be as much restrained by the coupling-rein as it would be and is by the bearing-rein. Its excellence consists in keeping horses’ mouths fresh—in enabling a coachman to indulge a horse with liberty of rein, without letting him be all abroad, which he would be with his head quite loose, and of additional safety to the coach-horse, as proved by the fact of either that or the crupper always giving way when he falls down. There are, however, teams in which it may be dispensed with, and the horses have an advantage in their working against hills. As to the comparison of the road coach-horses on the Continent and our own, let any one examine the knees of the French diligence and post-horses, which are allowed perfect liberty of head, and he will be convinced that the use of the bearing-rein does not keep them on their legs.’ The teams in which it may be dispensed with are those in which the horses naturally carry their heads well; that is, much in the same position in which the bearing-rein would place them.

The mouth is injured much oftener than the careless owner suspects by the pressure of a sharp bit. Not only are the bars wounded and deeply ulcerated, but the lower jaw, between the tush and the grinders, is sometimes worn even to the bone, and the bone itself affected, and portions of it exfoliate away. It may be necessary to have a sharp bit for the headstrong and obstinate beast; yet if that bit is severely and unjustifiably called into exercise, the animal may rear, and endanger himself and his rider. There can, however, be no occasion for a thousandth part of the torment which the trappings of the mouth often inflict on a willing and docile servant, and which either render the mouth hard, and destroy all the pleasure of riding, or cause the horse to become fretful or vicious.

Small ulcers are sometimes found in various parts of the mouth, said to be produced by rusty bits, but oftener arising from contusions inflicted by the bit, or from inflammation of the mouth. If the curb-bit is in fault, a snaffle or Pelham-bit should be used. If there is inflammation of the mouth, a little cooling medicine may be administered; and to the ulcers themselves, tincture of myrrh, diluted with water, or alum dissolved in water, may be applied with advantage.

#### THE BONES OF THE MOUTH.

The bones constituting and giving form to the mouth are the superior maxillary or upper jaw (*b*, p. 140, and *l*, p. 145), containing the upper grinders and tushes; the anterior maxillary, or lower part of the upper jaw (*f*, p. 140, *n*, p. 145), containing the upper-nippers or cutting-teeth; the palatine bone (*c*, p. 197) and the posterior maxillary or under jaw (*a*, p. 140), containing all the under teeth.

The superior maxillary is, with the exception of the lower jaw, the largest bone in the face. It unites above with the lachrymal bone, and more on the side, with the malar or cheek bone, and a portion of it, continued upward, and underneath, enters into the orbit. Above, and on the front of the face, it unites with the bones of the nose, and below, with the inferior maxillary. That which most deserves notice in it externally is the ridge or spine, continued from the base of the zygomatic arch, and across the malar bone. It and the surface beneath serve to give attachment to the masseter muscle, concerned, almost as much as the temporal one, in the act of chewing. On the anterior surface is a foramen or hole, through which a branch of the fifth pair of nerves proceeds to give sensibility to the lower part of the face. As it approaches the teeth, this bone

separates into two plates, and these are divided by long partitions, which contain and firmly hold the upper grinders. The lower plate then projects inwards, and forms the principal portion of the roof of the mouth, and the floor of the cavity of the nose. The corresponding bone on the other side meets its fellow in the centre of the palate. The upper jaw-bone contains in its large cavities besides those for the teeth, and these open into and enlarge the cavity of the nose. They are connected with the voice, but not with the smell, for the expansion of the olfactory or smelling nerve has never been traced beyond the bones and membranes of the proper cavity of the nose. The maxillary sinuses are generally filled with matter in bad cases of glanders.

Below these are the anterior maxillary bones, containing the upper cutting teeth, with the tushes belonging both to the upper and anterior bones. These are the bones to which the upper lip is attached. The superior and anterior maxillary bones are separated in animals with long faces, like the horse, that, by overlapping each other, strength might be gained.

The palatine bone forms but a very small portion of the palate. It surrounds the edge of the communication between the cavity of the nose and the back parts of the mouth.

#### THE PALATE.

Adhering to a portion of the three bones just described, and constituting the lining of the roof of the mouth, is the palate, composed of an elastic and dense substance divided into several ridges called *Bars*. The following cut gives a view of them.

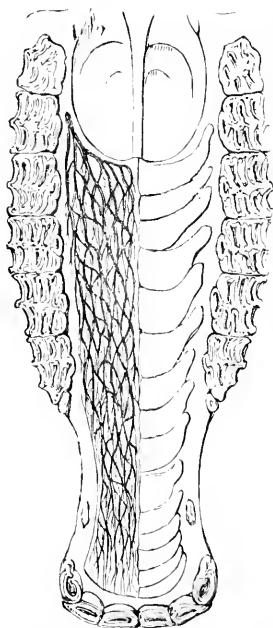
It will also point out the bleeding place, if it should occasionally be deemed advisable to abstract blood from the mouth; or if the horse should

be attacked with megrims on a journey, and the driver, having no lancet, should be compelled to make use of his knife, the incision should be made between the central and second nippers on either side, about an inch within the mouth, and cutting through the second bar. A stream of blood will be thus obtained, which will usually cease to flow when two or three quarts have escaped, or may generally be arrested by the application of a sponge filled with cold water.

This, however, is a make-shift sort of bleeding that may be allowable on a journey, and possibly in some cases of lampas, but which is decidedly objectionable as the usual mode of abstracting blood. The quantity withdrawn cannot be measured, the degree of inflammation cannot be ascertained by the manner in which it coagulates, and there may be difficulty to the operator, and annoyance and pain to the horse, in stopping the bleeding.

This cut likewise depicts the appearance of the roof of the mouth if the bars were dissected off, and of the numerous vessels, arterial and venous, which ramify over it.

At the back of the palate, and attached to the crescent-shaped border of the palatine bone, is a dense membranous curtain. Its superior and back surface is a continuation of the lining membrane of the nose, and its anterior



or inferior one that of the palate. It is called the *velum palati*, or veil of the palate. It extends as far back as the larynx, and lies upon the dorsum of the epiglottis, and is a perfect veil or curtain interposed between the cavities of the nose and mouth, cutting off all communication between them. Tied by its attachment to the palatine bone, it will open but a little way, and that only in one direction. It will permit a pellet of food to pass into the œsophagus; but it will close when any pressure is made upon it from behind. Two singular facts necessarily follow from this; the horse breathes through the nostrils alone, and these are capacious and easily expansible to a degree seen in no other animal, and fully commensurate to the wants of the animal.

It is also evident that, in the act of vomiting, the contents of the stomach must be returned through the nostril, and not through the mouth. On this account partly it is that the horse can with great difficulty be excited to vomit. There is a structure at the entrance to the stomach which, except under very peculiar circumstances, prevents its return to the throat, and consequently to the mouth.

#### LAMPAS.

The bars occasionally swell, and rise to a level with, and even beyond the edge of, the teeth. They are very sore, and the horse feeds badly on account of the pain he suffers from the pressure of the food on them. This is called the LAMPAS. It may arise from inflammation of the gums, propagated to the bars, when the horse is shedding his teeth—and young horses are more subject to it than others—or from some slight febrile tendency in the constitution generally, as when a young horse has lately been taken up from grass, and has been over-fed, or not sufficiently exercised. At times it appears in aged horses, the process of growth in the teeth of the horse continuing during the whole life of the animal.

In the majority of cases the swelling will soon subside without medical treatment; or a few mashes, and gentle alteratives, will relieve the animal. A few slight incisions across the bars with a lancet or penknife will relieve the inflammation, and cause the swelling to subside; indeed, this scarification of the bars in lampas will seldom do harm, although it is far from being so necessary as is supposed.

The brutal custom of the farrier, who sears and burns down the bars with a red-hot iron, is most objectionable. It is torturing the horse to no purpose, and calculated to do serious injury to the parts. It may be prudent in case of lampas to examine the grinders, and more particularly the tushes, in order to ascertain whether either of them is making its way through the gum. If it is so, two incisions across each other should be made, on the tooth, and the horse will experience immediate relief.

#### THE LOWER JAW.

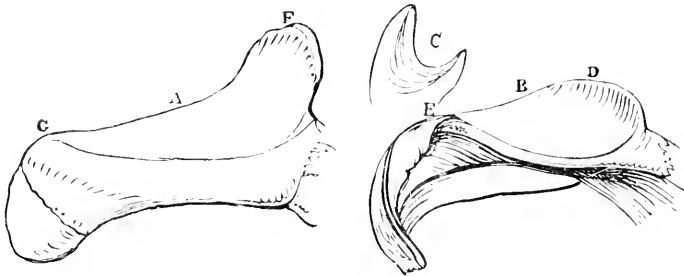
The posterior or lower jaw may be considered as forming the floor of the mouth. The body or lower part of it contains the under cutting teeth and the tushes, and at the sides are two flat pieces of bone containing the grinders. On the inside is a foramen or hole through which blood-vessels and nerves enter to supply the teeth, and some of which escape again at another orifice on the outside, and near the nippers. The branches are broader and thinner, rounded at the angle of the jaw, and terminating in two processes. One, the *coracoid*, from its sharpness or supposed resemblance to a beak, passes under the zygomatic arch (see p. 140); and the temporal muscle, arising from the whole surface of the parietal bone, is inserted into it, and wrapped round it; and by its action, principally, the jaw is moved, and the food is ground. The other, the *condyloid*, or

rounded process, is received into the glenoid (shallow) cavity of the temporal bone, at the base of the zygomatic arch, and forms the joint on which the lower jaw moves. This joint is easily seen in the cut at p. 140; and being placed so near to the insertion of the muscle, or the centre of motion, the temporal muscle must act with very considerable mechanical disadvantage, and, consequently, must possess immense power.

The joint is admirably contrived for the purpose which the animal requires. It will admit freely and perfectly of the simple motion of a hinge, and that is the action of the jaw in nipping the herbage and seizing the corn. But the grass, and more particularly the corn, must be crushed and bruised before it is fit for digestion. Simple champing, which is the motion of the human lower jaw, and that of most beasts of prey, would very imperfectly break down the corn. It must be put into a mill; it must be actually ground.

It is put into the mill, and as perfect a one as imagination can conceive.

The following cuts represent the glenoid cavity, in a carnivorous or flesh-eating, and herbivorous or grass-eating, animal, viz. the tiger and the horse; the one requiring a simple hinge-like motion of the lower jaw to tear and crush the food; the other, a lateral or grinding motion to bring it into a pulpy form. We first examine this cavity in the tiger represented at B. At the root of the zygomatic process D, is a hollow with a ridge along the greater part of the upper and inner side of it, standing to a considerable height, and curling over the cavity. At the lower and op-



posite edge of the cavity, but on the outside, is a similar ridge, E, likewise rising abruptly and curling over. At C is another and more perfect view of this cavity in a different direction. The head of the lower jaw is received into this hollow, and presses against these ridges, and is partially surrounded by them, and forms with them a very strong joint where dislocation is scarcely possible, and the hinge-like or cranching motion is admitted to its fullest extent; permitting the animal violently to seize his prey, to hold it firmly, and to crush it to pieces; but from the extent and curling form of the ridges, forbidding, except to a very slight degree, all lateral and grinding motion, and this because the animal does not want it.

As before mentioned, the food of the horse must be *ground*. Simple bruising and champing would not sufficiently comminute it for the purposes of digestion. We then observe the different construction of the parts to effect this. A, gives the glenoid cavity of the horse. First, there is the upper ridge assuming a rounded form, F, and therefore called the *mastoid process*; sufficiently strong to support the pressure and action of the lower jaw when cropping the food or seizing an enemy, but not encircling the head of that bone, and reaching only a little way along the side of the cavity, where it terminates, having its edges rounded off so as to admit, and to be evidently destined for, a circular



motion about it. At the other and lower edge of the cavity, and on the outside, G is placed — not a curling ridge as in the tiger, but a mere tubercle: and for what reason? evidently to limit this lateral or circular motion—to permit it as far as the necessities of the animal require it, and then to arrest it. How is this done? Not suddenly or abruptly; but the tubercle, of which we have already spoken as strengthening this portion of the zygomatic arch, now discharging another office, has a smooth and gradual ascent to it, up which the lower jaw may climb to a certain extent, and then, by degrees, be stopped. We speak not now of the moveable cartilage which is placed in this cavity, and between the bones, to render the motion easier and freer. It is found in this joint in every quadruped; and it is found wherever motions are rapid and of long continuance.

So great is the conformity between the structure of the animal and his destination, that a tolerable student in comparative anatomy, by a mere inspection of the glenoid cavity, would at once determine whether the animal to which it belonged was carnivorous, and wanted no lateral motion of the jaw; or omnivorous, living occasionally on all kinds of food, and requiring some degree of grinding motion; or herbivorous, and needing the constant use of this admirably-constricted mill.

At *g*, p. 199, is represented the *masseter* muscle, an exceedingly strong one, constituting the cheek of the horse—arising from the superior maxillary under the ridge continued from the zygomatic arch, and inserted into the lower jaw, and particularly round the rough border at the angle of the jaw. This acts with the temporal muscle in closing the jaw, and in giving the direct cutting or champing motion to it.

Within the lower jaw, on either side, and occupying the whole of the hollowed portion of them, and opposite to the masseters, are the pterygoid muscles, going from the jaws to bones more in the centre of the channel, likewise closing the mouth, and also, by their alternate action, giving that grinding motion which has been described.

The space between the branches of the lower jaw, called the *channel*, is of considerable consequence. It can scarcely be too wide; for if it is too narrow, the horse will never be able to bend his head freely and gracefully; he will be always pulling or boring upon the hand, nor can he possibly be well reined in.

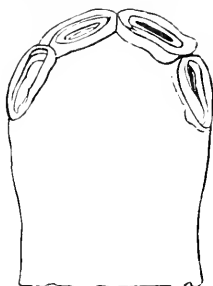
The jaws contain the teeth, which are the millstones employed in comminuting the food. The mouth of the horse at five years old contains forty teeth, viz. six nippers or cutting teeth in front, above and below, a tush on each side, and six molars, or grinding teeth, on each side, above and below. They are contained in cavities in the upper and lower jaws, surrounded by bony partitions, to which they are accurately fitted, and by which they are firmly supported. For a little way above these bony cavities, they are surrounded by a firm substance called the gum, so dense, and adhering so closely to the teeth and the jaws, as not to be separated without very great difficulty—singularly compact, that it may not be wounded by the hard or sharp particles of the food, and almost devoid of feeling, for the same purpose.

Seven or eight months before the foal is born, the germs or beginnings of the teeth are visible in the cavities of the jaws. The tooth grows, and presses to the surface of the gum, and forces its way through it; and, at the time of birth, the first and second grinders have appeared, large compared with the size of the jaw, and seemingly filling it. In the course of seven or eight days the two central nippers are seen as here represented.



They likewise appear to be large, and to fill the front of the mouth; although they will afterwards be found to be small, compared with the permanent teeth that follow. In the course of the first month the third grinder appears above and below, and, not long after, and generally before six weeks have expired, another incisor above and below will be seen on each side of the two first, which have now considerably grown, but not attained their perfect height. This cut will represent the appearance of the month at that time.

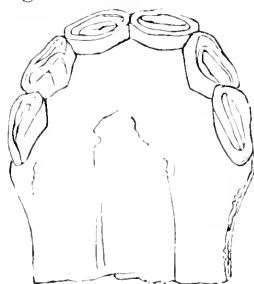
At two months, the central nippers will have reached their natural level, and between the second and third month the second pair will have overtaken them. They will then begin to wear away a little, and the outer edge, which was at first somewhat raised and sharp, is brought to a level with the inner one, and so the mouth continues until some time between the sixth and ninth month, when another nipper begins to appear on each side of the two first, making six above and below, and completing the colt's mouth; after which, the only observable difference, until between the second and third year, is in the wear of these teeth.



The term *nipper* is familiar to the horseman and the farrier, and much better expresses the action of these teeth than the word *incisor* or *cutter*, which is adopted by anatomists. Whoever has observed a horse in the act of browsing, and the twitch of the head which accompanies the separation of each portion of grass, will perceive that it is nipped or torn rather than cut off.

These teeth are covered with a polished and exceedingly hard substance, called the enamel. It spreads over that portion of the teeth which appears above the gum, and not only so, but as they are to be so much employed in nipping the grass, and gathering up the animal's food, and in such employment even this hard substance must be gradually worn away, a portion of it, as it passes over the upper surface of the teeth, is bent inward, and sunk into the body of the teeth, and forms a little pit in them. The inside and bottom of this pit being blackened by the food, constitutes the *mark* of the teeth, by the gradual disappearance of which, in consequence of the wearing down of the edge, we are enabled, for several years, to judge of the age of the animal.

The colt's nipping teeth are rounded in front, somewhat hollow towards the mouth, and present at first a cutting surface, with the outer edge rising in a slanting direction above the inner edge. This, however, soon begins to wear down until both surfaces are level, and the *mark*, which



was originally long and narrow, becomes shorter, and wider, and fainter. At six months the four nippers are beginning to wear to a level. The annexed cut will convey some idea of the appearance of the teeth at twelve months. The four middle teeth are almost level, and the corner ones becoming so. The mark in the two middle teeth is wide and faint; in the two next teeth it is darker, and longer, and narrower; and in the corner teeth it is the darkest, and longest, and narrowest.

The back teeth, or grinders, will not guide us far in ascertaining the age of the animal, for we cannot easily inspect them; but there are some interesting particulars connected with them. The foal is born with two grinders in each jaw, above and below;

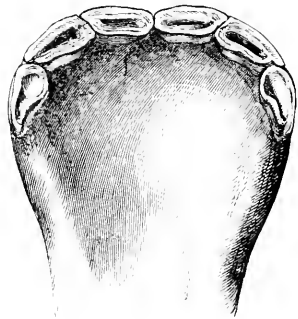
or they appear within three or four days after the birth. Before the expiration of a month they are succeeded by a third, more backward. The crowns of the grinders are entirely covered by enamel on the top and sides, but attrition soon wears it away from the top, and there remains a compound surface of alternate layers of *crusta petrosa*, enamel and ivory, which are employed in grinding down the hardest portions of the food. Nature has therefore made an additional provision for their strength and endurance.

This cut represents a grinder sawed across. It seems to be a most irregular and intricate structure: but the explanation is not difficult. The tooth is formed and prepared in cavities within the jaw-bones. A delicate membranous bag, containing a jelly-like substance, is found, in the unborn animal, in a little cell within the jaw-bone. It assumes, by degrees, the form of the tooth that is to appear, and then the jelly within the membrane begins to change to bony matter, and a hard and beautiful crystallisation is formed on the membrane without, and so we have the cutting tooth covered by its enamel. In the formation, however, of each of these grinders of the horse, there are originally five membranous bags in the upper jaw, and four in the lower, filled with jelly. This by degrees gives place to bony matter, which is thrown out by little vessels penetrating into it, and is represented by the darker portions of the cut with central black spots. The crystallisation of enamel can be traced round each, and there would be five distinct bones or teeth. A third substance, however, is now secreted (which is represented by the white spaces), and is a powerful cement, uniting all these distinct bones into one body, and making one tooth of the five. This being done, another coat of enamel spreads over the sides, but not the top, and the tooth is completed. By no other contrivance could we have the grinding tooth capable, without injury and without wearing, to rub down the hay, and oats, and beans, which constitute the stable-food of horses.



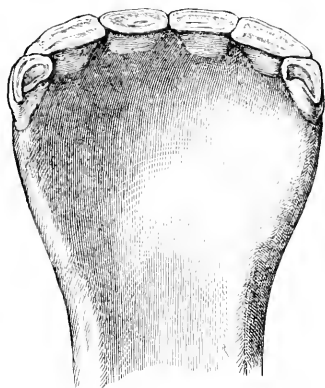
The grinders in the lower jaw, having originally but four of these bags or shells, are smaller, and narrower, and more regular than the upper ones. They are not placed horizontally in either jaw; but in the lower, the higher side is within, and shelving gradually outward; in the upper jaw the higher side is without, and shelving inward, and thus the grinding motion is most advantageously performed. There is also an evident difference in the appearance and structure of each of the grinders, so that a careful observer could tell to which jaw every one belonged, and what situation it occupied.

At the completion of the first year, a fourth grinder usually comes up, and the yearling has then, or soon afterwards, six nippers and four grinders above and below in each jaw, which, with the alteration in the appearance of the nippers that we have just described, will enable us to calculate nearly the age of the foal, subject to some variations arising from the period of weaning and the nature of the food.



At the age of one year and a half, the mark in the central nippers will be much shorter and fainter; that in the two other pairs will have undergone an evident change, and all the nippers will be flat.

At two years this will be more manifest. The accompanying cut deserves attention, as giving an accurate representation of the nippers in the lower jaw of the two-years-old colt.



About this period a fifth grinder will appear, and now, likewise, will commence another process. The first teeth are adapted to the size and wants of the young animal. They are sufficiently large to occupy and fill the colt's jaws; but when these bones have expanded with the increasing growth of the animal, the teeth are separated too far from each other to be useful, and another and larger set is required. Evident provision is made for them, even before the colt is foaled. In cavities in the jaw, beneath the first and temporary teeth, are to be

seen the rudiments of a second and permanent set. These gradually increase, some with greater rapidity than others, and, pressing upon the roots or fangs of the first teeth, do not, as would be imagined, force out the former ones, but the portion pressed upon gradually disappears. It is *absorbed*—taken up, and carried away, by numerous minute vessels, whose office it is to get rid of the worn-out or useless part of the system. This absorption continues to proceed as the second teeth grow and press upwards, until the whole of the fang is gone, and the crown of the tooth, or that part of it which was above the gum, having no longer firm hold, drops out, and the second teeth appear, larger and stronger and permanent. In a few instances, however, the second teeth do not rise immediately under the temporary or milk teeth, but somewhat by their side; and then, instead of this gradual process of absorption and disappearance from the point of the root upwards, the root being compressed sideways, diminishes throughout its whole bulk. The crown of the tooth diminishes with the root, and the whole is pushed out of its place, to the fore part of the first grinder, and remains for a considerable time under the name of a *wolf's tooth*, causing swelling and soreness of the gums, and frequently wounding the cheeks. They would be gradually quite absorbed, but the process might be slow and the annoyance would be great, and, therefore, they are extracted.

The change of the teeth commences in those which earliest appeared, and, therefore, the front or first grinder gives way at the age of two years, and is succeeded by a larger and permanent tooth.

During the period between the falling out of the central milk nippers, and the coming up of the permanent ones, the colt, having a broken mouth, may find some difficulty in grazing. If he should fall away considerably in condition, he should be fed with mashes and corn, or cut meat.

The next cut will represent a three-years-old mouth. The central teeth are larger than the others, with two grooves in the outer convex surface, and the mark is long, narrow, deep and black. Not having yet attained their full growth, they are rather lower than the others. The mark in the two next nippers is nearly worn out, and it is wearing away in the corner nippers. Is it possible to give this mouth to an early two-years-old? The age of all horses used to be reckoned from May, but some are foaled even so early as January, and being actually four months over the two years, if they have been well nursed and fed, and are strong and large, they may, with the inexperienced, have an additional year put upon them. The central nippers are punched or drawn out, and the others appear three or four months earlier than they otherwise would. In the natural process

they could only rise by long pressing upon, and causing the absorption of the first set. But opposition from the first set being removed, it is easy to imagine that their progress will be more rapid. Three or four months will be gained in the appearance of the teeth, and these three or four months may enable the breeder to term him a late colt of a preceding year. To him, however, who is accustomed to horses, the general form of the animal—the little development of the fore-hand—the continuance of the mark on the next pair of nippers—its more evident existence in the corner ones, some enlargement or irregularity about the gums from the violence used in forcing out the teeth—the small growth of the first and fifth grinders and the non-appearance of the sixth grinder, which, if it is not through the gum at three years old, is swelling under it, and preparing to get through—any or all of these circumstances, carefully attended to, will be a sufficient security against deception.

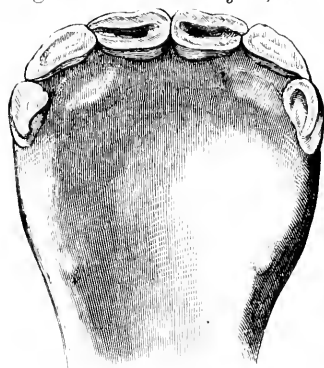
A horse at three years old ought to have the central permanent nippers growing—the other two pairs wasting—six grinders in each jaw, above and below—the first and fifth level with the others and the sixth protruding. The sharp edge of the new incisors, although it could not be well expressed in the cut, will be very evident when compared with the neighbouring teeth.

As the permanent nippers wear, and continue to grow, a narrower portion of the cone-shaped tooth is exposed to the attrition, and they look as if they had been compressed, but it is not so. The mark, of course, gradually disappears as the pit is worn away.

At three years and a half, or between that and four, the next pair of nippers will be changed, and the mouth at that time cannot be mistaken. The central nippers will have attained nearly their full growth. A vacancy will be left where the second stood, or they will begin to peep above the gum, and the corner ones will be diminished in breadth, worn down, and the mark becoming small and faint. At this period, likewise, the second pair of grinders will be shed. Previously to this may be the attempt of the dealer to give to his three-years-old an additional year, but the fraud will be detected by an examination similar to that which has been already described.

At four years, the central nippers will be fully developed; the sharp edge somewhat worn off, and the mark shorter, wider and fainter. The next pair will be up, but they will be small, with the mark deep, and extending quite across them. The corner nippers will be larger than the inside ones, yet smaller than they were, and flat, and the mark nearly effaced. The sixth grinder will have risen to a level with the others, and the tushes will begin to appear.

Now, more than any other time, will the dealer be anxious to put an additional year upon the animal, for the difference between a four-years-old colt and a five-years-old-horse, in strength, utility and value, is very great; but, the want of wear in the other nippers—the small size of the corner ones—the little



growth of the tush—the smallness of the second grinder—the low forehead—the legginess of the colt, and the thickness and little depth of the mouth, will, to the man of common experience among horses, at once detect the cheat.

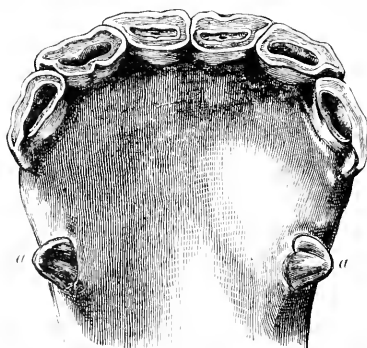
The tushes (see below *a, a*) are four in number, two in each jaw, situated between the nippers and the grinders—much nearer to the former than the latter, and nearer in the lower jaw than in the upper, but this distance increasing in both jaws with the age of the animal. In shape it somewhat resembles a cone; it protrudes about an inch from the gum, and has its extremity sharp-pointed and curved. At the age now under consideration, the tushes are almost peculiar to the horse, and castration does not appear to prevent or retard their development. All mares, however, have the germs of them in the chambers of the jaw, and they appear externally in the majority of old mares. Their use is not evident. Perhaps, in the wild state of the animal, they are weapons of offence, and he is enabled by them more firmly to seize, and more deeply wound his enemy.

The breeder often attempts to hasten the appearance of the tush, and he cuts deeply through the gum to remove the opposition which that would afford. To a little extent he succeeds. He may possibly gain a few weeks, but not more. After all, there is much uncertainty as to the appearance of the tush, and it may vary from the fourth year to four years and six months. It belongs, in the upper jaw, both to the inferior and superior maxillary bones; for, while its fang is deeply imbedded in the inferior maxillary, the tooth penetrates the process of the superior maxillary at the union of those bones.

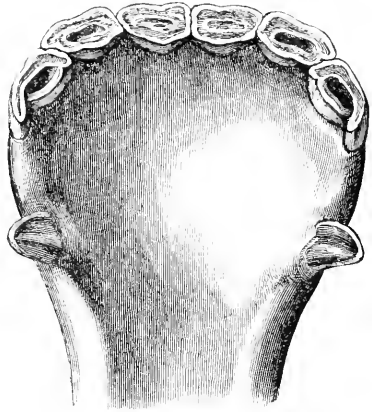
At four years and a half, or between that and five, the last important change takes place in the month of the horse. The corner nippers are shed, and the permanent ones begin to appear. The central nippers are considerably worn, and the next pair are commencing to show marks of usage. The tush has now protruded, and is generally a full half-inch in height; externally it has a rounded prominence, with a groove on either side, and it is evidently hollowed within. The reader needs not to be told that after the rising of the corner nipper the animal changes its name—the colt becomes a horse, and the filly a mare.

At five years the horse's month is almost perfect. The corner nippers are quite up, with the long deep mark irregular on the inside; and the other nippers bearing evident tokens of increasing wearing. The tush is much grown—the grooves have almost or quite disappeared, and the outer surface is regularly convex. It is still as concave within, and with the edge nearly as sharp, as it was six months before. The sixth molar is quite up, and the third molar is wanting. This last circumstance, if the general appearance of the animal, and particularly his forehead and the wearing of the centre nippers, and the growth and shape of the tushes, are likewise carefully attended to, will prevent deception, if a late four-years-old is attempted to be substituted for a five. The nippers may be brought up a few months before their time, and the tushes a few weeks, but the grinder is with difficulty displaced. The three last grinders and the tushes are never shed.

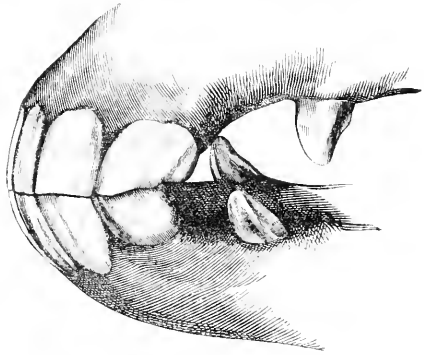
At six years the *mark* on the central nippers is worn out. There will



still be a difference of colour in the centre of the tooth. The cement filling the hole, made by the dipping in of the enamel, will present a browner hue than the other part of the tooth, and it will be evidently surrounded by an edge of enamel, and there will even remain a little depression in the centre, and also a depression round the case of enamel; but the deep hole in the centre of the teeth, with the blackened surface which it presents, and the elevated edge of enamel, will have disappeared. Persons not much accustomed to horses have been puzzled here. They expected to find a plain surface of a uniform colour, and knew not what conclusion to draw when there was both discolouration and irregularity.



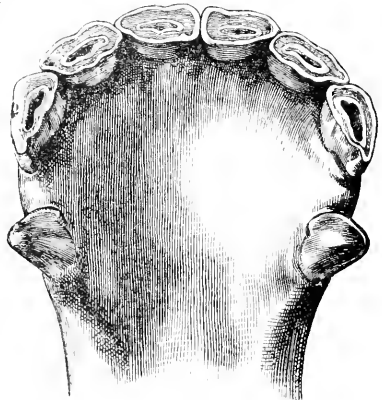
In the next incisors the mark is shorter, broader, and fainter; and in the corner teeth the edges of the enamel are more regular, and the surface is evidently worn. The tush has attained its full growth, being nearly or quite an inch in length; convex outward, concave within; tending to a point, and the extremity somewhat curved. The third grinder is fairly up; and all the grinders are level.



At six years old the profile of the mouth exhibits the teeth in a firm and upright position, which is gradually lost as the animal increases in age.

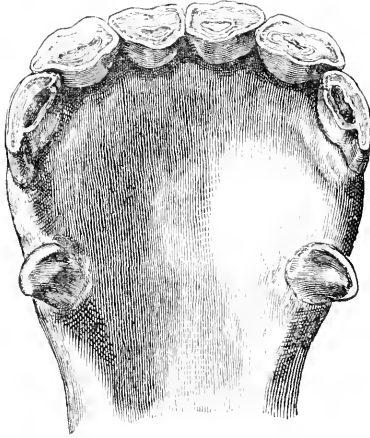
The horse may now be said to have a perfect mouth. All the teeth are produced, fully grown, and have hitherto sustained no material injury.

During these important changes of the teeth the animal has suffered less than could be supposed possible. In children, the period of teething is fraught with danger. Dogs are subject to convulsions, and hundreds of them die from the irritation caused by the cutting or shedding of their teeth; but the horse appears to feel little inconvenience. The gums and palate are occasionally somewhat hot and swollen; but the slightest scarification will remove this. The teeth of the horse are more necessary to him than those of the other animals are to them. The child may be fed, and the dog will bolt his food; but that of the horse must be well ground down, or the nutriment cannot be extracted from it.



At seven years, the mark, in the way in which we have described it, is worn out in the four central nippers, and fast wearing away in the corner teeth; the tush also is beginning to be altered. It is rounded at the point; rounded at the edges; still round without; and beginning to get round inside.

At eight years old, the tush is rounder in every way; the mark is gone from all the bottom nippers, and it may almost be said to be out of the mouth. There is nothing remaining in the bottom nippers that can afterwards clearly show the age of the horse, or justify the most experienced examiner in giving a positive opinion.



Dishonest dealers have resorted to a method of prolonging the mark in the lower nippers. It is called *bishoping*. With an engraver's tool a hole is dug in the now almost plain surface of the corner teeth, and in shape and depth resembling the mark in a seven-years-old horse. The hole is then burned with a heated iron, and a permanent black stain is left; but the irregular appearance of the cavity, the dif-

fusion of the black stain, and the general appearance of the mouth, can never deceive a careful examiner.

Horsemen, after the animal is eight years old, are accustomed to look to the nippers in the upper jaw, and some conclusion has been drawn from the appearances which they present. It cannot be doubted that the mark remains in them some years after it has been obliterated from the nippers in the lower jaw; because the hard substance, a kind of cement by which the pit or funnel in the centre of the tooth is occupied, does not reach so high, and there is a greater depth of tooth to be worn away in order to come at it. To this it may be added, that the upper nippers are not so much exposed to friction and wear as the under. The lower jaw alone is moved, and pressed forcibly upon the food: the upper jaw is without motion, and has only to resist that pressure.

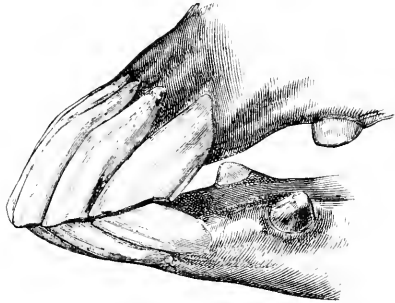
There are various opinions as to the intervals between the disappearance of the marks from the different cutting-teeth in the upper jaw. Some have averaged it at two years, and others at one. The author is inclined to adopt the latter opinion, and then the age will be thus determined: at nine years the mark will be worn out from the middle nippers, from the next pair at ten, and from all the upper nippers at eleven. During these periods the tush is likewise undergoing a manifest change; it is blunter, shorter, and rounder. In what degree this takes place in the different periods, long and most favourable opportunities for observation can alone enable the horseman to decide.

The tushes are exposed to but little wear and tear. The friction against them must be slight, proceeding only from the passage of the food over them, and from the motion of the tongue, or from the bit: and their alteration of form, although generally as we have described it, is frequently uncertain. The tush will sometimes be blunt at eight; at other times it will remain pointed at eighteen. The upper tush, although the latest in appearing, is soonest worn away.



Are there any circumstances to guide our judgment after this? There are those which will prepare us to guess at the age of the horse, or to approach within a few years of it, until he becomes very old; but there are none which will enable us accurately to determine the question, and the indications of age must now be taken from the shape of the upper surface of the nippers. At eight, they are all oval, the length of the oval running across from tooth to tooth; but as the horse gets older, the teeth diminish in size, and this commencing in their width, and not in their thickness. They become a little apart from each other, and their surfaces are rounded. At nine, the centre nippers are evidently so; at ten, the others begin to have the oval shortened; at eleven, the second pair of nippers are quite rounded; and at thirteen, the corner ones have that appearance. At fourteen, the faces of the central nippers become somewhat triangular. At seventeen, they are all so. At nineteen, the angles begin to wear off, and the central teeth are again oval, but in a reversed direction, viz. from outward, inward; and at twenty-one they all wear this form. This is the opinion of some Continental veterinary surgeons, and Mr. Percivall first presented them to us in an English dress.

It would be folly to expect perfect accuracy at this advanced age of the horse, when we are bound to confess that the rules which we have laid down for determining this matter at an earlier period, although they are recognised by horsemen generally, and referred to in courts of justice, will not guide us in every case. Stabled horses have the mark sooner worn out than those that are at grass; and a crib-biter may deceive the best judge by



one or two years. At nine or ten the bars of the mouth become less prominent, and their regular diminution will designate increasing age. At eleven or twelve the lower nippers change their original upright direction, and project forward or horizontally, and become of a yellow colour. They are yellow, because the teeth must grow in order to answer to their wear and tear; but the enamel which covered their surface when they were first produced cannot be repaired, and that which wears this yellow colour in old age is the part which in youth was in the socket, and therefore destitute of enamel. The gums have receded and wasted away, and the tusks are worn to stumps, and project directly outward.

In connection with the age of the horse should be mentioned the valuable information, for which we are indebted to Professor Simonds, of the Royal Veterinary College, on the age of other domesticated animals—in two lectures delivered before the Royal Agricultural Society of England, and which were published at the request of that body; he very clearly elucidated the development of the teeth as indicative of the age of the ox, the sheep, and the pig. The result of his investigations, most systematically pursued, would appear to be, that the ox has his teeth fully developed at from three years to three years and nine months old, the sheep at from three years to three years and a half, and the pig at one year and a half.

## DISEASES OF THE TEETH.

Of the diseases of the teeth in the horse we know little. Carious or hollow teeth are occasionally, but not often seen; but the edges of the grinders, from the wearing off of the enamel or the irregular growth of the teeth, become rough, and wound the inside of the cheek; it is then necessary to adopt a summary but effectual method of cure, namely, to rasp them smooth; the outside edges of the grinders in the upper jaw alone require the application of the tooth rasp, and if the finger is carefully introduced inside the cheek, before and after its use, the result will be unmistakable. Many bad ulcers have been produced in the mouth by the neglect of this.

The teeth sometimes grow irregularly in length, and this is particularly the case with the grinders, from not being in exact opposition to each other when the mouth is shut. The growth of the teeth still going on, and there being no mechanical opposition to it, one of the back teeth, or a portion of one of them, shoots up considerably above the others. Sometimes it penetrates the bars above, and causes soreness and ulceration; at other times it interferes partially, or altogether, with the grinding motion of the jaws, and the animal pines away without the cause being suspected. Here the saw should be used, and the projecting portion reduced to a level with the other teeth. The horse that has once been subjected to this operation should afterwards be frequently examined, and especially if he loses condition: and, indeed, every horse that gets thin or out of condition, without fever, or other apparent cause, should have his teeth and mouth carefully examined, and especially if, without any indication of sore throat, he quids—partly chewing and then dropping—his food, or if he holds his head somewhat on one side, while he eats, in order to get the food between the outer edges of the teeth. A horse that has once had very irregular teeth is materially lessened in value, for, although they may be sawn down as carefully as possible, they will project again at no great distance of time. Such a horse is to all intents and purposes unsound. In order to be fit for service, he should be in possession of his full natural powers, and these powers cannot be sustained without perfect nutrition, and nutrition would be rendered sadly imperfect by any defect in the operation of mastication. Not only do some diseases of the teeth render the act of mastication difficult and troublesome, but, from the food acquiring a foetid odour during its detention in the mouth, the horse acquires a distaste for aliment altogether.

The continuance of a carious tooth often produces disease of the neighbouring ones, and of the jaw itself. It should therefore be removed, as soon as its real state is evident. Dreadful cases of fungus hæmatodes have arisen from the irritation caused by a carious tooth.

The mode of extracting the teeth requires much reformation, and considerable improvements have been made in dental instruments by Mr. Gowing of Camden Town, by which the extraction or division of a tooth is considerably facilitated. The hammer and the punch should never be had recourse to. The keyed instrument of the human subject, but on a larger scale, is the only one that should be permitted.

This is the proper place to speak more at length of the effect of dentition on the system generally. Horsemen in general think too lightly of it, and they scarcely dream of the animal suffering to any considerable degree, or absolute illness being produced; yet he who has to do with young horses will occasionally discover a considerable degree of febrile affection, which he can refer to this cause alone. Fever, cough, catarrhal affections generally,

disease of the eyes, cutaneous affections, diarrhoea, dysentery, loss of appetite, and general derangement, will frequently be traced, by the careful observer, to irritation from teething.

It is a rule scarcely admitting of the slightest deviation, that, when young horses are labouring under any febrile affection, the mouth should be examined, and if the tushes are prominent and pushing against the gums, a crucial incision should be made across them. 'In this way,' says Mr. Percivall, 'I have seen catarrhal and bronchial inflammations abated, coughs relieved, lymphatic and other glandular tumours about the head reduced, cutaneous eruptions got rid of, deranged bowels restored to order, appetite returned, and lost condition repaired.'

#### THE TONGUE.

The tongue is the organ of taste. It is also employed in disposing the food for being ground between the teeth, and afterwards collecting it together, and conveying it to the back part of the mouth, in order to be swallowed. It is likewise the main instrument in deglutition, and the canal through which the water passes in the act of drinking. The root of it is firmly fixed at the bottom of the mouth by a variety of muscles; some of these muscles originate from the *os hyoides* or bone of the tongue, which constitutes its base, and is connected with the temporal bone, the larynx, and the pharynx; the fore part is loose in the mouth. It is covered by a continuation of the membrane that lines the mouth, and which, doubling beneath, and confining the motions of the tongue, is called its *frænum*, or bridle. On the back of the tongue, this membrane is thickened and roughened, and is covered with numerous conical *papillæ*, or little eminences, on which the fibres of the gustatory branch of the fifth pair, and the Glossa Pharyngeal nerves expand, communicating the sense of taste. The various motions of the tongue are accomplished by means of the ninth pair of nerves. The substance of the tongue is composed of muscular fibres, with much fatty matter interposed between them, and which gives to this organ its peculiar softness.

#### DISEASES OF THE TONGUE.

The tongue is sometimes exposed to injury from carelessness or violence in the act of drenching or administering a ball, it being pressed against and cut by the edges of the grinders. A little diluted tincture of myrrh, or alum dissolved in water, or even nature unassisted, will speedily heal the wound. The horse will sometimes bite his tongue, most frequently in his sleep. If the injury is trifling, it requires little care; but, in some instances, a portion of the tongue has been deeply lacerated or bitten off. The assistance of a veterinary practitioner is here required.

There are some interesting accounts of the results of this lesion. Mr. Dickens of Kimbolton relates a case, in the sixth volume of the 'Veterinarian,' in which he found a portion of the tongue of a mare, extending as far as the *frænum* beneath, lying in the manger in a strangely lacerated condition, and fast approaching to decomposition. He had her cast, and, excising all the unhealthy portions, he dressed the wound with chloride of soda and tincture of myrrh. In less than a week the laceration was nearly healed, and, soon afterwards, she could eat with very little difficulty, and keep herself in good condition. The injury was proved to have been inflicted by a brutal horsebreaker, in revenge for some slight affront.

A curious case is recorded in the Memoirs of the Society of Calvados. A horse was difficult to groom. The soldier who had the care of him, in order the better to manage him, fixed in his mouth and on his tongue a strong chain of iron, deeply serrated, while another man gave to this chain

a terrible jerk whenever the horse was disposed to be rebellious. The animal, under such torture, became unmanageable, and the man who held the chain sawing away with all his strength, the tongue was completely cut off at the point which separates its base from the free portion of it. The wound healed favourably, and he was soon able to manage a mash. After that some hay was given to him in small quantities. He took it and formed it into a kind of pellet with his lips, and then, pressing it against the bottom of his manger, he gradually forced it sufficiently back into the mouth to be enabled to seize it with his grinders.

Another horse came to an untimely end in a singular way. He had scarcely eaten anything for three weeks. He seemed to be unable to swallow. The channel beneath the lower jaw had much enlargement about it. There was not any known cause for this, nor any account of violence done to the tongue. At length a tumour appeared under the jaw. Mr. Young of Muirhead punctured it, and a considerable quantity of purulent matter escaped. The horse could drink his gruel after this, but not take any solid food. A week afterwards he was found dead. Upon separating the head from the trunk, and cutting transversely upon the tongue, nearly opposite to the second grinder, a needle was found lying longitudinally, and which had penetrated from the side to the inferior portion of the tongue. It was an inch and a quarter in length, and the neighbouring substance was in a state of gangrene.

Vesicles will sometimes appear along the under side of the tongue, which will increase to a considerable size. The tongue itself will be much enlarged, the animal will be unable to swallow, and a great quantity of ropy saliva will drivel from the mouth. This disease often exists without the nature of it being suspected. If the mouth is opened, one large bladder, or a succession of bladders, of a purple hue, will be seen extending along the whole of the under side of the tongue. If they are lanced freely and deeply, from end to end, the swelling will very rapidly abate, and any little fever that remains may be subdued by cooling medicine. A mild solution of alum, applied by means of a small piece of sponge frequently during the day, will accelerate the cure. The cause of this disease is not clearly known.

#### THE SALIVARY GLANDS.

In order that the food may be properly comminuted preparatory to digestion, it is necessary that it should be previously moistened. The food of the stabled horse, however, is dry, and his meal is generally concluded without any fluid being offered to him. Nature has made a provision for this. She has placed in the neighbourhood of the month various glands to secrete, and that plentifully, a limpid fluid, somewhat saline to the taste. This fluid is conveyed from the glands into the mouth, by various ducts, in the act of chewing, and, being mixed with the food, renders it more easily ground, more easily passed afterwards into the stomach, and better fitted for digestion.

The principal of these is the *parotid* gland (see cut, p. 199). It is placed in the hollow which extends from the root of the ear to the angle of the lower jaw. The portion of it, *g*, is represented as turned up, to show the situation of the blood-vessels underneath. In almost every case of cold connected with sore throat, an enlargement of the parotid gland is evident to the feeling, and even to the eye. It is composed of numerous small glands connected together, and a minute tube proceeding from each, to carry away the secreted fluid. These tubes unite in one common duct. At the letter *u*, the parotid duct is seen to pass under the angle of the lower jaw, together with the submaxillary artery, and a branch of the

jugular vein, and they come out again at *w*. At *r*, the duct is seen separated from the other vessels, climbing up the cheek, and piercing it to discharge its contents into the mouth, opposite to the second grinder. The quantity of fluid thus poured into the mouth from each of the parotid glands amounts to a pint and a half in an hour, during the action of mastication; and, sometimes, when the duct has been accidentally opened, it has spirted out to the distance of several feet.

The parotid gland sympathises with every inflammatory affection of the upper part of the throat, and therefore it is found swollen, hot, and tender, in almost every catarrh or cold. The catarrh is to be treated in the usual way; while a stimulating application, almost amounting to a blister, well rubbed over the gland, will best subdue the inflammation of that body.

In bad strangles, and, sometimes, in violent cold, this gland will be much enlarged and ulcerated, or an obstruction will take place in some part of the duct, and the accumulating fluid will burst the vessel, and a fistulous ulcer be formed that will be very difficult to heal. Similar results may be produced by its being wounded by a lancet in opening an abscess, and it occasionally occurs from accidental wounds. The application of collodium, accompanied with the adhesive plaister, should be promptly had recourse to, as if the wound assumes a fistulous character the cure is tedious and difficult. A veterinary surgeon alone will be competent to the treatment of either case; and the principle by which he will be guided will be to heal the abscess in the gland as speedily as he can, and, probably, by the application of the heated iron; or, if the ulcer is in the duct, either to restore the passage through the duct, or to form a new one.

A second source of the saliva is from the *submaxillary* glands, or the glands under the jaw. One of them is represented at *s*, p. 199. The submaxillary glands occupy the space underneath and between the sides of the lower jaw, and consist of numerous small bodies, each with its proper duct, uniting together, and forming on each side a common duct or vessel that pierces through the muscles at the root of the tongue, and opens in little projections, or heads, upon the *frænum*, or bridle of the tongue, about an inch and a half from the front teeth. When the horse has catarrh or cold, these glands, like the parotid gland, enlarge. This is often to be observed after strangles, and several distinct kernels are to be felt under the jaw. It has already been stated that they may be distinguished from the swellings that accompany or indicate glanders, by their being larger, generally not so distinct, more in the centre of the channel, or space between the jaws, and never adhering to the jaw-bones. The farriers call them *VIVES*, and often adopt cruel and absurd methods to disperse them,—as burning them with a lighted candle, or hot iron, or even cutting them out. They will, in the majority of instances, gradually disperse in proportion as the disease which produced them subsides; or they will yield to slightly stimulating embrocations; or, if they are obstinate in their continuance, they are of no further consequence, than as indicating that the horse has laboured under severe cold or strangles.

During catarrh, or inflammation of the mouth, the little projections marking the opening of these ducts on either side of the bridle of the tongue are apt to enlarge, and the mouth under the tongue is a little red and hot and tender. The farriers call these swellings *BARBS* or *PAPS*; and as soon as they discover them, mistaking the effect of disease for the cause of it, they set to work to cut them close off. The bleeding that follows this operation somewhat abates the local inflammation, and affords temporary relief; but the wounds will not speedily heal. The saliva continues to flow from the orifice of the duct, and, running into the

irregularities of the wound, causes it to spread and deepen. Even when it heals, the mouth of the duct being frequently closed, and the saliva continuing to be secreted by the submaxillary gland, it accumulates in the duct, until that vessel bursts, and abscesses are formed which eat deeply under the root of the tongue and long torment the poor animal. When, after a great deal of trouble, they are closed, they are apt to break out again for months and years afterwards.

All that is necessary with regard to these paps or barbs is to abate the inflammation or cold that caused them to appear, and they will very soon and perfectly subside. He who talks of cutting them out is not fit to be trusted with a horse.

A third source of saliva is from glands under the tongue—the *sublingual glands*, which open by many little orifices, under the tongue resembling little folds of the skin of the mouth, hanging from the lower surface of this organ, or found on the bottom of the mouth. These likewise sometimes enlarge during catarrh or inflammation of the mouth, and are called *gigs*, and *bladders*, and *flaps in the mouth*. They have the appearance of small pimples, and the farrier is too apt to cut them away, or burn them off. The better way is to let them alone—for in a few days they will generally disappear. Should any ulceration remain, a little tincture of myrrh, or a solution of alum, will readily heal them.

Beside these three principal sources of saliva, there are small glands to be found on every part of the mouth, cheeks, and lips, which pour out a considerable quantity of fluid, to assist in moistening and preparing the food.

#### STRANGLES.

This is a disease principally incident to young horses—usually appearing between the second and fourth year, and oftener in the spring than in any other part of the year. It is preceded by cough, and can at first scarcely be distinguished from common cough, except that there is more discharge from the nostril, of a yellowish colour, mixed with pus, and generally without smell. There is likewise a considerable discharge of rosy fluid from the mouth, and greater swelling than usual under the throat. This swelling increases with uncertain rapidity, accompanied by some fever, and disinclination to eat, partly arising from the fever, but more from the pain which the animal feels in the act of mastication. There is considerable thirst, but after a gulp or two the horse ceases to drink, yet is evidently desirous of continuing his draught. In the attempt to swallow, and sometimes when not drinking, a convulsive cough comes on, which almost threatens to suffocate the animal—and thence, probably, the name of the disease.

The tumour is under the jaw, and about the centre of the channel. It soon fills the whole of the space, and is evidently one uniform body, and may thus be distinguished from glanders, or the enlarged glands of catarrh. In a few days it becomes more prominent and soft, and evidently contains a fluid. This rapidly increases; the tumour bursts, and a great quantity of pus is discharged. As soon as the tumour has broken, the cough subsides, and the horse speedily mends, although some degree of weakness may hang about him for a considerable time. Few horses, possibly none, escape its attack; but, the disease having passed over, the animal is free from it for the remainder of his life. Catarrh may precede, or may predispose to, the attack, and, undoubtedly, the state of the atmosphere has much to do with it, for both its prevalence and its severity are connected with certain seasons of the year and changes of the weather.

Messrs. Percivall and Castley have come the nearest to a satisfactory

view of the nature of strangles. Mr. Castley in 'The Veterinarian' says that 'the period of strangles is often a much more trying and critical time for young horses than most people seem to be aware of; that when colts get well over this complaint, they generally begin to thrive and improve in a remarkable manner, or there is sometimes as great a change for the worse: in fact, it seems to effect some decided constitutional change in the animal.'

Mr. Percivall adds, 'The explanation of the case appears to me to be, that the animal is suffering more or less from what I would call *strangle fever*,—a fever the disposition and tendency of which is to produce local tumour and abscess, and most commonly in that situation underneath the jaws, in which it has obtained the name of strangles.'

Professor Dick, of Edinburgh, adds that which is conclusive on the subject, that 'although the disease commonly terminates by an abscess under the jaw, yet it may, and occasionally does, give rise to collections of matter on other parts of the surface.'

To this conclusion then we are warranted in coming,—that strangles is a specific affection to which horses are naturally subject at some period of their lives, and the natural cure of which seems to be a suppurative process. From some cause, of the nature of which we are ignorant, this suppurative process usually takes place in the space between the branches of the maxillary bone, and occurring there it appears in the mildest form, and little danger attends. When the disease is ushered in by considerable febrile disturbance, and the suppuration takes place elsewhere, the horse too frequently sinks under the attack.

The treatment of strangles is very simple. As the essence of the disease consists in the formation and suppuration of the specific tumour, the principal, or almost the sole attention of the practitioner should be directed to the hastening of these processes: therefore, as soon as the tumour of strangles is decidedly apparent, the part should be actively blistered. Old practitioners used to recommend poultices, which, from the thickness of the horse's skin, must have very little effect, even if they could be confined on the part; and from the difficulty and almost impossibility of this, and their getting cold and hard, they necessarily weakened the energies of nature, and delayed the ripening of the tumour. Fomentations are little more effectual. A blister will not only secure the completion of the process, but hasten it by many days, and save the patient much pain and exhaustion. It will produce another good effect—it will, previously to the opening of the tumour, abate the internal inflammation and soreness of the throat, and thus lessen the cough and wheezing.

As soon as the swelling is soft on its surface, and evidently contains matter, it should be freely and deeply lanced. It is a bad, although frequent practice, to suffer the tumour to burst naturally, for a ragged ulcer is formed, very slow to heal, and difficult of treatment. If the incision is deep and large enough, no second collection of matter will be formed: and that which is already there may be suffered to run out slowly, all pressure with the fingers being avoided. The part should be kept clean, and a little Friar's balsam daily injected into the wound.

The remainder of the treatment will depend on the symptoms. If there is much fever, and evident affection of the chest, which should carefully be distinguished from the oppression and choking occasioned by the pressure of the tumour, it will be proper to give cooling medicines, as nitre, emetic tartar, and perhaps digitalis, as the case requires. The appetite, or, rather, the ability to eat, will generally return with the opening of the abscess. Bran-mashes, fresh-cut grass or tares, should be liberally supplied, which will not only afford sufficient nourishment to recruit the

strength of the animal, but keep the bowels gently open. In cases of debility, a small quantity of tonic medicine, as chamomile, gentian, or ginger may be administered. It must however be borne in mind, that in a great majority of cases, little or no treatment is required, and in very many instances, the disease in colts has run its course altogether unnoticed. On the other hand, it occasionally is productive of great suffering, and this is more especially the case where the abscess bursts internally, when, to use the graphic account of Mr. Percivall in the sixth volume of 'The Veterinarian,' 'while purulent matter is issuing in profusion from his swollen nostrils, and slaver foams out from between his tumified lips, it is distressing to hear the noise that he makes in painful and laboured efforts to breathe. There is imminent danger of suffocation in such a case as this; and even although some relief, so far as the breathing is concerned, may be obtained from the operation of *tracheotomy*, yet, from the pain and irritation he is suffering, added to the impossibility of getting aliment into his stomach, he must speedily sink to rise no more.'—*Veterinarian*, vol. vi. p. 611.

---

## CHAPTER XI.

### THE ANATOMY AND DISEASES OF THE NECK AND NEIGHBOURING PARTS.

THE neck of the horse, and of every animal belonging to the class *mammalia*, except one species, is composed of seven bones called *vertebrae*, moveable or turning upon each other (see cut, p. 140). They are connected together by strong ligaments, and form so many distinct joints, in order to give sufficiently extensive motion to this important part of the body. The bone nearest to the skull is called the *atlas*, because, in the human being, it supports the head. In the horse the head is suspended from it. It is a mere ring-shaped bone, with broad projections sideways; but without the sharp and irregular processes which are found on all the others.

The second bone of the neck is the *dentata*, having a process like a tooth, by which it forms a joint with the first bone. In the formation of that joint, a portion of the spinal marrow, which runs through a canal in the centre of all these bones, is exposed or covered only by ligament; and by the division of the marrow at this spot an animal is instantly destroyed. The operation is called *pithing*, from the name (*the pith*) given by butchers to the spinal marrow.

The other neck or *rack* bones, as they are denominated by the farrier (B, p. 140), are of a strangely irregular shape, yet bearing considerable resemblance to each other. They consist of a central bone, perforated for the passage of the spinal marrow with a ridge on the top for the attachment of the ligament of the neck, and four irregular plates or processes from the sides, for the attachment of muscles; at the base of one of which, on either side, with the exception of the seventh, are holes for the passage of the vertebral arteries. At the upper end of each is a round head or ball, and at the lower end a cavity or cup, and the head of the one being received into the cup of the other, they are united together, forming so many joints. They are likewise united by ligaments from these processes, as well as the proper ligaments of the joints, and so securely, that no dislocation can take place between any of them, except the first and second, the consequence of which would be the immediate death of the animal.

The last, or seventh bone, has the elevation on the back or top of it

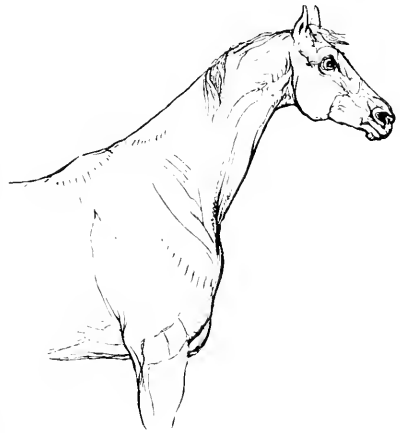


continued into a long and sharp prolongation (*a spinous process*), and is the beginning of that ridge of bones denominated *the withers* (see cuts, pp. 140 and below); and as it is the base of the column of neck bones, and there must be a great pressure on it from the weight of the head and neck, it is curiously contrived to rest upon and unite with the two first ribs.

#### THE MUSCLES AND PROPER FORM OF THE NECK.

The bones of the neck serve as the framework to which numerous muscles concerned in the motions of the head and neck are attached. The weight of the head and neck is supported by the ligament without muscular aid, and without fatigue to the animal; but in order to raise the head higher, or to lower it or turn it in every direction, a complicated system of muscles is necessary. Those whose office it is to raise the head are most numerous and powerful, and are placed on the upper and side part of the neck. The cut in p. 199 contains a few of them.

c marks a tendon common to two of the most important of them, the *splenius* or splint-like muscle, and the *complexus major*, or larger complicated muscle. The *splenius* arises from the processes of all the bones of the neck with the exception of the last three, and posteriorly from the sides of the anterior dorsal vertebræ with tendons running from the upper part of it to the first bone of the neck, and to a process of the temporal bone of the head. Its action is sufficiently evident, namely, very powerfully to elevate the head and neck. The principal beauty of the neck depends on this muscle. It was admirably developed in the horse of whose neck the annexed cut gives an accurate delineation.



If the curve were quite regular from the poll to the withers, we should call it a perfect neck. It is rather a long neck, and we do not like it the less for that. In the carriage-horse, a neck that is not half concealed by the collar is indispensable, so far as appearance goes; and it is only the horse with a neck of tolerable length that can bear to be reined up, so as to give this part the arched and beautiful appearance which fashion demands. It is no detriment to the riding-horse, and there are few horses of extraordinary speed that have not the neck rather long. The race-horse at the top of his speed not only extends it as far as he can, that the air passages may be as straight as he can make them, and that he may therefore be able to breathe more freely, but the weight of the head and neck, and the effect increasing with their distance from the trunk, add materially to the rapidity of the animal's motion. It has been said, that a horse with a long neck will bear heavy on the hand; neither the length of the neck nor even the bulk of the head has any influence in causing this. They are both counterbalanced by the power of the ligament of the neck. The *setting on* of the head is most of all connected with heavy bearing on the hand, and a short-necked horse will bear heavily, because, from the thickness of the lower part of the neck, consequent on its shortness, the head cannot be rightly placed, nor, generally, the shoulder.

Connected with the *splenius* muscle, and partly produced by it, are the thickness and muscularity of the neck, as it springs from the shoulders, in

this cut; the height at which it comes out from them forming nearly a line with the withers; and the manner in which it tapers as it approaches the head. The neck of a well-formed horse, however fine at the top, should be muscular at the bottom, or the horse will generally be weak and worthless. Necks devoid of this muscularity are called *loose* necks by horsemen, and are always considered a very serious objection to the animal. If the neck is thin and lean at the upper part, and is otherwise well shaped, the horse will usually carry himself well, and the head will be properly curved for beauty of appearance and ease of riding. When an instance to the contrary occurs, it is to be traced to very improper management, or to the space between the jaws being unnaturally small.

The *splenius* muscle, although a main agent in raising the head and neck, may be too large, or covered with too much cellular substance or fat, thus giving an appearance of heaviness or even clumsiness to the neck. This peculiarity of form constitutes the distinction between the perfect horse and the mare, and also the gelding, unless castrated at a very late period.

This tendon belongs also to another muscle, which makes up the principal bulk of the lower part of the neck, and is called the *complexus major*, or larger complicated muscle. It arises partly as low as the transverse processes of the four or five first bones of the back, and from all the bones of the neck, except the first; and the fibres from these various sources uniting together, form a very large and powerful muscle, the largest and strongest in the neck. As it approaches the head, it lessens in bulk, and terminates partly with the splenius, in this tendon, but is principally inserted into the back part of the occipital bone, by the side of the ligament of the neck. Its office is to raise the neck and elevate the head; and being inserted into such a part of the occiput, it will more particularly protrude the nose, while it raises the head. Its action, however, may be too powerful; it may be habitually so, and then it may produce deformity. The back of the head being pulled back, and the muzzle protruded, the horse cannot by possibility carry his head well. He will become what is technically called a star-gazer;—heavy in hand, boring upon the bit, and unsafe. To remedy this, recourse is had, and in the majority of cases without avail, to the martingale, against which the horse is continually fighting, and which is often a complete annoyance to the rider. Such a horse is almost useless for harness.

Inseparable from this is another sad defect, so far as the beauty of the horse is concerned;—he becomes *ewe-necked*; *i.e.* he has a neck like a ewe—not arched above, and straight below, until near to the head, but hollowed above and projecting below; and the neck rising low out of the chest, even lower sometimes than the points of the shoulders. There can scarcely be anything more unsightly in a horse. His head can never be got fairly down, and the bearing reign of harness must be to him a source of constant torture. In regarding, however, the length and the form of the neck, reference must be had to the purpose for which the horse is intended. In a hackney few things can be more abominable than a neck so disproportionable, so long that the hand of the rider gets tired in managing the head of the horse. In the race-horse this lengthening of the neck is a decided advantage.

Among the muscles employed in raising the head, are the *complexus minores* (smaller complicated), and the *recti* (straight), and the oblique muscles of the upper part of the neck, and belonging principally to the two first bones of the neck.

Among the muscles employed in lowering the head, some of which are given in the same cut, is the *sterno-maxillaris*, *d*, belonging to the breast-bone and the lower jaw. It can likewise be traced, although not quite

distinctly, in the cut, page 237. It lies immediately under the skin, projecting from, or constituting, the front of the breast bone (H, p. 140), and proceeds up the neck, of no great bulk or strength. At about three-fourths of its length upward, it changes to a flat tendon, which insinuates itself between the parotid and submaxillary glands, in order to be inserted into the angle of the lower jaw. It is used in bending the head towards the chest.

Another muscle, the termination of which is seen, is the *levator humeri*, raiser of the shoulder (b, p. 199). This is a much larger muscle than the last, because it has more duty to perform. It rises from the back of the head and four first bones of the neck and the ligament of the neck, and is carried down to the shoulder, mixing itself partly with some of the muscles of the shoulder, and finally continued down to and terminating on the humerus (J, p. 140). Its office is double. If the horse is in action, and the head and neck are fixed points, the contraction of this muscle will draw forward the shoulder and arm; if the horse is standing, and the shoulder and arm are fixed points, this muscle will depress the head and neck.

The muscles of the neck are all in pairs. One of them is found on each side of the neck, and the office which has been attributed to them can only be accomplished when both act together; but supposing that one alone of the elevating muscles should act, the head would be raised, but it would at the same time be turned towards that side. If one only of the depressor muscles were to act, the head would be bent downwards, but it would likewise be turned towards that side. Then it will be easily seen that by this simple method of having the muscles in pairs, provision is made for every kind of motion, upwards, downwards, or on either side, for which the animal can possibly have occasion. Little more of a practical nature could be said of the muscles of the neck, although they are proper and interesting studies for the anatomist.

This is the proper place to speak of *the mane*, that long hair which covers the crest of the neck, and adds so much to the beauty of the animal. This, however, is not its only praise. In a wild state the horse has many battles to fight, and his neck deprived of the mane would be a vulnerable part. The hair of the mane, the tail, and the legs, is not shed in the same manner as that on the body. It does not fall so regularly nor so often; for if all were shed at once, the parts would be left for a long time defenceless.

The mane is generally dressed so as to lie on the right side—some persons divide it equally on both sides. For ponies it used to be cut off near the roots; only a few stumps being left to stand perpendicularly. This was termed the hog-mane. The groom sometimes bestows a great deal of pains in getting the mane of his horse into good and fashionable order. It is wetted, plaited, and loaded with lead; and every hair that is a little too long is pulled out. The mane and tail of the heavy draught-horse are seldom thin, but on the well-bred horse the thin and well-arranged mane is ornamental.

#### THE BLOOD-VESSELS OF THE NECK

Running down the under part of the neck are the principal blood-vessels going to and returning from the head, with windpipe and gullet. The external arteries are the *carotid*, of which there are two. They ascend the neck on either side, close to the windpipe, until they have reached the middle of the neck, where they somewhat diverge, and lie more deeply. They are covered by the sterno-maxillaris muscle, which has been just described, and are separated from the jugulars by a small portion of

muscular substance. Having reached the larynx, they divide into three branches, the external, the internal, and the ramus anastomaticus; the first goes to every part of the face, the second to the brain, and the third to join the vertebral artery.

The vertebral arteries run through canals in the bones of the neck, with the exception of the seventh, supplying the neighbouring parts as they advance, and at length form the junction before stated with the third branch of the carotid, and ramify on and supply the brain.

Few cases can happen in which it would be either necessary or justifiable to bleed from an artery. Even in mad-staggers the bleeding is more practicable, safer, and more effectual, from the jugular vein than from the temporal or any other artery. If an artery is opened in the direction in which it runs, there is sometimes very great difficulty in stopping the bleeding; it has even been necessary to tie the vessel in order to accomplish this purpose. If the artery is cut across, its coats are so elastic that the two ends are often immediately drawn apart under the flesh at each side, and are thereby closed; and after the first gush of blood no more can be obtained.

#### THE VEINS OF THE NECK.

The external veins which return the blood from the head to the heart are the jugulars. The horse has but one on either side. The human being and the ox have two. The jugular takes its rise from the base of the skull; it then descends, receiving other branches in its way towards the angle of the jaw and behind the parotid gland; and emerging thence, and being united to a large branch from the face, it takes its course down the neck. Veterinary surgeons and horsemen have agreed to adopt the jugular, a little way below the union of these two branches, as the usual place for bleeding; and a very convenient one it is, for it is easily got at, and the vessel is large. The manner of bleeding, and the states of constitution and disease in which it is proper, will be hereafter spoken of.

#### POLL-EVIL.

From the horse rubbing and sometimes striking his poll against the lower edge of the manger, or hanging back in the stall and bruising the part with the halter,—or from the frequent and painful stretching of the ligaments and muscles by unnecessary tight reining, and, occasionally, from a violent blow on the poll, carelessly or wantonly inflicted, inflammation ensues, and a swelling appears, hot, tender, and painful. It used to be a disease of frequent occurrence, but it is now, from better treatment of the animal, of comparatively rare occurrence.

It has just been stated that the ligament of the neck passes over the atlas, or first bone, without being attached to it, and the seat of inflammation is between the ligament and the bone beneath; and being thus deeply situated, it is serious in its nature and difficult of treatment.

Another cause, especially amongst cart-horses, is the injury inflicted to the poll by forcing a small collar over the animal's head. To these also may be added hereditary predisposition. Many instances are on record of the stock from parents suffering from poll-evil becoming affected with the same disease.

The first thing to be attempted is to abate the inflammation by bleeding, physic, and the application of cold lotions to the part. In a very early period of the case, a blister might have considerable effect. Strong purgatives should also be employed. By these means the tumour will sometimes be dispersed. This system, however, must not be pursued too far. If the swelling increases, and the heat and tenderness likewise increase, matter

will form in the tumour; and then our object should be to hasten its formation by warm fomentations, poultices, or stimulating embrocations. As soon as the matter is formed, which may be known by the softness of the tumour, and before it has time to spread around and extend into the neighbouring parts, it should be evacuated. Now comes the whole art of treating poll-evil; *the opening into the tumour must be so contrived that all the matter shall run out*, and continue afterwards to run out as quickly as it is formed, and not collect at the bottom of the ulcer, irritating and corroding it. This can be effected by a seton alone. The needle should enter at the top of the tumour, penetrate through its bottom, and be brought out at the side of the neck, a little below the abscess. Without anything more than this, except frequent fomentation with warm water, in order to keep the part clean, and to obviate inflammation, poll-evil in its early stage will frequently be cured.

If the ulcer has deepened and spread, and threatens to eat into the ligaments of the joints of the neck, it may be necessary to stimulate its surface, and perhaps painfully so, in order to bring it to a healthy state, and dispose it to fill up. In extreme cases, some highly stimulating application may be employed, but not the scalding mixture of the farriers of the olden time. All measures, however, will be ineffectual, unless the pus or matter is, by the use of setons, or by a free and extensive incision, perfectly evacuated. The application of these setons or the making the incision will require the skill and anatomical knowledge of the veterinary surgeon. In desperate cases, the wound may not be fairly exposed to the action of the caustic without the division of the ligament of the neck. This may be effected with perfect safety; for although the ligament is carried on to the occipital bone, and some strength is gained by this prolongation of it, the main stress is on the second bone, and the head will continue to be supported. The divided ligament, also, will soon unite again, and its former usefulness will be restored when the wound is healed.

#### INFLAMMATION OF THE VEIN.

It is usual and proper, after bleeding, to bring the edges of the wound carefully together, and to hold them in contact by inserting a pin through the skin, with a little tow twisted round it. In ninety-nine cases out of a hundred the wound quickly heals, and gives no trouble; but in a few instances, from using a blunt instrument, or a dirty or rusty one; or striking too hard and bruising the vein; or, in the act of pinning up, pulling the skin too far from the neck and suffering some blood to insinuate itself into the cellular texture; or neglecting to tie the horse up for a little while, and thus enabling him to rub the bleeding place against the manger and tear out the pin; or from the animal being worked immediately afterwards; or the reins of the bridle rubbing against it; or several blows having been clumsily given, and a large and ragged wound made; or from some disposition to inflammation about the horse (for the bleeder is not always in fault), the wound does not heal, or, if it closes for a little while, it re-opens. A slight bleeding appears—some tumefaction commences—the edges of the orifice separate, and become swollen and red—a discharge of sanious bloody fluid proceeds from the wound, followed, perhaps, in a few days, by purulent matter. The neck swells, and is hot and tender both above and below the incision. The lips of the wound become everted—the swelling increases, particularly above the wound, where the vein is most hard and cordy—the horse begins to loathe his food, and little abscesses form round the orifice. The cordiness of the vein rapidly increases. Not only the vein itself has become obstructed and its

coats thickened, but the cellular tissue inflamed and hardened, and is an additional source of irritation and torture.

Human surgeons say that inflammation of a vein spreads *towards* the heart. In the horse, and we will venture to say in every animal, it spreads in the direction in which the coagulation is formed, and that in the jugular must be upward, although *from* the heart. In the veins of the arm and leg it will likewise spread upward, and then *towards* the heart, because the coagulation takes place in that direction.

The two grand questions here are, the cause and the cure. The first would seem to admit of an easy reply. A long list of circumstances has been just given which would seem to refer the matter entirely to the operator; yet, on the other hand, experience tells us that he has little to do with these morbid effects of bleeding. Mr. Percivall states, that Mr. Cherry tried several times to produce inflammation by the use of rusty lancets, and escharotics of various kinds, and ligatures, and frequent separation and friction of the granulating edges, but in vain. Professor Spooner tried to produce the disease, but could not.

On the other hand, it is well known, that while inflammation rarely or never follows the operation of bleeding by some practitioners, others are continually getting into scrapes about it. The writer of this work had three house-pupils, two of whom he used to trust to bleed his patients, and no untoward circumstance ever occurred; but as surely as he sent the third, he had an inflamed vein to take care of.

There is something yet undivulged in the process of healing the vein, or in the circumstances by which that healing is prevented. The most powerful causes probably are, that the lips of the wound have not been brought into immediate apposition, or that a portion of the hair—a single hair is sufficient—has insinuated itself. The horse has not, perhaps, had his head tied up to the rack after bleeding, which should always be done for at least an hour, during which time the extravasated blood will become firmly coagulated, and the flow of blood to the heart will establish its uninterrupted course. It is also probable that atmospheric agency may be concerned in the affair, or a diseased condition of the horse, and particularly a susceptibility of taking an inflammatory action, although the exciting cause may be exceedingly slight.

Of the means of cure it is difficult to speak confidently. The wound should be carefully examined—the divided edges brought into exact apposition, and any hair interposed between them removed—the pin withdrawn—the part carefully and long sponged with cold water, repeated at short intervals day and night—the head should be kept steadied by being tied short to the rack, and cold slop diet alone allowed; the effect of the cold water will be aided by the addition of spirits of wine, which will increase the evaporation, and the application of ice itself, if obtainable, is very desirable. In six-and-thirty hours, should not the appearance of the wound have improved, should not the very circumscribed swelling around it have subsided, apply a blister, the size of a crown, immediately over the wound; the prompt use of this remedy will in very many instances cut short the disease.

If two or three days have passed and the discharge still remains, the application of the budding iron—not too large or too hot—may produce engorgement of the neighbouring parts, and union of the lips of the wound. This should be daily, or every second day, repeated, according to circumstances. The blister may be repeated over the orifice, and should not the lips of the incision be united, a solution of the sulphate of zinc or sulphate of copper may be injected twice a day: this is the mode of treatment the veterinary surgeon consulted would most probably adopt. ‘Sometimes,’

says Mr. Cartwright, in the fourth volume of the abstracts of the Veterinary Medical Association, 'when the vein is in an ulcerative state I have laid it open, and applied caustic dressing, and it has healed up. I have lately had a case in which five or six abscesses had formed above the original wound, and the two superior ones burst through the parotid gland, the extent of the ulceration being evident in the quantity of saliva that flowed through each orifice.'

But another very serious result of an inflamed vein is one but rarely noticed, and to which too little attention has been paid, but which when it does occur is of a sufficiently alarming character; this is secondary hæmorrhage—the ulcerative process has extended to the vein itself, and a most profuse bleeding ensues. Pressure by any means, with considerable elevation of the head, is the only immediate check, until the arrival of the veterinary surgeon, when the application of a ligature round the vein *above* the orifice constitutes the permanent cure. In four cases, in our country practice, this operation perfectly succeeded.

The owner of the horse will find it his interest to apply to a veterinary practitioner as soon as a case of inflamed vein occurs.

Should the vein be destroyed, the horse will not be irreparably injured, and perhaps, at no great distance of time, scarcely injured at all; for nature is ingenious in making provision to carry on the circulation of the blood. All the vessels conveying the blood from the heart to the different parts of the frame, or bringing it back again to the heart, communicate with each other by so many channels, and in such various ways, that it is impossible by the closure or loss of any one of them long materially to impede the flow of the vital current. If the jugular is destroyed, the blood will circulate through other vessels almost as freely as before; but the horse could not be considered as sound, for he might not be equal to the whole of the work required of him.

---

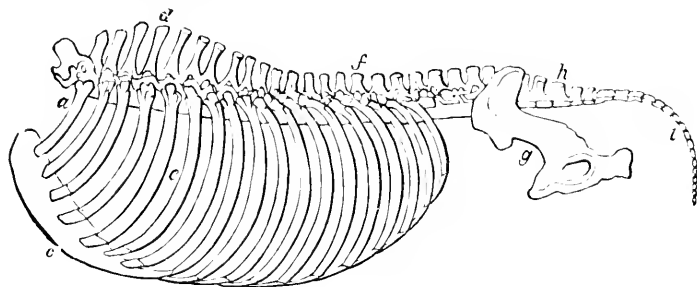
## CHAPTER XII.

### THE CHEST.

THE CHEST, in the horizontal position in which it is placed in the cut, is of a somewhat oval figure, with its extremities truncated. The spine is its roof; the sternum, or breast, its floor; the ribs, its sides; the trachea, œsophagus, and great blood-vessels passing through its anterior extremity and the diaphragm, being its posterior. It is contracted in front, broad and deep towards the central boundary, and again contracted posteriorly. It encloses the heart and the lungs, the origin of the arterial, and the termination of the venous trunks and the collected vessels of the absorbents. The windpipe penetrates into it, and the œsophagus traverses its whole extent.

A cavity whose contents are thus important should be securely defended. The roof is not composed of one unyielding prolongation of bone, which might possibly have been strong enough, yet would have subjected it to a thousand rude and dangerous shocks; but there is a curiously-contrived series of bones, knit together by strong ligaments and dense fibro-cartilaginous substance, forming so many joints, each possessed but of little individual motion, but the whole united and constituting a column of such exquisitely-contrived flexibility and strength, that all concussion is avoided, and no external violence or weight can injure that which it protects. It is supported chiefly by the anterior extremities, and beautiful are the

contrivances adopted to prevent injurious connection. There is no inflexible bony union between the shoulders and the chest; but while the spine is formed to neutralise much of the concussion that might be received—while the elastic connections between the vertebrae of the back, alternately affording a yielding resistance to the shock, and regaining their natural situation when the external force is removed, go far, by this playful motion, to render harmless the rudest motion—there is a provision made by the attachment of the shoulder-blade to the chest calculated to prevent the possibility of any rude concussion reaching the thorax. ‘Had,’ says Mr.



- a The first rib.
- b The cartilages of the ten hindermost, or *false ribs*, connected together, and uniting with that of the eighth or last *true rib*.
- c The breast-bone.
- d The top, or point, of the withers, which are formed by the lengthened spinous, or upright processes of the ten or eleven first bones of the back. The bones of the back are eighteen in number.
- e The ribs, usually eighteen on each side; the eight first united to the breast-bone by cartilage; the cartilages of the remaining ten united to each other as at *b*.
- f That portion of the spine where the loins commence, and composed of five bones.
- g The bones forming the hip, or haunch, and into the cavity at the bottom of which the head of the thigh-bone is received.
- h The portion of the spine belonging to the haunch, and consisting of five pieces called the sacrum.
- i The bones of the tail, usually thirteen in number.

Percivall in the fifteenth volume of ‘The Veterinarian,’ ‘the entire rib been one solid piece of bone, a violent blow might have broken it to pieces. On the other hand, had the ribs been composed from end to end of cartilage only, the form of the arch could not have been sustained, but, sooner or later it must have bent inward, and so have encroached upon the cavity of the chest as to have compressed the organs of respiration and circulation to that degree that could not but have ended in suffocation and death of the animal. It was only the judicious and well-arranged combination of bone and gristle in the construction of the chest that could answer the ends an all-wise Providence had in view.’

At the shoulder is a muscle of immense strength, with tendinous composition, the *serratus magnus*, spreading over one-third of the internal surface of the shoulder-blade and extending to the four last cervical vertebrae and a portion of the chest. A spring of easier play could not have been attached to the carriage of any invalid. It is a carriage hung by springs between the scapulae, and a delightful one it is for easy travelling; while there is combined with it, and the union is not a little difficult, strength enough to resist the jolting of the roughest road and the most rapid pace.

Laterally there is sufficient defence against all common injury by the expansion of the shoulder over the chest from between the first and second



to the seventh rib; and behind and below that there is the bony structure of the ribs, of no little strength; and their arched form, although a flattened arch; and the yielding motion at the base of each rib, resulting from its jointed connection with the spine above and its cartilaginous union with the sternum below.

A still more important consideration with regard to the parietes of the thorax is the manner in which they can adapt themselves to the changing bulk of the contents of the cavity. The capacity of the chest is little affected by the external contraction and dilatation of the heart, for when its ventricles are collapsed its auricles are distended, and when its auricles are compressed its ventricles expand; but with regard to the lungs it is a very different affair. In their state of collapse and expansion they vary in comparative bulk, one-sixth part or more, and, in either state, it is necessary for the proper discharge of the function of respiration that the parietes of the chest should be in contact with them.

The ribs are eighteen in number on either side. Eight of them are perfect, and commonly called the *true*, or, more properly, *sternal* ribs, extending from the spine to the sternum. The remaining ten are posterior and shorter, and are only indirectly connected with the sternum.

The ribs are united to the corresponding vertebræ or bones of the spine, so as to form perfect joints—or rather, each rib forms two joints. The head of the rib is received between the vertebræ or bones of the spine, before and behind, so that it shall always present two articulating surfaces, one opposed to the vertebræ immediately before, and the other to that immediately behind, and each forming a distinct joint, with a perfect capsular ligament, and admitting of a rotatory motion. The tubercle of the rib seems to be received into the cartilaginous ligamentous substance between the vertebræ, and is articulated to the transverse process of the posterior vertebræ connected with the head. Nothing could be more admirably devised for motion, so far as it is required, and for strength of union, that can scarcely be broken.

Before the ribs reach the sternum, they terminate in a cartilaginous prolongation, or the lower part of the rib may be said to be cartilaginous; and where it unites with the sternum there is a third joint, with a perfect and complete capsular ligament.

The cartilage of the posterior ribs are also united to the bony portion. They are not, however, prolonged so far as the sternum; but the extremity of one lies upon the body of that which is immediately before it, bound down upon it by a cellular substance approaching to the nature of ligament, yet each having some separate motion, and all of them connected indirectly with the sternum by means of the last sternal rib. It is an admirable contrivance to preserve the requisite motion which must attend every act of breathing, every extension and contraction of the chest, with a degree of strength which scarcely any accident can break through.

*The Sternum*, or breast-bone, is more complicated than it at first appears to be. It constitutes the floor of the chest, and is a long flat spongy bone, fixed between the ribs on either side, articulating with their cartilages, and serving as a point of support to them. It is composed of from seven to nine pieces, united together by cartilage; and whatever changes may take place in other parts of the frame, this cartilage is not converted to bone even in extreme old age, although there may, possibly, be some spots of ossific matter found in it.

The point of the breast-bone may be occasionally injured by blows or by the pressure of the collar. It has been, by brutal violence, completely broken off from the sternum; but oftener, and that from some cruel usage,

a kind of tumour has been formed on the point of it, which has occasionally ulcerated, and proved very difficult to heal.

The front of the chest is a very important consideration in the structure of the horse. It should be prominent and broad, and full, and the sides of it well occupied. When the breast is narrow, the chest has generally the same appearance; the animal is flat-sided, the proper cavity of the chest is less, and the stamina of the horse are materially diminished, although, perhaps, his speed for short distances may not be affected. When the chest is narrow and the fore legs are too close together, in addition to the want of bottom they will interfere with each other, and there will be wounds on the fetlocks and bruises below the knee.

A chest too broad is not desirable, but a fleshy and a prominent one; yet even this, perhaps, may require some explanation. When the fore legs appear to recede and to shelter themselves under the body, there is a faulty position of the fore limbs, a bend or standing over, an unnatural lengthiness about the fore parts of the breast, sadly disadvantageous in progression.

There is also a posterior appendix to the sternum, which is also cartilaginous. It is called the *ensiform* cartilage, although it bears little resemblance to a sword. It is flat and flexible, yet strong, and serves as the commencement of the floor or support of the abdomen. It also gives insertion to some of the abdominal muscles, and more conveniently than it could have been obtained from the body of the sternum.

*The intercostal Muscles.*—The borders of the ribs are anteriorly concave, thin and sharp—posteriorly rounded, and presenting underneath a longitudinal depression or channel, in which run both blood-vessels and nerves. The space between them is occupied by muscular substance firmly attached to the borders of the ribs. These muscles are singularly distributed; their fibres cross each other in the form of an X. There is a manifest advantage in this. If the fibres ran straight across from rib to rib, they might act powerfully, but their actions would be exceedingly limited. A short muscle can contract but a little way, and only a slight change of form or dimension can be produced. By running diagonally from rib to rib, these muscles are double the length they could otherwise have been. It is a general rule with regard to muscular action, that the power of the muscle depends on its bulk, and the extent of its action on its length.

The ribs, while they protect the important viscera of the thorax from injury, are powerful agents, when acted on by the respiratory muscles, in extending and contracting the chest in the alternate inspiration and expiration of air. In what proportion they discharge the labour of respiration is a disputed question, and into the consideration of which we cannot enter until something is known of the grand respiratory muscle, the diaphragm. Thus far, however, may be said, that they are inactive in natural respiration, or they certainly act only a secondary part; but in hurried respiration, and when the demand for arterialised blood is increased by violent exertion, they are valuable and powerful auxiliaries.

This leads to a very important consideration, the most advantageous form of the chest for the proper discharge of the natural or extraordinary functions of the thoracic viscera. The contents of the chest are the lungs and the heart: the first, to render the blood nutrient and stimulating, and to give or restore to it that vitality which will enable it to support every part of the frame in the discharge of its function, and devoid of which the complicated and beautiful machine is inert and dead; and the second, to convey this purified arterialised blood to every part of the frame.

In order to produce and to convey to the various parts a sufficient quantity of blood, these organs must be large. If it amounts not to

hypertrophy, the larger the heart and the larger the lungs, the more rapid the process of nutrition, and the more perfect the discharge of every animal function.

Then it might be imagined that, as a circle is a figure which contains more than any other of equal girth and admeasurement, a circular form of the chest would be most advantageous. Not exactly so; for the contents of the chest are alternately expanding and contracting. The circular chest could not expand, but every change of form would be a diminution of capacity.

That form of chest which approaches nearest to a circle, while it admits of sufficient expansion and contraction, is the best—certainly for some animals, and for all under peculiar circumstances, and with reference to the discharge of certain functions. This was the grand principle on which Mr. Bakewell proceeded, and on which all our improvements in the breeding of cattle were founded.

The principle holds good with regard to some breeds of horses. We value the heavy draught horse not only on account of his simple muscular power, but the weight which, by means of that power, he is able to throw into the collar. A light horse may be preferable for light draught, but we must oppose weight to weight when our loads are heavy. In the dray-horse we prize the circular chest, not only that he may be proportionally heavier before—to him no disadvantage—but that, by means of the increased capacity of his chest, he may obtain the bulk and size which best fit him for our service. But he would not do for speed, he would not do for ordinary quick exertion, and if he were pushed far beyond his pace, he would become broken-winded or have inflamed lungs.

Some of our saddle-horses and cobs have barrels round enough, and we value them on account of it, for they are always in condition and they rarely tire. But when we look at them more carefully, there is just that departure from the circular form of which mention has been made—that happy medium between the circle and the ellipse which retains the capacity of the one and the expansibility of the other. Such a horse is invaluable for common purposes, but he is seldom a horse of speed. If he is permitted to go his own pace, and that not a slow one, he will work on for ever; but if he is too much hurried he is soon distressed.

*The Broad Deep Chest.*—Then for the usual purposes of the road, and more particularly for rapid progression, search is made for that form of the chest which shall unite, and to as great a degree as possible, considerable capacity in a quiescent state, and the power of increasing that capacity when the animal requires it. There must be the broad chest for the production of muscles and sinews, and the deep chest, to give the capacity or power of furnishing arterial blood equal to the most rapid exhaustion of vitality.

This form of the chest is consistent with lightness, or at least with all the lightness that can be rationally required. The broad-chested horse, or he that, with moderate depth at the girth, swells and barrels out immediately behind the elbow, may have as light a forehead and as elevated a wither as the horse with the narrowest chest; but the animal with the barrel approaching to near to rotundity is invariably heavy about the shoulders and low in the withers. It is to the mixture of the Arabian blood that we principally owe this peculiar and advantageous formation of the chest of the horse. The Arab is light; some would say too much so before; but immediately behind the arms the barrel almost invariably swells out, and leaves plenty of room, and where it is most wanted for the play of the lungs, and at the same time where the weight does not press so exclusively on the fore legs, and expose the feet to concussion and injury.

Many horses with narrow chests, and a great deal of daylight under them, have plenty of spirit and willingness for work. They show themselves off well, and exhibit the address and gratify the vanity of their riders on the parade or in the park, but they have not the appetite nor the endurance that will carry them through three successive days' hard work.

Five out of six of the animals that perish from inflamed lungs are narrow-chested, and it might be safely affirmed that the far greater part of those who are lost in the field after a hard day's run, have been horses whose training has been neglected, or who have no room for the lungs to expand. The most important of all points in the conformation of the horse is here elucidated. An elevated wither, or oblique shoulder, or powerful quarters, are great advantages; but that which is most of all connected with the general health of the animal, and with combined fleetness or bottom, is a deep, and broad, and swelling chest, with sufficient lengthening of the sternum, or breast-bone, beneath.

If a chest that cannot expand with the increasing expansion and labour of the lungs is so serious a detriment to the horse, everything that interferes with the action of the intercostal muscles is carefully to be avoided. Tight girthing ranks among these, and foremost among them. The closeness with which the roller is buckled on in the stable must be a serious inconvenience to the horse; and the partially depriving these muscles of their power of action, for so many hours in every day, must indispose them for labour when quicker and fuller respiration is required. At all events, a tight girth, though an almost necessary nuisance, is a very considerable one, when all the exertion of which he is capable is required from the horse. Who has not perceived the address with which, by bellying out the chest, the old horse renders every attempt to girth him tight comparatively useless; and when a horse is blown, what immediate relief has ungirthing him afforded, by permitting the intercostals to act with greater power?

A point of consequence regarding the capacity of the chest is the length or shortness of the carcase; or the extent of the ribs from the elbow backward. Some horses are what is called *ribbed home*; there is but little space (see cuts pp. 140 and 244) between the last rib and the hip-bone. In others the distance is considerably greater, and is plainly evident by the falling in of the flank. The question then is, what service is required from the horse? If he has to carry a heavy weight, and has much work to do, he should be ribbed home—the last rib and the hip-bone should not be far from each other. There is more capacity of chest and of belly, there is less distance between the points of support, and greater strength and endurance. A hackney (and we would almost say a hunter) can scarcely be too well ribbed home.

If speed, however, is required, there must be room for the full action of the hinder limbs; and this can only exist where there is sufficient space between the last rib and the hip-bone. The owner of the horse must make up his mind as to what he wants from him, and be satisfied if he obtains that; for, let him be assured that he cannot have everything, for this would require those differences of conformation that cannot possibly exist in the same animal.

The thorax, or chest, is formed by the spine *f*, above (p. 244); the ribs *e*, on either side; and the sternum, or breast-bone, *c*, beneath.

## THE SPINE AND BACK.

The spine, or back, consists of a chain of bones from the poll to the extremity of the tail. It is made up of twenty-three bones from the neck to the haunch; eighteen, called *dorsal vertebrae*, composing the back; and five, *lumbar vertebrae*, occupying the loins. On this part of the animal the weight or burden is laid, and there are two things to be principally considered, easiness of carriage and strength. If the back were composed of unyielding materials—if it resembled a bar of wood or iron, such jarring and jolting, in the rapid motion of the animal, could not possibly be endured. In order to avoid this, as well as to assist in turning, the back is divided into numerous bones; and between each pair of bones there is interposed a cartilaginous substance, most highly elastic, that will yield and give way to every jar, not so much as to occasion insecurity between the bones, or to permit considerable motion between any one pair, but forming altogether an aggregate mass of such perfect elasticity that the rider sits almost undisturbed, however high may be the action or however rapid the pace.

Strength is as important as ease; therefore the bones are united together with peculiar firmness. The round head of one is exactly fitted to the cup or cavity of that immediately before it; and between them is placed the elastic ligamentous substance which has been just described, so strong, that in endeavouring to separate the bones of the back they will break before this substance will give way. In addition to this there are ligaments running along the broad under-surface of these bones—ligaments between each of the *transverse* processes, or side projections of the bones—ligaments between the *spinous* processes or upright projections, and also a continuation of the strong ligament of the neck running along the whole course of the back and loins, lengthening and contracting, as in the neck, with the motions of the animal, and forming a powerful bond of union between the bones.

By these means the hunter will carry a heavy man without fatigue or strain through a long chase; and those shocks and jars are avoided which would be annoying to the rider and injurious and speedily fatal to the horse.

These provisions, however, although adequate to common or even severe exertion, will not protect the animal from the consequences of brutal usage; and, therefore, if the horse is much overweighted, or violently exercised or too suddenly pulled upon his haunches, these ligaments are strained. Inflammation follows. The ligaments become changed to bone, and the joints of the back lose their springiness and ease of motion; or rather, in point of fact, they cease to exist. On account of the too hard service required from them, and especially before they had gained their full strength, there are few old horses who have not some of the bones of the back or loins *anchylosed*—united together by bony matter and not by ligament. When this exists to any considerable extent the horse is not pleasant to ride; he turns with difficulty in his stall, he is unwilling to lie down, and when down to rise again, and he has a singular straddling action. Such horses are said to be *broken-backed* or *chinked in the back*.

The length of the back is an important consideration. A long-backed horse will be easy in his paces, because the increased distance between the fore and hind legs, which are the supports of the spine, will afford greater room for the play of the joints of the back. A long spring has much more play than a short one, and will better obviate concussion. A long-backed horse is likewise formed for speed, for there is room to bring his hinder legs more under him in the act of galloping, and thus more powerfully propel

or drive forward the body: but, on the other hand, a long-backed horse will be comparatively weak in the back, and easily overweighted. A long spring may be easily bent or broken. The weight of the rider, likewise, placed farther from the extremities, will act with mechanical disadvantage upon them, and be more likely to strain them. A short-backed horse may be a good hackney, and able to carry the heaviest weight, and possess more endurance; but his paces will not be so easy, nor his speed so great, and he may be apt to overreach.

The comparative advantage of a long or short carcase depends entirely on the use for which the horse is intended. For general purposes the horse with a short carcase is very properly preferred. He will possess health and strength; for horses of this make are proverbially hardy. He will have sufficient easiness of action not to fatigue the rider, and speed for every ordinary purpose. Length of back will always be desirable when there is more than usual substance generally, and particularly when the loins are wide and the muscles of the loins large and swelling. The two requisites, strength and speed, will then probably be united.

The back should be depressed a little immediately behind the withers; and then continue in an almost straight line to the loins. This is the form most consistent with beauty and strength. Some horses have a very considerable hollow behind the withers. They are said to be *saddle-backed*. It seems as if a depression were purposely made for the saddle. Such horses are evidently easy goers, for this curve inward must necessarily increase the play of the joints of the back; but in the same proportion they are weak and liable to sprain. To the general appearance of the horse, this defect is not in any great degree injurious; for the hollow of the back is uniformly accompanied by a beautifully arched crest.

A few horses have the curve outward. They are said to be *roach-backed*, from the supposed resemblance to the arched back of the roach. This is a very serious defect; altogether incompatible with beauty, and materially diminishing the usefulness of the animal. It is almost impossible to prevent the saddle from being thrown on the shoulders, or the back from being galled; the elasticity of the spine is destroyed; the rump is badly set on; the hinder legs are too much under the animal; he is continually overreaching, and his head is carried awkwardly low.

#### THE LOINS.

The loins are attentively examined by every good horseman. They can scarcely be too broad and muscular. The strength of the back, and, especially, the strength of the hinder extremities, will depend materially on this. The breadth of the loins is regulated by the length of the transverse or side processes of that part. The bodies of the bones of the loins are likewise larger than those of the back; and a more dove-tailed kind of union subsists between these bones than between those of the back. Every provision is made for strength here. The union of the back and loins should be carefully observed, for there is sometimes a depression between them. A kind of line is drawn across, which shows imperfection in the construction of the spine, and is regarded as an indication of weakness.

#### THE WITHERS.

The spinous or upright processes of the dorsal vertebra, or bones of the back, above the upper part of the shoulder, are as remarkable for their length as are the transverse or side processes of the bones of the loins. They are flattened and terminated by rough blunted extremities. The elevated ridge which they form is called the *withers*. It will be seen in the cuts (pp. 140 and 244), that the spine of the first bone of the back has

but little elevation and is sharp and upright. The second is longer and inclined backward; the third and fourth increase in length, and the fifth is the longest; they then gradually shorten until the twelfth or thirteenth, which becomes level with the bones of the loins.

High withers have been always, in the mind of the judge of the horse, associated with good action, and generally with speed. The reason is plain enough: they afford larger surface for the attachment of the muscles of the back; and in proportion to the elevation of the withers, these muscles act with greater advantage. The rising of the foreparts of the horse, even in the trot, and more especially in the gallop, depends not merely on the action of the muscles of the legs and shoulders, but on those of the loins, inserted into the spinous processes of these bones of the back, and acting with greater power in proportion as these processes, constituting the withers, are lengthened. The arm of the lever to which the power is applied will be longer; and in proportion to the length of this arm will be the ease and the height to which a weight is raised. Therefore good and high action will depend much on elevated withers.

It is not difficult to understand how speed will likewise be promoted by the same conformation. The power of the horse is in his hinder-quarters. In them lies the mainspring of the frame, and the fore-quarters are chiefly elevated and thrown forward to receive the weight forced on them by the action of the hinder-quarters. In proportion, however, as the fore-quarters are elevated, will they be thrown farther forward, or, in other words, will the stride of the horse be lengthened. Yet many racers have the forehead low. The unrivalled Eclipse (see p. 69) was a remarkable instance of this; but the ample and finely-proportioned quarters, and the muscularity of the thigh and fore-arm, rendered the aid to be derived from the withers perfectly unnecessary. The heavy draught-horse does not require elevated withers. His utility depends on the power of depressing his fore-quarters, and throwing their weight fully into the collar; but for common work in the hackney, in the farmer's horse, and in the hunter, well-formed withers will be an essential advantage, as contributing to good and safe action, and likewise to speed.

#### MUSCLES OF THE BREAST.

There are some important muscles attached to the breast connected with that expansion of the chest which every horse should possess. In the cut, page 237, are seen a very important pair of muscles, the *pectorales transversi*, or pectoral muscles, forming two prominences in the front of the chest, and extending backward between the legs. They come from the fore and upper part of the breast-bone; pass across the inward part of the arm, and reach from the elbow almost down to the knee. They confine the arm to the side in the rapid motion of the horse, and prevent him from being, what horsemen would call, and what is seen in a horse pushed beyond his natural power, 'all abroad.' Other muscles, *pectorales magni et parvi*, the great and little pectorals, rather above but behind these, go from the breast-bone to the arm, in order to draw back the point of the shoulder, and bring it upright. Another and smaller muscle goes from the breast-bone to the shoulder, to assist in the same office. A horse, therefore, thin and narrow in the breast, must be deficient in important muscular power.

Between the legs and along the breast-bone is the proper place in which to insert rowels, in cases of inflamed lungs.

## MUSCLES OF THE BACK.

The most important muscles which belong to this part of the frame are principally those which extend from the continuation of the ligament of the neck, along the whole of the back and loins; and likewise from the last cervical bone;—the *superficialis* and *transversalis costarum*, or superficial and transverse muscles of the ribs, going from this ligament to the upper part of the ribs to elevate them, and to assist in the expansion of the chest—also the large mass of muscle, the *longissimus dorsi*, or longest muscle of the back, from the spinous and transverse processes of the vertebrae to the ribs, and by which all the motions of the spine, and back, and loins, to which allusion has been made, are principally produced; by which the fore-quarters are raised upon the hind ones, or the hind upon the fore ones, according as either of them is the fixed point. This is the principal agent in rearing and kicking.

The last muscle to be noticed is the *spinalis dorsi*, the spinal muscle of the back, from the spinous processes of some of the last bones of the back to those of the fore-part; thick and strong about the withers, and broadly attached to them; and more powerfully attached, and more strongly acting, in proportion to the elevation of the withers; and proceeding on to the three lowest bones of the neck, and therefore mainly concerned, as already described, in elevating the fore-quarters, and producing high and safe action, and contributing to speed.

## FISTULOUS WITHERS.

When the saddle has been suffered to press long upon the withers, a tumour will be formed, hot and exceedingly tender. It may sometimes be dispersed by the cooling applications recommended in the treatment of poll-evil; but if, in despite of these, the swelling should remain stationary, and especially if it should become larger and more tender, warm fomentations and poultices, and stimulating embrocations, should be diligently applied, in order to hasten the formation of pus. As soon as that can be fairly detected, a seton should be passed from the top to the bottom of the tumour, so that the whole of the matter may be evacuated, and continued to be discharged as it is afterwards formed; or the knife may be freely used, in order to get at the bottom of every sinus. The knife has succeeded many a time when the seton has failed. The after treatment must be precisely that which was recommended for a similar disease in the poll.

In neglected fistulous withers the ulcer may be larger and deeper, and more destructive than in poll-evil. It may burrow beneath the shoulder-blade, and the pus appear at the point of the shoulder or the elbow; or the bones of the withers may become carious.

Very great improvement has taken place in the construction of saddles for common use and in the cavalry service. Certain rules have now been laid down from which the saddler should never deviate, and attending to which the animal is saved from much suffering, and the mechanic from deserved disgrace.

The first rule in the fitting of a saddle is, that it should bear upon the back, and not on the spine or the withers, for these are parts that will not endure pressure.

Next in universal application is the understanding that the saddle should have everywhere an equal bearing, neither tilting forward upon the points nor backward upon the seat.

When the saddle is on, and the girths fastened, there should remain space sufficient between the withers and the pommel for the introduction of the hand underneath the latter.



The *points* of the tree should clip or embrace the sides without pinching them, or so standing outward that the pressure is all downwards, and upon one place, instead of being in a direction inwards as well as downwards, so as to be distributed uniformly over every part of the point that touches the side. Horses that have low and thick withers are most likely to have them injured, in consequence of the continual riding forward of the saddle, and its consequent pressure upon them. Fleehy and fat shoulders and sides are also subject to become hurt by the points of the trees either pinching them from being too narrow in the arch, or from the bearing being directly downward upon them.

Injury occasionally results from the interruption which a too forward saddle presents to the working or motion of the shoulder, and the consequent friction the soft parts sustain between the shoulder-blade inwardly and the points of the saddle-tree outwardly.

#### SITFASTS, AND SADDLE GALLS.

On other parts of the back tumours and very troublesome ulcers may be produced by the same cause. Those resulting from the pressure of the saddle are called *saddle galls*, and, when they ulcerate, they frequently become *sitfasts*. Saddle galls are small circular bruises, or extravasations of blood, where there has been an undue pressure of the saddle or harness. If a horse is subject to these tumours, the saddle should remain on him two or three hours after he has returned to the stable. It is only for a certain time, however, that this will perfectly succeed, for by the frequent application of the pressure the skin and the cellular substance are bruised or otherwise injured, and a permanent sore or tumour, of a very annoying description, takes place. The centre of the sore gradually loses its vitality. A separation takes place from the surrounding integument, and there is a circular piece of dried and hard skin remaining in the centre; by removing this with the knife, more is done in a few minutes than days will effect in the old routine of poulticing and blistering; and the wound will readily heal by the use of turpentine dressings, more or less stimulating, according to circumstances.

With regard, however, to all these tumours and excoriations, the humane man will have the saddle eased and padded as soon as it begins to be of the least inconvenience to the horse.

#### DROPSY OF THE SKIN OF THE CHEST.

Dropsical swellings often appear between the fore legs and on the chest. They are effusions of fluid underneath the skin. They accompany various diseases, particularly when the animal is weakened by them, and sometimes appear when there is no other disease than the debility, which, in the spring and fall of the year, accompanies the changing of the coat. The treatment will vary with the cause of the affection or the accompanying disease. Small punctures with the lancet will seldom do harm; friction of the part, if it can be borne, will be serviceable; mild exercise should be used; diuretics given, mixed with some cordial, as carrots, malt mashes, and occasionally a very mild dose of physic, and that followed by tonics and cordials, with diuretics. The vegetable tonics, as gentian and columbo with ginger, will be most effectual.

---

## CHAPTER XIII.

## THE ANATOMY AND DISEASES OF THE RESPIRATORY ORGANS.

HAVING in the previous chapter given a brief outline of the external formation of the chest, and surrounding parts, we now proceed to a description of its contents, and the organs directly connected with the functions of respiration.

## THE DIAPHRAGM.

Bounding the thorax posteriorly—the base of the cone in the human subject—the interposed curtain between the thorax and the abdomen in the horse, is the diaphragm. It is an irregular muscular expansion, proceeding from the inferior surface of the lumbar vertebræ posteriorly and superiorly, adhering to the ribs and cartilages on either side, and extending obliquely forward and downward to the sternum; or, rather it is a flattened muscle arising from all these points, with its fibres all converging towards the centre, and terminating there in an expansion of tendinous substance. It is lined anteriorly by the pleura or investing membrane of the thoracic cavity, and posteriorly by the peritoneum or investing membrane of the abdominal cavity.

*Anatomy of the Diaphragm.*—In the short account which it is proposed to give of the structure of the diaphragm, the description of Mr. Percivall will be closely followed. ‘The diaphragm may be divided into the main circular muscle, with its central tendinous expansion forming the lower part, and two *appendices*, or *crura*, as they are called, from their peculiar shape, constituting its superior portion. The fleshy origin of the grand muscle may be traced laterally and inferiorly, commencing from the cartilage of the eighth rib anteriorly, and closely following the union of the posterior ribs with their cartilages; excepting, however, the two last. The attachment is peculiarly strong; it digitates with the transverse muscle of the abdomen, and encircles the whole of the lateral and inferior part of the chest, as far as the sternum, where it is connected with the ensiform cartilage. Immediately under the loins are the *appendices* of the diaphragm, commencing on the right side, from the inferior surfaces of the five lumbar vertebræ, by strong tendons, which soon become muscular, and form a kind of pillar; and on the left, proceeding from the two first lumbar vertebræ only, and from the sides rather than the bodies of these vertebræ, and these also unite and form a shorter pillar, or leg. The left crus, or appendix, is shorter than the right, that it may be more out of the way of pressure from the left curvature of the stomach, which, with the spleen, lies underneath. Opposite to the seventeenth dorsal vertebræ these two pillars unite and form a thick mass of muscles, detached from the vertebræ, and leaving a kind of pouch between them and the vertebræ. They not only unite, but they decussate; their fibres mingle and again separate from each other, and then proceed onward to the central tendinous expansion towards which the fibres from the circular muscle, and the appendices, all converge.’

This muscle, so important in its office, is plentifully supplied with blood-vessels. As the posterior aorta passes beneath the crura of the diaphragm, it gives out sometimes a single vessel which soon bifurcates; sometimes two branches, which speedily plunge into the appendices or crura, while numerous small vessels, escaping from them, spread over the central tendinous expansion. As the larger muscle of the diaphragm springs from the sides and the base of the chest, it receives many ramifications from the

internal pectoral, derived from the anterior aorta; but more from the posterior intercostals which spring from the posterior aorta.

The veins of the diaphragm belong exclusively to the posterior vena cava. There are usually three on either side; but they may be best referred to two chief trunks which come from the circumference of the diaphragm, converge towards the centre, and run into the posterior cava as it passes through the tendinous expansion.

The functional nerve of the diaphragm, or that from which it derives its principal action, and which constitutes it a muscle of respiration, is the phrenic or diaphragmatic. Although it does not proceed from that portion of the medulla oblongata which gives rise to the glosso-pharyngeus and the par vagum, yet there is sufficient to induce us to suspect that it arises from, and should be referred to, the lateral column between the superior and inferior, the sensitive and motor nerves, and which may be evidently traced from the pons varolii to the very termination of the spinal chord.

The diaphragm is the main agent in the work of respiration. The other muscles are mere auxiliaries, little needed in ordinary breathing, but affording the most important assistance, when the breathing is more than usually hurried. The mechanism of respiration may be thus explained:—Let it be supposed that the lungs are in a quiescent state. The act of expiration has been performed, and all is still. From some cause enveloped in mystery—connected with the will, but independent of it—some stimulus of an unexplained and unknown kind—the phrenic nerve acts on the diaphragm, and that muscle contracts; and, by contracting, its convexity into the chest is diminished, and the cavity of the chest is enlarged. At the same time, and by some consentaneous influence, the intercostal muscles act; with no great force, indeed, in undisturbed breathing; but, in proportion as they act, the ribs rotate on their axes, their edges are thrown outward, and thus a twofold effect ensues; the posterior margin of the chest is expanded, the cavity is plainly enlarged, and also, by the partial rotation of every rib, the cavity is still more increased.

By some other consentaneous influence, the spinal accessory nerve likewise exerts its power, and the sterno-maxillaris muscle is stimulated by the anterior division of it, and the motion of the head and neck corresponds with and assists that of the chest; while the posterior division of the accessory nerve, by its anastomoses with the motor nerves of the levator humeri and the splenius, and many other of the muscles of the neck and the shoulder, and by its direct influence on the rhomboideus, associates almost every muscle of the neck, the shoulder, and the chest, in the expansion of the thorax. These latter are muscles which, in undisturbed respiration, the animal scarcely needs; but which are necessary to him when the respiration is much disturbed, and to obtain the aid of which he will, under pneumonia, obstinately stand until he falls exhausted or to die.

The cavity of the chest is now enlarged. But this is a closed cavity, and between its contents and the parietes of the chest a vacuum would be formed; or rather an inequality of atmospheric pressure is produced from the moment the chest begins to dilate. As the diaphragm recedes, there is nothing to counterbalance the pressure of the atmospheric air communicating with the lungs through the medium of the nostrils, and it is forced into the respiratory tubes already described, and the lungs are expanded and still kept in contact with the receding walls of the chest. There is no sucking, no inhalent power in the act of inspiration; it is the simple enlargement of the chest from the entrance and pressure of the air.

From some cause, as inexplicable as that which produced the expansion of the chest, the respiratory nerves cease to act; and the diaphragm, by the inherent elasticity of its tendinous expansion and muscular fibres, re-

turns to its natural form, once more projecting its convexity into the thorax. The abdominal muscles, also, which had been put on the stretch by the forcing of the viscera into the posterior part of the abdomen, by means of the straightening of the diaphragm, contract and accelerate the return of that muscle to its quiescent figure; and the ribs, all armed with elastic cartilages, regain their former situation and figure. The muscles of the shoulder and the chest relax, a portion of the lungs are pressed on every side, and the air with which they were distended is again forced out. There is only one set of muscles actively employed in expiration, namely, the abdominal; the elasticity of the parts displaced in inspiration being almost sufficient to accomplish the purpose.

The lungs, however, are not altogether passive. The bronchial tubes, so far as they can be traced, are lined with cartilage, divided and subdivided for the purpose of folding up when the lungs are compressed, but elastic enough to afford a yielding resistance against both unusual expansion and contraction. In their usual state the air-tubes are distended beyond their natural calibre; for if the parietes of the thorax are perforated, and the pressure of the atmosphere rendered equal within and without them, the lungs immediately collapse.

#### THE MEMBRANE OF THE NOSE.

The mucous membrane of the nose is distinguished from other mucous surfaces, not only by its thickness, but its vascularity. The blood-vessels are likewise superficial; they are not covered even by integument, but merely by a mucous coat. They are deeper seated, indeed, than in the human being, and they are more protected from injury; and therefore there is far less hæmorrhage from the nostril of the horse than from that of the human being, whether spontaneous or accidental. Lying immediately under the mucous coat, these vessels give a peculiar, and, to the horseman, a most important tinge to the membrane, and particularly observable on the septum. They present him with a faithful indication of the state of the circulation, and especially in the membranes of the other respiratory passages with which this is continuous.

The horseman and the veterinary surgeon do not possess many of the auxiliaries of the human practitioner. Their patients are dumb; they can neither tell the seat nor the degree of pain; and the blunders of the practitioner are frequently buried with the patient. Well, he must use greater diligence in availing himself of the advantages he does possess; and he has some, and very important ones too. The varying hue of the Schneiderian membrane is the most important of all; and, with regard to the most frequent and fatal diseases of the horse—those of the respiratory passages—it gives almost all the information with regard to the state of the circulation in those parts that can possibly be required. Veterinarians too generally overlook this. It has not yet been sufficiently taught in our schools, or inculcated in our best works on the pathology of the horse.

It is the custom with almost every horseman who takes any pains to ascertain the state of his patient to turn down the lower eye-lid, and to form his opinion of the degree of general inflammation by the colour which the lining membrane of the lid presents. If it is very red, he concludes that there is considerable fever; if it is of a pale pinkish hue, there is comparatively little danger. This is a very important examination, and the conclusion which he draws from it is generally true; but on the septum of the nose he has a membrane more immediately continuous with those of the respiratory organs, more easily got at, presenting a larger surface, the ramifications of the blood-vessels better seen, and what is truly important, indicating not only the general affection of the membranes, but of those with which he is most of all concerned.

We would, then, say to every horseman and practitioner, study the character of that portion of the membrane which covers the lower part of the membrane of the nose—that which you can most readily bring into view. Day after day, and under all the varying circumstances of health and disease, study it until you are enabled to recognise, and you soon will, and that with a degree of exactitude you would have scarcely thought possible, the pale pink line when the horse is in health—the increasing blush of red, and the general and uniform painting of the membrane, betokening some excitement of the system—the streaked appearance when inflammation is threatening or commencing—the intensely florid red of inflammation becoming acute—the starting of the vessels from their gossamer coat, and their seeming to run bare over the membrane, when the inflammation is at the highest—the pale ground with patches of vivid red, showing the half-subdued but still existing fever—the uniform colour, but somewhat redder than natural, indicating a return to a healthy state of the circulation—the paleness approaching to white, accompanying a state of debility, and yet some radiations of crimson, showing that there is still considerable irritability, and that mischief may be in the wind—the pale livid colour, warning you that the disease is assuming a typhoid character—the darker livid, announcing that the typhus is established, and that the vital current is stagnating—and the browner, dirty painting, intermingling with and subduing the lividness, and indicating that the game is up. These appearances will be guides to our opinion and treatment, which we can never too highly appreciate.

#### THE LARYNX

Is placed on the top of the windpipe, immediately below and in contact with the pharynx, and is the inner guard of the lungs if any injurious substance should penetrate so far: it is the main protection against the passage of food into the respiratory tubes, and it is at the same time the instrument of voice. In this last character it loses much of its importance in the quadruped, but still in the dumb animal it is a beautiful piece of mechanism.

THE EPIGLOTTIS is a heart-shaped cartilage, placed at the superior opening into the larynx, with its back opposed to the pharynx, so that when a pellet of food passes from the pharynx in its way to the œsophagus, it presses down the epiglottis, and by this means, as already described, closes the aperture of the larynx, and prevents any portion of the food from entering it. The food having passed over the epiglottis, it, from its own elasticity, and that of the membrane at its base, and more particularly the power of the hyo-epiglottideus muscle, rises again and resumes its former situation.

THE THYROID CARTILAGE occupies almost the whole of the external part of the larynx, both anteriorly and laterally. It envelopes and protects all the rest; a point of considerable importance, considering the injury to which the larynx is exposed, by our system of curbing and tight-reining. It also forms a point of attachment for the insertion of the greater part of the delicate muscles by which the other cartilages are moved. The other cartilages are the cricoid and two arytenoid. The cricoid, or ring-like cartilage, is placed at the base of the thyroid, connecting it with the *trachea* or windpipe: the two arytenoid, or ewer-shaped cartilages, form the upper and back part of the larynx, as the thyroid does the upper front and lateral portion. It is principally supplied with nerves by the laryngeal branches of the par vagum and the recurrent nerves; and there are also frequent anastomoses with the motor nerves of the spinal cord.

The beautiful mechanism of the larynx is governed or worked by a

somewhat complicated system of muscles, for a description of which the reader is referred to the 5th vol. of 'The Veterinarian,' p. 447. The entire process of respiration is partly under the control of the will, and the muscles of the larynx concerned in one stage of it are likewise so, but they also act independently of the will, for during sleep and unconsciousness the machine continues to work.

The origin of the artery which supplies these parts with blood is sometimes derived from the main trunk of the carotid, but oftener it is a branch of the thyroideal artery.

The lining membrane is a continuation of that of the pharynx above and the trachea below. It is covered with innumerable follicular glands, from whose mouths there oozes a mucous fluid that moistens and lubricates its surface. It is possessed of very great sensibility, which is derived from the superior laryngeal nerve, and its function requires it. It is, as has been already stated, the inner guard of the lungs, and the larynx must undergo a multitude of changes of form in order to adapt itself to certain changes in the act of respiration, and in order to produce the voice. The voice of the horse is, however, extremely limited, compared with that of the human being; the same sensibility, therefore, is not required, and exposed as our quadruped slaves are to absurd and barbarous usage, too great sensibility of any part, and particularly of this, would be a curse to the animal.

#### THE TRACHEA, OR WINDPIPE.

The course of the inspired air from the larynx to the lungs is now to be traced, and it will be found to be conveyed through a singularly constructed tube, passing along the anterior portion of the neck, and reaching from the lower edge of the cricoid cartilage to the lungs. In the commencement of its course it is somewhat superficially placed, but as it descends towards the thorax it becomes gradually deeper, and more concealed. In order to discharge its functions as an air-tube, it is essential that it should always be pervious, or, at least, that any obstruction to the process of respiration should be but momentary. Attached to a part endowed with such extensive motion as the neck, it is also necessary that it should be flexible. It is composed of cartilage, an exceedingly elastic substance, and at the same time possessing a certain degree of flexibility.

The windpipe is composed of cartilage, but not of one entire piece, for that would necessarily be either too thick and firm to be flexible, or if it were sufficiently flexible to accommodate itself to the action of the neck, it would be too weak to resist even common pressure or injury, and the passage through it would often be inconveniently or dangerously obstructed. Besides, it is necessary that this tube should occasionally admit of elongation to a considerable degree. When the neck is extended in the act of grazing or otherwise, the trachea must be lengthened.

The structure of the cartilage of the windpipe is admirably adapted to effect every purpose. It is divided into rings, fifty or fifty-two in number, each possessing sufficient thickness and strength to resist ordinary pressure, and each constituting a junction with the one above and below, and thus admitting of all the flexibility that could be required. These rings are connected together by an interposed fibro-ligamentous substance, extensible, elastic, and yet so strong that it is scarcely possible to rupture it; and the fibres of that ligament not running vertically from one to another, and therefore admitting of little more motion than the rotation of the head, but composed of two layers running obliquely, and in contrary directions, so as to adapt themselves to every variety of motion.

These rings are thickest in front, and project circularly, opposing an

archlike form. There, too, the ligament is widest, in order to admit of the greatest motion in the direction in which it is most needed, when the head is elevated or depressed. Laterally these rings are thinner, because they are, to a great degree, protected by the surrounding parts; and, posteriorly, they overlap each other, and the overlapping portions are connected together by a strong ligamentous substance. This, while it does not impede the motion of the tube, gives firmness and stability to it.

Within the trachea is another very curious structure. At the points at which, posteriorly, the rings begin to bend inwardly, a muscle is found stretching across the windpipe, dividing the canal into two unequal portions—the anterior one constituting the proper air-passage, and the posterior one occupied by cellular texture. It is to give additional strength to parts. It is the tie which prevents the arch from spurring out. In the natural state of the windpipe this muscle is, probably, quiescent; but when any considerable pressure is made on the crown of the arch at the upper part by tight-reining, or at the lower end by an ill-made collar, or anywhere by brutal or accidental violence, this muscle contracts, every serious expansion or depression of the arch is prevented, and the part is preserved from serious injury.

It may also be readily imagined that, when in violent exertion, every part of the respiratory canal is on the stretch, this band may preserve the windpipe from injury or laceration. There are many beautiful points in the physiology of the horse which deserve much greater attention than has hitherto been paid to them.

The windpipe should project from the neck. It should almost seem as if it were detached from the neck, for two important reasons: first, that it may easily enter between the channels of the jaw, so that the horse may be reined up without suffering inconvenience; and next, that being more loosely attached to the neck, it may more readily adapt itself to the changes required than if it were enveloped by fat, or muscle to a certain degree unyielding: therefore, in every well-formed neck—and it will be seen in the cut (p. 237)—it is indispensable that the windpipe should be prominent and loose on the neck. This is not required in the heavy cart-horse, and we do not often find it, because he is not so much exposed to those circumstances that will hurry respiration, and require an enlargement in the size of the principal air-tube.

When the trachea arrives at the thorax, it suddenly alters its form, in order to adapt itself to the narrow triangular aperture through which it has to pass. It preserves the same cartilaginous structure; for if it has not the pressure of the external muscles, or of accidental violence, to resist, it is exposed to the pressure of the lungs, when they are inflating, and it shares in the pressure of the diaphragm, and of the intercostal muscles, in the act of expiration. Having entered the chest, it passes a little to the right, leaving the œsophagus, or gullet, on the left; it separates from the dorsal vertebræ; it passes through the duplicature of the mediastinum to the base of the heart, and it divides beneath the posterior aorta. Its divisions are called the *bronchial tubes*, and have much to do with the well-being of the horse.

Its rings remain as perfect as before, but a new portion of cartilage begins to present itself: it may be traced as high as the tenth ring from the bottom; it spreads over the union between the posterior terminations of the rings; it holds them in closer and firmer connection with each other; it discharges the duty of the transverse muscle, which begins here to disappear, and the support of the cervical and dorsal vertebræ; it prevents the separation of the rings when the trachea is distended; it spreads down upon, and defends the commencement of the bronchial tubes. Some other

small plates of cartilage reach a considerable way down the divisions of the bronchi, and the last ring has a central triangular projection, which covers and defends the bifurcation of the trachea.

#### THE BRONCHIAL TUBES.

The windpipe has been traced through its course down the neck into the chest. It is there continued through the mediastinum to the base of the heart, and then divided into two tubes corresponding with the two divisions of the lungs—the BRONCHIAL TUBES—the right of which is rather the largest. These trunks enter deeply into the substance of the lungs. They presently subdivide, and the subdivision is continued in every direction, until branches from the trachea penetrate every assignable portion and part of the lungs. They are still air-passages, carrying on this fluid to its destination, for the accomplishment of a vital purpose.

They also continue exposed to pressure; but it is pressure of a new kind, a pressure alternately supplied and removed. The lungs in which they are embedded alternately contract and expand; and these tubes must contract and expand likewise. Embedded in the lungs, the cartilaginous ring of the bronchi remains, but it is divided into five or six segments connected with each other. The lungs being compressed, the segments overlap each other, and fold up and occupy little space; but the principle of elasticity is still at work; and as the pressure is removed, they start again, and resume their previous form and calibre. It is a beautiful contrivance, and exquisitely adapted to the situation in which these tubes are placed, and the functions they have to discharge.

#### THE LUNGS.

The lungs are the seat of a peculiar circulation. They convey through their comparatively small bulk the blood, and other fluids scarcely transformed into blood, or soon separated from it, which traverse the whole of the frame. They consist of countless ramifications of air-tubes and blood-vessels connected together by intervening cellular substance.

They form two distinct bodies, the right somewhat larger than the left, and are divided from each other by the duplicature of the pleura, which has been already described—the mediastinum. Each lung has the same structure, and properties, and uses. Each of them is subdivided, the right lobe consisting of three lobes, and the left of two. The intention of these divisions is probably to adapt the substance of the lungs to the form of the cavity in which they are placed, and to enable them more perfectly to occupy and fill the chest.

If one of these lobes is cut into, it is found to consist of innumerable irregularly formed compartments, to which anatomists have given the name of *lobules*, or little lobes. They are distinct from each other, and impervious. On close examination, they can be subdivided almost without end. There is no communication between them, or if perchance such communication exists, it constitutes the disease known by the name of *broken wind*.

On the delicate membrane of which these cells are composed, innumerable minute blood-vessels ramify. They proceed from the heart, through the medium of the *pulmonary artery*—they follow all the subdivisions of the bronchial tubes—they ramify upon the membrane of these multitudinous lobules, and at length return to the heart, through the medium of the pulmonary veins, the blood, the character of which has been essentially changed. The office of the lungs may be very shortly stated. The blood passing through the capillaries of the body and contributing to the nourishment of the frame, and furnishing all the secretions, becomes, as



we have described, changed. It is no longer able to support life: it is possessed of a poisonous principle, and that principle is a superabundance of a substance called *carbon*, which must be got rid of, before the blood can again be usefully employed. There is an ingredient in the atmospheric air called *oxygen*, which has a strong attraction for this carbon, and which will unite with it wherever it finds it. The chest enlarges by the action of the diaphragm, and the intercostal and other muscles, as we have narrated, and the lungs expanding with the chest, in order to fill up the vacuum which would otherwise exist between them and the sides of the chest, these cells enlarge, and a kind of vacuum is formed in each of them, and the air rushes down and fills them, and being divided from the venous and poisoned blood by these membranes alone, it is enabled to act upon the blood, the oxygen combines with the carbon to form carbonic acid, and thus purifies it, and renders it arterial blood, and fit for the purposes of life. This being accomplished, the chest contracts, the lungs are pressed into smaller compass, and a portion of the air impregnated with carbonic acid, and rendered poisonous in its turn, is pressed out. Presently the chest expands again, and the lungs expand with it, and fresh, pure air is admitted, which is shortly pressed out again, empoisoned by the carbon of the blood: and these alternate expansions and contractions constitute the act of breathing.

#### THE PLEURA.

The walls of the chest are lined, and the lungs are covered, by a smooth glistening membrane, *the pleura*. It is a *serous* membrane, so called from the nature of its exhalation, in distinction from the *mucous secretion* yielded by the membrane of the air-passages. The serous membrane generally invests the most important organs, and always those that are essentially connected with life, and lines all the enclosed cavities of the body; while the mucous membrane lines the interior of those cavities which have external openings. The pleura is the investing membrane of the lungs, and a mucous membrane the lining one of the bronchial tubes.

Among the circumstances principally to be noticed, with regard to the pleura, is the polish of its internal surface. The glistening appearance of the lungs, and of the inside of the chest, is to be attributed to the membrane by which they are covered, and by means of which the motion of the various organs is freer and less dangerous. Although the lungs, and the bony walls which contain them, are in constant approximation with each other, both in expiration and inspiration, yet in the frequently hurried and violent motion of the animal, and, in fact, in every act of expiration and inspiration, of dilatation and contraction, much and injurious friction would ensue if the surfaces did not glide freely over each other by means of the peculiar polish of this membrane.

Every serous membrane has innumerable exhalent vessels upon its surface, from which a certain quantity of fluid is poured out. In life and during health it exists in the chest only as a kind of dew, just sufficient to lubricate the surfaces. When the chest is opened soon after death, we recognise it in the steam that arises, and in the few drops of fluid, which, being condensed, are found at the lowest part of the chest.

The quantity, however, which is exhaled from all the serous membranes must be very great. It is perhaps equal or superior to that which is yielded by the vessels on the surface of the body. If very little is found in ordinary cases, it is because the absorbents are as numerous and as active as the exhalents, and, during health, that which is poured out by the one is taken up by the other; but in circumstances of disease, either when the exhalents are stimulated to undue action, or the power of the

absorbents is diminished, the fluid rapidly and greatly accumulates. Thus we have hydrothorax or dropsy of the chest, as one of the consequences of inflammation of the chest; and the same disturbed balance of action will produce similar effusion in other cavities.

The adaptation of membrane generally is nowhere more strikingly displayed than in the serous membranes, and particularly in that under consideration. How different the bulk of the lungs before the act of inspiration has commenced, and after it has been completed, and especially in the laborious respiration of disease or rapid exertion! In either state of the lungs the pleura is perfectly fitted to that which it envelopes.

The pleura, like other serous membranes, is possessed of very little sensibility. Few nerves from the sensitive column of the spinal cord reach it. Acute feeling would render these membranes generally, and this membrane in particular, unfit for the function they have to discharge. It has too much motion, even during sleep; and far too forcible friction with the parietes of the thorax in morbid or hurried respiration, to render it convenient or useful for it to possess much sensation. Some of those anatomists, whose experiments on the living animal do no credit to their humanity, have given most singular proof of the insensibility, not only of these serous membranes, but of the organs which they invest. Bichat frequently examined the spleen of dogs. He detached it from some of its adhesions, and left it protruding from the wound in the abdomen, in order 'to study the phenomena;' and he saw 'them tearing off that organ, and eating it, and thus feeding upon their own substance.' In some experiments, in which part of their intestines were left out, he observed them, as soon as they had the opportunity, tear to pieces their own viscera without any visible pain.

Although it may be advantageous that these important organs shall be thus devoid of sensibility when in health, in order that we may be unconscious of their action and motion, and that they may be rendered perfectly independent of the will, yet it is equally needful that, by the feeling of pain, we should be warned of the existence of any dangerous disease: and thence it happens that this membrane, and also the organ which it invests, acquire under inflammation the highest degree of sensibility. The countenance of the horse labouring under pleurisy or pneumonia will sufficiently indicate a state of suffering; and the spasmed bend of his neck, and his long and anxious and intense gaze upon his side, tell us that that suffering is extreme.

Nature, however, is wise and benevolent even here. It is not of every morbid affection, or morbid change, that the animal is conscious. If a mucous membrane is diseased, he is rendered painfully aware of that, for neither respiration nor digestion could be perfectly carried on while there was any considerable lesion of it; but, on the other hand, we find tubercles in the parenchyma of the lungs, or induration or hepatisation of their substance, or extensive adhesions, of which there were few or no indications during life.

The pleura adheres intimately to the ribs and to the substance of the lungs, yet it is a very singular connection. It is not a continuance of the same organisation; it is not an interchange of vessels. The organ and its membrane, although so closely connected for a particular purpose, yet in very many cases, and where it would least of all be suspected, have little or no sympathy with each other. Inflammation of the lungs will sometimes exist, and will run on to disorganisation, while the pleura will be very little affected: and, much oftener, the pleura will be the seat of inflammation and will be attended by increased exhalation to such an extent as to suffocate the animal, and yet the lungs will exhibit little other

morbid appearance than that of mere compression. The disease of a mucous membrane spreads to other parts—that of a serous one is generally isolated. It was to limit the progress of disease that this difference of structure between the organ and its membrane was contrived.

The investing membrane of the lungs and that of the heart are in continual contact with each other, but they are as distinct and unconnected, as if they were placed in different parts of the frame. Is there no meaning in this?

It is to preserve the perfect independence of organs equally important, yet altogether different in structure and function—to oppose an insuperable barrier to hurtful sympathy between them, and especially to cut off the communication of disease.

Perhaps a little light begins to be thrown on a circumstance of which we have occasional painful experience. While we may administer physic, or mild aperients at least, in pleurisy, not only with little danger, but with manifest advantage, we may just as well give a dose of poison as a physic-ball to a horse labouring under pneumonia. The pleura is connected with the lungs, and with the lungs alone, and the organisation is so different, that there is very little sympathy between them. A physic-ball may, therefore, act as a counter-irritant, or as giving a new determination to the vital current, without the propagation of sympathetic irritation; but the lungs or the bronchial tubes that ramify through them are continuous with the mucous membranes of the digestive as well as all the respiratory passages; and on account of the continuity and similarity of organisation, there is much sympathy between them. If there is irritation excited at the same time in two different portions of the same membrane, it is probable that, instead of being shared between them, the one will be transferred to the other—will increase or double the other, and act with fearful and fatal violence.

#### SPASM OF THE DIAPHRAGM.

The diaphragm is subject to injury and disease of a serious and varied character. Whatever may be the original seat of thoracic or abdominal ailment, the diaphragm soon becomes irritable and inflamed. This accounts for the breathing of the horse being so much affected under every inflammation or excitement of the chest or belly. The irritability of this muscle is often evinced by a singular spasmodic action of a portion, or the whole of it.

Mr. Castley, in 'The Veterinarian' for 1831, thus describes a case of it:—"A horse had been very much distressed in a run of nearly thirteen miles, without a check, and his rider stopped on the road towards home, to rest him a little. With difficulty he was brought to the stable. Mr. Castley was sent for, and he says,—“When I first saw the animal, his breathing and attitude indicated the greatest distress. The prominent symptom, however, was a convulsive motion, or jerking of the whole body, audible at several yards' distance, and evidently proceeding from his inside; the beats appeared to be about forty in a minute. On placing my hand over the heart, the action of that organ could be felt, but very indistinctly; the beating evidently came from behind the heart, and was most plainly to be felt in the direction of the diaphragm. Again placing my hand on the abdominal muscles, the jerks appeared to come from before backwards; the impression on my mind, therefore, was, that this was a spasmodic affection of the diaphragm, brought on by violent distress in running.”"

Mr. Castley's account is inserted thus at length, because it was the first of the kind on record, with the exception of an opinion of Mr.

Apperley, in his work 'Nimrod on the Condition of Hunters,' which came very near to the truth. 'When a horse is very much exhausted after a long run with hounds, a noise will sometimes be heard to proceed from his inside, which is often erroneously supposed to be the beating of his heart, whereas it proceeds from the excessive motion of the abdominal muscles.'

Mr. Castley shall pursue his case (it will be a most useful guide to the treatment of these cases): 'Finding that there was little pulsation to be felt at the submaxillary artery, and judging from that circumstance that any attempt to bleed at that time would be worse than useless, I ordered stimulants to be given. We first administered three ounces of spirit of nitric ether, in a bottle of warm water; but this producing no good effect, we shortly afterwards gave two drachms of the sub-carbonate of ammonia in a ball, allowing the patient, at the same time, plenty of white water to drink. About a quarter of an hour after this, he broke out into a profuse perspiration, which continued two hours, or more. The breathing became more tranquil, but the convulsive motion of the diaphragm still continued without any abatement. After the sweating had ceased, the pulse became more perceptible, and the action of the heart more distinct, and I considered this to be the proper time to bleed. When about ten pounds had been extracted, I thought that the beating and the breathing seemed to increase; the bleeding was stopped, and the patient littered up for the night. In the morning, the affection of the diaphragm was much moderated, and about eleven o'clock it ceased, after continuing eighteen or nineteen hours. A little tonic medicine was afterwards administered, and the horse soon recovered his usual appetite and spirits.'

Later surgeons administer, and with good effect, opium in small doses, together with ammonia, or nitric ether, and have recourse to bleeding as soon as any reaction is perceived.

Over-fatigue, of almost every kind, has produced spasm of the diaphragm, and so has over-distension of the stomach with grass.

#### RUPTURE OF THE DIAPHRAGM.

This is an accident, or the consequence of disease, very lately brought under the cognisance of the veterinary surgeon. The first communication of its occurrence was from Mr. King, a friend of Mr. Percivall, in 'The Veterinarian,' 1828. It occurred in a mare that had been ridden sharply for half a dozen miles when she was full of grass. She soon afterwards exhibited symptoms of broken-wind, and, at length, died suddenly, while standing in the stable. The diaphragm was lacerated on the left side, through its whole extent, throwing the two cavities into one.

Since that period, from the increasing and very proper habit of examining every dead horse, cases of this accident have rapidly multiplied. Mr. Percivall states, in his 'Hippopathology,' that it may follow any act of extraordinary exertion, and efforts of every kind, particularly on a full stomach, or when the bowels are distended with green or other food likely to generate gas. Considerable caution, however, should be exercised when much gaseous fluid is present, for the bowels may be distended, and forced against the diaphragm to such a degree as to threaten to burst.

An interesting case of rupture of the diaphragm was related by Professor Spooner at one of the meetings of the Veterinary Medical Association. A horse having been saddled and bridled for riding, was turned in his stall and fastened by the bit-straps. Something frightened him—he reared, broke the bit-strap, and fell backward. On the following morning he was evidently in great pain, kicking, heaving, and occasionally lying down. Mr. S. was sent for to examine him, but was not told of the event of the preceding day. He considered it to be a case of enteritis, and treated it

accordingly. He bled him largely, and, in the course of the day, the horse appeared to be decidedly better, every symptom of pain having vanished. The horse was more lively—he ate with appetite, but his bowels remained constipated.

On the following day there was a fearful change. The animal was suffering sadly—the breathing was laborious, and the membrane of the nose intensely red, as if it were more a case of inflammation of the lungs than of the bowels. The bowels were still constipated. The patient was bled and physicked again, but without avail. He died, and there was found rupture of the diaphragm, protrusion of intestine into the thoracic cavity, and extensive pleural and peritoneal inflammation.

In rupture of the diaphragm the horse occasionally sits on his haunches like a dog, but this is far from being an infallible symptom of the disease. It accompanies intromission, as well as rupture of the diaphragm. The weight of the intestines may possibly cause any protruded part of them to descend again into the abdomen.

#### CATARRH, OR COLD.

*Catarrh*, or *cold*, is attended by a slight defluxion from the nose—now and then, a slighter weeping from the eyes, and some increased labour of breathing, on account of the uneasiness which the animal experiences from the passage of the air over the naturally sensitive and now more than usually irritable surface, and from the air-passage being diminished by a thickening of the membrane. When this is a simply local inflammation, attended by no loss of appetite or increased animal temperature, it may speedily pass over.

In many cases, however, the inflammation of a membrane naturally so sensitive, and rendered so morbidly irritable by our absurd treatment, rapidly spreads, and involves the fauces, the lymphatic and some of the salivary glands, the throat, the parotid gland, and the membrane of the larynx. We have then increased discharge from the nose, greater redness of the membrane of the nose, more defluxion from the eyes, and loss of appetite from a degree of fever associating itself with the local affection, and there also being a greater or less degree of pain in the act of swallowing, and which if the animal feels he will never eat. Cough now appears more or less frequent or painful; but with no great acceleration of the pulse, or heaving of the flanks.

Catarrh may arise from a thousand causes. Membranes subjected to so many sources of irritation soon become irritable. Exposure to cold or rain, change of stable, change of weather, change of the slightest portion of clothing, neglect of grooming, and a variety of circumstances apparently trifling, and which they who are unaccustomed to horses would think could not possibly produce any injurious effect, are the causes of catarrh. In the spring of the year, and while moulting, a great many young horses have cough; and in the dealers' stables, where the process of making up the horse for sale is carrying on, there is scarcely one of them that escapes this disease.

In the majority of cases, a few warm mashes, warm clothing, and a cool stable, and a fever ball or two, will set all right. Indeed, all would soon be right without any medicine; and much more speedily and perfectly than if the cordials, of which grooms and farriers are so fond, had been given. Nineteen horses out of twenty with common catarrh will do well; but in the twentieth case, a neglected cough may be the precursor of bronchitis, and pneumonia. These chest affections often insidiously creep on, and inflammation is frequently established before any one belonging to the horse is aware of its existence. Purgative medicines

should never be given in catarrh. It can scarcely be known what sympathy may exist between the portion of membrane already affected, and the mucous membranes generally. In severe thoracic affection, or in that which may soon become so, a dose of physic would be little better than a dose of poison. If, however, careful investigation renders it evident that there is no affection of the lungs, and that the disease has not proceeded beyond the fauces, small doses of aloes may with advantage be united with other medicines in order to evacuate the intestinal canal, and reduce the fecal discharge to a pultaceous form.

If catarrh is accompanied by sore throat; if the parotids should enlarge and become tender—there are no tonsils, *amygdalæ*, in the horse—or if the submaxillary glands should be inflamed, and the animal should quid his food and gulp his water, this will be an additional reason for care, and also for warm clothing and a comfortable stable. A hot stable is not meant by the term comfortable, in which the foul air is breathed over and over again, but a temperature some degrees above that of the external air, and where that determination to the skin and increased action of the exhalent vessels, which in these cases are so desirable, may take place. Every stable, both for horses in sickness and in health, should have in it a thermometer.

Some stimulating liniment may be applied over the inflamed gland, strong enough to produce considerable irritation on the skin, but not to blister, or to destroy the hair. An embrocation sufficiently powerful, and yet that never destroys the hair, consists of equal parts of hartshorn, oil of turpentine, and camphorated spirit, with a small quantity of laudanum.

#### INFLAMMATION OF THE LARYNX.

Strictly speaking, this refers to inflammation confined to the larynx, but either catarrh or bronchitis, or both, frequently accompany the complaint.

Its approach is often insidious, scarcely to be distinguished from catarrh except by being attended with more soreness of throat, and less enlargement of the parotid glands. There are also more decided and violent paroxysms of coughing than in common catarrh, attended by a gurgling noise, which may be heard at a little distance from the horse, and which, by auscultation, is decidedly referable to the larynx. The breathing is shorter and quicker, and evidently more painful than in catarrh; the membrane of the nose is redder; it is of a deep modena colour; and the horse shrinks and exhibits great pain when the larynx is pressed upon. The paroxysms of coughing become more frequent and violent, and the animal appears at times almost suffocated.

As the soreness of the throat proceeds, the head of the animal is projected, and the neck has a peculiar stiffness. There is also much difficulty of swallowing. Considerable swelling of the larynx and the pharynx ensues, and also of the parotid, sublingual, and submaxillary glands. As the inflammation increases, the cough becomes hoarse and feeble, and in some cases altogether suspended. At the commencement there is usually little or no nasal defluxion, but the secretion soon appears, either pure or mixed with an unusual quantity of saliva.

Auscultation is a very important aid in the discovery of the nature and serious or trifling character of this disease. It cannot be too often repeated that it is one of the most valuable means which we possess of detecting the seat, intensity and results, of the maladies of the respiratory passages. No instrument is required; the naked ear can be applied evenly and flatly, and with a very slight pressure, on any part that it is of importance to examine. The healthy sound, when the ear is applied to

the windpipe, is that of a body of air passing uninterruptedly through a smooth tube of somewhat considerable calibre: it very much resembles the sound of a pair of forge bellows, when not too violently worked.

He who is desirous of ascertaining whether there is any disease in the larynx of a horse, should apply his ear to the lower part of the windpipe. If he finds that the air passes in and out without interruption, there is no disease of any consequence either in the windpipe or the chest; for it would immediately be detected by the loudness or the interruption of the murmur. Then let him gradually proceed up the neck with his ear still upon the windpipe. Perhaps he soon begins to recognise a little gurgling, grating sound. As he continues to ascend, that sound is more decisive, mingled with an occasional wheezing, whistling noise. He can have no surer proof that here is the impediment to the passage of the air, proceeding from the thickening of the membrane and diminution of the passage, or increased secretion of mucus, which bubbles and rattles as the breath passes. By the degree of the rattling or whistling, the owner will judge which cause of obstruction preponderates—in fact, he will have discovered the seat and the state of the disease, and the sooner he has recourse to professional advice the better.

*Chronic laryngitis* is of more frequent occurrence than acute. Many of the coughs that are most troublesome are to be traced to this source.

In violent cases laryngitis terminates in suffocation; in others, in thick wind or in roaring. Occasionally it is necessary to have recourse to the operation of tracheotomy.

In acute laryngitis the treatment to be pursued is sufficiently plain. Blood must be abstracted, and that from the jugular vein, for there will then be the combined advantage of general and local bleeding. The blood must be somewhat copiously withdrawn, depending on the degree of inflammation—the practitioner never for a moment forgetting that he has to do with inflammation of a mucous membrane, and that what he does he must do quickly. He will have lost the opportunity of struggling successfully with the disease when it has altered its character and debility has succeeded. The cases must be few and far between when the surgeon makes up his mind to any determinate quantity of blood, and leaves his assistant or his groom to abstract it; he must himself bleed, and until the pulse flutters or the constitution is evidently affected.

Next must be given the fever medicine already recommended: the nitre, and emetic tartar, with aloes. Aloes may here be safely given, because the chest is not yet implicated. To this must be added, and immediately, a blister, and a sharp one. The surgeon is sure of the part, and he can bring his counter-irritant almost into contact with it.

Inflammation of the larynx, if not speedily subdued, produces sad disorganisation in this curiously formed and important machine. Lymph is effused, morbidly adhesive, and speedily organised—the membrane becomes thickened, considerably, permanently so—the submucous cellular tissue becomes œdematous; the inflammation spreads from the membrane of the larynx to the cartilages, and difficulty of breathing, and at length confirmed roaring, ensue.

#### INFLAMMATION OF THE TRACHEA.

Inflammation of the membrane of the larynx, and especially when it has run on to ulceration, may rapidly spread, and involve the greater part or the whole of the lining membrane of the trachea. Auscultation will discover when this is taking place. If the disease is extending down the trachea, it must be followed. A blister must reach as low as the rattling sound can be detected, and somewhat beyond this, and the fever medicines must be administered in somewhat increased doses.

Generally speaking, however, although the inflammation is now approaching the chest, its extension into the trachea is not an unfavourable symptom. It is spread over a more extended surface, and is not so intense or untractable. It is involving a part of the frame less complicated, and where less mischief can be effected. True, if the case is neglected, it must terminate fatally; but it is coming more within reach, and more under command, and, the proper means being adopted, the change is rather a favourable one.

The disorganisations produced in the trachea are similar to some which have been described in the larynx. The same formation of organised bands of coagulated lymph, the same thickening of membrane, diminution of calibre, and foundation for roaring.

#### ROARING.

The present will be the proper place to speak of that singular impairment of the respiratory function recognised by this name. It is an unnatural, loud grunting sound made by the animal in the act of breathing when in quick action or on any sudden exertion. On carefully listening to the *sound*, it will appear that the roaring is produced in the act of inspiration and not in that of expiration. If the horse is briskly trotted on a level surface, and more particularly if he is trotted up hill, or if he is suddenly threatened with a stick, this peculiar sound will be heard and cannot be mistaken. When dishonest dealers are showing a horse that roars, but not to any great degree, they trot away gently, and as soon as they are too far for the sound to be heard, show off the best paces of the animal: on returning, they gradually slacken their speed when they come within a suspicious distance. This is sometimes technically called 'the dealers' long trot.'

Roaring is exceedingly unpleasant to the rider, and it is manifest unsoundness. It is the sudden and violent rushing of the air through a tube of diminished calibre; and if the impediment, whatever it is, renders it so difficult for the air to pass in somewhat increased action, sufficient cannot be admitted to give an adequate supply of arterialised blood in extraordinary or long-continued exertion. Therefore, as impairing the function of respiration, although, sometimes, only on extraordinary occasions, it is unsoundness. In as many cases as otherwise, it is a very serious cause of unsoundness. The roarer, when hardly pressed, is often blown even to the hazard of suffocation, and there are cases on record of his suddenly dropping and dying when urged to the top of his speed.

It must not, however, be taken for granted that the roarer is always worthless. There are few hunts in which there is not one of these horses, who acquits himself very fairly in the field; and it has occasionally so happened that the roarer has been the very crack horse of the hunt: yet he must be ridden with judgment, and spared a little when going up-hill. There is a village in the West Riding of Yorkshire, through which a band of smugglers used frequently to pass in the dead of night: the horse of the leader, and the best horse of the troop, and on which his owner would bid defiance to all pursuit, was so rank a roarer that he could be heard at a considerable distance. The clattering of all the rest scarcely made so much noise as the roaring of the captain's horse. When this became a little too bad, and he did not fear immediate pursuit, the smuggler used to halt the troop at some convenient hayrick, on the roadside, and, having suffered the animal to distend his stomach with this dry food, as he was always ready enough to do, he would remount and gallop on, and, for a while, the roaring was scarcely heard. It is somewhat difficult to account for this. Perhaps the loaded stomach now pressing against the diaphragm,



that muscle had harder work to displace this viscus in the act of enlarging the chest and producing the act of inspiration, and accomplished it more slowly, and therefore, the air passing more slowly by, the roaring was diminished. We do not dare to calculate what must have been the increased labour of the diaphragm in moving the loaded stomach, nor how much sooner the horse must have been exhausted. This did not enter into the owner's reckoning, and probably the application of whip and spur would deprive him of the means of forming a proper calculation of it.

Roaring proceeds from obstruction in some portion of the respiratory canal, and oftenest in the larynx, where there is the least room to spare—that cartilaginous box being occupied by the mechanism of the voice: next in frequency it is in the trachea, but, in fact, obstruction anywhere will produce it. Mr. Blaine, quoting from a French journalist, says, that a piece of riband lodged within one of the nasal fossæ produced roaring, and that even the displacement of a molar tooth has been the *supposed* cause of it. Polypi in the nostrils have been accompanied by it. Mr. Sewell found, as an evident cause of roaring, an exostosis between the two first ribs, and pressing upon the trachea; and Mr. Percivall goes farther, and says that his father repeatedly blistered and fired a horse for bad roaring, and even performed the operation of tracheotomy, and at length the roaring being so loud when the horse was led out of the stable, that it was painful to hear it—the poor animal was destroyed. No thickening of the membrane was found, no disease of the larynx or trachea; but the lungs were hepatised throughout the greater part of their substance, and many of the smaller divisions of the bronchi were so compressed, that they were hardly pervious.

*Bands of Coagulated Lymph.*—A frequent cause of roaring is bands of coagulated lymph, morbidly viscid and tenacious, adhering firmly on one side, and by some act of coughing brought into contact with and adhering to the other side, and becoming gradually organised. At other times there have been rings of coagulated lymph adhering to the lining of the trachea, but not organised. In either case they form a mechanical obstruction, and will account for the roaring noise produced by the air rushing violently through the diminished calibre, in hurried respiration. Thickening of the membrane is a more frequent cause of roaring than the transverse bands of coagulated lymph. In many morbid specimens it is double or treble its natural thickness, and covered with manifold ulcerations. This is particularly annoying in the upper part of the windpipe, where the passages in their natural state are narrow. Thus it is that roaring is the occasional consequence of strangles and catarrh, and other affections of the superior passages.

There is scarcely a horse of five or six years old who has not a portion of the thyroid cartilage ossified. In some cases the greater part of the cartilages are becoming bony, or sufficiently so to weaken or destroy their elastic power, and consequently to render it impossible for them to be freely and fully acted upon by the delicate muscles of the larynx.

Chronic cough occasionally terminates in roaring. Some have imagined that the dealers' habit of *coughing* the horse, *i.e.* pressing upon the larynx to make him cough, in order that they may judge of the state of his wind by the sound that is emitted, has produced inflammation about the larynx, which has terminated in roaring, or assisted in producing it. That pain is given to the animal by the rough and violent way in which the object is sometimes attempted to be accomplished, is evident enough, and this must, in process of time, lead to mischief; but sufficient inflammation and subsequent ossification of the cartilages would scarcely be produced, to be a cause of roaring.

There can be no doubt of the fact, that the majority of roarers are draught-horses, and horses of quick draught. They are not only subject to the usual predisposing causes of this obstruction, but there is something superadded,—resulting from their habits or mode of work;—not indeed necessarily resulting, but that which the folly as well as cruelty of man has introduced—the system of tight-reining. To a certain extent, the curb-rein is necessary. Without it there would be scarcely any command over a wilful horse, and it would need a strong arm occasionally to guide even the most willing. Without the curb-rein the horse would carry himself low; he would go carelessly along; he would become a stumbler; and if he were disposed at any time to run away, the strongest arm would have little power to stop him: but there is no necessity for the tight rein, and for the long and previous discipline to which the carriage-horse is subjected. There is no necessity that the lower jaw, whether the *channel* is wide or narrow, should be so forced on the neck, or that the larynx and the portion of the windpipe immediately beneath it should be flattened, and bent, and twisted, and the respiratory passage not only obstructed, but in a manner closed. The mischief is usually done when the horse is young. It is effected in some measure by the impatience of the animal, unused to control, and suffering pain. In the violent tossing of his head he irritates the larynx, and produces inflammation. The head of the riding-horse is gradually brought to its proper place by the hands of the breaker, who skilfully increases or relaxes the pressure, and humours and plays with the mouth; but the poor carriage-horse is confined by a rein that never slackens, and his nose is bent in at the expense of the larynx and windpipe. The injury is materially increased if the head is not naturally well set-on, or the neck is thick or the jaws narrow.

Connected with this is the common notion that crib-biting is a cause of roaring. That is altogether erroneous. There is no possible connection between the complaints: but one of the methods that used to be resorted to in order to cure crib-biting might be a cause of roaring, namely, the strap so tightly buckled round the upper part of the neck as to compress, and distort, and paralyse the larynx.

The question, however, as to the ordinary and common cause of roaring remained for years an open one, but the answer has at length been satisfactorily received,—the cause of roaring in the great majority of cases, is a paralysis or atrophy of the muscles on the left side of the larynx, affording, in contrast with the healthy muscles on the right side, one of the most striking examples of pathological anatomy that can possibly be conceived. But what is the cause of this atrophy or wasting of the muscles, and why are the muscles thus affected always those of the left side? The cause is paralysis of the left recurrent nerve, the motor nerve by which they are stimulated to action, and this stimulus lost, they, like the muscles in any other part of the body in a paralysed person, lose their fullness, their colour, and their function, and become impotent and flaccid. But still, why does this occur always on the left side? The reason would appear to be this—nerves in general when distributed in pairs, and nearly all nerves are so, take the same course on either side of the body; the recurrent nerves, however, which are the motive nerves of the muscles of the larynx, are an exception to this rule, the left one has a longer and more complicated route than the right: the consequence has been found to be, that it is more liable to morbid change, disease, and wasting than its fellow, and the muscles it ought to supply with nervous energy perish away from the want of it, and cease to perform their share in regulating the action of the larynx; its opening in consequence becomes distorted, and roaring is the result. The foreshadowing of this was first

noticed by the late John Field, who, in the course of some experiments, having divided the left recurrent nerve, the horse immediately became a roarer, and continued so to the day of his death.

It has required the experience of years, however, to prove that this, which might have been considered a merely curious coincidence, is absolutely an universally-recognised cause of this disease—the other causes already enumerated may occasionally produce the same result, but in the present day they will be received as mere exceptions to a very general rule.

Facts have established the hereditary predisposition to roaring, beyond the possibility of doubt.

In France it is notorious that three-fourths of the horses from Cottentin are roarers and some of them are roarers at six months old; but about La Hague and Le Bocase, not a roarer is known. There is certainly a considerable difference in the soil of the two districts; the first is low and marshy, the latter elevated and dry: but tradition traces it to the introduction of some foreign horses into Cottentin, who bequeathed this infirmity to their progeny.

In our own country, there is as decisive a proof. There was a valuable stallion in Norfolk, belonging to Major Wilson, of Diddlington. He was a great favourite, and seemed to be getting some excellent stock; but he was a roarer, and some of the breeders took alarm at this. They had occasionally too painful experience of the communication of the defects of the parent to his progeny; and they feared that roaring might possibly be among these hereditary evils. Sir Charles Bunbury was requested to obtain Mr. Cline's opinion on the subject, Mr. Cline was a deservedly eminent human surgeon: he had exerted himself in the establishment of the Veterinary College: he was an examiner of veterinary pupils, and therefore it was supposed that he must be competent to give an opinion. He gave one, and at considerable length:—'The disorder in the horse,' said he, 'which constitutes a roarer, is caused by a membranous projection in a part of the windpipe, and is the consequence of that part having been inflamed from a cold, and injudiciously treated. A roarer, therefore, is not a diseased horse, for his lungs and every other part may be perfectly sound. The existence of roaring in a stallion cannot be of any consequence. It cannot be propagated any more than a broken bone, or any other accident.'—A fair specimen of the horse-knowledge of one of the best of the medical examiners of veterinary pupils.

Sir Charles returned full of glee; the good people of Norfolk and Suffolk were satisfied; Major Wilson's horse was in high request: but in a few years a great part of the two counties was overrun with roarers, and many a breeder half ruined. Roaring is not, however, necessarily hereditary. Mr. Goodwin, whose name is great authority, states that Taurus, a celebrated racer that had become a roarer, had covered several mares, and their produce all turned out well, and had won several races. In no instance did his progeny exhibit this defect, notwithstanding that his own family were notorious for being roarers. Eclipse also is said to have been a roarer.

What then is to be done with these animals? Abandon them to their fate? No, not so; but there is no necessity rashly to undertake a hopeless affair. All possible knowledge must be obtained of the origin of the disease. Did it follow strangles, catarrh, bronchitis, or any affection of the respiratory passages? Is it of long standing? Is it now accompanied by cough or any symptoms of local or general irritation? Can any disorganisation of these parts be detected? Any distortion of the larynx? Did it follow breaking-in to harness? The answer to these questions will materially guide any future proceedings.

If there is plain distortion of the larynx or trachea, or the disease

can be associated, in point of time, with breaking-in to harness, or the coachman or proprietor has been accustomed to rein the animal in too tightly or too cruelly, or the sire was a roarer, it is almost useless to have anything to do with the case. But if it is of rather recent date, and following closely on some disease with which it can be clearly connected, careful examination of the patient may be commenced. Is there cough? Can any heat or tenderness be detected about the larynx or trachea? Is there in every part the same uniform rushing noise; or, on some particular spot, can a more violent breathing, a wheezing or whistling, or a rattling and guggling, be detected? Is that wheezing or rattling either confined to one spot, or less sonorous as the ear recedes from that spot above or below; or is it diffused over a considerable portion of the trachea?

In these cases it would be fair to purge, and most certainly to blister. The ear will guide to the part to which the blister should be applied. The physic having set, a course of fever medicine should be commenced. It should be considered as a case of chronic inflammation, and to be subdued by a continuance of moderate depletory measures. A second dose of physic should be given, and, most certainly, the blister should be repeated, or kept discharging by means of some stimulating unguent.

Of late years the actual cautery has been employed, and firing horses' throats for roaring is at the present time a very fashionable remedy with some practitioners, but it possesses no particular curative power, further than being a more powerful counter-irritant than the common blister ointment, but has the disadvantage of causing a permanent blemish. The degree of success which attends these measures would determine the farther pursuit of them. No one would eagerly undertake a case of roaring; but, having undertaken it, he should give the measures that he adopts a fair trial, remembering that, in every chronic case like this, the only hope of success depends on perseverance.

The terms wheezing and whistling are simply varieties of roaring, and express the noise made in the act of respiration. Wheezing is a sound not unlike that of an asthmatic person when hurried, and sometimes arises from impediments in the air-passages of the lungs. It can be heard at all times, even when the horse is at rest in the stable. The whistler utters a shriller sound than the wheezer, but only when in exercise, and that of some continuance. A sudden motion will not always produce it. A sharp gallop up-hill will generally detect the whistler, although in some instances, when slight, it will be heard more distinctly in slow paces. It usually proceeds from the same causes as roaring and frequently terminates in that disease. Both these states constitute unsoundness.

When the obstruction seems to be principally in the nose, the horse loudly puffs and blows, and the false nostrils are dilated to the utmost, while the flanks are comparatively quiet. This animal is said to be a **HIGH-BLOWER**. With all his apparent distress, he often possesses great speed and endurance. The sound is unpleasant, but the lungs may be perfectly sound.

#### INFLUENZA, OR EPIDEMIC CATARRH.

Various names are given to this disease—influenza, distemper, catarrhal fever, and epidemic catarrh—its usual history is as follows.

In the spring of the year—a cold wet spring—and that succeeding to a mild winter, and especially among young horses, and those in high condition, or made up for sale, or that have been kept in hot stables, or exposed to the usual causes of inflammation, this disease principally prevails. Those that are in moderate work, and that are correspondingly fed,

occasionally escape, or, even when it appears in most of the stables of any particular district, horses in barracks, regularly worked and moderately fed, although far from being entirely exempt, are comparatively less frequently affected.

If it has been observed from the beginning, it will be found that the attack is sudden, frequently ushered in by shivering, and that quickly succeeded by acceleration of pulse, heat of mouth, staring coat, diminution of appetite, painful but not hard cough, redness of the membrane of the nose, swollen and weeping eye, dejected countenance—these are the symptoms of catarrh. The leading characteristics are the typhoid or debilitating character of the disease and the accompanying sore throat—and the ease and certainty with which this sore throat is detected is remarkable, for almost the slightest pressure of the finger and thumb on the larynx or upper part of the windpipe, of which the animal would not take the slightest notice when in health, will at once induce short, sore, and abrupt, or a restrained, but evidently painful, attempt to cough: intense thirst is the invariable accompaniment of this attack, and the struggles made to relieve it are unpleasant to witness, the water returning by the nostril as fast as it is taken into the mouth, the act of swallowing being too painful an effort for the animal to persist in. This is the form under which the disease is usually now seen.

It clearly is not inflammation of the lungs; for there is no coldness of the extremities, no looking at the flanks, no stiff immovable position, no obstinate standing up. It is not simple catarrh; for as early as the second day there is evident debility. The horse staggers as he walks.

It is inflammation of the respiratory passages generally. It commences in the membrane of the nose, but it gradually involves the whole of the respiratory apparatus. Before the disease has been established four-and-twenty hours, there is sore throat. The horse quids his hay, and gulps his water. There is no great enlargement of the glands; the parotids are a little tumefied, the submaxillary somewhat more so, but not at all equivalent to the degree of soreness. That soreness is excessive, and day after day the horse will obstinately refuse to eat. Discharge from the nose soon follows in considerable quantity: thick, very early purulent, and sometimes foetid. The breathing is rather accelerated and laborious at the beginning, but does not always increase with the progress of the disease—nay, sometimes, a deceitful calm succeeds, and the pulse, quickened and full at first, soon loses its firmness, and although it usually maintains its unnatural quickness, yet it occasionally deviates from this, and subsides to little more than its natural standard. The extremities continue to be comfortably warm, or at least the temperature is variable, and there is not in the manner of the animal, or in any one symptom, a decided reference to any particular part or spot as the chief seat of disease.

Thus the malady proceeds for an uncertain period: occasionally for several days—in not a few instances through the whole of its course, and the animal dies exhausted by extensive or general irritation: but in other cases the inflammation assumes a local determination, and we have bronchitis or pneumonia, but of no very acute character, yet difficult to treat, from the general debility with which it is connected. Sometimes there are considerable swellings in various parts, as the chest, the belly, the extremities, and particularly the head. And when epidemic catarrh first made its appearance in this country, in 1820–21, the leading symptom was engorgement or swelling of the extremities, accompanied by great debility—the two fore-legs, the two hind-legs, or all four, would in the course of a night be distended to three or four times their natural size—or the head would receive the first shock, swelling out of all shape, the nostrils

thickened and nearly closed, the eyes supercharged with fluid, and the eyelids puffed out and completely closed—the sore throat always more or less present, but only as a secondary symptom; and in this distressing form we occasionally meet with it still.

The most decided character in this disease is debility. Not the stiff, unwilling motion of the horse with pneumonia, and which has been mistaken for debility—every muscle being needed for the purposes of respiration, and therefore imperfectly used in locomotion—but actual loss of power of the muscular system generally. The horse staggers from the second day. He threatens to fall if he is moved. He is sometimes down, permanently down, on the third or fourth day. The emaciation is also occasionally rapid and extreme.

At length the medical treatment which has been employed succeeds, or nature begins to rally. The cough somewhat subsides; the pulse assumes a more natural standard; the countenance acquires a little more animation; the horse will eat a small quantity of some choice thing; and health and strength slowly, very slowly indeed, return: but at other times, when there has been no decided change during the progress of the disease, a strange exacerbation of symptoms accompanies the closing scene. The extremities become deathly cold; the flanks heave; the countenance betrays greater distress; the membrane of the nose is of an intense red; and inflammation of the substance of the lungs, and congestion and death, speedily follow.

At other times the redness of the nostril suddenly disappears: it becomes purple, livid, dirty brown, and the discharge is bloody and fœtid, the breath and all the excretions becoming fœtid too. The mild character of the disease gives way to malignant typhus: swellings, and purulent ulcers, spread over different parts of the frame, and the animal is soon destroyed.

*Post-mortem Examination.*—Examination after death sufficiently displays the real character of the disease,—inflammation first of the respiratory passages, and, in fatal or aggravated cases, of the mucous membranes generally. From the pharynx to the termination of the small intestines, and often including even the larger ones, there will not be a part free from inflammation; the upper part of the trachea will be filled with adhesive spume, and the lining membrane thickened, injected, or ulcerated; the lining tunic of the bronchi will exhibit unequivocal marks of inflammation; the substance of the lungs will be engorged, and often inflamed; the heart will partake of the same affection; its external coat will be red, or purple, or black, and its internal one will exhibit spots of ecchymosis; the pericardium will be thickened, and the pericardiac and pleuritic bags will contain an undue quantity of serous, or bloody-serous, or semi-purulent fluid.

The œsophagus will be inflamed, sometimes ulcerated—the stomach frequently so; the small intestines will uniformly present patches of inflammation or ulceration. The liver will be inflamed—the spleen enlarged—no part, indeed, will have escaped; and if the malady has assumed a typhoid form in its latter stages, the universality and malignancy of the ulceration will be excessive.

This disease is clearly attributable to atmospheric influence, but of the precise nature of this influence we are altogether ignorant. It is some foreign injurious principle which mingles with and contaminates the air, but whence this poison is derived, or how it is diffused, we know not. It is engendered, or it is most prevalent, in cold ungenial weather; or this weather may dispose the patient for catarrh, or prepare the tissues to be affected by causes which would otherwise be harmless, or which may at all times exist.

It is most frequent in the spring of the year, but it occasionally rages in autumn and in winter. It is *epidemic*; it spreads over large districts. It sometimes pervades the whole country. Scarcely a stable escapes. Its appearance is sudden, its progress rapid. Mr. Wilkinson had thirty-six new cases in one day. It is said that a celebrated practitioner in London had nearly double that number in less than twenty-four hours.

At other times it is endemic. It pervades one town; one little tract of country. It is confined to spots exceedingly circumscribed. It is dependent on atmospheric agency, but this requires some injurious adjuvant, and the principle of contagion may probably be called into play. It has been rife enough in the lower parts of the metropolis, while in the upper and north-western districts scarcely a case has occurred. It has occasionally been confined to a locality not extending half-a-mile in any direction. In one of the cavalry barracks the majority of the horses on one side of the yard were attacked by epidemic catarrh, while there was not a sick horse on the other side. These prevalences of disease, with these exceptions, are altogether unaccountable. The stables, and the system of stable management, have been most carefully inquired into in the infected and the healthy districts, and no satisfactory difference could be ascertained. One fact, however, has been established, and a very important one it is to the horse proprietor as well as the practitioner. The probability of the disease seems to be in proportion to the number of horses inhabiting the stable. Two or three horses shut up in a comparatively close stable may escape. Out of thirty horses, distributed through ten or fifteen small stables, not one may be affected; but in a stable containing ten or twelve horses the disease will assuredly appear, although it may be proportionally larger and well ventilated. It is on this account that postmasters and horse-dealers dread its appearance. In a sickly season their stables are never free from it; and if, perchance, it does enter one of their largest stables, almost every horse will be affected. Therefore also it is that grooms have so much dread of a distempered stable, and that the odds are so seriously affected if distemper has broken out in a racing establishment.

Does this lead to the conclusion that epidemic catarrh is contagious? Not necessarily, but it excites strong suspicion of its being so, and there are so many facts of the disease extending to nearly every animal in the stable, that it has been considered both infectious and contagious. There are many well-informed grooms, and extensive owners of horses, and living much among them, and even veterinary surgeons of considerable practice, who have considerable doubt about the matter—they lose sight, however, of the fact, that there is in reality no occasion to fly to either infection or contagion to explain this. In a stable of twenty horses the same cause that affects one may, and sometimes does, affect the other nineteen, or any intermediate number; knowing this to be the cause, why look for adventitious causes when the same malaria, or whatever else you may please to call it, may equally prostrate one, one score, or one hundred?

With regard to the treatment of epidemic catarrh there should not be any considerable difficulty. It is a disease of the mucous membrane, and thus connected with much debility; but it is also a disease of a febrile character, and the inflammation is occasionally considerable. The veterinary surgeon, therefore, must judge for himself. Is the disease in its earliest stage marked by inflammatory action? Is there much redness of the nasal membrane? much acceleration of the pulse? some heaving of the flank? and, if so, must not blood be abstracted? No, a thousand times no! Every drop lost may afterwards be wanted. May be?—nay, most surely will be wanted, and alas! wanted in vain. The disease is a typhoid fever,

and debilitates while it excites. The seat of the disease is a mucous membrane, and nature's cure for a disease of a mucous membrane is to increase its secretion, and thus throw off the morbid cause. Will bleeding assist the debility, or enable the membrane to increase its functional discharge? It will, so far from it, prostrate the powers of nature and disable her from having recourse to those health-restoring measures on which life itself may depend.

The treatment of catarrh should consist of giving a fever draught containing an ounce of spirits of nitric ether, with six or eight ounces of liquor ammoniæ acetatis, in a pint of water, twice a day. It has been objected that no medicine whatever should be given while the throat is so inflamed and sore; but so far from this being an objection, it is the very reason why a draught should be administered; for, however small a quantity may be swallowed, it acts as a gargle to the throat, and soon modifies the diseased action of the mucous membrane. Counter-irritation to the throat is most important; for as sure as the outer skin becomes sore the internal surface of the throat becomes less so. The best application is the infusion or tincture of Spanish flies diluted with a little soap liniment and spirit of turpentine. This should be well rubbed in, enough having been applied to well moisten the skin, till the horse shakes his head at you as the indication of feeling it; and may be repeated night and morning till the thick scurf is thrown out on the skin. Should this fail in giving relief in forty-eight hours, the throat should be blistered; and if the cough continues troublesome, the insertion of a seton for a fortnight or three weeks will generally remove it. Can fomentations be applied to relieve the inflamed and turgid membrane of the mouth, nostrils, and fauces? Yes, and to the very parts, by steaming the head. For this purpose a pail or nose-bag should be half filled with hay, boiling water poured on it, and the horse's head kept steadily over it as long as the steam ascends, turning the hay occasionally. The hay is a much better medium for applying the steam than bran, and is not so likely to clog the nostrils.

The appetite is seldom altogether lost, although the horse may refuse to eat the two or three first days; this, however, is more from inability than from disinclination; and, generally, on the third day tonics may be had recourse to. The best of these is the sulphate of iron, which may be given in ʒij. doses, dissolved in a pint of water twice a day, or it may be alternated with the tincture or infusion of gentian or columbo.

From the first hour a pail of chilled water should be placed within his reach; and if this is refused do not hesitate after a short time to give him cold—anything to relieve the intolerable thirst. He will be paddling in it with his lips and tongue hours during the day, even if he cannot drink. A little mash of scalded oats and bran in one corner of the manger, a few dry oats and bran in another, a little damp hay or green meat thrown on the litter, to induce him to hold his head low, so that the increased secretion may the more readily escape. The green meat should be offered early,—grass, tares, lucerne, and carrots,—varying the material so as to tempt his fastidious palate. A stricter attention must be paid to diet than the veterinarian usually enforces, or the groom dreams of.

The practitioner will often and anxiously have recourse to auscultation. He will listen for the mucous rattle, creeping down the windpipe, and entering the bronchial passages. If he cannot detect it below the larynx, he will apply a strong blister, reaching from ear to ear, and extending to the second or third ring of the trachea. If he can trace the rattle in the windpipe, he must follow it,—he must blister as far as the disease has spread. This will often have an excellent effect, not only as a counter-irritant, but as rousing the languid powers of the constitution.



A hood is a useful article of clothing in these cases. It increases the perspiration from the surface covering the inflamed part—a circumstance always of considerable moment, and the legs should be warmly bandaged up to the hocks and the knees.

An equable warmth should be preserved, if possible, over the whole body. The hand-rubber should be gently used every day, and harder and more effectual rubbing applied to the legs. The patient should, if possible, be placed in a loose box, in which he may move about, and take a little exercise, and out of which he should rarely, if at all, be taken. The exercise of which the groom is so fond in these cases, and which must in the most peremptory terms be forbidden, has destroyed thousands of horses. The air should be fresh and uncontaminated, but never chilly; for the object is to increase and not to repress cutaneous perspiration; to produce, if possible, a determination of blood to the skin, and not to drive it to the part already too much overloaded. In order to accomplish this, the clothing should be rather warmer than usual.

The case may proceed somewhat slowly, and not quite satisfactory to the practitioner or his employer. There is not much fever—there is little or no local inflammation; but there is great emaciation and debility, and total loss of appetite.

The feeding should now be sedulously attended to. As before stated, almost every kind of green meat that can be obtained should be given, particularly carrots nicely scraped and sliced. The food should be changed as often as the capricious appetite prompts; and occasionally, if necessary, the patient should be given gruel as thick as it will run from the horn, but the gradual return of health should be well assured, before a full allowance of corn is given.

In a communication received from the late Mr. Percivall, the following account of a new and destructive epidemic amongst horses in 1833-4 is given:—

‘From the close of the past year and the beginning of the present, up to the time I am writing, the influenza among horses has continued to prevail in the metropolis and different parts of the country with more or less fatality. In London it has assumed the form of *laryngitis*, associated in some instances with *bronchitis*; in others—in all I believe where it has proved fatal—with *pleurisy*. The parenchymatous structure of the lungs has not partaken of the disease, or but consecutively and slightly. The earliest and most characteristic symptom has been *sore throat*; causing troublesome dry short cough, but rarely occasioning any difficulty of deglutition, and, in no instance that I have seen, severe or extensive enough to produce anything like disorgement or return of the masticated matters through the nose, and yet the slightest pressure on the larynx has excited an act of coughing. But seldom has any glandular enlargement appeared. The symptom secondarily remarkable after the sore throat and cough has been a dispiritedness and dullness, for which most epidemics of the kind are remarkable. The animal, at the time of sickening, has hung his head under the manger, with his eyes half shut, and his lower lip pendent, without evincing any alarm or even much notice, though a person entered his abode or approached him; and if in a box, his head is often found during his illness turned towards the door or window. Fever, without any disturbance of the respiration, has always been present; the pulse has been accelerated, though rather small and weak in its beat than defective of strength; the mouth has been hot, sometimes burning hot, afterwards moist, and perhaps saponaceous; the skin and extremities in general have been warm. Now and then the prostration and appearance of debility have been such, and so rapid in their manifestations, that shortly after

being attacked, a horse has staggeringly walked twenty yards only—the distance from his stable into the infirmary-box. The appetite, though impaired much, has seldom been altogether lost. Generally, if a little fresh hay has been offered, it has been taken and eaten; but to mashes there has been commonly great aversion. During the long continuance of the wind in the east, the sore throat and cough have been unattended by any flux from the nose; but since the wind has shifted within this last fortnight or three weeks, discharges from the nostrils have appeared, profuse even in quantity, and purulent in their nature; in fact, the disease has assumed a more catarrhal character—*ergo*, I might add, a more favourable one.

‘The disorder has exhibited every phase and degree of intensity, from the slightest perceivable dullness, which has passed off with simply a change in the diet, to an insidious, unyielding, unsubduable pleurisy, ending in hydrothorax, in spite of everything that could be done, and most timely done. So long as the disease has confined itself to the throat, and that there has been along with that only dejection, prostration, and fever, there has existed no cause for alarm; but when such symptoms have, after some days’ continuance, not abated, and have, on the contrary, rather increased, and others have arisen which but too well have authorised suspicion that “mischief was brewing in the chest,” then there became the strongest reasons for alarm for the safety of the patient. What is now to be done? The practitioner durst not bleed a second time, at least not generally, for the patient’s strength would not endure it, although he is sure a pleurisy is consuming his patient. He possesses no effectual means for topical blood-letting. Neither blisters nor rowels, nor plugs nor setons, will take any effect. Cathartic medicine he must not administer; nauseants are uncertain and doubtful in their efficacy; sedatives, tonics, and stimulants, and narcotics, appear counter-indicated, inflammation existing, and when tried under such circumstances, have, I believe, never failed to do harm.

‘Dissatisfied with one and all of these remedies in the late influenza—though the losses I have experienced have, after all, not been so very comparatively great, being no more, since the beginning of the year, than three out of nearly forty cases—I repeat, having, as I thought, reason to be dissatisfied for losing even these three cases, considering that they came under my care at the earliest period of indisposition, I determined, in any similar cases that might occur, to have recourse to that medicine which, in all membranous inflammations in particular, is the physician’s sheet-anchor, and which I had exhibited, and still continue to do, myself, in other disorders, though I had never given it a fair trial in epidemics having that tendency which I have described the present one uniformly to have indicated, viz. the destruction of life by an inflammation attacking membranous parts, of a nature over which, being forbidden to bleed, we appeared to possess little or no power. Could we have drawn blood from the sides or breast, by cupping or by leeches, in any tolerable quantity, we might have had some control over the internal disease; but barred from this, and without any remedy save a counter-irritant, which we could not make act, or an internal medicine, whose action became extremely dubious, if not positively hurtful, what was to be done? I repeat, I made up my mind to experiment with the surgeon’s remedy in the same disease, namely, mercury; and that I have had reason to feel gratified at the result will, I think, appear from the following cases:—

‘Case I.—April 8. Every symptom of the prevailing epidemic: and considerably aggravated on the 10th, when the horse laboured under much prostration of strength, and staggered considerably in his gait. The

following ball was then ordered to be given him twice a day : ℞ Hydrag. chlorid. ℥i, farin. avenæ ℥ss. terebinth. vulg. q. s. ut fiat bol. One to be given morning and night. He soon began to improve; and was returned to the stable on the 26th, convalescent. A second patient of the same character was cured in eighteen days, and a third in nineteen days.' The author of this work had the pleasure of witnessing these cases.

Mr. Percivall adds, 'Lest it should be said, after the perusal of these three cases, that they do not appear to have been of a dangerous character, or to have required anything out of the ordinary line of treatment, I beg to observe, that at the periods at which I submitted them to the action of mercury, they so much resembled three others that had preceded them, and the disease had proved fatal, that, under a continuance of treatment of any ordinary kind, I certainly should have entertained fears for their safety.

'It must be remembered that they were cases in which blood-letting, except at the commencement, was altogether forbidden; and that at the critical period when mercury was introduced they had taken an unfavourable turn, and that nothing in the shape of remedy appeared available save internal medicine and counter-irritation, and that the latter had not and did not show results betokening the welfare of the patients. Under these circumstances the mercury was exhibited. That it entered the system, and must have had more or less influence on the disease, appears evident from its effect on the gums. That it proved the means of cure, I cannot, from so few cases, take upon myself to assert; but I would recommend it in similar cases to the notice of practitioners.'

#### THE MALIGNANT EPIDEMIC.

Continental veterinarians describe a malignant variety or termination of this disease, and the imperfect history of veterinary medicine in Britain is not without its records of it. So lately as the year 1815, an epidemic of a malignant character reigned among horses. Three out of five who were attacked died. It reappeared in 1823, but was not so fatal. It was said that the horses that died were ultimately farcied: the truth was, that swellings and ulcerations, with fetid discharge, appeared in various parts, or almost all over them—the natural swellings of the complaint which has just been considered, but aggravated and malignant. Our recollection of the classic lore of our early years will furnish us with instances of the same pest in distant times and countries. We have not forgotten the vivid description of Apollo darting his fiery arrows among the Greeks, and involving in one common destruction the human being, the mule, the horse, the ox, and the dog. Lucretius, when describing the plague at Athens, speaks of a malignant epidemic affecting almost every animal—

Nor longer birds at noon, nor beasts at night  
 Their native woods deserted; with the pest  
 Remote they languished, and full frequent died:  
 But chief the dog his generous strength resigned.

In 1714, a malignant epidemic was imported from the Continent, and in the course of a few months destroyed 70,000 horses and cattle. It continued to visit other countries, with but short intervals, for fifty years afterwards. Out of evil, however, came good. The continental agriculturists became alarmed by this destruction of their property. The different governments participated in the terror, and veterinary schools were established, in which the anatomy and diseases of these animals might be studied, and the cause and treatment of these periodical pests discovered. From the time that this branch of medical science began to receive the

attention it deserved, these epidemics, if they have not quite ceased, have changed their character, and have become comparatively mild and manageable. As, however, they yet occur, and are far too fatal, we must endeavour to collect the symptoms, and point out the treatment of them.

The malignant epidemic was almost uniformly ushered in by inflammation of the mucous membrane of the respiratory passages, but soon involving other portions, and then ensued a diarrhoea, which no art could arrest. The fever, acute at first, rapidly passed over, and was succeeded by great prostration of strength. The inflammation then spread to the cellular texture, and there was a peculiar disposition to the formation of phlegmonous tumours: sometimes there were pustular eruptions, but, oftener, deep-seated tumours rapidly proceeding to suppuration. Connected with this was a strong tendency to decomposition, and unless the animal was relieved by some critical flux or evacuation, malignant typhus was established, and the horse speedily sunk.

The most satisfactory account of one of these epidemics is given us by Professor Brugnone, of Turin. It commenced with loss of appetite, staring coat, a wild and wandering look, and a staggering from the very commencement. The horse would continually lie down and get up again, as if tormented by colic, and he gazed alternately at both flanks. In the moments of comparative ease, there were universal twitchings of the skin, and spasms of the limbs. The temperature of the ears and feet was variable. If there happened to be about the animal any old wound or scar from setoning or firing, it opened afresh and discharged a quantity of thick and black blood. Very shortly afterwards the flanks, which were quiet before, began to heave, the nostrils were dilated, the head extended for breath. The horse had by this time become so weak that, if he lay or fell down, he could rise no more; or if he was up, he would stand trembling, staggering, and threatening to fall every moment. The mouth was dry, the tongue white, and the breath foetid; a discharge of yellow or bloody foetid matter proceeded from the nose, and foetid blood from the anus. The duration of the disease did not usually exceed twelve or twenty-four hours; or if the animal lingered on, swellings of the head and throat, and sheath, and scrotum, followed, and he died exhausted or in convulsions.

Black spots of extravasation were found in the cellular membrane, in the tissue of all the membranes, and on the stomach. The mesenteric and lymphatic glands were engorged, black, and gangrenous. The membrane of the nose and the pharynx was highly injected, the lungs were filled with black and frothy blood, or with black and livid spots. The brain and its meninges were unaltered.

It commenced in March 1783. The barracks then contained one hundred and sixteen horses; all but thirteen were attacked, and seventy-eight of them died. The horses of both officers and men were subject to the attack of it; and three horses from the town died, two of which had drawn the carts that conveyed the carcasses away, and the other stood under a window, from which the dung of an infected stable had been thrown out. The disease would probably have spread, but the most summary measures for arresting its progress were adopted; every horse in the town was killed that had the slightest communication with those in the barracks. One horse was inoculated with the pus discharged from the ulcer of an infected horse, and he died. A portion of his thymus gland was introduced under the skin of another horse, and he also died.

*Cause.*—The disease was supposed to be connected with the food of the horses. All the oats had been consumed, and the *lolium temulentum*, or awned darnel, had been given instead. *It is said* that the darnel is occa-

sionally used by brewers to give an intoxicating quality to their malt liquor. For fifteen days no alteration of health was perceived, and then, in less than eighteen hours, nearly forty perished. The stables were not crowded, and there was no improper treatment. A man disinterred some of the horses to get at the fat; swellings rapidly appeared in his throat, and he died in two days. A portion of their flesh was given to two pigs and some dogs, and they died.

M. Brugnone found that bleeding only accelerated the death of the patient. He afterwards tried, and ineffectually, acids, cordials, purgatives, vesicatories, and the actual cautery; and he frankly attributes to the power of nature the recovery of the few who survived.

*Gilbert's Account of the Epidemic of 1795.* — M. Gilbert describes a malignant epidemic which appeared in Paris in 1795, characterised by dullness, loss of appetite, weakness, pulse at first rapid and full, and afterwards continuing rapid, but gradually becoming small, weak, and intermittent. The bowels at first constipated, and then violent purging succeeding. The weakness rapidly increasing, accompanied by fetid breath, and fetid evacuations. Tumours soon appeared about the limbs, under the chest, and in the head, the neck, and loins. If they suppurated and burst, the animal usually did well; but otherwise he inevitably perished. The formation of these tumours was critical. If they rapidly advanced, it was considered as a favourable symptom; but if they continued obscure, a fatal termination was prognosticated.

Bleeding, even in an early stage, seemed here also to be injurious, and increased the debility. Physic was given, and mild and nutritious food, gruel, and cordials. Deep incisions were made into the tumours, and the cautery applied. Stimulating frictions were also used, but all were of little avail.

These cases have been narrated at considerable length, in order to give some idea of the nature of this disease, and because, with the exception of a short but very excellent account of the malignant epidemic in the last edition of Mr. Blane's 'Veterinary Outlines,' there will not be found any satisfactory history of it in the writings of our English veterinarians. It is evidently a disease of the mucous membranes, both the respiratory and digestive. It is accompanied by early and great debility; loss of all vital power, vitiation of every secretion, effusions and tumours everywhere, and it runs its course with fearful rapidity. If it was seen at its outset, the practitioner would probably bleed; but if a few hours only had elapsed, he would find, with Messrs. Brugnone and Gilbert, that venesection would only hasten the catastrophe. Stimulants should be administered mingled with opium, and the spirit of nitric ether in doses of three or four ounces, with an ounce of laudanum. The quantity of opium should be regulated by the spasms and the diarrhoea. These medicines should be repeated in a few hours, combined, perhaps, with ginger and gentian.

A pint of stout or bitter ale, or better still, when within reach, of good old port wine, given three or four times a day, has saved many an animal which otherwise would have sunk prostrated under the virulence of the disease.

If these fail, there is little else to be done. Deep incisions into the tumours, or blisters over them, might be proper measures; but the principal attention should be directed to the arresting of the contagion. The diseased should be immediately removed from the healthy. All offensive matter should be carefully cleared away, and no small portion of chloride of lime used in washing the animal, and particularly his ulcers. It might with great propriety be administered internally, while the stable, and everything that belonged to the patient, should undergo a careful ablution with the same powerful disinfectant.

## BRONCHITIS.

This may be produced by several causes, such as sudden changes of temperature from hot to cold, and vice versâ. Excitement as a result of over-exertion will sometimes cause it, but it is not generally a primary disease. That inflammation of the superior respiratory passages, constituting catarrh, gradually creeps downwards and involves the larynx and the trachea, and at length, possibly, the farthest and the minutest ramifications of the air-tubes. When it is found to be thus advancing its progress should be carefully watched by the assistance of auscultation. The distant murmur of the healthy lung cannot be mistaken, nor the crepitating sound of pneumonia; and in bronchitis the blood may be heard filtering or breaking through the divisions of the lobuli, and accounting for that congestion or filling of the cells with mucus and blood, which is found after intense inflammation. Inflammation precedes this increased discharge of mucus. Even that may be detected. The inflamed membrane is thickened and tense. It assumes an almost cartilaginous structure, and the murmur is not only louder, but has a kind of snoring sound. Some have imagined that a sound like a metallic ring is mingled with it; but this is never very distinct.

The interrupted whizzing sound has often and clearly indicated a case of bronchitis, and there are many corroborative symptoms which should be regarded. The variable temperature of the extremities will be an important guide—not intensely cold as in pneumonia, nor of increased temperature as often in catarrh, but with a tendency to coldness, yet this varying much. The pulse will assist the diagnosis. It will be quick, but feeble, from 70 to 80 per minute,—more rapid than in catarrh, much more so than in the early stage of pneumonia; not so hard as in pleurisy, more so than in catarrh, and not oppressed as in pneumonia. The respiration should next be examined, abundantly more rapid than in catarrh, pneumonia, or pleurisy; generally as rapid and often more so than the pulse, and accompanied by a wheezing sound, heard at some distance. Mr. Percivall relates a case in which the respiration was more than one hundred in a minute. Mr. C. Percivall describes an interesting case in which the respiration was quick in the extreme; and he remarks, that he does ‘not remember to have seen a horse with his respiration so disturbed.’

In addition to these clearly characteristic symptoms, will be observed a haggard countenance, to which the anxious look of the horse labouring under inflammation of the lungs cannot for a moment be compared; also an evident dread of suffocation, expressed, not by inability to move, as in pneumonia, but frequently an obstinate refusal to do so; cough painful in the extreme; breath hot, yet no marked pain in the part, and no looking at the side or flanks.

As the disease proceeds there will be a short, frequent, pectoral cough, with considerable discharge from the nostrils, much more than in catarrh, because greater extent of membrane is affected. It will be muco-purulent at first, but will soon become amber-coloured or green, or greyish green; and that not from any portion of the food being returned, but from the peculiar hue of the secretion from ulcers in the bronchial passages. Small organised portions will mingle with the discharge,—shreds of mucus condensed and hardened, and forced from the inside of the tube. If the disease proceeds, the discharge becomes bloody, and then, and sometimes earlier, it is foetid.

The termination of this disease, if unchecked, is frequently pneumonia. Although we cannot trace the air-tubes to their termination, the inflammation will penetrate into the lobuli, and affect the

membranes of the air-cells or divisions which they contain. There is metastasis of inflammation oftener here than in pure pneumonia, and the disease is sometimes transferred to the feet. If, however, there is neither pneumonia nor metastasis of inflammation, and the disease pursues its course, the animal dies from suffocation. If the air-passages are clogged, there can be no supply of arterialised blood. If the inflammation be subdued, resolution may take place: but it far more frequently assumes a chronic form, giving rise to an imperfect state of breathing known as 'thick wind.'

Like every other inflammation of the respiratory passages, bronchitis is at times epidemic. There is a disposition to inflammation in the respiratory apparatus generally, but it depends on some unknown atmospheric influence whether this shall take on the form of catarrh, bronchitis, or pneumonia. It is not, however, contagious.

This is a disease of the mucous,—and an extended mucous,—surface; and while our measures must be prompt, there is a tendency to debility which we should never forget: therefore bleeding should not be had recourse to.

The medical attendant should be also cautious in the administration of *purgatives*, for the reasons that have again and again been stated: but if the bowels are evidently constipated, half a pint of oil may be given, and its speedy action promoted by injections, so that a small quantity may suffice. Sedatives should be employed, as  $\zeta i.$  to  $\zeta ij.$  of extract of belladonna, in combination with spirits of nitric ether and liquor ammoniæ acetatis. The animal should be placed in a warm, but well-ventilated stable, and the extremities kept warm by friction and flannel bandages.

A blister is always indicated in bronchitis. It can never do harm, and it not unfrequently affords decided relief. It should extend over the brisket and sides, and up the trachea to the larynx. The food, if the horse is disposed to eat, should be mashes. No corn should be offered, nor should the horse be coaxed to eat.

#### PNEUMONIA.—INFLAMMATION OF THE LUNGS.

The ultimate structure of the lungs has never till lately been satisfactorily demonstrated. They appear, however, to be composed of minute cells or pouches, into which the air is conducted, and over the delicate membrane constituting the divisions of which myriads of minute blood-vessels are ramifying. The blood is not merely permeating them, but it is undergoing a vital change in them; there is a constant decomposition of the air, or of the blood, or of both; and, during the excitement of exercise, that decomposition proceeds with fearful rapidity. Then it can readily be conceived that a membrane so delicate as this must be, in order that its interposition should be no hindrance to the arterialisation of the blood—so fragile also, and so loaded with blood-vessels—will be exceedingly subject to inflammation, and that of a most dangerous character.

Inflammation of the substance of the lungs is the not unfrequent consequence of all the diseases of the respiratory passages that have been treated on. Catarrh, influenza, bronchitis, if neglected or badly managed, or sometimes in spite of the most skilful treatment, will spread along the mucous membrane, and at length involve the termination of the air-passages. At other times, there is pure pneumonia. The cellular texture is the primary seat of inflammation. It is often so in the over-worked horse. After a long and hard day's hunt, it is very common for horses to be attacked by pure pneumonia. A prodigiously increased quantity of blood is hurried through these small vessels, for the vast expenditure of arterial blood in rapid progress must be provided for. These minutest of the capillaries are distended and irritated, their contractile power is

destroyed, inflammation is produced, mechanical injury is effected, the vessels are ruptured, blood is poured into the interstitial texture, and congestion and intense inflammation, with all their train of fatal consequences, ensue.

The following are the most frequent causes of pneumonia. A sudden transition from heat to cold; a change from a warm stable to a cold one; a neglect of the usual clothing; a neglect even of some little comforts; riding far and fast against a cold wind, especially in snowy weather; loitering about when unusual perspiration has been excited; waiting tediously by the side of a covert on a chilly blowing morning.

It has, but not frequently, happened that when horses have been turned out too early to grass, or without gradual preparation, pneumonia has supervened. Few are, under any management, so subject to pneumonia as those who, in poor condition and without preparation, are turned into a salt-marsh.

On the other hand, a sudden and considerable change from cold to heat will very probably be followed by inflammation of the lungs. Many horses perish in the dealers' stables from this cause. The circulation is considerably quickened; more blood, and that with more than natural rapidity, is driven through the lungs, previously disposed to take on inflammatory action. The sudden removal from a heated stable to the cold air has also much to do with the production of disease.

Whether it is the consequence of previous disease of the respiratory passages, or that inflammation first appears in the cellular texture of the lungs, pneumonia is usually ushered in by a shivering fit. The horse is cold all over; this, however, soon passes off, and we have general warmth, or heat of the skin above the usual temperature, but accompanied by coldness of the extremities—intense deadly coldness. This is a very diagnostic symptom. It will seldom deceive. It is an early symptom. It is found when there is little or no constitutional disturbance; when the pulse is scarcely affected, and the flanks heave but little, but the horse is merely supposed to be dull and off his food. It is that by which the progress of the disease may be unhesitatingly marked, when many scarcely suspect its existence.

The pulse is always, even at first, much increased in rapidity, but is rarely or never hard; it is obscure, oppressed; it rises at once from thirty-two or three to fifty; with increased danger it is found at seventy or eighty; and in fatal cases from one hundred to one hundred and twenty. The heart is labouring to accomplish its object; the circulation through the lungs is impeded; the vessels are engorged—they are often ruptured; blood is extravasated into the air-cells; it accumulates in the right side of the heart and in the larger vessels; and in the venous circulation generally there is a mechanical obstruction which the heart has not the power to overcome. Hence the obscure, oppressed pulse; the ineffectual attempt to urge on the blood; and hence, too, the remarkable result of bleeding in inflammation of the lungs, for the pulse becomes rounder, fuller, quicker. When blood is abstracted, a portion of the opposing force is removed, and the heart being enabled to accomplish its object, the pulse is developed.

It is only, however, in the early insidious stage that the flanks are occasionally quiet. If the compressibility of the lungs is diminished by the thickening of the membrane, or the engorgement of the vessels, or the filling of the cells, it will be harder work to force the air out; there must be a stronger effort, and the pressure which cannot be accomplished by one effort is attempted over and over again. The respiration is quickened—laborious: the inspiration is lengthened; the expiration is rapid; and when, after all, the lungs cannot be compressed by the usual means, every



muscle that can be brought to bear upon the part is called into action. Hence the horse will not lie down, for he can use the muscles of the spine and the shoulder with most advantage as he stands; hence, too, the very peculiar stiffness of position—the disinclination to move. The horse with decided pneumonia can scarcely be induced to move at all; he cannot spare for a moment the assistance which he derives from certain muscles, and he will continue obstinately to stand until he falls exhausted or dying. How eagerly does the veterinarian ask when he goes into the stable—‘Was he down last night?’ And he concludes that much progress has not been made towards amendment in the case when the answer is in the negative. When the patient, wearied out, lies down, it is only for a moment; for if the inflammation is not subdued, he cannot dispense with the auxiliary muscles. He frequently, and with doleful expression, looks at his sides—at one side or at both, accordingly as one or both are involved. There is not, however, the decidedly haggard countenance of bronchitis; and in bronchitis the horse rarely or never gazes at his flanks. His is a dread of suffocation more than a feeling of pain. The head is protruded, and the nostrils distended, and the mouth and the breath intensely hot. The nose is injected from the earliest period; and soon afterwards there is not merely injection, but the membrane is uniformly and intensely red. The variation in this intensity is anxiously marked by the observant practitioner; and he regards with fear and with despair the livid or dirty brownish hue that gradually creeps on. Pneumonia very rarely runs its course as a pure disease; the pleura very early becomes implicated, and pleuro-pneumonia more frequently attacks the horse than is generally imagined.

The unfavourable symptoms are, increased coldness of the ears and legs, if that be possible; partial sweats, evident weakness, staggering, the animal not lying down. The pulse becomes quicker, and weak and fluttering; the membrane of the nose paler, but of a dirty hue; the animal growing stupid, comatose. At length he falls, but he gets up immediately. For a while he is up and down almost every minute, until he is no longer able to rise; he struggles severely; the pulse becomes more rapid, fainter, and he dies of suffocation. The disease sometimes runs its course with strange rapidity. A horse has been destroyed by pure pneumonia in twelve hours. The vessels ramifying over the cells have yielded to the fearful impulse of the blood, and the lungs have presented one mass of congestion.

The favourable symptoms are, the return of warmth to the extremities—the circulation beginning again to assume its natural character, and, next to this, the lying down quietly and without uneasiness; showing us that he is beginning to do without the auxiliary muscles. These are good symptoms, and they will rarely deceive.

Congestion is a frequent termination of pneumonia. Not only are the vessels gorged—the congestion which accompanies common inflammation—but their parietes are necessarily so thin, in order that the change in the blood may take place although they are interposed, that they are easily ruptured, and the cells are filled with blood. This effused blood soon coagulates, and the lung, when cut into, presents a black, softened, pulpy kind of appearance, termed, by the farrier and the groom, *rotteness*, and being supposed by them to indicate an old disease. It proves only the violence of the disease, the rupture of many a vessel surcharged with blood; and it also proves that the disease is of recent date, for in no great length of time, the serous portion of the blood becomes absorbed, the more solid one becomes organised, the cells are obliterated, and the lungs are hepatised, or bear considerable resemblance to liver.

In every case of pneumonia early and anxious recourse should be had to

auscultation. Here again is the advantage of being perfectly acquainted with the deep distant murmur presented by the healthy lung. This sound is most distinct in the young horse, and especially if he is a little out of condition. On such a horse the tyro should commence his study of the exploration of the chest. There he will make himself best acquainted with the respiratory murmur in its full state of development. He should next take an older and somewhat fatter horse; he will there recognise the same sound, but fainter, more distant. In still older animals, there will sometimes be a little difficulty in detecting it at all. Repeated experiments of this kind will gradually teach the examiner what kind of healthy murmur he should expect from every horse that is presented to him, and thus he will be better able to appreciate the different sounds exhibited under disease.

If pneumonia exists to any considerable degree, this murmur is soon changed for, or mingled with, a curious crepitating sound, which, having been once heard, cannot afterwards be mistaken. Its loudness and perfect character will characterise the intensity of the disease, and the portion of the chest at which it can be distinguished will indicate its extent.

The whole lung, however, is not always affected, or there are only portions or patches of it in which the inflammation is so intense as to produce congestion and hepatisation. Enough remains either unaffected, or yet pervious for the function of respiration to be performed, and the animal lingers on, or perhaps recovers. By careful examination with the ear, this also may be ascertained. Where the lung is impervious—where no air passes—no sound will be heard, not even the natural murmur. Around it the murmur will be heard, and loudly. It will be a kind of rushing sound; for the same quantity of blood must be arterialised, and the air must pass more rapidly and forcibly through the remaining tubes. If there is considerable inflammation and tendency to congestion, the crepitating, crackling sound will be recognised, and in proportion to the intensity of the inflammation. The advantages to be derived from the study of auscultation are not overrated. It was strong language lately applied by an able critic to the use of auscultation, that 'it converts the organ of hearing into an organ of vision, enabling the listener to observe, with the clearness of ocular demonstration, the ravages which disease occasionally commits in the very centre of the rib-cased cavity of the body.'

A horse with any portion of the lungs hepatised cannot be sound. He cannot be capable of continued extra exertion. His imperfect and mutilated lung cannot supply the arterialised blood which long continued and rapid progression requires, and that portion which is compelled to do the work of the whole lung must be exposed to injury and inflammation from many a cause that would otherwise be harmless.

Another consequence of inflammation of the substance of the lungs is the formation of tubercles. A greater or smaller number of distinct cysts are formed—cells into which some fluid is poured in the progress of inflammation: these vary in size from a pin's point to a large egg. By degrees the fluid becomes concrete; and so it continues for a while—the consequence and the source of inflammation; this constitutes a tubercle. It occupies a space that should be employed in the function of respiration, and by its pressure it irritates the neighbouring parts, and disposes them to inflammation.

By and by, however, another process, never sufficiently explained, commences. The tubercle begins to soften at its centre,—a process of suppuration is set up, and proceeds until the contents of the cyst become again fluid, but of a different character, for they now consist of pus. This smooth defined collection of matter is called a vomica. The

pus increases ; the cyst becomes more and more distended ; it encroaches on the substance of the lungs ; it comes into contact with other vomicæ, and the walls opposed to each other are absorbed by their mutual pressure ; they run together, and form one cyst, or regular excavation, and this sometimes proceeds until a considerable portion of the lung is, as it were, hollowed out. By and by, however, the vomicæ press upon some bronchial passage ; the cyst gives way, and the purulent contents are poured into the bronchiæ, and got rid of by the act of coughing. At other times the quantity is too great to be thus disposed of, and the animal is suffocated. Occasionally it will break through the pleuritic covering of the lung, and pour its contents into the thorax.

Abscesses may form in the lungs undiscovered.—It is scarcely conceivable to what extent they sometimes exist in animals of slow work, without being detected by the usual means of examination. Mr. Hales says that he gave a physic ball to a cart-mare with a bad foot, and she soon afterwards died suddenly. When inquiring as to the cause of death, he was told, and not very good-humouredly, that his physic had killed her. He asked, if it had purged her violently? 'No!' it was replied, 'it had not operated at all.' She was opened, and the mystery was all unravelled. The thorax was deluged with pus, and there were then in the lungs several large abscesses, one of which contained at least a quart of pus. The mare had not shown a symptom of chest affection, and the gentleman to whom she belonged declared that he had believed her to be as sound as any horse he had in his possession.

The resolution or gradual abatement of inflammation is the termination most to be desired in this disease, for then the engorgement of the vessels will gradually cease, and the thickening of the membrane and the interstitial deposit be taken up, and the effusion into the cells likewise absorbed, and the lungs will gradually resume their former cellular texture, yet not perfectly ; for there will be some induration, slight but general ; or some more perfect induration of certain parts ; or the rupture of some of the air-cells ; or an irritability of membrane predisposing to renewed inflammation. The horse will not always be as useful as before ; there may be chronic cough, thick wind, broken wind ; but these merit distinct consideration ; and, for the present, we proceed to the treatment of pneumonia.

Our treatment will much depend upon the causes in operation producing the disease, and the progress it has made. If the animal be only in the early stage, every means should be adopted to encourage the circulation ; a diffusible stimulant, such as one or two ounces of the spirit of nitric ether combined with eight ounces of the liquor ammoniæ acetatis, the ammonia being in excess, should be at once administered, a mustard liniment well rubbed on the bosom and sides, and great attention paid to keeping the external surface of the body warm. If the symptoms of inflammation appear to increase by the pulse rising to seventy or eighty per minute, and the breathing being increased and laboured, more active treatment must be adopted. We must bear in mind that there is inflammation of that organ through which all the blood in the frame passes—that organ most of all subject to congestion. Then nothing can be so important as to lessen the quantity of blood which the heart is endeavouring to force through the minute vessels of the lungs, distended, irritated, breaking. Immediate recourse must be had to the lancet, and the stream of blood must be suffered to flow on until the pulse falters, and the animal bears heavy upon the pail. The blood must be extracted as quickly as possible, and the lancet should be broad-shouldered and the orifice large. This is the secret of treating inflammation of a vital organ. The disease is

weakened or destroyed without permanently impairing the strength of the patient; whereas by small bleedings, and with a small stream, the strength of the patient is sapped, while the disease remains untouched.

From the debilitating form diseases of the respiratory system are apt to assume, many practitioners never resort to blood-letting in this disease, and there cannot be a doubt that it should be cautiously adopted, and only in those cases in which the attack is sudden and violent, and the animal's general condition in a state to bear it. In all cases of pneumonia resulting from influenza, fever, and other debilitating diseases, bleeding would only hasten a fatal termination. When blood-letting is found necessary it should be copious, taken as rapidly as possible, and not repeated.

Next comes purging, if we dared; for by having recourse to it some cause of excitement would be got rid of, the circulating fluid would be lessened, and a new determination of the vital current produced; but experience teaches, that in pneumonia there is so much sympathy with the abdominal viscera,—there is such a fatal tendency in the inflammation to spread over every mucous membrane, that purging is almost to a certainty followed by inflammation, and that inflammation bids defiance to every attempt to arrest it. It may be said with perfect confidence that, in the majority of cases, a dose of physic would be a dose of poison to a horse labouring under pneumonia.

May we not relax the bowels? Yes, if we can stop there. We may, after the inflammation has evidently a little subsided, venture upon, yet very cautiously, small doses of aloes in our fever medicine, and we may quicken their operation by frequent injections of warm soap and water; omitting the purgative, however, the moment the feces are becoming pul-taceous. We must, however, be assured that the inflammation is subsiding, and there must be considerable constipation, or the purgative had better be let alone.

If we must not give physic, we must endeavour to find some other auxiliary to the bleeding, and we have it in *nitre*, *emetic tartar*, the *spirits of nitric ether*, and the extract of *belladonna*, which has been so often recommended.

The greatest care should be taken with the patient labouring under this complaint. His legs should be well hand-rubbed, in order to restore, if possible, the circulation to the extremities; and a liniment composed of equal parts of water of ammonia, spirits of turpentine, and soap liniment will materially assist this. Comfortable flannel bandages should encase the legs from the foot to the knee. He should be covered up warm. There cannot be a doubt about this. As for air, he cannot have too much. In cold weather his box must be airy, but not chilly. We want to determine the blood to the extremities and the skin; but not all the clothing in the world will keep our patient warm, if he is placed in a cold and uncomfortable situation.

As for food, we think not of it. In nine cases out of ten he will not touch anything; or if he is inclined to eat, we give him nothing but a bran-mash, or a little green meat, or a few carrots.

We now look about us for some counter-irritant. We wish to excite some powerful action in another part of the frame, and which shall divert the current of blood from that which was first affected. We recognise it as a law of nature, and of which we here eagerly avail ourselves, that if we have a morbid action in some vital organ—and unusual determination of blood to it—we can abate, perhaps we can at once arrest, that morbid action by exciting a similar or a greater disturbance in some contiguous and not dangerous part. Therefore we blister the sides and the brisket, and produce all the irritation we can on the integument; and in pro-

portion as we do so, we abate, or stand a chance of abating, the inflammation within.

We have recourse to a blister in preference to a seton ; and decidedly so, for our stimulus can be spread over a larger surface,—there is more chance of its being applied to the immediate neighbourhood of the original inflammation—and most assuredly, from the extent of surface on which we can act, we can employ a quantity of stimulus beyond comparison greater than a seton would permit us to do. The first blister should be applied to the brisket ; the whole of the front of the chest, from the throat to well down between the fore-legs, should be included, and the blister well rubbed in for at least ten minutes or a quarter of an hour. The result of this will be extensive swelling and bagging of the skin between the fore-legs, from the large effusion of serum that is poured out into the cellular tissue under the loose skin. One or two long setons, the entire depth of the chest, may be inserted at the same time, and become valuable drains for the effused fluid. The next day a blister, large and extensive, should be applied on each side of the chest, immediately behind the elbows, of at least a foot each in diameter.

In the *latter* stage of disease the blister will not act, because the powers of nature are exhausted. We must repeat it,—we must rouse the sinking energies of the frame, if we can, although the effort will generally be fruitless. The not rising of a blister, in the latter stage of the disease, may too often be regarded as the precursor of death, especially if it is accompanied by a livid or brown colour of the membrane of the nose. Should the usual blisters fail to act, they should be washed off, and the tartar-emetic ointment well rubbed in in their place. This ointment, composed of a drachm of tartar emetic to an ounce of lard, will rouse the action of the skin when every other application would be impotent. No case, indeed, should be allowed to proceed to a fatal termination,—the blisters having failed to operate,—without this powerful counter-irritant being had recourse to.

Pneumonia, like bronchitis, requires anxious watching. The first object is to subdue the inflammation, and our measures must be prompt and decisive. The good which we can do must be done at first, or not at all.

The commencement of the state of convalescence requires the same guarded practice as in bronchitis. As many horses are lost by impatience now, as by want of decision at first. If we have subdued the disease we should let well alone. We should guard against the return of the foe by the continued administration of our sedatives in smaller quantities, and give tonics if debility is rapidly succeeding. When we have apparently weathered the storm, we must still be cautious ; we must consider the nature and the seat of the disease, and the predisposition to returning inflammation. If the season will permit, two or three months' run at grass should succeed to our medical treatment ; but if this is impracticable, we must put off the period not only of active work but of lengthened exercise as long as it can be delayed, and even after that permit the horse to return as gradually as may be to his usual employment and food.

Most frequent in occurrence, in connection with inflammation of the lungs, is

#### PLEURISY.

This disease of the investing membrane of the lungs and of the thoracic cavity, namely the pleura, next demands our attention.

The prevailing causes of pleurisy are the same as those which produce pneumonia—exposure to wet and cold, sudden alternations of temperature, partial exposure to draughts of cold air, riding against a keen wind,

immersion as high as the chest in cold water, and extra work of the respiratory machine. To these may be added—wounds penetrating into the thorax and lacerating the pleura, fracture of the ribs, or violent contusions on the side, the inflammation produced by which is propagated through the parietes of the chest.

It is sometimes confined to one side or to one of the pleuræ on either side, or even to patches on that pleura, whether pulmonary or costal. The inflammation of the lungs which occasionally accompanies rabies is characterised by a singular patchy appearance. That produced on the costal pleura, arising from violence or other causes, rarely reaches the pulmonary covering; and that which is communicated to the tunica of the lungs, by means of the intensity of the action within, does not often involve the costal pleura. In some cases, however, it affects both pleuræ and both sides, and spreads rapidly from one to the other.

The first symptom is *rigor*, followed by increased heat and partial sweats; to these succeed loss of appetite and spirits, and a low and painful cough. The inspiration is a short sudden effort, and broken off before it is fully accomplished, indicating the pain felt from the distension of the irritable because inflamed membrane. This symptom is exceedingly characteristic. In the human being it is well expressed by the term *stitch*, and an exceedingly painful feeling it is. The expiration is retarded, as much as possible, by the use of all the auxiliary muscles which the animal can press into the service, but it at length finishes abruptly in a kind of spasm. This peculiarity of breathing, once carefully observed, cannot be forgotten. The next character is found in the tenderness of the sides when the costal pleura is affected. This tenderness often exists to a degree scarcely credible. If the side is pressed upon the horse will recede with a low painful grunt; he will tremble, and try to get out of the way before the hand touches him again. The attempt to turn him short, or quickly round, will produce the same effect. Then comes another indication, both of pain and the region of that pain,—the intercostal muscles affected by the contiguous pleura, and in their turn affecting the panniculus carnosus or subcutaneous muscular expansion without—there are twitchings of the skin on the side—corrugations—waves creeping over the integument. This is never seen in pneumonia. There is however, as we may expect, the same disinclination to move, for every motion must give intense pain.

The pulse should be anxiously studied. It presents a decided difference of character from that of pneumonia. It is increased in rapidity, but instead of being oppressed, and sometimes almost unappreciable, as in pneumonia, it is round, full, and strong. Even at the last, when the strength of the constitution begins to yield, the pulse is wiry, although small.

The extremities are never deathly cold; they may be cool, they are oftener variable, and they sometimes present increased heat. The body is far more liable to variations of temperature; and the cold and the hot fit more frequently succeed each other. The mouth is not so hot as in pneumonia, and the breath is rarely above its usual temperature.

A difference of character in the two diseases is here particularly evident on the membrane of the nose. Neither the crimson nor the purple injection of pneumonia is seen on the lining of the nose, but a somewhat darker dingier hue.

Both the pneumonic and pleuritic horse will look at his flanks, thus pointing out the seat of disease and pain; but the horse with pneumonia will turn himself more slowly round, and long and steadfastly gaze at his side, while the action of the horse with pleurisy is more sudden, agitated, spasmodic. The countenance of the one is that of settled distress; the other brightens up occasionally. The pang is severe, but it is transient,

and there are intervals of relief. While neither will lie down or willingly move, and the pneumonic horse stands fixed as a statue, the pleuritic one shrinks and crouches almost to falling. If he lies down it is on the affected side, when the disease is confined to one side only. The head of the horse, with inflammation of the substance of the lungs, hangs heavily—that of the other is protruded.

We here derive most important assistance from *Auscultation*. In a case of pleurisy we have no crepitating crackling sound, referable to the infiltration of the blood through the gossamer membrane of the air-cells; we have not even a louder and distincter murmur. Perhaps there is no variation from the sound of health, or, if there is any difference, the murmur is fainter; for the pleural membrane is thickened and its elasticity is impaired, and the sound is not so readily transmitted. There is sometimes a slight rubbing sound, and especially towards the superior region of the chest, as if there was friction between the thickened and indurated membranes.

To this may be added the different character of the cough, sore and painful enough in both, but in pneumonia generally hard, and full, and frequent. In pleurisy it is not so frequent, but faint, suppressed, cut short, and attended by a thin ichorous discharge dropping from the nose.

These are sufficient guides in the early stage of the disease, when it is most of all of importance to distinguish the one from the other. Pleurisy more frequently exists in a purer form than pneumonia, for every now and then death is the result solely of suffocation, but in most cases the structure of the lungs is implicated to a greater or less extent.

If after a few days the breathing becomes a little more natural, the inspiration lengthened and regular, and the expiration, although still prolonged, is suffered to be completed—if the twitchings are less evident and less frequent—if the cough can be fully expressed—if the pulse softens, although it may not diminish in frequency, and if the animal begins to lie down, or walks about of his own accord, there is hope of recovery. But if the pulse quickens and, although smaller, yet possesses the wiry character of inflammation—if the gaze at the flanks, previously by starts, becomes fixed as well as anxious, and the difficulty of breathing continues (the difficulty of *accomplishing* it, although the efforts are oftener repeated)—if patches of sweat break out, and the animal gets restless—paws—shifts his posture every minute—is unable longer to stand yet hesitates whether he shall lie down—determines on it again and again, but fears, and at length drops rather than lies gently down, a fatal termination is at hand.

The most frequent cause of death is effusion in the chest (hydrothorax), compressing the lungs on every side, rendering expiration difficult and at length impossible, and destroying the animal by suffocation. For some time before his death the effusion and extent will be evident enough. The violence of the symptoms will suddenly abate, the pulse falling from eighty or ninety to forty or fifty, and in some cases becoming softer in its character. The membranes also will assume a pale colour as the effusion increases. The animal not only walks unwillingly, but on the slightest exercise his pulse is strangely accelerated; the feeling of suffocation comes over him, and he stops suddenly, looks wildly about, and trembles; but he quickly recovers himself, and proceeds. There is frequently also, when the effusion is confirmed, œdema of some external part, and that occasionally to a very great extent. This is oftenest observed in the abdomen, the chest, and the point of the breast. The very commencement of effusion may be detected by auscultation. There will be the cessation of the respiratory murmur at the sternum, and the increased grating—not the crepitating

crackling noise as when congestion is going on—not the febler murmur as congestion advances, but the absence of it, beginning from the bottom of the chest.

It is painfully interesting to watch the progress of the effusion—how the stillness creeps up, and the murmur gets louder above, and the grating sound louder too, until at length there is no longer room for the lungs to play, and suffocation ensues.

The fluid contained in the chest varies in quantity as well as appearance and consistence. Many gallons have been found in the two sacs, pale or yellow or bloody, often differing in the two sides or the thorax—occasionally a thick adventitious coat covering the costal or the pulmonary pleura—rarely much adhesion, but the lungs purple-coloured, flaccid, compressed, not one-fourth of their usual size, immersed in the fluid, and rendered incapable of expanding by its pressure.

Here, as in pneumonia, the bleeding should be prompt and copious. Next, and of great importance, aperient medicine should be administered—that, the effect of which is so desirable, but which we do not dare to give when the mucous membrane of the respiratory passages is the seat of disease. Here we have to do with a serous membrane, and there is less sympathy with the mucous membranes of either cavity. Small doses of aloes should be given with the usual fever-medicine, and repeated morning and night until the dung becomes pultaceous, when it will always be prudent to stop. The sedative medicine is that which has been recommended in pneumonia, and in the same doses. Next should follow *a blister* on the chest and sides. It is far preferable to setons, for it can be brought almost into contact with the inflamed surface, and extended over the whole of that surface. An airy, but a comfortable box, is likewise even more necessary than in pneumonia, but the practice of exposure, uncovered, to the cold is both absurd and destructive. The blood, repelled from the skin by the contractile, depressing influence of the cold, would rush with fatal impetus to the neighbouring membrane, to which it was before dangerously determined. Warm and comfortable clothing cannot be dispensed with in pleurisy.

The sedative medicines, however, should be omitted much sooner than in pneumonia, and succeeded by diuretics. The common turpentine is as good as any, made into a ball with linseed-meal, and given in doses of two or three drachms twice in the day. If the constitution is much impaired, tonics may be cautiously given, as soon as the violence of the disease is abated. The spirit of nitrous ether is a mild stimulant and a diuretic. Small quantities of gentian and ginger may be added, but the turpentine must not be omitted.

There is in pleurisy a far greater tendency to relapse than in pneumonia. The lungs do not perfectly recover from their state of collapse, nor the serous membrane from its long maceration in the effused fluid: oedema, cough, disinclination to work, incapability of rapid progression, colicky pains, as the unobservant practitioner would call them, but in truth pleuritic stitches—these are the frequent sequelæ of pleurisy. This will afford another reason why the important operation of paracentesis should not be deferred too long.

There is much greater disposition to metastasis than in pneumonia: indeed, it is easy to imagine that the inflammation of a mere membrane may more readily and oftener shift than that of the substance of so large a viscus as the lungs. The inflammation, shifting its first ground, attacks almost every part indiscriminately, and appears under a strangely puzzling variety of forms. Dropsy is the most frequent change. Effusion in the abdomen is substituted for that of the chest, or rather the exhalant or absorbent



vessels of the abdomen, or both of them, soon sympathise in the debility of those of the thorax.

### PHTHISIS PULMONALIS, OR CONSUMPTION.

When describing the accompaniments and consequences of inflammation of the lungs in the horse, mention was made of this fatal complaint. It is usually connected with or the consequence of pneumonia or pleurisy, and especially in horses of a peculiar formation or temperament.

If a narrow-chested, flat-sided horse is attacked with inflammation of the lungs, or severe catarrhal fever, experience tells us that we shall have more difficulty in subduing the disease in him, than in one deeper in the girth or rounder in the chest. The lungs, deficient in bulk according to the diminished contents of the chest, have been overworked in supplying the quantity of arterial blood expended in the various purposes of life, and particularly that which has been required under unusual and violent exertion. Inflammation of the lungs has consequently ensued, and that inflammatory action has acquired an intense character under circumstances by which another horse would be scarcely affected.

When this disease has been properly treated, and apparently subdued, the horse cannot be quickly and summarily dismissed to his work. He is sadly emaciated — he long continues so — his coat stares — his skin clings to his ribs — his belly is tucked up, notwithstanding that he may have plenty of mashes and carrots, and green meat and medicine — his former gaiety of spirit does not return, or if he is willing to work he is easily tired, sweating on the least exertion, and the sweat most profuse about the chest and sides — his appetite is not restored, or, perhaps, never has been good, and the slightest exertion puts him completely off his feed.

We observe him more attentively, and even as he stands quiet in his stall, the flanks heave a little more laboriously than they should do, and that heaving is painfully quickened when sudden exertion is required. He coughs sorely, and discharges from the nose a mucus tinged with blood, or a fluid decidedly purulent — the breath becomes offensive — the pulse is strangely increased by the slightest exertion.

When many of these symptoms are developed, the animal will exhibit considerable pain on being gently struck on some part of the chest; the cough then becomes more frequent and painful; the discharge from the nose more abundant and foetid, and the emaciation and consequent debility more rapid, until death closes the scene.

The lesions that are presented after death are very uncertain. Generally there are tubercles — sometimes very minute, at other times large in size. They are in different states of softening, and some of them, having suppurated, burst into the bronchial passages, and exhibit abscesses of enormous bulk. Other portions of the lungs are shrunk, flaccid, indurated or hepatised, and of a pale or red-brown colour; and there are occasional adhesions between the lungs and the sides of the chest.

Is this an hereditary disease? There is some difficulty in deciding the point. It has been scarcely mooted among horsemen. One thing only is known — that the side has been flat, and the belly tucked up, and the animal has had much more ardour and willingness than physical strength. These conformations and this disposition we know to be hereditary, and thus far phthisis may be said to be so too. Low and damp situations, or a variable and ungenial climate, may render horses peculiarly susceptible of chest-affections. All the absurd or cruel or accidental causes of pneumonia lay the foundation for phthisis; and, particularly, those causes which tend to debilitate the frame generally, render the horse more liable to chest-affections, and less able to ward off their fatal consequences. The

most numerous instances of phthisis occur in those poor persecuted animals that are worn-out before their time, and they are frequent enough among cavalry horses after the deprivations and fatigues of a long campaign.

What is the medical treatment of confirmed phthisis? The practitioner must be guided by circumstances. If the horse is not very bad, and it is the spring of the year, *a run at grass* may be tried. It will generally seem to renovate the animal, but the apparent amelioration is too often treacherous. It should always be tried, for it is the best foundation for other treatment. The summer, however, having set in, the medicinal effect of the grass ceases, and the flies tease and irritate the animal.

The medical treatment, if any is tried, should consist of *counter-irritants*; they will rarely do harm. They should be applied in the form of blisters, extending over the sides, and thus brought as near as possible to the affected part.

*Sedative medicines* should be perseveringly administered; belladonna should be given in small doses, and the strength of the constitution maintained by a continued exhibition of tonic medicine. *Nitre* may be added as a diuretic, and *pulvis antimonialis* as a diaphoretic.

The tonic effect of mild and nutritious food—green meat of almost every kind (carrots particularly), mash, and now and then a malt mash—will be found of great service. Nothing further than this? We may try, but very cautiously, those tonics which stimulate the digestive system yet comparatively little affect the circulatory one. Small doses of ginger and gentian may be given, but should be carefully watched, and omitted if the flanks should heave more, or the cough be aggravated; but the safest tonic that can be had recourse to is the sulphate of iron, commonly known as green vitriol; half an ounce of this may be given, dissolved in the water, morning and evening.

The treatment of phthisis is a most unsatisfactory subject of consideration as it regards the practice of the veterinarian. If after the human being has been subjected to medical treatment, for a long course of time and at very considerable expense, he so far recovers that life is rendered tolerably comfortable to him, he and his connections are thankful and satisfied, and he will submit to many a privation in order to ward off the return of a disease, to which he is conscious there will ever be a strong predisposition; but the case is different with the horse, and this, the scope and bound of the human practitioner's hope, is worthless to the veterinarian. His patient must not only live but must be *sound* again. Every energy, every capability, must be restored. Can we cause the tubercles to be absorbed? Can we disperse or dispel the hepatisation? Can we remodel the disorganised structure of the lungs? Our consideration, then, will be chiefly directed to the detection of the disease in its earliest state, and the allaying of the irritation which causes or accompanies the growth of the tubercles. This must be the scope and bound of the veterinarian's practice—always remembering that the owner should be forewarned of the general hopelessness of the case, and that the continuance of his efforts should be regulated by the wish of the proprietor and the value of the patient.

#### CHRONIC COUGH.

It would occupy more space than can be devoted to this part of our subject to treat of all the causes of obstinate cough. The irritability of so great a portion of the air-passages, occasioned by previous and violent inflammation of them, is the most frequent. It is sometimes connected with worms. There is much sympathy between the lungs and the intestines, and the one readily participates in the irritation produced in the

other. That it is caused by glanders can be easily imagined, because that disease is, in its early stage, seated in or near the principal air-passages, and little time passes before the lungs become affected. It is the necessary attendant of thick-wind and broken-wind, for these proceed from alterations of the structure of the lungs.

Notwithstanding the clearness of the cause, the cure is not so evident. If a harsh hollow cough is accompanied by a staring coat and the appearance of worms, a few worm-balls may expel these parasites, and remove the irritation of the intestinal canal. If it proceeds from irritability of the air-passages—which will be discovered by the horse coughing after drinking, or when he first goes out of the stable in the morning, or by his occasionally snorting out thick mucus from the nose—medicines may be given, and sometimes with advantage, to diminish irritation generally. Small doses of belladonna, or tartar emetic, and nitre, administered every night, frequently have a beneficial effect. These balls should, if necessary, be regularly given for a considerable time; they are sufficiently powerful to quiet slight excitement of this kind, but not to nauseate the horse, or interfere with his food or his work. A blister, extending from the root of one ear to that of the other, taking in the whole of the channel, and reaching six or eight inches down the windpipe, has been tried, and often with good effect, on the supposition that the irritation may exist in the fauces or the larynx. The blister has sometimes been extended through the whole course of the windpipe, until it enters the chest.

Feeding has much influence on this complaint. Too much dry meat, and especially chaff, increases it. It is aggravated when the horse is suffered to eat his litter, and it is often relieved when spring-tares are given. Carrots afford decided relief.

The seat of the disease, however, is so uncertain, and all our means and appliances so inefficacious, and the cough itself so little interfering, and sometimes interfering not at all, with the health of the animal, that it is scarcely worth while to persevere in any mode of treatment that is not evidently attended with benefit. The principal consideration to induce us to meddle at all with chronic cough is the knowledge that horses afflicted with it are more liable than others to be affected by changes of temperature, and that inflammation of the lungs, or of the respiratory passages, often assumes in them a very alarming character; to which may be added, that a horse with chronic cough cannot be warranted sound.

When chronic cough chiefly occurs after eating, the seat of the disease is evidently in the substance of the lungs. The stomach distended with food presses upon the diaphragm, and the diaphragm upon the lungs; and the lungs, already labouring under some congestion, are less capable of transmitting the air. In the violent effort to discharge their function, irritation is produced, and the act of coughing is the consequence of that irritation.

The Veterinary Surgeon labours under great disadvantage in the treatment of his patients. He must not only subdue the malady, but he must remove all its consequences. *He must leave his patient perfectly sound, or he has done comparatively nothing.* This is a task always difficult and sometimes impossible to be accomplished. The two most frequent consequences of severe chest-affections in the horse are recognised under the terms *thick-wind* and *broken-wind*. The breathing is hurried in both, and the horse is generally much distressed when put upon his speed; but it is simply quick breathing in the first, with a peculiar sound like *half-roaring*—the inspirations and expirations being rapid, forcible, but equal. In the second the breathing is also hurried, but the inspiration does not differ materially from the natural one, while the expiration is difficult, or doubly

laborious. The changes of structure which accompany these states of morbid respiration are as opposite as can be imagined. Induration of the substance of the lungs, diminution of the number or the caliber of the air-passages, are the causes of *thick-wind*. If the portion of lung employed is lessened, or the bronchial tubes will not admit so much air, the quick succession of efforts must make up for the diminished effect produced by each. In *broken-wind* there is rupture of the air-cells, and an unnatural intercommunication between them in the same lobule, or between those of the neighbouring lobuli. The structure of the lung, and the discharge of function, and the treatment too, being so different, these diseases require separate consideration.

#### THICK-WIND.

When treating of pneumonia, it was observed, that not only are the vessels which ramify over the delicate membrane of the air-cells gorged with blood, but they are sometimes ruptured, and the cells are filled with blood. The black, softened, pulpy appearance of the lungs thus produced, is the *rottenness* of the groom and farrier, proving equally the intensity of the inflammation and that it is of recent date. If the horse is not speedily destroyed by this lesion of the substance of the lungs, the serous portion of the effused blood is absorbed, and the solid becomes organised. The cells are obliterated, and the lung is *hepatised*,—its structure bears considerable resemblance to that of the liver. This may occur in patches, or it may involve a considerable portion of the lung.

If a portion of the lung is thus rendered impervious, the remainder will have additional work to perform. The same quantity of blood must be supplied with air; and if the working part of the machine is diminished, it must move with greater velocity as well as force—the respiration must be quicker and more laborious. This quick and laboured breathing can be detected even when the animal is at rest, and it is indicated plainly enough by his sad distress when he is urged to unusual or continued speed. The inspirations and the expirations are shorter as well as more violent—the air must be more rapidly admitted and more thoroughly pressed out, and this is accompanied by a peculiar sound that can rarely be mistaken.

We may guess at the commencement of the evil by the laborious heaving of the flanks, but by auscultation alone can we *ascertain* its progress. The increase of the crepitus will tell us that the mischief is beginning, and the cessation of the murmur will clearly mark out its extent.

The inflammatory stage of the disease having passed, and comparative health being restored, and some return to usefulness having been established,—the horse being now *thick-winded*, auscultation will be far more valuable than is generally imagined. It will faithfully indicate the quantity of hepatisation, and so give a clue to the degree of usefulness, or the extent to which we may tax the respiratory system; and it will also serve to distinguish, and that very clearly, between the cause of *thick-wind*, and the morbid changes that may have resulted from bronchitis, or thickening of the parietes of the air-passages, and not the obliteration of the air-cells.

Of the *Treatment* little can be said. We know not by what means we can excite the absorbents to take up the solid organised mass of hepatisation, or restore the membrane of the cells and the minute vessels ramifying over them, now confounded and lost. We have a somewhat better chance, and yet not much, in removing the thickening of the membrane; for counter-irritants, extensively and perseveringly applied to the external parietes of the chest, may do something. If thick-wind immediate'y

followed bronchitis, it would certainly be justifiable practice to blister the brisket and sides, and that repeatedly; and to administer purgatives if we dared, or diuretics, more effectual than the purgatives and always safe.

Our attention must be principally confined to diet and management. A thick-winded horse should have his full proportion, or rather more than his proportion, of corn and beans, and a diminished quantity of less nutritious food, in order that the stomach may never be overloaded, and press upon the diaphragm, and so upon the lungs, and increase the labour of these already overworked organs. Particular care should be taken that the horse is not worked immediately after a full meal; the overcoming of the pressure and weight of the stomach will be a serious addition to the extra work which the lungs already have to perform from their altered structure.

Something may be done in the *palliation* of thick-wind, and more than has been generally supposed, by means of exercise. If the thick-winded horse is put, as it were, into a regular system of training—if he is daily exercised to the fair extent of his power, and without seriously distressing him, his breathing will become freer and deeper, and his wind will materially improve. We shall call to our aid one of the most powerful excitants of the absorbent system—pressure, that of the air upon the tube—the working part of the lung upon the disorganised; and adjusting this so as not to excite irritation or inflammation, we may sometimes do wonders. This is the very secret of training, and the power and the durability of the hunter and the racer depends entirely upon this.

Thick-wind, however, is not always the consequence of disease. There are certain cloddy round-chested horses that are naturally thick-winded, at least to a certain extent. They are capable of that slow exertion for which nature designed them, but they are immediately distressed if put a little out of their usual pace. A circular chest, whether the horse is large or small, indicates thick-wind. The circular chest is a capacious one, and the lungs which fill it are large; and they supply sufficient arterialised blood to produce plenty of flesh and fat, and these horses are always fat. This is the point of proof to which we look when all that we want from the animal is flesh and fat; but the expanding form of the chest is that which we require in the animal of speed—the deep as well as the broad chest—always capacious for the purpose of muscular strength, and becoming considerably more so when arterialised blood is rapidly expended in quick progression. We cannot enlarge the capacity of a circle; and if more blood is to be furnished, that which cannot be done by increase of surface must be accomplished by frequency of action. Therefore it is that many of our heavy draught-horses are thick-winded. It is of little detriment to them, for their work is slow—or rather it is an advantage to them; for the circular chest, always at its greatest capacity, enables them to acquire that weight which is so advantageous for them to throw into the collar.

#### BROKEN-WIND.

This is immediately recognisable by the manner of breathing. The inspiration is performed in somewhat less than the natural time, and without an increased degree of labour: but the expiration has a peculiar difficulty accompanying it. It is accomplished by a double effort, in the first of which, as Mr. Blaine has well explained it, 'the usual muscles operate: and in the other the auxiliary muscles, particularly the abdominal, are put on the stretch to complete the expulsion more perfectly; and, that being done, the flank falls, or the abdominal muscles relax with a kind of jerk or spasm.'

The majority of veterinary surgeons attribute broken-wind to an emphysematous state of the lungs. In almost every broken-winded horse which has been examined after death, there has been found dilatation of some of the air-cells, and particularly towards the edges of the lobes. There has been rupture through the parietes of some of the cells, and they have evidently communicated with one another, and the air could be easily forced from one portion of the cells to another. There was also a crepitating noise while this pressure was made, as if the attenuated membrane of some of the cells had given way. These were the true broken cells, and hence the derivation of the name of the disease.

Broken-wind is preceded or accompanied by cough—a cough perfectly characteristic, and by which the horseman would, in the dark, detect the existence of the disease. It is short, suppressed, and hollow, increased when the animal is feeding, or exposed to variations of temperature. When the animal is suddenly struck or threatened, there is a low grunt of the same nature as that of roaring, but not so loud. Broken-wind is usually preceded by cough; the cough becomes chronic, leads on to thick-wind, and then there is but a step to broken-wind. It is the consequence of the cough which accompanies catarrh and bronchitis oftener than that attending or following pneumonia, and of inflammation and, probably, thickening of the membrane of the bronchiæ, rather than of congestion of the air-cells.

Laennec, whose illustrations of the diseases of the chest are invaluable to the human surgeon, comes to our assistance, and, while describing emphysema of the lungs of the human being, gives us an explication of broken-wind more satisfactory than is to be found in any of our veterinary writers. He attributes what he calls dry catarrh 'to the partial obstruction of the smaller bronchial tubes, by the swelling of their inner membrane. The muscles of inspiration are numerous and powerful, while expiration is chiefly left to the elasticity of the parts; then it may happen that the air, which during inspiration had overcome the resistance opposed to its entrance by the tumid state of the membrane, is unable to force its way through the same obstacle during expiration, and remains imprisoned in the cells, as it were, by a valve. The succeeding inspirations introduce a fresh supply of air, and gradually dilate the cells to a greater or less extent; and if the obstruction is of some continuance, the dilated condition of the cells becomes permanent.'

Emphysema, or dilatation or rupture of the tissues of the lungs, is of two descriptions: in one, termed vesicular emphysema, the air-cells or vesicles which receive the air in the act of inspiration alone are affected; they may be dilated, enlarged, each separate cell, but when the vacant space is of considerable size, it is the result of the union of several air-cells broken into one by the stretching or destruction of the partitions that naturally divide and isolate them—in the other, termed the pulmonary or interlobular emphysema, the air-cells are ruptured, and the air escapes into the cellular tissue which connects them, the cells being distended by a full inspiration; and the air being unable easily to escape through the obstructed air-tubes, a strong effort at expiration is made, a rupture takes place, and forms a communication between the air-cells and the cellular tissues. This interlobular effusion of air may take place in a few minutes or seconds, while the vesicular emphysema, or that limited to the air-vesicles only, is slow and gradual, their permanent dilatation being the work of time; in both descriptions the emphysematous portion of the lung is paler, drier, and lighter than the rest, for the air being shut up in these portions, they do not subside, as the adjoining portions do, when left to their own elasticity, and in consequence of this they possess

fewer capillary bloodvessels, less blood, and consequently less moisture — they are dry and light, and float upon water like a bladder filled with air. Broken-wind may be the result of either of these states: when it comes on slowly, following an attack of bronchitis, and consequent thick-wind, it is owing to the overloaded air-cells pressing on, breaking down, and coalescing with each other; when it is developed suddenly, it depends on a rupture of the air-cells into the areolar tissue from some very severe exertion, and the result is sudden and immediate.

Some circumstances attending this disease may now, probably, be accounted for. A troublesome cough, and sometimes of long continuance, is the foundation of the disease, or indicates that irritable state of the bronchial membrane with which broken-wind is almost necessarily associated. Horses that are greedy feeders, or devour large quantities of slightly nutritious food, or are worked with a stomach distended by this food, are very subject to broken-wind. More depends upon the management of the food and exercise than is generally supposed. The post-horse, the coach-horse, and the racer are comparatively seldom broken-winded. They are fed, at stated periods, on nutritious food that lies in little compass, and their hours of feeding and of exertion are so arranged that they seldom work on a full stomach. The agricultural horse is too often fed on the very refuse of the farm, and his hours of feeding and of work are frequently irregular; and the carriage-horse, although fed on more nutritious food, is often summoned to work by his capricious master the moment his meal is devoured.

A rapid gallop on a full stomach has often produced broken-wind. When the exertion has been considerable and long-continued, we can easily conceive a rupture of the air-cells of the soundest lungs; but we are inclined to believe, that were the history of these cases known, there would be found to have been a gradual preparation for this result. There would have been chronic cough, or more than usually disturbed respiration after exercise, and then it required little more to perfect the mischief. Galloping after drinking has been censured as a cause of broken-wind, yet we cannot think that it is half so dangerous as galloping with a stomach distended by solid food. It is said that broken-winded horses are foul feeders, because they devour almost everything that comes in their way, and thus impede the play of the lungs; but there is so much sympathy between the respiratory and digestive systems, that one cannot be much deranged without the other evidently suffering. Flatulence and a depraved appetite may be the consequence as well as the cause of broken-wind; and there is no pathological fact of more frequent occurrence than the coexistence of indigestion and flatulence with broken-wind. Flatulence seems so invariable a concomitant of broken-wind, that the old farriers used to think the air found its way from the lungs to the abdomen in some inexplicable manner, and hence their 'holes to let out broken-wind;' they used literally to make a hole near to or above the fundament in order to give vent to the imprisoned wind. The sphincter muscle was generally divided; and although the trumping ceased, there was a constant although silent emission of fetid gas, that made the remedy worse than the disease.

Young horses are seldom found the subject of broken-wind, but there is no class amongst which it is so prevalent as aged horses employed for agricultural purposes. In these animals it usually comes on gradually, and can generally be traced to a paralysed condition of the pneumogastric nerve. It may therefore be considered as primarily a disease of the digestive organs, depending upon the indigestible nature of the food, and the irregular manner in which these animals are fed. There can be little

doubt that amongst all horses, especially those last mentioned, broken-wind is to a certain extent hereditary.

Is there any cure for broken-wind? None! no medical skill can repair the broken-down structure of the lungs.

If, however, we cannot cure, we may in some degree palliate broken-wind: and, first of all, we must attend carefully to the feeding. The food should lie in little compass,—plenty of oats and split beans, with a moderate allowance of chaff. Hay is objectionable, from the rapidity with which it is usually devoured, and the stomach overdistended. Water should be given in moderate quantities, but the horse should not be suffered to drink as much as he likes until the day's work is over. Green meat will always be serviceable. Carrots are particularly useful; they are readily digested, and appear to have a peculiarly beneficial effect on the respiratory system.

It is from the want of proper attention to the feeding that many horses become broken-winded even in the straw-yard. There is little nutriment in the provender which they find there; and in order to obtain enough for the support of life, they are compelled to keep the stomach constantly full, and pressing upon the lungs. It has been the same when they have been turned out in coarse and innutritive pasturage. The stomach was perpetually gorged, and the habitual pressure on the lungs cramped and confined their action, and inevitably ruptured the cells when the horse gambolled with his companions, or was wantonly driven about.

Next in importance stands exercise. The broken-winded horse should not stand idle in the stable a single day. It is almost incredible how much may be done by attention to food and exercise. The broken-winded horse may thus be rendered comfortable to himself, and no great nuisance to his owner; but inattention to feeding, or one hard journey,—the animal unprepared, and the stomach full,—may bring on inflammation, congestion, and death. Occasional physic, or alterative medicine, will often give considerable relief.

#### THE HEART.

The heart is placed between a doubling of the pleura—the *mediastinum*, by means of which it is supported in its natural situation, and all dangerous friction between these important organs is avoided. It is also surrounded by a membrane or bag of its own, called the *pericardium*, whose office is of a similar nature. By means of the heart the blood is circulated through the frame.

It is composed of four cavities—two above, called *auricles*, from their supposed resemblance to the ear of a dog; and two below, termed *ventricles*, occupying the substance of the heart. In point of fact, there are two hearts—the one on the left side impelling the blood through the frame, the other on the right side through the pulmonary system; but, united in the manner in which they are, their junction contributes to their mutual strength, and both circulations are carried on at the same time.

The first is the arterial circulation. No function can be discharged, life cannot exist, without the presence of arterial blood. The left ventricle that contains it contracts, and by the power of that contraction, aided by other means, which the limits of our work will not permit us to describe, the blood is driven through the whole arterial circulation—the capillary vessels and the veins—and returns again to the heart, but to the right ventricle. The other division of this viscus is likewise employed in circulating the blood thus conveyed to it, but not the same fluid which was contained in the left ventricle. It has gradually lost its vital power as it has passed along; it has changed from a bright to a dark red, and from a vital to a poisonous fluid. Ere it can again convey the principle of nutri-



tion, or give to each organ that impulse or stimulus which enables it to discharge its function, it must be materially changed.

When the right ventricle contracts, and the blood is driven into the lungs, it passes over the gossamer membrane of which the lobules of the lungs have been described as consisting; these lobules being filled with the air which has descended through the bronchial tubes in the act of inspiration. This delicate membrane permits some of the principles of the air to permeate it. The oxygen of the atmosphere combines with a portion of the superabundant carbon of this blood, and the expired air is poisoned with carbonic-acid gas. Some of the constituents of the blood attract a portion of the oxygen of the air, and obtain their distinguishing character and properties as arterial blood; and being thus revived, it passes on over the membrane of the lobes, unites into small and then larger vessels, and at length pours its full stream of arterial blood into the left auricle, thence to ascend into the ventricle and to be diffused over the frame.

#### DISEASES OF THE HEART.

It may be readily supposed that an organ so complicated is subject to disease. It is so to a fearful extent, and it sympathises with the maladies of every other part. Until lately, however, this subject has been shamefully neglected, and the writers on the veterinary art have seemed to be unaware of the importance of the organ, and the maladies to which it is exposed. The owners of horses and the veterinary profession generally are deeply indebted to Percivall in his 'Hippopathology' and to the pages of 'The Veterinarian' (vol. vi.) for much valuable information on this subject. To Dr. Hope also, and particularly to Laennec, we owe much. Mr. Percivall well says, 'This class of diseases may be regarded as the least advanced of any in veterinary medicine—a circumstance not to be ascribed so much to their comparative rarity, as to their existing undiscovered, or rather being confounded during life with other disorders, and particularly with pulmonary affections.'

The best place to examine the beating of the heart is immediately behind the elbow, on the left side. The hand applied flat against the ribs will give the number of pulsations. The ear thus applied will enable the practitioner better to ascertain the character of the pulsation. The stethoscope affords an uncertain guide, for it cannot be flatly and evenly applied.

**PERICARDITIS.**—The bag, or outer investing membrane of the heart, is liable to inflammation, in which the effused fluid becomes organised, and deposited in layers, increasing the thickness of the pericardium, and the difficulty of the expansion and contraction of the heart. The only symptoms on which dependence can be placed are—a quickened and irregular respiration; a bounding action of the heart in an early stage of the disease, but that, as the fluid increases and becomes concrete, assuming a feeble and fluttering character.

**HYDROPS PERICARDII** is the term used to designate the presence of the fluid secreted in consequence of this inflammation, and varying from a pint to a gallon or more. In addition to the symptoms already described, there is an expression of alarm and anxiety in the countenance of the animal which no other malady produces. The horse generally sinks from other disease, or from constitutional irritation, before the cavity of the pericardium is filled; or if he lingers on, most dreadful palpitations and throbbings accompany the advanced stage of the disease. It is seldom or never that this disease exists alone, but is combined with dropsy of the chest or abdomen.

CARDITIS is the name given to inflammation of the muscular substance of the heart. A well-authenticated instance of inflammation of the substance of the heart does not stand on record. Some other organ proves to be implicated in the mischief, even when the disturbance of the heart has been most apparent.

INFLAMMATION OF THE LINING OF THE HEART.—Mr. Simpson relates, in 'The Veterinarian' for 1834, a case in which there were symptoms of severe abdominal pain; the respiration was much disturbed, and the action of the heart took on an extraordinary character. Three or four beats succeeded to each other, so violently as to shake the whole frame, and to be visible at the distance of several yards, with intervals of quietude of five minutes or more. At length this violent beating became constant.

On dissection both lungs were found to be inflamed, the serum in the pericardium increased in quantity, and the internal membrane of the heart violently inflamed, with spots of ecchymosis.

This would seem to be a case of inflammation of the heart; but in a considerable proportion of the cases of rabies, these spots of ecchymosis and this general inflammation of the heart are seen.

HYPERTROPHY is an augmentation or thickening of the substance of the heart; and, although not dreamed of a few years ago, seems now to be a disease of no rare occurrence among horses. The heart has been known to acquire double its natural volume, or the auricle and ventricle on one side have been thus enlarged. Mr. Thomson relates in 'The Veterinarian' a very singular case. A horse was brought with every appearance of acute rheumatism, and was bled and physicked. On the following day he was standing, with his fore-legs widely extended, the nostrils dilated, the breathing quick and laborious, the eyes sunk in their orbits, the pupils dilated, his nose turned round almost to his elbow, sighing, and his countenance showing approaching dissolution. The pulse had a most irregular motion, and the undulation of the jugular veins was extending to the very roots of the ears. He died a few hours afterwards.

The lungs and pleura were much inflamed; the pericardium was inflamed and distended by fluid; the heart was of an enormous size and greatly inflamed; both the auricles and ventricles were filled with coagulated blood; the greater part of the chordæ tendinæ had given way; the valves did not approximate to perform their function, and the heart altogether presented a large disorganised mass, weighing thirty-four pounds. The animal worked constantly on the farm, and had never been put to quick or very laborious work.

DILATATION is increased capacity of the cavities of the heart, the parietes being generally thinned. It is probable that this is a more frequent disease than is generally supposed; and from the circulating power being lessened, or almost suspended, on account of the inability of the cavities to propel their contents, it is accompanied by much and rapid emaciation. In the Gardens of the Zoological Society of London this is a disease considerably frequent, and almost uniformly fatal. It attacks the smaller animals, and particularly the quadrumana, and has been found in the deer and the zebra. It is characterised by slow emaciation, and a piteous expression of the countenance; but the mischief is done when these symptoms appear.

OSSIFICATION OF THE HEART.—There are too many instances of this both in the right and the left auricles of the heart, the aortic valves, the abdominal aorta, and also the bronchial and other glands. Mr. Percivall observes of one of these cases, that 'the cavity could have been but a

passive receptacle for the blood, and the current must have been continued without any or with hardly any fresh impulse.'

OF AIR IN THE HEART destroying the horse there are some interesting accounts; and also of rupture of the heart, and *aneurism*, or dilatation of the aorta, both thoracic and abdominal, and even farther removed from the heart and in the iliac artery. The symptoms that would certainly indicate the existence of aneurism are yet unknown, except tenderness about the loins and gradual inability to work are considered as such: but it is interesting to know of the existence of these lesions. Ere long the veterinary surgeon may possibly be able to guess at them, although he will rarely have more power in averting the consequences of aneurism than the human surgeon possesses with regard to his patient.

This will be the proper place to describe a little more fully the circulation of the blood, and various circumstances connected with that most important process.

#### THE ARTERIES.

The vessels which carry the blood from the heart are called arteries (*keeping air*,—the ancients thought that they contained air). They are composed of three coats: the outer or elastic is that by which they are enabled to yield to the gush of blood, and enlarge their dimensions as it is forced along them, and by which also they contract again as soon as the stream has passed; the middle coat is a muscular one, by which this contraction is more powerfully performed, and the blood urged on in its course; the inner or membranous coat is the mere lining of the tube.

The arteries divide as they proceed through the frame, and branch out into innumerable minute tubes, termed capillaries (hair-like tubes), and they even become so small as to elude the sight. The slightest puncture cannot be inflicted without wounding some of them. In these little tubes the nourishment of the body and the separation of all the various secretions is performed, and in consequence of this the blood is changed. When these capillaries unite together, and begin to enlarge, it is found to be no longer arterial or of a florid red colour, but venous, or of a blacker hue; therefore the principal termination of the arteries is in the veins. The point where the one ends and the other commences cannot be ascertained. It is when the red arterial blood, having discharged its function by depositing the nutritious parts, is changed to venous or black blood.

#### THE VEINS.

These vessels carry back to the heart the blood which had been conveyed to the different parts by the arteries. They have the same number of coats as arteries, but are thin and comparatively weak. They are more numerous and much larger than the arteries, and consequently the blood, lessened in quantity by the various secretions separated from it, flows more slowly through them. It is forced on partly by the first impulse communicated to it by the heart, also in the extremities and external portions of the frame, by the pressure of the muscles; and in the cavity of the chest, its motion is assisted or principally caused by the sudden expansion of the ventricles of the heart, after they have closed upon and driven out their contents, and thereby causing a vacuum which the blood rushes on to fill. There are curious valves in various parts of the veins, which prevent the blood from flowing backward to its source.

## THE PULSE

Is caused by the yielding of the coats of the artery to the gush of blood forced into it by the contraction of the heart. It is a very useful assistant to the practitioner of human medicine, but much more so to the veterinary surgeon, whose patients cannot describe either the seat or degree of ailment or pain. The number of pulsations in any artery will give the number of the beatings of the heart, and so express the irritation of that organ, and of the frame generally. In a state of health, the heart beats in a horse from about thirty-two to thirty-six times in a minute. This is said to be the *standard* pulse—the pulse of health. It varies singularly little in horses of the same size and breed, and where it beats naturally there can be little materially wrong. The most convenient place to feel the pulse is at the lower jaw (p. 199) a little behind the spot where the sub-maxillary artery and vein and the parotid duct come from under the jaw. There the number of pulsations will be easily counted, and the character of the pulse, a matter of fully equal importance, will be clearly ascertained. Many horsemen put the hand to the side. They can certainly count the pulse there, but they can do nothing more. We must be able to press the artery against some hard body, as the jawbone, in order to ascertain the manner in which the blood flows through it, and the quantity that flows.

When the pulse reaches fifty or fifty-five, some degree of fever may be apprehended, and proper precaution should be taken; seventy or seventy-five will indicate a dangerous state, and put the owner and the surgeon not a little on the alert. Few horses long survive a pulse of one hundred, for by this excessive action the energies of nature are speedily worn out.

Some things, however, should be taken into account in forming our conclusion from the frequency of the pulse. Exercise, a warm stable, and fear will wonderfully increase the number of pulsations. In the pregnant condition of the mare the pulse will also be found increased.

When a careless brutal fellow goes up to a horse, and speaks hastily to him, and handles him roughly, he adds ten beats per minute to the pulse, and will often be misled in the opinion he may form of the state of the animal. A judicious person will approach the patient gently, and pat and soothe him, and even then probably the circulation will be a little disturbed. He should take the additional precaution of noting the number and quality of the pulse a second time before he leaves the animal.

If a *quick* pulse indicate irritation and fever, a *slow* pulse will likewise characterise diseases of an opposite description. It accompanies the sleepy stage of staggers, and every malady connected with deficiency of nervous energy.

The heart may not only be excited to more frequent but also to more violent action. It may contract more powerfully upon the blood, which will be driven with greater force through the arteries, and the expansion of the vessels will be greater and more sudden. Then we have the *hard* pulse, the sure indicator of considerable fever.

Sometimes the pulse may be hard and jerking, and yet *small*: the stream though forcible is not great. The heart is so irritable that it contracts before the ventricle is properly filled. The practitioner knows that this indicates a dangerous state of disease. It is an almost invariable accompaniment of inflammation of the bowels.

A *weak* pulse, when the arterial stream flows slowly, is caused by the feeble action of the heart. It is the reverse of fever, and expressive of debility.

The *oppressed* pulse is when the arteries seem to be fully distended with blood. There is obstruction somewhere, and the action of the heart can hardly force the stream along, or communicate pulsation to the current. It is the case in sudden congestion of the lungs. They are overloaded and gorged with blood which cannot find its way through their minute vessels. This accounts for the well-known fact of a copious bleeding increasing a pulse previously oppressed. A portion being removed from the distended and choked vessels, the remainder is able to flow on.

There are many other varieties of the pulse, which it would be tedious here to particularise; it must, however, be observed, that during the act of bleeding, its state should be carefully observed. Many veterinary surgeons, and gentlemen too, are apt to order a certain quantity of blood to be taken away, but do not condescend to superintend the operation. This is unpardonable in the surgeon and censurable in the owner of the horse. The animal is bled for some particular purpose. There is some state of disease, indicated by a peculiar quality of the pulse, which we are endeavouring to alter. The most experienced practitioner cannot tell what quantity of blood must be abstracted in order to produce the desired effect. The change of the pulse can alone indicate when the object is accomplished; therefore, the operator should have his finger on the artery during the act of bleeding, and, comparatively regardless of the quantity, continue to take blood, until, in inflammation of the lungs, the oppressed pulse becomes fuller and more distinct, or the strong pulse of considerable fever is evidently softer; or the animal exhibits symptoms of faintness.

#### INFLAMMATION

Consists of a disturbed action of the circulation, by which an increased flow of blood is determined to a particular part. It is characterised by redness, swelling, heat and pain. The redness proceeds from the greater quantity of blood flowing through the part, occasioned by the dilated condition of the vessels. The swelling arises from the same cause, and from the deposit of fluid in the neighbouring substance. The natural heat of the body is produced by the gradual change which takes place in the blood, in passing from an arterial to a venous state. If more blood is driven through the capillaries of an inflamed part, and in which this change is effected, more heat will necessarily be produced there; and the pain is easily accounted for by the distension and pressure which must be produced, and the participation of the nerves in the disturbance of the surrounding parts.

If the inflammation be slight, and arrested by treatment in its early stages, resolution and a return to a healthy condition of the part will follow; but if it be acute and go on unchecked, it will terminate either in effusion, adhesion, suppuration, or gangrene.

In the treatment of inflammation, blood-letting has always held a prominent position. In times past it was carried to an injurious extent; there is, perhaps, a tendency at the present day to go to the other extreme, by neglecting many opportunities when great benefit might result from the abstraction of blood, especially in local inflammations. An eminent writer on this subject says 'it is a measure, life-giving in its proper use, and deadly if abused. Its benefits may be explained on any theory; by diminishing the mass of blood, it lessens the labour of the heart and lungs, and allows the remaining blood to be oxygenated and purified by natural influences. It diminishes the rush of blood to the inflamed part, and allows distended venous capillaries to empty themselves; it decreases the specific gravity, and increases the absorptive power of the blood; it promotes the action of the skin and bowels, and imitates the spontaneous

hemorrhage by which nature often gives relief.' Blood is generally abstracted from the jugular vein, and so the general quantity may be lessened; but if it can be taken from the neighbourhood of the diseased part, it will be productive of tenfold benefit. One quart of blood abstracted from the coronet in acute founder, by unloading the vessels of the inflamed part, and enabling them to contract, and, in that contraction, to acquire tone and power to resist future distension, will do more good than five quarts taken from the general circulation. An ounce of blood obtained by scarifying the swelled vessels of the inflamed eye, will give as much relief to that organ as a copious bleeding from the jugular. It is a principle in the animal frame which should never be lost sight of by the veterinary surgeon, or the horseman, that if by bleeding the process of inflammation can once be checked,—if it can be suspended but for a little while,—although it may return, it is never with the same degree of violence, and in many cases it is got rid of entirely. Hence the necessity of bleeding early, and bleeding largely. Many horses are lost for want or insufficiency of bleeding, but very rarely is one materially injured by the most copious extraction of blood in the *early* stage of acute inflammation. The horse will bear, and with advantage, the loss of an almost incredible quantity of blood; four quarts taken from him will be comparatively little more than one pound taken from the human being. We can scarcely conceive of a considerable inflammation of any part of the horse, whether proceeding from sprains, contusions, or any other cause, in which bleeding, local (if possible), or general, will not be of essential service.

Next in importance to bleeding, is purging. Something may be removed from the bowels, the retention of which would increase the general irritation and fever. The quantity of blood will be materially lessened; for the serous or watery fluid which is separated from it by a brisk purge, the action of which in the horse continues frequently more than twenty-four hours, is enormous. While the blood is thus determined to the bowels, less even of that which remains will flow through the inflamed part. When the circulation is directed to one set of vessels, it is proportionately diminished in other parts. It was first directed to the inflamed portions, and they were overloaded and injured,—it is now directed to the bowels, and the inflamed parts are relieved. While the purging continues, some degree of languor and sickness are felt, and the force of the circulation is thereby diminished, and the general excitement lessened. The importance of physic in every case of considerable external inflammation is sufficiently evident. If the horse is laid by for a few days from injury of the foot, or sprain, or poll-evil, or wound, or almost any cause of inflammation, a physic-ball should be given.

In cases of internal inflammation, much judgment is required to determine when a purgative may be beneficial or injurious. In inflammation of the lungs, it should never be given. There is so strong a sympathy between the various contents of the cavity of the chest, that no one of them can be inflamed to any great extent without all the others being disposed to become so; and, therefore, a dose of physic in inflamed lungs would perhaps be as fatal as a dose of poison. The excitement produced on the bowels by the purgative may run on to inflammation, which no medical skill can stop.

The means of abating external inflammation are various, and seemingly contradictory. The heat of the part very naturally led to the application of cold embrocations and lotions. Heat has a strong tendency to equalise itself, or to leave that substance which has a too great quantity of it, or little capacity to retain it, for another which has less of it, or more capacity. Hence the advantage of cold applications, by which a great

deal of the unnatural heat is speedily abstracted from the inflamed part. When benefit is derived from these applications, it is to be attributed in some measure to their coldness. The cold tends to brace up and invigorate the parts, and the evaporation from the blood, consequent upon the application of moisture, conduces rapidly to reduce the inflammation. A bandage well wetted, partially wrung out, and renewed every half hour or less, during the continuance of active inflammation, will cause it to subside considerably. When the acute stage has passed off, the wet bandage must be well wrung out, covered by three or four folds of dry linen, changed every three or four hours, and wet hand-rubbing for five or ten minutes applied twice or thrice a day.

Sometimes, however, we resort to warm fomentations, and the benefit derived from their use is to be traced to the warmth of the fluid, more than to any medicinal property in it. Warm water will do as much good to the horse, who has so thick a skin, as any decoction of chamomile, or marsh-mallow, or poppy heads, or any nostrum that the farrier may recommend. Fomentations increase the warmth of the skin, and open the pores of it, and promote perspiration, and thus lessen the tension and swelling of the part, assuage pain, and relieve inflammation. Fomentations, to be beneficial, should be long and frequently applied, and at as great a degree of heat as can be used without giving the animal pain. Poultices are more permanent, or longer-continued fomentations. The part is exposed to the influence of warmth and moisture for many hours or days without intermission, and perspiration being so long kept up, the distended vessels will be very materially relieved. The advantage derived from a poultice is attributable to the heat and moisture, which, by means of it, can be long applied to the skin, and it should be composed of materials which will best retain this moisture and heat. The bran poultice of the farrier is, consequently, objectionable. It is never perfectly in contact with the surface of the skin, and it becomes nearly dry in a few hours, after which it is injurious rather than beneficial. Linseed-meal is a much better material for a poultice, for, if properly made, it will remain moist during many hours. The two, however, may be mixed with advantage; and, if judiciously and carefully applied—that is, in close contact with the skin—are of considerable efficacy.

It is occasionally very difficult to decide when a cold or a hot application is to be used, and no general rule can be laid down, except that in cases of superficial inflammation, and in the early stage, cold lotions will be preferable; but, when the inflammation is deeper seated, or fully established, or extended over a large surface, warm fomentations will be most serviceable.

Stimulating applications are frequently used in local inflammation. When the disease is deeply seated, a stimulating application to the skin will cause some irritation and inflammation there, and lessen or sometimes remove the original malady; hence the use of rowels and blisters in inflammation of the chest. Inflammation to a high degree cannot exist in parts that are so near each other. If we excite it in one, we shall abate it in the other, and also, by the discharge which we establish from the one, we shall lessen the determination of blood to the other.

Stimulating and blistering applications should never be applied to a part already inflamed. A fire is not put out by heaping more fuel upon it. Hence the mischief which the farrier often does by rubbing his abominable oils on a recent sprain, hot and tender. Many a horse has been ruined by this absurd treatment. When the heat and tenderness have disappeared by the use of cold lotions or fomentations, and the leg or sprained part remains enlarged, or bony matter threatens to be deposited, it may then

be right to excite inflammation of the skin by a blister, in order to rouse the deeper-seated absorbents to action, and enable them to take up this deposit; but, except to hasten the natural process and effects of inflammation, a blister, or stimulating application, should never be applied to a part already inflamed.

#### FEVER.

Fever is general increased arterial action, either without any local affection, or in consequence of the sympathy of the system with inflammation in some particular part.

The first is *pure fever*. Some have denied that that exists in the horse, but they must have been strangely careless observers of the diseases of that animal. The truth of the matter is, that the usual stable management and general treatment of the horse are so absurd, and various parts of him are rendered so likely to take on inflammation, that pure fever will exist a very little time without degenerating into inflammation. The lungs are so weakened by the heated and foul air of the ill-ventilated stable, and by sudden changes from almost insufferable heat to intense cold, and the feet are so injured by hard usage and injudicious shoeing, that, sharing from the beginning in the general vascular excitement which characterises fever, they soon become excited far beyond other portions of the frame; and that which commenced a fever becomes inflammation of the lungs or feet. Pure fever, however, is sometimes seen, and runs its course regularly.

It frequently begins with a cold or shivering fit, which, although not essential to fever, will very frequently be found preceding it. The horse is dull, unwilling to move, has a staring coat, and cold legs and feet. This is succeeded by increased warmth of the body; unequal distribution of warmth to the legs; one hot, and the other three cold, or one or more unusually warm, and the others unusually cold, but not the deathlike coldness of inflammation of the lungs; the pulse quick, soft, and often indistinct; the breathing a little quickened; but no cough, or pawing, or looking at the flanks. The animal will scarcely eat, and is very costive. While the state of pure fever lasts, the shivering fit returns at nearly the same hour every day, and is succeeded by a warm one, and that often by a slight degree of perspiration; and these alternate during several days until local inflammation appears, or the fever gradually subsides. A horse rarely dies of pure fever. If he is not destroyed by inflammation of the lungs, or feet, or bowels succeeding to the fever, he generally recovers. In the treatment of fever care should be taken to husband the strength of the animal as much as possible. The horse should be placed in a cool well-ventilated stable, and his body and extremities warmly clothed. Bleeding, and the administration of aloes or other active purgatives, should on no account be had resort to; the former as being likely to increase the debility which generally attends this disease, and the latter from the danger of excessive purgation, in consequence of the irritable condition of the mucous membrane of the bowels. Fever medicines in combination with diffusible stimulants should be administered, such as the spirit of nitric ether in combination with the liquor ammoniæ acetatis, and nitrate of potash. The constipation of the bowels usually present should be relieved by clysters of warm soap and water, or if necessary by a small dose of oil. The animal should be kept on soft food for the first few days, when a more generous diet may be allowed. If the disease run its course as pure fever, we may soon begin the administration of tonic medicine with advantage, such as ginger, gentian, or chincona bark, the latter being especially serviceable. Fever, however, terminates in inflammation of some important organ, particularly the lungs. The same treatment should



now be adopted as recommended in pneumonia, with the exception of bleeding and other depleting measures, and the earlier resort to tonic agents.

*Symptomatic fever* is increased arterial action, proceeding from some local cause. No organ of consequence can be much disordered or inflamed without the neighbouring parts being disturbed, and the whole system gradually participating in the disturbance. Inflammation of the feet or of the lungs never existed long, or to any material extent, without being accompanied by a considerable degree of fever.

The treatment of symptomatic fever should resemble that of simple fever, except that particular attention must be paid to the state of the part originally diseased. If the inflammation which existed there can be subdued, the general disturbance will usually cease.

#### PURPURA HÆMORRHAGICA.

This is a peculiar disease of the blood, more frequently met with in the horse than in any other animal. Little is understood respecting the cause of it, but it is said to be produced by an altered condition of the blood, dependant upon a deranged condition of the secreting organs, such as the kidneys, liver, &c. It assumes two forms—the acute, and chronic. In the former it occurs most in the summer months, and generally makes its appearance suddenly. In the early stage there will be slight bleeding from the nostrils; swellings in the softer parts of the body, especially about the labia and rectum; the eyes will also be swollen and blood-shot, with blood trickling from them; pulse very rapid and wavering; breathing hurried and difficult, often sonorous. This disease is generally fatal, and runs its course very rapidly. The swellings, especially about the head, will generally increase, in some instances threatening suffocation; the other symptoms will go on, and the animal not unfrequently falls down and dies in the course of eight or ten hours from the commencement of the attack. The treatment, if seen at the commencement of the disease, should consist of moderate blood-letting; but if, as is generally the case, the disease has made considerable progress, we must not bleed, but give diffusible stimulants and diuretics, as the spirits of nitric ether or the spirits of turpentine, the latter being the best. The animal should be placed in a well-ventilated box, and the body and extremities well clothed. If the swelling increase so as to threaten suffocation, tracheotomy should be had resort to. The chronic form of this disease depends upon a directly opposite state of the blood, and frequently follows catarrhal affections, influenza, and any debilitating causes. There is generally swelling in the same parts, but not to the same extent; and we have no bleeding from the nostril, the Schneiderian membrane being studded with petechial spots. The pulse is weak and tremulous, and the bowels torpid. It may exist in this state for two or three weeks, and rarely passes away in less than ten or twelve days. In treating this form of the disease, the animal should be placed in a well-ventilated box, the body and extremities warmly clothed, and allowed a generous diet. Tonics, such as columba, gentian, and ginger, should be given daily, with diffusible stimulants such as the spirit of nitric ether, to restore the functions of the kidneys and skin. If there be much effusion, it will be advisable to give sulphate of iron. This form of the disease, unlike the former, generally yields to treatment.

#### RHEUMATISM.

This is essentially a disease depending upon the accumulation of some poisonous agent (probably lactic acid) in the blood. It is only of late years that it has been admitted into the list of the diseases of the

horse, although it is in truth a very common affection. Animals at all ages are subject to it, but it is most frequently met with in old horses that have been early abused, and amongst younger ones whose powers have been severely taxed. In the majority of cases, however, it will be met with in animals recovering from some debilitating disease, especially pneumonia and influenza. The animal will be found very lame on one or both limbs. On examination, considerable swelling, attended with great heat and pain on pressure, will be found about the fetlock joint. This may suddenly leave the part affected and attack another limb, and as suddenly return again. The lameness is frequently excessive, and the pain is evidently excruciating. The animal fears to rest his weight on the limb, or even to touch the ground with his toe. He is heaving at the flanks, sometimes sweating profusely, his countenance plainly indicative of the agony he feels. With proper treatment the pain and lameness generally disappear; but in other instances the ligaments become thickened and rigid, the capsules of the joint are loaded with fibrinous deposits, and the joint is evidently enlarged. In some instances it assumes a somewhat chronic form. Most horsemen will recollect cases in which the animal that seemed the preceding day to be perfectly sound becomes decidedly lame, and limps as though he had lost the use of his limbs. The lameness is indicated rather by an unwillingness to use the limb than by an expression of pain in stepping on it. There will be considerable swelling, extending frequently from the knee to the fetlock down the whole course of the flexor tendons, and all the constitutional irritation usually attending excessive pain. These symptoms may gradually disappear in the course of a fortnight and the animal appear perfectly sound, but in a short time the disease will again return with all its former violence. This is a very troublesome form of rheumatism, and one which is rarely cured. It is considerably influenced by cold or wet weather.

Mr. Cooper, of Coleshill, relates a case very applicable to the present subject. A farmer purchased a horse, to all appearance sound, and rode him home—a distance of ten miles. He was worked on the two following days, without showing the least lameness. On the third day it was with great difficulty that he managed to limp out of the stable. Mr. Cooper was sent for to examine him. The horse had clean legs and excellent feet. The owner would have him blistered all round. It was done. The horse was turned out to grass for two months, and came up perfectly sound. The weather soon afterwards became wet and cold, and the horse again was lame; in fact, it presently appeared that the disease was entirely influenced by the changes of the atmosphere. ‘Thus,’ adds Mr. C., ‘in the summer a horse of this description will be mostly sound, while in the winter he will be generally lame.’

Rheumatism sometimes affects the muscles, assuming a neuralgic character. In this form of the disease there may be no acute inflammation or pain on pressure. The following account of acute rheumatism, by Mr. Thompson, of Beith, is too valuable to be omitted:—‘I have had,’ says he, ‘fourteen cases of this disease. The muscles of the shoulders and arms were generally the parts affected. The cure was effected in a few days, and consisted of a good bleeding from the jugular, and a sharp purge.

‘One of these cases was uncommonly severe. The disease was in the back and loins. The horse brought forward his hind-legs under his flanks, roached his back, and drew up his flanks with a convulsive twitch, accompanied by a piteous groan, almost every five minutes. The sympathetic fever was alarming, the pulse was 90, and there was obstinate constipation of the bowels. The horse literally roared aloud if any one attempted to

shift him in the stall, and groaned excessively when lying. He was bled almost to fainting; and three moderate doses of aloes were given in the course of two days. Injections were administered, and warm fomentations were frequently applied to the back and loins. On the third day the physic operated briskly, accompanied by considerable nausea and reduction of the pulse. From that time the animal gradually recovered.

'These horses are well fed, and always in good condition; but they are at times worked without mercy, which perhaps makes them so liable to these attacks.'

In the treatment of rheumatism attention should be paid to the probable nature and causes producing it. When it follows pneumonia, influenza, or other debilitating causes, our first object should be to restore the general health of the animal by the judicious administration of tonic medicines and nutritious foods; an occasional diuretic may also be given. Our local applications should consist in the acute stage of warm fomentations, to be soon followed by some stimulating liniment, such as the compound soap liniment or the vinegar of cantharides. By these means this form of the disease will generally quickly disappear. When rheumatism suddenly attacks an animal in apparent health much more active means must be resorted to. We must endeavour to arouse the excretory organs, as the liver and kidneys, into increased action. Half a drachm of calomel and opium combined with three drachms of aloes should be at once administered, followed in a day or two by active diuretics. Warm fomentations should be applied to the parts, and when the acute inflammation is subdued, a blister; the animal being kept perfectly quiet, and allowed nothing but bran mash or other soft foods. Colchicum, guaiacum, and other medicines which are esteemed as valuable remedial agents on the human subject in this disease, appear to produce but little effect upon the horse.

---

## CHAPTER XIV.

### THE ANATOMY AND DISEASES OF THE DIGESTIVE ORGANS.

WE have already described the anatomy of the lips, tongue, teeth, and other organs connected with the digestive system in the mouth of the animal, and we now pass on to the back of the mouth, and arrive at what is called the

#### PHARYNX.

It is a funnel-shaped cavity (*carrying or conveying* the food towards the œsophagus). It commences at the root of the tongue, is separated from the mouth by the soft palate, which hangs down from the palatine bone, and extends to the epiglottis or covering to the windpipe. When the food has been sufficiently ground by the teeth, and mixed with the saliva, it is gathered together by the tongue, and by the action of the cheeks and tongue, and back part of the mouth, forced against the soft palate, which, giving way, and being raised upwards towards the entrance into the nostrils, prevents the food from proceeding that way. It passes to the pharynx, and the soft palate again falling down, prevents its return to the mouth, and also prevents, except in extreme cases, the act of vomiting in the horse. Whatever is returned from the stomach of the horse, passes through the nose.

The sides of the pharynx are lined with muscles which now begin

powerfully to contract, and by that contraction the bolus is forced on until it reaches the gullet, which is the termination of the pharynx. Before, however, the food proceeds so far, it has to pass over the entrance into the windpipe, and should any portion of it enter that tube, much inconvenience and danger might result; therefore, this opening is not only lined by muscles which close it at the pleasure of the animal, but is likewise covered by a heart-like elastic cartilage, the epiglottis, with its back towards the pharynx, and its hollow towards the aperture. The epiglottis yields to the pressure of the bolus passing over it, and lying flat over the opening into the windpipe, prevents the possibility of anything entering into it. No sooner, however, has the food passed over it, than it rises again by its own elasticity, and leaves the upper part of the windpipe once more open for the purpose of breathing.

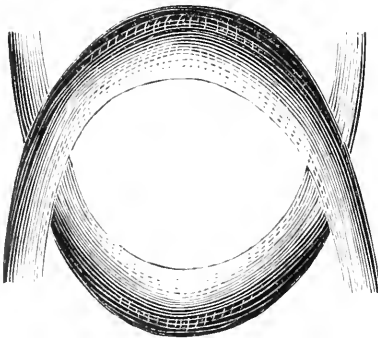
#### THE ŒSOPHAGUS, OR GULLET.

The œsophagus consists of a muscular membranous tube extending from the pharynx to the stomach, and conveys the food from the mouth to the stomach. At the top of the neck, it is immediately behind the windpipe, but it soon inclines to the left, and runs down the neck close to the windpipe, and on its left. Having entered the chest between the first two ribs, the gullet passes along the upper part of it, and then piercing the diaphragm, or midriff, enters the stomach. It is composed of three coats; the outer one of slight loose cellular substance: the middle one muscular, and divided into two distinct layers, the outermost layers having the fibres lengthways, by which the gullet may be shortened, and in shortening widened for the reception of the food;—the fibres of the inner layers running circularly round the tube, so that the portion immediately above a pellet of food will by its contraction force the food downward, and by successive actions drive it into the stomach. The inner coat, which is a continuation of the membrane of the pharynx, lies in folds or plaits, extending lengthways. The muscular coat, being highly elastic, readily gives way to the pressure of the food, and these plaits enable the inner or cuticular coat, likewise, sufficiently to dilate.

The œsophagus does not, however, enter straight into the stomach, and with a large open orifice; but there is an admirable provision made to prevent the regurgitation of the food when the stomach is filled and the horse suddenly called upon to perform unusually hard work. The œsophagus enters the stomach in a somewhat curved direction,—it runs obliquely through the muscular and cuticular coats for some distance, and

then its fibres arrange themselves around the opening into the stomach. Close observation has shown that they form themselves into segments of circles, interlacing each other, and by their contraction plainly and forcibly closing the opening, so that the regurgitation of the food is almost impossible.

The annexed diagram by Mr. Ferguson, of Dublin, will give a general idea of the structure of the termination of the œsophagus, and the manner in which it encircles the orifice of the stomach.



A microscope of very feeble power will beautifully show this singular construction. It is not precisely either a sphincter muscle or

a valve, but it is a strong and almost insuperable obstacle to the regurgitation of the food.

## THE STOMACH.



- a* The œsophagus or gullet, extending to the stomach.
- b* The entrance of the gullet into the stomach. The circular layers of the muscles are very thick and strong, and, by their contractions, help to render it difficult for the food to be returned or vomited.
- c* The portion of the stomach which is covered by cuticle, or insensible skin.
- d d* The margin, which separates the cuticular from the villous portion.
- e e* The mucous, or villous (velvet) portion of the stomach, in which the food is principally digested.
- f* The communication between the stomach and the first intestine.
- g* The common orifice through which the bile and the secretion from the pancreas pass into the first intestine. The two pins mark the two tubes here united.

The stomach is situated on the left side of the abdomen, in what is termed the hypochondriac region, a small portion extending to the epigastric region. Its anterior part is in connection with the liver; its left extremity with the diaphragm and spleen.

The situation of the stomach will at once explain the reason why a horse is so much distressed, and sometimes irreparably injured, if worked hard immediately after a full meal. The stomach must be displaced and driven back by every contraction of the diaphragm, or act of inspiration; and in proportion to the fulness of the stomach will be the weight to be overcome, and the labour of the diaphragm, and the exhaustion of the animal. If the stomach is much distended, it may be too weighty to be forced sufficiently far back to make room for the quantity of air which the animal in a state of exertion requires. Hence the frequency and labour of the breathing, and the quickness with which such a horse is blown, or possibly destroyed. Hence also the folly of giving too full a meal, or too much water, before the horse starts on a journey or for the chase; and, in like manner, the absurdity and danger of that unpardonable custom of some grooms to gallop the horse after his drink, in order to warm it in his belly, and prevent gripes.

The horse was destined to be the servant of man, and to be always at his call whether fasting or full: it would seem, therefore, that, to lessen much

inconvenience or danger, a smaller stomach, in proportion to his size, is given to the horse than to almost any other animal. The bulk of the horse, and the services required of him, demand much nutriment, and that of such a nature as to occupy a very considerable space; yet his stomach, compared with his bulk, is not half so large as that of the human being: therefore, although he, like every other animal, feels inconvenience from great exertion immediately after a full meal, he suffers not so much as other quadrupeds, for his stomach is small, and his food passes rapidly through it, and descends to a part of the intestines distant from the diaphragm, and where the existence and pressure of the food cannot cause him any annoyance.

The stomach has four coats. The outermost is the lining of the cavity of the belly, and the common covering of all the intestines—that by which they are confined in their respective situations, and from which a fluid is secreted that prevents all friction between them. This is a serous membrane called the *peritoneum*—that which stretches round the outside of the stomach.

The second is the muscular coat, consisting of three layers of fibres, one running lengthways, the other circularly, and the other obliquely, and by means of which a constant gentle motion is communicated to the stomach, mingling the food more intimately together, and preparing it for digestion, and by the pressure of which the food when properly prepared is urged on into the intestines.

The third, or cuticular (*skin-like*) coat, *c*, covers a portion of the inside of the stomach. It is a continuation of the lining of the gullet. There are numerous glands on it, which secrete a mucous fluid; and it is probably intended to be a reservoir in which a portion of the food is retained for a while, and softened and better prepared for the action of the other or true digestive portions of the stomach. The cuticular coat occupies nearly one-half of the inside of the stomach.

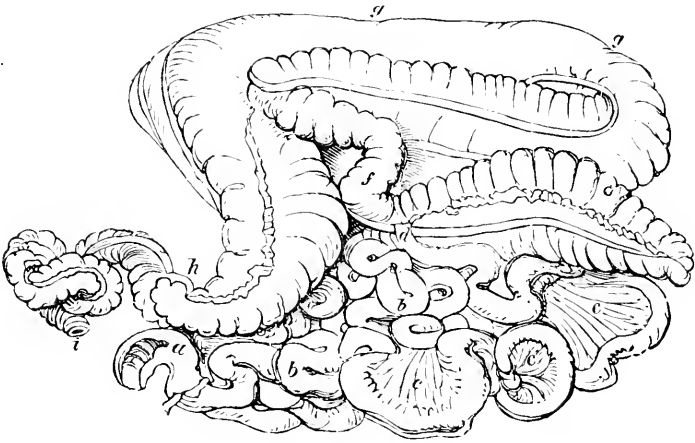
The other portion of the stomach is lined by the villous portion, from which the true gastric juice is secreted, where the work of digestion properly commences. The mouths of numerous little vessels open upon it, pouring out a peculiar fluid, the *gastric* (stomach) juice, which mixes with the food already softened, and converts it into a fluid called *chyme*. As this is formed, it passes out of the other orifice of the stomach, the *pylorus* (doorkeepers), *f*, and enters the first small intestine; the harder and undissolved parts being turned back to undergo farther action.

Every portion of the muscular coat has the power of successively contracting and relaxing, and thus, in the language of Dr. Bostock, ‘the successive contraction of each part of the stomach, by producing a series of folds and wrinkles, serves to agitate the alimentary mass, and, by bringing every part of it in its turn to the surface, to expose it to the influence of the gastric juice, while at the same time the whole of the contents are gradually propelled forwards, from the orifice which is connected with the œsophagus to that by which they are discharged.’

The pneumo-gastric nerve is the agent in producing these alternate contractions and relaxations. It is the motor nerve belonging to these parts. It has to keep the parietes of the stomach in contact with the food, and the food in contact with the gastric juice. It has to bring the different parts of the food in successive contact with the stomach, and to propel them through this portion of the alimentary canal in order that they may be discharged into the duodenum.

## THE INTESTINES.

The food having been partially digested in the stomach, and converted into chyme, passes through the pyloric orifice into the intestines.



- a* The commencement of the small intestines. The ducts which convey the bile and the secretion from the pancreas are seen entering a little below.
- b b* The convolutions or windings of the small intestines.
- c c c* Portions of the mesentery.
- d* The small intestines, terminating in the caecum.
- e* The caecum or blind gut, with the bands running along it, puckering and dividing it into numerous cells.
- f* The beginning of the colon.
- g* The continuation and expansion of the colon, divided, like the caecum, into cells.
- h* The termination of the colon in the rectum.
- i* The termination of the rectum at the anus.

The intestines of a full-grown horse are not less than ninety feet in length. The length of the bowels in different animals depends on the nature of the food. The nutritive matter is with much more difficulty extracted from vegetable than animal substances; therefore the alimentary canal is large, long, and complicated in those which, like the horse, are principally or entirely fed on corn or herbs. They are divided into the small and large intestines; the former of which occupy about sixty-six feet, and the latter twenty-four.

The intestines, like the stomach, are composed of three coats.

The outer one consists of a peritoneum—that membrane which has been already described as investing the contents of the abdomen. By means of this coat, the intestines are confined in their proper situations; and, this membrane being smooth and moist, all friction and concussion are prevented. Did the bowels float loosely in the abdomen, they would be subject to constant entanglement and injury amid the rapid and violent motions of the horse.

The middle coat, like that of the stomach, is muscular, and composed of two layers of fibres, one running longitudinally and the other circularly; and by means of these muscles, which are continually contracting and relaxing in a direction from the upper part of the intestines to the lower, the food is propelled along the bowels.

The inner coat is the mucous or villous one. It abounds with innu-

merable small glands, which secrete a mucous fluid to lubricate the passages and defend it from irritating or acrimonious substances; and it is said to be villous, from its soft velvet-like feeling. This coat is crowded with innumerable minute orifices that are the commencement of vessels called *lacteals*, from the milky appearance of their contents, by which the nutritive part of the food is taken up; and these vessels, uniting and passing over the mesentery, carry this nutritive matter to a proper receptacle for it, whence it is conveyed into the circulation, and distributed to every part.

The intestines are chiefly retained in their relative positions by the *mesentery, c* (middle of the intestines), which is a doubling of the peritoneum, including each intestine in its folds, and also enclosing in its duplicatures the arteries, the veins, the nerves, and the vessels which convey the nutriment from the intestines to the circulation.

The first of the small intestines, and commencing from the right extremity of the stomach, is the *duodenum, a*, a very improper name for it in the horse, for in that animal it is nearly two feet in length. It is the largest and shortest of all the small intestines. It receives the food converted into chyme by the digestive power of the stomach, and here it undergoes another and very important change. It is mixed with the bile, and the secretion from the pancreas, which enter this intestine about five inches from its commencement. The bile seems to be the principal agent in the change now effected, for no sooner does it mingle with the chyme than that fluid begins to be separated into two distinct ingredients—a white thick liquid termed *chyle*, containing the nutritive part of the food, and a yellow pulpy substance, the innutritive or excrementitious portion, which, when the chyle is all pressed from it, is evacuated through the rectum.

The process of digestion being thus to a certain extent completed, the food passes through the other small intestines, and during that passage the chyle, or nutritious portion, is absorbed by the lacteals, so called from the milky appearance of their contents, to be conveyed into the circulation, and converted into blood, while the non-nutritious portion passes on to the larger intestines.

The next portion of the small intestines is the *Jejunum*, so called because it is generally found to be empty. It is smaller in bulk and paler in colour than the duodenum. It is more loosely confined in the abdomen—floating comparatively unattached in the cavity of the abdomen, and the passage of the food being comparatively rapid through it.

There is no separation or distinction between it and the next intestine—the *Ileum*. There is no point at which the jejunum can be said to terminate and the ileum commence. Together they form that portion of the intestinal tube which floats in the umbilical region: the latter, however, is said to occupy three-fifths, and the former two-fifths, of this portion of the intestines, and the five would contain about eleven gallons of fluid. The ileum is evidently less vascular than the jejunum, and gradually diminishes in size as it approaches the larger intestines.

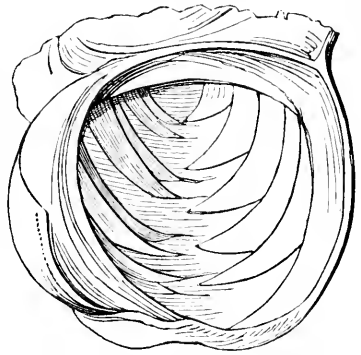
These two intestines are attached to the spine by a loose doubling of the peritoneum, and float freely in the abdominal cavity, their movements and their relative positions being regulated only by the size or fulness of the stomach, and the stage of the digestive process.

The small intestines derive their blood from the anterior mesenteric artery, which divide into innumerable minute branches that ramify between their muscular and villous coats. Their veins, which are destitute of valves, return the blood into the *vena portæ*.

The large intestines are three in number:—the *cæcum*, the *colon*, and



the *rectum*. The first of them is the *cæcum* (blind gut), (*e*),—it has but one opening into it, consequently everything that passes into it, having reached the blind or closed end, must return, in order to escape. It is not a continuation of the ileum, but the ileum pierces the head of it, as it were, at right angles (*d*), and projects some way into it, and has a valve—the *valvula coli*—at its extremity, so that the food that has passed from the small intestines into the larger cannot again be returned. Along the outside of the *cæcum* run three strong bands, each of them shorter than that intestine, and thus puckering it up, and forming it into three sets of cells, as shown in the accompanying side cut.



That portion of the food which has not been taken up by the lacteals or absorbent vessels of the small intestines passes through this valvular opening of the ileum, and a part of it enters the colon, while the remainder flows into the *cæcum*. Then, from this being a blind pouch, and from the cellular structure of this pouch, the food must be detained in it a very long time; and in order that, during this detention, all the nutriment may be extracted, the *cæcum* and its cells are largely supplied with blood-vessels and absorbents. It is principally the fluid part of the food that seems to enter the *cæcum*. A horse will drink at one time a great deal more than his stomach will contain; or even if he drinks a less quantity, it remains not in the stomach or small intestines, but passes on to the *cæcum*, and there is retained, as in a reservoir, to supply the wants of the system. In his state of servitude the horse does not often drink more than twice or thrice in a day, and the food of the stabled horse being chiefly dry, this *water stomach* is most useful to him. The *cæcum* will hold four gallons.

The *colon* is an intestine of exceedingly large dimensions, and is capable of containing no less than twelve gallons of liquid or pulpy food. At its union with the *cæcum* and the ileum, although larger than the latter intestine (*f*), it is of comparatively small bulk; but it soon swells out to an enormous extent. It has likewise, in the greater part of its course, three bands like the *cæcum*, which also divide it, internally, into the same description of cells. The intention of this is evident,—to retard the progress of the food, and to give a more extensive surface on which the vessels of the lacteals may open; and therefore, in the colon, all the chyle is finally separated and taken up. This intestine is of considerable length; it completely traverses the diameter of the abdominal cavity, and is then reflected on itself, and retraverses the same space. When this is nearly accomplished, the construction of the colon is somewhat changed:—we find but two bands towards the rectum, and these not puckering the intestine so much, or forming such numerous or deep cells. The food does not require to be much longer detained, and the mechanism for detaining it is gradually disappearing. The blood-vessels and absorbents are likewise rapidly diminishing. The colon, also, once more contracts in size, and the chyle having been all absorbed, the remaining mass, being of a harder consistence, is moulded into pellets or balls in its passage through these shallower cells.

At the termination of the colon, the *rectum* (straight gut) commences. It is smaller in circumference and capacity than the colon, although it will contain at least three gallons of water. It serves as a reservoir for the

ding until it is evacuated. It has none of these bands, because, all the nutriment being extracted, the passage of the excrement that remains should be hastened and not retarded; still, however, it would be very disagreeable were the horse to void his feces in the same fluid state as does the cow. To prevent this the inner coat of the rectum and a portion of the colon form a series of cells, in which the excrementitious portion of the food lodges until it becomes drier and more compact, and it is then evacuated in a much less offensive form. The feces descend to the rectum, which somewhat enlarges to receive them; and when they have accumulated to a certain extent, the animal, by the aid of the diaphragm and the muscles of the belly, presses upon them, and they are evacuated. A curious circular muscle, and always in action, and called the *sphincter* (constrictor muscle), is placed at the anus, to prevent the constant and unpleasant dropping of the feces, and to retain them until the horse is disposed voluntarily to expel them. This is effected by the efforts of the animal, assisted by the muscular coat of the rectum, which is stronger than that of any of the other intestines, and aided by the compression of the internal oblique and transverse muscles.

The larger intestines derive their blood from the posterior mesenteric artery. Their veins terminate in the vena portæ.

#### THE LIVER

Is situated principally in the right side of the abdominal cavity, but extending partially into the left, and is surrounded by the ribs, diaphragm, and stomach, its right lobe or division in contact with the diaphragm, the duodenum and the right kidney, and the middle and left divisions with the stomach. It is an irregularly shaped, reddish-brown substance, of considerable bulk, and performs a very singular and important office.

It has been already stated (p. 303) that the blood, which has been conveyed to the different parts of the body by the arteries, is brought back to the heart by the veins; but that which is returned from the stomach and intestines, and spleen, and pancreas, and mesentery, instead of flowing directly to the heart, as the blood from every other part of the body does, has an extra duty to perform before again entering into the general circulation—to secrete the bile: to effect this, it is collected in a large but short vein, called the vena portæ, which enters the liver by two large branches, that spread by means of innumerable minute branches through every part of it. As the blood traverses this organ, a fluid is separated from it, called the *bile*, which answers an important purpose, for the progress of digestion is promoted by the bile changing the nutritive portion of the food from chyme into chyle, and separating it from that which, containing little or no nutriment, is voided as excrement. Having performed this additional duty the fluid is returned from one vein into another, that is, from the vena portæ, which conveys it to the liver for the secretion of bile, to the hepatic veins, which return it to the general circulation.

Almost every part of the liver is closely invested by the peritoneum, which seems to discharge the office of a capsule to this viscus. Its arteries are very small, considering the bulk of the liver, to nourish which, however, is their only duty; their place in the secretion of bile is curiously supplied by a vein—the *vena portæ*—a vessel formed by the union of the splenic and mesenteric veins, and which seems, if it does not quite usurp the office and discharge the duty of the artery, to be alone concerned in the secretion of the bile. There is a free intercourse between the vessels of the two.

The bile, thus formed, is in most animals received into a reservoir, the *gall-bladder*, whence it is conveyed into the duodenum (y, p. 313) at the

times, and in the quantities, which the purposes of digestion require; but the horse has no gall-bladder, and, consequently, the bile flows into the intestine as rapidly as it is separated from the blood. The reason of this is plain. A small stomach was given to the horse in order that the food might pass quickly out of it, and the diaphragm and the lungs might not be injuriously pressed upon, when we require his utmost speed; and also that we might use him with little danger compared with that which would attach to other animals, even when his stomach is distended with food. Then the stomach, so small, and so speedily emptied, must be oftener replenished; the horse must be oftener eating, and food oftener or almost continuously passing out of his stomach. How admirably does this comport with the uninterrupted supply of bile!

#### THE PANCREAS.

In the domestic animals which are used for food, this organ is called the *sweet-bread*. It lies between the stomach and the left kidney. It much resembles in structure the salivary glands in the neighbourhood of the mouth, and the fluid which it secretes resembles the saliva in its properties. The pancreatic fluid is carried into the intestines by a duct which enters at the same aperture with that from the liver. It contains a peculiar substance named *pancratine*. Its use, whether to dilute the bile or the chyme, or to assist in the separation of the chyme from the feculent matter, has never been ascertained: it is, however, clearly employed in aiding the process of digestion.

#### THE SPLEEN.

This organ, often called the *melt*, is a long, bluish-brown substance, broad and thick at one end, and tapering at the other; lying along the left side of the stomach, and between it and the short ribs. It is of a spongy nature, divided into numerous little cells not unlike a honeycomb, and over which thousands of minute vessels thickly spread. The particular use of this organ has never been clearly ascertained, for in some cruel experiments it has been removed without apparent injury to digestion or any other function. It is, however, useful, at least occasionally, or it would not have been given to the animal. It is probably concerned in the renovation of the blood, and in the preparation of it for the secretion of bile.

#### THE OMENTUM,

Or *cawl*, is a doubling of the peritonæum. It is supposed to have been placed between the intestines and the walls of the belly in order to prevent concussion and injury during the rapid movement of the animal. That, however, cannot be its principal use in the horse, from whom the most rapid movements are required; for in him it is unusually short, extending only to the pancreas and a small portion of the colon. Being, however, thus short, the horse is exempt from a very troublesome and, occasionally, fatal species of rupture, when a portion of the omentum penetrates through some accidental opening in the covering of the belly.

The structure of the urinary organs and the diseases to which they are exposed will be hereafter considered.

#### CHOKING.

Although choking is rare in the horse as compared with the bovine tribe, it is attended with much greater danger in the former. It generally arises from the impactment of some hard substance either in the larynx or œsophagus, more frequently the latter. Horses that are voracious feeders frequently swallow their food so rapidly that mastication is not half

performed, and portions of it get lodged in the œsophagus, producing choking. It may also be caused by the animal swallowing pieces of carrot or turnip, showing the necessity of always *slicing* this kind of food into small pieces, when given to the horse. Another source of choking arises from the absurd and dangerous practice of the groom, who, by way of improving the condition of the horse, forces eggs into the animal's throat. The writer has often seen several cases arise from hay being given to the horse, when stopping for gruel or water on the return from hunting. The animal begins to eat the hay, and before he has had many mouthfuls the gruel or water is brought; the thirst being great, he plunges his nose into the fluid and drinks rapidly; by this means a portion of the half-masticated material is carried into the œsophagus, and all the effects of choking speedily follow. When an animal is choked, the following symptoms will generally be present:—a dejected but somewhat anxious countenance, skin bedewed with perspiration, saliva dropping from the mouth, frequent pawing with the feet, and the animal making attempts to swallow, which brings on a peculiar spasmodic constriction of the neck. The pulse and breathing are accelerated. When water is offered he will generally drink, but the fluid returns through the nostril. The treatment should consist in ascertaining the cause and situation of the obstruction. If it be caused by hay or chaff, attempts should be made to soften it, and hasten its passage, by frequently drenching the animal with warm water, and linseed oil; if the obstruction can be felt, careful manipulation may be employed to assist in breaking it up. These means should always be had resort to in the early stages, and, when the obstruction depends upon the above causes, good results will often follow; but when choking is caused by a hard substance like a piece of carrot or an egg, recourse must be had to the probang, with a view of pushing it down the œsophagus. It must be borne in mind, however, that the probang is much more difficult and dangerous to pass in the horse than in the ox, in consequence of the bent condition of the animal's neck, and should not be had resort to until nearly every other means had been tried. When even this fails to afford relief, and the position of the obstruction can be ascertained, the operation of œsophogotomy may be performed and the obstructing material removed. The method of performing this will be found under the head of operations. It is seldom attended with good results in the horse, as stricture of the œsophagus very frequently ensues. After the animal has been relieved, great care should be taken respecting the nature of the food which is given to him, as there still remains a great tendency to choke again. For the next four days he should be allowed nothing but sloppy mash, and even after that time considerable caution must be adopted.

Rupture of the œsophagus sometimes takes place either from the distension of its coats by the obstructing material, or the passing of the probang or other instrument to remove it. When this takes place we shall find an emphysematous swelling down the neck. Little can here be done, and a fatal termination may be expected.

#### RUPTURED STOMACH.

The situation of the stomach, and the important part it fulfils in the digestive process, render it liable to inflammation and various other lesions. Simple inflammation of the stomach of the horse is rarely met with, except as the result of some powerful irritant applied to its surface, and will be more particularly noticed under the head of poisons. We have already alluded to the effects on this organ produced by the consumption of large quantities of indigestible food under the name of stomach staggers, but the most serious lesion of the stomach is one which, although admitting

of no remedial agents being successfully employed, is nevertheless of much importance to distinguish from other diseases of the alimentary canal which its symptoms often resemble, viz. rupture of the stomach. It may arise from a variety of causes, such as blows, falls, or any violent exertion, especially when the stomach is full of food. Corrosive poisons and large numbers of bots have also produced it. But we most commonly meet with it amongst aged horses as a result of the frequent engorged state of the stomach. It is not uncommon amongst cab horses, when kept out many hours without the nose-bag, and allowed a large quantity of food when brought home. The rupture is generally situated on the right side of the stomach, along its greater curvature. The symptoms of ruptured stomach somewhat resemble those of colic. The animal will give evidence of severe pain, by great restlessness, pawing with his feet, lying down and at times raising himself on his haunches, at others resting on his breast. The countenance is distressed but anxious, the body bedewed with perspiration, pulse very quick and feeble, breathing much accelerated. The animal will also make efforts to vomit, and in some instances this has taken place shortly before death; the vomited material, passing through the nostril, is discharged from the nose. These symptoms will continue for a greater or less time, dependent upon the extent of the rupture. If but a small opening exist, they may last several days; but if the opening be large, and a considerable quantity of ingesta has escaped into the abdominal cavity, the symptoms will increase rapidly in violence, and the animal frequently dies in convulsions in a few hours.

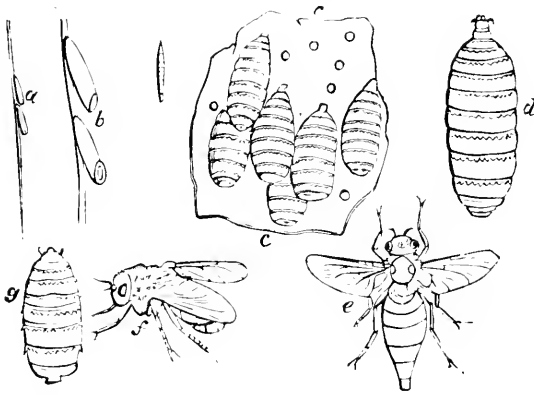
#### BOTS.

Bots are a peculiar kind of grub, which at certain seasons are found in considerable quantities adhering to the cuticular lining of the stomach of the horse. The two varieties most generally met with are the *æstrus equi* or large spotted horse bot, and the *æstrus hemorrhoidalis* or fundament bot. Their history is curious, and we are indebted to Mr. Bracy Clark for almost all we know of them.

A species of gad-fly, *c*, the *æstrus equi*, is in the latter part of the summer exceedingly busy about the horse. It is observed to be darting with great rapidity towards the knees and sides of the animal. The females are depositing their eggs on the hair, and which adhere to it by means of a glutinous fluid with which they are surrounded (*a* and *b*). In a few days the eggs are ready to be hatched, and the slightest application of warmth and moisture will liberate the little animals which they contain. The horse in licking himself touches the egg, which adheres to the tongue, and is conveyed with the food into the stomach. There it clings to the cuticular portion of the stomach, *c*, by means of a hook on either side of its mouth; and its hold is so firm and so obstinate, that it must be broken before it can be detached. It remains there feeding on the mucus of the stomach during the whole of the winter, and until the end of the ensuing spring; when, having attained a considerable size, *d*, and being destined to undergo a certain transformation, it disengages itself from the cuticular coat, is carried into the villous portion of the stomach with the food, passes out of it with the chyme, and is evacuated with the dung.

The *larva* or maggot seeks shelter in the ground, and buries itself there; it contracts in size, and becomes a chrysalis or grub, in which state it lies inactive for a few weeks, and then bursting from its confinement, assumes the form of a fly. The female, becoming impregnated, quickly deposits her eggs on those parts of the horse which he is most accustomed to lick, and thus the species is perpetuated.

The smaller or fundament bot, *g*, is not so frequently found. The fly *f* in this instance, deposits her eggs on the lips of the horse, and they then



*a* and *b* The eggs of the gad-fly, adhering to the hair of the horse.

*c* The appearance of the bots on the stomach, firmly adhering by their hooked mouths.

The marks or depressions are seen which are left on the coat of the stomach when the bots are detached from their hold.

*d* The bot detached.

*e* The female of the gad-fly, of the horse, prepared to deposit her eggs.

*f* The gad-fly by which the fundament bot is produced.

*g* The smaller, or fundament bot.

pass through the same stages as the one just described, and quit their habitation at the same season of the year. In their passage with the dung, however, they not unfrequently adhere to the verge of the anus, and cause a considerable amount of irritation.

There are several plain conclusions to be drawn from this history. The bots seldom, while they inhabit the stomach of the horse, give the animal any pain, for they have fastened on the cuticular and insensible coat. They cannot stimulate the stomach, and increase its digestive power, for they are not on the digestive portion of the stomach. They cannot, by their roughness, assist the trituration or rubbing down of the food, for no such office is performed in that part of the stomach—the food is softened, not rubbed down. They are rarely injurious to the horse, for he enjoys the most perfect health when the cuticular part of his stomach is filled with them, and their presence is not even suspected until they appear at the anus. They cannot be removed by medicine, because they are not in that part of the stomach to which medicine is usually conveyed: and if they were, their mouths are too deeply buried in the mucus for any medicine, that can safely be administered, to affect them; and, last of all, in due course of time they detach themselves, and come away. Therefore, the wise man will leave them to themselves, or content himself with picking them off when they collect under the tail and annoy the animal.

#### SPASMODIC COLIC.

The passage of the food through the intestinal canal is effected by the alternate contraction and relaxation of the muscular coat of the intestines. When that action is simply increased through the whole of the canal, the food passes more rapidly, and purging is produced; but the muscles of every part of the frame are liable to irregular and spasmodic action, and

the muscular coat of some portion of the intestines may be thus affected. The spasm may be confined to a very small part of the canal. The gut has been found, after death, strangely contracted in various places, but the contraction not exceeding five or six inches in any of them. In the horse, the ileum is the usual seat of this disease. It is of much importance to distinguish between spasmodic colic and inflammation of the bowels, for the symptoms have considerable resemblance, although the mode of treatment should be very different.

The attack of colic is usually very sudden. There is often not the slightest warning. The horse begins to shift his posture, look round at his flanks, raise his head, curl the upper lip, and make frequent attempts to void his urine; he will then paw violently, strike his belly with his feet, and crouch in a peculiar manner, advancing his hind limbs under him; he will then suddenly lie, or rather fall down, and roll himself upon his back, with his feet resting on his belly. The pain now seems to cease for a little while, and he gets up, and shakes himself, and begins to feed; the respite, however, is but short—the spasm returns more violently—every indication of pain is increased—he heaves at the flanks, breaks out into a profuse perspiration, and throws himself more recklessly about. In the space of an hour or two, the spasms begin to relax, and the remissions are of longer duration, and, in the great majority of cases, cease altogether, and the horse shortly resumes his work. Or, on the other hand, when the causes are of a more serious or mechanical nature, the torture is augmented at every paroxysm; the intervals of ease are fewer and less marked, and inflammation and death supervene. The pulse is but little affected at the commencement, but, if relief is not obtained, it becomes frequent and contracted, and at length is scarcely tangible.

It will presently be seen that many of the symptoms very closely resemble those of inflammation of the bowels: it may therefore be useful to point out the leading distinctions between them.

COLIC.	INFLAMMATION OF THE BOWELS.
Sudden in its attack.	Less sudden in its approach, with previous indications of fever.
Pulse rarely much quickened in the early period of the disease, and during the intervals of ease.	Pulse very much quickened, but small, and often scarcely to be felt.
Legs and ears of the natural temperature.	Legs and ears cold.
Relief obtained from rubbing the belly.	Belly exceedingly tender and painful to the touch.
Intervals of ease.	Constant pain.
Strength scarcely affected.	Rapid and great weakness.

Among the causes of colic are, the drinking of cold water when the horse is heated. There is not a surer origin of violent spasm than this. Hard water is very apt to produce this effect. Colic will sometimes follow the exposure of a horse to the cold air or a cold wind after strong exercise. Green meat, although, generally speaking, most beneficial to the horse, yet, given in too large a quantity, or when he is hot, will frequently produce gripes. Doses of aloes, both large and small, are not unfrequent causes of colic. In some horses there seems to be a constitutional predisposition to colic. They cannot be hardly worked, or exposed to unusual cold, without a fit of it. In many cases, when these horses have died, calculi have been found in some part of the alimentary canal. Habitual costiveness and the presence of calculi are frequent causes of spasmodic colic. The seat of colic is occasionally the duodenum, but oftener the ileum or the jejunum; sometimes, however, both the cæcum and colon are affected.

Fortunately, we are acquainted with several medicines that allay these spasms; and the disease often ceases almost as suddenly as it appeared. Amongst these, perhaps the best is the tincture of opium and spirit of nitric ether, given in doses of one ounce of the former with two ounces of the latter, in a pint of warm water. Should the spasm not be relieved, this may be repeated in two hours. If the attack proceed from the indigestible nature of the food upon which the animal has been feeding, a pint and a half of linseed oil may be given, half an hour after the first dose. The belly should be well rubbed with a brush or hard wisp of straw. The rectum should be unloaded and clysters of warm water administered. The patent syringe will here be exceedingly useful. A clyster of tobacco-smoke may be thrown up as a last resort. In some instances relief has been afforded by moving the animal about, but, if this be adopted, he should never exceed a walk. In the majority of cases, however, a loose box, well littered, in which he can lie down and roll about, is very much more rational treatment.

When relief has been obtained, the clothing of the horse should be removed, his skin rubbed dry, and fresh and dry clothes substituted. He should be well littered down in a warm stable or box, and have bran mashes and luke-warm water for the two or three next days.

Some persons give gin, or gin and pepper, in cases of gripes. This course of proceeding is, however, exceedingly objectionable. It may be useful, or even sufficient, in ordinary cases of colic; but if there should be any inflammation, or tendency to inflammation, it cannot fail to be highly injurious.

#### FLATULENT COLIC.

This is altogether a different disease from the former. It is not spasm of the bowels, but inflation of them from the presence of gas emitted by undigested food. Whether collected in the stomach, or small or large intestines, all kinds of vegetable matter are liable to ferment. In consequence of this fermentation, gas is evolved to a greater or less extent—perhaps to twenty or thirty times the bulk of the food. This may take place in the stomach; and if so, the life of the horse is in immediate danger, for, as will plainly appear from the account that has been given of the œsophagus and upper orifice of the stomach, the animal has no power to expel this dangerous flatus by eructation.

This extrication of gas usually takes place in the colon and cæcum, and the distension may be so great as to rupture either the one or the other, or sometimes to produce death, without either rupture or strangulation, and that in the course of from four to twenty-four hours.

In some ill-conducted establishments, it is a highly dangerous disease, and is especially fatal to horses of heavy draught. An overloaded stomach is one cause of it, and particularly so when water is given either immediately before or after a plentiful meal, or food to which the horse has not been accustomed is given.

The symptoms, according to Professor Stewart, are, 'the horse suddenly slackening his pace—preparing to lie down, or falling down as if he were shot. In the stable he paws the ground with his fore feet, lies down, rolls, starts up all at once, and throws himself down again with great violence, looking wistfully at his flanks, and making many fruitless attempts to void his urine.'

Hitherto the symptoms are not much unlike spasmodic colic, but the real character of the disease soon begins to develop itself. It is in one of the large intestines, and the belly swells all round, but mostly on the



right flank. As the disease proceeds, the pain becomes more intense, the horse more violent, and at length death closes the scene.

The treatment is at first but little different from that of spasmodic colic. The gas which causes the swelling in the early stages generally consists of carbonic acid, and here the preparations of ammonia would be of great service; one ounce of tincture of opium combined with two ounces of aromatic spirit of ammonia should be given in a quart of cold water, and repeated if necessary. As the disease progresses, combinations of hydrogen are generated, and the preparations of chlorine, such as the chloride of lime and the chlorate of potash, may be advantageously employed. If some compound of chlorine, dissolved in water, is administered in the form of a drink, the chlorine unites with the hydrogen, and muriatic gas is formed. This gas, having a strong affinity for water, is absorbed by any fluid that may be present, and quitting its gaseous form, either disappears, or does not retain a thousandth part of its former bulk. All this may be very rapidly accomplished, for the fluid is quickly conveyed from the mouth to every part of the intestinal canal. This should speedily be followed by four or five drachms of aloes in solution, with copious and repeated injections.

As a last resource, when the danger is imminent and every other means have been tried without success, the trochar may be used, in order to open a way for the escape of the gas. The trochar should be small, but longer than that which is used for the cow, and the puncture should be made in the middle of the right flank, for there the large intestines are most easily reached. In such a disease it cannot be expected that the intestines shall always be found precisely in their natural situations, but usually the origin of the ascending portion of the colon, or the base of the cæcum, will be pierced. Much of the danger would be avoided by using a very small trochar, and by withdrawing it as soon as the gas has escaped. The wound in the intestines will then probably close, from the innate elasticity of the parts.

#### INFLAMMATION OF THE BOWELS.

There are two varieties of this malady. The first is inflammation of the external coats of the intestines, accompanied by considerable fever, and usually costiveness. The second is that of the internal or mucous coat, and almost invariably connected with purging.

#### ENTERITIS.

Inflammation of the external coats of the intestines, whether the peritoneal or muscular, or both, is a frequent and very fatal disease.

The causes of this disease are, first of all and most frequently, sudden exposure to cold. If a horse that has been highly fed, carefully groomed, and kept in a warm stable, is heated with exercise, and has been during some hours without food, and in this state of exhaustion is suffered to drink freely of cold water, or is drenched with rain, or have his legs and belly washed with cold water, an attack of inflammation of the bowels will often follow. An over-fed horse, subjected to severe and long-continued exertion, if his lungs were previously weak, will probably be attacked by inflammation of them; but if the lungs were sound, the bowels will on the following day be the seat of disease. Stones in the intestines are an occasional cause of inflammation, and colic neglected or wrongly treated will terminate in it. It speedily runs its course, and it is of great consequence that its early symptoms should be known. If the horse has been carefully observed, restlessness and fever will have been seen to precede the attack. In many cases a direct shivering fit will occur: the

mouth will be hot, and the nose red. The animal will soon express the most dreadful pain by pawing, striking at his belly, looking wildly at his flanks, groaning, and rolling. The pulse will be quickened and wiry; the ears and legs cold; the belly tender, and sometimes hot; the breathing quickened; the bowels costive; and the animal becoming rapidly and fearfully weak.

The reader will probably here recur to the sketch given in page 323 of the distinction between spasmodic colic and inflammation of the bowels, or enteritis.

The horse paws and stamps as in colic, but without the intervals of ease that occur in that disease. The pulse also is far quicker than in colic. The breathing is more hurried, and the indication of suffering more evident. 'The next stage,' in the graphic language of Mr. Percivall in his *Hippopathology*, 'borders on delirium. The eye acquires a wild, haggard, unnatural stare—the pupil dilates—his heedless and dreadful throes render approach to him quite perilous. He is an object not only of compassion but of apprehension, and seems fast hurrying to his end; when, all at once, in the midst of agonising torments, he stands quiet, as though every pain had left him, and he were going to recover. His breathing becomes tranquillised—his pulse sunk beyond all perception—his body bedewed with a cold clammy sweat—he is in a tremor from head to foot, and about the legs and ears has even a dead-like feel. The mouth feels deadly chill; the lips drop pendulous; and the eye seems unconscious of objects. In fine, death, not recovery, is at hand. Mortification has seized the inflamed bowel—pain can no longer be felt in that which a few minutes ago was the seat of exquisite suffering. He again becomes convulsed, and in a few more struggles less violent than the former he expires.' The course of the disease, fortunately for the sufferings of the poor beasts afflicted with it, is a short one; death may supervene in forty-eight, twenty-four, or even twelve hours—it may be considered the most fatal disease of the horse.

The treatment of inflammation of the bowels, like that of the lungs, should be prompt and energetic. The first and most powerful means of cure will be bleeding. From six to eight or ten quarts of blood, in fact as much as the horse can bear, should be abstracted as soon as possible. The speedy weakness that accompanies this disease should not deter from bleeding largely. The weakness is the consequence of violent inflammation of these parts; and if that inflammation is subdued by the loss of blood, the weakness will disappear. The bleeding should be effected on the first appearance of the disease, for there is no malady that more quickly runs its course.

A full dose (5 i. to 5 ij. of opium) should immediately follow the bleeding; this may be repeated every four or five hours if necessary, but, considering the irritable state of the intestines at this period, purgatives should not be given. After the patient has somewhat recovered we may however give a small dose of oil. Back-raking, and injections, consisting of warm water or very thin gruel, should be early resorted to; and too much fluid can scarcely be thrown up. If the common ox-bladder and pipe is used, it should be frequently replenished; but with Read's patent pump, already referred to, sufficient may be injected to penetrate beyond the rectum, and reach to the colon and cæcum, and dispose them to evacuate their contents. Enemas of tobacco-smoke may be also administered.

It will now be prudent to endeavour to excite considerable external inflammation as near as possible to the seat of internal disease, and therefore the whole of the belly should be blistered. In a well-marked case of this disease, no time should be lost in applying fomentations, but the blister at

once resorted to. The tincture of Spanish flies, made with turpentine, should be thoroughly rubbed in. The legs should be well bandaged in order to restore the circulation in them, and thus lessen the flow of blood to the inflamed part; and, for the same reason, the horse should be warmly clothed; but the air of the stable or box should be cool.

The horse should be encouraged to drink plentifully of warm water or thin gruel, and no corn or hay should be allowed during the disease, but bran mashes, and green meat if it can be procured. The latter will be the best of all food, and may be given without the slightest apprehension of danger. When the horse begins to recover, a handful of corn may be given two or three times in the day; and, if the weather is warm, he may be turned into a paddock for a few hours in the middle of the day. Clysters of gruel should be continued for three or four days after the inflammation is beginning to subside, and good hand-rubbing applied to the legs.

The second variety of inflammation of the bowels affects the internal or mucous coat, and is generally the consequence of physic in too great quantity, or of an improper kind.

When the mucous membrane is in an irritable condition, or from sympathy, as in inflammation of the lungs, a small dose of purgative medicine will sometimes produce this disease. The purging is more violent and continues longer than was intended; the animal shows that he is suffering great pain; he frequently looks round at his flanks; his breathing is laborious, and the pulse is quick and small—not so small, however, as in inflammation of the peritoneal coat, and, contrary to some of the most frequent and characteristic symptoms of that disease, the mouth is hot, and the legs and ears are warm. Unless the purging is excessive, and the pain and distress great, the surgeon should hesitate at giving any astringent medicine at first; but he should plentifully administer wheat-flour gruel, or arrow-root, or thin starch; removing all hay and corn, and particularly green meat. He should thus endeavour to soothe the irritated surface of the bowels, while he permits all remains of the purgative to be carried off. If, however, twelve hours have passed, and the purging and the pain remain undiminished, he should continue the gruel, adding to it chalk, catechu, and opium, repeated every six hours. As soon as the purging begins to subside, the astringent medicine should be lessened in quantity, and gradually discontinued. The horse should be warmly clothed and placed in a comfortable stable, and his legs should be hand-rubbed and bandaged.

Violent purging, and attended with much inflammation and fever, will occur from other causes. Green meat will frequently purge. A horse worked hard upon green meat will sometimes scour. The remedy is change of diet, or less labour. Young horses will often be strongly purged, without any apparent cause. Astringents should be used with much caution here. It is probably an effort of nature to get rid of something that offends. A few doses of gruel will assist in effecting this purpose, and the purging will cease without astringent medicine.

Many horses that are not *well-ribbed home*—having too great space between the last rib and the hip-bone—are subject to purging if more than usual exertion is required from them. They are recognised by the term of *washy* horses. They are often free and fleet, but destitute of continuance. They should have rather more than the usual allowance of corn, with beans, when at work. A cordial ball, with catechu and opium, will often be serviceable either before or after a journey.

## PHYSICKING.

This would seem to be the proper place to speak of physicking horses—a mode of treatment necessary under various diseases, often useful for the augmentation of health, and yet which has often injured the constitution and absolutely destroyed thousands of animals. When a horse comes from grass to hard meat, or from the cool open air to a heated stable, a dose or even two doses of physic may be useful to prevent the tendency to inflammation which is the necessary consequence of so sudden and great a change. To a horse that is becoming too fat, or has surfeit, or grease, or mange, or that is out of condition from inactivity of the digestive organs, a dose of physic is often most serviceable; but the reflecting man will enter his protest against the periodical physicking of all horses in the spring and the autumn, and more particularly against that severe system which is thought to be necessary in order to train them for work, and also the absurd method of treating the animal when under the operation of physic.

A horse should be carefully prepared for the action of physic. Two or three bran mashes given on that or the preceding day are far from sufficient when a horse is about to be physicked, whether to promote his condition or in obedience to custom. Mashes should be given until the dung becomes softened. A less quantity of physic will then suffice, and it will more quickly pass through the intestines, and be more readily diffused over them. Four drachms of aloes, given when the dung has thus been softened, will act much more effectually and much more safely than seven drachms, when the lower intestines are obstructed by hardened feces. The best time to give physic is about eleven o'clock in the morning, as it then usually begins to operate early on the following day, and an opportunity is better afforded of watching the animal, in case he should be griped, than in the night. On the day after the physic is given, the horse should have walking exercise for a quarter of an hour, two or three times in the day; but after the physic begins to operate freely he should not be moved from his stall. Exercise would then produce gripes, irritation, and possibly dangerous inflammation. As much mash should be given as the horse will eat, and as much water, with the coldness of it taken off, as he will drink. If, however, he obstinately refuses to drink warm water, it is better that he should have it cold, than to continue without taking any fluid.

Eight or ten tolerably copious motions will be perfectly sufficient to answer every good purpose, although the groom or the carter may not be satisfied unless double the quantity are procured. The consequence of too strong purgation will be, that weakness will hang about the animal for several days or weeks, and inflammation will often ensue from the over-irritation of the intestinal canal.

Long-continued custom has made ALOES the almost invariable purgative of the horse, and very properly so; for there is no other at once so sure and so safe. The Barbadoes aloes, although sometimes very dear, should alone be used. The dose, with a horse properly prepared, will vary from four to six drachms. The preposterous doses of nine, ten, or even twelve drachms, are now, happily for the horse, generally abandoned. Custom has assigned the form of a ball to physic, and very properly, for it can be so given with certainty, and without annoyance to the animal, while in the form of a draught there is both annoyance to the horse and a waste of the medicine; but there is good sense in having recourse to the solution of aloes, as acting more speedily, effectually, and safely in cases of sickness, when it has to be given in small doses and frequently repeated.

The only other purgative on which dependence can be placed is the CROTON. The farina or meal of the nut is generally used; but from its acrimony it should be given in the form of ball, with linseed meal. The dose varies from a scruple to half a drachm. It acts more speedily than the aloes, and without the nausea which they produce; but it causes more watery stools and, consequently, more debility.

LINSEED-OIL is an uncertain but safe purgative, in doses from a pound to a pound and a half. OLIVE-OIL is more uncertain, but safe; but CASTOR-OIL, that mild aperient in the human being, is both uncertain and unsafe. EPSOM-SALTS are inefficacious, except in the immense dose of a pound and a half, and then they are not always safe.

### CALCULI, OR STONES, IN THE INTESTINES.

These are a cause of inflammation in the bowels of the horse, and more frequently of colic. They are generally found in the cæcum or colon, varying considerably in shape according to the nucleus round which the sabulous or other earthy matter collects, or the form of the cell in which they have been lodged. They differ in weight, from an ounce to between thirty and forty pounds, and in size vary from a small marble to a man's head. When small, they are occasionally found in considerable numbers, but when of the larger size, there is rarely more than one. From the horizontal position of the carcase of the horse, the calculus, when it begins to form, does not gravitate as in the human being, and therefore calculous concretions remain and accumulate until their very size prevents their expulsion, and a fatal irritation is too frequently produced by their motion and weight. They are oftenest found in heavy draught, and in millers' horses. In some of these horses they have the appearance of grit-stone or crystallised *quæss*. It is probable that they partly consist of those very minerals, combined with the bran which is continually floating about. An analysis of the calculi favours this supposition. They are a source of continual irritation wherever they are placed, and are a fruitful cause of colic. Spasms of the most fearful kind have been clearly traced to them.

Professor Morton, of the Royal Veterinary College,—in his valuable Essay on Calculous Concretions,—gives an interesting account of these substances in the intestinal canal of the horse. Intestinal calculi are composed of the phosphates of lime, magnesia, and ammonia, combined with animal matter; the phosphates are deposited from the food, when digestion is not sufficiently complete for them to be completely dissolved and carried into the circulation. Little advance has been or can be made to procure their expulsion, or even to determine their existence; and even when they have passed into the rectum, although some have been expelled, others have been so firmly impacted as to resist all mechanical means of withdrawal, and a few have broken their way through the parietes of the rectum, and lodged in the abdominal cavity. Mr. Percivall, in his 'Elementary Lectures on the Veterinary Art,' has recorded several fearful cases of this.

Other concretions are described under the head of *oat-hair calculi*. Their surface is tuberculated and their forms irregular. They are usually without any distinct nuclei, and are principally composed of the hairy material which exists on the glume of the oat. They are moderate in size, brown in colour, soft, semi-elastic, and flesh-like in feel; this feeling depends on the principal ingredients, a number of minute hairs which invest the oat, combined with a portion of earthy matter, and inspissated mucus. The professor very properly adds, and it is a circumstance which deserves

much consideration, that such oats as are linsky, with a deficiency of farinaceous matter, are likely to give rise to these accumulations, whenever impaired digestion exists. It is also an undoubted fact, that a great proportion of horses affected with calculi are the property of millers, or brewers. A third species of concretion too frequently existing is the *dung-ball*, or *mixed calculus*. It is made up of coarse, indigestible, excrementitious matter, mixed with portions of the '*out-hair calculus*,' and many foreign substances, such as pieces of coal, gravel, &c., and the whole agglutinated together. They are commonly met with in horses that are voracious feeders, and mingled with particles of coal and stone.

#### INTROSUSCEPTION OF THE INTESTINES.

The spasmodic action of the ileum being long continued may have been occasioned, or may be succeeded, by an inverted one from the cæcum towards the stomach, more powerful than in the natural direction; and the contracted portion of the intestine will be thus forced into another above it that retains its natural calibre. The irritation caused by this increases the inverted action, and an obstruction is formed which no power can overcome. Even the natural motion of the bowels will be sufficient to produce introsusception, when the contraction of a portion of the ileum is very great. There are no symptoms to indicate the presence of this, except continued and increasing pain.

Introsusception is not confined to any particular situation. A portion of the jejunum has been found invaginated within the duodenum,—and also within the ileum, and the ileum within the cæcum,—and one portion of the colon within another, and within the rectum. The ileum and jejunum are occasionally invaginated in various places. More than a dozen distinct cases of introsusception have occurred in one animal, and sometimes unconnected with any appearance of inflammation, but in other cases, or in other parts of the intestinal canal of the same animal, there will be inflammation of the most intense character. In the majority of cases, perhaps it is an accidental consequence of pre-existing disease, and occasioned by some irregular action of the muscular tunic, or some irritation of the mucous surface.

An equally formidable, but not so frequent disease, is

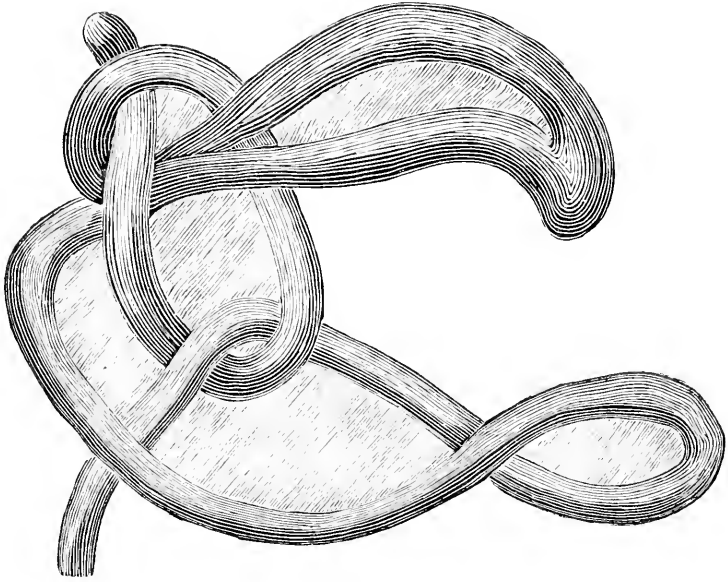
#### ENTANGLEMENT OF THE BOWELS.

This is another and singular concomitant of colic. Although the ileum is enveloped in the mesentery, and its motion to a considerable degree confined, yet under the spasm of colic, and during the violence with which the animal rolls and throws himself about, portions of the intestine may become so entangled as to be twisted into nooses and knots, drawn together with a degree of tightness scarcely credible. Nothing but the extreme and continued torture of the animal can lead us to suspect that this has taken place, and, could we ascertain its existence, there would be no cure.

An interesting case occurred in the practice of Mr. Spooner of Southampton. A mare at grass was suddenly taken ill. She discovered symptoms of violent colic, for which anti-spasmodic and aperient medicines were promptly administered, and she was copiously bled. The most active treatment was had recourse to, but without avail, and she died in less than four-and-twenty hours without a momentary relief from pain.

The small intestines were completely black from inflammation, and portions of them were knotted together in the singular way delineated in the subjoined cut. The parts are a little loosened in order better to show the

entanglement of the intestines, but in the animal they were drawn into a tight knot, and completely intercepted all passage.



## WORMS.

Worms of different kinds inhabit the intestines; but, except when they exist in very great numbers, they are not so hurtful as is generally supposed, although the groom or carter may trace to them hidebound, and cough, and loss of appetite, and gripes, and megrims, and a variety of other ailments. Of the origin or mode of propagation of these parasitical animals we can say little; neither writers on medicine, nor even on natural history, have given us any satisfactory account of the matter.

The long white worm (*Lumbricus teres*), much resembling the common earth-worm, and being from six to ten inches in length, inhabits the small intestines. It is a formidable-looking animal, and if there are many of them they may consume more than can be spared of the nutritive part of the food or the mucus of the bowels. A tight skin, and rough coat, and tacked up belly, are sometimes connected with their presence. They are then, however, voided in large quantities.

A smaller, darker-coloured worm, called the needle-worm, or *ascaris vermicularis*, inhabits the large intestines. Hundreds of them sometimes descend into the rectum, and immense quantities have been found in the cæcum. These are a more serious nuisance than the former, for they cause a very troublesome irritation about the fundament, which sometimes sadly annoys the horse.

In the treatment for the expulsion of worms an immense variety of remedies have been employed, many of which are calculated to do serious mischief to the animal. Large doses of aloes, calomel, tartar emetic, arsenic, corrosive sublimate, powdered glass, pewter tin scraped fine, &c., have each had their advocates as vermifuges. But in the treatment for the removal of these parasites it should not be forgotten that the intestinal canal is their natural habitation, and unless from some peculiarity of the system they accumulate in large quantities, they are not likely to produce

mischief. Perhaps there is no cause to which their undue influence can more generally be traced than a debilitated condition of the animal, whether as a result of age, the bad quality of the food upon which he has been kept, or disease. Bearing this in mind, our chief effort in treatment should consist in restoring the general vigour of the system. The animal should be well attended to, and kept on the most nutritious foods, such as oats, or beans, and good hay; a bran mash should also be allowed twice a week. Our medicinal agents should consist of the early administration of a pint and a half of linseed oil, which may be repeated every ten days for three times. A drachm also of powdered sulphate of iron should be given every night, for a fortnight, in the animal's food. By these means we shall frequently succeed in sufficiently restoring the general health of the animal to produce their expulsion, without running the risk of doing that injury which by the employment of many of those agents above mentioned we are liable to produce.

#### HERNIA, OR RUPTURE.

A portion of the intestine protrudes out of the cavity of the belly, either through some natural or artificial opening. In some cases it may be returned, but from the impossibility of applying a truss or bandage it soon escapes again. At other times the opening is so narrow that the gut, gradually distended by gas or feces, or thickened by inflammation, cannot be returned, and *strangulated* hernia is then said to exist. The seat of hernia is either in the scrotum of the perfect horse, or the canal leading to it—this is called inguinal, or scrotal; or at the navel in the centre of the abdomen—this is umbilical hernia; then there are hernia arising from wounds or bruises, and these are most frequently found in the flank, and are known as ventral hernia; and occasionally there is rupture of and hernia through the diaphragm, called diaphragmatic. The causes are violent struggling when under operations, over-exertion, kicks, or accidents. The assistance of a veterinary surgeon is here indispensable.

The following case of operation for hernia will be acceptable to the owner of horses as well as to the veterinary surgeon. It occurred in the practice of Professor Simonds, of the Royal Veterinary College. We extract this account of it from 'The Veterinarian.'

'The patient was an aged black cart-mare, that had been lent by the owner to a neighbour for a day or two. I cannot speak positively as to the cause of the injury which she received, but I believe that it resulted from her falling in the shafts of a cart laden with manure. She was brought to my infirmary on the next day, October 18, 1837.

'The most extensive rupture I had ever seen presented itself on the left side. The sac formed by the skin, which was not broken, nor even the hair rubbed off, extended as far forwards as the cartilages of the false ribs, and backwards to the udder. A perpendicular line drawn from the superior to the inferior part of the tumour measured more than twelve inches. It appeared, from its immense size and weight, as if by far the larger part of the colon had protruded.

'To my surprise, there was comparatively little constitutional disturbance. The pulse was 45, and full, with no other indication of fever, and no expression of pain on pressing the tumour.

'She was bled until the pulse was considerably lowered. A cathartic was given, and the sac ordered to be kept constantly wet with cold water, and to be supported with a wide bandage. She was placed on a restricted and mash diet.

'On the next day, being honoured with a visit by Messrs. Morton, Spooner, and Youatt, I had the pleasure and advantage of submitting the



ease to their examination, and obtaining their opinion. They urged me to attempt to return the protruding viscera, and secure them by a surgical operation; and Mr. Spooner kindly offered to be present, and to give me his valuable assistance.

‘On the 24th, our patient was considered to have had sufficient preparatory treatment, and she was operated upon. We availed ourselves of the opportunity of putting to the test that which some among us had doubted, and others had positively denied, but which had always been maintained by our talented chemical lecturer—the power of opium to lull the sensation of pain in the horse. We therefore gave her two ounces and a half of the tincture of opium, shortly before she was led from the box to the operating house, and the power of the drug was evident through the whole of the operation.

‘After a careful examination, externally, as well as per rectum, in order to ascertain the situation and probable size of the laceration of the muscles, an incision was carefully made through the integument into the sac, in a line with the inferior border of the cartilages of the false ribs, which incision was about seven inches in length. This, as we had hoped, proved to be directly upon the aperture in the muscular parietes of the abdomen. The intestines were exposed; and, after having sufficiently dilated the opening to permit the introduction of the hand, they were quickly returned, portion after portion, into their proper cavity, together with a part of the omentum, which we found somewhat annoying, it being frequently forced back again through the laceration.

‘At times it required the exertion of our united strength to prevent the escape of the intestines, and which was only effected by placing our hands side by side, covering and pressing upon the opening. By these means we succeeded in keeping in the viscera, until we were satisfied that we had placed them all within their proper cavity. At about the central part of the aperture, we decidedly found the greatest pressure of the intestines to effect an escape.

‘A strong metallic suture of flexible wire was then passed through the edges of the laceration, taking in the peritoneum and portions of the transversalis, rectus, and internal abdominal muscles; and other sutures, embracing the same parts, were placed at convenient distances, so as nearly to close the aperture. Two sutures of smaller metallic wire, and three of stout silk cord, were then passed through the external abdominal muscles, and their aponeuroses, which effectually shut up the opening into the abdomen. The integument was then brought together by the interrupted suture, taking care to bring out the ends of the other sutures, and which had been purposely left long, so that in case of supervening inflammation, or swelling, they might be readily examined. The whole operation occupied rather less than an hour, our poor patient being occasionally refreshed with some warm gruel.

‘The hobbles were now quietly removed, and, after lying a few minutes, she got up, and was placed in a large loose box. A compress and a suspensory bandage, that could be tightened at pleasure, were applied to the wound. The result was very satisfactory, and at the end of three months she returned to her usual work.’

In umbilical hernia we get a protrusion of the intestines into the umbilicus. On examination, a tumour varying in size will be found about the centre of the abdomen, which is soft to the feel, and can generally be reduced by pressure, when the rounded edges of the peritoneal cavity from which the intestine has escaped will be distinctly felt. By way of treatment, persistent pressure, in the form of a truss, will sometimes be effectual; but the following method will generally be attended with the

greatest success:—The animal should be kept without food for twelve hours, and then cast, and placed upon his back, the intestine pushed back into its proper place. A piece of skin should then be gathered up, and a ligature placed tightly round it. With a view of preventing the ligature slipping off, two small iron skewers are sometimes passed transversely through the skin, and the ligature tied above them. In a short time the piece of skin will slough off, and permanent obliteration of the sac, and closure of the opening into the abdominal cavity, will generally follow.

#### DISEASES OF THE LIVER.

As veterinary practice has improved, much light has been thrown on the diseases of the liver—not perhaps on the more advanced and fatal stages; but giving us the promise that, in process of time, they may be detected at an earlier period, and in a more manageable state.

#### SOFTENING AND RUPTURE OF THE LIVER.

If horses, destroyed on account of their complaints, are examined when they are not more than five years old, the liver is usually found in the most healthy state; but when they arrive at eight or nine or ten years this viscus is frequently increased in size—it is less elastic under pressure—it has assumed a granulated or broken down appearance—the blood does not so readily permeate its vessels, and at length, in a greater or less quantity, it begins to exude, and it is either confined under the peritoneal covering, or oozes into the cavity of the belly. There is nothing for awhile to indicate the existence of this. The horse feeds well, is in apparent health, in good condition, and capable of constant work, notwithstanding so fatal a change is taking place in this important viscus; but, at length, the peritoneal covering of the liver suddenly gives way, and the contents of the abdomen are deluged with blood, or a sufficient quantity of this fluid has gradually oozed out to interfere with the functions of the viscera.

The symptoms of this sudden change are pawing, shifting the posture, distension of the belly, curling of the upper lip, sighing frequently and deeply, the mouth and nostrils pale and blanched, the breathing quickened, the pulse flagging or imperceptible, restlessness, debility, fainting, and death.

On opening the abdomen, the intestines are found to be deluged with dark venous blood. The liver is either of a fawn, or light yellow, or brown colour—easily torn by the finger, and, in some cases, completely broken down. This affection is comparatively very rare in the country, but in the metropolis is of no unfrequent occurrence.

If the hæmorrhage has been slight at the commencement, and fortunately arrested, yet a singular consequence will frequently result. The sight will gradually fail: the pupil of one or both eyes will gradually dilate, the animal will have *gutta serena*, and become perfectly blind. This will almost assuredly take place on a return of the affection of the liver. Little can be done in a medical point of view. Astringent and styptic medicines may, however, be tried. Turpentine, alum, or sulphuric acid, will afford the only chance. The veterinary world is indebted to the late Mr. John Field for much that is known of this sad disease.

#### HEPATITIS—INFLAMMATION OF THE LIVER.

This may consist in inflammation either of the capsule of the liver or of its internal structures, or more often of both. It is rare in the horse, compared with man, and may be looked upon as an obstinate and fre-

quently fatal disease. It will arise from a variety of causes, such as a plethoric state of the system, induced by high feeding and want of exercise, over-exertion especially in hot weather, injuries to the side, and sympathy with other inflamed organs, as the lungs or bowels. In the early stages of the disease the animal will generally be found dull, and off his feed; he will give evidence of abdominal pain, by restlessness and frequently looking at his sides, but not so much as in enteritis. The breathing and pulse will also be slightly increased. As the disease progresses the internal membrane of the mouth, nose, and eyes will become of a yellow colour, the bowels are constipated, and the small quantities of hard faeces voided, will be of a clayish yellow colour. The urine also will be highly coloured with bile. The animal will now give evidence of pain, on pressure being applied to the right side, over the region of the liver; lameness of the off fore-limb will also occasionally be present. If the symptoms go on increasing in severity, and no relief be afforded, a fatal termination will probably be the result in eight or ten days. Our treatment should consist in the immediate abstraction of blood to the extent of five or six quarts. This should be at once followed by  $\zeta$ i. calomel, with  $\zeta$ ij. to  $\zeta$ iv. aloes. Counter-irritation, also, in the form of a blister, should be applied to the right side. The animal should be placed in a cool well-ventilated stable, kept as quiet as possible, and allowed nothing in the shape of food, except bran mash, and linseed or oatmeal gruel. If the symptoms yield to treatment, and the animal begins to recover, he should for some time be kept on light, nutritious foods. Vegetable tonics may also be given to restore the tone of the digestive system, great attention being paid to the state of the bowels.

#### JAUNDICE,

Commonly called THE YELLOWS, is a more frequent, but more tractable disease. It is the introduction of bile into the general circulation. This is usually caused by some obstruction in the ducts or tubes that convey the bile from the liver to the intestines. The horse, however, has but one duct, through which the bile usually flows as quickly as it is formed, and there is no gall-bladder. Jaundice does, however, occasionally appear, either from an increased flow or altered quality of the bile, or obstruction even in this simple tube. The yellowness of the eyes and mouth, and of the skin where it is not covered with hair, mark it sufficiently plainly. The dung is small and hard; the urine highly coloured; the horse languid, and the appetite impaired. If he is not soon relieved, he sometimes begins to express considerable uneasiness; at other times he is dull, heavy, and stupid. A characteristic symptom is lameness of the right fore-leg, resembling the pain in the right shoulder of the human being in hepatic affections. The principal causes are over-feeding or over-exertion in saltry weather, or too little work generally speaking, or inflammation or other disease of the liver itself.

It is first necessary to enquire whether this affection of the liver is not the consequence of the sympathy of that organ with some other part, for, to a very considerable degree, it frequently accompanies inflammation of the bowels and the lungs. These diseases being subdued, jaundice will disappear. If there is no other apparent disease to any great extent, an endeavour to restore the natural passage of the bile by purgatives may be tried—not consisting of large doses, lest there should be some undetected inflammation of the lungs or bowels, in either of which a strong purgative would be dangerous; but given in small quantities, repeated at short intervals, and until the bowels are freely opened. Plenty of water slightly warmed, or thin gruel, should be given. The horse should be

warmly clothed, and the stable well ventilated, but not cold. Carrots or green meat will be very beneficial. Should the purging, when once excited, prove violent, we need not be in any haste to stop it, unless inflammation is beginning to be connected with it, or the horse is very weak. The medicine recommended under diarrhœa may then be exhibited. A few slight tonics should be given when the horse is recovering from an attack of jaundice.

THE SPLEEN is sometimes very extraordinarily enlarged, and has been ruptured. We are not aware of any means by which this may be discovered, nor any treatment calculated to afford relief.

#### THE KIDNEYS.

The blood contains a great quantity of watery fluid unnecessary for the nutriment or repair of the frame. There likewise mingle with it matters that would be noxious if suffered to accumulate too much. The kidneys are actively employed in separating this fluid, and likewise carrying off a substance which constitutes the peculiar ingredient in urine, called the *urea*, and consisting principally of that which would be poisonous to the animal. The kidneys are two large oval glandular bodies, placed under the loins, of the shape of a kidney-bean, of immense size. The right kidney is most forward, lying behind the liver; the left is more backward. A large artery runs to each, carrying not less than a sixth part of the whole of the blood that circulates through the frame. This artery is divided into innumerable little branches most curiously complicated and coiled upon each other, and the blood, traversing these convolutions, has its watery parts, and others the retaining of which would be injurious, separated from it, and, thus separated, passes into a muscular membranous tube connected with the pelvis of each kidney, and is conveyed through them into the bladder.

This fluid varies materially both in quantity and composition, even during health. There is no animal in which it varies so much as in the horse—there is no organ in that animal so much under our command as the kidney; and no medicines are so useful, or may be so injurious, as diuretics—not only on account of their febrifuge or sedative effects, but because of the power which they exert. They stimulate the kidneys to separate more aqueous fluid than they otherwise would do, and thus lessen the quantity of blood which the heart is labouring to circulate through the frame, and also that which is determined or driven to parts already overloaded. The main objects to be accomplished in these diseases is to reduce the force of the circulation, and to calm the violence of excitement. Diuretics, by lessening the quantity of blood, are useful assistants in accomplishing these purposes. At the anterior edges of the kidneys are two vascular bodies called the renal capsules, large and of a deep red colour in fetal life, while in maturity they are smaller and lighter in colour: their functions are unknown.

The horse is subject to effusions of fluid in particular parts. Swelled legs are a disease almost peculiar to him. The ox, the sheep, the dog, the ass, and even the mule, seldom have it, but it is for the removal of this deposit of fluid in the cellular substance of the legs of the horse that we have recourse to diuretics. The legs of many horses cannot be rendered fine, or kept so, without the use of diuretics; nor can grease—often connected with these swellings, producing them or caused by them—be otherwise subdued. It is on this account that diuretics are ranked among the most useful of veterinary medicines.

In judicious hands, however, these medicines are sadly abused.

Among the absurdities of stable-management there is nothing so injurious as the frequent use of diuretics. Not only are the kidneys often over-excited, weakened, and disposed to disease, but the whole frame becomes debilitated; for the absorbents have carried away a great part of that which was necessary to the health and condition of the horse, in order to supply the deficiency of blood occasioned by the inordinate discharge of urine. There is likewise one important fact of which the groom or the horseman seldom thinks, viz. :—That, when he is removing these humours by the imprudent use of diuretics, he is only attacking a symptom or a consequence of disease, and not the disease itself. The legs will fill again, and the grease will return. While the cause remains, the effect will be produced.

In the administration of diuretics, one thing should be attended to, and the good effect of which the testimony of every intelligent man will confirm: *the horse should have plenty to drink*. Not only will inflammation be prevented, but the operation of the medicine will be much promoted.

#### NEPHRITIS—INFLAMMATION OF THE KIDNEYS.

This is no uncommon disease in the horse, and is more unskilfully and fatally treated than almost any other. The early symptoms are those of fever generally, but the seat of the disease soon becomes evident. The horse looks anxiously round at his flanks; stands with his hinder legs wide apart; is unwilling to lie down; straddles as he walks; expresses pain in tarning; shrinks when the loins are pressed, and some degree of heat is felt there. The urine is voided in small quantities; frequently it is high-coloured, and sometimes bloody. The attempt to urinate becomes more frequent, and the quantity voided, smaller, until the animal strains painfully and violently, but the discharge is nearly or quite suppressed. The pulse is quick and hard; full in the early stage of the disease, but rapidly becoming small, yet not losing its character of hardness. These symptoms clearly indicate an affection of the urinary organs; but they do not distinguish inflammation of the kidney from that of the bladder. In order to effect this, the hand must be introduced into the rectum. If the bladder is felt full and hard under the rectum, there is inflammation of the neck of it; if it is empty, yet on the portion of the intestines immediately over it there is more than natural heat and tenderness, there is inflammation of the body of the bladder; and if the bladder is empty, and there is no increased heat or tenderness, there is inflammation of the kidney.

The causes of this disease are, too powerful or too often repeated diuretics, which induce inflammation of the kidney, or a degree of irritation and weakness of that organ that disposes to inflammation, from causes that otherwise would have no injurious effect. If a horse is sprained in the loins, by being urged on, far and fast, by a heavy rider, or compelled to take too wide a leap, or by being suddenly pulled up on his haunches, the inflammation is often transferred from the loins to the kidneys, with which they lie in contact. Exposure to cold is another frequent origin of this malady, especially if the horse is drenched with rain, or the wet drips upon his loins; and more particularly, if he was previously disposed to inflammation, or these organs had been previously weakened. For this reason, coach and cab horses, and others exposed to the vicissitudes of the weather, should have their loins protected by some waterproof covering. It may also be produced by some irritating agent, contained in the food on which the animal is fed, such as dark mow-burnt hay, or what are called foxy oats, &c.

The chief cause, however, of nephritis, is the unnecessary quantity, or

undue strength, of the diuretic medicines that are given by ignorant grooms. This is an evil carried to a most injurious extent, and which every horseman should positively forbid.

The treatment will only vary from that of inflammation of other parts, by a consideration of the peculiarity of the organ affected. Bleeding must be promptly resorted to, and carried to its full extent. An active purge should next be administered; and a counter-inflammation excited as nearly as possible to the seat of disease. For this purpose the loins should be fomented with hot water, or covered with a mustard-poultice—the horse should be warmly clothed; but no cantharides or turpentine should be used, nor any diuretic be given internally. When the groom finds this difficulty or suppression of staling, he immediately has recourse to a diuretic ball to force on the urine; and by thus needlessly irritating a part already too much excited, he adds fuel to fire, and frequently destroys the horse. Clysters also of warm soap and water, should be thrown up the rectum every three or four hours; they will not only promote the early action of the purgative medicine, but will also, to a certain extent, act as a fomentation to the inflamed part.

The action of the purgative having begun a little to cease, carbonate of soda in half-ounce doses should be given two or three times a day. The patient should be warmly clothed, a fresh sheep-skin thrown over the loins and frequently changed, and his legs well bandaged. The food should be carefully examined, and anything that could have excited or that may prolong the irritation carefully removed. He should be allowed to drink freely of mucilaginous fluids, such as linseed gruel, and be kept on soft food, as bran mash, for some time.

#### DIABETES, OR PROFUSE STALING,

Is a comparatively rare disease. It is generally the consequence of undue irritation of the kidney, by bad food or strong diuretics, and sometimes follows inflammation of that organ. It can seldom be traced in the horse to any disease of the digestive organs. Among the causes of diabetes are improper food, and particularly hay that has been mow-burnt, or oats that are musty. The farmer should look well to this. Oats that have been dried on a kiln acquire a diuretic property, and if horses are long fed on them, the continual excitement of this organ which they produce will degenerate into diabetes.

In the human subject the disease is characterised by the large quantities of urine voided, and the amount of sugar contained in it; hence the name given to it of diabetes mellitis. In the horse we have the same unusual discharge of urine of a pale colour, but it contains no sugar, but a substance analogous to gum; hence it is termed diabetes incipidus. It frequently affects several horses at the same time, and sometimes assumes a chronic form. It is not an inflammatory disease, and the kidneys will generally be found paler in colour, and softer in texture.

The treatment is not always satisfactory, and the results often uncertain. It is evidently increased action of the kidneys, and therefore the most rational plan of treatment is to endeavour to abate that action. In order to effect this, our first care should be to change the diet upon which the animal has been feeding; and, indeed, the mere substitution of sweet and wholesome provender, for the indigestible, mow-burnt, and musty diet, will materially assist the cure. Very careful attention should be paid to the food. The hay, oats, and split beans, should be of the best quality; green-meet and carrots will also be serviceable. The animal should be kept short of water, in which may be mingled a small quantity of lime. Our medicinal agents should consist of either mineral or vegetable tonics.

The iodide of iron, in ʒj to ʒij doses repeated every twelve hours, may be given for a few days.

#### BLOODY URINE—HÆMATURIA.

The discharge of urine of this character is of occasional occurrence. Pure blood is sometimes discharged which immediately coagulates—at other times it is more or less mixed with the urine, and does not coagulate. The cause of its appearance and the source whence it proceeds cannot always be determined, but it is probably the result of some strain or blow. It may or may not be accompanied by inflammation.

Should it be the result of strain or violence, or be evidently attended by inflammation, soothing and depleting measures should be adopted. Perhaps counter-irritation on the loins might be useful. If there is no apparent inflammation, some gentle stimulus may be administered internally.

#### ALBUMINOUS URINE.

A peculiar mucous state of the urine of some horses has lately attracted attention. It has been associated with stretching out of the legs, stiffness, disinclination to move, a degree of fever, and costiveness. Slight bleeding, mild physic, the application of gentle stimulants to the loins, quietness, and gentle opiates have been of service. We are indebted to Mr. Percivall for what we do know of the disease. It is a subject worthy of the attention of the veterinary surgeon.

#### THE BLADDER.

The urine separated from the blood by the kidneys is discharged by the minute vessels, of which we have spoken, into some larger canals, which terminate in a cavity or reservoir in the body of each kidney, designated its *pelvis*. Thence it is conveyed by a duct called the *ureter*, to a larger reservoir, the *bladder*; this duct does not directly perforate the coats of the bladder, but enters obliquely one coat after another, thus forming a perfect obstruction to the return of the urine.

The bladder lies in, and when distended by urine, nearly fills the cavity of the great bones of the haunch, termed the *pelvis*. It has three coats, the outer one covering the greater part (the anterior portion) of it, and being a continuation of the peritoneum: the muscular, consisting of two layers of fibres, as in the stomach; the external, running longitudinally, and the inner circularly, so that it may yield to the pressure of the urine as it enters, and contract again into an exceedingly small space as it runs out, and by that contraction assist in the expulsion of the urine. The inner coat contains numerous little glands, which secrete a mucous fluid to defend the bladder from the acrimony of the urine. The bladder terminates in a small neck, round which is a strong muscle, called the sphincter or closing muscle, keeping the passage closed, and retaining the urine until, at the will of the animal, or when the bladder contains a certain quantity of fluid, the muscular coat begins to contract, the diaphragm is rendered convex towards the intestines, and presses them on the bladder, and by these united powers, the sphincter muscles becoming relaxed, the fluid is forced through the neck of the bladder, and escapes.

#### INFLAMMATION OF THE BLADDER.

There are two varieties of this disease, inflammation of the body of the bladder, and of its neck. The symptoms are nearly the same as those of inflammation of the kidney, except that instead of a total suppression of urine, it is voided very frequently and in small quantities, and there is heat felt in the rectum over the situation of the bladder. The causes are

the presence of some acrid or irritant matter in the urine, or of calculus or stone in the bladder. With reference to inflammation of the body of the bladder, mischief has occasionally been done by the introduction of cantharides or some other irritating matter, in order to hasten the period of horsing in the mare. The treatment in this case will be the same as in inflammation of the kidneys, except that it is of more consequence that the animal should drink freely of water or thin gruel.

In inflammation of the neck of the bladder there is, on the contrary, a great dread of and disinclination to urinate, and often ending in almost total suppression; and to such an extent does this proceed, that the case can never be mistaken by him who will pay sufficient attention to the case, for the bladder is distended with urine, and can be distinctly felt under the rectum. It is spasm of the sphincter, closing the neck of the bladder so powerfully, that the contraction of the bladder and the pressure of the muscles are unable to force out the urine.

Here the object to be attempted is sufficiently plain. This spasm must be relaxed, and the most likely means to effect it is to bleed largely, and even to fainting. This will sometimes succeed, and there will be at once an end to the disease. To the exhaustion and loss of muscular power occasioned by copious bleeding, should be added the nausea consequent on physic. Should not this speedily have effect, another mode of abating spasm must be tried—powdered opium, made into a ball or drink, should be given every two or three hours, and at the same time half an ounce of crude opium should be introduced into the rectum; while active counter-irritation is applied externally. The evacuation of the bladder, both in the mare and the horse, should be effected through the medium of a veterinary surgeon.

#### STONE IN THE BLADDER.

The urine is a very compound fluid. In the state of health it contains several acids and alkalies variously combined, which, under disease, are increased both in number and quantity. It is very easy to conceive that some of these may be occasionally separated from the rest, and assume a solid form both in the pelvis of the kidney and in the bladder. This is known to be the case both in the human being and the brute. These calculi or stones are in the horse oftener found in the kidney than in the bladder, contrary to the experience of the human surgeon. The explanation of this, however, is not difficult. In the human being the kidney is situated above the bladder, and these concretions descend from it to the bladder by their weight. The belly of the horse is horizontal, and the force of gravity can in no way affect the passage of the calculus; therefore it occasionally remains in the pelvis of the kidney, until it has increased so much in size as to fill it. We know not of any symptoms that would satisfactorily indicate the presence of a stone in the kidney; and, if the disease could be ascertained, we are unable to say what remedial measures could be adopted. The composition of calculi found in the bladder differs from those in the intestines—in the latter the phosphate of lime is the principal ingredient, in the former they consist of the carbonate of lime and animal matter.

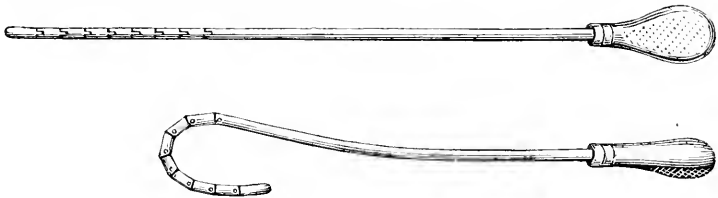
The symptoms of stone in the bladder much resemble those of spasmodic colic, except that, on careful enquiry, it will be found that there has been much irregularity in the discharge of urine and occasional suppression of it. When fits of apparent colic frequently return, and are accompanied by any peculiarity in the appearance or the discharge of the urine, the horse should be carefully examined. This generally may be satisfactorily done by introducing the hand into the rectum, and with the other manipu-



lating the groin, when with the aid of an assistant it will readily be felt—should this not prove decisive the horse may be thrown. If there is stone in the bladder, it will, while the horse lies on its back, press on the bowel, and may be distinctly felt by the hand in the rectum. Several cases have lately occurred of successful extraction of the calculus; but to effect this it will always be necessary to have recourse to the aid of a veterinary practitioner.

Both the practitioner and the amateur will be gratified by the description of a catheter, invented by Mr. Taylor, a veterinary surgeon of Nottingham, which may be introduced into the bladder without difficulty or pain, and the existence and situation of the calculus readily ascertained.

It is made of polished round iron, three feet long, one and a half inch in circumference, and with eight joints at its farther extremity. The solid part between each joint is one and a quarter inch in length, and one and a half in circumference, the moveable part being ten inches, and the solid part two feet two inches. The latter has a slight curve, commencing one foot from the handle, and continuing to the first joint of the moveable part, in order to give it facility in passing the urethra, where it is attached to the parietes of the abdomen. The joints are on the principle of a half joint, so that the moveable part would only act in a straight line, or curve in one direction. The joints are perfectly rounded and smooth when acting either in a straight line or a curve. It is represented both in its straight and curved state in the following cuts.



Many horses occasionally void a considerable quantity of gravel, sometimes without inconvenience, and at others with evident spasm or pain; and in some few cases a small calculus has escaped from the bladder and remained in the urethra. A diuretic might be useful in the first case, as increasing the flow of urine, and possibly washing out the concretions before they become too numerous or bulky, but in the latter the canal must be dilated to allow the stone to pass, or opened for its removal.

The urine having passed the neck of the bladder, flows along the urethra, and is discharged. The sheath of the penis is sometimes considerably enlarged. When at the close of acute disease, there are swellings and effusions of fluid under the chest and belly, this part seldom escapes. Diuretics will be beneficial, but in extreme cases slight scarifications may be necessary. The inside of the sheath is often the seat of disease. The mucous matter, naturally secreted there to defend the part from the acrimony of the urine, accumulates and becomes exceedingly offensive, and produces swelling, tenderness, and even excoriation, with considerable discharge. Fomentation with warm water, and the cleansing of the part with soap and water, aided perhaps by the administration of a diuretic ball, will speedily remove every inconvenience. Carters are too often apt to neglect cleanliness in this respect.

## CHAPTER XV.

## THE SKIN AND ITS DISEASES.

THE skin of the horse resembles in construction that of other animals. It consists of two chief parts, viz., the *cuticle* and *cutis*, materially differing in their structure and office. The outer one is the cuticle—the epidermis or scarf-skin, extending over the whole external part of the animal. It is composed of two parts, the external or scaly, and the internal or cellular. If the epidermis is examined by means of a microscope, the existence of the scales somewhat like those of a fish will be readily detected on its surface. There is always a singular change taking place in this outward covering of the animal, a constant alteration and renewal of every part of it, and the scales which fall off in the shape of dandruff are the cells of which the internal portion of the epidermis is made up, having undergone compression, on their being forced upward to the surface of the skin. In the action of a blister they are raised from the skin beneath, in the form of pellucid bladders, and in some diseases are thrown up in hard, dry, white scales, numerous layers of which are placed one above another. The cellular portion of the epidermis is in contact with the papillated surface of the cutis or true skin, from which it is secreted. The name of rete mucosum has been given to this part of the epidermis from its web-like structure and soft mucous consistence. In the cells of which it is made up, the material which gives colour to the animal is secreted. In horses with white hair the rete mucosum is white; it is brown in those of a brown colour; black in the black, and in patches of different colours with those, the hue of whose integument varies. The cuticle does not possess either nerves or blood-vessels; it is therefore devoid of sensibility, but it fulfils a most important function in furnishing a protection to the parts beneath, which are so often exposed to a morbid sensibility. In every part of the body the cuticle is perforated by innumerable pores, some of which permit the passage of the hair; through others the perspirable matter finds a passage; while from others various unctuous secretions make their escape. The cutis or true skin lies beneath the rete mucosum. Like the cuticle, it consists of two principal parts, the upper or papillated, and the corium or deeper layer. The papillated layer lies beneath and in contact with the rete mucosum or cellular portion of the epidermis, and is so named from numerous conical prominences or papillæ on its surface. It is exceedingly vascular, highly sensitive, and differently arranged in various parts of the body. The sensitive lamina of the foot is the papillated surface of the dermis, arranged in a different manner. Beneath this we have the corium, made up principally of areola mixed with white and yellow fibrous tissue. The corium makes up the chief thickness of the skin, and constitutes the pliant and yielding part of it. It varies in its structure in different animals; in the better bred one we have a larger development of the yellow elastic tissue, and in the coarser breed a large amount of white fibrous tissue. It is the substance which is converted into leather when removed from the body, and binds together the different parts of the frame. In some places it does this literally, and clings so closely to the substance beneath that it scarcely admits of any motion: this is the case about the forehead and the back, while upon the face, the sides and flanks, it hangs in loosened folds. In the parts connected with progression it is folded into various duplicatures, that the action of the animal may admit of the

least possible obstruction. The cutis is thinnest, and most elastic, on those parts that are least covered with hair, or where the hair is altogether deficient, as the lips, the muzzle, and the inside of the flanks.

Over a great part of the frame lies a singular muscle peculiar to quadrupeds, and more extensive and powerful in the thin-skinned and thin-haired animals, than in those with thicker hides. It reaches from the poll over the whole of the carcase, and down to the arm before, and the stifle behind. By its contraction the skin is puckered in every direction; and if it acts strongly and rapidly, the horse is not only enabled to shake off any insect or fly that may annoy him, but sometimes to displace a great part of his harness, and to render it difficult for the most expert rider to keep his seat. This muscle also assists the skin in bracing that part of the frame which it covers, and, perhaps, gives additional strength to the muscles beneath. It is called the *panniculus carnosus*, or fleshy panicle or covering.

The skin answers the double purpose of protection and strength. Where it is necessary that the parts should be bound and knit together, it adheres so tightly that we can scarcely raise it.

It is tight along the muscles of the back and loins, and down the yet more powerful muscles of the quarters; but in other places it is loosely attached, that it may not interfere with the motions of the animal. About the brisket, and within the arms and at the flanks, it hangs even in folds.

Of its strength we have abundant proof, both in the living and dead animal. Its fibres are interlaced in a most curious and intricate manner, so as, when living, to be scarcely lacerable, and converted into leather after death.

It is, while the animal is alive, one of the most elastic bodies with which we are acquainted. It not only perfectly adapts itself to the slow growth or decrease of the body, and appears equally to fit, whether the horse is in the plumpest condition or reduced to a skeleton; but when a portion of it is distended to an extraordinary degree, in the most powerful action of the muscles, it quickly again contracts to its usual dimensions.

When the horse is in health, and every organ discharges its proper functions, a certain quantity of sebaceous matter is spread over the surface of the skin, and is contained in all the pores that penetrate its substance, and the skin becomes pliable, easily raised from the texture beneath, and presenting that peculiar yielding softness and elasticity which experience has proved to be the best proofs of the condition, or, in other words, the general health of the animal. Then, too, from the oiliness and softness of the skin, the hair lies in its natural and proper direction, and is smooth and glossy. When the system is deranged, and especially the digestive system, and the vessels concerned in the nourishment of the animal feebly act, those of the skin evidently sympathise. This oily secretion is no more thrown out; the skin loses its pliancy; it seems to cling to the animal, and we have that peculiar appearance which we call *hide-bound*. This, however, requires attentive consideration.

We observe a horse in the summer. We find him with a thin, smooth, glossy coat, and his extremities clean and free almost from a single rough or misplaced hair. We meet him again towards the winter, when the thermometer has fallen almost or quite to the freezing point, and we scarcely recognise him in his thick, rough, coarse, colourless coat, and his legs enveloped in long shaggy hair. The health of the horse is, to a certain degree, deranged. He is dull, languid, easily fatigued. He will break into a sweat with the slightest exertion, and it is almost impossible thoroughly to dry him. He may perhaps feed as well as usual, although that will not

generally be the case, but he is not equal to the demands which we are compelled to make upon him.

This process goes on for an uncertain time, depending on the constitution of the animal, until nature has effected a change, and then he once more rallies; but a great alteration has taken place in him—the hair has lost its soft and glossy character, and is become dry and staring. The skin ceases to secrete that peculiar uctuous matter which kept it soft and flexible, and becomes dry and scaly; and the exhalents on the surface, having become relaxed, are frequently pouring out a profuse perspiration, without any apparent adequate cause for it.

So passes the approach to winter, and the owner complains sadly of the appearance of his steed, and, according to the old custom, gives him plenty of cordial balls,—perhaps too many of them,—on the whole not being unserviceable at this critical period, yet not productive of a great deal of good. At length the animal rallies of himself, and although not so strong and full of spirits as he ought to be, is hardier and more lively than he was, and able to struggle with the cold of the coming winter.

What a desideratum in the management of the horse would be a course of treatment that would render all this unnecessary! This desideratum has been found—a free escape of perspiration, a moist and softened state of the skin, and evident increase of health and capability of enduring fatigue, and working on shorter supply of food than he could before. This is performed by the clipping and singeing systems.

Mr. Thomas Turner, who was almost one of the earliest advocates of these systems, states, in the fourteenth vol. of the 'Veterinarian,' that during the months of October and November an inordinate growth of hair is observed over the whole surface of the body, and in many horses as early as the beginning of September, and almost invariably prevails, more or less, in every horse that is not thorough-bred. The debilitating effects thereby induced are profuse perspiration on the least possible exertion—depression of the animal spirits, and temporary loss of appetite. The removal of all the superfluous hair by close clipping, instantly proves so powerful a tonic to the animal, that he unhesitatingly affirms it to be inferior to none at present known in our pharmacopœia.

We may not, perhaps, be able satisfactorily to explain the apparently magical effects of clipping and singeing on the general constitution, and particularly the wind of the horse, or the respiratory functions generally, but there is no doubt of their existence. An increased tone is given to the system generally; and, probably, in some way not yet sufficiently developed, the increased current of the electric fluid may have much to do with it.

Mr. Snewing gives an interesting account of the effect of clipping on two horses in his establishment. He had a cob, with a fixed catarrh of several months' standing. It did not interfere with the animal's general health, but was a source of considerable annoyance. At length the owner determined to sell him; but first he had him clipped. After a few days his attention was drawn to the circumstance, that either the horse's cough must have left him, or, from repeatedly hearing it, he had ceased to regard it. He watched the animal, and, truly enough, he found that the cough had entirely disappeared. He rode him through the winter and the following summer, and there was no return of it.

The other instance was in a mare which he had after this one was sold. In the months of August, September, and October, 1841, she was continually the subject of intermittent cough. He had her clipped, and in a few days she ceased to cough, and has not been heard to cough from that time.

## PORES OF THE SKIN.

Besides the openings already mentioned through which proceeds the unctuous fluid that supple and softens the skin, there are others more numerous, by means of which a vast quantity of aqueous fluid escapes, and perspiration is carried on. As in the human being, this actually exists in a state of health and quietness, although imperceptible; but when the animal is excited by exercise, or labours under some stages of disease, it becomes visible, and appears in the form of drops.

This process of perspiration is not, however, so far under the control of medicine as in the human being.

We are not aware of any drugs that will certainly produce it. Warm clothing seems occasionally to effect it, but this is more in appearance than reality. The insensible perspiration cannot escape through the mass of clothing, and assumes a visible form. This, perhaps, is the case when sheep-skins are applied over the back and loins in 'locked jaw.' They produce a good effect, acting as a warm poultice over the part, and so contributing to relax the muscular spasms. There are, however, a few medicines, as antimony and sulphur, that have an evident and very considerable effect on the skin.

Of the existence of absorbent vessels on the skin, or those which take up some fluid or substance, and convey it into the circulation, we have satisfactory proof. A horse is even more easily salivated than the human being. Salivation has been produced by rubbing a splint with mercurial ointment, previous to blistering; and a very few drachms rubbed on the inside of the thighs will probably produce a greater effect than the practitioner desires.

## THE HAIR.

The hair is the natural clothing of all our domestic quadrupeds. It is some protection from violence, and more so from cold; and it varies with the climate in which they live. It springs from below the skin. There are found on the cellular and fatty substance immediately in contact with the internal surface of the skin, numerous little bulbs, which penetrate into and pass through the skin, and which arriving at the cuticle the hair protrudes from the summit of them. The hair itself, when examined through a microscope, is seen to be a little tube containing a pulpy matter, which runs through the whole length of it, and by which, probably, the hair is fed and rendered pliant, and the loss of which under disease may add to the hard and unthrifty feeling of the coat of a horse out of condition. There is no essential difference in the structure of the hair, in different parts, as the mane, the tail, and the body, except that the former is larger, longer, and stronger.

The base of the bulb whence the hair proceeds being beneath the true skin, it is easy to perceive that the hair will grow again, although the cuticle may have been destroyed. A good blister, although it may remove the cuticle, and seemingly for a while the hair with it, leaves no lasting trace. Even firing, lightly and skilfully performed, and not penetrating through the skin, leaves not much blemish; but when, in broken knees, the true skin is cut through or destroyed, there will always remain a spot devoid of hair.

## COLOUR.

The colour of the hair admits of every variety, and each colour becomes in turn fashionable. Like that of the skin, it is influenced by, or depends on, the mucous mesh-work under the cuticle. There are comparatively

few perfectly white horses now remaining. The snow-white palfrey, with its round carcass and barb head, originally from Spain, or perhaps from Barbary, and rarely exceeding the size of a Galloway, is nearly extinct. They are of good constitution, and pleasant in their paces. The majority of white horses are those that have become so. Light-grey colts begin to grow white before they are five years old, especially if they have not much dark mixture about the joints.

Grey horses are of different shades, from the lightest silver to a dark iron-grey. The silver-grey reminds the observer of the palfrey, improved by an admixture of Arab blood. He does not often exceed fourteen hands and a half in height, and is round-carcassed—thin-legged—with oblique pasterns, calculated for a light carriage, or for a lady's riding—seldom subject to disease—but not very fleet, or capable of hard work.

The iron-grey is usually a larger horse; higher in the withers, deeper and thinner in the carcass, more angular in all his proportions, and in many cases a little too long in the legs. Some of these greys make good hackneys and hunters, and especially the Irish horses; but they are principally used for the carriage. They have more endurance than the flatness of their chest would promise; but their principal defect is their feet, which are liable to contraction, and yet that contraction not so often accompanied by lameness as in many other horses.

The dappled grey is generally a handsomer and a better horse. All the angular points of the iron grey are filled up, and with that which not only adds to symmetry, but to use. Whether as a hackney, or, the larger variety, a carriage horse, there are few better, especially since his form has been so materially improved, and so much of his heaviness got rid of, by the free use of foreign blood. There are not, however, so many dappled greys as there used to be, since the bays have been bred with so much care. The dappled grey, if dark at first, generally retains his colour to old age.

Some of the greys approach to a nutmeg, or even bay colour. Many of these are handsome, and most of them are hardy.

The roans, of every variety of colour and form, are composed of white mixed with bay, or red, or black. In some it seems to be a natural mixture of the colours; in others it appears as if one colour was powdered or sprinkled over another. They are pretty horses for ladies or light carriages, and many of them easy in their paces, but they do not usually display much blood, nor are they celebrated for endurance.

The strawberry horse is a mixture of sorrel with white; usually handsome and pleasant, but more celebrated for these qualities than for strength and endurance.

The pied horse is one that has distinct spots or patches of different colours, but generally of white with some other colour. When the white is mixed with black it is called 'pie-bald,' with bay the name of 'skew-bald' is given to it. They are not liked as hackneys, on account of their peculiarity of colour, nor in teams of horses; but they look well when tolerably matched in a phaeton or light carriage. Their value must depend on their breed.

The dun, of the Galloway size, and with considerable blood, is often attached to the curriole or the phaeton. The larger variety is a true farmer's or miller's horse, with no great speed or extraordinary strength, yet a good-tempered, good-feeding, good-constitutioned, useful horse enough. Varieties of the dun, shaded with a darker colour, or dappled, and with some breeding, and not standing too high, are beautiful animals, and much sought after for light carriages.

The cream-colour, of Hanoverian extraction, with his white iris and

red pupil, is appropriated to royal use. Attached to the state-carriage of the monarch, he is a superb animal. His bulky, yet perfectly formed body, his swelling crest, and his proud and lofty action, as if conscious of his office, qualify him for the service that is exacted from him, but we have little experience how far he would suit other purposes.

Of the chestnuts there are three varieties—the pale red or the sorrel, usually with some white, either on the face or the legs—generally lightly made, yet some of them bulky enough for the heaviest loads. Their colour is generally objectionable, and they are supposed to be somewhat deficient in endurance.

The light chestnut, with less red and a little more bay or brown, is considered a preferable animal, especially if he has little or no white about him; yet even he, though pleasant to ride, is sometimes irritable, and generally weak. We must except one variety, the Suffolk punch; a heavy horse, and adapted for slow work, but perfect of his kind—whom no labour can daunt, no fatigue overcome. This is a breed now, unfortunately, nearly extinct. The present variety, however crossed, is not equal to the old Suffolk.

The dark chestnut is as different a horse from the hackney-like chestnut as can be well imagined; round in the carcass; powerful in the quarters, but rather fine in the legs; possessed of great endurance, and with a constitution that rarely knows an ailment, except that the feet are small and disposed to contraction, and the horse is occasionally of a hot and unmanageable temper.

Of the bays, there are many varieties, and they include the very best of our horses of every description. The bright yellow bay, although very beautiful, and especially if his mane and tail are black, is the least valuable—the lightness of his colour seems to give him some tenderness of constitution. The pure bay, with no white about him, and black from the knees and hocks to the feet, is the most desirable of all. He has generally a good constitution, and good feet; and, if his conformation is not faulty, will turn out a valuable horse for almost every purpose.

The bay-brown has not always so much show and action, but, generally, more strength and endurance, and usefulness. He has greater substance than the lighter bay, and more depth of leg; and, if he had the same degree of breeding, he would be as handsome, and more valuable.

When, however, we arrive at the browns, it is necessary to examine the degree of breeding. This colour is not so fashionable, and therefore these horses have been considerably neglected. There are many good ones, and those that are good are valuable; others, probably, are only a half or a quarter bred, and therefore comparatively coarse, yet useful for the saddle and for harness—for slow work, and, occasionally, for that which is more rapid.

The black-brown is generally more neglected, so far as its breed is concerned, and should be more carefully examined. It is valuable if it retains the goodness of constitution of the brown and bay-brown.

Of the black, greater care has been taken. The heavy black of Lincolnshire and the midland counties is a noble animal, and would be almost beyond price if he could be rendered more active. The next in size constitute the majority of our waggon-horses, and perhaps our best; and, on a smaller breed, and to the improvement of which much attention has been devoted, many of our cavalry are mounted. A few black thoroughbred horses and black hunters are occasionally seen, but the improvement of horses of this colour has not been studied, except for the purposes that have been mentioned. Their peculiar high action, while not objectionable for draught, and desirable for the parade, would be unbearable in the

roadster. Black horses have been said to be more subject to vice, disease, and blindness, than those of any other colour. This charge is not true to its full extent; but there certainly are a great many worthless black horses in every part of the country.

After all, there is an old saying, that a good horse cannot be of a bad colour; and that it is far more necessary to attend to the conformation and points of the animal than to his colour. The foregoing observations, however, although they admit of many exceptions, may be useful in guiding to the judicious purchase of the horse.

#### MOULTING.

Twice in the year the hair of the body of the horse is changed. The short fine coat of summer would afford little protection against the winter, and that of the winter would be oppressive to the animal if it appeared during the summer. The hair of the mane and tail remains. The bulbous root of the hair does not die, but the pulpy matter seems to be removed from the root of the hair, which, thus deprived of its nourishment, perishes and drops off, and a new hair springs at its side from the same bulb. The hair which is produced in the autumn, is evidently different from that which grows in the spring; it is coarser, thicker, and not so glossy as the other. As moulting is a process extending over the whole of the skin, and requiring a very considerable expenditure of vital power, the health of the animal is generally affected at these times. That energy and nervous and vital influence, which should support the whole of the frame, is to a great degree determined to the skin, and the animal is languid, and unequal to much hard work. He perspires greatly with the least unusual exertion, and if he is pressed beyond his strength becomes seriously ill.

The treatment which the groom in this case adopts is most absurd and dangerous. The horse, from the deranged distribution of vital power, is disposed to fever, or he labours under a slight degree of fever, sufficiently indicated by the increased quickness of pulse, redness of nose, and heat of mouth. The lassitude and want of appetite which are the accompaniments of this febrile state, are mistaken for debility; and cordials of various kinds, some of them exceedingly stimulating, are unsparingly administered. At length, with regard to the hunter, the racer, and even in the hackney and the carriage horse, the scissors or the lamp are introduced, and a new method is established of guarding against this periodical debility, setting at defiance the occasional exposure to cold, and establishing a degree of health and strength previously unknown. Friction may be allowed, to assist the falling off of the old hair, and to loosen the cuticle for the appearance of the new hair, but it is somewhat more gently applied than it used to be. The currycomb is in a great measure banished, and even the brush is not applied too hard or too long. The old hair is not forced off before the young hair is ready to take its place.

Nature adapts the coat to the climate and to the season. The Sheltic has one as long and thick as that of a bear; and, as the summer is short and cold in those northern islands, the coat is rough and shaggy during the whole of the year. In the southern parts of our country the short and light and glossy coat of summer gradually yields to the close and heavy, and warm clothing of winter. In the deserts of Arabia, where the winter is rarely cold, the coat remains short and glossy throughout the year. These are wise and kind provisions of nature, and excite our admiration.



## HIDE-BOUND.

This is not so much a diminution of the cellular or fatty substance between the skin and the muscles beneath, as it is an alteration in the skin itself. It is a hardness and unyieldingness of the skin, from the want of the oily matter on its surface and in its substance. It is the difference that is presented to the feeling by well-carried and supple leather, and that which has become dry and unyielding.

The surface of the skin becoming dry and hard, the scales of the cuticle are no longer penetrated by the hair, but, separating themselves in every direction, give that peculiar roughness to the coat which accompanies want of condition. It betokens impaired function of the vessels everywhere, and particularly those of the stomach and bowels. Hide-bound is not so much a disease as a symptom of disease, and particularly of the digestive organs; and our remedies must be applied not so much to the skin—although we have, in friction and in warmth, most valuable agents in producing a healthy condition of the integuments—as to the *cause* of the hide-bound, and the state of the constitution generally. Every disease that can affect the general system may produce this derangement of the functions of the skin. Glanders, when become constitutional, is strongly indicated by the unthrifty appearance of the coat. Chronic cough, grease, farcy, and founder, are accompanied by hide-bound; and diet too sparing, and not adequate to the work exacted, is an unfailing source of it. If the cause is removed, the effect will cease.

Should the cause be obscure, as it frequently is—should the horse wear an unthrifty coat, and his hide cling to his ribs, without any apparent disease, we shall generally be warranted in tracing it to sympathy with the actual, although not demonstrable, suspension of some important secretion of function, either of the alimentary canal or the respiratory functions. A few mashes, and a mild dose of physic, are first indicated, and, simple as they appear to be, they often have a very beneficial effect. The regular action of the bowels being re-established, that of all the organs of the frame will speedily follow. If the horse cannot be spared for physic, alteratives may be administered. There is no better alterative for hide-bound and an unthrifty coat, than that which is in common use, levigated antimony, nitre, and sulphur. The peculiar effect of the antimony and sulphur, and electric influence on the skin, with that of the sulphur on the bowels, and of the nitre on the urinary organs, will be here advantageously combined.

Should the horse not feed well, and there is no indication of fever, a slight tonic may be added, as gentian, or ginger; but in the majority of cases attended by loss of condition, and an unthrifty coat, and hide-bound, tonics and aromatics should be carefully avoided.

The cause of the impaired action of the vessels being removed, the powers of nature will generally be sufficient, and had better be left to themselves.

Friction may be employed with advantage in the removal of hide-bound. It has repeatedly been shown that this is one of the most efficacious instruments we can use to call into exercise the suspended energies either of the absorbent or secreting vessels. Warmth may likewise be had recourse to—not warmth of stable, which has been shown to be so injurious, but warmth arising from exercise, and the salutary, although inexplicable, influence of clipping and singeing.

**SURFEIT.**

Large pimples or eruptions often appear suddenly on the skin of the horse, and especially in the spring of the year. Occasionally they disappear as quickly as they came. Sometimes they seem to be attended with great itching, but at other times the annoyance is comparatively little. When these eruptions have remained a few days, the cuticle frequently peels off, and a small scaly spot—rarely a sore—is left. This is called a surfeit, from its resemblance to some eruptions on the skin of the human being when indigestible or unwholesome food has been taken. The surfeit is, in some cases, confined to the neck; but it oftener spreads over the sides, back, loins, and quarters. The cause is enveloped in some obscurity. The disease most frequently appears when the skin is irritable during or after the process of moulting, or when it sympathises with any disorder of the stomach. It has been known to follow the eating of poisonous herbs or mow-burnt hay, but, much oftener, it is to be traced to exposure to cold when the skin was previously irritable, and the horse heated by exercise. It has also been attributed to the immoderate drinking of cold water when the animal was hot. It is obstruction of some of the pores of the skin and swelling of the surrounding substance, either from primary affection of the skin, or a plethoric state of the system, or sympathy with the digestive organs.

The state of the patient will sufficiently guide the surgeon as to the course he should pursue. If there is simple eruption, without any marked inflammatory action, alteratives should be resorted to, and particularly those recommended for hide-bound in page 349. They should be given on several successive nights. The night is better than the morning, because the warmth of the stable will cause the antimony and sulphur to act more powerfully on the skin. The horse should be warmly clothed—half an hour's walking exercise should be given, an additional rug being thrown over him—such green meat as can be procured should be used in moderate quantities, and the chill should be taken from the water.

Should the eruption continue or assume a more virulent character, bleeding and aloetic physic must be had recourse to, but neither should be carried to any extreme. The physic having set, the alteratives should again be had recourse to, and attention should be paid to the comfort and diet of the horse.

If the eruption, after several of these alternate appearances and disappearances, should remain, and the cuticle and the hair begin extensively to peel off, a worse affection is to be feared, for surfeit is too apt to precede, or degenerate into, mange. This disorder, therefore, must next be considered.

**MANGE.**

This disease affects most of our domesticated animals, in different forms, and in the human subject a similar disease is known by the name of itch. In an animal affected with mange, the cuticle and the hair fall off, and there is, as in obstinate surfeit, a bare spot covered with scurf—some fluid oozing from the skin beneath, and this changing to a scab, which likewise soon peels off, and leaves a wider spot. This process is attended by considerable itching and tenderness, and thickening of the skin, which soon becomes more or less folded, or puckered. The mange generally first appears on the neck at the root of the mane, and its existence may be suspected even before the blotches appear, and when there is only considerable itchiness of the part, by the ease with which the short hair at the root of the mane is plucked out. From the neck it spreads upward

to the head, or downward to the withers and back, and occasionally extends over the whole carcass of the horse.

One cause of it, although an infrequent one, has been stated to be neglected or inveterate surfeit. Several instances are on record in which poverty of condition, and general neglect of cleanliness, preceded or produced the most violent mange. A remark of Mr. Blane is very important:—'Among the truly healthy, so far as my experience goes, it never arises spontaneously, but it does readily from a spontaneous origin among the unhealthy.' The most common cause is contagion. Amidst the whole list of diseases to which the horse is exposed, there is not one more highly contagious than mange. If it once gets into a stable, it spreads through it, for the slightest contact seems to be sufficient for the communication of this noisome complaint.

If the same brush or currycomb is used on all the horses, the propagation of mange is assured; and horses feeding in the same pasture with a mangy one rarely escape, from the propensity they have to nibble one another. Mange in cattle has been propagated to the horse, and from the horse to cattle. There are also some well-authenticated instances of the same disease being communicated from the dog to the horse, but not from the horse to the dog.

Mange has been said to originate in want of cleanliness in the management of the stable. The comfort and the health of the horse demand the strictest cleanliness. The eyes and the lungs frequently suffer from the noxious fumes of the putrefying dung and urine; but, in defiance of common prejudice, there is no authentic instance of mange being the result. It may, however, proceed from poverty. When the animal is half starved, and the functions of digestion and the power of the constitution are weakened, the skin soon sympathises, and mange is occasionally produced, instead of surfeit and hide-bound. Every farmer has proof enough of this being the case. If a horse is turned on a common where there is scarcely sufficient herbage to satisfy his appetite, or if he is placed in one of those straw-yards that are under the management of mercenary and unfeeling men, and are the very abodes of misery, the animal comes up a skeleton, and he comes up mangy too. Poverty and starvation are fruitful sources of mange, but it does not appear that filth has much to do with it, although poverty and filth generally go hand in hand. The actual cause of mange, however, is the existence of a parasite burrowing in the skin, the knowledge of which is comparatively of recent date in this country, although it has been for some time known on the Continent; the name of the insect is the *Acarus equi*, and is precisely analogous to the parasite producing the itch in man—it belongs to the family of mites, one of the most widely disseminated families in the animal creation; they are found in the most delicate preparations in our museums; in all kinds of preserved animal and vegetable substances; in our very food—in the skin of man, producing the itch, in the skin of the horse and the dog, producing the mange. It is to the valuable aid of the microscope we are indebted for the discovery of this most mischievous and troublesome insect—a regular set of scourgers, burrowing under the epidermis, or scarf-skin in man, and in the horse, sucking up and thus clearing away the impurities on the skin, which filth and dirt accumulate, and in return depositing their eggs, rearing their progeny, and giving unmistakable evidence of their existence. The acarus has eight legs, most of which terminate in a cup-like form, which acting like a sucker, enables the mite to adhere to the skin in a most pertinacious manner. It is to a paper by Mr. Erasmus Wilson, read in connection with the

Veterinary Medical Association, we are indebted for these and many other most interesting particulars.

The propriety of bleeding in cases of mange depends on the condition of the patient. If mange is the result of poverty, and the animal is much debilitated, bleeding will increase the evil, and will probably deprive the constitution of the power of rallying. Physic, however, is indispensable in every case. It is the first step in the progress towards cure. In this, however, mange in the horse resembles itch in the human being—medicine alone will never effect a cure. There must be some local application. There is this additional similarity—that which is most effectual in curing the itch in the human being must form the basis of every local application for the cure of the mange in the horse. Sulphur is indispensable in every unguent for mange. It is the sheet-anchor of the veterinary surgeon. In an early and not very acute state of mange, equal portions of sulphur, turpentine, and train-oil, gently but well rubbed on the part, will be applied with advantage. Farriers are fond of the black sulphur, but that which consists of earthy matter, with the mere dregs of various substances, cannot be so effectual as the pure sublimed sulphur. A tolerably stout brush, or even a currycomb, lightly applied, should be used, in order to remove the dandruff or scurf, wherever there is any appearance of mange. After that, the horse should be washed with strong soap and water as far as the disease has extended; and, when he has been thoroughly dried, the ointment should be well rubbed in with the naked hand, or with a piece of flannel. More good will be done by a little of the ointment being well rubbed in, than by a great deal being merely smeared over the part. The rubbing should be daily repeated.

The sulphur seems to have a direct influence on the disease—the turpentine has an indirect one, by exciting some irritation on the skin of a different nature from that produced by the mange, and under the influence of which the irritation of mange will be diminished, and the disease more easily combated. During the application of the ointment, and as soon as the physic has set, an alterative ball or powder, similar to those recommended for the other affections of the skin, should be daily given. If, after some days have passed, no progress should appear to have been made, half a pound of sulphur should be well mixed with a pint of oil of tar, and the affected parts rubbed, as before. On every fifth or sixth day the ointment should be washed off with warm soap and water. The progress towards cure will thus be ascertained, and the skin will be cleansed, and its pores opened for the more effectual application of the ointment.

The horse should be well supplied with nourishing, but not stimulating food. As much green meat as he will eat should be given to him, or, what is far better, he should be turned out, if the weather is not too cold. It is necessary, however, to be assured that every mangy place has been anointed. It will be prudent to give two or three dressings after the horse has been apparently cured, and to continue the alteratives for ten days or a fortnight.

The cure being completed, the clothing of the horse should be well soaked in water, to which a fortieth part of the saturated solution of the chloride of lime has been added; after which it should be washed with soap and water, and again washed and soaked in a solution of the chloride of lime. Every part of the harness should undergo a similar purification. The currycomb may be scoured, but the brush should be burned. The rack, and manger, and partitions, and every part of the stable which the horse could possibly have touched, should be well washed with a hair-broom—a pint of the chloride of lime being added to three gallons of water. All the wood-work should then be scoured with soap

and water, after which a second washing with the chloride of lime will render all secure. Some farmers have pulled down their stables, when they have been thoroughly infected with mange. This is being unnecessarily cautious. The efficacy of the chloride of lime was not then known; but if that is carefully and sufficiently applied to every part of the stable and its furniture, there cannot afterwards be danger.

Every case of itchiness of the skin should be regarded with suspicion. When a horse is seen to rub the root of his tail, or his head, or neck, against the manger, the parts should be carefully examined. Some of the hair may have been rubbed or torn off, but if the roots remain firmly adherent, and there is only redness and not scurfiness of the skin, it probably is not mange but only inflammation of the skin, from too great fullness of the blood. A little blood should be abstracted—a purgative administered—and the alteratives given. The mange ointment cannot do harm, and may possibly prevent this heat of the skin from degenerating into mange, or arrest the progress of mange if it has commenced. If a scurfiness of skin should appear on any of the points that are pressed upon by the collar or harness, the veterinary surgeon will do right to guard against danger by alterative medicine and the use of the ointment.

#### RINGWORM.

This is a highly contagious disease, and affects in a greater or less degree most of our domestic animals. Young animals are most susceptible of it, but it is sometimes met with in old ones, and is frequently connected with a debilitated condition of the system, either the result of disease or poverty. The name ringworm would indicate that this disease was produced by some animal, but although such is not the case, there is no doubt it is the result of a parasitic vegetable fungus composed of minute oval spores and short curved filaments, which pervades and splits up the roots of the hairs. The disease affects the skin in circular patches varying in size, frequently as large as half a crown. The skin is first raised, and, in a few days, the hair comes off, leaving a bald round space the surface of which is dry and scaly. They are found in almost all parts of the body, but more especially about the neck and quarters, and if neglected will increase rapidly and prove a very troublesome disease. The treatment should at once consist in removing the animal to a place where there would be no liability to his being brought in contact with other animals, great care being observed by the attendant in keeping everything connected with his treatment, away from any other horse. Ringworm is so contagious in its nature that it may be propagated in a variety of ways, and sometimes baffles our most careful efforts to prevent its extension; therefore too great caution cannot be observed on the part of those under whose care the animal is placed. Great numbers of remedial agents have been employed in the cure of ringworm, but none will be found simpler or better than the biniodide of mercury made into an ointment in the proportion of half a drachm of the biniodide to one ounce of lard, a small quantity being well rubbed on the whole surface of the ringworm every third day. By this means the parasitic fungus will be destroyed, and a gentle stimulating effect produced upon the skin, which will hasten the growth of the hair. Attention should also be paid to the general health of the animal; if suffering from debility, a more generous diet will be found the best tonic, and materially hasten the cure. If, as is sometimes the case, the animal affected be in good condition, a dose of physic followed by alteratives may be necessary.

## GREASE.

Grease is a specific inflammation of the sebaceous follicles of the skin of the heels, sometimes of the fore feet, but oftener of the hind ones, followed by an increased morbid secretion.

There is a peculiarity about the skin of the heel of the horse. In its healthy state there is a secretion of greasy matter from it, in order to prevent excoriation and chapping, and the skin is soft and pliable. Too often, however, from bad management, the secretion of this greasy matter is stopped or altered, and the skin of the heel becomes red, and dry, and scurfy. The joint still continuing to be extended and flexed, cracks of the skin begin to appear, and these, if neglected, rapidly extend, and the heel becomes a mass of soreness and ulceration.

The distance of the heel from the centre of circulation, and the position of the hind limbs, render the return of blood slow and difficult. There is also more variation of temperature here than in any other part of the frame. As the horse stands in the closed stable, the heat of this part is too often increased by its being imbedded in straw. When the stable door is open the heels are nearest to it, and receive first, and most powerfully, the cold current of air. When he is taken from his stable to work, the heels are frequently covered with mire and wet, and they are oftentimes and most intensely chilled by the long and slow process of evaporation which is taking place from them. No one, then, can wonder at the frequency with which the heels, especially the hind ones, are attacked by inflammation, and the difficulty there is in subduing it.

Some horses are more subject to grease than others, especially draught horses, both heavy and light, but particularly the former, and if they have no degree of breed in them. It was the experience of this which partly contributed to the gradual change of coach and other draught horses to those of a lighter breed. In the great majority of cases, grease arises from mismanagement and neglect.

Everything that has a tendency to excite inflammation in the skin of the heel is a cause of grease. Therefore want of exercise is a frequent source of this disease. The fluid which accumulates about the extremities, and is unable to return, is a source of irritation by its continued pressure. When high feeding is added to irregular or deficient exercise, the disease is evidently still more likely to be produced. Want of cleanliness in the stable is a fruitful source of grease. When the heels are imbedded in filth, they are weakened by the constant moisture surrounding them—irritated by the acrimony of the dung and the urine, and little prepared to endure the cold evaporation to which they are exposed when the horse is taken out of the stable. The absurd practice of washing the feet and legs of horses when they come from their work, and either carelessly sponging them down afterwards, or leaving them to dry as they may, is, however, the most common origin of grease.

When the horse is warmed by his work, and the heels share in the warmth, the momentary cold of washing may not be injurious, if the animal is immediately rubbed dry; yet even this would be better avoided: but to wash out the heels, and then leave them partially dry or perfectly wet, and suffering from the extreme cold that is produced by evaporation from a moist and wet surface, is the most absurd, dangerous, and injurious practice that can be imagined. It is worse when the post-horse or the plough-horse is plunged up to his belly in the river or pond, immediately after his work. The owner is little aware how many cases of inflammation of the lungs, and bowels, and feet and heels follow. It

would, therefore, be an excellent rule never to wash the heels of these horses. After they have been suffered to stand for twenty minutes in the stable, during which time the horse-keeper or the carter may be employed in taking care of the harness, or carriage, or beginning to dress the horse, the greater part of the dirt which had collected about the heels may be got rid of with a dry brush; and the rest will disappear in a quarter of an hour afterwards under the operation of a second brushing. The trouble will not be great, and the heels will not be chilled and subject to inflammation.

Much error has prevailed, and it has led to considerable bad practice, from the notion of humours flying about the horse, and which, it is said, must have vent somewhere, and attack the heels as the weakest part of the frame. Thence arise the physicking, and the long course of diuretics, which *truly* weaken the animal, and often do irreparable mischief.

Grease is a local complaint. It is produced principally by causes that act locally, and it is most successfully treated by local applications. Diuretics and purgatives may be useful in abating inflammation; but the grand object is to get rid of the inflammatory action which exists in the skin of the heel, and to heal the wounds, and remedy the mischief which it has occasioned.

The skin soon cracks, and is followed by the exudation of a greasy and very fetid fluid. As the disease progresses it involves the skin at the back part of the leg, especially where there is long hair, and sometimes extends nearly to the hock, but rarely above it. When cracks appear, the mode of treatment will depend on their extent and depth. If they are but slight, a lotion, composed of sulphate of zinc or alum ointment, will often speedily dry them up, and close them.

If the cracks are deep, with an ichorous discharge and considerable lameness, it will be necessary to poultice the heel. A poultice of linseed meal and bran will be generally effective, unless the discharge is thin and offensive, when an ounce of finely powdered charcoal should be mixed with the linseed meal; or a poultice of carrots, boiled soft and mashed. The efficacy of a carrot poultice is seldom sufficiently appreciated in cases like this.

When the inflammation and pain have evidently subsided, and the sores discharge good matter, the calamine ointment may be applied with advantage; and the cure will generally be quickened if a diluted solution of sulphate of zinc or alum is applied. An application that will be found nearly a specific, after the poulticing and physicking have been had recourse to, is a mixture of from two drachms to half an ounce of sulphuric acid to a pint and a half of water, making a quart mixture. A little of this applied morning and evening, also as soon as the legs have been dressed after work, will be found highly beneficial.

After the chaps or cracks have healed, the legs will sometimes continue gorged and swelled. A flannel bandage, evenly applied over the whole of the swelled part, will be very serviceable; or, should the season admit of it, a run at grass, particularly spring grass, should be allowed.

In some cases the cracks are not confined to the centre of the heels, but spread over them, and extend on the fetlock, and even up the leg, while the legs are exceedingly swelled, and there is a watery discharge from the cracks, and an apparent oozing through the skin at other places. The legs are exceedingly tender and sometimes hot, and there is an appearance which the farrier thinks very decisive as to the state of the disease, and which the better-informed man should not overlook—the *heels smoke*—the skin is so hot that the watery fluid partly evaporates as it runs from the cracks or oozes through the skin.

There will be a great danger, it is said, in suddenly stopping this discharge. Inflammation of a more important part, it is apprehended, may rapidly succeed to the injudicious attempt. The local application should be directed to the abatement of the inflammation. The poultices just referred to should be diligently used night and day, and especially the carrot-poultice; and when the heat, and tenderness, and stiffness of motion have diminished, astringent lotions may be applied—either the alum lotion or a strong decoction of oak-bark, changed, or used alternately, but not mixed. The cracks should likewise be dressed with the ointment above mentioned; and, the moment the horse can bear it, a flannel bandage should be put on, reaching from the coronet to three or four inches above the swelling.

The medicine should be confined to mild diuretics, or, if the horse is gross, and the inflammation runs high, a dose of physic may be given. If the horse is strong, and full of flesh, physic should always precede and sometimes supersede the diuretics. In cases of much debility, diuretics, with aromatics or tonics, will be preferable.

The feeding should likewise vary with the case, but with these rules, which admit of no exception, that green meat should be given, and more especially carrots, when they are not too expensive, and mashes, if the horse will eat them, and never the full allowance of corn.

Walking exercise should be resorted to as soon as the horse is able to bear it, and this by degrees may be increased, but in no stage of the disease neglected.

From bad stable management at first, and neglect during the disease, a yet worse kind of grease occasionally appears. The ulceration extends over the skin of the heel and the fetlock, and fungoid growths spring from the surface of both, highly sensitive, bleeding at the slightest touch, and interspersed with scabs. By degrees, portions of the fungoid growths begin to be covered with a horny substance protruding in the form of knobs, and collected together in bunches. These are known by the name of *grapes*, and consist of an altered state of the papillated surface of the dermis. A fœtid and very peculiar exudation proceeds from nearly the whole of the unnatural substance. The horse evidently suffers much as he is gradually worn down by the discharge. The assistance of a veterinary surgeon is here indispensable.

There has been some dispute as to the propriety of cutting the hair from the heels. Professor Stewart has the following observations:—‘During two very wet winters, I have had opportunity of observing the results of trimming and no trimming, among upwards of 500 horses. More than 300 of these have been employed in coaching and posting, or work of a similar kind, and about 150 are cart-horses. Grease, and other skin diseases of the heels have been of most frequent occurrence where the horses are both trimmed and washed; they have been common where the horses were trimmed but not washed, and there have been very few cases where washing or trimming were forbidden or neglected.’ Custom has very properly retained the hair on our farm-horses. Nature would not have given it had it not been useful. It guards the heel from being injured by the inequalities of the ploughed field; it prevents the dirt, in which the heels are constantly enveloped, from reaching and caking on, and irritating the skin; it hinders the usual moisture which is mixed with the clay and mould from reaching the skin, and it preserves an equal temperature in the parts. If the hair is suffered to remain on the heels of the farm-horses, there is greater necessity for brushing and hand-rubbing the heels, and never washing them.

Fashion and utility have removed the hair from the heels of our hack-



ney and carriage horses. When the horse is carefully tended after his work is over, and his legs quickly and completely dried, the less hair he has about them the better, for then both the skin and the hair can be made perfectly dry before evaporation begins, or proceeds so far as to deprive the legs of their heat. Grease is the child of negligence and mismanagement. It is driven from our cavalry, and it will be the fault of the gentleman and the farmer if it is not speedily banished from every stable.

#### WARTS.

These are tumours of variable size, arising from the cuticle, and produced by an altered (hypertrophied) state of the papillated structure of the dermis. There are several varieties in different parts of the body. The scaly wart which frequently acquires considerable size, and the surface of which is generally covered with moisture, is found usually on the abdomen. The round one on the eyelids and face, and the pointed one on the teats. Another kind called the encysted wart sometimes exists in large numbers on the inside of the thigh and prepuce. There is no alteration in the external appearance of the skin, but a hard moveable tumour is felt depending upon the obliteration of some of the sebaceous follicles, by an increase of the contents of the whole gland. The walls of the cyst are composed of condensed areolar tissue. Warts must be removed by an operation. If the root be very small it may be snipped asunder with a pair of scissors close to the skin, and the root touched with the lunar caustic. If the pedicle or stem be somewhat larger, a ligature of waxed silk may be passed firmly round it, and tightened every day. The source of nutriment being thus cut off, the tumour will, in a few days, die and drop off. If they are large or in considerable clusters, it will be necessary to cauterise the horse, to cut them off close to the skin, and sear the root with a red-hot iron. Unless these precautions are used, the warts will speedily sprout again. In encysted warts an opening should be freely made over the centre, and the contents squeezed out.

#### MALLENDERS AND SALLENDERS.

On the inside of the hock, or a little below it, as well as at the bend of the knee, there is occasionally a scurfy eruption called *mallenders* in the fore-leg, and *sallenders* in the hind-leg. They seldom produce lameness; but if no means are taken to get rid of them, a discharge proceeds from them which it is afterwards difficult to stop. They usually indicate bad stable management.

A diuretic ball should be occasionally given, and an ointment composed of carbonate of zinc and lard rubbed over the part. Should this fail, a weak mercurial ointment may be used.

#### VERMIN.

Both the biped and quadruped are subject to the visitation of insects that fasten on the skin, and are a constant nuisance from the itching which they occasion. If the horse, after being turned out for the winter, is taken up again in the spring, long and rough in his coat and poor in condition, and with evident hide-bound, he will almost invariably be afflicted with vermin. In our present acquaintance with natural history, it is difficult to account for the appearance of certain insects, and of those alone on the integument of one animal, while others, of an altogether different character, are found on its neighbour. Each one has a tormentor peculiar to itself. The vermin of the horse can be destroyed by an

infusion of tobacco, or, what is equally effectual, a decoction of stavesacre seeds. The skin being once cleansed of them, attention to the condition of the animal, and cleanliness will prevent their re-appearance.

## CHAPTER XVI

### THE FORE-LEGS.

WE arrive now at those parts of the frame which are most essentially connected with the action and value of the horse, and oftenest and most annoyingly the subjects of disease. The extremities contain the whole apparatus of voluntary motion, with which the action, and speed, and strength of the horse are most concerned.

The fore-legs, when viewed in front, should be widest at the chest, and should gradually approach to each other as we descend towards the fetlock. The degree of width must depend on the purpose for which the horse is wanted. The legs of a heavy draught-horse can scarcely be too far apart. His rounded chest enables him to throw more weight into the collar; and not being required for speed, he wants not that occasionally increased expansion of chest which the circular form is not calculated to give. A hunter, a hackney, and a coach-horse should have sufficient expansion of the chest, or the legs sufficiently wide apart, to leave room for the play of the lungs; but depth more than roundness of chest is here required, because the deep chest admits of most expansion when the horse, in rapid action, and the circulation proportionally quickened, needs most room to breathe; yet, if the breast is too wide, there will be considerable weight thrown before, and the horse will be heavy in hand and unsafe.

Whether the legs are near to each other or wide apart, they should be straight. The elbow should not have the slightest inclination inward or outward. If it inclines toward the ribs, its action will be confined, and the leg will be thrown outward when in motion, and describe a curious and awkward curve. This will give a peculiar rolling motion, unpleasant to the rider and unsafe to the animal. The toe will likewise be turned outward, which will not only prevent the foot from coming flat on the ground in its descent, but be usually accompanied by cutting, even more certainly than when the toe turns inward. If the elbow is turned outward the toes will necessarily be turned inward, which is a great unsightliness, and to a considerable degree injurious, for the weight cannot be perfectly distributed over the foot—the bearing cannot be true. There will also be undue pressure on the inner quarter, a tendency to unsafeness, and a disposition to splint and corn. The legs should come down perpendicularly from the elbow. If they incline backward and under the horse, there is undue stress on the extensor muscles; and, the legs being brought nearer the centre of gravity, too great weight is thrown forward, and the horse is liable to knuckle over and become unsafe. Another very unsightly defect is that called calf-legged, when the knee, instead of being straight under the arm, curves backwards—it is an unsafe and useless variation of form. If the legs have a direction forward, the flexor muscles are strained, and the action of the horse is awkward and confined. The toe should be found precisely under the point of the shoulder. If it is a little more forward, the horse will probably be deficient in action; if it is more under the horse, unsafeness will be added to still greater defect in going.

We commence with the upper portion, of which the fore extremity, the shoulder, is seen at G, page 140.

### THE SHOULDER.

The *scapula* or shoulder-blade, situated forward on the side of the chest, is a bone of a somewhat triangular shape, with its apex or narrowest point downward, and its broad and thin expansion upward. The point of the shoulder lies opposite to the first and second ribs; the hinder expansion of the base reaches as far back as the seventh rib; it therefore extends obliquely along the chest. It is divided, externally, into two unequal portions by a ridge or spine running through almost the whole of its extent, and designed, as will be presently seen, for the attachment of important muscles. The broad or upper part, having no muscles of any consequence attached to it, is terminated by cartilage.

The shoulder-blade is united to the chest by muscle alone. There is one large muscle, with very remarkable tendinous fibres and of immense strength (the *serratus magnus*, great saw-shaped muscle), attached to the chest, all the true ribs, and to the upper third of the internal surface of the shoulder-blade, and the four last cervical vertebræ, and by which, assisted, or rather strengthened, by the other muscles, the weight of the body is supported, and the shock of the widest leap, or the most rapid motion, sustained. Had there been a bony union between the shoulder and the body, the vital parts contained in the chest could not have endured the dreadful shock which they would occasionally have experienced; nor could any bone have long remained whole if exposed to such violence. The muscles within the shoulder-blade act as powerful and safe springs. They yield, as far as necessary, to the force impressed upon them. By their gradual yielding they destroy the violence of the shock, and then by their elastic power, immediately gain their former situation.

### SLANTING DIRECTION OF THE SHOULDER.

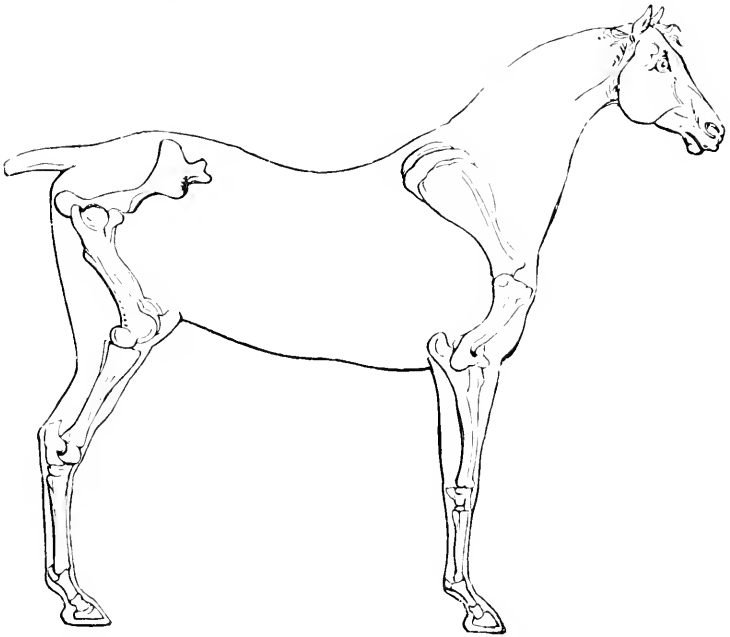
The lessening or breaking of the shock, from the weight being thrown violently on the fore legs, is effected in another way. It will be observed, that (see G and J, p. 140) the shoulder-blade and the lower bone of the shoulder are not connected together in a straight line, but form a very considerable angle with each other. This will be more evident from the following cut, which represents the fore and hind extremities in the situations which they occupy in the horse.

This angular construction of the limbs reminds us of a similar arrangement of the springs of a carriage, and the ease of motion, and almost perfect freedom from jolting, which are thereby obtained.

It must not perhaps be said, that the form of the spring was borrowed from this construction of the limbs of the horse, but the effect of the carriage-spring beautifully illustrates the connection of the different bones in the extremities of this quadruped.

The obliquity or slanting direction of the shoulder effects other very useful purposes. That the stride in the gallop, or the space passed over in the trot, may be extensive, it is necessary that the fore part of the animal should be considerably elevated. The shoulder, by means of the muscles which extend from it to the inferior part of the limb, is the grand agent in effecting this. Had the bones of the shoulder been placed more upright than we see them, they could not then have been of the length which they now are—their connection with the chest could not have been so secure—and their movements upon each other would have been

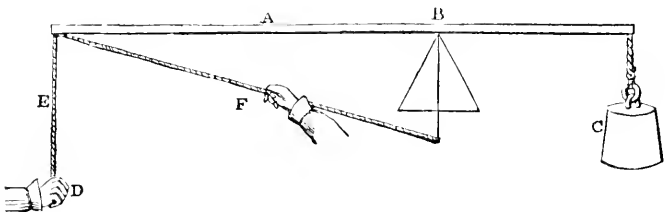
comparatively restricted. The slightest inspection of this cut, or of that at page 140, will show that, just in proportion as the point of the shoulder is brought forward and elevated, will be the forward action and elevation of the limb, or the space passed over at every effort.



The slanting shoulder accomplishes a most useful object. The muscles extending over the shoulder-blade to the lower bone of the shoulder are the power by which motion is given to the whole of the limb. The extent and energy of that motion depend much on the force exerted or the strength of the muscle, but there are circumstances in the relative situations of the different bones which have far greater influence.

Let it be supposed that, by means of a lever, some one is endeavouring to raise a certain weight.

A is a lever, resting or turning on the pivot B; C is the weight to be raised; and D is the power, or the situation at which the power is applied. If the strength is applied in a direction perpendicular to the lever, as represented by the line, E, the power which must be exerted can easily be calculated.



In proportion as the distance of the power from the pivot or centre of motion exceeds that of the weight from the same place, so will be the ad-

vantage gained. The power here is twice as far from the centre as the weight is, and therefore advantage is gained in the proportion of two to one; or if the weight is equal to 200 lbs., a force of 100 lbs. will balance it. If the direction in which the power is applied is altered, and it is in that of the line F, will 100 lbs. effect the purpose? No; nothing like it. How then, is the necessary power to be calculated? The calculation of the force which must be exerted in a direction intermediate between the direction of the line E and of the lever A B, involves questions of geometry somewhat foreign to the object of these pages. But though the exact estimation of the exact power to be exerted at intermediate positions is a question of some difficulty, a very little consideration will serve to show that the force to be applied, increases with, and in a greater degree than, the angle between the directions of E and F. For suppose the direction of F to coincide with that of A B, then no force exerted, however great, would support C, the whole effect being to move the lever in the direction of its length.

Let the shoulder of the horse be considered. The point of the shoulder—the shoulder-joint—is the pivot or centre of motion; the leg attached to the bone of the arm is the weight; the shoulder-blade being more fixed, is the part whence the power emanates, and the muscles extending from the one to the other are the lines in which that power is exerted. These lines approach much more nearly to a perpendicular in the oblique than in the upright shoulder (see cut). In the upright one, the shoulder-blade and the bone of the arm are almost in a straight line, and the real action and power of the muscles are considerably diminished. In this point of view the oblique shoulder is most important. It not only gives extensive action, but facility of action. The power of the muscles is more than doubled by being exerted in a line approaching so much nearer to a perpendicular.

There is yet another advantage of the oblique shoulder. The point of the shoulder is projected forward; and therefore the pillars which support the fore part of the horse are likewise placed proportionately forward, and they have less weight to carry. They are exposed to less concussion, and especially concussion in rapid action. The horse is also much safer; for having less weight situated before the pillars of support, he is not so likely to have the centre of gravity thrown before and beyond them by an accidental trip; or, in other words, he is not so likely to fall; and he rides more pleasantly, for there is far less weight bearing on the hand of the rider, and annoying and tiring him. It likewise unfortunately happens that nature, as it were to supply the deficiency of action and of power in an upright shoulder, has accumulated on it more muscle, and therefore the upright shoulder is proverbially thick and cloddy; and the muscles of the breast which were designed to strengthen the attachment of the shoulders to the chest, and to bind them together, must, when the point of the shoulder lies backward, and under the horse, be proportionately thickened and strengthened, and the horse is thus still more heavy before, more unpleasant, and more unsafe to ride.

Then, ought every horse to have an oblique shoulder? No. The question has relation to those horses that are designed to ride pleasantly, or from which extensive and rapid action is required. In them it has been said that an oblique shoulder is indispensable: but there are others which are seldom ridden; whose pace is slow, and who have nothing to do but to throw as much weight as possible into the collar. To them an upright shoulder is an advantage, because its additional thickness gives them additional weight to throw into the collar, which the power of their hinder quarters is fully sufficient to accomplish; and because the upright position

of the shoulder gives that direction to the collar which enables the horse to act upon every part of it, and that inclination of the traces which will enable his weight or power to be most advantageously employed.

An improved breed of our heavy draught-horses has of late years been attempted, and with much success. Sufficient uprightness of shoulder is retained for the purposes of draught, while a slight degree of obliquity has materially quickened the pace and improved the appearance.

Above its junction with the humerus, or lower division of the limb, the shoulder-blade forms what is called the point of the shoulder. There is a round blunted projection, best seen in the cut (p. 360). The neck of the shoulder-blade there forms a shallow cavity, into which the head of the next bone is received.

The cavity is shallow because extensive motion is required, and because both of the bones being so moveable, and the motion of the one connected so much with that of the other, dislocation was less likely to occur. A *capsular* ligament, or one extending round the heads of both bones, confines them securely together.

#### THE HUMERUS, OR LOWER BONE OF THE SHOULDER.

Forming a joint with the shoulder-blade at the point of the shoulder is the *humerus*. It is a short strong bone, slanting backward in an opposite direction to the shoulder-blade. At the upper part it has a large round head, received into the shallow cavity of the shoulder-blade, or as Mr. Percivall has graphically described it, 'it is the segment of a globe, smooth and polished, evidently for the purpose of playing like a spherical hinge within the cup-like concavity occupying the place of the apex of the scapula. There are no two bones in the skeleton whose articular connection is of a nature to admit more varied and extensive motion than exists between the scapula and the humerus. If we attempt to lift a horse's fore-leg, we cannot merely bring it forward and carry it backward, but we can also to a considerable extent make it perform a sort of rotatory motion, in consequence of the mobility existing in this joint between the socket of the scapula and the head of the humerus.' It has several protuberances for the insertion of muscles, and is terminated below by two *condyles* or heads, which in front receive the principal bone of the arm between them as in a groove, thus adding to the security and strength of the joint, and limiting the action of this joint and of the limb below to mere bending and extension, without any side motion. Farther behind, these heads receive the elbow deep between them, in order to give more extensive action to the arm. In a well-formed horse this bone can scarcely be too short, in order that the fore-legs may be as forward as possible, for reasons already stated, and because when the lower bone of the shoulder is long, the shoulder must be too upright. Dislocation can scarcely occur in either of the attachments of the bone, and fracture of it is very rare. The lower bone of the shoulder and the shoulder-blade are by horsemen confounded together, and included under the appellation of the *shoulder*, and in compliance with general usage we have described them as combining to form the shoulder. This, however, is not correct, and will lead to error when we wish to compare the fore-leg of the horse with the arm of man. In man the arm, of which the humerus is the bone, is perfectly free and detached from the body; in the horse it lies in juxtaposition with the chest, and is included in the integument covering the body: and this fact has led to the error so commonly made of calling that part of the fore-leg of the horse the arm, which is in reality the fore-arm, corresponding with the fore-arm of man below the elbow. The knee as it is called, in

the horse, corresponds with the human wrist; and the joints below it with the fingers, supposing they were all united in one.

### SPRAIN OF THE SHOULDER.

These muscles are occasionally injured by some unexpected shock. Although in not more than one case in twenty is the farrier right when he talks of his shoulder-lameness, yet it cannot be denied, that the muscles of the shoulder are occasionally sprained. This is effected oftener by a slip or side-fall, than by fair although violent exertion. The muscles are also sometimes injured, by the shoulder being brought violently in contact with some hard substance, such as a tree or wall, when jumping, or running away. It is of considerable importance to be able to distinguish the shoulder-lameness from injuries of other parts of the fore extremity. There may not be much tenderness, or heat, or swelling, if it is a sprain of muscles deeply seated, and where these symptoms of injury are not immediately evident. If, on standing before the horse, and looking at the size of the two shoulders, or rather their points, one should appear evidently larger than the other, this must not be considered as indicative of sprain of the muscles of the shoulder. It probably arises from bruise of the point of the shoulder, which a slight examination will determine.

The symptoms, however, of shoulder-lameness can scarcely be mistaken, and, when we relate them, the farmer will recollect that they very seldom occurred when the village smith pointed to the shoulder as the seat of disease, and punished the animal to no purpose. In sprain of the shoulder, the horse evidently suffers extreme pain while moving, and, the muscle underneath being inflamed and tender, he will extend it as little as possible. *He will drag his toe along the ground.* It is in the lifting of the foot that the shoulder is principally moved. If the foot is lifted high, let the horse be ever so lame, the shoulder is little, if at all, affected. In sprain of the back sinews, it is only when the horse is in motion that the injured parts are put to most pain; the pain is greatest here when the weight rests on the limb in shoulder-lameness, and there is a peculiar quickness in catching up the limb the moment the weight is thrown on it. This is particularly evident when the horse is going down hill, and the injured limb bears an additional portion of the weight. In the stable too, when, in other cases, the horse points or projects one foot before the other, that foot is usually flat on the ground. In shoulder-lameness, the toe alone rests on the ground. The circumstance which most of all characterises this affection is, that when the foot is lifted and then brought considerably forward the horse will express very great pain, which he will not do if the lameness is in the foot or the leg. This point has been longer dwelt upon, in order that the reader may be enabled to put to the test the many cases of shoulder-lameness, which exist only in the imagination of the groom or the farrier.

In sprain of the internal muscles of the shoulder, local measures can be adopted. A dose of physic should be given, warm fomentations applied, and the horse should be kept as quiet as possible. The injury is sometimes too deeply seated for external stimulants to have very great effect, yet an embrocation composed of oil of turpentine, water of ammonia, and soap liniment may be applied twice daily after the fomentation, and afterwards a blister or setons may very properly be resorted to, if the lameness is not removed. The *swimming* of the horse is an inhuman practice; it tortures the animal, and increases the inflammation. The *pegging* of the shoulder (puncturing the skin, and blowing into the cellular structure beneath until it is considerably puffed up) is another relic of ignorance and barbarity.

## THE ARM.

The *Arm*, extending from the elbow to the knee (see K and L, p. 140, and also cut, p. 360), consists in the young horse of two distinct bones. The long and front bone, called the *radius*, is nearly straight, receiving into its upper end the lower head of the humerus; and the lower end corresponding with the upper layer of the bones of the knee. The short and hinder bone is called the *ulna*. It has a very long and powerful projection, received between the heads of the humerus and called the elbow; it then stretches down, narrowing by degrees (see L, p. 140, and the cut, p. 360) to below the middle of the front bone, where it terminates in a point. The two bones are united together by cartilage and ligament; but these are by degrees absorbed and changed to bone, and before the horse becomes old the whole of the arm consists of one bone only.

It will be perceived that, from the slanting direction of the humerus, the weight of the horse, and the violence of the concussion, will be shared between the *radius* and the *ulna*, and therefore less liable to injure either. The circumstance, also, of so much weight and jar being communicated to them, will account for the extensive and peculiarly strong union between these bones in the young horse; the speedy inflammation of the uniting substance and absorption of it, and the substitution of bone, and complete bony union between the *radius* and *ulna*, in the old horse. The immense muscles that are attached to the point of the elbow likewise render it necessary that the union between these bones should be very strong.

The arm is a most important part of the horse, as will be seen when we describe the muscles which belong to it. The muscles proceeding from the shoulder-blade and the humerus, and inserted into the elbow, are the grand agents in extending the arm, and in proportion to the power which they exert will be the quickness and the length of the stride. The strength of the horse, so far as his fore-limbs are concerned, principally resides here. Then there will naturally be a large and muscular arm, and such a formation of the limb, and particularly of the elbow, as will enable these muscles to act with most advantage.

The principle of the lever (referred to at p. 360) is here beautifully applicable. The elbow-joint is the centre of motion; the whole of the lower part of the leg is the weight to be raised; and the power by which it is to be raised, in one act of progression—the extending of the limb, is the muscles inserted into the elbow. In proportion as the weight is more distant than the power from the centre of motion, as it is in the construction of this limb, so will be the greater degree of energy requisite to be exerted. Supposing that the weight, taking the knee to be the centre of it, is eighteen inches from the elbow joint—that the limb weighs 60 lbs., and that the elbow projects two inches from the joint—then an energy equal to nine times the weight, or 540 lbs., will be needed to move and extend the limb, because the weight is nine times farther from the centre of motion than the power is. If in another horse the point of the elbow projects three inches from the joint, the weight of the leg remaining the same, only six times the force, or 360 lbs., will be required, making a difference in, or saving of, muscular action, equal to 180 lbs. in each extension of the arm. If a few pounds in the weight of the rider tell so much for or against the horse in a long race, this saving of power must make an almost incalculable difference; and, therefore, judges of the horse rightly attach so much importance to the depth of the elbow, or the projection of the point of the elbow from the joint.



When describing the proper obliquity of the shoulder, it was stated that the power was exerted with most advantage in a line perpendicular to the arm of the lever, and that the slightest deviation from that line was manifestly disadvantageous. If the reader will examine the cut, he will perceive that muscles from the shoulder and the bone of the arm take a direction much nearer to a perpendicular line in the long than in the short elbow, and therefore act with proportionably greater advantage; and if this advantage from the direction in which the power is applied to that which we gain from the increased length of the bone is considered, it will be plain that the addition of one-third to the length or projection of the elbow would be attended by a saving of one-half in the expenditure of muscular power. There is, however, a limit to this. In proportion as the elbow is lengthened, it must move over a greater space in order to give the requisite extension to the limb; and consequently the muscles which act upon it must be lengthened, otherwise, although the action might be easy, it would be confined. There must be harmony of proportion in the different parts of the limb, but a deep elbow, within a certain range, is always connected with increased power of action.

Enlargements sometimes appear about the elbow, either the consequence of a violent blow, or from the calkins of the shoes injuring this part when the horse sleeps with his legs doubled under him. If a seton is passed through the tumour, it will sometimes rapidly diminish, and even disappear; but if it is of considerable magnitude, the skin should be opened along the middle of the swelling, and the tumour dissected out. The result of these operations may be successful, but if the operator does not repent of having performed them long before they heal again, he is a very fortunate fellow. The better part of valour, however, is discretion, and in the cases alluded to, supposing, as is generally the case, that no bad effect beyond the eyesore accompanies it, it had better, much better, be left alone.

One of the most powerful muscles for bending the leg, the *flexor brachii*, arises from the point of the shoulder, in the form of a large round tendon, which runs over a groove or pulley in the front of the humerus; it then swells out into a round fleshy body, contributing materially to the bulk in front of the arm, and is inserted into a tubercle in the inner and upper part of the radius. It is the main muscle by which, almost alone, the whole of the leg below the arm is bent. It acts at great disadvantage. It is inserted into the very head of the bone of the arm, and expanded even upon the joint. Then the power is applied almost close to the centre of motion, while the weight to be raised is far distant from it. The power is thirty times nearer the centre of motion than is the weight, and calculating as before, the weight of the arm and rest of the limb at 60 lbs., it must act with a force of thirty times sixty, or 1,800 lbs. In addition to this, the line of the direction of the force strangely deviates from a perpendicular: the direction of the muscle is nearly the same as that of the limb, and the mechanical disadvantage is almost incalculably great. We will take it as only ten times more: then this muscle, and its feeble coadjutors, act with a force of ten times 1,800 or 18,000 lbs. Why this almost incredible expenditure of muscular power? First, that the beauty of the limb might be preserved, and the joint might be compact. If the tendon had been inserted half way down the arm, the elbow-joint would have offered a very unsightly appearance.

Beauty of form, however, is but the least result of this conformation. Extensive and rapid motion are among the excellences of the horse. He is valuable in proportion as he has them combined with stoutness; and by this conformation of the limb could he alone obtain them. Therefore the tendon is at first unusually strong: it plays through the natural but

perfect pulley of the bone of the arm without friction; the body of the muscle is mixed with tendinous fibres, and the insertion into the fore-arm is very extensive, lest the application of such immense force should tear it from its adhesions. There is sufficient strength in the apparatus; the power may be safely applied at this mechanical disadvantage; and it is applied close to the joint to give an extent and rapidity of motion which could not otherwise have been obtained, and without which the horse would have been comparatively useless.

It is sufficiently plain that the arm should be large and muscular, otherwise it could not discharge all these duties. Horsemen differ on a variety of other points, but here they agree. A full and swelling fore-arm is the characteristic of every thorough-bred horse. Whatever other good points the animal may possess, if the arm is narrow in front and near the shoulder, flat on the side, and altogether deficient in muscular appearance, that horse is radically defective. He can neither raise his knee for rapid action, nor throw his legs sufficiently forward.

The arm should likewise be long. In proportion to the length of the muscle is the degree of contraction of which it is capable; and in proportion also to the degree of contraction will be the extent of motion in the limb beneath. A racer, with a short arm, would be sadly deficient in stride; a hunter, with the same defect, would not be able to double his legs well under him in the leap. There is, however, a medium in this, and the advantage of length in the arm will depend on the use to which the horse is applied. The lady's horse, the cavalry horse, every horse in which prancing action is esteemed a beauty, and in which utility is, to a certain degree, sacrificed to appearance, must not be too long in the arm. If he is long there, he will be proportionably short in the leg; and although this is an undoubted excellence, whether speed or continuance is regarded, the short leg will not give the grand and imposing action which fashion may require. In addition to this, a horse with short legs may not have quite so easy action as another whose length is in the shank rather than in the arm.

#### THE KNEE.

The *Knee* (M, p. 140, and cut p. 360), answering to the human wrist, constitutes the joint or joints between the arm and the shank or leg; and is far more complicated than any joint that has been yet considered. Beside the lower heads of the bone of the arm, and the upper heads of the three bones of the leg, there are no less than six other bones interposed, arranged in two rows, three in each row, and two others, the seventh and eighth, placed behind.

What was the intention of this complicated structure? A joint between the elbow and the fetlock was absolutely necessary to the action of the horse. An inflexible pillar of that length could scarcely have been lifted from the ground, much less far enough for rapid or safe motion. It was likewise necessary that the interposing joint should be so constituted as to preserve this part of the limb in a straight direction, and possess sufficient strength to resist all common work and accidents. Being in a straight direction, the shock or jar between the ends of the bones of the arm and the leg would be dreadful, and would speedily inflict irreparable injury. The heads of all bones are covered with cartilage, in order to protect them from injury by concussion; but this would be altogether insufficient here. Six distinct bones are therefore placed here, each covered above and below by a thick coating of cartilage, connected together by strong ligaments, but separated by interposed fluids and membranes. The

concussion is thus spread over the whole of them, shared by the whole of them, and, by the peculiarity of their connection, rendered harmless.

These six distinct bones, united to each other by numerous and powerful ligaments, will also afford a far stronger joint than the apposition of any *two* bones, however perfect and strong might be the capsular ligament, or by whatever other ligaments it might be strengthened. In addition to the connection between the individual bones, there are three capsular ligaments, one extending from the radius to the first row of metacarpal bones, the second from the first to the second row, and the third from the second row to the metacarpal bones; and the result of the whole is, that the hardest work and the severest accidents produce little deformity, and no dislocation in the knee; nor do the shocks and jars of many a year cause inflammation or disease. It is an undeniable fact that such is the perfect construction of this joint, and to so great a degree does it lessen concussion, that the injuries resulting from hard work are, almost without an exception, found below the knee, which seems to escape the injuries of the hock. There is a remarkable difference in the effects of work on the knee and the hock. The knee is subject to enormous concussion, but to a certain extent escapes those bony enlargements and inflammations of the ligaments, like spavins.

The seventh bone, the *trapezium*, so called from its quadrangular figure, is placed (see M, p. 140) behind the others, and does not bear the slightest portion of the weight. It, however, is exceedingly useful. Two of the flexor muscles proceed from the bone of the arm, and are inserted into it; and, being thus thrown off the limb, have a less oblique direction given to them, and, therefore, according to the principle of the lever, act with considerably more power. It is also useful in another way. As the tendons of the various muscles descend the limbs, they are tied down, as we have described, by strong ligamentous bands: this is particularly the case in the neighbourhood of the joints. The use of it is evident. The extensor tendons, which lie principally on the front of the leg, are prevented from starting and strengthened and assisted in their action; but the flexor tendons, which are at the back, would be liable to friction, and their motion impeded, if they were bound down too tightly. This projecting bone prevents the annular or ring-like ligament from pressing too closely on the main flexor tendons of the foot; and, while it leaves them room to play, leaves room likewise for a synovial sheath to surround them, supplying the course of the tendons with a fluid that prevents much injurious friction. The eighth bone, small in size, being not larger than a pea a little flattened, is called the *pisiform*; it is placed posteriorly at the inner and lower part of the knee.

The knee should be broad. It should present a very considerable width, compared with the arm above, or the shank below. In proportion to the breadth of the knee is the space for the attachment of muscles, and for the accumulation of ligamentous expansions and bands. In proportion to the breadth of the knee there will be more strength; and likewise the direction of some muscles will be less oblique, and the course of others will be more removed from the centre of motion, in either of which cases much power will be gained.

#### BROKEN KNEES.

The treatment of broken knees is a subject of considerable importance, for many horses are sadly blemished, and others are destroyed, by wounds in the knee-joint. The horse when falling, naturally throws his knees forward; they receive all his weight and are sometimes very extensively lacerated. The first thing to be done is by very careful washing with

cold water, to cleanse the wound from all gravel and dirt. It must then be ascertained whether the joint is penetrated. The grating of the probe on one of the bones of the knee, or the depth to which the probe enters the wound, will too plainly indicate that the joint has been opened. Should any doubt exist, a linseed-meal poultice must be applied. This will at least act as a fomentation to the wound, and will prevent or abate inflammation; and when, twelve hours afterwards, it is taken off, the *synovia* or *joint-oil*, in the form of a glairy, yellowish, transparent fluid, will be seen, if the capsular ligament has been penetrated.

It having been ascertained that the interior of the joint is not injured, attention must be paid to the wound that is actually made. The horse should wear a cradle to prevent his getting at the wound. A stimulating application—turpentine and oil in equal parts is as good as any—should be lightly applied every day until healthy pus is produced on the wound, and then a little friar's balsam will probably effect a cure.

The opening of the joint, however, being ascertained, the first and immediate cure is to close the orifice; for the fluid which separated and lubricated the bones of the knee being suffered to escape, they will be brought into contact with, and will rub upon, each other; the delicate membrane with which they are covered will be highly inflamed; the constitution will be speedily affected, and a degree of fever will ensue that will destroy the horse; while, in the meantime, of all the tortures that can be inflicted on the poor animal, none can equal that which accompanies inflammation of the membranes lining the joints.

The manner of closing the orifice must be left to the judgment of the veterinary surgeon, who alone is capable of properly treating such a case. It may be effected by a compress enclosing the whole of the wound, and not to be removed for many days; or it may be attempted by the old and generally successful method of applying the hot iron over the wound, and particularly over the spot where the ligament appears to be lacerated.

The surgeon will find no difficulty in determining whether the sharp edge of the common firing-iron should be used, as would be the case if the laceration is considerable; or whether the budding-iron should be resorted to. After the use of the cautery, the application of a blister may, in some cases, be serviceable. Should the joint-oil continue to flow, the iron may be applied a second, or even a third time. By its application synovia is coagulated, so much swelling is produced on the immediate puncture, and in the neighbouring parts, as mechanically to close and plug up the orifice.

If, however, the opening into the joint is extensive, and the joint-oil continues to flow, and the horse is evidently suffering much pain, humanity will dictate that he should be destroyed. The case is hopeless. A high degree of fever will ere long carry him off, or the inflammation will cause a deposit of matter in the cavity of the joint that will produce incurable lameness.

The pain caused by the iron is doubtless great; it is, however, necessary: but let no reader of 'The Horse' permit the torturing experiments of the farrier to be tried, who will frequently *inject* stimulating fluids, and even oil of vitriol, into one of the most sensible and irritable cavities in the whole frame.

A person well acquainted with the anatomy of the part will judge of the probability of a favourable result, not merely by the extent, but by the situation of the wound. If it is low down, and opposite to the bottom row of the bones of the knee, a small opening into the joint will be easily closed. A larger one needs not to cause despair, because there is little motion between the lower row and the bones of the leg. If it is high up,

there is more danger, because there is more motion. If it is situated opposite to the union of the two rows, the result is most to be dreaded, because between these is the principal motion of the joint, and that motion will not only disunite and irritate the external wound, but cause dreadful friction between the bones brought into actual contact with each other, through the loss of the joint-oil.

When the knee has been much lacerated, although the wound may be healed, some blemish will remain. The extent of this blemish will depend on that of the original wound, and more especially on the nature of the treatment that has been adopted. Every caustic application will destroy a portion of the skin, and leave a certain mark. Should the blemish be considerable, a mild blister may be applied over the part, after the wound has healed. It will stimulate the hair to grow more rapidly and thickly round the scar, and particularly hair of the natural colour; and, by contracting the skin, it will lessen the scar itself. Many persons have great faith in ointments that are said to promote the growth of the hair. If they have this property, it must be from their stimulating the skin in which the roots of the hair are imbedded. These ointments usually contain a small portion of blistering matter, in the form of turpentine, or the Spanish fly. The common application of gunpowder and hard may, by blackening the part, conceal the blemish, but can have no possible effect in quickening the growth of the hair.

In examining a horse for purchase, the knees should be very strictly scrutinised. A small blemish on them should not induce us at once to condemn the animal, for a bad rider or the merest accident may throw the safest horse. A broken knee, however, is a suspicious circumstance, and calls for the most careful observation of the make and action of the horse. If it is accompanied by a thick and upright shoulder, and legs far under the horse, and low slovenly action, he is unwise who does not take the hint. This faulty conformation has produced its natural consequence. But if the shoulder is oblique, and the pastern of the proper length and inclination, and the fore-arm strong, the good judge will not reject the animal because he may have been accidentally thrown. From the complicated nature of this joint, from its being placed so immediately under the centre of gravity, and having to receive the entire weight of the horse and rider, the concussion is so severe as frequently to produce diffuse inflammation of the synovial and other tissues. Race-horses are very frequently lame from diseased knees, which veterinary authors say but little about.

The animal should have rest; a dose of physic should be given, with antiphlogistic applications to the knee, to be followed by counter-irritation in the shape of a blister. Several valuable race-horses have suffered from this disease, some of them when only two years old.

#### THE LEG.

The part of the limb between the knee and the fetlock consists of three bones: a large one in front, called the *cannon* or *shank*, and two smaller or *splint* bones behind (see N, p. 140). The shank-bone is rounded in front, and flattened, or even concave, behind. It is the straightest of the long bones, as well as the most superficially situated, for in some parts it is covered only by the skin. The upper head is flat, with slight depressions corresponding with the lower row of the bones of the knee. The lower head is differently and curiously formed. It resembles a double pulley. There are three elevations; the principal one in the centre, and another on each side. Between them are two slight grooves, and these so precisely correspond with deep impressions and slight prominences in the

upper head of the larger pastern, and are so enclosed and guarded by the elevated edges of that bone, that when the shank-bone and pastern are fitted to each other, they form a perfect hinge. They admit of the bending and extension of the limb, but of no lateral or side motion. This is a circumstance of very great importance in a joint so situated, and having the whole weight of the horse thrown upon it.

The smaller bones are placed behind the larger ones on either side. A slight projection of the head of each can alone be seen in front. The heads of these bones are enlarged, and receive part of the weight conveyed by the lower row of the bones of the knee. They are united to the larger bone by the same kind of substance which is found in the colt between the bone of the elbow and the main bone of the arm; and which is designed, by its great elasticity, to lessen the concussion or jar when the weight of the animal is thrown on them. They reach from one half to two thirds of the length of the shank-bone, and, through their whole extent, are united to it by this substance; but, as in the elbow, from the animal being worked too soon or too violently, bony matter is deposited in the room of the ligamentous, and a bony union takes place instead of the natural one. There is no doubt that the ease of motion is somewhat lessened by this substitution of bone, but other elastic principles are probably called into more powerful action, and the value of the horse is not perceptibly impaired, although it is hard to say what secret injury may be done to the neighbouring joints, and the cause of which, the lameness not appearing until a distant period, is not suspected.

In this process, however, mischief does often immediately extend to the neighbouring parts. The disposition to deposit bone, reaches beyond the circumscribed space between the larger and smaller bones of the leg, and a tumour, first callous, and afterwards bony, is found, with part of its base resting on the line of union between these bones. This is called a

#### SPLINT.

The splint is generally found on the outside of the small bones, and frequently on the inside of the leg. Why it should appear on the outside of the small bones it is difficult to explain, except that the space between these bones is occupied by an important mechanism, which will be presently described; and, as in the case of abscess, a natural tendency was given to them to determine outward, that vital parts might not be injured. The cause of their almost exclusive appearance on the inside of the leg admits of easier explanation. The inner splint-bone is placed nearer the centre of the weight of the body than the other, and, from the nature of its connection with the bones of the knee, actually receives more of the weight than does the outer bone, and therefore is more liable to injury, from the jar and concussion occasioned by the action of the horse with a superadded weight above, and harsh unyielding roads below, inflammation is set up, and this consequent deposit of bony matter. The inner bone receives the whole of the weight transmitted to the small bone of the knee. It is the only support of that bone. A portion only of one of the bones rests on the outer splint-bone, and the weight is shared between it and the shank. In addition to this there is the absurd practice of many smiths of raising the outer heel of the shoe to an extravagant degree, which throws still more of the weight of the horse on the inner splint-bone. Bony tumours occasionally appear on other parts of the shank-bone, being the consequence of violent blows or other external injuries, and are commonly called splints.

When the splint of either sort is forming, the horse is frequently lame, for the periosteum or membrane covering the bone is painfully stretched

but when this membrane has accommodated itself to the tumour that extended it, the lameness subsides, and altogether disappears, unless the splint be in a situation in which it interferes with the action of some tendon or ligament, or in the immediate neighbourhood of a joint. Pressing upon a ligament or tendon, it may cause inflammation of those substances; or, being close to a joint, it may interfere with its action. Splints, then, although, strictly speaking, cause unsoundness, may not materially lessen the action or value of the horse. The treatment of splints is exceedingly simple. The hair should be closely shaved off round the tumour, and this followed by an active blister.

If the splint is of recent formation, it will generally yield to this, or to a second blister. Should it however resist these applications, it can rarely be advisable to canterise the part, unless the tumour materially interferes with the action of the suspensory ligament, or the flexor tendon; for it not unfrequently happens, that, although the splint may have apparently resisted this treatment, it will afterwards, at no great distance of time, begin rapidly to lessen, and quite disappear. There is also a natural process by which the greater part of splints disappear when the horse grows old.

The late Professor Sewell introduced a new treatment of splints described in the eighth volume of the 'Veterinarian,' which is certainly ingenious, and generally successful. He removes any inflammation about the part by the use of poultices or fomentations, and then, the horse being cast, an operation is performed; this is commenced by pinching up the skin, immediately above the bony enlargement, with the finger and thumb of the left hand, and with the knife, or lancet, or scissors, making an orifice sufficient to introduce a probe-pointed bistoury, with the edge on the convex side. This is passed under the skin along the whole length of the ossification beneath, cutting through the thickened periosteum down to the bone; and this being effectually completed by drawing the knife backwards and forwards several times, a small tape or seton is inserted, and, if the tumour is of long standing, kept in a few days. The operation is attended with very little pain to the animal. Perhaps slight inflammation may appear, which subsides in a few days if fomentation is used. The inflammation being removed, the enlargement considerably subsides, and in many cases becomes quite absorbed. This is a great improvement on the practice, though the effect and the result are the same as in the old system formerly adopted in many parts of the country, and not now obsolete where veterinary assistance is not within reach, of at once cutting down on the splint, when the pain is at once removed, and the wound heals readily, with little or no blemish.

The inside of the leg, immediately under the knee, and extending to the head of the inner splint-bone, is subject to injury from what is termed the *speedy cut*. A horse with high action, and in the fast trot, violently strikes this part, either with his hoof or the edge of the shoe. Horses that are termed dancing masters from turning out their toes, are more specially liable to this serious defect, from the peculiar position of the limbs inevitably producing a crossing in their action. Sometimes bony enlargement is the result, at others great heat and tenderness; and the pain from the blow seems occasionally to be so great that the horse drops as if he were shot. The only remedy is to take care that no part of the shoe projects beyond the foot; and to let the inner side of the shoe—except the country is very deep, or the horse used for hunting—have but one nail, and that near the toe. Care should likewise be taken that the shoe is of equal thickness at the heel and the toe, and that the bearing is equal on both sides. This, however, is a very serious defect, for the animal is in danger of falling suddenly without the slightest warning, and if it

cannot be corrected by a change of shoeing, should always be viewed with suspicion.

### PEREOSTITIS (SORE SHINS).

This disease is most frequently met with amongst race-horses, and consists of a diffused inflammation of the periosteum or covering of the bone, as a result of the great amount of work upon the hard ground which these young animals have to undergo in the process of training. The animal is generally very lame, and will give evidence of pain on pressure being applied to the front of the leg. Our treatment should consist in keeping the animal at rest, the application of warm fomentations, and the administration of a dose of physic. If the inflammation be very acute blood may be drawn from the brachial vein. When the inflammation has abated, the application of a gentle stimulant, such as the vinegar of cantharides, will be very beneficial.

### SPRAIN OF THE FLEXOR TENDONS OR BACK SINEWS.

At the back of the arm are flexor muscles of great power, to bend the lower portions of the limb. The first is the *perforated flexor* muscle: the reason of the name will presently appear. It arises from the lower and back part of the inner head of the lower bone of the shoulder, and intermixed with, or rather between the origins of the muscles next to be described, and called the perforating muscle. As it descends along the bone of the arm it becomes tendinous; and approaching the knee it is bound down by bands of ligament. Proceeding from the knee it widens, and partly wraps round the tendon of the perforating muscle, and they run down together in contact, yet not adhering; freely playing over each other, and synovial fluid obviating all friction. Both of them are enclosed in a sheath of dense cellular substance, and they are likewise supported by various ligamentous expansions. Near the fetlock the tendon still farther expands, and forms a complete ring round the tendon of the perforating muscle. The use of this will be best explained when we are treating of the fetlock. The perforated tendon soon afterwards divides, and is inserted into the smaller and larger pastern-bones, and flexes or bends them. The next is the *perforating flexor* muscle. It has nearly the same origin as the other, but with somewhat distinct heads. It continues muscular farther down the arm than the perforated, and lies before it. At the knee it passes, like the perforated, under strong ligamentary bands, which confine it to its situation. It then becomes round, and is partly wrapped up in the perforated, and at the fetlock is entirely surrounded by it. It emerges from the perforated when that tendon divides, and continues its progress alone, after the other has inserted itself into the pasterns, and, passing over the navicular-bone, terminates on the base of the coffin-bone, or bone of the foot.

As they descend the back part of the leg, the tendons of the perforated and perforating flexor muscles should be far and distinctly apart from the shank-bone. There should be space free from thickening for the finger and thumb on either side to be introduced between them and the bone, and that extending from the knee to the fetlock. In a perfect leg, and towards its lower part, there should be three distinct and perfect projections visible to the eye, as well as perceptible by the finger; the sides of the shank-bone being the most forward of the three; next, the suspensory ligament; and, hindermost of all, the flexor tendons. When these are not to be distinctly seen or felt, or there is considerable thickening about and between them, and the leg is round instead of flat and deep,



there has been what is commonly, but improperly, called a sprain of the back tendons.

These tendons are enclosed in a sheath of dense cellular substance, in order to confine them in their situation, and to defend them from injury. Between the tendon and the sheath there is a fluid to prevent friction; but when the horse has been over-worked, or put to sudden and violent exertion, the tendon presses upon the delicate membrane lining the sheath, and inflammation is produced. A different fluid is then thrown out, which *coagulates*, and adhesions are formed between the tendon and the sheath, and the motion of the limb is more difficult and painful. At other times, from violent or long-continued exertion, some of the fibres which confine the tendons are ruptured. A slight injury of this nature is called a sprain of the back sinews or tendons; and, when it is more serious, the horse is said to have *broken down*. The first injury is confined to inflammation of the sheath, or rupture of a few of the attaching fibres. This inflammation, however, is often very great, the pain intense, and the lameness excessive. The anguish expressed at every bending of the limb, and the local swelling and heat, will clearly indicate the seat of injury.

In every serious affection of this kind, care should be taken that the local inflammation does not produce general disturbance of the system; and therefore the horse should be bled and physicked. The bleeding may be at the toe, by which an important local, as well as general, effect will be produced. The vessels of the heart will be relieved, while fever will be prevented. Let not the bleeding be performed in the farrier's usual way of first paring down the sole, and then taking out a piece of it at the toe of the frog; in which case a wound is made often difficult to heal, and through which fungous granulations from the sensible parts beneath will obstinately spring: but, after the sole has been well thinned, let a groove be cut with the rounded head of a small drawing-knife, at the junction of the sole and the crust. The large vein at the toe will thus be opened, or the groove may be widened backward until it is found. When the blood begins to appear, the vein may be more freely opened by a small lancet thrust horizontally under the sole, and almost any quantity of blood may be easily procured. The immersion of the foot in warm water will cause the blood to flow more rapidly. A sufficient quantity having been withdrawn, a bit of tow should be placed in the groove, and a patten shoe tacked on, by which the heels may be raised from the ground, and much tension removed from the sinews. The bleeding will thus be immediately stopped, and the wound will readily heal. A full dose of physic should be given as soon as the horse could be prepared; and, after its operation, low and moist diet should be persisted in till the inflammation and pain have subsided.

As a local application, no hot farrier's oil should come near the part, but the leg should be well fomented with warm water two or three times in the day, and an hour at each time. The beneficial effect depends simply on the warmth of the water and the moisture. All stimulating applications will infallibly aggravate the mischief.

The horse beginning to put his foot better to the ground, and to bear pressure on the part, and the heat having disappeared, the object to be accomplished is changed. Recurrence of the inflammation must be prevented, the enlargement must be got rid of, and the parts must be strengthened. The two latter purposes cannot be better effected than by using a bandage: one of thin flannel used to be the best, but is now entirely superseded by the linen ones. This will sustain and support the limb, while by few means are the absorbents sooner induced to take up the effused coagulable matter of which the swelling is composed

than by moderate pressure. The bandage should be kept constantly wet with cold water—to each pint of which a quarter of a pint of spirit of wine has been added—the skin will be slightly stimulated and contracted, and the cold produced by the constant evaporation will tend to subdue the remaining and deep-seated inflammation. This bandage should be daily tightened in proportion as the parts are capable of bearing increased pressure, and the treatment should be persisted in for a fortnight. If, at the expiration of that period, there is no swelling, tenderness, or heat, the horse may gradually, and very cautiously, be put to his usual work.

Should there, however, remain the slightest lameness or considerable enlargement, the leg must be blistered, and, indeed, it would seldom be bad practice to blister after every case of severe sprain: for the inflammation may lie deep in the sheath of the tendons, and the part once sprained may long remain weak, and subject to renewed injury, not only from unusual, but even ordinary exertion. If a blister is resorted to, time should be given for it to produce its gradual and full effect, and the horse should be afterwards turned out for one or two months. We must here be permitted to repeat that a blister should never be used while heat or tenderness remains about the part, otherwise the slightest injury may be, and often is, converted into incurable lameness.

Very severe sprains, or much oftener, sprains badly treated, will require the application of the cauterly. If from long-continued inflammation the structure of the part is materially altered, — if the swelling is becoming callous or the skin is thickened and prevents the free motion of the limb, no stimulus short of the hot iron will be sufficient to rouse the absorbents to remove the injurious deposit. The principal use of firing is to rouse the absorbents to such increased action that they shall take up and remove the diseased thickness of the skin, and likewise the unnatural deposit in the cellular substance beneath. The firing should be applied in straight lines, because the skin, contracting by the application of the cauterly, and gradually regaining its elastic nature, will thus form the best bandage over the weakened part. It should likewise be as deep as it can be applied, even occasionally penetrating the skin. Here, even more particularly than in the blister, time should be given for the full action of the firing. This removal of diseased matter is a work of slow progress. Many weeks pass away before it is perfectly accomplished; and, after firing, the horse should have at least a six months', and it would be better if he could be given a twelve months' run at grass. When the animal has been set to work in a few weeks, and the enlargement remains, or lameness returns, the fault is to be attributed to the impatience of the owner, and not to the want of power in the operation or skill in the operator.

Farriers are apt to blister immediately after firing. A blister may be useful six weeks or two months after firing, if lameness remains; but can never be wanted immediately after the severe operation of the cauterly. If the iron has been skilfully applied, subsequent blistering inflicts on the animal, already sufficiently tortured, much unnecessary and useless pain, and should never be resorted to by him who possesses the slightest feeling of humanity.

In examining a horse for purchase, the closest attention should be paid to the appearance of these flexor tendons. If there is any thickness of cellular substance around them, that horse has been sprained violently, or the sprain has not been properly treated. This thickening will probably fetter the motion of the tendon, and dispose the part to the recurrence of inflammation and lameness. Such a horse, although at the time perfectly free from lameness, should be regarded with suspicion, and cannot fairly

be considered as sound. He is only patched up for a while, and will probably fail at the close of the first day's hard work.

#### WIND-GALLS.

In the neighbourhood of the fetlock there are occasionally found considerable enlargements, oftener on the hind-leg than the fore-one, which are denominated *wind-galls*. Between the tendons and other parts, and wherever the tendons are exposed to pressure or friction, and particularly about their extremities, little bags or sacs are placed, containing, and suffering to ooze slowly from them, a mucous fluid to lubricate the parts. From undue pressure, and that most frequently caused by violent action and straining of the tendons, or often from some predisposition about the horse, these little sacs are injured. They take on inflammation, and sometimes become large and indurated. There are few horses perfectly free from them. When they first appear, and until the inflammation subsides, they may be accompanied by some degree of lameness; but otherwise, except when they attain a great size, they do not interfere with the action of the animal, or cause any considerable unsoundness. The farriers used to suppose that they contained wind—hence their name, wind-galls; and hence the practice of opening them, by which dreadful inflammation was often produced, and many a valuable horse destroyed. It is not uncommon for wind-galls entirely to disappear in aged horses.

The treatment for wind-galls cannot begin too soon. When they appear bandage the limb, from the coronet to the knee, daily with wet bandages. The wet bandage must be well wrung out of very cold water, and changed every two, three, or four hours.

Upon every change of bandage the limb must be well hand-rubbed with wet hands for several minutes. The width of the bandage should not exceed three and a half inches. The wind-gall will often diminish or disappear by this treatment, but will too frequently return when the horse is again hardly worked. A blister is a more effectual, but too often temporary remedy: wind-galls will return with the renewal of work. Firing is still more certain, if the tumours are sufficiently large and annoying to justify our having recourse to measures so severe; for it will not only effect the immediate absorption of the fluid, and the reduction of the swelling, but, by contracting the skin, will act as a permanent bandage, and therefore prevent the reappearance of the tumour. The iodine and mercurial ointments have occasionally been used with advantage, in the proportion of three parts of the former to two of the latter.

#### LESIONS OF THE SUSPENSORY LIGAMENT.

At the back of the shank just below the knee, and in the space between the two splint-bones, behind the perforatus and perforans tendon, is found an important ligament, admirably adapted to obviate concussion. It originates in the head of the shank-bone, and also in the heads of the splint-bones; then, descending down the leg, it fills the groove between the splint-bones, but is not attached to either of them. A little lower down it expands on either side, and, approaching the pasterns, bifurcates, and the branches are inserted into two small bones found at the back of the upper pastern, one on each side, called the *sesamoid*-bones. The internal branch of this ligament is somewhat longer than the outer, more especially in limbs of a peculiar formation, such, for instance, as those in which the toes are everted or turned out. (See page 360.) The bones form a kind of joint both with the lower head of the shank-bone and the upper

pastern-bone, to both of which they are united by ligaments (*i* and *g*), but much more closely tied to the pastern than to the shank. The flexor tendons pass down between them through a large synovial bag, to relieve them from the friction to which, in so confined a situation, they would be exposed. The suspensory ligament is continued over the sesamoids, and afterwards obliquely forward over the pastern to unite with the long extensor tendon, and downward to the perforated tendon, which it surrounds and fixes in its place, and also to the smaller pastern-bone.

It will be easy to perceive, from this description of the situation of the suspensory ligament, why splints placed backward on the leg are more likely to produce lameness than those which are found on the side of it. They may interfere with the function of this ligament, or, if they are large, may bruise and wound it.

The principal action of these ligaments is with the sesamoid-bones, which they seem to suspend in their places, and they are therefore called the suspensory ligaments. The pasterns (see cut, p. 360) are united to the shank in an oblique direction, differing in degree in the different breeds of horses, and in each adapted to the purpose for which that breed was designed. The weight falls upon the pastern in the direction of the shank-bone, and the pastern being set on obliquely, a portion of that weight must be communicated to the sesamoids. Much concussion is saved by the yielding of the pasterns, in consequence of their oblique direction; and the concussion which would be produced by that portion of weight which falls on the sesamoid-bones is completely destroyed, for there is no bone underneath to receive it. They are suspended by this ligament—an *elastic* ligament, which gradually yields to, and is lengthened by, the force impressed upon it, and in this gradual yielding and lengthening, materially lessening, or generally preventing, all painful or dangerous concussion.

If the ligament lengthens, the sesamoid-bones must descend when the weight is thrown on them, and it would appear that they do so. If the thorough-bred horse with his long pasterns is carefully observed as he stands, the tuft at the fetlock will be some inches from the turf; but when he is in rapid motion, and the weight is thrown violently on this joint, the tuft descends and sweeps the very ground. This, however, is from the combined action of the fetlock and pastern-joints, and the sesamoid-bones. The sesamoids do not actually descend; but they revolve, they partly turn over. The strong ligament by which they are attached to the pastern-bone acts as a hinge, and the projecting part of the bone, to which the suspensory ligament is united, turns round with the pressure of the weight; so that part of the bone becomes lower. How is it raised again? This ligament, exceptionally constructed as a ligament, is elastic. It yields to the force impressed upon it and lengthens; but as soon as the foot is lifted from the ground, and the weight no longer presses, and the force is removed, its elastic power is exerted, and it regains its former dimensions, and the sesamoid-bone springs back into its place, and by that forcible return assists in raising the limb.

Mr. Percivall very clearly describes this in his Lectures: 'Furthermore, it seems to us that these elastic parts assist in the elevation of the feet from the ground in those places in which they are called into sudden and forcible action. The suspensory ligament, by its reaction, instantaneously after its extension, aids the flexor muscles in bending the pastern-joints. The astonishing activity and expedition displayed in the movements of the race-horse at speed, seem to be referable, in part, to the promptitude with which the suspensory ligament can act before the flexor muscles are duly

prepared ; the latter we should say *catch*, as it were, and then direct the limb first snatched from the ground by the powers of elasticity.'

It may be supposed that ligaments of this character, and discharging such functions, will occasionally be subject to injury, and principally to strains. Mr. W. C. Spooner gives a very satisfactory account of this. He says that 'hunters and race-horses are considerably more liable to lesions of the suspensory ligament than any other description of horses. The character of these strains is very rarely so acute as that of the tendons. They generally come on gradually, with little inflammation or lameness. Occasionally the injury is sudden and severe, but then it is rarely confined to these ligaments, for although they may be principally involved, the neighbouring parts are generally implicated. The usual symptoms are a slight enlargement and lameness at first, or there may be the former without the latter. The enlargement is commonly confined to the ligament below the place of bifurcation, and sometimes one division alone is affected. With the exception of strains of the flexor sinews, this unfits more animals for racing than any other cause — indeed horses are rarely or never fit for the turf after the suspensory ligaments have been diseased,' or for hunting.

The suspensory ligament is sometimes strained and even ruptured by extraordinary exertion. The sesamoids, which in their natural state are suspended by it, and from which function its name is derived, are in the latter case let down, and the fetlock almost touches the ground. This is generally mistaken for rupture of the flexor tendon ; but one circumstance will sufficiently demonstrate that it is the suspensory ligament which is concerned, viz., that the horse is able to bend his foot. Rupture of this ligament is a bad, and almost desperate, case. The horse is frequently lame for life, and never becomes perfectly sound. Keeping him altogether quiet, bandaging the leg, and putting on a high-heeled shoe, will afford the most probable means of temporary relief ; but the application of the actual cautery, in its severest form, will alone give a chance of ultimate utility.

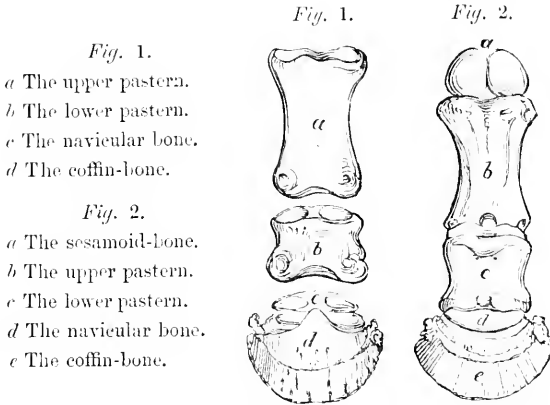
The common injury to this ligament is sprain, indicated by lameness and swelling and heat, more or less severe in proportion as the neighbouring parts are involved. This will sometimes yield to rest and cooling treatment ; but, if the case is obstinate, it will be necessary to have recourse to the actual cautery. The hunter and the race-horse are most subject to lesions of these ligaments ; the hunter from leaping the fence, and the race-horse from the violent efforts which are occasionally demanded of him. In both cases, the neighbouring parts usually share in the injury, and a cure is rarely completely effected.

#### THE PASTERNS.

The *upper pastern-bone* (*a* in the first figure, and *b* in the second, in the following cuts) receives the lower pulley-like head of the shank-bone, and forms a hinge joint admitting only of bending and extension, but not of side motion ; it likewise articulates with the sesamoid-bones. Its lower head has two rounded protuberances, which are received into corresponding depressions in the lower pastern. On either side above the pastern-joint, are roughened projections, for the attachment of very strong ligaments, both the capsular ligaments, and many cross ligaments, which render the joint between the two pasterns sufficiently secure.

The *lower pastern* (*b* in the first figure, and *c* in the second, in the next cut) is a short and thick bone with its larger head downward. Its upper head

has two depressions to receive the protuberances on the lower head of the upper bone, bearing some resemblance to a pulley, but not so



decidedly as the lower head of the shank-bone. Its lower head resembles that of the other pastern, and has also two prominences, somewhat resembling a pulley, by which it articulates with the coffin-bone; and a depression in front, corresponding with a projection in the coffin-bone. There are also two slight depressions behind, receiving eminences of the navicular bone. Neither of these joints admits of any lateral motion. The ligaments of this joint, both the capsular and the cross ones, are, like those of the pastern-joint, exceedingly strong. The tendon of the extensor muscle is inserted

into the forepart both of the upper and lower pastern-bones, as well as into the upper part of the coffin-bone; and at the back of these bones the suspensory ligament is expanded and inserted, while a portion of it goes over the fore part of the upper pastern to reach the extensor tendon. These attachments in front of the bones are seen in the accompanying cut, in which *a* represents the lower part of the shank-bone; *b* the sesamoid-bones; *c* the upper pastern; *d* the lower pastern; and *e* the coffin-bone; *f* one of the two branches of the suspensory ligaments going to unite with the extensor tendon; *g* the long extensor tendon; *h* ligaments connecting the two pastern-bones together; *i* the lateral cartilages of the foot, and *k* the coronary ligament.



The length and obliquity of the pastern vary in the different breeds of horses, and on it depends the elastic action of the animal, and the easiness of his paces. The pastern must be long in proportion to its obliquity, or the fetlock will be too close to the ground, and, in rapid action, come violently into contact with it. It is necessary that the fetlock should be elevated a certain distance from the ground, and this may be effected either by a short and upright, or a long and slanting pastern. In proportion as the pastern is oblique or slanting, two consequences will follow, less weight will be thrown on the pastern, and more on the sesamoid, and, in that proportion, concussion will be prevented.

Every advantage, however, has, to a certain extent, its corresponding disadvantage. In proportion to the obliquity or slanting of the pastern, will be the stress on the fetlock-joint, and, therefore, the liability of that

joint to injury and strain; and also the liability to sprain of the back sinews from the increased action and play of the flexor tendons; and likewise to injuries of the pastern-joints, for the ligaments will be weak in proportion to their length. The long and slanting pastern is advantageous in the race-horse, from the elasticity of action and greater extent of stride by which it is accompanied. A less degree of it is given in the hunter, who is to unite continuance of exertion with ease of pace. For the hackney there should be sufficient obliquity to give pleasantness of going, but not enough to endanger continuance and strength. Experience among horses will alone point out the most advantageous direction of the pastern for the purpose required; but the slightest observation will show the necessity of considerable variety in the structure of this part. Let the reader imagine the heavy dray-horse with his short and upright pasterns contending in the race; or the race-horse with his long and weak pasterns, endeavouring to dig his toe into the ground in order to move some heavy weight. The concussion which attends the common action of the cart-horse is little because his movements are slow, and therefore the upright and strong pastern is given to him, which he can force into the ground, and on which he can throw the whole of his immense weight. The oblique pastern is given to the race-horse because that alone is compatible with extent of stride and great speed. Except a horse for general purposes, and particularly for riding is very hardly used, a little too much obliquity is a far less evil than a pastern too upright. While the jolting of the upright pastern is an insufferable nuisance to the rider, it is injurious and most unsafe to the horse, and produces many diseases in the feet and legs, and particularly ringbone, ossification of the cartilages, and contracted feet.

#### THE FETLOCK.

The fetlock-joint is a very complicated one, and from the stress which is laid on it, and its being the principal seat of motion below the knee, it is particularly subject to injury. There are not many cases of sprain of the back sinew that are not accompanied by inflammation of the ligaments of this joint; and numerous supposed cases of sprain higher up are simple affections of the fetlock. It requires a great deal of care, and some experience, to distinguish the one from the other. The heat about the part, and the point at which the horse least endures the pressure of the finger, will be the principal guides. Occasionally, by the application of cooling lotions the inflammation may be subdued, but, at other times, the horse suffers dreadfully, and is unable to stand. A serious affection of the fetlock-joint demands treatment more prompt and severe than that of the sheaths of the tendons.

#### GROGGINESS.

The peculiar knuckling of the fetlock-joint, and the tottering of the whole of the fore-leg, known by the name of *grogginess*, and which is so often seen in old and over-worked horses, is seldom an affection of either the fetlock or the pastern-joints simply. Indeed it is not difficult to fix on the particular joint; it is that which is deep in the foot, and where the flexor tendon runs over the navicular bone. When disease attacks these tissues, as the fearful number of cases of navicular disease proves to be so often the case, the horse, to avoid throwing a portion of his weight on the flexor tendon, which in a healthy state is so well able to receive it, goes as much as possible on his toes, steps short and lightly, producing that appearance of unsteadiness to which the term is applied. It may be combined with a want of power in the ligaments of the joints generally, produced by

frequent and severe sprains, or by ill-judged and cruel exertion. Professor Stewart very truly says, in his 'Stable Economy,' that, 'it is common among all kinds of fast workers, and long journeys at a fast pace will make almost any horse groggy. Bad shoeing and want of stable care may help to increase, but never can alone produce grogginess. It is one of the evils of excessive work. In the majority of cases it admits of no remedy.'

#### CUTTING.

The inside of the fetlock is often bruised by the shoe or the hoof of the opposite foot. Many expedients used to be tried to remove this; the inside heel has been raised and lowered, and the outside raised and lowered; and sometimes one operation has succeeded, and sometimes the contrary; and there was no point so involved in obscurity, or so destitute of principles to guide the practitioner. The most successful remedy, and that which in the great majority of cases supersedes all others, is to put on a shoe, of equal thickness from heel to toe, and having but one nail, and that near the toe on the inside of the shoe; care being taken that the shoe shall not extend beyond the edge of the crust, and that the crust shall be rasped a little at the quarters.

There are some defects, however, in the natural form of the horse, which are the causes of cutting, and which no contrivance will remedy; as when the legs are placed too near to each other, or when the feet are turned inward or outward. A horse with these defects should be carefully examined at the inside of the fetlock, and if there are any sore or callous places from cutting, there will be a good reason for not purchasing the animal. Some horses will cut only when they are fatigued or lame and old; many colts will cut before they arrive at their full strength.

#### SPRAIN OF THE COFFIN-JOINT.

The proof of this is when the lameness is sudden, and the heat and tenderness are principally felt round the coronet. Bleeding at the toe, physic, fomentation, and blisters are the usual means adopted. This lameness is not easily removed, even by a blister; and if removed, like sprains of the fetlock and of the back sinews, it is apt to return, and finally produce a great deal of disorganisation and mischief in the foot. Sprain of the coffin-joint sometimes becomes a very serious affair. Not being always attended by any external swelling, and being detected only by heat round the coronet, the seat of the lameness is often overlooked by the groom and the farrier; and the disease is suffered to become confirmed before its nature is discovered.

#### RINGBONE.

Ringbone is a deposit of bony matter on one of the pasterns, and usually near the joint. From a disposition to spread, and at first around the pastern-joint, which is situated just above the coronet, the disease has acquired the name of ringbone.

Horses with short upright joints, and with small feet and high action, are oftenest, as may be supposed, the subjects of this disease, which is the consequence either of concussion or sprain of the pastern-joints. It is also hereditary in its nature and may come on either with or without inflammation.

It is more frequent in the hind limb than the fore: from the violent action of the hind legs in propelling the horse forward, the pasterns are more subject to ligamentary injury; yet the lameness is not so great there, because the disease is confined principally to the ligaments, and the bones have not been injured by concussion: while, from the position of the fore



limbs, there will generally be in them injury of the bones to be added to that of the ligaments. In its early stage, and when recognised by a bony enlargement on both sides of the pastern-joint, or in some few cases on one side only, if the lameness is considerable, the animal should be kept at rest and antiphlogistic treatment adopted. The parts should be fomented with warm water and a dose of purgative medicine administered. When the acute inflammation has subsided, we apply counter-irritation, either in the shape of a blister (the biniodide of mercury and lard, in the proportion of a drachm of the former to one ounce of the latter, being the best), or the actual cautery. When it comes on without lameness the latter treatment may be adopted at once.

But there is so much wear and tear in this part of the animal, that the inflammation and the disposition to the formation of bone rapidly spread. The pasterns first become connected together by bone instead of ligament, and thence results what is called an ankylosed or fixed joint.

---

## CHAPTER XVII.

### THE HIND LEGS.

---

#### THE HAUNCH.

THE haunch (see O, p. 140; and the cut, p. 360) is composed of three bones. The first is the ilium, principally concerned in the formation of the haunch. Its extended branches behind the flanks are prominent in every horse. When they are more than usually wide, the animal is said to be *ragged-hipped*. A branch runs up to the spine at the commencement of the sacral vertebrae, and here the haunch-bones are firmly united with the bones of the spine. The ischium, or hip-bone, is behind and below the ilium. Its tuberosities or prominences are seen under the tail (cut, p. 140). The pubis unites with the two former below and behind. These three bones are perfectly distinct in the fœtus, but in the horse become so intimately united as to constitute one solid bone.

From the loins to the setting on of the tail a line should be carried on almost straight, or drooping only in a slight degree. Thus the haunch-bones will be most oblique, and will produce a corresponding obliquity, or slanting direction, in the thigh-bone—a direction in which, as stated when the fore legs were described, the muscles act with most advantage. This direction of the quarters is characteristic of the thorough-bred horse; and by the degree in which it is found, we judge to a considerable extent of the breeding of the animal. If the bones at D and E, p. 140, take a somewhat arched form, as they do in the cart-horse, it is evident that the haunch-bone O would be more upright. The thigh-bone P would likewise be so. The stifle Q would not be so far under the body, and the power of the horse would be considerably impaired. The oblique direction of the haunch and thigh-bones, produced by the straightness of the line of the spine, does not, as is commonly supposed, afford increased surface for the attachment of muscles, but places the muscles in a direction to act with great advantage. It is in the advantageous direction, quite as much as in the bulk of the muscle, that the strength of the horse consists.

It will be seen, from the different cuts, that the angles formed by the fore and hind extremities have different directions. One points forward,

and the other backward. The action of the fore legs thus least interferes with the chest, and that of the hind legs with the belly.

Width of haunch is a point of great consequence, for it evidently affords more room for the attachment of muscles; and even though it should be so wide as to subject the horse to the charge of being *ragged-hipped*, and may somewhat offend the eye, it will not often be any detriment to action. If the loins are broad and the horse well ribbed home, the protuberances of the ilia can scarcely be too far apart. Many a ragged-hipped horse has possessed both fleetness and strength, while but few that were narrow across the haunch could boast of the latter quality.

The opening in the centre of these bones, which constitutes the passage through which the young animal is expelled from the mother, is large in the mare, and in every quadruped, because there cannot, on account of the form of the animal, be any danger of abortion from the weight of the foetus pressing on the part.

The only portion of these bones exposed to injury or fracture are the tuberosities or prominences of the haunch. A fall or blow may chip off or disunite a portion of them, and, if so, there are no means of forcibly bringing the disunited parts together again, and retaining them in their natural position, the horse is then said to be down in the hip. The power of nature, however, will gradually unite them, but that union will always be attended by deformity and occasionally by lameness. A *charge*, or very strong adhesive plaster, across the haunch may be useful, as helping, in some slight degree, to support the parts, and hold them together.

#### THE THIGH.

In the lower and lateral part of the hip-bones is a deep cavity or cup for the reception of the head of the thigh-bone. This, the true thigh-bone, is so concealed by thick muscles that its situation and shape are not visible to the eye. It is therefore frequently overlooked by horsemen, who call the next bone, extending from the stifle to the hock, the thigh. In this respect, it is analogous to the humerus or arm-bone of the fore leg, which, as before mentioned, lies as it were in the trunk, instead of being pendent from it. So here the thigh-bone forms a portion of the trunk itself; the pendent portion commencing at the stifle, the joint analogous to the knee-joint in man. Although in the movement of the hind legs there cannot be the concussion to which the fore legs are exposed (for the weight of the body is seldom thrown violently upon them), yet in the powerful action of these limbs there is much strain on the joints, and we shall, therefore, find that there are, in all of them, admirable provisions against injury. The head of the upper bone of the thigh is received into the deep cup mentioned above (the *acetabulum*), by which it is surrounded on every side; this constitutes the hip-joint, and dislocation from which would seem almost impossible. But the bony cup may give way? Not so, provision is made against this. All three of the haunch-bones unite in the formation of this cup, and the sutures by which they are held together are of such a nature, that generally speaking, no shock, or exertion, or accident, can disunite them. There is even something more in order to make the attachment doubly sure. In addition to the usual capsular and other ligaments, a singularly strong one rises from the base of the cup, and is inserted into the head of the thigh-bone, called the *ligamentum teres* or round ligament, seeming as if it would render separation or dislocation altogether impossible. Such, however, is the great power of the muscles of the hind limbs, that, with all these attachments, sprain of the ligaments of the thigh, or the *round bone*, as horsemen call it, and dislocation and even fracture of it, are occasionally found.

The thigh-bone is both the largest and strongest in the frame. It is short and thick, and exhibits singular prominences and roughnesses and hollows for the insertion of the immense muscles that belong to it. Four prominences, in particular, called by anatomists *trochanters*, two on the outside, one on the inside, and one near the head of the bone.

This bone is commonly called the *Round Bone*. It has, in some rare instances, been dislocated and fractured. It is much oftener sprained, but not so frequently as the groom or farrier imagines. There is nothing peculiar in the lameness to detect injury of this part, except that the horse will drag his leg after him. Injury of the round bone will be principally discovered by heat and tenderness in the situation of the joint.

A part so deeply situated is treated with difficulty. Fomentations should first be used to abate the inflammation, and, after that, an active blister should be applied. Strains of this joint are not always immediately relieved, and the muscles of the limb in some cases waste considerably: it therefore may be necessary to repeat the blister, while absolute rest should accompany every stage of the treatment. It may even be requisite to fire the part,—or, as a last resort, a *charge* may be placed over the joint, and the horse turned out for two or three months.

#### THE STIFLE.

The inferior extremity of the femur presents a pulley-like articular surface in front, over which plays the patella, and two condyles, rounded and smooth, presenting inferiorly and posteriorly, and which are received into slight depressions on the upper surface of the lower bone, the tibia; while in front is a curious groove, over which plays a small irregular bone, the patella, or stifle-bone. The whole is commonly called *the stifle-joint*. The patella (Q, p. 140) answers to the kneecap in the human subject. Some of the tendons of the strongest muscles of the upper bone of the thigh are inserted into it. This important joint is much strengthened by the proper ligaments between the upper and lower bones, and additional ligaments from the patella, forming altogether a very powerful union. The patella likewise answers another and even more important purpose. The tendons of some strong muscles are inserted into it. When these muscles are not in action, the patella lies in the groove which nature has contrived for it; but when they begin to contract, it starts from its partial hiding-place, becomes prominent from the joint, and alters the line of direction in which the muscles act. It increases the angle, and thus very materially increases the power of the muscles.

The lower bone of the thigh consists of two parts. The larger portion, in front, extending from the stifle to the hock, is called *the tibia*. The smaller bone, or *jibula*, behind (see R, p. 140), reaches not more than a third of the way down. It is united to the shank-bone, like the splint-bone, by a cartilaginous substance, which is soon changed into a bony one. Of the use of the smaller bone we cannot speak.

The lower bone of the thigh forms an angle with the upper one, being the reverse of that which exists between the upper bone and the pelvis. The object of this is twofold,—to obviate concussion, and to give a direction to the muscles favourable to their powerful action; and in proportion to the acuteness of the angle, or the degree in which the stifle is brought under the horse, will these purposes be accomplished. There is much difference in this in different horses, and the construction of this part of the frame is a matter worthy of more regard than is generally paid to it.

This part of the thigh should likewise be long. In proportion to the

length of the muscle is the degree of contraction of which it is capable; and also in proportion to the contraction of the muscle is the extent of motion in the limb: but it is still more necessary that this part of the thigh should have considerable muscle, in order that strength may be added to such extent or compass of motion. Much endurance would not be expected from a horse with a thin arm. A horse with thin and lanky thighs will not possess the strength which considerable exertion would sometimes require. The principal muscles of this part of the thigh are usually somewhat prominent, and may readily be traced in the living animal.

#### SPRAIN OF THE STIFLE.

The stifle-joint is occasionally subject to sprain from some violent exertion or sudden slip of the animal. From its somewhat exposed position, it is also liable to injury, either from the kick of another horse, or from coming in contact with some hard substance. In these cases there will generally be sufficient heat, tenderness, and swelling in the part to point out the seat of injury. The animal will also step short on the affected limb, being unable to extend it. The treatment should consist in resting the animal, applying warm fomentations to the part, and administering a dose of physic. If the inflammation runs very high it may be further relieved by bleeding from the femoral vein. When the acute symptoms have subsided, a blister may be applied to the part.

#### DISLOCATION OF THE PATELLA.

This is not a very uncommon disease, and may arise from several causes, such as a congenitally relaxed condition of the ligaments of the joints, and weak state of the muscles. It is sometimes caused by some inordinate force, such as muscular contraction, especially when the condyles over which the patella plays are not sufficiently developed. Cramp and sudden unconscious movements will also produce it, and it frequently follows debilitating diseases such as influenza, fever, &c. Young well-bred animals are particularly subject to this affection. The symptoms are well marked and will not easily be mistaken. The animal is quite unable to move or extend the injured limb, and a careful examination will generally detect an unnatural enlargement on the outside of the stifle-joint. The aid of the veterinary surgeon is here requisite; still, however, an attempt should be made to reduce the dislocation as soon as it is discovered. A strap should be placed below the fetlock-joint, and the limb drawn forward by an assistant as far under the abdomen as possible; the operator should then steadily press the patella in an inward, downward, and forward direction, when a moderate degree of force will generally replace it. The animal should then be tied up and not allowed to lie down for some time, and a blister applied over the whole surface of the joint, or in bad cases, the actual cautery may be used. In young animals we sometimes get a kind of partial dislocation of the patella; it slips partly off the condyle, and when the animal moves a peculiar snapping sound is heard. This is a result of a relaxed condition of the ligaments of the joint and generally disappears as the animal gets older, especially if the joint has been repeatedly blistered.

#### THOROUGH-PIN.

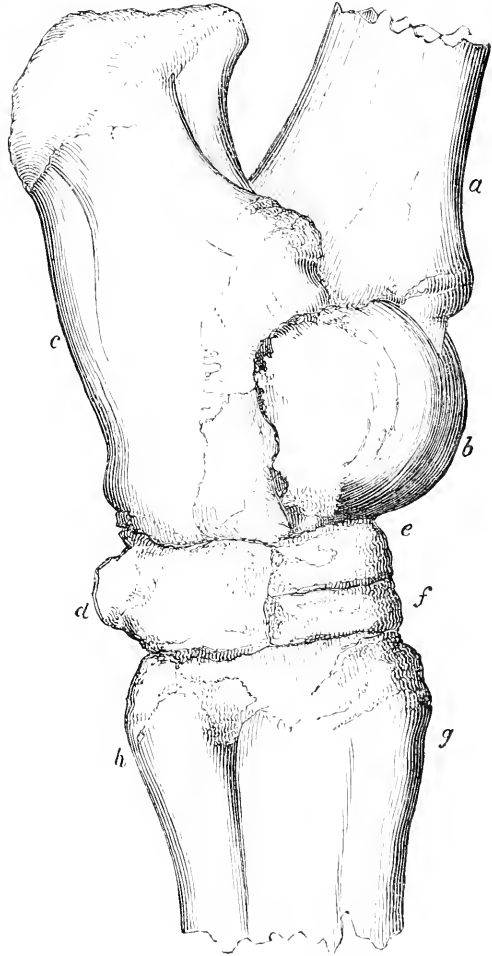
Mention has been made of *wind-galls* and their treatment. A similar enlargement is found above the hock, between the tendons of the flexor of the foot and the extensor of the hock. As from its situation it generally projects on both sides of the hock, in the form of a round swelling, it

is called a *thorough-pin*, *a*. It is an indication of considerable work, but is rarely attended by lameness. The mode of treatment must resemble that for wind-galls, but blistering or firing should be earlier had resort to.

## THE HOCK.

This is a most important joint, occasionally the evident, and much oftener the unsuspected, seat of lameness, and the proper formation of which is essentially connected with the value of the horse. It answers to the ankle in the human being.

The inferior head of the tibia is formed into two deep grooves, with three sharpened ridges, one separating the grooves, and the other two constituting the sides of them. It is seen at *a* in the accompanying cut. It rests upon a singularly-shaped bone, *b*, the *astragalus*, which has two circular risings or projections, and, with a depression between them, answering exactly to the irregularities of the tibia. At the posterior part, its convex surface is received into a concavity near the base of another bone, and with which it is united by very strong ligaments. This bone, *c*, is called the *os calcis*, or bone of the heel, and it projects upwards, flattened at its sides, and receives, strongly implanted into it, the tendons of powerful muscles. These bones rest on two others, the *os cuboides*, *d* (cube-formed), behind, and



the larger *cuneiform* or wedge-shaped bone, *e*, in front. The larger wedge-shaped bone is supported by two smaller ones, *f*, and these two smaller ones, and the cuboides, by the upper heads of the shank-bone, *g*, and the splint-bones, *h*. The cuboides is placed on the external splint-bone, and the cannon-bone, or principal bone of the leg; the small wedge-bone is principally resting on the inner splint-bone, not seen in the cut; and the middle wedge-bone on the shank-bone only, *g*. These bones are all connected together by very strong ligaments, which prevent dislocation, but allow a slight degree of motion between them, and the surfaces which are opposed to each other are thickly covered by elastic cartilage.

Considering the situation and action of this joint, the weight and stress thrown upon it must be exceedingly great, and it is necessarily liable to much injury in rapid and powerful motion. What are the provisions to prevent injury? The grooved or pulley-like heads of the tibia and the astragalus, received deeply into one another, and confined by powerful ligaments, admitting freely of hinge-like action, but of no side motion, to which the joint would otherwise be exposed in rapid movement, or on an uneven surface. A slight inspection of the cut will show that the stress or weight thrown by the tibia, *a*, on the astragalus, *b*, does not descend, perpendicularly, but in a slanting direction. By this, much concussion is avoided, or more readily diffused among the different bones; and, the joint consisting of six bones, each of them covered with elastic cartilage, and each admitting of a certain degree of motion, the diminished concussion is diffused among them all, and thereby neutralised and rendered comparatively harmless. Each of these bones is covered not only by cartilage, but by a membrane secreting synovia: so that, in fact, these bones are formed into so many distinct joints, separated from each other, and thereby guarded from injury, yet united by various ligaments — possessing altogether sufficient motion, yet bound together so strongly as to defy dislocation. When, however, the work which this joint has to perform, and the thoughtlessness and cruelty with which that work is often exacted, are considered, it will not excite any surprise if this necessarily complicated mechanism is sometimes deranged. The hock, from its complicated structure and its work, is the principal seat of lameness behind.

#### ENLARGEMENT OF THE HOCK.

First, there is inflammation arising from injury, such as kicks or blows, or *sprain of the hock-joint generally*, arising from sudden violent concussion, by some check at speed, or overweight, and attended with enlargement of the whole joint, and great tenderness and lameness. This, however, like other diffused inflammations, is not so untractable as an intense one of a more circumscribed nature, and by rest and fomentation, local bleeding and physic, followed by counter-irritation, the limb recovers its action, and the horse becomes fit for ordinary work. When it is the result of external violence, especially, as is frequently the case, from being kicked by another animal, inflammation often runs very high, the hock being much swollen and great pain and lameness present. This may go on increasing in violence for several days, and sometimes extends to the interior of the joint, and terminates in the joint becoming open, or the pain and lameness gradually decrease. The swelling, however, does not always subside, and enlargement spread over the whole of the hock-joint sometimes remains. The treatment should consist in keeping the animal perfectly at rest, and the continued application of fomentations of warm water for two or three hours at a time. A dose of physic should be given, and blood may be abstracted from the femoral vein. If the inflammation extend to the interior of the joint and it becomes open, no treatment will do much good, as the excessive irritation will often destroy the animal. If, however, when the violence of the symptoms have abated, considerable enlargement of the hock remains, it should be repeatedly blistered. A horse with an enlarged hock must always be regarded with suspicion. In truth, he is unsound. The parts, altered in structure, must be to a certain degree weakened. The animal may discharge his usual work during a long period, without return of lameness; but if one of those emergencies should occur when all his energies require to be exerted, the disorganised and weakened part will fail. The purchase, therefore, of a horse with enlarged hock will depend

on circumstances. If he has other excellences, he will not be uniformly rejected; for he may be ridden or driven moderately for many a year without inconvenience, yet one extra hard day's work may lame him for ever.

### CURB.

There are often injuries of particular parts of the hock-joint. *Curb* is an affection of this kind. It is an enlargement at the back of the hock, three or four inches below its point. It is either a strain of the ring-like ligament which binds the tendons in their place, or of the sheath of the tendons; oftener, however, of the ligament than of the sheath. Any sudden action of the limb of more than usual violence may produce it, and therefore horses are found to 'throw out curbs' after a hardly contested race, an extraordinary leap, a severe gallop over heavy ground, or a sudden check in the gallop. Young horses are particularly liable to it, and horses that are *cow-hocked*—whose hocks and legs resemble those of the cow, the hocks being turned inward, and the legs forming a considerable angle outwards. This is intelligible enough; for in hocks so formed, the annular ligament must be continually on the stretch, in order to confine the tendon.

Curbs are generally accompanied by considerable lameness at their first appearance, but the swelling is not always great. They are best detected by observing the leg sideway.

The first object in attempting the cure is to abate inflammation, and this will be most readily accomplished by cold evaporating lotions frequently applied to the part. Equal portions of spirit of wine, water, and vinegar, will afford an excellent application. It will be almost impossible to keep a bandage on. If the heat and lameness are considerable, it will be prudent to give a dose of physic; and whether the injury is of the annular ligament, or the sheath of the tendon, more active means will be necessary to perfect the cure.

The heels of the shoe should for a time be raised; by this means part of the stress on these parts will be removed. Either a liquid blister should be rubbed on the part, consisting of vinegar of cantharides, and this daily applied until some considerable swelling takes place; or, what is the preferable plan, the hair should be cut off, and the part blistered with biniodide of mercury as soon as the heat has been subdued. The blister should be repeated until the swelling has disappeared, and the horse goes sound. In severe cases it will be necessary to fire; but although a fair trial should be given to milder measures, this will generally effect the most permanent cure.

There are few lamenesses in which absolute and long-continued rest is more requisite. It leaves the parts materially weakened, and if the horse is soon put to work again, the lameness will frequently return. No horse that has had curbs should be put even to ordinary work in less than a month after the apparent cure, and, even then, he should very gradually resume his former habits.

A horse with a curb is manifestly unsound. A horse with the vestige of curb should be regarded with much suspicion, or generally condemned as unsound. Some judgment, however, is required to authorise a decided opinion, for hocks, in every other respect unexceptionable, will occasionally be disfigured by slight curbs, and yet they are equal to their work and the horse remains sound for life; but where the hocks are not otherwise well formed, the case is very different—when they are round, fleshy, full, and curved, instead of straight, clean, and thin, when, in short, they present that imperfect development which every horseman recognises by

the term 'curby,' they tend more to render a horse worthless than almost any other defect to which he is liable.

Curb is also an hereditary complaint, and therefore a horse that has once suffered from it should always be regarded with suspicion, especially if either of the parents has exhibited it.

#### BOG SPAVIN.

The hock is plentifully furnished with reservoirs of synovia to lubricate the different portions of this complicated joint. Some of these are found on the inside of the joint. From over-exertion of the joint they become inflamed, and considerably enlarged. They are wind-galls of the hock. The femoral vein passes over the inside of the hock, over some of these enlarged synovial reservoirs, and is compressed between them and the external integument—the course of the blood is partially arrested, and a portion of the vein below the impediment, and between it and the next valve, is distended, and causes the soft tumour on the inside of the hock, called *Blood Spavin*.

Bog spavin is a very troublesome disease, attended with no great, but often permanent lameness, and too apt to return when the enlargement has subsided under medical treatment. It must be considered as decided unsoundness. In a horse for slow draught it is scarcely worth while even to attack it. And in one destined to more rapid action, the probability of a relapse should not be forgotten, when the chances of success and the expenses of treatment are calculated.

The cause of the disease—the enlarged synovial capsule—lies deep, and is with difficulty operated upon. Uniform pressure would sometimes cause the absorption of the fluid contained in cysts or bags like these, but in a joint of such extensive motion as the hock, it is difficult, or almost impossible, to confine the pressure on the precise spot at which it is required. Could it be made to bear on the enlarged bag, it would likewise press on the vein, and to a greater degree hinder the passage of the blood, and increase the dilatation below the obstruction. The old and absurd method of passing a ligature above and below the enlarged portion of the vein, and then dissecting it out, is not in the advanced stage of veterinary science practised by any surgeon who regards his reputation; it being merely the consequence, not the cause, of the disease. The only method of relief which holds out any promise even of temporary success, is exciting considerable inflammation on the skin, and thus rousing the deeper-seated absorbents to carry away the fluid effused in the enlarged bag. For this purpose, blisters or firing may be tried; but in the majority of cases the disease will bid defiance to all appliances, or will return and baffle our hopes when we had seemed to be accomplishing our object.

A horse with bog spavin will do for ordinary work. He may draw in a cart, or trot fairly in a lighter carriage, with little detriment to his utility; but he will never do for hard or rapid work.

#### BONE SPAVIN.

A still more formidable disease ranks under the name of *Spavin*, and is an affection of the bones of the hock-joint. It has been stated that the bones of the leg, the shank-bone, *g*, page 385, and the two small splint-bones behind, *h*, support the lower layer of the bones of the hock. The cube-bone, *d*, rests principally on the shank-bone, and in a slight degree on the outer splint-bone. The middle wedge-bone, *f*, rests entirely upon the shank-bone, and the smaller wedge-bone (not seen in the cut) presses



in a very slight degree on the shank-bone, but principally or almost entirely on the inner splint-bone. Then the splint-bones sustain a very unequal degree of concussion and weight. Not only is the inner one placed more under the body and nearer the centre of gravity, but it has almost the whole of the weight and concussion communicated to the smaller cuneiform bone carried on to it. It is not, therefore, to be wondered at, that in the violent action of this joint in galloping, leaping, heavy draught, and especially in young horses, and before the limbs have become properly knit, the inner splint-bone or its ligaments, or the substance which connects it with the shank-bone, should suffer material injury.

The smith increases the tendency to this by his injudicious management of the feet. It is a common notion that cutting, and wounds in the feet—from one foot treading on the other—are prevented by putting on a shoe with a *calkin* on the outer heel, that is, the extremity of the heel being considerably raised from the ground. It is not unusual to see whole teams of horses with the outer heel of the hind foot considerably raised above the other. This unequal bearing, or distribution of the weight, cannot fail of being injurious. It places an unequal strain on the ligaments of the joints, and particularly of the hock-joint, and increases the tendency to spavin. It, should, therefore, be considered as an axiom, that whenever it is necessary, in order to give the animal a firmer hold or footing—to turn up or caulk the outside heel of the shoe, the inside should invariably be thickened to an equal extent.

The weight and concussion thus thrown on the inner splint-bone produce inflammation of the cartilaginous substance that unites it to the shank-bone. In consequence of it, the cartilage is absorbed, and bone deposited; the union between the splint-bone and the shank becomes bony, instead of cartilaginous; the degree of elastic action between them is destroyed, and there is formed a splint of the hind leg. This is uniformly on the inside of the hind leg, because the greatest weight and concussion are thrown on the inner splint-bones. As in the fore leg, the disposition to form bony matter having commenced, and the cause which produced it continuing to act, bone continues to be deposited, and it generally appears in the form of a tumour, where the head of the splint-bone is united with the shank, and in the front of that union. This is called *Bone Spavin*. Inflammation of the ligaments of any of the small bones of the hock, proceeding to bony tumour, would equally class under the name of spavin; but, commonly, the disease commences on the precise spot that has been described.

Spavins, especially when the result of hereditary predisposition, will sometimes be found of considerable size without either pain or lameness being present during their formation. But when the result of inflammatory action caused by concussion or other injury, lameness will nearly always be present. When the membrane of the bone has accommodated itself to the tumour that extended it, the lameness subsides or disappears, or depends upon the degree in which the bony deposit interferes with the motion of the joint. It is well known to horsemen, that many a hunter, with spavin that would cause his rejection by a veterinary surgeon, stands his work without lameness. The explanation is this; there is no reason why an old bony tumour on the outside of any of the bones of the hock, free from connection with the next bone, and from any tendon, should be at all injurious; as, for instance, one immediately under *e* or *f*, p. 385, but from the complicated nature of the hock, it is difficult, if not impossible, to be quite sure of the place or extent, from inspection of the tumour; and, besides, the disposition to throw out bone beneath the tumour may

continue and extend to the joint. The surgeon, therefore, cannot be perfectly safe in pronouncing a bone spavin to be of no consequence. Horses with exceedingly large spavins are often seen that are only slightly lame, or that merely have a stiffness in their gait at first starting, but which gradually goes off after a little motion; while others, with the bony tumour comparatively small, have the lameness so great as to destroy the usefulness of the horse. There is always this peculiarity in the lameness of spavin, that it abates, and sometimes disappears, on exercise: and therefore, a horse with regard to which there is any suspicion of this affection should be examined when first in the morning it is taken from the stable.

If the spavin continues to increase, the bony deposit first spreads over the lower wedge-bones, *f*, page 385, for these are nearest to its original seat. They are capable of slight motion, and share in every action of the joint, but their principal design is to obviate concussion. The chief motion of the joint, and that compared with which the motion of the other bones is scarcely to be regarded, is confined to the tibia, *a*, and the astragalus, *b*, and therefore stiffness rather than lameness may accompany spavin, even when it is beginning to affect the small bones of the joint. Hence too is the advantage of these bones having each its separate ligaments and membranes, and constituting so many distinct joints, since injury may happen to some of them, without the effect being propagated to the rest. When the bony deposit continues to enlarge, and takes in the second layer of bones—the larger wedge-bones, *c*—and even spreads to the cuboid bones on the other side, the lameness may not be very great, because these are joints, or parts of the joints, in which the motion is small; but when it extends to the union of the tibia, *a*, and the astragalus, *b*—when the joint, in which is the chief motion of the hock, is attacked—the lameness is indeed formidable, and the horse becomes nearly or quite useless.

Young horses are more subject to spavin than old ones, and although the chief active agent in their production may be traced to concussion or sprain, there cannot be a doubt but that in many instances, like curb, there is an hereditary predisposition inherited from the parents of the animal, which requires but some very slight cause to hasten its formation. We cannot too clearly impress upon all breeders of horses the great importance of giving attention to this well-established fact; and inducing them to select only those animals to breed from that are free from those diseases, such as spavin, ringbone, curb, roaring, &c. &c., which will assuredly sooner or later develop themselves in their produce.

The symptoms by which we may detect spavin in its early stages, when no bony enlargement can be felt, are somewhat obscure. There are, however, some peculiarities in the action of the animal that will assist us. When first brought out he goes stiffly and does not flex the limb properly, only getting his toe to the ground, which will be more evident when turning a corner; after a little exercise the stiffness will generally disappear. If, however, ulcerative disease be going on, the lameness will increase with motion. The horse frequently rests the affected limb in the stable, and when made to move from one side to the other will generally give evidence of lameness. The history of the case, and absence of any other source of lameness, will also materially assist in pointing out the seat of disease.

Spavined horses are generally capable of slow work. They are equal to the greater part of the work of the farm, and therefore they should not be always rejected by the small farmer, as they may generally be procured at little price. These horses are not only capable of agricultural

work, but they generally improve under it. The lameness in some degree abates, and even the bony tumour to a certain degree diminishes. There is sufficient moderate motion and friction of the limb to rouse the absorbents to action, and cause them to take up a portion of the bony matter thrown out, but not enough to renew or prolong inflammation. It cannot be said that the plough affords a *cure* for spavin, but the spavined horse often materially improves while working at it.

For fast work, and for work that must be regularly performed, spavined horses are not well calculated; for this lameness behind produces great difficulty in rising, and the consciousness that he will not be able to rise without painful effort occasionally prevents the horse from lying down at all; and the animal that cannot rest well cannot long travel far or fast.

The treatment of spavin is simple enough, but far from being always effectual. The owner of the horse will neither consult his own interest, nor the dictates of humanity, if he suffers the chisel and mallet, or the gimlet, or arsenic, to be used.

When acute inflammation is present we must endeavour to abate it by antiphlogistic measures. The animal should be kept at rest, a high-heeled shoe placed on the foot, and the hock frequently fomented with warm water. A dose of physic should be given, and the animal kept on soft diet. In extreme cases, blood may be abstracted from the femoral vein. When the acute inflammation has subsided, or when we meet with it in a chronic form, measures of considerable severity must be resorted to. Repeated blisters will usually cause either the absorption of the bony deposit, or the abatement or removal of the inflammation of the ligaments. Setons also are at present a very favourite remedy: two of them inserted perpendicularly the whole depth of the joint, and their action kept up for three weeks or a month, often prove efficacious; or, as a last resource, the heated iron must be applied.

The account of the diseases of the hock is not yet completed. It is well known that the horse is frequently subject to lameness behind, when no ostensible cause for it can be found, and there is no external heat or enlargement to indicate its seat. Farriers and grooms pronounce these to be affections of the stifle, or round bone; or, if the gait of the horse and peculiar stiffness of motion point out the hock as the affected part, yet the joint may be of its natural size, and neither heat nor tenderness can be discovered, the groom has his own method of unravelling the mystery. He says that it is the beginning of spavin; but months and years pass away, and the spavin does not appear, and the horse is at length destroyed as incurably lame.

Horsemen are indebted to Mr. W. J. Goodwin, late Veterinary Surgeon to Her Majesty, for the discovery of the seat of frequent lameness behind. The cut, p. 385, represents the two layers of small bones within the hock—the larger wedge-like bone, *e*, above; and the middle, *f*, and the smaller one below; and it will be seen that almost the whole of the weight of the horse, communicated by the tibia, *a*, is thrown upon these bones. The cube-bone, *d*, does little more than support the point of the os calcis, *c*. It is then easy to imagine that, in the concussion of hard work or rapid traveling, these bones, or the delicate and sensible membrane in which they are wrapped, may be severely injured. Repeated dissections of horses that have been incurably lame behind, without any external indication, during life, to point out the place or cause of lameness, have shown that inflammation of the membranes lining these joints, and secreting the fluid that lubricates them, has taken place.

Mr. Goodwin narrates a very interesting case in corroboration of this account of hock lameness. The author of this work had the honour of

being present when the examination took place. 'The patient was a harness horse of unusual perfection, both in shape and action, and was a great favourite with a late illustrious personage. He suddenly became lame behind on the off-leg, but without the least accident or alteration of structure to account for it. He was turned out for a short time, and the lameness disappeared. He was then incautiously made to perform his usual work, until perfectly incapacitated for it by returning and aggravated lameness. Suspecting the seat of lameness to be in the hock, although the joint was perfectly unaltered in form, he was, three months after the commencement of the lameness, blistered and fired, and placed either in a loose place or paddock, as circumstances seemed to require. Not the least amendment took place at the end of six months, even in his quiescent state, and, after twelve months from the time of his being given up for treatment, he was destroyed, his case being naturally considered a hopeless one. Ulceration of the synovial membrane was found, taking its origin between the two cuneiform bones. These bones had become carious, and the disease had gradually extended itself to other parts of the joint. Mr. Goodwin had no doubt that if the animal had been suffered to work on for any greater length of time, necrosis, or ankylosis of every bone concerned in the hock, would have been the result.' These opinions of the seat and nature of obscure hock-lameness are now maintained by the majority of veterinary surgeons, although some of them differ a little with regard to the articulation that is generally affected, and the manner in which the depressions or excavations on the surface of these bones is effected.

#### CAPPED HOCK.

The point of the hock is sometimes swelled. A soft fluctuating tumour appears on it.

It is seldom accompanied by lameness, and yet it is a somewhat serious business, for it is usually produced by blows, and mostly by the injuries which the horse inflicts upon himself in the act of kicking: therefore it is that a horse with a capped hock is very properly regarded with a suspicious eye. The whole of the hock should be carefully examined, in order to discover whether there are other marks of violence, and the previous history of the animal should be carefully enquired into. Does he kick in harness or in the stall, or has he been lying on a thin bed, or on no bed at all; and thus may the hock have been bruised, and the swelling produced?

It is exceedingly difficult to apply a bandage over a capped hock; and puncturing the tumour, or passing a seton through it, would be a most injudicious practice. Blisters, or iodine, repeated as often as may be necessary, are the best means to be employed. Occasionally the tumour will spontaneously disappear; but at other times it will attain a large size, or assume a callous structure, that will bid defiance to all the means that can be employed.

#### THE HIND LEG.

The line of direction of the legs beneath the hocks should not be disregarded. The leg should descend perpendicularly to the fetlock. The weight and stress will thus be equally diffused, not only over the whole of the hock, but also the pasterns and the foot. Some horses have their hocks closer than usual to each other. The legs take a divergent direction outward, and the toes also are turned outward. These horses are said to be *Cat* or *Cow-hocked*. They are generally supposed to possess considerable speed. Perhaps they do so; and it is thus accounted for. The cow-hocked

horse has his legs not only turned more outward, but bent more under him, and this increases the distance between the point of the hock and the tendons of the perforating muscle. It increases the space which is usually occupied by the thorough-pin. Then the point of the hock, moved by the action of the muscles, is enabled to describe a greater portion of a circle; and in proportion to the increased space passed over by the point of the hock, will the space traversed by the limb be increased, and so the stride of the horse may be lengthened, and, thus far, his speed may be increased. But this advantage is more than counterbalanced by many evils. This increased contraction of the muscles is an expenditure of animal power; and, as already stated, the weight and the concussion being so unequally distributed by this formation of the limbs, some part must be overstrained and over-worked, and injury must ensue. On this account it is that the cow-hocked horse is more subject than others to thorough-pin and spavin; and is so disposed to curbs, that these hocks are denominated by horsemen *curby* hocks. The mischief extends even farther than this. Such a horse is peculiarly liable to wind-gall, sprain of the fetlock, cutting, and knuckling.

A slight inclination to this form in a strong powerful horse may not be very objectionable, but a horse decidedly cow-hocked should never be selected.

#### SWELLED LEGS.

The fore legs, but oftener the hind ones, and especially in coarse horses, are sometimes subject to considerable enlargement. Occasionally, when the horse does not seem to labour under any other disease, and sometimes from an apparent shifting of disease from other parts, the hind legs suddenly swell to an enormous degree from the hock and almost from the stifle to the fetlock, attended by a greater or less degree of heat, and tenderness of the skin, and sometimes excessive and very peculiar lameness. The pulse likewise becomes quick and hard, and the horse evidently labours under considerable fever. It is acute inflammation of the cellular substance of the legs, and that most sudden in its attack, and most violent in its degree, and therefore attended by the effusion of a considerable quantity of fluid into the cellular membrane. It occurs in young horses, especially those used for agricultural purposes, and in those which are over-fed and little exercised. Fomentation, diuretics, or purgatives, or, if there is much fever, a moderate bleeding from the foot, will often relieve the distension almost as suddenly as it appeared.

The kind of swelled legs most frequently occurring and most troublesome is of a different nature, or rather it is most various in its kind and causes, and consequences and mode of treatment. Sometimes the legs are filled, but there is little lameness or inconvenience. At other times the limbs are considerably gorged, and with a great degree of stiffness and pain. Occasionally the horse is apparently well at night, but, on the following morning, one or both of the legs are tremendously swollen; and on its being touched, the horse catches it up suddenly, and nearly falls as he does so. In these cases, fomentations with flannels dipped and wrung out of hot water, for twenty minutes, or half an hour, will afford considerable relief, and after each fomentation some mild stimulating liniment, with the addition of a little tincture of opium, will prove beneficial. Many horses, in seemingly perfect health, if suffered to remain several days without exercise, will have swelled legs. If the case is neglected, abscesses appear in various parts of the legs; the heels are attacked by grease, and, if proper measures are not adopted, the horse has an enlarged leg for life.

The cure, when the case has not been too long neglected, is sufficiently plain. Physic or diuretics, or both, must be had recourse to. Mild cases will generally yield to their influence; but, if the animal has been neglected, the treatment must be decisive. If the horse is in high condition these should be preceded or accompanied by bleeding; but if there are any symptoms of debility, bleeding would only increase the want of tone in the vessels. Not unfrequently the cause of this complaint is a want of tone in the absorbents, their action is sluggish and inert, the quantity of fluid secreted is merely the usual one, but its removal is not in due proportion; in these cases, indicated by the absence of pain or tenderness, the combination of half a tonic and half a diuretic ball, given night and morning, will effect an equalised action of the exhalant and absorbent vessels. In all cases of enlarged leg, whether from undue action of the exhalant vessels or defective action of the absorbents, on examining the inside of the thigh, close up to the groin, the femoral vein will be found hard and distended, or the cluster of absorbent vessels around will be rigid and engorged; the one or the other evidently overloaded and unable freely to forward their contents. The application of a stimulus to this particular part will have a remarkably good effect. A teaspoonful of the tincture or infusion of cantharides, carefully and gradually rubbed over a space of two inches, will rouse the action of the vessels and give immediate relief.

Horses taken from grass and brought into close stables very speedily have swelled legs, because the difference of food and increase of nutriment rapidly increase the quantity of the circulating fluid, while the want of exercise takes away the means by which it might be got rid of. The remedy here is sufficiently plain. Swelled legs, however, may proceed from general debility. They may be the consequence of starvation, or disease that has considerably weakened the animal; and these parts, being farthest from the centre of circulation, are the first to show the loss of power by the accumulation of fluid in them. Here the means of cure would be to increase the general strength, with which the extremities would sympathise. Mild diuretics and tonics would therefore be evidently indicated.

Horses in the spring and fall are subject to swelled legs. The powers of the constitution are principally employed in providing a new coat for the animal, and the extremities have not their share of vital influence. Mingled cordials and diuretics are indicated here—the diuretic to lessen the quantity of the circulating fluid, and the cordial to invigorate the frame.

Swelled legs are often teasing, in horses that are in tolerable or good health: but where the work is somewhat irregular the cure consists in giving more equable exercise, walking the horse out daily when the usual work is not required, and using plenty of friction in the form of hand-rubbing. Bandages have a greater and more durable effect, for nothing tends more to support the capillary vessels, and rouse the action of the absorbents, than moderate pressure. Haybands will form a good bandage for the agricultural horse, and their effect will probably be increased by previously dipping them in water. A loose box is an invaluable adjunct in the treatment of these cases.

## CHAPTER XVIII.

## THE FOOT.

A The external crust seen at the quarter.

B The coronary ring.

c The little-horny plates lining the crust.

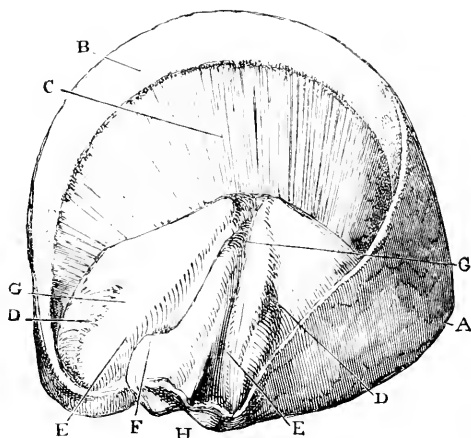
D The same continued over the bars.

E E The two concave surfaces of the inside of the horny frog.

F That which externally is the cleft of the frog.

G The bars.

H The rounded part of the heels, belonging to the frog.



This smaller cut exhibits, in as satisfactory a manner, the mechanism and structure of the base of the foot.

- a a The frog.  
 b The sole.  
 c c The bars.  
 d d The crust.



The foot is composed of the horny box that covers the extremities of the horse, and the contents of that box. The hoof or box is composed of the crust or wall, the coronary ring and band, the bars, the horny laminae, the sole, and the horny frog.

## THE CRUST OR WALL OF THE HOOF.

The *crust* or *wall* is that portion which is seen when the foot is placed on the ground, and reaches from the termination of the hair to the ground. It is deepest in front, where it is called the toe, measuring there about three inches and a half in depth, shallower at the sides, which are denominated the quarters, and of least extent behind, where it is seldom more than an inch and a half in height, and is termed the heel. The crust in the healthy foot presents a flat and narrow surface to the ground, ascending obliquely backwards, and possessing different degrees of obliquity in different horses. In a sound hoof the proper degree of obliquity is calculated at forty-five degrees, or the fourth part of a semicircle, at the front of the foot. When the obliquity is greater than this, it indicates undue flatness of the sole, and the crust is said to have 'fallen in.' If the obliquity is very much increased the sole projects, and is said to be puniced or convex.

If the foot is more upright, or forms a greater angle than forty-five degrees, it indicates much contraction, and a sole too concave; and this

difference of obliquity is often so great, that the convexity or concavity of the sole may be affirmed without the trouble of raising the foot for the purpose of examination.

It is of some importance to observe whether the depth of the crust appears rapidly or slowly to decrease from the front to the heel. If the decrease is little, and even at the heel the crust is high and deep, this indicates a foot liable to contraction, sand-crack, thrush, and inflammation. The pasterns are upright, the paces of that horse are not pleasant. On the other hand, if the crust rapidly diminishes in depth, and the heels are low, this is accompanied by too great slanting of the pastern, and disposition to sprain in the back sinew. The foot, generally, is liable to be weak and flat, and bruised, and there is more tendency to the frequent, but obscure lameness, of which there will presently be occasion to treat—the navicular-joint disease.

The crust is composed of numerous horny fibres, connected together by an elastic adhesive substance, and extending from the coronet to the base of the hoof. Perhaps as good an idea of its structure as can be obtained, is, supposing it to consist of a number of hairs or bristles connected together by a strong glue. It differs materially in its texture, its elasticity, its growth, and its occasional fragility, according to the state in which it is kept, and the circumstances that are acting upon it.

The exterior wall of the hoof should be smooth and level. Protuberances or rings round the crust indicate that the horse has had inflammation in the feet, and that to such a degree as to produce an unequal growth of horn, and probably to leave some injurious consequences in the internal part of the foot. If there is a depression or hollow in the front of the foot, it betrays a sinking of the coffin-bone, and a flat or pumiced sole. If there is a hollow at the quarters, it is the worst symptom of bad contraction.

The thickness of the crust, in the front of the foot, is rather more than half an inch; it becomes gradually thinner towards the quarters and heels, but this often varies to a considerable extent. In some hoofs, it is not more than half the above thickness. If however there is not, in the majority of horses, more than half an inch for nail-hold at the toe, and not so much at the quarters, it will not appear surprising that these horses are occasionally wounded in shoeing, and especially as some of them are very unmanageable while undergoing this process.

While the crust becomes thinner towards both quarters, it is more so at the inner quarter than at the outer, because more weight is thrown upon it than upon the outer. It is more under the horse. It is under the inner splint-bone, on which so much more of the weight rests than on the outer; and, being thinner, it is able to expand more. Its elasticity is called more into play, and concussion and injury are avoided. When the expansion of the quarters is prevented by their being nailed to an unbending shoe, the inner quarter suffers most. Corns are oftenest found there; contraction begins there; sand-crack is seated there. Nature meant that this should be the most yielding part, in order to obviate concussion, because on it the weight is principally thrown, and therefore when its power of yielding is taken away it must be the first to suffer.

A careful observer will likewise perceive that the inner quarter is higher than the outer. While it is thin to yield to the shock, its increased surface gives it sufficient strength.

On account of its thinness, and the additional weight which it bears, the inner heel wears away quicker than the outer; a circumstance that should never be forgotten by the smith. His object is to give a plane and level bearing to the whole of the crust. To accomplish this, it will be



often scarcely necessary to remove anything from the inner heel, for this has already been done by the wear of the foot. If he forgets this, as he too often seems to do, and cuts away with his knife or his buttress an equal portion all round, he leaves the inner and weaker quarter lower than the outer; he throws an uneven bearing upon it; and produces corns and sand-cracks and splints, which a little care and common sense might have avoided.

### THE CORONARY RING.

The crust does not vary much in thickness (see *a*, page 395, and *b*, in the accompanying cut), until near the top, at the *coronet*, or union of the horn of the foot with the skin of the pasterns, where it rapidly gets thin. It is in a manner scooped and hollowed out. It likewise changes its colour and consistence, and seems almost like a continuation of the skin, but easily separable from it by maceration or disease. This thin part is called the *coronary ring*. It extends round the upper portion of the hoofs, and receives, within it, or covers, a thickened and bulbous prolongation of the skin, called the *coronary ligament* (see *b*, in the accompanying cut) This prolongation of the skin—it is nothing more—is thickly supplied with blood-vessels. It is almost a mesh of blood-vessels connected together by fibrous texture, and many of them are employed in secreting or forming the crust or wall of the foot. Nature has enabled the sensitive laminae of the coffin-bone, *c*, which will be presently described, to secrete a certain quantity of horn, in order to afford an immediate defence for itself when the crust is wounded or taken away. Of this there is proof when in sand-crack or quittor it is necessary to remove a portion of the crust. A pellicle of horn, or of firm hard substance resembling it, soon covers the wound; but the crust is principally formed from this coronary ligament. Hence it is, that in sand-crack, quittor, and other diseases in which strips of the crust are destroyed, it is so long in being renewed, or *growing down*. It must proceed from the coronary ligament, and so gradually creep down the foot with the natural growth or lengthening of the horn, of which, as in the human nail, a supply is slowly given to answer to the wear and tear of the part.

Below the coronary ligament is a thin strip of horny matter, which has been traced to the frog, and has been supposed by some to be connected with the support or action of that body, but which is evidently intended to add to the security of the part on which it is found, and to bind together those various substances which are collected at the coronet. It resembles, more than anything else, the strip of skin that surrounds the root of the human nail, and which is placed there to strengthen the union of the nail with the substance from which it proceeds.

### THE BARS.

At the back part of the foot the wall of the hoof, instead of continuing round and forming a circle, is suddenly bent in at each heel on itself as in the small cut, in page 395, where *d* represents the base of the crust, and *e* its inflection or bending at the heel. The bars are, in fact, a continuation of the crust, forming an acute angle, and meeting at a point at the toe of the frog—see *a*, *b*, and *c*, in the smaller cuts—and the inside of the bars, like the inside of the crust—see the first and larger cut—presents a continuance of the horny leaves, showing that it is a part of the same substance, and helping to discharge the same office.

It needs only the slightest consideration of the cut, or of the natural



hoof, to show the importance of the bars. The arch which these form on either side between the frog and the quarters, is admirably contrived both to admit of and to limit to its proper extent the expansion of the foot. When the foot is placed on the ground, and the weight of the animal is thrown on the leaves of which mention has just been made, these arches will shorten and widen, in order to admit of the expansion of the quarters—the bow returning to its natural curve, and powerfully assisting the foot in regaining its usual form. It can also be conceived that these bars must form a powerful protection against the contraction, or *wiring in*, of the quarters. A moment's inspection of the cut (see *g*, page 395) will show that, if the bars are taken away, there will be nothing to resist the contraction or falling in of the quarters when the foot is exposed to any disease or bad management that would induce it to contract. One moment's observation of them will also render evident the security which they afford to the frog (*f*), and the effectual protection which they give to the lateral portions of the foot.

Then appears the necessity of passing lightly over them, and leaving prominent, when the foot is pared for shoeing, that which so many smiths cut perfectly away. They imagine that it gives a more open appearance to the foot of the horse. Horses shod for the purpose of sale have usually the bars removed with this view; and the smiths in the neighbourhood of the metropolis and large towns, shoeing for dealers, too often habitually pursue, with regard to all their customers, the injurious practice of removing the bars. The horny frog, deprived of its guard, will speedily contract, and become elevated and thrushy; and the whole of the heel, having lost the power of resilience or reaction which the curve between the bar *c* and the crust *d* gave it (*vide* p. 395, cut), will speedily fall in.

#### THE HORNY LAMINÆ.

The inside of the crust is covered by thin horny leaves (*c*, p. 395), extending all round it, and reaching from the coronary ring to the toe. They are about 500 in number, broadest at their base, and terminating in the most delicate expansion of horn. They not a little resemble the inner surface of a mushroom. In front they run in a direction from the coronet to the toe, and towards the quarters they are more slanting from behind forwards. They correspond, as will be presently shown, with similar fleshy leaves on the surface of the coffin-bone, and form a beautiful elastic body, by which the whole weight of the horse is supported.

#### THE SOLE

Is under and occupies the greater portion of the concave and elastic surface of the foot (see *b*, p. 395), extending from the crust to the bars and frog. It is not so thick as the crust, because, notwithstanding its situation, it does not support any weight; and because it was intended to expand, in order to prevent concussion, when, by the descent of the bone of the foot, pressure was made on it. It is not so brittle as the crust, and it is more elastic. It does not consist of an equally dense fibrous tissue as the crust, but is developed in layers or scales, which freely exfoliate as they accumulate at the bottom of the foot. It is thickest at the toe, because the first and principal stress is thrown on that part. The coffin-bone is driven forward and downward in that direction. It is likewise thicker where it unites with the crust than it is towards the centre, for a similar and evident reason, because there the weight is first and principally thrown.

In a state of nature it is, to a certain degree, hollow. The reason of this is plain. It is intended to descend or yield with the weight of the

horse, and by that gradual descent or yielding most materially lessen the shock which would result from the sudden action of the weight of the animal in rapid and violent exercise; and this descent can only be given by a hollow sole. A flat sole, already pressing upon the ground, could not be brought lower; nor could the functions of the frog be then discharged; nor would the foot have so secure a hold. Then if the sole is naturally hollow—and hollow it should be because it must descend—the smith should not interfere with this important action. When the foot will bear it, he must pare out sufficient of the horn to preserve the proper concavity; also a small portion at the toe and near the crust, and cutting deeper towards the centre. He must put on a shoe which shall not prevent the descent of the sole, and which not only shall not press upon it, but shall leave sufficient room between it and the sole to admit of this descent. If the sole is pressed upon by the coffin-bone during the lengthening of the elastic lamina, and the shoe will not permit its descent, the sensitive part between the coffin-bone and the horn will necessarily be bruised, and inflammation and lameness will ensue. It is from this cause, that if a stone insinuates itself between the shoe and the sole, it produces so much lameness. Of the too great concavity of the sole, or the want of concavity in it, we shall treat when we arrive at diseases of the foot.

#### THE FROG.

In the space between the bars, and accurately filling it, is the frog. It is a triangular portion of horn, projecting from the sole, almost on a level with the crust, and covering and defending a soft and elastic substance called the *sensitive frog*. It is wide at the heels, and there extending beyond a portion of the crust; narrowing rapidly when it begins to be confined between the bars, and terminating in a point at somewhat more than half the distance from the heel to the toe. It consists of two rounded or projecting surfaces, with a fissure or cleft between them reaching half way down the frog, and the two portions again uniting to form the point or toe of the frog.

The frog is firmly united to the sole, but it is perfectly distinct from it. It is of a different nature, being softer, and far more elastic; and it is secreted from a different surface, for it is thrown out from the substance which it covers. It is very analogous in texture to a piece of india-rubber, being neither so fibrous as the crust, nor as scaly as the sole. It very much resembles a wedge with a sharp point forwards: and it is placed towards the back part of the foot. The foot is seldom put flush and flat upon the ground, but in a direction downwards, yet somewhat forwards; then the frog evidently gives safety to the tread of the animal, for it occasionally ploughs itself into the ground, and prevents the horse from slipping. This is of considerable consequence, when some of the paces of the horse are recollected, in which his heels evidently come first to the ground, and in which the danger from slipping would be very great. Reference needs only be made to the gallop as illustrative of this.

The frog being placed at, and filling, the hinder part of the foot, discharges a portion of the duty sustained by the crust; for it supports the weight of the animal. It assists, likewise, and that to a material degree, in the expansion of the foot. It is formed internally of two prominences on the sides (see *a*, p. 395), and a cleft in the centre, presenting two concavities with a sharp projection in the middle, and a gradually rounded one on each side. It is also composed of a substance peculiarly flexible and elastic. What can be so well adapted for the expansion of the foot when a portion of the weight of the body is thrown on it? How easily will these irregular surfaces yield and spread out, and how readily return

again to their natural state! In this view, therefore, the horny frog is a powerful agent in opening the foot; and the diminution of the substance of the frog, and its elevation above the ground, are both the cause and the consequence of contraction—the cause, as being able no longer powerfully to act in expanding the heels, and the consequence, as obeying a law of nature, by which that which no longer discharges its natural function is gradually removed. It is, however, the cover and defence of the internal and sensible frog, which will be presently treated of; enough, however, has been said to show the absurdity of the common practice of unsparingly cutting it away. In order to discharge, in any degree, some of the offices which we have assigned to it, and fully to discharge even one of them, it must come in occasional contact with the ground. In the unshod horse it is generally so; but the additional support given by the shoes, and more especially the hard roads over which the horse is now compelled to travel, render this complete exposure of the frog to the ground not only unnecessary, but injurious. Being of so much softer consistence than the rest of the foot, it would be speedily worn away; occasional pressure, however, or contact with the ground, it must have.

The rough and detached parts should be cut off at each shoeing, and the substance of the frog itself, so as to bring it just above or within the level of the shoe. It will then, in the descent of the sole, when the weight of the horse is thrown upon it in the putting down of the foot, descend likewise, and pressing upon the ground, do its duty; while it will be defended from the wear, and bruise, and injury that it would receive if it came upon the ground with the first and full shock of the weight. This will be the proper guide to the smith in shoeing, and to the proprietor in the direction which he gives. The latter should often look to this, for it is a point of very great moment. A few smiths carry the notion of *frog pressure* to an absurd extent, and leave the frog beyond the level of the sole—a practice which is dangerous in the horse of slow draught, and destructive to the hackney or the hunter; but the majority of them err in a contrary way, and, cutting off too much of the frog, lift it above the ground, and destroy its principal use. It should be left *just above, or within the level of the shoe*.

#### THE COFFIN-BONE.

The interior part of the foot must now be considered. The lower pastern, a small portion of which is contained in the horny box, has been already described, p. 378; beneath it, and altogether enclosed in the hoof, is the coffin-bone, or proper bone of the foot. It is fitted to, and fills the forepart of the hoof, occupying about half of it. It is of a light and spongy structure, (see *d*, fig. 1, page 378), and filled with numerous minute foramina or holes. Through these pass the blood-vessels and nerves of the foot, which are necessarily numerous, considering the important and various secretions there carrying on, and the circulation through the foot which could not possibly be kept up if these vessels did not run through the substance of the bone. Considering the manner in which this bone is enclosed in the horny box, and yet the important surfaces around and below it that are to be nourished with blood, the circulation which is thus carried on within the very body of the bone is one of the most beautiful provisions of nature that is to be found in the whole frame. No inconvenience can arise from occasional or constant pressure, but the bone allows free passage to the blood, and protects it from every possible obstruction.

The forepart of the coffin-bone is not only thus perforated, but it is curiously roughened for the attachment of the numerous minute laminae

about to be described. On its upper surface it presents a concavity for the head of the lower pastern. In front is a striking prominence, into which is inserted the extensor tendon of the foot. At the back it is sloped for articulation with the navicular bone, and more underneath is a depression for the reception of the perforans tendon, continued down the leg, passing over the navicular bone, and at length inserted into this bone. On either side are projections, called the wings, or heels of the coffin-bone, and at the bottom it is hollowed to answer to the convexity of the internal part of the sole.

That which deserves most attention in the coffin-bone is the production of the numerous laminae round its front and sides. They are prolongations of the thick and elastic membrane covering it, and consist of fleshy plates, proceeding from it, running down the coffin-bone, and corresponding with and received between the horny leaves that line the inside of the hoof—each horny plate being received between two sensitive plates, and *vice versa*. These laminae are exceedingly sensitive and vascular, and elastic, and, as first simply and beautifully explained by Mr. Percivall, their elasticity is not inherent in the laminae, but in the substance which connects these laminae with the coffin-bone, and which, while it contains highly elastic properties, affords a convenient bed for the numerous vessels that secrete the laminae. While the animal is at rest, the whole weight of the horse is supported by them, and not by the sole. This extraordinary fact has been put to the test of experiment. The sole, bars, and frog were removed from the foot of a horse, and yet as he stood, the coffin-bone did not protrude, or in the slightest degree descend; but when the rapidity with which the foot descends is added to the weight of the horse, these little leaves, horny and fleshy, gradually lengthen, and suffer the bones to press upon the sole. The sole then descends, and, in descending, expands; and so, by an admirable mechanism, the violent shock which would be produced by the pressure of such a weight as that of the horse, and the velocity with which it descends, is lessened or destroyed, and the complicated apparatus of the foot remains uninjured. When the foot is again lifted, and the weight which pressed upon it is removed, the principle of elasticity is called into exercise, and by it the sole resumes its concavity, and the horny frog its folded state;—the quarters return to their former situation,—the leaves regain their former length, and every thing is prepared for a repetition of action.

#### THE SENSITIVE SOLE.

Between the coffin-bone and the horny sole is situated the sensitive sole, formed above of a substance of a fibrous nature, and below of a cuticular or skin-like substance, plentifully supplied with blood-vessels. It was placed between the coffin-bone and the sole, by its yielding structure to assist in preventing concussion, and also to form a supply of horn for the sole. It extends beyond the coffin-bone, but not at all under the frog. Leaving a space for the frog, it proceeds over the bars, and there is covered by some laminae, to unite with those that have been described, page 397, as found in the bars. It is here likewise thicker, and more elastic, and by its elasticity is evidently assisting in obviating concussion. It is supplied with nervous fibres, and is highly sensitive, as the slightest experience in horses will evince. The lameness which ensues from the pressure of a stone or of the shoe on the sole is caused by inflammation of the sensitive sole.

## THE SENSITIVE FROG.

The coffin-bone does not occupy more than one half of the hoof. The posterior part is filled by a soft mass, which is fibrous and elastic in its nature. Its shape below corresponds with the cavities of the horny frog; in front it is attached to the inferior part of the coffin-bone; and farther back, it adheres to the lower part of the cartilages of the heels, where they begin to form the rounded protuberances that constitute the heel of the foot. It occupies the whole of the back part of the foot above the horny frog and between the cartilages. Running immediately above the frog, and along the greater part of it, we find the perforans flexor tendon, which passes over the navicular bone, and is inserted into the heel of the coffin-bone.

## THE NAVICULAR BONE

Is placed behind and beneath the lower pastern bone, and behind and above the heel of the coffin-bone, so that it forms a joint with both bones, and answers a very important office in strengthening the union between these parts, in receiving a portion of the weight which is thrown on the lower pastern, and in enabling the flexor tendon to act with more advantage. Supposing that this tendon were inserted into the coffin-bone without the intervention of the navicular bone, it would act at great mechanical disadvantage in bending the pastern, for it is inserted near the end of the coffin-bone, and the weight, concentrated about the middle of the bone, is far off, and requires a great power to raise it; but when the navicular bone is interposed, the centre of motion becomes the posterior edge of that bone, where it is in contact with the tendon, and then it will be seen that the distance of the power from the centre of motion is nearly or quite the same as the weight, and very great expenditure of muscular power will be saved. In the one case, the power must be at least double the weight, in the other they will be nearly equal; and also the angle at which the tendon is inserted is considerably more advantageous. Perhaps this is the principal use of the navicular bone; yet at the same time we are aware of the benefit which accrues from a portion of the weight being taken from the coffin-bone, and thrown on the navicular bone, and from it on the tendon, and the tendon resting on the elastic frog underneath. The navicular bone is sometimes, but inaccurately, said to descend with the motion of the foot. It does not do that. It cannot; for it is connected both with the pastern and coffin-bones by inelastic ligaments. When, however, the horny bulb, with its tuft of hair at the back of an oblique fetlock, descends in the rapid gallop, and almost touches the ground, the navicular bone, being as it were a part of the pastern, must descend with it. With this exception, both in the extending and the bending of the pastern, the navicular bone turns or rolls upon the other bones rather than descends or ascends, and with this remarkable advantage, that when the pastern is extended, the navicular bone is placed in that situation which enables the flexor tendon to act with greatest advantage in again bending the foot.

## THE CARTILAGES OF THE FOOT.

There is a groove extending along the upper part of the coffin-bone and on either side, except at the protuberance which receives the extensor tendon, occupied by cartilage, which, like the crust, is convex outwards and concave inwards. It extends to the very posterior part of the foot, rising about the quarters half an inch or more above the hoof, and dimi-

nishing in height forward and backward. These cartilages occupy a considerable portion of the foot, and extend behind the coffin-bone. They are held in their situation not merely by this groove, but by other connections with the coffin-bone, the navicular bone, and the flexor tendon, and are thus perfectly secured.

Between these cartilages is the sensitive frog, filling up the whole of the space, and answering several important purposes, being an elastic bed on which the navicular bone and the tendon can play with security, and without concussion or shock, by which all concussion communicated to the cartilages of the foot is destroyed—by which these cartilages are kept asunder, and the expansion of the upper part of the foot preserved. As the descent of the sole increases the width of the lower part of the foot, so the elevation of the frog, a portion of it being pressed upward and outward by the action of the navicular bone and tendon, causes the expansion of its upper part. Precisely as the strong muscle peculiar to quadrupeds at the back of the eye, being forcibly contracted, presses upon the fatty matter in which the eye is imbedded, which may be displaced but cannot be squeezed into less compass, and which, being forced towards the inner corner of the eye, drives before it that important and beautiful mechanism the haw, so the elastic and yielding substance the frog, being pressed upon by the navicular bone and the tendon, and the pastern, and refusing to be condensed into less compass, forces itself out on either side of them, and expands the lateral cartilages, which again, by their inherent elasticity, recur to their former situation, when the frog no longer presses them outward. It appears, that by a different mechanism, but both equally admirable, and referable to the same principle, viz. that of elasticity, the expansion of the upper and lower portions of the hoof is effected, the one by the descent of the sole, the other by the compression and rising of the frog.

It is this expansion upward which contributes principally to the preservation of the usefulness of the horse, when our destructive methods of shoeing are so calculated to destroy the expansion beneath. In draught horses, inflammation is occasionally produced, which terminates in the cartilages being changed into bony matter.

---

## CHAPTER XIX.

### THE DISEASES OF THE FOOT.

OF these there is a long list. That will not be wondered at by those who have duly considered the complicated structure of the foot, the duty it has to perform, and the injuries to which it is exposed. It will be proper to commence with that which is the cause of many other diseases of the foot, and connected with almost all.

#### INFLAMMATION OF THE FOOT, OR ACUTE FOUNDER.

The sensitive laminae, on the front and sides of the coffin-bone, being replete with blood-vessels, are, like every other vascular part, liable to inflammation. Laminitis, or inflammation of the laminae of the feet, is most prevalent amongst the heavier breeds of horses, especially when the feet are flat and weak. It may be produced by several causes, but we most often meet with it as a result of rapid and long-continued exertion on hard ground. When we reflect how the feet have been battered and bruised

in a hard day's journey, it will be no wonder that inflammation of the overworked parts should sometimes ensue. It may also be caused by keeping the animal in a fixed standing position for a length of time; by these means the laminae are kept constantly on the stretch; hence its frequency amongst horses as the result of a prolonged voyage on board a ship.

Sometimes there is a sudden metastasis—change of inflammation from one organ to another. A horse may have laboured for several days under evident inflammation of the lungs or pleura; all at once that will subside, and the disease will appear in the feet, or inflammation of the feet may follow in cases also of superpurgation or excessive purging, whether from physic or irritation of the mucous membrane of the bowels. To this latter cause may perhaps be attributed the inflammation of the feet, which frequently follows when animals have been allowed new corn, especially wheat.

To the attentive observer the symptoms are clearly marked, and yet there is no disease so often overlooked by the groom and the carter, and even by the veterinary surgeon. The disease may assume an acute or a chronic form. The earliest symptoms of fever in the feet are fidgetiness, frequent shifting of the fore-legs, but no pawing, much less any attempts to reach the belly with the hind-feet. If only the fore-feet be affected, he will throw them very forward, and rest on the heels. If it attack all the feet, the hind-legs will be placed under the belly and the fore-feet considerably advanced. The pulse is quickened, the flanks heaving, the nostrils red, the body covered with perspiration, and the horse, by his anxious countenance, indicating great pain. Presently he looks about his litter, as if preparing to lie down, but he does not do so immediately; he continues to shift his weight from foot to foot; he is afraid to draw his feet sufficiently under him for the purpose of lying down; but at length he drops. The circumstance of his lying down at an early period of the disease will sufficiently distinguish inflammation of the feet from that of the lungs, in which the horse obstinately persists in standing until he drops from mere exhaustion; but the distinction is by no means so clear when, as frequently happens, he obstinately stands until he drops. The same fixedness of limb, the same disinclination to move, as is perceptible in severe cases of inflammation of the lungs, will be found to exist occasionally in this disease, and it is the fact of the attention not having been attracted to the feet, that has led to the fallacious opinion, that the disease has dropped from the lungs to the feet, when in fact it has been in the feet from the very commencement—the hurried and laboured respiration being sympathetic with and dependent on the pain in the feet, not on inflammation of the lungs themselves. His quietness when down will distinguish it from colic or inflammation of the bowels, in both of which the horse is up and down, and frequently rolling and kicking when down. When the grievance is in the feet, the horse experiences so much relief, from getting rid of the weight painfully distending the inflamed and highly sensitive laminae, that he is glad to lie as long as he can.

If the feet are now examined, they will be found evidently hot. The patient will express pain if they are slightly rapped with a hammer, and the artery at the pastern will throb violently. No great time will now pass, if the disease is suffered to pursue its course, before he will be perfectly unable to rise; or, if he is forced to get up, and one foot is lifted, he will stand with difficulty on the other, or perhaps drop at once from intensity of pain.

The treatment will resemble that of other inflammations, with such differences as the situation of the disease may suggest. Bleeding is in-



dispensable ; and that to its fullest extent. If the disease is confined to the fore-feet, blood should be freely abstracted from the brachial veins, but if all the feet be implicated, six or eight quarts of blood should be taken as soon as possible from the jugular vein. The shoes should be at once removed, and poultices of linseed meal or bran, made very soft with warm water, should cover the whole of the foot and pastern, and be frequently renewed, which will promote evaporation from the neighbouring parts, and possibly through the pores of the hoof, and, by softening and rendering supple the hoof, will relieve its painful pressure on the swelled and tender parts beneath. There used to be occasional doubt as to the administration of physic, from fear of metastasis of inflammation, but the fear is groundless ; a full dose of physic may be given immediately after the bleeding.

The horse should be kept on mash diet, unless green meat can be procured for him ; and even that should not be given too liberally, nor should he, in the slightest degree, be coaxed to eat. When he appears to be recovering, his getting on his feet should not be hurried. It should be left perfectly to his own discretion ; nor should even walking exercise be permitted until he stands firm on his feet. When that is the case, a blister should be applied to the coronets, and when the season will permit, two months' run at grass will be very serviceable.

It is not always, however, or often, that inflammation of the feet is thus easily subdued ; and, if it is subdued, it sometimes leaves after it some fearful consequences. The loss of the hoof is not an unfrequent one. About six or seven days from the first attack, a slight separation will begin to appear between the coronet and the hoof. This should be carefully attended to, for the separated horn will never again unite with the parts beneath, but the disunion will extend, and the hoof will be lost. It is true that a new hoof will be formed, but it will be smaller in size and weaker than the first, and will rarely stand hard work. When this separation is observed, it will be a matter of calculation with the proprietor of the horse whether he will suffer the medical treatment to proceed.

In other cases, a separation will take place between the sensitive and horny laminae, by which the coffin-bone is let down, producing what is called pumiced feet.

#### CHRONIC LAMINITIS.

This is a milder form of the preceding disease. There is lameness, but it is not so severe as in the former case. The horse stands as usual. The crust is warm, and that warmth is constant, but it is not often probably greater than in a state of health. The surest symptom is the action of the animal. It is diametrically opposite to that in the navicular disease. The horse throws as much of his weight as he can on the posterior parts of his feet.

The treatment should be similar to that recommended for the acute disease—blood-letting, cataplasms, fomentations, and blisters, and the last much sooner and much more frequently than in the former disease.

#### PUMICED FEET.

The sensitive and horny laminae which were partially separated during the intensity of the inflammation of founder, will never perfectly unite again, or will have lost much of their elasticity, and the coffin-bone, no longer fully supported by them, presses upon the sole, and the sole becomes flattened, or convex, from this unnatural weight, and the horse acquires a PUMICED FOOT. This will also happen when the animal is used too soon after an attack of inflammation of the feet, and before the

laminae have regained sufficient strength to support the weight of the horse, or to contract again by their elastic power when they have yielded to the weight. When the coffin-bone is thus thrown on the sole, and renders it pumiced, the crust at the front of the hoof will '*fall in,*' leaving a kind of hollow about the middle of it.

Pumiced feet, especially in horses with large wide feet, are frequently produced without this acute inflammation. Undue work, and especially much battering of the feet on the pavement, will extend and sprain these laminae so much, that they will not have the power to contract, and thus the coffin-bone will be thrown backward on the sole. A very important law of nature will unfortunately soon be active here. When pressure is applied to any part, the absorbents become busy in removing it; so, when the coffin-bone begins to press upon the sole, the sole becomes thin from the increased wear and tear to which it is subjected by contact with the ground, and also because these absorbents are rapidly taking it away.

This is one of the diseases of the feet for which there is no cure, and used to be the common result of fever in the feet; it is therefore a point of primary importance, to have all the available remedies applied before this irremediable mischief occurs, for then the result is inevitable. No skill is competent to effect a reunion between the separated sensitive and horny laminae, or to restore to them the strength and elasticity of which they have been deprived, or to take up that hard horny substance which speedily fills the space between the crust and the receding coffin-bone. Some efforts have been made to palliate the disease, but they have been only to a slight degree successful. If horses, on the first appearance of flat feet, were turned out in a dry place, or put into a box for two or three months, sufficient stress would not be thrown on the laminae to increase the evil, and time might be given for the growth of horn enough in the sole to support the coffin-bone; yet it is much to be doubted whether these horses would ever be useful, even for ordinary purposes. The slowest work required of them would drive the coffin-bone on the sole, and the projection would gradually reappear, for no power and no length of time can again unite the separated leaves of the coffin-bone and the hoof. All that can be done in the way of palliation is by shoeing. Nothing must press on the projecting and pumiced part. If the projection is not considerable, a thick bar shoe is the best thing that can be applied; but should the sole have much descended, a shoe with a very wide web, bevelled off so as not to press on the part, may be used. These means of relief, however, are only temporary, the disease will proceed; and, at no great distance of time, the horse will be useless.

The occasional removal of the shoe, and compelling the horse to stand for a while on the crust and laminae, has been resorted to. The bar shoe and the leathern sole, and occasional dressing with tar ointment, have had their advocates, and it is sufficiently plain that the pumiced foot should have plenty of cover.

#### SEEDY TOE.

This consists in a separation between the fibres of the sensitive and horny laminae, producing a hollow space between them. The sensitive laminae, however, are not exposed, but covered by a plastic horny material. It is sometimes met with in both the fore and hind-feet, but more frequently in the former. It is a species of dry rot, and generally caused by some violence to the upper part of the hoof by which it is rendered unnaturally brittle. There is usually a bulging out of some part of the wall of the foot, which, on being rapped, sounds hollow, and on the shoe being removed and the part examined, a space of greater or less

extent will be found to exist between the hoof and internal structures of the foot, generally commencing at the toe and extending upwards. In its early stages, it is not generally attended with lameness, but as the disease progresses, we frequently get considerable pain and lameness. Our treatment, when the disease has not made much progress, should consist in cleaning out the hollow, and filling the space with pitch combined with tar, placing a leather sole on the foot, and taking care to avoid driving the nails near the diseased part. If the animal can be spared, a blister should be applied to the coronet. Should the disease have far advanced, and considerable lameness be present, the detached wall forming the boundary of the hollow, must all be cut away and tar dressing applied to the surface. A bar shoe should be placed on the foot, and the coronet well blistered. The animal should be thrown out of work, and the blister several times repeated. The object of the blister will be to stimulate the secretion of new horn, which, under any circumstances, will be found a very slow process.

#### CONTRACTION.

The cut, page 395, will give a fair idea of the young healthy foot, approaching nearly to a circle, and of which the quarters form the widest part, and the inner quarter (this is the near foot) rather wider than the outer. This shape is not long preserved in many horses, but the foot increases in length, and narrows in the quarters, and particularly at the heel, and the frog is diminished in width, and the sole becomes more concave, and the heels higher, and lameness, or at least a shortened and feeling action, ensues.

It must be premised that there is a great deal more horror of contracted heels than there is occasion for. Many persons reject a horse at once if the quarters are *wiring in*; but the fact is, that although this is an unnatural form of the hoof, it is slow of growth, and nature kindly makes that provision for the slowly altered form of the hoof which she does in similar cases—she accommodates the parts to the change of form. As the hoof draws in, the parts beneath, and particularly the coffin-bone, and especially the heels of that bone, diminish; or, after all, it is more a change of form than of capacity. As the foot lengthens in proportion as it narrows, so does the coffin-bone, and it is as perfectly adjusted as before to the box in which it is placed. Its laminae are in as intimate and perfect union with those of the crust as before the hoof had begun to change. On this account it is that many horses, with very contracted feet, are perfectly sound, and no horse should be rejected merely because he has contraction. He should undoubtedly be examined more carefully, and with considerable suspicion; but if he has good action, and is otherwise unexceptionable, there is no reason that the purchase should not be made. A horse with contracted feet, if he goes sound, is better than another with open but weak heels.

The opinion is perfectly erroneous that contraction is the necessary consequence of shoeing. There can be no doubt that an inflexible iron ring being nailed to the foot prevents, to a very considerable degree, the descent of the sole and the expansion of the heels below; and it is likewise probable, that when the expansion of the heels is prevented, they often begin to contract. But here again nature, cut off from one resource, finds others. If one of the jugular veins is lost, the blood pursues its course by other channels, and the horse does not appear to suffer in the slightest degree. Thus also if the expansion of the heels below is diminished, that of the cartilages above is made more use of. If the coffin-bone has not so much descent downward, it probably acquires one

backward, and the functions of the foot are usefully if not perfectly performed. The plain proof of this is, that although there are many horses that are injured or ruined by bad shoeing, there are others, and they are a numerous class, who suffer not at all from good shoeing, and scarcely even from bad. Except it be from accident, how seldom is the farmer's horse lame; and it might even be farther asked, how seldom is his foot much contracted? Some gentlemen who are careful of their horses have driven them twenty years, and principally over the rough pavements of towns, without a day's lameness. Shoeing may be a necessary evil, but it is not the evil which some speculative persons have supposed it to be; and the undoubted fact is, that when the horse is put to real hard work, and when the injury produced by shoeing in destroying the expansibility of the foot would most of all show itself, the foot lasts a great deal longer than the leg; nay, horsemen tell us that one pair of good feet is worth two pair of legs.

Having thus premised that contraction is not inevitably accompanied by lameness, and that shoeing, with all its evils, does not necessarily produce it, those cases of contraction, too numerous, which are the consequence of our stable management, and which do cripple and ruin the horse, may be considered. There is nothing in the appearance of the feet which would enable us to decide when contraction is or is not destructive to the usefulness of the animal; his manner of going, and his capability for work, must be our guides. Lameness sometimes accompanies the beginning of contraction; it is frequently attendant on rapid contraction, but it does not always exist when the *wiring in* is slow or of long standing.

A very excellent writer, particularly when treating of the foot of the horse, Mr. Blaine, has given us a long and correct list of the causes of injurious contraction, and most of them are, fortunately, under the control of the owner of the animal. He places at the head of them, *neglect of paring*. The hoof is continually growing, the crust is lengthening, and the sole is thickening. This is a provision for the wear and tear of the foot in an unshod state; but when it is protected by a shoe, and none of the horn can be worn away by coming in contact with the ground, and the growth of horn continues, the hoof grows high, and the sole gets thick, and, in consequence of this, the descent of the sole and the expansion of the heels are prevented, and contraction is the result. The smith might lessen, if not prevent the evil, by carefully thinning the sole and lowering the heels at each shoeing; but the first of these is a matter of considerable labour, and the second could not be done effectually without being accompanied by the first, and therefore they are both neglected. The prejudice of many owners of horses assists in increasing the evil; they imagine that a great deal of mischief is done by *cutting away the foot*. Mischief may be the result of injudicious cutting, when the bars are destroyed, and the frog is elevated from the ground; but more evil results from the unyielding thickness of the horn of the sole impairing the elastic and expansive principle of the foot. If gentlemen would occasionally stand by, and see that the sole is properly thinned, and the heels lowered, they would be amply repaid in the comfort and usefulness of the horse.

Ill-judged economy is another source of this disease. If the shoes of one smith will, with ordinary work, last a little more than three weeks, while another contrives to make his last six weeks, he is supposed to be the better workman and the more honest man, and he gets the greater part of the custom. His shoe is suffered to remain on during the whole time, to the manifest injury of the feet, and that injury is materially increased by the greater thickness and weight of these shoes, and the tightness with

which they are fastened on, the nails being necessarily placed nearer to the quarters, and possibly an additional nail or two used in the fastening, and these also applied at the quarters. There is no rule which admits of so little exception as that, once in about every three weeks, the growth of horn, which the natural wear of the foot cannot get rid of, should be pared away—the toe should be shortened in most feet—the sole should be thinned, and the heels lowered. Every one who has carefully observed the shape of the horse's foot, must have seen that in proportion to its height or neglected growth, it contracts and closes round the coronet. A low-heeled horse might have other serious defects, of which it will be our duty to speak, but he has seldom a contracted foot.

Another source of contraction is the want of natural moisture. The unshod colt has seldom contracted feet, nor does the horse at grass acquire them, because the hoof is kept cool and damp by occasional rain, and by the regular dew. It is thus rendered supple, and its elasticity is preserved, and the expansive power of the foot is uninjured. The hoof of the stabled horse sometimes has not one drop of moisture on it for several days. The effect of this, in the contraction of the horn, is sufficiently evident. Hence the propriety of stopping the feet where there is the least tendency to contraction. The intelligent and careful groom will not omit it a single night. Cow-dung, with a small portion of clay to give it consistence, is a common and very good stopping. A better one is cow-dung with a small proportion of tar mixed with it. A good one is a piece of thick felt cut to the shape of the sole and soaked in water. The common stopping of tar and grease is peculiarly applicable to the crust or wall, making it tough and elastic instead of being brittle and shelly.

The usual management of the farmer's horse that is often turned out after his daily task is exacted, or whose work is generally performed where the feet are exposed to moisture, is an excellent preventive against contraction.

Some persons have complained much of the influence of litter. If the horse stands many hours in the day with his feet imbedded in straw, it is supposed that the hoof must be unnaturally heated; and it is said that the horn will contract under the influence of heat. It is seldom, however, that the foot is so surrounded by the litter that its heat will be sufficiently increased to produce this effect. The question is not, however, whether the litter will heat the feet, but to what extent. From its being a bad conductor of heat, it is injurious; and from this cause it will be found that the heat of the feet, instead of being carried off as fast as it is generated, as it would be were it a good conductor, accumulates and produces mischievous results. There are thousands of horses that stand upon straw twenty hours out of the twenty-four, without receiving the slightest injury from it. The author of this work is not one of those who would, during the day, remove all litter from under the horse. It gives a naked and uncomfortable appearance to the stable. Humanity and a proper care of the foot of the horse should induce the owner to keep some litter under the animal during the day; but his feet need not sink so deeply in it that their temperature becomes much affected. If the straw is suffered to remain until it is wet, hot, and rotten, the effluvia proceeding from it may produce cough, or inflammation of the eyes, or thrushes in the feet; but a light bed of straw, with tolerable attention to cleanliness, can never do harm. 'There are horses,' says Professor Stewart, 'that, in the habit of pawing and stamping, slip about and sometimes lame themselves on the bare stones; many disposed to lie down during the day will not, or ought not, to do it, with a slight portion of litter under them. It is a frequent observation without regard to road horses, and many others, that the more a horse

lies the better he works. Lamé or tender-footed horses cannot lie too much, and a great deal of standing ruins the best legs and feet. Some horses, indeed, do not need this day-bedding, but many are the better for it, and none are the worse.'

Thrushes are much oftener the consequence than the cause of contraction. The horny frog, yielding to the pressure of the contracted quarters, is diminished in size, and the lower portion of the fleshy frog becomes imprisoned, irritated, and inflamed, and pus or matter is discharged at the cleft; yet there are many heels in the last stage of contraction that are not thrushy. On the other hand, thrush never long existed, accompanied by much discharge, without producing a disposition to contraction; therefore, thrush may be considered as both the cause and consequence of contraction.

The removal of the bars takes away a main impediment to contraction. Their use in assisting the expansion of the foot has been already stated, and should a disposition to contraction be produced by any other cause, the cutting away of the bars would hasten and aggravate the evil; but the loss of the bar would not of itself produce contraction.

The contraction, however, that is connected with permanent lameness, although increased by the circumstances which we have mentioned, usually derives its origin from a different source, and from one that acts violently and suddenly. Inflammation of the little plates covering the coffin-bone is a frequent cause; and a degree of inflammation not sufficiently intense to be characterised as acute founder, but quickly leading to sad results, may and does spring from causes almost unsuspected. There is one fact to which we have alluded, and that cannot be doubted, that contraction is exceedingly rare in the agricultural horse, but frequently occurs in the stable of the gentleman and the coach-proprietor. It is rare where the horse is seemingly neglected and badly shod; and frequent where every care is taken of the animal, and the shoes are unexceptionable and skilfully applied. Something may depend upon the breed. Blood horses are particularly liable to contraction. Not only is the foot naturally small, but it is disposed to become narrower at the heels. On the other hand, the broad, flat foot of the cart-horse is subject to diseases enough, but contraction is seldom one of the number.

Whatever is the cause of that rapid contraction or narrowing of the heels which is accompanied by severe lameness, the symptoms may be easily distinguished. While standing in the stable, the horse will point with, or place forward, the contracted foot, or, if both feet are affected, he will alternately place one before the other. When he is taken out of the stable, he will not, perhaps, exhibit the decided lameness which characterises sprain of the flexor tendon, or some diseases of the foot; but his step will be peculiarly short and quick, and the feet will be placed gently and tenderly on the ground, or scarcely lifted from it in the walk or the trot. It would seem as if the slightest irregularity of surface would throw the animal down, and so it threatens to do, for he is constantly tripping and stumbling. If the fore-feet are carefully observed, one or both of them will be narrowed across the quarters and towards the heels. In a few cases the whole of the foot appears to be contracted and shrunk; but in the majority of instances, while the heels are narrower, the foot is longer. The contraction appears sometimes in both heels; at other times in the inner heel only; or, if both are affected, the inner one is *wired* in the most, either from the coronet to the base of the foot, or only or principally at the coronet—oftener near the base of the foot—but in most cases the hollow being greatest about midway between the coronet and the bottom of the foot. This irregularity of contraction, and uncertainty as to the

place of it, prove that it is some internal disorganisation, the seat of which varies with the portion of the attachment between the hoof and the foot that was principally strained or injured. In every recent case the contracted part will be hotter than the rest of the foot, and the sole will, in the majority of cases, be unnaturally concave.

Of the treatment of contraction attended with lameness little can be said that will be satisfactory. Numberless have been the mechanical contrivances to oppose the progress of contraction, or to force back the foot to its original shape, and many of them have enjoyed considerable but short-lived reputation. A clip was placed at the inside of each heel, which, resting on the bars, was intended to afford an insurmountable obstacle to the farther wiring in of the foot, while the heels of the shoe were bevelled outward in order to give the foot a tendency to expand. The foot, however, continued to contract, until the clip was imbedded in the horn, and worse lameness was produced.

A shoe jointed at the toe, and with a screw adapted to the heels, was contrived, by which, when softened by poulticing, or immersion in warm water, the quarters were to be irresistibly widened. They were widened by the daily and cautious use of the screw until the foot seemed to assume its natural form, and the inventor began to exult in having discovered a cure for contraction: but no sooner was the common shoe again applied, and the horse had returned to his work, than the heels began to narrow, and the foot became as contracted as ever. Common sense would have foretold that such must have been the result of this expansive process; for the heels could have been only thus forced asunder at the expense of partial or total separation from the interior portions of the foot with which they were in contact.

The contracted heel can rarely or never permanently expand, for this plain reason, that although we may have power over the crust, we cannot renew the laminae, or restore the portion of the frog that has been absorbed.

If the action of the horse is not materially impaired, it is better to let the contraction alone, be it as great as it will. If the contraction has evidently produced considerable lameness, the owner of the horse will have to calculate between his value if cured, the expense of the cure, and the probability of failure.

The medical treatment should alone be undertaken by a skilful veterinary surgeon, and it will principally consist in abating any inflammation that may exist, by local bleeding and physic, paring the sole to the utmost extent that it will bear; rasping the quarters as deeply as can be, without their being too much weakened, or the coronary ring (see *b*, p. 395) injured; rasping deeply likewise at the toe, and perhaps scoring at the toe. The horse is afterwards made to stand during the day in wet clay, placed in one of the stalls. He is at night moved into another stall, and his feet bound up thickly in wet clothes; or he is turned out into wet pasturage, with tips, or, if possible, without them, and his feet are frequently pared out, and the quarters lightly rasped. In five or six months the horn will generally have grown down, when he may be taken up, and shod with shoes unattached by nails on the inner side of the foot, and put to gentle work. The foot will be found very considerably enlarged, and the owner will, perhaps, think that the cure is accomplished. The horse may, possibly, for a time stand very gentle work, and the inner side of the foot being left at liberty, its natural expansive process may be resumed: the internal part of the foot, however, has not been healthily filled up with the expansion of the crust. If that expansion has been effected forward on the quarters, the crust will no longer be in contact with the lengthened

and narrowed heels of the coffin-bone. There will not be the natural adhesion and strength, and a very slight cause, or even the very habit of contraction, will, in spite of all care and the freedom of the inner quarter, in very many instances cause the foot to wire in again as badly as before.

#### NAVICULAR DISEASE.

Many horses with well-formed and open feet become sadly and permanently lame, and veterinary surgeons have been puzzled to discover the cause. The farrier has had his convenient explanation, 'the shoulder;' but the scientific practitioner may not have been able to discover an ostensible cause of lameness in the whole limb. There are few accustomed to horses who do not recollect an instance of this.

Behind and beneath the lower pastern-bone, and behind and above the heel of the coffin-bone, is a small bone called the navicular or shuttle-bone. It is so placed as to strengthen the union between the lower pastern and the coffin-bone, and to enable the flexor tendon, which passes over it in order to be inserted into the bottom of the coffin-bone, to act with more advantage. It forms a kind of joint with that tendon. There is a great deal of weight thrown on the navicular bone, and from the navicular bone on the tendon; and there is a great deal of motion or play between them in the bending and extension of the pasterns.

Numerous dissections have shown that this joint, formed by the tendon and the bone, has been the frequent, and the almost invariable, seat of this obscure lameness. The membrane covering the cartilage of the bone has been found in an ulcerated state; the cartilage itself has been ulcerated and eaten away; the bone has become carious or decayed, this caries, or decay, however, does not occur in that surface of the bone forming a portion of the coffin-joint—but on that surface over which the flexor tendon passes, and as the disease progresses, the tendon itself becomes much attenuated. Navicular disease is seldom met with in young horses, or those employed for slow work, but generally amongst well-bred horses, with strong feet, used for fast purposes on hard ground.

Stable management has little to do with the production of this disease, any farther than if a horse stands idle in the stable several days, and the structure of the foot, and all the apparatus connected with motion, become unused to exertion, and indisposed for it, and he is then suddenly and violently exercised, these parts are very liable to be bruised and injured. This, amongst other evils, will be lessened by a loose box, in which a horse will always take some exercise.

Amongst the predisposing causes, none ought to be more thoroughly known than that navicular disease is hereditary in its nature, and there cannot be a surer method of propagating this destructive disease than breeding from parents afflicted with it. The exciting cause is usually violence applied to the part the result of concussion. By this means inflammation is set up in the tissue of the navicular bone, which leads to ulceration and destruction of a portion of the cartilage covering its surface. As a result of this, the flexor tendon will be in contact with an ulcerated rough surface, instead of the beautifully smooth and elastic one, when free from disease. The ulceration always takes place on the lower surface of the navicular bone, and usually first exhibits itself on the convexity in the centre of the bone. The disease is nearly always confined to the fore-feet, and is generally slow in its progress, although in some instances great concussion has caused rapid ulceration.

The symptoms by which this disease will be recognised are not very distinct, especially in the early stages. There is slight lameness at start-



ing, which will probably disappear after going a short distance, and there is also a peculiarity in the action of the animal, which to a great extent is characteristic of this disease. The horse 'goes upon his toes,' and brings the heel of the foot but slightly in contact with the ground. This will in some measure account for horses with navicular disease going lamer down hill, the weight being then thrown upon the heels, and stress principally placed on the affected parts. The very reverse of this will be observed in the action of horses suffering from laminitis. When placed in the stable after a journey, the animal will point his feet: if one foot only be affected, this will be placed at rest in advance of the other; if both feet, he will rest and advance them alternately. This is a marked symptom of navicular disease, and although it may be occasionally observed in other injuries to the posterior part of the foot, it should always be looked upon with considerable suspicion. In the majority of cases more or less contraction of the hoof will be present. There will be a wiring in at the quarters, and the heels will generally be found narrow and upright. Contraction is rarely a cause, but a frequent result, of navicular disease; and although in combination with other symptoms, it will materially assist us in pointing out the affection, it should be borne in mind that we sometimes get navicular lameness without any contraction, and on the other hand meet with one or both feet contracted without any lameness whatever.

The cure of navicular disease is difficult and uncertain. The first and all-important point is the removal of the inflammation. Local bleeding, poulticing, and physic will be our principal resources. If there is contraction, this must, if possible, be removed by the means already pointed out. If there is no contraction, it will nevertheless be prudent to get rid of all surrounding pressure, and to unfetter, as much as possible, the inside heel of the coffin-bone, by paring the sole and rasping the quarters, and using the shoe without nails on the inner quarter, and applying cold poultices to the coronet and the whole of the foot. This is a case, however, which must be turned over to the veterinary surgeon, for he alone, from his knowledge of the anatomy of the foot, and the precise seat of the disease, is competent to treat it. If attacked on its earliest appearance, and before ulceration of the bone has taken place, it may be radically cured: but ulceration will never be healed, and caries of the bone will for ever remain.

Blistering the coronet will often assist in promoting a cure by diverting the inflammation to another part, and it will materially quicken the growth of the horn. A seton passed through the frog by a skilful operator, and approaching as near as possible to the seat of disease, has been very serviceable.

As a last resource, if there is no great inflammation (and that would be readily detected by the heat of the foot), neurotomy may be practised with the hope of alleviating the sufferings of the animal, and thus removing a portion of the lameness; but if the lameness is extreme, either with or without contraction, and especially if there is heat about the foot, the operation is dangerous. There is, probably, ulceration—possibly, decay of the bone; and the additional friction to which the parts would be subjected, by the freer action of the horse, the sense of pain being removed, would cause that ulceration or decay to proceed more rapidly until the bone would be completely disorganised, or the tendon would be gradually worn through by rubbing against the roughened surface of the bone.

#### SAND-CRACK.

This, as its name imports, is a *crack* or division of the hoof from above downward, and into which *sand* and dirt are too apt to insinuate them-

selves. It is so called, because it most frequently occurs in sandy districts, the heat of the sand applied to the feet giving them a disposition to crack. It occurs both in the fore and the hind-feet. In the fore-feet it is usually found in the inner quarter, but occasionally in the outer quarter, because there is the principal stress or effort towards expansion of the foot, and the inner quarter is weaker than the outer. In the hind-feet the crack is almost invariably found in the front, because in the digging of the toe into the ground in the act of drawing, the principal stress is in the front.

This is a most serious defect. It indicates a brittleness of the crust, sometimes natural, but oftener the consequence of mismanagement or disease, which, in spite of every means adopted, will probably be the source of future annoyance. On a hoof that has once been thus divided no dependence can be placed, unless, by great care, the natural suppleness of the horn has been restored and is retained.

It is always necessary to examine the inner quarter of the foot at the time of purchase, for it has more than once occurred that, by low dealers, and particularly at fairs, a sand-crack has been neatly covered with pitch, and then, the whole of the hoof having been oiled, the injury was so adroitly concealed that an incautious person might be easily deceived.

The crack sometimes does not penetrate through the horn. It then causes no lameness; nevertheless, it must not be neglected. It shows that there is brittleness, which should induce the purchaser to pause; and, if proper means are not taken, it will generally soon penetrate to the quick. It should be pared or rasped fairly out; and if the paring or rasping has been deep, the foot should be strengthened by a coating of pitch or tar, with coarse tape bound over it, and a second coating of pitch covering this. Every crack should be pared or rasped to ascertain its depth. If it penetrates through the crust, even although no lameness exists, a firing-iron, red-hot, should be passed somewhat deeply above, in order to prevent its lengthening—the edges should be thinned to remove any painful or injurious pressure, and the foot should be bound up in the manner directed, care being taken that the shoe does not press upon the crust immediately under the sand-crack.

If the crack has penetrated through the crust, and lameness has ensued, the case is more serious. It must be carefully examined, in order to ascertain that no dirt or sand has got into it; the edges must be more considerably thinned, and if any fungus is beginning to protrude through the crack, and is imprisoned there, it must be destroyed by the application of nitric acid. This is preferable to the cantery, because the edges of the horn will not be thickened or roughened, and thus become a source of after-irritation. The iron may then be run deeply across, above the crack; a pledget of dry tow being placed in the crack, in and over it, and the whole bound down as tightly as possible. A blister applied to the coronet is an useful adjunct, relieving the pain by its counter-irritation, and stimulating the growth of new horn at the same time. On the third day the part should be examined, and the caustic again applied if necessary; but if the crack is dry and defended by a hard horny crust, the sooner the pitch plaster is put on the better.

The most serious case is, when, from *tread* or neglect, the coronet is divided. The growth of horn proceeds from the coronary ligament, and unless this ligament is sound, the horn will grow down disunited.

In this case, as in almost every one of sand-crack, the horse should be kept as quiet as possible. It is not in the power of the surgeon to effect a perfect cure if the owner will continue to use the animal. When the horn is divided at the coronet, it will be several months before it will grow fairly down, and not before that should the animal be used even for ordi-

nary work. When, however, the horn is grown an inch from the coronet, the horse may be turned out—the foot being well defended by the pitch plaster, and that renewed as often as it becomes loose—a bar-shoe being worn, chambered so as not to press upon the hoof immediately under the crack, to prevent which the crust should be also pared away in a small half-moon form, and that shoe being taken off, the sole pared out, and any bulbous projection of new horn being removed once in every three weeks.

To remedy the undue brittleness of the hoof, there is no better application than an ointment composed of one part of tar to two of lard, applied to the crust daily, the sole being covered at the same time with the common cow-dung or felt stopping.

#### TREAD AND OVER-REACH.

Under these terms are comprised bruises and wounds of the coronet, inflicted by the other feet.

A TREAD is said to have taken place when the inside of the coronet of one foot is struck by the calkin of the shoe of the other, and a bruised or contused wound is inflicted. The coronary ring is highly vascular externally, and within it is cartilaginous; the blow, therefore, often produces much pain and hæmorrhage, and contusion and destruction of the parts. The wound may appear to be simple, but it is often of a sadly complicated nature, and much time and care will need to be expended in repairing the mischief. Mr. Percivall, in his 'Hippopathology,' very accurately states that 'the wound has, in the first place, to cast off a slough, consisting of the bruised, separated, and deadened parts; then the chasm thereby exposed has to granulate; and, finally, the sore has to cicatrise and form new horn.'

A tread, or wound of the coronet, must never be neglected, lest gravel should insinuate itself into the wound, and form deep ulcerations, called *sinuses* or *pipes*, and which constitute *quittor*. Although some mildly stimulating escharotic may be occasionally required, the caustic, too frequently used by farriers, should in the early stage be carefully avoided, not only lest *quittor* should be formed, but lest the coronary ligament should be so injured as to be afterwards incapable of secreting perfect horn. When properly treated, a tread is seldom productive of much injury. If the dirt is well washed out of it, and a pledget of tow, dipped in Friar's balsam, bound over the wound, it will, in the majority of cases, speedily heal. Should the bruise be extensive or the wound deep, a poultice may be applied for one or two days, and then the Friar's balsam, or digestive ointment. Sometimes a soft tumour will form on the part, which will be quickly brought to suppuration by a poultice; and when the matter has run out, the ulcer will heal by the application of the Friar's balsam, or a weak solution of blue vitriol; but supposing that, instead of the wound healing readily, a foul unhealthy sinus should remain, pouring out a foul sanious discharge, then more active measures are imperatively demanded, and nothing short of an active caustic, to produce a thorough slough of the diseased surface, will effect a cure.

An OVER-REACH is a tread upon the heel of the coronet of the fore-foot by the shoe of the corresponding hind-foot, and either inflicted by the toe or by the inner edge of the inside of the shoe. The preventive treatment is the bevelling, or rounding off, of the inside edge or rim of the hind-shoes. The cure is the cutting away of the loose parts, the application of Friar's balsam, and protection from the dirt.

There is a singular species of over-reaching, termed FORGING or CLICKING.

This unpleasant noise arises from the toe of the hind-shoe knocking against the toe of the shoe of the fore-foot. In the trot, one fore-leg and the opposite hind leg are first lifted from the ground and moved forward, the other fore-leg and the opposite hind-leg remaining fixed; but, to keep the centre of gravity within the base, and as the stride, or space passed over by these legs, is often greater than the distance between the fore and hind-feet, it is necessary that the fore-feet should be alternately moved out of the way for the hind ones to descend. Then, as occasionally happens with horses not perfectly broken, and that have not been taught their paces, and especially if they have high hinder quarters and low fore ones, if the fore-feet are not raised in time the hind-feet will strike them. The fore-foot will generally be caught when it has just begun to be raised, and the toe of the hind-foot will meet the middle of the bottom of the fore-foot. It is an unpleasant noise, and not altogether free from danger; for it may so happen that a horse, the action of whose feet generally so much interferes with each other, may advance the hind-foot a little more rapidly, or raise the fore one a little more slowly, so that the blow may fall on the heel of the shoe, and loosen or displace it; or the two shoes may be locked together, and the animal may be thrown; or the contusion may be received even higher, and on the tendons of the leg, and considerable swelling and lameness may follow them; these, however, are rare occurrences.

If the animal is young, the action of the horse may be materially improved; otherwise nothing can be done, except to keep the toe of the hind-foot as short and as square as it can safely be, removing the clip from the toe and placing two smaller ones, one on each side of it; and to bevel off and round the toe of the shoe, like that which has been worn by a stumbler for a fortnight, and perhaps a little to lower the heel of the fore-foot.

A blow received on the heel of the fore-foot in this manner has not unfrequently, and especially if neglected, been followed by quittor.

#### FALSE QUARTER.

If the coronary ligament, by which the horn of the crust is secreted, is divided by some cut or bruise, or eaten through by any caustic, there will occasionally be a division in the horn as it grows down, either in the form of a permanent sand-crack, or one portion of the horn overlapping the other. It occasionally follows neglected sand-crack, or it may be the consequence of quittor. This is exteriorly an evident fissure in the horn, and extending from the coronet to the sole, but not always penetrating to the laminae. It is a very serious defect, and exceedingly difficult to remedy; for occasionally, if the horse is over-weighted or hurried on his journey, the fissure will open and bleed, and very serious inconvenience and lameness may ensue. Grit and dirt may insinuate itself into the aperture, and penetrate to the sensitive laminae. Inflammation will almost of necessity be produced; and much mischief will be effected. While the energies of the animal are not severely taxed, he may not experience much inconvenience or pain; but the slightest exertion will sometimes cause the fissure to expand, and painful lameness to follow.

This is not only a very serious defect, but one exceedingly difficult to remedy. The coronary ligament must be restored to its perfect state, or at least to the discharge of its perfect function. Much danger would attend the application of the caustic in order to effect this. A blister, sufficiently active, applied to the coronet at the injured part, affords the best chance of success; but when any portion of the secreting surface has been destroyed, there is no remedy will restore it—the edges of the horn on either side of the crack may be thinned, the hoof supported—and

the separated parts held together by a firm encasement of pitch, as described when speaking of the treatment of sand-crack. The coronet must be examined at least once in every fortnight, in order to ascertain whether the desired union has taken place; and as a palliative during the treatment of the case, or if the treatment should be unsuccessful, a bar-shoe may be used, and care taken that there be **no bearing** at or immediately under the separation of the horn. This will be best effected, when the crust is thick and the quarters strong, by paring off a little of the bottom of the crust at the part, so that it shall not touch the shoe; but if the foot is weak, an indentation or hollow should be made in the shoe. Strain or concussion on the immediate part will thus be avoided, and, in sudden or violent exertion, the crack will not be so likely to extend upward to the coronet, when whole and sound horn has begun to be formed there. James Clark, whose works have not been valued as they deserve, expresses in few words the real state of the case, and the course that should be pursued:—‘We may so far palliate the complaint as to render the horse something useful by using a shoe of such a construction as will support the limb without resting or pressing too much upon the weakened quarter.’ A proper stopping should also cover the sole, on which some coarse tow may be placed, and a piece of leather over that; the whole being confined by a broad web shoe.

In some cases false quarter assumes a less serious character. The horn grows down whole, but the ligament is unable to secrete that which is perfectly healthy, and therefore a narrow slip of horn of a different and lighter colour is produced. This is sometimes the best result that can be procured when the surgeon has been able to obliterate the absolute crack or separation. It is, however, to be regarded as a defect not sufficient to condemn the horse, but indicating that he has had sand-crack, and that a disposition to sand-crack may possibly remain. There will also, in the generality of cases, be some degree of tenderness in that quarter, which may produce slight lameness when unusual exertion is required from the horse, or the shoe is suffered to press long on the part.

#### QUITTOR.

This has been described as being the result of neglected or bad tread or over-reach; but it may be the consequence of any wound in the foot, and in any part of the foot. In the natural process of suppuration, matter is thrown out from the wound. It precedes the actual healing of the part. The matter which is secreted in wounds of the foot is usually pent up there, and increasing in quantity, and urging its way in every direction, it forces the little fleshy plates of the coffin-bone from the horny ones of the crust, or the horny sole from the fleshy sole, or even penetrates deeply into the internal parts of the foot. These pipes or sinuses run in every direction, and constitute the essence of *quittor*.

If it arises from a wound at the bottom of the foot, the purulent matter which is rapidly formed is pent up there, and the nail of the shoe or the *stub* remains in the wound, or the small aperture which was made is immediately closed again. This matter, however, continues to be secreted, and separates the horny sole from the fleshy one to a considerable extent, and at length forces its way upwards, and appears at the coronet, and usually at the quarter, and there slowly oozes out, while the aperture and the quantity discharged are so small that the inexperienced person would have no suspicion of the extent of the mischief within, and the difficulty of repairing it. The opening may scarcely admit a probe into it, yet over the greater part of the quarter and the sole the horn may have separated from the foot, and the matter may have penetrated under the cartilages

and ligaments, and into the coffin-joint. Not only so, but two mischievous results may have been produced,—the pressure of the matter wherever it has gone has formed ulcerations that are indisposed to heal, and that require the application of strong and painful stimulants to induce them to heal; and, worse than this, the horn, once separated from the sensitive parts beneath, will never again unite with them. Quittor may occur in both the fore and the hind-feet.

It will be sufficiently plain that the aid of a skilful practitioner is here requisite, and also the full exercise of patience in the proprietor of the horse. It may be necessary to remove much of the horny sole, which will speedily be reproduced when the fleshy surface beneath can be brought to a healthy condition; but if much of the horn at the quarters must be taken away, five or six months may probably elapse before it will be sufficiently grown down again to render the horse useful.

Measures of considerable severity are indispensable. The application of some caustic will alone produce a healthy action on the ulcerated surfaces; but on the ground of interest and of humanity we protest against the brutal practice, or at least the extent to which it is carried, that is pursued by many ignorant smiths, of coring out, or deeply destroying the healthy as well as the diseased parts—and parts which no process will again restore. The unhealthy surface must be removed; but the cartilages and ligaments, and even portions of the bone, need not to be sacrificed.

The experienced veterinary surgeon will alone be able to counsel the proprietor of the horse, when, in cases of confirmed quittor, there is reasonable hope of permanent cure. A knowledge of the anatomy of the foot is necessary to enable him to decide what parts indispensable to the action of the animal may have been irreparably injured or destroyed, or to save these parts from the destructive effect of torturing caustics. When any portion of the bone can be felt by the probe, the chances of success are diminished, and the owner and the operator should pause. When the joints are exposed, the case is hopeless, although, in a great many instances, the bones and the joints are exposed by the remedy and not by the disease. One hint may not be necessary to the practitioner, but it may guide the determination and hopes of the owner: if, when a probe is introduced into the fistulous orifice on the coronet, the direction of the *sinuses* or *pipes* is backward, there is much probability that a cure may be effected; but if the direction of the sinuses is forward, the cure is at best doubtful. In the first instance, there is neither bone nor joint to be injured; in the other, the more important parts of the foot are in danger, and those in which the principal action and concussion are found.

Neglected bruises of the sole sometimes lay the foundation of quittor. When the foot is flat, it is very liable to be bruised if the horse is ridden fast over a rough and stony road; or, a small stone, insinuating itself between the shoe and the sole, or confined by the curvature of the shoe, will frequently lame the horse. The heat and tenderness of the part, the occasional redness of the horn, and the absence of puncture, will clearly mark the bruise. The sole must then be thinned, and particularly over the bruised part; and, in neglected cases, it must be pared even to the quick, in order to ascertain whether the inflammation has run on to suppuration. The principal causes of bruises of the foot are leaving the sole too much exposed by means of a narrow-webbed shoe, or the smith paring out the sole too closely, or the pressure of the shoe on the sole, or the introduction of gravel or stones between the sole and the shoe.

The modes of cure in this disease are various; by some the mild or stimulating plan, by others the caustic or sloughing one. They are both excellent, and, so far as can well be the case, satisfactory.

The former is thus described by Mr. Newport, in the first volume of the 'Veterinarian':—'After the shoe has been removed, thin the sole until it will yield to the pressure of the thumb; then cut the under parts of the wall in an oblique direction from the heel to the anterior part, immediately under the seat of complaint, and only as far as it extends, and rasp the side of the wall thin enough to give way to the pressure to the over-distended parts, and put on a bar-shoe rather elevated from the frog. Ascertain with a probe the direction of the sinuses, and introduce into them a *saturated solution of sulphate of zinc*, by means of a small syringe. Place over this dressing the common cataplasm, or the turpentine ointment, and renew the application every twenty-four hours. I have frequently found three or four such applications complete a cure. I should recommend that when the probe is introduced, in order to ascertain the progress of cure, that it be gently and carefully used, otherwise it may break down the new-formed lymph. I have found the solution very valuable, where the synovial fluid has escaped, but not to be used if the inflammation of the parts is great.'

The latter is thus given by Mr. Percivall in his 'Hippopathology.' Mr. Percivall says:—'The ordinary mode of cure consists in the introduction of *caustic* into the sinus; and so long as the cartilage preserves its integrity—by which I mean, is free from caries—this is perhaps the most prompt and effectual mode of proceeding. The farrier's practice is to mix about half a drachm of corrosive sublimate in powder with twice or thrice the quantity of flour, and make them into a paste with water. This he takes up by little at a time with the point of his probe, and works it about in the sinus until the paste appears rising in the orifice above. After this is done, he commonly has the horse walked about for an hour or two, or even sent to slow work again, which produces a still more effectual solution of the caustic, at the same time that it tends greatly to its uniform and thorough diffusion into every recess and winding of the sinus. The consequence of this sharp caustic dressing is a general slough from the sinus. Every part of its anterior surface is destroyed, and the dead particles become agglutinated, and cast off along with the discharges in the form of a dark firm curdled mass, which the farrier calls the core; and so it commonly proves, for granulations follow close behind it, and fill up the sinus.'

#### PRICK, OR WOUND IN THE SOLE OR CRUST.

This is the most frequent cause of quitter. It is evident that the sole is very liable to be wounded by nails, pieces of glass, or even sharp flints. Every part of the foot is subject to injuries of this description. The usual place at which these wounds are found is in the hollow between the bars and the frog, or in the frog itself. In the fore-feet the injury will be generally recognised on the inner quarter, and on the hind-feet near the toe. In fact these are the thinnest parts of the fore and hind-feet. Much more frequently the laminae are wounded by the nail in shoeing; or if the nail does not penetrate through the internal surface of the crust, it is driven so close to it that it presses upon the fleshy parts beneath, and causes irritation and inflammation, and at length suppuration. When a horse becomes suddenly lame, after the legs have been carefully examined, and no cause of lameness appears in them, the shoe should be taken off. In many cases the offending substance will be immediately detected, or the additional heat felt in some parts of the foot will point out the seat of injury; or, if the crust is rapped with the hammer all round, the flinching of the horse will discover it; or pressure with the pincers will render it evident.

When the shoe is removed for this examination, the smith should never be permitted to wrench it off, but each nail should be drawn separately, and examined as it is drawn, when some moisture appearing upon it will not unfrequently reveal the spot at which matter has been thrown out.

Sudden lameness occurring within a few days after the horse has been shod, will lead to the suspicion that the smith has been in fault; yet no one who considers the thinness of the crust, and the difficulty of shoeing many feet, will blame him for sometimes pricking the animal. His fault will consist in concealing or denying that of which he will almost always be aware at the time of shoeing, from the flinching of the horse, or the dead sound, or the peculiar resistance that may be noticed in the driving of the nail. We would plead the cause of the honest portion of an humble class of men, who discharge this mechanical part of their business with a skill and good fortune scarcely credible; but we resign those to the reproaches and the punishment of the owner of the horse, who too often, and with bad policy, deny that which accident, or possibly momentary carelessness, might have occasioned, and the neglect of which is fraught with danger, although the mischief resulting from it, might at the time have been easily remedied.

When the seat of mischief is ascertained, the sole should be thinned round it, and at the nail-hole, or the puncture, it should be pared to the quick. The escape of some matter will now probably tell the nature of the injury, and remove its consequences. If it be puncture of the sole effected by some nail, or any similar body, picked up on the road, all that will be necessary is a little to enlarge the opening, and then to place on it a pledget of tow dipped in Friar's balsam, and over that a little common stopping. If there is much heat and lameness, a poultice should be applied.

The part of the sole that is wounded and the depth of the wound should be taken into consideration. A deep puncture towards the back part of the sole, and penetrating even into the sensitive frog, may not be productive of serious consequence. There is no great motion in the part, and there are no tendons or bones in danger. A puncture near the toe may not be followed by much injury. There is little motion in that part of the foot, and the internal sole covering the coffin-bone will soon heal. A puncture, however, about the centre of the sole may wound the flexor tendon where it is inserted into the coffin-bone, or may even penetrate the joint which unites the navicular bone with the coffin-bone, or pierce through the tendon into the joint which it forms with the navicular bone, and a degree of inflammation may ensue, that, if neglected, may be fatal. Many horses have been lost by the smallest puncture of the sole in these dangerous points. All the anatomical skill of the veterinarian should be called into requisition, when he is examining the most trifling wound of the foot.

If the foot has been wounded by the wrong direction of a nail in shoeing, and the sole is well pared out over the part on the first appearance of lameness, little more will be necessary to be done. The opening should be somewhat enlarged, the Friar's balsam applied, and the shoe tacked on, with or without a poultice, according to the degree of lameness or heat, and on the following day all will often be well. It may, however, be prudent to keep the foot stopped for a few days. If the accident has been neglected, and matter begins to be formed, and to be pent up and to press on the neighbouring parts, and the horse evidently suffers extreme pain, and is sometimes scarcely able to put his foot to the ground, and much matter is poured out when the opening is enlarged, further precautions must be adopted. The fact must be recollected that the living and dead



horn will never unite, and every portion of the horny sole that has separated from the fleshy sole above must be removed. *The separation must be followed as far it reaches.* Much of the success of the treatment depends on this. No small strip or edge of separated horn must be suffered to press upon any part of the wound; some soft tow, dipped in Friar's balsam, being spread on the part, the foot stopped, and a poultice placed over all if the inflammation seems to require it. On the following day a thin pellicle of horn will frequently be found over a part or the whole of the wound. If there is an appearance of fungus sprouting from the exposed surface, the application of a caustic such as nitric acid may be necessary, the tow being again placed over it, so as to afford considerable yet uniform pressure. Many days do not often elapse before the new horn covers the whole of the wound. In these extensive openings the Friar's balsam will not always be successful, but if not, the cure must be effected by the judicious and never-too-severe use of the caustic. A dose of physic will be resorted to as a useful auxiliary when much inflammation arises.

In searching the foot in order to ascertain the existence of prick, there is often something very censurable in the carelessness with which the horn is cut away between the bottom of the crust and the sole, so as to leave little or no hold for the nails, although some months must elapse before the horn will grow down sufficiently far for the shoe to be securely fastened.

When a free opening has been made below, and matter has not broken out at the coronet, it will rarely be necessary to remove any portion of the horn at the quarters, although he may be able to ascertain by the use of the probe that the separation of the crust extends for a considerable space above the sole.

#### CORNS.

In the angle between the bars (c, p. 395) and the quarters, the horn of the sole has sometimes a red appearance, and is more spongy and softer than at any other part. The horse flinches when this portion of the horn is pressed upon, and occasional or permanent lameness is produced. This disease of the foot is termed CORNS: bearing this resemblance to the corn of the human being that it is produced by pressure, and is a cause of lameness. When corns are neglected, so much inflammation is produced in that part of the sensitive sole that suppuration follows, and the matter either undermines the horny sole, or is discharged at the coronet.

The pressure hereby produced manifests itself in various ways. When the shoe is suffered to remain on too long, it becomes imbedded in the heel of the foot; the external crust grows down on the outside of it, and the bearing is thrown on this angular portion of the sole. No part of the sole can bear pressure, and inflammation and corns are the result. From the length of wear the shoe sometimes becomes loosened at the heels, and gravel insinuates itself between the shoe and the crust, and accumulates in this angle, and sometimes seriously wounds it.

The bars are too frequently cut away, and then the heel of the shoe must be bevelled inward, in order to answer to this absurd and injurious shaping of the foot. By this slanting direction of the heel of the shoe inward, an unnatural disposition to contraction is given, and the sole must suffer in two ways,—in being pressed upon by the shoe, and squeezed between the outer crust and the external portion of the bar. The shoe is often made unnecessarily narrow at the heels, by which this angle, seemingly less disposed to bear pressure than any other part of the foot, is exposed to accidental bruises. If, in the paring out of the foot, the smith should leave

the bars prominent, he too frequently neglects to pare away the horn in the angle between the bars and the external crust; or if he cuts away the bars, he scarcely touches the horn at this point; and thus, before the horse has been shod a fortnight, the shoe rests on this angle, and produces corns. The use of a shoe for the fore-feet, thickened at the heels, is, and especially in weak feet, a source of corns, from the undue bearing there is on the heels, and the concussion to which they are subject.

The unshod colt rarely has corns. The heels have their natural power of expansion, and the sensitive sole at this part can scarcely be imprisoned, while the projection of the heel of the crust and the bar is a sufficient defence from external injury. Corns seem to be the almost inevitable consequence of shoeing, which, by limiting, or in a manner destroying, the expansibility of the foot, must, when the sole attempts to descend, or the coffin-bone has a backward and a downward direction, imprison and injure this portion of the sole. This evil consequence is increased when the shoe is badly formed, or kept on too long, or when the paring is omitted or injudiciously extended to the bars. By this unnatural pressure of the sole, blood is thrown out, and enters into the pores of the soft and diseased horn which is then secreted; therefore the existence and the extent of the corn is judged of by the colour and softness of the horn at this place.

Corns are most frequent and serious in horses with thin horn and flat soles, and low weak heels. And the cause in these cases is an external one, namely, undue pressure from the heel of the shoe. But they are found occasionally in high, strong, contracted feet, and in these they are not produced by the heel of the shoe, but by the concussion produced by the superincumbent weight jarring against the hard, thick, unnaturally concave horny sole below. They generally occur on the inside heel, from its being more under the centre of gravity, and consequently having greater weight thrown on that part. The method adopted by shoeing-smiths to ascertain the existence of corn by the pain evinced when they pinch the bar and crust with their irons, is very fallacious. If the horn is naturally thin, the horse will shrink under no great pressure, although he has no corn, and occasionally the bars are so strong as not to give way under any pressure.

The cure of old corns is difficult; recent corns, however, will generally yield to good shoeing.

The first thing to be done is well to pare out the angle between the crust and the bars. Two objects are answered by this: the extent of the disease will be ascertained, and one cause of it removed. A very small drawing-knife must be used for this purpose. The corn must be pared out to the very bottom, taking care not to wound the sole. It may then be discovered whether there is only effusion of blood or matter underneath. If this is suspected, an opening must be made through the horn, the matter evacuated, the separated horn taken away, the course and extent of the sinuses explored, and the treatment recommended for quittor adopted.

In bad cases a bar-shoe may be put on, so chambered that there shall be no pressure on the diseased part. This may be worn for one or two shoeings, but not constantly, for there are few frogs that would bear the constant pressure of the bar-shoe: and the want of pressure on the heel, generally occasioned by their use, would produce a softened and bulbous state of the heels, that would of itself be an inevitable source of lameness.

Mr. Spooner, of Southampton, very properly states, that the corns occasionally fester, and the purulent matter which is secreted, having no

dependent orifice, ascends, torturing the animal to a dreadful extent, and breaks out at the coronet. These cases are very troublesome. Sinuses are formed, and the evil may end in quittor. A large and free dependent orifice must then be made, and a poultice applied; to which should succeed a solution of sulphate of zinc, with the application of the compound tar ointment.

The cause of corn is a most important subject of enquiry, and which a careful examination of the foot and the shoe will easily discover. The cause being ascertained, the effect may, to a great extent, be afterwards removed. Turning out to grass, after the horn is a little grown, first with a bar-shoe, and afterwards with the shoe nailed on the outside, or with tips, will often be serviceable. A horse that has once had corns to any considerable extent should, at every shoeing, have the seat of corn well pared out, and the butyr of antimony applied. The *seated* shoe (hereafter to be described) should be used, with a web sufficiently thick to cover the place of corn, and extending as far back as it can be made to do without injury to the frog.

Low weak heels should be rarely touched with the knife, or anything more be done to them than lightly to rasp them, in order to give them a level surface. The inner heel should be particularly spared. Corns are seldom found in the hind-feet, because the heels are stronger, and the feet are not exposed to so much concussion; and when they are found there, they are rarely or never productive of lameness. There is nothing perhaps in which the improvement in the veterinary art has relieved the horse from so much suffering as shoeing.

#### THRUSH.

This is a discharge of offensive matter from the cleft of the frog. It is inflammation of the lower surface of the sensitive frog, and during which pus is secreted together with, or instead of horn. When the frog is in its sound state, the cleft sinks but a little way into it; but when it becomes contracted or otherwise diseased, it extends in length, and penetrates even to the sensitive laminae within, and through this unnaturally deepened fissure the thrushy discharge proceeds. A plethoric state of the body may be a predisposing cause of thrush, but the immediate and grand cause is moisture. This should never be forgotten, for it will lead a great way towards the proper treatment of the disease. If the feet are habitually covered with any moist application—his standing so much on his own dung is a fair example—thrush will inevitably appear. It is caused by anything that interferes with the healthy structure and action of the frog. We find it in the hinder feet oftener and worse than in the fore, because in our stable management the hinder feet are too much exposed to the pernicious effects of the dung and the urine, moistening, or as it were macerating, and at the same time irritating them. The distance of the hinder feet from the centre of the circulation would also, as in the case of grease, more expose them to accumulations of fluid, and discharges of this kind. In the fore-feet, thrushes are usually connected with contraction. We have stated that they are both the cause and the effect of contraction. The pressure on the frog from the wiring in of the heels will produce pain and inflammation: and the inflammation, by the increased heat and suspended function of the part, will dispose to contraction. Horses of all ages, and in almost all situations, are subject to thrush. The unshod colt is frequently thus diseased.

Thrushes are not always accompanied by lameness. In a great many cases the appearance of the foot is scarcely or not at all altered, and the disease can only be detected by close examination, or the peculiar smell of

the discharge. The frog may not appear to be rendered in the slightest degree tender by it, and therefore the horse may not be considered by many as unsound. Every disease, however, should be considered as legal unsoundness, and especially a disease which, although not attended with present detriment, must not be neglected, for it will eventually injure and lame the horse. All other things being right, a horse should not be rejected because he has a slight thrush, for if the shape of the hoof is not altered, experience tells us that the thrush is easily removed; but if this is not soon done, the shape of the foot and the action of the horse will be altered, and manifest unsoundness will result. A favourite hobby of the late talented Professor Coleman was that pressure on the frog was the only one thing needful to prevent contraction and thrush, and to such an extent did he carry out this idea, that he took out a patent for a shoe to cover the toe of the foot only, with a bar projecting back to cover the frog and receive the weight of the animal; this proved to be an utter fallacy, and was very soon abandoned. A clever modification of the same idea has lately emanated from a very talented amateur holding an important position, and this is, that a thin plate of wood or gutta percha should be applied to the frog in the stable, one end, the narrow one, being secured under the toe of the shoe, and the other, the broad one, tied round the hock. This is certainly a much more possible and practicable proposition than that of the late Professor.

The progress of a neglected thrush, although sometimes slow, is sure. The frog begins to contract in size—it becomes rough, ragged, brittle, tender—the discharge is more copious and more offensive—the horn gradually disappears—a mass of hardened mucus usurps its place—this easily peels off, and the sensitive frog remains exposed; the horse cannot bear it to be touched—fungous granulations spring from it—they spread around—the sole becomes under-run, and canker steals over the greater part of the foot.

There are few errors more common or more dangerous than this, that the existence of thrush is a matter of little consequence, or even, as some suppose, a benefit to the horse—a discharge for superabundant humours—and that it should not be dried up too quickly, and in some cases not dried up at all. If a young colt, fat and full of blood, has a bad thrush, with much discharge, it will be prudent to accompany the attempt at cure by a dose of physic or a course of diuretics. A few diuretics may not be injurious when we are endeavouring to dry up thrush in older horses; but the disease can scarcely be attacked too soon, or subdued too rapidly, and especially when it steals on so insidiously, and has such fatal consequences in its train. If the heels once begin to contract through the baneful effects of thrush, it will, with difficulty, or not at all, be afterwards removed.

There are many recipes to stop a running thrush. Almost every application of an astringent, but not of too caustic nature, will have the effect; the best for ordinary use will be found to be the sulphate of zinc, or white vitriol and tar ointment. The zinc should be finely powdered, and used in the proportion of a drachm to one ounce of the ointment; a small pledget of tow, moistened with this, should be lightly introduced into the cleft of the frog every evening. The common *Ægyptiacum* (vinegar boiled with honey and verdigrease) is a good liniment; but the most effectual and the safest—drying up the discharge speedily, but not suddenly—is a paste composed of blue vitriol, tar, and lard, in proportions according to the virulence of the thrush.

A pledget of tow covered with it should be introduced as deeply as possible, yet without force, into the cleft of the frog every night, and removed

in the morning before the horse goes to work. Attention should at the same time, as in other diseases of the foot, be paid to the apparent cause of the complaint, and that cause should be carefully obviated or removed. Before the application of the paste, the frog should be examined, and every loose part of the horn or hardened discharge removed; and if much of the frog is then exposed, a larger and wider piece of tow covered with the paste may be placed over it, in addition to the pledget introduced into the cleft of the frog. It will be necessary to preserve the frog moist while the cure is in progress, and this may be done by filling the feet with tow covered by common stopping, or using the felt pad, likewise covered with it. Turning out would be prejudicial rather than of benefit to thrushy feet, except the dressing is continued, and the feet defended from moisture.

#### CANKER

Is a separation of the horn from the sensitive part of the foot, and the sprouting of fungous growths instead of it, occupying a portion or even the whole of the sole and frog. Nor do these constitute the only seats of its devastations; it turns over the lower edge of the foot, and insidiously creeps up the front or sides, disorganising the laminae in its progress, and this in some cases to such an extent that the connection between the sensitive and insensitive laminae is entirely destroyed, and the hoof may drop from the foot on the road or in the stable. It is the occasional consequence of bruise, puncture, corn, quitor, and thrush, and is exceedingly difficult to cure. It is more frequently the consequence of neglected thrush than of any other disease of the foot, or rather it is thrush involving the frog, the bars, and the sole, and making the foot one mass of disease.

Although canker is often the result of neglected thrush, it is distinguished from it by its malignant nature, and the great tendency to the formation of fungoid growths; the latter are not found in ordinary thrush.

It is oftenest found in, and is almost peculiar to the heavy breed of cart horses, and partly resulting from constitutional predisposition. Horses with white legs and thick skins, and much hair upon their legs,—the very character of many dray horses,—are subject to canker, especially if they have had an attack of grease, or their heels are habitually thick and greasy. The disposition to canker is certainly hereditary. The dray horse likewise has this disadvantage, that in order to give him *foot-hold*, it is sometimes necessary to raise the heels of the hinder feet so high, that all pressure on the frog is taken away; its functions are destroyed, and it is rendered liable to disease. Canker, however, arises most of all from the neglect of the feet and the filthiness of the stable in these establishments.

Although canker is a disease most difficult to remove, it is easily prevented. Attention to the punctures to which these heavy horses, with their clubbed feet and brittle hoofs, are more than any others subject in shoeing, and to the bruises and treads on the coronet, to which from their awkwardness and weight they are so liable, and the greasy heels which a very slight degree of negligence will produce in them, and the stopping of the thrushes, which are so apt in them to run on to the separation of the horn from the sensitive frog, will most materially lessen the number of cankered feet. Where this disease often occurs, the owner of the team may be well assured that there is mismanagement either in himself or his horsekeeper, or the smith, and it will rarely be a difficult matter to detect the precise nature of that mismanagement.

The cure of canker is the business of the veterinary surgeon, and a

most painful and tedious business it is. The principles on which he proceeds are, first of all, to remove the extraneous fungous growth, and for this purpose he will need the aid of the knife and the caustic, or the cautery, for he should cut away every portion of horn which is in the slightest degree separated from the sensitive parts beneath. He will have to discourage the growth of fresh fungus, and to bring the foot into that state in which it will again secrete healthy horn. Here he will remember that he has to do with the *surface* of the foot; that this is a disease of the surface only, and that there will be no necessity for those deeply-corroding and torturing caustics which penetrate to the very bone. A slight and daily application of nitric acid, and that not where the new horn is forming, but on the surface which continues to be diseased, and accompanied by as firm but equal pressure as can be made—the careful avoidance of the slightest degree of moisture—the horse being exercised or worked in the mill, or wherever the foot will not be exposed to wet, and that exercise adopted as early as possible, and even from the beginning, if the malady is confined to the sole and frog—these means will succeed if the disease is capable of cure. Humanity, perhaps, will dictate, that, considering the long process of cure in a cankered foot, and the daily torture of the caustic, and the suffering which would otherwise result from so large or exposed a surface, the nerves of the leg should be divided in order to take away the sense of pain; and also to induce the animal to place the foot freely to the ground, and thus produce that pressure which is so essential to reduce these fungoid growths. But this will rarely be necessary, inasmuch as it is a disease which does not generally cause much pain. It sometimes assumes a very malignant form, and extends rapidly, implicating the coffin-bone and other parts of the foot. In this stage of the disease, all attempts at cure will be fruitless, and the animal should be destroyed.

Medicine is not of much avail in the cure of canker. It is a local disease; or the only cause of fear is, that so great a determination of blood to the extremities having existed during the long progress of cure, it may in some degree continue, and produce injury in another form. It may, therefore, be prudent, when the cure of a cankered foot is nearly effected, to subject the horse to a course of alteratives or diuretics.

#### OSSIFICATION OF THE CARTILAGES. (SIDE-BONES.)

Mention has been made of the side or lateral cartilages of the foot, occupying a considerable portion of the external side and back part of the foot. They are designed to prevent concussion and preserve the expansion of the upper part of the foot, and especially when that of the lower part is limited or destroyed by careless shoeing. These cartilages are subject to inflammation, and the result of that inflammation is, that the cartilages are absorbed, and bone substituted in their stead. This ossification of the cartilages frequently accompanies ringbone, but it may exist without any affection of the pastern joint. It is oftenest found in horses of heavy draught. Very few heavy draught horses arrive at old age without this change of structure; and particularly if they are much employed in the paved streets. The change commences sometimes at the anterior part of the cartilage, but much oftener at the posterior and inferior part.

There are few diseases in which the influence of hereditary predisposition is more apparent than in connection with ossification of the lateral cartilages. So much does this prevail in some districts, and especially in the midland counties, that it is somewhat difficult to find a cart-horse eight or nine years old without more or less ossification of the

cartilages. The extent to which this disease exists in these districts from the continued pernicious system of breeding from parents affected with it, will render its removal, even with the most careful attention to breeding, a matter attended with much difficulty, and extending over a considerable time. Although side-bones, as the result of hereditary predisposition, do not as a rule cause lameness, or materially deteriorate the usefulness of the agricultural horse, it should be remembered by the breeder that it is a disease which renders the animal unsound, and consequently considerably reduces his commercial value. Concussion is the most frequent exciting cause of ossification of the cartilage. 'From the combined operation' (says Mr. W. Spooner, in his work on the 'Foot of the Horse') 'of great weight and high action, the feet, and particularly the heels, come with great force on the ground. The cartilages, being embedded in the heels of the feet, are, therefore, the parts that receive the greatest degree of concussion, the consequence of which is that subacute inflammation is set up, and the secreting vessels deposit ossific instead of cartilaginous matter, in the room of that which is absorbed in the usual process of nature.'

It sometimes arises from direct injury to the parts, such as over-reach. When the result of the latter, the ossification is confined to the injured cartilage. Side-bones are more frequently met with in the fore than in the hind-feet, but when hereditary, all the feet will not unfrequently be found affected.

No evident inflammation of the foot, or great, or perhaps even perceptible lameness, accompanies this change; a mere slight degree of stiffness may have been observed, which, in a horse of more rapid pace, would have been lameness. Even when the change is completed, there is not in any cases anything more than a slight increase of stiffness, little, or not at all, interfering with the usefulness of the horse. When this altered structure appears in the lighter horse, the lameness is more decided, and means should be taken to arrest the progress of the change. These are blisters or firing; but after the parts have become bony, no operation will restore the cartilage. When the ossific deposit is thrown out on one side of the foot only, which not unfrequently occurs, the operation of neurotomy on the affected side will, as has been before stated, be found a very valuable remedy.

Connected with ringbone the lameness may be very great. This has been spoken of.

#### WEAKNESS OF THE FOOT.

This is more accurately a bad formation than a disease; often, indeed, the result of disease, but in many instances the natural construction of the foot. The term *weak foot* is familiar to every horseman, and the consequence is too severely felt by all who have to do with horses. In the slanting of the crust from the coronet to the toe, a less angle is almost invariably formed, amounting probably to not more than forty instead of forty-five degrees; and after the horse has been worked for one or two years, the line is not straight, but a little indented or hollow, midway between the coronet and the toe. This has been described as the accompaniment of pumiced feet, but it is often seen in weak feet, that, although they might become pumiced by severity of work, do not otherwise have the sole convex. The crust is not only less oblique than it ought to be, but it has not the smooth even appearance of the good foot. The surface is sometimes irregularly roughened, but it is much oftener roughened in circles or rings. The form of the crust likewise presents too much the appearance of a cone; the bottom of the foot is unnaturally wide in

proportion to the coronet ; and the whole of the foot is generally, but not always, larger than it should be.

When the foot is lifted, it will often present a round and circular appearance, with a fulness of frog that would mislead the inexperienced, and indeed be considered as almost the perfection of structure ; but, being examined more closely, many glaring defects will be seen. The sole is flat, and the smith finds that it will bear little or no paring. The bars are small in size. They are not cut away by the smith, but they can be scarcely said to have any existence. The heels are low, so low that the very coronet seems almost to touch the ground ; and the crust, if examined, appears scarcely thick enough to hold the nails.

Horses with these feet can never stand much work. They will be subject to corns, to bruises of the sole, to convexity of the sole, to punctures in nailing, to breaking away of the crust, to inflammation of the foot, and to sprain and injury of the pastern, and the fetlock, and the flexor tendon.

These feet admit of little improvement. Shoeing as seldom as may be, and with a light and yet concave web and leather soles : little or no paring at the time of shoeing, and as little violent work as possible, and especially on rough roads, may protract for a long period the evil day, but he who buys a horse with these feet will sooner or later have cause to repent his bargain.

**MANAGEMENT OF THE FEET.**—This is a part of stable management that is often sadly neglected by the carter and groom. The feet should be carefully examined every morning, for the shoes may be loose, and the horse would have been stopped in the middle of his work ; or the clenches may be raised, and endanger the wounding of his legs ; or the shoe may begin to press upon the sole or the heel, and bruises of the sole, or corn, may be the result ; and, the horse having stood so long in the stable, every little increase of heat in the foot, or lameness, will be more readily detected, and serious disease may often be prevented.

When the horse comes in at night, and after the harness has been taken off and stowed away, the heels should be well brushed out. Hand-rubbing will be preferable to washing, especially in the agricultural horse, whose heels, covered with long hair, can scarcely be dried again. If the dirt is suffered to accumulate in that long hair, the heels will become sore, and grease will follow ; and if the heels are washed, and particularly during the winter, grease will result from the coldness occasioned by the slow evaporation of the moisture. The feet should be stopped—even the feet of the farmer's horse, if he remains in the stable. Very little clay should be used in the stopping, for it will get hard and press upon the sole. Cowdung is the best stopping to preserve the feet cool and elastic ; but, before the stopping is applied, the picker should be run round the whole of the foot, between the shoe and the sole, in order to detect any stone that may have insinuated itself there, or a wound on any other part of the sole. For the hackney and hunter, stopping is indispensable. After several days' hard work, it will afford very great relief to take the shoes off, having put plenty of litter under the horse, or to turn him, if possible, into a loose-box ; and the shoes of every horse, whether hardly worked or not, should be removed or changed once in every three weeks.

---



## CHAPTER XX.

## ON SHOERING.

THE period when the shoe began to be nailed to the foot of the horse is uncertain. William the Norman introduced it into our country.

We have seen, in the progress of our inquiry, that, while it affords to the foot of the horse that defence which seems now to be necessary against the destructive effects of our artificial and flinty roads, it has entailed on the animal some evils. It has limited or destroyed the beautiful expansibility of the lower part of the foot—it has led to contraction, although that contraction has not always been accompanied by lameness—in the most careful fixing of the best shoe, and in the careless manufacture and setting on of the bad one, irreparable injury has occasionally been done to the horse.

We will first attend to the preparation of the foot for the shoe, for more than is generally imagined, of its comfort to the horse, and its safety to the rider, depends on this. If the master would occasionally accompany the horse to the forge, more expense to himself and punishment to the horse would be spared, than, perhaps, he would think possible, provided he will take the pains to understand the matter himself, otherwise he had better not interfere.

The old shoe must be first taken off. We have something to observe even here. The shoe was retained on the foot by the ends of the nails being twisted off, turned down, and clenched. These clenches should be first raised, which the smith seldom takes the trouble thoroughly to do; but after looking carelessly round the crust and loosening one or two of the clenches, he takes hold first of one heel of the shoe, and then of the other, and by a violent wrench separates them from the foot; then, by means of a third wrench, applied to the middle of the shoe, he tears it off. By these means he must enlarge every nail-hole, and weaken the future and steady hold of the shoe, and sometimes tear off portions of the crust, and otherwise injure the foot. The horse generally shows by his flinching that he suffers from the violence with which this preliminary operation too often is performed. The clenches should always be raised off; and, where the foot is tender, or the horse is to be examined for lameness, each nail should be partly punched out. According to the common system of procedure, many a stub is left in the crust, the source of future annoyance.

The shoe having been removed, the smith proceeds to rasp the edges of the crust. Let not the stander-by object to the apparent violence which he uses, or fear that the foot will suffer. It is the only means that he has to detect whether any stubs remain in the nail-holes; and it is the most convenient method of removing that portion of the crust into which dirt and gravel have insinuated themselves.

Next comes the important process of paring out, with regard to which it is almost impossible to lay down any specific rules. This, however, is undoubted, that far more injury has been done by the neglect of paring than by carrying it to too great an extent. The act of paring is a work of much more labour than the proprietor of the horse often imagines. The smith, except he is overlooked, will frequently give himself as little trouble about it as he can; and that portion of horn which, in the unshod foot, would be worn away by contact with the ground, is suffered to accumulate

month after month, until the elasticity of the sole is destroyed, and it can no longer descend, and its other functions are impeded, and foundation is laid for corn, and contraction, and inflammation, and navicular disease. That portion of horn should be left on the foot which will defend the internal parts from being bruised, and yet suffer the external sole to descend. How is this to be ascertained? The strong pressure of the thumb of the smith will be the best guide. The buttress, that most destructive of all instruments, being, except on very particular occasions, banished from every respectable forge, the smith sets to work with his drawing-knife, and removes the growth of horn, until the sole will yield, although in the slightest possible degree, to the strong pressure of his thumb. The proper thickness of horn will then remain.

If the foot has been previously neglected, and the horn is become very hard, the owner must not object if the smith resorts to some other means to soften it a little, and takes one of his flat irons, and having heated it, draws it over the sole, and keeps it, a little while, in contact with the foot. When the sole is really thick, this rude and apparently barbarous method can do no harm, but it should never be permitted with the sole that is regularly pared out.

The quantity of horn to be removed in order to leave the proper degree of thickness will vary with different feet. From the strong foot a great deal must be taken. From the concave foot the horn may be removed until the sole will yield to a moderate pressure. From the flat foot little needs to be pared; while the pumiced foot should be deprived of nothing but the ragged parts.

The paring being nearly completed, the knife and the rasp of the smith must be a little watched, or he will reduce the crust to a level with the sole, and thus endanger the bruising of it by its pressure on the edge of the seating. The crust should be reduced to a perfect level, all round, but left a little higher than the sole.

The heels will require considerable attention. From the stress which is thrown on the inner heel, and from the weakness of the quarter there, the horn usually wears away considerably faster than it would on the outer one, and if an equal portion of horn were pared from it, it would be left lower than the outer heel. The smith should, therefore, accommodate his paring to the comparative wear of the heels, and be exceedingly careful to leave them precisely level.

If the reader will recollect what has been said of the intention and action of the bars, he will readily perceive that the smith should be checked in his almost universal fondness for opening the heels, or, more truly, removing that which is the main impediment to contraction. The portion of the heels between the inflexion of the bar and the frog should scarcely be touched—at least the ragged and detached parts alone should be cut away. The foot may not look so fair and open, but it will last longer without contraction.

The bar, likewise, should be left fully prominent, not only at its first inflexion, but as it runs down the side of the frog. The heel of the shoe is designed to rest partly on the heel of the foot and partly on the bar, for reasons that have been already stated. If the bar is weak, the growth of it should be encouraged; and it should be scarcely touched when the horse is shod, unless it has attained a level with the crust. The reader will recollect the observation which has been already made, that the destruction of the bars not only leads to contraction by removing the grand impediment to it, but by adding a still more powerful cause in the slanting direction which is given to the bearing at the heels, when the bar does not contribute to the support of the weight.

It will also be apparent that the horn between the crust and the bar should be carefully pared out. Every horseman has observed the relief which is given to the animal lame with corns when this angle is well thinned. This relief, however, is often but temporary; for when the horn grows again, and the shoe presses upon it, the torture of the horse is renewed.

The degree of paring to which the frog must be subjected will depend on its prominence, and on the shape of the foot. The principle has already been stated, that it must be left so far projecting and prominent, that it shall be just within and above the lower surface of the shoe; it will then descend with the sole sufficiently to discharge the functions that have been attributed to it. If it is lower, it will be bruised and injured; if it is higher, it cannot come in contact with the ground, and thus be enabled to do its duty. The ragged parts must be removed, and especially those occasioned by thrush, but the degree of paring must depend entirely on the principle just stated.

It appears, then, that the office of the smith requires some skill and judgment in order to be properly discharged; and the proprietor of horses will find it his interest occasionally to visit the forge, and complain of the careless, or idle, or obstinate fellow, while he rewards by some trifling gratuity the expert and diligent workman. He should likewise remember that a great deal more depends on the paring out of the foot than on the construction of the shoe; that few shoes, except they press upon the sole, or are made outrageously bad, will lame the horse; but that he may be very easily lamed from ignorant and improper paring out of the foot.

#### THE PUTTING ON OF THE SHOE.

The foot being thus prepared, the smith looks about for a shoe. He should select one that as nearly as possible fits the foot, or may be easily altered to the foot. He will sometimes, and especially if he is an idle and reckless fellow, care little about this, for he can easily alter the foot to the shoe. The toe-knife is a very convenient instrument for him, and plenty of horn can be struck off with it, or removed by the rasp, in order to make the foot as small as the shoe; while he cares little, although by this destructive method the crust is materially thinned where it should receive the nail, and the danger of puncture and of pressure upon the sole is increased; and a foot so artificially diminished in size will soon grow over the shoe, to the hazard of considerable or permanent lameness.

While the horse is travelling, dirt and gravel are apt to insinuate themselves between the web of the shoe and the sole. If the shoe were flat, they would be permanently retained there, and would bruise the sole, and be productive of injury; but when the shoe is properly bevelled off, it is scarcely possible for them to remain. They must be shaken out almost every time that the foot comes in contact with the ground.

The web of the shoe is likewise of that thickness that when the foot is properly pared, the prominent part of the frog shall lie just within and above its ground surface, so that in the descent of the sole the frog shall come sufficiently on the ground to enable it to act as a wedge and to expand the quarters, while it is defended from the wear and injury it would receive if it came on the ground with the first and full shock of the weight.

The nail-holes are, on the ground side, placed as near the outer edge of the shoe as they can safely be, and brought out near the inner edge of the seating. The nails thus take a direction inward, resembling that of the crust itself, and have firmer hold, while the strain upon them in the

common shoe is altogether prevented, and the weight of the horse being thrown on a flat surface, contraction is not so likely to be produced.

The smith sometimes objects to the use of this shoe on account of its not being so easily formed as one composed of a bar of iron, either flat or a little bevelled. It likewise occupies more time in the forging; but these objections would vanish when the owner of the horse declared that he would have him shod elsewhere, or when he consented—as, in justice, he should—to pay somewhat more for a shoe that required better workmanship and longer time in the construction.

It is expedient not only that the foot and ground surface of the shoe should be most accurately level, but that the crust should be exactly smoothed and fitted to the shoe. Much skill and time are necessary to do this perfectly with the drawing-knife. The smith has adopted a method of more quickly and more accurately adapting the shoe to the foot. He pares the crust as level as he can, and then he brings the shoe to the heat somewhat below a red-heat, and applies it to the foot, and detects any little elevations by the deeper colour of the burnt horn. This practice has been much inveighed against; but it is the abuse, and not the use of the thing, which is to be condemned. If the shoe is not too hot, nor held too long on the foot, an accuracy of adjustment is thus obtained which the knife would be long in producing, or would not produce at all. If, however, the shoe is made to burn its way to its seat, with little or no previous preparation of the foot, the heat must be injurious both to the sensitive and insensitive parts of the foot.

The heels of the shoe should be examined as to their proper width. Whatever is the custom of shoeing the horses of dealers, and the too prevalent practice in the metropolis of giving the foot an open appearance, although the posterior part of it is thereby exposed to injury, nothing is more certain than that, in the horse destined for road-work, the heels, and particularly the seat of corn, can scarcely be too well covered. Part of the shoe projecting externally can be of no possible good, but will prove an occasional source of mischief, and especially in a heavy country. A shoe, the web of which projects inward as far as it can without touching the frog, affords protection to the angle between the bars and the crust.

Of the manner of attaching the shoe to the foot the owner can scarcely be a competent judge; he can only take care that the shoe itself shall not be heavier than the work requires—that, for work a little hard the shoe shall still be light, with a bit of steel welded into the toe—that the nails shall be as small, and as few, and as far from the heels as may be consistent with the security of the shoe; and that for light work at least, the shoe shall not be driven on so closely and firmly as is often done, nor the points of the nails be brought out so high up as is generally practised.

#### CALKINS.

There are few cases in which the use of calkins (a turning up or elevation of the heel) can be admissible in the fore-feet, except in frosty weather, when it may in some degree prevent unpleasant or dangerous slipping. If, however, calkins are used, they should be placed on both sides. If the outer heel only is raised with the calkin, as is too often the case, the weight cannot be thrown evenly on the foot, and undue straining and injury of some part of the foot or of the leg must be the necessary consequence. Few things deserve more the attention of the horseman than this most absurd and injurious of all the practices of the forge. One quarter of an hour's walking, with one side of the shoe or boot raised considerably above the other, will painfully convince us of what the horse must suffer

from this too common method of shoeing. It cannot be excused even in the hunting shoe. If the horse is ridden far to cover, or galloped over much hard and flinty ground, he will inevitably suffer from this unequal distribution of the weight. If the calkin is put on the outer heel, in order to prevent the horse from slipping, either the horn of that heel should be lowered to a corresponding degree, or the other heel of the shoe should be raised to the same level by a gradual thickening. Of the use of calkins in the hinder foot we shall presently speak.

#### CLIPS.

These are portions of the upper edge of the shoe, hammered out, and turned up so as to embrace the lower part of the crust, and which is usually pared out a little, in order to receive the clip. They are very useful, as more securely attaching the shoe to the foot, and relieving the crust from that stress upon the nails which would otherwise be injurious. A clip at the toe is almost necessary in every draught horse, and absolutely so in the horse of heavy draught, in order to prevent the shoe from being loosened or torn off by the pressure which is thrown upon the toe in the act of drawing. A clip on the outside of each shoe, at the beginning of the quarters, will give security to it. Clips are likewise necessary on the shoes of all heavy horses, and of all others who are disposed to stamp, or violently paw with their feet, and thus incur the danger of displacing the shoe; but they are evils, inasmuch as they press upon the crust as it grows down, and they should only be used when circumstances absolutely require them. In the hunter's shoe they are not required at the sides. One at the toe is sufficient.

#### THE HINDER SHOE.

In forming the *hinder* shoes it should be remembered that the hind limbs are the principal instruments in progression, and that in every act of progression, except the walk, the toe is the point on which the whole frame of the animal turns, and from which it is propelled. This part, then, should be strengthened as much as possible; and, therefore, the hinder shoes are made thicker at the toe than the fore ones. Another good effect is produced by this, that, the hinder foot being shortened, there is less danger of *overreaching* or *forging*, and especially if the shoe is wider on the foot surface than on the ground one. The shoe is thus made to slope inward, and is a little within the toe of the crust.

The shape of the hinder foot is somewhat different from that of the fore foot. It is straighter in the quarters, and the shoe must have the same form. For carriage and draught horses generally, calkins may be put on the heels, because the animal will be thus enabled to dig his toe more firmly into the ground, and urge himself forward, and throw his weight into the collar with greater advantage: but the calkins must not be too high, and they must be of an equal height on each heel, otherwise, as has been stated with regard to the fore feet, the weight will not be fairly distributed over the foot, and some part of the foot or the leg will materially suffer. The nails in the hinder shoe may be placed nearer to the heel than in the fore shoe, because, from the comparatively little weight and concussion thrown on the hinder feet, there is not so much danger of contraction.

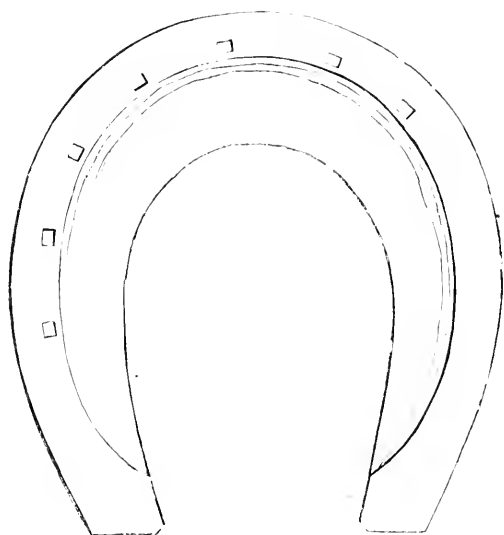
#### DIFFERENT KINDS OF SHOES.

The shoe must vary in substance and weight with the kind of foot, and the nature of the work. A weak foot should never wear a heavy shoe, nor any foot a shoe that will last longer than a month. Here, perhaps, we

may be permitted to caution the horse-proprietor against having his cattle shod by contract, unless he binds down his farrier or veterinary surgeon to remove the shoes once at least in every month; for if the contractor, by a heavy shoe, and a little steel, can cause five or six weeks to intervene between the shooings, he will do so, although the feet of the horse must necessarily suffer. The shoe should never be heavier than the work requires, for an ounce or two in the weight of the shoe will sadly tell at the end of a hard day's work. This is acknowledged in the hunting shoe, which is narrower and lighter than that of the hackney, although the foot of the hackney is smaller than that of the hunter. It is more decidedly acknowledged in the racer, who wears a shoe only sufficiently thick to prevent it from bending when it is used.

#### THE CONCAVE-SEATED SHOE.

The proper form and construction of the shoe is a subject deserving of very serious enquiry, for it is most important to ascertain, if possible, the kind of shoe that will do the least mischief to the feet. A cut is subjoined of that which is useful and valuable for general purposes. It is employed in many of our best forges, and promises gradually to supersede the flat and the simple concave shoe.



It presents a perfectly flat surface to the ground, in order to give as many points of bearing as possible, except that, on the outer edge, there is a groove of *fuller*, in which the nail-holes are punched, so that, sinking into the fuller, their heads project but a little way, and are soon worn down level with the shoe. The ground surface of the common shoe used in the country is somewhat convex, and the inner rim of the shoe comes first on the ground: the consequence of this is, that the weight, instead of being borne fairly on the crust, is supported by the nails and clinches, which must be injurious to the foot, and often chip and break it.

The web of this shoe is of the same thickness throughout, from the toe to the heel: and it is sufficiently wide to guard the sole from bruises, and, as much so as the frog will permit, to cover the seat of corn.

On the foot side it is *seated*. The outer part of it is accurately flat, and

of the width of the crust, and designed to support the crust, for by it the whole weight of the horse is sustained.

Towards the heel this flattened part is wider and occupies the whole breadth of the web, in order to support the heel of the crust, and its reflected part—the bar: thus, while it defends the horn included within this angle from injury, it gives that equal pressure upon the bar and the crust, which is the best preventive against corns, and a powerful obstacle to contraction.

It is fastened to the foot by nine nails—five on the outside, and four on the inner side of the shoe; those on the outside extending a little farther down towards the heel, because the outside heel is thicker and stronger, and there is more nail-hold; the last nail on the inner quarter being farther from the heel on account of the weakness of that quarter. For feet not too large, and where moderate work only is required from the horse, four nails on the outside, and three on the inside, will be sufficient; and the last nail being far from the heels, will allow more expansion there.

The inside part of the web is bevelled off, or rendered concave, that it may not press upon the sole. Notwithstanding our iron fetter, the sole does, although to a very inconsiderable extent, descend when the foot of the horse is put on the ground. It is unable to bear constant or even occasional pressure, and if it came in contact with the shoe, the sensitive sole between it and the coffin-bone would be bruised, and lameness would ensue. Many of our horses, from too early and undue work, have the natural concave sole flattened, and the disposition to descend and the degree of descent are thereby increased. The concave shoe prevents, even in this case, the possibility of much injury, because the sole can never descend in the degree in which the shoe is or may be bevelled. A shoe bevelled still farther is necessary to protect the projecting or puniced foot.

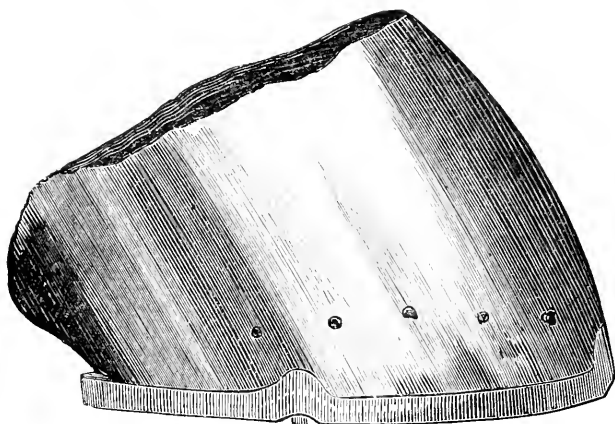
#### THE UNILATERAL, OR ONE SIDE NAILED SHOE.

For a material improvement in the art of shoeing, we are indebted to Mr. Turner of Regent Street. What was the state of the foot of the horse a few years ago? An unyielding iron hoof was attached to it by four nails in each quarter, and the consequence was, that in nine cases out of ten, the foot underwent a very considerable alteration in its form and in its usefulness. Before it had attained its full development—before the animal was five years old, there was, in a great many cases, an evident contraction of the hoof. There was an alteration in the manner of going. The step was shortened, the sole was hollowed, the frog was diseased, the general elasticity of the foot was destroyed—there was a disorganisation of the whole horny cavity, and the value of the horse was materially diminished. What was the grand cause of this? It was the restraint of the shoe. The firm attachment of it to the foot by nails in each quarter, and the consequent strain to which the quarters and every part of the foot were exposed, produced a necessary tendency to contraction, from which sprang almost all the maladies to which the foot of the horse is subject.

The unilateral shoe has this great advantage: it is identified with the grand principle of the expansibility of the horse's foot, and of removing or preventing the worst ailments to which the foot of the horse is liable. It can be truly stated of this shoe, that while it affords to the whole organ an iron defence equal to the common shoe, it permits, what the common shoe never did or can do, the perfect liberty of the foot.

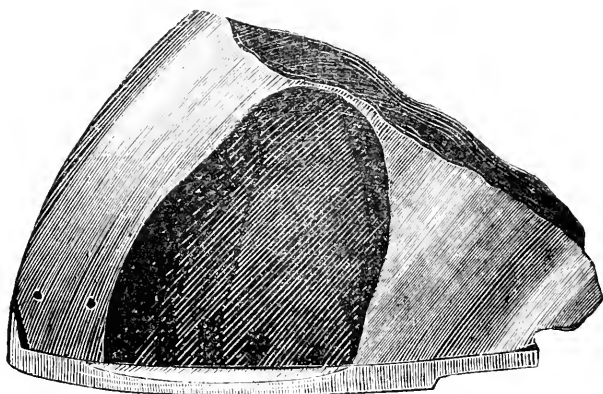
We are enabled to present our readers with the last improvement of the unilateral shoe.

The first cut gives a view of the outer side of the off or right unilateral shoe. The respective situations of the five nails will be observed;



the distance of the last from the heel, and the proper situations at which they emerge from the crust. The two clips will likewise be seen—one in the front of the foot, and the other on the side between the last and second nail.

The second cut gives a view of the inner side of the unilateral shoe. The two nails near the toe are in the situation in which Mr. Turner directs that they should be placed, and behind them is no other attachment, between the shoe and the crust. The heel of this shoe exhibits the method which Mr. Turner has adopted, and with considerable success, for the cure of corns; he cuts away a portion of the ground surface at the heel, and all injurious compression or concussion is rendered in a manner impossible in ordinary cases; however, with the exception of being rather thinner the inside heel of the shoe would be the counterpart of the outer.



There can be no doubt that this one-sided nailing has been exceedingly useful. It has, in many a case that threatened a serious termination, restored the elasticity of the foot, and enabled it to discharge its natural functions.



Although the unilateral shoe has still its advocates, they are few compared with the period when it was first introduced. This may be attributed partly to the different views taken with reference to the expansion of the foot, and also from the great difficulty in fixing it securely on the foot. It is an exceedingly useful method of shoeing, in some cases, but for ordinary work no shoe equals the ordinary seven-nailed concave-seated shoe.

It is difficult to tell what was the character of 'the old English shoe.' It certainly was larger than there was any occasion for it to be, and nearly covered the lower surface of the foot. The nail-holes were also far more numerous than they are at present. The ground side was usually somewhat convex. 'The effect of this,' says Mr. W. C. Spooner, in his treatise on the Foot, 'was to place the foot in a kind of hollow dish, which effectually prevented its proper expansion, the crust resting on a mere ledge instead of a flat surface; and, on the ground side, from the inner rim coming to the ground first, the weight was almost supported by the nails and clinches, which were placed, four or five on each side, at some distance from the toe, and approaching nearly to the heels.'

It was an improvement to make the ground surface flat, and to take care that it did not press on the sole. At length, however, came the concave-seated shoe of Osmer, which was advocated by Mr. Clark of Edinburgh, improved by Mr. Moorcroft, and ultimately became very generally and usefully adopted.

#### THE HUNTING SHOE.

The hunter's shoe is different from that commonly used, in form as well as in weight. It is not so much bevelled off as the common concave-seated shoe. Sufficient space alone is left for the introduction of a picker between the shoe and the sole, otherwise, in going over heavy ground, the clay would insinuate itself, and by its tenacity loosen, and even tear off the shoe. The heels likewise are somewhat shorter, that they may not be torn off by the toe of the hind-feet when galloping fast, and the outer heel is frequently but injudiciously turned up to prevent slipping. If calkins are necessary, both heels should have an equal bearing.

#### THE BAR-SHOE.

A bar-shoe is often exceedingly useful. It is the common shoe with the heels carried round to meet each other, thus forming a bar, which covers or rests on, as the case may require, the frog, and from whence the name is derived, and by means of it the pressure may be taken off from some tender part of the foot, and thrown on another which is better able to bear it, or more widely and equally diffused over the whole foot. It is principally resorted to in cases of corn, the seat of which it perfectly covers,—in puniced feet, the soles of which may be thus elevated above the ground and secured from pressure,—in sand-crack, when the pressure may be removed from the fissure, and thrown on either side of it,—and in thrushes, when the frog is tender, or is become cankered, and requires to be frequently dressed, and the dressing can by this means alone be retained. In these cases the bar-shoe is an excellent contrivance, if worn only for one or two shoeings, or as long as the disease requires it to be worn, but it must be left off as soon as it can be dispensed with.

If it is used for the protection of a diseased foot, however it may be chambered and laid off the frog, it will soon become flattened upon it; or if the pressure of it is thrown on the frog, in order to relieve the sand-crack or the corn, that frog must be very strong and healthy which can long bear the great and continued pressure. More mischief is often produced in the frog than previously existed in the part that was relieved.

It will be plain that in the use of the bar-shoe for corn or sand-crack, the crust and the frog should be precisely on a level: the bar also should be the widest part of the shoe, in order to afford as extended a bearing as possible on the frog, and therefore less likely to be injurious. Bar-shoes are evidently not safe in frosty weather. They are never safe when much speed is required from the horse, and they are apt to be wrenched off in a heavy, clayey country.

#### TIPS.

Tips are short shoes, reaching only half round the foot, and worn while the horse is at grass, in order to prevent the crust being torn by the occasional hardness of the ground, or the pawing of the animal. The quarters at the same time being free, the foot disposed to contract has a chance of expanding and regaining its natural shape.

#### THE EXPANDING SHOE.

Our subject would not be complete if we did not describe the supposed expanding shoe, although it is now almost entirely out of use. It is either seated or concave like the common shoe, with a joint at the toe, by which the natural expansion of the foot is said to be permitted, and the injurious consequences of shoeing prevented. There is, however, this radical defect in the jointed shoe, that the nails occupy the same situation as in the common shoe, and prevent, as they do, the gradual expansion of the sides and quarters, and allow only of a hinge-like motion at the toe. It is a most imperfect accommodation of the expansion of the foot to the action of its internal parts, and even this accommodation is afforded in the slightest possible degree, if it is afforded at all. Either the nails fix the sides and quarters as in the common shoe, and then the joint at the toe is useless; or, if that joint merely opens like a hinge, the nail-holes near the toe can no longer correspond with those in the quarters, which are unequally expanding at every point. There will be more stress on the crust at these holes, which will not only enlarge them and destroy the fixed attachment of the shoe to the hoof, but often tear away portions of the crust. This shoe, in order to answer the intended purpose, should consist of many joints, running along the sides and quarters, which would make it too complicated and expensive and frail for general use. The introduction of this shoe into general use, was for the greater portion of his life the main object of that very scientific and acute professor of the veterinary art, Mr. Bray Clark, and it is only within these few years, that finding the uncertainty of its effects more than negatived its supposed advantages, that he has given it up.

While the shoe is to be attached to the foot by nails, we must be content with the concave-seated or unilateral one, taking care to place the nail-holes as far from the heels, and particularly from the inner heel, as the state of the foot and the nature of the work will admit; and where the country is not too heavy nor the work too severe, omitting all but two on the inner side of the foot.

#### FELT OR LEATHER SOLES.

When the foot is bruised or inflamed the concussion or shock produced by the hard contact of the elastic iron with the ground gives the animal much pain, and aggravates the injury or disease. A strip of felt or leather, corresponding in shape with the shoe, is therefore sometimes placed between the seating of the shoe and the crust, which, from its elasticity, deadens or materially lessens the vibration or shock, and the horse treads more freely and is evidently relieved. This is a good contrivance while the inflamma-

tion or tenderness of the foot continues, but a very bad practice if constantly adopted. The nails cannot be driven so surely or securely when this substance is interposed between the shoe and the foot. The contraction and swelling of the felt or leather from the effect of moisture or dryness will soon render the attachment of the shoe less firm—there will be too much play upon the nails—the nail-holes will enlarge, and the crust be broken away.

After wounds or extensive bruises of the sole, or where the sole is thin and flat and tender, it is sometimes covered with a piece of leather, fitted to the sole, and nailed on with the shoe. This may be allowed as a temporary defence of the foot; but there is the same objection to its permanent use from the insecurity of fastening, and the strain on the crust, and the frequent chipping of it. There are also these additional inconveniences, that if the hollow between the sole and the leather is filled with stopping and tow, it is exceedingly difficult to introduce them so evenly and accurately as not to produce partial or injurious pressure. The long contact of the sole with stopping of almost every kind will produce a healthy, elastic horn, and if the hollow is not thus filled, gravel and dirt will insinuate themselves, and injure the foot. Facts, however, are stubborn things, and it is notorious that there are hundreds of horses doing their daily work over the London stones, with comparative comfort, that otherwise would be actual cripples working in pain and misery. Any alleviation to the artificial and laborious life of the horse in London and other large cities, must be hailed with satisfaction for its policy and humanity.

The general habit of stopping the feet requires some consideration. It is a very good or a very bad practice, according to circumstances. When the sole is flat and thin it should be omitted, except on the evening before shoeing, and then the application of a little moisture may render the paring of the foot safer and more easy. If it were oftener used it would soften the foot, and not only increase the tendency to descent, but the occasional occurrence of lameness from pebbles or irregularities of the road.

Professor Stewart gives a valuable account of the proper application of stopping. 'Farm horses seldom require any stopping. Their feet receive sufficient moisture in the fields, or, if they do not get much, they do not need much. Cart-horses used in the town should be stopped every Saturday night, until Monday morning. Fast going horses should be stopped once a week, or oftener during winter, and every second night in the hot weeks of summer. Groggy horses, and all those with high heels, concave shoes, or hot and tender feet, or an exuberance of horn, require stopping almost every night. When neglected, especially in dry weather, the sole becomes hard and rigid, and the horse goes lame, or becomes lame if he were not so before.'

One of two substances, or a mixture of both, is generally used for stopping the feet—clay and cow-dung. The clay used alone is too hard, and dries too rapidly. Many horses have been lamed by it. If it is used in the stable, it should always be removed before the horse goes to work. It may, perhaps, be applied to the feet of heavy draught horses, for it will work out before much mischief is done.

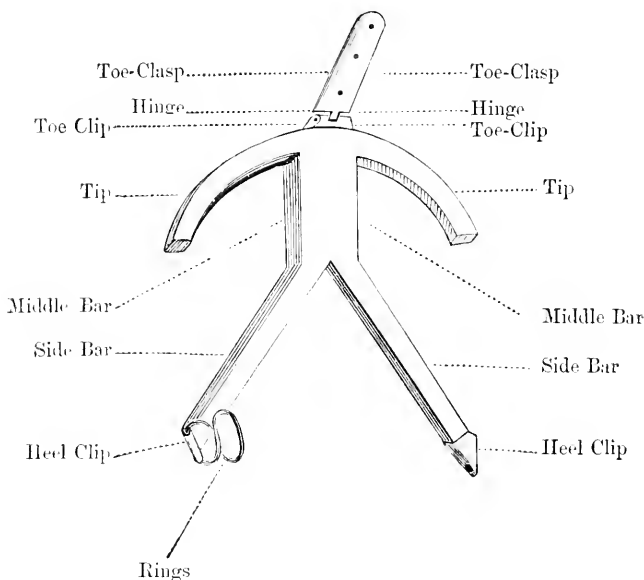
Cow-dung is softer than the clay, and it has this good property, that it rarely or never becomes too hard or dry. For ordinary work, a mixture of equal parts of clay and cow-dung will be the best application; either of them, however, must be applied with a great deal of caution, where there is any disposition to thrush. Tow used alone, or with a small quantity of tar, will often be serviceable.

In the better kind of stables a felt pad is frequently used. It was first introduced by principal Veterinary Surgeon Cherry. It keeps the foot cool

and moist, and is very useful, when the sole has a tendency to become flat. For the concave sole, tow would be preferable.

The shoe is sometimes displaced when the horse is going at an ordinary pace, and more frequently during hunting; and no person who is a sportsman needs to be told in what a vexatious predicament every one feels himself who happens to lose a shoe in the middle of a chase, or just as the hounds are getting clear away with their fox over the open country.

Mr. Percivall has invented a sandal which occupies a very small space in the pocket, can be buckled on the foot in less than two minutes, and will serve as a perfect substitute for the lost one, on the road or in the field; or may be used for the race-horse when travelling from one course to another; or may be truly serviceable in cases of diseased feet that may require at the same time exercise and daily dressing. The following is a short sketch of the horse sandal.



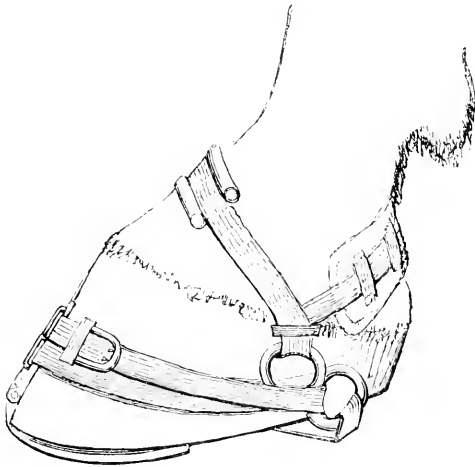
From an inspection of this cut it will be seen, that the shoe, or iron part of the sandal, consists of three *principal* parts, to which the others are appendages; which are, the *tip*, so called from its resemblance to the horse-shoe of that name; the *middle bar*, the broad part proceeding backward from the tip; and the *side bars*, or branches of the middle bar, extending to the heels of the hoof. The *appendages* are, the *toe-clasp*, the part projecting from the front of the tip, and which moves by a hinge upon the *toe-clip*, which toe-clasp is furnished with two *iron loops*. The *heel-clips* are two clips at the heels of the side bars which correspond to the toe-clip; the latter embracing the toe of the crust, while the former embrace its heels. Through the heel-clips run the *rings*, which move and act like a hinge, and are double, for the purpose of admitting both the straps. In the plate, the right ring only is represented; the left being omitted, the better to show the heel-clip. The *straps*, which are composed of web, consist of a *hoof-strap* and a *heel and coronet strap*.

The *hoof-strap* is furnished with a buckle, whose office it is to bind the

shoe to the hoof; for which purpose it is passed through the lower rings and both loops of the shoe, and is made to encircle the hoof twice.

The *heel and coronet strap* is furnished with two pads and two sliding loops; one, a moveable pad, reposes on the heel, to defend that part from the pressure and friction of the strap; the other, a pad attached to the strap near the buckle, affords a similar defence to the coronet, in front. The heel-strap runs through the upper rings, crosses the heel, and encircles the coronet, and its office is to keep the heels of the shoe closely applied to the hoof, and to prevent them from sliding forward.

In the application of the sandal the foot is taken up with one hand, and the shoe slipped upon it with the other. With the same hand the shoe is retained in its place, while the foot is gradually let down to rest on the ground. As soon as this is done, the straps are drawn as tight as possible and buckled.



The above cut presents an accurate delineation of the sandal, when properly fastened on the foot. The application of the sandal has recently been considerably simplified and improved, the toe-clip has but a single loop, and the heel-clips each a single ring; a vulcanised india-rubber band, which is slipped over the hoof, effectually secures the sandal; the front part of the band is retained in front of the hoof by the loop of the toe-clip; the back part being slipped over the heels, prevents all displacement.

---

## CHAPTER XXI.

### FRACTURES.

ACCIDENTS of this description are not of frequent occurrence, but when they do happen it is not always that the mischief can be repaired; occasionally, however, and much more frequently than is generally imagined, the life of a valuable animal might be saved if the owner, or the veterinary surgeon, would take a little trouble, and the patient is fairly tractable; and that, in the majority of cases, he will soon become. The number of

valuable animals is far too great that are destroyed under a confused notion of the difficulties of controlling the patient, or the incurable character of the accident. Messrs. Blaine and Percivall have given a valuable record of the usual cases and treatment of fracture which occur in the practice of the English veterinary surgeon; and the splendid work of Hurtrel d'Arboval contains a record of all that has been attempted or effected on the Continent. The author of this volume must confine himself to a rapid survey of that which they have described, adding a few cases that have been brought under his own observation, or communicated to him by others.

With the exception of accidents that occur in casting the animal for certain operations, and his struggles during the operation, the causes of FRACTURE are usually blows, kicks, or falls, and the lesion may be considered as *simple*, confined to one bone, and not protruding through the skin — or *compound*, the bone or bones protruding through the skin — or *comminuted*, where the bone is broken or splintered in more than one direction. The duty of the veterinary surgeon resolves itself into the replacing of the displaced bones in their natural position, the keeping of them in that position, the healing of the integument, and the taking of such measures as will prevent any untoward circumstances from afterwards occurring.

In the greater number of cases of fracture it will be necessary to place the horse under considerable restraint, and even to suspend or sling him.

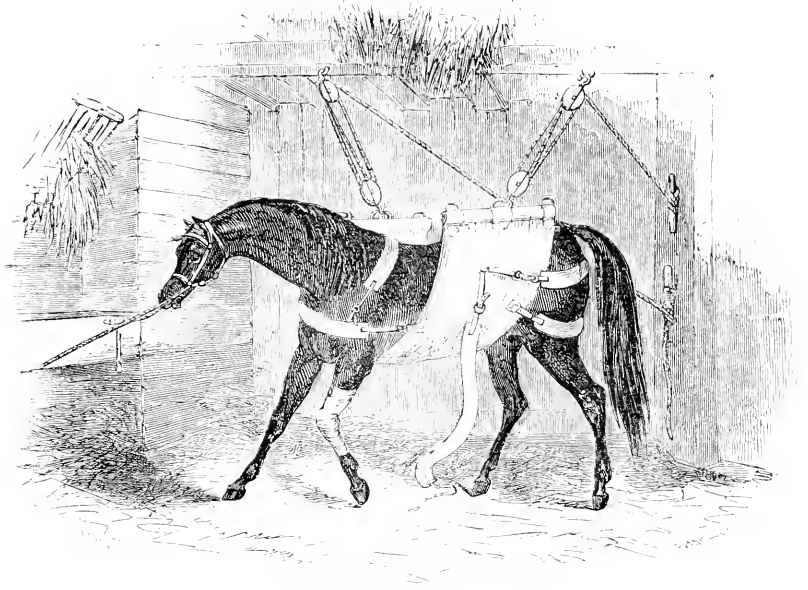
The cut in the next page contains a view of the suspensory apparatus used by Mr. Percivall. A broad piece of sail-cloth, furnished with two breechings, and two breast-girths, is placed under the animal's belly, and, by means of ropes and pulleys attached to a cross-beam above, he is elevated or lowered as circumstances may require. It will seldom be necessary to lift the patient quite off the ground, and the horse will be quietest, and most at his ease, when his feet are suffered just to touch it. The head is confined by two collar ropes, and the head-stall well padded. Many horses may plunge about and be difficult to manage at first, but, generally speaking, it is not long ere they become perfectly passive.

The use of the different buckles and straps which are attached to the sail-cloth will be evident on inspection. If the horse exhibits more than usual uneasiness, other ropes may be attached to the corners of the sail-cloth. This will afford considerable relief to the patient, as well as add to the security of the bandages.

In many cases the fracture, although a simple one, may be visible on the slightest inspection; in others, there may be merely a suspicion of its existence. Here will be exhibited the skill and the humanity of the educated surgeon, or the recklessness and brutality of the empiric. The former will carefully place his patient in the position at once the least painful to the sufferer, and the most commodious for himself. He will proceed with patience, gentleness, and management—no rough handling or motion of the parts, inflicting torture on the animal, and adding to the injury already received. It is interesting to observe how soon the horse comprehends all this, and submits to the necessary inspection; and how complete and satisfactory the examination terminates under the superintendence of the humane and cautious practitioner, while the brute in human shape fails in comprehending the real state of the case.

Heat, swelling, tenderness, fearfulness of the slightest motion, crepitus, and especially change of the natural position of the limb, are the most frequent indications of fracture. It should be laid down as a general rule, that cases of simple fracture only afford a probable chance of cure;—in compound fractures, that is, where the fracture of the bone is complicated

with an external wound, the chances are much more unfavourable; and in the comminuted fracture, that is, where the bone is smashed into small pieces, no reasonable chance of a cure can be entertained.



The probability of reunion of the parts depends upon the depth of the wound connected with the fracture—the contusion of the soft parts in the immediate neighbourhood of it—the blood-vessels, arterial or venous, that have been wounded—the propinquity of some large joint to which the inflammation may be communicated—dislocation of the extremities of the fractured joint—injuries of the periosteum—the existence of sinuses, caries, or necrosis, or the fracture being compound, or broken into numerous spiculae or splinters.

In a horse that is full of flesh, the cure of fracture is difficult; likewise in an old or worn-out horse—or when the part is inaccessible to the hand or to instruments—or when separation has taken place between the parts that were beginning to unite—or where the surrounding tissues have been or are losing their vitality—or when the patient is already afflicted with any old or permanent disease.

It may be useful briefly to review the various seats of fracture.

**FRACTURE OF THE SKULL.**—The skull of the horse is so securely defended by the yielding resistance of the temporal muscle, that fracture rarely occurs except at the occipital ridge; and should a depression of bone be there effected, it will produce complete coma, and bid defiance to all surgical skill. Fracture of the skull is generally accompanied by stupidity, convulsive motions of the head or limbs, laborious breathing, and a staggering walk. The eyes are almost or quite closed, the head is carried low, and the lower lip hangs down. Blows on the cranium, which the brutality of man too often inflicts, as well as many accidents, are very serious matters, and require considerable attention, for, although it may have been ascertained that the cranium is uninjured, there may be considerable concussion of the brain.

It having been known that a horse had received a violent blow on the head, the strictest examination of the part should take place. An artillery horse broke loose from his groom, and, after galloping about, dashed in to his own stall with such force as sadly to cut his face under the forelock. The farrier on duty sewed up the wound, proper dressings were applied, and in a little more than a fortnight the wound was healed and the horse dismissed, apparently well. Four days afterwards the patient moved stiffly; the jaws could not be separated more than a couple of inches, and there was evident locked jaw. The horse was cast, and the place where the wound had been was most carefully examined. On cutting to the bottom of it, a fracture was discovered, and a piece of bone three-fourths of an inch long was found on the centre of the parietal suture. This was removed—the wound was properly dressed, and a strong aloetic drink was given with great difficulty. The aloetic drink was repeated—the bowels became loosened—the tetanic symptoms diminished, and in less than three weeks the horse was perfectly cured.

This case, related in the seventh volume of the ‘*Veterinarian*,’ is a very interesting one. There was some carelessness in entrusting the treatment of the wound to the farrier; but the surgeon afterwards repaired the error as well as he could, and no one was better pleased than he was at the result. A violent blow being received on the forehead, the part should always be most carefully examined.

Hurtrel D’Arboval relates three cases of fracture of the skull. One occurred in a mare that ran violently against a carriage. The skull was depressed, and a portion of bone was removed, but it was four months ere complete reunion of the edges was effected. Another horse received a violent kick on the forehead. The union of the depressed bones was effected after the external wound was healed, but there was always a depression, an inch in length. An aged mare met with the same kind of accident. A depression here remained as large as a finger.

**FRACTURE OF THE ARCH OF THE ORBIT OF THE EYE.**—Mr. Pritchard, in the second volume of the ‘*Veterinarian*,’ relates an interesting case of fracture of the orbit of the eye. A chestnut mare, he says, received a blow which fractured the orbit from the superciliary foramen, in a line through the zygomatic processes of the temporal and malar bones, to the outer angle of the eye. The detached bone, together with the divided integument, hung over the eye so as to intercept vision. On examining the place where the accident occurred, two portions of bone were found belonging to the orbital arch. After carefully inspecting the wound and finding no other detached portions, nor any spiculæ which might irritate or wound, the adjacent portions of the skin were carefully drawn together and secured by a silver wire, which closed the wound, and confined the detached portion of bone in its proper place. A mash diet was ordered. On the following day there was considerable inflammation. The eye was bathed with warm water, and a dose of physic administered. On the third day the inflammation and swelling had still more increased. Blood was abstracted from the vein at the angle of the eye. The swelling and inflammation now speedily abated, and on the fifteenth day the wound had quite healed. If a fracture of this kind is suspected, its existence may be easily determined, by introducing the thumb under, and keeping the fore-finger upon, the edge of the orbit.

**FRACTURE OF THE NASAL BONES.**—This will sometimes occur from falling, or be produced by a kick from another horse, or the brutality of the attendant or the rider. We have seen a passionate man strike a horse about the head with a heavy hunting-whip. The danger of punishment of this kind is obvious; and so would be the propriety of using the whip



for another purpose. A fracture of this kind is generally accompanied by a laceration of the membrane of the nose, and considerable hæmorrhage, which, however, may generally be arrested by the application of cold water. The fractured portion of bone is usually depressed, and, the space for breathing being diminished, difficulty of respiration occurs. The author had a case of fracture of both nasal bones. He was enabled to elevate the depressed parts, but the inflammation and swelling were so great, that the animal was threatened with suffocation. The operation of tracheotomy was resorted to, and the animal did well.

If there is fracture of the nasal bones with depression, and only a little way from the central arch and the section between the nostrils, a slightly curved steel rod may be cautiously introduced into the passage, and the depressed portions carefully raised. If this cannot be effected, the trephine must be applied a little above or below the fracture, and the elevator or steel rod be introduced through the aperture. If the fracture is in any other part of the bone, it will be impossible to reach it with the elevator, for the turbinated bones are in the way. The trephine must then be resorted to in the first instance. The wound, if there is any, must be covered, and a compress kept on it.

A writer in a French journal relates a case in which a horse was violently kicked, and there was a contused wound with depression of bone. The trephine was applied. Fifteen splinters were extracted, and the case terminated well. It, nevertheless, too often happens that, in these injuries of the nasal membrane, the inflammation will obstinately continue in despite of all that the surgeon can do, and an obstinate and almost incurable nasal gleet will result.

If, however, this do not appear, some portion of bone may remain depressed, or the membrane may be thickened by inflammation. The nasal passage will then be obstructed, and a difficulty of breathing, resembling roaring, will ensue.

THE SUPERIOR MAXILLARY OR UPPER JAW-BONE will occasionally be fractured. Mr. Cartwright had a case in which it was fractured by a kick at the situation where it unites with the lachrymal and malar bones. He applied the trephine, and removed many small pieces of bone. The wound was then covered by adhesive plaster, and in a month the parts were healed.

Mr. Clayworth speaks of a mare who, being ridden almost at speed, fell and fractured the upper jaw, three inches above the corner incisors. The front teeth and jaw were turned like a hook completely within the lower ones. She was cast, a balling iron put into her mouth, and the surgeon, exerting considerable force, pulled the teeth outward into their former and proper situation. She was then tied up so that she could not rub her muzzle against anything, and was well fed with bean-meal, and linseed tea. Much inflammation ensued, but it gradually subsided, and, at the expiration of the sixth week, the mouth was quite healed, and scarcely a vestige of the fracture remained.

A very extraordinary and almost incredible account of a fracture of the superior maxillary bone is given in the records of the Royal and Central Society of Agriculture in France. A horse was kicked by a companion. There was fracture of the upper part of the superior maxillary and zygomatic bones, and the eye was almost forced out of the socket. Few men would have dared to undertake a fracture like this, but M. Revel shrunk not from his duty. He removed several small splinters of bone—replaced the larger bones—returned the eye to its socket—confined the parts by means of sufficient sutures—slung the horse, and rendered

it impossible for the animal to rub his head against anything. In six weeks the cure was complete.

THE INFERIOR MAXILLARY BONE, OR LOWER JAW, is more subject to fracture, and particularly in its branches between the tushes and the lower teeth, and at the symphysis between the two branches of the jaw. Its position, its length, and the small quantity of muscle that covers it, especially anteriorly, render it more liable to fracture, and the same circumstances combine to render a reunion of the divided parts more easy to be accomplished. Mr. Blaine relates that in a fracture of the lower jaw he succeeded by making a strong leather frame that exactly encased the whole jaw. The author of this volume has effected the same object by similar means.

M. H. Boulay relates, in the *Rec. de Méd. Vét.* for Nov. 1838, that he attended a horse, fracture of whose lower maxillary had taken place at the neck of that bone, between the tushes and the corner incisor teeth. The whole of the interior part of the maxillary bone in which the incisor teeth were planted was completely detached from the other portion of the bone, and the parts were merely held together by the membrane of the month.

The horse was cast—the corner tooth on the left side extracted—the wound thoroughly cleansed—the fractured bones brought into contact—some holes were drilled between the tushes and the second incisor teeth, above and below, through which some pieces of brass wire were passed, and thus the jaws were apparently fixed immovably together. The neck of the maxillary bone was surrounded by a sufficient compress of tow, and a ligature tied around it, with its bearing place on the tushes, and all motion thus prevented.

The horse was naturally an untractable animal, and in his efforts to open his jaws the wires yielded to his repeated struggles, and were to a certain degree separated. The bandage of tow was, however, tightened, and was sufficient to retain the fractured edges in apposition.

The month now began to exhale an infectious and gangrenous odour; the animal was dispirited, and would not take any food; gangrene was evidently approaching, and M. Boulay determined to amputate the inferior portion of the maxillary bone, the union of which seemed to be impossible. The sphacelated portion of the maxillary was entirely removed; every fragment of bone that had an oblique direction was sawn away, and the rough and uneven portions which the saw could not reach were rasped off.

Before night, the horse had recovered his natural spirits, and was searching for something to eat. On the following day a few oats were given to him, and he ate them with so much appetite and ease, that no one looking at him would think that he had been deprived of his lower incisor teeth. On the following day some hay was given to him, which he ate without difficulty, and in a fortnight was dismissed, the wounds being nearly healed.

In the majority of these cases of simple fracture a cure might be effected, or should, at least, be attempted, by means of well adapted bandages around the muzzle, confined by straps. It will always be prudent to call in veterinary aid, and it is absolutely necessary in case of compound fracture of the lower jaw.

FRACTURE OF THE SPINE.—This accident, fortunately for the horse, is not of frequent occurrence, but it has been uniformly fatal. It may take place in different parts of the vertebræ. In fracture of the cervical vertebræ, especially if it occurs above the fifth or sixth bone, the diaphragm will become palsied and death from suffocation will instantly result. This,

what is commonly termed 'broken neck,' is not often met with, and is generally produced by falls or blows. But by far the most frequent seat of fractured vertebræ is in the lumbar region. It sometimes happens in the act of falling, as in leaping a wide ditch; but it is oftener produced by the violence of some sudden unconscious movement of the animal, such as dropping the hind legs into some unseen grip or trench when going fast with hounds. It has also occurred during the struggles of the animal when cast and undergoing some painful operation.

It is generally sufficiently evident while the horse is on the ground. Either a snap is heard, indicative of the fracture, or the struggles of the hind-limbs suddenly and altogether cease. In a few cases the animal has been able to get up and walk to his stable; in others, the existence of the fracture has not been apparent for several hours: showing that the vertebræ, although fractured, may remain in their place for a certain period of time. The bone that is broken is usually one of the posterior dorsal or anterior lumbar vertebræ. There is no satisfactory case upon record of reunion of the fractured parts.

In the human being, the depressed portion of the spinal arch and of the fractured vertebræ have been removed by a dexterous operation, and sensibility and the power of voluntary motion have, in cases few and far between, been restored; but in the horse this has rarely or never been effected. We should consider him a bold operator, but we should not very much dislike him, who made one trial, at least, how far surgical skill might be available here.

Mr. W. C. Spooner relates an interesting case in the eleventh volume of the 'Veterinarian,' and many such have probably occurred. A horse had been clipped about three weeks, and was afterwards galloped sharply on rough ground, and pulled up suddenly and repeatedly, for the purpose of sweating him. After that he did not go so well as before, and would not canter readily, although he had previously been much used to that pace. Two days before he was destroyed, the groom was riding him at a slow pace, when he suddenly gave way behind, and was carried home and could not afterwards stand. He had, doubtless, fractured the spine slightly when pulled up suddenly, but without displacing the bones.

M. Dupuy was consulted respecting a mare apparently palsied. She had an uncertain and staggering walk, accompanied by evident pain. After various means of relief had in vain been tried during five-and-twenty days, she was destroyed. A fracture of the last dorsal vertebræ was discovered. It had never been quite complete, and ossific union was beginning to take place.

**FRACTURE OF THE RIBS.**—These fractures are not always easily recognised. Those that are covered by the scapula may exist for a long time without being detected, and those that are situated posteriorly are so thickly covered by muscles as to render the detection of the injury almost impossible. In the third volume of the 'Veterinarian' it is related that a man was trying to catch a mare in a field. She leaped at the gate, but failing to clear it, she fell on her back on the opposite side. She lay there a short time, and then got up and trotted to the stable. She was saddled, and her master, a heavy man, cantered her more than three miles. She then became unusually dull and sluggish, and was left on the road. She was bled; and on the following morning an attempt was made to lead her home. She was not, however, able to travel more than a mile. On the following morning she was evidently in great pain, and a veterinary surgeon, discovering a slight depression of the spinous processes of the eleventh and twelfth dorsal vertebræ, and detecting a certain crepitus,

ordered her to be destroyed. On post-mortem examination, the twelfth dorsal vertebra was found fractured, and the eleventh, twelfth, and thirteenth ribs on the near side were all fractured about two inches from their articulation with the vertebræ.

Hurtrel D'Arboval says that 'the two ribs behind the elbow are the most subject to fracture, and the false ribs, from the yielding motion which they possess, are least liable.' The ordinary causes of fracture are kicks and blows, or falls on the chest, and especially in leaping. The fractures are generally about their middle, and, in the true ribs, commonly oblique. They are occasionally broken into splinters, and if those splinters are directed inward, they may seriously wound the pleura, or lungs. In order most certainly to detect the situation and extent of these fractures, it may be necessary to trace the rib through its whole extent, and, should there be any irregularity, to press firmly upon it above and below in order to ascertain the nature and extent of the injury.

If fracture is detected, it is not often that much essential good can be done. If there is little or no displacement, a broad roller should be tightly drawn round the chest, in order to prevent as much as possible the motion of the ribs in the act of breathing, and to throw the labour on the diaphragm and the abdominal muscles until the fractured parts are united. If the fractured parts protrude outwards, a firm compress must be placed upon them. If they are depressed, it will always be advisable to place a firm bandage over the seat of fracture, although, perhaps, there may be scarcely the possibility of elevating them to any considerable degree. Should much irritation be the consequence of the nature or direction of the fracture, proper means must be adopted to allay the constitutional disturbance that may be produced. General or local bleedings will be most serviceable.

**FRACTURE OF THE PELVIS.**—This is not of frequent occurrence, on account of the thickness of the soft parts which surround the pelvis, and protect it from injury, but it is of a most serious character when it does take place, on account of the violence which must have been necessary to produce it. The usual causes are falls from a considerable height, or heavy blows on the pelvis. The injury may have reference to the internal or external portion of the pelvis. In the first case, the danger may not be discovered until irreparable mischief is produced. When it is chiefly external, the altered appearance of the hip speaks for itself. It is rarely in our power to afford any assistance in cases like this, except when there are fractured portions of the bone that may be partially or entirely removed, or the projecting spine of the ilium is only partially fractured.

M. Levrat gives an interesting account of a case of fracture of the right side of the pelvis, near the acetabulum, in leaping a wide ditch when hunting. 'The lameness which it occasioned,' says he, 'was such that the toe of the foot was scarcely permitted to touch the ground while the motion was at all rapid. When the motion was slow the foot was placed flat on the ground, but with great difficulty moved forward. On applying my right hand to the fractured part, which did not exhibit any heat, and seizing with my left hand the point of the thigh, I felt a movement of the ischium, which easily enabled me to judge of the fracture and its seat, and to discover that none of the fractured parts were displaced. I ordered her to be kept quiet for three weeks, and then permitted to wander about the stable. At the end of two months she was mounted and exercised at a foot pace, and in another month she was enabled to sustain the longest day's work without lameness. In the following year she was placed in the stud of the Baron de Staël, where she produced some good foals.'

The annals of the school at Alfort contain the case of an old mare with fracture of the pelvis and of the left ischium, and in whom union of the bones was effected so promptly, that on the thirtieth day very little lameness remained, and she shortly returned to her usual work. She soon afterwards died from some other cause, and the state of the osseous parts was thoroughly examined. These cases, however, stand almost alone, and post-mortem examination discovers fractures of the ischium and the pelvis, and each bone divided into many pieces, so that it is impossible for the hind quarters of the animal to be supported—also fractures of the external angle of the ilium, which rarely is again consolidated, and roughness of the bony fragments, which produce sad laceration of the soft parts. Fracture of the ischium presents almost insuperable difficulties—that of the ilium is uniformly fatal.

The upper and projecting part of the ilium or hip-bone is not unfrequently fractured, by the animal coming in contact with some hard substance, such as the side of the stable-door, or from getting cast in the stable. It generally causes lameness, but after a time the bone unites, although from the action of the muscles attached to this part, it assumes a different position, producing various degrees of deformity, and constitutes what is termed 'hip down' or 'let down on the hip.'

**FRACTURE OF THE TAIL.**—This accident is not of frequent occurrence, except from accidental entanglement, or the application of brute force. The fracture is easily recognised, frequently by the eye and always by the fingers. If the tail is not amputated, a cord passed over a pulley, and with a small weight attached to it, will bring the separated bones again into apposition, and in about a month the natural condition of the part will be sufficiently reinstated.

**FRACTURES OF THE LIMBS.**—These, fortunately, are of rare occurrence in the horse, for although their divided edges might be easily brought again into apposition, it would be sometimes impossible to retain them in it, for the slightest motion would displace them. A rapid survey of each may not, however, be altogether useless.

**FRACTURE OF THE SCAPULA.**—The author is not aware of the successful treatment of this accident by any English veterinary surgeon. Mr. Fuller says, in the eighth volume of the 'Veterinarian,' that he attempted it, but from the difficulty of keeping the divided edges of the bone in apposition with each other, and the natural untractableness of the animal, and symptoms of tetanus beginning to appear, the patient was destroyed. The fracture was a little above the neck of the scapula, and the muscles were dreadfully lacerated.

**FRACTURE OF THE HUMERUS.**—It is not at all times easy to discover the existence and precise situation of fracture of the humerus. The lameness is very great—the animal will not bear at all upon the broken limb—he will drag it along the ground—he will move slowly and with difficulty, and his progression will consist of a succession of short leaps. The lifting of the foot will give very great pain. If he is roughly handled, he will sometimes rear or throw himself suddenly down. By careful application of the hand a crepitus will more or less distinctly be heard. The chances are always materially against the union of a fracture of the humerus. The patient must be kept constantly suspended, and bandages carefully applied. M. Delaguette relates in the *Journal Pratique* for December 1831, that he attended an entire draught-horse whose humerus had been fractured by the kick of a mare. The fracture extended longitudinally through two-thirds of the length of the bone, and the parts were separated from each other. They were brought again into apposition, and kept so by means of pitch plasters and splints. The horse was put into slings; the pavement

of the stable was taken up; a hollow dug under the fractured limb, and this depression filled with straw, in order to afford a soft support for the foot. He was bled, gruel alone given as food, and injections daily administered.

On the 25th day the rollers were removed and replaced. On the 40th day he began to rest on the fractured limb. On the 60th day the bandages were removed, the fracture had been well consolidated, and the horse rested his weight upon it. It is reluctantly added that he was afterwards destroyed on account of some disease of the loins.

**FRACTURE OF THE RADIUS.**—This accident is not of infrequent occurrence. It commonly takes an oblique direction, and is usually first discovered by the displacement of the limb. Mr. Gloag, of the 10th Hussars, in the fourth volume of the 'Veterinarian,' gives an interesting account of a case that occurred in his practice. 'An entire black cart-horse was grazing in a field, into which some mares were accidentally turned. One of them kicked him severely a little above the knee. He, however, contrived to get home, and, being carefully examined, there was found a simple fracture of the radius, about an inch and a half above the knee. The ends of the fractured bone could be heard distinctly grating against each other, both in advancing the leg and turning it sideway from the body. He was immediately placed in a sling, not completely elevated from the ground, but in which he could occasionally relieve himself by standing. The leg was well bathed with warm water, and the ends of the bone brought as true to their position as possible. Some thin slips of green wood were then immersed in boiling water until they would readily bend to the shape of the limb, and they were tied round the part, the ends of them being tied with tow.

A fortnight afterwards he became very troublesome, knocking his foot on the ground, and when, at the expiration of the sixth week, he was taken from the slings, there was a considerable bony deposit above the knee. This, however, gradually subsided as the horse regained his strength, and, with the exception of turning the leg a little outwards, he is as useful as ever for common purposes.

**FRACTURE OF THE ULNA.**—This is far more exposed to danger than the last two bones, and is oftener fractured. The fracture is generally an oblique one, and about two-thirds from the summit of the bone. It is immediately detected by the altered action and different appearance of the limb. It is not so difficult of reduction as either the humerus or the scapula, when the fracture is towards the middle of the bone. A great quantity of tow saturated with pitch must be placed around the elbow, and confined with firm adhesive plasters, the ground being hollowed away in the front of the injured leg, so that no pressure shall be made by that foot.

**FRACTURE OF THE FEMUR.**—Considering the masses of muscle that surround this bone, and the immense weight which it supports, it would naturally be deemed impossible to reduce a real fracture of the femur. If the divided bones are ever united, it is a consequence of the simple repose of the parts, and their tendency to unite. Professor Dick, however, relates in the second volume of the 'Veterinarian,' a very singular and interesting account of the cure of fracture of the femur. He was requested to attend a bay mare that had met with an accident in leaping a sunken fence. He found a wound in the stifle of the hind leg running transversely across the anterior of the articulation, about an inch and a half in length, and in it was a portion of bone that had been fractured, and that had escaped from its situation towards the inside of the stifle, where it was held by a portion of ligament. The isolated nature of the

fractured portion, the difficulty, or rather impossibility of replacing it in its situation, and the few vessels which the connecting medium possessed, rendered it impossible that union would be effected; he therefore determined to remove it.

Having enlarged the wound, and divided the portion of capsular ligament which retained it in its place, he extracted the bone, and found it to be the upper part of the inner anterior condyle of the femur, measuring three inches in length, one inch and a half in breadth, and about an inch in thickness, and being in shape nearly similar to the longitudinal section of a hen's egg.

After the removal of the bone the animal seemed very much relieved; the wound was firmly sewed up, adhesive strapping applied over it, and the part kept wet with cold water.

Two days afterwards considerable swelling had taken place; she seemed to suffer much, and there was some oozing from the wound. Fomentations were again applied, and she was shung.

She now began rapidly to improve, and, although one of the largest articulations in the body had been laid open, and a part of the articular portion of the bone removed, the wound healed so rapidly that in three weeks she walked with little lameness to a loose box. At the expiration of another three weeks, the Professor again visited her. On being led out she trotted several times along the stable yard, apparently sound, with the exception of moving the limb in a slight degree wider than usual, and so completely was the part covered that, had it not been for a small scar that remained, a stranger could not have known that such an accident had taken place.

**FRACTURE OF THE PATELLA.**—This does occasionally, though very seldom occur. It is usually the consequence of violent kicks or blows, and if this singular bone is once disunited, no power can bring the divided portions of the bone together again.

**FRACTURE OF THE TIBIA.**—This affection is of more frequent occurrence, and of more serious consequence than we were accustomed to imagine it to be. Mr. Trump, twelve years ago, first called the attention of the profession to some singular circumstances connected with the tibia, in the third volume of the 'Veterinarian.' A large draught-horse belonging to the Dowlais Iron Company at Merthyr Tydvil, came in from his labour very lame in the near hind leg, but with no visible sign of any severe injury being received. The foot was searched, but nothing farther was done. He stood in the stable several days, and then was turned into a field, and was discovered one morning with the limb dependent, and a fracture of the tibia just above the hock.

Fourteen or sixteen months after that, another horse came home from a journey of seven miles, lame, with a slight mark on the inside of the thigh—a mere scratch, and very little tumefaction. There was nothing to account for such severe lameness: but a few mornings afterwards, the tibia was seen to be fractured. The front of the bone was splintered as from a blow.

Two months after that, another horse had been observed to be lame seven or eight days. A slight scratch was observed on the inside of the thigh, with a little swelling, and increased heat and tenderness just above the hock. Mr. Trump had examined the foot during the time that the horse stood in the stable, not being satisfied that the apparently slight injury on the thigh could account for the lameness. He was turned to grass, and three days afterwards the tibia was found broken at the part mentioned, and evidently from a blow. Were there not positive proof of

the circumstance, it would have been deemed impossible that a fracture, and of such a bone, could have existed so long without detection.

Mr. J. S. Mayer gives an interesting account of the successful treatment of a case of fracture of the tibia, in the Transactions of the Vet. Med. Association, in which some other cases, successfully treated, are narrated. The simplicity of the process will, we trust, encourage many another veterinary surgeon to follow his example.

'A horse received a blow on the tibia of the near leg, but little notice was taken of it for two or three days. When, however, we were called in to examine him, we found the tibia to be obliquely fractured about midway between the hock and the stifle, and a small wound existing on the inside of the leg. It was set in the following manner:—The leg from the stifle down to the hock was well covered with an adhesive compound; it was then wrapped round with fine tow, upon which another layer of the same adhesive mixture was laid, the whole being well splintered and bandaged up, so as to render what was a slightly compound fracture a simple one. The local inflammation and sympathetic fever that supervened were kept down by antiphlogistic measures. At the end of six weeks the bandages and splints were removed, and readjusted in a similar way as before, and at the termination of three months from the time of the accident, he was discharged cured, the splints being wholly taken off, and merely an adhesive stay kept on the leg. The horse is now at work and quite sound, there being merely a little thickening, where the callus is formed.'

**FRACTURE OF THE BONES OF THE HOCK.**—This is not of frequent occurrence, but very difficult to treat, from the almost impossibility of finding means to retain the bone in its situation. A case, however, somewhat simple in its nature, occurred in the practice of Mr. Cartwright. A colt, leaping at some rails, got his leg between them, and, unable to extricate himself, hung over on the other side. After being liberated, it appeared on examination that there was a simple horizontal fracture of the whole of the os calcis about the middle. A splint was contrived so as to reach from the middle of the tibia to that of the cannon bone, and this was applied to the front of the leg, keeping the hock from its usual motion, and relaxing the muscles inserted into the os calcis. Underneath this splint a charge was applied about the part, in order to form a level surface for the splint to rest upon. The whole was bound together by proper adhesive bandages, and he was ordered to be kept quiet in the stable, but not to be slung. In about two months the hock was fixed and became perfectly sound.

**FRACTURE OF THE CANNON OR SHANK BONE.**—This is of more frequent occurrence than that of any other bone, on account of the length of the leg, and the danger to which it is exposed. There is rarely any difficulty in detecting its situation, but there is sometimes a great deal in bringing the divided edges of the bone again into apposition. A kind of windlass, or a power equal to it, is occasionally necessary to produce sufficient extension in order to effect the desired purpose: but the divided edges being brought into apposition are retained there by the force of the muscles above. Splints reaching from the foot to above the knee should then be applied. The horse should be placed in slings, after which, if the case is going on well, the animal may often be turned out.

In cases of compound fracture the wounds should be carefully attended to: but Mr. Percivall says, in his 'Hippopathology,' that he knows one or two old practitioners, who are in the habit of treating these cases in a very summary and generally successful manner. They employ such common support, with splints and tow and bandages, as the case seems to



require, and then the animal with his leg bound up is turned out, if the season permits: otherwise he is placed in a yard or box, where there is not much straw to incommode his movements. The animal will take care not to impose too much weight on his fractured limb; and, provided the parts are well secured, nature will generally perform the rest.

**FRACTURE OF THE SESAMOID BONES.**—There are but few instances of this on record. One is related by Mr. Fuller, of March, in the third volume of the 'Veterinarian.' He was galloping steadily and not rapidly a horse of his own, when the animal suddenly fell as if he had been shot. He was broken down in both fore legs. The owner very humanely ordered him to be immediately destroyed. Both the perforans and perforatus tendons of the near fore leg were completely ruptured, just where they pass over the sesamoid bone, which was fractured in a transverse direction. The sesamoid bone of the off leg was fractured in the same direction, but the tendons were entire.

Another case is one described by Mr. Harris, of Preston, in the fifth volume of the 'Veterinarian.' A strong coach-like animal was galloped rapidly. He had not gone more than a hundred yards before he suddenly fell, and it was with great difficulty that he could be led home, a distance of about two miles. There was soon considerable swelling in the off fore leg—great pain on the animal's attempting to walk, and his fetlock nearly touched the ground. Some slight crepitus could be detected, but the exact seat of it could not be ascertained. Mr. Harris considered the case as hopeless, but the owner would have some means tried to save the animal. He was accordingly bled and physicked, and cold lotions and bandages were applied to the foot. Two days afterwards some bony spiculæ began to protrude through the skin, and, the case being now perfectly hopeless, the animal was destroyed. The inner sesamoid bone was shivered to atoms.

**FRACTURE OF THE UPPER PASTERN.**—Thick and strong, and moveable as this bone seems to be, it is occasionally fractured. This has been the consequence of a violent effort by the horse to save himself from falling when he has stumbled,—it has happened when he has been incautiously permitted to run down a steep descent—and has occurred when a horse has been travelling on the best road, and at no great pace.

The existence of fracture in this bone is, generally speaking, easily detected. The injured foot is as lightly as possible permitted to come in contact with the ground. As little weight as may be is thrown on it, or, if the animal is compelled to use it, the fetlock is bent down nearly to the ground, and the toe is turned upward. If the foot is rotated a crepitus is generally heard.

This, however, is not always the case. A case is related in the *Rec. de Méd. Vét.*, November, 1831, in which M. Levrat was requested to examine a horse that had suddenly become lame. The near hind leg was retracted, and the foot was kept from touching the ground. He carefully examined the foot, and discovered that much pain was expressed when the pastern was handled. He suspected fracture of the bone, but he could not detect it. He bled the animal, ordered cooling applications to the part, and gave a dose of physic. Three days afterwards he again saw his patient, and readily detected a fracture, taking a direction obliquely across the pastern.

The probability of success in the treatment of this fracture, depends on its being a simple or compound one. If it runs laterally across the bone, it may be readily and successfully treated—if it extends to the joints above and below, it will probably terminate in ankylosis, and if the bone is shivered, as it too frequently is, into various parts, there would scarcely seem the possibility of a successful treatment of the case. The instances,

however, are numerous in which the case terminates successfully. Hurtrel D'Arboval recommends that a bandage steeped in some adhesive matter should be applied from the coronet to the middle of the leg. On this some wet pasteboard is to be moulded, enveloped afterwards in a linen bandage. A small splint is now to be applied before and behind and on each side, and the hollow places are filled with tow, in order to give them an equal bearing. If this does not appear to be sufficiently secure, other splints, thicker and broader, are placed over those, extending to the knee or the hock.

The case related by M. Levrat was treated in this way. It will be comparatively seldom that it will be necessary to suspend the patient. The animal under the treatment of M. Levrat, kept his foot in the air for nearly three weeks. At the end of that period he now and then tried to rest his toe on the litter. Six weeks after the accident he began to throw some weight on the foot; and a few days afterwards he was able to go to a pond, about fifty paces from his stable, and where, of his own accord, he took a foot-bath for nearly an hour at a time. At the expiration of another month he was mounted, and went very well at a walking-pace; he was, however, still lame when he was trotted.

Another horse, treated by the same surgeon, was soon able to rest on the bad leg, in order to change his position—he was allowed three weeks after that, and then commenced his former daily work—the drawing of a heavy cart. He limped a little when he was trotted; but did as much slow work as he was ever accustomed to do.

**FRACTURE OF THE LOWER PASTERNS.**—Although this bone is much shorter than the upper pastern, there are several instances of fracture of it. The fractures of this bone are commonly longitudinal, and often present a lesion of continuity extending from the larger pastern to the coffin-bone. It is frequently splintered, the splinters taking this longitudinal direction. Hurtrel D'Arboval relates three cases of this, and in one of them the bone was splintered into four pieces. In several instances, however, this bone has been separated into eight or ten distinct pieces. When the fracture of the bone is neither compound nor complicated, it may be perfectly reduced by proper bandaging, and, in fact, there have been cases, in which union has taken place with slight assistance from art beyond the application of a few bandages.

M. Gazot relates a very satisfactory termination of fracture of this bone in a carriage-horse in the *Recueil de Méd. Vét.* for 1834. The animal fell, and was totally unable to rise again. He was placed on some hurdles, and drawn home. A veterinary surgeon being consulted, recognised fracture of the lower pastern in both feet, and advised that the animal should be destroyed. It was a favourite horse, between five and six years old, and the owner determined to give it a chance of recovery.

M. Gazot was consulted. He plainly recognised a transverse fracture in the lower pastern of the right leg, and a longitudinal one in the left pastern. They were both of them simple fractures. The horse was manageable, and seemed to comprehend the whole affair. He was a favourite of the groom as well as the master, and it was determined to give him a chance of recovery. He had plenty of good litter under him, which was changed twice in the day. The first object that was attempted to be accomplished was the healing of the excoriations that had taken place in drawing him home, and abating the inflammation that was appearing about the pasterns.

At the termination of the first week all these were healed, the horse fed well, and was perfectly quiet, except that when he was tired of lying on one side he contrived to get on his knees, and then to raise himself on his

haunches, and, having voided his urine and his dung, he turned himself upon the other side, without the bandages round his pasterns being in the slightest degree interfered with.

At the expiration of the second week he seemed to wish to get up. The groom had orders to assist him, and a sling was passed under him. Some oats were placed in the manger, and he seemed to enjoy the change for a little while. Soon afterwards he began to be uneasy, and a copious perspiration appeared on every part. He was immediately lowered, when, with evident delight, he stretched out his head and his legs, and lay almost without motion during several hours. On the following day he was again placed in the sling, and again lowered as soon as he appeared to be fatigued.

At the expiration of a month from the time of the accident he could get up without assistance, and would continue standing two or three hours, when he lay down again, but with a degree of precaution that was truly admirable. The bandages around the pasterns had been continued until this period, and had been kept wet with a spirituous embrocation. The horse was encouraged to walk a little, some corn being offered to him in a sieve. He was sadly lame, and the lameness was considerably greater in the left than in the right foot. A calculous enlargement could also be felt in the direction of the fracture on each pastern; but it was greatest in the left fetlock, and there was reason to fear the existence of ankylosis between the pastern bones of the left leg. That foot was surrounded with emollient cataplasms, and, two days afterwards, was pared out, and the cauterly applied over both pasterns, the spirituous embrocation being continued.

A fortnight afterwards the effect of the cauterly was very satisfactory. The action of the part was more free, and there was no longer any fear of ankylosis. It was, however, deemed prudent to apply the cauterly over the right pastern. Walking exercise was now recommended, and in the course of another month the lameness was much diminished. It was most on the left side, which, however, had resumed its former degree of inclination.

At the expiration of four months the horse was sent to work. His master, however, doubting the stability of the cure, sold him, for which he ought to have had his own legs broken, and he fell into bad hands. He was worked hardly and half-starved; nevertheless, the calculus continued to diminish, and the lameness altogether disappeared. He soon, however, passed into better hands. He was bought by a farmer at Chalons, in whose service he long remained, in good condition, and totally free from lameness. His last owner gave him the name of *Old Broken Leg*.

**FRACTURE OF THE COFFIN-BONE.**—This is an accident of very rare occurrence, and difficult to distinguish from other causes of lameness. The animal halts very considerably—the foot is hot and tender—the pain seems to be exceedingly great, and none of the ordinary causes of lameness are perceived. According to HURTREL D'ARBOVAL, it is not so serious an accident as has been represented. The fractured portions cannot be displaced, and in a vascular bone like this, the union of the divided parts will be readily effected.

Mr. Percivall very properly remarks, that, 'buried as the coffin and navicular bones are within the hoof, and out of the way of all external injury, as well as of muscular force, fracture of them cannot proceed from ordinary causes. It is, perhaps, thus produced:—in the healthy foot, in consequence of the elasticity of their connections, these bones yield or spring under the impression they receive from the bones above, and thus are enabled to bear great weights, and sustain violent shocks without injury; but, disease in the foot is often found to destroy this elasticity, by changing the cartilage into bone, which cannot receive the same weight

and concussion without risk of fracture. Horses that have undergone the operation of neurotomy more frequently meet with this accident than others, because they batter their senseless feet with a force which, under similar circumstances, pain would forbid the others from doing.

FRacture OF THE NAVICULAR BONE has been sufficiently considered under the article 'Navicular Joint Disease,' p. 413.

Mr. Mayer sums up his account of the treatment of fractures in a way that reflects much credit on him and the profession of which he is a member. 'Let your remedies,' says he, 'be governed by those principles of science, those dictates of humanity, and that sound discretion, which, while they raise the moral and intellectual superiority of man, distinguish the master of his profession from the bungling empiric.'

## CHAPTER XXII.

### OPERATIONS.

THESE belong more to the veterinary surgeon than to the proprietor of the horse, but a short account of the manner of conducting the principal ones should not be omitted.

It is frequently necessary to bind the human patient, and in no painful or dangerous operation should this be omitted. It is more necessary to bind the horse, who is not under the control of reason, and whose struggles may not only be injurious to himself but dangerous to the operator.

The *trevis* is a machine indispensable in every continental forge; even the quietest horses are there put into it to be shod.

The *side-line* is a very simple and useful method of confining the horse, and placing him in sufficient subjection for the operation of docking, nicking, and slight firing. The long line of the *hobbles*, or a common cart-rope with a noose at the end, is fastened on the pastern of the hind-leg that is not to be operated on. The rope attached to it is then brought over the neck and round the withers, and there tied to the portion that comes from the leg. The leg may thus be drawn so far forward that, while the horse evidently cannot kick with that leg, he is disarmed of the other; for he would not have sufficient support under him if he attempted to raise it: neither can he easily use his fore-legs, or, if he attempts it, one of them may be lifted up, and then he becomes nearly powerless. If necessary, the aid of the twitch or the barnacles may be resorted to.

For every minor operation, and even for many that are of more importance, this mode of restraint is sufficient, especially if the operator has active and determined assistants; and we confess that we are no friends to the casting of horses, if it can possibly be prevented. When both legs are included in the hobble or rope—as in another way of using the *side-line*—the horse may appear to be more secure; but there is greater danger of his falling in his violent struggles during the operation.

For castrating and severe firing, the animal must be thrown. The safety of the horse and of the operator will require the use of the *improved* hobbles, by which any leg may be released from confinement, and returned to it at pleasure; and, when the operation is ended, the whole of the legs may be set at liberty at once without danger. The method of putting the legs as closely together as possible before the pull—the necessity of the assistants all pulling together—and the power which one man standing at

the head and firmly holding the snaffle-bridle, and another at the haunch pushing the horse when he is beginning to fall, have in bringing him on the proper side, and on the very spot on which he is intended to lie, need not to be described; but a much preferable plan to having a man at the haunch is to have a roller round the body, with a rope attached to a ring on the top of it, by pulling this rope in the opposite direction at the same moment as the hobbles are tightened, the side on which he falls is a matter of certainty. This, however, is a method of securing the horse to which we repeat that we are not partial, and to which we should not resort except necessity compelled; for in the act of falling, and in the struggles after falling, many accidents have occurred both to the horse and the surgeon.

Among the minor methods of restraint, but sufficient for many purposes, are the *twitch* and the *burnacles*. The former consists of a noose passed through a hole at the end of a strong stick, and in which the muzzle is enclosed. The stick being turned round, the muzzle is securely retained, while the horse suffers considerable pain from the pressure—sufficiently great, indeed, to render him comparatively inattentive to that which is produced by the operation; at the same time he is afraid to struggle, for every motion increases the agony caused by the twitch, or the assistant has power to increase it by giving an additional turn to the stick.

The degree of pain produced by the application of the twitch should never be forgotten or unnecessarily increased. In no case should it be resorted to when milder measures would have the desired effect. Grooms and horsekeepers are too much in the habit of having recourse to it when they have a somewhat troublesome horse to manage. The degree of useless torture which is thus inflicted in large establishments is dreadful; and the temper of many a horse is too frequently completely spoiled.

The *burnacles* are the handles of the pincers placed over and enclosing the muzzle, and which, being compressed by the assistant, give pain almost equal to that of the twitch. These may appear to be barbarous modes of enforcing submission, but they are absolutely indispensable. In a few instances the blindfolding of the horse terrifies him into submission; but this is not to be depended upon. The twitch should be resorted to when the least resistance is offered; and when that, as it occasionally does, renders the horse more violent, recourse must be had to the side-line or the hobbles.

In the painful examination of the fore-leg or foot while on the ground, the other foot should be held up by an assistant; or, if his aid is required in an operation, the knee may be fully bent, and the pastern tied up to the arm. When the hind-leg is to be examined in the same way, the fore-leg on that side should be held or fastened up.

#### CASTRATION.

The period at which this operation may be best performed depends much on the breed and form of the colt, and the purpose for which he is destined.

If the horse is designed either for the carriage or for heavy draught, the farmer should not think of castrating him until he is at least a twelve-month old; and, even then, the colt should be carefully examined. If he is thin and spare about the neck and shoulders, and low in the withers, he will materially improve by remaining uncut another six months; but if his fore-quarters are fairly developed at the age of a twelve-month, the operation should not be delayed, lest he become heavy and gross before, and perhaps has begun too decidedly to have a will of his own. No specific age, then, can be fixed; but the castration should be performed

rather late in the spring or early in the autumn, when the air is temperate and particularly when the weather is dry.

The only preparation necessary for the colt is keeping him without food for twelve hours before performing the operation. In the majority of cases, no after-treatment will be necessary, except that the animal should be sheltered from intense heat, and more particularly from wet. In temperate weather he will do much better running in the field than nursed in a close and hot stable. The moderate exercise that he will take in grazing will be preferable to perfect inaction. A large and well ventilated box, however, may be permitted.

The manner in which the operation is performed will be properly left to the veterinary surgeon; although we must confess we are disposed to adhere to the old way of opening the scrotum with the hot iron and searing off the testicle with it. The writer has operated on some hundreds of colts in this manner, and, however fearful the operation may appear, experience proves that it is attended with the most successful results. It possesses the advantage of great simplicity in performing the operation, and also from the wound made through the scrotum by the hot iron, taking a considerably longer period to heal than an ordinary incised one, more time is allowed for the slough from the cord to pass through the opening, and thus prevent that swelling and inflammation which so frequently follow, when the opening in the scrotum has closed before the slough has separated from the end of the cord.

There are several other modes adopted by practitioners in performing this operation. Amongst some, what is called the caustic clam is the favourite method. This consists in opening the scrotum and compressing the cord between two pieces of wood on which some caustic preparation has been placed, and by this means arresting hæmorrhage. There is at least an appearance of brutality in this, and we believe much unnecessary pain inflicted when the spermatic cord (the vessels and the nerve) is tightly compressed between two pieces of wood, as in a powerful vice, and left there either until the testicle drops off or is removed on the following day by the operator. By others, the scrotum is opened and the testicle removed with a scalpel, hæmorrhage being prevented by a ligature placed round the cord. Another mode of castration has been lately introduced; it is called the operation by *Torsion*. An incision is made into the scrotum as in the latter mode of operation, and the *vas deferens* is exposed and divided. The artery is then seized by a pair of forceps contrived for the purpose, and twisted six or seven times round. It retracts as soon as the hold on it is quitted, the coils are not untwisted and all bleeding has ceased. The testicle is removed, and there is no sloughing or danger. The most painful part of the operation—the application of the firing-iron or the clams—is avoided, and the wound readily heals. To the practice of some farmers of *twitching* their colts at an early period, sometimes so early as a month, there is strong objection. When the operation of twitching is performed, a small cord is drawn as tightly as possible round the scrotum between the testicle and the belly. The circulation is thus stopped, and, in a few days, the testicles and the scrotum drop off; but not until the animal has sadly suffered, and inflammation and death frequently ensue.

#### BLEEDING.

This operation is performed with a fleam or a lancet. The first is the common instrument, and the safest, except in skilful hands. The lancet, however, has a more surgical appearance, and will be adopted by the veterinary practitioner. A blood-stick—a piece of hard wood loaded at

one end with lead — is used to strike the fleam into the vein. This is sometimes done with too great violence, and the opposite side of the coat of the vein is wounded. Bad cases of inflammation have resulted from this. If the fist is doubled, and the fleam is sharp and is struck with sufficient force with the lower part of the hand, the blood-stick may be dispensed with.

For general bleeding the jugular vein is selected. The horse is blind-folded on the side on which he is to be bled, or his head turned well away. The hair is smoothed along the course of the vein with the moistened finger; then, with the third and little fingers of the left hand, which holds the fleam, pressure is made on the vein sufficient to bring it fairly into view, but not to swell it too much, for then, presenting a rounded surface, it would be apt to roll or slip under the blow. The point to be selected is about two inches below the union of the two portions of the jugular at the angle of the jaw (see *cut*, p. 199). The fleam is to be placed in a direct line with the course of the vein, and over the precise centre of the vein, as close to it as possible, but its point not absolutely touching the vein. A sharp rap with the blood-stick or the hand on that part of the back of the fleam immediately over the blade, will cut through the vein, and the blood will flow. A fleam with a large blade should always be preferred, for the operation will be materially shortened, and this will be a matter of some consequence with a fidgety or restive horse. A quantity of blood drawn speedily will also have far more effect on the system than double the weight slowly taken, while the wound will heal just as readily as if made by a smaller instrument. There is no occasion to press so hard against the neck with the pail, or can, as some do; a slight pressure, if the incision has been large enough and straight, and in the middle of the vein, will cause the blood to flow sufficiently fast; or, the finger being introduced into the mouth between the tushes and the grinders, and gently moved about, will keep the mouth in motion, and hasten the rapidity of the stream by the action and pressure of the neighbouring muscles.

When sufficient blood has been taken, the edges of the wound should be brought closely and exactly together, and kept together by a small sharp pin being passed through them. Round this a little tow, or a few hairs from the mane of the horse, should be wrapped, so as to cover the whole of the incision: and the head of the horse should be tied up for several hours to prevent his rubbing the part against the manger. In bringing the edges of the wound together, and introducing the pin, care should be taken not to draw the skin too much from the neck, otherwise blood will insinuate itself between it and the muscles beneath, and cause an unsightly and sometimes troublesome swelling.

The blood should be received into a vessel the dimensions of which are exactly known, so that the operator may be able to calculate at every period of the bleeding the quantity that is subtracted. Care likewise should be taken that the blood flows in a regular stream into the centre of the vessel, for if it is suffered to trickle down the sides, it will not afterwards undergo those changes by which we partially judge of the extent of inflammation. The pulse, however, and the symptoms of the case collectively, will form a better criterion than any change in the blood. Twenty-four hours after the operation, the edges of the wound will have united, and the pin should be withdrawn. When the bleeding is to be repeated, if more than three or four hours have elapsed, it will be better to make a fresh incision rather than to open the old wound.

Few directions are necessary for the use of the lancet. They who are competent to operate with it, will scarcely require any. If the point is sufficiently sharp the lancet can scarcely be too broad-shouldered; and an

abscess lancet will generally make a freer incision than that in common use. Whatever instrument is adopted, too much care cannot be taken to have it perfectly clean and very sharp. It should be carefully wiped and dried immediately after the operation, otherwise, in a very short time, the edges will begin to be corroded.

For general bleeding the jugular vein is selected at the largest superficial one, and most easily got at. In every affection of the head, and in cases of extended inflammatory action, it is decidedly the best place for bleeding. In local inflammation, blood may be taken from any of the superficial veins. In supposed affections of the shoulder, or of the fore-leg or foot, the radial vein, which comes from the inside of the arm, and runs upwards directly in front of it towards the jugular, may be opened. In affections of the hind extremity, blood is sometimes extracted from the *saphæna*, or thigh-vein, which runs across the inside of the thigh. In foot cases it may be taken from the coronet, or, much more safely, from the toe; not by cutting out, as the farrier does, a piece of the sole at the toe of the frog, which sometimes causes a wound difficult to heal, and sometimes followed by festering; but cutting down with a fine drawing-knife, called a searcher, at the union between the crust and the sole at the very toe until the blood flows, and if necessary, encouraging its discharge by dipping the foot in warm water. The mesh-work of both arteries and veins will be here divided, and blood is generally obtained in any quantity that may be needed. The bleeding may be stopped with the greatest ease, by placing a bit of tow in the little groove that has been cut, and tacking the shoe over it.

The operation of bleeding having been described, we would remind our readers of the necessity in every case, in which it is required, of making a large orifice, and abstracting the blood as rapidly as possible, for the constitution will thus be the more speedily and beneficially affected; and also of the propriety of never determining to take a precise quantity of blood, but of keeping the finger on the artery until the pulse begins to falter — until the strong pulse, becomes softer or the animal is faint, or the oppressed pulse is rounder and fuller.

The change which takes place in the blood after it is drawn from the vein, is very diligently noticed by many practitioners, and is certainly deserving of some attention. The blood coagulates soon after it is taken from the vein. The coagulable part is composed of two substances; these, by degrees, separate from each other, and the red particles sink to the bottom. If the coagulation takes place slowly, the red particles have more time to sink through the fluid, and there appears on the top a thick, yellowish, adhesive coat, called the buffy coat. It is supposed that the slowness of coagulation, and the thickness of buffy coat, are indicative of the degree of inflammation.

In a healthy state of the system, the coagulation is more rapid, the red particles have not time to fall through, and the buffy coat is thin. These appearances are worth observing; but much more dependence is to be placed on the character and change of the pulse, and the symptoms generally. When the horse is exhausted and the system nearly broken up, the blood will sometimes not coagulate, but be of one uniform black colour and loose texture. When the blood runs down the side of the vessel in which it is received, the coagulation will be very imperfect. When it is drawn in a full stream, it coagulates slowly, and when procured from a smaller orifice, the coagulation is more rapid. Every circumstance affecting the coagulation and appearance of the blood, the pulse, and the general symptoms, should be most attentively regarded.



## BLISTERING.

We have spoken of the effect of BLISTERS, when treating of the various diseases to which they are applicable. The principle on which they act is, that no two intense inflammations can exist in neighbouring parts, or perhaps in the system, at the same time. Hence we apply some irritating substance to the skin, in order to excite external inflammation, and thus lessen or remove that which exists in some deeper-seated and, generally, not far distant part. Hence, also, we blister the sides in inflammation of the lungs—the abdomen in that of the bowels—the legs in that of the cellular substance surrounding the sheaths of the tendons, or the sheaths themselves, and the coronet in inflammation of the navicular joints.

Blisters have likewise the property of increasing the activity of the neighbouring vessels: thus we blister to bring the tumour of strangles more speedily to a head—to rouse the absorbents generally to more energetic action, and cause the disappearance of tumours, and even callous and bony substances.

The judgment of the practitioner will decide whether the desired effect will be best produced by a sudden and violent action, or by the continuance of one of a milder character. Inflammation should be met by active blisters; old enlargements and swellings will be most certainly removed by milder stimulants—by the process which farriers call *sweating down*.

There are few more active or effectual blisters than the cantharides or Spanish fly, mixed with the proportions of lard and resin that will be hereafter stated. The best liquid or sweating blister is an infusion of the fly in vinegar, olive oil, or spirit of turpentine, according to the degree of activity required.

In preparing the horse for blistering, the hair should be clipped or shaved as closely as possible, and the ointment thoroughly rubbed in. Much fault is often found with the ointment if the blister does not rise, but the failure is generally to be attributed to the idleness of the operator.

The head of the horse should be tied up during the first two days; except that, when the sides are blistered, the body-clothes may be so contrived as to prevent the animal from nibbling and blemishing the part, or blistering his muzzle. At the expiration of twenty-four hours, a little olive oil should be applied over the blister, which will considerably lessen the pain and supple the part, and prevent cracks in the skin that may be difficult to heal. The oil should be applied morning and night, until the scabs peel off.

Every particle of litter should be carefully removed from the stall, for the sharp ends of the straw coming in contact with a part rendered so tender and irritable by the blister, will cause a very great annoyance to the animal. After the second day the horse may be suffered to lie down; but the possibility of blemishing himself should be prevented by a *cradle* or wooden necklace, consisting of round strips of wood, strung together, reaching from the lower jaw to the chest, and preventing him from sufficiently turning or bending his head, to get at the blistered part.

A blister thus treated will rarely produce the slightest blemish. When the scabs are all removed, the blister may be repeated, if the case should appear to require it, or the horse may be turned out.

In inflammations which threaten life, a blister can scarcely be too active or extensive. In inflammation of the lungs it should reach over the whole of the sides, and the greater part of the brisket, for, should a portion of the fly be absorbed, and produce *strangury* (inflammation, or spasmodic affection of the neck of the bladder,) even this new irritation

may assist in subduing the first and more dangerous one. In blistering, however, for injuries or diseases of the legs or feet, some caution is necessary. When speaking of the treatment of sprain of the back sinews, it was stated, that 'a blister should never be used while any great heat or tenderness remained about the part,' for we should then add to the superficial inflammation, instead of abating the deeper-seated one, and enlargements of the limb and extensive ulcerations might follow, which would render the horse perfectly unserviceable. When there is a tendency to grease, a blister is a dangerous thing, and has often aggravated the disease. In winter, the inflammation of the skin produced by blistering is apt to degenerate into grease; therefore, if it should be necessary to blister the horse during that season, great care must be taken that he is not exposed to cold, and, particularly, that a current of cold air does not come upon the legs.

The inhuman practice of blistering *all round* at the same time, and perhaps high on the legs, cannot be too strongly reprobated. Many a valuable horse has been lost through the excessive general irritation which this has produced, or its violent effect on the urinary organs, and that has been particularly the case, when corrosive sublimate has entered into the composition of the blister.

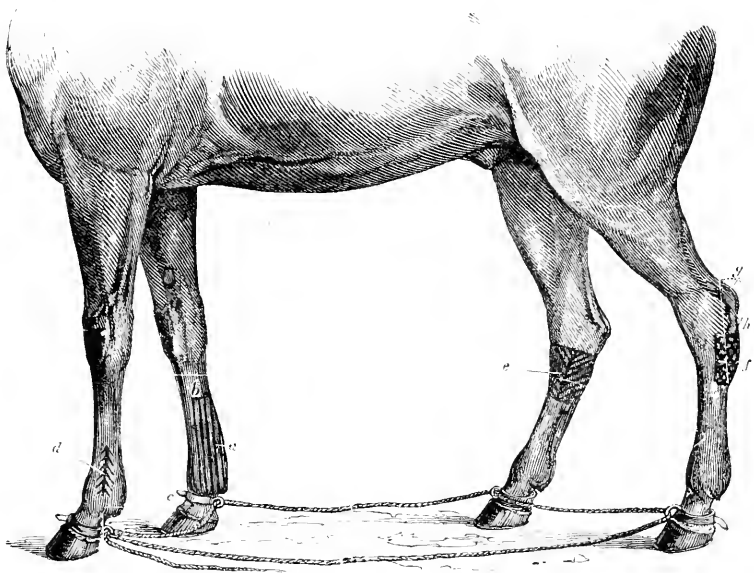
Amongst other substances employed as counter-irritants, the preparations of iodine have recently occupied a prominent position; all the preparations of iodine are more or less valuable from their marked effect on the absorbent system, but the one most commonly used as a counter-irritant is a combination of iodine and mercury, named the biniodide of mercury, in the form of ointment consisting of one drachm of the biniodide to one ounce of lard. This should be applied in the same manner as the ointment of cantharides, but not over so great a surface on account of its irritating effects. For bony enlargements such as splint, spavin, or ring-bone, this preparation will be found far superior to all others. When immediate action is required, half a pound or a pound of good mustard powder, made into a paste with cold water, and applied, will often produce as good a blister as cantharides. It is a preferable one, when, as in inflammation of the kidneys, the effect of cantharides on the urinary organs is feared. Hartshorn is not so effectual.

#### FIRING.

Whatever seeming cruelty may attend this operation, it is in many cases indispensable. The principle on which we have recourse to it is similar to that which justifies the use of a blister—by producing superficial inflammation we may be enabled to get rid of a deeper-seated one, or we may excite the absorbents to remove an unnatural bony or other tumour. It raises more intense external inflammation than we can produce by any other means. It may be truly said to be the most powerful agent that we have at our disposal. Humanity, however, will dictate, that on account of the inflammation which it excites, and the pain it inflicts, it should only be had recourse to when milder means have failed, except in those cases in which experience has taught us that milder means rarely succeed.

The part which is to be submitted to the operation should be shaved, or the hair cut from it as closely as possible with the trimming scissors. This is necessary in order to bring the iron into immediate contact with the skin, and likewise to prevent the smoke that will arise from the burned hair obscuring the view of the operator. The horse must then be thrown. This is absolutely necessary for the safety both of the operator and the animal. The side-line may be applied in a shorter time, and so many

hands may be not wanted to cast the horse; but no person can fire accurately, or with the certainty of not penetrating the skin, except the animal is effectually secured by the hobbles. Although accidents have occurred in the act of casting, yet many more have resulted to the operator, the assistants, or the horse, in a protracted operation, when the side-line only has been used.



*The common hobbles, and the mode of fixing them; also the seat of several diseases, and the different methods of firing, &c.*

- |  |  |
|--|--|
| <i>a</i> , Enlargement of the flexor tendons, and the vertical method of firing.               | <i>e</i> , The seat of bone spavin, and a mode of firing for ditto.        |
| <i>b</i> , The seat of splint.   | <i>f</i> , A curb, and another, though not an advisable, method of firing. |
| <i>c</i> , The seat of ringbone.   | <i>g</i> , The seat of capped hock.  |
| <i>d</i> , The seat of enlargement of the suspensory ligament, and a mode of firing for ditto. | <i>h</i> , The seat of thorough-pin.                                       |

The details of the operation belong to the veterinary surgeon. The grand points to be attended to are to have the edge of the iron round and smooth—the iron itself at, or rather below, a red heat—to pass it more or less rapidly over the skin, and with slighter or greater pressure according to the degree of heat—to burn into the skin until the line produced by the iron is of a brown colour, rather light than dark, and, by all means, in ordinary cases, to avoid *penetrating* the skin. Leaving out of the question the additional cruelty of deep firing, when not absolutely required, we may depend on it that if the skin is burned through, inflammation, and ulceration, and sloughing will ensue, that will be with much difficulty combated,—that will unavoidably leave unnecessary blemish, and that has destroyed many valuable horses. It may happen, nevertheless, that by a sudden plunge of the animal the skin will be unavoidably cut through. The act of firing requires much skill and tact, and the practitioner cannot be always on his guard against the struggles of the tortured beast. It will, also, and not unfrequently, occur that the skin, partially divided, will separate in two or three days after the operation. This must not be attributed to any neglect or unskilfulness of the surgeon, and the ulceration

thus produced will be slight and easily treated, compared with that caused by actually burning through the skin.

A very considerable change has taken place in the breed of many of the varieties of the horse, and the labour exacted from him. As illustrations of this we refer to the altered character and pace of the modern hunter, and the additional increase of speed required from the coach and the post horse; the exertion being limited only by the degree to which every muscle and every nerve can be extended, while the calculation between the utmost exaction of cruelty and the expenditure of vital power is reduced to the merest fraction. The consequence of this is, that the horse is subjected to severer injuries than he used to be, and severer measures are and must be employed to remedy the evil. Hence the horrible applications of the actual cautery to the horse that have disgraced the present day. Lesions—gashes have been made on either side of the tendon of the leg, which it took no fewer than seven months to heal. Was there nothing short of this lengthened torture that could have been done to relieve the victim? Could he not have been more lightly fired for the road or for the purposes of breeding? Was there no pasture on which he had earned a right to graze?—or could he not have been destroyed? These sad lesions will occasionally come before the practitioner and the owner. It will be for the first to advocate that which, on a careful view of the case, mercy prompts; and the latter, except there is a reasonable prospect of ultimate enjoyment, as well as usefulness, should never urge a continuation of suffering.

Supposing, however, that prospect to exist, the surgeon must discharge his duty. These gashes, after a while, begin to close, and then commences the beautiful process of granulation. Little portions of the integument form on the centre of the wound, and the sides of the wound creep closer together, and the skin steals over the surface until the chasm is perfectly closed. In order to insure the continuance of this, a ridge of contracted integument as hard as any cartilage, but without its elasticity, runs from one end of the lesion to the other, tighter, and harder, and more effectual every week, and month, and year, and lasting during the life of the animal. Therefore, the veterinary surgeon is not to be too severely censured, if, after due consideration, he is induced to undertake one of these fearful operations: but let him do it as seldom as he can, and only when every circumstance promises a favourable result.

Some practitioners blister immediately after firing. As a general usage it is not desirable. It may be required in bony tumours of considerable extent, and long standing, and interfering materially with the action of the neighbouring joint. Spavin accompanied by much lameness, and ring-bone spreading round the coronet and involving the side cartilages or the pastern joint, may justify it. The inflammation is rendered more intense, and of considerably longer duration. In old affections of the round bone it may be admitted, but no excuse can be made for it in slighter cases of sprain or weakness, or staleness.

On the day after the operation, it will be prudent gently to apply some olive oil, or lard, over the wound. This will soften the skin, and render it less likely to separate or ulcerate. A bandage would add to the irritation of the part. Any cracks of the skin, or ulcerations that may ensue, must be treated with the calamine ointment.

It will be evident that there is an advantage derived from firing to which a blister can have no pretension. The skin, partially destroyed by the iron, is reinstated and healed, not merely by the formation of some new matter filling up the vacancy, but by the gradual drawing together and closing of the separated edges. The skin, therefore, is lessened in

surface. It is tightened over the part, and it acts, as just described, as a salutary and permanent bandage. Of the effect of pressure in removing enlargements of every kind, as well as giving strength to the part to which it is applied, we have repeatedly spoken, and it is far from being the least valuable effect of the operation of firing, that, by contracting the skin, it affords a salutary, equable, and permanent pressure. It was on this principle, but the practice cannot be defended, that colts which were not very strong on the legs, used to be fired round the fetlock, and along the back sinew, or over the hock, in order to brace and strengthen the parts. It is on the same principle that a racer or hunter, that has become stale and stiff, is sometimes fired and turned out. For whatever reason the horse is fired, he should, if practicable, be turned out, or soiled in a loose box, for three or four months at least. The full effect intended to result from the external irritation is not soon produced, and the benefit derived from pressure proceeds still more slowly. In the thickened and tender state of the skin, and the substance beneath, a return to hard work for some weeks after firing would be likely to excite new inflammation, and cause even worse mischief than that which before existed.

Some weeks pass before the tumefied parts begin to contract—and they only who have had experience in these cases can imagine how long—with gentle voluntary exercise, the process of absorption is carried on. He who would expect that much good should accrue from the operation of firing must be content to give up his horse for three or four months; but if he will use him sooner, and a worse lameness should follow, let him blame his own impatience, and not the inefficiency of the means, or the want of skill in the surgeon.

The firing in every case should be either in longitudinal or oblique lines. On the back sinews, the fetlock, and the coronet, this is peculiarly requisite, for thus only will the skin contract so as to form the greatest and most equable pressure.

Some practitioners may pride themselves on the accuracy of their diamonds, lozenges, and feathers, but plain straight lines, about half an inch from each other, will constitute the most advantageous mode of firing. The destroying of deeply-seated inflammation, by the exciting of violent inflammation on the skin, is as well obtained; and common sense will determine, that in no way can the pressure which results from the contraction of the skin be so advantageously employed—to which may be added, that it often leaves but slight blemish.

#### SETONS

Are pieces of tape, passed, by means of an instrument resembling a large flat and thin needle, either through abscesses, or the base of ulcers with deep sinuses, or between the skin and the muscular or other substances beneath. They are retained there by the ends being tied together, or by a knot at each end. The tape is moved in the wound twice or thrice in the day, and occasionally wetted with some digestive fluid or ointment, in order to increase the inflammation which it produces, or the discharge which is intended to be established.

In abscesses, such as occur in the withers or the poll, when passed from the summit to the very bottom of the swelling, setons are highly useful, by discharging the purulent fluid, and suffering any fresh quantity of it that may be secreted to flow out; and by the degree of inflammation which they excite on the interior of the tumour, stimulating it to throw out healthy granulations, which gradually occupy and fill the hollow. In deep fistulous wounds they are indispensable, for except some channel is made through which the matter may flow from the bottom of the

wound, it will continue to penetrate deeper into the part, and the healing process will never be accomplished. On these accounts, a seton passed through the base of the ulcer in poll-evil and fistulous withers is of so much benefit.

Setons are sometimes useful by promoting a discharge in the neighbourhood of an inflamed part, and thus diverting and carrying away a portion of the fluids which distend or overload the vessels of that part; thus a seton is placed with considerable advantage in the cheek, when the eyes are much inflamed. We confess, however, that we prefer a rowel under the jaw.

With this view, and to excite a new and different inflammation in the neighbourhood of a part already inflamed, and especially so deeply seated and so difficult to be reached as the navicular joint, a seton has occasionally been used with manifest benefit, but we must peremptorily object to the indiscriminate use of the frog-seton for almost every disease of the frog or the foot.

In inflammations of extensive organs setons afford only feeble aid. Their action is too circumscribed, and they are only really valuable when used in combination with the blister.

On the principle of exciting the absorbents to action for the removal of tumours, as spavin or splint, a blister is quicker in its action, and far more effectual than any seton. Firing is still more useful.

#### DOCKING.

The shortening of the tail of the horse is an operation which fashion and the convenience of the rider require to be performed on most of these animals. The length of the dock, or stump, is a matter of mere caprice. To the close-cropped tail of the waggon-horse, however, we decidedly object, from its perfect ugliness, and because the animal is deprived of every defence against a thousand tortures. The supposition that the blood which would have gone to the nourishment of the tail causes greater development and strength in the quarters, is too absurd to deserve serious refutation. It is the rump of the animal being wholly uncovered, and not partly hidden by the intervention of the tail, that gives a false appearance of increased bulk. The plan has however become entirely obsolete, and is now alluded to merely to show how recently such thoughtless cruelties were indulged in.

The operation is simple. That joint is searched for which is the nearest to the desired length of tail. The hair is then turned up, and tied round with tape for an inch or two above this joint; and that which lies immediately upon the joint is cut off. The horse need not be fettered with the side-line, but with merely the twitch on the nose, and the near fore-leg held up; the veterinary surgeon with his docking-machine cuts through the tail at one stroke. Considerable bleeding ensues, and frightens the timid and the ignorant; but if the blood were suffered to flow on until it ceased of its own accord, the colt, and especially if he were very young, would rarely be seriously injured. The hair being loosened and dropped over the joint, a small pledget of tow moistened with a little tincture of myrrh or aloes is placed on the wound, the hair tied over it, and by the pressure thus simply applied, the hæmorrhage ceases. The next morning the string may be cut, the pledget allowed to drop off, and no further care is required. Contrast this humane, rational, and simple treatment with the system adopted by the farrier, and, shameful to say, not by the farrier only, even of the present day, of stopping the bleeding by the application of a red-hot iron to the stump: the horse plunging and rushing round the forge or stable, and the operator valiantly following, alternately brandish-

ing and searing with the hot iron, most cunningly contrived to stop this most formidable bleeding. It is one of the most useless and wanton acts of cruelty that the poor horse is subjected to.

Some farmers dock their colts a few days after they are dropped. This is a commendable custom on the score of humanity. No colt was ever lost by it; and neither the growth of the hair, nor the beauty of the tail, is in the least impaired.

#### NICKING.

This barbarous operation was once sanctioned by fashion, and the breeder and the dealer even now are sometimes tempted to inflict the torture of it in order to obtain a ready sale for their colts. It is not, however, practised to the extent that it used to be, nor attended by so many circumstances of cruelty.

We must here introduce a small portion of the anatomy of the horse, which we had reserved for this place. The eighteen dorsal vertebræ or bones of the back (see *d*, p. 244), and the five lumbar vertebræ or bones of the loins (*f*, p. 244), have already been described. The continuation of the spine consists of the sacrum, composed of five bones (*h*, p. 244), which, although separate in the colt, are in the full-grown horse united into one mass. The bones of the ilium, the upper and side portion of the haunch, articulate strongly with the sacrum, forming a bony union rather than a joint. The spinal cord and the blood-vessels here generally begin to diminish, and numerous branches of nerves are given out, which, joined by some from the vertebræ of the loins, form the nervous apparatus of the hind legs.

The bones of the tail are a continuation of those of the sacrum. They vary in number, generally fifteen, gradually diminishing in size, and losing altogether the character of the spinal vertebræ. Much attention is paid by persons who are acquainted with the true form of the horse to this continuation of the sacral and tail-bones. From the loins to the setting on of the tail the line should be nearly straight, or inclining only a slight degree downward. There is not a surer test of the breed of the horse than this straight line from the loins to the tail; nor, as was shown when the muscles of the quarters were described, is there any circumstance so much connected with the mechanical advantage with which these muscles act.

The tail seems to be designed to perfect the beauty of the horse's form, and also as a means of defence against the presence of flies and other insects on the skin. There are three sets of muscles belonging to the tail—the *erector coccygis*, situated on the superior and lateral part of it, and by the action of which the tail may be both elevated and drawn on one side—the *depressor coccygis*, on the inferior and lateral part of it, by the action of which the tail may be both lowered and drawn on one side—and the *curvator coccygis*, by the action of which the tail may be curved or flexed on either side. The depressor and lateral muscles are more powerful than the erector ones, and when the horse is undisturbed, the tail is bent down close on the buttocks; but when he is excited, and particularly when he is at speed, the erector muscles are called into action, the tail is elevated, and there is an appearance of energy and spirit which adds materially to his beauty. To perpetuate this, the operation of *nick-ing* was contrived. The depressor muscles and part of the lateral ones are cut through, and the erector muscles, left without any antagonists, keep the tail in a position more or less erect, according to the whim of the operator or the depth to which the incisions have been carried.

The operation is thus performed. The side-line is put on the horse, or

some persons deem it more prudent to cast him, and that precaution we should be disposed to recommend. The hair at the end of the tail is securely tied together, for the purpose of afterwards attaching a weight to it. The operator then grasps the tail in his hand, and, lifting it up, feels for the *centre* of one of the bones—the prominences at the extremities will guide him—from two to four inches from the root of the tail, according to the size of the horse. He then, with a sharp knife, divides the muscles deeply from the edge of the tail on one side to the centre, and, continuing the incision across the bone of the tail, he makes it as deep on the other side. One continued incision, steadily yet rapidly made, will accomplish all this. If it is a blood-horse that is operated on, this will be sufficient. For a hunter, two incisions are usually made, the second being about two inches below the first, and likewise as nearly as possible in the centre of one of the bones.

On the hackney, or *cocktail*, a third incision is made; for fashion has decided that his tail shall be still more elevated and curved. Two incisions only are made in the tail of a mare, and the second not very deep.

When the second incision is made, some fibres of the muscles between the first and second will project into the wound, and must be removed by a pair of curved scissors. The same must be done with the projecting portions from between the second and third incisions. The wounds should then be carefully examined, in order to ascertain that the muscles have been equally divided on each side, otherwise the tail will be carried awry. This being done, pledgets of tow must be introduced deeply into each incision, and confined, but not too tightly, by a bandage. A very profuse bleeding will alone justify any tightness of bandage, and the ill consequences that have resulted from nicking are mainly attributable to the unnecessary force that is used in confining these pledgets. Even if the bleeding, immediately after the operation, should have been very great, the roller must be loosened in two or three hours, otherwise swelling and inflammation, and even death, may possibly ensue. Twenty-four hours after the operation, the bandage must be quite removed; and, then all that is necessary, so far as the healing of the incisions is concerned, is to keep them clean.

If, however, the tail were suffered to hang down, the divided edges of the muscles would again come in contact with each other, and close; the natural depression of the tail would remain; and the animal would have been punished for no purpose. The wounds must remain open, and that can only be accomplished by forcibly keeping the tail curved back during two or three weeks. For this purpose a cord, one or two feet in length, is affixed to the end of the hair, which terminates in another divided cord, each division going over a pulley on either side of the back of the stall. A weight is hung at either extremity sufficient to keep the incisions properly open, and regulated by the degree in which this is wished to be accomplished. The animal will thus be retained in an uneasy position, although, after the first two or three days, probably not one of acute pain. It is barbarous to increase this uneasiness or pain by affixing too great a weight to the cords; for it should be remembered that the proper elevated curve is given to the tail not by the weight keeping it in a certain position for a considerable time, but by the depth of the first incisions, and the degree in which the wounds are kept open. By every ounce of weight beyond that which is necessary to keep the incisions apart, unnecessary suffering is inflicted. Some practitioners use only one pulley; others do not use any, but put on a light girth; and tie a cord from the end of the tail to the girth, bending it over the back. The double pulley,



however, is the least painful to the horse, and more perfectly secures the proper elevation and straight direction of the tail.

The dock should not, for the first three or four days, be brought higher than the back. Dangerous irritation and inflammation would probably be produced. It may, after that, be gradually raised to an elevation of forty-five degrees. The horse should be taken out of the pulleys, and gently exercised once or twice every day; but the pulleys cannot finally be dispensed with until a fortnight after the wounds have healed, because the process of contraction, or the approach of the divided parts, goes on for some time after the skin is perfect over the incisions, and the tail would thus sink below the desired elevation.

If the tail has not been unnecessarily extended by enormous weights, no bad consequences will usually follow; but if considerable inflammation should ensue, the tail must be taken from the pulley and diligently fomented with simple warm water, and a dose of physic given. Locked-jaw has in some rare instances followed, under which the horse generally perishes. In order to prevent the hair from coming off, it should be unplaited and combed out every fourth or fifth day.

#### NEUROTOMY.

The division of the nerve, as a remedy for intense pain in any part of the frame, was systematically practised by human surgeons more than a century ago. Mr. Moorecroft has the honour of introducing the operation of neurotomy in the veterinary school.

He frequently met with a strangely formidable disease, in what was called 'coffin-joint lameness,' but to which Mr. James Turner afterwards gave the very appropriate name of 'navicular-joint disease.' It was inflammation of the navicular bone, where the tendon plays over that bone; and it was accompanied by pain, abrasion, and gradual destruction of these parts.

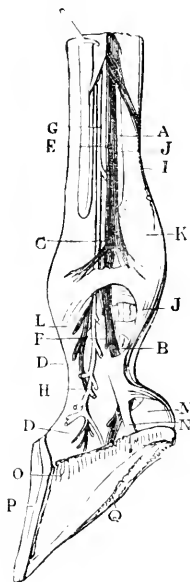
For a long time he was foiled in every attempt which he made to remove or even to alleviate the disease. At length he turned his thoughts to the probability of subduing the increased sensibility of the part by diminishing the proportion of nervous influence distributed on the foot. He laid bare one of the metacarpal nerves, and divided it with a pair of scissors. There was always an immediate and decided diminution of the lameness, and, sometimes, the horse rose perfectly sound. This happy result, however, was not always permanent, for the lameness returned after the lapse of a few weeks, or on much active exertion. He next cut out a small piece of the nerve. The freedom from lameness was of longer duration, but it eventually returned.

He then tried a bolder experiment. He excised a portion of the nerves going both to the inner and outer metacarpals. We transcribe his own account of the result of the first case of complete neurotomy—excision of the nerve on both sides of the leg—that ever was performed.

'The animal, on rising, trotted boldly and without lameness, but now and then stumbled with the foot operated on. The wounds healed in a few days, and the patient was put to grass. Some weeks afterwards a favourable account was received of her soundness; but she was soon brought again to us, on account of a large sore on the bottom of the foot operated on, and extending from the point of the frog to the middle and back part of the pastern. The mare, in galloping over some broken glass bottles, had placed her foot upon a fragment of the bottom of one of them, and which had cut its way through the frog and tendon into the joint, and stuck fast in the joint for some seconds, while the animal continued its course apparently regardless of injury. The wound bled profusely, but

the mare was not lame. Many days had elapsed before I saw her, and large masses of loose flesh were cut from the edges of the wound without the animal showing the slightest sign of suffering pain. The processes usually attending sores went on, with the same appearances, that took place in sores of parts not deprived of sensibility. Such extensive injury, however, had been done to the joint, as rendered the preservation of free motion in it very improbable, even were the opening to close, which was a matter of doubt, and therefore she was destroyed. It appeared clearly from this, that *by the destruction of sensibility the repairing powers of the parts were not injured*; but that the natural guard against injury being taken away by the division of both the nerves, an accident was rendered destructive, which, in the usual condition of the foot, might have been less injurious.

The following cut gives a view of the nerve on the inside of the leg, as it approaches the fetlock. It will be seen that branches are given off above the fetlock, which go to the fore part of the foot and supply it with feeling. The continuation of the nerve below the fetlock is given principally to the quarters and hinder part of the foot. The grand consideration, then, with the operator is—does he wish to deprive the whole of the foot of sensation, or is the cause of lameness principally in the hinder part of the foot, so that he can leave some degree of feeling in the fore part, and prevent that alteration in the tread and going of the horse which the horseman so dislikes?



- A The metacarpal nerve on the inside of the off leg at the edge of the shank bone, and behind the vein and artery.
- B The continuation of the same nerve on the pastern, and proceeding downward to supply the back part of the foot with feeling.
- C The division of the nerve on the fetlock joint.
- D The branch which supplies with feeling the fore part of the foot.
- E The artery between the vein and nerve.
- F The continuation of the artery on the pastern, close to, and before the nerve.
- G The vein before the artery and nerve.
- H The same vein spreading over the pastern.
- I One of the flexor tendons, the *perforatus* (perforated).
- J The deeper flexor tendon, the *perforans* (perforating, contained within the other).
- K The tendinous band in which the flexors work.
- L One of the extensors of the foot.
- M The internal or sensitive frog.
- N The posterior lateral ligament.
- O The fleshy or sensitive laminae covering the coffin-bone, the horny crust being removed.
- P The horny crust.
- Q The sole.

The horse must be cast and secured, and the limb to be operated on removed from the hobbles and extended—the hair having been previously shaved from the part. The operator then feels for the throbbing of the artery, or the round firm body of the nerve itself, on the side of the shank bone or the larger pastern. The vein, artery, and nerve here run close together, the vein nearest to the front of the leg, then the artery, and the nerve behind. He cautiously cuts through the skin for an inch and a half in length. The vessels will then be brought into view, and the nerve will

be distinguished from them by its lying behind the others, and by its whiteness. A curve blunt needle, with a handle, is then passed under it, in order to raise it a little. It is dissected from the cellular substance beneath, and about three quarters of an inch of it cut out, — the first incision being made at the upper part, in which case the second incision will not be felt. The horse must then be turned, and the operation performed on the other side; for there is a nervous trunk on both sides. The wounds are now closed, a bandage placed over them, the head tied up for a couple of days, and the animal kept rather low, and as quiet as possible. The incisions will generally rapidly heal; and in three weeks or a month, and sometimes earlier, the horse will be fit for work.

For ringbone — the side cartilages becoming bony, and there being partial stiffness of the pastern and coffin-joints — the operation of nerving will probably be beneficial. The sense of pain being taken away, the animal will use these parts more, and they will, to a certain extent, recover their natural action and motion. These are, indeed, some of the most satisfactory cases in which it can be had recourse to; and when the enlargement exists in one of the lateral cartilages only, that is on but one side of the coronet, requiring the operation on but the outer or inner nerve, as the case may be, the effect is very satisfactory without the sensation of the foot being lost. For the same reason, in old contraction of the feet, it is highly beneficial. The torture occasioned by the pressure of the horny crust on the sensitive parts within being no longer felt, and the foot coming fully and firmly in contact with the ground, not only is lameness relieved, but the elasticity and form of the foot partially restored. Where lameness has long existed, unattended with heat of the foot or alteration of shape, and the seat of which could not be ascertained, although probably existing between the navicular bone and the back tendon that plays over it, neurotomy may be resorted to with decided advantage.

Mischief, however, will result from the operation if the pastern or coffin-joints are perfectly stiff, because the concussion occasioned by the forcible contact of the foot with the ground, and unbroken by the play of the joints, must necessarily still more injure the bone. When the sole of the foot is convex or *pumiced*, the effect of neurotomy will be most destructive. The sole, scarcely able to bear the pressure of the coffin-bone, even when pain induces the animal to put his foot as gently as possible on the ground, being forced below its natural situation, would be speedily worn through and destroyed. So if inflammation existed, although its pain might be removed, yet its progress would be quickened by the bruising to which the parts might be subjected; and more especially would this be the case, if there was any ulceration of the ligaments or cartilages.

To some extent, immediate good effect is produced as it regards the actual disease. We remove that general constitutional irritability which long-continued pain occasions, and which heightens and perpetuates local disease. We obtain for the patient an interval of repose, and every local ailment soon subsides or disappears, at least to a very considerable extent, and the whole constitution becomes invigorated.

Mr. Percivall relates two valuable cases of this. A mare with contracted feet was never subject to periodical œstrum, and her owner lamented in vain that he could not breed from her. She underwent the operation of neurotomy and became an excellent brood mare. A stallion with many a good point about him was useless in the stud: he was suffering from some disease in the feet. A portion of the nerve was excised — his constitution underwent a complete change, and he became sire to a numerous and valuable progeny.

The principle of neurotomy is plain and simple—*it is the removal of pain*. Taken on this ground, it is a noble operation. It is that in which every friend of humanity will rejoice. It may be abused. If no auxiliary means are adopted—if in canker, or quittor, no means are used to lessen the concussion and the pressure—the destruction of the part and the utter ruin of the horse are the inevitable consequences. The primary result is the removal of pain. It is for the operator to calculate the bearing of this on the actual disease, and the future usefulness of the animal.

On the question of the reproduction of the nerves there is no doubt. A horse is lame, and he undergoes the operation of neurotomy. At the expiration of a certain time the lameness returns, and he is probably destroyed. In the majority of cases it is found that the nerves had united, or rather that a new veritable nervous substance had been interposed. The time at which this is effected is unknown. There have not been any definite experiments on the point.

Can the horse that has undergone the operation of neurotomy be afterwards passed as sound? Most certainly not. There is altered, impaired structure; there is impaired action; and there is the possibility of the return of lameness at some indefinite period. He has been diseased. He most probably is diseased now; but the pain being removed, there are no means by which the mischief can always be indicated. Besides, by the very act of neurotomy, he is peculiarly exposed to various injuries and affections of the foot from which he would otherwise escape. It must, indeed, be borne in mind, as an invariable rule, that it is never to be had recourse to till the science and skill of the veterinary practitioner has utterly failed in giving relief. When disease cannot be cured, it is an act of humanity to relieve the animal, if possible, from the pain and suffering attendant on it: this, in well-selected cases, the operation of neurotomy will generally effect; this is its legitimate object, and with this object only in view should it ever be performed.

#### TRACHEOTOMY.

The respiratory canal is occasionally obstructed, to an annoying and dangerous degree. Polypi have been described as occupying the nostrils; long tumours have formed in them. Tumours of other kinds have pressed into the larynx. The tumour of strangles has, for a while, occupied the passage. The larynx has been distorted; the membrane of the windpipe, on the larynx, has been thickened, and ulcers have formed in one or both, and have been so painful that the act of breathing was laborious and torturing. In all these cases it has been anxiously enquired whether there might not be established an artificial opening for the passage of the air, when the natural one could no longer be used; and it has been ascertained that it is both a simple and safe operation, to excise a portion of the trachea, on or below the point of obstruction.

The operation must be performed while the horse is standing, and secured by a side-line, for he would, probably, be suffocated amidst the struggles with which he would resist the act of throwing. The twitch is firmly fixed on the muzzle; and an assistant holds a scalpel, a bistoury, scissors, curved needles armed, and a moist sponge.

The operator should once more examine the whole course of the windpipe, and the different sounds which he will be able to detect by the application of the ear, and likewise the different degrees of temperature and of tenderness which the finger will detect, will guide to the seat of the evil.

The hair is to be closely cut off from the part, the skin tightened across

the trachea with the thumb and fingers of the left hand, and then a longitudinal incision cautiously made through the skin, three inches in length. This is usually effected, when there is no express indication to the contrary, on the fifth and sixth rings; a slip from which, and the connecting ligament above and below, about half the width of each ring, should be excised with the intervening ligament. The remaining portion will then be strong enough to retain the perfect arched form of the trachea.

If the orifice is only to be kept open while some foreign body is extracted, or tumour removed, or ulcer healed, or inflammation subdued, nothing more is necessary than to keep the lips of the wound a little apart, by passing some thread through each, and slightly everting them, and tying the threads to the mane.

If, however, there is any permanent obstruction, a tube will be necessary. It should be two or three inches long, curved at the top, and the external orifice turning downwards with a little ring on each side, by which, through the means of tubes, it may be retained in its situation.

The purpose of the operation being answered, the flaps of integument must be brought over the wound, the edges, if necessary, diminished, and the parts kept in apposition by a few stitches. The cartilage will be perfectly reproduced, only the rings will be a little thicker and wider.

The following account will illustrate the use and the danger of the tracheotomy tube. A mare at Alfort had great distortion of the rings of the trachea. She breathed with difficulty. She became a roarer almost to suffocation, and was quite useless. Tracheotomy was effected on the distorted rings, and a short canula introduced. She was so much relieved that she trotted and galloped immediately afterwards without the slightest distress. Six months later she again began to roar. It seemed that the rings were now distorted below the former place.

M. Barthélemy introduced another canula, seven inches long, and which reached below the new distortion. She was once more relieved. She speedily improved in condition, and regularly drew a cabriolet at the rate of seven or eight miles in the hour; and this she continued to do for three years, when the canula became accidentally displaced in the night, and she was found dead in the morning.

#### PARACENTESIS THORACIS (TAPPING THE CHEST).

By auscultation and other modes of examination, the existence of effusion in the chest is ascertained, and, possibly, it is increasing. Is there any mechanical way of getting rid of it? There is one to which recourse should be had as soon as it is evident that there is considerable quantity of fluid in the chest. The operation of *Paracentesis*, or tapping, should be performed; it is a very simple one. One of the horse's legs being held up, and, counting back from the sternum to between the seventh and eighth ribs, the surgeon should first make a longitudinal incision through the skin, and then pass a moderate-sized trochar into the chest immediately above the cartilages. He will not have selected the most dependent situation, but as near it as he could with safety select; for there would not have been room between the cartilages if the puncture had been lower; and these would have been injured in the forcing of the instrument between them, or, what is worse, there would have been great hazard of wounding the pericardium, for the apex of the heart rests on the sternum. Through this aperture, close to the cartilages, the far greater part of the fluid may be evacuated. The operator will now withdraw the stilette, and let the fluid run through the canula. He will not trouble himself afterwards about the wound; it will heal readily enough; perhaps too quickly, for, could it be kept open a few days, it might act as a very useful

drain. *It should be attempted early.* Recourse should be had to the operation as soon as it is ascertained that there is considerable fluid in the chest, for the animal will at least be relieved for a while, and some time will have been given for repose to the overlaboured lungs, and for the system generally to be recruited. The fluid will be evacuated before the lungs are too much debilitated by laborious action against the pressure of the water, and a state of collapse brought on, from which they will be incapable of recovering. They only who have seen the collapsed and condensed state of the lung that had been long compressed by the fluid, can conceive of the extent to which this is carried. It should be added—a fact important and alarming—that the records of veterinary surgery contain very few cases of permanently successful performance of the operation. This should not discourage the practitioner from attempting it, but should induce him to consider whether he may not perform it under happier auspices, before the lungs and the serous membrane which lines the cavity have been too much disorganised, and the constitution itself sadly debilitated. There could not be any well-founded objection to an earlier resort to paracentesis, and he must be a bungler indeed who wounded any important part.

It should be ascertained by auscultation whether there is fluid in both cavities. If there should be, and in considerable quantity, it will not be prudent to operate on both sides at once. If much fluid is discharged, there will be acceleration and difficulty of respiration to a very great degree. The practitioner must not be alarmed at this; it will pass over, and on the next day he may attack the other side; or open both at once, if there is but little fluid in either.

---

## CHAPTER XXIII.

### A LIST OF THE MEDICINES USED IN THE TREATMENT OF THE DISEASES OF THE HORSE.

He will rarely consult his own interest, who, not having had the advantage of a veterinary education, undertakes the treatment of any of the serious diseases of his horses. Many of the maladies of the horse nearly resemble each other. They are continually varying their character, and require, in their different stages, a very different treatment; and in the plainest case not only the characteristic symptoms of disease are obscure, but even the indications of returning health, or increasing danger, are often scarcely ascertainable, consequently the sick horse, as well as the human being, needs the care of one whom study and experience have qualified for the task. A list of the drugs generally employed, with a slight account of their history, adulterations, and medicinal effects, will be interesting to the horse-proprietor as well as to the veterinary surgeon; and may occasionally be useful when professional aid cannot be obtained.

Frequent reference will be made to Professor Morton's most valuable *Manual of Pharmacy*. This work will be found to be a treasure to every veterinary surgeon. Mr. W. C. Spooner's *Materia Medica*, in his recent compendium of White's account of the horse, will occasionally be laid under contribution.

*ACACIA GUMMI*.—Many varieties of *gum arabic* are procured from Africa, Arabia, and the East Indies. It is an exudation from the trunk and

branches of various trees. It is employed in the form of a mucilage, made by dissolving it in water, in the proportion of one part of the gum to three or four of water. Various insoluble powders may be thus suspended, or oils rendered miscible, or emulsions formed. Emulsions composed of gum arabic are supposed to be useful in urinary affections.

**ACIDUM ACETICUM, ACETIC ACID, VINEGAR.**—Acetic, or pyroligneous acid is obtained by the destructive distillation of wood. It is about six times as strong as ordinary vinegar, and is seldom used except in this diluted form. Vinegar is obtained by what is called the acetous fermentation, excited in a saccharine solution. Everyone is familiar with the properties of vinegar, it has been employed for sprains and bruises, and equal parts of cold vinegar and boiling water will form a good fomentation. As an internal remedy, vinegar is rarely given, nor has it, except in large doses, any considerable medicinal power.

**ACIDUM ARSENIOSUM, ARSENIC.**—Were it not that some practitioners continue to use it as a tonic, in doses of from five to ten grains daily, and others employ it to core out old ulcers, we would not include it in our list, for we have little faith in it. There are better and safer tonics, and far better and safer caustics. The method of detecting the presence of arsenic, in cases of poisoning, will be found described at page 500.

**ACIDUM MURIATICUM, or HYDROCHLORIC ACID: SPIRIT OF SALT.**—This acid is obtained by distilling a mixture of sulphuric acid and common salt and water. The acid is generated in the form of gas, and is converted into a liquid by admixture with water in the receiver. In this state, when pure, it is colourless, but the ordinary acid met with in commerce is of a yellowish colour. When exposed to the air, it emits suffocating fumes, and, from its great affinity for water, should be always kept in well-stopped bottles. It is chiefly employed as a caustic in ulcers and other ill-conditioned wounds. When applied to any living part, a change of colour is perceived, the parts becoming blanched. For canker, wounds in the foot not attended by healthy action, and for every case where the superficial application of a caustic is needed, this acid will be found especially valuable. It has also been given in a diluted form as a solvent of calculi in the kidneys and bladder.

**ACIDUM NITRICUM: NITRIC ACID, AQUAFORTIS.**—This acid is obtained by distilling together a mixture of sulphuric acid and nitrate of potassa. It is a pale straw-coloured fluid, with a pungent acrid smell, and possessing very corrosive properties. Aquafortis is a diluted form of this acid. Nitric acid is a valuable external application. It is both a caustic and an antiseptic. It destroys fungoid excrescences. A pledget of tow should be dipped in the acid, and then firmly pressed on the cankerous surface. Every part with which the acid has come into contact will be deadened and slough off, and healthy granulations will spring up.

**ACIDUM HYDROCYANICUM: PRUSSIC ACID.**—It is prepared by mixing together cyanide of silver, hydrochloric acid, and water. In this state it will be found a colourless liquid, with a pungent bitter taste, and a peculiar odour somewhat resembling bitter almonds. The hydrocyanic of the London Pharmacopœia contains about two per cent. of acid, while Scheele's acid, which is more generally used in veterinary practice, contains from four to five per cent. In a concentrated state, it is truly a deadly poison; a few drops of it will kill a large animal. In a diluted form, it is a powerful sedative. In doses of half a drachm to a drachm, largely diluted, it abates both pulmonary and gastric irritation. It has also been used with good effect in the form of enema in cases of tetanus. It may also be given by the mouth in the same disease. Nothing is more likely to tranquillise the general excitement of the nervous system. The

author of this work was the first person who applied the hydrocyanic acid for the purpose of allaying irritation of the skin in dogs. It seldom fails of producing the desired effect, and it has had a similar good effect in subduing itchiness and mange in the horse.

**ACIDUM SULPHURICUM: SULPHURIC ACID.**—This acid, which is familiarly known by the name of oil of vitriol, is obtained in commerce by the combustion of sulphur and nitrate of potassa in leaden chambers containing water. Thus obtained it is an oily-looking colourless fluid, devoid of smell, but intensely acid and powerfully corrosive. It destroys the cuticle, and acts as a caustic, charring both animal and vegetable substances, combining with the water and setting free the carbon. In its diluted state, it is sometimes administered internally as a tonic and astringent. When thus given, it should be largely diluted with water, or inflammation of the stomach and bowels may result. This is sometimes produced by the dangerous practice adopted by waggoners sprinkling this acid amongst the food of the animal, with a mistaken view of improving his condition. The antidotes in such a case would be magnesia, carbonate of soda or potash, and large quantities of soap and water. As an external application, when mixed with tar in the proportion of an ounce to the pound, it has been used for thrush and canker, but both the hydrochloric and nitric acids are better applications.

**ADEPS, HOG'S LARD,** very properly forms the basis of most of our ointments. It is tasteless, inodorous, and free from every stimulating quality. That cannot be said of all the ingredients used in the composition of our unguents.

**ALCOHOL, RECTIFIED SPIRIT.**—In its pure state alcohol is seldom used, but more frequently employed in the diluted form of either rectified or proof spirit, in the preparation of tinctures. It is obtained from the fermentation of saccharine solutions of different varieties of grain or fruit, and repeated distillation of the product. Internally administered, its action would be stimulant and antispasmodic. Its chief value as an external application consists when mixed with water, in forming a cold evaporating lotion.

**ALOES.**—There are two kinds used in horse practice, the Barbadoes and the Cape. The Socotrine, preferred by the human surgeon, are very uncertain in their effect on the horse, and are seldom to be met with pure. Of the Barbadoes and the Cape, the first are much to be preferred. They are obtained principally from the island of Barbadoes, and are the juice of the large leaves of the aloe boiled to a considerable thickness, and then poured into gourds in which they gradually harden. The true Cape are the extract of a species of aloe chiefly cultivated at the Cape of Good Hope. The Barbadoes aloe are of a reddish-brown colour, with a strong aromatic smell, broken with difficulty, and the fracture dull. The Cape are darker coloured, very brittle, and the fracture perfectly glossy. Every veterinary surgeon who uses much aloe should buy them in the mass, and powder them at home, and then, by attending to this account of the difference of the two, he can scarcely be imposed upon. It is, however, the fact, that these are mostly adulterated, by their being melted together. Aloes purchased in powder are too often sadly adulterated.

The Barbadoes aloe have a greater purgative power than the Cape, exclusive of griping less and being safer. In addition to this, the action of the bowels is kept up longer by the Barbadoes aloe than by the Cape. If the horse is well mashed, and carefully exercised, and will drink plenty of warm water, the Cape may be ventured on, or at least mixed with equal quantities of the Barbadoes; but if there is any neglect of preparation for physic, or during the usual operation of the physic, the Cape are not



always to be depended upon. The combination of alkaline compounds with aloes alters the results of the medicine. Their action is quickened, but their purgative properties are impaired, and they cease to operate specifically on the larger intestines. Such is the opinion of Professor Morton, and undoubtedly the latter would be an advantage gained. Mashies are useful helps when physic is administered.

Some persons are fond of what are called half-doses of physic. Three or four drachms are given on one day, and three or four on the following; and perhaps if the medicine has not operated, as in this divided state it will not always, two or three additional drachms are given on the third day. The consequence is, that the bowels having been rendered irritable by the former doses, the horse is over-purged, and inflammation and death occasionally ensue. In physicking a horse, whatever is to be done should be done at once. Whatever quantity is intended to be given should be given in one dose.

The system of giving small doses of aloes as alteratives is not good. These repeated minute doses lodging in some of the folds of the intestines, and at length uniting, often produce more effect than is desirable. It is never safe to ride a horse far or fast, with even a small dose of aloes within him.

Most of all objectionable is the custom of giving small doses of aloes, as a nauseant, in inflammation of the lungs. There is so much sympathy between the contents of the chest and the belly in the horse, and inflammation of one part is so likely to be transferred to another, that it is treading on very dangerous ground, when, with much inflammation of the lungs, that is given which will stimulate and may inflame the intestines.

Aloes are most commonly, because most easily, administered in the form of ball, but in a state of solution their effect is more speedy, effectual, and safe.

Aloes are useful in the form of tincture. Eight ounces of powdered aloes, and one ounce of powdered myrrh, may be put into two quarts of rectified spirit, diluted with an equal quantity of water. The mixture should be daily well shaken for a fortnight, and then suffered to stand, in order that the undissolved portion may fall to the bottom. This will constitute a very excellent application for wounds, whether recent or of long standing and indisposed to heal. It is not only a gentle stimulant, but it forms a thin crust over the wound, and shields it from the action of the air.

The principal adulteration of aloes is by means of resin, and the alteration of colour is concealed by the addition of charcoal or lamp-black. This adulteration is easily enough detected by dissolving the aloes in hot water. All aloes contain some resinous matter, which the water will not dissolve, and which has very slight purgative effect. The excess of this resin at the bottom of the solution will mark the degree of adulteration.

**ACONITUM, MONKSHOOD.**—This plant, which was introduced into this country from Germany, is found growing in most of our flower gardens. As a medicinal agent, it has recently come somewhat prominently into notice in veterinary practice. The preparations chiefly used are the tincture and extract of aconite. It is said to possess narcotic, diaphoretic, and diuretic properties, but its action upon the horse is at present but little understood. It is a very powerful and highly deleterious agent, and should never be used except by the veterinary attendant.

**ALTERATIVES** are a class of medicines the nature and effect of which are often much misunderstood, and liable to considerable abuse. It is a very convenient name in order to excuse that propensity to dose the horse with medicines, which is the disgrace of the groom, and the bane of the stable.

By alteratives we understand those drugs which effect some slow change in the diseased action of certain parts without interfering with the food or work; but by common consent the term seems to be confined to medicines for the diseases of the circulation, or of the digestive organs, or of the skin. If a horse is heavy and incapable of work from too good keep, or if he is off his food from some temporary indigestion—or if he has mange or grease, or cracked heels, or swelled legs, a few alteratives are prescribed, and the complaint is expected to be gradually and imperceptibly removed. For all skin affections there is no better alterative than that so often recommended in this treatise, consisting of black antimony, nitre, and sulphur. If there is any tendency to grease, some resin may be added to each ball. If the complaint is accompanied by weakness, a little gentian and ginger may be farther added, but we enter our protest against the ignorant use of mercury in any form, or any of the mineral acids, or mineral tonics, or heating spices, as alteratives. We indeed should be pleased if we could banish the term alterative from common usage. The mode of proceeding which reason and science would dictate is to ascertain the nature and degree of the disease, and then the medicine which is calculated to restore the healthy action of the part, or of the frame generally.

ALUM is occasionally used internally in cases of super-purgation in the form of alum-whey, two drachms of the powder being added to a pint of hot milk; but there are much better astringents, although this may sometimes succeed when others fail. If alum is added to a vegetable astringent, as oak-bark, the power of both is diminished. Its principal use is external. A solution of two drachms to a pint of water forms alone, or with the addition of a small quantity of white vitriol, a very useful wash for cracked heels, and for grease generally; and also for those forms of swelled legs attended with exudation of moisture through the skin. Some add the Goulard lotion, forgetting the chemical decomposition that takes place; the result of which is the formation of a mixture with no astringency at all.

The BURNT ALUM is inferior to the common alum for the purposes mentioned, and we have better stimulants, or caustics, to apply to wounds.

AMMONIA, which has been termed the volatile alkali, is given off during the decomposition of animal substances, and to the injury of the horse, plentifully extricated from the putrefying dung and urine in badly managed stables. In its pure state ammonia exists in the form of gas, but is freely absorbed by water, and in this form is generally employed. Administered internally, either in the form of the aromatic spirit or carbonate of ammonia, it acts as a stimulant and antacid, and has been given with decided benefit, when other things have failed, in flatulent colic. In the form of acetate of ammonia, it forms a valuable febrifuge medicine. As an external application, water of ammonia acts as good counter-irritant, in cases of sore throat, and is also useful in dispersing indolent tumours. Another preparation, the hydrochlorate of ammonia, or *sal ammoniac*, mixed with dilute acetic acid, has been used as a stimulant to chronic sprains.

ANISI SEMINA, ANISE-SEED.—This seed is here mentioned principally as a record of old times, when it was one of the sheet anchors of the farrier. It is not yet quite discarded from his shop as a stimulant, a carminative, and a cordial.

ANTIMONY.—There are several valuable preparations of this metal.

THE BLACK SESQUI-SULPHURET OF ANTIMONY, a compound of sulphur and antimony, is a good alterative. It is given with more sulphur and with nitre, in varying doses, according to the disease, and the slow or rapid

effect intended to be produced. It should never be bought in powder. whatever trouble there may be in levigating it, for it is often grossly adulterated with lead, manganese, forge dust, and arsenic. The adulteration may be detected by placing a little of the powder on a red-hot iron plate. The pure sulphuret will evaporate without the slightest residue—so will the arsenic: but there will be an evident smell of garlic. A portion of the lead and the manganese will be left behind.

ANTIMONI POTASSIO TARTRAS, EMETIC TARTAR.—The tartrate of potash and antimony, or a combination of super-tartrate of potash and oxide of antimony, is a very useful nauseant, and has considerable effect on the skin. It is particularly valuable in inflammation of the lungs, and in every catarrhal affection. It is given in doses of from one drachm to a drachm and a half, and combined with nitre and digitalis. It has also been externally applied in chest affections, in combination with lard, and in quantities of from one drachm to two drachms of the antimony to an ounce of the lard; but except in extreme cases, recourse should not be had to it, on account of the extensive sloughing which it sometimes produces.

PULVIS ANTIMONII COMPOSITUS, THE COMPOUND POWDER OF ANTIMONY, —commonly known by the name of *James's Powder*. It is employed as a sudorific in fever, either alone or in combination with mercurials. The dose is from one to two drachms. The late Mr. Bloxam used to trust to it alone in the treatment of Epidemic Catarrh in the horse. It is, however, decidedly inferior to Emetic Tartar. It is often adulterated with chalk and burnt bones, and other white powders, and that to so shameful a degree, that little dependence can be placed on the antimonial powder usually sold by druggists. The muriatic or sulphuric acids will detect most of these adulterations.

ANTI-SPASMODICS.—Of these our list is scanty, for the horse is subject only to a few spasmodic diseases, and there are fewer medicines which have an anti-spasmodic effect. Opium stands first for its general power. Oil of turpentine and spirit of nitric ether are also valuable anti-spasmodics. Camphor, assafetida, and various other medicines, used on the human subject, have a very doubtful effect on the horse, or may be considered as almost inert.

ARGENTUM, SILVER.—One combination only of this metal is used, and that as a manageable and excellent caustic, viz. the nitrate of silver, or *Lunar Caustic*. It is far preferable to the hot iron, or to any acid, for the destruction of the part if a horse should have been bitten by a rabid dog; and it stands next to the mineral acids for the removal of fungus generally. It has not yet been administered internally to the horse.

BALLS.—The usual and the most convenient mode of administering veterinary medicines is in the form of balls, compounded with glycerine, syrup, or treacle, the former being the best on account of their longer keeping soft and more easily dissolving in the stomach. Balls should never weigh more than an ounce and a half, otherwise they will be so large as not to pass without difficulty down the gullet. They should not be more than an inch in diameter and three inches in length. The mode of delivering balls is not difficult to acquire; but the balling-iron, while it often wounds and permanently injures the bars, occasions the horse to struggle more than he otherwise would against the administration of the medicine. The horse should be backed in the stall;—the tongue should be drawn gently out with the left hand on the off side of the mouth, and there fixed, not by continuing to pull at it, but by pressing the fingers against the side of the lower jaw. The ball, being now taken between the tips of the fingers of the right hand, is passed rapidly up the mouth, as near to the palate as possible, until it reaches the root of the tongue. It

is then delivered with a slight jerk, and the hand being withdrawn and the tongue liberated, the ball is forced through the pharynx into the cesophagus. Its passage should be watched down the left side of the throat; and if the passage of it is not seen going down, a slight tap or blow under the chin will generally cause the horse to swallow it, or a few gulps of water will convey it into the stomach. Very few balls should be kept ready made, for they may become so hard as to be incapable of passing down the gullet, or dissolving in the stomach, and the life of the horse may be endangered or lost. This is peculiarly liable to be the case if the ball is too large, or wrapped in thick paper. The balling-probong, which may be obtained of any veterinary instrument maker, affords great facility in administering a ball, avoiding that risk of an awkward scratch or bruise on the back of the fauces which cannot always be avoided. They are now made in a very portable form, and should be found in every large establishment.

**BARK, PERUVIAN.**—There are several varieties of cinchona or Peruvian bark, but the one most commonly employed is the *Cinchona Flava* or yellow bark, the produce of a tree growing in different parts of South America. Administered either in the form of infusion or powder, it possesses very valuable tonic properties, and is especially serviceable in those cases where great debility is present as the result of influenza. Its active properties depend upon a principle named *quinine*, which is highly valued as a tonic in human medicine, but at the present time is too expensive for general use in veterinary practice.

**BASILICON** is a valuable digestive ointment, composed of resin, bees-wax, and olive-oil. If it is needed as a stimulant, a little turpentine and verdigris may be added.

**BELLADONNÆ EXTRACTUM, EXTRACT OF DEADLY NIGHTSHADE.**—The inspissated juice of the *Atropa Belladonna* is principally used as a narcotic and sedative, and indicated where there is undue action of the nervous and vascular systems, as in tetanus, pneumonia, and nervous affections generally. Externally, it is beneficially applied to the eye, on which its action is most peculiar and extraordinary, its sole effect being on the iris or curtain of the eye. This curtain, as has been detailed elsewhere, has two sets of muscles, one set to enlarge, the other to close the pupillary opening. The great peculiarity is, that it is only on the muscles that dilate the pupil that this medicine has any power; and when they are under its influence, the pupil becomes as fully distended as in paralysis of the optic nerves.

**BLISTERS** are applications to the skin, which separate the cuticle in the form of vesicles containing a serous fluid. They excite increased action in the exhalant vessels of the skin, by means of which this fluid is thrown out. The part or neighbouring parts are somewhat relieved by the discharge, but more by the inflammation and pain that are produced, and lessen that previously existing in some contiguous part. On this principle we account for the decided relief often obtained by blisters in inflammation of the lungs, and their efficacy in abating deeply-seated disease, as that of the tendons, ligaments, or joints; and also the necessity of previously removing, in these latter cases, the superficial inflammation caused by them, in order that one of a different kind may be excited, and to which the deeply-seated inflammation of the part will be more likely to yield. The blisters used in horse-practice are composed of preparations of cantharides or the biniodide of mercury, to which some have added a tincture of the croton-nut.

For some important remarks on the composition, application, and management of the blister, see page 461.

**BOLE ARMENIAN** is an argillaceous earth combined with iron, and is supposed to possess some astringent property. On account of its supposed astringency, it is employed externally to give consistence to ointments for grease. Even the bole Armenian has not escaped the process of adulteration, and is largely mixed with inferior earths. The fraud may be suspected, but not satisfactorily detected, by the colour of the powder, which should be a bright red.

**CALAMINE.**—See **ZINC**.

**CALOMEL.**—See **MERCURY**.

**CAMPHOR** is the produce of one of the laurus species (*Laurus Camphora*), a native of Japan, and too often imitated by passing a stream of chlorine through oil of turpentine. According to Professor Morton, it is a narcotic. It diminishes the frequency of the pulse, and softens its tone. When long exhibited, it acts on the kidneys. Externally applied, it is said to be a discutient and an anodyne for chronic sprains, bruises, and tumours. The camphor ball is a favourite one with the groom, and occasionally administered by the veterinary surgeon. Mr. W. C. Spooner uses it, mixed with opium, in cases of locked-jaw, and in doses of from one to two drachms. In the form of camphorated oil, it promotes the absorption of fluids thrown out beneath the skin, the removal of old callus, and the suppling of joints stiff from labour. Combined with oil of turpentine, it is more effective.

**CANTHARIDES** are the basis of the most approved and useful veterinary blisters. The *cantharis vesicatoria* is a fly, the native of Italy and the south of France. It is destroyed by the fumes of sulphur or vinegar, and dried in the sun or a warm apartment. Its action is intense, and yet superficial; it plentifully raises the cuticle, yet rarely injures the true skin, and therefore seldom blemishes. The application of other acrid substances is occasionally followed by deeply-seated ulcerations; but a blister composed of the Spanish fly alone, while it does its duty, leaves, after a few weeks have passed, scarcely a trace behind.

The art of blistering consists in cutting, or rather shaving, the hair perfectly close; then well rubbing in the ointment, for at least ten minutes; and, afterwards, and what is of the greatest consequence of all, applying a little more of the ointment lightly over the part, and leaving it. As soon as the vesicles have perfectly risen, which will be in twenty or twenty-four hours, the torture of the animal may be somewhat relieved by the application of olive oil, or any emollient ointment.

When too extensive a blister has been employed, or, from the intensity of the original inflammation, the blister has not risen (for no two intense inflammations can exist in neighbouring parts at the same time), strangury—great difficulty in passing urine, and even suppression of it—has occurred. The careful washing off of the blister, and the administration of plenty of warm water, with opium, and bleeding, if the symptoms run high, will generally remove this unpleasant effect.

An infusion of the flies in olive oil, vinegar, or oil of turpentine, for several days, is occasionally used as a liquid blister; and, when sufficiently lowered with common oil, it is called a *sweating oil*, for it maintains a certain degree of irritation and inflammation on the skin, yet not sufficient to blister, and thus gradually abates or removes some old or deep inflammation or cause of lameness.

Of late cantharides have come into more general use. They were recommended by Mr. Vines, in combination with vegetable bitters, as a stimulating tonic, in cases of debility. He next applied them for the cure of glanders. The veterinary public is much indebted to Mr. Vines for the steadiness with which he has followed up the employment of the Spanish

fly. The dose is from five to eight grains given daily, but withheld for a day or two when diuresis supervenes.

**CAPSICI BACCÆ, CAPSICUM BERRIES.**—They are valuable as stimulants affecting the system generally, yet not too much accelerating the pulse. Their beneficial effect in cases of cold has seldom been properly estimated. The dose is from a scruple to half a drachm.

**CARUI SEMINA, CARAWAY SEEDS.**—These and ginger, alone or combined, are the best carminatives used in horse-practice.

**CASCARILLÆ CORTEX, CASCARILLA BARK.**—Tonic as well as aromatic. It must not, however, be used with the sulphates of iron or zinc.

**CASTOR OIL, OLEUM RICINI.**—Is obtained by expression from the seeds of the *Ricinus communis*, a plant growing in the East and West Indies. It is a valuable purgative, acting mildly but quickly, and particularly eligible when it is desirable to produce but little irritation along the intestinal canal.

**CATECHU, JAPAN EARTH,** yet no earth, but extracted from the wood of one of the acacia trees, is a very useful astringent. It is given in super-purgation, in doses of one or two drachms, with opium, as a yet more powerful astringent; chalk, to neutralise any acid in the stomach or bowels; and powdered gum, to sheath the over-irritated mucous coat of the intestines. It is not often adulterated in our country, but grossly so abroad—fine sand and aluminous earth being mixed with the extract. It is seldom given with any alkali, yet the prescription just recommended contains chalk: but, although the chalk, as an alkali, may weaken the astringency of the catechu, it probably neutralises some acid in the stomach or bowels, that would have diminished the power of the catechu to a greater degree. It must not be given in conjunction with any metallic salt, for the tannin or gallic acid, on which its power chiefly or entirely depends, has an affinity for all metals, and will unite with them, and form a gallate of them, possessing little astringent energy. Common ink is the union of this tannin principle with iron.

A tincture of catechu is sometimes made by macerating three ounces of the powder in a quart of spirit for a fortnight. It is an excellent application for wounds; and, with the aloes, constitutes all that we want of a balsamic nature for the purpose of hastening the healing process of wounds.

**CAUSTICS** are substances that burn or destroy the parts to which they are applied. First among them stands the red-hot iron, or actual cantery, and then pure alkalies, potash, and soda, and the sulphuric and nitric acids. Milder caustics are found in the nitrate of silver, sulphate of copper, red precipitate, burnt alum, and verdigris. They are principally used to destroy fungous excrescences, to stimulate indolent tumours, or remove portions of cellular substance, or muscle infected by any poison.

**CRETA PREPARATA, CHALK,** is principally used in combination with catechu and opium in cases of super-purgation. All adventitious matters are removed by washing, and the prepared or levigated chalk remains in the form of an impalpable powder. It is usually administered in doses of two or three ounces. It is externally applied over ulcers that discharge a thin and ichorous matter.

**CHAMOMILE, ANTHEMIS.**—The powder of the flower, or infusion of the plant, is a useful vegetable tonic, and the mildest in our list. It is given in doses of one or two drachms, and is exhibited in the early stage of convalescence in order to ascertain whether the febrile stage of the disease is passed, and to prepare the way for a more powerful tonic, the gentian. If no acceleration of pulse, or heat of mouth, or indication of return of fever, accompanies the cautious use of the chamomile, the gentian, with sulphate of iron, may be safely ventured upon; but if the gentian had

been first used, and a little too soon, there might have been considerable, and perhaps dangerous return of fever.

CHARCOAL is occasionally used as an antiseptic, being made into a poultice with linseed meal, and applied to foul and offensive ulcers, and to cracked heels. It removes the fœtid and unwholesome smell that occasionally proceeds from them.

CHARGES are thick adhesive plasters spread over parts that had been strained or weakened, and, being applied to the skin, adhere for a considerable time. The following mixture makes a good charge—Burgundy or common pitch, five ounces; tar, six ounces; yellow wax, one ounce, melted together, and when they are becoming cool, half a drachm of powdered cantharides well stirred in. This must be partially melted afresh when applied, and spread on the part with a large spatula, as hot as can be done without giving the animal too much pain. Flocks of tow should be scattered over it while it is warm, and thus a thick and adhesive covering will be formed that cannot be separated from the skin for many months. It is used for old sprains of the loins, and also strains of the back sinews. The charge acts in three ways — by the slight stimulant power which it possesses, it gradually removes all deep-seated inflammation—by its stimulus and its pressure, it promotes the absorption of any callus or thickening beneath; and acting as a constant bandage, it gives tone and strength to the part.

CLYSTERS.—These are useful and too often neglected means of hastening the evacuation of the bowels when the disease requires their speedy action. The old ox bladder and wooden pipe may still be employed, and a considerable quantity of fluid thrown into the intestine; but the patent stomach and clyster pump of Mr. Reid is far preferable, as enabling the practitioner to inject a greater quantity of fluid, and in a less time.

Two ounces of soft or yellow soap, dissolved in a gallon of warm water, will form a useful aperient clyster. It will detach or dissolve many irritating substances that may have adhered to the mucous coat of the bowels. For a more active aperient, half a pound of Epsom salts, or even of common salt, may be dissolved in the same quantity of water. A stronger injection, but not to be used if much purgative medicine has been previously given, may be composed of an ounce of Barbadoes aloes, dissolved in two or three quarts of warm water. If nothing else can be procured, warm water may be employed; it will act as a fomentation to the inflamed and irritable surface of the bowels, and will have no inconsiderable effect even as an aperient.

In cases of over-purging or inflammation of the bowels, the injection must be of a soothing nature. It may consist of gruel alone, or if the purging is considerable and difficult to stop, the gruel must be thicker, and four ounces of prepared or powdered chalk well mixed with or suspended in it, with two scruples or a drachm of powdered opium.

No oil should enter into the composition of a clyster, except that linseed oil may be used for the expulsion of the ascarides, or needle-worms.

In epidemic catarrh, when the horse sometimes obstinately refuses to eat or to drink, his strength may be supported by nourishing clysters; but they should consist of thick gruel only, and not more than a quart should be administered at once. A greater quantity would be ejected soon after the pipe is withdrawn. Strong broths, and more particularly ale and wine, are dangerous ingredients. They may rapidly aggravate the fever, and should never be administered except under the superintendence, or by the direction, of a veterinary surgeon.

The principal art of administering a clyster consists in not frightening the horse. The pipe, well oiled, should be very gently introduced, and

the fluid not too hastily thrown into the intestine ; its heat being as nearly as possible that of the intestine, or about 96° of Fahrenheit's thermometer.

**COLLYRIA, LOTIONS FOR THE EYES.**—These have been sufficiently described when inflammation of the eyes was treated of.

**COPAIBA, BALSAM OF COPAIBA.**—The resin is obtained from a tree growing in South America and the West India Islands. It is expensive, much adulterated, and seldom used ; for its properties differ but little from those of common diuretics.

**COPPER.**—There are two combinations of this metal used in veterinary practice, the verdigris or subacetate, and the blue vitriol or sulphate.

*Verdigris* or *Subacetate of Copper* is produced by subjecting that metal to the action of acetic acid. It has been given internally by some practitioners, in doses of two or three drachms daily, as a tonic, and particularly for the cure of farcy. It is, however, an uncertain and dangerous medicine. Verdigris is, however, usefully applied externally as a mild caustic. Either alone, in the form of fine powder, or mixed with an equal quantity of the sugar (superacetate) of lead, it eats down proud flesh, or stimulates old ulcers to healthy action. When boiled with honey and vinegar, it constitutes the farriers' *Egyptiacum*, certainly of benefit in cankered or ulcerated mouth, and no bad application for thrushes ; but yielding, as it regards both, to better remedies, that are mentioned under the proper heads. Some practitioners use alum and oil of vitriol in making their *Egyptiacum*, forgetting the strange decomposition which is produced.

*Blue Vitriol* or *Sulphate of Copper* is the union of sulphuric acid and copper. It is a favourite tonic with many practitioners, and has been vaunted as a specific for glanders ; while others, and we think properly, have no very good opinion of it. As a cure for glanders, its reputation has nearly passed away. As a tonic, when the horse is slowly recovering from severe illness, it is dangerous, and its internal use should be confined to cases of long continued discharge from the nostril, when catarrh or fever have ceased. It may then be given with benefit in doses of from one to two drachms twice in the day, either in the food or combined with gentian and ginger. It is principally valuable as an external application, dissolved in water in the proportion of two drachms to a pint, and acting as a gentle stimulant. If an ounce is dissolved in the same quantity of water, it becomes a mild caustic. In the former proportion, it rouses old ulcers to a healthy action, and disposes even recent wounds to heal more quickly than they otherwise would do ; and in the latter, it removes fungous granulations or proud flesh. The blue vitriol is sometimes reduced to powder and sprinkled upon the wound for this purpose : it is also a good application for canker in the foot.

**CORDIALS** are useful or injurious according to the judgment with which they are given. When a horse comes home thoroughly exhausted, and refuses his food, a cordial may be beneficial. It may rouse the stomach and the system generally, and may prevent cold and fever ; but it is poison to the animal when administered after the cold is actually caught and fever begins to appear. More to be reprobated is the practice of giving *frequent* cordials, that by their stimulus on the stomach (the skin sympathising so much with that viscus) a fine coat may be produced. The artificial excitement of the cordial soon becomes as necessary to enable the horse to do even common work, as is the excitement of the dram to sustain the animal spirits of the drunkard.

In order to recall the appetite of the horse slowly recovering from illness, a cordial may sometimes be allowed ; or to old horses that have been worked hard and used to these excitements when young ; or to



draught horses, that have exhibited slight symptoms of staggers when their labour has been unusually protracted and their stomachs left too long empty; or mixed with diuretic medicine, to fine the legs of the overworked and debilitated animal; but in no other case should they obtain a place in the stable, or be used at the discretion of the carter or the groom.

**CORROSIVE SUBLIMATE.**—See **MERCURY**.

**CREOSOTE** has very lately been introduced into veterinary practice, and is much valued on account of its antiseptic properties. It is obtained by the destructive distillation of various substances, as pyroligneous acid, tar, wood smoke, &c. Pure creosote is colourless and transparent; its odour is that of smoked meat, and its taste is caustic and burning. It coagulates the albumen of the blood, and hence has been lately employed in stopping hæmorrhages. It acts very powerfully on the general system, and quickly destroys small animals. Professor Morton gives a very interesting and faithful account of it. It is, according to him, both a stimulant and a tonic. In an undiluted state, it acts as a caustic. When diluted, it is a general excitant and an antiseptic. In the form of a lotion, a liniment, or an ointment, it has been useful in farcy and glanders, also in foot-rot, canker, and thrush,—mange, caries, excessive suppuration, and the repression of fungous granulations. As a caustic, it acts as a powerful stimulant, and it is an antiseptic.

**CROTON TIGLI SEMINA, CROTON SEEDS.**—The croton-nut has not been long introduced into veterinary practice, although it has been used from time immemorial by the inhabitants of India as a powerful purgative. An oil has been extracted from it, and both it and the meal are adopted by the veterinarian. It is given in doses from a scruple to half a drachm, and, from its acrid nature, in the form of a ball, with an ounce of linseed meal. When it does operate, the effect is generally observed in six or eight hours, the stools being profuse and watery, and the patient frequently griped. On account of its speedy operation, it may be given in locked-jaw and staggers: and also in dropsy of the chest or belly, from the watery and profuse stools which it produces; but it is often uncertain in its operation, and its griping, and the debility which it occasions, are serious objections to it as common physic. The oil, when placed on the tongue of the horse in quantities varying from twenty to forty drops, produces purging, but the membrane of the mouth frequently becomes violently inflamed. This likewise happens, but not to so great a degree, when it is given in the form of a drink, or in a mash.

**DEMULCENTS** are substances that have the power of diminishing the effect of acrimonious or stimulating substances. The first, by some oily or mucilaginous substance, sheaths the sensitive parts. The other dilutes the stimulus, and diminishes its power. It will rarely be difficult to determine which effect should be produced, and the means by which it is to be effected.

**DIAPHORETICS** are medicines that increase the sensible and insensible perspiration of the animal. As it regards the horse, they are neither many nor powerful. Antimony in its various forms, spirit of nitric ether, sulphur, and camphor have some effect in opening the pores of the skin, and exciting its vessels to action, and especially when assisted by warmth of stable or clothing, and therefore are useful in those diseases in which it is desirable that some portion of the blood should be diverted from the overloaded, and inflamed, and vital organs of the chest, to the skin or the extremities. The only diaphoretics, however, on which much confidence can be placed, and especially to produce condition, are warm clothing and good grooming.

**DIGESTIVES** are applications to recent or old wounds, as mild stimulants, in order to produce a healthy appearance and action in them, and to cause them more speedily to heal. A weak solution of blue vitriol is an excellent digestive; so is the tincture of aloes, and the tincture of myrrh. The best digestive ointment is one composed of three parts of calamine ointment (Turner's cerate) and one of common turpentine.

**DIGITALIS.**—The leaves of the *digitalis purpurea*, or common foxglove, gathered about the flowering time, dried carefully in a dark place, and powdered, and kept in a close black bottle, form one of the most valuable medicines in veterinary practice. It is a direct and powerful sedative, diminishing the frequency of the pulse, and the general irritability of the system, and acting also as a mild diuretic; it is therefore useful in every inflammatory and febrile complaint, and particularly in inflammation of the chest. It is usually given in combination with emetic tartar and nitre. The average dose is one drachm of digitalis, one and a half of emetic tartar, and three of nitre, repeated twice or thrice in the day.

Digitalis seems to have an immediate effect on the heart, lessening the number of its pulsations; but effecting this in a singular manner—not by causing the heart to beat more slowly, but producing certain intermissions or pauses in its action. When these become marked—when at every sixth or seventh beat, the pulsations are suspended while two or three can be slowly counted, this is precisely the effect that is intended to be produced, and however ill the horse may appear to be, or however alarming this intermittent pulse may seem to the standers-by, from that moment the animal will frequently begin to amend. The dose must then be diminished one-half, and in a few days it may be omitted altogether: but the emetic tartar and the nitre should be continued during some days after the practitioner has deemed it prudent to try the effect of mild vegetable tonics.

There is no danger in the intermittent pulse thus produced; but there is much when the digitalis fails to produce any effect on the circulation. The disease is then too powerful to be arrested by medicine. Digitalis requires watching; but the only consequence to be apprehended from an over-dose is, that the patient may be reduced a little too low, and his convalescence retarded for a day or two.

In the form of infusion or tincture, digitalis is very useful in inflammation of the eyes. It is almost equal in its sedative influence to opium, and it may with great advantage be alternated with it, when opium begins to lose its power. The infusion is made by pouring a quart of boiling water on an ounce of the leaves. When it is become cold, a portion of the liquid may be introduced into the eye. One or two drops of the tincture may be introduced with good effect. This may be obtained by macerating three ounces of the digitalis in a quart of spirit.

The infusion has been serviceable in mange; but there are better applications.

**DIURETICS** constitute a useful but much abused class of medicines. They stimulate the kidneys to secrete more than the usual quantity of urine, or to separate a greater than ordinary proportion of the watery parts of the blood. The deficiency of water in the blood, thus occasioned, must be speedily supplied, or the healthy circulation cannot be carried on, and it is generally supplied by the absorbents taking up the watery fluid in some part of the frame, and carrying it into the circulation. Hence the evident use of diuretics in dropsical affections, in swelled legs, and also in inflammation and fever, by lessening the quantity of the circulating fluid, and, consequently, that which is sent to the inflamed parts.

All this is effected by the kidneys being stimulated to increased action; but if this stimulus is too often or too violently applied, the energy of the

kidney may be impaired, or inflammation may be produced. That inflammation may be of an acute character, and destroy the patient; or, although not intense in its nature, it may by frequent repetition assume a chronic form, and more slowly, but as surely, do irreparable mischief. Hence the necessity of attention to that portion of the food which may have a diuretic power. Mow-burnt hay and foxy oats are the unsuspected causes of many a disease in the horse, at first obscure, but ultimately referable to injury or inflammation of the urinary organs. Hence, too, the impropriety of suffering medicines of a diuretic nature to be at the command of the ignorant carter or groom. In swelled legs, cracks, and inflammations which are said to be produced by humours floating in the blood, diuretics are evidently beneficial; but they should be as mild as possible, and not oftener given or continued longer than the case requires. For some cautions as to the administration of diuretics, and a list of the safest and best, the reader is referred to page 337.

**DRINKS.**—Many practitioners and horse-proprietors have a great objection to the administration of medicines in the form of drinks. A drink is not so portable as a ball, it is more troublesome to give, and a portion of it is usually wasted. If the drink contains any acid substance, it is apt to excoriate the mouth, or to irritate the throat already sore from disease, or the unpleasant taste of the drug may unnecessarily nauseate the horse. There are some medicines, however, which must be given in the form of drink, as in colic; and the time, perhaps, is not distant when purgatives will be thus administered, as more speedy, and safer in their operation. In cases of much debility and entire loss of appetite, all medicine should be given in solution, for the stomach may not have sufficient power to dissolve the paper in which the ball is wrapped, or the substance of the ball.

An ox's horn, the larger end being cut slantingly, is the usual and best instrument for administering drinks. The noose of a halter is introduced into the mouth, and then, by means of a stable fork, the head is elevated by the groom considerably higher than for the delivery of a ball. The assistant stands on a pail or stable-basket on the off-side of the horse, and with the right hand introduces the horn gently into the mouth, and over the tongue, and by a dexterous turn of the horn empties the whole of the drink—not more than about six ounces—into the back part of the mouth. The horn is now quickly withdrawn, and the greater portion of the fluid will be swallowed. A portion of it, however, will often be obstinately held in the mouth for a long time, and the head must be kept up until the whole is got rid of, which a quick, but not violent slap on the muzzle will generally compel the horse to do. The art of giving a drink consists in not putting too much into the horn at once; introducing the horn far enough into the mouth, and quickly turning and withdrawing it, without bruising or wounding the mouth, the tongue being loosened at the same moment. A bottle is a disgraceful and dangerous instrument to use, except it be a flat pint bottle, with a long and thick neck.

**FERRUM, IRON.**—Of this metal there are two preparations adopted by veterinarians. The *Carbonate* is a mild and useful tonic in doses of from two to four drachms. The *Sulphate* (green vitriol or COPPERAS) is more powerful. It should never be given in the early stages of recovery, and always with caution. The dose should be the same as that of the carbonate. The sulphate has lately been recommended for the cure of that deceitful stage or form of glanders, in which there is nothing to characterise the disease but a very slight discharge from the nostrils. It is to be dissolved in the common drink of the horse. It is worth a trial, but too sanguine expectations must not be encouraged of the power of any drug

over this intractable malady. The iron should be given in combination with gentian and ginger, but never with any alkali or nitre or soap, or catechu, or astringent vegetable. Sulphate of iron may conveniently be given in the water; from one to two drachms so dissolved will be freely drank by the horse.

FOMENTATIONS open the pores of the skin and promote perspiration in the part, and so abate the local swelling, and relieve pain and lessen inflammation. They are often used, and with more benefit when the inflammation is somewhat deeply seated than when it is superficial. The effect depends upon the warmth of the water, and not on any herb that may have been boiled in it. They are best applied by means of flannel several times folded, frequently dipped in the hot water, or on which the water is poured, and wrung dry, and the heat should be as great as the hand will bear. The benefit that might be derived from them is much impaired by the absurd method in which the fomentations are conducted. They are rarely continued long enough, and when they are removed, the part is left wet and uncovered, and the coldness of evaporation succeeds to the heat of fomentation. The perspiration is thus suddenly checked; the animal suffers considerable pain, and more harm is done by the extreme change of temperature than if the fomentation had not been attempted.

GENTIAN stands at the head of the vegetable tonics, and is a stomachic as well as a tonic. It is equally useful in chronic debility, and in that which is consequent on severe and protracted illness. It is generally united with ginger, and, when the patient will bear it, sulphate of iron. Four drachms of gentian, one of sulphate of iron, and one of ginger will make an excellent tonic ball. An infusion of gentian is one of the best applications to putrid ulcers.

GINGER is as valuable as a cordial as gentian is as a tonic. It is the basis of the cordial ball, and it is indispensable in the tonic ball. If the root is large, heavy, and not worm-eaten, the dark ginger is as good as the white, and considerably cheaper. The powder is adulterated with bean-meal and the sawdust of boxwood, and rendered warm and pungent by means of capsicum.

HELLEBORUS NIGER, BLACK HELLEBORE.—This is used mostly as a local application, and as such it is a very powerful stimulant. Mr. E. Stanley, of Birmingham, frequently resorts to it in fistulous affections of the poll and withers, and with considerable success. The abscess having formed, and exit being given to the imprisoned fluid, it is allowed to discharge itself, for two or three days, being dressed by an ordinary digestive ointment. When the pus assumes a laudable character, he introduces a few portions of the fibrous part of the root, passing them down to the bottom of the sinus, and letting them remain for a fortnight or more; in the mean time, merely keeping the surrounding parts clean. On examination it will be found that the healing process has commenced.

Professor Morton says, that an ointment formed of the powder of either the black or white hellebore, in the proportion of one part of the powder to eight of lard, will be found exceedingly active for the dressing of rowels and setons.

HEMLOCK, CONIUM MACULATUM, is used by some practitioners, instead of digitalis or hellebore, in affections of the chest, whether acute or chronic; but it is inferior to both. The dose of the powder of the dried leaves is about a drachm.

HYDRARGYRUM (MERCURY).—This metal is found native in many countries in the form of minute globules. It also occurs in the form of sulphuret, from which it is obtained by distillation with lime or iron. It has the singular property of being liquid in the natural temperature of our earth. It

freezes, or assumes a singular species of crystallisation at  $39^{\circ}$  below 0 of Fah., and at  $660^{\circ}$  above 0 of Fah. it boils and rapidly evaporates. In its metallic state it appears to have no action on the animal system, but its compounds are mostly powerful excitants, and some of them are active caustics.

The *Common Mercurial Ointment* may be used for ringworm, and that species of acarus which seems to be the source, or the precursor of, mange. The compound mercurial ointment is also useful in the destruction of the same insect. For most eruptions connected with or simulating mange, the author of this work has been accustomed to apply the following ointment with considerable success:—

Sublimed sulphur . . . . .	1 pound.
Common turpentine . . . . .	4 oz.
Mercurial ointment . . . . .	2 oz.
Linseed oil . . . . .	1 pint.

The *Mercurial Ointment* is prepared by rubbing quicksilver with lard, in the proportion of one part of mercury to three of lard, until no globules appear. The practitioner should, if possible, prepare it himself, for he can seldom get it pure or of the proper strength from the druggist. It is employed with considerable advantage in preparing splints, spavins, or other bony or callous tumours, for blistering or firing. One or two drachms, according to the nature and size of the swelling, may be daily well rubbed in; but it should be watched, for it sometimes salivates the horse very speedily. The tumours more readily disperse, at the application of a stronger stimulant, when they have been thus prepared. Mercurial ointment in a weaker state is sometimes necessary for the cure of mallenders and sallenders; and in very obstinate cases of mange, one-eighth part of mercurial ointment may be added to the ointment recommended at page 357.

*Calomel*, the submuriate or protochloride of mercury, is obtained by mixing together mercury and sulphuric acid, adding chloride of sodium, and then sublimed by heat. It is useful in some cases of chronic cough, in farcy, and in jaundice. Alone it has little purgative effect on the horse, but it assists the action of other aperients. It is given in doses from a scruple to a drachm. As soon as the gums become red, or the animal begins to quid or drop his hay, it must be discontinued.

*Corrosive Sublimate*, the oxymuriate or bichloride of mercury, combined with chlorine in a double proportion, is a useful tonic in farcy. It should be given in doses of ten grains daily, and gradually increased to a scruple, until the horse is purged, or the mouth becomes sore, when it may be omitted for a few days, and resumed. Some have recommended it as a diuretic, but it is too dangerous a medicine for this purpose. It is used externally in solution; in substance in quittor, as a stimulant to foul ulcers; and in the proportion of five grains to an ounce of rectified spirit in obstinate mange, or to destroy vermin on the skin. It is, however, too uncertain and too dangerous a medicine for the horse-proprietor to venture on its use.

*Æthiop's Mineral*, the black sulphuret of mercury, is not often used in horse practice, but it is a good alternative for obstinate surfeit or foulness of the skin, in doses of three drachms daily. Four drachms of cream of tartar may be advantageously added to each dose.

INFUSIONS.—The active matter of some vegetable substances is partly or entirely extracted by water. Dried vegetables yield their properties more readily and perfectly than when in their green state. Boiling water is poured on the substance to be infused, and which should have been previously pounded or powdered, and the vessel then covered and placed

near a fire. In five or six hours the transparent part may be poured off, and is ready for use. In a few days, however, all infusions become thick, and lose their virtue, from the decomposition of the vegetable matter.

The infusion of chamomile is advantageously used instead of water in compounding a mild tonic drench. The infusion of catechu is useful in astrigent mixtures; that of linseed is used instead of common water in catarrh and cold; and the infusion of tobacco in some injections.

**IODINE.**—This substance has not been long introduced into veterinary practice. The first object which it seemed to accomplish was the reduction of the enlarged glands that frequently remain after catarrh, but it soon appeared that it could reduce almost every species of tumour. Much concerned in the first introduction of iodine into veterinary practice, the writer of the present work bears willing testimony to the zeal and success of others, in establishing the claims of this most valuable medicine. Professor Morton has devoted much time and labour to the different combinations of iodine, and they are described at length in his useful 'Manual of Pharmacy.' He gives the formulæ of the composition of a liniment, an ointment, and a tincture of iodine, adapted to different species and stages of disease. He next describes the preparation of the iodide of potassium—the combination of iodine and potash,—and then the improvement on that under the name of the diiodide of copper—the union of two parts of the iodide of potassium with four of the sulphate copper.

The action of this compound is an admirable tonic and a stimulant to the absorbent system, if combined with vegetable tonics, and, occasionally, small doses of cantharides. Professor Spooner and Mr. Daws applied this compound, and with marked success, to the alleviation of farey, nasal gleet, and glanders. It is pleasing to witness these triumphs over disease, a little while ago so unexpected, and now so assured.

**JUNIPER, OIL OF.**—This essential oil is retained because it has some diuretic property, as well as being a pleasant aromatic. It frequently enters into the composition of the diuretic ball.

**LEAD, PLUMBUM.**—This metal in its natural state is generally found in combination with sulphur, in the form of sulphuret of lead, from which it is obtained by mixing with lime and exposure to heat. In its metallic state, it is of a bright bluish-white colour, with little taste, but a disagreeable odour. In its pure state, it has little effect on the animal system, but there are several compounds which possess medicinal and even poisonous properties. Amongst the latter the *Carbonate of Lead* has a deleterious effect on the biped and the quadruped in the neighbourhood of lead works and rifle butts. They are subject to violent griping pains, and to constipation that can with great difficulty, or not at all, be overcome. Something of the same kind is occasionally observed in the cider counties, and the 'painter's colic' is a circumstance of too frequent occurrence—the occasional dreadful pains, and the ravenous appetite extending to every thing that comes in the way of the animal. Active purgatives followed by sulphuric acid and opium are the most effectual remedies.

The *Acetate of Lead, Plumbi Acetas.*—Sugar of lead is seldom given internally to the horse, but is used as a collyrium for inflammation of the eyes.

The *Liquor Plumbi Subacetatis*, or *Goulard's Extract*, or, as it used to be termed at the Veterinary College, the *Aqua Vegeto*, is a better collyrium, and advantageously used in external and superficial inflammation, and particularly the inflammation that remains after the application of a blister.

LIME was formerly sprinkled over cankered feet and greasy heels, but there are less painful caustics, and more effectual absorbents of moisture. Lime-water is rarely used, but the *Chloride of Lime* is exceedingly valuable. Diluted with twenty times its quantity of water, it helps to form the poultice applied to every part from which there is the slightest offensive discharge. The fœtid smell of fistulous withers, poll-evil, canker, and ill-conditioned wounds, is immediately removed, and the ulcers are more disposed to heal. When mangy horses are dismissed as cured, a washing with the diluted chloride will remove any infection that may lurk about them, or which they may carry from the place in which they have been confined. One pound of the chloride mixed with three gallons of water, and brushed over the walls and manger and rack of the foulest stable, will completely remove all infection. Professor Morton, very properly, says that the common practice of merely whitewashing the walls serves only to cover the infectious matter, and perhaps to preserve it for an indefinite length of time, so that, when the lime scales off, disease may be again engendered by the exposed virus. The horse furniture worn by a glandered or mangy animal will be effectually purified by the chloride. Internally administered, it seems to have little or no power.

LINIMENTS are applications designed either to soothe an inflamed surface, or, by gently stimulating the skin, to remove deeper-seated pain or inflammation. As an emollient liniment, one composed of half an ounce of Goulard's extract and four ounces of olive oil will be useful. For sprains, old swellings, or rheumatism, two ounces of hartshorn, the same quantity of camphorated spirit, an ounce of oil of turpentine, and half an ounce of laudanum, may be mixed together; or an ounce of camphor may be dissolved in four ounces of sweet oil, to which an ounce of oil of turpentine may be afterwards added. A little powdered cantharides, or tincture of cantharides, or mustard powder, will render either of these more powerful, or convert it into a liquid blister.

LINSEED.—An infusion of linseed is often used instead of water, for the drink of the horse with sore-throat or catarrh, or disease of the urinary organs or of the bowels. A pail containing it should be slung in the stable or loose box. Thin gruel, however, is preferable; it is as bland and soothing, and it is more nutritious. Linseed meal forms the best poultice for almost every purpose.

MAGNESIA.—The sulphate of magnesia, or EPSOM SALTS, should be used only in promoting the purgative effect of clysters, or, in repeated doses of six or eight ounces, gently to open the bowels at the commencement of fever. Some doubt, however, attends the latter practice; for the dose must occasionally be thrice repeated before it will act, and then, although safer than aloes, it may produce too much irritation in the intestinal canal, especially if the fever is the precursor of inflammation of the lungs.

MASHES constitute a very important part of horse-provender, whether in sickness or health. A mash given occasionally to a horse that is otherwise fed on dry meat prevents him from becoming dangerously costive. To the overworked and tired horse nothing is so refreshing as a warm mash with his usual allowance of corn in it. The art of getting a horse into apparent condition for sale, or giving him a round and plump appearance, consists principally in the frequent repetition of mashes, and, from their easiness of digestion and the mild nutriment which they afford, as well as their laxative effect, they form the principal diet of the sick horse.

They are made by pouring boiling water on bran, and stirring it well, and then covering it over until it is sufficiently cool for the horse to eat.

If in the heat of summer a cold mash is preferred, it should, nevertheless, be made with hot water, and then suffered to remain until it is cold. This is not always sufficiently attended to by the groom, who is not aware that the efficacy of the mash depends principally on the change which is effected in the bran and the other ingredients by the boiling water rendering them more easy of digestion, as well as more aperient. If the horse refuses the mash, a few oats may be sprinkled over it, in order to tempt him to eat it; but if it is previously designed that corn should be given in the mash, it should be scalded with the bran, in order to soften it and render it more digestible. Bran mashes are very necessary preparatives for physic, and they are given during its operation. They very soon become sour, and the manger of the horse of whose diet they form a principal part should be daily and carefully cleaned out.

When horses are weakly and much reduced, malt mashes will often be very palatable to them and very nutritive: but the water that is poured on a malt mash should be considerably below the boiling heat, otherwise the malt will be set, or clogged together. If the owner was aware of the value of a malt mash, it would be oftener given when the horse is rapidly getting weaker from protracted disease, or when he is beginning to recover from a disease by which he has been much reduced. The only exception to their use is in cases of chest affection, in which they must not be given too early. In grease, and in mange accompanied by much emaciation, malt mashes will be peculiarly useful, especially if they constitute a principal portion of the food.

**MUSTARD, SINAPIS.**—This will be found occasionally useful, if, in inflammation of the throat, chest, or bowels, it is well rubbed on the throat, chest, or the abdomen. The external swelling and irritation which it excites may, to a greater or less degree, abate the inflammation within.

**MYRRH** may be used in the form of tincture, or it may be united to the tincture of aloes as a stimulating and digestive application to wounds. Diluted with an equal quantity of water, it is a good application for canker in the mouth, but as an internal medicine, it seems to be inert, although some practitioners advocate its use, combined with opium, in cases of chronic cough.

**NITRIC ETHER, SPIRIT OF,**—is obtained from the distillation of a mixture of rectified spirit and nitric acid. It is a colourless liquid, very volatile, with a peculiar odour and somewhat acid taste. As a medicinal agent, it is one of the most valuable diffusible stimulants we possess; it also acts as a diaphoretic and mild diuretic. It is a useful remedy in the early stages of influenza and catarrh, and also in those cases of congestion of important organs such as the lungs, the result of sudden exposure or exhausting work. Given in combination with tincture of opium, it forms an excellent draught for spasmodic colic. It is also a very useful medicine in the advanced stages of fever, for while it, to a certain degree, rouses the exhausted powers of the animal, and may be denominated a stimulant, it never brings back the dangerous febrile action which was subsiding. It is given in doses of half an ounce to two ounces.

**OLIVE OIL** is an emollient and demulcent. Its laxative effect is very inconsiderable and uncertain in the horse.

**OPIMUM.**—This consists of the inspissated juice of the papaver somniferum, or white poppy. It is obtained by making incisions into the unripe capsule of the poppy and scraping off the juice which exhales, and drying it in the sun. The best kind of opium is brought to this country in chests from Turkey and India. Good opium should be of a blackish-brown colour externally and reddish-brown internally, with a powerful narcotic odour, and a strong and permanently bitter taste. However underrated by some,



there is not a more valuable drug on our list. It does not often act as a narcotic except in considerable doses; but it is a powerful antispasmodic, sedative, and astringent. As an antispasmodic, it enters into the colic drink, and it is the sheet-anchor of the veterinarian in the treatment of tetanus or locked-jaw. As a sedative, it relaxes that universal spasm of the muscular system which is the characteristic of tetanus; and, perhaps, it is only as a sedative that it has such admirable effect as an astringent, for when the irritation around the mouth of the vessels of the intestines and kidneys is allayed by the opium, the undue purging and profuse staling will necessarily be arrested.

Opium should, however, be given with caution. It is its secondary effect that is sedative, and, if given in cases of fever, its primary effect in increasing the excitation of the frame may be very considerable and highly injurious. In the early and acute stage of fever, it would be bad practice to give it in the smallest quantity; but when the fever has passed, or is passing, there is nothing which so rapidly subdues the irritability that accompanies extreme weakness. It becomes an excellent tonic, because it is a sedative.

If the blue or green vitriol, or cantharides, have been pushed too far, opium, sooner than any other drug, quiets the disorder they have occasioned. It is given in doses of one or two drachms, in the form of ball. Other medicines are easily combined with it, according to the circumstances of the case.

Externally, it is useful in ophthalmia. In the form of decoction of the poppyhead, it may constitute the basis of an anodyne poultice; but it must not be given in union with any alkali, with the exception of chalk, in over-purging; nor with the superacetate of lead, by which its powers are materially impaired; nor with sulphate of zinc, or copper, or iron.

From its high price, it is much adulterated, and it is not always met with in a state of purity. The best tests are its smell, its taste, its toughness and pliancy, its fawn or brown colour, and its weight, for it is the heaviest of all the vegetable extracts, except gum arabic; yet its weight is often fraudulently increased by stones and bits of lead dexterously concealed in it.

PITCH is used to give adhesiveness and firmness to charges and plasters. The common pitch is quite as good as the more expensive Burgundy pitch. The best plaster for sand-crack consists of one pound of pitch and an ounce of yellow bees-wax melted together.

PHYSIC.—The cases which require physic, the composition of the most effectual and safest physic ball, and the mode of treatment under physic, have been already described.

POTASH.—Two compounds of potash are used in veterinary practice. The Nitrate of Potash (*Nitre*) is a valuable cooling medicine and a mild diuretic, and, therefore, it should enter into the composition of every fever-ball. Its dose is from two to four drachms. Grooms often dissolve it in the water. There are two objections to this: either the horse is nauseated, and will not drink so much water as he ought; or the salt taste of the water causes considerable thirst, and disinclination to solid food. Nitre, while dissolving, materially lowers the temperature of water, and furnishes a very cold and useful lotion for sprain of the back sinews, and other local inflammations. The lotion should be used as soon as the salt is dissolved, for it quickly becomes as warm as the surrounding air. The Bitartrate of Potash (*Cream of Tartar*) is a mild diuretic, and, combined with *Æthiop's* mineral, is used as an alternative in obstinate mange or grease. The objection, however, to its use in such an animal as the horse is the little power which it seems to exercise.

**POULTICES.**—Few horsemen are aware of the value of these simple applications in abating inflammation, relieving pain, cleansing wounds, and disposing them to heal. They are applications of the best kind continued much longer than a simple fomentation can be. In all inflammations of the foot they are very beneficial, by softening the horn hardened by the heat of the foot and contracted and pressing on the internal and highly sensitive parts. The moisture and warmth are the useful qualities of the poultice; and that poultice is the best for general purposes in which moisture and warmth are longest retained. Perspiration is most abundantly promoted in the part, the pores are opened, swellings are relieved, and discharges of a healthy nature procured from wounds.

Linseed meal forms the best general poultice, because it longest retains the moisture. Bran, although frequently used for poultices, is objectionable, because it so soon becomes dry; the combination of the two in proportion of one part of meal to two or three of bran is a very useful one. To abate considerable inflammation, and especially in a wounded part, Goulard may be added, or the linseed meal may be made into a paste with a decoction of poppy-heads. To promote a healthy discharge from an old or foul ulcer; or separation of the dead from the living parts, in the process of what is called coring out; or to hasten the ripening of a tumour that must be opened; or to cleanse it when it is opened,—two ounces of common turpentine may be added to a pound of linseed meal: but nothing can be so absurd, or is so injurious, as the addition of turpentine to a poultice that is designed to be an emollient. The drawing poultices and stoppings of farriers are often highly injurious, instead of abating inflammation.

If the ulcer smells offensively, two ounces of powdered charcoal may be added to the linseed meal, or the poultice may be made of water, to which a solution of the chloride of lime has been added in the proportion of half an ounce to a pound. As an emollient poultice for grease and cracked heels, and especially if accompanied by much unpleasant smell, there is nothing preferable to a poultice of mashed carrots with charcoal. For old grease some slight stimulant must be added, as a little yeast or the grounds of table-beer.

There are two errors in the application of a poultice, and particularly as it regards the legs. It is often put on too tight, by means of which the return of the blood from the foot is prevented, and the disease is increased instead of lessened; or it is too hot, and unnecessary pain is given, and the inflammation aggravated.

**POWDERS.**—Some horses are very difficult to ball or drench, and the violent struggle that would accompany the attempt to conquer them may heighten the fever or inflammation. To such horses powders must be given in mashes. Nitrate of potassa may be generally used in cases of inflammation or fever; or calomel or even the farina of the croton-nut for physic; but powders are too often an excuse for the laziness or awkwardness of the carter or groom. The horse frequently refuses them, especially if his appetite has otherwise begun to fail; the powder and the mash are wasted, and the animal is unnecessarily nauseated. All medicine, if possible, should be given in the form of ball or drink.

**RESIN.**—The yellow resin is that which remains after the distillation of oil of turpentine. It is used externally to give consistence to ointments, and to render them slightly stimulant. Internally it is a useful diuretic, and is given in doses of five or six drachms made into a ball with soft soap. The common liquid turpentine is, however, preferable.

**ROWELS.**—The manner of rowelling has been already described. As exciting inflammation on the surface, and so lessening that which had pre-

viously existed in a neighbouring but deeper-seated part, they are decidedly inferior to blisters, for they do not act so quickly or so extensively; therefore they should not be used in acute inflammation of the lungs or bowels, or any vital part. When the inflammation, however, although not intense, has long continued, rowels will be serviceable by producing an irritation and discharge that can be better kept up than by a blister. As promoting a permanent, although not very considerable discharge, and some inflammation, rowels in the thighs are useful in swelled legs and obstinate grease. If fluid is thrown out under the skin in any other part, the rowel acts as a permanent drain. When sprain of the joint or the muscles of the shoulders is suspected, a rowel in the chest will be serviceable. The wound caused by a rowel will readily heal, and with little blemish, unless the useless leather of the farrier has been inserted.

**SECALE CORNUTUM, the Ergot of Rye.**—This is well known to be an excitant in assisting parturition in cattle, sheep, and dogs. It has been used with success in the mare by Mr. Richardson, of Lincoln. It should only be applied in difficult cases, and the dose should be two drachms, combined with some carminative, and given every hour.

**SEDATIVES** are medicines that subdue irritation, repress spasmodic action, or deaden pain. We will not enquire whether they act first as stimulants: if they do, their effect is exceedingly transient, and is quickly followed by depression and diminished action. Digitalis, aconite, hellebore, opium, hydrocyanic acid, are medicines of this kind. They constitute a class of remedies that should be used with great caution and unremitting watchfulness. Digitalis, and more especially hellebore, often produce effects extremely prejudicial to the operations of nature, and too often produce unfavourable results in the cases in which they have been employed. Their effect in different diseases or stages of disease, and the circumstances which indicate the use of any one of them in preference to the rest, are considered under their respective titles. The most important sedative which has ever been introduced into the veterinary pharmacopœia is chloroform, important, not as a medicinal agent in the cure of disease, but from its power of rendering the horse partially or totally insensible to the infliction of pain. A piece of sponge, saturated with one or two ounces of chloroform, two-thirds enveloped in a piece of bladder or gutta-percha, held near one nostril, while the other is partially closed by the hand, will, as it becomes inhaled, render the animal quickly and effectually insensible,—held near the nostril, be it remembered, not close to it, as the fumes of the chloroform require dilution, from mixing with a proportion of atmospheric air, or its inhalation would be fatal. It was at first hoped that this important discovery would supersede the necessity of casting or throwing the horse; experience, however, has shown that this is not the case, for so great is his repugnance to inhale it, and so violent are his struggles while its effect is being produced, added to which the uncertainty of the direction and spot in which he might fall, that it is now only had recourse to after the animal has been secured by the hobbles; then, indeed, its effects are most extraordinary; the severest operations, the greatest pain and the most acute suffering, are endured with a passive unconsciousness, equally desirable for the operator and the patient. Its effect may be continued or renewed as long and often as the occasion may require, and no perceptible ill effects follow the application.

**SODA.**—*The Carbonate of Soda* is a useful antacid, but it is not much used in veterinary practice. *The Chloride of Soda* is not so efficacious for the removal of unpleasant smells and all infection as the chloride of lime; but it is exceedingly useful in changing malignant and corroding and destructive sores into the state of simple ulcers, and in ulcers that are not

malignant, it much hastens the cure. Poll-evil and fistulous withers are much benefited by it, and all farcy ulcers. It is used in the proportion of one part of the solution to twenty-four of water.

**SODII CHLORIDUM**, *Common Salt*, is very extensively employed in veterinary practice. It forms an efficacious aperient clyster, and a solution of it has been given as an aperient drink. Sprinkled over the hay, or in a mash, it is very palatable to sick horses; and in that languor and disinclination to food which remain after severe illness, few things will so soon recall the appetite as a drink composed of six or eight ounces of salt in solution. To horses in health it is more useful than is generally imagined, as promoting the digestion of the food, and, consequently, condition. In the proportion of an ounce of salt to four ounces of water, it is a good embrocation for sore shoulders and backs; and if it does not always disperse warbles and tumours, it takes away much of the tenderness of the skin.

**SODE SULPHAS**,—*Sulphate of Soda*.—*Glauber's Salt*.—This medicine is seldom used in the treatment of the horse. It appears to have some diuretic property.

**SOAP** is supposed to possess a diuretic quality, and therefore enters into the composition of some diuretic masses. See **RESIN**. By many practitioners it is made an ingredient in the physic-ball, but uselessly or even injuriously so; for if the aloes are finely powdered and mixed with palm oil, they will dissolve readily enough in the bowels without the aid of the soap, while the action of the soap on the kidneys will impair the purgative effect of the aloes.

**STARCH** may be substituted with advantage for gruel in obstinate cases of purging, both as a clyster, and to support the strength of the animal.

**STOPPINGS** constitute an important, but too often neglected part of stable management. If a horse is irregularly or seldom worked, his feet are deprived of moisture; they become hard and unyielding and brittle, and disposed to corn and contraction and founder. The very dung of a neglected and filthy stable would be preferable to habitual standing on the cleanest litter without stopping. In wounds, and bruises, and corns, moisture is even more necessary, in order to supple the horn, and relieve its pressure on the tender parts beneath. As a common stopping, nothing is better than cow-dung with a fourth part of clay well beaten into it, and confined with splints from the binding or larger twigs of the broom. In cases of wounds a little tar may be added; but tar, as a common stopping, is too stimulating and drying. Pads made of thick felt have lately been contrived, which are fitted to the sole, and swelling on being wetted, are sufficiently confined by the shoe. Having been well saturated with water, they will continue moist during the night. They are very useful in gentlemen's stables; but the cow-dung and clay are sufficient for the farmer.

**STRYCHNIA** is obtained from the seed of the *strychnos nux vomica*. It is a white crystalline substance, without odour, but with an intensely bitter taste. It is but slightly soluble in water, but more so in dilute alcohol. It is a powerfully poisonous agent, and should be given with great caution. This drug has frequently been employed with decided advantage in cases of paralysis in the dog; and lately, and with decided advantage, it has been administered to the horse. The dose is from one to three grains, given twice in the day.

**SULPHUR**, or, as it is familiarly known, *Brimstone*, is found in considerable abundance in Sicily and other volcanic countries. In this country it is chiefly obtained by roasting the sulphuret of copper and collecting the fumes; it is then purified and run into moulds, constituting what is termed roll sulphur. Sublimed or flowers of sulphur is obtained by heating roll

sulphur and collecting the vapour. Sulphur is the basis of the most effectual applications for mange. It is an excellent alterative, combined usually with antimony and nitre, and particularly for mange, surfeit, grease, hide-bound, or want of condition. When given alone, it seems to have little effect, except as a laxative in doses of six or eight ounces; but there are much better aperients. The black sulphur consists principally of the dross after the pure sulphur has been separated.

TAR melted with an equal quantity of grease forms the usual stopping of the farrier. It is a warm, or slightly stimulant, and therefore useful, dressing for bruised or wounded feet; but its principal virtue does not consist in preventing the penetration of dirt and water to the wounded part, but in its softening properties on the horn itself, rendering it softer, more elastic, and less likely to break away. As a common stopping it has been considered objectionable; but a small proportion, mixed with the cow-dung, checks that disposition to thrush which occasionally follows the constant use of the latter. From its drying properties it is the usual and proper basis for thrush ointments; and from its adhesiveness, and slightly stimulating power, it often forms an ingredient in applications for mange. Some practitioners give it, and advantageously, with the usual cough medicine, and in doses of two or three drachms for chronic cough. The common tar is as effectual as the Barbadoes for every veterinary purpose. The oil, or spirit (rectified oil) of tar is sometimes used alone for the cure of mange, but it is not to be depended upon. The spirit of tar, mixed with double the quantity of fish oil, is, from its peculiar penetrating property, one of the best applications for hard and brittle feet. It should be well rubbed with a brush every night, both on the crust and sole.

TIKTURES.—The medicinal properties of many substances are extracted by spirit of wine, but in many cases in such small quantities as to be scarcely available for internal use in veterinary practice. There are several exceptions to this, however, such as the tincture of opium, tincture of aconite and several others, which are constantly used, and produce very powerful effects. As applications to wounds or inflamed surfaces, the tinctures of aloes, digitalis, myrrh, and opium, are highly useful.

TOBACCO, in the hands of the skilful veterinarian, may be advantageously employed in cases of extreme or dangerous colic; but should never be permitted to be used as an external application for the cure of mange, or an internal medicine to promote a fine coat.

TOXICS are valuable medicines when judiciously employed; but, like cordials, they have been fatally abused. Many a horse recovering from severe disease has been destroyed by their too early, or too free use. The veterinary surgeon occasionally administers them injuriously, in his anxiety to gratify the impatience of his employer. The mild vegetable tonics, chamomile, gentian, and ginger, and, perhaps, the sulphate of iron, may sometimes be given with benefit, and may hasten the perfect recovery of the patient; but there are few principles more truly founded on reason and experience, than that disease once removed, the powers of nature are sufficient to re-establish health. Against the more powerful mineral tonics, except for the particular purposes that have been pointed out under the proper heads, the horse proprietor and the veterinarian should be on his guard.

TURPENTINE.—The common liquid turpentine has been described as one of the best diuretics, in doses of half an ounce, and made into a ball with linseed meal and powdered ginger. It is added to the calamine or any other mild ointment in order to render it stimulating and digestive, and, from its adhesiveness and slightly stimulating power, it is an ingredient

in mange ointments. The oil of turpentine is an excellent antispasmodic. Forming a tincture with cantharides, it is the basis of the sweating blister for old sprains and swellings. As a blister it is far inferior to the common ointment. As a stimulant frequently applied, it must be sufficiently lowered, or it may blemish.

WAX.—The yellow wax is used in charges and some plasters, to render them less brittle.

ZINC.—The impure carbonate of zinc, under the name of *Calamine Powder*, is used in the preparation of a valuable healing ointment, called Turner's Cerate. Five parts of lard and one of resin are melted together, and when these begin to get cool, two parts of the calamine, reduced to an impalpable powder, are stirred in. If the wound is not healthy, a small quantity of common turpentine may be added. This salve justly deserves the name which it has gained, 'The Healing Ointment.' The calamine is sometimes sprinkled with advantage on cracked heels and superficial sores.

The sulphate of zinc, *White Vitriol*, in the proportion of three grains to an ounce of water, is an excellent application in ophthalmia, when the inflammatory stage is passing over; and quittor is most successfully treated by a saturated solution of white vitriol being injected into the sinuses. A solution of white vitriol of less strength forms a wash for grease that is occasionally useful, when the alum or blue vitriol does not appear to succeed.

ZINGIBERIS RADIX,—*Ginger Root*.—This is an admirable stimulant and carminative. It is useful in loss of appetite and flatulent colic, while it rouses the intestinal canal to its proper action. The cordial mass resorted to by the best surgeons consists of equal parts of ginger and gentian beaten into a mass with treacle.

---

## CHAPTER XXIV.

### POISONS.

THE poisons by which the horse may be affected are divided into three classes, viz. animal, vegetable, and mineral. The virulent effects of animal poisons, such as the bite of venomous reptiles, are frequently observed in hot climates, but rarely in this country. The vegetable poison is generally the result of the animal partaking of it in connection with his food. As a rule, certain characters are possessed by these poisonous plants, which, assisted by a peculiar instinct on the part of the animal, causes him to avoid them. But it not unfrequently happens, partly from the artificial state in which the animal is kept and the long-continued allowance of dry food, that the keener instincts of his nature become altered, and as soon as he is turned out to grass or the opportunity presents itself, he eagerly devours almost any green succulent plant that comes in his way, and thus produces injurious and often fatal results. The poisonous effects of the third division or mineral poisons, is usually caused either by their wilful administration or by an overdose when given as a medicinal agent.

We cannot do better than abbreviate the list of poisonous agents, and the means of averting their fatal influence, given by Professor Morton. It will occasionally be exceedingly useful to the proprietor of horses.

He begins with the ANIMAL POISONS. The bite of the VIPER has been occasionally fatal to dogs and sheep. A horse was brought to the Veteri-

mary College that had been bitten in the hind-leg while hunting. There was considerable swelling, and the place of the bite was evident enough. Mr. Armstrong mentions a case in which a horse, bitten by a viper, sunk into a kind of coma, from which he could not be roused. The antidote, which seldom or never fails, is an alkaline solution of almost any kind, taken internally and applied externally. There is no chemical effect on the circulation, but the alkali acts as a powerful counter-irritant. In very bad cases opium may be added to the alkaline solution.

**HORNETS, WASPS, &c.**—These are spoken of, because there are records of horses being attacked by a swarm of them, and destroyed. The olive oil is the best external application.

**CANTHARIDES** constitute a useful drug in some cases. It is the chief constituent of most applications used in order to excite the process of blistering. It is occasionally employed as a medicine in small quantities, and, combined with vegetable tonics, it has been given in small doses, for the cure of glanders, farcy, and nasal gleet. It is valuable in cases of general and extreme debility. It is a useful general stimulant when judiciously applied: but it must be given in small doses, and never except under the direction of a skilful practitioner. A drachm of the powdered fly would destroy almost any horse. In the breeding season it is too often shamefully given as an excitant to the horse and the mare, and many a valuable animal has been destroyed by this abominable practice. It is usually given in the form of ball, in which case it may be detected by the appearance of small glittering portions of the fly, which are separated on the inner side of the dung-ball in hot water. If the accidental or too powerful administration of it is suspected, recourse should be had to bleeding, purging, and plentiful drenching with oily and demulcent fluids.

The leaves of the *Yew* (*Taxus Baccata*) are dangerous to the horse, as well as to many other animals. 'Two horses that had been employed in carrying fodder, were thoughtlessly placed under a large yew-tree, which they cropped with eagerness. In three hours they began to stagger—both of them dropped, and, before the harness could be taken off, they were dead. A great quantity of yew leaves were found in the stomachs, which were contracted and inflamed.' Mr. W. C. Spooner mentions a case of violent suspicion of the poisoning of an ass and a mare in the same way. On the other hand, Professor Sewell says that on the farm on which he resided in his early years, the horses and cattle had every opportunity of eating yew. They pastured and slept under the shelter of yew-trees, and were often observed to browse on the branches. He thinks that these supposed cases of poisoning have taken place only when enormous quantities of the yew had been eaten, and that it was more acute indigestion than poisoning. There are, however, too many cases of horses dying after feeding on the yew to render it safe to cultivate it in the neighbourhood of a farm, either in the form of tree or hedge.

The treatment should consist in the administration of large doses of oleaginous purgatives, and diffusible stimulants, such as the spirit of nitric ether or aromatic spirit of ammonia largely diluted with water.

The *Water Dropwort* (*Enanthe crocata*), common in ditches and marshy places, is generally refused by horses; but brood mares, with appetite somewhat vitiated by their being in foal, have been destroyed by it. The antidote would be vinegar and gruel, and bleeding if there is inflammation.

The *Euphorbium*, or Spurge, so common and infamous an ingredient in the Farrier's Blister, has destroyed many a horse from the irritation which it has set up, and the torture it has occasioned, and should never find a place in the Veterinary Pharmacopœia.

*Colocynth* and *Elaterium* fairly rank among the substances that are

poisonous to the horse; and so does the *Bryony Root* (*Bryonia dioica*), notwithstanding that it is frequently given to horses, in many parts of the country, as a great promoter of condition. Many a young horse has been brought into a state of artificial condition and excitement by the use of the Bryony. It is one of the abominable secrets of the horse-breaker. This state of excitation, however, soon passes away, and is succeeded by temporary or permanent diminution of vital power. We have occasionally traced much mischief to this infamous practice.

Not less injurious is the *Savin* (*Juniperus Sabina*). It is well known as a vermifuge in the human subject, and it is occasionally given to the horse for the same purpose; but it is a favourite with the carter and the groom as a promoter of condition. A very great proportion of farmers' servants regard it as a drug effecting some good purpose, although they can scarcely define what that purpose is; and there is scarcely a country stable in which it is not occasionally found, and in which the horse is not endangered or perhaps destroyed by its use. It is high time that the horse-master looked more carefully to this, and suffered no drug to be administered to his horses and cattle, except by his direction or that of the medical attendant. The farmer and the gentleman can scarcely conceive to what an abominable extent this vile practice prevails. The presence of savin will be best detected in the stomach of a horse that has died under suspicious circumstances, by the *black-currant-leaf* smell of the contents when boiled in a little water, or beaten in a mortar.

Of the MINERAL POISONS it will be necessary to mention only three. *Arsenic* was once in great repute as a tonic and vermifuge. Large doses have been given in many instances with impunity. In some cases, however, the dose has proved too powerful, and the animal was destroyed. Many horses and other animals have also been destroyed by the arsenical fumes given off from the tin-burning houses in Cornwall and other parts. Other cases are recorded in which death has resulted from its wilful administration, and also through the ignorance of the waggoner in mixing it with the food of the animal with a view of giving him a sleek coat. The following symptoms will generally be present in poisoning by arsenic:—One of the earliest indications is a shivering fit; there will be also loss of appetite, great prostration of strength, a quick but very feeble pulse, cold extremities, purging and other symptoms of abdominal irritation. The post-mortem appearance, will generally indicate considerable inflammation of the internal surface of the stomach and bowels, the lining membrane being eroded in patches. The antidotes in a case of poisoning by arsenic should consist in the administration of lime-water, chalk and water, or soap and water in large quantities, but the best remedy if it can be obtained is the hydrated peroxide of iron. Professor Morton says, 'this is to be given in large quantities, newly prepared, and in the form of a soft paste.'

The following tests by which it may be recognised are given in Professor Morton's Manual of Pharmacy:—'Arsenic, if mixed with charcoal and heated, emits a very perceptible smell of garlic. Sulphuretted hydrogen, added to a watery solution of arsenic, throws down a yellow precipitate—lime-water a white one—and the ammonio-sulphate of copper a green one.' There are also two other very valuable tests in the hands of the chemist, viz., by nascent hydrogen, by what is termed Marsh's apparatus, a very delicate and beautiful modification of which was introduced by Professor Morton a few years ago. The other, which is called Reinsch's test, consists in obtaining the deposition of the arsenic on fine copper gauze, and afterwards reducing it in a tube by means of heat.

*Corrosive Sublimate* is given internally, and occasionally with advantage,



in farcy, and, as an external application, it is used to destroy vermin, to cure mange, and to dispose deep and fistulous ulcers to heal.

It may, however, be given in too large a dose, the symptoms of which are loss of appetite, discharge of saliva from the mouth, pawing, looking eagerly at the flanks, rolling, profuse perspiration, thready pulse, rapid weakness, violent purging and straining, convulsions, and death.

The stomach will be found intensely inflamed, with patches of yet greater inflammation. The whole course of the intestines will be inflamed, with particular parts black and gangrenous.

The antidote, if it is not too late to administer it, would be the white of eggs mixed with water, or thick starch or arrow-root.

The following also are the tests of corrosive sublimate:—‘It is sublimed by heat, leaving no residuum, and is soluble in water, alcohol, and sulphuric ether. Lime-water gives either a lemon-yellow precipitate, or a brick-dust red one. The iodide of potassium occasions a scarlet precipitate. The most curious test is, however, by means of galvanism. A drop of the suspected solution is placed on a sovereign, and a small key being brought into contact simultaneously with both the gold and the solution, an electric current is produced which decomposes the bichloride of mercury, for such it is. The chlorine unites with the iron, and the mercury with the gold.

*Lead.*—This in its metallic state has little if any effect upon the horse, and some of its salts appear to have been given in very large doses without producing serious results. Numerous instances, however, are recorded of the fatal effects of the oxide and carbonate of this metal, upon horses and cattle in the vicinity of lead-works and rifle-butts. The symptoms generally extend over a considerable length of time, and consist in general derangement of the digestive system, such as loss of appetite, falling away in strength and condition, frequent attacks of colic, with obstinate constipation of the bowels. The latter is not always present, but sometimes continued diarrhœa. The animal also will frequently suffer to a greater or less extent from paralysis. The remedial agents for lead poison should consist of active purgatives, sulphate of magnesia and croton oil being the best; this should be followed by opium. If diarrhœa be present we may give the dilute sulphuric acid and opium, with an occasional dose of oil; the animal in the meantime being kept on the most nutritious diet. The tests for the salts of lead are the iodide of potassium, which throws down a yellow precipitate of iodide of lead, dilute sulphuric acid produces an abundant white precipitate, and hydrosulphuret of ammonia or sulphuretted hydrogen gas causes a brown-black precipitate. So delicate is the latter test that Dr. Taylor asserts that ‘a current of this when properly employed will reveal by the production of a brown tinge, a quarter of a grain of a salt of lead in a gallon of water, i. e. about 1-300,000th part.’

Is there really occasion for the owner of horses to be acquainted with these things? Long experience has taught the author that poisoning with these drugs is not so rare a circumstance as some imagine. In the farmer’s stable he has occasionally been compelled unwillingly to decide that the death of one or more horses has been attributable to arsenic or corrosive sublimate, and not to any peculiar disease, or to anything wrong in the manner of feeding. A scoundrel was executed in 1812 for administering arsenic and corrosive sublimate to several horses. He had been engaged in these enormities during four long years. The discarded or offended carter has wreaked his revenge in a similar way; but, oftener, in his eagerness to get a more glossy coat on his horses than a rival servant could exhibit, he has tampered with these dangerous drugs.

## CHAPTER XXV.

## THE VICES AND DISAGREEABLE OR DANGEROUS HABITS OF THE HORSE.

THE horse has many excellent qualities, but he has likewise defects, and these occasionally amounting to vices. Some of them may be attributed to natural temper, for the human being scarcely discovers more peculiarities of habit and disposition than does the horse. The majority of them, however, as perhaps in the human being, are consequences of a faulty education. Their early instructor has been ignorant and brutal, and they have become obstinate and vicious.

## RESTIVENESS.

At the head of the vices of the horse is RESTIVENESS, the most annoying and the most dangerous of all. It is the produce of bad temper and worse education; and, like all other habits founded on nature and stamped by education, it is inveterate. Whether it appears in the form of kicking, or rearing, or plunging, or bolting, or in any way that threatens danger to the rider or the horse, it rarely admits of cure. A determined rider may to a certain extent subjugate the animal; or the horse may have his favourites or form his attachments, and with some particular person he may be comparatively or perfectly manageable; but others cannot long depend upon him, and even his master is not always sure of him. It is a rule, that admits of very few exceptions, that he neither displays his wisdom nor consults his safety, who attempts to conquer a restive horse.

An excellent veterinary surgeon, and a man of great experience in horses, Mr. Castley, truly said, in 'The Veterinarian,'—'From whatever cause the vicious habits of horses may originate, whether from some mismanagement or from natural badness of temper, or from what is called in Yorkshire a *mistetch*, whenever these animals acquire one of them, and it becomes in some degree confirmed, they very seldom, if ever, altogether forget it. In reference to driving it is so true, that it may be taken as a kind of aphorism, that if a horse kicks once in harness, no matter from what cause, he will be liable to kick ever afterwards. A good coachman may drive him, it is true, and may make him go, but he cannot make him forget his vice; and so it is in riding. You may conquer a restive horse—you may make him go quiet for months, nay, almost for years together; but I affirm that, under other circumstances, and at some future opportunity, he will be sure to return to his old tricks.'

Mr. Castley gives two singular and conclusive instances of the truth of this doctrine. 'When a very young man,' says he, 'I remember purchasing a horse at a fair in the north of England, that was offered very cheap on account of his being unmanageable. It was said that nobody could ride him. We found that the animal objected to have anything placed upon his back, and that, when made to move forward with nothing more than a saddle on, he instantly threw himself down on his side with great violence, and would then endeavour to roll upon his back.

'There was at that time in Yorkshire, a famous colt-breaker, known by the name of JUMPER, who was almost as celebrated in that country for taming vicious horses into submission, as the famed WHISPERER was in Ireland. We put this animal into Jumper's hands, who took him away,

and in about ten days brought him home again, certainly not looking worse in condition, but perfectly subdued and almost as obedient as a dog; for he would lie down at this man's bidding, and only rise again at his command, and carry double or anything. I took to riding him myself, and may say, that I was never better carried for six or eight months, during which time he did not show the least vice whatever. I then sold him to a Lincolnshire farmer, who said that he would give him a summer's run at grass, and show him as a very fine horse at the great Horncastle fair.

'Happening to meet this gentleman on the following year, I naturally enough enquired after my old friend. "Oh," said he, "that was a bad business—the horse turned out a sad rebel. The first time we attempted to mount him, after getting him up from grass, he in an instant threw the man down with the greatest violence, pitching him several yards over his head; and after that he threw every one that attempted to get on his back. If he could not throw his rider, *he would throw himself down*. We could do nothing with him, and I was obliged at last to sell him to go in a stage-coach."

In the next story, Jumper's counterpart and superior, the Irish Whisperer, is brought on the stage, and although he performed wonders, *he* could not radically cure a restive horse. 'At the Spring meeting of 1804, Mr. Whalley's KING PIPPIN was brought on the Curragh of Kildare to run. He was a horse of the most extraordinary savage and vicious disposition. His particular propensity was that of *flying at and worrying* any person who came within his reach, and if he had an opportunity, he would get his head round, seize his rider by the leg with his teeth, and drag him down from his back. For this reason he was always ridden with what is called a *sword*; which is a strong flat stick, having one end attached to the cheek of the bridle, and the other to the girth of the saddle, a contrivance to prevent a horse of this kind from getting at his rider.

'King Pippin had long been difficult to manage and dangerous to go near to, but on the occasion in question he could not be got out to run at all. *Nobody could put the bridle upon his head*. It being Easter Monday, and consequently a great holiday, there was a large concourse of people assembled at the Curragh, consisting principally of the neighbouring peasantry; and one countryman, more fearless than the rest of the lookers-on, forgetting, or perhaps never dreaming, that the better part of courage is discretion, volunteered his services to bridle the horse. No sooner had he committed himself in this operation, than King Pippin seized him somewhere about the shoulders or chest, and, says Mr. Watts (Mr. Castley's informant), "I know of nothing I can compare it to so much as a dog shaking a rat." Fortunately for the poor fellow, his body was very thickly covered with clothes, for on such occasions an Irishman of this class is fond of displaying his wardrobe, and if *he has three coats at all in the world*, he is sure to put them all on.

'This circumstance in all probability saved the individual who had so gallantly volunteered the forlorn hope. His person was so deeply enveloped in extra teguments, that the horse never got fairly hold of his skin, and I understand that he escaped with but little injury, beside the sadly rent and totally ruined state of his holiday toggery.

'The Whisperer was sent for, who, having arrived, was shut up with the horse all night, and in the morning he exhibited this hitherto ferocious animal, following him about the course like a dog—lying down at his command—suffering his mouth to be opened, and any person's hand to be introduced into it—in short, as quiet almost as a sheep.

'He came out the same meeting, and won his race, and his docility

continued satisfactory for a considerable time; *but at the end of about three years his vice returned*, and then he is said to have *killed a man*, for which he was destroyed.

It may not be uninteresting, in connection with this, to give some account of this tamer of quadruped vice. However strange and magical his power may seem to be, there is no doubt of the truth of the account that is given of him. The Rev. Mr. Townsend, in his Statistical Survey of Cork, first introduced him to the notice of the public generally, although his fame had long spread over that part of Ireland. We, however, give the following extract from 'Croker's Fairy Legends and Traditions of Ireland,' part ii. p. 200, for his performances seem the work of some elfin sprite, rather than of a rude and ignorant horse-breaker.

'He was an awkward, ignorant rustic of the lowest class, of the name of Sullivan, but better known by the appellation of the Whisperer. His occupation was horse-breaking. The nickname he acquired from the vulgar notion of his being able to communicate to the animal what he wished by means of a whisper; and the singularity of his method seemed in some degree to justify the supposition. In his own neighbourhood the notoriety of the fact made it seem less remarkable, but I doubt if any instance of similar subjugating talent is to be found on record. As far as the sphere of his control extended, the boast of *veni, vidi, vici*, was more justly claimed by Sullivan than even by Caesar himself.

'How his art was acquired, and in what it consisted, is likely to be forever unknown, as he has lately (about 1810) left the world without divulging it. His son, who follows the same trade, possesses but a small portion of the art, having either never learned the true secret, or being incapable of putting it into practice. The wonder of his skill consisted in the celerity of the operation, which was performed in privacy, without any apparent means of coercion. Every description of horse or even mule, whether previously broken or unhandled, whatever their peculiar habits or vices might have been, submitted without show of resistance to the magical influence of his art, and in the short space of half an hour became gentle and tractable. This effect, though instantaneously produced, was generally durable. Though more submissive to him than to others, the animals seemed to have acquired a docility unknown before.

'When sent for to tame a vicious beast, for which he was either paid according to the distance, or generally two or three guineas, he directed the stable, in which he and the object of the experiment were, to be shut, with orders not to open the door until a signal was given. After a *tête-à-tête* of about half an hour, during which little or no bustle was heard, the signal was made, and, upon opening the door, the horse appeared lying down, and the man by his side, playing with him like a child with a puppy dog. From that time he was found perfectly willing to submit to any discipline—however repugnant to his nature before.' 'I once,' continues Mr. Croker, 'saw his skill tried on a horse, which could never before be brought to stand for a smith to shoe him. The day after Sullivan's half hour's lecture, I went, not without some incredulity, to the smith's shop, with many other curious spectators, where we were eye-witnesses of the complete success of his art. This, too, had been a troop horse, and it was supposed, not without reason, that after regimental discipline had failed, no other would be found availing. I observed that the animal appeared terrified whenever Sullivan either spoke to or looked at him; how that extraordinary ascendancy could have been obtained, is difficult to conjecture.

'In common cases this mysterious preparation was unnecessary. He seemed to possess an instinctive power of inspiring awe, the result, per-

haps, of natural intrepidity, in which, I believe, a great part of his art consisted; though the circumstance of the *tête-à-tête* shows that, on particular occasions, something more must have been added to it. A faculty like this would, in some hands, have made a fortune, and I understand that great offers were made to him for the exercise of his art abroad. But hunting was his passion. He lived at home in the style most agreeable to his disposition, and nothing could induce him to quit Duhallow and the fox-hounds.'

Mr. Castley witnessed the total failure of the younger Sullivan. He says, 'We have in the regiment a remarkably nice horse, called Lancer, that has always been very difficult to shoe; but seven or eight years ago, when we first got him, he was downright vicious in that respect. When the regiment was stationed at Cork, the farrier-major sought out the present Sullivan, the son of the celebrated Whisperer, and brought him up to the barracks in order to try his hand upon Lancer, and make him more peaceable to shoe; but I must say this person did not appear to possess any particular controlling power over the animal more than any other man. Lancer seemed to pay no attention whatever to his charm, and at last fairly beat him out of the forge. Time, however, and a long perseverance in kind and gentle treatment, have effected what force could not. The horse is now pretty reasonable to shoe.'

#### BACKING OR GIBBING.

One of the first kinds of restiveness, taking them in alphabetical order, is backing or gibbing. These are so closely allied that we hardly know how to separate them. Some horses have the habit of backing at first starting, and that more from playfulness than desire of mischief. A moderate application of the whip will usually be effectual. Others, even after starting, exhibit considerable obstinacy and viciousness. This is frequently the effect of bad breaking. Either the shoulder of the horse had been wrung when he was first put to the collar, or he had been foolishly accustomed to be started in the break *up-hill*, and, therefore, all his work coming upon him at once, he gradually acquired this dangerous habit.

A hasty and passionate breaker will often make a really good-tempered young horse an inveterate gibber. Every young horse is at first shy of the collar. If he is too quickly forced to throw his weight into it, he will possibly take a dislike to it, that will occasionally show itself in the form of gibbing as long as he lives. The judicious horse-breaker will resort to no severity, even if the colt should go out several times without even touching collar. The example of his companion will ultimately induce him to take to it voluntarily and effectually.

A large and heavy stone should be put behind the wheel before starting, when the horse, finding it more difficult to back than to go forward, will gradually forget this unpleasant trick. It will likewise be of advantage, as often as it can be managed, so to start that the horse shall have to back *up-hill*. The difficulty of accomplishing this will soon make him readily go forward. A little coaxing, or leading, or moderate flagellation, will assist in accomplishing the cure.

When, however, a horse, thinking that he has had enough of work, or has been improperly checked or corrected, or beginning to feel the painful pressure of the collar, swerves, and gibs, and backs, it is a more serious matter. Persuasion should first be tried; and afterwards, reasonable coercion, but no cruelty: for the brutality which is often exercised in attempting to compel a gibbing horse to throw himself habitually into the

collar, never yet accomplished the purpose. The horse may, perhaps, be whipped into motion ; but if he has once begun to gib, he will have recourse to it again whenever any circumstance displeases or annoys him, and the habit will be so rapidly and completely formed, that he will become insensible to all severity.

It is useless and dangerous to contend with a horse determined to back, unless there is plenty of room, and, by tight reining, the driver can make him back in the precise direction he wishes, and especially up-hill. Such a horse should be immediately sold, or turned over to some other work. In a stage-coach as a wheeler, and particularly as the near-wheeler ; or, in the middle of a team at agricultural work, he may be serviceable. It will be useless for him to attempt to gib there, for he will be dragged along by his companions whether he will or not ; and finding the inutility of resistance, he will soon be induced to work as well as any horse in the team. The reformation will last while he is thus employed, but, like restiveness generally, it will be delusive when the horse returns to his former occupation. The disposition to annoy will very soon follow the power to do it. Some instances of complete reformation may have occurred, but they are rare.

When a horse, not often accustomed to gib, betrays a reluctance to work, or a determination not to work, common sense and humanity will demand that some consideration should be taken before measures of severity are resorted to. The horse may be taxed beyond his power. He soon discovers whether this is the case, and by refusing to proceed, tells his driver that it is so. The utmost cruelty will not induce many horses to make the slightest effort, when they are conscious that their strength is inadequate to the task. Sometimes the withers are wrung, and the shoulders sadly galled, and the pain, which is intense on level ground and with fair draught, becomes insupportable when he tugs up a steep acclivity. These things should be examined into, and, if possible, rectified ; for, under such circumstances, cruelty may produce obstinacy and vice, but not willing obedience.

They who are accustomed to horses know what seemingly trivial circumstances occasionally produce this vice. A horse, whose shoulders are raw, or have frequently been so, will not start with a cold collar. When the collar has acquired the warmth of the parts on which it presses, the animal will go without reluctance. Some determined gibbers have been reformed by constantly wearing a false collar, or strip of cloth round the shoulders, so that the coldness of the usual collar should never be felt ; and others have been cured of gibbing by keeping the collar on night and day, for the animal is not able to lie down completely at full length, which the tired horse is always glad to do. When a horse gibs, not at starting, but while doing his work, it has sometimes been useful to line the collar with cloth instead of leather ; the perspiration is readily absorbed, the substance which presses on the shoulder is softer, and it may be far more accurately eased off at a tender place.

Mr. Rarey's method of curing the gibbing horse is of the simplest nature. At starting he pats the head and neck, talking to the horse in the most soothing accents. He then stands immediately in front of him, takes the bridle reins close up to the bit in both hands, and gently induces the animal to move his fore legs alone two or three paces to the left. He then pauses, caresses the horse afresh, and moves him as many paces to the right. Mr. R. continues this process until he has induced the horse to move entirely round, or as much as possible in a circle in both directions. By that time the horse will have borne well upon the collar, and will not refuse to draw in any direction. Should the horse evince determined vice,

then the taming and training system must be repeated several times a-day, or until the horse has become perfectly tractable.

#### BITING.

This is either the consequence of natural ferocity, or a habit acquired from the foolish and teasing play of grooms and stable-boys. When a horse is tickled and pinched by thoughtless and mischievous youths, he will first pretend to bite his tormentors; by degrees he will proceed farther, and actually bite them, and, very soon after that, he will be the first to challenge to the combat, and, without provocation, seize some opportunity to gripe the incautious tormentor. At length, as the love of mischief is a propensity too easily acquired, this war, half playful and half in earnest, becomes habitual to him, and degenerates into absolute viciousness.

It is not possible to enter the stall of some horses without danger. The animal gives no warning of his intention; he is seemingly quiet and harmless: but if the incautious by-stander comes fairly within his reach, he darts upon him, and seldom fails to do some mischief. A stallion addicted to biting is a most formidable creature. He lifts the intruder—he shakes him—he attacks him with his feet—he tramples upon him, and there are many instances in which he effects irreparable mischief. A resolute groom may escape. When he has once got firm hold of the head of the horse, he may back him, or muzzle him, or harness him; but he must be always on his guard, or in a moment of carelessness he may be seriously injured.

It is seldom that anything can be done in the way of cure. Kindness will aggravate the evil, and no degree of severity will correct it. 'I have seen,' says Professor Stewart, in his 'Stable Economy,' 'biters punished until they trembled in every joint, and were ready to drop, but have never in any case known them cured by this treatment, or by any other. The lash is forgotten in an hour, and the horse is as ready and determined to repeat the offence as before. He appears unable to resist the temptation, and in its worst form biting is a species of insanity.'

With a biting horse there should be no time lost in commencing and continuing the taming and training system of Mr. Rarey. The operator may, nearly as soon as he has thrown the horse down, confine his treatment to lifting the head, bringing it close to his own body as he sits upon the shoulder, and forcing both of the jaws into immediate and repeated contact. In the act of mounting care must be taken, that a strong strain be made upon the off rein, so that the muzzle of the horse be well inclined from the limb or person of the rider. In approaching a biting colt in a loose box, it will be quite necessary to be armed with a pliable cutting whip to use upon great emergency. The science of throwing the lasso would prove invaluable in this instance. For safety, place the colt in a loose box having the half-door open. Remain by the open door, but out of reach, until the curiosity of the animal be excited, and he approaches to smell the open hand, then proceed to handle him in the gentlest manner.

Prevention, however, is in the power of every proprietor of horses. While he insists on gentle and humane treatment of his cattle, he should systematically forbid this horse-play. It is that which can never be considered as operating as a reward, and thereby rendering the horse tractable; nor does it increase the affection of the animal for his groom, because he is annoyed and irritated by being thus incessantly teased

#### GETTING THE CHEEK OF THE BIT INTO THE MOUTH.

Some horses that are disposed to be mischievous try to do this, and are very expert at it. They soon find what advantage it gives them over their

driver, who by this manœuvre loses almost all command. Harsh treatment is here completely out of the question. All that can be done is, by some mechanical contrivance, to render the thing difficult or impossible, and this may be managed by fastening a round piece of leather on the inside of the cheek of the bit.

#### KICKING.

This, as a *vice*, is another consequence of the culpable habit of grooms and stable-boys of teasing the horse. That which is at first an indication of annoyance at the pinching and tickling of the groom, and without any design to injure, gradually becomes the expression of anger, and the effort to do mischief. The horse likewise too soon recognises the least appearance of timidity, and takes advantage of the discovery. There is no cure for this vice; and he cannot be justified who keeps a kicking horse in his stable.

Some horses acquire, from mere irritability and fidgetiness, a habit of kicking at the stall or the bail, and particularly at night. The neighbouring horses are disturbed and the kicker gets capped hocks, or some more serious injury. This is also a habit very difficult to correct, if suffered to become established. Mares are far more subject to it than horses.

Before the habit is inveterately established, a thorn bush or a piece of furze fastened against the partition or post will sometimes effect a cure. When the horse finds that he is pretty severely pricked he will not long continue to punish himself. In confirmed cases it may be necessary to have recourse to the log, but the legs are often not a little bruised by it. A rather long and heavy piece of wood attached to a chain has been buckled above the hock, so as to reach about half way down the leg. When the horse attempts to kick violently, his leg will receive a severe blow; this, and the repetition of it may, after a time, teach him to be quiet.

A much more serious vice is kicking in harness. From the least annoyance about the rump or quarters, some horses will kick at a most violent rate, and destroy the bottom of the chaise, and endanger the limbs of the driver. Those that are fidgety in the stable are most apt to do this. If the reins should perchance get under the tail, the violence of the kicker will often be most outrageous; and while the animal presses down his tail so tightly that it is almost impossible to extricate the reins, he continues to plunge until he has demolished everything behind him.

This is a vice standing foremost in point of danger, and which no treatment will always conquer. It will be altogether in vain to try coercion. If the shafts are very strong and without flaw, or if they are plated with iron underneath, and a stout kicking-strap resorted to which will barely allow the horse the proper use of his hind limbs in progression, but not permit him to raise them sufficiently for the purpose of kicking, he may be prevented from doing mischief; or if he is harnessed to a heavy cart, and thus confined, his efforts to lash out will be restrained: but it is frequently a very unpleasant thing to witness these attempts, though ineffectual, to demolish the vehicle, for the shafts or the kicking-strap may possibly break, and extreme danger may ensue. A horse that has once begun to kick, whatever may have been the original cause of it, can never be depended upon again, and he will be very unwise who ventures behind him. The man, however, who must come within reach of a kicker should come as close to him as possible. The blow may thus become a push, and seldom is injurious. Should the horse commence kicking when in harness at a distance from home, and the leg-straps not at hand, then a piece of rope or a pocket-handkerchief must be used to bind up the near



fore-leg without loss of time. The horse must be thus driven upon three legs for some distance, or until he has become completely tired and subdued. If the vice be exhibited in a saddle horse, the rider in mounting should always bend the head round nearly to the right flap of the saddle, and will thus, by the strain upon the vertebrae of the neck, effectually prevent the animal from completing his purpose. In approaching a kicking colt in the loose box, have a pliable cutting-whip in the right hand, so that, should he turn suddenly round to kick, the whip may smack well upon his hind legs, and thus make him more frightened than hurt. The whip should be used but very rarely.

#### UNSTEADINESS WHILE BEING MOUNTED.

When this merely amounts to eagerness to start—very unpleasant, indeed, at times, for many a rider has been thrown from his seat before he was fairly fixed in it—it may be remedied by an active and good horseman. We have known many instances in which, while the elderly, and inactive, and fearful man has been making more than one ineffectual attempt to vault into the saddle, the horse has been dancing about to his annoyance and danger; but the animal had no sooner been transferred to the management of a younger and more agile rider than he became perfectly subdued. Severity will here, more decidedly than in any other case, do harm. The rider should be fearless—he should carelessly and confidently approach the horse, mount at the first effort, and then restrain him for a while; patting him, and not suffering him to proceed until he becomes perfectly quiet. Horses of this kind should not be too highly fed, and should have sufficient daily exercise.

#### REARING.

This sometimes results from playfulness, carried, indeed, to an unpleasant and dangerous extent; but it is oftener a desperate and occasionally successful effort to unhorse the rider, and consequently a vice. The horse that has twice decidedly and dangerously reared, should never be trusted again, unless, indeed, it was the fault of the rider, who had been using a deep curb and a sharp bit. Some of the best horses will contend against these, and then rearing may be immediately and permanently cured by using a snaffle-bridle alone.

The horse-breaker's remedy, that of pulling the horse backward on a soft piece of ground, should be practised by reckless and brutal fellows alone. Many horses have been injured in the spine, and others have broken their necks, by being thus suddenly pulled over; while even the fellow, who fears no danger, is not always able to extricate himself from the falling horse. If rearing proceeds from vice, and is unprovoked by the bruising and laceration of the mouth, it fully partakes of the inveteracy which attends the other divisions of restiveness.

A rearing horse must be thoroughly tamed and subdued by a great number of lessons, so that the voice of the operator will be perfectly familiar to his ear. He will then be obedient to command, and will desist from rearing on the instant of being spoken to.

#### RUNNING AWAY.

Some headstrong horses will occasionally endeavour to bolt with the best rider. Others, with their wonted sagacity, endeavour thus to dislodge the timid or unskilful one. Some are hard to hold, or bolt only during the excitement of the chase; others will run away, prompted by a vicious propensity alone. There is no certain cure here. The method which affords any probability of success is, to ride such a horse with a strong curb and

sharp bit ; to have him always firmly in hand ; and, if he will run away, and the place will admit of it, to give him (sparing neither curb, whip, nor spur) a great deal more running than he likes.

#### VICIOUS TO CLEAN.

It would scarcely be credited to what an extent this exists in some horses that are otherwise perfectly quiet. It is only at great hazard that they can be cleaned at all. The origin of this is probably some maltreatment. There is, however, a great difference in the sensibility of the skin in different horses. Some seem as if they could scarcely be made to feel the whip, while others cannot bear a fly to alight on them without an expression of annoyance. In young horses the skin is peculiarly delicate. If they have been curried with a broken comb, or hardly rubbed with an uneven brush, the recollection of the torture they have felt makes them impatient, and even vicious, during every succeeding operation of the kind. Many grooms, likewise, seem to take delight in producing these exhibitions of uneasiness and vice ; although, when they are carried a little too far, and at the hazard of the limbs of the groom, the animals that have been almost tutored into these expressions of irritation are brutally kicked and punished.

This, however, is a vice that may be conquered. If the horse is dressed with a lighter hand, and wisped rather than brushed, and the places where the skin is most sensitive are avoided as much as thorough cleanliness will allow, he will gradually lose the recollection of former ill-treatment, and become tractable and quiet. Horses that are troublesome to clean are rendered quite manageable by the strapping up of the near fore-leg.

#### VICIOUS TO SHOE.

The correction of this is more peculiarly the business of the smith ; yet the master should diligently concern himself with it, for it is oftener the consequence of injudicious or bad usage than of natural vice. It may be expected that there will be some difficulty in shoeing a horse for the first few times. It is an operation that gives him a little uneasiness.—The man to whom he is most accustomed should go with him to the forge ; and if another and steady horse is shod before him, he may be induced more readily to submit. It cannot be denied that, after the habit of resisting this necessary operation is formed, force may sometimes be necessary to reduce our rebellious servant to obedience ; but we unhesitatingly affirm that the majority of horses *vicious to shoe* are rendered so by harsh usage, and by the pain of correction being added to the uneasiness of shoeing. It should be a rule in every forge that no smith should be permitted to strike a horse, much less to twitch or to gag him, without the master-farrier's order ; and that a young horse should never be twitched or struck. There are few horses that may not be gradually rendered manageable for this purpose by mildness and firmness in the operator. They will soon understand that no harm is meant, and they will not forget their usual habit of obedience ; but if the remembrance of corporal punishment is connected with shoeing, they will always be fidgety, and occasionally dangerous.

This is a very serious vice, for it not only exposes the animal to occasional severe injury from his own struggles, but also from the correction of the irritated smith, whose limbs and whose life being in jeopardy, may be forgiven if he is sometimes a little too hard-handed. Such a horse is very liable, and without any fault of the smith, to be pricked and lamed in shoeing ; and if the habit should be confirmed, and should increase, and it at length becomes necessary to cast him, or to put him in the trevis, the owner may be assured that many years will not pass ere some formidable

or fatal accident will take place. If, therefore, mild treatment will not correct this vice, the horse cannot be too soon got rid of. Horses that have been vicious for a lifetime are frequently rendered quiet to shoe on being thrown down, and thoroughly handled, when in the horizontal position, the smith can shoe the horse with the greatest ease.

#### SWALLOWING WITHOUT GRINDING.

Some greedy horses habitually swallow their corn without properly grinding it, and the power of digestion not being adequate to the dissolving of the husk, no nutriment is extracted, and the oats are voided whole. This is particularly the case when horses of unequal appetite feed from the same manger. The greedy one, in his eagerness to get more than his share, bolts a portion of his corn whole. If the farmer, without considerable inconvenience, could contrive that every horse shall have his separate division of the manger, the one of smaller appetite and slower feed would have the opportunity of grinding at his leisure, without the fear of the greater share being stolen by his neighbour.

Some horses, however, are naturally greedy feeders, and will not, even when alone, allow themselves time to chew or grind their corn. In consequence of this they carry but little flesh, and are not equal to severe work. If the rack was supplied with hay when the corn was put into the manger, they will continue to eat on, and their stomachs will become distended with half-chewed and indigestible food. In consequence of this they will be incapable of considerable exertion for a long time after feeding, and, occasionally, dangerous symptoms of staggers will occur.

The remedy is, not to let such horses fast too long. The nose-bag should be the companion of every considerable journey. The food should likewise be of such a nature that it cannot be rapidly bolted. Chaff should be plentifully mixed with the corn, and, in some cases, and especially in horses of slow work, it should, with the corn, constitute the whole of the food. This has been treated on more at large under the article 'FEEDING.'

In every case of this kind the teeth should be carefully examined. Some of them may be unduly lengthened, particularly the first of the grinders: or they may be ragged at the edges, and may abrade and wound the cheek. In the first case the horse cannot properly masticate his food, in the latter he will not; for these animals, as too often happens in sore throat, would rather starve than put themselves to much pain.

#### CRIB-BITING.

This is a very unpleasant habit, and a considerable defect, although not so serious a one as some have represented. The horse lays hold of the manger with his teeth, violently extends his neck, and then, after some convulsive action of the throat, a slight grunting is heard, accompanied by a sucking or drawing in of air. It is not an effort at simple eructation, arising from indigestion. It is the inhalation of air. It is that which takes place with all kinds of diet, and when the stomach is empty as well as when it is full.

The effects of crib-biting are plain enough. The teeth are injured and worn away, and that, in an old horse, to a very serious degree. A considerable quantity of corn is often lost, for the horse will frequently crib with his mouth full of it, and the greater part will fall over the edge of the manger. Much saliva escapes while the manger is thus forcibly held, the loss of which must be of serious detriment in impairing the digestion. The crib-biting horse is notoriously more subject to colic than other horses, and to a species difficult of treatment and frequently dangerous.

Although many a crib-biter is stout and strong, and capable of all ordinary work, these horses do not generally carry so much flesh as others, and have not their endurance. On these accounts crib-biting has very properly been decided to be unsoundness. We must not look to the state of the disease at the time of purchase. The question is, does it exist at all? A case was tried before Lord Tenterden, and thus decided: 'A horse with crib-biting is unsound.'

It is one of those tricks which are said to be exceedingly contagious, and every companion of a crib-biter in the same stables is considered likely to acquire the habit, and it is the most inveterate of all habits; but it must be confessed that more than one crib-biter in a stable is a very rare occurrence, nor can the writer recall a single instance in which he has seen two together. The edge of the manger will in vain be lined with iron, or with sheep-skin, or with sheep-skin covered with tar or aloes, or any other unpleasant substance. In defiance of the annoyance which these may occasion, the horse will persist in the attack on his manger. A strap buckled tightly round the neck, by compressing the windpipe, is the best means of preventing the possibility of this trick; but the strap must be constantly worn, and its pressure is too apt to produce a worse affection, viz. an irritation in the windpipe, which terminates in roaring.

Some have recommended turning out for five or six months; but this has never succeeded except with a young horse, and then rarely. The old crib-biter will employ the gate for the same purpose as the edge of his manger, and we have often seen him galloping across a field for the mere object of having a gripe at a rail. Medicine will be altogether thrown away in this case.

The only remedy is a muzzle, with bars across the bottom; sufficiently wide to enable the animal to pick up his corn and to pull his hay, but not to grasp the edge of the manger. If this is worn for a considerable period, the horse may be tired of attempting that which he cannot accomplish, and for a while forget the habit, but, in a majority of cases, the desire of crib-biting will return with the power of gratifying it.

The causes of crib-biting are various, and some of them beyond the control of the proprietor of the horse. It is often the result of imitation; but it is more frequently the consequence of indigestion. The high-fed and spirited horse must be in mischief if he is not usefully employed. Sometimes, but we believe not often, it is produced by partial starvation, whether in a bad straw-yard, or from unpalatable food. An occasional cause of crib-biting is the frequent custom of grooms, even when the weather is not severe, of dressing them in the stable. The horse either catches at the edge of the manger, or at that of the partition on each side, if he has been turned, and thus he forms the habit of laying hold of these substances on every occasion.

#### WIND-SUCKING.

This bears a close analogy to crib-biting. It arises from the same causes; the same purpose is accomplished; and the same results follow. The horse stands with his neck bent; his head drawn inward; his lips alternately a little opened and then closed, and a noise is heard as if he were sucking. If we may judge from the same comparative want of condition and the flatulence which we have described under the last head, either some portion of wind enters the stomach, or there is an injurious loss of saliva. This diminishes the value of the horse almost as much as crib-biting; it is as contagious, and it is as inveterate. The only remedies, and they will seldom avail, are tying the head up, except when the horse is feeding, or putting on a muzzle with sharp spikes towards the neck,

and which will prick him whenever he attempts to rein his head in for the purpose of wind-sucking.

#### NOT LYING DOWN.

It not uncommonly happens that a horse will seldom or never lie down in the stable. He sometimes continues in apparent good health, and feeds and works well; but generally his legs swell, or he becomes fatigued sooner than another horse. If it is impossible to let him loose in the stable, or to put him into a spare box, we know not what is to be done. No means, gentle or cruel, will force him to lie down. The secret is that he is tied up, and either has never dared to lie down through fear of the confinement of the halter, or he has been cast in the night, and severely injured. If he can be suffered to range the stable, or have a comfortable box, in which he may be loose, he will usually lie down the first night. Some few horses, however, will lie down in the stable, and not in a loose box. A fresh well-made bed will generally tempt the tired horse to refresh himself with sleep.

#### PAWING.

Some hot and irritable horses are restless even in the stable, and paw frequently and violently. Their litter is destroyed, the floor of the stable broken up, the shoes worn out, the feet bruised, and the legs sometimes sprained. If this habit does not exist to any great extent, yet the stable never looks well. Shackles are the only remedy, with a chain sufficiently long to enable the horse to shift his posture, or move in his stall; but these must be taken off at night, otherwise the animal will seldom lie down. Except, however, the horse possesses peculiar value, it will be better to dispose of him at once, than to submit to the danger and inconvenience that he may occasion.

#### QUIDDING.

A horse will sometimes partly chew his hay, and suffer it to drop from his mouth. If this does not proceed from irregular teeth, which it will be the business of the veterinary surgeon to rasp down, it will be found to be connected with sore-throat, and then the horse will exhibit some other symptom of indisposition, and particularly the swallowing of water will be accompanied by a peculiar gulping effort. In this case the disease (catarrh, with sore throat) must be attacked, and the quidding will cease.

#### ROLLING.

This is a very pleasant and perfectly safe amusement for a horse at grass, but cannot be indulged in the stable without the chance of his being dangerously entangled with the collar rein, and being cast. Yet, although the horse is cast, and bruised, and half-strangled, he will roll again on the following night, and continue to do so as long as he lives. The only remedy is not a very pleasant one to the horse, nor always quite safe; yet it must be had recourse to if the habit of rolling is inveterate. 'The horse,' says Mr. Castley, 'should be tied with length enough of collar to lie down, but not to allow of his head resting on the ground; because in order to roll over, a horse is obliged to place his head quite down upon the ground.'

#### SHYING.

We have briefly treated of the cause of this vice at page 165, and observed that while it is often the result of cowardice, or playfulness, or

want of work, it is at other times the consequence of a defect of sight. It has been remarked, and we believe very truly, that shying is oftener a vice of half or quarter-bred horses than of those who have in them more of the genuine racing blood.

In the treatment of shying, it is of great importance to distinguish between that which is the consequence of defective sight, and what results from fear, or newness of objects, or mere affectation or skittishness. For the first, the nature of which we have explained at page 166, every allowance must be made, and care must be taken that the fear of correction is not associated with the imagined existence of some terrifying object. The severe use of the whip and the spur cannot do good here, and are likely to aggravate the vice tenfold. A word half encouraging and half scolding, with a gentle pressure of the heel, or a slight touch of the spur, will tell the horse that there was nothing to fear, and will give him confidence in his rider on a future occasion. It should be remembered, however, that although a horse that shies from defective sight may be taught considerable reliance on his rider, he can never have the cause of the habit removed. We may artificially strengthen the human sight, but that of the horse must be left to itself.

The shying from skittishness or affectation is quite a different affair, and must be conquered; but how? Severity is altogether out of place. If he is forced into contact with the object by dint of correction, the dread of punishment will afterwards be associated with that object, and, on the next occasion, his startings will be more frequent and more dangerous. The way to cure him is to go on, turning as little as possible out of the road, giving a harsh word or two, and a gentle touch with the spur, and then taking no more notice of the matter. After a few times, whatever may have been the object which he chose to select as the pretended cause of affright, he will pass it almost without notice.

In page 114, under the head 'breaking in,' we described how the colt may be cured of the habit of shying from fear or newness of objects; and, if he then is accustomed as much as possible to the objects among which his services will be required, he will not possess this annoying vice when he grows to maturer age.

Mr. John Lawrence, in his last work on the Horse, says: 'These animals generally fix on some particular shying butt: for example, I recollect having, at different periods, three hacks, all very powerful; the one made choice of a windmill for the object or butt, the other a tilted waggon, and the last a pig led in a string. It so happened, however, that I rode the two former when amiss from a violent cold, and they then paid no more attention to either windmills or tilted waggons than to any other objects, convincing me that their shying when in health and spirits was pure affectation; an affectation, however, which may be speedily united with obstinacy and vice. Let it be treated with marked displeasure, mingled with gentle, but decided firmness, and the habit will be of short endurance.'

'We will suppose a case,' writes an anonymous correspondent in the first volume of the 'Veterinarian,' 'a very common one, an every-day one. A man is riding a young horse upon the high road in the country, and meets a stage coach. What with the noise, the bustle, the imposing appearance altogether, and the slashing of the coachman's whip, the animal at its approach erects his head and crest, pricks his ears, looks affrighted, and no sooner comes alongside of the machine than he suddenly starts out of the road. His rider, annoyed by this, instantly commences a round of castigation with whip, spur, and curb, in which he persists until the horse, as well as himself, has lost his temper; and then one whips, spurs,

and palls, and the other jumps, plunges, frets, and throws up his head, until both, pretty well exhausted by the conflict, grow tranquil again and proceed on their journey, though not for some time afterwards in their former mutual confidence and satisfaction. Should they in their road, or even on a distant day, meet with another coach, what is the consequence? The horse is not only more alarmed than before, but now, the moment he has started, being conscious of his fault and expecting chastisement, he jumps about in fearful agitation, making plunges to strike into a gallop, and attempting to run away. So that by this correction, instead of rendering his horse tranquil during the passage of a coach, the rider adds to the evil of shying that of subsequently plunging, and perhaps running away.'

It is now generally admitted by all riding-masters and colt-breakers, that a great deal more is to be effected by lenient than by harsh treatment. Rewards are found to operate more beneficially than punishments; and therefore the most scientific and practised riding-masters adopt methods based upon the former. The writer of the present work remembers a very remarkable instance of the efficacy of this plan, or rather of its vast and decided superiority over violence of the worst description. A vicious thorough-bred horse had baffled the efforts of every one into whose hands he had been put in order to be rendered tractable: at length a foreigner of considerable repute among the equestrians of the 'school' took him to make a trial of; and in the course of a twelvemonth had rendered him so quiet that not only could any person ride him with the utmost safety, but, at the same time, he was so docile and tractable that he could be induced, by certain signs, to lie down and permit his rider to mount before he rose again. This gentleman must have been the Rarey of his day. It is sufficiently proved to us now that, generally speaking, colts, and most horses, will shy at strange objects, but that as soon as they have smelt at and touched these objects with their nose, the fear of them almost instantly ceases. Therefore, in approaching any object at which the horse is likely to be alarmed, or in bringing such object to the horse, the person or rider must use the greatest gentleness and forbearance, and permit the animal to gratify the powerful curiosity inherent in his nature in his own way, and not to add to his timidity by abusive treatment.

The same forbearance and humanity have been practised with the same beneficial results upon shy horses. With all such persons as are best able to give counsel in cases of shyness, the language is now-a-days, 'Let the horse alone,'—'Take no notice of his shyness,'—'Work him well, and accustom him to the objects he dislikes, and in time he will of himself leave off his trick of shying.'

This is good advice; but, let it not be misinterpreted. Let it not be understood to mean that the animal is to receive any encouragement to shy; for by no other expression can be characterised that erroneous and foolish practice of patting the horse, or 'making much of him,' either just before or during the time he evinces shyness. The former is bad, because it draws the attention of the animal to the object he dreads; the latter is worse, because it fills him with the impression either that the object itself is really terrific, or that he has acted right in shying at it, and ought to do so again.

Whether we are approaching the frightful object, or the horse is actually shying, 'we should let him alone'—'we should take no notice whatever of him'—neither letting him perceive that we are aware that we are advancing towards anything he dislikes; nor do more with him, while in the act of shying, than is necessary for due restraint with a steady hand upon the rein. We may depend upon it, that battling on our part will only serve

to augment fright and arouse resistance on his, and that the most judicious course we can pursue is to persevere in mild forbearant usage.

*Shying on coming out of the stable* is a habit that can rarely or never be cured. It proceeds from the remembrance of some ill-usage or hurt which the animal has received in the act of proceeding from the stable, such as striking his head against a low door-way, or entangling the harness. Coercion will but associate greater fear and more determined resistance with the old recollection. Mr. Castley gives an interesting anecdote, which tends to prove that while severity will be worse than useless, even kind treatment will not always break a confirmed habit. 'I remember a very fine grey mare that had got into this habit, and never could be persuaded to go through a doorway without taking an immense jump. To avoid this, the servant used to back her in and out of the stable; but the mare happening to meet with a severe injury of the spine, was no longer able to back; and then I have seen the poor creature, when brought to the door, endeavouring to balance herself, with a staggering motion, upon her half-paralysed hind extremities, as if making preparation and summoning up resolution for some great effort; and then, when urged, she would plunge headlong forward with such violence of exertion as often to lose her feet, and tumble down, altogether most pitiable to be seen. This I merely mention,' he continues, 'as one proof how inveterate the habits of horses are. They are evils, let it always be remembered, more easy to prevent than to cure.'

When the cure, however, is early attempted, it may be so far overcome that it will be unattended with danger or difficulty. The horse should be bridled when led out or in. He should be held short and tight by the head, that he may feel he has not liberty to make a leap, and this of itself is often sufficient to restrain him. Punishment or a threat of punishment will be highly improper. It is only timid or high-spirited horses that acquire this habit, and rough usage invariably increases their agitation and terror. Some may be led out quite at leisure when blindfolded; others when they have the harness bridle on; some will best take their own way, and a few may be ridden through the doorway that cannot be led. By quietness and kindness, however, the horse will be most easily and quickly subdued.

#### SLIPPING THE COLLAR.

This is a trick at which many horses are so clever that scarcely a night passes without their getting loose. It is a very serious habit, for it enables the horse sometimes to gorge himself with food, to the imminent danger of staggers; or it exposes him, as he wanders about, to be kicked and injured by the other horses, while his restlessness will often keep the whole team awake. If the web of the halter, being first accurately fitted to his neck, is suffered to slip only one way, or a strap is attached to the halter and buckled round the neck, but not sufficiently tight to be of serious inconvenience, the power of slipping the collar will be taken away.

#### TRIPPING.

He must be a skilful practitioner or a mere pretender who promises to remedy this habit. If it arises from a heavy forehead, and the fore-legs being too much under the horse, no one can alter the natural frame of the animal: if it proceeds from tenderness of the foot, grogginess, or old lameness, these ailments are seldom cured. Also, if it is to be traced to habitual carelessness and idleness, no whipping will rouse the drone. A known stumbler should never be ridden, or driven by any one who values



his safety or his life. A tight hand or a strong bearing rein are precautions that should not be neglected, although they are generally of little avail; for the inveterate stumbler will rarely be able to save himself, and this tight rein may sooner and farther precipitate the rider. If, after a trip, the horse suddenly starts forward, and endeavours to break into a sharp trot or canter, the rider or driver may be assured that others before him have fruitlessly endeavoured to remedy the nuisance.

If the stumbler has the foot kept as short and the toe pared as close as safety will permit, and the shoe is rounded at the toe, or has that shape given to it which it naturally acquires in a fortnight from the peculiar action of such a horse, the animal may not stumble quite so much; or if the disease which produced the habit can be alleviated, some trifling good may be done, but in almost every case a stumbler should be got rid of or put to slow and heavy work. If the latter alternative is adopted, he may trip as much as he pleases, for the weight of the load and the motion of the other horses will keep him upon his legs.

#### WEAVING.

This consists in a motion of the head, neck, and body, from side to side, like the shuttle of a weaver passing through the web, and hence the name which is given to this peculiar and incessant and unpleasant action. It indicates an impatient, irritable temper, and a dislike to the confinement of the stable. A horse that is thus incessantly on the fret will seldom carry flesh, or be safe to ride or drive. There is no cure for it, but the close tying up of the animal, or at least allowing him but one loose rein, except at feeding-time.

---

## CHAPTER XXVI.

### ON SOUNDNESS, AND THE PURCHASE AND SALE OF HORSES.

THERE are few sources of greater annoyance both to the purchaser and the seller of the horse than disputes with regard to the soundness of the animal. Although, in describing the various parts of the horse, we have glanced at the connection of certain natural conformations, and some alterations of structure, and accidents, and diseases, with the question of soundness or unsoundness, it may not be uninteresting to those for whom our work is designed, if we now bring into one point of view the substance of that which has been scattered over many pages.

That horse is sound in whom there is no disease, and no alteration of structure that impairs, or is likely to impair, his natural usefulness. The horse is unsound that labours under disease, or has some alteration of structure which does interfere, or is likely to interfere, with his natural usefulness. Since the publication of our first edition, this definition or rule as to soundness or unsoundness has received very high judicial sanction. We shall adhere to it as our test of soundness or unsoundness throughout this chapter, not forgetting that, from recent decisions, it may now be considered as settled law, that the breach of a warranty of soundness does not entitle the purchaser to return the horse, but only to recover the difference of value of the horse with or without the particular unsoundness. The question of temporary maladies, producing no permanent deterioration of the animal, would, generally speaking, only involve a

right to damages merely nominal. The term '*natural usefulness*' must be borne in mind. One horse may possess great speed, but is soon knocked up; another will work all day, but cannot be got beyond a snail's pace; a third with a heavy forehead is liable to stumble, and is continually putting to hazard the neck of his rider; another, with an irritable constitution and a loose washy form, loses his appetite and begins to scour if a little extra work is exacted from him. The term unsoundness must not be applied to either of these; it would be opening far too widely a door to disputation and endless wrangling. The buyer can discern, or ought to know, whether the form of the horse is that which will render him likely to suit his purpose, and he should try him sufficiently to ascertain his natural strength, endurance, and manner of going. Unsoundness, we repeat, has reference only to disease, or to that alteration of structure which is connected with, or will produce, disease, and lessen the usefulness of the animal.

The principles will be best illustrated by a brief consideration of the usually supposed appearances or causes of unsoundness.

**BROKEN KNEES** certainly do not constitute unsoundness, after the wounds are healed, unless they interfere with the action of the joint; for the horse may have fallen from mere accident, or through the fault of the rider, without the slightest damage more than the blemish. No person, however, would buy a horse with broken knees, until he had thoroughly tried him, and satisfied himself as to his form and action.

**CAPPED HOCKS** may be produced by lying on an unevenly paved stable, with a scanty supply of litter, or by kicking generally, in neither of which cases would they constitute unsoundness, although in the latter they would be an indication of vice; but, in the majority of instances, they are the consequence of sprain, or of latent injury of the hock, and, accompanied by enlargement of it, would constitute unsoundness. A special warranty should always be taken against capped hocks.

**CONTRACTION** is a considerable deviation from the natural form of the foot, but not necessarily constituting unsoundness. It requires, however, a most careful examination on the part of the purchaser or veterinary surgeon, in order to ascertain that there is no heat about the quarter, or ossification of the cartilage—that the frog, although diminished in size, is not diseased—that the horse does not step short, and go as if the foot were tender, and that there is not the slightest trace of lameness. Unless these circumstances, or some of them, are detected, a horse must not be pronounced to be unsound because his feet are contracted; for many horses with very contracted feet do not suffer at all in their action. A special warranty, however, should be required where the feet are at all contracted.

**CORNS** manifestly constitute unsoundness. The portion of the foot in which bad corns are situated will not bear the ordinary pressure of the shoe; and accidental additional pressure from the growing down of the horn, or the introduction of dirt or gravel, will cause serious lameness. They render it necessary to wear a thick and heavy shoe, or a bar shoe, in order to protect the weakened and diseased part; and they are very seldom radically cured. There may be, however, and frequently is, a difference of opinion, as to the actual existence or character of the corn. A veterinary surgeon may consider it so slight and insignificant as not apparently to injure the horse, and he pronounces the animal to be sound; but he should be cautious, for there are corns of every shade and degree, from the slightest degree to the most serious evil. They may be so slight and manageable as, though ranging under the class of morbid alteration of structure, yet not to diminish the natural usefulness of the horse in any degree. Slight

corns will disappear on the horse being shod with ordinary skill and care, even without any alteration in the shoe.

**COUGH.**—This is a disease, and consequently unsoundness. However slight may be its degree, and of whatever short standing it may be, although it may sometimes scarcely seem to interfere with the usefulness of the horse, yet a change of stabling, or slight exposure to wet and cold, or the least over-exertion, may, at other times, cause it to degenerate into many dangerous complaints. A horse, therefore, should never be purchased with a cough upon him, without a special warranty; or if—the cough not being observed—he is purchased under a general warranty, that warranty is thereby broken. It is not law, that a horse may be returned on breach of the warranty. The seller is not bound to take him back, unless he has contracted so to do; but he is liable in damages. Lord Ellenborough has completely decided this matter. ‘I have always held,’ said he, ‘that a warranty of soundness is broken, if the animal, at the time of sale, had any infirmity upon him that rendered him less fit for present service. It is not necessary that the disorder should be permanent or incurable. While he has a cough, he is unsound, although that may either be temporary or prove mortal.’ In deciding on another case, the same judge said: ‘I have always held it that a cough is a breach of the warranty. On that understanding I have always acted, and think it quite clear.’ It was argued on the other hand that two-thirds of the horses in London had coughs, yet still the judge maintained that the cough was a breach of warranty.

**ROARING, WHEEZING, WHISTLING,** being the result of alteration of structure, or disease in some of the air-passages, and interfering with the perfect freedom of breathing, especially when the horse is put on his speed, without doubt constitute unsoundness. There are decisions to the contrary, which are now universally admitted to be erroneous. **BROKEN WIND** is still more decidedly unsoundness.

**CRIB-BITING.**—Although some learned judges have asserted that crib-biting is simply a trick or bad habit, it must be regarded as unsoundness. This unnatural sucking in of the air must to a certain degree injure digestion. It must dispose to colic, and so interfere with the strength, and usefulness, and health of the horse. Some crib-biters are good goers, but they probably would have possessed more endurance had they not acquired this habit; and it is a fact well established, that, as soon as a horse becomes a crib-biter he, in nine cases out of ten, loses condition. He is not to the experienced eye the horse he was before. It may not lead on to strongly marked disease, or it may rarely do so to any considerable degree; but a horse that is morbidly deficient in condition must, to that extent, have his capability for extraordinary work diminished, and so be brought within our definition of unsoundness. In its very early stage, it may be a mere trick—confirmed, it must have produced morbid deterioration. The wear of the front teeth, and the occasional breaking of them, make a horse old before his time, and sometimes render it difficult or almost impossible for him to graze, when the state of the animal or the convenience of the owner requires that he should be turned out.

**CURB** constitutes unsoundness while it lasts, and perhaps while the swelling remains, although the inflammation may have subsided; for a horse that has once thrown out a curb is, for a while at least, very liable to do so again, to get lame in the same place on the slightest extra exertion; or, at all events, he would there first fail on extraordinary exertion. A horse, however, is not returnable, although he should spring a curb five minutes after the purchase; for it is done in a moment, and does not necessarily indicate any previous unsoundness or weakness of the part.

**CUTTING** renders a horse liable to serious injury of the legs, and indicates

that he is either weak, or has an awkwardness of gait inconsistent with safety. Many horses go lame for a considerable period after cutting themselves severely; and others have dropped from the sudden agony, and endangered themselves and their riders. Although perhaps not constituting unsoundness, cutting is a serious defect, and very material objection to a horse, and should therefore always have its consequences guarded against by a special warranty.

**ENLARGED GLANDS.**—The enlargement of the glands under the jaw has not been so much considered as it ought to have been in our estimate of the soundness of the horse. Simple catarrh will occasionally, and severe affection of the chest will generally, be accompanied by swelling of these glands which does not subside for a considerable time after the cold or fever has apparently been cured. To slight enlargements of the glands under the jaw much attention need not be paid; but if they are of considerable size, and especially if they are tender, and the glands at the root of the ear partake of the enlargement, and the membrane of the nose is redder than it should be, we should hesitate in pronouncing that horse to be sound. We must consider the swelling as a symptom of disease.

**ENLARGED HOCK.**—A horse with enlarged hock is unsound, the structure of this complicated joint being so materially affected that, although the horse may appear for a considerable time to be capable of ordinary work, he will occasionally fail even in that, and a few days' hard work will always lame him.

**THE EYES.**—That inflammation of the eye of the horse which usually terminates in blindness of one or both eyes, has the peculiar character of receding or disappearing for a time, once or twice, or thrice, before it fully runs its course. The eye, after an attack of inflammation, regains so nearly its former natural brilliancy that a person even well acquainted with horses will not always recognise the traces of former disease. After a time, however, the inflammation returns, and the result is inevitable. A horse that has had one attack of this complaint is long afterwards unsound, however perfect the eye may seem to be, because he carries about with him a disease that will probably again break out, and eventually destroy the sight. Whether, therefore, he may be rejected or not, depends on the possibility of proving an attack of inflammation of the eye, prior to the purchase. Next to direct evidence of this are appearances about the eye, of which the veterinary surgeon at least ought not to be ignorant. Allusion has been made to them in page 164. They consist chiefly of a puckering of the lids towards the inner corner of one or both eyes—a difference in the size of the eyes, although perhaps only a slight one, and not discovered except it be looked for—a gloominess of the eye—a dulness of the iris—a little dulness of the transparent part of the eye generally—a minute, faint, dusky spot, deep in the eye, and generally with little radiations of white lines proceeding from it. If these symptoms, or the majority of them, existed at the time of purchase, the animal had assuredly been diseased before, and was unsound. Starting has been considered as an equivocal proof. It is usually an indication of defective sight, but it is occasionally a trick. Connected, however, with the appearances just described, it is a very strong corroborative proof. There is another cause of blindness, however, by which the inexperienced horseman may be woefully deceived, that is, *Gutta serena*, or paralysis of the optic nerve. In this irremediable affection, the textures of the eye appear natural and unimpaired; there is no apparent alteration of structure, no cloudiness, no opacity, the only indication being the large and immovable state of the pupils, which remain equally distended in the dusk of evening and the glare of the noon-day sun.

LAMENESS, from whatever cause arising, is unsoundness. However temporary it may be, or however obscure, there must be disease which lessens the utility of the horse, and renders him unsound for the time. So says common sense, but there are contradictory decisions on the case. 'A horse labouring under a temporary injury or hurt, which is capable of being speedily cured or removed, is not, according to Chief-Justice Eyre, (as given, 2 Espin. Rep. 673, *Garment v. Boors*), an unsound horse; and where a warranty is made that such a horse is sound it is made without any view to such an injury; nor is a horse so circumstanced within the meaning of the warranty. To vitiate the warranty, the injury the horse had sustained, or the malady under which he laboured, ought to be of a permanent nature, and not such as may arise from a temporary injury or accident.'

On the contrary, Lord Ellenborough says (4 Campbell, 251, *Elton v. Brogden*), 'I have always held, and now hold, that a warranty of soundness is broken if the animal at the time of sale has any infirmity upon him which renders him less fit for present service. It is not necessary that the disorder should be permanent or incurable. While a horse has a cough he is unsound, although it may either be temporary or may prove mortal. The horse in question having been lame at the time of sale, when he was warranted to be sound, his condition subsequently is no defence to the action.' The decisions of Mr. Baron Parke, already referred to, confirm this doctrine.

NAVICULAR DISEASE, however slight, renders the animal decidedly unsound.

NEUROTOMY.—A question has arisen, how far a horse that has undergone the operation of the division of the nerve of the leg, and has recovered from the lameness with which he was before affected, and stands his work well, may be considered to be sound. Chief-Justice Best held such a horse to be unsound, and in our opinion there cannot be a doubt about the matter. The operation of neurotomy does not remove the disease causing the lameness, but only the sensation of pain. A horse on whom this operation has been performed may be improved by it—may cease to be lame—may go well for many years; but there is no certainty of this, and he is unsound, within our definition, unless nature gave the nerve for no useful purpose.

OSSIFICATION OF THE LATERAL CARTILAGES (side-bones) constitutes unsoundness, as interfering with the natural expansion of the foot, and, in horses of quick work, almost invariably producing lameness.

PUMICED FOOT.—When the union between the horny and sensitive laminae, or little plates of the foot, is weakened, and the coffin-bone is let down, and presses upon the sole, and the sole yields to this unnatural weight, and becomes rounded, and is brought in contact with the ground, and is bruised and injured, that horse must be unsound, and unsound for ever, because there are no means by which we can raise the coffin-bone again into its place.

QUIDDING.—If the mastication of the food gives pain to the animal, in consequence of soreness of the mouth or throat, he will drop it before it is perfectly chewed. This, as an indication of disease, constitutes unsoundness. Quidding sometimes arises from irregularity in the teeth, which wound the cheek with their sharp edges; or a protruding tooth renders it impossible for the horse to close his jaws so as to chew his food thoroughly. Quidding is unsoundness for the time; but the unsoundness may cease when the teeth are properly filed, or the soreness or other cause of this imperfect chewing removed.

QUITTOR is manifestly unsoundness.

**RINGBONE.**—Although when the bony tumour is small, and on one side only, there is little or no lameness—and there are a few instances in which a horse with ringbone has worked for many years without its return—yet from the action of the foot, and the stress upon the part, the inflammation and the formation of bone may acquire a tendency to spread so rapidly, that we must pronounce the slightest enlargement of the pasterns, or around the coronet, to be a cause of unsoundness.

**SAND-CRACK** is manifestly unsoundness. It may, however, occur without the slightest warning, and no horse can be rejected on account of a sand-crack that has sprung after purchase. Its usual cause is too great brittleness of the crust of the hoof; but there is no infallible method of detecting this, or the degree in which it must exist in order to constitute unsoundness. When the horn round the bottom of the foot has chipped off so much that only a skilful smith can fasten the shoe without pricking the horse, or even when there is a tendency in the horn to chip and break in a much less degree than this, the horse is unsound, for this brittleness of the crust is a disease of the part, or it is such an altered structure of it as to interfere materially with the usefulness of the animal.

**SPAVIN.**—Bone spavin, comprehending in its largest sense every bony tumour on the hock, is unsoundness. If the tumour affects in the slightest degree the action of the horse, it is unsoundness; even if it does not, it is seldom safe to pronounce it otherwise than unsoundness. But it may possibly be (like splint in the fore-leg) so situated as to have no tendency to affect the action. A veterinary surgeon consulted on the purchase will not always reject a horse because of such a tumour, but he will invariably point out the defect. His evidence on a question of soundness will depend on the facts. The age of the animal, the situation and history of the tumour, may be such as to enable him to give a decisive opinion in a horse going sound, but not often.

**BOG or BLOOD SPAVIN** is unsoundness, because, although it may not be productive of lameness at slow work, the rapid and powerful action of the hock in quicker motion will produce permanent, yet perhaps not considerable lameness, which can scarcely ever be with certainty removed.

**SPLINT.**—Strictly speaking, splint constitutes unsoundness, but so few horses are entirely free from this disease, that it would be highly injurious to reject every animal for this defect. It depends entirely on the situation of the bony tumour on the shank-bone, whether it is likely to cause lameness. If it is not in the neighbourhood of any joint, so as to interfere with its action, and if it does not press upon any ligament or tendon, it may not cause lameness, although it is often very unsightly. In many cases it may not lessen the capability and value of the animal. This, however, should be left to the judgment of the veterinary surgeon.

**SRINGHALT.**—This singular and very unpleasant action of the hind-leg is decidedly an unsoundness. It is an irregular communication of nervous energy to some muscle of the thigh, observable when the horse first comes from the stable, and gradually ceasing on exercise. It has usually been accompanied by a more than common degree of strength and endurance. It must, however, be traced to some morbid alteration of structure or function; and it rarely or never fails to deteriorate and gradually wear out the animal.

**THICKENING OF THE BACK SINEWS.**—Sufficient attention is not always paid to the fineness of the legs of the horse. If the flexor tendons have been sprained, so as to produce considerable thickening of the cellular substance in which their sheaths are enveloped, they will long afterwards, or perhaps always, be liable to sprain, from causes by which they would otherwise be scarcely affected. The continuance of any considerable

thickness around the sheaths of the tendons indicates previous and violent sprain. This very thickening will fetter the action of the tendons, and, after much quick work, will occasionally renew the inflammation and the lameness; therefore, such a horse cannot be sound. It requires, however, a little discrimination to distinguish this from the *gumminess*, or roundness of leg, peculiar to some breeds. There should be an evident difference between the injured leg and the other.

**THOROUGHPIN**, except it is of great size, and attended with lameness, can hardly be termed unsoundness; but as it is the consequence of hard work, and now and then does produce lameness, the hock should be most carefully examined, and there should be a special warranty against it.

**THRUSH**.—There are various cases on record of actions on account of thrushes in horses, and the decisions have been much at variance, or perfectly contradictory. Thrush has not been always considered by legal men as unsoundness. We, however, decidedly so consider it; as being a disease interfering and likely to interfere with the usefulness of the horse. Thrush is inflammation of the lower surface of the inner or sensitive frog—and the secretion or throwing out of pus—almost invariably accompanied by a slight degree of tenderness of the frog itself, or of the heel a little above it, and, if neglected, leading to diminution of the substance of the frog, and separation of the horn from the parts beneath, the production of fungus and canker, and, ultimately, a diseased state of the foot, destructive of the present, and dangerous to the future usefulness of the horse.

**WINDGALLS**.—There are few horses perfectly free from windgalls, but they do not interfere with the action of the fetlock, or cause lameness, except when they are numerous or large. They constitute unsoundness only when they cause lameness, or are so large and numerous as to render it likely that they will cause it.

In the purchase of a horse the buyer usually receives, embodied in the receipt, what is termed a **WARRANTY**. It should be thus expressed:—

‘Received of A. B. forty pounds for a grey mare, warranted only five years old, sound, free from vice, and quiet to ride and drive.

‘£40.

‘C. D.’

A receipt, including merely the word ‘warranted,’ extends only to soundness,—‘warranted sound’ goes no farther; the age, freedom from vice, and quietness to ride and drive, should be especially named. This warranty comprises every cause of unsoundness that can be detected, or that lurks in the constitution at the time of sale, and to every vicious habit that the animal has hitherto shown. To establish a breach of the warranty, and to be enabled to tender a return of the horse and recover the difference of price, the purchaser must prove that it was unsound or viciously disposed at the time of sale. In case of cough, the horse must have been heard to cough immediately after the purchase, or as he was led home, or as soon as he had entered the stable of the purchaser. Coughing, even on the following morning, will not be sufficient; for it is possible that he might have caught cold by change of stabling. If he is lame, it must be proved to arise from a cause that existed before the animal was in the purchaser’s possession. No price will imply a warranty, or be equivalent to one; there must be an express warranty. A fraud must be proved in the seller, in order that the buyer may be enabled to return the horse or maintain an action for the price. The warranty should be given at the time of sale. A warranty, or a promise to warrant the horse given at any period antecedent to the sale, is invalid; for horseflesh is a very perishable commodity, and the constitution and usefulness of the animal

may undergo a considerable change in the space of a few days. A warranty after the sale is invalid, for it is given without any legal consideration. In order to complete the purchase there must be a transfer of the animal, or a memorandum of agreement, or the payment of earnest-money. The least sum will suffice for earnest. No verbal promise to buy or to sell is binding without one of these. The moment either of these is effected, the legal transfer of property or delivery is made, and whatever may happen to the horse, the seller retains, or is entitled to the money. If the purchaser exercises any act of ownership, by using the animal without leave of the vendor, or by having any operation performed, or any medicines given to him, he makes him his own. The warranty of a servant is considered to be binding on the master: the weight of authority denoting that the master is bound by the act of the servant. Lord Kenyon, however, had some doubt on the subject.

If the horse should be afterwards discovered to have been unsound at the time of warranty, the buyer may tender a return of it, and if it be not taken back, may bring his action for the price; but the seller is not bound to rescind the contract, unless he has agreed so to do.

Although there is no legal compulsion to give immediate notice to the seller of the discovered unsoundness, it will be better for it to be done. The animal should then be tendered at the house or stable of the vendor. If he refuses to receive him, the animal may be sent to a livery-stable and sold; and an action for the difference in price may be brought. The keep, however, can be recovered only for the time that necessarily intervened between the tender and the determination of the action. It is not legally necessary to tender a return of the horse as soon as the unsoundness is discovered. The animal may be kept for a reasonable time afterwards, and even proper medical means used to remove the unsoundness; but courtesy, and indeed justice, will require that the notice should be given as soon as possible. Although it is stated, on the authority of Lord Loughborough, that 'no length of time elapsed after the sale, will alter the nature of a contract originally false,' yet it seems to have been once thought it was necessary to the action to give notice of the unsoundness in a reasonable time. The cause of action is certainly complete on breach of the warranty.

It used to be supposed that the buyer had no right to have the horse medically treated, and that he would waive the warranty by doing so. The question, however, would be, has he injured or diminished the value of the horse by this treatment? It will generally be prudent for him to refrain from all medical treatment, because the means adopted, however skilfully employed, may have an unfortunate effect, or may be misrepresented by ignorant or interested observers.

The purchaser possibly may like the horse, notwithstanding his discovered defect, and he may retain, and bring his action for the depreciation in value on account of the unsoundness. Few, however, will do this, because his retaining the horse will cause a suspicion that the defect was of no great consequence, and will give rise to much cavil about the quantum of damages, and after all, very slight damages will probably be obtained. 'I take it to be clear law,' says Lord Eldon, in the cause *Curtis v. Hannay*, 3 Esp. 83, 'that if a person purchases a horse that is warranted, and it afterwards turns out that the horse was unsound at the time of the warranty, the buyer may, if he pleases, keep the horse, and bring an action on the warranty; in which he will have a right to recover the difference between the value of a sound horse and one with such defects as existed at the time of warranty; or he may return the horse, and bring an action to recover the full money paid: but in the latter case,



the seller has a right to expect that the horse shall be returned to him in the same state he was when sold, and not by any means diminished in value; for if a person keeps a warranted article for any length of time after discovering its defects, and when he returns it, it is in a worse state than it would have been if returned immediately after such discovery, I think the party can have no defence to an action for the price of the article on the ground of non-compliance with the warranty, but must be left to his action on the warranty to recover the difference in the value of the article warranted and its value when sold.'

Where there is no warranty, an action may be brought on the ground of fraud; but this is very difficult to be maintained, and not often hazarded. It will be necessary to prove that the dealer knew the defect, and that the purchaser was imposed upon by his false representation, or other fraudulent means. If the defect was evident to every eye, the purchaser has no remedy—he should have taken more care; but if a warranty was given, that extends to all unsoundness, palpable or concealed. Although a person should ignorantly or carelessly buy a blind horse, warranted sound, he may reject it—the warranty is his guard, and prevents him from so closely examining the horse as he otherwise would have done; but if he buys a blind horse, thinking him to be sound, and without a warranty, he has no remedy. Every one ought to exercise common circumspection and common sense.

A man should have a more perfect knowledge of horses than falls to the lot of most, and a perfect knowledge of the vendor too, who ventures to buy a horse without a warranty.

If a person buys a horse warranted sound, and discovering no defect in him, and, relying on the warranty, re-sells him, and the unsoundness is discovered by the second purchaser, and the horse returned to the first purchaser, or an action commenced against him, he has his claim on the first seller, and may demand of him not only the price of the horse, or the difference in value, but every expense that may have been incurred.

Absolute exchanges, of one horse for another, or a sum of money being paid in addition by one of the parties, stand on the same ground as simple sales. If there is a warranty on either side, and that is broken, an action may be maintained: if there be no warranty, deceit must be proved.

The trial of horses on sale often leads to disputes. The law is perfectly clear, but the application of it, as in other matters connected with horseflesh, attended with glorious uncertainty. The intended purchaser is only liable for damage done to the horse through his own misconduct. The seller may put what restriction he chooses on the trial, and takes the risk of all accidents in the fair use of the horse within such restrictions.

If a horse from a dealer's stable is galloped far and fast, it is probable that he will soon show distress; and if he is pushed farther, inflammation and death may ensue. The dealer rarely gets recompensed for this; nor ought he, as he knows the unfitness of his horse, and may thank himself for permitting such a trial; and if it should occur soon after the sale, he runs the risk of having the horse returned, or of an action for its price.

In this, too, he is not much to be pitied. The mischievous and fraudulent practice of dealers, especially in London, of giving their horses, by overfeeding, a false appearance of muscular substance, leads to the ruin of many a valuable animal. It would be a useful lesson to have to contest in an action or two the question whether a horse overloaded with fat can be otherwise than in a state of disease, and consequently unsound.

It is proper, however, to put a limit to what has been too frequently asserted from the bench, that a horse warranted sound must be taken as fit for immediate use, and capable of being immediately put to any fair work the owner chooses. A hunter honestly warranted sound is certainly

warranted to be in immediate condition to follow the hounds. The mysteries of condition, as has been shown in a former part of the work, are not sufficiently unravelled.

In London, and in most great towns, there are repositories for the periodical sale of horses by auction. They are of great convenience to the seller, who can at once get rid of a horse with which he wishes to part, without waiting month after month before he obtains a purchaser, and he is relieved from the nuisance or fear of having the animal returned on account of breach of the warranty, because in these places only two days are allowed for the trial, and if the horse is not returned within that period, he cannot be afterwards returned. They are also convenient to the purchaser, who can thus in a large town soon find a horse that will suit him, and which, from this restriction as to returning the animal, he will obtain twenty or thirty per cent. below the dealers' prices. Although an auction may seem to offer a fair and open competition, there is no place at which it is more necessary for a person not much accustomed to horses to take with him an experienced friend, and, when there, to depend on his own judgment, or that of his friend, heedless of the observations or manœuvres of the bystanders, the exaggerated commendation of some horses, and the thousand faults found with others. There are always numerous groups of low dealers, copers, and chaunters, whose business it is to delude and deceive. Very different views will be found to be taken of the question of soundness in the present day to those existing some years ago; and very different conclusions are now drawn from the indications of disease to what would then have been done. The leading point in all cases used to be to decide how long the disease had existed—if, for instance, a spavin is discovered in an animal two months after purchase, *ergo* it must have existed at the time of purchase; if a young plethoric animal is taken from a dealer's stable some distance home, and a few days or a week after is found to be ill—suffering from disease of the throat, lungs or chest, which disease may result in a fatal termination, then the seeds of the disease must have existed prior to the sale, and, that being the case, the horse must have been unsound, and the seller must bear the loss; or, again, the new purchase is discovered to be a roarer, or lame, or losing his condition within a few weeks of the transaction, either of which is a most grievous annoyance to the purchaser; but, fortunately for him, the cause of these afflictions must have existed at the time of purchase, and therefore the animal can be returned; and not only were these views surmised among purchasers, but they were too often adopted by the professional man by whom the horse is examined. Now a day, however, these things have altered a little; the question no longer is, how long must the cause of unsoundness have existed? but, in how short a space of time may it have been produced? But this difference in the mode of viewing the matter may cause remarkably different results. A horse may have a splint developed in a few hours; in eight-and-forty he may become a roarer; a spavin is thrown out in the course of a day or two; a curb may be sprung in a moment; and disease of the throat or lungs, which may terminate fatally, or at any rate seriously deteriorate the value of the horse, may have commenced within twelve hours of his leaving the stable of the seller; and these views must have this important effect, the absolute proof of the state of the animal at the time of sale, for, however shortly after the unsoundness may be discovered to exist, there has been sufficient time both for its commencement and its development; and, therefore, unless its existence can be clearly proved at the time of sale, it is not, of itself, a proof of unsoundness at the time of purchase.

## ON DRAUGHT.

---

THE investigation of the subject of draught by animal power, to which this treatise is devoted, and which will form an appropriate supplement to an account of the Horse, has frequently occupied the attention of theoretical and practical men; so much so, that our object will be to collect what has been said and done, and, by arranging it methodically, to show in what manner the information may be applied and rendered useful, rather than to attempt to produce anything absolutely new upon the subject. Notwithstanding, however, all that has been written, if we open any of the authors who have treated the subject, in the hope of obtaining direct practical information, we shall be much disappointed.

It might have been expected that the particular result of every method known and in use for the conveyance of a load from one spot to another, by animal power, whether by sledges, by wheel-carriages, or by water, as in canals, being so constantly and necessarily a matter of practical experiment, would have been accurately known and recorded; but the contrary is too much the case.

The theoretical investigations have been made with too little reference to what really takes place in practice; and the practical portion of the subject has not generally been treated in that useful and comprehensive manner which it deserves and demands.

In fact, there is hardly a question in practical mechanics on which, though much has been written, opinions are apparently less fixed; or on which the information we do possess is in a less defined and available state.

One great object of research has been the average force of traction or power of the horse.

If we consult the most approved authors and experimentalists, Desaguiliers, Smeaton, &c., we find this power variously stated as equal to 80 lbs., 100 lbs., 150 lbs., and even 200 lbs.; we are therefore left almost as ignorant as before; but the knowledge of this average power is fortunately of little importance in practice. It is the knowledge of the best application, and of the effect, of that power which alone is useful; and these are governed by circumstances so varying and dissimilar, such as the form and state of the road, the structure of the carriage, the size and friction of the wheels, &c., &c., that scarcely any two cases of draught would, as regards the effect of the power of the horse, present the same results.

The difference of opinion here manifest is still greater when existing on a purely practical question.

In the enquiries instituted by a committee of the House of Commons in 1806 and 1808, on the subject of roads and carriages, two well-informed practical men, Mr. Russell of Exeter and Mr. Deacon of Islington, the most extensive carriers in England, were examined upon an important question, viz. the advantage and disadvantage of a particular form of wheel. It was stated by one that, having given the wheels in question a twelve months' trial, he found that they tended to injure the road and

increase the draught in the proportion of four to five; while it was stated by the other, who had also made the experiment on a large scale, that he found they materially assisted in keeping the roads in repair, and diminished the draught in the proportion of five to four.

Amidst such conflicting and contradictory opinions it would appear difficult to come to any useful conclusion, and we might naturally be disposed to adopt a very common practice, that of taking an average result.

A little consideration, however, will show that these apparent discrepancies and contradictions arise in great measure from attempting to generalise and apply to practice the results of experiments made in, and therefore applicable only to, particular cases.

The results of experiments thus made at various times and places, and without that identity of condition and circumstance so necessary when standard rules are to be deduced from them, have nevertheless been used for that purpose; and this circumstance, combined with the variety of distinct points to be considered before we can estimate accurately what even constitutes draught, will perhaps account for the disagreement among the practical and scientific authorities alluded to.

We must therefore examine severally all these points; and then, by considering their relative bearing upon each other, we may hope to reconcile the different opinions advanced, without which we cannot collect from them any information which will lead us to a practical and beneficial result.

We shall proceed to divide the subject under separate and distinct heads, and under each head to examine the methods or means now in use, or which have been proposed, and endeavour to estimate their comparative advantages by availing ourselves of what is already written and known upon each.

It will be necessary first, however, to explain and define clearly some terms which will occur frequently in the course of this paper, and especially the word 'draught,' which is itself the title of the treatise.

This word is used in such a very general and vague sense, that it would be difficult, if not impossible, to give an explanation which should apply equally to all its different meanings.

In the expression 'draught by animal power,' it would seem to mean the action itself of drawing; while, on the other hand, it is frequently used to signify the amount of power employed, as well as the degree of resistance—as when we say the draught of a horse, or the draught of a carriage. 'Draught power' is also an expression used. We shall, however, confine our use of the word to the two meanings—*draught*, the action of dragging—and *draught*, the amount of resistance to the power employed to drag any given weight.

'Force of traction' is another expression requiring explanation; but here we must enter into more detail, and give a practical illustration of our meaning.

A force is most conveniently measured by the weight which it would be capable of raising; but it is not therefore necessarily applied vertically, in which direction weight or gravity acts.

If a weight of 100 lbs. be suspended to a rope, it is clearly exerting upon this rope a force of 100 lbs.; but if the rope be passed over a pulley void of friction, and continued horizontally, or in any other direction, and then attached to some fixed point, the weight still acts upon all parts of this rope, and consequently upon the point to which it is fixed, with a force equal to 100 lbs.; and so inversely, if a horse be pulling at a rope with a force which, if the rope were passed over a pulley, would raise 100 lbs., the force of traction of the horse is in this case 100 lbs. Spring steel-

yards being now commonly in use, we may be permitted to refer to them as affording another clear exemplification of our meaning. In pulling at a steel-yard of this description, if the same force be exerted, whether horizontally or vertically, the index will, of course, show the same amount; and, consequently, if the strength of the horse be measured by attaching the traces to one of these steel-yards, the number of pounds indicated on the dial will be the exact measure of the strain the horse exerts, and the amount of strain is called his 'force of traction.'

Having fixed as nearly as possible the meaning of these terms, which will frequently occur in the course of our progress, we shall proceed to the division of the subject.

It is evident that there are three distinct agents and points of consideration in the operation of draught, which are quite independent of each other. They are—First, the moving power and the mode of applying it; Secondly, the vehicle for conveying the weight to be moved; Thirdly, the canal, road, or railway, or what may be generally termed the channel of conveyance.

All these individually influence the amount of draught, and require separate consideration; but the mode of combining these different agents has also a material effect upon the result,—consequently, they must be considered in relation to each other; and to obtain the maximum useful effect, with the greatest economy, in the employment of any given power, it is evidently necessary that these different agents should not only each be the best adapted to its purpose, and perfect to the greatest possible degree, but also that they should all be combined to the greatest advantage.

We shall proceed, then, to examine the different agents now employed, the modes of applying them, and the proportionate effects produced.

And, first, with regard to the species of moving power;—this may be of two kinds, animal and mechanical.

By 'animal power' we mean the direct application of the strength of any animal to dragging or pulling, as in the simple case of a horse dragging a cart. By 'mechanical,' the application of any power through the intervention of machinery: the source of power in this latter case may still, however, be animal power, or a purely mechanical agent, as a steam-engine.

The latter is the only species of mechanical power which it has been attempted, with any prospect of success, to apply practically to locomotion; and therefore that alone we propose to compare with the animal power.

Now, although these two powers, viz., simple animal power and the steam-engine, may in most instances be applied so as to produce the same effect, and may therefore, to a superficial observer, appear similar; yet there do exist such essential differences in the mode of action, or the means by which the effect is produced, that there are many cases in which the one may be used, wherein the other may be totally inapplicable.

In this treatise, draught by animal power is the principal object of consideration; but as great efforts have been made for many years, and are still now perseveringly made, to supersede animal power entirely by mechanical,—to dismiss our old servant the horse, and supply his place by the steam-engine,—it may be as well, in justice to the former, to say a few words in his defence, and to take a brief view of the distinguishing features of the two agents.

To enter into all their respective merits, and to weigh their comparative advantages in all circumstances, would involve us in many questions foreign to that under our immediate consideration, and would embrace subjects which may supply matter well worthy of our future attention. It is sufficient

for our present purpose to show that there still exist great objections to the universal application of machinery to draught,—objections which do not equally apply to the use of animal power; that there are many advantages in the latter, which are not yet obtained by the former; and that animal power continues, for all the ordinary purposes of traffic upon common roads, to be the most simple in its application, and certain in its effect.

We shall confine ourselves particularly to the consideration of that part of the question which relates to the slow transport of heavy goods, as being the most important branch of the subject, especially for agricultural purposes. Economy is, of course, the grand desideratum in the consideration of this question; consequently, the comparative expense of the two powers, supposing them for the moment equally convenient and applicable, will first demand our attention.

A difficulty arises here, however, from the want of a certain measure of comparison. The power of a one-horse engine is by no means exactly the same thing as that of a horse. As we have before stated, the mode of applying them being different, the variations in the results are different, and consequently the effects do not bear a constant proportion to each other, in different circumstances: we must therefore be careful not to fall into the mistake which we have ourselves pointed out as a very common source of error, viz., the drawing general conclusions from data obtained in a particular case. We shall take the power of the horse, and that of the steam-engine as ascertained practically on railways, where the effect of each is less influenced by accidental circumstances, and consequently can be better ascertained than on a road. We shall confine our calculations of expense to this particular case, and then endeavour to discover how far the same results are to be expected, or what modifications are likely to take place, and what alterations are to be made in the results under different circumstances. As regards the first, viz., the comparative cost of animal and mechanical power on a railway, we cannot do better than quote the words of the late Mr. Tredgold upon this subject, and we accordingly extract the following passage from his work upon Railways:—

‘The relative expense of different moving powers for railways is an interesting enquiry, and the same materials being necessary to estimate the absolute expense for any time or place, it is desirable to give some particulars to aid the researches of those who wish to make such comparative estimates. The annual expense of a horse depends on:—

- ‘1. The interest of purchase-money.
- ‘2. Decrease of value.
- ‘3. Hazard of loss.
- ‘4. Value of food.
- ‘5. Harness, shoeing, and farriery.
- ‘6. Rent of stabling.
- ‘7. Expense of attendance.

‘According to the average duration of a horse in a state fit for labour, of the description required on a railway, the first three items may be estimated at one-fourth of the purchase-money; the food, harness, shoeing, &c., included in the 4th, 5th, and 6th, will most likely not exceed 40*l.* per annum, nor yet be much short of that amount; and supposing one man to attend to two horses, this would add 15*l.* 12*s.* if the man’s wages were 2*s.* per day; and, at this rate, the labour of a horse of the value of 20*l.* would cost 60*l.* 12*s.* per year; or, since there are 312 working days in the year, the daily expense would be 3*s.* 10½*d.*, or 186 farthings. But the power of a horse is about 125 lbs. when travelling at the rate of three miles per hour, and the day’s work eighteen miles.

'The annual expense of a high-pressure locomotive engine, or steam carriage, consists of:—

- '1. The interest of the first cost.
- '2. Decrease of value.
- '3. Hazard of accidents.
- '4. Value of coals and water.
- '5. Renewals and repairs.
- '6. Expense of attendance.

'It is difficult to procure these particulars from the experience of those who employ engines; we will therefore annex, by way of example, such sums as we think likely to cover the expense. The first cost of the engine and its carriage may be stated at 50*l.* per horse-power, and its decrease of value and hazard will render its annual expense about one-fifth of its first cost, or 10*l.* per annum per horse-power. The expense of fuel and water per day will be not less than one bushel and a half of coals per horse-power and fourteen cubic feet of water; and, taking the coals at 6*d.* per bushel, and the water and loading with fuel at 3*d.*, the annual expense will be 15*l.* 12*s.*; the renewals and repairs, at 20 per cent. on the first cost will be 10*l.*, which is as little as can be expected to cover them. Attendance, suppose one man and one boy for each six-horse engine, at 6*s.* per day, or 1*s.* per day for each horse-power, or 15*l.* 12*s.* per annum; therefore the total annual expense of one horse-power would be 51*l.* 4*s.*, or 158 farthings per day.'—This power is equal to a force of traction of 166 $\frac{2}{3}$  lbs. for the same number of miles per day as the horse; but from this gross amount of power we must deduct that necessary to move the engine with its supply of coals: this will reduce it at least to 155 lbs.; consequently, in the one case we have a force of traction of 125 lbs., at an expense of 186 farthings, and, in the other, a force of 155 lbs., at an expense of 158 farthings; and reducing them both to one standard quantity of work done, we find the expense of the horse is  $\frac{186}{125}=1.488$ , and of the locomotive engine, 1.019, or about as 147 is to 100. In this case, therefore, there appears to be a decided economy in the use of the steam-engine, and accordingly its application has become very general, and is becoming more so every day.

Let us now examine what alterations are requisite before we can apply these calculations to the case of draught upon common roads; supposing both species of power equally convenient and applicable, and confining our observations merely to the amount of power and proportionate expense.

The force of traction of the horse, and the yearly cost, will remain so nearly the same, that for our present purpose we may consider them quite unaltered. Not exactly so with the locomotive engine.

All the parts of the machine must be made much stronger and heavier, and consequently more expensive for road-work than for a railway, and, therefore, the first cost will be greater—the wear and tear will also be greater, and as the work will be more variable, the consumption of fuel will be increased as well as the price, which, generally speaking, will be much less on a line of railway than it can possibly be elsewhere.

Still all these circumstances will not influence the result so much as the increased effect of the weight of the engine. On a railway with the carriage, as now constructed, the force of traction is not much more than  $\frac{1}{50}$  or  $\frac{1}{200}$  of the weight moved; consequently, the power necessary to move the engine itself is not very considerable. On a road, however, this proportion is materially altered; here the average force required to move a well-constructed carriage cannot be estimated in practice at less, even when the roads are in good repair, than  $\frac{1}{25}$ ; the engine, according to the construction of the best locomotive engines now in use, will weigh, with its carriage and fuel, at least one-half ton, or 1120 lbs. per horse-power, and  $\frac{1}{25}$  of 1120

is nearly 45 lbs., which we have to deduct from the gross power of the engine, and which leaves only  $121\frac{2}{3}$  lbs. as the available power. The proportional expense of the horse and the steam-engine is now therefore about as 115 to 100, and this without taking into account the causes of increased expenditure already alluded to as regards the prime cost, the repairs, and the consumption of fuel. From these calculations it would appear, that even if mechanical power was found as convenient and applicable in practice as horse-power, still no great economy can be expected from the employment, upon common roads, of small locomotive engines, such as the best of those now in use, and known to the public, unless it is in cases where other means may fail to produce some particular effect which may be required; if, for instance, a considerable velocity is necessary, the power of a horse is very nearly exhausted in moving his own body, and then there can be no doubt that a mechanical agent, in which power may always be exchanged for a proportional velocity, will have some advantages on a very good road, which in fact approaches very nearly to a railway. But in every case in which velocity is not a principal object, as in the one now under consideration, and where, consequently, little momentum is acquired, and frequent though slight obstructions occur, as on an ordinary road, an animal appears to possess decided advantages. He adapts himself admirably to the work, increasing or diminishing his efforts according to the variations of the draught, resting himself, as it were, and acquiring vigour where his utmost strength is not called for, and thus becomes enabled to make exertions far beyond his *average* strength where any impediment or obstruction is to be overcome. Indeed, he appears rather to increase the *average effect of his powers* by these alternations of exertion and comparative relaxation; and when it is considered that the draught will, in an ordinary road, frequently vary in the proportion of six or eight to one, and that these changes may succeed each other suddenly, the importance of such an accommodating faculty will be immediately appreciated.

By mechanical power, such as a steam-engine affords, these advantages are not easily obtained. Without great weight or rapid motion no momentum can be acquired; and, unless when the carriage is in very rapid motion, a very small obstruction will check, and perhaps totally stop, the machine. For instance, supposing the carriage to be advancing steadily under the effect of a force of traction of 500 lbs., and that a stone or rut suddenly causes a resistance, which it would require 800 or 1000 lbs. to overcome, a case by no means rare even on tolerable roads; if the impetus or momentum of the mass be not sufficient to carry it over this obstruction, the machine must stop until some increased power be given to it.

It is also to be remembered, that what we are accustomed, in practice, to consider as the average power of a horse, is the average excess remaining over and above that necessary to carry his own body; and that in all ordinary cases he is able to maintain and continue nearly the same exertions, although the comparative draught of the carriage be considerably increased. Thus, if the road be slightly muddy or sandy, or newly gravelled, the draught, as we shall see more accurately laid down when we come to the subject of wheeled carriages, will be double and even treble what it is on the same road when freed from dust and dirt; but the average power of the horse remains nearly the same, and, practically speaking, equal in both circumstances; that is to say, that the power necessary to move the weight of the horse's body, which forms no inconsiderable portion of his whole power, is not materially increased by a state of road which will even treble the draught of the carriage; consequently, the excess, or available portion of his power, remains unimpaired, and the



full benefit of it, as well as of any increased exertions of the animal, is felt and is applied solely to dragging the load.

Not so with a locomotive steam-engine, because, beyond the power necessary to perform the work of dragging the load, a large additional power must be provided to move the engine itself. In other words, if an engine of ten-horse power be capable of dragging a certain load, the weight of this engine forming a portion of the load to be moved, a corresponding portion of the power is unprofitably absorbed in moving it, and the excess, or remaining power, is alone available for useful purposes, and can alone be compared to the animal or horse-power. Now, if the draught is augmented, as we have just supposed, by any sand, dirt, or roughness of the road or any other impediment, the force required to move the useless weight (of the engine) is proportionally increased; it may even, as we have stated, be doubled or trebled; and the whole power of the engine remaining the same, the surplus or remaining portion is considerably diminished, and that at the very moment when, as before stated, it produces only one-half or one-third the effect.

Moreover, if at any part of the road a power equal to twenty horses is required, the engine, as regards its construction, must be a 20-horse engine. It is erroneous to suppose that a steam-engine, because it is a high-pressure engine, can therefore, as occasion requires, be worked for any length of time beyond its nominal power, by merely raising the steam. Every part of a machine is calculated and arranged for a certain pressure and corresponding power, and that is the real power of it. It is optional to work at or below that power, but, if below, it will be to a disadvantage, as the bulk and weight of the machine will be as great as if it were always worked to its full extent, and both have to be carried over all those parts of the road where a far less power would be sufficient. The velocity of the carriage might indeed be increased, while travelling on the good and level portion of the road; but these alternations in the speed and power cannot be effected without a considerable degree of complexity, weight, and expense in the machinery; and, as we are confining ourselves to the consideration of the case where *velocity is not required*, and might even be an inconvenience, the excess of power will be wasted.

These objections to the use of mechanical power, in certain cases, are pointed out, not as being insurmountable obstacles to the use of machinery, but as serious difficulties which, in practice, have not yet been overcome. In fact, there is not at present any practical substitute for horse-power on common roads, and, as far as the public is concerned, nothing has yet been done. We, therefore, must consider them as objections remaining to be overcome; and we are compelled to draw the conclusion, that, at the present moment, animal power (always confining ourselves to the question of the economical transport of heavy goods upon common roads) is superior to any mechanical agent, and that beasts of draught, and particularly the horse, although the most ancient, still remain the most advantageous source of power.

Long experience has pointed out various modes of applying animal power; but it is frequently ill directed, owing to the want of an adequate knowledge of the mechanical structure of the animal, and the manner in which he exerts his strength.

In the most powerful steam-engine, if too great a resistance be applied, or practically speaking, if we attempt to make it do more work than it is calculated for, there is an immediate loss of power, in consequence of the diminution of velocity caused thereby; and if we continue to oppose a still greater resistance, we reach the point at which it is unable to overcome it, and it ceases to produce any effect. Again, a very small obstacle may

be so applied as greatly to impede an engine of considerable power, or even to stop it altogether. The power of an engine is limited, and resistance must always be proportioned to it; and there is a proportion beyond which it is useless to go, and less than which would not absorb the whole force.

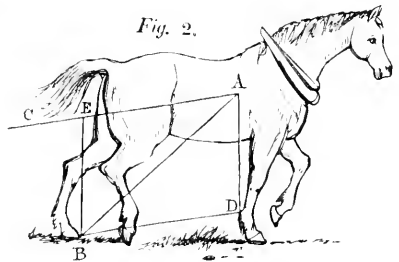
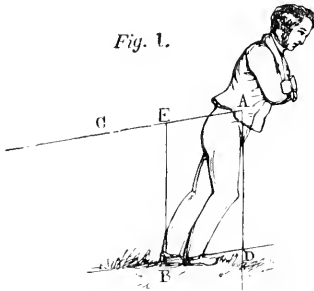
An animal is but a beautiful piece of machinery, and although perfect in its construction, and wonderfully accommodating in its movements, it still, like the engine, has a limited power, and has its peculiar modes of action, its strong and its feeble parts; and we must well consider its structure, to be able to apply the resistance in that degree, and in that manner, which shall enable it to produce the greatest effect. The consideration of the comparative effects of the exertions of a man and a horse will at once exemplify this, and lead us more clearly to the knowledge of the peculiar qualities or faculties of the horse.

If a horse be made to carry a heavy weight rapidly up a steep ascent, or if a man be employed to drag slowly a heavy carriage along a rough road, the strength of both will be soon exhausted, and little effect produced; but if a man be made to carry a weight up a ladder, and if a horse draw a heavy carriage along a road, they will each produce a considerable effect: yet, in the former case, the horse and the man are as strong as in the latter, but their power is not properly applied, and is consequently wasted.

These different results are easily explained, by considering the mechanical structure of the two bodies, and the mode in which their muscular strength is exerted.

The action of pulling is effected in either case by throwing the body forward beyond the feet, which form the fulcrum, and allowing the weight of the body, in its tendency to descend, to act against the resistance applied horizontally, and drag it forward; as the resistance yields, the feet are carried forward; and the action renewed, or rather continued.

Let A (*fig. 1*) be the centre of gravity, or the point in which the whole



of the weight of the body may be supposed to be accumulated, and B the fulcrum, or point of resistance; AC the direction of the power to be overcome.

If the legs are inflexible, the body, acting by its gravity, tends in its descent to describe a circle around the point B, but is opposed by the resistance AC; and it is demonstrable, by the law of the resolution of forces, that if BD be drawn parallel to AC, the lengths of the lines AD, AB, and DB represent respectively the proportions between the weight of the body, the strain upon the point of support, and the effect produced; that is, if AD be taken as the measure of the weight of the body, then AB is the measure of the strain upon the legs, and BD or AE the power pulling in the direction of AC.

Consequently, the effect increases with the weight of the body and the

distance which it is thrown beyond the feet, and is limited only by the capability of resistance at B, or the muscular strength of the legs. This is evidently the case in practice; for even if the body were brought nearly horizontal, when its weight would act to the greatest advantage, still, if the legs are incapable of resisting the strain, they would yield, and no effect be produced. In a man, this muscular strength of the limbs is very great, and he can lift or carry immense weights, and ascend easily, even loaded, a ladder; but he is not well adapted to the purpose of dragging: as his own weight is small proportionally to his strength, and the centre of gravity is low, and by the construction of his body cannot be thrown far beyond the fulcrum at his feet; consequently, however capable his legs may be of resisting a great strain, AE remains small, and his muscular force is not advantageously brought into action.

A horse, on the contrary, by the formation of the body, can relieve his weight partly from his fore-legs; and, extending his hind-legs as in *fig. 2*, throw the centre of gravity a considerable distance in front of his feet B. AE is here proportionably much greater than in the former case, and the whole of his force is, therefore, advantageously employed. He is, in fact, by his mechanical construction, a beast of draught.

The same train of reasoning which has here pointed out the species of work peculiarly adapted to the different structures of the man and of the horse, if continued further, will now serve to show the circumstances in which the power of the latter is best applied, and the greatest effect produced.

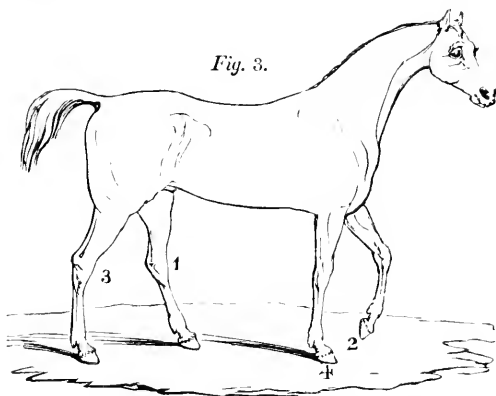
We shall here consider both the quality and the degree of the draught.

And first, it is to be observed, that, although the weight of the animal's body is the immediate cause in the action of pulling, yet, as before stated, it is by the action of the muscles in advancing the legs and raising the body, that this cause is constantly renewed, and the effort continued. The manner and the order of succession in which a horse thus lifts and advances his legs may, of course, influence the movement of his body, and ought therefore to be examined into: accordingly we find that many writers upon draught have touched upon this part of the subject, but they appear to have contented themselves with inventing in their closet the manner in which they conceived a horse must have moved his legs, rather than to have taken the trouble to go out of doors to see what really did take place, and, consequently, many have arrived at erroneous conclusions. The ancient sculptors, who generally studied nature so faithfully, either neglected this point, or otherwise our modern horses, by constant artificial training, have altered their step: for we find in the celebrated frieze from the Parthenon at Athens, a portion of which, now in England, is more commonly known under the name of the Elgin Marbles, the only horses which are represented trotting have both their legs on the same side of the body raised at once, the other two being firm upon the ground—a position which horses of the present day never assume while trotting.

In the case of these relievos, it is true that there are only four horses, out of more than two hundred, which are in the action of trotting, all the others being represented in a canter or gallop; and only two of these four are entirely in the foreground, and distinct from the other figures. It would not be safe, therefore, to draw too general a conclusion from this example alone; but we have another decided proof of the remark we have made, in the case of the four horses of the church of St. Marc at Venice.

Whether this was then the mode of trotting or not, it is certain that it is never seen to occur in nature in the present day; and indeed it appears quite inconsistent with the necessary balancing of the body, and was, therefore, more probably an error of the artist.

It perhaps may have been found difficult or troublesome to watch the movement of a horse's legs; but a very little practice will enable anybody to verify what we are about to state: by keeping near the side of a horse that is walking, it will be easily seen that, immediately after the raising of either of the hind-legs from the ground, the fore-leg of the corresponding side is also raised, so that the latter leaves the ground just before the former touches it. If the fore-legs be then watched, it will be seen that, immediately after the movement of either of these, the hind-leg upon the opposite side is put in action, so that the order of succession appears to be in walking, as numbered in *fig. 3.*



If the horse be now examined from a short distance, it will be seen that, when he is walking freely, the successive movements of the legs are at equal intervals of time, and that the muscular force of one limb only is brought into action at the same moment. But if a horse which is dragging a load with some considerable exertion be watched, it will be seen that he then acts longer upon his legs, and allows a less interval of time for raising and advancing them; and, at the same time, the regularity of the movement is generally destroyed; the limbs on the same side generally being moved more simultaneously, or at nearer intervals of time, than those at the opposite corners: thus, the muscular forces of two limbs are always acting together; the movement of the whole body is less continued and uniform than in the former case, but each impulse is more powerful, and a resistance, which would be too great for the muscles of one leg, is overcome by the united exertion of two. We shall point out, hereafter, the necessity of attending to this in the application of this power to draught.

In trotting, the action is of course quicker, and a less resistance will, as might be expected, cause the horse to move his legs at two intervals instead of at four equal intervals of time: indeed, a horse accustomed to go in harness generally acquires the habit of that action. There is this striking difference between trotting and walking: in walking, we have seen that the interval between the movement of the legs on the same side was less than the other interval of time: in trotting, on the contrary, the legs situated diagonally, or at opposite corners, move almost simultaneously. Owing to the velocity and the momentum which the body acquires in consequence of that velocity, in trotting fast, the successive impulses are less distinctly perceptible, and the movement more continued and uniform than in a slow trot, or in walking.

In galloping, the movement is totally different: the fore-legs are thrown forward nearly simultaneously, and the hind-legs brought up quickly, and nearly together; it is, in fact, a succession of leaps, by far the greatest

interval of time elapsing while the legs are extended after the leap is taken: this is the position, therefore, which catches the eye, and which must be represented in a drawing to produce the effect of a horse in a gallop, although it is the moment when the animal is making no exertion.

The canter is to the gallop very much what the walk is to the trot, though probably a more artificial pace. The exertion is much less, the spring less distant, and the feet come to the ground in more regular succession: it is a pace of ease, quite inconsistent with any exertion of draught.

The consequence of these peculiar movements in the limbs of the animal is, that a succession of impulses is conveyed to the body; and when the movement is slow, and the body of the horse does not acquire any considerable impetus or momentum, the resistance should be such as to receive each of these impulses, and leave the horse unrestrained in the intervals.

It must, therefore, be a rigid resistance, void of elasticity.

It must not, however, be a constant unremitted resistance.

For it is a well-known fact, that, however powerful may be the muscles of a limb, they must not be kept constantly on the stretch. Thus we feel even more fatigue by standing than by walking, because one particular set of muscles is then kept constantly exerted. It is evident, therefore, that the resistance or draught must not be perfectly constant, but should afford frequent opportunities of relaxing the efforts. Neither must it be a yielding resistance, as in that case the animal could not make any great exertion; for if he applied too much power, he would be liable to fall forward; and should he at any time fall short of the necessary exertion, he would be drawn back by the strain, and it would require a considerable effort to restore the motion.

If a horse be made to drag a rope passing over a pulley and descending into a well with a certain weight, say of 200 lbs., attached to it, it is obvious that he could not make an effort greater than 200 lbs. without instantly considerably increasing his velocity, which would be a waste of power; nor must he for an instant relax his efforts, or fall below that mark, for he would then be unable even to resist the pull and would be overcome by the weight. Such an extreme case as this, of course, is not likely to occur often in practice, but the disadvantage of the principle is obvious.

An arrangement of this sort is, indeed, sometimes made use of, for raising the earth from excavations, or the materials of a building; but the exertion is continued only for a few seconds, or for a distance of not more than ten or twenty yards: if prolonged, the inconvenience would be seriously felt, as it is, to a certain degree, in towing canal boats; the length and curve of the rope give an elasticity to the strain, and the necessity of keeping the rope out of the water, or from dragging along the towing-path compels the animal to keep up a constant unremitted pull, and that, too, in an oblique direction, so as to throw him into an unfavourable position. We accordingly find that, in these circumstances, the average work of a horse is equivalent only to about four-fifths of that given by Smeaton, Desagnilliers, and others, who estimated the power of the horse from the work done in a horse-mill, where the resistance is inelastic, and all circumstances favourable, with the exception of the circular path.

The disadvantage of this kind of resistance is well known to carmen, though of course without consideration of the reason. A horse is said to pull better when he is close to his work, that is to say, when he is attached at once to the body to be moved, because every exertion he makes is then communicated at once to the mass; but the leader of a team, unless he

keeps the traces constantly on the stretch, may frequently waste a powerful effort without producing much effect upon the carriage.

Another inconvenience resulting from harnessing horses in a team, or one before the other, is, that the leader, by tightening the traces, is continually relieving the strain from the body horse, and reciprocally the body horse from the leader; so that these horses labour under all the disadvantages of a long, elastic, and constantly yielding connection with the load, which is not only fatiguing to them, but in cases where the resistance is variable, prevents the full and united effect of their exertions being properly communicated to the carriage. For, if a slight obstacle, as a rut or stone in a road, checks the progress of the vehicle, the shaft horse can immediately throw his whole weight into the collar, and the united effect of his strength and impetus is conveyed unimpaired to the vehicle, and forces it over the obstacle; but if any elasticity is interposed between the power and the resistance, as in the case of the traces of the leader of a team, the whole, or the greater part of the effect of impetus is lost, and that force which, if concentrated in one effort, would effect the object, being lengthened into a continued and comparatively feeble pull, is insufficient.

If we wish to destroy the impetus of a body moving with violence, we receive it with a yielding resistance; the action of catching a cricket-ball exemplifies this perfectly; and, therefore, if the full effect of momentum is wanted, all elasticity in the direction of the movement should be avoided.

We have entered rather fully into the consideration of this particular point, because the principle is not only applicable to the mode of communicating the immediate action of the moving power, but will be found also of considerable importance when we arrive at the subject of wheel-carriages.

A consideration of these various points brings us to this conclusion, that the draught ought neither to be constantly uniform nor without remission, nor yet yielding or elastic: sudden shocks or violent changes in the velocity must also evidently be disadvantageous, as tending to distress and injure the animal.

Having determined upon the necessary quality of the resistance, we will proceed to examine into the quantity or the degree of resistance or draught, and the speed best adapted to the exertion of the animal. The useful effect of a horse, or the work done, must evidently depend upon three things, viz., the rate at which he is made to travel, *the power of traction he can exert*, and *the number of hours he can continue to work daily at that speed*; and where there is no fixed condition which determines any one of these, such as a particular load to be moved, or a certain velocity which it is desirable to attain, or a limited time to perform the work in, then the object must be to search for those proportions of the three by which, at the end of the day, the greatest quantity of work shall have been produced.

With respect to the first two, viz., the speed and power exerted, it will be obvious, that where a horse travels unloaded, the greatest distance he can go in any given time for several days in succession without injurious fatigue is the limit of his velocity: on the other hand, the load may be so great that he can scarcely put it in motion—this is the limit of his power: in both cases, the useful effect is nothing. But between these limits of velocity and power, there is a proportion which affords the maximum quantity of effect, and which, therefore, must be the most advantageous for the application of horse-power.

It has been asserted by theorists, and the theory appears to be supported by experience, that the velocity corresponding to this maximum, or that at which a horse working continually a certain number of hours per day will do the most work, is equal to half the extreme or limit of velocity of the

same horse working the same number of hours unloaded; and that the force of traction corresponding to this speed is equal to half the limit of his power. For instance, if six hours be the length of a day's work decided upon, and if a horse working that time can go six miles per hour unloaded, and therefore producing no useful effect, and supposing the limit of power of the same horse be equal to 250 lbs., it is found that he will do the most work in the same number of hours when drawing a load at the rate of half six, or three miles per hour; and half of 250, or 125 lbs., will be the strain corresponding to this speed. Our next step, then, must be to *find* these *limits*: now, the limit of velocity depends upon the length of time during which the speed is kept up; we subjoin therefore a Table deduced from experiments, and which represents the proportion of the duration of labour and maximum velocity of the average of horses accustomed to their respective velocities.

	Hours.									
	1	2	3	4	5	6	7	8	10	
Duration of labour . . . . .										
Maximum velocity unloaded, in } miles, per hour . . . . .	14 $\frac{3}{4}$	10 $\frac{1}{2}$	8 $\frac{1}{2}$	7 $\frac{1}{3}$	6 $\frac{2}{3}$	6	5 $\frac{1}{2}$	5 $\frac{1}{4}$	4 $\frac{2}{3}$	

This within the range here given may be considered as very nearly the law of decrease of speed by increased duration of labour; and at the first glance we see the great advantage of reducing the speed and prolonging the exertion. There are, however, many causes to limit the duration of a day's work of a horse. Tredgold, in his work on Railways, before quoted, says: 'The time assigned for the day's work of a horse is usually eight hours; but it is certain, from experience, that some advantage is gained by shortening the hours of labour; and we have observed that a horse is least injured by his labour where his day's work is performed in about six hours; where the same quantity of labour is performed in less than six hours, the over-exertion in time shows itself in stiffened joints, while the wearying effects of long-continued action become apparent, if the duration of the day's work be prolonged much beyond eight hours. Indeed, under the management of a good driver, a full day's work may be completed in the time before mentioned—six hours—with benefit to the health and vigour of the animal.'

We may be permitted, however, to abandon the idea of improving the health of the animal, or of rendering his business a pleasure to him—an attempt, the success of which is, we should think, very questionable, and content ourselves with endeavouring to check the barbarous practice of working horses to death either by overdriving or overloading them; and we shall, as is generally the case, consult our own interests, and follow the dictates of humanity at the same time, by not injuring so useful an animal: and we think experience proves there will be no danger of doing this by working eight or nine hours a day. By referring to the foregoing Table, we see that the maximum velocity of the average of horses corresponding to eight hour's work is five miles and a half per hour, consequently, the rate at which he would travel when loaded is a little more than two miles and a half per hour. There is no doubt that some horses could conveniently travel faster; but as the speed must generally be governed by that of other horses, the average is, in this case, the rate to be adopted. The force exerted under these circumstances depending upon the quality of the horse, it is very difficult to obtain even an approximate value of it, unless the experiment be made upon each individual horse: it is fortunately, however, of no great consequence in practice, because if we feel sure that we are employing all the *power* we can command to the greatest advantage, it is not of any very great importance that we should know the *exact amount* of that power.

In comparing animal horse-power with that of the steam-engine, we estimated it at about 125 lbs., but we believe that, with tolerably good horses, it may generally be taken at more than that.

We have thus far confined our attention to the cases where velocity, as well as duration of labour, was left to choice; this is far from being always the case. In stage-coaches, or other conveyances for passengers, speed is absolutely necessary, and it only remains to learn how that speed can be obtained with the greatest economy. The following Table, extracted from Tredgold, will show the great reduction in the effect produced by increasing the velocity.

The first column being the velocity or rate per hour, continued for six hours per day; the second represents the force of traction of which the animal is capable; and the third the comparative effects produced. A force of traction of 125 lbs. continued for six hours at the rate of three miles per hour being taken as the standard, and considered equal to the arbitrary number 1000.

Miles per hour.	Force of traction in lbs.	Effect produced.
2	166	888
3	125	1000
3½	104	972
4	83	888
4½	62½	750
5	41½	555
5½	36½	500

If, however, the hours of labour be lessened, taking the velocity corresponding to the greatest useful effect, the results will be much greater, and the velocity may be raised much higher, as will be seen in the following Table.

Here the first column is the length of day's work, the second the best velocity corresponding to that time, or half the limit of velocity shown in Table (1), and the third column the comparative effect produced, the force of traction being in each case 125 lbs.

Duration of labour in hours.	Velocity, miles per hour.	Effect produced.
2	5½	578
3	4½	709
4	3¾	813
5	3¼	909
6	3	1000
7	2¾	1063
8	2½	1110

To attain higher velocity, it is necessary still further to reduce the load, and the next Table is calculated upon the supposition of the strain being only one-half the last, viz., 62½ lbs.; this is about the average exertion of each horse in a four-horse heavy stage-coach.

Duration of labour, hours per day.	Velocity.	Effect produced.
4	5½	613
3	6½	534
2	7½	434
1	11	307

In mails or light coaches, where ten, eleven, and even eleven and a half or twelve miles an hour is attained, the average strain of each horse is barely 40 lbs., and the effect produced, or value of work done, not much more than one-half the above.

It must be remembered, that these tables are all calculated upon the supposition of the road being good, and the work such as not to cause any immediate injury to the animal, and is adapted only to the average quality of horses. They are not, therefore, at once applicable as data for calculations in all ordinary cases, but only serve to show the comparative forces which may be exerted under different degrees of speed. The results or



effects of this force will always be influenced by the quality of the resistance, as we have already observed, in the cases of slow travelling; but in rapid travelling the power is much more expensive, owing to the great loss which we see by the tables is sustained by increased velocity; and it is, therefore, the more important to study well the means of applying the power in question.

In this rapid travelling, the bad consequences of a uniform and constant strain is still more felt by the horses, and the necessity of occasional relief is still more urgent than at low velocities. It is universally admitted by horse proprietors and postmasters, whose interests make them peculiarly sensible on this point, that a flat piece of road is more destructive of horses than the same length of road where gentle rises and alternate flat and swelling ground occur; and that a long hill is easier surmounted where there are occasional short levels, and even descents, than when the whole is one uniform ascent.

It only remains for us, before we dismiss the subject of the moving power, to consider the particular mode of applying it, or the manner of harnessing the horses.

Under this head comes the question of the be t direction of the traces, or, as it has generally but less clearly been called, the angle of inclination of the line of traction. This question appears to have been always considered one of great importance: the point has been frequently discussed, and various opinions have been advanced; some having recommended it to be horizontal, others inclined; and, as they have each in their turn, in demonstrating the correctness of their own theory, proved the error of others, there can be no presumption in laying them all aside, and in taking a different, but, at the same time, a more simple and practical view of the case. By referring to a figure similar to that by which we showed the mode of action of the horse in pulling, we see that if AD represent that portion of his whole weight which is relieved from his forelegs, and AE the direction of the traces, then AF is the measure of the horizontal pull upon the carriage.

Now, AF bears a constant proportion to AB, which represents the strain upon the legs; and AD being constant, AB, and, consequently, AF, increase or diminish according as the angle ADB is increased or diminished: that is to say, the horizontal pull applied to the carriage is proportionate to the strain upon the legs; but they are both dependent upon the angle formed by the traces, increasing or diminishing as the latter are inclined downwards or upwards from the collar; so that whether the traces be inclined upwards, as *fig. 4*, or downwards, as *fig. 6*, or whether they be horizontal as *fig. 5*, makes no difference in the manner of pulling. In the first case, a portion of the animal's weight is borne by the traces, and is transferred by them to the carriage. AF is here small, but the strain upon the

Fig. 4.

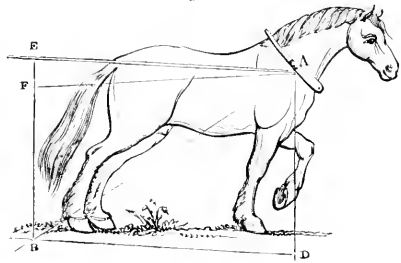


Fig. 5.

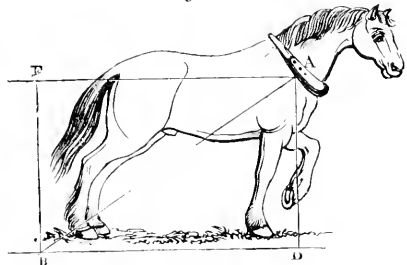
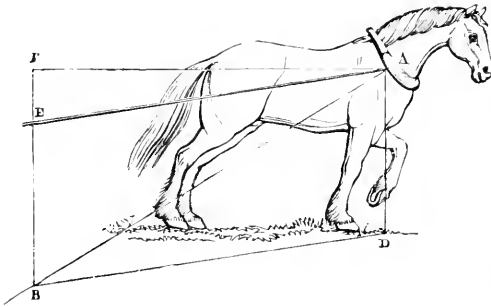


Fig. 6.



legs AB, is also proportionably less than in the second case, where the traces are horizontal. In *fig. 6*, where the traces incline downwards, we see that the horizontal force AE is much more considerable; but, at the same time, AB is increased, and consequently the muscular exertion required in the legs is proportionately great; in fact, here a portion of the weight

of the load is transferred to his shoulders.

The comparative advantages, therefore, of the three do not follow any general rule, but depend simply upon the peculiar qualities of the particular animal employed, and his relative capabilities of lifting and pulling, or the proportion existing between the weight of his body and his muscular strength. To render this more clear to our own feelings, we will take the case of a man. We have already seen that an able-bodied man is more adapted for lifting than pulling; consequently, in his case, it would be advantageous to throw a certain portion of the weight upon him, by making him pull upwards, as in *fig. 7*, or what we are more accustomed to see, and

Fig. 7.



Fig. 8.

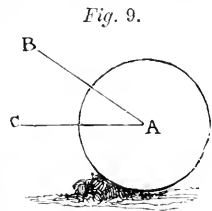


which amounts to the same thing, applying his strength to a wheelbarrow, *fig. 8*, and we have frequently seen an ordinary man wheel 800 lbs. in this manner.

If, however, we take a person unaccustomed to hard work, and consequently not so strong in the legs, although he may be unable even to lift the wheelbarrow which the other moved with ease, still he may, by pushing horizontally, put in motion a considerable load; and lastly, in the case of an invalid who can barely carry his own weight, if he lean on the back of a garden-chair, he will not only walk himself, but push on the chair; or a child who is yet too weak to stand, can, if part of his weight be supported in a go-cart, not only move himself, but also the frame which supports him. These are very familiar and homely comparisons, but they are cases exactly similar to the three positions of the traces; and the argument will equally apply to horses as to men. It is true, we rarely use for draught a horse that cannot stand; but the case is very possible that a large heavy horse, otherwise not strong, or one which it was not desirable to fatigue, might pull better and longer, if part of the weight was borne upon the carriage, or if, in other words, the traces inclined upwards. And we know by experience, that in the case of stage-coaches,

where, owing to the speed, the weight of the horse's body is already generally a burden to him, it is disadvantageous to increase that weight by inclining the traces much downwards; on the contrary, where we wish to obtain the utmost effect of a powerful horse, or of a horse that is muscular, but without much weight forward, it is highly advantageous to augment the effect of his gravity by inclining the traces downwards even as much as  $15^{\circ}$ , or about 1 upon 3; the strain upon the traces will be then considerably increased, and the effect augmented, provided always that he is able to exert the necessary strength in his legs. As far, therefore, as the mere force of traction is concerned, there is no particular angle which will always produce the greatest effect—but it must depend upon the particular capability of the horse; and this in its turn varies, and is affected by circumstances; for the same horse that upon a level road requires no addition to his weight, might be materially assisted by a slight addition when ascending a hill, if not continued too long; and most horses would be benefited considerably by the opposite arrangement in a descent, that is, by a portion of their weight being borne up; they should at least have no additional load thrown on them while descending a hill.

There is also a time, when inclining the traces downwards is almost indispensable; it is when dragging a four-wheeled waggon over a rough broken road. If the front wheel, which is generally small, meets with an obstacle by falling into a hole, or stopping against a stone, it requires no profound reasoning to show, that a force pulling upwards in the direction AB, *fig. 9*, will rise the whole wheel over the obstacle with much greater facility than if applied horizontally, as AC; this is the only circumstance, unconnected with the horse, that ought to govern the direction of the traces, and the degree of the inclination here must, of course, still be proportioned to the power of the horse. We see therefore that, in proportion as the horse is stronger, or that we are disposed to make him exert a greater effort, the traces should be inclined downwards from the collar; with a good average horse, perhaps one-sixth or one-seventh of the distance from the collar to the extremity; with a horse of inferior capabilities, arising from weakness in the limbs, and not want of weight, or with an ordinary horse when travelling above six miles an hour, the traces should be nearer the horizontal line, except when the circumstance of a rough road, before alluded to, requires some modification of this. To be able to apply these rules generally in practice, it would be necessary to have some means of altering the traces while on the road; as we have stated that they should be differently arranged according as the road is level or rough, or ascending or descending; this would not be difficult to contrive, and has, indeed, been suggested by some writers upon this subject; but it is probable that, except in stage-waggons, where the same carriage goes along a great extent, and consequent variety of road, it will be sufficient to adjust the traces according to the average state of the roads in the neighbourhood; and we cannot greatly err, if we bear in mind that inclining the traces downwards from the collar to the carriages amounts to the same thing as throwing part of the weight of the load on to the shafts, a thing frequently done in two-wheeled carts, and a manœuvre which all good carmen know how to put in practice. The impossibility of inclining the traces of the leaders, owing to their distance from the carriage, is an additional reason to those given before, why they (the leaders) cannot, when required, exert such an effort as the shaft-horse or wheeler; and on rough cross-roads, is a great argument in favour of harnessing horses abreast.



Yet what can be more contrary to the rules here laid down than the injudicious mode frequently adopted in harnessing horses? How constantly do we see the efforts of horses paralysed by misapplication of their

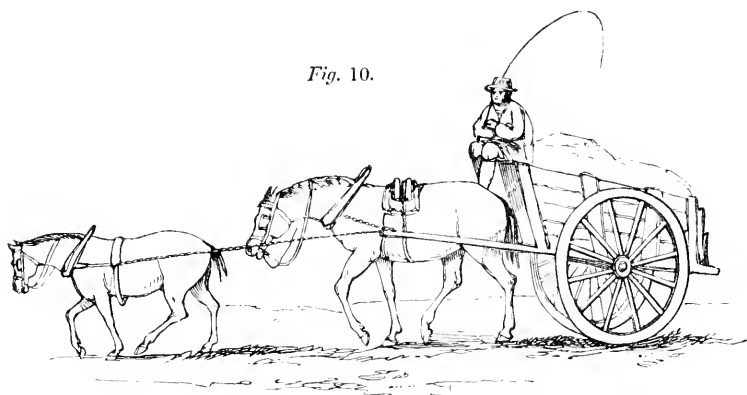


Fig. 10.

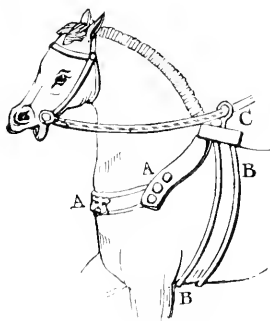
respective qualities! In the annexed sketch (*fig. 10*) for instance, which represents a very common specimen of this, the light, muscular, little horse, which is capable of considerable exertion, is nearly lifted from the ground, and prevented from making any exertion, by the traces leading upwards; while the feeble old horse, scarcely capable of carrying his own body, is nearly dragged to the ground, and compelled to employ his whole strength in carrying himself, and even part of the weight of the leader; so that the strength of the one willing and able to work is not employed, and the other is so overloaded as to be useless.

The mode of attaching the traces does not admit of much variety. The shoulders have always been made use of for this purpose.

Homer, who is supposed to have lived about 900 years B.C., describes very minutely, in the twenty-fourth book of the *Iliad*, the mode of harnessing horses at the time of the siege of Troy, nearly 3000 years ago; but if we suppose that his description was taken from the harness in use in his own time, it is still referring to a period about twenty-seven centuries back.

A simple strap, formed of several thicknesses of leather, so as to be very stiff, and fitted well to the neck and shoulders, served as a collar, as seen at AA, (*figs. 11, 12*). A second strap, BB, passed round the body, and was attached to the shoulder-strap at the withers. At this point was fixed the yoke, CC, which was fixed

Fig. 11.

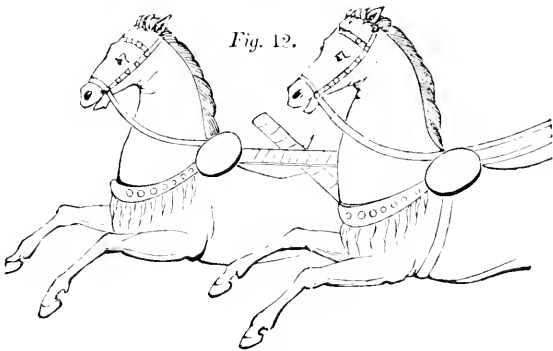


to the pole.

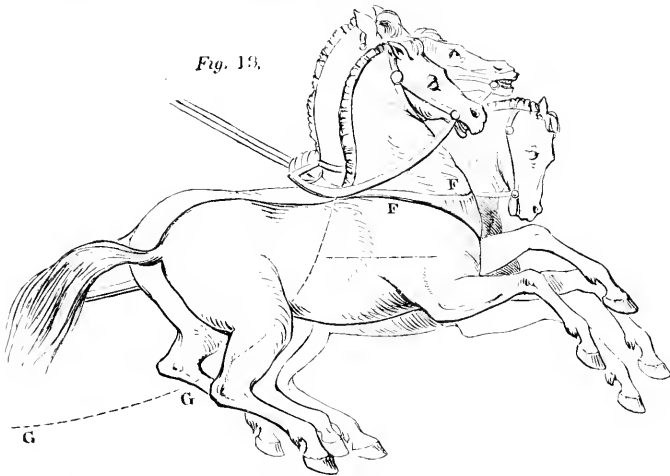
A pair of horses were thus yoked together, without traces or breechings, as oxen are seen at the present time in many parts of the country.

This was a simple arrangement, but by no means a bad one; and it would appear that they performed all the manœuvres of cavalry with chariots and horses thus harnessed. The pair yoked to the pole were called yoked horses; abreast of these was frequently placed what was called an outer horse, with a simple shoulder-strap or collar FF, and a single trace, GG, passing inside, as in *fig. 13*. Sometimes there were two of these horses, one on each side, each furnished with his strap or collar

and trace. These straps, if well fitted, were not bad ; but as they must have pressed in some degree upon the throat, they could not be equal to the collar of the yoked horses, still less to the collar at present used.



In more modern times these shoulder-straps gave place to the breast-strap. A horse can no doubt exert a considerable strain against such a strap, but in action it must impede the movement of the shoulder.



In some parts of South America the trace is fixed to the pommel of the saddle, which in its turn is well secured to the horse by saddle-girths, breast-straps, and breechings ; and we are informed that horses in this manner drag very considerable loads. It resembles completely the harness of the ancients, with the addition of the breechings. It is, of course, a mere temporary arrangement, convenient only as requiring no preparation. The trace is, in fact, the lasso of the rider, which is always fastened to the saddle ; and when he has entangled it round the horns of a bull, or attached it to anything he may have occasion to transport, he takes one or two turns of the thong round the pommel of the saddle, and the horse will at full gallop drag the load after him. Here the load being generally upon the ground, the trace must incline considerably downwards : and this, added to the weight of the rider, will perhaps account in some degree for the extraordinary effects of a young powerful horse goaded to the utmost, and continuing the exertion only for a short time.

A gentleman who travelled some time in this part of America, and

frequently witnessed the practical effects of this arrangement has suggested the propriety of introducing it into the Artillery, by means of which a number of horses might in an instant be attached to a gun, to extricate it from any heavy or broken ground in which it might be entangled. Certainly, the length of these traces would enable these additional horses to secure a good footing; and any number of horses might thus be made to lend their assistance in time of need. We do not pretend, however, to judge of the practical utility of this measure, but merely record the suggestion of another.

The collar now generally used is an improvement upon the ancient shoulder-strap described by Homer; and it is probably the best possible mode of attaching the traces to the horses. If the connection is made at the proper place on the collar, the latter bears flat and evenly upon the muscles which cover the collar-bone, and the shoulders of the horse are left almost as free in their action as if the collar were not there. About A, (*figs.* 14, 15), is the point of the shoulder where the trace should come; and

Fig. 14.

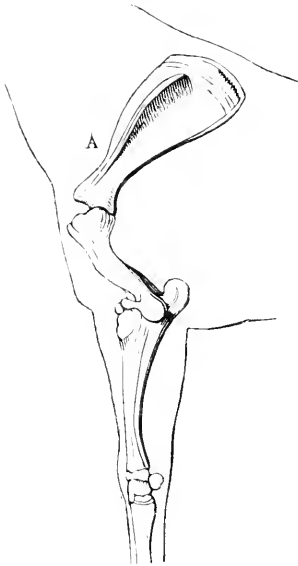


Fig. 15.



a little inclination downwards, which can easily be effected in the case of the shaft-horse by the shafts, and in the others by the belly-band, will, if necessary, prevent the collar rising up, and inconveniencing the throat of the horse.

Reflecting upon the various circumstances which we have shown to occur in the application of animal power, and the various conclusions we have drawn while considering the best and most advantageous application of this power—and we must be excused the frequent repetition of the terms, for the sake of the clearness gained by it—it would appear that the resistance should be as much as possible rigid and inelastic, so as to receive immediately, and unimpaired, the direct effects of the slightly irregular exertions of the animal; that this resistance should not be such as to yield directly to a sudden impulse; that it should be so far uniform as to be free from violent changes or sudden shocks, but not so constant as to allow of no remission, nor of those alternations of exertion and comparative relaxa-

tion which we have stated to be advantageous to the perfect development of animal power.

That, as regards the degree of resistance where velocity is not required, a force of traction of from 100 lbs. to 125 lbs., or even 150 lbs., according to the strength of the horse, continued for eight hours a day, at about two and a half to three miles per hour, is the best proportion of quantity and duration of labour. The load which will produce this amount of draught will be determined when we consider the subject of the roads, on the quality of which it will be seen that this mainly depends; that where six or eight miles per hour is required, the duration of the day's work should be shortened to five or six hours, and the draught reduced to 80 lbs. or 100 lbs. At still higher velocities the draught must not exceed 50 lbs. or 60 lbs., and the time of working two or three hours. But this speed can only be attained by the sacrifice of the horse; and consequently the question will rather be what the horse is capable of doing than what can be done with economy; and it becomes a matter of calculation, depending altogether upon the first cost of the horse, and the profits arising from his employment.

With respect to the mode of harnessing the horse, it is hardly necessary to say that great care should be taken in fitting the collar and in attaching the traces to the proper point. As to the direction of the traces, it must, as we have shown, entirely depend upon the circumstances of the case. Where the draught is heavy and slow, if the road be good, the traces should be nearly horizontal, unless the journey be short, or the traffic be only in one direction, and the cart return empty, or unless any other reason render it desirable to compel the horse to exert himself more than he would naturally do; the traces should then be inclined downward towards the carriage, with an inclination perhaps of one upon four or five, provided always that the horse is capable of continuing the exertion which, by the additional load thrown upon his shoulders, he is thus called upon to make. If, in the same case of low speed, the road be very heavy, or broken and rough, the proportion of draught upon each horse must be lessened by diminishing the load, but the traces should be attached still lower to the carriage, at a slope of one upon three or four, by which much greater power is given to the animal to drag the load over any obstruction.

At all high velocities, the traces should generally be horizontal. The cases of rough roads or powerful horses may slightly affect this arrangement, as at low velocities, but not in so great a degree.

We will now proceed to examine the mode in which these conditions are practically to be fulfilled, and the result of the application of the principles which we have laid down, by considering the subject of *the vehicles for conveying the weight to be moved*.

Those in present use are boats, as canal-boats, sledges, and wheeled carriages, which last of course include every species of carriage, whether waggon or cart, heavy or light.

Canal-boats and canals we suspect are gradually going out of use, and will, excepting in some peculiar cases, or unless some great improvement takes place in time, be superseded entirely by railways; but still it must be many years before this can be effected; and in the meantime, the produce of the most extensive manufactories in the world, and the supply of immense masses of people, will be transported over these beautifully smooth, level, and noiseless roads; and, even if their beds were dry, and become the course of railways (an event which may perhaps befall some of them), we must, out of respect for the extraordinary benefits we have derived from their assistance, and the almost incredible effect they have produced upon the commerce and riches of the country, have devoted a few

lines to that part of their consideration which bears upon our subject, viz. the draught of canal-boats.

The great advantage in the transport of goods by water conveyance is the smallness of the power required. A body floating in water is left so very free in its movements, that motion may be gradually communicated to it by any power, however small—at least the limit is very far removed; but although a very slow movement may thus easily be obtained, the slightest increase of speed causes a very great increase of resistance.

The resistance to a body moving in a fluid arises principally from the striking of the particles of the fluid against the front of the moving body, so that if the speed of the vessel be increased, not only does it encounter a proportionably greater number of particles, but also it is struck by each with a force proportionate to the velocity, and consequently the resistance is found to increase as the square of the velocity; thus if the speed of the vessel be trebled, the number of particles, or the quantity of water which it meets in its progress for a certain space of time, is trebled, and the resistance of each particle being also three times as great, owing to the boat's striking it with treble the velocity, the united effect is nine times as great; therefore, if in the first instance it required one pound to draw the vessel, it would now require nine, but nine times the weight or resistance, moved at three times the velocity, will require twenty-seven times the *quantity* of power in action; consequently, we see that the resistance increases as the square of the velocity, and the power required to be exerted for a given time increases as the cube of that velocity.

This law of the increase of resistance is modified however by other causes, which have been observed and deeply investigated within the last few years, and which produce such an effect, that with boats of a peculiar form a diminution of resistance actually occurs at a certain increased velocity, and very high rates of speed, such as even 10 or 12 miles per hour, have been attained. There are also some small sources of resistance, such as the friction of the water, which do not increase in the ratio above named, but at moderate velocities the rule applies, and as yet no means have been discovered by which, with the present dimensions of canals and their locks, larger quantities and weights can be conveyed at any but very low rates of speed. The draught of an ordinary canal-boat, at the velocity of  $2\frac{1}{2}$  miles per hour, is about  $\frac{1}{500}$  of its weight, that is to say, a canal-boat, with its load weighing 33 tons, or 73,920 lbs., is moved at the rate mentioned, by a force equivalent to 80 lbs., being  $\frac{1}{528}$  part of the load. This is found by Mr. Bevan to be the result upon the Grand Junction Canal, and a force of traction of 80 lbs. is here found to be equivalent to a horse-power. The average power of an ordinary horse is certainly rather more; and, in the commencement of this paper, we mentioned this as an instance of a small effect being produced, most probably owing to the peculiar application of the power. We believe it to be the case, and think it likely, that if the disadvantages before alluded to, arising from the mode of applying the power, could be removed, the effect might be raised 100 lbs., or 120 lbs. of traction, and consequently the load moved would then be 40 or 50 tons; this is an increase well worthy of consideration.

We now come to the consideration of the means of transport employed on land. These are sledges, rollers, and wheel carriages. The order in which they are here mentioned is probably that in which they were invented or first employed. A sledge is certainly the rudest and most primitive form of vehicle; the wheeled carriage, and even the placing the load itself upon rollers, is the effect of a much more advanced state of the mechanical arts, and is probably of much later date than the sledge.

When man first felt the necessity or the desire of transporting any



article from one spot to another, he doubtless endeavoured to lift or carry it: if it proved too heavy for him to carry, he would naturally endeavour to drag it. Here frequent experiments would soon show him how much less labour was required to drag a body with a smooth surface in contact with the ground, than when the contrary was the case; and if the body to be moved did not itself present a smooth surface on any of its sides, but was, on the contrary, rough and angular in all directions, he would naturally be led to interpose between it and the ground some plane surface which should prevent the angles and projections of the body from entering the ground and impeding the progress; and we may presume that sledges were thus very early brought into use. When attempting to transport still heavier masses, the accidental presence of round stones, or of a piece of timber, may have shown the advantage of interposing rolling bodies, and thus may rollers have been invented and first brought into use.

These steps appear natural and likely to have led to these results; they are at any rate sufficient to account for the first introduction of these two means of facilitating transport, but no steps of this kind appear capable of leading to the beautiful yet simple contrivance of a wheel.

A roller is by no means an imperfect wheel, as it may at first appear to be; they have nothing in common but their rotatory or revolving action, but the effect of this motion is totally different in the two. In a roller, friction is avoided altogether by it, in a wheel this friction exists as completely as in a sledge, but the sliding surfaces, being at the centre of the wheel instead of on the ground, are always the same, and being under control, may be kept in that state which shall cause as little friction as possible; moreover, the friction is at a point where we have the means of overcoming it, by acting with the power of a considerable lever, as we shall hereafter show.

There is, indeed, a kind of roller which partakes somewhat of the character of the wheel, but without possessing the advantages of it.

This species of roller might have been an intermediate step between the two, and we shall therefore describe it when we have dismissed the subject of sledges and rollers.

In England sledges are at the present time very little in use. In some commercial towns the facility with which bulky and heavy articles can be placed upon them, without being raised to the height of a cart, has caused them still to be employed, but even in these cases, they are in general used only upon the pavement where the friction is not considerable, and for short distances, in which case the saving of labour, in loading and unloading, more than compensates for the increase of power absorbed by the draught. Low-wheeled trucks, however, in these cases, possess the same advantage, and have gradually been substituted for them, where this advantage was indispensable: for agricultural purposes they are almost become obsolete, and for all purposes of traffic between distant points they are quite abandoned.

It is only in the North of England and in some parts of Cornwall that they are sometimes used in farms; but wherever good roads exist, and mechanical arts keep pace with the improvements of the age, they have given place to wheel carriages. An examination into their nature and action will immediately account for this.

A sledge is merely a frame, generally of wood, upon which the load is placed, and resting at once upon the ground, the friction between the under surface of the sledge and the ground bears a considerable proportion to the load; but if the ground be very uneven and full of holes, the sledge, by extending over a great surface, avoids the holes, and slides only upon the eminences, which being naturally the stones of the hard portions of the ground, cause less friction; on such a road, a wheel would

be continually sinking into those holes, and thus oppose considerable resistance, and would also expose the load to frequent danger of upsetting.

It would appear, therefore, that over broken ground, or even upon a very bad uneven road, a sledge may sometimes be more advantageous than wheels, and its extreme simplicity of construction renders it very economical as regards first cost; but the ground must indeed be very bad, or the country be very poor and little cultivated, where the formation of roads would not amply repay themselves by allowing the use of wheels; for the power required to draw a loaded sledge will be at least four or five times greater than that required for an equally loaded cart upon a tolerably good road.

The draught of a sledge, even upon the pavement, is about one-fifth of the load, so that to draw a ton weight, requires a force of traction of about four hundred weight; upon roads the friction will be much greater: it is difficult to state its amount, as it must depend so much upon the nature of the ground, but with the load before mentioned, viz. one ton, the force of traction will probably vary from five to seven hundred weight: over a strong rocky surface the resistance of a sledge will be much the same as on pavement. Its use, therefore, must be confined to very particular cases, where the absence of roads, or the want of means, prevents the adoption of more improved vehicles; and these cases are fortunately too rare in England to render it worth our while to bestow much time upon its description.

Sledges are generally formed of two longitudinal pieces of timber, four or five feet apart, with their lower edges shod with iron: and transverse planks, bolted to these, form the floor, and they are thus easily constructed. The traces should be more inclined than with wheeled carriages, because the friction bearing a greater proportion to the load, it is more advantageous to throw a portion of that load upon the horse, and being used upon uneven ground it is more important to be able to lift the front of the sledge over obstacles.

Although in this country the use of sledges is very limited, in many parts of the world they constitute the best, and, indeed, the only means of conveyance. Upon ice the friction is so trifling that they oppose less resistance even than wheels, for the reasons before stated, of their covering a larger surface, and thereby sliding over those asperities which would impede the progress of a wheel; upon snow the advantage is still more decided: where a wheel would sink a considerable depth and become almost immovable, a sledge will glide upon the thin frozen crust without leaving a trace, and with an ease truly wonderful. In all cold climates they are consequently in general use; and the depth of winter is there the season for the transport of merchandise.

The Esquimaux with their dogs, the Laplanders with their rein-deer, and the Russians with horses, use the sledge to a great extent in the winter, over the frozen rivers or the hard snow.

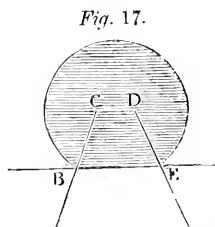
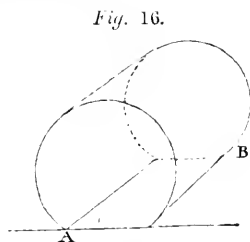
In the warm climates, on the contrary, not only are they now almost unknown, but the records which refer to periods so far removed as 3000 years make no mention of such conveyances.

Rollers come next under consideration; they certainly afford the means of transporting a heavy weight with less power than any other means with which we are acquainted; their motion is not necessarily attended with any friction. A cylinder, or a sphere, can roll upon a plane without any rubbing of the surfaces whatever, and consequently without friction; and, in the same manner, a plane will roll upon this roller without friction; in practice, this is more or less the case, according to the perfection of workmanship in the formation of the rollers, and, if cylindrical, the care with which they are placed at right angles to the direction at which they are to move. There is only one source of resistance which is inseparable

from the use of rollers, viz. the unevenness of the surfaces, or the yielding of the material, which amounts to nearly the same thing.

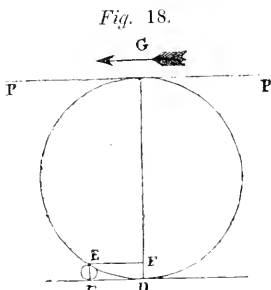
A circle resting upon a straight line can only touch it in a single point, and the contact of a cylinder with a plane is merely a line: consequently, if the material of the roller, and the surface on which it rolled, were perfectly hard and inelastic, such would be their contact, whatever weight might be placed upon the roller.

But in practice no such material can be obtained, and rollers, on the contrary, are generally made of wood, and, when loaded, they must yield until the surface *AB*, *fig. 16*, is proportionate to the pressure. Still, if the substance were perfectly elastic; that is to say, if it would return to its original form with the same force and velocity which were required to distort it, this alteration would not cause any resistance; the elasticity at *E* would tend to raise the back of the roller with a force *DE*, *fig. 17*, equal to, and exactly similar, but opposite to *CB*, and would consequently balance it.



Although perfect elasticity is unattainable, yet most hard substances possess this quality to some extent; consequently, when the load is not sufficient to crush the materials, the resistance is not much increased by even a considerable yielding, provided this yielding, as we before said, arises from elasticity. Thus if a bladder be filled with air and used as a roller, the resistance will not be greater than if a perfect and hard cylinder were employed, although the bladder may be nearly flattened under the weight; but the permanent compression of the roller, and the crushing of dust or other extraneous substances lying in the way, are the great impediments to its movements; these constitute a resistance in the direction *BC*, which is not counterbalanced by any force arising from elasticity on the opposite side. The effect of this resistance is dependent upon the diameter of the roller, diminishing when the latter is increased, though not in so rapid a proportion.

If to a circle a horizontal force *P* be applied at *G*, *fig. 18*; if an obstacle be placed at *E*, the force *P* will tend to push the roller over the obstacle, and will act with a lever equal to *GF*, and for all small obstacles *GF* may be considered equal to *GD* the diameter. The weight upon the roller pressing it down, acts with a lever equal to *EF*; but *EF* is equal  $\sqrt{GF} \times \sqrt{FD}$ ; therefore *EF*, which is equal to *FD*, remaining constant, and the diameter being increased, *EF* increases only as the square root of diameter, and consequently, the force necessary to advance the roller is inversely as the square root of the diameter; that is to say, if a roller be increased four times in diameter, the resistance arising

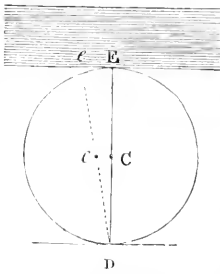


from the causes now under consideration will be reduced to  $\frac{1}{\sqrt{4}}$  or  $\frac{1}{2}$ , and if increased nine times in diameter, the resistance will be only equal to  $\frac{1}{\sqrt{9}}$  or  $\frac{1}{3}$ .

This being the only source of resistance to the action of a roller, it will easily be conceived that, in practice, by laying a plank or any other plane surface upon the ground, and preparing in like manner the lower surface of the body to be moved, and interposing rollers between the two, a very great weight may be moved with comparatively small power; but, on the other hand, there is a serious practical inconvenience attending the use of the roller, which prevents its adoption except in very particular cases.

A weight moved upon rollers proceeds at twice the rate of the roller;

Fig. 19.  
w



for if C, *fig. 19*, be the centre of the roller, D the point of contact with the ground, and E that with the weight to be moved, and W the weight, if this weight be put in motion, the point D is for an instant stationary, since it is in close contact with the ground. The diameter E C D moves, therefore, round the point D as a centre, and, consequently, E being twice as far from D as C is, describes E e twice as great a distance as C c; fresh points are now brought to the summit and in contact with the ground, and again the latter is stationary, while the former moves twice the distance which the point C does. The summit, therefore, or that point which

is in immediate contact with the weight, always moves with twice the velocity of the centre of the roller; but the velocity of the centre is, of course, that of the roller, and the velocity of the point E, which is in contact with, and is moved by, the weight, is the same as that of the weight moved; therefore, as the weight is forced forward, it moves at twice the rate of the roller, it will gain upon the rollers, and others must be continually supplied in front—an inconvenience much felt in practice.

This confines the use of the roller to cases where the distance is very short, or where the weight conveyed is exceedingly great, and reduction in the resistance of more importance than the inconvenience alluded to.

The most remarkable instance of the application of rollers is the transport of the rock which now serves as the pedestal of the equestrian statue of Peter the Great at St. Petersburg.

Fig. 20.

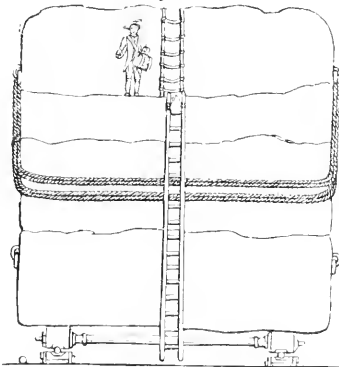
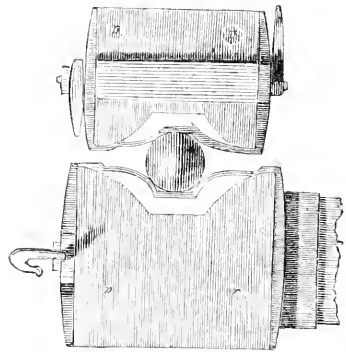
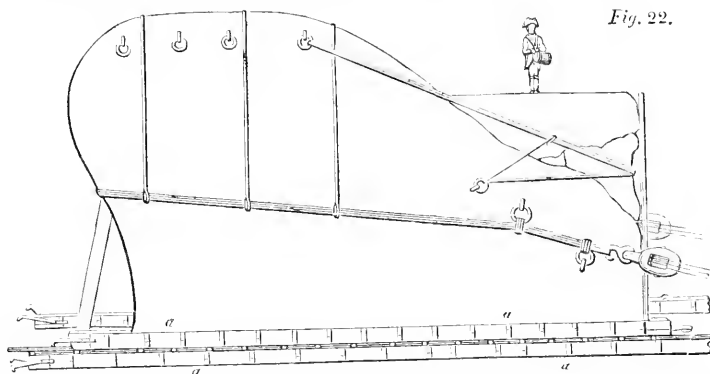


Fig. 21.



This rock, a single block of granite, was discovered in the centre of a bog, four miles from the waterside; it weighed, after being cut into a convenient shape, 1217 tons. Notwithstanding its enormous weight it was raised and turned upon its side, and placed upon a frame. A road was made across the bog, and a timber railway laid down: the whole was then left till the depth of winter, when the boggy ground was frozen, and the

operations then commenced. The railway consisted of two lines of timber *a a a*, (*figs.* 20, 21, 22,) furnished with hard metal grooves; similar and



corresponding metal grooves were fixed to the under side of the sledge, and between these grooves were placed the rollers, which were spheres of hard brass, about six inches diameter. The impossibility of confining cylindrical rollers to a perfectly parallel direction, and without which the friction would have been considerable, rendered the adoption of spherical rollers or balls running in a groove a matter of necessity, as otherwise the small surface upon which they can bear, and the consequent danger of crushing, or at least flattening that surface, is a serious objection to spheres; once placed upon the rollers, it was drawn by means of capstans. The resistance does not appear to have been great, considering the enormous weight, since sixty men at the capstans with treble purchase blocks moved it with ease.

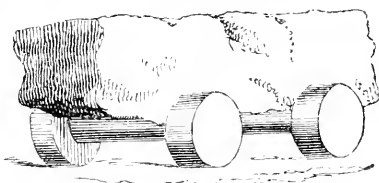
The transport of this enormous rock under such disadvantageous circumstances of country, over a distance of four miles, and its subsequent passage of thirteen miles by water in a vast caisson or vessel constructed for the purpose, was a work surpassing anything attempted by the ancients, and, indeed, in modern times the only thing which can be compared to it is the dragging a ship of the line up a slip; the weight is in this case nearly the same as that of the rock, but the distance traversed is short, and the difficulties to be overcome much less. A plane of inclined timber is prepared and well greased: a frame of wood, technically called a cradle, is fixed under the vessel, it is floated on to the inclined plane and drawn up by the united efforts of a number of well-manned capstans, with powerful tackle: in this case no rollers are used: it is a sledge, the surface being well covered with grease to lessen the friction.

We have stated that there was a particular construction of roller which might be considered, as regards its form merely, an intermediate step between the roller and the wheel. It consists of a roller with the diameter of the extremities increased, as in *fig.* 23; the only advantage of this roller is that the body rests upon the small part of the roller, see *fig.* 24, and when put

*Fig.* 23.

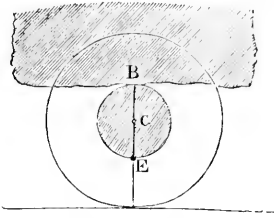


*Fig.* 24.



in motion, will not gain so rapidly on the rollers; or in other words, the roller will move with more than half the velocity of the body. A

*Fig. 25.*



mere inspection of *fig. 25* is sufficient to show that the velocity of the centre, C, will be to that of the body resting on the point B, as CD to BD, so that if the ends of the rollers are twice the size of the intermediate part, CD will be equal to two-thirds of BD, and the roller will move at two-thirds of the rate of the body; a less number of rollers are therefore required, and the re-

sistance is somewhat diminished by having larger rollers in contact with the ground.

In using a roller of this sort, the idea may have struck the workman, or it may have occurred accidentally, to confine the spindle of the roller, and compel it to move with the body; and thus a clumsy pair of wheels, fixed to a spindle, would have resulted from his experiment. Such a supposition is quite gratuitous, as we have no record of any such contrivance having existed before wheels were made; indeed it is inferior both to the roller and the wheel: the only argument in favour of such a theory is, that rollers of this sort have been employed in comparatively modern times.

At Rome, in 1588, an obelisk, ninety feet high, of a single block of stone, weighing upwards of 160 tons, and which had originally been brought from Egypt, was removed from one square, in which it stood, to another near the Vatican, and there again erected in the spot where it now is.

In dragging this through the streets of Rome, it was fixed in a strong frame of wood, which rested upon a smaller frame, which were furnished each with a pair of rollers, or spindles, of the form above referred to; they were turned by capstan bars: indeed they cannot be better described than by stating that they resembled exactly the naves of a pair of cart-wheels (all the spokes being removed), and fixed to a wooden axle. If a heavy waggon lay upon a pair of these, we can conceive that by putting bars into the mortices of the naves, we could force them round, and thus advance the waggon; but the resistance would evidently be greater than if either rollers or wheels were employed.

All the difficulties incidental to the use of the roller appear to be surmounted, and all objections met, by the contrivance of the wheel.

The wheel being attached to the load, or to the carriage which contains it, moves with it, is part of the machine, and consequently as we require only the number of wheels immediately necessary for the support of the load, we can afford to construct them of those dimensions and materials best suited to the purpose. By increasing their diameter, we are enabled to surmount impediments with much greater facility, as we have shown in the case of the roller; and although there is a resistance arising from friction at the axle, which does not exist in the roller, yet this may be so reduced, by increasing the diameter of the wheel, as to form an inconsiderable part of the whole resistance, or draught of the carriage.

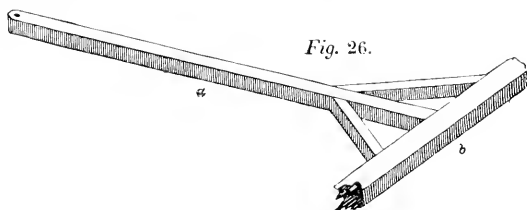
Of the first introduction of the wheel we have no record whatever. The principle appears to us so simple as to have been necessarily the result of pure invention, almost of inspiration; while, at the same time, it is so exceedingly effective and perfect, as hardly to admit of improvement.

The great antiquity of wheeled carriages or chariots precludes all hopes of discovering their origin. About fifteen hundred years before the Christian era they appear to have been in common use amongst the Egyptians

in their warfare. Pharaoh despatched six hundred chosen chariots in pursuit of the Israelites, while the rest of the army followed with all the chariots of Egypt: here, therefore, they were in general use, and serving as the cavalry of the present day. Moreover, the oldest records which enter into any detail of their construction describe them as in a very forward and perfect state.

At the siege of Troy, nearly three thousand years ago, they formed, according to Homer, the cavalry of the Greeks and Trojans; and every officer or hero of good blood possessed, at least, a pair of horses and a charioteer.

These chariots being built to run over broken ground, where no roads existed, were made low and broad, and they were by no means badly contrived for the purpose for which they were intended; the wheels were constructed with a nave and spokes, felloes and tires; and the pole *a*, appears to have been fixed on the axle-tree, *b*, in the manner shown in *fig. 26*.



The body of the chariot was placed upon this frame. The team generally consisted, as we have before stated, of a pair of horses, attached to the pole; six and even a greater number of horses were, however, frequently harnessed abreast, but in that case a second pole was generally affixed to the axle-tree, so as to have a pair of horses attached to each pole, and the axle-trees themselves were always made nearly as long as the whole width occupied by the horses.

They appear to have had light chariots for more domestic purposes, and four-wheeled carriages for conveyance of heavy goods; and certainly King Priam, when he went to the Grecian camp to ransom the body of his son Hector, travelled with some degree of comfort and luxury; he rode himself in a 'beautiful new-built travelling carriage,' drawn by favourite horses, while the treasures, intended as a ransom, were conveyed in a four-wheeled waggon drawn by mules. All these details, as well as the mode of harnessing the horses, which operation, it must be confessed, was performed by Priam himself and his sons, are fully described in the twenty-fourth book of the *Iliad*.

That Homer was well acquainted with the construction of the spoked wheel running freely upon the axle-tree, and, perhaps, even with the mode of hanging the body of the carriage upon straps for springs, in the same manner as the public coaches are to this day in many parts of France, and, till lately, even in the neighbourhood of Paris, is evident from the passage in which he describes Juno's chariot. He there says, while Juno was putting the golden bits to the horses, Hebe fastened on the wheels to the iron axles. 'These wheels had eight brazen spokes, and the felloes were of gold, and the tires of brass.'—The seat was fastened with gold and silver cords.'

This, of course, gives us Homer's ideas of perfection in a chariot.

All the epithets which could convey ideas of swiftness were applied to these chariots and to the horses, but we have no positive information as regards the real velocity with which they would travel: as roads were

scarce, and probably at best merely tracks, much could not be expected from vehicles constructed under such circumstances; the wheels were small, from twenty to thirty inches diameter, and all the parts of the chariots excessively heavy, so as to resist the repeated shocks to which they were subject.

The chariots represented upon the Frieze of the Parthenon, before alluded to, and which is probably upwards of 2200 years old, are very light in their construction, and only want springs to be called gigs.

The advancement of all the branches of the mechanical arts has necessarily introduced many improvements in the details of the construction of the wheel itself, as well as in that of the axle and the rest of the carriage, and by this means no doubt increased very greatly the use and advantage of it; but it is a remarkable fact that these improvements have been confined exclusively to the workmanship and mechanical detail, and that the *principle* has remained exactly the same, and has not even received *any addition* during this immense lapse of time.

Upwards of 3000 years ago, the wheels appear to have been independent of each other, and running upon fixed axles; we can say no more of the most improved wheel of the most finished carriage of the present day.

We are far from intending to cast any slight on modern invention, or to compare the groaning axle-trees and creaking wheels of the ancients with the noiseless Collinge's axles of the nineteenth century; but truth compels us to acknowledge that a period of thirty centuries, more than half the time which is supposed to have elapsed since the creation of the world, has produced no radical change nor brought into action any new principle in the use of the wheel as applied to carriages.

The particular form and construction of the wheel, as well as of all the other parts of the carriage, however, admit of great variety, and the draught is materially affected by their variation. We shall, therefore, after examining the action of wheels in general, describe the mode of construction now adopted, and then endeavour to point out the advantages and disadvantages of the various forms which have been given to the different parts of it.

First let us examine the theory of it, and suppose it acting on a level plane.

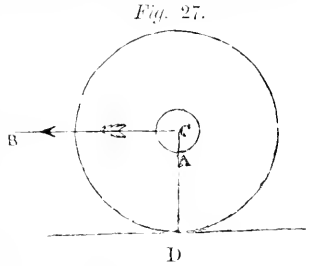
The wheel being a circle, the centre will remain always at the same height, and, consequently, will move parallel to the plane in a perfectly level line: if any weight be attached to or suspended from its centre, this will also move in a continued straight line without rising or falling, and consequently when once put in movement there is nothing to check its progress (neglecting for the moment the slight resistance of the air), and it will require no force to keep it in motion so long as the wheels continue to turn.

We have, therefore, in this case only to examine into the force necessary to turn the wheels. The wheels, if left to themselves, would roll on with perfect freedom, whatever might be their weight, or whatever weight might be attached to them, provided nothing in the mode of attaching that weight impeded their revolution; but in practice we cannot admit of the load revolving with the wheel, and we have no means of suspending it to the wheel, except by means of an axle fixed to the load, and passing through the centre of the wheel. This axle presses upon the lower surface of the hole, and consequently, when the wheel revolves, causes a friction proportionate to the load upon the axle. This friction is then the only source of resistance to the motion of a wheel, under the circumstances here supposed; and it is the action of this friction, the degree in which this affects the draught, and by what means this effect is increased and diminished, that we are now about to consider.



Let C, *fig. 27*, be the centre of a wheel, of which C D is the radius, and C A that of the axle passing through the wheel, and which being fixed to the load does not revolve with the wheel.

If a force C B be applied to the centre of the wheel, tending to advance it in the direction B, the point D being in contact with the ground, the wheel is compelled to turn or roll, and the force C B in turning the wheel acts with a leverage equal to C D, but the friction between the axle and the wheel is at the point A, and in preventing the turning of the wheel it acts only at the extremity of the lever C A;



consequently if C D be ten times as great as C A, the force C B need only be equal to one-tenth of the amount of the friction, and, as a general rule, the radius of the axle and the friction remaining the same, the force necessary to overcome the resistance arising from this friction will be *inversely as the radius or the diameter of the wheel*, or, in other words, the draught will, in this case, diminish exactly in proportion as the diameter of the wheel is increased.

The exact amount of resistance occasioned by friction will depend upon the nature of the substances in contact at the axle, as well as upon the proportionate dimensions of the wheel and axle.

The friction between polished surfaces bears a certain proportion to the pressure: if the pressure is doubled, the friction will, within certain limits, be also doubled; but the proportion between the friction and the pressure is only constant so long as the same substances are employed: it varies very much with different substances. Thus with soft wood sliding upon soft wood, the friction amounts to one-fourth or one-third of the pressure; while between hard brass and iron, the surfaces smooth and oiled, the resistance may be as low as  $\frac{1}{30}$  of the pressure. The relative advantages, therefore, of different materials, as applied to the axle and box of a wheel, is a point of much consequence.

Metals, generally speaking, are the best adapted for this purpose. Owing to their hardness, the friction between them is small, and they will bear without injury a greater pressure, proportionably to the surface; and, from their strength, the axle may be of much smaller dimensions than if made of wood; and we have proved that a reduction in the diameter of the axle causes a proportionate reduction in the resistance caused by friction. In consequence of these advantages, iron or steel axles, working in iron boxes, are now almost universally adopted. The friction in this case, when the parts are in proper order, greased, and the pressure upon them not excessive, amounts to about one-eighth, or, at the most, one-fifth of the pressure or weight; suppose it one-sixth, and if the diameter of the wheel is to that of the axle as 18 or 20 to 1, which is about the proportion in a large two-wheeled cart, the whole resistance arising from friction at the axle will be equal to  $\frac{1}{6}$  of  $\frac{1}{18}$ , or of  $\frac{1}{20}$ , which is equal to  $\frac{1}{108}$  and  $\frac{1}{120}$  respectively. So that to move one ton would not, in the latter case, require a force of traction greater than  $18\frac{1}{2}$  lbs.; and having overcome this resistance, the force of traction required remains nearly the same at all velocities; that is to say, friction is not materially affected by velocity: therefore the resistance arising from it is not sensibly augmented by a considerable increase in the speed. In practice, however, the friction at the axle is far from being the greatest impediment to the motion of a carriage. We have hitherto, for the purpose of considering friction alone, supposed the surface upon which the wheel moved as perfectly hard,

smooth, level, and plane; we need hardly say that such can never be the case in a road. The friction, however, remains, practically speaking, the same, and the laws which govern the amount and the effects of it remain unaltered; and we have only to ascertain what is the additional resistance arising from other sources, to obtain the whole draught of the carriage. We have already stated, when pointing out the difference between the roller and the wheel, that the movement of the latter was attended with two sources of resistance, viz. friction at the centre, which we have considered, and another, which is common both to the wheel and the roller, arising from impediments in the road, or the yielding of the materials.

The laws which affect the amount of this latter are, of course, the same in a wheel as in a roller.

We have found that the power required to overcome it is inversely as the square root of the diameter; therefore, by increasing the diameter of the wheel, the effect of friction, which is inversely as the diameter, diminishes much more rapidly than that caused by impediments in the roads; and on ordinary roads, with common carts, the amount of the latter is about three times as great as that of the former, and when the roads are at all injured by weather or by neglect, or if they are naturally heavy or sandy, it bears a much greater proportion. A light four-wheeled cart, weighing, with its load, 1,000 lbs., was repeatedly drawn upon different sorts of roads. The experiment was not made with a load of exactly 1,000 lbs., but the proportions of the results are calculated to this standard. The public are indebted to Mr. Bevan for these as well as for a great number of other highly useful and practical experiments upon the effects of power in various cases. The average of a number of experiments gave the following results:—

Description of Road.	Force of Traction required to move the Carriage.
Turnpike-road—hard, dry . . . . .	30½ lbs.
Ditto dirty . . . . .	39
Hard, compact loam . . . . .	53
Ordinary by-road . . . . .	106
Turnpike-road—new gravelled . . . . .	143
Loose, sandy road . . . . .	204

The friction at the axles, which were of wood, was, of course, nearly constant, and probably absorbed at least  $\frac{1}{8}$  of the weight, or 12½ lbs. of the force of traction, leaving, therefore, for the resistance caused by the road in the different cases, as under—

Description of Road.	Force of Traction required to move the Carriage, independent of the Friction at the Axles.
Turnpike-road—hard, dry, about . . . . .	18 lbs.
Ditto dirty . . . . .	26½
Ditto new gravelled . . . . .	130½
Loose, sandy road . . . . .	191½

So that in the last case, one by no means of rare occurrence in many parts of the country, the portion of draught immediately caused by the state of the road was ten times as great as on a good turnpike-road, and about fifteen times as great as that which arose from friction at the axles. It would be hopeless to attempt to remedy this by increasing the size of the wheel; the experiment was made with wheels of the ordinary size. To double their diameter would evidently be attended, in practice, with insurmountable difficulties; and yet, even if this were effected, it would barely reduce the total amount of the draught by one-fourth; but the form of the wheel may materially influence the state of the road; we shall, therefore, proceed to consider the various forms employed.

Some years ago, when the principal turnpike roads of the kingdom were at many parts, at particular seasons of the year, in little better condition

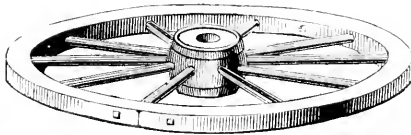
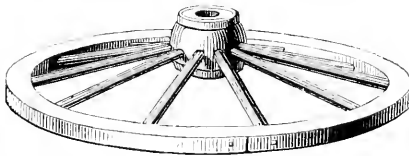
than that on which the last experiment was tried, various attempts were made to reduce the resistance, by using narrow wheels. These attempts, and the laws which it was found necessary to enact to prevent the entire destruction of the roads, led, at last, to curious results, having gradually caused the introduction of the worst-formed wheel which could probably be invented, either as regards increasing the draught or the destruction of the roads.

To understand these alterations clearly, we must describe the principal features of the wheel now in use.

The general construction of it presents a striking instance of strength arising from the judicious union of substances of very different qualities—wood and iron.

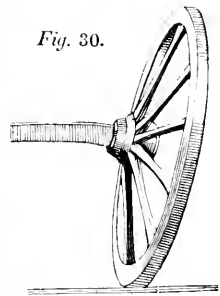
A strong circular frame of wood, composed of different segments, called felloes, is bound together by a hoop, or several hoops of iron, called tires, which thus, at the same time that it gives great strength, protects the outer surface from wear.

The nave, a circular block of wood, is sustained in the centre of this frame by the spokes, which, instead of being in the plane of the felloes, form a cone; this is called the dishing of the wheel. The object of it is to give stiffness, to resist lateral shocks, as when the wheel slips sideways, into a rut or hole. A reference to a comparative view of the wheel, with and without dishing, will more clearly explain our meaning. *Fig.* 28 is a wheel with the spokes all in one plane; *fig.* 29 a wheel with a considerable degree of dishing.

*Fig.* 28.*Fig.* 29.

Here it is evident that a small pressure on the nave in *fig.* 28 would have a tendency to push it through, and would meet with but little resistance. In *fig.* 29, on the contrary, this force would be opposed at once by the direction of the spokes, which form an arch, or dome, that cannot be flattened without bursting the felloes, or tires. The dishing, therefore, gives the wheel a very great degree of stiffness and strength, which it would not otherwise possess.

In consequence of this conical form, the necessity of keeping the lower spokes which support the weight as vertical as possible, has required that the whole wheel should be placed oblique, and the axle bent downwards, as in *fig.* 30; this, as we shall hereafter show, is attended with very serious evils. As a wheel is intended to roll upon the ground, without friction, it is natural to

*Fig.* 30.

suppose that the outer surface of the tires should be cylindrical, as it is the only form which admits of the wheel rolling freely in a straight line; but it is nevertheless the form of this surface, its breadth, and the degree of dishing which have varied so much from the causes before mentioned, viz. the state of the roads, and to the consideration of which we will now return.

A road, however much neglected and out of repair, will generally have, at a certain depth, a hard bottom; above this will be a coat of mud or loose stuff, more or less deep, according to the material used, and the frequency of repair or the quantity of wet to which it may be exposed. It is sinking through this, until it reaches the hard bottom, that causes the resistance to the progress of the wheel; whether the wheel be wide or narrow, it must squeeze or grind its way to the bottom of this mud; a narrow wheel evidently displaces less, and therefore offers less resistance. The great object of carriers, then, was very naturally to place as great a load as they could upon wheels which were as narrow as possible, consistent with the necessary strength.

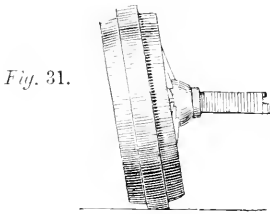
It was soon perceived that the entire destruction of the roads would be the consequence of this system, which had its origin in the bad state of the roads. A certain width of tire proportionate to the load was therefore required by law. The endeavour to evade this law was the cause of the absurd form of wheel we are about to describe and to condemn.

In apparent obedience to the law, the felloes of the wheels were made of an excessive breadth; but to retain the advantages of the narrow wheel, the middle tire was made to project so far beyond the others (see *fig. 31*.) that it in fact constituted the wheel, the others being added merely to give a nominal, and not a real width. The enormous loads which it was found advantageous to place on these wheels rendered it necessary to give them a considerable degree of dishing, to resist lateral shocks, and, besides, the carriers were by this means enabled to give a great width of floor to

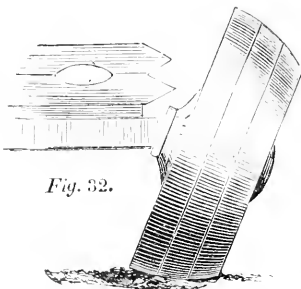
the carriage, still keeping the vehicle in the common tracts or ruts, so that the wheels ultimately assumed the form represented, *fig. 32*.

If such a machine had been constructed for the express purpose of grinding the materials of the road to powder, or of serving as a check or drag to the waggon, it might, indeed, have been judicious, but as a wheel it was monstrous. Yet this is the form of wheel upon which the contradictory opinions referred to in the first page of this treatise were given before a Committee of the House of Commons. A carrier of Exeter was in favour

of these wheels, and in support of his opinion, adopts them to this day. But a few days ago we saw one of his waggons with wheels, which, although only about twelve inches wide, were six inches smaller at the outside than at the inside. Such a cone, if set rolling and left to itself, would run round in a circle of little more than twenty feet diameter. What must be the grinding and the friction, then, when it is constantly compelled to go on in a straight line? yet enough has been written and said upon this subject to convince, we should imagine, the most prejudiced of the absurdity of the system.



*Fig. 31.*



*Fig. 32.*

We shall repeat the principal arguments which were made use of at the time of the enquiry mentioned.

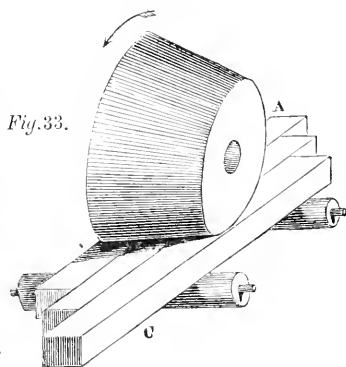
Mr. Cummins took great pains, by constructing models, to show that conical wheels were not adapted for rolling in a straight line, by making a small conical wheel run over longitudinal bars, as in *fig. 33*. It was seen that if the middle part of the tire rolled upon the centre bar without moving it, the bar A was pushed backwards, while the bar C was pushed forwards; clearly showing if, instead of sliding bars, the wheel had moved upon a road, how much it must have ground the road, and what a small portion of the tire was truly *rolling*.

That such must have been the case is, indeed, easily proved without a model. We will take only three different parts of the wheel, and consider them as independent hoops of different diameter; if these hoops are compelled to go the same number of revolutions, the large one will evidently gain upon the second, while the third will be left far behind. Now, if, instead of being independent of each other, they be fixed to the same axle, and compelled to revolve together, the large one not being able to advance faster than the other, must tear up the ground. The smaller one, on the contrary, being dragged forward faster than it would naturally roll, must drag up the ground; and this is what must take place, and does with any but a cylindrical wheel, and that to a very considerable extent.

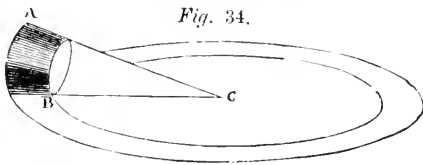
Suppose, for instance, a conical wheel, of an average diameter of four feet six inches; that is to say, that the centre advances about fourteen feet to every revolution of the wheel. If the inner tire be six inches larger in diameter than the outer tire, the circumference of it will be about eighteen inches greater; therefore, at each revolution of the wheel the inner tire would naturally advance eighteen inches more than the outer tire: but they are compelled to go over the same distance of ground. The one or the other, therefore, must have disturbed the ground, or, what is nearer the truth, upon every fourteen feet of road run, the former has passed over nine inches less ground than the development of its circumference, the latter nine inches more—the one pushing back the ground, the other dragging it forward, or, which would be equivalent to the dragging of the load with the wheel locked—a distance of four and a half inches upon every fourteen.

Every child knows that the front wheel of a carriage goes oftener round than the hind wheel. If, then, the front wheel were obliged to make only one revolution to every revolution of the other, but still impelled at the same rate, it must be partly dragged over the road. If these wheels be placed side by side, instead of one being in front of the other, the effects must be the same. Now, suppose them to be the outer and inner tire of same wheel, the circumstances are not thereby altered: the smaller circle and the larger circle cannot both roll upon the ground. A conical wheel is then constantly twisting the surface upon which it rests, and hence arises a very considerable resistance, as well as destruction to the roads.

If these arguments are not sufficient to decide the point completely, let the reader bear in mind simply, that a cone, when left to itself, will always roll in a circle. The frustrum of a cone, A B, *fig. 34*, is only a portion of

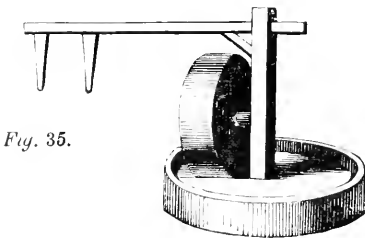


the entire cone, A B C, which will roll round the point C; if this entire cone be completely severed at the point B, the two parts will still continue



to roll round the same point, and if the portion B C be now abstracted, the motion of the remainder will not be altered. If a wine-glass or decanter — anything which is not of the same size at the two parts which are in contact with the surface

on which it rests, be rolled upon a table, those who are not already too familiar with the fact to require an illustration of it, will immediately see the truth of this statement. If, then, a wheel thus formed would naturally



quit the straight line; when compelled to follow it, it is clear that exactly the same effect must be produced as when a cylindrical mill-stone, as in *fig. 35*, which, if left to itself, would proceed in a straight line, is compelled to follow a straight line, and is constantly twisted round the centre C, it would grind everything beneath it to powder. Yet these travelling grindstones were in use upwards of twenty years to the destruction of the

roads, and at a great expense of power to those who have persisted in employing them.

The increased strain upon the axles, from this constant tendency of the wheel to be twisted outwards, with the consequent friction, is a source of resistance absorbed and rendered comparatively inconsiderable, by the far greater friction on the ground; but it is not the less a cause of great increase of draught, and the union of all these serious disadvantages justifies, we think, our assertion, that such a wheel is as injudicious a contrivance as could possibly be invented. We trust they will not long continue to disgrace our wheelwrights and injure our roads.

The cylindrical form is the only one which ought to be admitted. As a wheel must, however, always be liable to sink a little into the road, and cannot be expected always to bear perfectly flat upon the ground, the surface of the tires should be slightly curved, and the edges rounded off, as in *fig. 36*. As the rounding is rendered necessary by the yielding of the road, its degree must depend upon the state of the road, and the form of

*Fig. 36.*



the wheel may approach more nearly to the true cylinder, in proportion as the roads approach nearer to perfection in point of hardness and flatness. When the roads are good, a very little dishing will be sufficient, and a slight inclination of the wheel from the vertical will make it correspond with the barrel or curve of the road, which is now generally very trifling.

Next to the form, the breadth of the wheel is the point requiring most consideration; it is one, however, which depends entirely upon the state of the road.

We have seen, that the displacement or crushing of the materials forming the upper surface of the road is one of the principal causes of resistance. If the whole mass of the road were formed of a yielding substance, into which the wheel would sink to a depth exactly proportionate to the weight bearing upon it, it is probable that great breadth would be advantageous.

so that the wheel might form a roller, tending to consolidate the materials rather than cause any permanent displacement; but, in the improved state of modern roads, it may safely be considered that such is never the case.

A road, as we have before stated, always consists of a hard bottom, covered with a stratum, more or less thick, of soft, yielding material. A wheel, even moderately loaded, will force its way through, and form a rut in this upper coating. The resistance will be nearly proportionate to the breadth of this rut; the depth of it will not increase in the ratio of the pressure. In considering, then, simply, the case of a single wheel or a pair of wheels forming two distinct ruts, it is evident that it should form as narrow a rut as possible, but that it should not in any degree crush or derange the core or hard basis of the road. When a rut is thus formed, a small track or portion of the road is for a time rendered clean and hard, and consequently capable of bearing a greater load than before, and with less injury. It is, then, highly important in a four-wheel carriage that the hind wheels should follow exactly in the tract of the front wheels. If rollers were necessary for the road, as if, for instance, it was merely a bed of clay, then indeed, but only in such a case, might it be judicious to cause the wheels to run in different tracks, as has been proposed, and was at one time carried into effect under the encouragement of an Act of Parliament. Such wheels were called straddlers: they might have been necessary tools for the preservation of such roads as then existed, but the increased draught soon taught the public to evade the law which encouraged them.

Mr. Deacon, one of the principal carriers in England, in an excellent practical work on wheel-carriages, published in 1810, describing these wheels, says, 'If the axle of a six-inch wheel is of that length to cause the hind wheels to make tracks five inches outside the tracks of the fore-wheels, and nine-inch wheels seven inches outside, they are then called straddlers, and are allowed to carry a greater weight than if not so. The original intent of these was most excellent; but the effect has been defeated by the carrier or other person not only making the bed or axle contrary to what was intended, but also by carrying with them a false collar, with a joint therein, to put on and take off at pleasure; so that they have no great difficulty in making the wheels straddlers a little before they come to a weighing-machine, and making them not so when they have passed the same.'

On modern roads such an arrangement would hardly be beneficial, even to the road itself, and would nearly double the amount of draught.

Too great care and precaution cannot be taken to insure the wheels running in the same track. Let it be remembered that, on a good road, the forming the rut is the cause of three-fourths, and oftener five-sixths, of the whole resistance. Narrow wheels, therefore, running in the same track, without doubt offer the least resistance, provided there is surface sufficient to bear the weight, without destruction to the foundation of the road.

Six inches in breadth of the flat or cylindrical part, *a b*, *fig. 36*, independent of the rounded edges, will be quite sufficient, in a wheel of ordinary size, to bear a ton without injury to the roads, if in good condition; and according as the weight upon each wheel is more or less than this, the breadth should be proportionably increased or diminished.

The most simple innovation upon the original wooden wheel is the cast-iron nave. This we should think must be much less liable to wear than the wooden nave, which is literally honey-combed with the mortices for the spokes; and a wheel of this sort can be repaired by the most ordinary wheelwright, provided he has one of the castings at hand.

We should strongly recommend that these naves should be made with a double row of sockets for the spokes, so as to cross the dishing of them in the same manner as those of the wrought-iron wheels described above; and

we think they would then form a strong, durable, and economical wheel. There might be some danger from the effects of wet or damp remaining in the cast-iron sockets, and attacking the wood; but we should think a small hole bored into the socket to allow the moisture to escape, and common precaution in painting these parts, would prevent any evil consequences.

With respect to the size of wheels, we have shown that wheels of large diameter certainly offer less resistance than small ones; but expense and weight cause a limit to this. From 4 ft. 9 in. to 5 ft. 6 in. is a good size for cart-wheels, and is about the limit where any great increase of diameter would cause more inconvenience and expense than would be compensated for by any advantage gained; and if much less in diameter than this, the draught is unnecessarily augmented.

Yet the front wheels of a waggon are always below this standard; rarely exceeding four feet, and frequently much less. This is a serious evil attending the use of four wheels; it is an arrangement originally made for the purpose of enabling the front wheels to lock under the body of the waggon, which may thus turn in a small space.

Now it rarely happens that a waggon is required to turn short round, and it cannot cause any serious inconvenience if it be rendered altogether incapable of doing so.

In this respect a great improvement has taken place within a few years. In the place of those moving mountains which were formerly dragged slowly along upon immensely heavy and broad, but low, wheels, we now see, particularly on the roads leading northward from London, a great number of light, well-built waggons, with much larger wheels, especially the front wheels, which, instead of being small enough to turn under the floor of the waggon, are about four feet six inches in diameter. As those waggons are used principally on the road, and are never required to turn in a small compass, but a very small action is allowed to the fore axle, and the floor and body of the waggon is continued from end to end of nearly the same width.

A waggon with part of the floor and body cut away, so as to form a sort of recess for the front wheels to turn into, allows of considerable movement; and by this arrangement there is nothing to prevent the front wheel being made of larger diameter, as in the case just described. Our present object, however, is not to enter into a detailed description of how we should build a waggon, but simply to recommend the use of large front wheels, as tending much to diminish the draught. An intelligent wheelwright will always know how to construct a waggon so as to admit of this.

The consideration of the subject of wheels naturally includes that of the comparative advantages of two-wheeled and four-wheeled carriages. Upon this point opinions differ as much as upon any; and we fear that we are not likely to do more than to arrange the different opinions given by others, without advancing any of our own. If we succeed, however, in doing this clearly, we shall have done much, because we may thus enable each individual to separate those arguments which apply particularly to his own case; and combining these opinions with his own judgment, he will be more likely to arrive at a just conclusion than if he were altogether unaided by the experience of others.

The advocates of light two-wheeled carts assert that a horse working alone is capable of performing more work than when forming one of a team; and that in consequence of this increased effect, there is a saving of expense nearly in the proportion of three to two, or one-third.

The advocates for waggons assert, on the contrary, that it requires that each horse in a single-horse cart should be of a superior quality, and therefore more expensive than those of a team, where the average power



only is considered; that the wear and tear, first cost, and expense of attendance of several small carts, is greater than that of a waggon carrying the same load, and that in consequence there is an economy obtained by the latter.

Number of facts and the results of long experience are adduced on either side, all of which convey much useful information; and the substance of the whole appears to be, that with light single-horse two-wheeled carts, good horses are able to draw greater loads, and do more work in proportion than a waggon team; that these carts are easier loaded and unloaded, do less injury to the roads, and that they do not require more horses in action than are sufficient for the work to be performed.

On the other hand, it is found that the horses must be stronger and better fed; that being entirely dependent on their own exertions, and doing more work, they are more fatigued and sooner knocked up; that on rough roads they are liable to be shaken and injured by the sudden movements and shocks of the cart, all of which are conveyed by the shafts directly to the horse; that in ascending or descending hills, the whole weight being above the axle-tree, it destroys the balance, and is thrown too much upon the horse in the former case, or tends to raise him from the ground in the latter, which even if any alteration of the balance be found advantageous, is exactly the contrary of what would be necessary.

That with a waggon—the average power of several horses is obtained—horses of inferior quality may therefore be used; they are not so much fatigued, because by relieving each other they can alternately exert themselves or relax. Greater loads can be carried with less attendance of drivers, and they are less liable to accidents; they are easier withdrawn from any hole, or forced over any obstruction, because only half the load being upon each pair of wheels, the whole force of the team is applied successively to each half of the load, consequently in any bad road the power occasionally required is less, although the draught of the carriage, properly speaking, is greater than that of a two-wheeled cart. These various arguments would appear to lead to the conclusion, that upon good roads, and for short distances, with good horses, two-wheeled single-horse carts are the best; but that, with inferior roads and ordinary horses, light four-wheeled waggons, with a team of three or four horses, are the most advantageous.

Two-wheeled carts with two horses are decidedly inferior to either of these: the shaft horse suffers all the inconveniences complained of in the single-horse cart, and the leader does not produce more effect than when in a waggon team.

It is impossible to decide generally upon the comparative merits of the different arrangements, because the result depends entirely upon the circumstances of the case.

We may, however, endeavour to unite in some degree the advantages claimed by both. The draught of a cart is less than that of a waggon for several reasons: amongst others, because the wheels are larger, and the horse produces more effect, because his force is applied immediately to the resistance. A light waggon with large front wheels would not be much inferior in point of draught to the cart, and two horses abreast in double shafts would work with equal advantage to the single horse; while an additional horse may always be applied when an excessive load or the state of the roads should require it.

All that we have said with respect to the size and contrivance of wheels is equally applicable to light carriages as to heavy, and we shall now proceed to consider the different modes of placing the loads upon the wheels.

It might appear at first sight that this would not affect the amount of

the draught; that provided a weight to be moved were placed upon the wheels, and the wheels put in motion, that nothing more could be required. Upon a perfectly level smooth plane, and with a constant force of traction, this would, indeed, be the case; but, in practice, the conditions are entirely altered. Impediments are continually met with, which obstruct the progress of the wheels, and the draught is constantly varied by the different inclinations of the road; it is, therefore, necessary to study the means by which impediments can be easiest overcome, and by which the resistance thus caused will affect the animal, which is the source of power, in the least disadvantageous manner.

We have already stated that impetus is necessary to overcome an obstruction, and that elasticity *in the direction of the movement* is destructive of the full effect of impetus.

When, therefore, the wheel of a carriage comes in contact with any impediment, it is most essential that the whole of the impetus or momentum which the carriage has already obtained should be brought into full action, to force the wheel forward. To effect this, no elasticity should intervene between the wheel and the load, at least in the direction of the motion, that is, longitudinally; otherwise, as we instanced in the case of catching a cricket-ball, a force which would be quite irresistible if opposed by a rigid resistance, is checked with ease by a very little degree of elasticity; so with a wheel meeting a small stone, if the load were so placed, or hung upon the wheels, as to allow free or elastic action, longitudinally, that is, in the direction of the movement, the wheel being stopped against the stone, the whole load would be gradually checked, and brought to a full stop; whereas, if this same load had been fixed firmly to the wheel, its impetus would have carried the wheel over the stone, with very little loss of velocity.

In the first case, it would be necessary for the horses to drag the load over the stone by main force; in the latter, they would only have to make up by degrees for the loss of velocity which the mass had sustained in passing over the stone. The total *quantity* of power required will indeed be the same in either case; but in the one, the horses must exert it in a single effort, while in the other, this momentary exertion is borrowed, as it were, from the impetus of the mass in motion, and being spread over a greater space of time, as far as the horses are concerned, only augments in a small degree the average resistance. It is thus that the fly-wheel of a steam-engine in a rolling-mill accumulates power, sometimes for several minutes, till it is able to roll, with apparent ease, a large mass of metal which, without the effect of the fly-wheel, would stop the engine immediately; or, to mention a case more to the point, in the operation of scotching a wheel, a large stone, and even a brick, will render almost immoveable a waggon which, when in motion, would pass over the same stone without any sensible alteration of speed. It is most essential, therefore, that the effect of the momentum of the load should in no way be reduced by any longitudinal elasticity, arising either from the injudicious application of springs, or weakness in the construction of the carriage.

The action of impetus, and the effect of an injudicious mode of hanging the load, is of course more sensible at high than at low velocities, and in a carriage hung upon springs than in a waggon without springs; but although not so sensible to the eye, it nevertheless affects the draught materially even in the latter case. Carriages hung upon springs, as in *fig. 37*, which are called C springs, and which admit of very considerable longitudinal movement in the body of the carriage, are notoriously the most heavy to pull; and cabriolets, which are hung in this manner, are expressively called, in the stable, horse-murderers, and require heavy

and powerful horses to drag them ; while lighter animals are able to drag much greater weights in stanhopes and spring-carts, which do not admit of this elasticity.

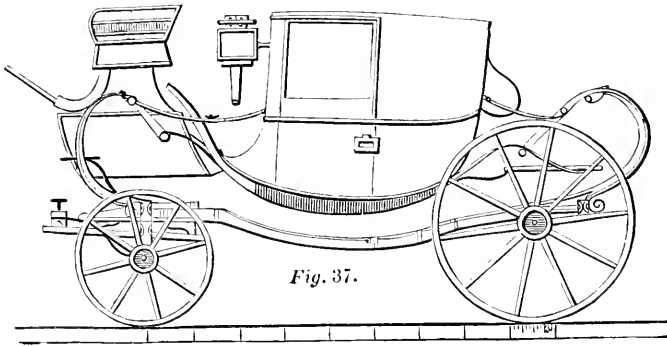


Fig. 37.

This is one of the reasons why the draught of a two-wheeled cart is less than that of a waggon. In a cart, the horse pulls at once on the shafts, which are fixed immediately both to the load and to the axletree, so that not only the impetus of the load, but also of the horse, acts directly and without elasticity upon the wheel. In a waggon, owing to the smallness of the front wheels, there is a considerable space between the fore-axle and the floor of the waggon, which is filled up with pieces of timber called bolsters : this admits of considerable play in the parts, and except in new-built or very strong waggons, there is never that firm connection between the load and the wheels which we have stated to be necessary. Large wheels would bring the axletrees much nearer the floors of the waggons, and, therefore, admit of a much stronger and firmer mode of attachment, which would be found to produce a very considerable effect in diminishing the draught.

We have been very particular in confining our observations to longitudinal elasticity, or yielding in the direction in which the power is applied, and in which the progressive movement takes place ; because elasticity in any other direction, instead of increasing the draught, tends very much to diminish it. Let us suppose the load placed upon perfectly easy springs, which allow it to move freely in every direction, except longitudinally, when any one of the wheels comes in contact with a stone, the elasticity of the spring will allow it to run over the stone without sensibly raising the load which is upon it ; and the force which is required to pull the wheel over the stone will be restored again by the descent of the wheel from the stone, which will tend to impel the mass forward, with exactly the same force as was required to draw it up to the top of this impediment. Without this elasticity, it would be necessary to raise the whole load with a sudden jerk, and thus instantaneously impart rapid movement to the whole mass, which would absorb much power, and which would by no means be returned by the load falling down from the stone. We see, therefore, that the use of springs is to enable the wheels to rise and fall according to the inequalities of the ground, while the load continues one constant equable motion. The advantages of this action are very clearly pointed out in a letter addressed to the Committee on the Highways of the Kingdom, by Mr. D. Giddy, and given in the Appendix to their first Report, printed in the year 1808 ; and this letter explains so clearly, and in such few words, the whole theory of wheels, as well as springs, that we think we cannot do better than quote it at length :—

‘Taking wheels completely in the abstract, they must be considered as answering two different purposes.

‘First, they transfer the friction which would take place between a sliding body and the rough uneven surface over which it slides, to the smooth, oiled peripheries of the axis and box, assisted by a leverage in the proportion of the diameter of the wheel to the axis.

‘Secondly, they procure mechanical advantage for overcoming obstacles, by introducing time proportioned to the square roots of their diameters, when the obstacles are small as compared with the wheels; and they pass over transverse ruts or hollows, small in the same comparison, with an absolute advantage proportioned to their diameters, and a mechanical one proportionate to the square roots of these diameters.

‘Consequently wheels, thus considered, cannot be too large; in practice, however, they are limited by weight, by expense, and by experience.

‘With reference to the preservation of roads, wheels should be made wide, and so constructed that the whole breadth may bear at once; and every portion in contact with the ground should roll on without any sliding.

‘It is evident, from the well-known properties of the cycloid, that the above conditions cannot all unite, unless the roads are perfectly hard, smooth, and flat; and the felloes of the wheels, with their tire, are accurate portions of a cylinder. These forms, therefore, of roads and wheels, would seem to be asymptotes, towards which they should always approximate, but which, in practice, they are never likely to reach.

‘Roads must have some degree of curvature to throw off water, and the peripheries of wheels should, in their transverse section, be as nearly as possible tangents to this curve; but since no exact form can be assigned to roads, and they are found to differ almost from mile to mile, it is presumed that a small transverse convexity given to the peripheries of wheels, otherwise cylindrical, will generally adapt them to all roads; and that the pressure of such wheels, greatest in the middle, and gradually diminishing towards the sides, will be less likely to disarrange ordinary materials, than a pressure suddenly discontinued at the edges of wheels perfectly flat.

‘The spokes of a wheel should be so arranged as to present themselves in a straight line against the greatest force they are in common cases likely to sustain. These must evidently be exerted in a direction pointed towards the carriage, from lateral percussions, and from the descent of either wheel below the level of the other; consequently, a certain degree of what is termed dishing must be advantageous, by adding strength, whilst this form is esteemed useful for protecting the nave, and for obviating the ill effects of expansions and contractions.

‘The line of traction is theoretically best disposed, when it lies exactly parallel to the direction of motion; and its power is diminished at any inclination of that line, in the proportion of the radius of the wheel to the cosine at the angle. When obstacles frequently occur, it had better, perhaps, receive a small inclination upward, for the purpose of acting with most advantage when these are to be overcome. But it is probable, that different animals exert their strength most advantageously in different directions; and, therefore, practice alone can determine what precise inclination of the line is best adapted to horses, and what to oxen. These considerations are, however, only applicable to cattle drawing immediately at the carriage; and the convenience of their draft, as connected with the insertion of the line of traction, which continued, ought to pass through the axis, introduces another limit to the size of the wheels.

‘Springs were in all likelihood first applied to carriages, with no other

view than for the accommodation of travellers; they have since been found to answer several important ends. They convert all percussions into mere increase of pressure, thus preserving both the carriage and the materials of the roads from the effect of blows; and small obstacles are surmounted when springs allow the frame and wheels freely to ascend, without sensibly moving the body of the carriage from its place.

‘If the whole weight is supposed to be concentrated on springs very long, extremely flexible, and with the frame and wheels wholly devoid of inertia, this paradoxical conclusion will most certainly follow: that such a carriage may be drawn over the roughest road without any agitation, and by the smallest increase of force.

‘It seems probable that springs, under some modification of form and material, may be applicable with advantage to the heaviest waggon.’

And there can be no doubt that, in the words of the writer, the application of springs would be highly advantageous. At high velocities, as we have before said, the effect of springs is still greater. What we have instanced as regards springs is generally well known and understood. All stage-coaches, and many travelling carriages, hang upon grasshopper-springs, which allow of perpendicular without any longitudinal action. It would be much to the interests of horse masters if the mode of suspending post-chaises were a little more attended to. The more elasticity, or in other words, the more action, there is in grasshopper-springs, the more effect it will produce in diminishing the draught: with a C spring a very contrary effect is produced. A carriage hung upon C springs may certainly be made the most comfortable to the rider; but all the ease that can be required, and much more than is found in the generality of post-chaises, may be obtained by well-constructed grasshopper-springs, and with considerable advantage to the horses.

The practice of loading coaches as high as possible to make them run light, as the coachmen have found by experience, is only a mode of assisting the springs. The mass being placed at a greater height above the wheels, at the extremity of a long lever, is not so easily displaced laterally by any motion of the wheels, which, therefore, rise and fall on either side as they run over the stones, acting only on the springs, which restore the full pressure and velocity in descending, from the obstacle which was imparted to them in ascending, and without producing any sudden concussions upon the load, which swings to and fro with long, easy movements. It is possible, also, that the weight, being thus swung from side to side, may, upon good roads, diminish the draught, as it is in fact generally running upon two of the wheels; while, in the other direction, it equally admits of the front and hind wheels successively passing over any impediments; and yet, by the manner in which it is fixed upon the springs, it does not admit of any longitudinal elasticity.

The fact of coaches thus loaded running light has been clearly proved by the failure of what were called Safety Coaches, in which the only difference consisted in placing the load very low. These coaches, although completely answering their purpose of safety, were discontinued solely, we believe, from their being found destructive of the horses.

Experiments, nevertheless, have been made to prove that this was only an idle prejudice of coachmen; but universally received opinions, even if leading to erroneous conclusions, generally have some good foundation; and coachmen, although they may not have been so much so at the time these experiments were published (in 1817) are certainly now rather an intelligent class of men. We should, therefore, prefer risking a theory, if a theory were necessary, in support of their prejudices rather than in opposition to them. The experiments alluded to were not in our opinion,

made under the circumstances which occur in practice. Small models (the wheels being seven inches in diameter) were drawn along a table across which were placed small strips of wood to represent the obstructions met with in a road; but these strips of wood came in contact with each pair of wheels at the same time, and never caused any lateral motion. They produced, therefore, a totally different effect from that which takes place in a road, where the action rarely affects more than one wheel at a time; consequently, in the model, the wheels, in passing over an obstruction, threw the whole weight backwards in a direction exactly opposite to the movement required; while, in practice, the carriage is generally thrown sideways, which does not affect its forward motion.

The conclusions drawn from these experiments are, therefore, as might be expected, at variance with practical results, and directly contrary to the opinions of those whose daily experience ought to enable them to judge correctly.

The effects, also, of velocity and momentum must be difficult to imitate in models.

The advantage of placing the load high will not, however, equally apply at low velocities, still less when springs are not used; it may frequently, indeed, in the latter case, produce quite a contrary effect.

In a rough road, the increased force with which the load would be thrown from side to side might prove very inconvenient, and even dangerous, and would certainly be liable to increase the resistance when the front wheels meet with any obstruction; but this, it must be particularly remembered, is only true in the case of low velocities and carriages without springs.

We have now considered in succession the various parts of the vehicle for conveying the weight, and shown in what manner they affect the draught, and how they should be constructed so as to diminish as much as possible the amount of this draught. We have endeavoured to point out the advantages and necessity of attending to the construction and size of the wheel. Thus it should be as nearly cylindrical and vertical as possible, and of as large a diameter as can conveniently be admitted. 2dly, That there should be a firm, unyielding connection in the direction of the movement between the power employed, the weight moved, and the wheels: in other words, that the force should always act directly and without elasticity both upon the load and upon the wheels; and that the impetus or momentum of the load, when in movement, should always act in the same manner, without elasticity, in propelling the wheels; and lastly, that it is highly advantageous to interpose as much elasticity as possible by means of springs in a vertical direction between the wheels and the body, so that the former may rise and fall over stones or irregularities in the road without communicating any sudden shocks to the load; and we believe that the proper application of springs in all cases, even with the heaviest loads, would be found productive of great good effect.

Attention to these points will tend to diminish considerably the amount of draught. As far as regards friction at the axles, and the resistance in passing over obstacles in the road, it will assist the favourable application of the force of traction when obtained from animal power; but that which we have shown to be the most considerable source of resistance is unfortunately least affected by any of those arrangements. We allude to the resistance arising from the yielding or crushing of the material of the road; we have seen that on a good turnpike-road the draught was increased in the proportion of thirty to forty, or about one-third, by the road being slightly dirty; and that, on a heavy, sandy road, the draught was increased to 205, or nearly seven times. Springs will not affect this; and even increasing the diameter of the wheel will be of very slight assistance; nothing

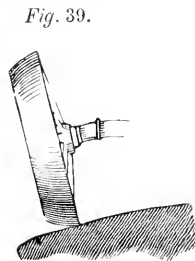
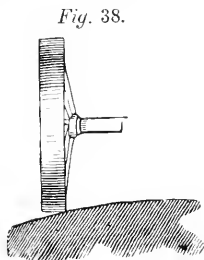
but removing at once the prime source of this evil, improving the roads, can remedy this. We are thus naturally led to the third division of our subject, viz. the road, or channel of conveyance. In considering this as a branch of the subject of draught by animal power, we shall merely point out what are the principal desiderata in the formation of a good road, and what are the evils principally to be avoided. To enter into all the details of their construction, dependent as it is on the different materials to be found in the neighbourhood, their comparative cost, the quality of the ground over which the road is made, and many other points, would be to enter upon a much more extensive field than is at all required for the proper consideration of the subject of draught by animal power. The requisites for a good road are all that we shall indicate.

Channel of conveyance, in a general point of view, would include canals, roads, and railways. Of the first, however, we shall say little; their construction does not materially affect the amount of draught, and we have already examined the mode of applying the power, and the quantity of effect produced. We shall proceed therefore at once to the question of roads.

The inquiry into the best form and construction of wheel carriages has taught us what we might indeed have foreseen, that perfection in a road would be a plain, level, hard surface: to have learned this only would not have advanced us much, as such perfection is unattainable; but we have learned also the comparative advantages of these different qualities of hardness, smoothness, and level. We have come to the conclusion, that slight alterations of level which shall vary the exertion required of the animal, without at any time causing excessive fatigue, are rather advantageous for the full development of his power than otherwise; that the inconvenience of roughness is obviated by the use of springs; and that even when the ordinary carts and waggons without springs are used, still the resistance arising from mere unevenness of surface, when not excessive, is not nearly so great as that which is caused by the yielding of the substance of the road. *Hardness*, therefore, and consequently the *absence of dust and dirt*, which is easily crushed or displaced, is the great desideratum in roads.

To satisfy this condition, however, smoothness is to a certain degree requisite, as the prominent parts would be always subject to abrasion and destruction: for the same reason, even if for no other, ruts and everything which can tend to form them must be avoided.

A road should, in its transverse section, be nearly flat. A great curvature or barrel, as it is termed, is useless; for the only object can be to drain the water from it; but if there are ruts, or hollow places, no practicable curvature will effect this; and if the road is hard and smooth, a very slight inclination is sufficient. Indeed, an excess of curvature is not only useless with the present construction of carriages, but facilitates the destruction of the road; for there are few wheels perfectly cylindrical: yet these, when running on a barrelled or curved road, can bear only upon one edge, as in *fig. 38*. The conical wheels still in use, although much inclined at the axle, are never sufficiently so to bring the lower surface of the wheel even, horizontal, and therefore are constantly running upon the edge, as in *fig. 39*, until they have formed a rut coinciding with their own shape. In a barrelled or curved road, the



mischief done will, of course, be great in proportion to this curvature. This form is, therefore, mischievous as well as useless. Six inches rise in the centre of a road of twenty feet wide is more than sufficient to ensure drainage, if drainage is not effectually prevented by ruts or hollow places, and less than this will suffice where the road is good, and is kept in proper order.

The hardness of the surface, the most important feature, will of course principally depend upon the materials used, and the formation of the road, and still more upon the state of repair in which it is kept. It is easy to form a good road when the foundation is already laid by the existence of an old one: levelling the surface—applying a covering of eight or ten inches in thickness of broken stones—having as few round or smooth surfaces as possible, the hardest that can be obtained—and above all things securing good drainage, both from the surface and from the bottom—is all that is required; but constant repair and unremitting attention are necessary to keep a road thus formed in good condition.

These repairs and attention do not consist in laying on at certain intervals of time large quantities of materials, but in constantly removing the sand which is formed, and which, in wet weather, holds the water, and prevents drainage; in filling up as quickly as possible, with fresh materials, any ruts or hollows; and particularly in keeping clear all the drains, and even in scraping small drains from ruts, or such parts of the road as may contain the water, and which it may not be possible immediately to fill up.

By attention to these points, those who are interested in the preservation of the roads, and the expenses attending it, will find that economy will ultimately be the result; and those who are interested in diminishing the labour and expense of draught, we shall only refer again to the table (page 558) of the resistances of a waggon upon different roads, from which they will see that a horse upon a clean road will do one-third more than upon one slightly muddy, more than four times as much as upon new-laid gravel, and nearly seven times as much as upon a heavy sandy road.

No arguments that we can put forward can at all strengthen the effect that such facts must produce; and we shall, therefore, quit the subject of roads, and conclude our observations on draught by a few words explanatory of the object of railroads, and their effects as regards diminishing draught.

The great desideratum in the formation of a good road is the facilitating the rolling of the wheels. We have shown that, for this purpose, a hard, smooth surface is necessary; and, as this is only required for the wheels, two longitudinal tracks, of such surface, of proper width, are sufficient for the mere passage of the carriage. If, therefore, there is a considerable traffic between two points along a line of road, without much interruption from crossing, all the qualities of a good road may be obtained in a very superior degree, by having two parallel rails, or tracks of wood or iron, raised a little above the general level of the ground. This is a railroad. It evidently affords the means of attaining any degree of perfection in those essentials for a good road—hardness and smoothness of surface for the wheels to roll upon. It requires, however, that the carriages should be all nearly alike, as regards the width and form of the wheels; and experience has proved that such a road is not generally worth constructing, unless the traffic is sufficient to allow of carriages being built expressly for that or similar roads. This being the case, the form and dimensions of the rails, and the general construction of the carriages, are uncontrolled by any other consideration than that of diminishing draught.

A considerable improvement upon this point may, therefore, be ex-



pected in the railway over the common road. A railway, as now constructed, consists simply of two parallel bars of iron, having a flat upper surface of about two and a half inches wide. With the exception of this surface, the forms adopted for the bars are various, depending principally on the mode selected for supporting them, some resting on and secured to blocks of stone, placed at intervals of about three feet—others secured in like manner to ‘sleepers,’ or beams of wood which are placed transversely, resting on the ground; while according to a third system the bars are secured along their whole length to longitudinal timbers. The wheels at the present time, generally made of wrought iron, and from 3 to 4 feet in diameter, are made slightly conical with a flange about one inch deep on the inner side. This slight flange, and the cone of the wheel, which is also very slight, are found sufficient to keep the wheels from running off the rails, even at the highest velocities. This brief description is sufficient to give a general idea of the construction of railways, which is all that is necessary for our present purpose. It will be easily conceived that hard, cast-iron wheels, running upon smooth edges of iron in this manner, can meet with but little resistance except that arising from friction at the axle.

Accordingly we find, upon a well-constructed railway in good order, that the resistance at moderate velocities does not exceed, in any sensible degree, that which must arise from this cause. It has been found that a force of traction of 1 lb. will put in motion a weight of 200, 300, and even, in some cases, 350 lbs.; so that a horse, exerting an effort of only 125 lbs., would drag on a level 12 or 14 tons. This is ten or twelve times the average effect of his work upon a good common road, and, as it arises entirely from the hardness and smoothness of the surface, we cannot conclude our observations by a more striking and unanswerable argument than this, in proof of the immense advantages and saving of expense which would result from greater attention to the state of the roads.



# INDEX.

## ABY

**ABYSSINIAN** horse, the, 18  
Acetabulum, description of the, 382  
Acetic acid, its properties, 474  
Aconitum, tincture and extract of, 477  
Action of the hackney described, 87; high, not indispensable in the hackney, 88  
Adeps, properties of, 476  
Æthiop's mineral, an alterative, 489  
Age, natural, of the horse, 229; of the horse as indicated by the teeth, 222; other indications of, 206  
Air, a supply of pure, necessary for the health of the horse, 122; air in the heart, 302  
Alcohol, its medicinal properties, 476  
Alfred, his attention to the improvement of the horse, 55  
Aloes, Barbadoes, far preferable to Cape, 476; description of the different kinds of, 476; principal adulterations of, 477; tincture of, its composition and use, 477  
Alteratives, the best, 478; nature and effect, 478  
Alum, the use of, in restraining purging, 478; solution of a good wash for grease, 478; burnt, a stimulant and caustic for wounds, 478  
Amaurosis, or gutta serena, nature and treatment of, 194  
American horse, description of the, 41  
Ammonia, given in flatulent colic, 478; vapour of, plentifully extricated from dung and urine, most injurious to the eyes and lungs, 478  
Anchylolysis of bones, what, 249  
Anderson, Dr., his account of the Galloway, 103  
Animal poisons, an account of, 499  
Animal power compared with that of the steam-engine, 529; its advantage over mechanical, except where velocity is required, 532  
Animals, zoological divisions of, 139  
Anise-seed, its properties, 478  
Antea-spinatus muscle, description of the, 143  
Antimonial powder, a good febrifuge, 479  
Antimony, black sesqui-sulphuret of, method of detecting its adulterations, 479; used as an alterative, 479; tartarized, used as a nauseant diaphoretic and worm medicine, 479

## BAL

Antispasmodics, nature of, 479  
Apoplexy, nature and treatment of, 171  
Aqueous fluid, an, why placed in the labyrinth of the ear, 155; humour of the eye, description of the, 163  
Arab breed, the, introduced by James I., 64  
Arabia, not the original country of the horse, 22; few good horses there even in the seventh century, 23  
Arabian horse, history of the, 22; Bishop Heber's description of, 26; comparison between, and the Barb, 24; general form of, 24; qualities of, 24; scanty nourishment of, 27; treatment of, 27; varieties of, 25  
Arabs, attachment of, to their horses, 26; value their mares more than their horses, 27  
Arched form of the skull, advantage of, 150  
Arm, description of the, 364; action of, explained on the principle of the lever, 361, 364; extensor muscles of the, 365; flexor muscles of the, 365; full and swelling, advantage of, 366; should be muscular and long, 366; fracture of the, 450  
Arsenic, treatment under poison by, 500  
Arteries, description of the, 239, 303; of the arm, 364; of the face, 199; neck, 239  
Ascaris, account of the, 331  
Ascot course, length of the, 74  
Astragalus, account of the, 385  
Athelstan, his attention to the improvement of the horse, 55  
Atlas, anatomy of the, 236  
Attechi, the, an Arabian breed, 23  
Auscultation, the importance of, 266  
Australian horse, description of the, 32  
Axle, friction of the, dependent on the material employed, 570

**BACK**, general description of the, 249; proper form of the, 249; long and short, comparative advantages of, 249; anatomy of the, 249; muscles of the, 252  
Backing, of the colt, 505; a bad habit of the horse, usual origin of it, 505  
Back-sinews, sprain of the, 372; thickening of the, constituting unsoundness, 252  
Balls, the manner of giving, 479; the manner of making, 480

## BAR

- Barb, description of the, 18, 20, 73; comparison between, and the Arabian, 24
- Barbs or paps, treatment of, 233
- Bark, Peruvian, the properties of it, 480
- Barley considered as food for the horse, 133
- Barnacles, use of the, as a mode of restraint, 457
- Bar-shoe, description and use of, 437
- Barrel, proper shape of the, in the hunter, 82
- Bars, description and office of the, 397; proper paring of, for shoeing, 398; folly of cutting them away, 398; removal of, a cause of contraction, 398; corns, 398
- Basilicon ointment, 480
- Bay horses, description of, 24, 347; Malton, account of him, 69
- Beans, good for hardy worked horses, and that have a tendency to purge, 134, 137; should always be crushed, 134
- Bearing-rein, the use and abuse of, 217
- Beet, the nutritive matter in, 137
- Belladonna, extract of, 480
- Berners, Juliana, authoress of the first book on hunting, 84
- Bible, history of the horse in the, 2
- Bile, account of the, 318, 319
- Birman horse, account of the, 32
- Bishoping the teeth, description of, 228
- Biting, a bad habit, and how usually acquired, 507; remedy for, 119
- Bit, the, often too sharp, 217; the ancient, 10; sometimes got into the mouth, 507
- Bitting of the colt, 114
- Black horses, description and character of, 101, 347
- Bladder, description of the, 339; inflammation of, symptoms and treatment, 339; neck of, 340; stone in the, 340, 341
- Bleeding, best place for general, 458; directions for, 459; from veins rather than arteries, 305; finger should be on the pulse during, 305; importance of, in inflammation, 306, 459; at the toe described, 460; comparison between the fleam and lancet, 458
- Blindness, usual method of discovering, 163; discovered by the pupil not dilating or contracting, 164; of one eye, 164
- Blistering all round at once, barbarity and danger of, 462, 480; after firing, absurdity and cruelty of, 461, 464
- Blisters, best composition of, 461; the different kinds and uses of, 461; best mode of applying, 461; caution with regard to their application, 461; the principle of their action, 480; use of, in inflammation, 461; comparison between them and rowels and setons, 466
- Blood, change in after bleeding, 460; coagulation of, 460; diseases of the blood, 309; spavin, nature and treatment of, 252
- Blood horses liable to contraction, 410
- Bloody urine, 339
- Bog spavin, nature and treatment of, 388
- Bole Armenian, medical use of, 481
- Bone, round, 383
- Bone-spavin, nature and treatment of, 388

## CAN

- Bots in the stomach, natural history of, 321; not usually injurious, 322
- Bournon horse, description of the, 21
- Bowels, inflammation of the, 325; enlargement of the, 330
- Brain, description of the, 150; its cortical and cineritious composition, 151; the office of each, 151; concussion of the, 168; pressure on the, 169; inflammation of the, 172
- Bran, as food for the horse, 134
- Breaking in should commence in the second winter, 113; description of its various stages, 115; necessity of gentleness and patience in, 115; of the farmer's horse, 113; of the hunter or hackney, 114; the South American, 38; cruel Arabian method of, 281; Mr. Rarey's system, 116
- Breast, muscles of the, 251
- Breathing, the mechanism of, 256
- Breeding, 92; as applied to the farmer's horse, 92; qualities of the mare as much importance as those of the horse, 92, 108; the peculiarity of form and constitution inherited, 108; in-and-in, observations on, 109
- Brewers' horses, account of them, 101; portrait of one, 102; account of their breed, 102
- Bridle, the ancient, 10
- Broken down, what, 372
- Broken knees, treatment of, 367; method of judging of the danger of, 368; when healed, not unsoundness, but the form and action of the horse should be carefully examined, 518
- Broken wind, nature and treatment of, 297; influenced much, and often caused by the manner of feeding, 299
- Bronchial tubes, description of the, 260
- Bronchitis, nature and treatment of, 282
- Bronchocele, account of, 270
- Brood mare, description of the, 109; should not be too old, 111; treatment of, after covering, 111; after foaling, 111
- Brown horses, description of, 347
- Bryony, dangerous, 500
- Buccinator muscle, description of the, 200
- Bucephalus, account of, 9
- Burleigh, Lord, his opinion of hunting, 84
- Busbequius, his interesting account of the Turkish horse, 36
- CABBAGE, the nutritive matter in, 137
- Cæcum, description of the, 317
- Calamine powder, account of, 498
- Calculi in the intestines, 329
- Calkins, advantages and disadvantages of, 432; should be placed on both heels, 433
- Calnuck horse, description of the, 49
- Camphor, the medical use of, 481
- Canadian horse, description of the, 41
- Canals, advantages and disadvantages of, 547; smallness of power requisite for the transmission of goods by them, 548
- Canal-boat, calculation of the draught of, 548; the ease of draught of, might be increased by a different mode of applying the power, 546
- Canker of the foot, nature and treatment of, 425

## CAN

Cannon, or shank-bone, description of the, 369  
 Canter, action of the horse during, 537  
 Cantharides, form the best blister, 481, 499;  
 given for the cure of glanders, 481  
 Cape of Good Hope, the horses of, 21  
 Capillary vessels, the, 305  
 Capivi, balsam of, 484  
 Capped hock, nature and treatment of, 392;  
 description of, 392; although not always un-  
 soundness there should be a special warranty  
 against it, 518  
 Capsicum berries, their stimulating effect, 482  
 Carbonate of iron, a mild tonic, 487  
 Carditis, 302  
 Carraways, a good aromatic, 482  
 Carriage-horses produced by crossing the Suf-  
 folk with a hunter, 101  
 Carriages, two and four-wheeled, comparison  
 between, 567; light, should have no longi-  
 tudinal elasticity in the hanging or springs,  
 568; disadvantage of C springs in, 567;  
 hung on straps or springs in the time of  
 Homer, 544  
 Carrots, excellent effects of in disease, 136;  
 the nutritive matter in, 137  
 Carts, two-wheeled, computation of the friction  
 of, 564; can perform proportionably more  
 work than waggons, 565; easier loaded, and  
 do not so much injure the roads, 565; require  
 better horses and more attendants, 565; the  
 horse sooner knocked up, and injured by the  
 shocks of the shafts, 565; on good roads and  
 for short distances, superior to waggons, 565;  
 with two horses, disadvantage of, 565; have  
 less draught than waggons, reason why, 565  
 Cartilages of the foot, description and action of  
 the, 402; ossification of the, 426, 521; a  
 cause of unsoundness, 521  
 Caruncula lacrymalis, the, 189  
 Cascarella bark, a tonic and aromatic, 482  
 Castley, Mr., on restiveness in the horse, 502  
 Castor-oil, not a purgative for the horse, 482  
 Castration, method of, 457; proper period for,  
 457; the operation by torsion, 458  
 Cataract in the eye, nature of, 191; cannot be  
 operated on in the horse, 191; method of  
 examination for, 191; the occasional appear-  
 ance and disappearance of, 193  
 Catarrh, description and treatment of, 265;  
 distinguished from inflammation of the lungs,  
 265; epidemic, or influenza, 272  
 Catarrhal fever, nature and treatment of, 265  
 Catechu, a good astringent, method of giving,  
 and adulterations of, 482  
 Catheter, description of one, 341  
 Caustic, an account of the best, 482  
 Cavalry horse, description of the, 94; anecdotes  
 of the, 94  
 Cawl, description of the, 319  
 Cerebellum, description of the, 151  
 Cerebrum, description of the, 151  
 Chalk, its medicinal use in the horse, 482  
 Chaff, attention should be paid to the goodness  
 of the ingredients, 130; best composition of,  
 131; when given to the hard worked horse,  
 much time is saved for repose, 131; quantity  
 of necessary for different kinds of horses, 131

## COL

Chamomile, a mild tonic, 482  
 Channel of the jaws, what, 221  
 Charcoal, useful in a poultice, and as an anti-  
 septic, 483  
 Charges, composition and use of, 483  
 Chariots, the first account of the use of, 3; in  
 Solomon's time, 6; the Grecian, 12; descrip-  
 tion of that of Priam, 555; that of Juno  
 described, 555; on the frieze of the Par-  
 thenon, description of, 556; used by the  
 Egyptians 1500 years before the Christian  
 æra, 554; at the siege of Troy, 555; descrip-  
 tion of the ancient, 555; of the ancients,  
 could not move with much velocity, 555  
 Chest, anatomy of the, 243; proper form of  
 the, 244, 246; cut of the, 246; the import-  
 ance of depth of, 245; narrow and rounded,  
 comparison between, 246; the broad chest,  
 247; dropsy of the skin of the chest, 253;  
 paracentesis, or tapping the chest, 473  
 Chesnut horses, varieties of, 347  
 Chillaby, friendship between him and a cat, 73  
 Chinese horse, description of the, 32  
 Chinked in the chine, what, 249  
 Chloride of lime, an excellent disinfectant, 491;  
 of soda, useful in unhealthy ulcers, 495  
 Choking, 319; treatment, 320  
 Choroid coat of the eye, description and use of  
 the, 161  
 Chyle, the formation of, 316  
 Ciliary processes of the eye, description of the,  
 163  
 Cineritious matter of the brain, nature and  
 function of the, 152  
 Circassian horse, description of the, 30  
 Cleveland Bay, description of the, 93  
 Clicking, cause and remedy of, 415  
 Clipping, recommendation of, 344  
 Clips, when necessary, 433  
 Clover, considered as an article of food, 136,  
 137  
 Clysters, the composition and great usefulness  
 of, 483; directions as to the administration  
 of, 483  
 Clydesdale horse, description of the, 101  
 Coaches, calculation of the power of horses in  
 drawing according to their speed, 540;  
 loaded high, run lighter, especially in rapid  
 travelling, 569; safety, heavy draught of,  
 570  
 Coach-horse, description of the, 95; best breed  
 of, 96  
 Coat, fine, persons much too solicitous to pro-  
 cure it, 128  
 Cocktail horse, mode of docking, 468  
 Collin-bone, description of the, 400; the lamellæ,  
 or leaves of, 401; fracture of, 431  
 Coffin-joint, sprain of, 380  
 Cold, common, description and treatment of,  
 265  
 Colic, flatulent, account of, 324; spasmodic,  
 description and treatment of, 322  
 Collar, the best method of attaching the traces  
 to the horse, 547; proper adaptation of to  
 the shoulder, 540  
 Colocynth, is poisonous, 500  
 Colon, description of the, 117

## COL

Colonel, portrait of, 66; account of his performances, 77  
 Colour, remarks on, 345  
 Colt, early treatment of the, 112 *et seq.*  
 Complexus, major, description of the, 238; minor, description of the, 238  
 Concave-seated shoe, the, described and recommended, 434  
 Conestoga horses, description of the, 42  
 Conical wheels, compared with flat ones, 559; extreme absurdity of, 561; strange degree of friction and dragging with them, 561; afford great resistance and destroy the road, 561; are in fact travelling grindstones, 562  
 Conjunctiva, description of the, 161; appearance of, how far a test of inflammation, 161  
 Consumption, account of, 293; treatment of, 294  
 Contraction of the foot, nature of, 587, 518; the peculiarity of permanent lameness produced by, 410; how far connected with the navicular disease, 412; is not the necessary consequence of shoeing, 407; produced by neglect of paring, 408; wearing the shoes too long, 408; want of natural moisture, 409; the removal of the bars, 410; not so much produced by litter as imagined, 409; the cause rather than the consequence of thrush, 410; best mode of treating, 411; rarely permanently cured, 411; does not necessarily imply unsoundness, 518; although not necessarily unsoundness, should have a special warranty against it, 518; blood horses very subject to, 410  
 Convexity of the eye, the proper, not sufficiently attended to, 161  
 Copaiba, account of the resin, 484  
 Copper, the combinations of, used in veterinary practice, 484  
 Corded veins, what, 212  
 Cordials, the use and abuse of, in the horse, 484  
 Cornea, description of the, 161; mode of examining the, 161; its prominence or flatness, 161; should be perfectly transparent, 161  
 Corns, the nature and treatment of, 421; produced by cutting away the bars, 421; not paring out the foot between the crust and bars, 422; pressure, 422; very difficult to cure, 422; constitute unsoundness, 518  
 Coronary ligament, description of the, 397; the crust principally produced from, 397; ring, description of the, 397  
 Coronet, description of the, 397  
 Corrosive sublimate, treatment under poison by 500; a good tonic for farcy, 489, 500  
 Corsican horse, account of the, 46  
 Cortical substance of the brain, description and fracture of, 151  
 Cossack horse, description of the, 49; beaten in a race by English blood horses, 49  
 Cough, chronic nature and treatment of, 294; constitutes unsoundness, 519; the occasional difficulty with regard to this, 523  
 Cow hocks, description of, 392  
 Cradle, a safe restraint upon the horse when blistered, 461  
 Cramp, the nature and treatment of, 183

## DOG

Cream-coloured horses, account of, 346; peculiarity in their eyes, 163  
 Cream of tartar, a mild diuretic, 493  
 Creasote, its use in veterinary practice, 485  
 Crib-biting, description of, 511; causes and cure, 512; injurious to the horse, 512; constitutes unsoundness 519  
 Cricket ball, the action of catching a, 538  
 Cricoid cartilage of the windpipe, the, 257  
 Cromwell, Oliver, his stud of race-horses, 64  
 Cropping off the ear, absurdity of, 154  
 Croton, the farina of, used as physic, 485  
 Crusaders, the improvement of the horse neglected by them, 58  
 Crust of the foot, description of the, 395; composition of the, 396; consisting within of numerous horny plates, 393; proper degree of it, slanting, 396; proper thickness of the, 396; brittleness of, remedy for, 398; the cause of sandcrack, 413  
 Crystalline lens, description of the, 165  
 Cuboid bones, description of the, 385  
 Cuneiform bones, description of the, 385  
 Curbs, nature and treatment of, 387; hereditary, 93; constitute unsoundness, 519  
 Cuticle, description of the, 342  
 Cutis, or true skin, account of the, 342  
 Cutting, cause and cure of, 380, constitutes unsoundness, 519; away the foot, unfounded prejudice against, 408

## DANDRIF, the nature of, 342

Darley Arabian, account of the, 68  
 Dartmoor ponies, description and anecdote of, 106  
 Deafness, 195  
 Deacon, Mr., his opinion on the forms of wheels, 527, 563  
 Denham, Major, interesting account of the loss of his horse, 27  
 Depressor labii inferioris muscle, description of the, 200  
 Desert horses, account of the, 21  
 Diabetes, the nature and treatment of, 338  
 Diameter of wheels, the effect of increasing the, 568  
 Diaphoretics, their nature and effects, 485  
 Diaphragm, description of the, 254; spasm of the, 263; rupture of, 264; its connection with respiration, 255  
 Digestion, the process of it described, 313  
 Digestive organs, anatomy and diseases of the, 311  
 Digestives, their nature and use, 486  
 Digitalis, highly recommended in colds and all inflammatory complaints, 486  
 Dilator magnus lateralis muscle, description of the, 200; naris lateralis muscle, description of the, 200  
 Dishing of wheels described, and effect of, 560; both inward and outward effect of, 564  
 Distressed horse, treatment of the, 85  
 Diuretic medicines, the use and abuse of, 486  
 Docking, method of performing, 466  
 Dogs, danger of encouraging them about the stable, 176

## DON

Doncaster course, the length of, 74  
 Dongola horse, description of the, 17  
 Draught, theory of, 527; has not been sufficiently explained, 527, 535; implies the moving power, the vehicle, and the road, 527; the moving power particularly considered, 527; considered in respect of the resistance, 532; calculation of, according to velocity and time, 532; much influenced by the direction of the traces, 537; the line of, should be parallel to the direction of motion, 538; in cattle should pass through the axle of the wheels, 539; in bad roads may have a slight inclination upward, 540; resistance of, should be as much as possible firm and inelastic, 538; how increased by the state of the road, 571; of boats, difficulty of, increasing rapidly with the velocity, 548; calculation of the power of, 548; of the sledge, 548; of the roller, 549; horse, the heavy, 99; horses, the inferior ones about the metropolis, wretched state of, 103  
 Dray horse, proper form of the, 101; the largest bred in Lincolnshire, 102; usually too large and heavy, 102  
 Drinks, how to administer, 487; comparison between them and balls, 487  
 Dropsy of the skin of the chest, 253; treatment of, 253; of the chest, 291; of the heart, 301  
 Drum of the ear, description and use of the, 155  
 Dun horse, account of the, 346  
 Dung-balls, 330  
 Duodenum, description of the, 316; diseases of the, 316  
 Dura mater, description of the, 150  
 Dutch horse, description of the, 54

**E**AR, description of the external parts, 154; internal parts, 155; bones of the, description and use of, 155; labyrinth of the, 155; indicative of the temper, 154; clipping and singeing, cruelty of, 155; treatment of wounds or bruises of, 194; cruel operations on the, 195  
 East Indian horse, description of the, 30  
 Eclipse, the pedigree and history of, 70; account of his proportions, 71  
 Edward II. introduced Lombardy horses into England, 58  
 Edward III., the breed of horses much improved by, 59; introduced Spanish horses, 59; had running horses, 59  
 Egypt, account of the horse of, 3, 17  
 Elasticity of the ligament of the neck, 149  
 Elaterium, poisonous, 500  
 Elbow, the proper form and inclination of, 364; capped, 365; fracture of, 450; punctured, 365  
 Elizabeth, Queen, the number and value of horses much diminished when she reigned, 63; a staunch huntress, 84  
 Emetic tartar, used as a nauseant, diaphoretic, and worm medicine, 479  
 Enamel of the teeth, account of the, 222  
 English horse, history of the, 54; first crossed by the Romans, 55; improved by Athelstan, 55; William the Conqueror, 56; John, 58  
 Eusiform cartilage, the, 246

## FET

Entanglement of the intestines, description of, 330  
 Enteritis, account of, 325, 326, and 327  
 Epidemic catarrh, nature and treatment of, 272; malignant, nature and treatment of, 279  
 Epiglottis, description of the, 257  
 Epilepsy, nature and treatment of, 174  
 Epsom salts, used as a purgative, 491  
 Epsom course, the length of, 74  
 Ergot of rye, the action of, 495  
 Ethmoid bone, description of the, 150  
 Ethiopian horse, account of, 18  
 Euphorbium, the abominable use of it, 499  
 Ewe-neck, unsightliness and inconvenience of, 238  
 Exchanges of horses stand on the same ground as sales, 525  
 Exercise, directions for, 129; the necessity of regular, 129; want of producing grease, 382; more injury done by the want of it than by the hardest work, 129  
 Exmoor pony, description of the, 105  
 Expansion shoe, description and use of the, 438  
 Expense of horse, calculation of the annual, 544  
 Eye, description of the, 155; cut of the, 160; fracture of the orbit of the, 168; healthy appearance of the, 159; diseases of the, 188; inflammation of, common, 189; ditto, specific, 190; ditto, causes, 192; ditto, medical treatment of, 192, 193; ditto, untractable nature of, 193; ditto, consequences of, 192, 193; ditto, marks of recent, 520; ditto, constitutes unsoundness, 520; ditto, hereditary, 192; indicative of the temper, 156; the pit above, indicative of the age, 146; muscles of the, 166  
 Eyebrows, substitute for, 157  
 Eyelashes, description of, 157; folly of singeing them, 157  
 Eyelid, description of, 156, 157  
 Eyelids, diseases of the, 188

**F**ACE, description of the, 186; cut of the muscles, nerves, and blood-vessels of, 199  
 Falling in of the foot, what, 406  
 False quarter, nature and treatment of, 416  
 Farcy, a disease of the absorbents of the skin, 212, 213; connected with glanders, 212; both generated and infectious, 214; symptoms of, 214; treatment of, 215; buds, what, 213; the effect of cantharides in, 215; diiodide of copper, 215  
 Farmer's horse, description of the, 92; fit for riding as well as draught, 92; the general management of 92; no blemished or unsound mare to be used for breeding, 93  
 Feeding, high, connected with grease, 382; regular periods of, necessity of attending to, 137; manner of, has much influence on broken wind, 299  
 Feeling of the mouth, constant, indispensable in the good rider, 88  
 Feet, good, importance of, in the hunter, 83; the general management of, 428; attention to, and stopping at night, recommended, 428  
 Felt soles, description and use of, 438  
 Femur, fracture of the, 450  
 Fetlock, description of the, 379

## FEV

Fever, idiopathic or pure, 308; symptoms of, 308; syn ptomatic, 309

Fibula, description of the, 383

Finland horse, description of the, 52

Firing, the principle on which resorted to, 462; mode of applying, 462; should not penetrate the skin, 465; absurdity and cruelty of blistering after, 464; horse should not be used for some months after, 465

Fistula lacrymalis, 158; in the poll, 240; fistulous withers, 252; flatulent colic, 324

Fits, symptoms, causes, and treatment of, 174

Flanders horse, description of the, 103; our heavy draught horses advantageously crossed with it, 103

Fleam and lancet, comparison between them, 458

Flemish horse, account of the, 54

Fleur-de-Lis, account of her performances, 77

Flexor of the arm, description of the, 365; metatarsi muscle, description of the, 384; pedis perforatus, the perforated muscle, description of the, 372; pedis perforans, the perforating muscle, description of the, 372; sprain of the flexor tendons, 372

Flying Childers, an account of him, 68

Foal, early treatment of, 112; early handling of, important, 113; importance of liberal feeding of, 112; time for weaning, 112

Fomentations, theory and use of, 488

Food of the horse, observations on, 130; a list of the usual articles of, 132, 133; should be apportioned to the work, 132

Foot, description of the, 395; the original defence of, 11; diseases of the, 403; canker, 425; corns, 421; contraction, 407; false quarter, 416; founder, acute, 403; chronic laminitis, 405; inflammation, 403; navicular joint disease, 412; overreach, 415; prick, 419; puniced, 405; quitter, 417; sanderack, 413; thrush, 423; tread, 415; weakness, 427; wounds, 419

Forehead, the different form of, in the ox and horse, 151

Fore-legs, description of, 358; diseases of them, 370; proper position of them, 358

Forrester, an example of the emulation of the horse, 76

Founder, acute, symptoms, causes, and treatment of, 403; chronic, nature and treatment of, 405

Foxglove, strongly recommended in colds, and all fevers, 486

Fracture of the skull, treatment of, 168, 442; general observations on fractures, 441; of the skull, 443; orbit of the eye, 444; nasal bones, 444; superior maxillary or upper jaw-bone, 445; inferior ditto, 446; spine, 446; ribs, 447; pelvis, 448; tail, 449; limbs, 449; scapula, 449; humerus, 449; radius, 450; ulna, 450; femur, 450; patella, 451; tibia, 451; bones of the hock, 452; leg, 452; sesamoid bones, 453; pastern, 453; lower pastern; 454; coffin bone, 455; navicular bone, 456

French horse, description of the, 44

Friction, comparison of, in the wheel and roller, 549; on the axle, dependent on the material employed, 571; is not materially increased by the velocity, 571; reduced, as the diameter

## GRO

of the axle is diminished, 571; inversely as the diameter of the wheel, 571

Frog, horny, description of the, 402; sensitive, description of the, 402; ditto, action and use of the, 402

Frontal bones, description of the, 145; sinuses, description of the, 146

Furze, considered as an article of food, 137

**G**ALL, account of the, 319; bladder, the horse has none, 318

Galloping, the action of the horse during, 536

Galloway, description of the, 103; anecdotes and performances of the, 103

Gall-stones, 335

Gancho, the South American, description of, 39; his method of taking and breaking the wild horse, 39; his boots, curious manufacture of, 39

Gentian, the best tonic for the horse, 488

Gibbing, a bad habit, cause of, and means of lessening, 505

Gigs, formation of, 234

Ginger, an excellent aromatic and tonic, 488, 497

Glands, nature of, 203, 206; symptoms, 206, 208, 210; slow progress of, 203, 206; appearances of the nose in, 203, 206; how distinguished from catarrh, 206; ditto from strangles, 206; connected with farcy, 205, 208; treatment of, 211; causes, 208; both generated and contagious, 210; oftenest produced by improper stable management, 208, 209; mode of communication, 210, 211; prevention of, 212; account of its speedy appearance, 208

Glands, enlarged, it depends on many circumstances whether they constitute unsoundness, 520

Glass-eye, nature and treatment of, 194

Glauber's salt, its effect, 496

Glaucoma, nature of, 194

Glutei muscles, description of the, 377

Godolphin Arabian, an account of the, 73

Gould's extract, the use of it much overvalued, 490

Grains, occasionally used for horses of slow work, 133

Grapes on the heels, treatment of, 356

Grasses, neglect of the farmer as to the proper mixture of, 135

Grasshopper springs, description of 568; would be advantageously adopted in post-chaises, 568

Grease, nature and treatment of, 354; cause of, 354; farmer's horse not so subject to it as others, 355; generally a mere local complaint, 355

Greece, early domestication of the horse in, 9; the horse introduced there from Egypt, 9

Grey horses, account of the different shades of, 346

Grinders, construction of the, 222

Grinding, of the food, accomplished by the mechanism of the joint of the lower jaw, 220; swallowing without, 511

Grogginess, account of, 379

Grooming, as important a s exercise to the horse,



## GRÜ

- 128; opens the pores of the skin, and gives a fine coat, 128; directions for, 128  
 Grunter, the, unsound, 519  
 Gullet, description of the, 312  
 Gum-arabic, for what purposes used, 475  
 Gutta serena, nature and treatment of, 194

## HABITS, vicious or dangerous, 502

- Hackney, description of the, 87; its proper action, 88; anecdotes of the, 87; coaches, account of, 96  
 Hair, account of the, 345; question of cutting it from the heels, 356  
 Hamilton, Duke of, the Clydesdale horses owe their origin to him, 100  
 Harnessing, the best mode as regards draught, 547; method of, in the time of Homer, 544  
 Haunch, description of the, 381; wide, advantage of, 382; injuries of the, 382; joint, singular strength of it, 381; also of the thigh bones, advantage of the oblique direction of, 382  
 Haw, curious mechanism of the, 160; diseases of, 189; absurdity and cruelty of destroying it, 160  
 Hay, considered as food, 131; mowburnt, injurious, 135; old preferable to new, 135  
 Head, anatomy of the, 145; the numerous bones composing it, the reason of this, 145; section of the, 146; importance of the proper setting on of, 89; beautiful provision for its support, 148  
 Head, Captain, his account of the South American horse, 38  
 Healing ointment, account of the, 498  
 Hearing of the horse, the very acute, 154  
 Heavy black horses account of, 101  
 Heart, description of the, 300; its action described, 300; inflammation of the, 301; dropsy of the, 301; carditis, 302; inflammation of the lining of the heart, 302; dilatation, 302; ossification, 302; air in the heart, 303; hypertrophy of, 302  
 Heber, Bishop, his account of the Arabian, 26;  
 Heels, question of cutting the hair from them, 356; low, disadvantage of, 423; proper paring of, for shoeing, 429  
 Hellebore, black, its use, 488  
 Hemlock, given in inflammation of the chest, 488  
 Henry VIII., tyrannical regulations concerning the horse, by him, 60; the breed of the horse not materially improved by him, 61  
 Hepatitis, nature and treatment of, 334;  
 Hernia, the nature and treatment of, 332; umbilical, 333  
 Hide-bound, the nature and treatment of, 349  
 High-blower, a description of the, 268; is unsound, 519  
 Highland pony, description of the, 106  
 Hind legs, description of the, 381  
 Hind wheels should follow the precise track of the fore ones, 563  
 Hip-joint, the great strength of the, 302  
 Hips, ragged, what, 381

## HOR

- Hisar, the East India Company's sale of horses at, 31  
 Hobbles, description of the best, 456  
 Hock, the advantage of its numerous separate bones and ligaments, 385; capped, 392; cow, 392; description of the, 386; enlargement of the, nature of, and how affecting soundness, 386, 520; inflammation of the small bones of, a frequent cause of lameness, 386; the principal seat of lameness behind, 387; lameness of it, without apparent cause, 392; fracture of, 452  
 Hog's lard, properties of, 476  
 Holstein horses, account of the, 52  
 Homer, his account of the method of harnessing horses, 544  
 Hæmaturia, 339  
 Hoof, cut of the, 395; description of the, 396  
 Horizontal direction of the traces, when proper, 547  
 Horn of the crust, secreted principally by the coronary ligament, 398; once separated from the sensible part within, will never again unite with it, 398  
 Hornet, sting of the, 499  
 Horse, the first allusion to him, 1; not known in Canaan at an early period, 2; description of, in early times, 14, 16; American, 41; not the native of Arabia, 4; Arabian, 22; Armenian, 7; Austrian, 47; English, 54; Barb, 18; Birman, 32; Bournou, 21; Cappadocian, 7; first used in the cavalry service, 3; chariot races formed part of the Olympic games, 13; calculation of the annual expense of, 540; Chinese, 32; Circassian, 30; was trained to draught before he was mounted, 6; Coach, proper form, qualities, breed of, 95; the different colours of the different breeds, 345; Corsican, 46; Cossack, 34; Dongola, 17; Dutch, 54; when first domesticated in Egypt and Canaan, 2; not domesticated until after many other animals, 2; not found in Egypt in the very early periods, 1; East Indian, 30; the flesh of, eaten, 34; English, history of, 54; farmers', 92; Finland, 51; Flemish, 54; his fossil remains found in every part of the world, 1; French, 44; the general management of, 122; among the Greeks, 4; heavy black, 101; early employed in hunting the ostrich, 1; heavy draught, 99; tyrannical regulations respecting, by Henry VIII., 60; grey, the, of Sir Edward Antrobus, 83; hiring, early regulations of, 56, 58; Hungarian, 49; Iceland, 51; Irish, 107; Italian, 46; sublime account of by Job, 2; much improved by John, 58; Lombardy, when first introduced into England, 58; market, first account of, 57; Mecklenburg, 52; Nubian, 17; Parthian, 8; Portuguese, 43; Russian, 49; Prussian, 53; Norwegian, 52; Persian, 8, 28; the early price of, 5; English, not used for the plough in early times, 56; power, calculation of, 56, 6, 37; price of, in Solomon's time, 5; prices of, at different periods, 56, 64; ridden, the first account of, 2; sagacity of, 90; can see almost in darkness, 131; Sardinian, 45; South American, 37; ditto, instinct and sagacity of, 37; manage-

## HOW

- ment of, in South America, 38; Spanish, 42; Swedish, 51; Tartarian, 34; Thessalian, 9; Toorkoman, 36; Turkish, 36; wild, 34, 37; English, improved under William the Conqueror, 56; zoological description of, 107; immense number of, in the armies of some ancient eastern monarchs, 3; numerous in Britain at the invasion of the Romans, 54
- Howell the Good, his laws respecting the horse, 55
- Humerus, description of the, 362
- Hungarian horse, description of the, 48
- Hunter, the, general account of, 81; proper degree of blood in, 81; form of, 82; spirit of, 83; anecdotes of, 85; management of, 84; symptoms of dangerous distress in, 85; management of the, when distressed, 86; summering of, 86; shoe, description of the, 437
- Hydatids in the cranial cavity, 168
- Hydrocyanic acid, its occasional good service, 475
- Hydrops pericardii, or dropsy of the heart, 301
- Hydrothorax, symptoms and treatment of, 291
- I**CELAND horse, description of the, 51
- Ileum, description of the, 316
- Inflammation, nature of, 305; treatment of, 306; hot or cold applications to guide in the choice of, 307; importance of bleeding in, 306, 459; when proper to physic in, 306; of the bowels, 325; ditto, distinction between it and colic, 323; brain, 172; eye, 189; foot, 403; kidneys, 337; larynx, 266; lungs, 283; trachea, 267; veins, 241; heart, 301; liver, 334
- Influenza, nature and treatment of, 272
- Infusions, manner of making them, 489
- Intercostal muscles, description of the, 246
- Intestines, description of the, 315, 316, 317; inflammation of the, 325
- Introsusception of the intestines, treatment of, 330
- Invertebrated animals, what, 139
- Iodine, usefulness of, in reducing enlarged glands, 490
- Iranee horse, description of the, 30
- Iris, description of the, 163
- Irish horse, description of the, 107
- Iritis, 190
- Iron, the carbonate of, a mild and useful tonic, 487; sulphate of, a stronger tonic, 487; ditto, recommended for the cure of glanders, 487
- Italian horse, description of the, 46
- Itchiness of the skin should always be regarded with suspicion, 353
- J**AMES I. established the first regulations for racing, 64; introduction of the Arabian blood by him, 64
- James's powder, 479
- Jaundice, symptoms and treatment of, 335
- Jaw, the lower, admirable mechanism of, 219, 220; upper, description of, 217

## LIM

- Je'unum, description of the, 316
- John, the breed of horses improved by, 58
- Jointed shoe, the description and use of, 438
- Jugular vein, anatomy of the, 460
- Jumper, the horse-breaker, anecdotes of his power over animals, 502
- Juniper, oil of, use of, 490
- Juno, her chariot described, 556
- K**ADISCHI, an Arabian breed of horses, 23
- Kicking, a bad and inveterate habit, 508
- Kidneys, description of the, 336; inflammation of, symptoms and treatment of, 337
- King Pippin, anecdotes of him as illustrating the inveterateness of vicious habits, 503
- Knee, an anatomical description of the, 366; broken, treatment of, 367, 518
- Kochlani, an Arabian breed of horses, 23
- Knowledge of the horse, how acquired, 144

- L**ABYRINTH of the ear, description and use of the, 155
- Lachrymal duct, description of the, 158; gland, description and use of the, 158
- Lamellæ or laminæ, horny, account of the, 398; fleshy, account of the, 398; weight of the horse, supported by the, 398
- Lameness, shoulder, method of ascertaining, 363; from whatever cause, unsoundness, 521
- Lampas, nature and treatment of, 219; cruelty of burning the bars for, 219
- Laminæ of the foot. See Lamellæ.
- Lancet and fleam, comparison between them, 458
- Lapland horse, account of the, 51
- Laryngitis, chronic and acute, 266, 267
- Larynx, description of the, 257; inflammation of the, 266
- Lasso, description of the, 39
- Laudanum, the use of in veterinary practice, 493
- Lead, the compounds of, used in veterinary practice, 490
- Leather soles, description and use of, 438
- Leg, cut of the, 470; description of the, 369; fracture of the, 452
- Legs, fore, the situation of, 358; hind, anatomical description of the, 358; of the hackney, should not be lifted too high, 88; swelled, 393
- Llevator humeri muscle, description of the, 239, 247
- Lever, muscular action explained on the principle of it, 360
- Ligament of the neck, description and elasticity of the, 149; suspensory, lesions of the, 375
- Light, the degree of, in the stable, 126
- Lightness in hand, of essential consequence in a hunter, 82
- Limbs, fracture of the, 449
- Lime, the chloride of, exceedingly useful for bad smelling wounds, &c., 491; the chloride of, valuable in cleansing stables from infection, 491

## LIN

Lincolnshire, the largest heavy black horses bred in, 102  
 Liniments, the composition and use of, 491  
 Linseed, an infusion of used in catarrh, 135, 491; meal forms the best poultice, 491, 494  
 Lips, anatomy and uses of the, 215; lips the hands of the horse, 215  
 Litter, the, cannot be too frequently removed, 125; proper substances for, 126; contraction not so much produced by it as some imagine, 410  
 Liver, the anatomy and use of it, 318; diseases of the, 334; softening and rupture, 334; inflammation of the, 334  
 Liverpool, account of the course at, 75  
 Locked jaw, symptoms, cause, and treatment of, 178  
 Loins, description of the, 250  
 Lombardy horse, the, when introduced into England, 58  
 Longissimus dorsi muscle, description of the, 252  
 Lucern, considered as an article of food, 136  
 Lumbricus teres, the, 331  
 Lunar caustic, a very excellent application, 479  
 Lungs, description of the, 260; symptoms of inflammation of the, 283; causes of, 284; consequences of, 286; treatment of, 287; bleeding in, 288; blisters preferable to rowels or setons in, 289

**MADNESS**, the symptoms and treatment of, 175  
 Magnesia, the sulphate of, 491  
 Mahratta horse, account of the, 31  
 Mallenders, the situation of, 357; the nature and treatment of, 357  
 Mammalia, the, an important class of animals, 139  
 Manchester, account of the course at, 75  
 Mane, description and use of the, 2, 239  
 Mange, description and treatment of, 350; causes of, 351; ointment, recipes for, 352; highly infectious, 352; method of purifying the stable after, 356  
 Manger-feeding, the advantage of, 130  
 Mare, put to the horse too early, 111; deterioration in, 109; her proper form, 109; breeding in-and-in, 109; time of being at heat, 111; time of going with foal, 111; best time for covering, 111; management of, when with foal, 111; management of, after foaling, 111; more concerned than the horse in breeding, 92; preferable to gelding for the farmer, 92; selection of, for breeding, 93  
 Mark of the teeth, what, 222  
 Markham's Arabian, an account of, 64  
 Marsk, the sire of many of the New-foresters, 104  
 Mashies, importance of their use, 491; best method of making them, 492  
 Masseter muscle, description of the, 199, 221  
 Maxillary bones, anatomy of the, 217; fractures of, 445

## NER

Meadow grasses, the quantity of nutritive matter in, 137  
 Mechanical power, objections to the use of, 533  
 Mecklenburg horses, account of, 52  
 Medleines, a list of the most useful, 474  
 Medullary substance of the brain, its nature and function, 150, 151  
 Megrims, cause, 174; symptoms, 174; treatment, 174; apt to return, 174  
 Melt, description of the, 319  
 Memory of the horse, instances of, 90  
 Mercurial ointment, the use of, in veterinary practice, 489  
 Mercury, its use in epidemic catarrh, 279  
 Merlin, the sire of many of the Welsh ponies, 104  
 Mesentery, description of the, 316  
 Moisture, want of, a cause of contraction, 409  
 Mojinniss horse, description of the, 30  
 Moon-blindness, the nature of, 190  
 Moulting, the process of, 348; the horse usually languid at the time of, 348; no stimulant or spices should be given, 348; mode of treatment under, 348  
 Mouth of the horse, description of the bones of, 217; should be always felt lightly in riding, 217; importance of its sensibility, 216, 217  
 Mowburnt hay injurious, 135  
 Murriatic acid, its properties, 475  
 Muscles, description of the, 141  
 Muscles of the back, description of the, 252; breast, ditto, 251; eye, ditto, 166; face, ditto, 199; neck, ditto, 237; ribs, ditto, 246; shoulder-blade, 359; lower bone of the shoulder, 359; the advantageous direction of, more important than their bulk, 359, 361  
 Muscular action, the principle of, 362  
 Mustard, the use of, 492  
 Myrrh, the use of, for canker and wounds, 492

**NASALIS** labii superioris muscle, description of the, 200  
 Nasal bones, fracture of, 444  
 „ gleet, 201  
 „ polypus, 200  
 Naves, cast-iron, to wheels, advantage of, 564; description of the best construction of, 564  
 Navicular bone, description of the, 402; the action and use of it, 492  
 Navicular disease, nature and treatment of the, 412; how far connected with contraction, 413; the cure very uncertain, 413; fracture of, 456; unsoundness, 521  
 Neapolitan horse, description of the, 46  
 Neck, anatomy and diseases of the, and neighbouring parts, 236; description of the blood-vessels of the, 239; description of the veins of the, 240; bones of the, 237; muscles and proper conformation of the, 237; comparison between long and short, 237; loose, what, 238  
 Nephritis, nature and treatment of, 337  
 Nerves, the construction and theory of, 145; spinal, the compound nature of, 153; of the face, 159

## NEU

- Neurotomy, or nerve operation, object and effect of it, 469; manner of performing it, 470; cases in which it should or should not be performed, 471; a vestige of the performance of it, constitutes unsoundness, 472
- Newcastle, the Duke of, his opposition to the introduction of the Arabian blood, 64
- New-foresier, description of the, 104
- Newmarket, races established at, by Charles I., 64; description of the different courses at, 110
- Nicking, the method of performing, 467; useless cruelty often resorted to, 468
- Nitre, a valuable cooling medicine, and mild diuretic, 493
- Nitric acid, for what employed, 475
- Nitric ether, spirit of, a mild stimulant and diuretic, 492
- Norman horse, description of the, 44
- Norwegian horse, description of the, 52
- Nose, description of the bones of the, 196; the importance of its lining membrane, 197, 256; the nose of the horse slit to increase his wind, 199; importance of the colour of the membrane of the, in judging of many diseases, 198
- Nosebag, importance of the, 138
- Nostrils, description of the, 196; the membrane of, important in ascertaining disease, 200, 54; importance of an expanded one, 198; slit by some nations to increase the wind of the horse, 198
- Nubian horse, account of the, 17
- Nutrient, the quantity of, contained in the different articles of food, 137
- O**ATS, the usual food of the horse, 132, 137; should be old heavy, dry, and sweet, 132; kiln-dried, injurious to the horse, 137; proper quantity of, for a horse, 137
- Oatmeal, excellent for gruel, and sometimes used as a poultice, 133
- Occipital bone, description of the, 146
- Oenanthe fistulosa, poisonous, 499
- Oesophagus, description of the, 312
- O'Kelly, Colonel, anecdotes of him, and Eclipse, 70
- Olfactory nerves, the importance of them, 197
- Olive oil, an emollient, 492
- Olympia, the races at, 13
- Omentum, description of the, 319
- Opacity of the eye, the nature and treatment of, 191
- Operations, description of the most important, 456; the dreadful ones caused by cruel treatment and driving, 97
- Ophthalmia, simple, 189; specific, or moon-blindness, 190
- Opium, its great value in veterinary practice, 492; adulterations of it, 493
- Orbit of the eye, fracture of, 168
- Ossification of the cartilages, cause and treatment of, 426
- Over-reach, the nature and treatment of, 415; often producing sand-crack or quittor, 415, 414, 417
- Ozena, account of, 202

## POL

- P**ACE, the effect of, in straining the horse, 97
- Pachydermata, an order of animals, 140
- Pack-horse, description of the, 105
- Pack-wax, description of the, 149
- Palate, the, 218
- Palsy, the causes and treatment of, 186
- Pancreas, description of the, 319
- Panniculus carnosus muscle, 343
- Paps or barbs, 233
- Paracentesis thoracis, operation of, 473
- Parietal bones, description of the, 146
- Paring out of the foot for shoeing, directions for, 429; neglect of, a cause of contraction, 408
- Parotid gland, description of the, and its diseases, 200, 232
- Parsnips, the nutritive matter in, 137
- Parthenon, description of the chariots on the frieze of it, 556
- Pastern, upper, fracture of, 453; lower, fracture of, 454; description of the, 377; bones of the, 378; cut of the, 378; proper obliquity of the, 378
- Patella or stifle bone, description of the, 383; dislocation of the, 384
- Pawing, remedy for, 513
- Payment of the smallest sum completes the purchase of a horse, 523
- Peas, sometimes, used as food, but should be crushed, 134, 137
- Pectorales muscles, description of the, 251
- Pelvis, fracture of the, 448
- Pereostitis, or sore shins, 372
- Pericarditis, 301
- Pericardium, description of the, 300
- Persian horse, description of the, 28; management of, 29
- Persian race, description of a, 29
- Perspiration, insensible, no medicines will certainly increase it, 345
- Peter the Great, the immense block of marble constituting the pedestal of his statue, how moved, 567
- Pharynx, anatomy of the, 311
- Phrenitis, 172
- Phthisis pulmonalis, description of, 293; treatment of, 294
- Physic balls, method of compounding the best, 477
- Physicking, rules for, 328
- Pia mater, description of the, 150
- Pied horse, account of the, 346
- Pigmentum nigrum, account of the, 162
- Pit of the eye, the, indicative of the age, 146
- Pitch, its use for charges and plasters, 493
- Pithing a humane method of destroying animals, 236
- Pleura, description of the, 261
- Pleurisy, the nature and treatment of, 289
- Pneumonia, the nature and treatment of, 283
- Poisons, account of the most frequent, 498; tests of the different ones, 501
- Poll-evil, the cause and treatment of, 240; importance of the free escape of the matter, 241

## PON

- Pony, varieties of the, 103  
 Porter, Sir R. Ker, his account of the Persian horse, 29  
 Portuguese horse, the, 43  
 Post, the first establishment of it, 78  
 Post-chaises, grasshopper springs would be advantageously adopted for, 567, 568  
 Postea spinatus muscle, description of the, 342  
 Potash, the compound of, 493  
 Potatoes, considered as an article of food, 137  
 Poultries, their various compositions, manner of acting, and great use, 494  
 Powders, comparison between them and balls, 494  
 Power of draught in the horse, illustrations of, 98; calculation of, 530; compared with that of the human being, 534; compared with that of a steam-engine on railways, 531; on common roads, 532; on bad roads, 532; dependent on his weight and muscular force, 532; how diminished when towing a boat on a canal, 537; greater when close to his work, 537; this depends on his strength and the time he can exert it, 538; the diminution of, according to his speed, table of, 539  
 Pressure on the brain, effect of, 169  
 Priam's chariot, a description of, 555; he har- nessed his own horses, 555  
 Prices of horses at different periods, 56, 58, 59, 60  
 Prick in the foot, treatment of, 419; injurious method of removing the horn in searching for, 421  
 Prussian horse, account of the, 53  
 Puffing the glims, a trick of fraudulent horse- dealers, 146  
 Pulling, the action of, explained, 534  
 Pulse, the natural standard of the, 304; varieties of the, 304; importance of attention to the, 198, 304; the most convenient place to feel it, 304; the finger on the pulse during the bleeding, 305  
 Punctured feet, description and treatment of, 405; do not admit of cure, 406; constitute un- soundness, 521  
 Pupil of the eye, description of the, 163; mode of discovering blindness in it, 164  
 Purchase, to complete the, there must be a me- morandum, or payment of some sum, how- ever small, 523  
 Purgatives, 328  
 Purging, violent treatment of, 325  
 Purpura hæmorrhagica, 309

**QUARTERS** of the horse, description of the, 381; importance of their muscularity and depth, 382; foot, description of, 395; the inner, crust thinner and weaker at, 395; folly of lowering the crust, 397  
 Quidding the foot, cause of, 513; unsoundness while it lasts, 521  
 Quinine, the sulphate of, 480  
 Quittor, the nature and treatment of, 417; the treatment often long and difficult, exercising the patience both of the practitioner and owner, 419; its unsoundness, 521

## ROA

- RABIES**, symptoms of, 175  
**R** Race-courses, different lengths of, 74  
 Races, early, mere running on train scent, 64; frequent cruelty of, 73, 77; different kinds of, described, 74; regular, first established at Chester and Stamford, 63; regulations for, established by James I., 64; patronised by Charles I., 64; Persian, description of, 29; the great length of the old courses, 74; con- sequences of the introduction of short races, 74, 75; the different lengths that are run, 75; the races at Smithfield, 57  
 Race-horse, his history, 66; form, 68; action, 73; emulation, 76  
 Racks, no openings should be allowed above them, 123  
 Radius, description of the, 364; fracture of the, 450  
 Ragged-hipped, what, 382; no impediment to action, 382  
 Railways, mechanical advantage of, 98, 556; they immensely increase the power of the horse, 572  
 Rearing, a dangerous and inveterate habit, 509  
 Recti muscles, of the neck, description of, 238  
 Rectum, description of the, 317, 318  
 Reins, description of the proper, 217  
 Resin, its use in veterinary practice, 494  
 Resistance in draught, observations on, 538  
 Respiration, description of the mechanism and effect of, 255  
 Respiratory organs, anatomy and diseases of, 254; nerves, the, 153  
 Restiveness, a bad habit, and never cured, 502; anecdotes in proof of its inveterateness, 502, 503  
 Retina, description of the, 165  
 Retractor muscle of the eye, description of it, 166  
 Rheumatism, nature and treatment of, 309, 310, 311  
 Ribbed-horn, advantage of being, 248  
 Ribs, anatomy of the, 245, 246  
 Richard Cœur-de-Lion, account of his Arabian horses, 58  
 Richmond, Duke of, his method of breeding good carriage horses, 100  
 Riding, directions for, 88  
 Ringbone, the nature and treatment of, 380; constitutes unsoundness, 522  
 Ringworm, nature and treatment of, 353  
 Roach-backed, what, 250  
 Roads, how affected by different wheels, 560; how influencing the proper breadth of the wheels, 570; the great extent to which they affect the draught, 571; soft and yielding, far more disadvantageous than rough ones, 571; slight alterations in their level advan- tageous, 571; hardness, the grand desider- atum in, 571; should be nearly flat, 571; necessity of constant repairs and attention to them, 572; calculation of the degree by which the resistance is increased by bad ones, 572  
 Roan horses, account of, 346  
 Roaring, the nature of, 268; curious history of, 269; constitutes unsoundness, 519; from tight-reining, 270; from buckling in crib- biting, 270; treatment of, 272

## ROL

Rollers, calculation of the draught of, 550; how probably first invented or brought into use, 550; comparison of their power with that of wheels, 555; mechanism and principle of, 553; particular circumstances in which their use is advantageous, 553; the weight moves with double the velocity of them, and therefore fresh rollers must be supplied in front, 553; the immense block of marble at St. Petersburg, description of its being moved on them, 553

Rolling, danger of, remedy for, 513

Roman nose in the horse, what, 196

Rome, the ancient races at, 15

Round-bone, the, can scarcely be dislocated, 383

Rewels, manner of inserting, and their operation, 494; comparison between them, blisters, and setons, 466

Running away, method of restraining, 509

Rupture, treatment of, 332; of the suspensory ligament, 375

Russian horse, account of the, 49

Rye-grass, considered as an article of food, 136

**SADDLES**, the ancient, 11; the proper construction of, 252, 253

Saddle-backed, what, 250; galls, treatment of, 253

Saddling the colt, 115

Safety coaches, the heavy draught of, 570

Sagacity of the horse, 90

Sainfoin used as an article of food, 136

Sal ammoniac, the medical use of, 478

Saliva, its nature and use, 232

Salivary glands, description of the, 232

Sallenders, nature and treatment of, 357

Salt, use of in veterinary practice, 496; value of, mingled in the food of animals, 136

Sandal, Mr. Percival's, 440

Sand-crack, nature and treatment of, 413; most dangerous when proceeding from tread, 414; liable to return, unless the brittleness of the hoof is remedied, 415; constitutes unsoundness, 522

Sardinian horse, account of the, 46

Savin, dangerous, 500

Scapula, description of the, 359; fracture of the, 449

Sclerotica, description of the, 161

Secale cornutum, the effect of, 495

Sedatives, a list of them, and their mode of action, 495

Serratus major muscle, description of the, 244, 359

Sesamoid bones, admirable use of, in obviating concussion, 378; fracture of, 453

Setons, mode of introducing, 465; cases in which they are indicated, 465; comparison between them and rewels and blisters, 466

Shank-bone, the, 369

Shetland pony, description of the, 106

Shins, sore, 372

Shoe, the concave-seated, cut of, 434; described and recommended, 434; the manner in which

## SOU

the old one should be taken off, 430; the putting on of the shoe, 431; it should be fitted to the foot, and not the foot to the shoe, 431; description of the hinder, 433; the unilateral, or one side nailed shoe, 433; the bar shoe, 437; the tip, 438; the hunting, 437; the jointed, or expansion, 438

Shoeing, not necessarily productive of contraction, 410; preparation of the foot for, 429, the principles of, 430

Short-bodied horses, when valuable, 83

Shoulder, anatomical description of the, 359; slanting direction of the, advantageous, 359, when it should be oblique, and when upright, 361; sprain of the, 363; lameness, method of ascertaining, 363; fracture of the, 449

Shoulder-blade, muscles of the, 359; why united to the chest by muscle alone, 359; lower bone of the, description of, 362; muscles of the, 365

Shying, the probable cause of, 165, 513; treatment of, 515; on coming out of the stable, description of, 516

Side-bones, or ossification of the cartilages, 426

Side-line, description of the, 456

Sight, the acute sense of, in the horse, 154

Silver, the nitrate of, an excellent caustic, 479

Singeing, recommendation of, 348

Sitfasts, treatment of, 253

Skeleton of the horse, description of the, 140

Skin, anatomical description of the, 342; function and uses of it, 342; pores of it, 345; when the animal is in health, is soft and elastic, 343; colour of the skin, 345; hide-bound, 349; diseases of the skin, 342

Skull, anatomical description of the, 146; arched form of the roof, 150; fracture of the, 168, 444

Smithfield market, early account of, 57

Sledges, calculation of the draught of, 548; description of the mechanism and use of, 549; where more advantageous than wheels, and where very disadvantageous, 550; calculation of the power of, 550; their advantage in travelling over ice and snow, 550; Esquimaux, an account of the, 551

Slipping the collar, remedy for, 516

Smell, the sense and seat of, 197; very acute in the horse, 197

Snewing, Mr., his advocacy of clipping, 348

Soap, its use in veterinary practice, 496

Soda, chloride of, its use in ulcers, 496; sulphate of, 496

Sole, the horny, description of, 398; descent of, 398; proper form of, 398; management of, in shoeing, 399; in sensitive, 401; felt or leather, their use, 438

Solomon imported horses from Egypt, 6

Sore-throat, symptoms and treatment of, 266

Soundness, consists in there being no disease or alteration of structure that does or is likely to impair the usefulness of the horse, 517; considered with reference to the principal causes of unsoundness, 518

South American horse, description of it, 37; management of it, 39

## SPA

- Spanish horse, description of it, 43  
 Spasmodic colic, nature and treatment of, 322  
 Spavin, blood, the nature and treatment of, 388;  
 is unsoundness, 522; bog, cause, nature and  
 treatment of, 388; bone, 388; why not always  
 accompanied by lameness, 388; is unsound  
 • ness, 522  
 Spavined horses, the kind of work they are cap-  
 able of, 390  
 Speed of the horse produces rapid diminution  
 of power, 538; and time of labour, the most  
 advantageous proportion of, 539—541; the  
 sacrifice of the horse in endeavouring to ob-  
 tain it, 540  
 Speedy-cut, account of, 371  
 Sphenoid bone, description of the, 150  
 Spinalis dorsi muscle, description of the, 252  
 Spine, description of the, 249; fracture of, 446  
 Spleen, description of the, 319; diseases of the, 336  
 Splenius muscle description of the, 237  
 Splint, nature and treatment of, 370; when con-  
 stituting unsoundness, 522; bones, descrip-  
 tion of the, 370  
 Sprain of the back sinews, treatment of, 372;  
 sometimes requires firing, 374; any remain-  
 ing thickening constitutes unsoundness, 522;  
 sprain of the shoulder, 363  
 Spring steel-yard, the force of traction illus-  
 trated by, 528  
 Springs to carriages, theory of their effect, 568;  
 with some modifications might be adapted to  
 the heaviest waggons, 569; great advantages  
 of, in rapid travelling, 569; grasshopper, de-  
 scription of, 569; C, disadvantages of, 569  
 Spur, the ancient, 11  
 Stables, dark, an occasional cause of inflam-  
 mation of the eye, 192; hot and foul, a fre-  
 quent one of inflammation of the eye, 192;  
 ditto, lungs, 122; ditto, glanders, 208, 209;  
 should be large, compared with the number of  
 horses, 122; the management of, too much  
 neglected by the owner of the horse, 123; the  
 ceiling of should be plastered, if there is a  
 loft above, 123; should be so contrived that  
 the urine will run off, 125; the stalls should  
 not have too much declivity, 126; should be  
 sufficiently light, yet without any glaring  
 colour, 126  
 Staggers, stomach, symptoms, cause, and treat-  
 ment of, 169, 138; sleepy, symptoms and  
 treatment, 170, 171; mad, symptoms and  
 treatment, 172  
 Staling, profuse, cause and treatment of, 338  
 Stallion, description of the proper, for breeding,  
 109  
 Stamford, races first established at, 63  
 Starch, useful in superpurgation, 496  
 Star-gazer, the, 238  
 Steam-engine, comparison of the, with the exer-  
 tion of animal power on railways, 532; com-  
 mon roads, 532; calculation of the expense,  
 531; small, has little advantage in expense  
 over horse power, 533  
 Steeple-chase, description and censure of it, 87  
 Sternum, or breast-bone, description of the, 245  
 Stifle, description of the, 383; sprain of the, 384  
 Stirrup, the ancient, 11

## TEA

- Stomach, description of the, 313, 314; very  
 small in the horse, 314; ruptured, 320; pump  
 recommended in apoplexy, 142  
 Stone in the bladder, symptoms and treatment  
 of, 340; kidney, 339  
 Stoppings, the best composition of, and their  
 great use, 497  
 Straddlers, wheels so called, description of, 563;  
 objection to them, 563; method of evading  
 the law concerning, 563  
 Strain, uniform and constant in draught, bad  
 consequences of, 542  
 Strangles, symptoms and treatment of, 234; dis-  
 tinguished from glanders, 206; the importance  
 of blistering early in, 235  
 Strangury, produced by blistering, 462; treat-  
 ment of, 462  
 Strawberry horse, account of the, 346  
 Stringhalt, nature of, 183; is decidedly unsound-  
 ness, 186, 522  
 Structure of the horse, importance of a know-  
 ledge of, 144  
 Strychnia, account of, 496  
 Stylo-maxillaris muscle, description of the, 199  
 Sublingual gland, description of the, 234  
 Submaxillary glands, description of the, 233;  
 artery, description of the, 200  
 Sub-scapulo hyoideus muscle, description of the,  
 199  
 Suffolk punch, description of the, 99; honesty  
 and continuance of the old breed, 99  
 Sugar of lead, use of, 490  
 Sullivan, the Irish whisperer, anecdotes of his  
 power over the horse, 502; the younger, did  
 not inherit the power of his father, anecdote  
 of this, 505  
 Sulphate of copper, use of in veterinary prac-  
 tice, 484; iron, 487; magnesia, 491; zinc,  
 498  
 Sulphur, an excellent alterative and ingredient  
 in all applications for mange, 496  
 Summering of the hunter, consideration of, 86  
 Surfeit, description and treatment of, 350; im-  
 portance of bleeding in, 350  
 Suspensory ligament, beautiful mechanism of  
 the, 375; rupture of the, 375  
 Suspensory muscle of the eye, description of the,  
 166  
 Swallowing without grinding, 511  
 Swedish horse, description of the, 51  
 Swelled legs, cause and treatment of, 393;  
 most frequently connected with debility,  
 394  
 Sweetbread, description of the, 319  
 Sympathetic nerves, description of the, 153
- T**AIL, anatomy of the, 243; fracture of the,  
 449; docking, 466; nicking, 467  
 Tar, its use in veterinary practice, 497  
 Tares, a nutritive and healthy food, 136  
 Tartar, cream of, 493  
 Tartarian horse, description of the, 34  
 Tazsee horse, description of the, 34  
 Team, disadvantages of draught in, explained,  
 537; their united power not equal to the  
 calculation of so many horses, 537

## TEA

- Tears, the secretion and nature of the, 158; how conveyed to the nose, 158; sometimes shed by the horse from pain and grief, 158
- Teeth, description of the, as connected with age, 221; at birth, 221; 2 months, 222; 12 months, 223; 18 months, 223; the front sometimes pushed out, that the next pair may sooner appear, and the horse seem to be older than he is, 224; 3 years, 224; 3½ years, 225; 4 years, 225; 4½ years, 226; 5 years, 226; 6 years, 227; 7 years, 228; 8 years, 228; change of the, 224; enamel of the, 222; irregular, inconvenience and danger of, 230; mark of the, 232; frauds practised with regard to the, 225; diseases of, 230
- Temper denoted by the eye, 156; by the ear, 154
- Temperature, sudden change of, injurious in its effect, 122
- Temporal bones, description of the, 146
- Tendons of the leg, 370
- Tetanus, symptoms, causes and treatment of, 178
- Thessalian horses, account of, 10
- Thick wind, nature and treatment of, 296; often found in round-chested horses, 297
- Thigh and haunch bones, description of, 382; form of, 383; should be long and muscular, 383; description of the muscle, of the inside of the upper bone of, 383; do. of the outside, 383; mechanical calculation of their power, 377
- Thorough-bred horses, the quality of, has not degenerated, 67
- Thorough-pin, the nature and treatment of, 384; is not unsoundness, 523
- Thrush, nature and treatment of, 423; the consequence, rather than the cause of contraction, 424; its serious nature and consequences not sufficiently considered, 424; constitutes unsoundness, 523
- Thyroid cartilage of the windpipe, description of the, 257
- Tibia, account of the, 383, 368; fracture of, 427
- Tinctures, account of the best, 497
- Tips, description and use of, 438
- Tobacco, when used, 497
- Toe, seedy, 406
- Tongue, anatomy of the, 231; diseases of, 231; bladders along the under part of, 232
- Tonics, an account of the best, 497; their use and danger in veterinary practice, 497
- Toorkoman horse, description of, 36
- Torsion, the mode of castration by, 357; forceps, description of, 357
- Traces, the direction of them, very important in draught, 541, 542; proper angle of the, 542; the proper inclination of them, depending on the kind of horse and the road, 543; they should be inclined downward on rough roads, 543; inclined downward, the same as throwing a part of the weight on the shafts, 542; direction of them rarely attended to, 548; the manner of affixing them in South America, 545
- Trachea, or windpipe, description of, 258; inflammation of, 267

## VIC

- Tracheotomy, 472; operation of, 473
- Traction, the force of, illustrated by reference to the spring steelyards, 528; the proper line of, very important in draught, 547
- Trapezium bone, description of the, 367
- Travelling, different rate of, at different times, 94; comparison of rapid and slow, 540
- Tread, nature and treatment of, 415; often producing sand-crack or quittor, 415
- Tredgold, Mr., his comparison of moving power in draught, 540
- Tripping, an inveterate habit, 516
- Trochanter of the thigh, description of the, 383
- Trochlearis muscle, the, 167
- Trotter, the performance of the hackney as, 90
- Trotting, cruel exhibitions of, 91; action of the horse during, 535; position of the limbs in, unfaithfully represented in the Elgin marbles, and the church of St. Mark, 535
- Turbinated bones, description of the, 197
- Turkish horse, description of the, 36
- Turner, Mr. T., on clipping, 348
- Turnips, considered as an article of food, 137
- Turpentine, the best diuretic, 336; a useful ingredient in many ointments, 497
- Tushes, description of the, 226
- Twitch, description of the, 457
- U**LCEERS in the mouth, treatment of, 207, 231, 232
- Ulna, description of the, 364
- Unguiculata, a tribe of animals, 139
- Ungulata, a tribe of animals, 139
- Unilateral shoe, 435
- Unsoundness, contraction does not always cause it, 410; being discovered, the animal should be tendered, 524; ditto, but the tender or return not legally necessary, 524; the horse may be returned and action brought for depreciation in value, but this not advisable, 524; medical means may be adopted to cure the horse, they are, however, better declined, lest in an unfortunate issue of the case they should be misrepresented, 524
- Unsteadiness, whilst mounting, remedy for, 509
- Urine, albuminous, 339; bloody, 339
- V**ASTUS muscle, description of the, 383
- Vatican, the obelisk in the, curious method of moving it, 554
- Vehicles of draught, comparison of the best, 565, 567
- Veins, description of the, 303; inflammation of the, treatment of, 241
- Velocity, calculation of, 539, 540
- Vena portarum, the, 318
- Ventilation, importance of attention to, in stables, 122
- Verdigris, an uncertain medicine, when given internally, 484; a mild caustic, 484
- Vermin, account of, 357
- Vertebrae, the dorsal and lumbar, 246
- Vertebrate animals, what, 139
- Vices of horses, account of the, 502
- Vicious to clean, a bad habit that should be con-



## VIN

- quered, 510; to shoe, a bad habit that may also be conquered, 510  
 Vinegar, its use in veterinary practice, 475  
 Vines, Mr., his use of the Spanish fly in glanders, 481  
 Viper, account of the bite of, 498  
 Vision, theory of, 162  
 Vitreous humour of the eye, account of the, 165  
 Vitriol, blue, use of, in veterinary practice, 484

## WAGGON horse, the, 100

- Waggons, inferior horses may be used in them, compared with carts, 565; horses drawing, not so fatigued as in carts, 565; require fewer drivers, and are not so liable to accidents, 565; with inferior roads and ordinary horses preferable to carts, 565; with large front wheels, advantage of, 564; particularly with two horses abreast, 564; reason why they have more draught than two-wheeled carts, 566  
 Walking, movement of the legs in, 536; different when drawing a load, 536  
 Wall-eyed horses, what, 163; whether they become blind, 164  
 War-horse, description of the ancient, 58  
 Warranty, the form of a, 523; breach of, how established, 523; no price will imply it, 523; when there is none, the action must be brought on ground of fraud, 523  
 Warts, method of getting rid of, 357  
 Washy horses, description and treatment of, 327  
 Wasps, treatment of the sting of, 499  
 Water, generally given too sparingly, 138; management of on a journey, 139; the difference in effect between hard and soft, 138; spring principally injurious on account of its coldness, 138; stomach of the horse, the, 317  
 Water farcy, nature and treatment of, 214  
 Water conveyance, smallness of power required in, 548; resistance to, increases with the square of the velocity, 549; power to be exerted in, increases as the cube of the velocity, 549  
 Water-dropwort, poisonous, 499  
 Wax used in charges and plasters, 498  
 Weakness of the foot, what, 427  
 Weaving indicating an irritable temper, and no cure for it, 517  
 Weight, calculation of the power of the horse to overcome, 98, 534, 538  
 Wellesley Arabian, account of the, 73  
 Welsh pony, description of the, 104  
 Wheat, considered as food for the horse, 133, 137; inconvenience and danger of it, 133  
 Wheels, the principle on which they act explained, 527; effect of increasing the diameter of the, 570; no record of the time of their invention, 555; spoked, known to Homer, 555; little improvement of the principle of, from the earliest times, 555; principle of, on a level surface, 556; theory of the degree of friction attending them, 557; friction of on the axle, dependent on the material employed, 557; consideration of the various forms of, 559; dishing of, described, 560; advantages of, 560; conical and flat, calculation between the effects of, 565, 572; obliquely placed, ill consequences of, 561; narrow and broad, comparison between, 560; conical, strange degree of friction and dragging with, 561; travelling grindstones, 561; cylindrical, the best form, 561; description of, and proper rounding of the edges, 563; but influenced by the state of the road, 563; hind, should follow the precise track of the fore ones, 563; considered as to their effect on the road, 563; straddlers, description of, and their effect, 563; proper breadth of, in proportion to the load, 564; with cast-iron naves, 564; size of, 564; advantage of large front ones, 564; should have the spokes so arranged as to present themselves against the greatest force, 568  
 Wheezer, unsound, 519  
 Whip, accustoming the colt to the, 115  
 Whipping, sound, cruelty of, 98  
 Whispeter, the, anecdotes of his power over the horse, 502  
 Whistler, unsound, 519  
 White Turk, account of the, 64  
 White lead, use of, 490; vitriol, its use in veterinary practice, 498  
 Wild horse, description of the, 34, 37  
 William the Conqueror, improvement effected in the English horse by him, 56  
 Wind, broken, nature and treatment of, 297; galls, description and treatment of, 375; ditto, unsoundness when they cause lameness, or are likely to do so, 523; thick, nature and treatment of, 296  
 Windpipe, description of the, 258; should be prominent and loose, 259  
 Wind-sucking, nature of, and remedy for, 512  
 Withers, description of the, 250; high, advantage of, 251; fistulous, treatment of, 252  
 Work of the horse, should not exceed six hours per diem, 539  
 Worms, different kinds, and treatment of, 331  
 Wounds in the feet, treatment of, 419
- XENOPHON, his account of the horse, 15
- YELLOWS, symptoms and treatment of the, 335  
 Yew, the leaves of, poisonous, 499
- ZINC, its use in medicine, 498  
 Zoological classification of the horse, 107  
 Zygomatic arch, reason of the strong construction of the, 147  
 Zygomaticus muscle, description of the, 199

LONDON : PRINTED BY  
SPOTTISWOODE AND CO., NEW-STREET SQUARE  
AND PARLIAMENT STREET

# TO AGRICULTURISTS.

*'The opinion of the public has been pronounced in favour of this excellent book in a manner not to be mistaken. It is the best, the most comprehensive, and the most practical work on Agriculture in the English Language.'*  
GARDENER'S CHRONICLE.

In One Volume, 8vo. with nearly Thirteen Hundred Woodcuts, price 21s.

## LOUDON'S ENCYCLOPÆDIA OF AGRICULTURE,

COMPRISING THE THEORY AND PRACTICE OF THE

VALUATION, TRANSFER, LAYING OUT, IMPROVEMENT, AND MANAGEMENT  
OF LANDED PROPERTY, AND OF THE CULTIVATION AND ECONOMY OF  
THE ANIMAL AND VEGETABLE PRODUCTIONS OF AGRICULTURE.  
THE FIFTH AND CHEAPER EDITION.

LOUDON'S *Agriculture*, admitted to be the best work on Cultivation, is now brought within the reach of Bailiffs, Farm Stewards, Emigrants, and those Landed Proprietors who wish to provide their Tenants with a complete work on the Theory and Practice of Agriculture. The work consists of above 1,400 closely-printed pages, minutely classified in all the divisions of Laying Out, Cultivation, Improvement, and Management of large and small Farms, and every description of Landed Property; illustrated with above Twelve Hundred Engravings on Wood. A figure is prefixed for reference to every paragraph; and the whole number is upwards of Eight Thousand Five Hundred. The Tables of Contents and Illustrations occupy Sixteen Pages, printed in double columns. The following selections indicate the general nature and variety of the subjects comprised in the work:—

History of Agriculture among Ancient and Modern Nations  
History of Agriculture during the Middle Ages, or from the Fifth to the Seventeenth Century  
Present State of Agriculture in Europe  
Modern History and present State of Agriculture in the British Isles  
Of the present State of Agriculture in Ultra-European Countries  
Agriculture as influenced by Geographical, Physical, Civil, and Political circumstances  
Of the Study of the Vegetable Kingdom with a view to Agriculture  
Of the Study of the Animal Kingdom with reference to Agriculture  
Animal Chemistry; or the Substances which enter into the Composition of the Bodies of Animals  
Principles of Improving the Domestic Animals used in Agriculture  
Of the Study of the Mineral Kingdom and the Atmosphere, with reference to Agriculture  
Of Earths and Soils  
Of the Uses of the Soil to Vegetables  
Of the Improvement of Soils  
Rotation of Crops Of Manures  
Of the Agency of Heat, Light, Electricity, and Water in Vegetable Culture  
Of the Agency of the Atmosphere in  
Of Agricultural Implements and Machines drawn by Beasts of Labour  
Machines for Sowing and Planting  
Harrows or Pronged Instruments  
For Scratching the Surface Soil  
Rollers [the Crop  
Machines for reaping and gathering

Machines for Laying Land even  
Machines for threshing and otherwise preparing Corn for Market  
Mechanical and other fixed Apparatus for the Preparation of Food for Cattle, and for grinding Manure  
Buildings for Live Stock  
Buildings as Repositories, and for performing in-door Operations  
The Farmer's Dwelling-house  
Cottages for Farm Servants  
Stack-yard, Dung-yard, and other Enclosures immediately connected with Farm Buildings  
Union of the different Farm Buildings and Enclosures in a Farmery  
Fences used in Agriculture  
Gates and Bridges appropriate to Agriculture  
Of the Operations of Agriculture  
Manual Labours and Operations  
Agricultural Operations requiring the Aid of Labouring Cattle  
Of the Valuation, Purchase, and Transfer of Landed Property  
Of the Laying Out, or general Arrangement, of Landed Estates  
Plantations, and Woodlands  
Orchards [of an Estate  
Of Improving the Culturable Lands  
Embanking and otherwise protecting Lands from the Overflowing or Encroachment of Rivers or the Sea  
Irrigation, or the Improvement of Culturable Lands and Farmeries by the means of Water  
Irrigation of Arable Lands, and Subterraneous Irrigation  
Artificial Means of Procuring Water for the Use of Live Stock

Improvement of Lands lying Waste, so as to fit them for Farm-Culture  
Improvement of Lands already in a State of Culture  
Management of Landed Property  
Duties of Managers of Estates  
Selection, Hiring, and Stocking of Farms  
Considerations, respecting Himself, which a Farmer ought to keep in view in selecting and hiring a Farm  
Choice of Stock for a Farm  
General Management of a Farm  
Culture of Farm Lands  
Weeds or Plants injurious to those cultivated in Agriculture  
The Economy of Live Stock and the Dairy  
The Horse  
Varieties of the Horse  
Diseases of the Horse  
Veterinary Operations  
Veterinary Pharmacopœia  
The Ass The Mue and Hinny  
Neat or Horned Cattle The Ox  
Breeding of Horned Cattle  
The Dairy and its Management  
The Sheep The Swine  
The Goat, Rabbit, Hare, Dormouse, Deer, and various other Animals  
Animals of the Bird kind employed in Agriculture  
Fish and Amphibious Animals subjected to Cultivation  
Insects and Worms which are or may be subjected to Culture  
Animals noxious to Agriculture  
Of the present State of Agriculture in the British Isles  
Of the future Progress of Agriculture in Britain

*On the same plan as the above, and in 1 vol. uniform in size and price.*

LOUDON'S ENCYCLOPÆDIA OF GARDENING: Comprising everything relative to Flower Gardens, Kitchen Gardens, Landscape Gardening, Hothouses, Conservatories, &c. New and cheaper Edition, corrected and improved by Mrs. LOUDON; with many Hundred Woodcuts. Price 21s.

London, LONGMANS & CO.

# NEW WORK on the DISEASES of CATTLE.

In crown 8vo. with numerous Illustrations, price 7s. 6d.

## THE OX: HIS DISEASES AND THEIR TREATMENT:

*With an Essay on Parturition in the Cow.*

By J. R. DOBSON,

MEMBER OF THE ROYAL COLLEGE OF VETERINARY SURGEONS.

SECOND EDITION, THOROUGHLY REVISED.

SINCE the elaborate work of the late Mr. YOUATT, no complete treatise upon the Diseases of the Ox has been attempted; and it is in some measure to supply this deficiency that the Author has ventured upon the publication of this treatise. His information is derived from nearly fifteen years' experience in country practice.

The Author has endeavoured, as far as possible, to avoid the use of technical terms, so as to render the work comprehensible to those for whom it is chiefly written—the farmer and stock-keeper. He has, at the same time, no wish to make 'every man his own cattle-doctor,' feeling convinced that those best consult their own interests who in all cases of difficulty or danger at once call in the aid of the properly qualified professional man.

### EXTRACTS FROM REVIEWS.

'To farmers and breeders of stock this book will be of great utility, as in it all the ills to which the bovine species is liable are described in language intelligible to all.' MIDLAND COUNTIES HERALD.

'Every farmer and stock-keeper should possess himself of this treatise. . . . By all means let our farming and stock-keeping friends put this work upon their tables, ready for perusal.' LEICESTER ADVERTISER.

The Author has no wish to make every man his own cattle-doctor; but it is for the farmer and stock-keeper that his book has been chiefly written, and it will certainly enable them often to decide, without professional advice, upon the treatment which their live stock may require.'

ATHENÆUM.

'In the work before us we find everything required to be known by the stock-breeder. Mr. YOUATT wrote an excellent book, it is true, upon this subject, but it is more adapted for the veterinary surgeon than the farmer, who requires a treatise divested as much as possible of technical terms. It is the very book to be in the hands of every intellectual farmer in the kingdom, as it well supplies a deficiency which has long been felt.'

DERBY REPORTER.

'A work full of practical advice to farmers, graziers, and dairymen.'

MORNING POST.

'His intention was, he says, to make his book comprehensible by the farmer and stock-keeper, and we think he has fairly succeeded.'

SPECTATOR.

'We consider the work before us, from its character, its convenient size, and its freedom from unnecessary technicalities, likely to prove exceedingly useful in the hands of breeders and stock-keepers.'

BELL'S WEEKLY MESSENGER.

'The present volume contains the most modern and approved methods of cure, expressed in simple language, unfettered as much as possible with technical terms, which renders it the more acceptable to the general reader.'

MARK LANE EXPRESS.

'The Author's directions are plain and popular. The farmer and stock-keeper, for whom the work is especially intended and adapted, will have no trouble in following Mr. DOBSON in his descriptions, as well as in his directions, diagnosis, and prescriptions. The veterinary practitioner or the cow-keeper who has not read Mr. DOBSON'S book has much to learn in his profession or calling.'

MORNING ADVERTISER.

London, LONGMANS & CO.

Webster Family Library of Veterinary Medicine  
Cummings School of Veterinary Medicine at  
Tufts University  
200 Westboro Road  
North Grafton, MA 01536

