

UC-NRLF



SB 103 107

LIPPINCOTT'S HOME MANUALS

Not to be taken from Room 303



HOUSEWIFERY

L. RAY BALDERSTON, A.M.

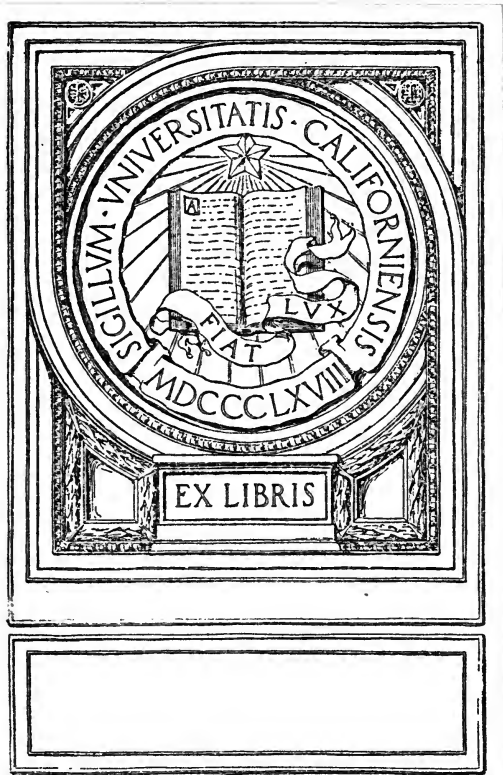

Ag. 66





"Survey our empire and behold our home!"
—BYRON.

LIPPINCOTT'S HOME MANUALS

EDITED BY

BENJAMIN R. ANDREWS, Ph.D.

ASSISTANT PROFESSOR OF HOUSEHOLD ECONOMICS, TEACHERS COLLEGE,
COLUMBIA UNIVERSITY

HOUSEWIFERY

A MANUAL AND TEXT BOOK
OF PRACTICAL HOUSEKEEPING

By LYDIA RAY BALDERSTON, A.M.

INSTRUCTOR IN HOUSEWIFERY AND LAUNDERING, TEACHERS COLLEGE,
COLUMBIA UNIVERSITY, NEW YORK CITY

LIPPINCOTT'S HOME MANUALS

Edited by BENJAMIN R. ANDREWS, PH.D.
Teachers College, Columbia University

CLOTHING FOR WOMEN

By LAURA I. BALDT, A.M., Teachers College, Columbia University.
454 Pages, 7 Colored Plates, 202 Illustrations in Text.

SUCCESSFUL CANNING AND PRESERVING

By OLA POWELL, Department of Agriculture, Washington, D. C. 425
Pages, 5 Colored Plates, 174 Illustrations in Text. Third Edition.

HOME AND COMMUNITY HYGIENE

By JEAN BROADHURST, Ph.D. 428 Pages, 1 Colored Plate, 118 Illustrations in Text.

THE BUSINESS OF THE HOUSEHOLD

By C. W. TABER, Author of *Taber's Dietetic Charts*, *Nurses' Medical Dictionary*, etc. 438 Pages. Illustrated. Second Edition, Revised.

HOUSEWIFERY

By L. RAY BALDERSTON, A.M., Teachers College, Columbia University.
351 Pages. Colored Frontispiece and 175 Illustrations in Text.

LAUNDERING

By LYDIA RAY BALDERSTON, A.M., Instructor in Housewifery and
Laundering, Teachers College, Columbia University. 152 Illustrations.

HOUSE AND HOME

By GRETA GREY, B.S., Director of Home Economics Department,
University of Wyoming. Illustrated.

MILLINERY (*In Preparation*)

By EVELYN SMITH TOBEY, B.S., Teachers College, Columbia University

LIPPINCOTT'S FAMILY LIFE SERIES

Edited by BENJAMIN R. ANDREWS, PH.D.
Teachers College, Columbia University

CLOTHING—CHOICE, CARE, COST

By MARY SCHENCK WOOLMAN, B.S. 290 Pages. Illustrated. Second
Edition.

SUCCESSFUL FAMILY LIFE ON THE MODERATE INCOME

By MARY HINMAN ABEL. 263 Pages.

THE FAMILY AND ITS MEMBERS

By ANNA GARLIN SPENCER, Special Lecturer in Social Science, Teachers
College, Columbia University.

UNIV. OF
CALIFORNIA



VARIOUS SILVER CLEANERS

LIPPINCOTT'S HOME MANUALS
EDITED BY BENJAMIN R. ANDREWS, Ph.D.
Teachers College, Columbia University

HOUSEWIFERY

A MANUAL AND TEXT BOOK
OF PRACTICAL HOUSEKEEPING

BY

LYDIA RAY BALDERSTON, A.M.

INSTRUCTOR IN HOUSEWIFERY AND LAUNDERING, TEACHERS COLLEGE, COLUMBIA
UNIVERSITY, NEW YORK CITY
AUTHOR OF "LAUNDERING"

175 ILLUSTRATIONS IN TEXT

SECOND EDITION, REVISED



PHILADELPHIA AND LONDON
J. B. LIPPINCOTT COMPANY

To Replace
392216

TX145
B3
1921

COPYRIGHT, 1919, BY J. B. LIPPINCOTT COMPANY
COPYRIGHT, 1921, BY J. B. LIPPINCOTT COMPANY

~~Household Art Department~~

*Electrotyped and Printed by J. B. Lippincott Company
The Washington Square Press, Philadelphia, U. S. A.*

AFFECTIONATELY DEDICATED

TO

E. M. BALDERSTON

539976

**“The poetry of life always
has a practical side to it, and
most practical affairs rightly
worked out are full of poetry.”**

PREFACE

THIS handbook of practical housekeeping is offered to women in the hope that it may show in some measure how to reduce tasks in the home and how to save time, money, and energy. This book will be of direct help to the many women who do their own work or supervise household employes and who are seeking guidance by consulting reference books as other professional workers do. The book is the outgrowth of many years of experience in housekeeping and in teaching housewifery to groups of practical housekeepers, with emphasis upon the technical processes of the home. It is designed to help not only the individual home woman but to serve as a text for study groups of rural extension and other club-women and in the housekeepers' courses given by schools and colleges. Any further study of the sciences, directly or indirectly connected with housewifery, may be carried on by means of the references suggested throughout the book.

Because of the many requests from former students, who are now teachers, for a book that brings housewifery topics within one cover, the author offers these suggestions from her experience. It is hoped that the outline of courses, the bibliography, and the suggestions for laboratory supervision will meet the need so often expressed by teachers.

The prices stated in the book are merely to give relative value, and can not be considered as definite in any locality.

It is with much appreciation that the author acknowledges assistance in reading the manuscript to Dr. B. R. Andrews, Teachers College; Miss Matilda J. McKeown, formerly Instructor of Housewifery, Teachers College; and Professor Emma H. Gunther, Department of Household Administration, Teachers College.

L. RAY BALDERSTON.



ACKNOWLEDGMENTS

ACKNOWLEDGMENT is herewith made for the use of illustrative material as follows:

Figures 1, 5, 6 and 7, drawn by Marcia Mead, of Schenck & Mead.

Figures 17, 18 and 19, U. S. Government Bulletin.

Figures 20 and 22, Standard Plumbing Company, Pittsburgh, Pennsylvania.

Figure 27, Home Helps Company, New York City.

Figure 29, J. L. Mott Iron Works, Newark, New Jersey.

Figure 33, Dangler Stove Company, Cleveland, Ohio.

Figure 44, Richardson & Boynton, New York City.

Figures 51 and 94, Consolidated Gas Company, New York City.

Figure 53, The Cleveland Metal Products Company, Cleveland, Ohio.

Figure 55, H. R. Corwin Manufacturing Company, Newark, New Jersey.

Figure 58, U. S. Department of Agriculture.

Figure 59, Caloric Cooker Company.

Figure 65, Janes & Kirtland, New York City.

Figures 70 and 71, Chas. N. Kain, Pittsburgh, Pa.

Figure 74, Dodge & Zuill, Syracuse, New York.

Figure 75, Hurley Manufacturing Company, New York City.

Figure 76, 1900 Manufacturing Company, Binghamton, New York.

Figure 77, Joseph L. Cohen, New York City.

Figure 78, Hill Dryer Company, Worcester, Massachusetts.

Figure 80, Chicago Dryer Company, Chicago, Illinois.

Figure 83, Roma Manufacturing Company, Chicago, Illinois.

Figure 87, Duntley Pneumatic Sweeper Company, Chicago, Illinois.

Figure 88, Franc Premier Company, Cleveland, Ohio.

Figure 89, Cadillac Cleaner Company, Chicago, Illinois.

Figure 136, E. C. Stearns & Company, Syracuse, New York.

Figure 159, The Metal Sanitary Toilet Cleaner, J. Anderson, New York City.



CONTENTS

CHAPTER	PAGE
I. HOUSEWIFERY AS A BUSINESS.....	1
II. PLUMBING.....	21
III. HEATING AND LIGHTING.....	52
IV. EQUIPMENT AND LABOR-SAVING APPLIANCES—I.....	84
V. EQUIPMENT AND LABOR-SAVING APPLIANCES—II.....	103
VI. HOUSEHOLD SUPPLIES.....	129
VII. HOUSEHOLD FURNISHINGS.....	148
VIII. STORAGE.....	204
IX. CLEANING AND CARE OF ROOMS, BEDS, BATHROOM, KITCHEN, METALS.....	240
X. CLEANING AND RENOVATION.....	273
XI. DISINFECTANTS AND FUMIGANTS.....	297
XII. HOUSEHOLD PESTS.....	307
XIII. SUGGESTIONS FOR TEACHERS.....	318



HOUSEWIFERY

CHAPTER I

HOUSEWIFERY AS A BUSINESS

“HOUSEWIFERY is the business of the mistress of the family.” If this definition were analyzed in detail, we should find the word “business” meaning concern; “mistress,” the person versed in everything; and “family,” a group of individuals living under one roof. Thus, to enlarge the definition, it would read: Housewifery is the concern of the person versed in everything pertaining to a group of individuals living under one roof.

The accepted fact to-day is that every housewife ought to become as proficient in her realm as the business man is in his. As a man can not do good work without the best facilities and the most careful organization in his office, so the housewife is handicapped unless her workshop is suitably planned and arranged.

In order that the plan of the house add to the efficiency of the housewife's work, there should be careful consideration given to the division of the space in the house, because it is only through dividing and planning that there can be any real organized business.

Division of Space in the Home.—Any house already built may involve conditions that are not ideal, but the division of most homes is into three parts: the work unit, the recreation unit, and the rest unit. No matter how small the house is, this division is automatically made. It increases or decreases in area according to the income, and the size of the family.

Work Unit.—The work unit of the house includes the kitchen, the pantry, the laundry, and the cellar. As long as this group of rooms is literally a workshop, these rooms must not only be arranged to give the worker good light, but the various tools and equipment ought to be so placed that the housewife is saved the fatigue which results from taking unnecessary steps, and from carrying tools and materials a greater distance than is necessary.

The *kitchen* work-shop itself is to be arranged by division into units. The units are controlled by different processes. For example, the mixing of food is usually at a table or cabinet with the shelves above it; the processes of cooking and baking are done around a stove; the washing of foods and dishes is done at a sink; so that the table, the stove, and the sink, each becomes a center of these units, about which should be placed the necessary small utensils and equipment.

In a large kitchen, as in many farm house kitchens, it will be a great saving if the room be divided by an imaginary line into the work part of the kitchen and the rest part. Under these conditions, a large kitchen is not a handicap (except for the extra space to clean) because it makes better ventilation possible; and if, in the work part of the kitchen, one groups in a close relationship stove, table, and sink, one not only reduces the work of the large kitchen but gains the benefit of better air. The housekeeper, who has so many interruptions in her work, might use this rest portion of her kitchen for her sewing machine and a small table, so that it would be possible for her to do some of her sewing, reading or studying during the time she is watching her food.

In the *laundry* there are two distinct units, so that automatically the laundry divides itself into parts, one where the washing is carried on, and the other where the ironing is done. The stove is the connecting link between these two laundry units and should be placed so that it is convenient to each.

The *pantry* is a part of the work unit, connecting the kitchen and the dining room. The dining room is between the work unit and the recreation unit, and therefore in its plan is influenced by both units. The efficiency of the pantry is increased by having a sink and sufficient closet room so that all the work of serving and clearing away may be done without going the greater distance into the kitchen. Such a pantry is called a butler's pantry. In order that it serve its purpose best, there should be two doors, one into the kitchen and one into the dining room. A kitchen pantry having only one door is less convenient.

When the housewife has all the work to do herself, she may not care to consider the butler's pantry, but instead may secure a close relationship between the dining room and the kitchen by having a large window-like opening made in the wall, fitted with a glass or

wooden slide to reduce the work of serving. To add to the convenience of such a slide, plan large shelves on both sides so as to have plenty of room for the dishes. Standing a screen on the dining room side will make this window serve the purpose of a pantry, and do away with the extra walking which the width of a pantry requires.

Recreation Unit.—The recreation unit may be one room, the living room, in which the family may assemble. Whether it also includes a library, a parlor, a reception room, a den, and other special rooms and porches, depends entirely upon the method of living of the family. The dining room belongs equally, of course, to the recreation unit.

Rest Unit.—The rest unit depends largely upon the number in the household. This is true to such an extent that if an architect is called for advice, the house plans are made around the number of bedrooms required. The bathroom belongs to this unit, and the comfort and convenience of the family depends to a large extent on the placing of the bathroom, and its relationship to the bedrooms. Every effort should be made to have this unit quiet, and accessible without going through the other two units. The arrangement of the hallways will be entirely responsible for this.

Small individual bedrooms, while making a larger house, are greatly preferred so that each may have his own room. Bedrooms are decidedly rooms for the individual. A guest room might be put in an especially quiet part of the house, for then it might be used as a sick room if needed. Each bedroom should have, if possible, two windows opening in different directions so as to secure currents of air, for much of the comfort of the night's rest will depend upon this. Let no architect's plea for low-lying roofs, which reduce the exposure of bedrooms to a single direction, have weight compared with the standard of "two windows for every bedroom, opening in different directions." The rest unit should have all the sunlight possible, remembering that the sun is one of the best disinfectants.

As the rest unit is best placed on the south or sunny side of the house, so the work unit may be placed at the north of the house, because these rooms require artificial heat in the work processes, then in winter they will be warm enough, and in summer they will be cooler away from the sun. The choice position for

the dining room is at the east, because the cheer of early morning sun is pleasanter than that of the low setting sun if the dining room were on the west.

Halls or passageways may connect the three units. This relationship, properly established, does much toward increasing the efficiency of the house and reducing its labor. The hallways make convenient the passing from one division of the home to another, improve ventilation, facilitate supervision, and may make the home more attractive by an interrelation of color in walls and furnishings. Houses without halls may not only be noisy, especially in the rest center, but, unless carefully planned, will not make for privacy.

All of these things may not be possible in a house which one rents, but in a new house they are possible through the suggestions of the housekeeper, her help in making architects' plans, and her coöperation with the builder.

Housewife's Suggestions to Architect.—If this thought of establishing units is kept in mind by the housewife, the new home may be planned in a most efficient manner, for there will be a close relationship of doors to the yards and to stairways, and windows will be so placed as to produce not only cross ventilation but to give proper light on the work. Wall spaces will be planned so as to furnish suitable backgrounds for the placement of stoves, tubs, sinks and furniture.

Cellar stairs should bring a close connection between kitchen and cellar; coal bins in the cellar should be so connected with the outside windows as to allow direct delivery of coal into the bins; and the furnace and the bin for furnace coal should be close enough together to eliminate the strain of carrying coal. Kitchen coal or wood, if not just outside the kitchen door, should be in a bin near the stairs leading from the cellar to the kitchen. To make the journey down cellar as easy as possible, plan comfortable cellar stairs that are not too steep, that is, with a wide tread and a step not too high; and for safety, plan that the stairs be well lighted from a window if possible, and certainly by the proper arrangement of artificial lighting.

Every workshop must have thorough ventilation. It is a proved fact that much fatigue and thus, indirectly, many accidents are caused by poor ventilation. The best ventilation is by windows which give cross drafts. Where such windows cannot possibly be

secured, transoms over doors add much to better ventilation; an objection to them is a greater possibility of noise and correspondingly less privacy.

For the convenience of cleaning, and for sanitary reasons, curved baseboards in kitchen, laundry, and bathroom, should be considered in the planning of a new house. If an old house is being made over, it is possible to set in a curved foundation, if a new floor is to be laid over the old.

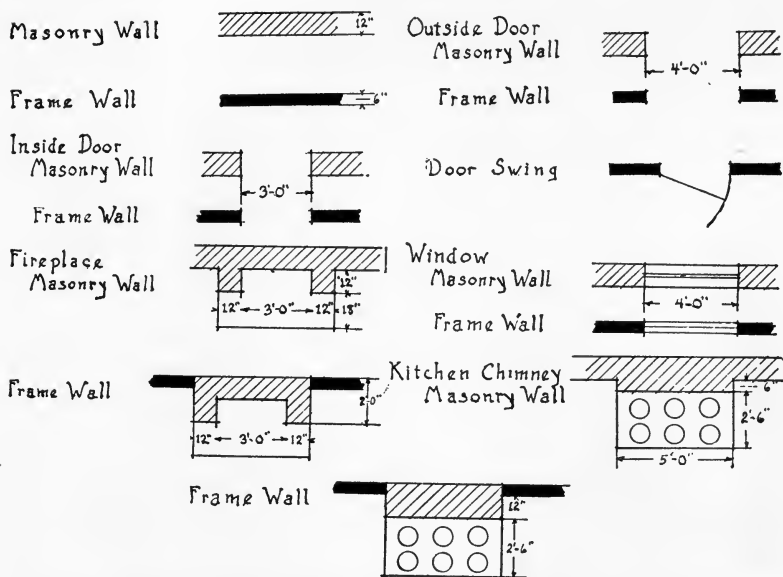

FIG. 1.—Architect's method of indicating houseplans. Easily drawn on special paper which is blocked off in quarter inch squares. Allow 1/4 inch for a foot.

That the housewife may be able not only to help make plans for the new house, and changes in the old, but to express herself to the architect so that he in turn may know what she wants, these drawings expressed in architectural form are presented to assist her. Figs. 1, 2, 3, 4 give examples of the various conventions used in architects' drawings. Figs. 5, 6, and 7 are architects' drawings of typical houseplans—for, respectively, a workman's house, a farm house, and a Colonial house.

Space for Furniture.—After the plan for the house has been made, and before it is accepted as final, the housewife should check up some very important points. For example, does the wall space in the bedroom allow for a space for the bed? Whether the furniture has been purchased or not, there are obviously certain pieces of furniture that will have to be placed in the house. In order to have the proper space for these pieces of furniture, she can measure and (to the same scale as the house plans) cut pieces of cardboard which represent the large pieces of furniture. These pieces of cardboard may be moved on the plan, and if the measurements are accurate, they will prove whether the space allowed for the bureau or bed or sideboard is large enough. If she has not

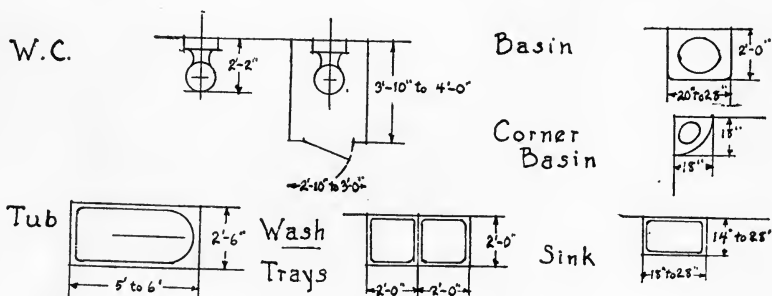

FIG. 2.—Indicating plumbing fixtures.

bought the furniture, she should measure for the standard sizes of furniture as found in the stores, and this standard may well be taken as a minimum space, anyway.

Placing Tools and Equipment.—After the house is planned, consideration next is given to purchasing tools and equipment, in fact, all the things needed for work. The housewife may buy her equipment and arrange her work-shop so that it represents the possibility of the greatest amount of work with the least possible cost for equipment, and the least possible expenditure of effort in accomplishing the work. (For suggestions which may be of service in buying equipment, see chapter on Equipment and Labor-saving Appliances.)

Until the housewife realizes that the standard of equipment she uses and the way it is arranged represent two-thirds of the

household work problem, she has not fully started the business of housekeeping. Until then she has no right to check up a maid as to whether she is slow or unskilful, because the best trained woman is handicapped in producing standard results if her tools are poorly selected and poorly arranged.

Makeshifts of tools may represent temporary money economy, but often there would be permanent money economy if the right tool

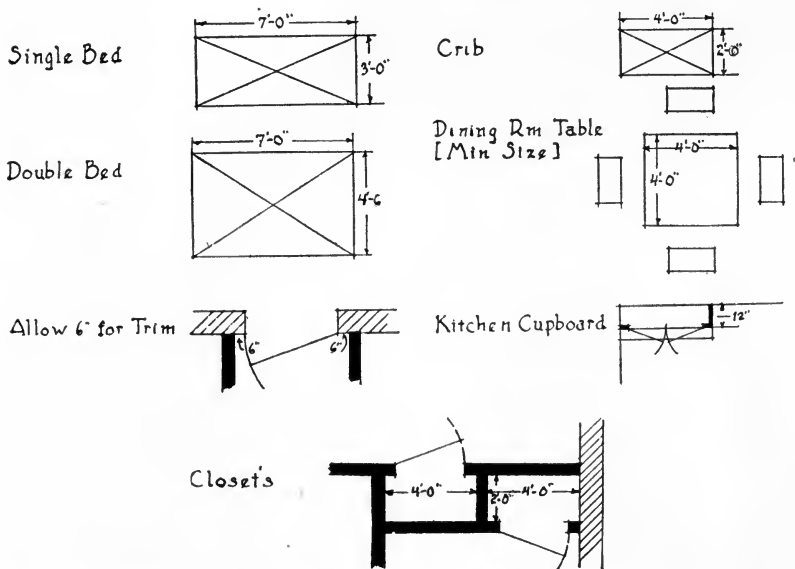

FIG. 3.—Indicating beds, tables, closets.

were chosen for the special task. It is on this point that the business man excels the woman in her business of housekeeping, for he plans to get the right tool, while she often plans to see how long she can do without buying it.

The best tools, poorly arranged, may give only fifty per cent. of their efficiency. Here again, in industry, men standardize tools and shop organization, selecting not only the best tools, but assembling them so that they may be used by the worker without loss of time and effort, thus securing a corresponding reduction of fatigue. A good example of assembling tools and small utensils in a

STAIRS

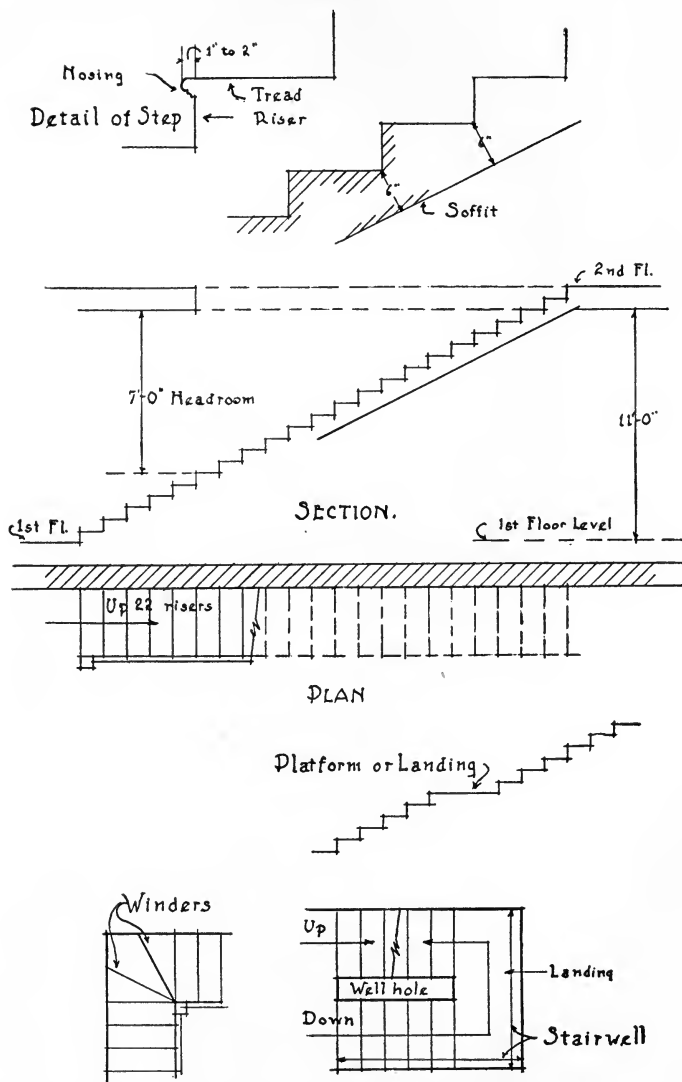

FIG. 4.—Indicating stairs and landings. The landing should be the width of the stairway.

kitchen might be taken from that of a chef's table in a hotel or a cook's kitchen on shipboard, where everything must be "ship shape." The arrangement of the rack above the table, the hooks beneath or at the side, the deep shelf or the additional shelf—all these bring the tools together and represent that well-organized economy which makes for scientific housekeeping.

Certain things have been done for so long—almost centuries—that the new ideas, so called, of the housewife are often considered non-workable. The placing of a washtub is one of the best illustrations of this, because almost since set washtubs have been in existence, they have been placed with their backs to the window. Such a position for a tub not only produces a strain on the worker's eyes, but is in no way as satisfactory as the side light secured by placing the tubs at the side of a window. The same rule holds good for placing sinks.

A most important point, too, is the height of tubs and other working surfaces. Until the last few years a woman who stood erect seems not to have been credited with doing work, because all her equipment has been placed so that she not only stoops over her work, but almost crouches over it. The whole idea of high washtubs and sinks is so modern that the housewife will find it difficult to obtain them to-day unless she stands guard over the work as the architects and plumbers are making their measurements and installations. Tables can be made higher; stoves can be lifted; portable ironing boards and washtubs can be made higher with so little cost that it is only the matter of the housewife demanding that the change be made. Sinks and stationary washtubs, however, can not be changed without some expense attached. For this reason, it is important that they be properly placed in the beginning if possible; if not, it may be worth the extra expense to have them lifted to a height that will be comfortable for the worker.

Standardizing.—*Tools and Tasks:* Fully as important, in turn, as the right selection and placement of tools and equipment is the matter of standardizing them for the work they have to do. The woman who has had training automatically tries to reduce the time and effort required for her work, and by means of her training becomes vitally interested in cutting down the time and eliminating unnecessary motions in her household tasks. Housework is indeed fascinating and interesting and much of its monotony

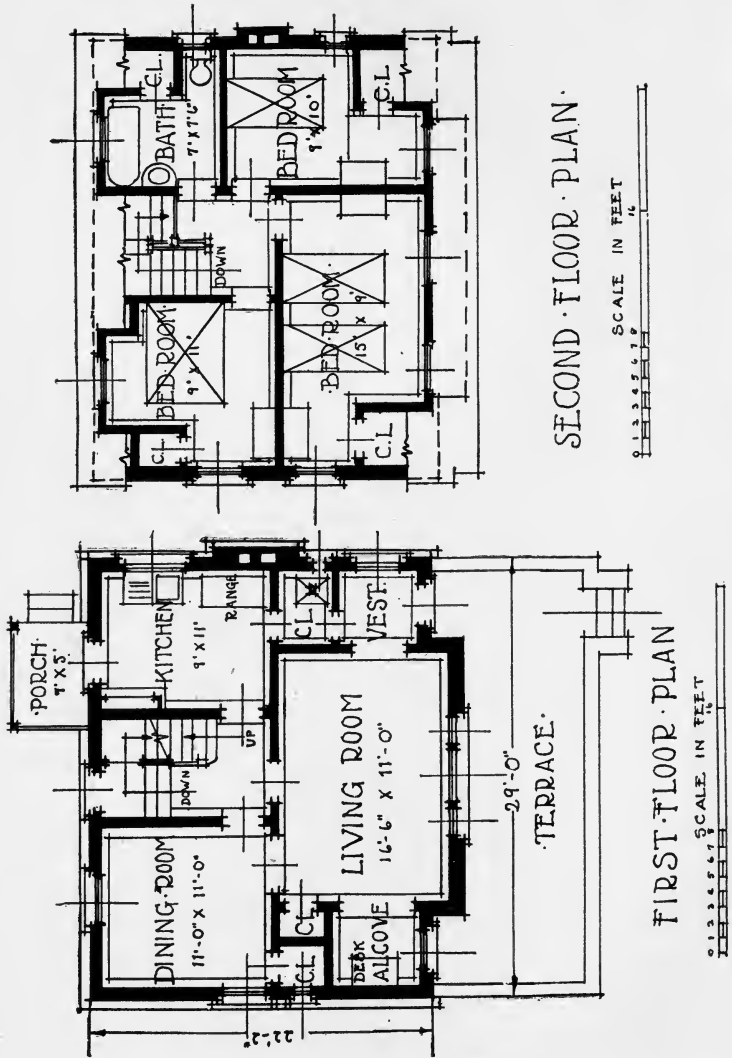

FIG. 5.—Workman's house. The living room may be planned as a dining room, leaving the dining room as a down-stairs bedroom, if needed.

is gone when she really "plays the game" intently. From this time-and-motion-study, she will learn not only how to do her work more scientifically, but the next time she purchases tools she will make a wider selection and a wiser choice in what she buys, because she has learned how some things hinder and other things help in her work.

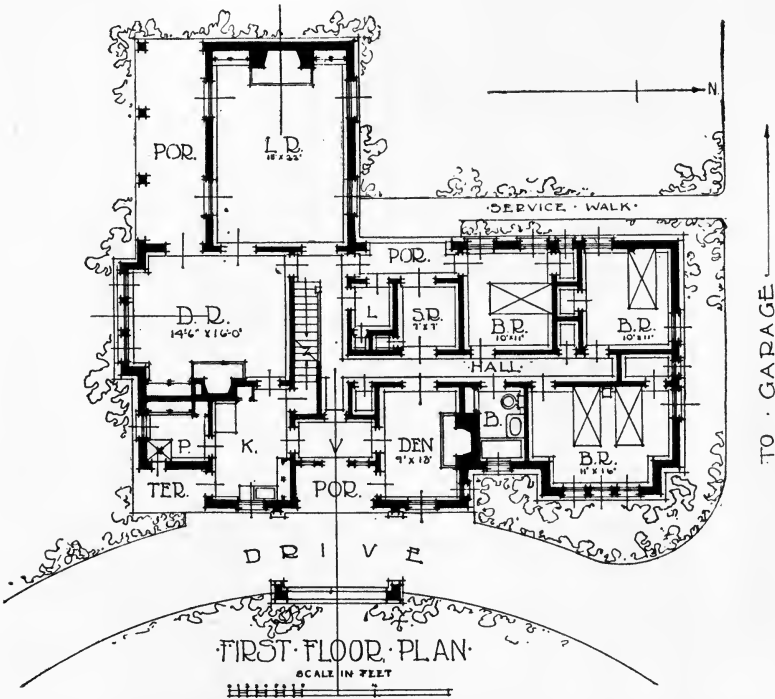
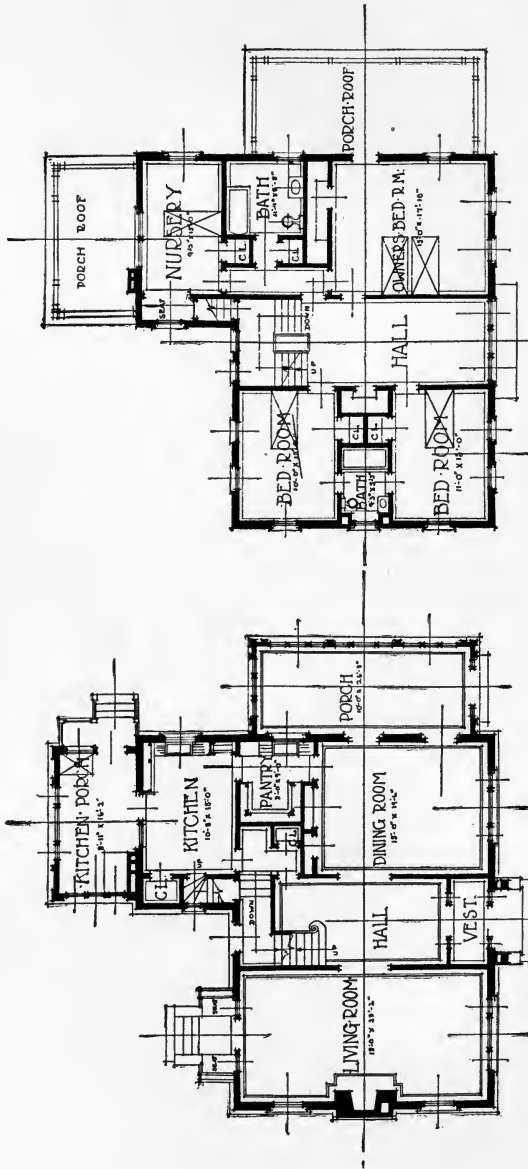

FIG. 6.—Farmhouse. The good feature of this plan is that it is a compact bungalow plan with each unit so distinct that it may be entirely closed off. Planning the kitchen to face the road adds cheer.

How many housewives have counted the motions necessary and unnecessary and kept account of the time in making a bed or cleaning a bathtub? Have they ever taken account, in making a bed, of the unnecessary steps in going from the bed to the chair where the clothes are airing? How many unnecessary motions

HOUSEWIFERY



FIRST FLOOR PLAN SECOND FLOOR PLAN
 Fig. 7.—Colonial house. Good plan for efficiency and comfort.

are used in the process of making? Of course, the gain from such a study is to see how the effort may be reduced and the standard of the finished product remain the same.

For a comparative study where tools and materials enter in, a bathroom might be chosen. The type of brush used versus a cloth; the question of soap powder versus soap; the rinsing by a bath spray versus filling the tub with water; a soft spongy cloth versus none, when a tub is spotted—all these play a part in the study. Such a study can in no way be called standardizing of tasks unless the worker has an ideal, and unless she is willing to check herself by many studies. But even brief efforts with such studies will prove stimulating and practically helpful.

If the housewife is interested in such a study, it will not take her long to note that the results are influenced by the skill of the worker, by the height of the working surface, by the tools and supplies being fitted to their tasks, and even by the time of day and the consequent fatigue of the worker. If she has become interested in any one study, she will soon find herself going about all the different tasks of housework, testing how these time-and-motion studies may be applied to routine processes like window washing, setting the table, dusting, and the like. She will become so interested in the study that the so-called drudgery of housework becomes an interesting game.

Score-Cards: Score cards are like a tally sheet in which rating of some task or tool or material is made on a percentage basis. The sum total for perfect conditions or results equals 100 per cent., and less perfect conditions are correspondingly reduced in score. The plan is to list in score form the various essential elements, and assign a number of points to each in proportion to its importance in the ideal. For example, score cards for testing bread are used in schools and in county fairs. Score cards have been widely used for tests of dairies and in agricultural experiment stations. Recent use has been made of them in scoring restaurants, housing conditions, etc.

While little has been done by the housewife, largely because each home has been thought such an individual problem, she may with profit make a test score card for herself. Examples are given below which might be modified to be fitted to her use.

HOUSEWIFERY

KITCHEN SCORE CARD

<i>Location:</i>		
Exposure	5	
Place in house	5	10
<i>Plan:</i>		
Size	5	
Proximity to cellar, pantry, dining room.....	5	
Division of space for work.....	5	
Window arrangement	5	
Closets	5	25
<i>Interior finish:</i>		
Floor-material	10	
Wall-material	3	
Color	2	15
<i>Sanitation:</i>		
Ventilation	5	
Cleanliness	5	10
<i>Equipment:</i>		
Choice of—for efficiency	10	
Arrangements—		
Working centers	5	
Grouped utensils	5	
Routing	5	
Condition	10	
Height of working surfaces.....	5	40
<i>Total</i>		<u>100</u>

SCORE CARD FOR GARMENTS

<i>Style:</i>		
Appropriate for purpose	5	
Appropriate for person	5	
<i>Material:</i>		
Color	5	
Kind	10	
Amount	5	
Trimming	5	
<i>Form:</i>		
Conformation to figure	9	
Uniformity } in shaping or cutting.....	16	
Accuracy }		
<i>Workmanship:</i>		
Uniformity	10	
Seams	10	
Stitching	10	
Finish	10	
<i>Total</i>		<u>100</u>

Organization.—In this business of housekeeping, the housewife must learn to organize. In business one of the most important principles of organization is a definite plan of work. This is just as necessary for the housewife in organizing and arranging the affairs of her household as for the business man.

Schedules: As the housewife becomes more and more proficient, she is better able to map out working schedules or plans for various tasks about the house. No one knows how much time to plan for a task until one has done it, and it is by just such planning and then checking of the plan by doing, that the housewife becomes a better business manager both of her own time and of her household employee if she has one.

Schedule Without Help.—The housewife without employed help has duties so varied that they are difficult to reduce to an exact program, or schedule. The exact duties and the amount of time each will require will vary according to such conditions as: life in city or in country; house or apartment living; size of family and ages of children; income available; etc. The following schedule is an estimate indicating the kinds of duties and the approximate amount of time necessary for each in a household where the mother does all the work:

Kind of work	Hours each day for regularly recurring tasks	Occasional additional hours per week
Food work.....	4- 6	2- 4
Laundry—washing	3- 5
ironing.....	4- 6
Care of clothing.....	1- 4
House care, cleaning, etc.....	1- 2	4
Children and miscellaneous.....	2- 3	2
Management, accounts, planning	1- 3
Total.....	7-11 hrs. per day and	17-28 additional hrs. per week

If the tasks in the second column are distributed through the week, an average of two to four hours a day would be called for, in addition to the seven to eleven hours for regular daily tasks of the household. This means a nine- to fifteen-hour work day for the

woman who does all her own work. In such a household it is very important for the housewife to have a daily schedule of special tasks: washing day (Tuesday is better than Monday); ironing day; baking day; cleaning days; mending day. Some items of work, for example, cleaning of silver, may well be brought in only

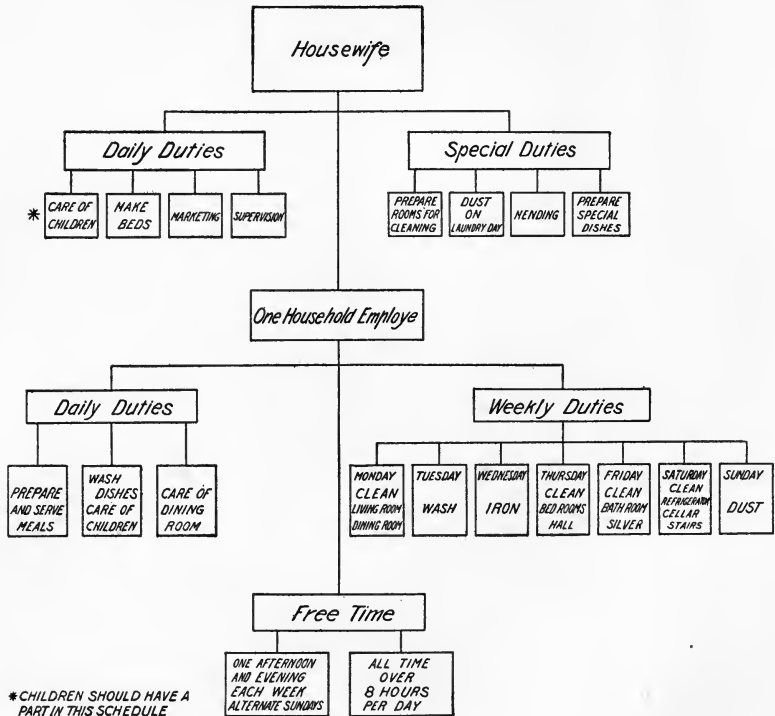
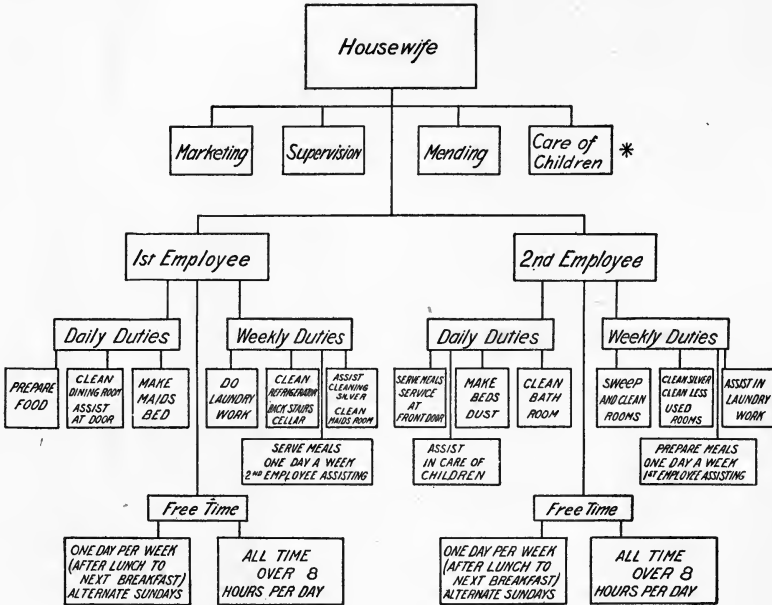

FIG. 8.—Chart showing duties of the housewife and maid and their relationship. Such a plan adds to the ease of checking up work schedules.

once in two weeks. It is also important for her to consider what work she can hire; for example, the family washing done by rough-dry method at pound rates.

Schedules with Employed Help (Figs. 8 and 9).—The housewife may list duties for which she is responsible, and plan how and when she will do them; if she employs one or more maids, the

greater the need for being able to present to them a similar list of duties. In making out the schedule she must take into account the number of rooms in the house, the size of the family, the number of guests, outside assistance (in washing, etc.), days off of helpers, etc. A good way to begin would be to list regular duties for every day in the week, such as cooking, washing dishes, bed making, and dusting. The next thing is to note special cleaning



* CHILDREN SHOULD HAVE A PART IN THIS SCHEDULE

FIG. 9.—Chart showing a larger organization as needed for two maids.

on certain days every week, and special cleaning on certain days every other week. If this is done, there can be schedules so that there will be an equal amount of cleaning every week. It is desirable that children have small household tasks and these too should be brought into the plans.

With either schedule, apportion the work so that no day is overcrowded, so that rest periods are possible for one or both helpers. It can be done—here is where the housewife's knowledge of the time required for each task is reflected in the organization.

Hour ServiceFor Professional PeopleTwo Maids

FIG. 10.—Chart showing time of hour service. Today when many housewives are having hour service instead of week service, such a chart is of great help, especially when there are several in service. Each broken vertical black line represents one person's hours of work.

One way to arrange work to advantage is as follows:
 Each week clean rooms used most.
 Once in two weeks clean silver.

Once in two weeks (alternate with cleaning silver) clean the rooms used least.

Should weekly cleaning for each part be demanded, either an outside helper would have to be employed, or the housewife assist in doing some of the work herself.

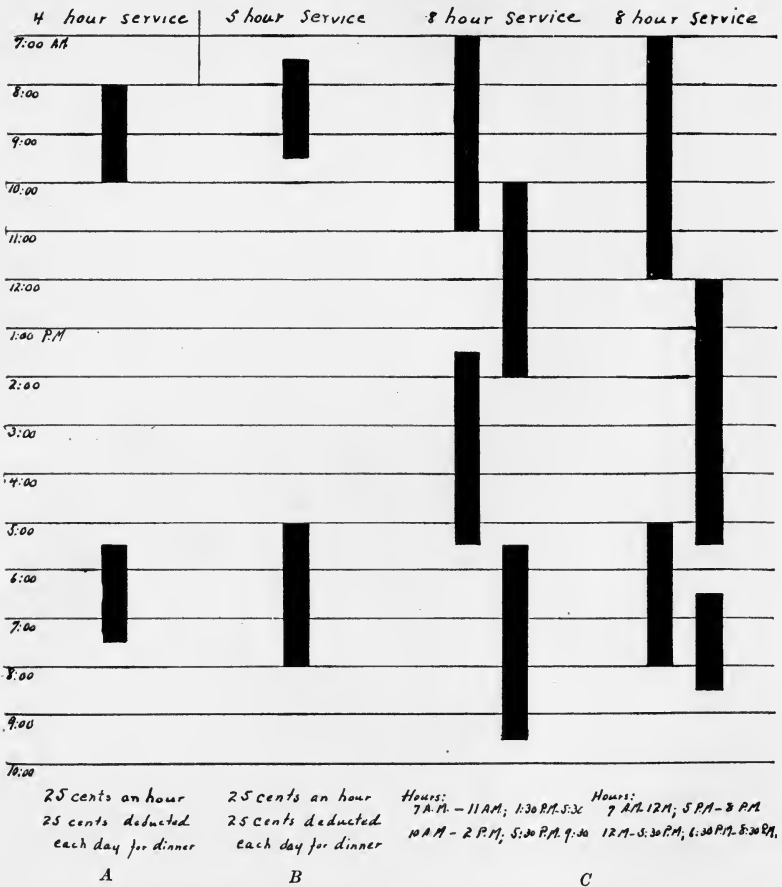
This is possible by her taking as her task that part of the work that she does well or the maid does poorly, making special desserts, salads, breads and cakes, or each day doing the beds and dusting, leaving only the cooking and general cleaning for the maid. If there is much entertaining one can hardly expect the one maid to do everything.

Hour Service.—Hour service, that is, bringing in of a hired worker for certain hours only, has much in its favor for both mistress and maid. For the mistress, the expense is much less because there is no expense of food for the help, although perhaps the rate per hour seems high. The arrangement is more like the store or factory with regular hours, and after workhours freedom to do as one pleases. The type of worker is more of the office type, superior in that she has more education, greater possibilities for intelligent organization of work and coöperation with her employer. For the maid, the time demanded for work is specified and any extra time is paid for as an extra.

On the accompanying charts arrangements of hours for different situations—the one-maid household and the two-maid household—are presented. Possible arrangements of hours for part time service are presented in chart form in Fig. 10. A shows an arrangement for a four-hour per day service—from eight to ten, and from five-thirty to seven-thirty in the evening; B shows an arrangement for five hours of service—seven-thirty to nine-thirty in the morning, and from five o'clock to eight in the evening; C illustrates two eight-hour-day plans for two maids in a household, with two different arrangements of hours which give each maid eight hours of work, and also time off every day.

SUGGESTIVE QUESTIONS

1. Draw two plans—of your own kitchen and one other you know. Compare them from the viewpoint of ease of doing work.
2. With the plan of your own kitchen, trace by dotted lines the journeys taken in making apple sauce and preparing for serving.
3. Modify the plan of your kitchen so that it will be a workshop with few steps and lessened labor.

4. Make a score card for washing dishes.
5. Discuss ways in which home management and office management may be alike. Ways in which they must be unlike.
6. In your housekeeping, how many ways have you found that "your head may save your heels?"
7. Given ten dollars to spend, what books would you buy for a housewife's library?

REFERENCES

- ANDREWS, B. R., EDUCATION FOR THE HOME. U. S. Bureau of Education, Bulletin No. 36.
- BARKER, HELENE, WANTED A YOUNG WOMAN TO DO HOUSEWORK. Moffat, Yard & Co.
- BARROWS, ANNA, FARM KITCHEN AS A WORKSHOP. U. S. Department of Agriculture, Farmers' Bulletin No. 607.
- BROADHURST, JEAN, HOME AND COMMUNITY HYGIENE. J. B. Lippincott Company.
- CAMPBELL, HELEN, HOUSEHOLD ECONOMICS. G. P. Putnam & Co.
- CHILD, G. B., THE EFFICIENT KITCHEN. McBride, Nast & Co.
- DODD, KATHARINE, HEALTHFUL FARM HOUSE. Whitcomb & Barrows.
- DONHAM, AGNES, MARKETING AND HOUSEWORK. Little, Brown & Co.
- FREDERICK, CHRISTINE, THE NEW HOUSEKEEPING. Doubleday, Page & Co.
- GILBRETH, FRANK, MOTION STUDY. D. Van Nostrand Co.
- KINNE, HELEN, and COOLEY, ANNA, HOME AND FAMILY. Macmillan Co.
- KITTREDGE, MABEL H., THE HOME AND ITS MANAGEMENT. Century Co.
- RICHARDSON, BERTHA J., THE WOMAN WHO SPENDS. Whitcomb & Barrows.
- TABER, C. W., THE BUSINESS OF THE HOUSEHOLD. J. B. Lippincott Company.
- TALBOT, MARION, THE MODERN HOUSEHOLD. Whitcomb & Barrows.
- TARBELL, IDA, THE BUSINESS OF BEING A WOMAN. Macmillan Co.
- TAYLOR, FREDERICK W., PRINCIPLES OF SCIENTIFIC MANAGEMENT. Harper & Bros.
- TERRILL, BERTHA, HOUSEHOLD MANAGEMENT. American School of Home Economics.
- THOMPSON, C. BERTRAND, THE THEORY AND PRACTICE OF SCIENTIFIC MANAGEMENT. Houghton, Mifflin Co.
- U. S. BUREAU OF STANDARDS, MATERIALS FOR THE HOUSEHOLD, Circular No. 70.
- UNIVERSITY OF MISSOURI, FARM KITCHEN. Agricultural Extension Service, Circular No. 12.
- UNIVERSITY OF TEXAS, THE PLANNING OF SIMPLE HOMES. Circular No. 39.
- WADHAMS, CAROLINE R., SIMPLE DIRECTIONS SERIES (for waitress, chambermaid, nurse, cook, butler, laundress). Longmans, Green Co.
- WHITE, CHARLES, SUCCESSFUL HOMES AND HOW TO BUILD THEM. Macmillan.
- WILBUR, MARY, EVERYDAY BUSINESS FOR WOMEN. Houghton Mifflin Co.
- YOUNG, MRS. H. B., PLANNING THE HOME KITCHEN. Cornell University, Bulletin No. 108.

CHAPTER II

PLUMBING

WATER SUPPLY—HOUSEHOLD WASTE—PLUMBING FIXTURES

THE convenience of good plumbing is such an accepted fact to-day that the question in town or city is not whether we can have plumbing but what plumbing do we need in a given house. In the open country, because of the lack of an adequate water supply under pressure, and because of the expense of installing the various pipes and connections required for bringing water and carrying away waste, the problem is, How can a single house supply its own system?

A system of waste disposal by running water is still unusual in the country. As the study of sanitation goes on, however, various systems are worked out, so simple and inexpensive that they can be introduced into small rural homes, and opportunities are thus given for every home to have some improved plumbing system. It is the duty of the architect and the builder to introduce the most modern system and the best materials appropriate to a given house, while the housekeeper should give intelligent coöperation in directing the spacing of tubs and sinks so that they will give the best service and get the best light. She is the one who should decide the quality of installation, whether convenience and efficiency are served equally by less expensive fixtures so that funds may be available for extra basins and lavatories. If a houseworker is to be employed, her quarters should be provided with proper plumbing. In the farm home where the hired man must be cared for, separate accommodations for him, a lavatory, at least, are more and more being included in plumbing installation.

The first question in establishing a plumbing system is how to get the water; the next, the kind of water; and then follows the question of what to do with waste water after it is used. Sewage disposal is thus a large problem in the plumbing situation.

WATER SUPPLY

Water supply in the city is taken as such a matter of course that many persons never think to ask, even, from where or how it comes, but just accept it. The country dweller is usually not so fortunate, unless he lives close to some town or city and is able to secure connection with its water supply.

Water must be pure in order to safeguard health. In purchasing a residence, one should investigate the purity of the water in that neighborhood, its degree of hardness, and the kind of minerals present in it. In choosing a new source of water supply the greatest care must be taken to get pure water and to keep it free from contamination. The water which is chosen for drinking purposes should be carefully examined by an expert before being piped to the house. It is not sufficient to send a sample of water to be examined but an expert should personally inspect the source of supply and the surrounding ground so as to discover possibilities of contamination if they exist.

Kinds of Water.—The chief sources of water for private systems are rain or roof water, wells, and springs. There are two kinds of water, "hard" water which has certain "salts" in solution, and "soft" water. Soft water is free from these salts and forms a suds with soap easily and quickly. Rain water, which is not necessarily pure water, is the best illustration of soft water, and is much used in rural districts for all sorts of housework.

Hard water is either permanently hard or temporarily hard. When it is *temporarily hard* it may be softened by boiling such as one does in heating wash water or in boiling water for vegetables. The reason boiling softens this water is that the mineral matter is held in the water in the form of carbonates, and the boiling drives off carbon dioxide, and in so doing the hardness of the water is "broken" and the lime is deposited as often seen in the teakettle.

There are processes for precipitating the mineral water. The carbonates are carbonates of chalk or magnesia, and a little lime water, in the proportion of one gallon to every gallon of the "hard" water, will soften the water for drinking purposes. The chemical action precipitates the magnesia or lime in an insoluble form. To make lime water for softening "temporarily hard" water use a lump of good stone lime about the size of an egg to two quarts of water. Let the lime settle and throw off the first water. Add

a second water, being careful to mix thoroughly, let stand and settle again, and use the clear top liquid. The residue of slaked lime may be used again, by adding water.

Permanently hard water contains lime in the form of chlorides and sulphides, and washing soda or soap will soften the water. This method of softening is of course of service only in case the water is used for washing. Either soap or washing soda may be used in hard water for washing dishes. It is not possible to give a definite proportion because the degree of hardness varies greatly in different waters. Scraps of soap dissolved in a jar of water will make a soap solution which if poured into the water will soften it for washing purposes. The soda should be kept in solution so as to be ready for dish washing, scrubbing, or washing clothes. Make the washing soda solution by filling a quart or two-quart glass jar with hot water and putting into it all the soda that will dissolve. Use about two or three tablespoonfuls of this dissolved soda to the amount of water in a dish pan or one-half cup to one cup in a washtub of water. Hot water put on soda crystals will dissolve them quickly and easily so there is no excuse for using it undissolved; soda must be dissolved for washing clothes. A washing soda is purchasable to-day in powder form for dish washing and laundering, which is instantly dissolved in hot water, and is not as caustic as ordinary soda and is consequently less harmful to the gilt of dishes and to the fabric of clothes.

For laundry purposes a combined method of softening may be used. Heat one pound of soap in four gallons of water over a low fire, then add one pound of soda. This will make a good soap solution for soaking clothes and washing where the water is too hard for good work. The scum from hard water and soap is called lime soap and if allowed to settle on the clothes produces streaks which require a great deal of soap to soften them, and sometimes in extreme cases kerosene is needed.

“Hard water soaps” are available, the formula of which is adjusted to meet different types of waters in different localities.

Rain water or roof water is the softest and most suitable water available for toilet and laundry purposes, but unless the collecting of rain water is done under close supervision the water may be most impure. Rain water for household use is best stored in containers called cisterns dug into the earth or built in the cellar.

The first fall of rain not only washes the air of its impurities but also the buildings of their dirt. To keep rain water in good condition, first, have a cut-off in the pipe so that the first fall of rain (for half an hour) may be prevented from going into the cistern; second, as an extra precaution, the water on its journey from the roof to the cistern may be led through a filter which may be a hogshead filled with gravel or small stones sometimes mixed with pieces of charcoal. In this way the water is filtered as it passes through the barrel to go into the cistern.

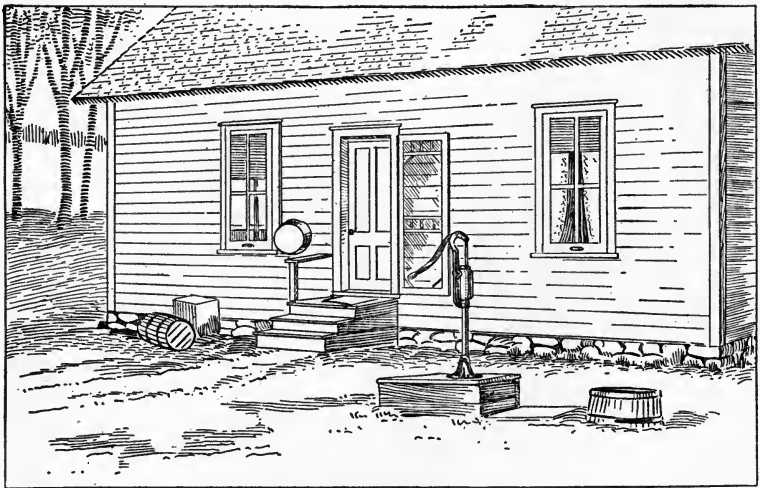

FIG. 11.—This pump could easily have been placed near the sink in the kitchen. It would have saved much work.

Water Storage.—Cisterns should be bricked or cemented on all sides so that the water in storage will be kept free from dirt and contamination. A cistern, like any other water container, needs to be cleaned occasionally. The best time to do this is just before a usual rainy season when there is a possibility of its being filled immediately, because if one is dependent on cistern water it is a great handicap to have the cistern emptied for cleaning. The aeration from chain or bucket pumps keeps cistern water in much better condition than with a less active pump, like the piston pump.

Wells like cisterns are home necessities which must be most

carefully built and supervised. The health of the family depends upon where they are located, how they are built, and from what source they are filled. Cisterns are filled from roof water. Wells are filled from springs or underground streams of water. There are two kinds of wells: the driven or drilled well, such as an artesian well, and dug wells. Driven or drilled wells are made by a closed iron pipe being driven down for varying distances, usually fifty feet or more, and sometimes as in deep artesian wells several hundred feet, through many layers of rock, to find water which has filtered its way down. This filtering tends to purify the water so that a deep driven well is entirely free from any surface contamination gives good water.

Dug wells are cemented or stone bowls which gather and hold water that runs in from underground streams or springs. The same general conditions should be planned for with the dug well as with a driven well. All wells are influenced by the surroundings, so for that reason be sure that no cesspool, privy or drainage of any kind can reach the spring that feeds the well, or can seep in at the top of the well. Do not be satisfied in thinking it is pure; have it analyzed—a state department will do it free in some states; and have an expert check up possible contamination by drainage into the water supply.

Pumps.—Water being present, the next question is, How may it be made accessible to the worker? Some form of pump is necessary to raise water from a lower level to the point where it is needed. There are several types of pumps—the piston pump, chain and bucket, force pump, and power pumps operated by windmill, hydraulic ram, gas engine, or electric motor.

The *piston pump* has almost everywhere replaced “the old oaken bucket” which was operated on a long sweep, or with a rope and windlass; the iron piston pump (Figs. 11, 12) is easier to operate and delivers water more rapidly. When the water is low in the well or reservoir it is necessary to start or prime the pump by pouring down enough water to fill the cylinder. So long as the water is deep enough to have it rise in the pipe, the pipe, of course, has water in it and is ready to deliver water. The piston is at the top of the cylinder, and the beginning stroke raising the handle results in forcing the piston down (1). The valve in the piston opens and lets the water pass into the space above it. When the piston

is at the bottom of the cylinder the water will be above it (2, 3). The up-journey of the piston forces the water into the spout (4).

Bringing the piston pump indoors and connecting it with a sink is one great improvement. It need not be placed directly over the well, as the pump will draw the water along a horizontal line as well as about thirty feet vertically.

Chain and bucket pumps operate by means of a crank handle. The water is elevated through a pipe by small buckets which are

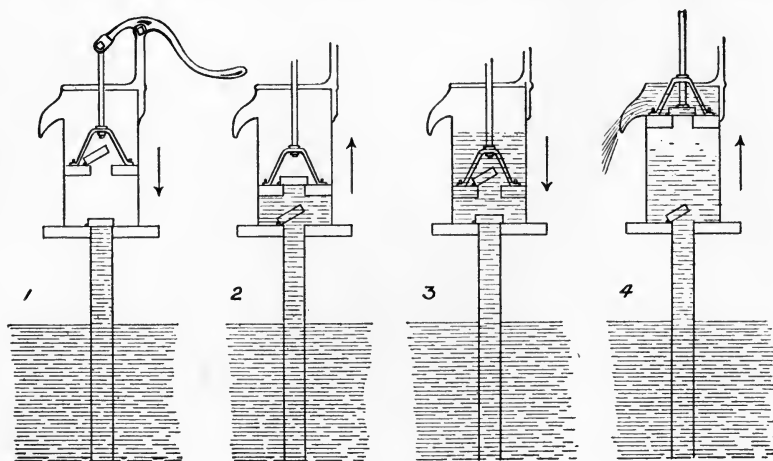

FIG. 12.—Piston pump.

fastened on an endless chain. These buckets are filled on their upward road to deliver water; if the pumping stops, the water left drops back through a very small opening in each of the buckets, thus working its way back to the cistern by dropping from bucket to bucket, and being thoroughly aerated in the process. (This is the same principle as aerating boiled water for drinking by pouring the water several times from one pitcher to another.)

Force pumps are piston pumps (Fig. 13, 1 and 2), which deliver water under pressure so that it can be forced through a pipe to some elevation or delivered through a hose for garden purposes. By means of a force pump elevated tanks in the attic or elsewhere may be filled, and so make possible a gravity home water system.

Gravity Water System.—For a system supplied by gravity from a spring a storage tank large enough to hold a supply for two or three days is sufficient. With a large elevated spring the tank may be dispensed with. In order to provide a gravity system, without pumping, the spring must be at such a height as to insure proper pressure to make the water flow through the pipe to the

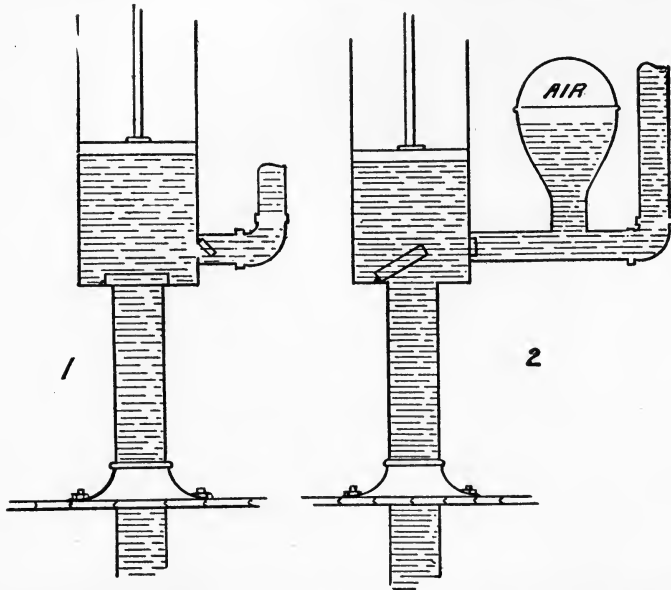

FIG. 13.—Types of force pumps. 1, water goes out on the down stroke; 2, water goes out on both up and down strokes.

house. The pressure depends upon the size of the pipes, the elevation of the spring, and the distance of the spring from the house. The pipe should be from $1\frac{1}{2}$ to 2 inches in diameter unless from a spring at great elevation, when a smaller pipe will do.

If the spring is located below the house, or if the water supply is from a well, the water must be pumped to the storage tank. In this case the size of the tank depends upon how often the owner wishes to pump. The water may be pumped by hand or by power. The power may be furnished by a windmill, gasoline or electric engine.

Pumping by Power.—The *windmill* is a wheel revolved by the wind, which in turn operates a pump or other device. By means of a windmill, water may be forced into a tank, and there stored at such an elevated height as to produce through gravity the convenience of a water system in all parts of the house and grounds. The pressure at the outlet depends upon the height above the outlet at which the tank is located.

Hydraulic Ram.—When flowing water, with a fall, is available, a hydraulic ram (Fig. 14) may be used to force water to a level much higher than the source of the supply. For example, on a farm, the water from a brook might be pumped to a tank situated on a high piece of ground and then distributed by gravity. The

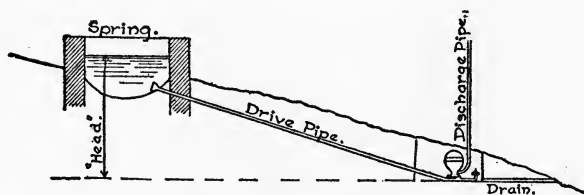

FIG. 14.—Setting of hydraulic ram.

pumping power of the ram is derived from the force of the falling water. For example, a two-inch stream of water falling a few feet into the ram will lift a three-fourth inch stream of water many times that height into a tank. Such rams are cheap to install and cost nothing to operate.

Gasoline engines are of special service on a farm for power of all kinds, including in the house the operation of pumps, washing machines, milk separators, etc. In thus operating a pump, fuel is of course required and also more attention than for a windmill, but the volume of water pumped is greater; and when a storage tank has a good capacity the pumping can be done at intervals according to the amount of water used. A $1\frac{1}{2}$ -H.P. gasoline engine will pump about $5\frac{1}{2}$ gallons a minute 250 feet high; it can be purchased for \$35 to \$45.

Electric Pumps.—Where electric power is available an electric motor may be installed directly connected with a water pump. Throwing an electric switch starts the pump and little attention is required.

Tanks.—The cheapest form of tank is one built in the attic or on top of the house. Placing the tank in the attic overcomes the possibility of freezing but introduces the danger of possible damage from leakage. It must be provided with a “clean out” and an “overflow” pipe to prevent leakage into the house. This type of tank is often built on a separate tower outside of the house and is sometimes built large enough to supply several houses. Elevated tanks are constructed of cedar or oak, bound with metal bands, and are often copper or zinc-lined; the tank should be painted to prevent its rotting. The cost of complete installation of tanks and pipes is small in amount compared with the conveniences resulting from the establishment of such a system. From elevated tanks the water is piped to the various fixtures in the usual way, and flows by gravity.

Air Pressure Tank System.—Another tank system is the air pressure tank system. This system includes a pumping outfit and a steel tank located in the cellar and so constructed that two-thirds of its capacity may be filled with water pumped in against the pressure of the air which fills the other one-third of the tank; the air is compressed as the water is pumped in until the air is under about 45 pounds pressure. The air pressure then forces the water through the pipes of the house.

Installation and Care of Water System.—In case the water supply system is to be used for the summer season only, all of the piping should be laid on such grades that the entire system can be drained in the fall, thereby preventing freezing and destruction of the piping system. All the sewage traps in a summer system should be drained and filled with oil.

In case the system is to be used all the year around, every part that is exposed, the piping, tanks, etc., should be made frost-proof. Piping is made frost-proof by laying it at sufficient distance below the surface of the ground and by not laying it in the outer walls of a house. Pipes outside the house which are not buried in the earth below the level at which freezing takes place (some two or three feet in the northern states), will freeze and often burst. Storage tanks must be enclosed and the water kept sufficiently warm to prevent freezing. The housewife's responsibility in this matter is to watch the original installation of pipes. Inside pipes are protected from freezing by not allowing rooms to get too cold.

However, freezing of pipes in kitchen, laundry, or in any room not sufficiently heated, is usually so slight as to be easily thawed out by the housewife.

To Thaw Pipes.—Do not put a candle under the pipe, as that would cause too rapid expansion, and probably burst the pipe. Cloths wrung out of hot water, wrapped like a bandage, are the safest and most successful means of opening a frozen pipe. Lead pipes that are frozen will bulge slightly. Iron pipes will not show this bulging. A pipe once thawed out may be kept warm by standing a lighted candle nearby.

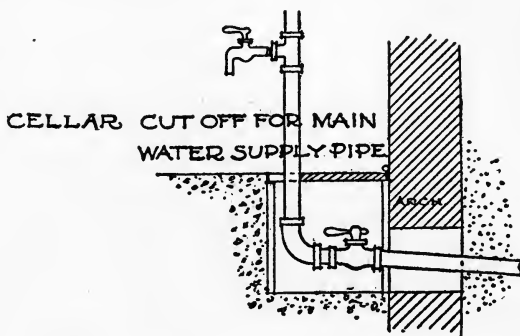

FIG. 15.—Cut-off for main water supply of the house.

Water Stop Cock and Shut-off.—The main water shut-off (Fig. 15) in houses is commonly inside the foundation or cellar wall. Be careful that a coal bin or other obstruction is not put around or in front of it. This is the direct connection with the street inflow pipe, and from this radiates all the water piping through the houses. The main thing is to know where it is, and that one should turn it off in case of a leak in the house; to turn it off is really nothing more than to turn a faucet. In some cases, the turn-off has a regular faucet handle, in other cases one must use a wrench to turn it. There is usually a turn-off in the cellar of the private house, which the housewife should ask to be shown, if she does not already know its location. After shutting off, the house pipes should be drained. In apartments the shut-off is often in a closet, and under sinks and washbasins the more modern plumbing has individual shut-offs for each such item of equipment.

To close the house, see chapter on Storage, page 232.

HOUSEHOLD WASTE

Household waste is of two kinds, organic and inorganic. Ashes, tin cans, and bottles are typical inorganic refuse, while garbage and sewage are the chief kinds of organic waste.

Inorganic waste accumulates very rapidly and must be removed. It is not only unsightly, but bottles and cans almost always contain some organic matter which soon ferments. It is such waste that promotes the breeding of flies and vermin. Sometimes this refuse is thrown into empty low lots to act as a filler, but such ground is thus made undesirable for housebuilding until sufficient time has elapsed for the waste organic matter in this refuse entirely to decompose.

Organic waste includes garbage or waste food materials and human waste, or excreta, but there may well be considered with them the problem of water waste, since human waste and household water form the sewage problem where there is a system of pipes for running water and pipes for waste disposal (Fig. 16) and where such a piped system is lacking, the sanitary and convenient disposal of human waste and of waste water is a very important problem.

Garbage on the farm should be used as feed as far as possible or turned into fertilizer. In the city it is usually hauled away to disposal plants because of increasing success in rescuing fats for industrial purposes, bones for glue and fertilizer, waste food for nitrogen in stock feeding, and finally materials that can be used as fuel.

Household Water Waste.—This concerns water used for bathing, for dishwashing, for laundering, and for housecleaning. If there is a piped system it goes into the sewage. In the absence of a plumbing system, all household waste water, including dishwater freed from food particles, can be led by means of a pipe from the sink to a garden some distance away from the house. This water will be of service fertilizing the garden. Such a sink and waste pipe for disposal of kitchen water should be installed in every house, on the farm or elsewhere as a minimum convenience, even if it is not possible to have more of plumbing and a running water supply. Be sure that this waste water flows away from the wells or cisterns.

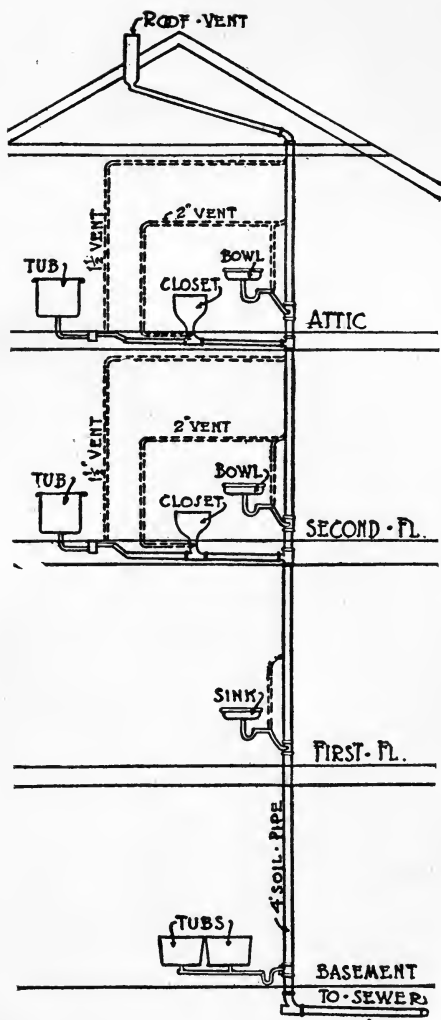

FIG. 16.—Sanitary plumbing stack.

Wash water, after laundering, is often used in the farm house, where water facilities are poor, for scrubbing. This is good use provided the water is clean or that the floors are rinsed afterward. The soapy soiled water one often sees in the washtub is not clean and will no longer clean other things. The floors washed with such water soon turn yellow or gray and often are slippery from the soap. Fixed washtubs can be installed just as a sink, to be emptied through a trough or pipe which conducts the water down into the garden far enough away from the house. Clean soapy water is a good disinfectant and if poured on plants or around the roots often keeps a plant free from insects.

Human Waste.—

The best method of sewage disposal is through a public sewer which is conducted to a community sewage disposal plant. Where there is no community system,

the best methods for a single house are the cesspool and septic tank, and of these the latter is safer; both of these require running water to carry off the waste; where there is no piped water supply, human waste is cared for by the privy.

Types of Privies.—The simplest method of disposal of human waste is by the earth closet (Fig. 17). These closets or privies

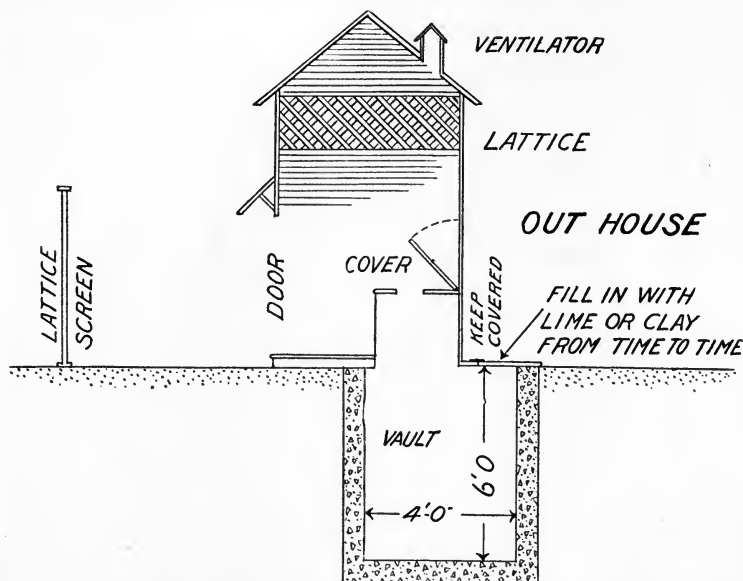
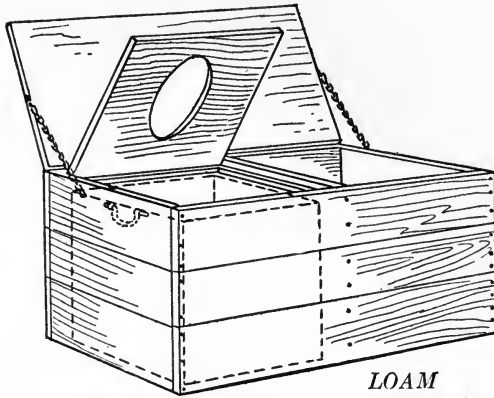

FIG. 17.—Outdoor privy vault. When necessary, the superstructure is removed and put over a new vault.

should be dug in sandy soil in such a position in relation to the house and water supply that there can be no chance whatever of contamination. Dry loam or fine sand mixed with particles of charcoal or lime should be kept in a box, and each person using the closet should be taught to use sand or loam as a cover, and not to throw extra water into the closet. The bacteria in the excreta decompose the wastes, and the loam absorbs the odor. Besides the danger from drainage, one meets another danger quite as imminent and serious, that is the contamination from flies. All waste vaults such as privies and manure piles, should be screened so that the access of flies is impossible.



*REMOVABLE
RECEPTACLE*

*LOAM
COMPARTMENT*

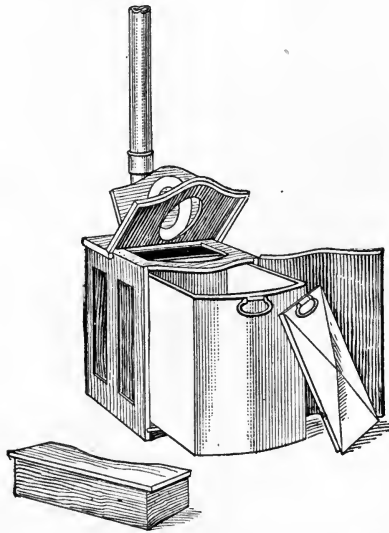

FIGS. 18 and 19.—Two forms of earth closets.

When the closet has to be emptied the best care of the waste is by burying. This involves another big question, Where and how to bury? Where—how far away from the house, and how—at

so low a level that there can be no question of wastes getting into surface water or into the water supply? This becomes an individual question answered by the contour of the land, its drainage, and its relationship through drainage to the water supply. For convenience and protection, the closet is often brought too near the house, but that is better decided by the natural drainage from the privy and how it affects conditions of a surrounding and lower level.

Some water closets are built of the type of drawer containers (Figs. 18 and 19). The drawer should be a galvanized iron box

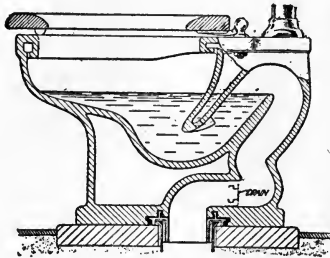

FIG. 20.—Flush closet.

and must also be kept in good condition by means of sand and lime and charcoal.

Another method is to build a water-tight concrete vault and remove the superstructure to a duplicate vault when the first is filled, being careful to cover the abandoned vault; the first vault may be re-used after fermentation has destroyed its contents.

Flush Closets.—Flush closets are of course the modern way of caring for human waste where there is a piped water supply. Flush closets are connected with the water system of the house and should be planned to have a free flow of water to flush waste down and out. There are two types of closets, one called the “open flush” (Fig. 20), and the other called the “siphon.” Both of these closets are to have connected with them in the plumbing an efficient water trap, and both are also partial traps themselves, because they always contain water. The care of the flush closet requires not only that it be flushed each time it is used, but that it be so flushed as to

insure clean water not only in the bowl of the closet but in the trap below. Flush closets in country houses are emptied into septic tanks or cesspools, and those in city dwellings into the sewage system.

For cleaning flush closets, see chapter on Cleaning and Care, page 258.

Water Traps.—Water traps are bends or enlargements in waste pipes which, as the water goes down the pipe, hold the last lot of water so that water constantly stands in the pipe, sealing it against the inflow of sewer gas through the pipe into the house. As more

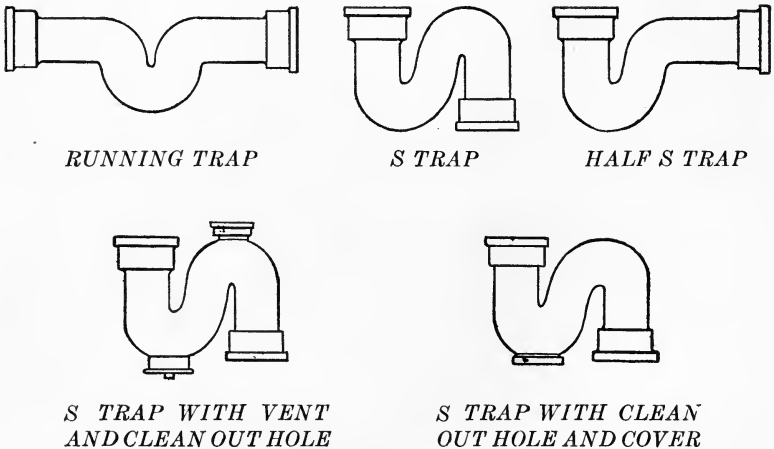

FIG. 21.—Types of traps.

water from above flows into the pipe, the water in the trap overflows off down the pipe, always leaving the trap level full.

The common forms of traps (Fig. 21) are the U-tube, the S, and the Half-S traps.

It will be seen at once that the water that is allowed to remain in the trap after the use of the sink, tub, or flush closet ought to be clean water, otherwise there can be not only disagreeable odors but more or less unhealthy conditions from this water which contains waste. Let it be the housewife's concern to teach the flooding of all traps after use. Kitchen sinks are often gradually stopped

up because of the grease in dishwater cooling and hardening on the sides of the pipes and trap. Continued repetition of this naturally closes the trap with the stoppage of grease. This causes an expense which could easily have been warded off had the sink after every dishwashing had a thorough flooding, before this grease had hardened, with hot water which would have melted and carried off the grease. See chapter on Cleaning and Care, page 266.

Grease traps are often put in with the plumbing connection in kitchen sinks, especially in large hotel or institution kitchens. This grease trap (Fig. 22) allows a storage of grease which may be taken out later and sold to the soap factory or used for home-made soap.

Sewage Disposal Without Community Sewers.—Where running water is available, but with no community sewers, a single house may dispose of the human waste and waste water by running its own sewer pipe into a private cesspool or septic tank. This requires proper provision of water traps, and, if desired, a grease trap, on the waste water piping.

Cesspools.—Cesspools may be built some thirty feet away from the house, choosing, if possible, a sandy soil for the outlet. Cesspools were originally built by making a well-like cistern (Fig. 23) lined with wood or stone which was to receive the waste from the house; the liquid material then leached through the sandy bottom, and the solid waste remained behind to purify itself by its own bacterial action.

The cesspool is likely to become a constant source of contamination to the water supply, as the liquid containing organic waste leaches out and contaminates the surrounding soil, and is very likely to reach the well or cistern. The cesspool may also become a nuisance by overflowing, if the soil is not porous enough to absorb the liquid. It may be necessary to empty out the cesspool in order to remove the sediment which has collected in too great amounts.

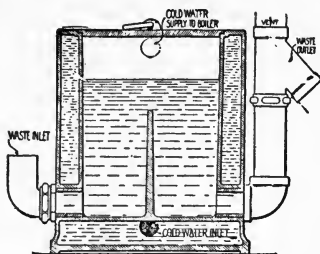

FIG. 22.—Grease trap. Composed of an inner chamber into which the waste water and grease pass, and an outer chamber through which the cold water supply for the house flows. The circulation of cold water around the outside chills or congeals the grease entering into the inner chamber; the grease, being lighter than water, gathers at the top and is thus prevented from passing through the outlet.

The frequency with which this must be done depends on the porosity of the soil; sometimes it is never necessary.

The Septic Tank (Fig. 24) is a more satisfactory method of sewage disposal. This tank is made entirely of concrete, is box-

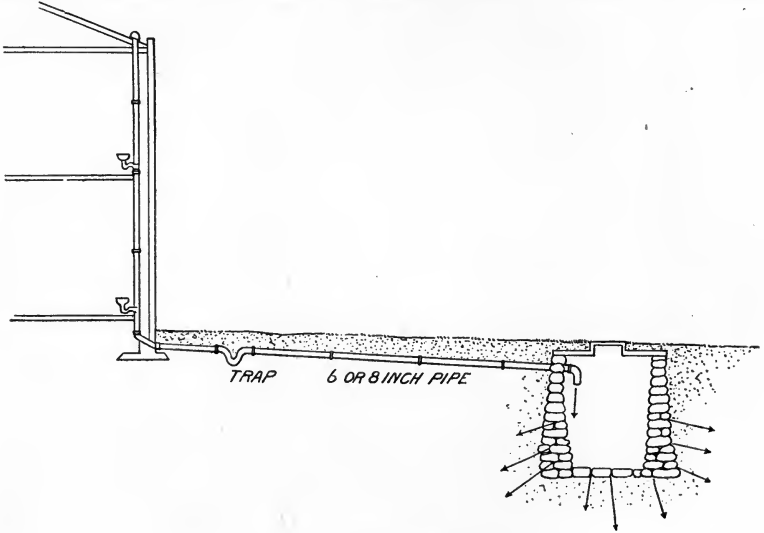

FIG. 23.—Leaching cess-pool.

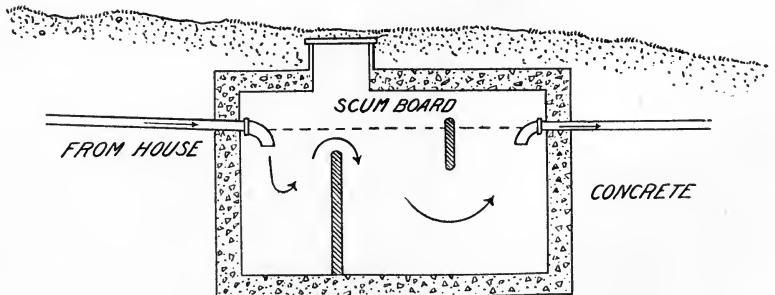

FIG. 24.—Septic tank.

shaped, and three times as long as wide; and the size varies with the number of persons living in the house with which the tank is connected, and also depends upon whether the total outflow from

the house passes through the tank, or only the outflow from the closets.

Assuming that no water is used during the eight sleeping hours, the tank is made of such a size as to hold the flow during eight hours, the entire flow passing through in sixteen hours; that is, the tank is made large enough to hold one-half of the entire quantity of water used per day. For example: take a family of five. The total water supply should be 100 gallons per person per day or 500 gallons per day. If the entire flow passes through the septic tank, the tank should be large enough to hold half this quantity, or 250 gallons. This necessitates a tank of $33\frac{1}{3}$ cu. ft. capacity. If the outflow only from the closets passes through the tank, then the tank need be only large enough to hold 10 gallons per person per day, or for a family of five large enough to hold 50 gallons, or about 7 cu. ft.

The outflow from the house passes through a pipe 6" or 8" in diameter to the tank. A trap should be placed between the house and the tank to prevent any gas passing back into the house. The liquid passes into the first compartment of the tank, where much of the sediment sinks to the bottom, then up over the partition which is built just higher than the mouth of the inlet pipe. In the second compartment a scum-board is placed to keep back any scum which rises to the top of the liquid. The outlet pipe should have an elbow extending down about 8" or 10" below the surface. The liquid finally passing through the outlet is practically clear but is not purified. A man-hole opening is constructed partly over each of the two compartments so that in case of necessity the tank may be opened and cleaned out and the sediment removed and buried. It may be necessary to remove the sediment every six months, or so little sediment may accumulate that it may never be necessary to remove it, depending upon the length of time the house is used during the year.

The disposal of the outflow of the tank is very important. With the proper care this outflow, together with the outflow from the bathtubs, sinks, and washtubs, which may not pass through the septic tank, may be used to advantage in irrigation of the garden or some nearby field. The liquid may be used in irrigation either by surface irrigation, which is accomplished by means of ditches through the cultivated area; or by subsoil irrigation, in which case

the outflow is led through the cultivated area by means of drain pipes, having open joints underneath the furrows. In both methods the results are best accomplished in porous soils. If the soil is not porous more active cultivation must be carried on to have the liquid absorbed.

The question of whether all the water waste of the house should pass through the septic tank or not is a matter of opinion among sanitary experts. If all the water passes through, the tank must be made larger and there is a greater amount of liquid contaminated by organic matter. Another disadvantage of having all the waste pass through the septic tank is that the grease from the kitchen sink is likely to become a nuisance by forming a film of grease on the tank and pipes and in the irrigation ditches. To prevent this a grease trap should be installed in the pipe leading from the kitchen sink, and all water run through it into the septic tank.

When one realizes the seriousness of the problem of the care of waste, it will be seen that the cost of the septic tank is very slight in comparison with the cost of the risk involved in the drainage from either poorly built or carelessly operated cesspools and privies. The privy must be kept dry so that the bacterial action will destroy the material without the risk of seepage into the water supply.

PLUMBING FIXTURES

All metal fixtures should be of good quality, the poorer quality while cheaper at first will require much care and soon will require refinishing. While the best quality for bathroom fixtures is silver-plated, the material usually chosen is first quality nickel, but to keep this in good condition it should be cleaned by carefully washing and wiping dry, and as far as possible cleaned without the use of strong metal polishes. Nickel is a coating on another metal, and naturally the friction as well as the chemical action of strong cleansers will remove this surface finish.

Faucets.—For the kitchen and laundry brass fixtures are usually chosen. They will oxidize, forming a green deposit of copper oxide, so that brass fixtures will need a good deal of care. Of the metal faucets, then, nickel kept free from chemicals and scratchy cleaners will give the best results at a medium first cost.

Enamel for handles is extensively used in the more modern

plumbing fixtures, first gaining use in connection with the sanitary outfit required in hospitals. The great advantage is the elimination of the extra work of polishing metals, the great disadvantage is its cost. This may be more than balanced by the saving in money and work on a metal handle. They are more expensive than nickel and less so than silver-plated handles.

The choice of faucet is an important item. Usually a screw (Fig. 25) or level faucet that stays open, until closed, is preferred, but where water rates are high, spring faucets that stay open only so long as held open may sometimes be chosen.

Foot-pressure faucets are used in cases where the hand must be free for other work or where it is a disadvantage to touch a common handle such as in operating rooms in hospitals. This device would be of great convenience in a kitchen where spring faucets are to be installed to save water, because it is a great hindrance to work at the sink and have to hold the faucets open.

Goose-neck faucets (Fig. 26), those with a high curved discharge pipe, are most useful in the pantry to assist in filling water bottles or pitchers.

As dishwashing devices (Fig. 27) and machines and washing machines are being more and more used, extra faucets which are connected with hot and cold water supply can be installed at various working points with little expense and great advantage. Such a faucet should have a screw end and then by means of a rubber hose either or both kinds of water can be easily drawn from a combination faucet such as is used in a bathtub.

On the outside of the house one should plan either plug or faucet attachments to be used for cleaning porches, watering flower beds, and for fire emergency.

Leaky Faucets.—Before repairing a faucet, close the house shut-off, otherwise when you begin to take the faucet apart, the water will spurt out and flood the room. In modern plumbing the pipes often have individual stopcocks under each fixture so it is not necessary to shut off all the house water supply to fix a faucet. In the absence of such a shut-off, all the water will have to be turned

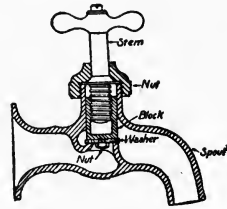

FIG. 25.—A typical spigot.

off. The faucet leaks because the leather or rubber washer on the end of the screw has worn with constant use and does not fit the opening through which the water flows. This washer is held in place with a screw or nut and the worn washer must be replaced by a new one. To do this loosen the big nut around the stem and take out the stem. Remove the old washer from the end of the block and put on a new one. Replace the stem in the faucet and

FIG. 26.



FIG. 26.—Porcelain sink, showing sink strainer and goose-neck faucet. Such an outfit is especially good for the laboratory; also for pantry.

FIG. 27.



FIG. 27.—Dish-washing device.

reset the big nut, using a monkey-wrench to turn it and make it so tight that it does not loosen when the faucet is used.

Filters.—Filters, when in the kitchen, are connected with the sink plumbing. They should be so placed as to be convenient for use in the kitchen, and to make the cleaning of the filter easy. It is a common belief that filters once installed are good for all time. Instead, they need very close supervision in order that they themselves may not become a breeding-place for bacteria. The filter

should supply clean water, and the better types with proper care do supply pure water, that is, free from bacteria.

Filtration means passing water through some medium with such close crevices and pores as to prohibit the passage of particles of dirt. If the pores of the filtering medium are of microscopic size, they keep back the germs as well as the dirt and such a filter is called germ proof. All sorts of cheaper filters have found their way into homes, with fillings of cotton batting, picked cotton or asbestos, sand, gravel, or broken charcoal. Many of these filters are built to be screwed to the cold water faucet. These filters will clean water as long as they are clean themselves, although they will never remove all bacteria, and be proof against germs and disease. In most cases they hold about a teacup of filler and so small an amount soon becomes oversaturated with dirt. Those with pads are to have the pad changed frequently, even daily. Directions given for many of these filters say to reverse the filter and flood with water to clean it. If this is done at least once a day, and the filter contents and all are boiled, there is a possibility that clean water might be attained, but no one would call it germ proof.

The many approved filters on the market are of the Pasteur type, which consist of a hollow cylinder of fine unglazed porcelain, called the candle, which is enclosed by one of metal, or glass. This outer cylinder is connected with the supply pipe and by means of the force of the water system the water to be filtered is forced through the pores of the porcelain to the inside of the candle; then dropping into the reservoir, it leaves the suspended matter as a coating on the exterior of the porcelain candle. Such water is germ proof if the filtration is not continued too many days. The length of time during which a sterile filtration may be obtained depends upon the temperature of the filter and its contents; at a temperature of 72° Fahr. the filter is said to be sterile for nine days, while at 95° Fahr. the time is only five days.

In some localities these filters may be rented per month with care assumed by the firm which rents. In such cases the filters should be inspected regularly and at not too long intervals. At this time, new candles are put in to replace the old ones which go to the factory to be baked in large ovens and rendered sterile.

Sinks.—The first thing to consider is the standard requirement of a sink. It should be smooth, easily cleaned, non-absorbent, and

non-rusting. The materials used are wood, iron, slate, soapstone (one grade of which is called alberene), copper, enamel-lined iron, and porcelain; the prices increase in the order named.

Sink Materials.—*Wood*: Many of the early sinks were made of wood, and a few wooden ones are used to-day. The only advantage of wood is that, in institutions where dishes may be washed in the sink, there is less danger of the dishes being chipped. The disadvantages so outnumber the advantages that in modern homes a wooden sink is not considered. It soaks water, becomes slimy, slowly softens, rots and splinters. It is almost impossible to keep it sweet-smelling, and free from grease.

Galvanized Iron.—Galvanized iron sinks are cheap and durable and can easily be kept clean and free from grease. The greatest disadvantage is that if the galvanized coating is worn off, it will become rusted. A few drops of oil wiped over the surface will help to prevent rust.

Slate.—Both slate sinks and soapstone sinks are smooth, inexpensive, and easily kept clean. However, there will be a gradual absorption of grease, which penetrates the material and which is impossible to remove.

Copper.—Copper sinks are seldom used except in pantries. They require much care to keep them clean and bright.

Enamel-lined and Porcelain.—Either of these materials would be the first choice of every housekeeper. Enamel is, as the word implies, an enamel covering on a metal surface, made like an enamel or agate saucepan, while the porcelain is like an earthenware bowl, molded and baked. The quality of the enamel is determined by its thickness, and its freedom from blisters, which cause chipping. If a stain once gets under the surface of enamel, it is beyond the reach of any cleaning agent. Care is necessary with both enamel and porcelain, because a sharp blow of any kind may result in cracking or chipping the surface finish.

Size of Sinks.—This is an important consideration, because a small sink means that it is impossible to wash and rinse dishes easily and without breakage. A shallow sink will be more easily kept in good condition than one which is so deep that it becomes a shallow tub. One chooses a tub-shaped sink only as a slop sink, or in institutions, for washing vegetables. A good general size

is one large enough so that washing and rinsing pans may both stand in the sink.

Drain Outlet.—The drain outlet should be flat with small openings so that, to a certain extent, it acts as a sieve, keeping back larger particles. Were it fine enough for the smallest bits of food, it would be too fine for rapid drainage. Some sinks are built with

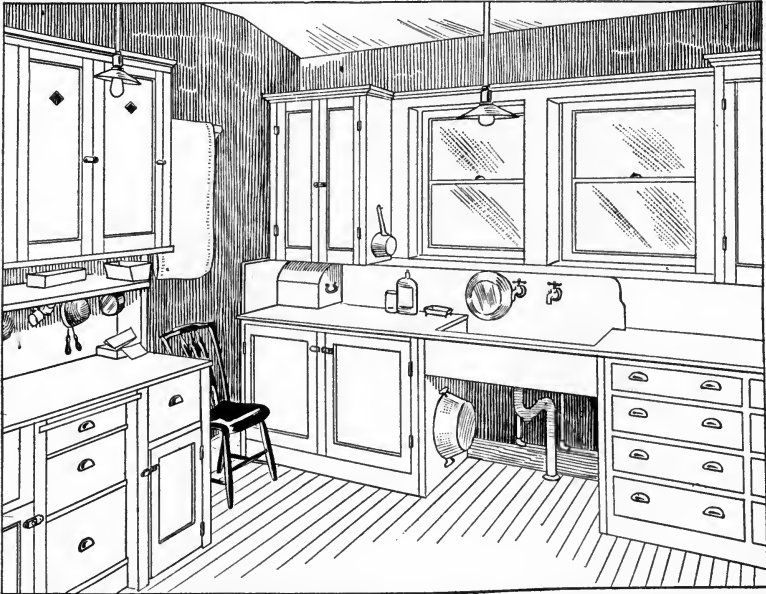

FIG. 28.—Well-planned sink. The working center is made complete by the excellent arrangement of windows, drawers, cupboards and the proximity of cabinet.

the outlet slightly sunken below the level of the sink; this is a great disadvantage, because it requires special care to keep it clean.

Sink-strainers should be kept at one end of the sink and should be used to prevent small particles getting into the trap.

Drain Boards.—Two drain boards, if space permits, are more satisfactory than one, because they make possible the separating and classifying of the dishes. These drain boards are usually of hard wood, most often oak, and should be grooved, with the grooves just deep enough to carry off the water; if they are too deep they

will be hard to clean. In limited spaces, it is often found an advantage to mount the drain board on an extension fixture, which allows the board when not in use to be pushed up against the wall, all of which is a great help in cleaning under the sink. If drawers or cupboards (Fig. 28) are built under these drain boards, either build them so that they fit tightly and solidly to the wall, base-board and floor, and prevent collection of dust and water; or build them on rollers so that they may be easily rolled out for frequent cleaning. In either case the cupboards must leave the plumbing quite open and must be proof against leaks and dirt.



FIG. 29.—Sink with two drainboards.

Open Plumbing.—Building drawers and closets under the drain board or sink should in no way close in a trap, because it must allow for thorough cleaning, and because it is a principle of sanitation to-day that all plumbing should be open so that traps are easily accessible (Fig. 29). A kitchen of good size need not have anything under the sink except perhaps the worker's stool. Towel racks and shelves are more out of the way above the drain level than below it.

Space-saving Sinks.—The idea of space-saving illustrated by built-in closets and drawers, may be further carried out in small kitchens by using appliances which combine sinks and washtubs, the former setting into the top of the latter, each having its own faucets, so that either is complete without depending upon the other. The drain of the sink meets an extension drain in the side of the tub, so that the washtub is in no way soiled by the waste

water from the sink. A sink mounted in this way is higher than most sinks, and is an excellent illustration of the saving of strain upon the back of the worker resulting from sinks set at the proper height.

Slop Sinks.—Slop sinks are low sinks used for waste water only. They are an especial advantage in institutions where there is much waste water like that from scrubbing, and many housekeepers like one on each floor. They are so much lower and deeper than a sink or washbasin, that they reduce the work of lifting pails of water, and also reduce the chance of splashing water.

Washtubs.—The discussion of materials for sinks may apply, in a measure, to washtubs. Wooden washtubs which are not used every day are likely to shrink, causing the cracks to open, with consequent leakage. A wooden washtub, like a wooden washing machine, should be stored in a cellar, where moisture is more or less prevalent, or it may be necessary to keep a wet sponge in the tub to prevent drying. Of course any constant moisture is apt to attract roaches.

Galvanized iron tubs give very good service, if care is taken to prevent the scraping or wearing off of the galvanized coating. Any rust spots will, of course, stain clothing.

Slate and soapstone make cheap and durable washtubs.

Enamel and porcelain are, as in the case of the sinks, the most desirable materials for washtubs, because smooth and easily kept perfectly clean; although yellow porcelain is sometimes used, white is the best color, as the clearness of the water is more easily tested, as well as the depth of color in the bluewater.

Height of Sinks and Tubs.—The placing of tubs and sinks is a matter over which the housekeeper must have very close supervision, because until the plumbing laws require a plumber to raise the height of kitchen sinks and washtubs, they will be too low for almost every woman old enough to work at them (Fig. 30). "Standards" or supports for sinks that are molded out of porcelain or cast out of iron are obtainable; but in order to get the right height, gas piping, which may be cut any length, may be used for legs. If this is to be done, be sure the plumber understands that the molded supports will not be needed. With some types of molded supports, the standard may be lengthened by attaching a small enamel extension by means of a metal bracelet

(Fig. 31). It will be wise to look into the question of cost because gas piping can be painted with aluminum paint, or white enamel paint, for that matter, and can easily be cleaned and is a cheap and satisfactory support.

The best height is that one which keeps the worker's arms bent at a right angle at the elbow. This position insures a straight



FIG. 30.—Sink only 50 per cent. efficient, because it is set too low for the worker. The standard of sink materials and drainboards good.

back, good poise of the body, and less fatigue. The depth of the sink must be considered in determining the height that is desired, for a shallow sink can be placed higher than a deep one. So long as the majority of sinks are too low it would be much wiser to plan for the usual worker's height, 5' 5"—5' 6"—5' 7", and set the sinks accordingly about 34"—40" from top of sink to floor; washtubs should be 36" to 40" from top to floor; then for the unusually short

worker a platform would make her work more comfortable, with no fatigue from a bad position. The objection to a platform, that it causes much stepping up and down, may be overcome by the use of large drain boards at each side, and by having the platform

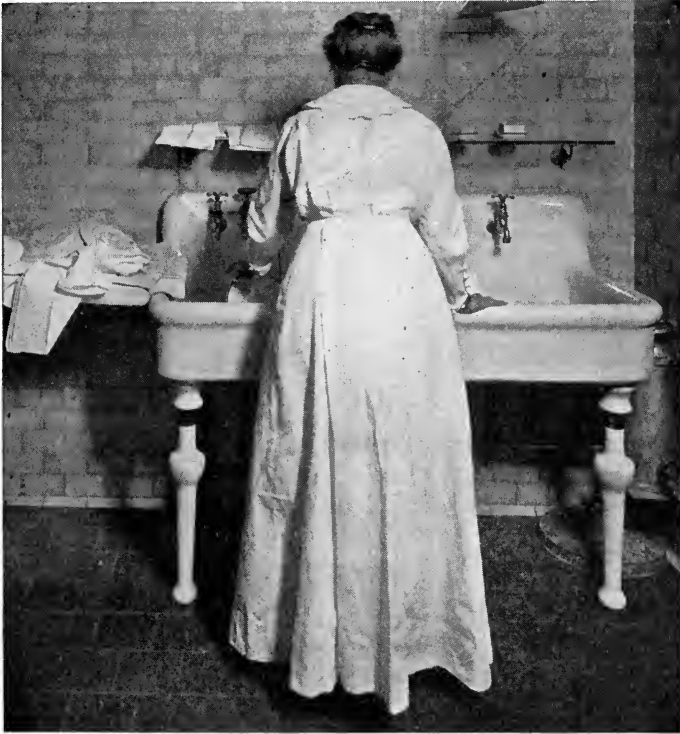

FIG. 31.—This shows the bracelet extension which may be used to raise all low sinks. This sink is divided to furnish a place for washing and rinsing dishes.

large enough to allow the worker to step about without having to step off. Such a platform, even if not needed by the housekeeper, makes it possible for older children to take their share of dish-washing without the fatigue of overreaching, and without the accompanying splashing caused by the height of work and worker not

being adjusted to each other. The device of a movable platform for children will be found very useful in all lavatories; it greatly reduces the mothers' task in washing hands and faces.



FIG. 32.—A well-arranged bathroom.

Bathtubs.—The cheapest bathtub is one of tin, either painted or bright finished. It requires a great amount of care, and needs to be renovated at least once a year, making it in the end an expensive tub.

The enamel or porcelain tub is by far the most satisfactory. A porcelain bathtub is very expensive, and really gives no better service than the heavy enamel (Fig. 32). The newest porcelain tubs are made without legs, set directly into the corner, and flat upon the floor, so that there is no chance for dust to gather under them. For materials, see Sinks, page 43.

Washbasins.—Washbasins are of either marble, enamel, or porcelain. Marble is more or less absorbent, and is affected by acids, which destroy the glaze. Enamel or porcelain is more satisfactory in all ways. Enamel-lined or porcelain would be the first choice of every housekeeper.

SUGGESTIVE QUESTIONS

1. What is the purpose of a plumbing system? Draw a diagram of a general plumbing system.
2. Where should "clean-outs" be placed? Why? Describe method of procedure in case of stoppage.
3. Why should you not have a perfectly straight pipe as an outlet to a sink or washbasin?
4. What do you consider the best substitute for a flush closet? Why?
5. What is the purpose of a shut-off? Where should it be placed? What is a "stop and waste"? What is a street box?
6. Considering the cost of building a brick or cement cistern, is the use of rain water economical? Why?
7. Why should water from hot-water boilers never be used for drinking?
8. How can hard water be converted into good water for laundering?
9. How could the housewife test soil for absorption and rapid drainage?

REFERENCES

- BAILEY, E. H. S., SANITARY AND APPLIED CHEMISTRY. Macmillan Co.
 BROADHURST, JEAN, HOME AND COMMUNITY HYGIENE. J. B. Lippincott Co.
 CLARK, T. M., THE CARE OF THE HOUSE. Macmillan Co.
 COSGROVE, J. J., PRINCIPLES AND PRACTICE OF PLUMBING. Standard Plumbing and Manufacturing Co.
 FARM HOME CONVENIENCES. U. S. Dept. of Agriculture, Washington, D. C., Farmers' Bulletin 927.
 FULLER, MYRON L., WATER FOR FARM HOMES. U. S. Geol. Survey, Washington, D. C.
 HARRINGTON, CHARLES, PRACTICAL HYGIENE. Ginn & Co.
 HERING-SHAW, A., DOMESTIC SANITATION AND PLUMBING. D. Van Nostrand Co.
 HOGDON, D. R., ELEMENTARY GENERAL SCIENCE. Hinds, Hayden & Eldridge.
 KEENE, E. S., MECHANICS OF THE HOUSEHOLD, McGraw-Hill Book Co.
 LAWLER, J. J., MODERN PLUMBING, STEAM AND HOT-WATER HEATING. Popular Publishing Co.
 LYNDE, C. J., PHYSICS OF THE HOUSEHOLD. Macmillan Co.
 OGDEN, HENRY N., RURAL HYGIENE. Macmillan Co.
 WILSON, E. T., MODERN CONVENIENCES FOR FARM HOME. U. S. Dept. of Agriculture, Farmers' Bulletin No. 270.
 WINSLOW, C. E. A., SEWAGE DISPOSAL. John Wylie & Sons.
 WOOD, H. B., SANITATION PRACTICALLY APPLIED. John Wylie & Sons.

CHAPTER III

HEATING AND LIGHTING

HEATING and lighting are as essential in their way as is plumbing. As modern plumbing, which is dependent upon water and sewer systems, makes possible greater conveniences in a house, so community lighting, and, in apartments, a common heating plant offer added comforts. Rural districts suffer a handicap, because, although the use of electric lighting is increasing, there is often no community lighting system, and the individual rural home must have its separate lighting arrangements as well as its separate stoves or furnace. The advance of time has made available for the country fuels which may take the place of city gas and electricity. Where the rural home has not adopted them, it is not because they are necessarily expensive; but because they are new in idea or the housewife has not taken time to consider the new device or mechanism which in the end would mean so much saving to her. Some of these other fuels (other than gas and electricity) which are **most** adaptable for heat and for cooking, are gasoline, kerosene, and acetylene. Kerosene, acetylene, and Presto (compressed acetylene) are used for both heat and light.

Humidity and the Heating Problem.—Recent investigation has shown that comfortable artificial heating is as much a problem of keeping the air moist as it is of burning fuel in the stove or furnace. This can be easily accomplished by putting water on the stove or radiator and letting it evaporate in the room. A considerable quantity of water is needed, so that it is a matter of constantly renewing the water as it evaporates.

Ventilation is brought about by circulation of air. Nature's law of gases will automatically control ventilation, because it provides that heated air rise and leave room for cold air to enter and fill the lower level. This air, in turn, heats and rises, and the air cycle which promotes ventilation is produced.

In the cook stove flues or openings increase the ventilation; and

in rooms spaces must be allowed for heated air to pass up and out. A room with fresh air heats more rapidly than one with stale, used air. With these two facts as a working basis, various suggestions may be given for ventilation.

Suggestions for Ventilation.—Lower window from the top.

Lower window from the top and raise from the bottom.

Have a window open and door opposite also open.

Use a window board, so that the air may sift in between the sashes.

Use a ventilator which is on the principle of a window board; manufactured ventilators usually have some form of shutter or pipe that can be regulated.

Doors opening into hallways and the hall act as a flue.

A grate with a fire or a candle burning in it will ventilate without windows being open.

In sick rooms cool, moist air may be supplied by hanging up a sheet which has been wrung out of cold water. As fast as it dries, remoisten.

FUELS

Fuel is food for the fire. It is rated in value in proportion as it produces heat for its cost and volume. Its price is controlled partly by the proximity of the supply to the local market; its efficiency in the home is rated by its freedom from dirt and odor, and the ease with which it is used; its economy by the amount needed to produce the required heat quickly and by its freedom from waste.

Wood burns rapidly and makes an intensely hot fire, but a fire of short duration, and unless one has an abundance of wood fuel at hand at little cost, it is a very expensive fuel. A wood fire is not so easy to keep as coal; but if it is possible to have two types of wood, the light softer wood being used for quick burning and the heavier hard wood for slow burning, the wood fire can be operated at much less cost, and at greater convenience.

Coal.—Of the two types of coal, hard and soft, hard coal is especially serviceable because of its freedom from the excess gases which are still in the soft coal. As hard coal is likely to corrode flues, careful attention will have to be given to the care of the flues.

Hard coal—Advantages	{	great heat burns slowly little care
Disadvantages	{	high burning point cost high corrodes flue
Soft coal—Advantages.	{	low burning point cheap
Disadvantages	{	less heat dirty smoke
Wood—Advantages....	{	low burning point little ash clean
Disadvantages	{	less heat rapid burning expensive requires watching

Coke is a charcoal made from soft coal when heated in great ovens with a small supply of air. It is secured, in most part, as a residue from coal in the manufacture of illuminating gas, and it is a cheaper fuel than coal. It has a low burning point and so is especially good for quick kitchen work.

Charcoal, which is made by partially burning wood, is more porous than either coke or soft coal, bursting into flame at low temperature, and is often used for broiling, since broiling over charcoal gives a special flavor.

Coal dust, which is so often wasted, is made into molded bricks, known as "briquettes," and is available in some markets. These bricks are used as lumps of coal. The greatest disadvantage of this type of substitute coal is a very heavy smoke which is given off in the first few minutes of its burning.

Other fuels, in some localities, play an important part: kerosene, gasoline, alcohol, acetylene, Presto-lite, gas, and electricity. These fuels each require a different type of burner, and vary in price under different conditions.

Kerosene is an oil which has a strong odor, burns with an odor, and is a fuel which necessitates much cleaning and care. Usually a wick is used in the lamp or stove to feed the flame with fuel. In the modern heaters, the oil is vaporized and so may burn without a wick.

Alcohol is an expensive fuel, but with a vaporizing burner has good heating power. One would hardly consider it, however, as a regular cooking or heating fuel. Wood alcohol and denatured alcohol are much less expensive than grain alcohol, which can not practically be considered a fuel because of its expense. Alcohol is easily used in little individual burners in traveling, with self-heating irons, and with various devices for heating water, chafing dishes, curling irons, etc. An alcohol stove is shown in Fig. 33.



FIG. 33.—Alcohol stove. Tank in the back.

Canned Heat and Light.—Solid alcohol, or canned heat, as it is sometimes called, is another emergency fuel which is available in small tin cans and is burned in its container without a special stove. Presto-lite might be spoken of as canned gas, in that tanks of Presto-lite or compressed acetylene gas, like tanks of oxygen, may be purchased and used. (See Acetylene below.)

Gasoline is a fuel that gives satisfactory service as a cooking fuel. Its disadvantages are its expense, and, more important, its danger. It vaporizes easily, mixes with air readily, and is most inflammable. It introduces a danger which, so long as there are so many other fuels equally as good, if not better, it is not necessary to incur.

Acetylene is a gas produced by allowing water to come in contact with calcium carbide. Acetylene is a poisonous gas, but will not explode unless it is under pressure, or until mixed with air.

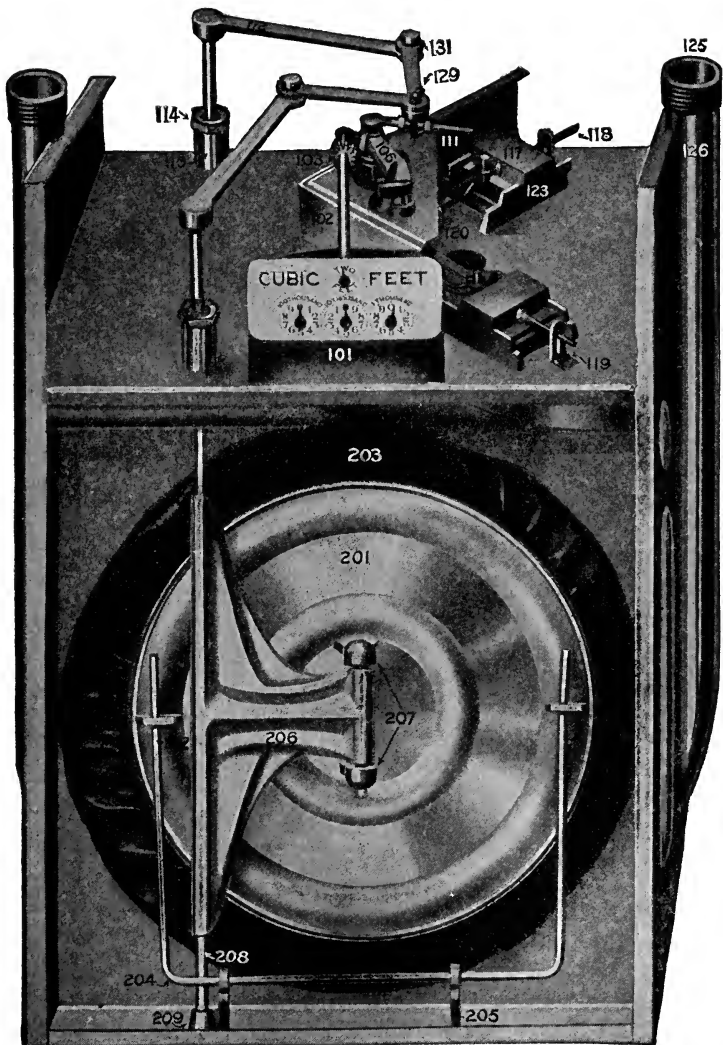

FIG. 34.—Interior of a gas meter, showing the bellows action. Courtesy of the Bureau of Standards, Washington, D. C.

Because of the gas being poisonous, one should be extremely careful that all burner connections are tight, and that by no chance the flame be turned so low that it would be likely to blow out. The carbide is purchased in water-tight containers and is perfectly safe so long as kept dry and in a well-ventilated storage place. The National Fire Underwriters issue rules which will serve as cautions. These can be obtained by writing to the office in any large city.

Gas, which is an invisible vapor secured from coal by heating, is used for lighting, heating, and cooking. In some localities natural gas is substituted for manufactured gas. Natural gas is obtained from the depths of the earth and is piped like oil or

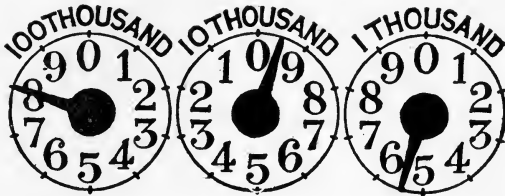

FIG. 35.—Gas meter—index reads 79,500 cubic feet.

water; it extends into the earth in veins which are so connected that if a second vein is tapped, the first may give out. Both manufactured and natural gas are furnished to consumers by companies that meter the gas (Fig. 34) and charge for it so much per thousand cubic feet. The cost price may be represented at about \$.25–\$.30 per thousand cubic feet for natural gas, and \$.80–\$1.00 for manufactured gas.

To Read the Meter (Fig. 35).—The dial on the right hand (marked 1 thousand) indicates 100 feet between any two figures; the middle dial indicates 1,000 feet between figures; and the dial on the left indicates 10,000 feet between figures. In reading, always read the lesser of the two numbers between which the hand rests. For example, the meter as shown reads 500 plus 9,000 plus 70,000, or 79,500 feet. The amount of gas used in a month would be the difference between the reading taken at the beginning of the month and the one taken at the end of the month.

Gas is distributed by small pipes and is controlled by stop cocks

and individual burners of various shapes (Figs. 36 and 37). For heating, cooking, and incandescent lighting, an air mixer commonly known as the Bunsen burner mixes the right proportion of air and gas so that it will burn with a blue flame and give the greatest heat. Gas unmixed with air burns yellow like a kerosene lamp and deposits soot in cooking. Be sure that the flame of the gas stove burns blue; a yellow tip to the flame means that there is not enough air going in at the mixer, which is between the stop

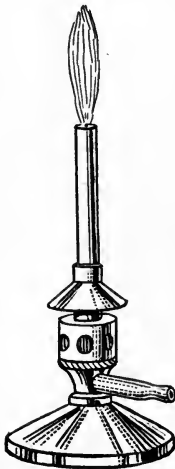

FIG. 36.—Blue flame for heat, as produced by the Bunsen burner which has holes for intake of air, which mixes with the gas before burning.

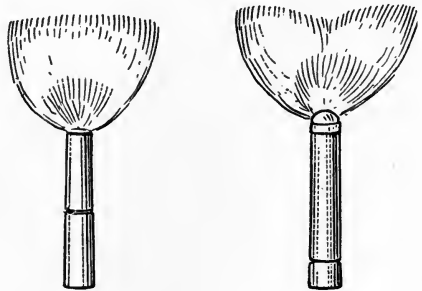

FIG. 37.—Yellow flame for light. This flame has no chance for air until at the point of burning.

cock and the flame. This is overcome by opening the ventilator into the mixer. A flame that pops on lighting and on turning out has too much air.

Gas pilot lights on gas heating and lighting appliances are a great convenience. A pilot light is a small gas jet which burns constantly near the burners on gas ranges, heaters, and light fixtures, and is used to ignite the gas as the valve or cock is opened. One must not feel that this pilot is not costing something, but to some its cost is more than balanced by its convenience. This is especially true with high chandelier lights and for lights that are

at the foot or the head of stairs, which may be easily turned on or off by pulling the chain of the gas cock.

An electric lighting system for gas is the method of using an electric spark produced by a dry battery with copper wire led from the battery to each individual gas tip. A second wire, attached to the lever operated by the chain, crosses the copper wire as the chain is pulled to open the gas valve; the two wires coming in contact produce a spark, which ignites the gas. Continual burning of pilots is not necessary in the use of gas stoves, because matches are cheap, and because at very little cost a flint lighter may be purchased which will at any time spark a light; it is much cheaper to turn on the gas and light matches than carelessly to keep the burner going. The newer type gas stoves have a pilot which is like a spark burner. The lever operating this pilot has a spring, which automatically shuts off the pilot as soon as released by the worker. This of course eliminates the extra cost of gas caused by most pilot lights.

Danger from Gas, Gasoline, Kerosene, Acetylene.—Any of the gases used for fuel will cause asphyxiation if breathed in quantity hence one must guard against leaks in the pipes, or against flames blowing out. Gas and the fumes of gas, if mixed with air in certain proportions, are highly explosive. One must therefore never hunt for a leak in gas pipes with an open flame as a candle, lamp, or match. Storage of kerosene and gasoline should always be with the thought of avoiding spread of odor and danger of fire. Kerosene is a safer fuel than gasoline to store, but both are more safely stored outside the house. Keeping any of the inflammables at a low temperature makes them safer to store.

Electricity.—There are two types of electric currents, the alternating and the direct. Knowing the difference between these two currents is not so necessary for the housekeeper as for her to know which of these two types of currents she is to use. The local electric company will of course furnish information. The alternating current is more often used, so that the motors which are to operate sewing machines, washing machines, ice cream freezers, electric fans, etc., are likely to be alternating motors, but one can buy any of these machines with direct current motors if one but asks for them.

Besides knowing the kind of electric current, one should know the voltage of the current. As the current is most often alternating,

so the voltage is usually 110. Home lights and home machines, then, are usually operated on alternating current and 110 voltage; but one should make inquiry of the local electric company before buying electric appliances and equipment. A low voltage electric utensil cannot be attached to a high voltage line without overheating and melting the wiring in the utensil. The pressure of the electric force is measured by voltage; the rate of flow by amperage; and the unit of resistance to the flow of the current through a conductor is called an ohm. A watt is the unit of electric power.

Heating or lighting by electricity is brought about by resistance offered by certain materials to the passage of the electrical current which produces heat. In the case of the stove, hot-water

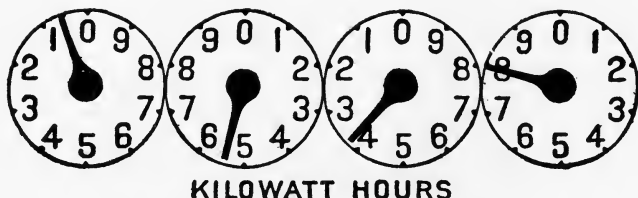

FIG. 38.—Dial of a watt-hour meter.

heaters, warming pads or electric irons, special wires radiate heat. In the lamp the wire is finer and of such composition as to become incandescent with heat and emit a white light.

To Read an Electric Meter.—Electricity is measured by a meter which indicates the number of watts used; as a watt is a small unit, the distributing unit of electricity is the kilowatt, or a thousand watts. Our electric bills then are in terms of "kilowatt-hours," that is, the number of hours that we have used a thousand watts of electric current. To read the meter (Fig. 38): A complete revolution of the right hand dial indicates 10 kilowatt hours; the next dial indicates 100 kilowatt hours; the third indicates 1,000 kilowatt hours; the last, on the extreme left, indicates 10,000 kilowatt hours. In reading, read from the right-hand dial to the left, and read the lesser of the two numbers between which the hand rests. To obtain the consumption, subtract the reading at the beginning of a period from that at the end of a period. If the

dial on the meter has "multiply," multiply the difference accordingly; if the dial is plain, as above, the reading is direct, and gives the actual consumption in kilowatt hours. The reading above is 8 plus 30 plus 500 plus 0000, or 538 kilowatt hours.

HEATING

Stoves for Cooking, Laundry, Heating.—Stoves and furnaces vary to some extent with the type of fuel which they use. Economy in the use of fuel depends in part upon the proper kind of heater, and partly upon the management of stoves and furnaces. Either

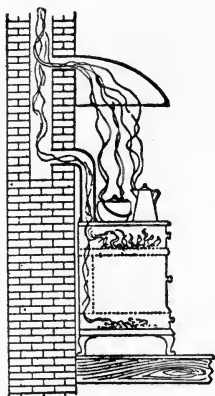

FIG. 39.—A hood over the stove for the escape of heated air and cooking odors must be connected with the chimney.

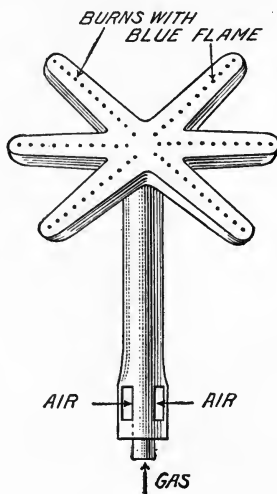

FIG. 40.—A Bunsen burner with the flame spreader. This kind of burner is used in the gas stove.

must have a compartment for fire called a fire-box, openings and passages to furnish cold air to the fire, and flues to carry off waste gases and dampers which open and close to regulate the draughts of cold air and of waste gases and hot air. The principle of firing is the same for stoves and furnaces. Coal and wood are the common fuels, particularly coal.

Cook stoves follow the general principles of all stoves and furnaces, but have the oven as an extra compartment for baking.

Coal cook stoves require a special damper for the heated waste gases and air which, when the damper is rightly adjusted, forces them to go around the oven box. Warming ovens used for food and dishes, that are heated like the oven, only to a much less degree, are extra conveniences, found in many cook stoves. A well chosen cook stove is one that is built without ornamentation of either casting or nickel. Every irregularity not only holds dirt

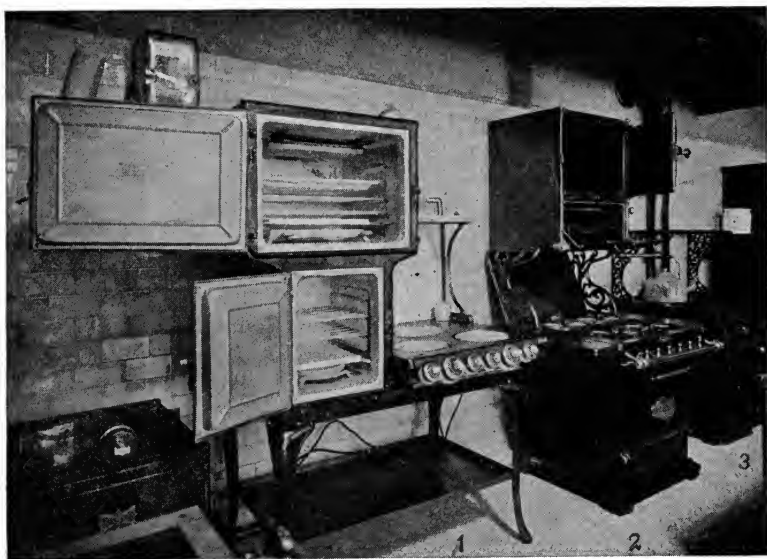

FIG. 41.—Different kinds of stoves: 1, electricity; 2, gas; 3, coal.

but adds much to the work of cleaning. A hood (Fig. 39) above the stove for the escape of heat and cooking odors adds much to the comfort of the kitchen.

Gas Cook Stoves.—A gas stove may consist of one burner, in which case it is usually called a burner or gas plate (Fig. 40). Two, three or four such burners put together are called gas plates; and if a portable oven be put on one burner, the combination is termed a stove. With perhaps three or four burners on top and an oven either below or above these burners, one has a gas range.

The more complete range has an oven, broiler, and often a warming closet, besides the top for cooking.

Electric Cook Stoves.—These stoves are not unlike the gas stove in form, except that they are heated by means of wire coils, through which the electricity passes. They may or may not have an oven. With the small cooking units like saucepans, toasters, and percolators, an electric plug attachment is the substitute for the more permanently connected stove top. As these plugs are



FIG. 42.—Blue flame kerosene stove, especially suitable for places where gas is not obtainable for a quick fuel.

standardized in size, it is possible to make any connections provided the voltage is the same (Fig. 41).

Kerosene Cook Stoves.—The kerosene stove is another type purchasable in single units, or in the large grouping of units that make cooking and baking possible. The modern kerosene stove (Fig. 42) produces a clear blue flame by first vaporizing the kerosene and then burning the vapor. This blue flame has brought into use the name "blue flame stove." This makes a very satisfactory range. As long as the burner is kept clean it is free from

odor. The wick of such a stove must be kept free from all charred particles, so that the flame will be even and will burn without sooting. A longer time must usually be allowed to cook over kerosene as the heat is not so intense as that of coal or gas. By means of a

special burner it is possible to burn kerosene in a coal or wood stove (Fig. 43).

Laundry Stoves.—Any stove that will heat a pan, like a cook stove, can be converted into a laundry stove, because either clothes boiler or irons can be set over such a fire. This, in fact, is necessary where kitchen and laundry must be combined. The ideal plan would be to keep the two workrooms separate, in which case the housewife might select a special laundry stove for the laundry.

A coal stove for the laundry may or may not contain a water-back, which will heat all the water for laundry use. They are usually built with a flat top to hold the boiler, while the sides of the stove are planned to heat the irons by having them rest up around the sides (Fig. 44). In this way the irons come into the very closest contact with the hottest part of the fire. As

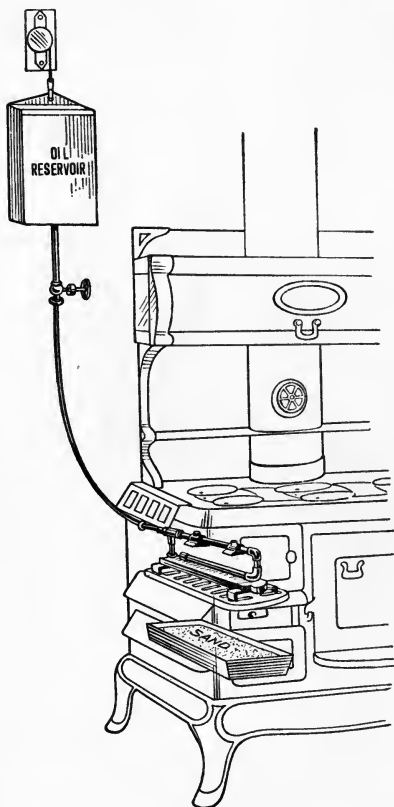

FIG. 43.—A device for burning kerosene in the cook stove.

the stove becomes very old, it naturally is gradually weakened by this intense heat, so care will have to be used not to throw the irons against the side.

Gas laundry stoves may be purchased with a central section just large enough to hold the average wash-boiler, and, to help in lifting the boiler, the stove is built with a lower working surface. In

this type of stove, on one or both sides of the central space are covered burners for heating the irons. These covered or hooded burners are fuel-savers because the heat is held in around the iron.

Heating by stoves, placed in one or more rooms, is still probably the most common method of heating individual houses. Despite its drawback of dust and dirt, of carrying coal through the house, of care involved, such stoves give a cheery heat and can be easily controlled to give as much heat as possible. Their management is like that of a furnace or cook stove fire.

Grate Fires.—Fireplaces utilize only a part of the heat produced, so that one must not expect to have the room as evenly heated as with furnaces or stoves. By means of iron air chambers about the fireplace opening into the room, it is possible to throw out more heat into the room, and it is also possible that the heat from the grate on the first floor may be conducted by flues to heat the rooms above. This is a more effective system than the simple fireplace grate, and is beginning to come into use. It will serve as a satisfactory method of heating houses located where winters are very mild or for summer houses not to be used in the severe cold weather. Fireplaces are useful for ventilating by the rise of hot air and the fall of cold air, whether or not the fires are built in them.

The old-fashioned Franklin stove is a stove designed to represent a fireplace, that really heats much like a stove, giving the pleasure of the open fire of a grate. It is placed out in the room and connects with the flue by a stovepipe. It will be found very satisfactory for occasional use.

Hot-air Furnaces.—Hot-air furnaces are really jacketed stoves (Fig. 45). The fire burns in the inner compartment and by radiation heats the cold air which is piped in from out-of-doors to the space between the jacket and the firebox. This cold-air flue extends to an opening in the cellar wall, which should be protected, by means of wire grating, from the chance entrance of animals. Cheese-



FIG. 44.—A coal stove designed for heating irons. A boiler may be connected with this stove allowing for hot water all over the house.

cloth sieves are often put over the openings so that as the air comes to the furnace, it is partially cleaned of street dust. As the principle of a hot-air furnace is circulation of air (Fig. 46), the cold air enters at a low level, is heated, expands, rises and passes from the jacket into the flues which are attached to it and through these rises to the various parts of the house. These flues are divided so that a separate flue reaches each room terminating in a register.

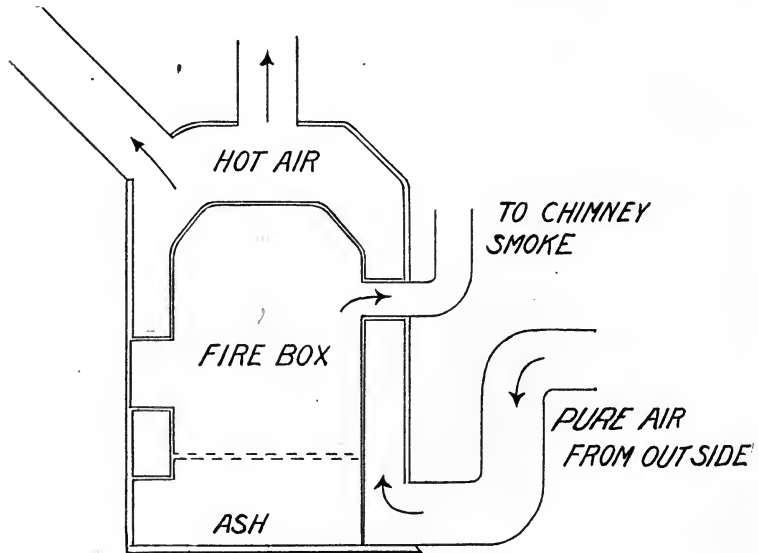

FIG. 45.—Diagram of hot-air furnace.

Hot-air heat is likely to be dusty and dry. The sifting of the air relieves the dust difficulty, and water in a tank arranged for the purpose in the air chamber of the furnace will moisten the air so as to make it less parched.

Hot water heating systems operate by the circulation of hot water through pipes or radiators located in the rooms (Fig. 47). The water as it cools in the radiators becomes heavier than the warm water and descends to the boiler, forcing other hot water to rise to the radiators, thus keeping up the circulation of heated water. This system is easily operated, and the heat is a pleasant one.

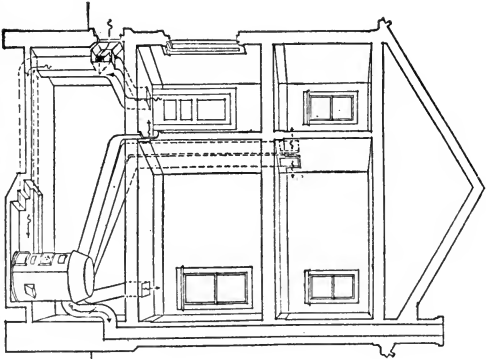

Fig. 46.—A hot air furnace should be located near the coldest part of the house and as centrally as possible. In order to give the leader pipes the maximum upward slope, the cellar should be deep or the furnace put in a pit (If a pit is used, provide for its drainage.)

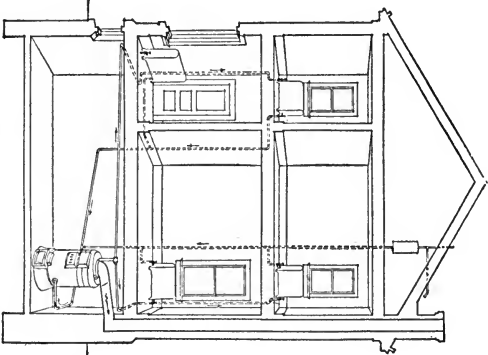

Fig. 47.—A hot-water system depends upon the cold water pushing the hot water to the top, because it is lighter and the cold water at the bottom. To take care of the water expansion, a tank is located near the roof with a vent for an overflow.

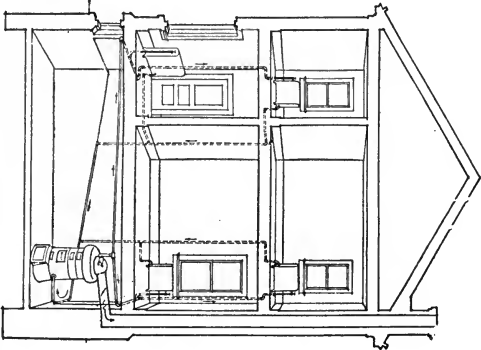

Fig. 48.—Steam heating depends on the condensation of steam in the radiators. One set of pipes carries the steam to the radiators and the other set allows cool water to return to the boiler. "A single pipe system" is also used—the pipes being graded so that condensed water runs back in the steam pipe.



One-pipe or Pipeless Heater.—A one-pipe or pipeless heater or furnace differs from the hot-air furnace, in that it has no flues to conduct the hot air through the house. One-pipe means that only the pipe connected with the chimney is necessary. This will carry off the smoke and gases from the fire.

The heater of the one-pipe system is best suited to a small house and one where the arrangement of rooms is quite compact. All halls and rooms should open into each other; otherwise, the free circulation of heated air is prohibited. The rooms on the

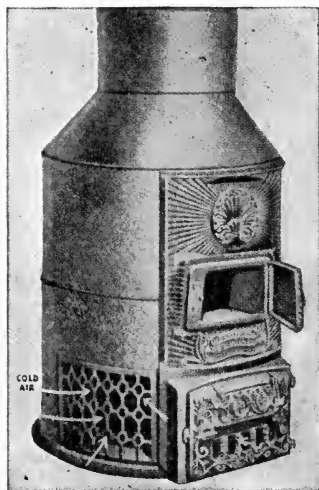

FIG. 48a.—One pipe heater

second floor are heated by means of registers set in the floor so that the heat of the lower floors may rise to the upper.

The ease with which such a furnace may be installed is about equal to the setting up of any stove. In an old house, which was built without planning for a furnace, it is possible to heat it without the expense and inconvenience of either breaking walls or having unsightly connections. The depth of the cellar or pit (see Fig. 46) is about $6\frac{1}{2}$ feet and could be easily arranged even in a house without a cellar.

The heater should be on the north side of the house. Coils for heating water may be placed in this furnace, but it must be remembered that the heat used to heat the water is that much less heat for the house. This may be overcome by using a larger furnace.

Steam heating apparatus is the most efficient heater for large buildings and in situations where there are bleak winds. The system operates by a low-pressure steam boiler in the basement from which steam rises through pipes to radiators; as it cools the steam changes to water, which runs back into the boiler (Fig. 48).

Hot Water Heating.—A cook stove often has a *water back* for heating the hot water supply of the house. Pipes are let

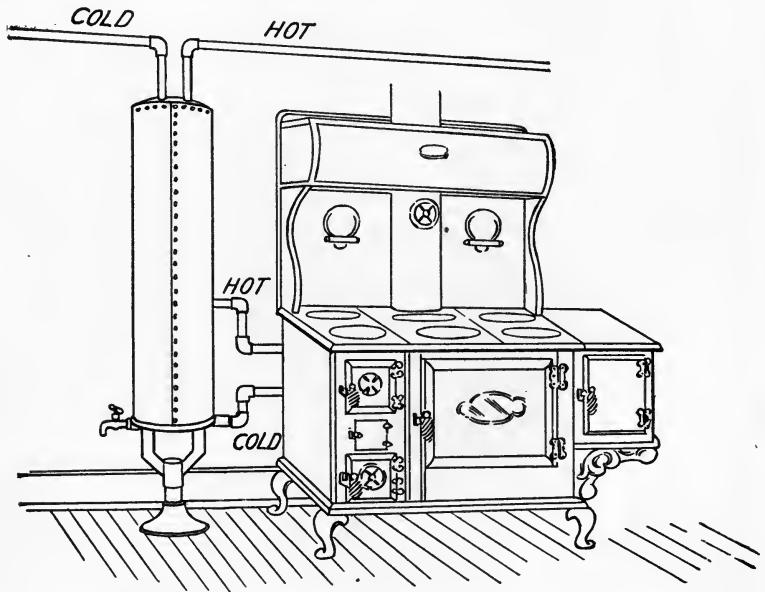

FIG. 49.—Diagram showing connection of hot-water boiler and cookstove.

through the back of the fire box, and by circulation of cold water from the bottom at a lower level into the heater, and hot water at a higher level on the return from the water back, the water is heated and stored as hot water in the boiler (Figs. 49, 50). Similar heating coils are often put into the fire boxes of furnaces. Special water-heating stoves are also available which heat water at small cost with a coal fire, and maintain a constant supply of hot water. The latter are more satisfactory, as water heating in a

stove to be used for other purposes will reduce the heat efficiency of the stove. It will take more coal to keep up the same degree of heat.

Gas water-heating is a very convenient method. The coiled water pipe (Fig. 51) under which the gas flame burns is the sim-

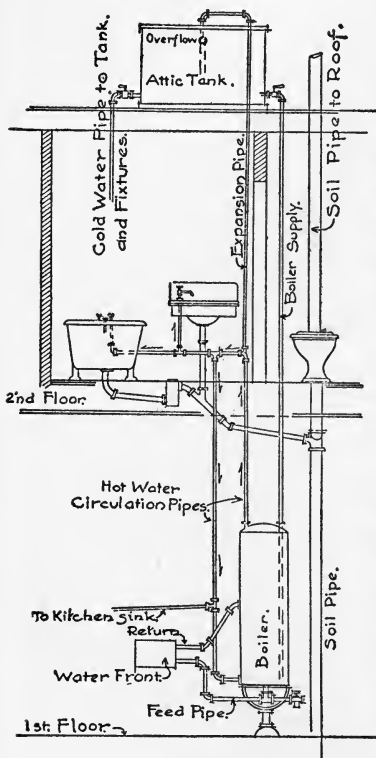

FIG. 50.—Hot-water circulation.

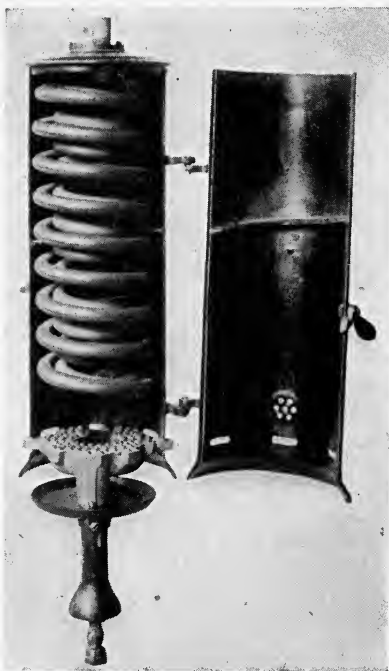

FIG. 51.—Gas hot-water heater. This heater may be used with the boiler which is connected with the cookstove. When there is no fire in the coal stove, this gas heater will heat the water for the house, using the same boiler.

plest type and may be attached with comparatively small cost to any boiler that may be installed with a coal range. Its special advantage is that in warm weather one may have hot water when needed and not have the continuous heat of the coal range. By

insulating the boiler the heated water may be kept warm for several hours.

Instantaneous gas water heaters may be placed in the bathroom for use directly with the tub and basin. This heater is chosen for houses where there is no hot-water plumbing system. The most convenient gas water heater is the automatic heater that furnishes hot water all over the house on the turn of the water faucet (Fig. 52). The gas burns continuously as a small pilot light, and when any faucet is opened, the change in water pressure turns the gas

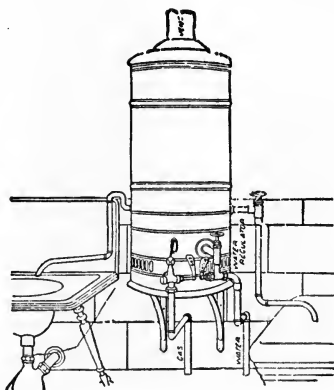

FIG. 52.—Instantaneous gas hot-water heater for bathroom.

burner on full, continuing as long as the water flows, and giving hot water immediately and as long as the faucet is opened. Careless use of water creates a large gas bill, as no matter how long the faucets run, the gas is on full force.

A *kerosene hot-water heater*, while not an instantaneous heater like the gas heater, makes the hot-water problem in the rural home an easy one if there is a water system to force the water through the pipes (Fig. 53).

MAKING AND REGULATING FIRES

Starting Fires in Stoves or Furnaces.—The fire-box or grate should be free from all ash and unburned material. Lay the material for the fire firmly but loosely so that when the fire begins to burn it will settle evenly and not topple over, as it may, reversing

the fuel. The easiest burning material should be put on the bottom, such as paper, or shavings, then wood and then coal. As a great

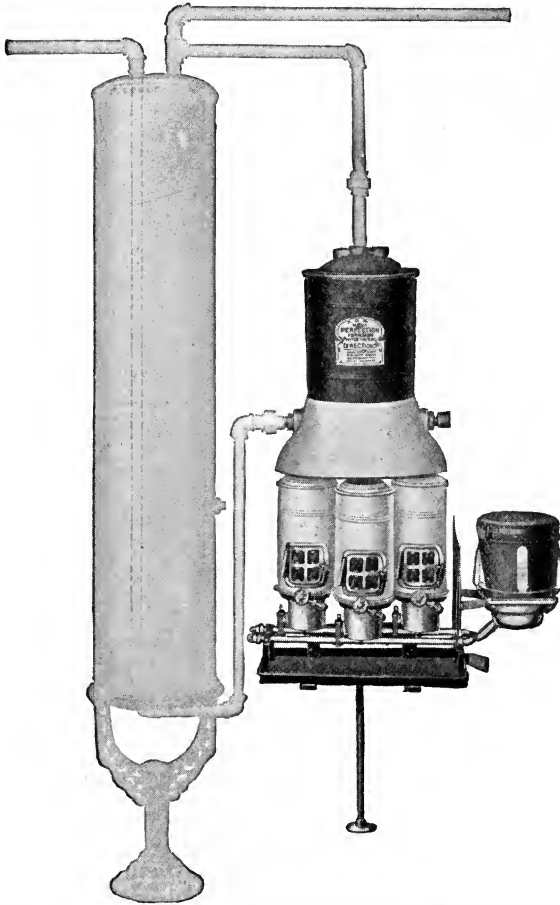

FIG. 53.—Blue flame hot-water heater. Such a heater gives great service in houses where there is no coal range and where a kerosene cookstove is used entirely.

deal of heat is required to bring the coal to its flaming point, start the fire with only enough coal to cover the wood lightly. As soon as this coal is hot or in flame, add more. Should any unburned coal,

not clinkers, be left from a former fire, it may be added to the fire when it is clear, hot, and thoroughly established.

The clinkers and ashes should be well cleaned out each day at a regular time and coal placed on the fire at regular times. When the fire is burned day in and day out it is cheaper to hold the fire over at night as it will take more coal to build a new fire than to keep an old fire.

Grate Fires.—When a grate or fireplace fire is made, the same general directions should be followed. In making a grate fire the ashes should be removed so as to have free access of air to the fire. In a fireplace, where wood is burned, the andirons or two or three bricks take the place of a grate. Usually the wood ashes are brushed far back in the fireplace and left, because when a fire is made these ashes will heat and assist in throwing out more heat. It is an economy to leave them sometimes until several inches deep but always pushed back—so far back as not to blow out, and so as to throw the heat forward into the room. In building a fireplace fire, place the back log across the andirons, lay the paper or shavings between the andirons, and cross the kindling sticks on the paper, but more in a hillock shape than flat as when making a furnace or range fire. Lay the heavier sticks on the kindling so that as the flame burns along the kindling, it will be led up to the heavier log that has been placed across the fire on the andirons.

A back log is a great help in building a fire. Usually a heavy chunky stick of hard wood is chosen; and it often lasts from one fire to another, and as it grows smaller may be brought forward and a new log put in. To keep a large log from burning, perhaps late at night when fire is no longer needed, stand the burning piece on end back in the corner or against the side, and as it is isolated from the heat of neighboring pieces it will stop burning. Such a piece can be used on the next fire.

In grate fires soft coal burns with a yellow flame, and because it is porous and full of gases it burns quickly and makes an excellent grate fire. It requires, in fact will stand, only little handling, because it burns slowly and steadily. Small paper bags filled with hard coal can be laid on the fire, and in that way the heavy lifting, dirt and noise of shoveling coal in the grate are eliminated.

In regulating the dampers of stoves and furnaces, opening the lowest front damper lets in air which will feed the fire and assist

its burning; opening the damper connected with the chimney allows the escape of carbon dioxide gas and water (Fig. 54 A) in the form of vapor, together with the smoke, and assists further in the burning. Closing these dampers, partly or entirely, checks the fire to the same degree. In a cook stove, the third damper controls the heating of the oven, so that if the oven is to be heated the oven damper should be closed. This will keep the heat from going out of the chimney and will cause it to go in a roundabout passage behind and under the oven. This is called the indirect draught (Fig. 54 B),

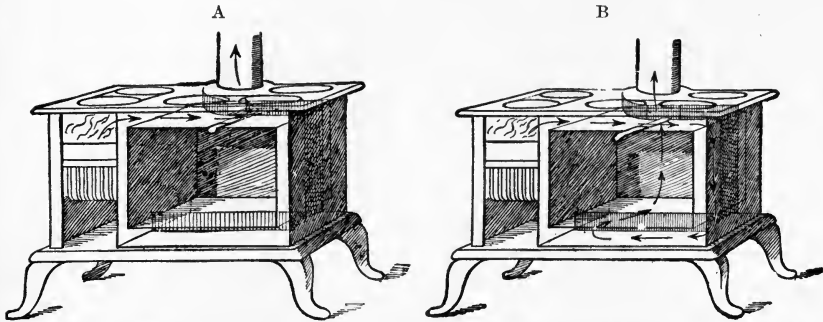

FIG. 54.—Diagram of coal stove. A, direct draught. B, indirect draught. From Parloa's Home Economics, Century Co.

whereas a direct turning of the heat up the chimney from the fire-box is called the direct draught; the latter is used especially in starting up the fire. To economize with fuel, whether the oven is to be used or not, and whether a cook stove or a furnace, the chimney damper should ordinarily be closed, that is, the indirect draught should be used, so as to save fuel and have more heat.

In taking care of a range fire, furnace or grate fire, do not pack on too much coal. Keep the coal from extending beyond the lining of the fire-box, keep the ash-pan clean, and keep the fire grate free from ashes, so as to let in air and prevent the grate bars from being overheated. If, as in a kitchen range, one has a water tank in the range, be sure to keep the ashes away from that part of the grate which is to heat the water. These water pipes are usually placed just back of the fire-brick at the back of fire-box.

Dampers of furnaces may be operated from the second floor by having chains extend up through the floor from the cellar. The

chain has a ring on it and by pulling the chain, the damper door is opened; the ring is then fastened on a hook and so long as it is, the damper is opened. By releasing the chain, the damper is allowed to close. This simple device can often be installed by the man of the family; its cost under any condition is nothing in comparison to the saving of strength in not going up and down stairs to open and close the draft. With a furnace well cleaned and coaled in the morning, the regulating of dampers during the day is usually all the care the fire will need until night. The man can attend to the fire in the morning, and the woman easily take care of the dampers during the day.

Ash Chutes.—In planning the house, ash chutes leading from the coal range or fireplace will be found to cost little; and these will accomplish so much in reducing the work of emptying ashes and the subsequent work of cleaning up, that they should certainly be included. There are special dustless ash trap-doors for fireplaces that are devised so as to reduce the blowing back of ashes when they are dropped down the chute.

To Remove Clinkers from the Fire-pot.—Certain coals form more clinkers than others, and if the fire is at white heat, these clinkers fuse and adhere to the fire-brick. To break them off with a poker is likely to break the fire-brick, so they are best removed by using oyster shells or lime. At the time when the fire is a good clear red, draw the hot coals away from the fire-brick, drop in about one quart of oyster shells, or a pint of lime, close the door, keep the fire hot and the lime in the oyster shell will cause the clinkers either to break off or to be very easily tapped off with the poker, when the fire is out.

Conservation of Heat.—Much is possible to-day in the way of economizing in the cost of fuel, especially by proper management of fires. There are also several special devices which result in heat conservation.

“Simmering Burner.”—Gas stoves have so-called “simmering burners,” which while they are small burners, are sufficiently large to keep a large pot at simmering temperature. It would be well for the housekeeper in purchasing a gas stove to investigate this question as to whether the stove has a small simmering burner; such a burner can also be put on old stoves.

Gas Stove Tops.—Tops are made of cast-iron like the top of a

kitchen range, which may be fitted to the entire top of the gas stove, and smaller ones are available that cover two burners (Fig. 55). The idea of this top is that with the heat of one burner two kettles may be used for cooking, with the more direct heat for the kettle directly over the burner, and the radiated heat for the kettle over a burner that is not lighted. The idea is the same as cooking on the back of a coal stove when the fire is in the front.

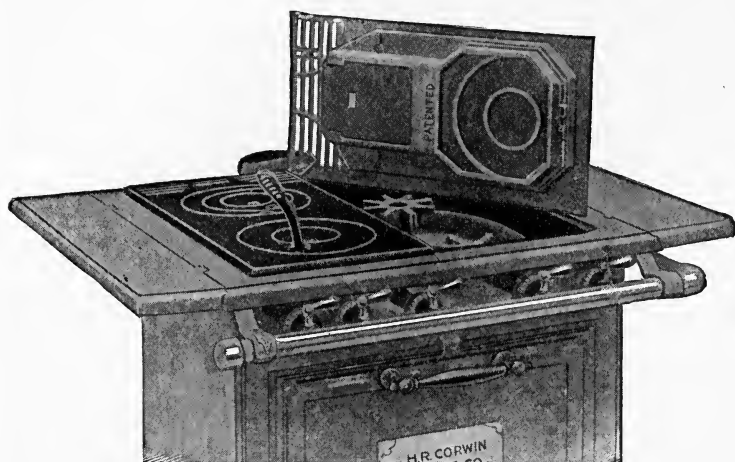

FIG. 55.—Cast-iron top for a gas stove. This is a good means of saving gas. The heat of the flame under the front burner is sufficient for slow cooking on the back burner. Such a top makes the gas stove top like the coal stove.

Economical Utensils.—More saving of the fuel is accomplished than one would realize by using the proper kind of saucepans; pans with a broad bottom will heat more quickly and make more economical use of the gas than those that have small bottoms and flare at the top. Covers to saucepans also conserve the heat, and hence save fuel. Burners that are flaring up the side of the saucepan do not give so much heat as those that are turned down enough to keep the heat directly under the bottom of the pan. The actual fuel cost for heating pans of different types of metal is approximately the same when the conditions are the same, so that it is more the way the burner is operated and the shape of the pan than it is the material of which the pan is constructed, that secures economy.

Dampers.—Saving of coal and wood in kitchen stoves is brought about through the proper adjustment of dampers. The most common waste of fuel is by keeping the oven damper open, that is, sending a direct current up the chimney and thus forcing the fire to burn more rapidly while the heat escapes up the flue. The lower damper will also cause more rapid burning but not so rapid when the oven damper is closed. Ashes in the fire will waste fuel because often it will check the fire so much that it dies out, and the unburned fuel is usually wasted with the ashes in cleaning out the fire-box and starting a new fire.

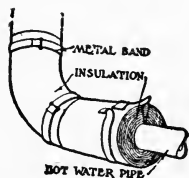

FIG. 56.—Insulated steam or hot water pipes. Courtesy of Charles E. White, *Ladies Home Journal*.

When the fire is not in use, leave it clear, that is, clean from ashes with a light covering of coal, with the lower front damper closed, the oven damper closed, and the upper front damper open.

Insulation.—Covering the hot air, steam, and hot-water pipes (Fig. 56) leading from the furnace with insulation covering will do much to conserve the heat. This asbestos covering comes in sections with metal bands to hold it in place. It is an easy matter to attach them. An insulating jacket for the hot-water boiler can be had for a few dollars.

Fireless cookers are at once fuel and labor savers. They are labor savers in that they reduce the work of constantly attending to food in the cooking process. The cooking time is longer than with a stove, and with many foods it is so long that the housewife may go about other work or pleasure for several hours. The time required to cook each thing is quite definite, and not indefinite as so many seem to think. Food should not be left in so long that it not only cooks, but has time to over-cook, and finally cool in the kettle. Constant steaming and cooling of foods will give the cooker a strong odor, and will give the food a strong flavor that has been called a "cooker taste." To overcome this give kettles and boxes thorough airing when not in use.

The first fireless cooker was a hay box in which the European peasant placed hot dishes, with the idea that when set in this non-conducting material they would finish cooking while the workers went about their work. Inexpensive cookers may be made with wooden flour pails or boxes filled with insulating material (Fig. 57), or when camping, may be made by digging a hole in the ground.

The kettle in which the food is heated must have a tight-fitting cover; the non-conducting material should be as free from odor as possible, such as asbestos, excelsior, crushed newspaper, bran, clean straw, or cotton (Fig. 58). The care of such a cooker is greater than of the manufactured ones, because the filling will soon need

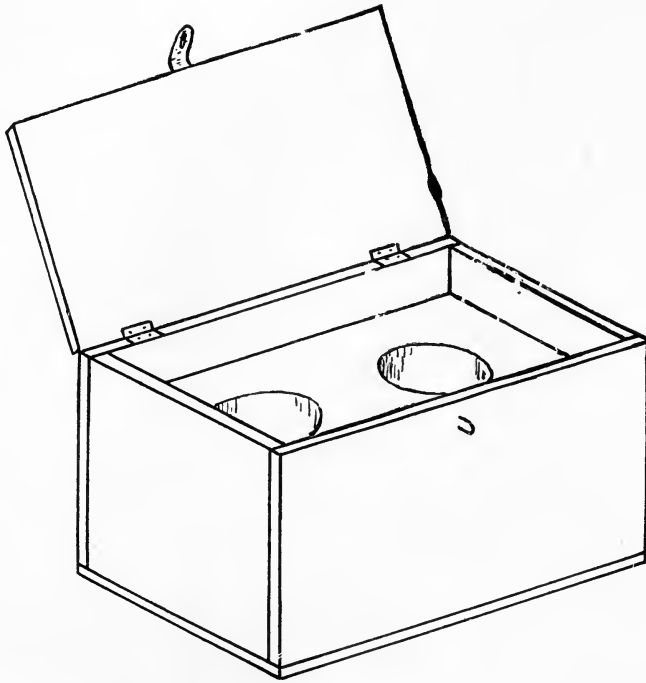

FIG. 57.—Home-made fireless cooker. Any convenient box may be used and any can of convenient size, such as a lard can, etc. The cans should be wrapped with about 4 or 5 layers of asbestos paper. The space around the cans should be at least 2 inches and filled with straw or wood shavings, etc. The top of the cans should be covered with a pad.

to be changed, and because the kettles in the manufactured cookers are aluminum with clamped covers, and non-rusting (Fig. 59). Such aluminum fireless cooker kettles can, however, be purchased separately for use in home-made cookers.

The cookers are manufactured to meet all needs, so one will find cookers with one, two, three, or four compartments, with kettles

of various sizes, and even in nests of small ones so that several different foods may be cooked simultaneously.

The essential thing for the housewife to know is the standard requirements for a good fireless cooker:

The box to have good insulation.

The kettles to have good, tightly-clamped covers, to be non-rusting.

The lining of compartments to be non-absorbing and easily cleaned—preferably aluminum.

Soap stones or iron plates provided for roasting, baking, and long boiling.

The efficiency of the fireless cooker is greatly increased by raising it from the floor to save bending and stooping on the part of the worker. The fireless cooker gives only fifty per cent. of its efficiency if operated in conjunction with a coal stove. The amount of fuel and the time necessary for a coal stove to get a kettle of water to boiling temperature or a stone disc hot enough to roast or bake, means enough fire to cook food for a long time, perhaps long enough to finish the process. For this reason a small gas burner or a blue flame stove will make the fireless cooker

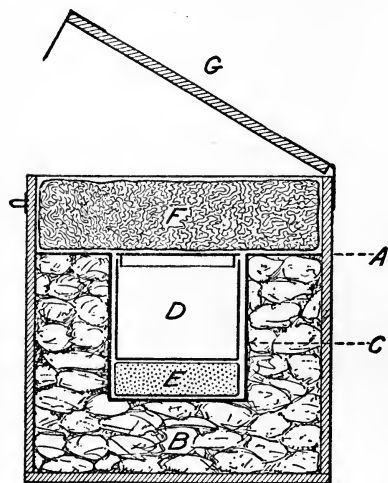

FIG. 58.—Home-made fireless cooker. A, outside container-box or trunk; B, insulating material—paper, sawdust, cinders; C, metal lining of nest—tin, zinc, aluminum; D, cooking kettle—aluminum, agate; E, soapstone plate, or some heat-containing material; F, pad of excelsior for covering; G, hinged cover for the top of the outside.

more of a fuel- and labor-saver than it is with a coal range.

In the *fireless cooker gas stove*, the fireless cooker principle is combined with the gas stove by making the oven with insulated walls to retain heat; this type of stove, properly used, is very economical. One or two of the burners on the top of some stoves have a non-conducting hood that may be lowered over the kettle, and at once, without lifting or changing, the food is in the fireless cooker. The ovens are so insulated that when the baking temperature is

reached, the fire may be turned out and the temperature is practically sustained until the baking or roasting is completed in the fireless cooker oven.

Vacuum bottles or containers are constructed on the same principle as the fireless cooker; while primarily a convenience, they do indirectly save fuel. They are double-walled glass containers with a metal jacket. The air is exhausted from between these two glass

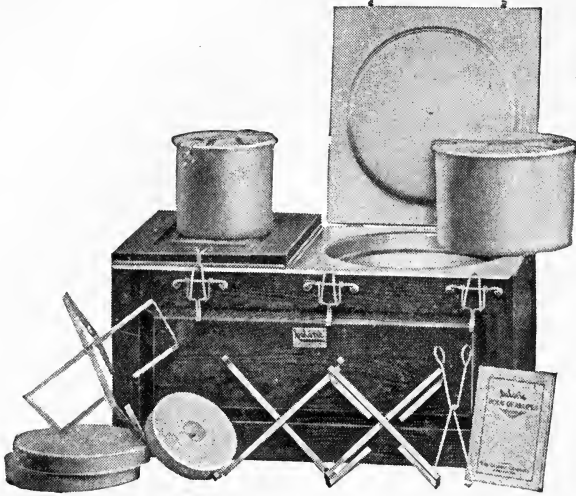

FIG. 59.—Caloric fireless cooker.

walls, thus forming a vacuum, and several linings of non-conducting material assist in retaining either heat or cold. The inside is silvered like a mirror, because the bright surface prevents radiation of heat. The vacuum bottle has a tight cork and screw top so as to prevent leakage of either heat or cold. In the new models the metal outer jacket can be unscrewed so that a new inner container may replace a broken one, thus saving in renewal cost.

LIGHTING

In building, one should study the location of lighting fixtures carefully, both ceiling lights and wall lights; with electricity, one should also locate "plugs" in the baseboard for attaching vacuum cleaners, cooking appliances, etc. Placing lights in rooms and halls

is really a matter for much thought, because bad positions are not only inconvenient, but too often mean unnecessary expense through having more burners lighted than is necessary. A good droplight for reading and sewing requires only one burner, and will give more and better light directly on the user at less cost than several ceiling light.

Types of shades influence the clearness of the light, and, like wall-paper, increase or decrease the amount of light used. The following table showing degrees of light absorption by different types of glass shades is interesting for a study of comparisons:

	Per cent.
Clear glass	5-12
Slightly ground	25
Ground all over	25-40
Opal	35-60
Colored or painted	64

White or light linings to dark shades will give a clear light most pleasant to the eyes.

Some modern lighting uses the principle of indirect lighting or reflection (Fig. 60). The light burns in a bowl fixture hanging from the ceiling; the light is reflected to the ceiling, and this, in turn, reflects it to the room. The angle of light is broadened and so spreads over the room surface. Such a light gives a brilliantly lighted room, without the softening effects of any shadows. It is most suitable for show rooms, stores, and large home rooms requiring clear, strong light. One would hardly depend entirely upon indirect lighting in bedrooms and libraries, as the light is tiresome because so general. To soften it, one would find relief in a dull opalescent or ground bowl, which absorbs some of the light.

Paraffin candles are most attractive, for occasional use, at least, in dining rooms, and for convenience in going about the house where there are no lights, provided one burns the better non-smokeless, non-drip candles. Such a candle will soon prove its value, because there will be no unpleasant smoke odor and no dripping of paraffine which, whether white or colored, is hard to remove.

Kerosene lamps give an excellent light when kept in good condition—properly filled, clean wick, and clean chimney. The light is a soft yellow, and is most pleasant. Kerosene lamps, however, do involve much care, give off a great deal of heat in the

room, consume much oxygen, and the smoke and odor from either a dirty lamp or one turned low is disagreeable. The chief reasons for their use are that the first cost is low, the fuel is easily obtained, and no expensive system is necessary. Kerosene lighting varies in its efficiency according to the type of burner used. Of ordinary wick burners, those with round, hollow wick and a center draft to furnish air within the flame are especially good. The kerosene mantle lamp, the newest type of kerosene lamp, has a mantle which increases the brilliancy of the light four-fold, with no extra cost for fuel. The

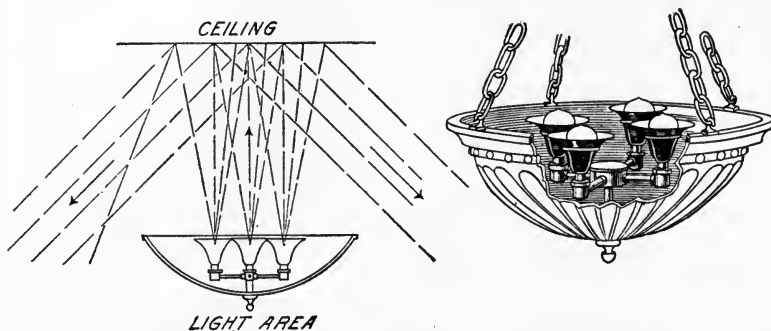

FIG. 60.—Inverted lighting. Specially suited for lighting large rooms.

mantle must be handled as carefully as a gas mantle and the wick must be kept carefully trimmed. To clean kerosene lamps, see chapter on Cleaning, page 250.

Acetylene and "**Presto**" (condensed acetylene) may be used with mantles like gas. Such a means of lighting is most adaptable to rural homes and to camps. Any gas fixture can be used, but the tip must be double so that the flames coming from two opposite holes in the burner strike each other and spread the flame.

In an acetylene house-lighting system, a tank is provided where the gas is stored as fast as it is formed, and from this tank the supply pipes branch.

Gas Lights.—Unless gas is supplied with a special burner, it burns with a yellow light, and it requires a globe or lamp shade to give service which is at all satisfactory. The old-fashioned gas-tip spreads the flame into a so-called "bat's wing" (see Fig. 37), or "fish tail," light. The newer burners, called "Welsbach,"

are Bunsen gas burners, which mix air with the gas before it is burned, and burn the flame into a white mantle (Fig. 61). This mantle becomes incandescent or glowing white, but does not itself burn. The mantle is often mounted on a calcium rod which, when heated, reflects a white glow, so that the entire Welsbach light is a white light, very clear, burning without soot. These mantles are

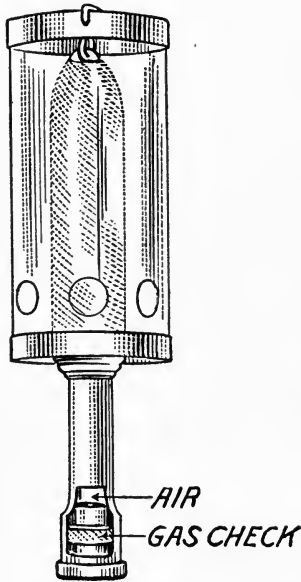

FIG. 61.—Bunsen burner. Produces a white light by heating a mantle to incandescence.

very frail, and will last much longer in places where there is no jarring and no draft. Should they blacken in burning, it means that there is not enough air going in from below to oxidize the flame. To clear the mantle, open the ventilator wide and let the gas burn until all the soot is burned off. For a few minutes the light will not be so good, but after the mantle is cleared, the regulator may be readjusted to give a good clear light. An old mantle may be saved, and may be used as a silver powder for cleaning silver.

Electric lamps have been improved since the first carbon lights, so that they give a whiter light, and at the same time use less electricity. The electric bulbs are vacuum glass globes in which a filament has been put before sealing the bulb; the air is exhausted so that when the lamp is heated there is no air present to

oxidize the filament. The first lamp filament used was of carbon, and is relatively inefficient because it uses so much electricity. The most modern filament is the tungsten, which gives a clear light with a small consumption of electricity. The different degrees of brightness depend upon the size of the filament and upon its composition. The modern tungsten filament is, for example, a finer filament than the carbon, and yet gives a greater light. A sixteen candle-power light, while using fifty-five watts with a carbon filament, consumes in the same time only twenty-five watts with a tungsten filament, making the consumption cost in the latter case about one-half of the former.

It pays to use electric lamps of two or three sizes in an ordinary household. A fifteen-watt lamp will do for closets and other places requiring little light; a forty-watt lamp is generally useful; a sixty-watt lamp will illuminate where a single larger light is desired.

Lighting Hints.—It requires more light in a room with dark walls than with white ones.

A flickering or dazzling light produces eye strain and headache.

The light should come from above and over the shoulder.

Be economical by turning lights out, when not in use.

A modern lighting system should not be selected on the basis of economy alone. Money spent in proper lighting may be saved in the oculist's bill.

SUGGESTIVE QUESTIONS

1. What are the main factors in successfully lighting a room?
2. Why is it necessary to heat above normal temperature a very damp room before the occupant will feel comfortable?
3. Why will a fireplace or stove smoke when the fire is first started?
4. Why do tall chimneys have a better draft than short chimneys?
5. If one were camping, how could a fireless cooker be made?
6. What causes the water to rise in a coffee percolator?
7. In what ways might a housewife's electric light bills be reduced?
8. What is the advantage and disadvantage of a highly polished stove?
9. Why is not a fireplace as economical as a stove?
10. How may you prevent too much heat from going to the attic radiators at the expense of those on the other floors?
11. Give methods of heating water. How does this affect the coal bill? Describe coils in a furnace. What precaution must be taken with them?

REFERENCES

- DRESSLER, FLETCHER B., RURAL SCHOOLHOUSES AND GROUNDS. U. S. Bureau of Education, Bulletin No. 12.
- FARMERS' BULLETIN 771, HOME-MADE FIRELESS COOKERS AND THEIR USE. U. S. Dept. Agriculture.
- HOGDON, D. R., ELEMENTARY GENERAL SCIENCE. Hinds, Hayden & Eldridge.
- KING, F. H., VENTILATION FOR DWELLINGS AND RURAL SCHOOLS, ETC. F. H. King.
- LANCASTER, MAUD, ELECTRIC COOKING, HEATING, CLEANING. D. Van Nostrand Co.
- LUCKIESH, M., LIGHTING THE HOME. The Century Co.
- MCPHERSON AND HENDERSON, GENERAL CHEMISTRY. Ginn & Co.
- ROSENAU, MILTON, J., PREVENTIVE MEDICINE AND HYGIENE. Appleton Co.
- U. S. BUREAU OF MINES, SAVING FUEL IN HEATING A HOUSE, Technical Paper No. 97.
- U. S. BUREAU OF STANDARDS, SAFETY FOR THE HOUSEHOLD. Circular No. 75.
- VULTÉ, HERMAN, HOUSEHOLD CHEMISTRY. Chemical Publishing Co.
- WHITE, MARION, FUELS FOR THE HOUSEHOLD. Whitcomb & Barrows.
- WRIGHT, S. S., THE KITCHEN FIRE AND HOW TO RUN IT. S. S. Wright.

CHAPTER IV

EQUIPMENT AND LABOR-SAVING APPLIANCES—I

GENERAL EQUIPMENT; KITCHEN

GIVEN a house with installation of plumbing, heating, and lighting, the next problem is adequate working equipment for the tasks of the household. Working equipment involves the tools, machinery, and other conveniences of various kinds—some of them often called labor savers—which are used in house work.

The subject is presented in two chapters: In this chapter the general principles regarding selection and placing of working equipment are stated, and the equipment of the kitchen is described; in the next chapter (V) the equipment for the laundry is presented, together with equipment for cleaning and miscellaneous tasks. In the succeeding chapter (VI), household supplies which are used with equipment in household work are described.

Besides this working equipment, the household has its furnishings for comfort and immediate satisfaction in use, rather than for work, such as furniture, hangings, etc.; these are discussed in a later chapter (VII) on household furnishings.

Selecting Equipment.—In buying equipment, the housewife is buying her working tools. This involves a certain amount of expense, and should mean that many of the things that are bought are not to be renewed for a considerable length of time. This, then, requires study on the part of the homekeeper so as to be able to answer the question, "What is a good tool?" In answer to that question, the following outline may help:

Construction—

Size

Shape

Material

Efficiency—

Fitted to its task

Results obtained

Time saved

Labor saved

Utility—

Wearing capacity

Renewal

Economy—

Purchasing cost

Renewal cost

Care cost

Related costs, as supplies

Construction considered in detail means—Is the tool of the proper shape to be fitted to its task? With the shape, the size is naturally considered. It is the old question of avoiding the round peg in a square hole. The proper material is also essential in the construction of a tool. Some types of fibre, for example, are better for scrubbing, or certain soft hair is better for brushing; some woods wear longer than others; solid backs to brushes will outwear a glued or tacked back.

Utility and *Efficiency* are in fact related matters, but one may consider utility as involving wearing power and the possibility of freshening or renewing the tool so that it is as good as new, without the expense being as great as that of first cost. Efficiency has to do with its power to do its work, depending upon the shape of the tool, its size, etc. It means this also—Does it take more time to use the tool and to care for it after use, than it does to do the work without the tool? If it is efficient, good or better results should be obtained, and time and labor should be saved by it.

Economy involves a careful comparison between the cost of one tool and the cost of another, the decision to come after answering for both tools the other requirements—Is it well constructed, has it wearing capacity, and is it efficient? If, in two tools—brushes or dusters or brooms—the conditions are equal, then the economical housewife should always buy the cheaper. She should be sure, however, that whether the cost be little or much, the tool can, by proper care (cleaning or oiling, etc.), be used for a reasonable period of service, thus eliminating excessive cost of purchasing new tools. Sometimes a tool takes much time and labor in caring for it, and is therefore not an economy but rather a hindrance. The matter of additional costs involved in the use of the tool, as for supplies, fuel, etc., should also be considered.

Labor-saving Appliances.—There are a number of larger labor-saving appliances such as the vacuum cleaner and the washing machine, which must be given serious consideration. One must not, however, judge them solely in terms of the purchasing cost. Granted that it is a large sum of money for the first expenditure, it is not fair to look at it except in a business-like way, and to compare this purchasing cost with the manpower cost of the same labor. This cost study should be made in the same way that an investment is considered. When one makes an investment, it is not expected to yield an income within a week, but only after a reasonable length

of time—a year or more. In just the same way, it is not fair to expect a motor washer to pay for itself in one washing. On the other hand, an appliance that breaks down after one or two trials is a poor investment, no matter how little it costs. One must figure the gain or loss on the basis of one year, or five years. One must figure on the renewal cost in the way of repairs, and of keeping in working order; the income from the investment by the amount and quality of work done under the new method as compared with the old; the income through saving the housewife from fatigue, and allowing time for other productive work such as mending, making and renovating of furnishings and garments, which otherwise must be hired out at considerable cost; and the income through allowing more time and energy for the necessary mental and spiritual life for the housewife and her family.

The only time when labor savers are not an investment is when they are hastily bought without study to find the best for the money; without definite knowledge of how to operate them. Under these conditions they may come into a home either to be so poorly operated that their efficiency is greatly reduced; or not to be used at all, as is often the case when the housewife does not learn how to operate them and cannot teach the maid to use them.

Labor savers, however, do not necessarily mean mechanical equipment with motors and pulleys, or vacuums and cylinders, or pressure and weight. Every tool, no matter how simple, and every convenience in work, is a labor saver. Here is where the housewife's study may open a door towards saving, by putting herself in a receptive frame of mind, and becoming willing to shift from old habits and methods. The simplest labor saver of all is to raise the height of working surfaces, to create a close working relationship between tools, and to group tools about the working center in which they are to be used.

Placing Equipment.—Much has been said in recent years on the efficiency produced by grouping together the tools that belong to a process. This is most helpful and is one of the best ways to reduce effort and fatigue in housework. It is this principle that suggests two cleaning closets for two floor levels, each closet equipped with its own working outfit so as to avoid the waste of time and effort in going over the stairs, and leaving one's work to go after the tools. Racks and shelves placed near the stove, near the sink, near the

kitchen table, make possible this grouping of tools, which is especially of service at these working centers. The working centers themselves should be so related that every possible extra step and movement is saved. This is especially true in the kitchen and in the laundry, where there are more permanent pieces of equipment and more detailed processes of operation. These facts of relationship of stationary equipment, height of working surfaces, and grouping of tools in best positions are all points to study and thoroughly work out when the house is planned, as it is often impossible to do it afterward without great inconvenience and expense. Even so, the saving in years of work which is to be done in the house that is bought finished may warrant the cost of extensive alterations.

A good way to make this study is to take the architect's plan of the kitchen, pantry, or laundry, and imagine it is a real room and do the work in it. For example, let the housekeeper pretend she is preparing creamed potatoes, remembering to begin by going after the potatoes. Where are they—down cellar, back porch, or the woodshed? Now carry them through all the processes—washing them, paring, boiling, draining after cooking, getting butter, cream, salt, pepper, dish; and, lastly, how far is it to the dining room? Creamed potatoes are not the real question; the question is, have we arranged all working centers so that they lead one to the other, or are we walking miles because we have not planned the kitchen properly?

Believing each room should, for efficiency, be a well-equipped workshop, it is wise for one to plan separate sets of equipment for each working center. If it is necessary to economize with money, of course some tools must be used in two places, but the disadvantage is that the tool is rarely ready for use, when and where it is wanted.

Height of Working Surfaces.—The equipment being chosen, much may be added to the satisfactory workshop by having the stationary tools, such as sinks, tables, washtubs, and stoves, placed at good working height. A low working surface means a crouched, uncomfortable position; it means unnecessary muscular fatigue in bending and stooping many times; it means backache and compressed lungs, all of which increase fatigue. The housekeeper who goes into a new house, over which she is giving her share of intelligent supervision, will insist upon raising the working levels of most of the permanent tools. Sinks have usually been set too low, most wash-tubs have given the feeling of going head first into them, and

tables are ordinarily far too low. Keep in mind that the bottom of the sink rather than the top is the working level, and that the side of the washtub rather than the bottom, and that the top of the table, are the places for work.

It is easy for the housekeeper to raise the working surfaces of tables and stoves; this is possible by means of blocks placed under

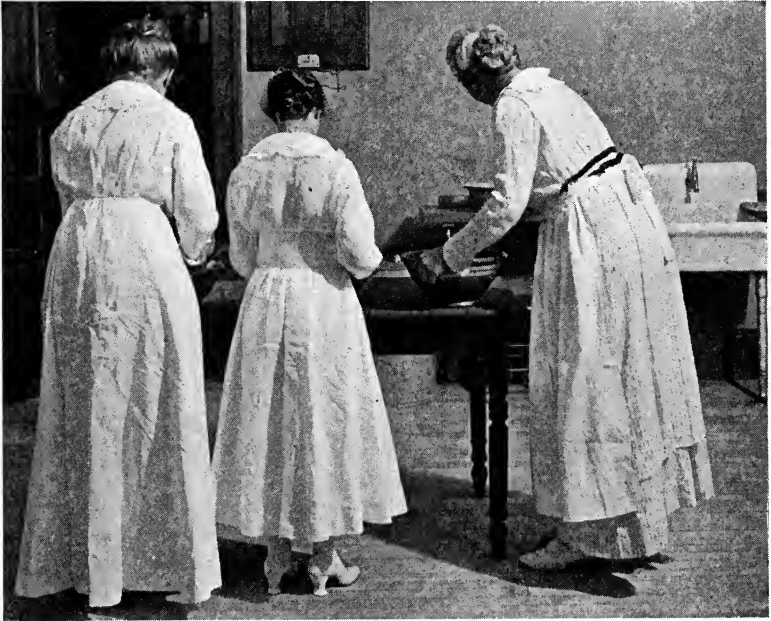

FIG. 62.—One working surface and three workers. The height of the regular kitchen table is suited only to the one worker who is abnormally short.

them. Sinks and tubs, unfortunately, when once set, can only be readjusted at a cost of some ten to fifteen dollars each time, because the plumbing law requires that there be tight connections in the drains of the sink or tub. Naturally these drains are not elastic or telescoped, so that up to the present time sinks and tubs cannot be readily raised or lowered. (See chapter on Plumbing, page 48.)

To help the housewife plan the height of working surfaces like sinks, tables, etc., it is well for her to stop to consider what her body

position would be if she did the work comfortably, and to notice how she has been forced to stand because in all these years the stationary equipment has been set too low (Fig. 62). Dishwashing, preparing vegetables, beating cakes, and mixing bread are done with the arms bent at right angles at the elbow. If the surface is too low, the body is bent down, giving fatigue at the waist line (Fig. 63). If the surface is too high, a raised arm and shoulder position brings the ache of fatigue up higher between the shoulders instead of at the back waist line. The table top can be higher than the sink bottom, the placing of the sink depending on its depth; the bottom of a deep sink cannot be mounted as high as the bottom of a shallow one, because the worker can not reach over the high wall of a deep sink if it is elevated too much; the worker's arm is used with the least strain when not constantly bent at the wrist.



FIG. 63.—The top of this tub is 36 inches from the floor. Note good position of worker's back.

Levels may be lower for washing clothes on a washboard, ironing, kneading bread, and in any process where there is need of pressure, because the angle at the elbow becomes wider and the arm line more nearly straight so as to produce leverage.

Let the housewife practice doing most of her work with her back straight; if bending is necessary with her work, bend forward at the hips, not at the waist; better, raise the working surfaces so that the body need not bend at waist or shoulders to reach to the work. Just how many inches high should a working surface be? That depends, of course, upon the worker's height, and there is no

better rule than to observe oneself and experiment. For persons of medium height—5 feet, 6 inches, or thereabouts—tables for standing work should be about 33–38 inches high; kitchen sinks should be about 34–40 inches to the top; and washtubs about 36–40 inches to the roll of the tub.

Surfaces for standing work are of course higher than those for sitting work (28–31 inches). Tables and other surfaces should be usually put at a standing height. There should always be a high stool available so that as much work as possible may be done sitting. The height of shelves where equipment is to be put away is also important; avoid as much as possible stooping down and stretching up high. Put heavy equipment on lower shelves.

KITCHEN EQUIPMENT

SUGGESTIONS FOR KITCHEN EQUIPMENT

Agate Ware:

- Double boiler
- Colander
- Funnel
- Ladle
- Pie plate, deep
- Pie plates, shallow
- Quart measure
- Sauce pans
 - 1 quart
 - 2 quart
 - 4 quart
 - 6 quart
 - 8 quart
- Skimmer

Spoon, large (basting)

Aluminum:

- Coffee percolator—6 cups
- Coffee pot
- Kettle covers
 - 1 for 1 quart pan
 - 2 for 2 quart pan
 - 1 for 4 quart pan
 - 1 for 6 quart pan
 - 1 for 8 quart pan
- Tea kettle—3 quarts

Brushes:

- Bottle brush
- Dust brush
- Pastry brush
- Refrigerator brush
- Scrubbing brush
- Silver brush

Sink brush

Vegetable brush

Earthenware:

- Butter crock
- Casserole
- Custard cups
- Mixing bowls
 - 2 large
 - 2 small
- Tea pot

Enamel, White:

- Bowls, small
- Dipper
- Dish pan, oval
- Pitcher
- Platter
- Refrigerator dishes
- Soap dish

Glass:

- Baking dish
- Butter dish with cover
- Containers for dry groceries
 - Fruit jars, 1 quart
 - 1 pint
 - Lemon squeezer
 - Measuring cup
 - Spice jars

Iron:

- Dripping pan
- Frying pan large
- Garbage can (galvanized)
- Griddle
- Kettle for deep fat frying

- Roasting pan, Russia iron
 Soup pot
- Japaned ware:*
 Bread box
 Cake box
 Dust pan
 Flour bin
 Sugar box
 Tray
- Linens and Cloths:*
 Chamois skin
 Cheesecloth
 Dish towels
 Dusters
 Floor cloths
 Glass towels
 Hand towels
 Holders, soft
 Oven cloths
- Silver (nickel):*
 2 forks
 3 tablespoons
 4 teaspoons
 1 half teaspoon
- Steel:*
 Bread knife
 Can opener
 Cork screw
 Hammer
 Ice pick
 Knife sharpener
 Meat skewers
 Metal mesh pot cleaner
 Nut cracker
 Paring knife
 Scissors
 Spatula
- Tin:*
 Angel cake tin
 Apple corer
 Biscuit, cookie and doughnut cutters
 Bread pans
 Cake pans, deep
 shallow
 Flour sifter
 Grater
 Measuring cups, standard $\frac{1}{2}$ pt.
 2 muffin tins, 6 cups each
 Pastry sheet
 Steamer, fits any kettle
- Wire:*
 Basket for deep fat frying
- Broiler
 Dish drainer
 Potato masher
 Purée sieve
 Sink strainer
 Soap shaker
 Toaster
 Tea or coffee strainer
 Wire egg beater
- Wooden:*
 Bread board
 Chopping bowl
 Dough board
 Ice cream freezer
 Knife board
 Rack for towels
 Rolling pin
 Salt box
 Spoon
 Step-chair
 Table, 3 feet long
- Miscellaneous:*
 Asbestos sheet
 Broom
 Calendar
 Carpet sweeper
 Clock
 Coffee mill
 Cork
 Labels
 Large needles
 Match box
 Pad and pencils
 Pail
 Paper
 Greasing
 Shelves and drawers
 Waxed
 Scales
 Scrap basket
 Screw hooks
 String
 Thread
 Thumb tacks
- Labor Savers:*
 Aluminum cleaning pan
 Bread mixers
 Cake mixers
 Fireless cooker
 Half-teaspoon measure
 Meat grinder
 Wheel egg-beater.

Kitchen Tables.—Firmness, height, and material are points to be considered in buying a table. Choose a strong, well-built table with substantial legs, as an unsteady table is especially troublesome. The lesser evil is short legs, because that may be overcome by putting blocks underneath to raise the table to the proper height. Settles, which may be purchased with square tops make not only excellent kitchen tables, but good laundry tables. A table is necessary in each of these rooms. The material for the table top should be smooth, of such close texture as to be non-absorbing and to resist stains, of such material as to be easily cleaned, and to resist wear and tear.

Wooden top tables require constant scrubbing unless they are stained with oil stain or are varnished, and even then, unless most carefully protected by working boards, trays or papers, great care will be needed to keep them in good condition. Waterproof varnish may be proof against water, but hardly against the marring of wear and tear. Wooden top tables may be covered with oilcloth, so that the only care needed is to wipe with a damp cloth. To tack this cover on, gives a table top which is quite serviceable and one that lasts long, unless hot pans are set on it, or knives are allowed to cut its surface. Sheets of zinc may be used as a cover, or zinc-top tables may be bought, but while they are serviceable so far as wear and tear are concerned, they are not easily kept in good condition. Both acids and alkalis affect zinc, so it is not suitable material to come directly in contact with food.

Glass-top tables are easily cleaned, not affected by chemicals, but are not proof against heat—that is, any hot dish, for example, a saucepan, set upon them, is likely to cause such rapid expansion as to produce breakage.

Enamel tables, before being accepted, should be guaranteed proof against chipping with such things as screwing on meat grinders and bread mixers, or by the knocking of heavy bowls or knife handles, which it is almost impossible to prevent. Very great heat, too, will chip an inferior quality of enamel. Enamel is being perfected to such a point that the housekeeper in buying stoves and tables should give careful consideration to the subject before refusing either. Enamelled gas stoves, as a matter of fact, are giving good service, and tables are being perfected which will meet all requirements.

Kitchen cabinets are combined tables and closets which have been constructed as the outcome of the study of efficiency methods.

They represent grouping about the working center the supplies and tools that belong to the work of that center (see page 86). The kitchen cabinet is really a kitchen table with a closet of shelves or boxes above, with containers for flours and meals either below or at the side, and with storage capacity for mixing bowls, knives, measuring utensils. Such cabinets may be purchased to-day in wood or in metal which has been enamel painted or enamelled (Figs. 64 and 65). The wooden cabinets were first in the market, and represent the same points in capacity and convenience that the metal ones do, but the question of cleanliness rather turns the attention to the metal ones. The metal cabinets are more noisy than the wooden ones, but are more likely to be proof against vermin, rats, and mice, and may be easily cleaned by water without becoming water-soaked. Metal cabinets are also non-absorbent to odors and to any spilled food.

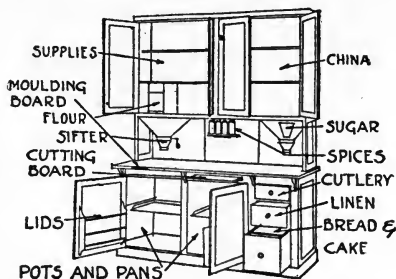

FIG. 64.—Kitchen cabinet. Courtesy of Charles E. White, *Ladies Home Journal*.

The housewife can make a home-made cabinet by using a kitchen table and grouping about it shelves, which may or may not have doors, while from the shelves and the side of the table saucepans, sifters, etc., may be hung. A man or woman handy with tools can make an excellent cabinet, one that may be divided to suit the special needs even better than a ready-made one. An old bookcase and a kitchen table make a good beginning.

Kitchen Utensils.—Kitchen utensils must be selected in part on the basis of the temperatures to which they will be subjected in the cooking processes (Figs. 66–68). Frying and roasting represent methods in which dry heat of high temperature is essential. Such material as Russia iron, sheet steel, cast-iron, crockery, Pyrex glass, are especially suited for this type of cooking. Bread pans and roasting pans are best of Russia iron or sheet steel, while cast-iron, because of its thickness, is an even cooker and retains a high temperature for some time, and hence is used for griddle and waffle irons, frying kettles, and skillets.

For boiling, stewing, or where moisture is part of the cooking

process, and where the temperature therefore is not over 212° Fahrenheit, agate, enamel, or tin may be purchased.

Aluminum is a metal that may be used for either method, as it may be heated to different degrees of heat with or without moisture. It is capable of being made into any shaped pan, but is more expensive than some metals. Aluminum is slightly affected by both acids and alkalis; vegetables, for example, will discolor it, whereas fruits and acid foods brighten and clean it. It should never be put to soak with soda water, and is most easily cleaned with dilute acids, such as rhubarb, lemon, or tomato. In fact, after cooking any of these foods in an aluminum pan, the pan is as bright as when new.

Crockery and *glass* are chosen for slow baking, as for casseroles and custards, and for baking acid foods like apples, tomatoes, or other fruits. There is a new glass cooking ware which is used for



FIG. 65.—White enamel kitchen cabinet.

baking utensils of all kinds, and which has been shown to cook in less time than that required for metal baking dishes, and therefore with a smaller consumption of fuel.

VARIOUS TYPES OF COOKING TOOLS



FIG. 66.—Utensils for dough work. Courtesy of Miss Mildred Maddocks, *Good Housekeeping*.

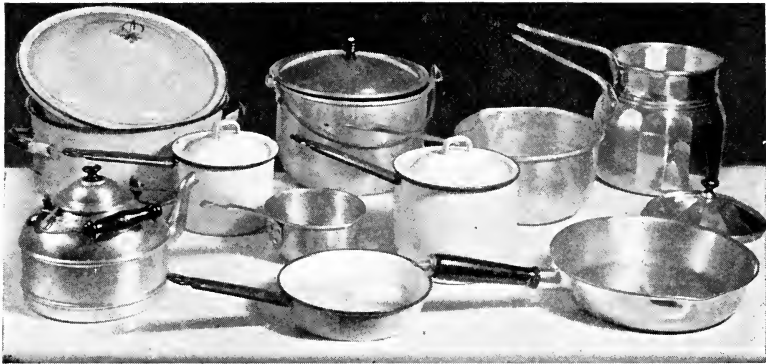

FIG. 67.—Different shapes and kinds of saucepans. Courtesy of Miss Mildred Maddocks, *Good Housekeeping*.



FIG. 68.—Baking dishes. Courtesy of Miss Mildred Maddocks, *Good Housekeeping*.

Enamel or *agate* is a glass like coating on sheet steel. With high temperatures like frying, the sheet steel heats and expands more than with boiling, and the expansion is so great that the enamel covering, which has almost no expansive power, is likely to chip off. One usually considers agate ware that which is gray or mottled, and the enamel as plain color, either blue, white, or brown. There is little difference in the wearing power, but there is a difference in the cost, in favor of the agate. Sudden change of temperature, as is given in professional testing, is a very severe test for enamel ware, and usually proves its worth. Enamel utensils will



FIG. 69.—Small kitchen necessities. Courtesy of Miss Mildred Maddocks, *Good Housekeeping*.

usually wear better if, before they are put into service, they are placed in a larger pan of cold water and boiled in that water; after boiling, let the pan cool in the water, as this seems to toughen the enamel.

Steel should be used for all cutlery, and the higher tempered steel should be chosen when sharp edges are required. It does not pay to buy a cheap grade of steel, as it neither takes a sharp edge nor holds one. The housekeeper should plan to have a carving knife of high-tempered steel, a good bread knife, and one small vegetable knife with a thin blade of high-grade steel so that it cuts thin parings. These better knives should be saved from the rougher work of the kitchen such as the work of turning food on a

griddle or in a frying pan, and as most of them are sharp-pointed they are not suitable for bowl scraping or for measuring. A spatula is best for dough work, for turning food, and for scraping; a round-ended case knife is best for measuring. Buy a cork-screw and a can opener, so that there is no need of taking a good knife to open bottles or tin cans. Get the butcher to crack or saw bones, so the knife need not be used for that work.

Tinware is made of a thin coating of tin on a sheet steel foundation. Tin melts at a comparatively low temperature, and is affected by acids. For this reason, a tin utensil should never be put over a fire without something in it for moisture, and it is not suitable for baking or stewing acid foods. The melting of tin is often seen in the globules of tin found on the outside of sauce-pans, and the dark rings on the bottom of baked apples show the effect of the acid of the apple on the tin of the dish.

Wireware is bought for dish drainers, strainers, bread and cake racks, frying baskets, and egg whips.

Woodenware is most suitable for spoons that are to be used for stirring and mixing, and for dough boards, bread, and meat boards.

General Standard.—In selecting all utensils, the following standards should be kept in mind: Avoid utensils with sharp edges, or with cracks or lines from which food may be cleaned only with difficulty. (To clean kitchen utensils, see chapter on Cleaning, pages 261, 262.)

Below are discussed some items of special importance in kitchen equipment in the nature of labor savers.

Aluminum Cleaning Pan or Disc for Silver.—Cost, \$1–\$3. The method of using is discussed in the chapter on Cleaning and



FIG. 70.—Folding wheel table. Especially suitable in small kitchen and where storage space must be considered.

Care, page 263. It saves time and the worker, and does not harm the silver—leaves it with a whiter finish and less of the satin gloss. (See also chapter on Supplies, page 134.)

Bread and Cake Mixers.—Cost of bread mixers, \$3.00–\$4.50; of cake mixers, \$2.00. These labor savers are time savers, because they can do a given amount of work in much less time, and like all machines the mechanism, if true, produces standard results. The bread mixer is an even greater necessity than the cake mixer. Making bread by the use of this machine is reduced to careful measuring and baking, with no energy expended in long kneading.

Cork for Cleaning Knives.—Any large flat cork like that from a big jug is a great labor saver for cleaning knives. It not only saves labor, but the wear and staining of a good dishcloth.

Dish Mops.—A string mop may be used for washing dishes, if one does not want to put the hands in water, but such mops must be kept very clean.

Fireless Cookers.—Cost, \$4–\$40. See chapter on Heating and Lighting, page 76.)

Half-teaspoon Measure.—Cost, 60 cents. Very handy and accurate in making small measurements.

Meat Grinders.—Cost, \$1.25–\$3.00. These helps represent an investment towards economy and efficiency. The grinders, through the possibility offered by the different knives, have an almost unlimited use, not only with meat, but bread, vegetables and other food materials. In this way when various meals and grains are to be converted into flours, the grinder may be used as a mill.

Metal-Mesh Pot Cleaner.—Cost, 10 cents. This device cleans pots and iron pans much more efficiently than a knife, which is soon dulled by such use; and it eliminates the use of an abrasive cleaner on the dish cloth, with its consequent wear on the cloth and with grit in the dish water.

Paper Dish Cloths.—Cost, 3 cents–5 cents. These are efficient, sanitary, and may be used several times before throwing away.

Palette Knives, called *Spatulas*.—Cost, from 25 cents up. Two strokes with the thin, flexible blade cleans a mixing bowl, instead of a dozen strokes with a case knife—less waste of material and greater efficiency. Also invaluable for turning food in frying pan or on griddle.

Sink Strainer.—Cost, 10 cents–40 cents. Such a labor saver kept in the sink reduces the sink cleaning to such a minimum that

no shovel and scraper are necessary to clean food scraps out of the sink, no force pumps needed to clean out the waste pipe, and the sink may be washed as easily as a china plate. This strainer may be a three-sided one of wire to keep in the corner of the sink, or it may be just a puree strainer with tin sides. The strainer is best of wire woven mediumly close; a purée strainer is too close.

Wheel Egg-beater.—Cost, 5 cents–15 cents. It is easily operated, and very efficient in making eggs light. It can be used as a cream whip.

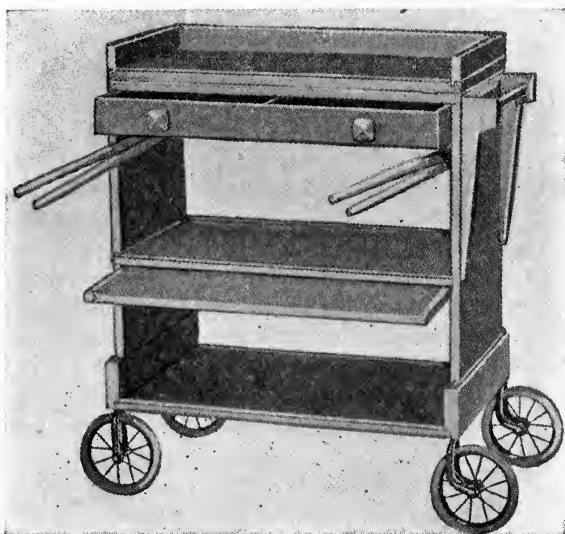

FIG. 71.—Wheel table. A wheel table is a real labor saver, provided it can be easily moved and cleaned. The extra shelves and top space make this one efficient.

Window Food-storage Box.—Cost, \$10–\$15. Any box put on the window sill or outside the window may be a “window box.” To increase its efficiency and to add to its sanitation, it should be put on two cleats to raise it above any moisture on the window sill; it should have a slanting rain-proof roof which projects to insure the dryness of contents; it should be well ventilated to keep it sweet smelling; it should be large and shelved to facilitate organization; and to make it easily cleaned, it should be painted with

white enamel paint. It should be located at a window near the food-work center. In building a new house a ventilated food storage closet can be built on the outside of the house, on the kitchen wall, and made to open directly into the kitchen by a special door through the wall.

Wire Dish Drainer.—Cost, 10 cents—\$1.50. This is a most helpful labor saver in draining hot, well-rinsed dishes. By using very hot water for rinsing, it eliminates the necessity of wiping dishes, thus saving labor and towels, and insuring clean dishes.

Wooden Spoons.—Cost, 5 cents—20 cents. There is no rasping noise, no black metal marks on bowl or worker's hand, better grip possible, hence less hand and arm ache, no burns from hot metal handles. After use, soaking them in cold water makes them easily cleaned.

Dish-washing Machine.—Cost, \$75—\$110. This should be a labor saver, and will be with a family of about six or eight, or more. If one stops to think that a considerable part of the dishwashing work is finished when the dishes are scraped, sorted, and stacked, and that this must be done whether the machine is used or not, it will be seen that the machine will prove an economy only in the large family. A labor-saving dishwashing method is perhaps the most economical in small families; try, as the dishes are brought from the dining-room, to rinse and stack, and have a pitcher or pan of water to receive the silver; this method is efficient, reducing considerably the time required for washing when there has been a disorderly piling of dishes.

In dish-washing machines, the dishes are arranged on a rack inside the tank of the machine, and the water, in which soap or soda has been dissolved, is forcibly sprayed over them. This requires that the dishes should be well scraped, and then so stacked that the soiled part is free to be washed. The racks hold the dishes apart from each other, and usually there is a holder especially designed for silver. Soda or soap powders must be dissolved and put into the water. As the hot water comes into the washer the suds is formed; then either by a hand or a power device, force is created which throws the water over the dishes and removes the soil. The soda solution is most often used because it saponifies the grease, and as the hot rinse leaves the dishes to drain dry—there is no wiping—a film is not left as is the case when glass or china has been

washed with soap and not properly rinsed. However, care must be used in washing gold-decorated dishes with soda as this will in time remove the gold. The machine does better work with plates and saucers than with silver and cups. Silver is not likely to be very clean, especially in small crevices as between fork tines, and cups too often lose their handles. The efficiency of a dish-washer may be rated by the number of pieces washed at one time, the possibility of doing cups and silver, the amount of breakage, the ease of cleaning the machine, and the kind of power—hand or mechanical. To make a dish-washer really useful, hot and cold water should be piped to it, and a waste pipe provided; an adequate supply of very hot water is also essential.

A wire frying basket may be used as an inexpensive substitute for a dish-washing machine. Fill the basket with dishes, then plunge it into a pan or tub of hot soapy water, and keep it moving until the dishes are clean.

Dumb-waiter.—Of course the ideal “dumb-waiter,” or small lift for parcels between floors, is one with an electric motor, the whole being an electric lift. Its cost—about \$1200—is too high to be considered except in the largest households, so the pulley dumb-waiter is commonly used. It can be as simple as to be only a pulley fastened in a strong beam, and a large basket or box suspended from it by ropes, all operating through a shaft; and in its simple standard form, in which there is a counter-weight to the box, it is not relatively expensive. For the housekeeper who must use her cellar or basement several times a day, it will greatly reduce the work of carrying up and down. Be sure to locate the dumb-waiter where it has the closest relationship to the kitchen, and can give the greatest service to the part of the house it is to serve. It is possible to have the dumb-waiter go down into the cellar; and instead of the housekeeper emptying it each time, it may stay in a walled-in or sunken place in the cellar floor, where it will be especially cool. This makes a cool storage receiving room which will save ice for many months in the year. The principle is the same as that of lowering food into a well to keep cool.

Wheel Table.—Cost, \$1.75–\$15.00. The \$1.75 table may be a home-made one from a cheap kitchen table plus the cost of four rollers. One desirable type has a top and bottom table surface, a drawer and a towel hanger; it is light, steady, and of such size as to

go easily through the door (Figs. 71 and 72). It saves the cost of many journeys from a room. A tray is its poor substitute, but even though poor, is better than carrying each thing singly.

SUGGESTIVE QUESTIONS

1. Given \$25.00 to spend, what labor-saving devices would you buy?
2. What points must a housewife know in purchasing an electrical device, whether a sweeper, a washer, or an ironer?
3. In what ways can you economize in operating an electrical machine?
4. What economies are represented in a wheel table?
5. Make a comparison between the different materials used for cooking utensils. Do this by listing advantages versus disadvantages.

REFERENCES

- CHILD, GEORGIA B., EFFICIENT KITCHEN. McBride, Nast & Co.
FARMERS' BULLETIN 927, FARM HOME CONVENIENCES. U. S. Dept. of Agriculture, Washington, D. C.
FREDERICK CHRISTINE, THE NEW HOUSEKEEPING. Doubleday, Page & Co.
GOOD HOUSEKEEPING INSTITUTE, HOUSEHOLD ENGINEERING. Good Housekeeping Institute.
PARLOA, MARIA, HOME ECONOMICS. Century Co.
U. S. BUREAU OF STANDARDS, MEASUREMENTS FOR THE HOUSEHOLD. Circular No. 55.
VULTÉ, HERMAN, HOUSEHOLD CHEMISTRY. Chemical Publishing Co.

CHAPTER V

EQUIPMENT AND LABOR-SAVING APPLIANCES—II

LAUNDRY EQUIPMENT

THE laundry process requires facilities for a water supply and disposal of waste water, which are discussed in the chapter on Plumbing, page 21. Laundry processes are given in the chapter on Laundering and Renovation, page 273. Herewith are listed the desirable items of laundry equipment and supplies, with a description of the more important items of laundry equipment (Fig. 72).

SUGGESTIONS FOR LAUNDRY EQUIPMENT

Asbestos mats	Iron holders
Boiler, copper bottom	Iron stand
Bottles, $\frac{1}{2}$ doz. 2 oz.	Ironing boards
Bowls	bosom
enamel 2 qts.	skirt
enamel 6 qts.	sleeves
large for starching	Ironing table
Brushes	Jars
fringe	1 doz. Mason, 1 qt.
scrubbing	$\frac{1}{2}$ doz. Mason, 2 qt.
spotting	Labels
Case knife	Measures—
Cheesecloth	1 teaspoon
Clothes-basket	1 tablespoon
Clothes-hamper	1 cup
Clothes-horse	1 quart
Clothes-line	1 graduate
Clothes-pins	Yard stick
Clothespin bag	Tape
Clothes-props	Mop for floor
Clothes-stick	Muslin, unbleached
Cloth, heavy, for washing tubs and boiler	Paper
Duster for line	blotting
Droppers	unglazed
Funnel	Pail, galvanized iron
Flannel	Pins, $\frac{1}{2}$ pound
Irons	Scales
1 heavy	Scissors
3 sad	Soap dish
1 gas or electric or gasoline	Sprinkler
1 fluting iron	Strainer
1 pointed small	Tape, cotton
1 polishing	Vacuum washer
	Wash bench

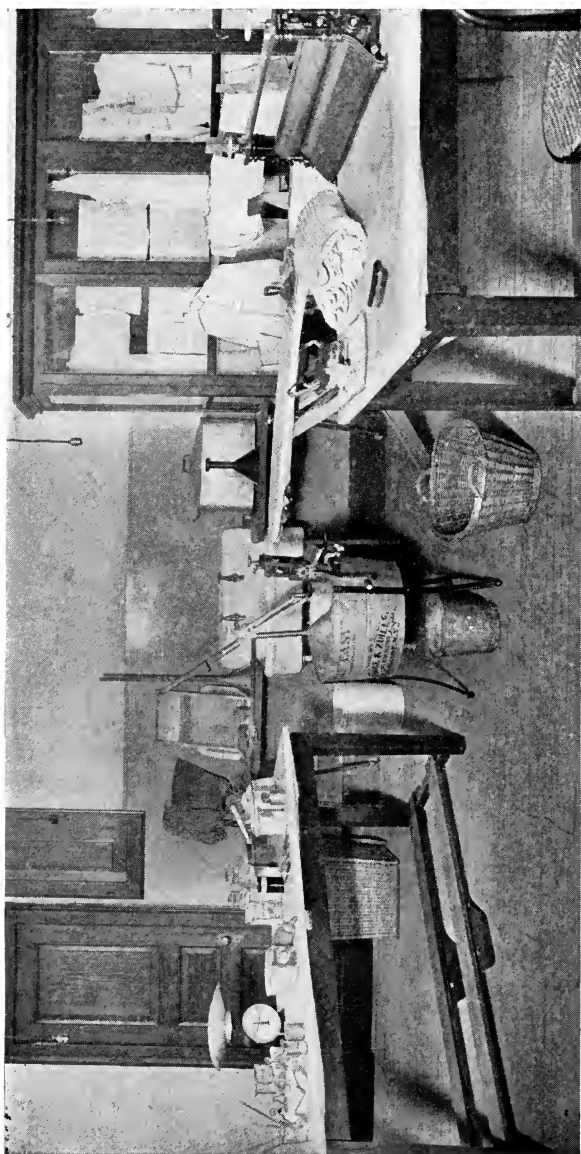

FIG. 72.—Laundry equipment.

Washboard, glass or zinc	Whisk broom
Washtubs, 2-3	Wringer
Washing machine	Wooden spoon
Wax	

SUGGESTIONS FOR LAUNDRY SUPPLIES

For detailed discussion see chapter on Supplies, pages 136-142.

Alum	Hyposulphite of soda
Alcohol	Javelle
Ammonia	Kerosene
Benzine	Oxalic acid
Blanket wash	Paraffin
Blue	Potassium permanganate
Borax	Soap
Bran	Soap bark
Chloride of lime	Soap solution
Chloroform	Soap chips
Detergent	Soda (powdered form, or crystals in solution)
Ether	Starch
French chalk	corn
Fuller's earth	rice
Gasoline	wheat
Hydrochloric acid	Turpentine
Hydrogen peroxide	

For Washing Process.—Washtubs.—Any material that is smooth, non-absorbing, and easily cleaned is good for washtubs, so that the type of tub is somewhat of a personal matter as to price. (See chapter on Plumbing, page 44.)

Wash benches should have long enough legs so as to lift the portable tub to the comfortable height which will save fatigue. Folding benches are great helps where space is limited.

Stationary tubs may be mounted on gas-pipe legs, cut to the proper length, rather than on the molded legs which are sold with the tubs. These molded legs are always too short, but may be made longer by means of a metal extension bracelet. (See chapter on Plumbing, page 47.) For ease and rapidity of work three tubs will be most efficient. With a washing machine one tub will do, though two are more convenient. Have the tubs so connected by the wringer board that it is possible to use the wringer on all tubs, and in either direction.

Wash-boards come in either glass, zinc, or galvanized iron. The metal ones will not crack with a knock or a fall as easily as will the glass. The glass ones, however, are just as efficient, are usually less sharp in their corrugations, and are more easily kept clean. The fact

of the corrugation being less pronounced is an advantage when the wear on the clothes is considered. Most washboards have very long feet, so that the board projects up beyond the tub; the feet may be shortened with a saw, and it is much easier to work with a lower board, and a lower board makes it possible to work with less

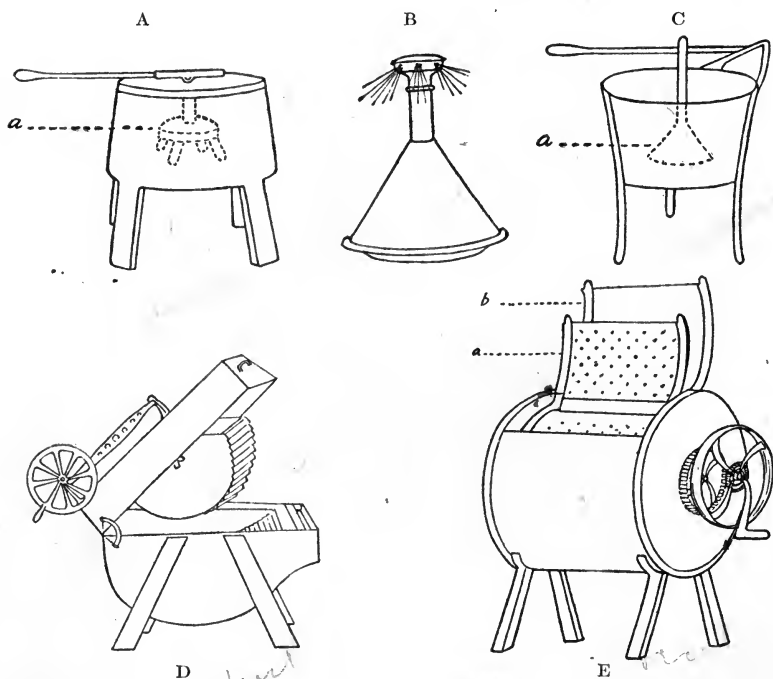

FIG. 73.—Types of washing machines. A, the Dolly type, a, dolly; B, a vacuum boiler washer; C, pressure and suction type, a, funnel; D, washer with corrugated lining; E, a revolving cylinder type; a, inner cylinder perforated; b, outer cylinder—wooden or copper. Courtesy *Country Gentleman*.

chance of spilling water. High washtubs will require shorter washboards.

Wringers are of greater service when reversible. The stronger ones have two side springs and ball-bearing action. The side springs add much to the strength and endurance of a wringer, and the ball-bearing action is smoother and easier. The wringers have usually three- and five-year guarantees, but even the cheaper wringer will go

far beyond that time if kept oiled and clean, and if the pressure is taken off when not in action. A three-year or five-year wringer is not expensive, and is a better purchase than the cheaper ones.

Washing Machines.—Cost, \$12–\$150. There are some two hundred washing machines on the market; but for study they may all be divided into five groups (Fig. 73). Of these five groups, two are usually found with wooden tubs, the other three are likely to have

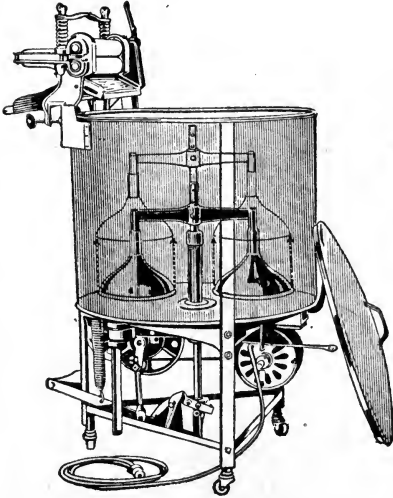

FIG. 74.—Pressure and suction washer.

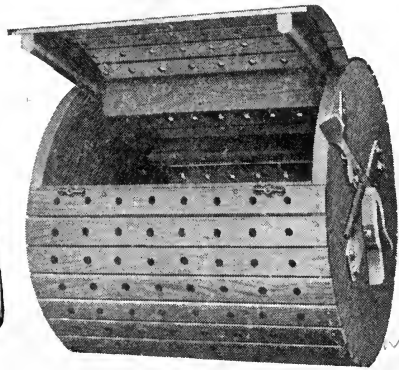

FIG. 75.—Rotary washer. The clothes are put in this inner cage which revolves in the soap and water. The action of the cage reverses, and the load should not be so full that the clothes do not drop on each revolution. The "drop" causes a displacement of the dirt.

metal tubs. A wooden tub machine is cheaper in first cost; it gives its best service when stored and used in cellars, sheds, barns, unheated rooms, or on porches. The continual heat of the house causes the wooden machine to dry and shrink, and soon leakage results. A wet sponge kept in the machine when not in use may furnish enough moisture to prevent this drying.

One type of the cheaper machines is called a "Dolly." This "dolly" is like a four-legged milking stool which by reverse rotations draws the clothes through the soapsuds. The clothes are cleaned by the displacement of dirt brought about by means of friction and agitation as they are drawn through the soapsuds.

The second type of machine has the *wash-board* principle. Two corrugated boards, shaped like discs or half cylinders, rub the clothes top and bottom, and the mechanical principle is friction, and this, with the solvent power of the water, cleans the clothes.

The remaining three types of machines are the pressure and suction, rotary and oscillating types. The action of the *pressure*

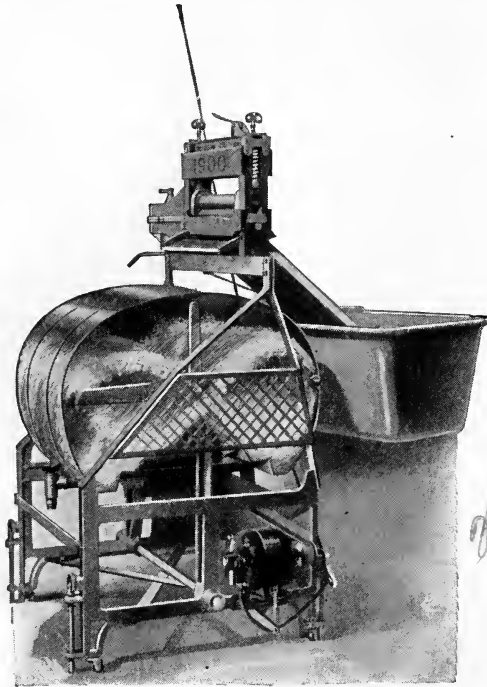

FIG. 76.—Oscillating washing machine.

and suction machines (Fig. 74) depends upon cones which rise and fall in the tub, pressing the clothes on the down stroke, and creating suction when the cones lift on the up stroke. The clothes are cleaned entirely by forcing soap and water through them. There is no friction.

Rotary machines (Fig. 75) are like cages which revolve the clothes in soap and water, on the same principle that the coffee

roaster turns the coffee beans in heated air. This cage has openings of either slits or holes so that soap and water enter freely in and around the clothes. The clothes are washed by agitation and by the throwing of the clothes, which action comes at each revolution of the cage.

The *oscillating* machine (Fig. 76) swings like a baby's cradle. This swinging throws the clothes back and forth and forces soap and water through them. There are several types of oscillating machines, but the principle of all is the same.

The washing machines range in cost from \$12 to \$150, the wide range being due to the fact that machines may be bought to be operated by hand, and by motor; and the wooden and the metal tubs vary greatly in price. Most motor-driven machines have power wringers, which are included in the cost. The housekeeper should take this into account when she is awed at first by the price of the machine, because she has not only a mechanical washer but a mechanical wringer as well, both of which are great labor and time savers. Hand-driven machines are not so much labor savers, because the hand work is hard, owing to the weight of the material when wet in the machine. A hand-driven machine keeps the operator busy during the process, while with a motor the woman is free to do other things. This must all be considered when cost is studied.

In localities where one does not have electrical power, the housekeeper should look into the question of water motors and gasoline engines. A water motor is possible in many localities where the water tax is low, and where there is a good force of water in the pipes. On farms where there are gasoline engines, it is very easy to attach the belt from the engine to the wheel of the power washer, and in this case the engine will do the washing and the wringing. A small engine may be purchased for the washer for \$40.

With all this labor saving by the machine itself, best results are lacking if, in arranging for the machine, one has not planned to have hot and cold water piped directly either by hose or by special plumbing to the machine, and the waste water piped directly away from the washer by a drain. Do not make this a closed drain, for should a small piece of lace or a button, for example, get into the drain it probably will be lost or clog the pipe. To set the washer into a sunken part of a cement floor which has its own outlet, is a very efficient way; if not of cement, this sunken portion may be

lined with a heavy metal pan, having an outlet for waste water connecting with a sewer or other house drain.

All washing machines are measured by "sheet capacity"—*i.e.*, the number of sheets that can be washed in one load, or an equivalent bulk. Most machines wash well six double sheets; four towels equal in bulk one sheet; three pillow cases equal one sheet. Those who expect to operate a washing machine should consider buying soap chips in barrel or half-barrel quantities, and also washing soda in powdered form. (See chapter on Supplies, page 138.)

Various washing devices are possible for the housewife who feels it unwise to spend a larger amount of money for a machine. A most complete aid may be made in the home by fastening a tin funnel to a shortened broom handle, cut down at one end to fit into the neck of the funnel. The funnel costs about 5 cents to 10 cents, and really makes a good vacuum hand-washer. Vacuum washing devices may be purchased from 75 cents to \$1.50. They have specially designed funnels, which often have smaller funnels inside. All this increases the suction. To increase their efficiency, there is a perforated soap cup, which produces suds as the washer works the funnel up and down in the water.

There are two percolating washing devices on the principle of the percolating coffee pot, which are to be put into the wash-boiler—\$1.50 to \$3.00. As the water heats and expands, it is forced out at the spray top of the funnel. A constant circulation is produced which forces soap and water through the clothes. The water is to percolate over the clothes, just as the liquid coffee does over the ground coffee, and after five minutes the clothes are cleaned. These percolating devices are suitable only for white cottons and linens, as boiling must be done to have the device work. The vacuum funnel device may be used on all types of materials, but requires constant work on the part of the woman. It is a most valuable aid for washing wools and silks, so valuable that it would pay to own one for that use alone.

For all these hand devices as for the power machines, the housewife should plan to buy and use soap chips instead of cake soap.

For Drying Process, *Baskets and Hampers.*—The container for soiled clothes should be free from ornamentation, which collects dirt and dust, so that a washable muslin bag, a papier-maché basket-shaped container, or a metal can (Fig. 77) are far better than the

much used willow hamper. The baskets to be used in the laundry process should be light in weight, and preferably have an adjustable muslin lining. These linings are easily cleaned, which is important, as the basket is so likely to be soiled.

Clothespin bags are most useful when shaped and worn like an apron with a wide pocket. It is best to have them not too deep, the whole apron being shallow and wide. Ticking is the most serviceable material and can be washed easily. For another very convenient bag, take a hook like a clothes-line hook, such as is screwed to the side of the house or the fence to hold the clothes-line, cut a square of heavy washable material, and sew the corners of the square to the screw. Such a bag will hook on the clothes-line and slide ahead of the worker, holding the pins always at hand.

Dryers. — The clothes-line, either hemp rope or copper wire, gives good service at little cost. The copper wire is more efficient as it is put up permanently, needing only to be wiped off just before use. The hemp line will stretch, and also will shrink when wet, and the soil enters its fibres so deeply when left out permanently that it is hard to clean, so that it is wiser to take it down after each use.

Patented hangers have been so perfected as to give excellent service, especially in small yards and on back porches where the clothes may dry in the air even if in a limited space. Some of the dryers are of special service for kitchen drying, because they pull up to the ceiling, when not in use or when full of clothes. Revolving umbrella hangers (Fig. 78), having good capacity, take up small yard or porch space, at the same time making it possible for the clothes to dry in the air.

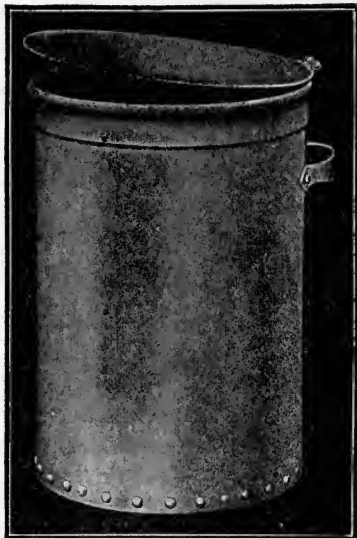

FIG. 77—Clothes container (papier maché).

The dryer that is most efficient for all kinds of weather is the indoor-heated dryer, because it is not dependent upon sunshine for drying. Such a dryer may be bought with a stove (Fig. 79) and be set up as the house is being built. It may be built into the corner of the laundry (Fig. 80), and the two walls so used will reduce the cost of installing the dryer, if bought complete and set up as a unit. These dryers are constructed like a kitchen stove, and use either coal, gas, or electricity. They must be connected with a flue so that the moist air from the drying clothes may pass out, and not con-

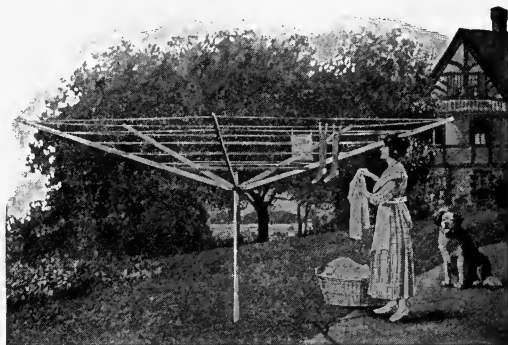

FIG. 78.—Revolving clothes dryer. Closes like an umbrella when not in use.

dense on the clothes. In such a dryer, the drying compartment takes the place of the oven in a stove. These dryers may be bought with one, two, or even three sections, and do better work if they have a metal track for the pulling out of the racks, for wooden wheels—pulley fashion—shrink and crack.

For Ironing Process.—*Sprinklers* pay to buy, because they do the work more rapidly, evenly, and thoroughly, than sprinkling with the hand. One of the best kinds costs ten cents and with its cork will fit any bottle. Other sprinklers are like flour or sugar shakers, or like a bath spray. If one buys this kind, be quite sure the holes are very small.

Ironing boards may be found to fit the various requirements of different housekeepers. Many need a kind that occupies little space when not in use. The housekeeper used to have to stretch such a board between two chairs or a table and a chair; whereas to-day it

is possible to purchase a folding board which fastens shelf-fashion in a metal bracket. This bracket may be put at any height, and the board quickly hooked into it. It is much more efficient and costs no more than some of the less substantial folding boards. Boards that are permanently set up can have a small drawer at the right-hand end for the storage of wax, iron holder, wiping cloth, and even the iron when cold could be stored in this way. This is a good way to store equipment in a laundry or laboratory that is limited in space. Most boards are 56 inches long, which is the standard size. To help in doing up shirtwaists and shirts, a square-ended board like those used in a commercial laundry is most useful (Fig. 81).

By spending more money, a gas stove may be piped directly to the ironing board, making the outfit a complete working unit, entirely saving the worker from wasting time and energy by walking back and forth to change irons. Elaborate ironing equipment of this kind may be purchased at some cost, but with a little planning on the part of the housewife, that is, getting gas and board together, she will have good equipment with little cost.

With an electric iron one is more likely to take the board to the iron. Sometimes it would be more satisfactory to work the other way round. Choose a good light place for the ironing board, and have an electric plug attachment placed right near to connect the iron (Fig. 82). This is a safer way to use the iron, because one is not running the risk of affecting the light. (See chapter on Heating and Lighting, page 57.)

Sleeve-boards are labor savers; not that the sleeve may not be ironed as well without the special board, but the time and work are

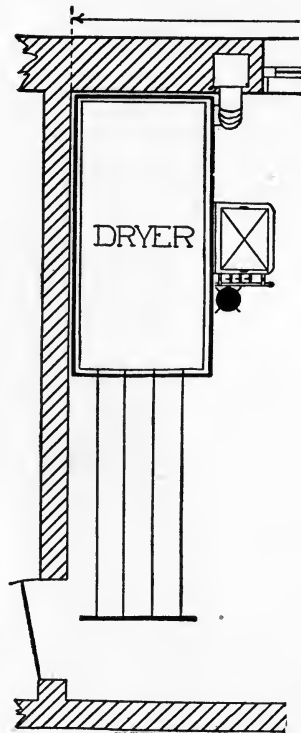

FIG. 79.—Diagram of clothes dryer.

much reduced. There is no need to pay the extra money for a so-called padded board, because the padding is usually only sheet wadding, with no lasting qualities. Two or three thicknesses of domet or outing flannel will make a much better pad. Every housewife may well plan to have that on hand, for it will pay to buy some remnants to use for house cloths, iron wipes, polishing cloths, and the many times when a heavy soft material is wanted.

Ironing-board Pads.—As old blankets do not give long service on the ironing board, they might preferably be kept for some other

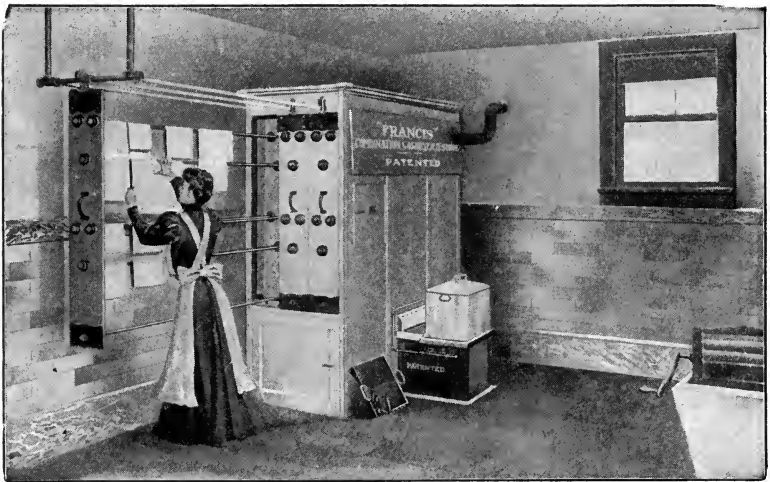

FIG. 80.—Metal clothes-drying cabinet. Stove is part of the dryer.

use. Heavy silence cloth, such as is sold to protect the dining-room table, makes a most serviceable padding. Two layers of the new, or three of the old, will make a good pad. The board is better not too much padded. Cut these felts large enough to allow about two inches for shrinkage; thumb tacks or tapes will hold them firm, unless one chooses to buy clamps that come for the purpose at 50 cents for three; six would be needed.

Embroidery pads are always needed for ironing heavy embroidery. These should be made, and kept ready to use as any other equipment, and then there will be less likelihood of using a good towel.

A piece of felt like that on the ironing board may be cut any size; there is no need to have it large and bulky, 12" x 18" is a good size. Cover the felt with muslin; sew the two together so the pad may be easily cleaned and kept always ready.

Ironing-board Covers.—Old sheets give no more lasting service than old blankets, and can be put to much better service than that of ironing-board covers. A heavy unbleached muslin 60" wide may be bought, and is most serviceable. The width of this muslin is



FIG. 81.—Good equipment for ironing.

long enough to equal the length of the ironing-board cover. Cut wide enough to turn under the board about two inches on each side, put on a half-inch hem, and sew four tapes on each side if tapes are to be used. Clamps or even pins are better than tacking, as it is better to choose a fastening that is so easy to remove that a fresh cover is possible each ironing day if needed.

Stationary boards should have dust covers kept on them when not in use. An easy way to make them is to cut them pillow-slip fashion, large enough to slip on easily. Portable boards will need covers unless one has a closet for laundry equipment, where the board may stand away from the dust.

Irons.—Flat-irons, or sad-irons, are of great service, but to be most efficient they should be purchased of different shapes and

weights—from five to eight pounds, allowing one or two small ones for such work as children's clothing. The usual number allowed to an ironer is three; this insures frequent changes for hot irons. Be sure the iron has a smooth base, as irregularities may cause them to catch in the goods and mar such materials as wools and silks by leaving a mark.

The asbestos irons, irons with removable asbestos jacket and handle, or irons with portable handles, are preferred by some, but are likely not to be as lasting as flat-irons because of the possibility of the handle becoming loose.

Puffing irons are not needed for the ironing of puffs to-day, but if one already owns one, it will be of great service in finishing small gathers as baby-dress sleeves and bonnets.

Iron holders may be purchased in any department or house-furnishing store. These usually have one side of asbestos. The housekeeper may make one of folded old stockings, covered with a soft, smooth outer cover of ticking, gingham, or muslin. The stockings are especially good as a foundation, because their weave makes them more or less non-conductors of heat, and because they are soft and easily fold about the handle of the iron. Two iron holders for each worker saves the hand, as a cold holder is very restful and helps to prevent the hand from getting parched and swollen from continual heat.

Iron rests are great savers to the ironing sheet; an asbestos sheet, such as is used under a sheet cake tin, will also save the end of the board where the iron is set. Put a paper, wiping cloth, iron rest, etc., on top of the asbestos sheet.

Gas, alcohol, kerosene, gasoline, and electric irons (cost, \$3-\$6) are labor savers because they carry their heat with them, and this saves walking to and from the stove to get a hot iron. The available fuel will determine which is best to use. These self-heating irons reduce the heat of the ironing room, and the heat on the worker's hand; and while gas and electricity are the most used and seem the safest, it is only a matter of care and of becoming familiar with the other fuels. The main thought must be to beware of unexpected draughts that may fan the flame. The gas-iron is operated at the end of a rubber gas-pipe; this pipe will be safer and give greater service if it is wound with spiral wire to prevent cracking the rubber. The electric iron is sensitive to a fall, and to being wet;

for increasing its length of service it should have its cord suspended by a coiled spring such as is used for a bird cage. To overheat the iron, either by using it too continually without turning off the power during the ironing of small pieces, or by letting it overheat through forgetting that it is turned on, will soon burn out the iron. A small one-candle incandescent light put in on the electric connection will indicate when the iron is on, and will be a protection against waste and danger. The cost of installing such a safety device is small.

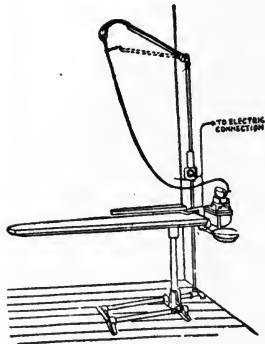

FIG. 82.—Electric ironing table.

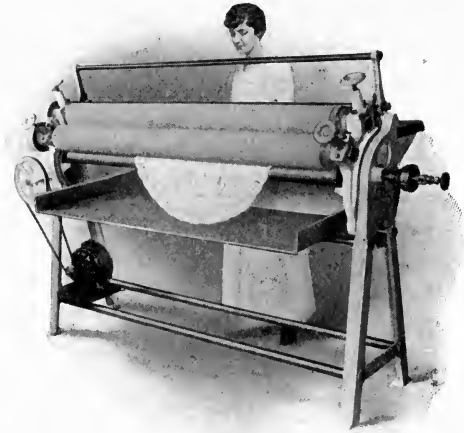

FIG. 83.—Flat-work ironer.

Flat-work ironers, commonly called mangles. Cost, \$95—\$235. These are especially helpful where one has a great many flat household pieces to iron. They are not suited to the ironing of body clothes, because no gathers, tucks, or buttons should be put through the machine. Such an ironer is not to be used for starched clothes because the starch left on the cloth rolls will later hinder the ironing of flat work.

The principle of a mangle involves two or more rolls, which press tightly on each other as the fabric passes between (Fig. 83). It is the same principle as that of a clothes wringer. The simplest ironer is called a cold mangle—costing about \$10—which has only two hard wooden rolls that smooth the garment without any heat. It does not gloss or sterilize. Other mangles have a steel roll which

is heated by gas, gasoline, electricity, or steam. This steel roll is like an iron, and the second roll is cloth covered like an ironing board. The iron and board revolve on each other.

The efficiency of a mangle is increased by being power driven, so that the hands of the worker are free to attend to the ironing. Better results are also obtained by having the machine wide enough to take towels, napkins in single thicknesses, and sheets when folded in half lengthwise. The economy of the machine, especially if electrically heated, is increased by being able to heat only one-half of it at a time, as in ironing handkerchiefs and other small pieces. The secret of good ironing is that the cylinders press evenly on each other, and also that linen be slightly and evenly dampened, and allowed to stand some time before ironing. Good sprinkling and folding is perhaps more of a help in machine ironing than in hand ironing. A heated power mangle of household size greatly reduces the labor of ironing flat-work; one family, for example, reported that these pieces take about one-fifth the time required for hand-work.

CLEANING

MATERIALS AND TOOLS FOR CLEANING

Supplies:

Alcohol (wood alcohol may be used)
Ammonia
Bath brick
Borax
Dutch cleanser
Fuller's earth or French chalk
Kerosene
Lemon oil or linseed oil
Lime
Oxalic acid
Porcella
Pumice stone
Putz metal polish
Rottenstone
Sal-soda
Salt
Silver soap or cream
Soap
Soap powder
Steel wool—size 00
Turpentine

Vinegar

Wax

Whiting

Equipment:

Bowls

Box or tray for cleaning materials

Brooms

Large

Small

Whisk

Brushes

Floor, soft hair

Radiator

Scrubbing, 2 sizes

Spotting

Wall

Carpet sweeper

Cloths and substitutes—

Broom bag

Cheese cloth

dusters

small cloths

Cork

Cover cloths, special cloths or old ticking, etc.	Knife
Dish cloth, tub cloth	Measuring spoon
Dust cloth	Mop
Floor cloth, loosely woven	Oil can
Newspapers	Pails
Polishing cloth	Sanitary tongs
Tissue paper	Scissors
Waste (cotton)	Screw driver
Dust pan	Skewer, wooden
Flush closet cleaner	Step ladder
Hammer	Vacuum cleaner
	Wrench

There are here presented the important items of cleaning equipment (Fig. 84), as brushes, mops, cleaning cloths, sweeping mixtures, including labor-saving appliances used in this work. The processes of cleaning and the supplies necessary are treated respectively in the chapters on Cleaning and Care (page 240), and Supplies (page 129).

Brooms and Brushes.—It does not pay to buy cheap brooms and brushes. The first cost is less but in the end the cost will be greater. The best brushes have solid backs that are made of hard wood which does not easily warp; and a good brush should be shaped for its special task. Solid backs are especially necessary for scrubbing brushes. Upholstery brushes should be made of soft hair like a paint brush. Some of them are tapered at the end for the crevices and folds around buttons of tufted furniture. For the dusting of portieres, satins, and brocades, the regular soft-haired paint brush is most satisfactory. Whisk brooms are better for cleaning heavy fabrics; they do not mark them as they would a velvet or velour. Long-handled brushes with hair bristles for hardwood floors will do the work with less dust, more thoroughly, and more easily. Silver brushes should be soft to prevent scratching, but firm enough to get in cracks and crevices. They give greater service if bought in two sizes, one very thin and narrow to clean around handles and in small grooves. Old tooth brushes will save the purchasing of a more expensive brush; old nail brushes are not so good because they are broad and stubby.

Brooms should be chosen with such good corn that there are no seeds. They may be bought with two types of handles, the light bamboo handle and the heavy wooden stick. The lighter broom is a great saving to the worker. Hanging the broom will do much to lengthen its wear; and if the new broom is plunged into a pail

of hot water, and allowed to remain in the water until it is cold, it seems to have a greater power of endurance. With a hot wire or skewer, bore a hole into the broom handle and insert a heavy string with which to hang the broom. Various patented hangers

are on the market, most of them in the nature of clamps, which hold the broom or brush so closely as to prevent swinging, which is noisy and marks the door or wall.

Dust covers, to be used for covering up the contents of a room while sweeping, are good cleaning aids, because they save walking, carrying, and much extra work that used to be considered part of a thorough cleaning. Unbleached muslin may be used, but checked gingham, or some other material with a distinct pattern and color which marks it from other sheets for the house, is even better. Make the covers of such generous size that they may be used for pieces of furniture of various sizes and shapes. No special size can be given except to suggest that two or three covers should be large enough to cover a bed, a couch, or the two or three



FIG. 84.—Tools for cleaning.

large pieces in each room. Smaller ones are desirable for the chairs and book shelves; and several one- and two-yard squares of the same material should be planned as covers for pictures, especially for those pictures with heavy carved or ornamented frames. Bags of this material can be made for covers, so that the portieres may

be dropped down into the bag, and then, by means of drawstrings and by pins, this pillowcase covering is brought up close to the curtain poles, entirely covering the portiere.

Long-handled Dustpans.—Cost, 50 cents—75 cents. The housekeeper will find that the long-handled dustpan (Fig. 85), even though it does cost about double the price of the short-handled one, will be a great saving. It does as good work, as far as dust



FIG. 85.—One worker saves her back; the other saves money.

FIG. 86.—Three tools for sweeping.

is concerned, as the short-handled one, and if used in conjunction with a small broom, often called a child's broom, will be a great back saver.

Dustless sweeper materials aid very much in the cleaning process, because they reduce the amount of dusting. These materials may be bought in packages at twenty-five cents, or in barrel quantities at about ten dollars. They are usually finely ground sawdust or fine sand into which oil has been worked. The oil takes up the dirt as the material is swept along. Bare floors such as tile, or wood floors, are most easily swept with these different sweeping

materials. The sand in most of the materials makes them inefficient in carpet or rug sweeping, because it settles in the carpet and is hard to remove. The housewife may make dustless sweeper material by using left-over tea leaves, or by tearing bits of newspaper which have been sprinkled with water. Sprinkle either the tea leaves or the paper on the carpet or floor, and as they are tossed ahead of the broom they gather the dirt. A moistened broom is a dustless sweeper, but hard on the colors of the carpet or on the polish of the floors.

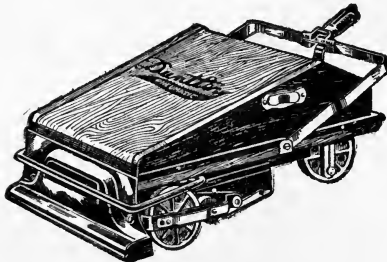

FIG. 87.—Vacuum sweeper

Carpet Sweeper.—Cost, \$3—\$6. This is a small box on wheels, containing revolving brushes which turn as the box is pushed over the floor. It makes no dust, is easily operated, takes up threads, and is excellent for removing surface dirt.

Vacuum Sweeper.—Cost, \$6—\$12. These sweepers (Fig. 87) are combined carpet sweepers and vacuum cleaners; they have the revolving brush of the carpet sweeper, and the bellows suction of the vacuum sweeper. Their cost is not excessive, and they are most satisfactory, with no more fatigue than with the carpet sweeper.

Vacuum Cleaners.—Cost, \$35—\$125. The so-called vacuum cleaners (Figs. 88 and 89) are divided into piston, bellows, and fan types. As washing machines may be divided into hand and power machines, so may vacuum cleaners; and the question comes again as to whether a hand tool which involves so much work on the part of the operator is a labor saver. The piston and bellows types may be bought in the hand machines; these are not truly labor savers, but are dust savers. The piston is like a water shotgun, in that the drawing up of the plunger leaves a vacuum into which air goes, carrying with it the dirt. This receiving chamber is lined with a soft woolly material to which the dirt adheres. These are small, inexpensive, and easily carried, but require a great deal of work on the part of the operator.

The big power machines are divided into fan type and bellows type, and may or may not have some form of brush. Sometimes these brushes are bristles; sometimes they are flat revolving bits of rubber. As the brush passes over the rug in the same way that the

carpet sweeper does, it stirs up the dust and throws it back ready for the suction to receive it. These machines are easily operated, efficient in their work, if they have sufficient suction, are not



FIG. 88.—Vacuum cleaner. Courtesy Franz-Premier.

necessarily very expensive. The bags into which the dust is sucked up are usually about equal in efficiency; they are dust proof and under ordinary conditions need not be washed.

The larger and more powerful machines, while more efficient

from the point of view of producing a better suction, since their weight keeps them close to the floor, are so heavy that they are difficult for the housewife to operate. The most powerful and most expensive machines cost several hundred dollars and are built to be established in the basement of the house with pipes extending throughout the house. If this type of machine is to be used, it should be planned for when the house is built, so that the various pipe connections may be made in the baseboards of each room, and lead back to the cellar. A flexible hose then connects the cleaner in any desired room with the permanent pipe opening in the baseboard.

The housewife should consider the weight of the machine; the ease with which it can be cared for; the convenience in oiling; the size of slot in the suction end, and facilities for keeping the slot on the floor, so that it is always close to the rug or carpet; and the final test, how much dust, if any, is left in the rug after cleaning. There is no better way to settle this latter question than to beat the rug and see how much dust can be raised.

The cheaper machines are usually lighter in weight and have a smaller motor; the better machines should have good weight, good suction, and the longer slot, which is an advantage in any machine. The question as to whether the machine should have a brush or not is still not decided. Some of the so-called brushes are hardly worthy of the name. What seems more important is whether the nozzle is wide and so swivelled as to adjust itself to irregularities of movement of the worker, and whether the motor is substantial and of good size.

Remember that the suction is broken when the slot is not close to the fabric to be cleaned. Vacuum cleaners are not wood polishers, but fabric cleaners; are not washers, but collectors of loose dirt. They themselves must be kept clean.

Mops.—Cost, 40 cents to \$1.50. The use of a mop, whether for dusting or for scrubbing, affords a great saving of strength, because it eliminates bending and stooping. There are two types of mops used in cleaning. A plain deck mop, one with strings fastened in a circle around a wooden handle, makes a good dry dust mop. A second type is the broad flat mop; in this the strings or pieces of cloth are held in a flat metal clasp attached to a wooden handle. This type of mop is best for scrubbing because it wrings better than a round one, either in patented mop wringers or by hand; besides,

it slips under places better than does the thicker round deck mop.

The housekeeper can make a mop like the round ones by using an old broom handle and tying about the end of the stick pieces of old undershirts or stockings, and then turning them back over the tied part and tying a second time. With the mop which has the flat clasp fastened to a handle, similar old cloths may be used instead of the woven cloth that comes especially for this purpose.

Dustless mops are string mops with shorter strings which are treated with an oil. This oil should be in small amounts, just enough to make the cloth hold loose dirt. If too much oil is used on a dustless mop or duster, it will leave a greasy surface which will soon attract dust. Continual dusting of this kind will make the wood dark and cloudy.

Mop Wringer.—Cost, \$2. This is a real labor saver because it saves arm and wrist strain in wringing, and protects the hands from chapping through being constantly wet; besides doing the work more thoroughly. The wringer should be bought with regard to the mop, because size, shape and thickness of the mop decide to some extent the kind of mop wringer to buy. It fits on the mopping pail (Figs. 90 and 91).

Cleaning cloths are legion to-day, but after all, the housekeeper with experience will learn that she can buy material by the yard of regular standard type, and feel quite assured that she has good cleaning material without too much additional expense. Without buying anything, good cloths may often be made from old worn garments, if they are clean, non-scratching, and non-linting. Many different materials may be used. For cleaning materials that are purchased plain cheesecloth, either unbleached, which is the cheapest, or white cheesecloth for a few cents more, and domet flannel (the household name for it is outing flannel), represent two standard types. Cheesecloth makes very good dusters, and, when wrung very dry out of water, is good for cleaning and may be used with

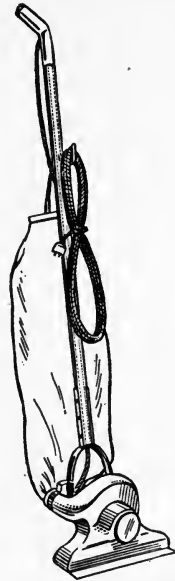

FIG. 89.—Vacuum cleaner.

the outing flannel for polishing furniture. Outing flannel makes good floor cloths, broom bags (Fig. 92, *A* and *B*), wall wipes, and may be used for polishing cloths. The first requirement is that the cloth be clean, free from scratchy material, absorbent, and non-linting.



FIG. 90.—The long-handled scrub brush, with its ball-and-socket adjustment, is a most complete scrub brush.



FIG. 91.—The mop and wringer means that a woman need never scrub on her knees.

In response to the demand to-day for more rapid work, special polishing cloths are made, which are treated with chemicals and powders that make unnecessary other cleaning powders or mixtures; these are used for cleaning silver and other metals. Their usual cost is at least twenty-five cents. (See chapter on Supplies, page 134.) These cloths, when not in use, should be kept in a box or a paper wrapping, so as to prevent their getting any extra soil.

MISCELLANEOUS EQUIPMENT

Sewing machines may be had in various types, and should be found in every home. The disappearing head machine in which

the sewing mechanism folds down into the case, leaving a compact flat top cabinet, is one desirable type. Electric motors are now available to run any sewing machine (\$15), and a special machine with the electric motor attached may be had for about \$40. With the small motor suggested below, the regular sewing machine may be operated by attaching a belt from the wheel of the motor to the wheel of the machine, although speed adjustment may be difficult.

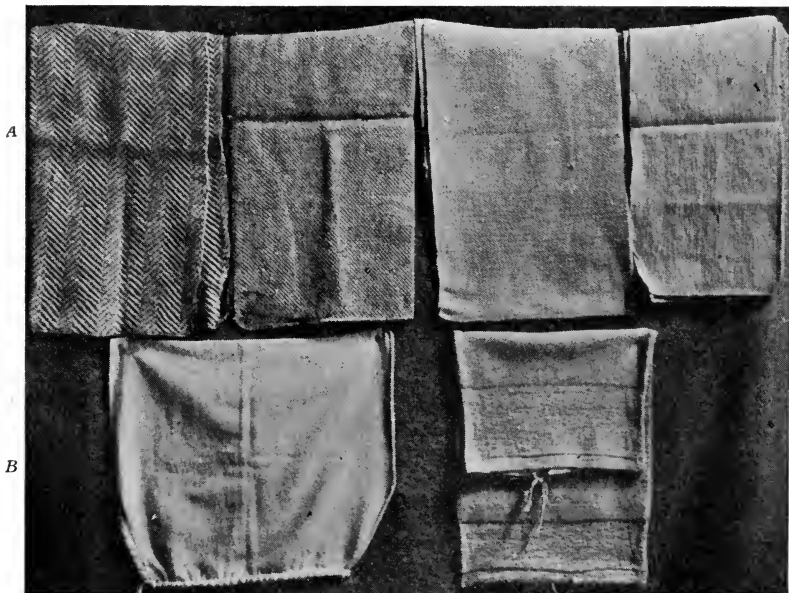

FIG. 92.—A, various types of floor cloths; B, broom bags found ready made in stores. Domet flannel makes good broom bags.

Small Electric Motor.—Cost, \$15–\$40. Efficiency students who are working with small electric motors for household use, pronounce them almost human in their serviceableness. Such a motor should be placed where it will be of most use, and when one is purchased separate motors for individual appliances are not needed. Such a motor could work the coffee mill, the sewing machine, the ice-cream freezer, the bread mixer, and the washing machine. Each machine must have a wheel for the belt which in

turn must be kept tight, and the motor must have power to do the work. Voltage and current must be considered. (See chapter on Heating and Lighting, page 60.)

Electric Fan.—Cost, \$5 up. An electric fan gives great service not only for use in the kitchen and laundry during hot weather, but also for use in the rest portion of the house. Modern science shows that we keep cool by rapidly changing the layer of air that surrounds us. On a cold day a fan directed against the steam- or hot-water radiator will more quickly warm a room. A fan is used in the latest method of drying fruits and vegetables.

Canning Outfit.—The outfit may consist of a pressure cooker (\$8–\$10), a soldering outfit, and a supply of tin cans, or of glass cans with new rubbers if preferred. Fruits and vegetables are now also preserved by drying in an oven, by the sun, or by air currents from an electric fan. The small utensils needed can of course be taken from the regular kitchen outfit.

Milk Separator.—In the farm home, a milk separator is indispensable. It is operated either by hand or by power; a power separator should be had if much milk is to be handled. The separator is a centrifuge in which, by the rapid revolution of a bowl or cylinder containing whole milk, the heavier part or the skim milk is thrown out toward the circumference, and the light part or cream is held toward the center, each passing out of the “separator” by an appropriate outlet. While separators vary in construction, the principle that the revolution throws the heavier liquid to the outer circumference is the same in all. The housekeeper must, of course, be very careful that the separator be kept clean and sweet-smelling.

SUGGESTIVE QUESTIONS

1. In what ways would you increase the efficiency of a washing machine?
2. What care should be given to a vacuum cleaner?
3. Were an electric motor or a gasoline engine to be attached to a sewing machine or a washing machine, what special care must be used in making the connections so as to get the most economical service?
4. What care should be given to an electric motor on a machine?
5. List five labor savers that are not operated by a motor.

REFERENCES

- BALDERSTON, L. RAY, LAUNDERING. L. Ray Balderston, 1224 Cherry St., Phila.
- COOLEY, M. S., VACUUM CLEANING SYSTEMS. Heating and Ventilating Magazine Co.
- MACLEOD, SARAH, HANDBOOK OF CLEANING. Harper & Bros.
- PARLOA, MARIA, HOME ECONOMICS. Century Co.

CHAPTER VI

HOUSEHOLD SUPPLIES

SUPPLIES go hand in hand with tools, so that the two together may rightly be called the working equipment. In buying supplies, as in selecting tools, the housewife should consider: quality, price, and quantity; and there is always the question of the kind of supplies best fitted to a task. In many cases there may be two or three equally good for a given use so that the housekeeper must make a personal selection. There may be no reason for one choice over another except likes and dislikes, that large personal equation which keeps housekeeping more or less an individual problem, and which will always prevent any complete standardizing of its tasks.

This chapter presents general rules in buying, applicable to all household supplies, and then presents standards for selecting cleaners and polishes, soaps, starch, blues, sewing supplies and paper and desk supplies for the home.

Rules for Buying All Supplies.—Choose a reliable store, where standards are good—this means fast colors; weight as stated; fresh goods; percentage of moisture, coarseness, etc., standard; size, measure, or count accurate.

Learn by experience which are your best stores and keep to them; if you are new in the neighborhood, go to the store where the standard seems too high to sell falsely.

Select the goods personally; until you know the store and the goods, and the store knows you, do not buy over the 'phone or through a catalogue.

Check up the amount, the quality, and the price on returning home; this will be the best study towards becoming an expert buyer.

Buy regular standard necessities when special sales are offered, but be sure to know the regular price and regular quality.

Buy only what is needed and can be used. It is not a bargain if it lies on the shelf until it deteriorates.

Be considerate of clerks.

Do not demand impossibilities.

Know what is wanted, hence reduce delivery service and eliminate return service.

Either pay cash or settle the bills promptly; stores demanding cash can sell more cheaply; you pay more for the privilege of charging—it may be worth the extra cost, but do your share by paying bills promptly.

Patronize stores for special supplies; *e.g.*, the paint store, the laundry supply house. Laundry supply houses are established in all large cities and the quality they handle is quite assured. Parcel post makes it possible to send an order; for after using any supply, it can easily be obtained again through its number or size.

CLEANERS AND POLISHES

The housekeeper who plans to do a great deal of the renewing or renovating of woodwork will need a small amount of many supplies. As the amount needed will often be less than she can buy, she will have to plan for storage either by buying suitable containers or by purchasing supplies in containers at perhaps extra cost. The matter of containers must be considered because much of this kind of material is either poisonous or inflammable. Label everything plainly (a little shellac will assure the labels sticking) and store away from the fire. Remember even the cloths and brushes used in this work, if not washed, must be stored in closed tin pails or stone crocks.

Beeswax is purchasable at the paint store or in the laundry supply house. Beeswax is the foundation of floor wax (see chapter on Renovation, page 295), and the same wax is used for waxing irons. It is sold as yellow or white wax, but usually is yellow, which is not only best but less expensive.

Paraffin wax is made from petroleum, and is often sold as white wax. It is the best wax for white goods because the yellow wax is likely to darken the wood. It is also used in laundering.

Paraffin oil is distilled as an after-product in distilling kerosene. It is a non-fatty oil, and therefore is most excellent for polishing woods. It mixes well with alcohol or turpentine and on account of color is good for light woods.

Linseed oil is the oil pressed from linseed, and may be purchased at the same place as the wax. It is sold as raw or boiled. The raw oil is the crude oil pressed from the seeds without warming them; the boiled oil has been treated in such a way as to increase

its drying power. For almost all household uses such as floors, wood-work, and furniture, the boiled linseed oil is used.

Kerosene is useful as a cleaning oil, because it dissolves rosin and wax; it is used for cleaning machinery, rusty iron, etc. It is in no way a lubricating oil like a machine oil.

Lemon oil is a volatile oil obtained from pressing the rinds of lemons, oranges, tangarines, or limes. The finer qualities are used for perfumes or flavorings, while the cruder oils which are added to light petroleum products may be purchased in paint shops or house-furnishing stores, to be used for the oiling of lighter colored woods, and are often used as floor oils. This oil is volatile enough to dry almost immediately, affording less opportunity for it to gather dust.

Turpentine is a distilled rosin-like liquid made from the pitch-pine tree. The volatile oil or spirit of turpentine passes over first in the distillation, and the residue is rosin. When fresh, turpentine is almost colorless and odorless, growing darker, so dark as to make a stain of its own if used as it so often is to remove paint from clothing. Combined with wax (see chapter on Cleaning and Renovation, page 295), it makes an excellent floor wax.

Turpentine should be kept away from fires and should be stored in tightly closed containers. Brushes and cloths used with turpentine should be washed or burned, or kept in tightly closed cans or crocks after their use.

Naphtha and **benzine** are sold as one and the same. Like kerosene and gasoline they are derived from mineral oil; they are volatile (second only to gasoline) and give off inflammable vapors. They should always be used with great care, with windows open and no fires or open light about, and should be kept tightly closed when not in use. Naphtha dissolves rubber and is used like kerosene for cleaning the rolls of clothes wringers (see rubber goods, chapter on Storage, page 235); it dissolves fat and is used for cleaning fabrics; it dissolves varnish and a drop on the rubbing cloth will often restore wood marred by heat; it kills vermin and is one of the insecticides most used for bedbugs, ants, and fleas (see chapter on Household Pests, pages 312, 314).

Gasoline is nearly as volatile and inflammable as naphtha and benzine, and should be used with the utmost care to prevent fire. With any one of the three materials, have all windows open, and no flames present from matches, lamps, or stoves; and after its

use allow plenty of time for thorough airing before bringing the article into service. This is especially true for mattresses or upholstered furniture that may have been gasolined for moths or other pests. Such thick material would be slow to allow evaporation of gasoline. Clothing that has been gasolined and *thoroughly* aired for several hours may be placed in a warm place, as heat will drive off the last unpleasant odors. Pressing with a warm iron produces the same result. But apply no heat until after thorough airing.

Machine oil should be of the best, free from rosin or any gum, and its quality will soon be proved because no gum residue will form to hinder the action rather than lubricate. Good sewing machine oil can be used for oiling washing machines, sewing or sweeping machines, or other household machinery.

Furniture Polishes.—Prepared furniture polishes may be expensive, and too often contain quite a little varnish which if used too frequently will result in a sticky gum deposit on the furniture. Cheap varnishes contain rosin which will in time give a sticky finish. It is a little more work to make a preparation, but if one has the ingredients in the house to use separately at various times, why not take time to combine them.

Miss Parloa¹ gives standard directions for the two following preparations:

Furniture Cleaner and Polisher.—Put into a quart bottle, in the order named:

- 1/2 cup powdered rottenstone
- 1/2 cup cold-drawn linseed oil
- 1/2 cup turpentine
- 1/2 cup naphtha
- 1/2 cup strong solution oxalic acid
- 1/4 cup wood alcohol
- 1/2 cup cold water to which has been added
1 tablespoon of sulphuric acid.

Wax for Polishing Furniture.—

- 1 lb. beeswax
- 1 pt. turpentine
- 1/2 pt. alcohol.

¹ Parloa, Maria, *Home Economics*, pages 332, 333.

Melt wax in an earthen bowl over water. When melted, withdraw from the fire and with a wooden spoon stir the other two ingredients into the wax. Stir continuously so the wax as it cools may hold the liquids. The mixture when finished is a grayish cream paste ready to be used any time. Apply with a soft woolen cloth, using only the least possible amount, but with much rubbing.

Rottenstone is a fine gray powder not unlike powdered pumice in appearance and action. It may be bought as pumice stone or powdered tripoli at the paint shop. Like any gritty substance, it works best with a lubricator like oil. In this way it cleans and polishes. Either powder may be purchased by the pound and stored any length of time.

Steel wool is a polishing material, sold in packages at the paint shop. It is steel shavings and may be bought in graded sizes like sandpaper. The heavier, coarser wool is more like shavings and is especially good to be used like heavy sandpaper on coarse uneven wood. Like the heavy sandpaper it will clean rapidly but leaves a deeply scratched surface which will need to be smoothed down by using either very fine sandpaper or the steel wool that is so fine it is like hair. This finer is graded as "00." Any of it may be bought in ten- and fifteen-cent packages.

Metal polishes are usually sold as pastes, powders, or liquids and are many in number. One distinction may be made, that silver and gold polishes should be free from grit and contain no acids; while brass, copper, and nickel polishes usually contain some acid. Aluminum polish should have no alkali like soda or potash.

These cleaners, like many supplies, should be bought in small rather than large jars, as part of the material is very volatile and the whole content is likely to dry and be wasted. Keep the covers on; take the paste out on the cloth rather than put the cloth in the jar. Moisten with alcohol when moisture is necessary. Keep the covers tightly screwed when not in use. If a liquid, always shake before using.

Silver Cleaners.—A good silver cleaner may be standardized from two viewpoints somewhat as follows: For the preservation of the silver, the best cleaner should be free from strong chemicals, and from coarse abrasive material; it should leave a good color tone—not a steel-like brightness. For the comfort of the worker, the

cleaner should be free from dust, and should not involve too much labor and time in its use.

Silver cleaners are divided into five groups: the rouge cloths, powders, pastes, soaps (prepared mixtures), cleaning pans (frontispiece).

The *rouge cloths* are soft cloths of the nature of outing flannel, dipped into a cleaning mixture which adheres to the cloth. They are effective cleaners, and very satisfactory for one having only jewelry or bedroom silver to clean, or for one travelling. They are expensive to use for a large household, because the cloths are very small and soon wear into a hole, and cannot be renovated. (See Cleaning Equipment, page 118.) These cloths are not washed, but the silver, after having been cleaned with them, should be washed thoroughly, as after all other cleaners.

Powders may be bought under trade names, or, more cheaply, as whiting or calcium carbonate, which is sold in packages labelled "Paris White," costing from five to ten cents a pound. The disadvantage of the powders is that they create considerable dust, which is disagreeable for the worker and necessitates an extra dusting after their use. This disadvantage may be partly overcome by moistening the powder with a few drops of water or alcohol; use only enough to make the powder into a thick paste. Owing to the objection to this dust, many of the former cleaning powders have been converted by the manufacturers into pastes, so that now the housewife may have her favorite cleaner in a form all ready to use.

The *pastes* and *soaps* are both satisfactory because they create no dust; another advantage lies in the fact that the careless worker cannot possibly avoid washing the silver afterward. The soaps are probably less wasteful than the pastes, but are no more satisfactory as cleaners.

Various "*silver cleaning pans*" are now on the market. Their action is very rapid, so much so that the housewife may question whether there is not possibly a harmful effect on the silver. While the action is chemical, it is more in the nature of electrolysis. In a cleaning pan, or a device to be put into a pan, there are usually two metals, zinc and aluminum; baking soda, salt, and hot water are the reagents used; when the silver is put into the pan, it rests on an aluminum base which is to a certain extent like an electrode, and action takes place between the metals and the chemicals. The

question as to whether the silver is injured by such a method may be answered by an examination of the cleaned silver under a magnifying glass. The surface will be found to be much less "irritated" than that of silver rubbed with some one of the polishes. The loss by weight is negligible. However, the silver will not have a soft satiny appearance after such cleaning. It seems that such a method with these pans, if not over-used, is not any more detrimental than any other method of cleaning silver. (See also chapters on Kitchen Equipment, page 97, and Cleaning and Care, page 263.)

Whiting is conveniently bought in pound packages. As it is the foundation of most cleaners, much can be done by buying whiting and making it into a paste with a liquid as indicated below. The liquid probably plays a two-fold part, forming the powder into a paste, and supplying a dirt, grease or metal solvent. Whiting with alcohol (wood or denatured) for silver; whiting with ammonia for nickel; whiting with dilute acid (see below) (kerosene may be added) for metals: aluminum, brass, copper, nickel; whiting with warm water for white enamel paint; whiting with steel wool for aluminum.

Bath brick is now put up in package form as a powdered brick dust, and is much more satisfactory. The old bath brick was sold in brick form, and had to be pulverized as needed. It is the best steel cleaner, and can also be used as the grit to clean soiled pots and pans.

Acids.—Oxalic acid, hydrochloric acid, salts of lemon, and citric acid, are of special service in the home. They are used to remove spots from clothing such as iron rust, ink (see chapter on Renovation, page 275); or as cleaners when mixed with oils and abrasive materials, as in furniture polishes and cleaners; and as cleaners for metals in dissolving the dark oxides such as form with any exposed metal. These acids are poisons, hence should be used with great care, so that they will not be mistaken for something else, and so that every trace will be washed out of all dishes used in cooking and serving. These acids should be properly labelled and stored where children can not reach them. For cleaning kettles, vinegar or lemon juice will do the same work in a slower way but without the risk of handling a poison.

Ammonia.—The housewife will find it economical to buy concentrated ammonia and dilute it with water, using 1 part ammonia

to 5 parts of water. The best quality of ammonia is cloudy. For scouring, ammonia in solid form is sold in cans as ammonium carbonate, but the liquid ammonia diluted is best for all purposes.

SOAP, SODA AND SCOURERS

Soap.—A good soap is one that is free from alkali (either soda or potash) and from any coloring which could hide impurities in the soap. Clean fat is light yellow or white, and if the soap is made from clean fat it will naturally be a very light color.

Alkali can be detected by a pungent odor, which cannot come from rosin if the soap is light or white. It is also possible to recognize the presence of alkali by the shrivelled, drawn, and finally dried feeling of the hands after its use. A surer test is to use a piece of moistened red litmus paper. Moisten it with clean water (not by the saliva of the mouth), and lay the paper on the soap to be tested, choosing a fresh cut surface preferably in the center of the cake. If there is excess alkali present, the red paper will quickly turn blue. Soap salesmen test for alkali by holding a bit of soap in the mouth to see if it bites the tongue. Alkali is caustic.

Rosin can be detected by the odor, by the stickiness of the soap, and by the gummy, sticky scum decidedly resinous in character, which forms on the water line of the clothes boiler. It is to the housewife's advantage to buy more of the so-called white soaps, because they are likely to contain little or no rosin, which is used as an adulterant to weight the soap. Rosin does produce a suds, and for that reason may be said to aid in the cleaning; but its sticky quality is a decided hindrance and in addition it is in the nature of an adulteration in the soap.

Ammonia, borax, or soda in the form of washing soda, is often added to the home-made soap by the housewife as the soap is forming, and before it is to be poured into molds. For scrubbing, and for general heavy work where brushes and mops are used, this soap has an advantage, because any of the ingredients mentioned cut the dirt. Ammonia and borax are mild alkalies and have no unpleasant action on the skin, but will affect delicate colors. Extra soda in a scrubbing soap is a great advantage because it cuts the grease. It is an advantage in purchasing scrubbing soaps, provided it is not bought at soap price, which is nearly three times that of soda.

Coloring matter in laundry soaps acts as a curtain to hide materials that are false constituents; white soaps are to be preferred. The toilet soaps are often colored violet or rose, for example, because the soaps are scented with the volatile oils from these flowers. The cost of scented and colored toilet soaps should warrant at least a good clean fat and a fine perfume. Usually such a soap is molded into a very small cake and its cost is double that of better household soaps, which are equally efficient as toilet soaps.

It is economical to buy soap in large quantities. In the first place, there is the usual grocery saving like six or three cakes for a quarter, and sometimes a larger saving in larger amounts. There is the advantage, too, to the housewife of having enough soap in storage to allow time for it to dry before use. Drying soap is a saving, but it fails in economy if the soap becomes so dry that it does not lather quickly, and the housewife's lost time more than offsets the money saving. In small families where soap is bought in box quantities because it is less expensive, and where it is not used up so quickly as in large families, it is wisest not to unwrap those cakes which are to be used last.

All scraps of soap should be saved for use in dishwashing, in the clothes boiler, or for soap solution for the washing machine. Put these scraps into a jar, with water, and as fast as the soap jelly is used, add more water to the remaining scraps of soap.

Soap Making.—The two things necessary to make soap are fat and alkali. Fat may be obtained in the kitchen by trying out meat trimmings and suet, and discarded fat from deep fat frying, and other fats. Store in a cool place until several pounds have accumulated. Prepare the fat by melting, a raw potato cooked with the fat will help to clarify it. When still warm strain through cheesecloth. The alkali is sold as caustic soda; it is bought in lump form at the drug store or chemists' supply house, or lye may be bought in cans. One pound of this soda combines with 7 pounds of fat to make soap.

To Prepare the Solution.—Dissolve 1 pound caustic soda in 5 pints of water, or 1 can lye in 1 quart water.

To Make the Soap.—One pound clean fat warmed, and 14 oz. ($1\frac{7}{8}$ cups) soda or lye solution. Warm the fat just enough to melt it. Stir the soda solution into the fat until the mixture becomes a smooth creamy mass, then mold.

To Mold.—Line an enamel pan or cardboard box with waxed paper cut into strips the width of the box (like the paper in candy boxes). Pour the soap mixture into the box and let stand until soap is well formed (24 hours). Before it dries remove the paper as from a warm cake after taking from the oven.

Soap chips, so-called, may be purchased from all soap manufacturing companies and from laundry supply houses. Most of the brands may be purchased in ten-, fifteen-, or twenty-five-pound packages or in barrel quantities. One pound of soap chips to four gallons of water makes a soap solution which is especially suitable for use in washing machines. One has used enough soap solution when the suds remain and a scum does not form in the washing. The greasy or more soiled clothes will need more soap. Often two cups of the above solution to a seven-sheet washer is enough.

Soda.—In the same place where soap is purchased a type of powdered washing soda, especially suitable for laundry purposes can be bought. This soda is sometimes spoken of in the trade as “acid alkali” because it is the washing soda with some of its astringent caustic properties removed. This soda makes a saving in the soap bill, because its cost is about one-third that of soap, and it is especially serviceable in doing laundry work where the water is very hard. It may be made into a soap solution by using one pound of soap, and one to two pounds of prepared soda to every four gallons of water. The saving will be very noticeable if the measurement of this prepared solution is compared with the solution without soda, remembering that soap enough has not been used in the water until a lasting suds is produced. Warm water produces more suds than cold.

Soap Powders.—Soap powders or washing powders are usually purchased in small packages from the grocery. These packages weigh from one to three pounds. It is possible, however, to buy these powders in barrel quantities. These powders are much used because, like soap chips, they readily dissolve, forming a suds.

Very few soap powders are pure soap. The proportion of soda varies, but its presence is easily tested by sprinkling a few grains in the fire, when a yellow flame characteristic of soda will appear; also, watch the effect on the skin, for a parched dry skin after washing and a much puckered skin during washing indicates soda.

A soap powder containing soda may be very extravagant if one

buys it at soap rates, or if used carelessly, or if used in washing gold-decorated china or fine woolens and silks, to say nothing of colors, all of which will probably be injured by it. When used, always dissolve in the wash water; never use except for white cottons and linens; never boil with clothes. Soda yellows silks and wools and too often fades colors.

All this shows why it is much better to buy soda as soda and soap as soap, and mix or use the two known supplies when and as needed.

Soap bark may be bought in laundry supply houses or in drug stores; it will be much cheaper from the former place. It keeps indefinitely, and as it is to be used in quantities of one cup of soap bark to one quart of wash water, it is advisable to buy it in large quantity, at least two or three pounds; it weighs light. Its special value is to wash dark silks and cottons, where the alkaline reaction of soap may do harm to the colors. Do not use for white or light fabrics.

Scourers or Cleaners.—Scourers should be bought after considering the various methods of cleaning, the different utensils and metals, as well as the different furnishings about the house. In this way one will be sure to have some soaps, some pastes, and some abrasive cleaners, together with one or two mixtures which may contain enough soda to be special cleaners for greasy substances. Buy these packages, cakes, or jars of scouring material in small quantities because many of them dry or deteriorate when exposed to the air. The small discount allowed to one buying such supplies in quantities is too small to warrant the risk of much waste. Workers in institutions should buy in larger, wholesale quantities.

STARCH

The essentials of a good starch are that it shall give a certain degree of stiffness but still keep the fabric pliable; give a body which is as lasting as possible to the fabric; resist moisture, and give clear good color as well as gloss and finish.

There are three kinds of starch, as well as several substitutes which are especially suited for the laundry. The usual starches are cornstarch, wheat starch, and rice starch. Potato starch is not desirable as it absorbs more water than the other starches when in the garment, so that the garment will not wear so well.

Cornstarch is a fine grain starch from corn, which has the special power of making a starch paste which resists moisture. It makes a fabric stiff, rough and brittle. Cornstarch is better adapted to the starching of cuffs and collars than to the finishing of a baby dress.

Wheat starch makes a soft pliable fabric, giving a smooth finish and a good gloss. It is most suitable for fine lingerie.

Corn and wheat starch combined give better results than if used singly. For this mixture use two-thirds to one-third, according to the stiffness or pliability desired. For example: for shirt bosoms, collars, cuffs, etc., use two-thirds cornstarch and one-third wheat; while for petticoats, dresses, etc., use one-third cornstarch to two-thirds wheat starch. Mixed starches blended for the purpose may be bought at laundry supply houses under the name of blended or modified.

Rice starch is used most often for fine French lingerie. It has a very small grain and makes starch of a very pliable nature. It may be bought in packages, or may be obtained by using the water in which rice is cooked.

Prepared Starches.—A specially prepared starch may be bought at the laundry supply houses in household quantities. This prepared starch has paraffin and borax mixed in standard proportions, so that with a standard recipe, using twelve ounces of starch to a gallon of water, one has a standard quality of paste. There are laundry and hospital supply houses in all large cities, from which these materials may be secured by parcel post. It is of especial advantage if one is attempting to do any of this work as a business.

Mourning starch is purchasable in pound packages, and is of service in laundering blacks and browns, but it is not necessary, as tea used with ordinary starch serves the same purpose.

Color tints may be obtained in powdered form or in pastes such as are used for coloring candies and icings. Some dyes may be purchased in soap form. Various shades of crêpe paper will bleed enough color in a quantity of water, and this water may be added to the rinse water or to starch water. Almost any shade of color may be obtained by combining various colors. Blues and pinks make violet, and brown turns pink to an apricot shade. Boiling the garment in the dye usually assures the fastness of the dye.

Starch substitutes are of great value in taking the place of starch in case of an emergency, or for doing fine lingerie work where the penetrability of the stiffening agent is the chief requirement:

Borax is usually bought in powder form. Voiles or dimities

and any sheer material like fine collars and jabots appear more like new material if rinsed in borax water instead of starch water. Borax is a bleach and if only a part of a garment is starched with borax, that part on standing will whiten.

Gum arabic may be purchased as a powder or in lump form. Either will dissolve quickly in warm water, requiring about half as much time for the powder as for the gum. Gum arabic is especially useful in stiffening silks and crêpes. It gives a new-fabric appearance. It is used in such small quantities and so seldom, that from two to four ounces from the drug store will be ample. It is used in the proportion of one teaspoonful to one quart of water and must be strained before using.

Dextrine is a gum. It is starch partially digested into a sugar and so is neither a starch nor a sugar. If one has gum arabic in the house, there is no need to use dextrine. Some especially prepared starches that are sold for fine lingerie are dextrinized starch. This starch makes a more penetrating stiffening.

Bran is used in the place of soap for washing cretonnes and colors and, like grated potato put in the water, will carry some starch with it. No bran is absolutely free from starch, and if the garment after washing is rinsed in bran water instead of clear water, it will take up some starch, enough to give the appearance of a new fabric.

BLUING

After rinsing the clothes entirely free from soap, the use of blue water will counteract the yellow of the fibre and the clothes will become whiter than without its use.

A good blue should entirely dissolve in water and should contain no iron.

An insoluble blue is an inconvenience because it settles on the sides and the bottom of the tub, and may even settle in the folds of the garment, causing streaks and spots which must be washed or boiled out. It is also an unnecessary expense because all the bluing bought is not usable. If an insoluble blue is used, the water should be stirred each time a garment is put in so as to keep the particles in suspension, otherwise they will settle.

Liquid blues are easy to use and are soluble, but care must be taken that they and other blues do not contain iron. Clothes that are not properly rinsed so as to be entirely free from soap before

bluing will often show, upon ironing, streaks or spots of iron rust. The soda or potash of the soap has combined with the iron of the blue, and iron rust develops on ironing. It is a chemical formation and may be overcome either by a better choice of blue, or by thoroughly rinsing out all soap before bluing.

To test a bluing for iron, put a teaspoonful of liquid blue, or shave off some of the ball or block blue, into a tablespoonful of water and to this add a strong solution of soap or soda. Heat this mixture, and if iron is present the bluing will change to a reddish brown.

To test solubility, put a few grains of powdered blue in water, shake and let stand to dissolve. Filter through filter paper or fine cloth and if soluble no residue will remain.

Bluing is usually bought at grocery stores, but the laundry supply houses have the greatest variety of blues, and will sell in small quantities like one ounce.

Aniline blue is the standard blue and is soluble and without iron. It is very strong, not being diluted, and may be purchased as a powder, ready to be dissolved. Put one ounce of powder into one gallon of warm water and all will dissolve; filter, bottle and store for use. Of this solution, use one teaspoon for an ordinary washtub of water. Aniline blues are sold by number, which indicates color, blue or violet, and whether an acid is needed to develop the color or not. For household purposes, buy the blue tint and the kind not needing an acid, called anti-sour.

SEWING SUPPLIES

So little time is used in being forehanded and so much lost when the needed article is not at hand. This is true with regard to all supplies, but is true to even a greater extent with sewing supplies. These supplies are usually of standard sizes and quantities and of permanent quality; so, as far as cost is concerned, it is as cheap to buy at one time as another, and certainly a needle and thread, or a hook and eye, when needed is most urgently needed at the moment.

The experienced housekeeper requires little help in this economy, but those younger in experience may be grateful for a suggestive list. Why not buy such requisites as the following the very first day one goes to a store, and then certain necessities will have become comforts, by being on hand when needed?

Thread:

- Spool cotton, white and black, sizes 40-90.
- Spool silk, white, O-A-B (2 size spools, large and small).
- Spool silk, black, O-A-B (2 size spools).
- Spool silk, light blue, A.
- Spool silk, light pink, A.
- Basting cotton, size 60.
- Heavy linen thread, spool or skein.
- Darning cotton, black and white mercerized.

Needles:

- Darning needles, sizes 3-9, 5-10. (Separate papers of one size may be bought.)
- Sewing needles, sizes 6, 7, 8, 9, 10.
- Large sack needle or heavy darning needle.
- Bodkin—tape needle.

Pins:

- Paper or box of pins (cheaper by the box; $\frac{1}{4}$ lb.).
- Two sizes are convenient, but if one size is bought choose one not too large.
- Safety pins, three sizes.
- Steel or nickel plated. The steel is more expensive but has a good needle point.

Hooks, Eyes, and Peets:

- Black and white, non-rusting, sizes 1, 2, 3.

Snappers:

- Black and white, sizes 4/0, 3/0, 2/0, 1/0, 00.

Measure:

- Tape measure.
- Yard stick.
- Neither expensive; the tape especially good for sewing, and yard stick for accurate measurements about the house.

Tapes:

- Cotton—two or three rolls of cheap cotton tape for broom bags, hanging loops, or places where tapes are firmer than string.
- English twilled—best quality for bindings.
- Linen—special bindings for shoe bags, for sturdy bindings and facings.
- Bias Bindings**—for finishing; for mending or replacing in tears. (Several sizes—2-8.)
- Ribbon Binding**—black and white. Used for rough edges of seams. Most useful for mending.
- Lingerie Tape**—for drawstrings in underwear; serviceable and washable; good to replace the broken drawstring.
- Feather Stitch Binding**—for finishing where a plain bias binding could be used.
- Belting**—to replace shrunken belts. (All belting shrinks about 2 inches to the yard.)
- Shoe Lacers**—black, both short and long. Color to match usual color worn.
- Corset Lacers**—a pair of short ones. One long lace.

Edging:

Narrow embroidery to set into tiers, 2 widths.

Narrow lace to set into tiers, 2 widths.

Coarse net for foundation for darning large tears.

Muslins:

Batiste or lawn, for mending.

Muslin, light weight, for mending.
heavy, for mending.

Emery Ball:

For cleaning needles.

Wax:

For waxing heavy threads.

Collar:

Bones or wires—3 sizes.

Crochet Needle:

For an emergency mend.

Stiletto:

For an emergency mend.

HOUSEHOLD PAPER SUPPLIES

Toilet paper should have a smooth surface and soft texture. It can be purchased in either of two forms: the roll, or the package of sheets. The latter is more economical because one is less likely to use the sheets carelessly. It is decidedly economical to put the package into a patented holder, and this is recommended for places where the use of such paper is likely to be extravagant, or where it is a rather large item of expense.

Tissue paper is especially useful for wrapping dainty or fragile materials. It comes about fifteen by twenty-two inches in size, and is sold by the quire or one hundred sheets. The odd pieces that come into the house as wrappings should be saved, for they make excellent window wipers. Tissue paper, too, is always valuable for packing, because it crushes and is so soft and light that it makes a good padding for fragile material.

Paraffin paper is a light-weight tissue coated with paraffin which is useful for wrapping foodstuffs. It may be purchased in packages, or by the roll of about twelve yards. If it is used very freely in the home, it will be found more economical to buy in pound or quire lots from a wholesale paper house.

Paper towels are sometimes used in the kitchen, where a clean towel is needed many times a day. This paper should be rough, really a blotting paper, so that it will absorb water readily. The towels are purchased in rolls of 7 yards each.

Paper toweling is excellent for draining foods which have been fried in deep fat. For greasing cake tins and molds, the paper toweling is far preferable to the piece of manila paper like that from a paper bag, or to the brush which must be cleaned or the fat collected on it would grow rancid.

Tray.—The tray of galvanized iron or even papier-maché is of untold service in the kitchen and dining-room. In the absence of a tray-wagon it is possible to carry several things at once. The work-tray makes the scrubbing of a kitchen table less necessary.

Wrapping paper is a great convenience to have on hand. It can be purchased either in sheets by the quire, or on rolls as one sees it used in stores. For economy's sake, save clean wrapping papers that come into the house.

WRITING DESK SUPPLIES

Paper—business size, 500 sheets to 1 ream.

Correspondence size, 24 sheets to 1 quire, 60-75 sheets to 1 package (Formerly sold as pound).

Envelopes—business size, 400 envelopes to 1 ream of paper.

Letter size.

1 pack to 1 quire paper.

2 packs to 1 package of paper.

Post cards.

Correspondence cards.

Newspaper wrappers.

Letter size pad—cheap paper.

Small memo pad—for notes. A decided color like yellow is desirable as it catches the eye.

Postage stamps—of various denominations including special delivery.

Blotters—large and small.

Printed stickers—pad for Parcel Post.

Laundry list pad—for those who send clothes out to a laundry.

Carbon paper—to copy lists.

Box of labels—not too small; two sizes.

Pad of printed household labels.

Elastic bands.

Glue.

Paste.

Key tags; trunk tags.

Mending tape—for music or books.

Sealing-wax.

Ball of string.

Ball of twine.

Paper clips.

Thumb-tacks.

Shears.

TABLE OF HOUSEHOLD WEIGHTS AND MEASURES.

Linear Measure:

12 inches = 1 foot
 3 feet = 1 yard
 5½ yards = 1 rod

320 rods = 1 mile
 1760 yards = 1 mile
 5280 feet = 1 mile

Square Measure:

144 square inches = 1 square foot
 9 square feet = 1 square yard
 30¼ sq. yards = 1 square rod

160 square rods = 1 acre
 1 square mile = 1 section
 36 square miles = 1 township

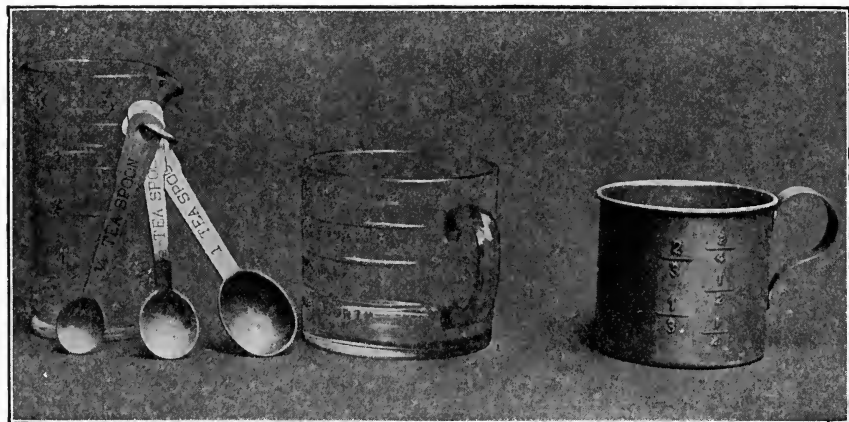

FIG. 93.—Every-day kitchen measures. Courtesy Bureau of Standards, Washington, D. C.

Avoirdupois Weight:

27.3 grains = 1 dram
 16 drams = 1 ounce
 16 ounces = 1 pound

100 pounds = 1 cwt.
 2000 pounds = 1 ton

Liquid Measure:

4 gills = 1 pint
 2 pints = 1 quart

4 quarts = 1 gallon
 31½ gals. = 1 bbl.

Dry Measure:

2 pints = 1 quart
 8 quarts = 1 peck

4 pecks = 1 bushel
 105 dry quarts = 1 bbl. (fruit, vegetables, etc.)

MISCELLANEOUS HOUSEHOLD MEASURES:

4	saltspoonfuls	=	1	teaspoonful
3	teaspoonfuls	=	1	tablespoonful
16	tablespoonfuls	=	1	cupful
2	gills	=	1	cupful
2	cupfuls	=	1	pint
1	cupful	=	8	fluid ounces
32	tablespoonfuls	=	1	lb. butter
2	cups butter	=	1	lb.
1	lb. butter	=	40	butter balls
4	cups flour	=	1	lb.
2	cups sugar	=	1	lb.
5	cups coffee	=	1	lb.
1	lb. coffee	=	40	cups of liquid coffee

$1\frac{7}{8}$ cups rice = 1 lb.

$2\frac{2}{3}$ cups oatmeal = 1 lb.

$2\frac{2}{3}$ cups cornmeal = 1 lb.

1 cup of liquid to 3 cups flour = a dough

1 cup of liquid to 2 cups flour = a thick batter

1 cup of liquid to 1 cup flour = a thin batter

2 teaspoonfuls soda to 1 pint sour milk

1 teaspoonful soda to 1 cup molasses

$\frac{1}{2}$ teaspoonful cream of tartar + 1 } = 2 teaspoonfuls baking powder
teaspoonful soda

SUGGESTIVE QUESTIONS

1. What practical suggestions for economizing soap can be taught?
2. What supplies should be bought in quantities? List.
3. List such supplies as may produce waste if bought in quantity.
4. Compare prices paid by one housekeeper and by yourself and find reason for differences.
5. Make a list that may be used as a purchasing list for cleaning supplies in the home.
6. How may the quality of soap and blue be tested in the home?

REFERENCES

- DONHAM, AGNES, *MARKETING AND HOUSEWORK*. Little, Brown & Co.
- PARLOA, MARIA, *HOME ECONOMICS*. Century Co.
- SOUDER, M. ATTIE, *NOTIONS*. Ronald Press Co.
- U. S. BUREAU OF STANDARDS, *MATERIALS FOR THE HOUSEHOLD*. Circular No. 70.
- U. S. BUREAU OF STANDARDS, *SAFETY FOR THE HOUSEHOLD*. Circular No. 75.
- VANDERBILT, SADIE B., *PHYSICAL AND CHEMICAL TESTS FOR THE HOUSEWIFE*. Teachers College Bureau of Publications, Bulletin No. 19.

CHAPTER VII

HOUSEHOLD FURNISHINGS

IN considering furnishings, it is helpful to begin with the appearance of the empty room, for the room when furnished is like a picture, to which the walls, ceiling, and floor serve as a background. To obtain best results for the background, utility, beauty, and economy may be considered together.

In planning their new home, the young couple usually have, as their ideal, the perfectly furnished house, complete in all its details. Their enthusiasm and desire to have it complete often act as a hindrance to the best results by causing them to buy hastily. With a limited sum to spend, their tendency will be to buy cheap furnishings which may represent bad lines, poor construction, and limited wearing power, for their one thought is to furnish the house.

Instead, why not plan to buy absolute necessities first, made of the best material, constructed so that they are easily cleaned, built according to approved standards, and harmonizing with things that may be bought later? As one lives in the house, sees what is wanted, and what money is available for purchasing, the many things needed and desired may be added.

It seems a more reasonable standard, moreover, to use less expensive equipment which may be had in adequate quantity, which is not too expensive to replace, and so is not a source of anxiety to the housewife. It is a poor rule for living to have material things for daily use that are so precious that they are a matter of concern. The housewife who every evening rolls up her solid silver and takes it upstairs to put under her pillow is not the American standard for the twentieth century.

Two hundred and fifty to three hundred dollars, if spent most carefully, may buy the bare necessities for a small plainly furnished home, of kitchen, dining-room, one bedroom, and bath. Even then, however, only necessities are possible.

In this chapter there are presented in turn standards for various

items of household furnishings, beginning with parts of the house itself which require care and renewal, such as walls and floors; then treating of floor coverings, draperies, furniture, linens, beds and bedding, silverware, china and glassware.

WALLS

Walls should be decorated in accordance with a few general rules: in the first place, the smaller the room, the plainer the paper or covering material. Next, for economy of light, the color should not be too dark (Fig. 94), because a dark color absorbs light, and one burns more light in order to have a brighter room. Yellows, reds, or pinks are best on dark or "cold" rooms, and grays, blues, greens, or lavenders on warm sunny rooms. The light shades and dainty patterns are good for rooms which are for individual use, such as bedrooms and dressing-rooms. The apparent form and size of rooms may be somewhat controlled by the choice of tints and colors of paper. A mirror may be hung to reflect the room, and so make it appear larger. It is often poor wall treatment that makes rooms seem like boxes divided from each other.

Wallpaper.—Wallpaper should be like mats used in framing; it should serve as background rather than itself be the picture. Two-tone papers are lighter, and often reflect more light and life than a one-tone paper; the two-tone effect may be brought about by a fine line of a lighter or contrasting color. Figures and stripes have much to do with the effect of a room. Stripes heighten ceilings, while figures, if large and geometrical, often make the walls appear close and hence lessen the size of the room. Special attention should be given to avoid "busy" papers—those that keep the occupant busy working out squares and diamonds, or constantly counting some unit of design.

Wallpapers are sold in double and single rolls, 48 and 24 feet long respectively. For a nine-foot wall, the double roll cuts to better advantage. A single roll cuts to better advantage on an eight-foot wall. If the wall height is a few inches over eight feet, the double roll is better economy. Papers with small figures, like any other material, cut with much greater economy because less is lost in matching the pattern.

Papers may be classified (Figs. 95 and 96) with approximate prices, as follows:

Cartridge	\$.15 per roll	Crepe	\$.60 per roll
Oatmeal30 per roll	Stipple	1.20 per roll
Tile30 per roll	Pressed	3.00 per roll
Engraved60 per roll	Japanese	4.50 per roll

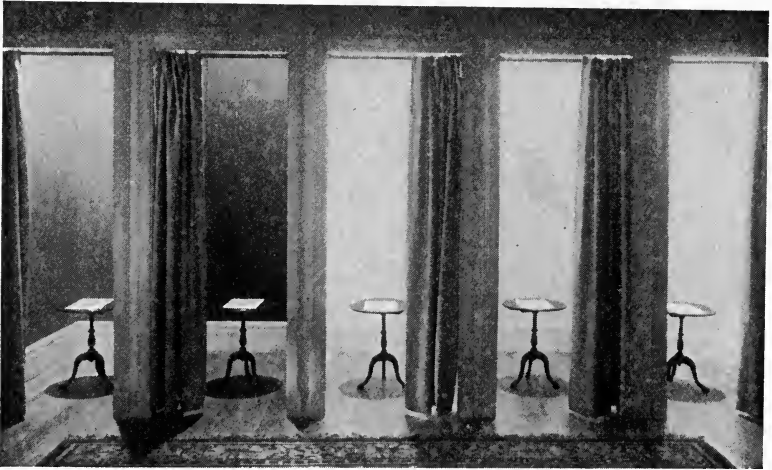

FIG. 94.—A study showing the absorption of light by wallpaper. The same sized room, the same sized burner.

To Put Wallpaper On.—Recipe for paste:

- 2 lbs. flour.
- Cold water to make thick paste.
- $\frac{1}{4}$ lb. glue.
- Boiling water to make like cream.

Save some pieces of wallpaper for future use in patching.

Hard Plaster or Cement Walls.—In rooms like the cellar, laundry, and kitchen, the walls are best finished with a hard finish which can be produced by hard plaster or cement. In either case the wall may be tinted. If desired, it may be first marked off to imitate tile or bricks, and then finished in enamel paint.

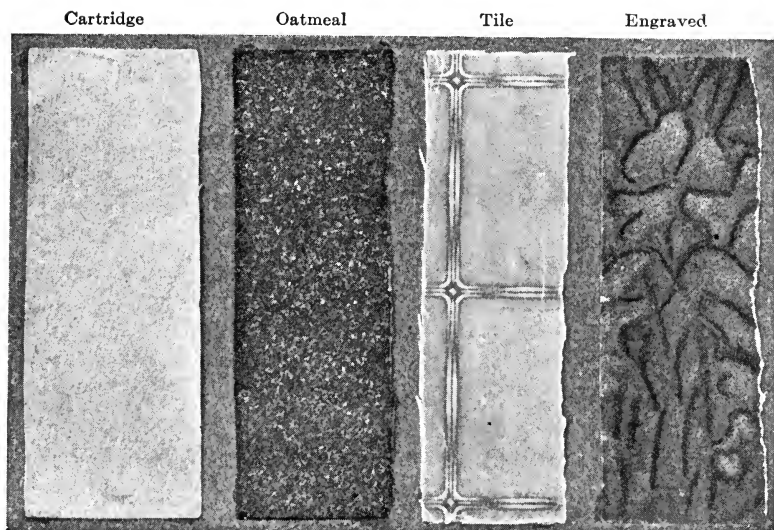

FIG. 95.—Samples of wallpaper.

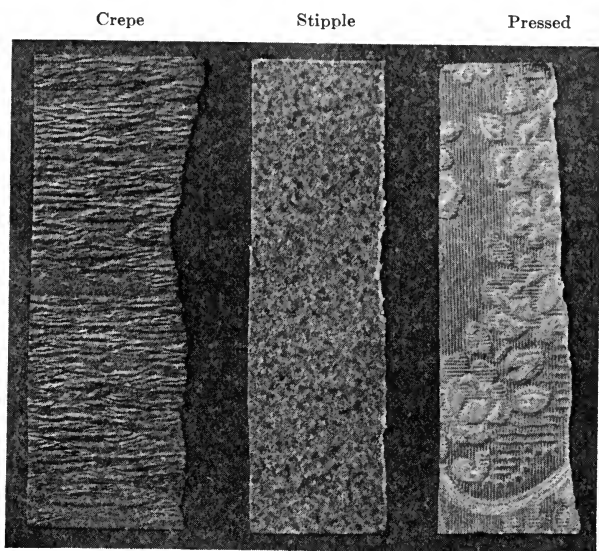

FIG. 96.—Samples of wallpaper.

Paint and Calcimine Walls.—Ordinary plaster, such as is most often used, can be finished with a hard surface by first covering with one or two coatings of flat house paint, and then applying one or two coats of enamel paint. Naturally the more coats the wall has, the more impervious to moisture it is and the more easily cleaned.

Calcimine and whitewash finish are cheaper at first cost, but will need frequent renewal, as both rub off easily, and are spotted with water. Good painted walls may be renewed by washing with soap and water.

Oilcloth or enamel cloth may be used for wall covering, and if well pasted it makes a water-proof finish and is an especially good way to freshen bathroom and kitchen walls. The tile effect possible in this enamel cloth makes an attractive wall covering.

Tile and Tile-like Walls.—As explained above, a hard plaster can be marked off to imitate tile, and this, with enamel paint, makes a good finish, which wears well. A metal, marked like tile, may be purchased in sheet form, and put over old plaster that is still firm, and then be enamel painted to give a good finish. This gives a most satisfactory wall finish, and is cheaper than porcelain tile. Tile wainscoting for five feet from the floor, with hard plaster enamelled for walls above for ceiling, while relatively expensive, makes an impervious wall finish most suitable for any room where moisture, odor, or grease may be present. This finish is most easily cleaned and is very durable. For greater ease in cleaning and for more sanitary walls, a curved baseboard of tiling is usually set in before the wainscot is set. Ornamented tile in the wall finish rather fails in the purpose of the use of the tile, for it is hard to clean, and naturally less sanitary.

FLOORS

Kinds of Woods.—The following woods are given with their advantages and disadvantages for use as floors. Sometimes one prefers to choose a wood for its special qualities, but more often it is an economical advantage to use a wood that is relatively cheap in the local market, provided it meets the requirements for serviceableness.

	<i>Advantages</i>	<i>Disadvantages</i>
Soft woods:		
White pine, 2nd quality	Moderate price Excellent floor for carpets Soft for tacks Shrinks little Lies permanently flat	Contains many knots Unattractive in appearance Unsuited for staining Too soft Knots show through
Spruce	Cheap Nearly free from knots White and agreeable in appearance when fresh Soft for tacks Takes stain well	Boards tend to curl at edges, forming ridges Hastens wearing out of carpet Splinters Stain soon wears off
Hard woods:		
North Carolina pine	Cheap as spruce Can be kept fairly polished with wax Possible to select boards which do not show sapwood	Shows sapwood, which injures appearance Does not take carpet tacks
Georgia pine	Next above North Carolina pine in hardness and cost Takes good polish with wax Must use rift boards	Grain monotonous if "rift boards" If of slashed boards, apt to splinter
Maple	Tough Whiteness desirable in parquetry or oiled floors to make the pattern	Boards acquire bluish tinge at ends Not often used for entire floor in home Boards must be cut narrow— 2½" or 2"
Ash	May be used for stairs that are to be covered, and for doors and door frames May make a good floor that is to be covered	Unsuited for severe wear Annual rings do not adhere, and floor slivers in places where wear comes
Birch	Very hard Contains white sapwood enclosing pink heart Very beautiful	Limited market
Oak	Best for floors Varied and agreeable grain Does not sliver	Liable to have knots which shrink and work loose Much waste in laying a floor

Fancy woods like cherry, mahogany, beech, walnut, and redwood are used only where one may pay large prices. Cherry often is used with or as mahogany, and usually takes the curved or bent lines of chair backs and arms. Mahogany is not pliable enough to form curves.

The mode of sawing and the part of the log used have much to do with the wearing qualities of wood, especially that used for floors. The young, immature, or sapwood is usually separated from good lumber, as it is soft and filled with much organic matter

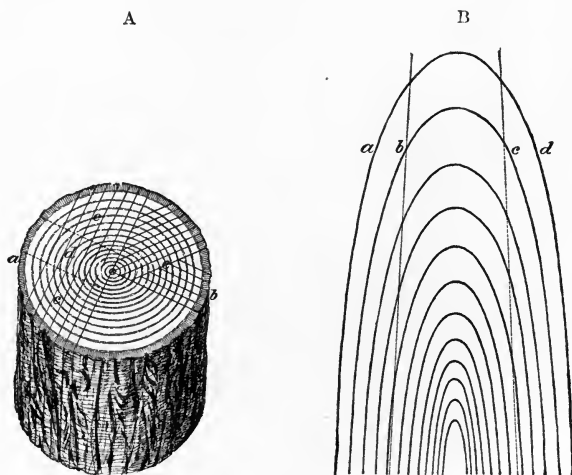

FIG. 97.—Mode of sawing wood produces different type boards. A, cutting a log; B, showing layers. From Parloa's *Home Economics*, Century Co.

that easily decays. The mature or heart wood is a darker, harder wood, with a very close grain; its organic material is in such small amounts that the chance for decay is eliminated.

This heart wood is sawed, and according to the method or the place from which the boards are sawed, we have first, rift or comb, second, slash or bastard wood. The log is cut according to the drawing (Fig. 97). In this way one or two broad boards are cut—A-a; then the log is cut and cut again, giving such boards as c and e, which will have the long annual layers or rings called rift; d will give short annual rings called slash. The wood is all cut across the grain as B shows. Slash wood slivers and so is bad for floors

as it would soon splinter; if used, it should be covered. The quartered or comb grain wood gives a board that is smooth and wears well. Boards shrink in width and depth, but rarely in length. They should be thoroughly dried so as to be permanent in size and shape, and so prevent the chance of warping and forming cracks.

Floor boards are usually tongue and grooved, or "matched" lumber, so that they make tight joints, and if well seasoned, will be lasting. Maple is most used for floors that are to be washed much and have hard wear like school rooms. Yellow pine or resinous woods resist decay, because the rosin prevents moisture soaking into the wood. Such a wood makes a good kitchen or laundry floor, if wood is to be chosen. Wood is resilient, but unless oiled or covered will soak moisture and grease. For the work quarters of the house the standard should be to have the floor easily cleaned, easy of tread, and non-absorbent to moisture and grease.

For the recreation and rest part of the house, wood flooring is most commonly used, and this plain laid wooden floor or the pine, maple, or oak may be stained or made into a pattern, or a so-called parquetry floor. Any of the woods may be oiled, waxed, or varnished, with or without a stain.

Waxed, Oiled, or Varnished Wood.—A wooden floor is the least expensive, hence most often found, in a house. A wooden floor may be *oiled* with warmed paraffine or linseed oil. The warmed oil will penetrate the wood and oil it so thoroughly that future grease spots are less likely to be made.

Oil and color together may be applied by a color dye. Whether plain oil or oil stain is used the object is to get the oil into the wood. The first coat will probably all go in so that in a few hours there will be almost nothing to wipe off. Several coats of oil on the stained floor will give a good finish, each coat making the floor darker than the first. Oiled hard-wood floors give good service with the exception of the care needed to keep them clean. Use light oils, like lemon or paraffin, very thin, and rub off every bit that has not been absorbed before it has had time to gather dust.

A *varnished* or *shellaced* floor is very glossy and unless the varnish is of excellent quality (free from rosin) and put on in thin layers, the service life is very short.

Waxed floors are most satisfactory for living rooms and general rest and recreation quarters so far as appearance is concerned, but

waxed floors must have care. Water leaves a dark spot on a waxed floor, and oil causes it to grow sticky. The best care is to keep it free from dust and water, and to rub it with a heavy polishing brush, usually weighted. Such a brush may be bought for the purpose; or sometimes carpet is fastened to the feet and the feet scuffed over the floor. The weight of the body increases the ease of producing the polish. (See chapter on Cleaning and Renovation, page 292.)

Whatever the floor, be sure to have it very smooth so that it

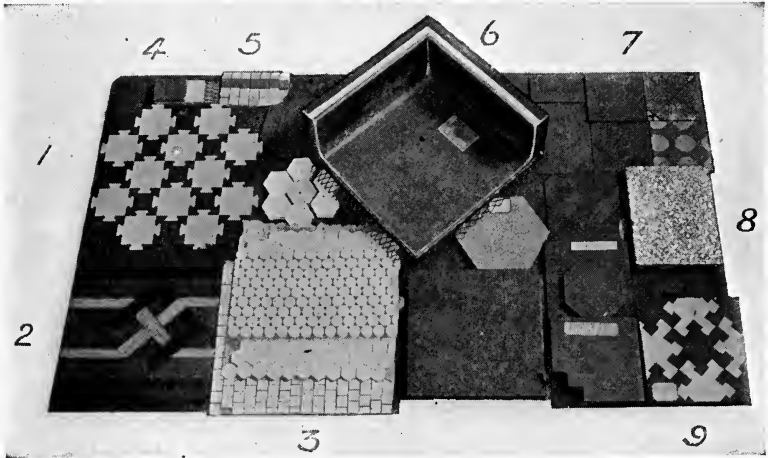

FIG. 98.—Types of flooring. 1, Interlocking rubber; 2, parquetry floor; 3, tile; 4, asbestolith; 5, colored tiles for borders; 6, marbleloid with sanitary base; 7, linoleums; 8, terrazzo; 9, dreadnaught.

will be easily cleaned. Curved baseboards in the tile, or special mouldings set in as a joining between walls and floors (Fig. 98), make a room not only easily cleaned, but more likely to prohibit vermin. Types of floorings are shown in Fig. 98.

Tile or Composition Floors.—Tile makes the most sanitary floor, but unfortunately not the easiest of tread, for it lacks resiliency. A floor which is easy of tread is said to have resiliency, *i.e.*, it gives the walker an impetus forward—as linoleum, cork carpet, interlocking rubber, or some of the composition floors which are spread with a trowel or laid in sections. These floors often represent tile, and may be bought in different colors and patterns. Curved baseboards are possible with all these floors.

Actual tile, if used, is most suitable for laundry, kitchen, and bathroom floors. Small many-sided tile usually gives the best service as there are more edges for contact with the adjoining tile and hence greater adhesion. Round and square tile are more likely to loosen, and the tile with a large surface is less likely to withstand heavy wear, as, for example, in delivery entries where trucking and delivery of heavy barrels and boxes are factors.

Heavy rough tiles like vitrified bricks are often well chosen for porch floors and vestibules. They present a sturdy "outdoor" atmosphere and their rough finish adds to their attractiveness.

Linoleum.—Linoleum is a material of cork composition which may be purchased at a great range of prices and in a correspondingly great variety of quality. A thin linoleum called oilcloth is the cheapest quality. The pattern is put on like a stencil, stamped on the surface, and naturally the wear soon causes the pattern to rub off, leaving only the cloth foundation. Varnish will help keep this cloth in good condition, but only in a small degree. Such linoleum would need at least three coats of varnish in a year.

The linoleum that has the pattern and color all through its depth is built up in blocks and pressed together. Naturally the color lasts as long as the linoleum lasts. These come in medium standard grades, and also in heavier grades known as "cork carpet" which is cork color, and "battleship linoleum" which is usually a plain dark brown. These two heavier grades cost more than standard weight linoleum, and this cost may be unnecessary for the lighter service of the small house; they are used in institutions where the wear is heavy.

The laying of a linoleum is almost more important than the difference in quality of the middle grades (Fig. 99). It should be most carefully measured and cut to fit the floor. Two weeks lying on the floor without tacking will give it time to stretch, and then it may be refitted and fastened down. The strips of linoleum are sealed together with a sealing cement, and the edges are sealed to the baseboard. Usually this is all that is done; but the housewife would find that the small extra cost, 15 to 25 cents per square yard, of having the whole piece of linoleum entirely sealed to the floor, would mean securing an almost permanent floor. The object of sealing is that no water can possibly get to the underside of the linoleum to water-soak it, causing it to swell and buckle. Linoleum, after it is laid, may be waxed like a wooden floor, and then the

pores will be closed, making it resist water. Medium-priced linoleum, waxed, and sealed to the floor, will give excellent service and has resiliency to give comfort to the worker. It makes the most satisfactory kitchen floor.

Kitchen Floors.—The kitchen floor should be easy of tread and impervious to moisture and grease. The materials most impervious to moisture and grease are not always resilient or easy for the worker's feet.

Such a floor as seems easiest for the worker may be obtained by using yellow pine or oak which is oiled for a finish; white pine or spruce covered with linoleum in its various forms; or some of the composition materials which are soft enough to have spring and still be close grained enough to resist soil as well as moisture and grease. These latter floors are spread on top of a board floor, and, if well chosen, this is one way to make over an old floor which may still be good enough to serve as a foundation.

If wood is used, it should be hard, close grained and closely laid. If an old floor, it should be planed smooth, as splinters are dangerous and a hindrance in any cleaning process. In old houses where the wood is so hard that planing is hard work and consequently expensive, it will be cheaper to make it as level as possible by planing a bit here and there and then covering the whole with medium quality linoleum. (See page 157.)

Oiling a wooden floor makes it less likely to show grease spots. Often, in order to cover old spots, an oil stain, such as may be purchased, or a potassium permanganate dye (page 281) may be put on over the floor. Apply with a paint brush. Either will sink into the wood and be lasting in proportion as the wood is hard or soft—a soft wood soaks much more easily and thoroughly than a hardwood.

To oil—use a warmed linseed oil and apply with a paint brush. Allow the oil time to soak into the wood and finally wipe off the oil that remains on the surface. If this is not done the floor will be slippery and will soon hold so much dust that the whole will be gummy with dirt.

A waxed floor is not so satisfactory for a kitchen floor, especially if much cooking is to be done. Waxed floors cannot be wet or washed, and for that reason seem less suitable for the kitchen. Every housewife feels that it is necessary to wash the kitchen floor

Ingrain

Brussels

Axminster

Wiltons

Oriental

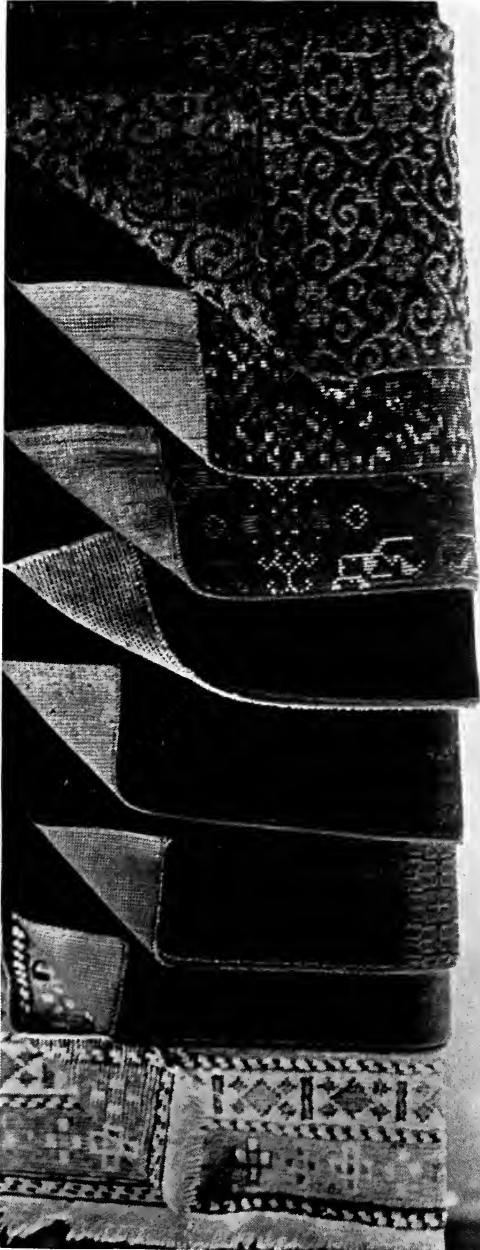

FIG. 100.—Samples of carpeting.



at times because of chance grease spots and soil. (See waxed floors, page 155.)

A varnished floor would give greater satisfaction than the waxed floor, but neither will give the service of an oiled floor or a floor covered with linoleum.

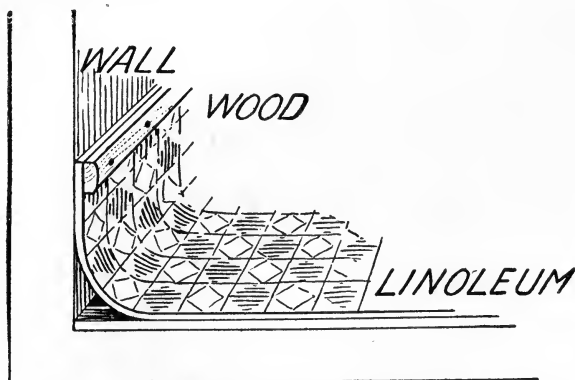

FIG. 99.—Proper wall attachment for linoleum floor covering.

Rugs and Carpets.—These differ from each other only in size, because the material is the same. The study of sanitation and efficiency has made a carpet unusual in the average home, since rugs are much more easily cleaned and handled. Carpets have been cut up into small squares called druggets, or have been stripped into rugs in about the reverse proportion that housekeepers used to buy strips of carpeting and sew them together into carpets. Some ingrain and brussels carpets have been stripped, fringed, and re-woven like rag rugs, except that the nap in weaving has been forced up. All this has been by way of getting rugs into the house to replace carpets.

The essential economic requirements of a floor covering are that it be durable, easily cleaned, and substantial enough to lie flat on the floor. The artistic requirements are good color and pattern and that the rug harmonize with the room. The rug should be the foundation of the room, and the color and pattern may be said to contribute to a harmonious whole when neither are so pronounced as to be the all-controlling factor in the design of the room. Types of rugs are shown on pages 159–165.

As to the size of a single rug for a room, a good general rule

to use for measuring is that the rug come up well to the fireplace, if there is one, and that the margin on opposite sides of the room be equal. A rug 9 x 12 feet looks best with a floor margin 12 to 15 inches, and a larger rug better with an 18-inch margin. If several small rugs are to be used, in various sizes, and arranged about the room to cover the main unit spaces, the lines of the rugs will usually best follow the lines of the room.

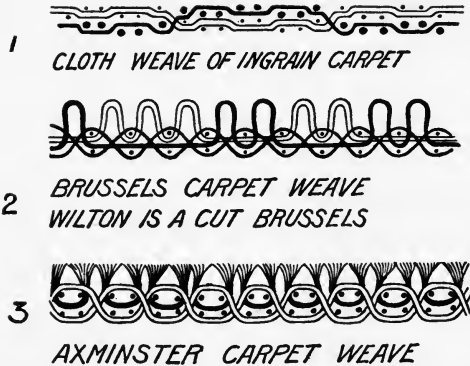

FIG. 101.—Diagram showing weaves of the different types of carpeting. 1, Cloth weave of Ingrain carpet; 2, Brussels carpet (Wilton is a cut Brussels); 3, Axminster carpet weave.

Rugs are classified according to the weave, as ingrain, pile, and tufted.

Ingrain (Fig. 101 (1)) is woven cloth fashion, with a warp and woof, and, like cloth, is reversible both as to finish and colors: that is, it may be used either side up.

Pile carpeting includes Brussels and Wiltons.

Brussels (Fig. 101 (2)) has only one usable side. It has a pile like velvet, but the pile is uncut. Its weave is like Wilton; that is, it consists of a locked stitch in which one thread is woven over the next, thereby locking and holding better. The woolen thread which constitutes the pile is looped in the warp, and held in loops during the weaving by stretched wires. When the fabric is about to be finished, the wires are drawn out, and the loops thus left constitute the pile. Brussels is only a middle grade carpet, both as to looks and to wear. But "body brussels" is better than "tapestry brussels," as the latter has much sizing and would have to be dry-cleaned rather than steam-cleaned.

Wilton is a heavy, more velvety, and more durable carpet or rug than Brussels. It is made with a pile like Brussels, but the pile is cut when it is finished and steamed, whereupon it appears like velvet. Wilton is especially good for living rooms; lay it with the pile against the light as with Oriental rugs. French Wiltons have cotton backs, and are usually woven in Oriental colors and patterns. Royal Wilton is a trade name for a cheaper quality. Wilton Velvet is a cheaper-grade rug, which is better in figures than in plain colors. Hartford Saxony is a Wilton with a longer nap, but not so serviceable, because the nap may be pulled out. Saxony is best in Chinese patterns; there is only one grade. Because Wiltons are so closely woven, they hold dust on their surface. For limited incomes the French Wilton is the best, as it gives the longest and most satisfactory service.

Tufted.—The third kind of carpeting is the tufted kind. It is of the nature of the old-fashioned hooked rugs, where the filling is woven in in tufts. This group includes Axminster, Chenille, Oriental rugs, and carpets.

Axminster (Fig. 101 (3)) is cheaper than a Wilton and less serviceable, as the tufts easily loosen. Much lint comes from the rug. Cotton Axminster is not reversible.

Chenille is of the tufted type, and is like Axminster in appearance and like Wilton in weave. It is the most expensive of domestic or European carpeting. It is more like an Oriental rug but not so adapted to hard wear, although it is often used to save costly Orientals. The cost of Chenille is determined by the depth of the pile and richness of color. Cotton Chenilles are reversible and washable, and are used for bathrooms.

Oriental rugs are hand-tufted, made by stretching the warp thread in a frame, and then looping in short or long lengths of wool filling (Fig. 102). Before finishing, the rugs are sheared to make the filling even. For tufted rugs, the most economical from the cleaning point of view are those that are sheared so the threads are not too long (Figs. 103, 104).

Hemp and Grass Rugs.—Various kinds of hemp and grass rugs, woven or braided, are much used for living rooms, sun parlors, and on porches. Because they are light, cool looking, and easily lifted to be cleaned, they are much used for summer homes, and where the income demands something inexpensive.

Rag Rugs.—Two other types of rugs are made by braiding strips of cloth and sewing the braided strips together, or by weaving strips of cloth as a woof in the warp thread. Denims and cretonnes are most effective for this work. Either of these materials, or strips of ticking or silk, may be hooked into burlap or crocheted into rugs.

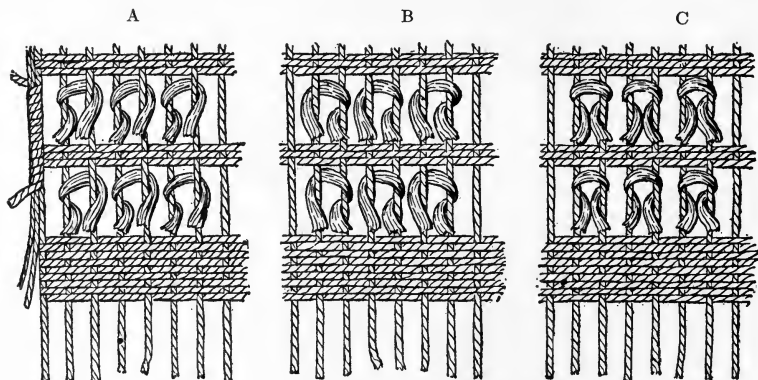

FIG. 102.—Diagram of Oriental rug weave. A, Persian—knots—right twist; B, Persian—knots—left twist; C, Turkish—knots—center twist. Courtesy of *Country Life in America*.

Other rug materials (Fig. 105), such as flax, jute, and wicking, are also used to produce variety and various degrees of cheaper rugs.

Comparative values of rugs and carpets are shown by the following table, though of course prices may vary greatly.

Kind	Carpet	Price	Rug	Price
	<i>Width</i>			
Flax, grass	3x6 ft.	\$1.56
Rag, woven	3x6 ft.	\$1.50-9.00
Rag, braided, oval	4x7 ft.	\$7.75
Ingrain, plain wool	1 yd.	\$1.45
figured	1 yd.	1.60
Body Brussels	1 yd.	3.00
		4.00
Wilton	1 yd.	3-5.00	3x5¼ ft.	20.00
Hartford Saxony	1 yd.	6-8.00	3x5¼ ft.	20.00
Axminster	1 yd.	2-4.00	3x5¼ ft.	7.50
Chenille, linen back	1 yd.	8.95
wool back	only wide widths	14.00	3x5¼ ft.	44.00

NOTE—Oriental not usually made in standard sizes; prices range from \$25 for a very small one to \$3,000 and \$4,000 for larger ones.

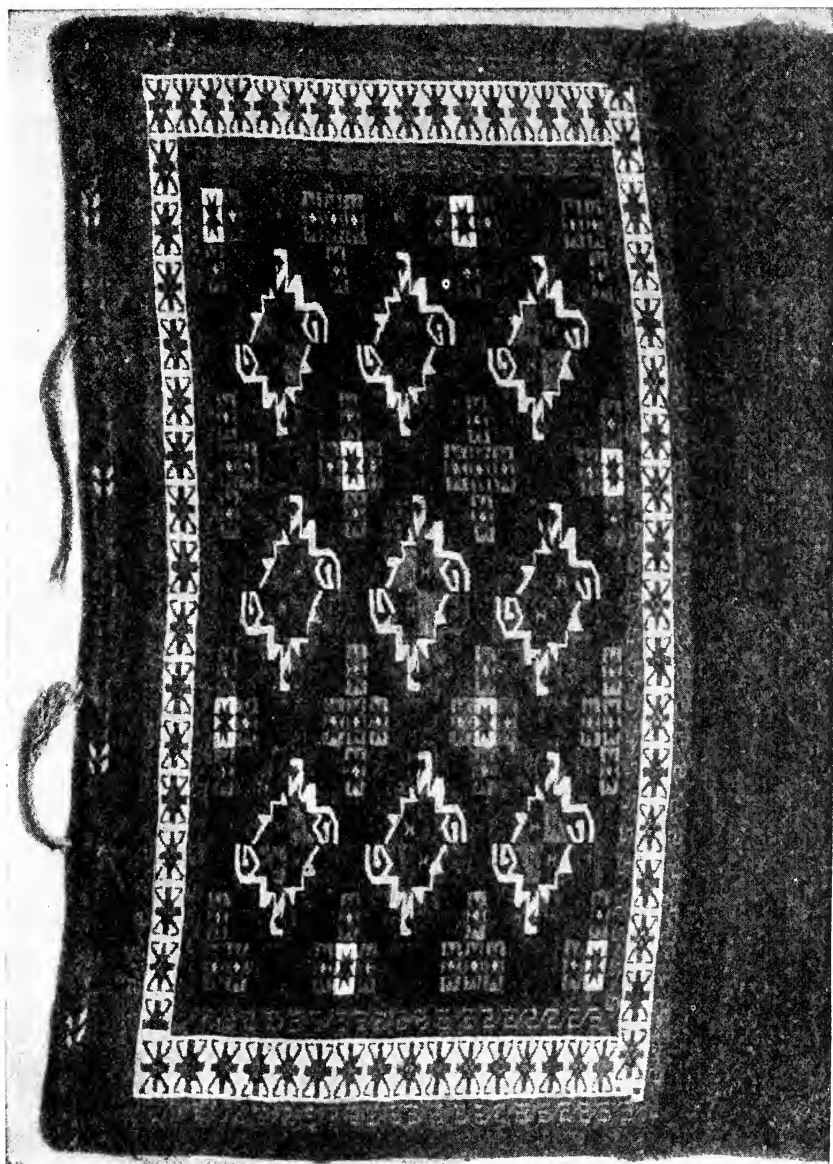

Property of Mr. J. M. Stanton, Auburn, N. Y.

FIG. 103.—Bokhara camel bag half. Size 4' × 2'10".

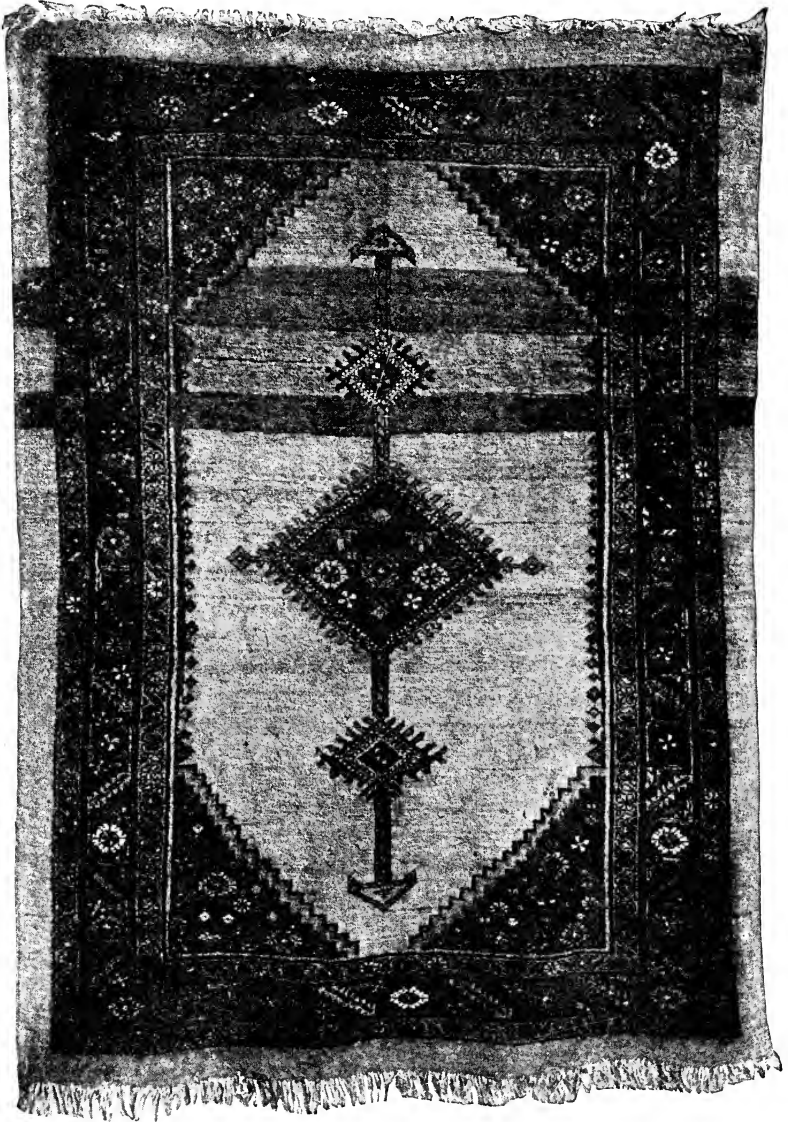

Property of Mr. A. U. Dilley.

FIG. 104.—Hamadan rug.

DRAPERIES AND CURTAINS

Draperies introduce warmth, cheer, and a contrasting touch of color into a room, and are often used to shield or close a room, door, or window. The heavy velours, plushes, velvets, and brocades furnish soft folds which give artistic effects of light and shadow; but they are high priced, hard to keep free from dust, and expensive

Klearflax.

Rag.

Coco matting.

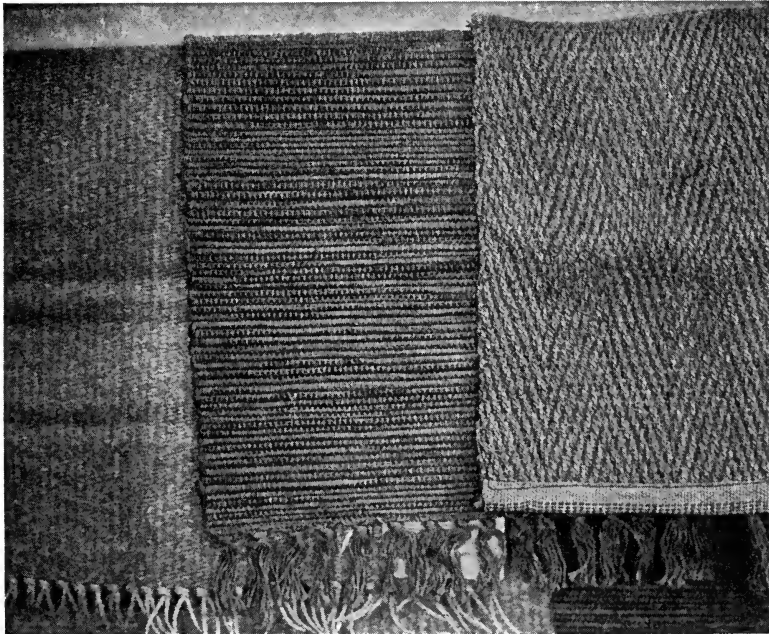

FIG. 105.—Cloth woven, heavy rugs, inexpensive.

to clean. They need to be lined with a soft fabric of harmonizing color, as their backs are usually cotton and not attractive. The two thicknesses of material, however, which have different possibilities of cleaning, add to the cost of renewal and often keep the curtains from being as clean as they should.

The universal attention to economy and sanitation has resulted in a supply of suitable and artistic draperies which are washable,



FIG. 106.—Cretonnes are effective for curtains and upholstery.

non-fading, and of such a nature as to resist dust. Cretonnes (Fig. 106), denims, sunfast (Fig. 107), and various silk and wool fabrics meet this requirement. Often a plain or solid color as a lining introduces a richness of tone, provided it harmonizes with the drapery material, and furnishes a lining which increases the weight and excludes the light.

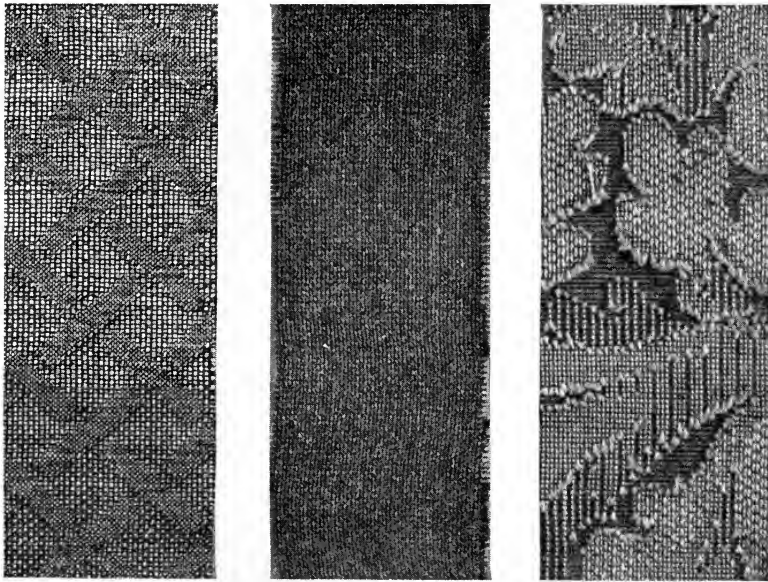

FIG. 107.—Sunfast fabrics—serviceable because of fast colors.

If strict economy must be practised, select a pattern that repeats so often as to prevent much waste in cutting lengths and matching patterns. Ups and downs, and rights and lefts, in patterns cut to poor advantage, as do large patterns which spread over large space before repeating. Usually plain hangings are best (Fig. 108), but if rugs and paper are plain, a figured hanging introduces light and contrast.

Dining-room and bedroom draperies should be washable and light weight so as to be easily shaken and aired. This is necessary

for rooms that play such a direct part in the life of the individual.

The range of material used is very extensive, including, in the order of cost, the following:

<i>Drapery Materials</i>	<i>Per yard</i>
Cotton fabrics, like crash	\$.35
Sunfast75 to \$1.00
Cretonnes25 to 1.50
Linen40 to .65
Poplins, monks' cloth50 to 1.50
Denims45 to .75
Velours	3.00 to 6.00
Velvets and plushes	3.00 to 5.00

Curtains.—Curtains have gone through the same changes as the heavy draperies. They are shorter, lighter in weight and pattern, and, if the housekeeper desires, she can find filmy pretty patterns which will shield the room from the passerby, but will not “bar” the window and shut out the light, sun, and air. Most of these materials (Fig. 109) are easily renewed by washing in the home, and the cost of renewal either in time or money is not so great but that the curtains may be fresh and crisp. The housekeeper will often find suitable for curtain use dress materials like voiles, crêpe, or dotted swiss that are of finer weave and prove much cheaper than the regular curtain materials which are sold at the drapery counter. About one-half inch to one inch should be allowed on each yard of washable material for shrinkage. Braid or gimp shrinks even more, so should be put on full enough to allow for this. If one has good facilities for laundering the material, it would be most practical to shrink the whole piece before cutting into curtain lengths. Besides allowing for shrinkage, if the material has an up and down or a large pattern, enough must be purchased to allow for matching designs.

The following relative prices may be of service in considering the cost of draping the windows:

Curtain Materials	Width	Price per yard
Cheese cloth.....	36 in.	\$0.10 to \$0.20
Dimities and lawns.....	27-32 in.	.20 to .75
Scrim, voile, marquissette, swiss ...	36-45 in.	.20 to .55
Organdy, Brussels net, filet.....	45-54 in.	.45 to 1.00

A

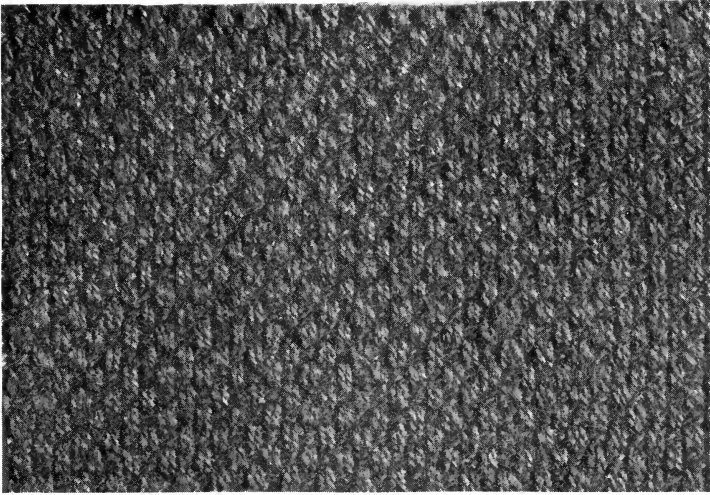

B

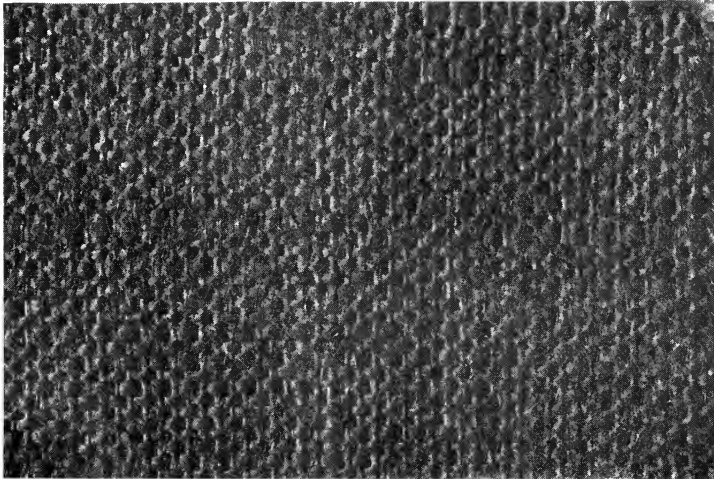

FIG. 108.—Cotton draperies and upholsteries. *A*, Burlap; *B*, Monk's cloth.



Hangers for Draperies and Curtains.—Wooden poles, brass rods, and wooden cornices support the curtains and draperies. Wooden poles are cut to fit, but for small windows the brass rods may be the adjustable extension type. This is not good if the length of the rod is over three feet as the weight of material will cause a long rod to sag. In this case have a solid metal rod cut the proper length; this may be either a brass rod, or a less expensive metal rod with a brass covering.

Wooden rods, 12 cents per foot; ends, 30 cents per pair.

Brass rods, 28 cents—75 cents per foot; ends, 50 cents per pair.

Goose neck rods, 40 cents per pair, single; 60 cents per pair, double.

Wooden rings, 50 cents per dozen.

For portieres and curtains that are to be drawn often, as in closing an archway or in drawing heavier curtains in the place of using window shades, one will find that a double cord and pulley fixture makes the drawing of the curtain most easy. Its cost for a five-foot window is about \$3.25.

Window Shades.—While the window shades are bought solely for protection from the outside, and to shade the inside from light, it will be a great saving to pay more at the beginning for a good linen one rather than buy a cheap starched cotton one. A "Holland" shade means a linen shade which can be sponged off with soapy water and wiped dry. The cheaper filled or starched shades will crack, and, if sponged, must be handled most carefully. There are also shades made in two colors, dark on one side and light on the other. The average width of shades is thirty-eight inches, and the cost is by the yard; it is also governed by the color. Comparative prices of a shade thirty-eight inches wide by two and a quarter yards long in various materials are as follows: linen (green), \$2.75; Holland (green), \$3.00; two-color shades, \$2.25.

Window Screens for Flies.—Copper screen is best, but very expensive; galvanized is next best, ungalvanized will rust out very quickly. Cotton netting of smallest mesh—14 threads to the inch—will serve well, but lasts only one season; use black netting. Screen the fireplace also.

Window Ventilators.—These help so much in keeping a room in good condition that every housekeeper should find out which one suits her needs best. A board about four inches wide and as long as the window, is possible for everyone. It is set in the

window frame, and the lower sash is brought down to meet it, thus causing a displacement of the sashes in the middle so that fresh air creeps in so gradually as to cause no one annoyance from drafts. Various patented ventilators are sold, and many have special advantages. One is made of cloth put on an extension frame like a fly screen, which filters the air; another is of glass, which may be set at two different angles from the window, and has the advantage of not shutting off the view. Other metal ones have slides, or flue-like pipes, and some have only holes by means of which air can work its way between two sets of uprights. With the ventilator problem should be considered the electric fan. (See Miscellaneous Equipment, page 128.)

FURNITURE

Furniture should be chosen for the home after certain fundamental principles have been considered. Its suitability as to size and shape; as to weight; and as to appearance, comfort and use; the style and the service each style may have to give; the cost and the possibility of renovation—all these must be taken into account.

Selection.—Size, in relation to the space in the room, must be considered. Very large pieces not only overcrowd a small room, but if they are also massive in appearance they seem to dwarf every thing else. They are hard to move, and so make cleaning difficult.

Shape.—The drawers in a piece of furniture should not be wider than three feet, nor deeper than eight inches, as a drawer larger than this is hard to manipulate and offers a temptation to over-crowding, making it too heavy to pull easily.

Service.—In choosing any article of furniture, measure its return in storage space, and in usefulness, against the space it consumes in the room. A library table whose top surface is its only usable portion, consumes more actual space than one with a lower shelf, and underhung book shelves, for instance. A serving table that combines the function of cupboard with an extra service-leaf saves the space of the extra article.

Woods used are likely to be oak, walnut, mahogany, with birch as a frequent substitute for the latter. Maple is occasionally chosen for bedroom furniture.

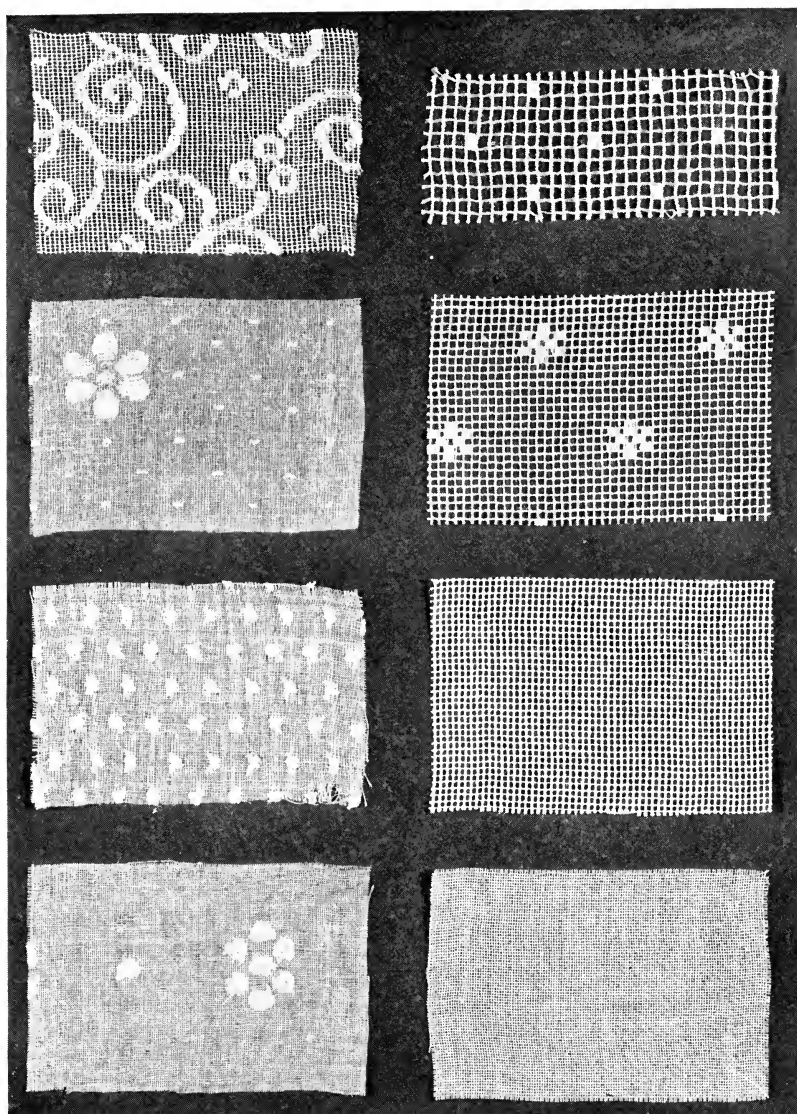
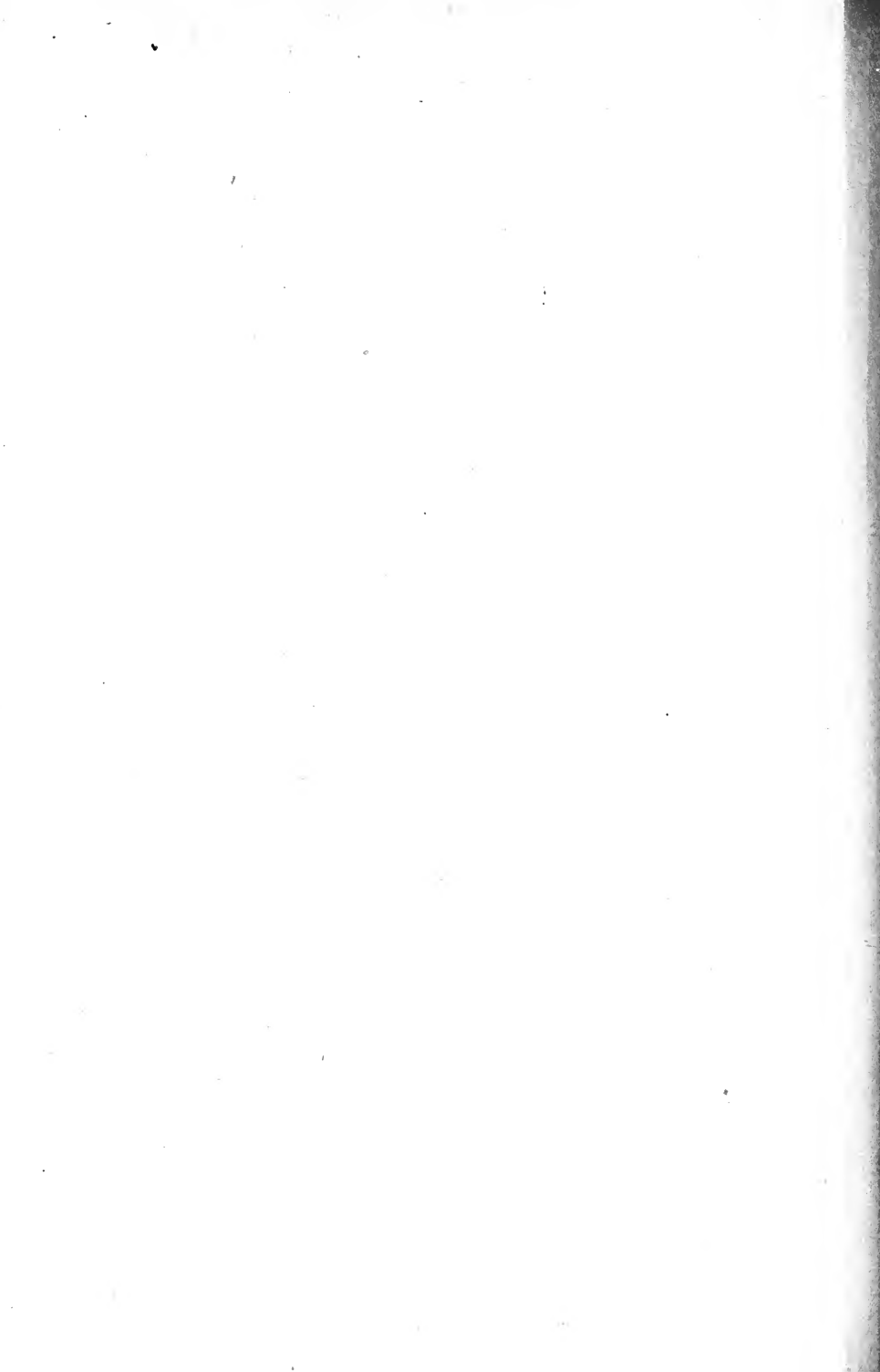

FIG. 109.—Washable curtain materials.



Oak is very satisfactory wood, of pleasing grain and texture, very durable, and capable of taking many different finishes. It is quite yellow in tone unless stained or "fumed" (treated with ammonia fumes to darken it) but it can be colored almost any shade, from greens, browns and even black. The highly varnished, shiny "golden oak" finish, has been replaced by the dull lustre of the waxed or oiled surface, which preserves the wood itself and prevents scratches from showing.

Walnut is the most beautiful native cabinet wood and has lost prestige because of the horrible style of the period in which it was most popular. It has a beautiful color, so rich and dark that it needs no stain, a fine, even, close grain, with very beautiful markings, at roots, and of so true a structure that it is the cabinet-maker's first choice for fine carving or inlay work.

Bird walnut has a grain like exaggerated bird's eye maple, and is used for veneer and panelling.

Mahogany is used for most expensive furniture, even though to many experts it has not as great beauty as walnut. It is all imported, and the choice "crotch" pieces, where the trunk leaves the roots, and where it starts to branch, are reserved for veneering. It has a fine, close, strongly marked grain, and before staining is about the color of native cherry wood. The better furniture-makers to-day are using a dark brown stain to tone its color, rather than the strong red which prevailed for so many years. In many pieces of furniture, back and sides, or unexposed parts, are made of birch, stained, and only the prominent surfaces are of mahogany. The grain and texture of birch make it an excellent substitute, but unfortunately, this substitution has led to our disregarding birch as a cabinet wood for its own sake. With all of these latter woods, as with oak, the finish to-day is a dull, waxed surface that does not reflect ugly glaring lights from every angle.

Construction of the piece is very important. It should be stoutly built with simple lines that give strength, and braces that reinforce points of natural strain, like the joining of seat and back in a chair, the joining of body and leg-posts in a cabinet, bureau, or any of the drawer-pieces. It should be arranged so as to give maximum convenience in use; it should set absolutely firm and solid

on a plane surface; it should give a clear space of at least five inches between its bottom line and the floor, for ease of cleaning. Any drawers should run smoothly on their tracks, and should be built with the sides dovetailed to the front, not nailed or glued. A protecting board completely closing or "sealing" the drawer-space makes them dustproof. Even inexpensive prices may be simple in line, harmonious in proportion, free from so-called decoration and finished in such a way that they will harmonize with any scheme of furnishing.

Style.—The lady's desk, set on four spindle legs, and with no space for keeping letters, records, or supplies, has no justification of beauty or utility. A plain, firm, flat top office desk will give double the satisfaction.

For a *bureau* it is a good plan to buy a plain chest of drawers, and get a separate mirror to hang above it, instead of the regulation dresser, as the chest of drawers can be used in many places where a "bedroom dresser" would be impossible. The modern "four-poster" *bed*, copied from Colonial models, has no excuse for modern reproduction, since bed hangings are ruled out by modern sanitation. Choose instead a bed of simple lines, with low head and footboard, easy to make up, and allowing free circulation of air to the sleeper.

Light Furniture.—With the bungalow and the summer house has come a light weight and light appearing furniture which is comparatively new and may be passing in style. It is made of papier-maché, twisted in cords and woven on frames; of grass fibre, twisted or braided and woven on frames; or of cretonnes braided and woven on frames.

Then there are more substantial types; the willow, which is made of the young sprouts woven on wooden frames, and the reed or rattan which is a plant sent from China which is barked here in America.

Willow furniture is made in most attractive types to-day, is strong, sanitary, durable, and harmonizes so well with almost any kind of wood that it fits in beautifully for the odd pieces, such as chairs, that are so often needed. It can be stained or painted to harmonize with any color scheme, and with cretonne as cushions cretonne is often useful in giving just the tone that a room may need.

Hand work, including hand carving, of course costs more than machine work, while real antiques are, of course, often priced very high. The present style is to take old furniture, even fine antiques, and paint them, but mahogany will not be harmed by this as many of the real antiques have been through the stage of the painted style.

Some housewives are informed regarding these differences in style and differences of value, and the woman who is informed is well repaid. If one is not trained, one can but depend upon a reliable store or dealer to get the best for the money to be spent; style controls what she will find at certain times, but let her controlling thought be that in selection, plain lines are the most satisfactory and durable, are always acceptable, and, what is important week in and week out, are the most easily cleaned.

The most noticeable difference in wooden furniture is that some is without upholstering, some is partially upholstered, while the heavy living-room and library furniture is often so entirely upholstered that no wood shows. In this kind of furniture the feet and tips of the arms are of good wood, while the frame upon which the chair is built is simply strong oak or pine.

Springs are well set in all good upholstered furniture, and besides the quality of steel in the spring, one must consider whether there is a sufficient number. For example, three rows of springs in a couch length will give more service than two.

Furniture Coverings.—In choosing the covering, cost, color, and pattern are to be considered, but serviceableness should be included with the other requirements.

Tapestries are usually combined fabrics—cotton and silk, or wool and silk. The real tapestry is all wool except the high lights of the picture, and they are in silk. It is soft in color, rich in tone, but because it is such a large part wool, it needs care to keep it clean and free from moths.

Leather.—Real leather is usually either cowhide or sheep skin. The cowhide is very expensive, but very serviceable, and its service is increased if one will give it frequent rubbings with oil, like linseed, vaseline, or lemon oil. Use a light-colored thin oil, as every dressing will do a bit toward darkening the leather. Sheep skin will peel or flake easily; it is a thinner skin than cowhide. Leather is very expensive; the price is by the whole skin, \$8 to \$30.

Enamel Cloth.—Enamel cloth is only an imitation leather, and,

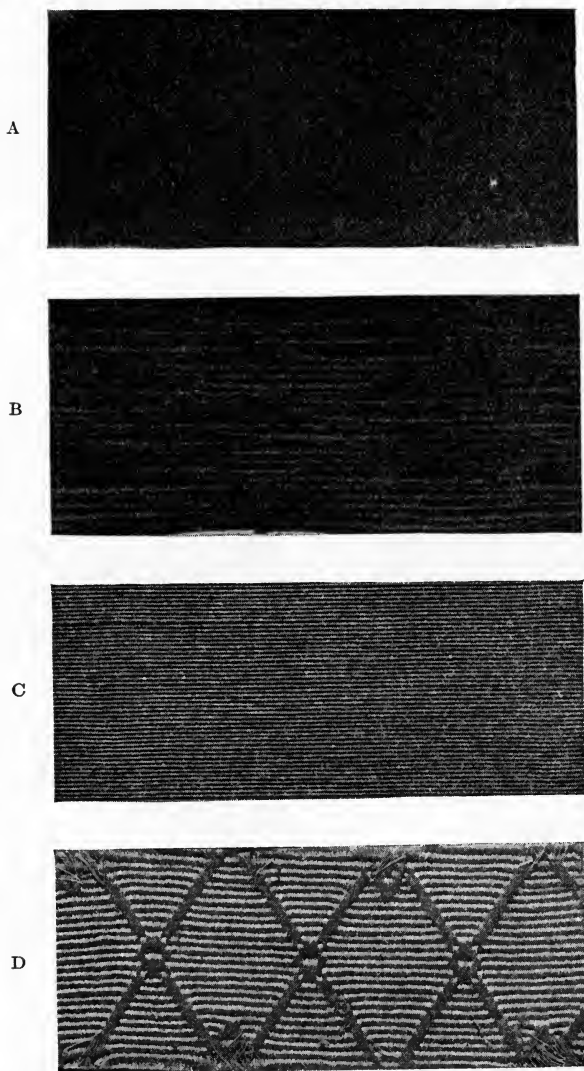

FIG. 110.—Cotton fabrics for draperies and upholstery. *A*, denim; *B*, cotton repp; *C*, poplin; *D*, cotton repp.

A

B

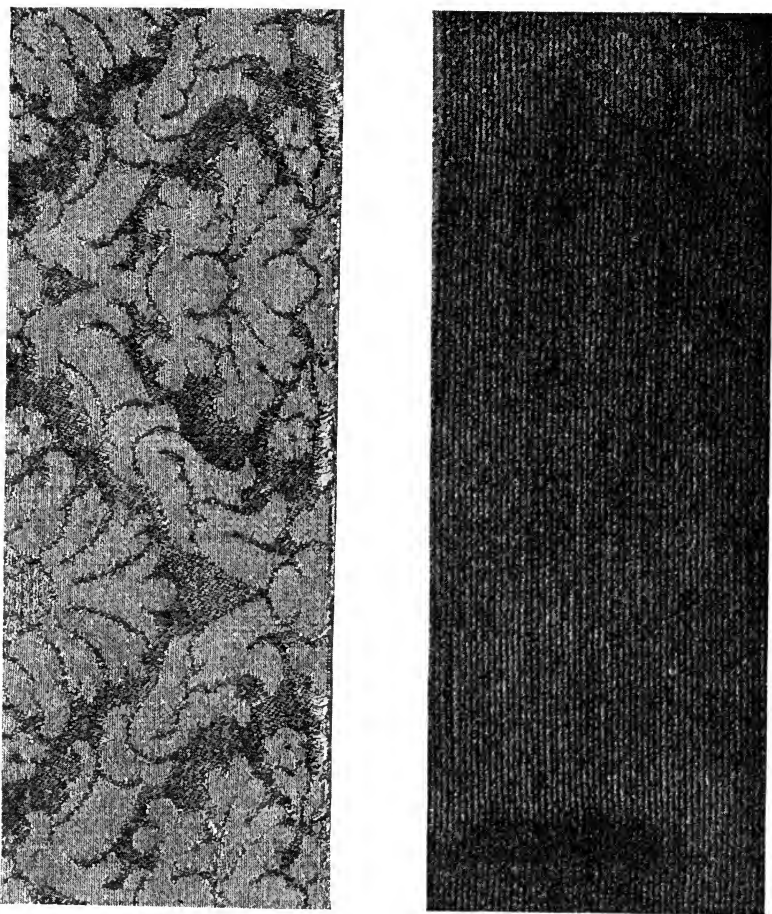

FIG. 111.—Fabrics used for upholstery and draperies. *A*, brocade; *B*, velours.

like patent leather, varies in quality. The soft enamel cloth will probably do less cracking as it will be more pliable to wear and tear.

Mohairs give excellent service and are especially pleasing in the patterns of to-day. The black hair as the warp, and the soft browns

or greens as the wool, produce a soft pretty color effect and warmth that the old-fashioned mohair so sadly lacked.

Repp is a cotton or a wool material woven like pique (Fig. 110) with deep ridges. It is serviceable, more expensive than denim, and because of its weave much richer in appearance.

Denims are inexpensive cotton fabrics, serviceable, easily dusted, but few are proof against fading.

Cretonnes are most attractive in their patterns and colorings, easily cleaned, not expensive for renewal, and most suitable for light decorations.

All kinds of upholstery material may be used for **cushions** (Fig. 111), and these may be filled with such material as excelsior, goat's hair, silk floss, cotton, or curled hair. The curled hair no longer good enough for bed mattresses will make excellent stuffing for upholstery. (See also Mattresses, page 189.)

LINEN

The qualities that make linen so very desirable for many uses are its smooth texture, ability to absorb and give up moisture rapidly, freshness and brilliancy of appearance, ease with which it gives up its soil, and its durability.

Tests for Purity of Linen.—There are so many clever adulterations of linen that it takes an expert to prove that it is not linen, but there are, however, some simple tests for linen which anyone may make:

Test	Method	Results	
		Linen	Cotton
Water.....	Apply a drop to material.	Water spreads and evaporates quickly.	Water acts more slowly.
Burning.....	Apply lighted match to ends of threads.	Burned ends sharp, smooth and even.	Burned ends like a paint brush.
Tearing.....	Tear across the material.	Hard to tear, sharp, shrill sound, edge smooth.	Easy to tear, dull, muffled sound, edge curled.
Glycerine.....	Apply a drop to material.	Forms transparent spot.	Is not absorbed but rolls up like mercury.

Essentials of Table Linen.—The qualities desired in table linen are freshness of appearance, weight of fabric sufficient so that it will lie flat on the table, but a quality at the same time soft and yielding in the folds. To give these qualities the linen must be pure.

In weaving linen the use of a single thread makes a single damask; two threads, a double damask. The double damask weave is the more desirable, and the pattern stands out distinctly, due to the play of light and shade on the threads. There is a distinct fashion in the patterns of table linen, due directly to the demands of the public for alternating styles; there are patterns permanently acceptable, however. Select a small "all-over" pattern rather than a large pattern, with very wide satin stripes, as the long overshot threads which make the large pattern are likely to be pulled or broken in ironing. Beware of over-sizing or starched linen as this is put on to cover up the poor quality of the linen, and disappears in the wash, leaving a flimsy fabric with no wearing qualities. "Union" means half linen and half cotton. It has some of the qualities of linen, but turns gray like cotton.

The firmness of the weave depends upon the number of threads per square inch, which are easily counted with a magnifying glass or weaver's glass. Medium quality linen has 180 warp threads and very fine quality 220 warp threads per square inch. The average weight is four and a half ounces per square yard. Weight and firmness are controlling characteristics—not stiffness. A good quality of single damask is better than a poor quality of double damask.

Linen may be purchased in the natural color (unbleached), silver bleached (quarter, half, and three-quarters bleached) and pure white. The unbleached, of course, has the greatest wearing qualities. The method of bleaching modifies the wearing qualities of the linen to a large degree, the sun and grass bleaching being far less injurious to the fibre than the more modern and rapid chemical bleach.

The linen varies according to its national origin (Fig. 112), Scotch being the cheapest, then Irish, and then French. Scotch linen is not the highest grade, but it gives long wear at a low cost, because it is mostly sun and grass bleached. Irish linen comes in both poorer and higher grades. It is noted for its snowy whiteness, evenness of texture, and beautiful designs; the snowdrop and

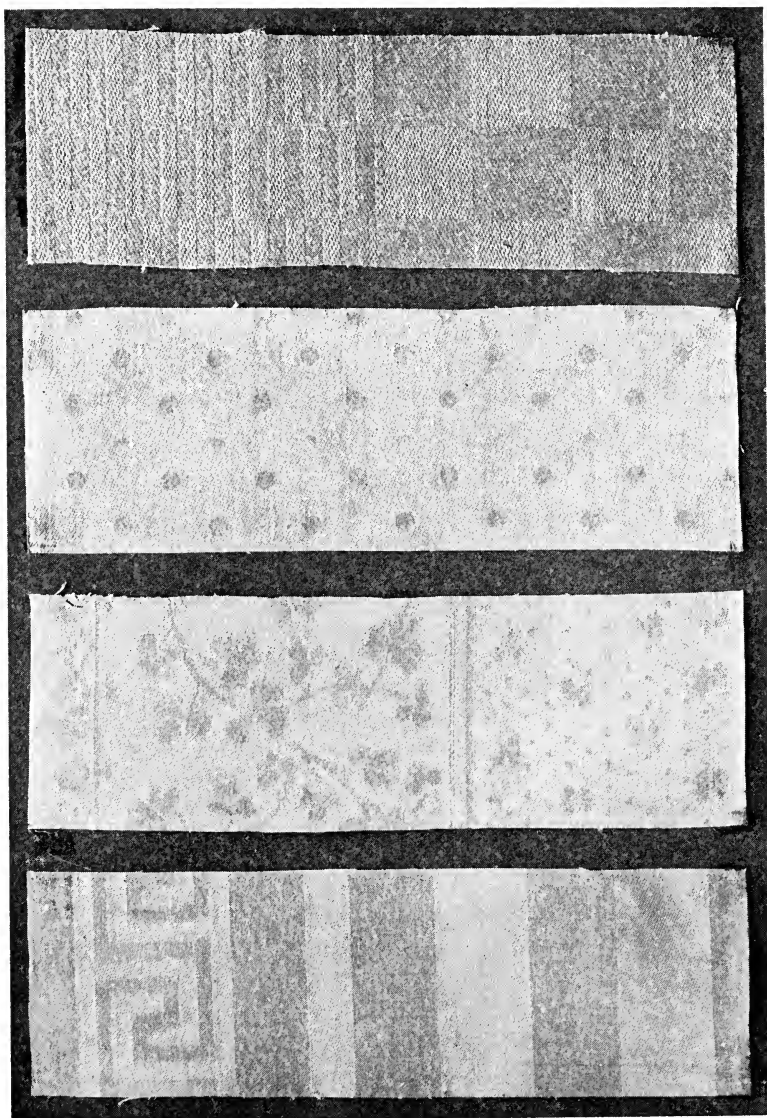

FIG. 112.—Table linens.

shamrock are typical Irish patterns. French linen is made only in the higher grades, and is very expensive, its cost being almost three times that of Scotch. It excels in design and wonderful finish. Belgian linen is highly recommended for its good quality and moderate cost. There is no domestic damask, as America has not developed the linen industry.

Sizes of Table Linen.

Sizes of tablecloths unhemmed:

Width in yards: Length in yards:

1	1 to 1 $\frac{3}{4}$
2	2 to 4
2 $\frac{1}{4}$	2 $\frac{1}{4}$ to 3 $\frac{1}{2}$
2 $\frac{1}{2}$	2 $\frac{1}{2}$ to 8
3	3 to 6
3 $\frac{1}{2}$	3 $\frac{1}{2}$ to 6 $\frac{1}{2}$
1, 2, 4, 5 yard squares for cutting round.	

Hemmed or scalloped tablecloths:

36 in. x 36 in.	(tea cloth)
54 in. x 54 in.	
72 in. x 72 in.	
80 in. x 80 in.	
90 in. x 90 in.	

Sizes of napkins unhemmed:

Breakfast	19 in. to 22 in.
Tea	16 in. to 18 in.
Dinner	24 in. to 32 in.

Size of doilies:

12 in., 14 in., 16 in., 20 in., 24 in.

The prices of table linen are so variable that it is not possible to quote prices with any degree of accuracy. Tablecloths by the yard are the cheapest; a cloth by the yard woven with a border on all sides will cost 50–75 cents more than the same sized cloth without the border. Round cloths come in 1, 2, 4, and 5 yd. squares for cutting, \$2 extra charge is made to hem these cloths.

Napkins.—Allow one dozen to each cloth. If the housekeeper is to have only one handsome set it is wise to allow two dozen napkins to each cloth; the napkins receive harder wear than the cloth.

Towels.—The greatest essential of a towel is that it should be soft, and should absorb moisture rapidly. An all-linen towel best meets these requirements. Huckaback towels (Fig. 113) are most

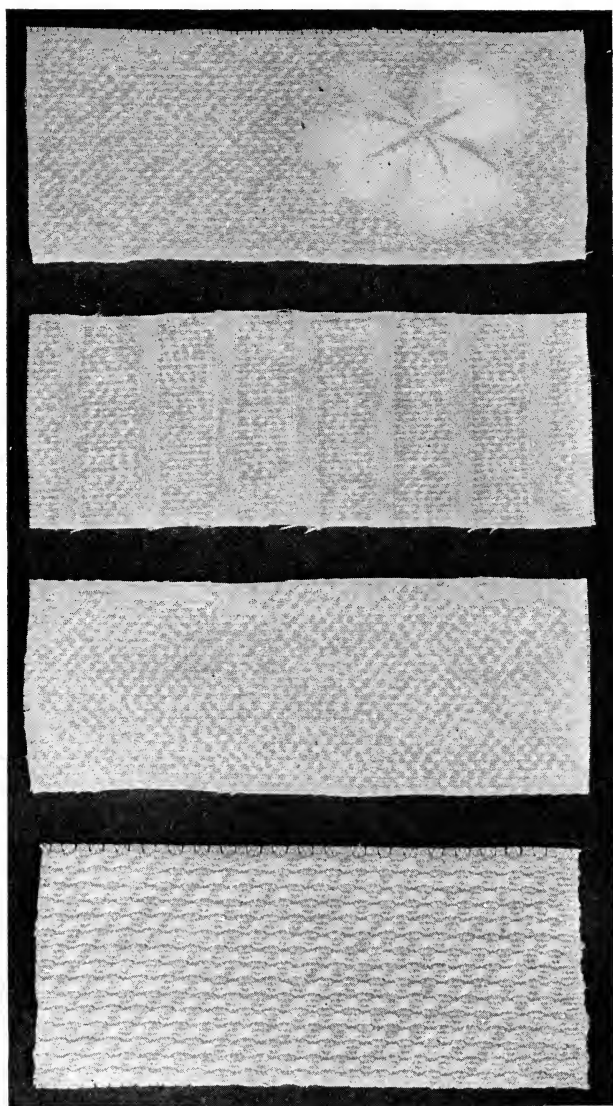

FIG. 113.—Different weaves of huckaback.

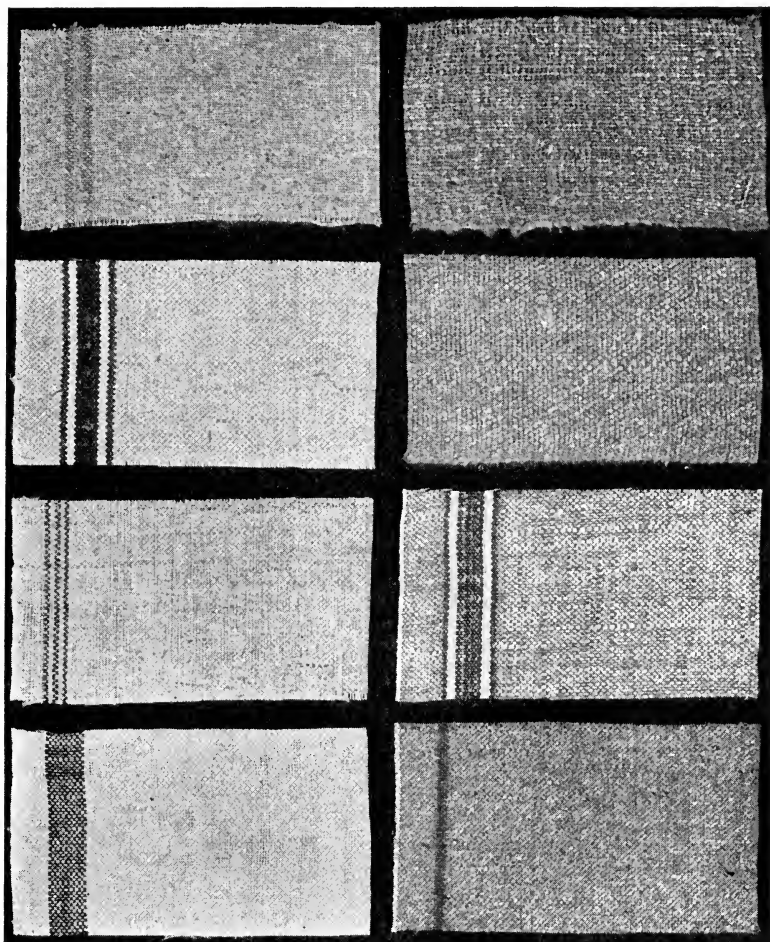

FIG. 114.—Showing different weaves of towelling. Crash towelling used mostly in the kitchen.

used, because their roughness and looseness of weave makes a good surface for absorption. Damask towels are very beautiful, but are not so efficient, as they do not absorb moisture readily.

Cotton or union towels (linen and cotton) are much cheaper,

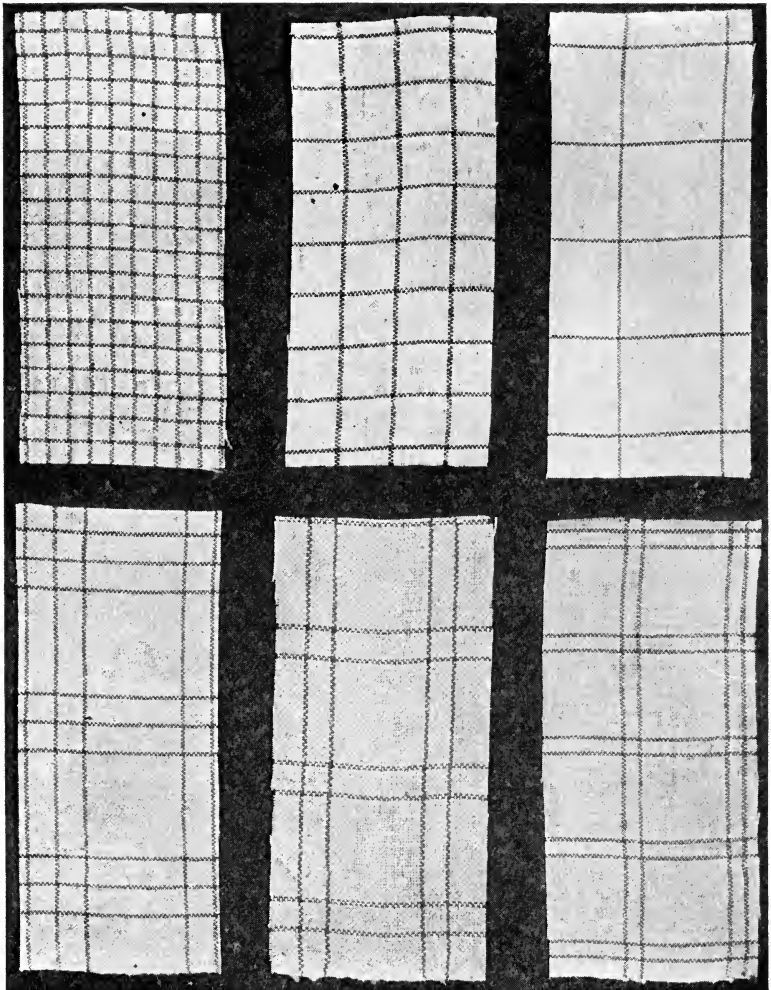

FIG. 115.—Samples of checked towelling, often called glass towelling.

but have two disadvantages: they are less absorbing, and because of the cotton they gray and darken with wear, making them look constantly dirty. Wash cloths and bath towels often illustrate this.

Towel Sizes.—The usual sizes for towels are 14 x 20 and 24 x 45 inches; prices per dozen vary according to the material about as follows: Cotton, \$1.75 to \$2.75; huck, \$5.00 to \$15.00; union, \$3.00 to \$4.50; damask, \$16.00 up.

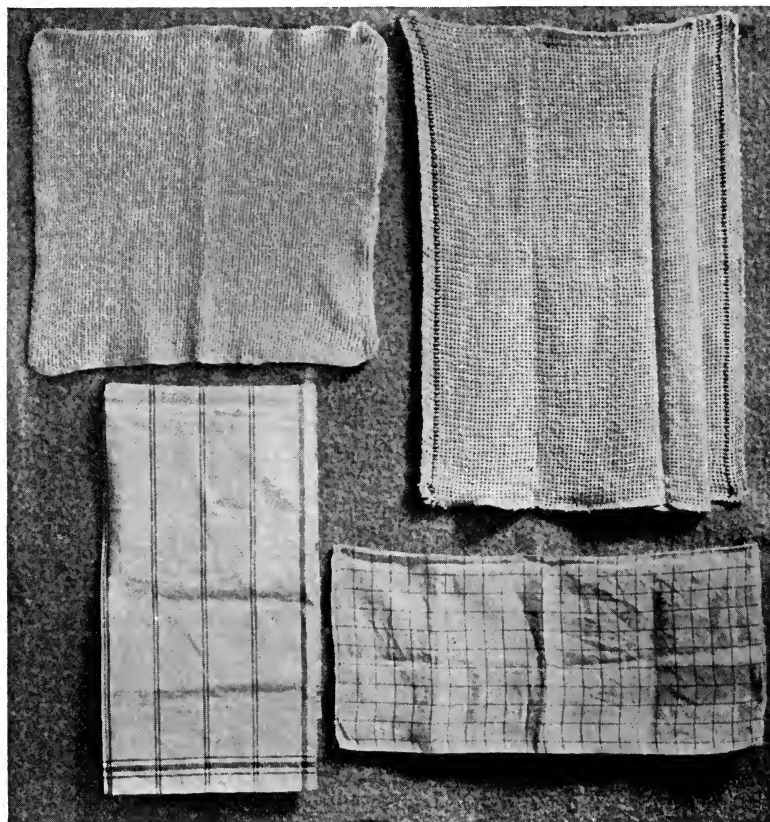

FIG. 116.—A, Dish cloths; B, dish towels.

Kitchen towels are of three types: glass towelling (Fig. 115), for glass and china; crash towelling (Fig. 114), to be used for heavy cooking utensils; and crash towelling, for hand towels. For glass towelling one may best choose a linen fabric, because linen has the

best power of absorption, and because it has no lint. Usually it is checked (Fig. 115); if so, the towelling with red lines or checks will keep the color better than that with blue. Crash towelling is a cheaper, sturdier quality of linen, and is better suited to the rough work such as drying cooking utensils and knives. The towel with the word "dish towel" or "glass towel" woven into it is one of the most expensive, and no better than the plain towels. Hand towels should be of softer weave, and may be bought with a pattern that makes them distinct from other towels in the kitchen. Kitchen towelling varies in width from seventeen to twenty-one inches. The prices range from twelve to eighteen cents for cotton to eighteen to thirty cents for linen. A cheaper linen towel is preferable to a finer cotton one.

Dish cloths and wash cloths should be chosen with a soft, spongy weave, rather rough, but always so spongy as either to hold water or to be easily wrung dry (Fig. 116).

Suggestions to Guide in Buying Linen.—An understanding of the qualities to look for in linen is the first essential of a successful buyer. Always buy linen of a reliable firm and of a salesman who knows quality. For economy, buy when some reliable house has a "sale" of good linen. These sales are business propositions to arouse trade, and are often planned to clear the shelves of patterns that are not in style at the time. Style stimulates trade. At these times the housekeeper may restock her shelves and have reserve linen on hand. Too much ahead is as poor planning as none, because linen will turn yellow and crack on the folds if kept too long. To prevent cracking, it would be wise occasionally to change the folding.

Suggested Quantities of Household Linen to Buy.—

- 4 sheets per bed or if beds are all of same size, 3 sheets per bed.
- 3 pillow cases per pillow.
- 2 blankets per bed.
- 2 spreads per bed.
- 6 face towels per person.
- 3 bath towels per person.
- 2 bath mats for bathroom.
- 1 large dinner table cloth.
- 3 changes of napkins (at least) per week.
- 3 everyday table cloths, if luncheon sets are used.
- 6 everyday table cloths if nothing else is used.
- 6 glass towels per week.
- 6 crash towels per week.
- 2 oven cloths per week.
- 7 hand towels per week.

Marking Linen.—Methods of marking are of two general kinds: Ink marking, such as pen and ink, stencil, and machine marking (like a typewriter); and thread marking, such as bonnay embroidery (chain stitch done by a machine), woven tapes, and hand embroidery (Fig. 117). Rapidity and cheapness characterize the ink method. Serviceableness, ease of application, and good style describe the thread method. For linen that is to be ironed by machinery, the bonnay and embroidered letter will be the least



FIG. 117.—Different ways of marking personal and household linen.

lasting. No matter how it is done, choose a regular place for the name to be put on each individual kind of linen article, as it does much to help in sorting laundered clothes. The accepted color for embroideries is usually white and separate initials are not only more legible, but considered better style than monograms.

The place for the mark varies with style, but the standard place is here given:

Tablecloths should show the marking when the cloth is on the table. A cloth hangs from the table $\frac{1}{4}$ or $\frac{1}{3}$ yard. The monogram

or initial should be on the top of the table about six inches from the edge, at the right of the host or hostess, unless there is a special medallion woven for a mark.

Napkins are marked in the corner, in the middle of the square produced by the final fold. They may be marked in the center, in which case the napkin must be folded in thirds when ironed.

Sheets, pillow-cases and *towels* are marked in the middle of the hemmed end, six inches from the end, so as to be read from the hem.

Handkerchiefs.—If marked with embroidered letter, in the corner; if with pen and ink, in the center.

BEDS AND BEDDING

Bedding is a problem to which one should give considerable thought, because the materials are purchased for lasting service, and because of the large first cost the possibility of renovation should be well considered.

The Bedstead.—Bedsteads, unless of special dimensions, are usually six feet three inches in length and four feet six inches in width for full size; four feet wide, for three-quarter beds; three feet and three feet six inches, for single beds; and three feet and two feet six inches wide for couch beds; while cribs are about two feet six inches wide by four feet six inches in length.

The least expensive bed is a couch or cot which serves two purposes, a day couch and a night bed. Special care must be given to the selection of strong springs on such a bed, as the day couch has often the strain of sitting on the springs. Larger beds are bought to be used as night beds and are less likely to have the strain of being sat upon. Strain is the only word to use as the hardest use that a spring has is that of being stretched on the sides by a person sitting on the bed.

Metal beds are the easiest to keep clean and are to be recommended rather than wooden bedsteads or such special types as rattan. The best quality iron bed finished in white enamel makes a serviceable, attractive bed at less cost than a brass bed, and one that is the easiest to care for. Iron may also be enamelled to represent wood, making a bed less like a cottage or institution bed and one that harmonizes with mahogany and walnut furniture. Brass

beds are expensive, as the better quality requires a good metal foundation and a heavy brass finish; and they require care to keep attractive in appearance. A good metal bed should have welded corners, no sign of a tube being seamed, and firm joints.

Springs.—No matter what the size, the springs may be classed under four types—woven wire, most common in cots and cheaper beds (Fig. 118, *a* and *b*); national springs (Fig. 119); and spiral,

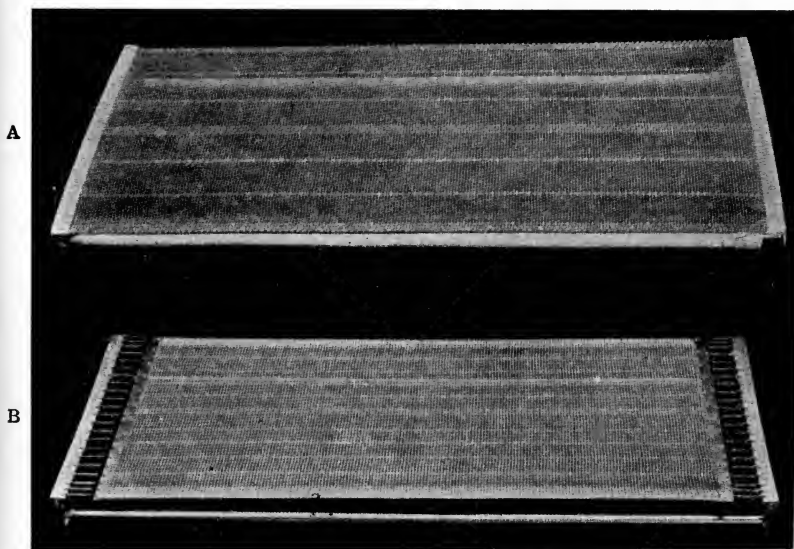

FIG. 118.—*A*, woven wire spring which cannot be renewed when stretched; *B*, woven wire spring with coil springs at each end. These end springs may be renewed.

which may or may not be boxed springs. A statement of the advantages and disadvantages of each kind may help the housekeeper to choose.

The weight of the body causes all springs to stretch and finally to sag. The cheapest *woven-wire* spring has little possibility of being tightened. To overcome this, the better makes are reinforced by weaving groups of wire at regular intervals to strengthen the structure so that it will resist stretching. The edges, too, are made of a

roll of woven wire, or even a steel rod may be run lengthwise of the edge to prevent stretching.

The *national* springs, being built up of sections of wire with strong springs at the end of each line of wire to give tension, may be renewed by replacing sections. For a medium priced spring, the national will give excellent service.

The *spiral* spring is a set of vertical wire spirals, similar to those used in upholstered furniture, the individual springs being

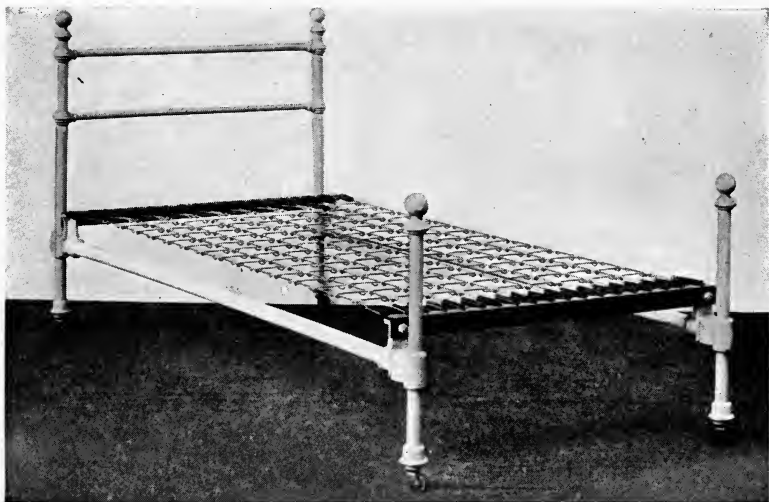

FIG. 119.—A national spring which may be repaired by replacing the springs at each end or by putting in new links.

set upon a metal or wood base. If individual spirals are broken, they can be replaced. It is a comfortable spring, but more difficult to clean than the woven and national types.

The *box* spring is the most expensive, and is made up of spiral springs with a padding like a thin mattress laid on the spirals and the whole enclosed in a ticking cover. This spring makes a warmer bed, and is the most comfortable spring; but because of being enclosed in ticking, it is the most difficult to keep clean. The relative cost is tabulated.

BEDS

Kinds	Size	
	Length	Width
Crib.....	4' 6"	2' 6"
Couch bed.....	6' 0"	2' 6", 3'
Iron or Brass.....	6' 3"	3' 0"
Wood.....	6' 3"	3' 3"
Iron or Brass.....	6' 3"	3' 6"
Iron or Brass.....	6' 3"	4' 0"
Iron, Brass, or Wood.....	6' 3"	4' 6"

SPRINGS

Kinds	Price		
	National	Woven Wire *	Box
Crib.....
Couch bed.....
Iron or Brass.....	\$5.75	\$5.75	\$20.00-\$40.00
Wood.....	6.75	6.75	
Iron or Brass.....	7.50	7.50	
Iron or Brass.....	8.75	8.75	
Iron, Brass, or Wood.....	10.75	10.75	

* The price of springs depends on amount of wire rather than kind.

MATTRESSES

Kinds	Hair		Cotton Felt	
	Price	Weight	Price	Weight
Crib.....	\$7.50-\$17.25	20-45 lbs. for full-sized mattress.	\$6.45-\$9.60	15 lbs.
Couch bed.....	10.00-23.00		8.00-20.00	22 lbs.
Iron or Brass.....	12.00-28.75		11.30-22.00	30 lbs.
Wood.....	12.00-30.00		12.30-22.75	30 lbs.
Iron or Brass.....	15.00-34.50		13.00-24.00	35 lbs.
Iron or Brass.....	17.50-40.25		13.60-25.50	40 lbs.
Iron, Brass, or Wood...	20.00-48.00		14.00-26.50	45 lbs.

Mattresses and **pillows** are usually sold by the same store or department that sells springs. The composition of a mattress, with regard to cleanliness of material, is sometimes controlled by state or

local legal standards or inspection. The cost varies according to the different materials used in the mattress (Fig. 120).

The mattress filling may be corn husk, grass or hay, wool or cotton, short hair like goat's hair, or good horse hair; and the latter, which is commonly used in better mattresses, may vary widely in quality. The corn husks, or grass and hay, if clean, will

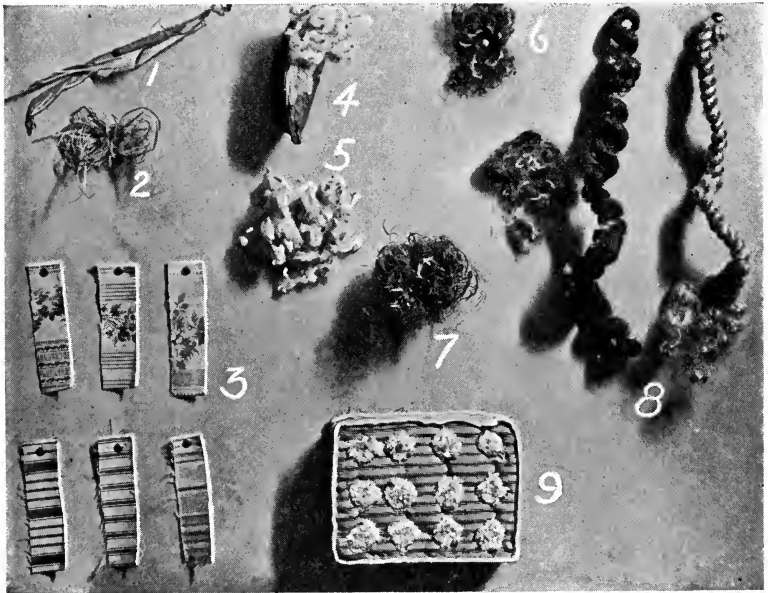

FIG. 120.—Mattress materials. 1, Corn husk; 2, excelsior; 3, ticking; 4 and 5, Kapoc silk floss; 6, goats' hair; 7, grass; 8, curled horse hair; 9, mattress made in classroom.

make a cheap mattress which will give service as long as it does not lump or break up into small pieces. Sometimes one-half of a mattress is made of a layer of cotton, with grass or husks in the other half, which adds much to the comfort.

Tufting.—Most mattresses have cotton tufting, arranged in diamond shape. The plain tacking seems more sanitary, but does not wear so well. Some prefer no tufting in the mattress. Such a mattress must be of good quality if the filling does not slip and

pack. The imperial rolled edge is considered the best finish; it has four rows of tacking in the boxing. All the better grades of mattresses have two or three rows of tacking, and may have round corners instead of square ones.

Cotton Felt.—The wool-felt or cotton-felt mattress is a cheap, comfortable, and durable mattress. All cotton mattresses are not cheap, nor in any way a makeshift; and the housekeeper may choose, after considerable investigation to buy one of the modern cotton-felt mattresses. A cotton-felt mattress is built up of layer upon layer of thin cotton, and the whole enclosed in a tick; it is not made by filling a tick with cotton stuffing. A cotton mattress, if of good quality, will give good wear, but it is not so suitable as some other materials for remaking. Sunning and airing the cotton mattress, and in fact, any mattress, keeps it in better condition.

Hair.—The standard mattress has been considered a horse hair mattress. The long mane and tail hair is used. Tail hair is first quality, and mane hair second quality. The hair is washed, sterilized under high pressure steam, and twisted in huge ropes which when uncoiled make a curled hair. The best hair comes from South America and Australia, and is either white, black or gray. The white, if a natural color, is the most expensive, but for general use it is far more important to buy a hair of good length regardless of color. Deterioration of the hair arises through the wear of a mattress causing the hair to break, shorten, and then lose its spring. Beating mattresses with stick beaters breaks the hair. Shorter hair is best used for upholstery and cushions, and should be cheaper in cost than the long hair. The average price and weight of cotton felt and hair mattresses are tabulated on page 189. The average life of a hair mattress, without renewal, is said by experts to be about four years. This of course varies according to the original grade of the mattress, and also the daily care given to it. To clean and care for a bed, see page 250.

Use of Feather Beds.—Feather beds are no longer being used as such, but as the feathers are really valuable, they may be renovated and used in one of two ways. They may be made into feather pillows, or into feather mattresses. The latter require a great many feathers, as they should be packed tightly.

Pillows, like mattresses, have a great range in quality. They may be stuffed with silk floss, hair, feathers, or down. The silk

floss, called Kapoc, from the cork-wood tree in the West Indies, is the cheapest; it is not suitable for bed pillows, but is much used for couch pillows.

Feathers may be white or gray. The best goose feathers are procured from the live bird in the spring, about six birds of average size furnishing one pound of feathers. The feathers are sold by the pound, the price depending upon the part of the feather used, and upon the way the feathers are mixed. The parts used are the whole feather, the split feather which has had the quill removed, and the down. The quality differs according to the source: chicken; chicken and duck, mixed feathers; duck and goose, mixed; goose and down, mixed; down. A split feather will give good service, down will pack, and is expensive.

Hair pillows are cooler and firmer than feather pillows, and while not often used regularly in the home, are sometimes kept on hand for use in case of sickness. In hotels, the hair pillow is often the bottom pillow, used in place of the bolster.

Pillows are not regular in size, varying from 18" x 30", weighing 2½ lbs., to 30" x 30", weighing 5 lbs. An average size is 22" x 30", weighing 3 lbs. Pillows vary in cost, from \$3 to \$5, according to size and quality of filling.

Mattress Pads and Covers.—Mattress pads protect the mattress from soil and are so easily washed that some sort of pad should be used on all beds. Often a folded blanket or cotton quilt is used but quilted pads may be purchased which are standardized to fit various mattresses.

Dust covers entirely covering the mattress are desirable to keep it free from dust. These covers may be bought when the mattresses are ordered at about \$4.50 for single bed size, or the housewife can easily make them by using two pieces of unbleached muslin, each the length and width of the mattress, and sewing in a five-inch strip of material to make a shallow, box-shaped bag large enough to enclose the mattress. The edges may be finished with a double seam by sewing first on one side and then turning and sewing the other. An extra half inch on all seams will have to be allowed in cutting for this double seam. If cotton braid is used for a bound seam, then one needs to make only a single seam. In any case leave one end open and make a fastening with tapes, or buttons and button-

holes, or hooks and eyes, or snappers. Be sure to allow for shrinkage; better still, shrink the muslin before cutting.

Sheets vary widely in quality and elaborateness of finish, but the fundamental difference is that some are linen and some cotton. The linen are best for summer use because linen radiates the heat from the body; cotton, on the contrary is warmer. Linen is a great deal more expensive; a standard double sheet, 90 x 100, costing from two to three times as much as the best cotton sheet. The best cotton sheet is called percale. There is a wide selection now available of various grades, in standard sizes, so that there is little reason for making sheets at home. Buy sheets that have been torn before hemming, as they are straighter than if cut; hem-stitching costs about ten to twenty cents more per sheet. Torn sheets are stamped as such. The saving in buying sheeting and making the sheets at home has little advantage from the money side, but does enable the housewife to have sheets of the precise size that she prefers.

Size.—There are a variety of standard sizes (see table on page 196), but the one most carefully chosen is one enough larger than the mattress to allow twelve to eighteen inches to turn in on all sides, that is, twenty-four to thirty-six inches longer and wider than the bed.

Bedspreads.—The housewife may choose almost any covering for the bed, if she has the spreads made (Fig. 121). Cretonne, lace over color, thread crocheted or knitted, crêpe, unbleached muslin tufted with heavy cotton thread—all are used in making up spreads. If one buys ready-made, the variety is limited to Marseilles, dimity, or lace. Marseilles is heavy and usually has a raised pattern, while the dimity is light in weight, easily cleaned, and is deservedly popular for a simple but serviceable spread (Fig. 122). Fringe is pretty on spreads that are not to be tucked in, but the tangling and tearing of the thread increases the work of laundering. For old-fashioned bed coverings, gimp is a pretty, quaint, and much more serviceable trimming than fringe.

Blankets.—The purchase of blankets requires a great deal of experience on the part of the purchaser. If one has had no experience, it is desirable to go to a store of good standing and be advised. A blanket should be soft and warm but not too heavy. The quality and percentage of the wool is the first important question. French blankets are beautifully finished. Scotch blankets are harsh and

have a poor finish, but are warm and durable. English blankets are much like the Scotch. Domestic blankets compare favorably with any of the others in both texture and finish. The great variety of blankets is due to the irregularity of length of wool fibre and the weave. Some of the poor qualities appear fluffy and woolly, but the short wool fibres have been blown into the warp and are not tightly woven. Such a blanket when washed will lose a large amount of wool and finally leave only the cotton warp.

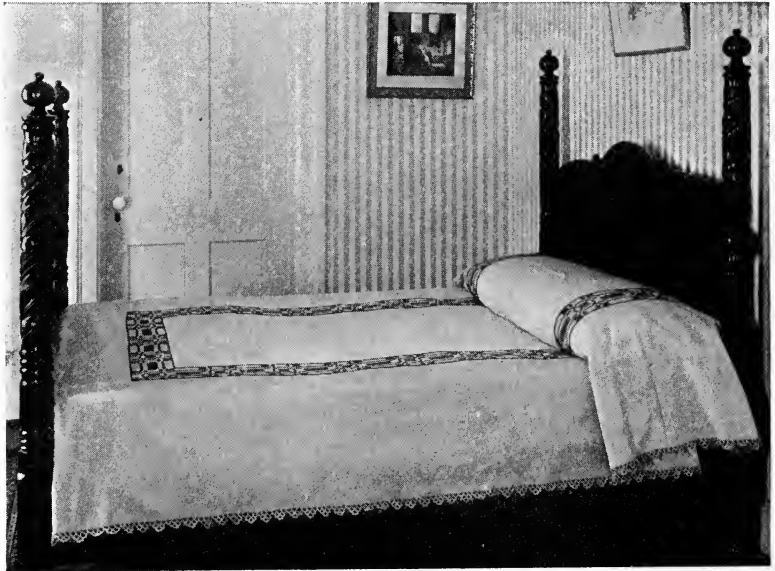

FIG. 121.—A hand-woven spread long enough to cover pillow. Made by Mrs. Jessie H. Woodruff, Dunkirk, N. Y.

The grade and percentage of wool really controls the quality and the selling price. The manufacturer knows the exact weight of wool and cotton in each blanket made, and the ticket attached to the blanket should give an honest statement. The blankets range from all cotton to all wool (98 per cent.). A 100 per cent. wool blanket really does not exist. A good medium grade is about 60 per cent. to 80 per cent. wool; the larger percentage of wool adds to the care necessary in washing.

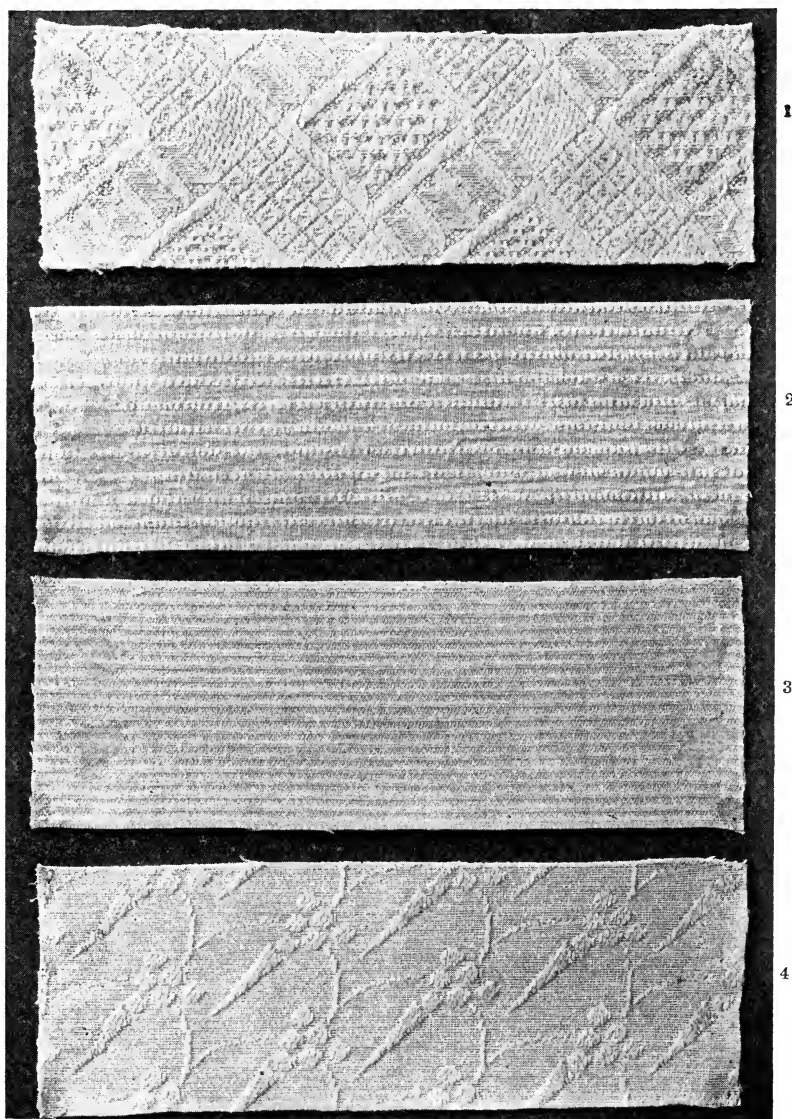

FIG. 122.—Various weaves of counterpanes. 1 and 4, Marseilles; 2 and 3, dimity.

Borders of blankets are more important than one would imagine. The variety of color plays little part, but what is more important is that the border is made of the same quality wool and not of cotton as is so often the case. The ruffled appearance which is seen after washing is due to the wool used for the border being run in lengthwise across the blanket and then shrinking in length. Hospital blankets are best without a border.

Blankets are usually sold double, *i.e.*, two blankets woven together at one end. For ease of handling, and to save the blanket, it is desirable to cut them in two and bind the cut edges. Blanket binding ribbon may be bought for this purpose.

Comfortables.—Comfortables may be made from cheesecloth or cotton batting fillings, but are better made from cheesecloth and "sheet wool." The wool can be purchased in stores from the bedding department just the size for single, three-quarter, and full-size comfortables. The wool washes better, and if tacked or quilted into fine cheesecloth, it will make an excellent comfortable, light, warm and easily cleaned. Silk-aline, challie, satins and silks make more elaborate comfortables, but what is most to be considered is the desirability of having this heavy bedding cleaned.

Down puffs wash very well, if made up in a washable cover. (See page 282.)

Sizes of Bedding:

Size of Sheets:

72 in. x 96 in.
72 in. x 108 in.
90 in. x 96 in.
90 in. x 108 in.

Size of Bedspreads:

72 in. x 90 in. }
72 in. x 100 in. } Single bed
80 in. x 100 in.—Three-quarter bed or
double not
hang down
90 in. x 100 in.—Double bed
97 in. x 116 in.—Extra size

Size of Pillow-slips:

22½ in. x 36 in.—Regulation
size
25 in. x 36 in.
27 in. x 36 in.

Size of Blankets:

60 in. x 80 in. }
60 in. x 90 in. } Single bed
72 in. x 82 in. }
72 in. x 90 in. } Three-quarter
bed
76 in. x 84 in. }
80 in. x 90 in. } Double bed

Comfortables, one size:

72 in. x 78 in.

SILVERWARE

Silverware is classed under the two headings—"solid" and "plated." Solid or sterling silver, which means about 925 parts of

silver to 75 parts of copper, is the best, the most expensive, and will outwear the best plate silver. The solid silver is an alloy of silver and copper. The plated ware has a coating of silver deposited by electrolysis upon a suitable base, *e.g.*, on steel for knives and forks, on German silver for spoons, and on Britannia metal for hollow ware. In sterling silver, the heavier weight is the most desirable, as the lighter weights, if given any hard use, bend, dent, or even break.

For constant use plated ware recommends itself to the average household. The better plated silver on the market compares very favorably with sterling silver in appearance and durability, and is much less expensive. Triple plate is the best plate, but often the most-used silver is double or even single plate. The idea expressed in these terms leads one to think that silver is dipped or coated so many times; instead, it means that a certain weight of silver is allowed as a coating to every dozen pieces. For example, it is better to have knives or forks stamped "15 dwt.," meaning that fifteen pennyweight has been used in coating a dozen. Tablespoons marked 20 dwt. will equal teaspoons marked "10 dwt.," because the area of a tablespoon is about twice that of a teaspoon. Bottoms of bowls and backs of handles should have an extra coating, because they receive the greatest amount of wear.

The number of pieces in the making of each finished piece of silver also controls the cost. A bowl made of two pieces costs about half what the same size and weight bowl will cost if made up of several pieces, *i.e.*, handles, spouts, and mounts. Sometimes the "mounts," which are bands or finishing sections, are ornamented, thus increasing the cost considerably. The bright finish costs slightly more than the frosted or satin finishes in silver.

Silver-plating solutions advertised for use in the home are very likely to be composed of solutions of mercury salts. In this case, mercury is deposited on the spoon, giving a bright silvery appearance, but the housewife must remember that mercury salts are poisonous.

Patterns and shapes in flat and hollow silverware vary from time to time to suit changing fashions, but plain, simple patterns are always in good taste and are permanently on the market. The very plain patterns will be more easily cleaned, but will show scratches more readily. In selecting the pattern it is therefore well

to consider the time and labor it will take to keep it as clean and attractive as when new, and to select in terms of economy in care as well as of appearance.

For Cleaning Silver, see pages 260-262.

HOUSEHOLD POTTERY AND GLASS

Household Pottery.—All household pottery, whether for kitchen or table use, is of two general types: earthenware and porcelain or china. All pottery is made of earth products molded and then baked at high temperature; and for household pottery the entire surface is covered with a glass-like glaze which is fired upon the pottery. The two types mentioned differ in the constituent materials and in the degree of hardness of the inner body. In earthenware the inner body is soft, and in porcelain or china it is hard.

Kitchen or cooking ware is ordinarily earthenware and is produced in various colors; porcelain cooking utensils are also now available. Ordinary cooking ware is given a hard glaze to prevent food getting below the surface; if in time the surface glaze "crazes" or cracks, the dish becomes discolored and may possibly impart a flavor to food cooked in it. Someone has said that the much-used old-fashioned porcelain pie plate needs only to be placed in the oven to produce a juicy, well-flavored pie. This cooking ware cannot be subjected to sudden changes of temperature like metal articles. To cool it suddenly in cold water may cause "crazing" or even peeling of the glaze, and cracking of the dish.

Table ware is available in the two general types of glazed ware, the earthenware which has the soft inner body, and the porcelain or china (Fig. 123) (so-called because first made in China) with the hard inner body. The earthen table ware is the familiar heavy white table ware often called "stoneware," which is less expensive than the porcelain and accordingly finds a wide use in homes and in restaurants and institutions.

China or porcelain, which is more expensive, differs from earthen- or white-ware in two ways. First, it is hard glazed and non-absorbing; even if chipped and the glaze broken no stain remains because of absorption. Ink may be used as a test. Secondly, it is translucent, showing light through. Porcelain is less likely to chip than earthenware, and so is more serviceable, but it is more brittle.



FIG. 123.—Good selection of china and silver. Three sections at the right holding flat silver are built as a sliding tray, thereby increasing the storage capacity of the drawer.

The best quality table china should be hard, compact, non-absorbent, highly glazed, and of fine grain. The finest ware is made of flint or feldspar. The higher the glaze and the more compact the body, the more brittle is the china.

To produce fine china, the materials must be properly proportioned, mixed, and prepared, and the baking must be exactly right as to intensity and duration of heat. To get this perfection of glaze, great patience and skill are required, and as a result china or porcelain is expensive. If the glaze and the body are not suited to each other, the glaze shrinks and causes "crazing."

There are two grades of table ware: "firsts," perfect in shape, design, and glaze, bring the highest price; "seconds" are imperfect in one, two, or all three requirements. One may select table ware imperfect in either shape or design, but should never accept a piece imperfect in glaze, as the glaze is the protection.

In selecting there are old standard patterns available as in table linen, such as "willow," "madrass," etc., and there are new designs. Two types that are popular are the band of colors, either solid or broken, and the band of gold. The colored bands are always in good taste, because the design is simple and pleasing when considered in combination with flowers, linen, and food. The single gold bands are most attractive, but more expensive and less durable because gold cannot be fired to such a high temperature. Avoid ridges in patterns; choose handles that are easily grasped; and china in general that is not overdecorated, especially if one must use the same set of dishes continually. It is greater economy to buy what is known as "open stock" pattern, so that any replacing of broken dishes may be done at any time and at little cost. This is possible in expensive as well as in cheaper dishes.

Suggestions for Buying China.—European and Oriental porcelains are "biscuited" at a low temperature which makes this kind of china superior as to glaze. European china is bluish white, while American china is cream white. There is no special value, however, in the color as far as wear is concerned. English and Oriental china are the more fragile, while the American has the stronger body, resisting shocks. American china is giving excellent service, and many good types have been developed which are equal to the imported porcelains. American china is most worthy of the housewife's consideration.

A rolled edge on china prevents chipping, and so is of special service for hotel and institution china; it does not necessarily mean a thick china.

Decorations on china are put on by hand, or by the decalcomania process. Decalcomania is a process of transferring designs directly upon the china, and is the process commonly used. To decorate by hand is, of course, very slow, detailed work, all of which means very expensive china.

Table Service for Six (Limited).—

China:

- 12 dinner plates
- 12 breakfast plates
- 12 soup dishes (plates or cups)
- 12 breakfast cups and saucers
- 12 tea cups and saucers
- 24 bread and butter plates
 - 1 10 in. dish
 - 1 12 in. dish
 - 1 16 in. dish
 - 1 18 in. dish
- 1 covered vegetable dish (oval)
- 1 covered vegetable dish (round)
- 2 platters, medium and large
- 1 soup tureen
- 1 sauce boat or bowl
- 1 salad bowl—can be used for vegetables
- 12 tea cups and saucers
- 6 after-dinner cups and saucers
- 1 chop platter
- 12 oatmeal dishes
- 12 sauce dishes

Glass:

- 12 glasses
- 6 finger bowls
- 1 pudding dish
- 1 creamer
- 1 sugar
 - might be in china,
 - silver, if not in
 - glass
- 12 sherbet glasses
- 2 salts
- 2 peppers
- 1 vase

Silver:

- 12 forks
- 12 knives
- 6 bread and butter knives
- 4 tablespoons
- 2½ teaspoons
- 6 dessert spoons—round bowl good for soup
- 1 sugar spoon
- 1 butter knife or fork

With regard to table equipment, the number of individual dishes is controlled by the size of the family, and the kind of service desired. Most housewives would choose dainty service and good style, and would prefer to have convenient dishes in adequate number and appropriate silver, even if less expensive china and silver and glass is chosen. For such a standard, which is strongly recommended, buy twice as many of all individual dishes, glasses, and silver, as the number in the family. This makes possible entertaining with much less worry and work, and relieves one of the feeling of not having enough. It is certainly a reasonable standard

to choose china, glass, and silver which is not expensive to replace and is, therefore, not a source of anxiety to the housewife.

Glassware.—Most people appreciate beautiful glass, for in table service particularly nothing can surpass it. It gives a finishing touch of beauty and simple elegance. Glassware is known as pure lead glass and lime glass. A preponderance of lime produces a very brittle glass, while lead gives a glass that is tough and wears well. Of the different grades, rock crystal or pure leaf glass is the clearest and finest produced. The determining qualities of glass are its smoothness, brilliancy, freedom from bubbles and cloudiness, whiteness, and transparency.

Decoration of glass is done by etching with acids or by cutting with emery wheels. Cut glass needs very great care. Sudden changes of temperature or a slight knock are likely to break the glass along the line of cut. It is therefore not desirable for constant family use. Pressed glass is much less expensive and some of the products are almost as beautiful as the more expensive cut glass, and for everyday service they are much more desirable. The poorest qualities are heavy and show the seam where the halves are joined.

Many makers of glass, like makers of china, stamp their name in the bottom of the piece. It is a great advantage to the purchaser to know some of these trade-marks and the quality which they represent.

Good plain lead table glasses cost from \$1.25 to \$1.75 per dozen. Cut glass varies widely in price according to the elaborateness of the design as well as the quality of the glass.

SUGGESTIVE QUESTIONS

1. Given a living room on the north side of the house, what colors would you choose for wallpaper, rugs and draperies?
2. How do home-made rugs compare, economically, with those purchased? Show to what extent the housewife may or may not be justified in making her own rugs.
3. List inexpensive materials which might be used in place of regular curtain materials.
4. What are the advantages of two-tone color materials for furnishings?
5. Why may not willow furniture always be an economical purchase?

REFERENCES

- BALL, KATHARINE, AND WEST, MIRIAM, HOUSEHOLD ARITHMETIC, J. B. Lippincott Co.
COOLEY, ANNA, MITCHELL, CORA, SPHOR, WILHELMINA, MARSHALL, JOSEPHINE, TEACHING HOME ECONOMICS. Macmillan Co., N. Y. City.

- COX, GEORGE J., POTTERY. Macmillan Co.
- EBERLEIN, HAROLD DONALDSON, THE PRACTICAL BOOK OF PERIOD FURNITURE. Lippincott, Phila., 1914.
- FARMERS' BULLETIN 1089, SELECTION AND CARE OF CLOTHING. U. S. Dept. of Agriculture, Washington, D. C.
- KELLOGG, ALICE, HOME FURNISHING—PRACTICAL AND ARTISTIC. Fred A. Stokes Co.
- KINNE, HELEN, AND COOLEY, ANNA, CLOTHING AND HEALTH. Macmillan Co.
- MCGOWAN, ELLEN, AND WAITE, CHARLOTTE, TEXTILES AND CLOTHING. Macmillan Co.
- PARSONS, FRANK, INTERIOR DECORATION. Doubleday, Page & Co.
- PRIESTMAN, MABEL, ART AND ECONOMY IN HOUSEHOLD DECORATION. John Lane Co.
- QUINN, MARY J., PLANNING AND FURNISHING THE HOME. Harper & Bros.
- ROLPH, AMY, HOME DECORATION. Macmillan Co.
- SOUDER, M. ATTIE, NOTIONS. Ronald Press Co.
- THOMPSON, ELIZA B., TEXTILES: COTTONS AND LINENS. Ronald Press Co.
- THOMPSON, ELIZA B., TEXTILES: SILKS. Ronald Press Co.
- VAN RENSSELAER, MARTHA, THE MANUAL OF HOME-MAKING. The Macmillan Co., New York City.
- VON HOLST, H. V., MODERN AMERICAN HOMES. American Technical Society.
- WOOLMAN, MARY SCHENCK, CLOTHING: CHOICE, CARE, COST. J. B. Lippincott Co.

CHAPTER VIII

STORAGE

STORAGE is such an important matter that the consideration of it should begin when the house is first planned with the architect. The architect should be eager to coöperate, so that in his skilled way he may express on paper the practical ideas of the housewife, whose suggestions may be most definite and valuable based on her experience in housekeeping.

Closets, bins, and boxes are a real necessity. Storage does not mean unnecessary hoarding; it means definite planning as to bin, box, or closet, and the systematic arrangement of the contents of each—a place for everything. One of the signs of the times is the definite stand housewives are taking regarding inadequate storage space both in city and in country houses, and the demand they are making that shelves, cupboards, and closets be thought out with the utmost care, and not “tucked in” as a last consideration. Each available space, every corner, under the stairs, and even panels, may with profit be utilized for storage.

Rural Home and Storage.—The rural home usually will have more commodious storage than the smaller town house, because the attic is a feature of such a home; and except in the southern section of the country, a cellar will usually be provided.

Commercial Storage.—In city homes where space is limited, storage facilities rented from commercial storage companies are an important factor. This includes the fur and woollen storage which can be had for furs at a cost of two per cent. of the valuation. For this price, the storage company sends for the goods, cares for them during the season, or an entire year if desired, and returns them on order. General storage is sometimes charged for by the cubic foot of space occupied. Furniture storage may be hired at so much a month per storage room, or so much per van load; the prices vary, too, according to the security of the warehouse, higher prices being charged for storage in absolutely fireproof buildings. The cost of placing fire insurance upon one's goods while they are in storage should also be learned in advance by inquiry of an insur-

ance broker; the saving in low storage rent is sometimes more than offset by a high rate of fire insurance upon the goods.

Carpet and rug storage in many cities is a specialty, and the storage companies also clean and repair the floor coverings if so ordered, before putting them into storage.

The storage of silver in special vaults is provided by certain banks and other storage companies, while valuable papers as stocks

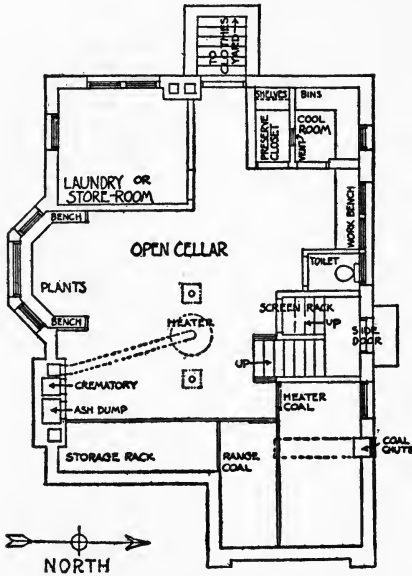

FIG. 124.—A plan for an ideal cellar. Courtesy of Charles E. White and *Ladies Home Journal*.

and bonds, and jewelry, are cared for in the small safe deposit boxes provided by banks, at from \$3 to \$10 a year.

CELLAR OR BASEMENT STORAGE

The cellar or basement is the place most often chosen for the storage of food, because it is cool and away from the light. One problem of the cellar is to keep it dry; its drainage will depend upon the location of the house where there is natural drainage, and upon the question of whether there is a good concrete floor. The provision of several small windows to provide cross ventilation

is important. If a part of the cellar used as a food room has but one window, ventilation can be secured by dividing the window into two parts and by building an air flue or box from one part of the window to within a few inches of the cellar floor, thus providing for a current of air.

If the cellar is divided into rooms or compartments (Fig. 124), the heating apparatus, together with the bins for fuel may be partitioned off by themselves, to keep the rest of the cellar clean, and also to keep the heat away from the food.

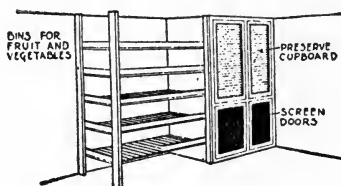

FIG. 125.—Vegetable and fruit storage. Courtesy of Charles E. White and *Ladies Home Journal*.

Coal and wood bins should be placed in close relationship to the furnace for the furnace coal, and to the cellar stairs for kitchen coal or wood. The latter, if possible, should be stored upstairs adjoining the kitchen. The cellar stairs should lead directly by a well-lighted passage to the kitchen.

For the convenience of the housekeeper and the coal man, the coal bins should be connected by good-sized windows, easily opened, to the driveway. Consider the convenience of this before deciding that any extra cost involved is too great.

Vegetable bins in the form of trays with wire bottoms are best, because the vegetables may then have a circulation of air. This will prevent their "sweating" and molding as much as they otherwise would. These bins may be mounted one above the other on uprights (Fig. 125), and may be raised from the floor enough to aid ventilation, and to permit cleaning beneath them. The fronts of these bins may be hinged to let down, and in that way it is easy to empty and clean them. (See also Vegetable Pits, page 216.)

Preserve closets should be in a cool, dark, dry part of the cellar, and should have plenty of shelf room. The shelves should be planned by reckoning the surface area required for so many jars and glasses, and the space between shelves should be enough to allow for height of jar or glass.

It is told by a large canning company that they are able to take account of stock in less than an hour, because it was planned that the shelves should hold so many rows of gallon, quart, or pint cans, and

each row should be so many cans deep. It was only a matter of counting and multiplying. In this method rows may be labelled rather than individual cans. Always put old jars in front to be used first.

Swinging shelves are the old-fashioned way of putting food high and dry for safety. They are especially serviceable where mice are troublesome.

Trunk Storage.—Housekeepers differ as to the best place for trunk storage, cellar or attic. It matters not, so long as the place is dry and clean, as well as convenient to reach. If possible, choose a place away from all pipes, so no sudden leak will endanger the trunks. A rack or platform of wood (Fig. 126) under the trunk in a basement ensures dryness, and a dust cover of paper, bed ticking, or unbleached muslin is worth providing.

The garret or attic is a storage place of practical importance. As to the holding-over of discarded clothing, furniture, and various other movable property, there is argument for and against. Furniture and clothing may later be utilized, in some emergency, but it is not wise to store so much that it amounts to hoarding. The general principle that should control the accumulation of discarded things would seem to be to save nothing unless it seems at the time to have possibilities of later use, and to keep things of a kind together in attic storage. The attic will also in many houses be the place of seasonal storage of things in current use; where summer things are put away over the winter, and *vice versa*; such storage is discussed elsewhere in this chapter.

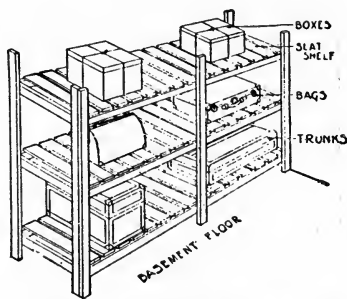

FIG. 126.—Trunk and bag storage. Courtesy of Charles E. White and *Ladies Home Journal*

LAUNDRY STORAGE

A clothes chute of metal may lead down from all floors to the basement and terminate there in a bin, closet, or wire cage. This should be planned to empty in or near the laundry, and have sufficient capacity to hold the week's soiled clothes. Hampers

and baskets throughout the house are not necessary with these conditions. This clothes bin or closet may be of metal or of papier maché. The clothes container at the bottom of the chute may be

enamelled or painted at such intervals of time as to insure its being clean and not rusting or mildewing.

Laundry Closet.—The closet in the laundry is best divided into two large compartments, so that one-half may be arranged with shelves and the other half divided to have a place for all large equipment, which, if allowed to remain out in the room, becomes dusty. Available space will help decide whether this storage should be built as a single closet with a division into two parts, or whether ironing equipment shall be kept in one closet in one part of the room, and washing equipment in another. This latter idea will appeal to the housewife whose efficiency study has proved to her that each tool is best stored near its working center.

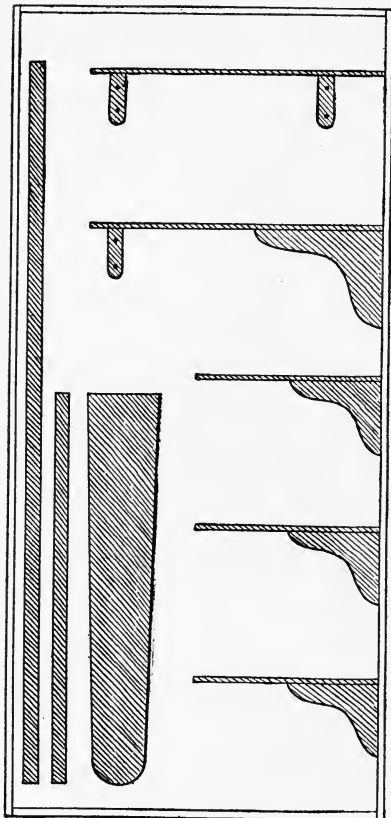

FIG. 127.—One section laundry equipment closet.

enough to take the boiler placed on end, besides the clothes basket, and a wringer if a hand-operated one is used. Neither the basket nor wringer are tools ready for service if they have stood in an open room all week. It is better to shelve the other section to hold the stain-removing outfit, such as bottles, droppers, a small bowl, and the jars of salt, paraffin, starch, and

borax. Other shelves make possible a grouping of soaps, soda, and kerosene on one shelf, and starch kettle, strainer and stirring spoons on another. On a lower shelf may be kept the irons and iron racks. A drawer may be planned to hold ironing-board covers, felts and cheesecloth. The shelved compartment need not be so deep as the other, in fact, is better just deep enough to hold the largest starch cooker or bowl.

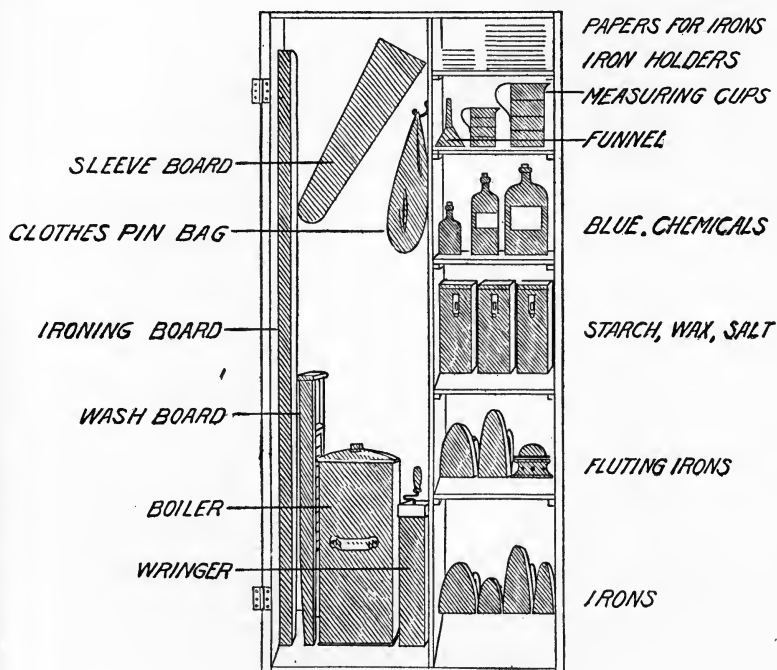

FIG. 128.—A laundry closet for the small home laundry.

For Laundry Closet Equipment, see Laundry Equipment, page 104.

KITCHEN STORAGE

Kitchen and Pantry Closets.—They are alike in general design. Usually they are divided into an upper and lower section, so as to divide the heavier utensils such as heavy kettles and boilers from the lighter pans and bowls (Fig. 129). Shelves half as wide as the closet is deep are best in these lower compartments. Special

cupboards should be built large enough to hold barrels of sugar and of flour. The top of these cupboards opens on a hinge, as well as the side, so as to make the top of the barrel easily reached without drawing out the barrel; barrel swivels on which to swing the barrels



FIG. 129.—Good type of kitchen closet.

may be put into these closets. Such cupboards are usually made of wood, of course, but one may now secure an all-metal closet (Fig. 129), which may be purchased in sections of white enamelled metal. Glass doors to the upper part of cupboards ensure a light, clean cupboard which is as open as open shelving, without having the dust. In narrow quarters it is better to have the closet doors slide.

The shelving should be planned to be within reach. This is possible if the housekeeper is careful to plan less waste of space on the so-called counter of the cupboard and less unused space between the shelves. A slanting roof to the closet is much more easily cleaned than the usual flat top.

About the sink by means of small shelves are best stored the dish-washing and sink-cleaning necessities. One or two narrow shelves directly over the sink provide a place near at hand for the scouring powder, the knife-cleaning material, a small jar of dissolved washing soda, a jar with soap scraps soaking in water to be used in dish washing, a cork for rubbing knives, and a silver cleaner. From the shelf may hang the soap shaker, the dish drainer, and perhaps the dishmop and bottle washer. On a hook under the drain-board may hang the dishpan and the draining rack. If space is limited, a case of drawers may be built under the draining board, on either or both sides. This in no way closes in the plumbing, for these drawers may be on rollers, so as to be pulled out easily. If these drawers are shallow, they give classified storage space for towels, aprons, and cloths.

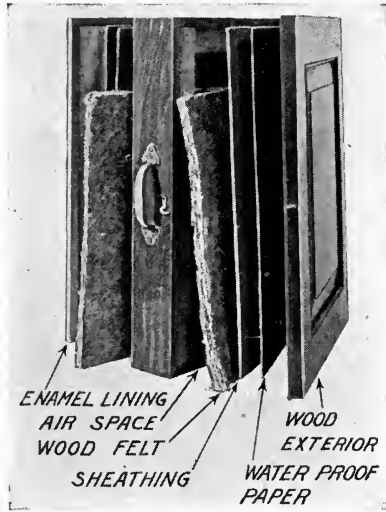

FIG. 130.—A sectional view of one wall of a refrigerator.

FOOD STORAGE

Food storage involves refrigeration, preservation from the air by canning, preserving by cellar or dug-outs, and also food containers for storage of current food supplies.

Refrigeration represents means of storage for food at a low temperature of about 45°–55° F. in an ice-box or refrigerator. In order that the refrigerator may be kept at a more or less even

temperature, it must be so constructed as to prevent the entrance through the walls of any heat from the outside. This is accomplished by the use of non-conducting materials (Fig. 130) placed in layers with air spaces between. The efficiency of the refrigerator depends almost entirely upon the perfection of this insulation.

Various conditions influence the possibility of not maintaining the temperature noted above, such as storing in a damp cellar,

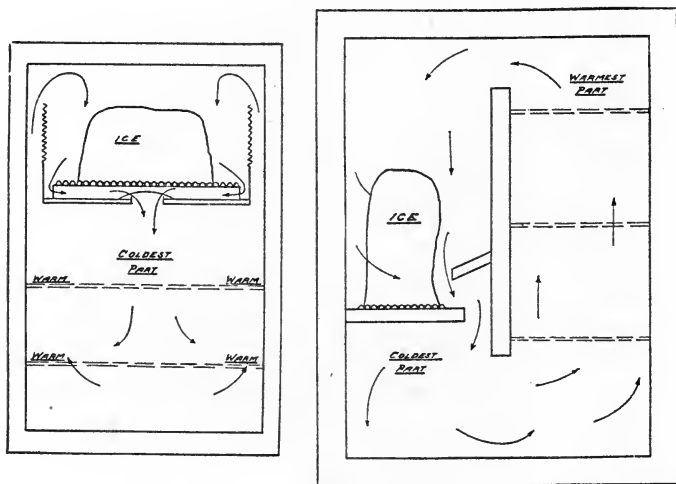

FIG. 131.—Diagram showing the circulation of air in two usual types of refrigerators. Air entering the ice chamber is cooled, and sinks through the bottom openings, drawing in the warmer air at the top. Butter, milk, and meats should occupy the cooler space, while food having a strong odor should be placed where the air is just about to enter the ice chamber.

exposure on an outside porch, putting in hot foods, and too frequent opening of the refrigerator, it being found that each time the door is opened, the temperature increases 1° to 3° . Someone has aptly said, "Do not open the door and camp out before the refrigerator while planning the next meal. It might be more costly than to lose the left-overs." In a refrigerator large enough for a family of four or five, the ice capacity should be 60 to 75 pounds. The refrigerator temperature is higher than cold storage, which is at 34° F. and a refrigerator, therefore, is not capable of keeping food for as long a time as cold storage.

Three conditions control economic preservation by refrigeration: low temperature, ventilation, and dryness. Low temperature can readily be secured by the melting of the ice in the refrigerator;



FIG. 132.—Refrigerator showing good interior arrangement.

ventilation is accomplished by the construction of the refrigerator, so that it will allow circulating spaces for warm and cool air (Fig. 131); the dryness depends upon rapid change of air in the ice-box, good drainage to carry away the ice when melted into water, and no covering of the ice by wet cloths or papers.

The proper construction of the refrigerator helps in its care. The best types keep the ice separate from the food, and subdivide the food compartment so that foods such as eggs, milk and butter, more sensitive to odors, may be kept by themselves (Fig. 132).

The interior construction of the box may be of wood, galvanized iron, enamel, or porcelain, but whatever it is, it should be smooth, free from cracks, made of material impervious to moisture and odors, and easily cleaned. For general efficiency the racks should be made of tubes or wire, so smooth as to be easily cleaned, so close together that there is little chance for tipping and spilling of dishes.

The hardware of the refrigerator, especially the door latches, should be of the best quality, but more important is the tightness with which the doors fit. They should be so tight that not even a thin calling card could be slipped inside a door when the door is fastened. The wooden refrigerators are cheaper and serviceable, but the metal lined ones are more easily cared for, as the metal naturally resists moisture and odors. The enamel refrigerator is a luxury, not a necessity, and without care will be no cleaner than the cheaper kind.

The drains should be open and easily cleaned. Be sure that the "elbow" and bends in the drain pipes are so arranged that they can be cleaned with a brush, or removed and scrubbed in cleaning. The refrigerator may be connected to the house drain by putting in a water trap. This is necessary to avoid any inflow of sewer gas. The refrigerator, even then, is not connected by a continuous pipe into the sewer, but drips into a metal lined open cup or box which is in turn connected with the sewer pipe. If such a connection cannot be arranged, a drip pan under the refrigerator is safer to use. For ease and cleanliness a door is often built in the back of the ice compartment, so that the ice may be put in through a window or small door from the outside wall of the house or porch.

To clean refrigerator, see chapter on Cleaning and Care, page 269.

On the farm, where there is an icehouse, the reserve supply of perishable foods can sometimes be stored in the ice house.

The "iceless refrigerator" (Fig. 133), convenient for the farmhouse or other detached houses, depends for its cool temperature upon the evaporation of water in moistened curtains hung about a food closet made of wire netting. The curtains, made of canton flannel, button tight about the food cage; they are kept moist by

keeping prolongations of their lower ends in a pail of water. Such an iceless box will keep milk and butter cool.

Refrigerator Dishes.—Much room is wasted in refrigerators by not having small compact food containers for the left-overs. Wide-topped flaring bowls, for example, represent great waste of space because, while they may have a small base, they project at the top far enough to prevent anything else standing beside them.

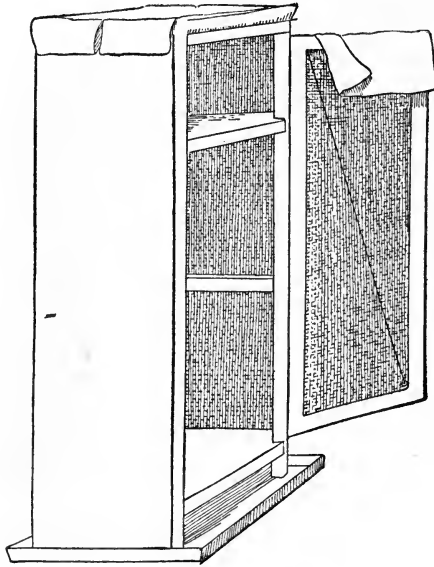

FIG. 133.—Iceless refrigerator.

Half-pint and pint fruit jars, and small straight-sided bowls, make good containers without costing much money. These containers also protect finer dishes, which should not be in the refrigerator, because of the likelihood of their being chipped. Wide-mouthed fruit jars are especially suitable for storing washed lettuce, because the top can be screwed on tight and the jar laid directly on the ice. A few covered containers should be purchased to take such things as left-over fish, cabbage, onions, and other strong smelling fish. Glass-covered butter containers insure the butter being kept in a sweet condition, because the glass is non-absorbing and easily cleaned.

Window food boxes serve as a substitute for a refrigerator, and can be used satisfactorily about eight months in the year in a large part of the United States. In building a house, it is well to provide a cool box built on the outside wall of the house, with a refrigerator door opening directly into the kitchen through the kitchen wall. (See chapter on Equipment, page 99.)

Food pits, dug-outs or caves where food, mostly vegetable, is buried for storage, furnish often in rural communities the most



FIG. 134.—Various types of containers for the house. 1, soiled clothes box, papier maché; 2, soiled clothes bag, paper; 3, bread box; 4 and 5, garbage; 6, waste basket, papier maché; 7, wooden flour bin; 8, ground glass-stoppered bottle; 9, porcelain flour jar; 10, glass flour jar.

feasible way to stow away large supplies. A straw or corn husk covering put over the top of the cave will prevent freezing. To open, one must remove the top covering and dig down to the food. It is operated in the best fashion when the food contents are not exposed too often, therefore the housekeeper should take out enough celery, turnips, etc., for perhaps a week's supply.

Food Containers.—As the study of housekeeping advances, merchants are meeting the varied demands for various food containers (Fig. 134). The housekeeper's demand to-day is that food containers be non-absorbent of both odors and grease; that they be easily handled; often that they be attractive in order to help make

the kitchen one of the most attractive rooms of the house. The housekeeper may even plan her kitchen with a color scheme, in which the containers may match in color the tiling, paint, and linoleum. If glass containers are used, the labels which are pasted on often introduce the color.

Tin.—Tin containers, painted or japanned, are the cheapest quality, but there is a range of prices even in these. Tin is light in weight but has two disadvantages, in that moisture is likely to rust the tin, and that it is not possible to see the amount of the contents. It can easily be seen that this may amount to considerable loss in time and in energy.

Earthen or Crockery.—Earthen or crockery food containers are the best looking on the market to-day, some of them having the same attractive decoration as dishes. They are easily cleaned and the uniformity of sets makes them attractive. They are expensive, breakable, and also hide the contents.

Glass.—Glass is perhaps the most sanitary material for food containers. It is obtainable in various sizes, prices, and shapes, is non-absorbent, and is particularly useful because it shows the contents. Some of the jars and bottles, especially those for the medicine case, will be found with the names etched into the glass. Black paint lettering, or labels which are shellaced on, are very helpful.

Canning and Preserving Containers.—Earthenware jars and crocks, and glass preserving jars, bottles, and glasses, are used for the storage of canned, preserved, salted, pickled, or dried foods. Paper and tin can containers are used increasingly in the private household. Large wooden containers may be used for pickling. Fruit jars should be examined for clearness and freedom from any dimming, since cheap glass products of this kind are not always insoluble. Fruit juices may leach out from inferior glass enough alkali to interfere with the preservation of the canned material; this may account for some otherwise mysterious spoiling of canned fruit.

In canning or preserving, the principle is to store away the food where it will be free from bacterial action. To accomplish this, the food is heated to the boiling point, and held at that temperature until all the bacteria and their spores (egg cells) are killed, and then it is put into hot sterile jars or bottles. The jar or container is then made air-tight. With glass jars this is done by having tight-fitting

covers which fasten down with a screw or lever fastener, and are made tighter by using new rubber rings for seals. A jar from which the liquid leaks out will leak air and let bacteria in. With tin containers, the cap is soldered or sealed tight. The sealing wax used for catsup bottles may be used for cans.

Containers for jellies and preserves are not made air tight, but are sealed with paraffin to keep mold from forming. This use of paraffin is satisfactory, and is all that is necessary, as the large amount of sugar used in the preserving makes the growth of bacteria impossible. Salting and pickling preserves the food without any sealing other than to keep the mold away. Bacteria do not grow in a salt medium.

Wash and wipe dry all empty glass jars and covers before putting away; fit covers to the jars, and put them away together, so as to save time in the canning season. Old rubbers often become soft and stretchy, and are one of the chief causes of fruit spoiling. Always use new ones or tested old ones. To test, press the ring of rubber into a fold, then reverse fold in exactly the same place. A good ring will not crack.

To reduce the expense of purchasing containers, dry as much food as possible.

Stone jars or crocks are used for storing eggs in water glass or liquid sodium silicate. The eggs must be clean, but unwashed. Water glass is purchased in pound bottles as a syrupy liquid, and used in the proportion of one pound of liquid glass to ten quarts of cooled boiled water, which is poured over the eggs.

GARBAGE STORAGE

Garbage Containers.—Garbage containers should be water-tight, vermin-proof, and have such tight-fitting covers that it is impossible for dogs and cats to push them off. In the winter it is desirable to keep the contents from freezing; for this reason, wooden pails are sometimes used, but they will never be proof against leaking or freezing, and have many disadvantages. Heavy galvanized pails are the most common, and, fitted with tight covers, are serviceable.

Enamelled pails make the best indoor garbage cans, as they are easily cleaned, and are more sightly if kept in the kitchen; but as they chip easily they are not suited to hard outdoor service. Some of the more modern enamelled waste containers are made with a foot

lever which will raise the cover, leaving the hands free to empty the garbage. These containers were first made for hospital waste receivers, but they are especially good in the small kitchen, where the housewife does her own work. It is a good plan to have a pail for the house, because it will eliminate much wasted time and effort in walking to the back porch or to the back gate with every little bit of waste. It is unsanitary to keep waste in an uncovered pan, waiting to be emptied, as such storage of garbage is apt to draw household pests, such as flies, ants, and roaches. By way of disinfecting the garbage, or attempting to make it distasteful to vermin, several of the cans are made with sifters in their lids. The disinfectant or insecticide is put into the cover, and the jar of putting on the cover shakes out a little powder on to the contents of the can. It is a better principle to keep the can clean, and empty the contents often.

One type of garbage container which is non-freezing in ordinary weather and proof against animals is set into the ground (Fig. 135). A cement well is built to receive the garbage container. A foot lever raises the cover of the well and a bail handle attached to the vessel is always on the outside of the pail, making it possible to lift the container to empty without any contact with the garbage.

Garbage bags are made for garbage containers. For the housewife who is doing light housekeeping and has only a little waste this will be satisfactory. The bags are of somewhat the same material as those for paper bag cookery and for laundry bags in hotels. They

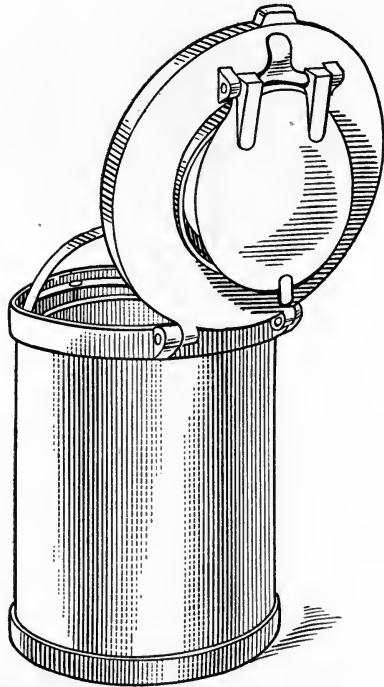

FIG. 135.—Underground garbage container.

may be bought by the hundred or gross. Racks may be purchased to hold the bag in place in the sink, and as the bag is made with holes the water drains off into the sink. The bag and contents are disposed of together. Cut circles of paper put into the garbage cans are of great advantage; or a newspaper opened out and put in without cutting often serves the purpose. They keep the can so that its cleaning amounts to very little.



FIG. 136.—One type of incinerator.

Incinerators represent a modern way of disposing of household garbage. A small incinerator was first made which fitted into a stove pipe. The plan was that the hot air as it passed up through the flue would slowly evaporate the moisture from the waste, the housekeeper being careful to have the least possible amount of moisture because of its great hindrance in carbonizing the garbage. After the garbage slowly dried, it charred, and then could be used as fuel.

Incinerators are built in large institutions, or may be bought ready to set up like a stove in the kitchen of small houses or apartments (Fig. 136). The most efficient types burn, without odor and without smoke, a quantity of garbage at one time. Gas is considered the best fuel because of creating very intense heat. A common size of incinerator has a bushel capacity, and as they burn

a quart or a bushel, one burning of garbage per day is all that is necessary. The incinerator in the kitchen is a garbage container as well as a garbage burner.

In places where the collection and utilization of garbage presents a difficulty, the incinerator is a proved solution. Its purchasing cost for the smaller home ranges from \$60.00 to \$75.00; its maintenance is not a large expense.

Garbage Utilization.—In rural or urban districts, the garbage is often collected to be used as food for the pigs. This method, under sanitary control, is one of the best for garbage disposal. Sufficient stress, too, has not been laid on the value of garbage as a fertilizer for the garden. If it is emptied into a pit, covered with a thin coating of lime, and the whole left buried for two or three months, it becomes an excellent fertilizer for the garden. The saving of fat, either by the individual housewife, or its recovery from garbage by the community, is of the greatest importance in national economy.

SPECIAL STORAGE CLOSETS

Broom and Cleaning Closets.—To plan for building a broom closet, arrange the things as they are to be stored when the closet is finished. Measure, and literally build the closet around them. The result will be that brooms and brushes with long handles will have a place to hang, shelves will be a proper distance apart to hold the jars, boxes and bottles. There will be a hook for every brush, the shelves and hooks will be labelled, and a drawer or two may be planned for clean cloths. The closet ought to be just deep enough to take the sweeper or vacuum cleaner, because a deep closet is less likely to be kept in good order, with its contents classified.

Broom closets should be high and narrow, and cleaning closets should have shelves and hooks. If the space makes it desirable, these two closets may be arranged separately. The idea is to have a special place for the various kinds of equipment so essential to good cleaning, and so unsightly when standing about. Besides, the cleaning outfit is not suitable to be put in with other things.

Plan such a broom and cleaning closet (Fig. 137) on each floor for a new house, even if some of the closets are small. The larger closet will store those solutions, cloths, and brushes not needed every day. In old houses where such a closet was not planned in the

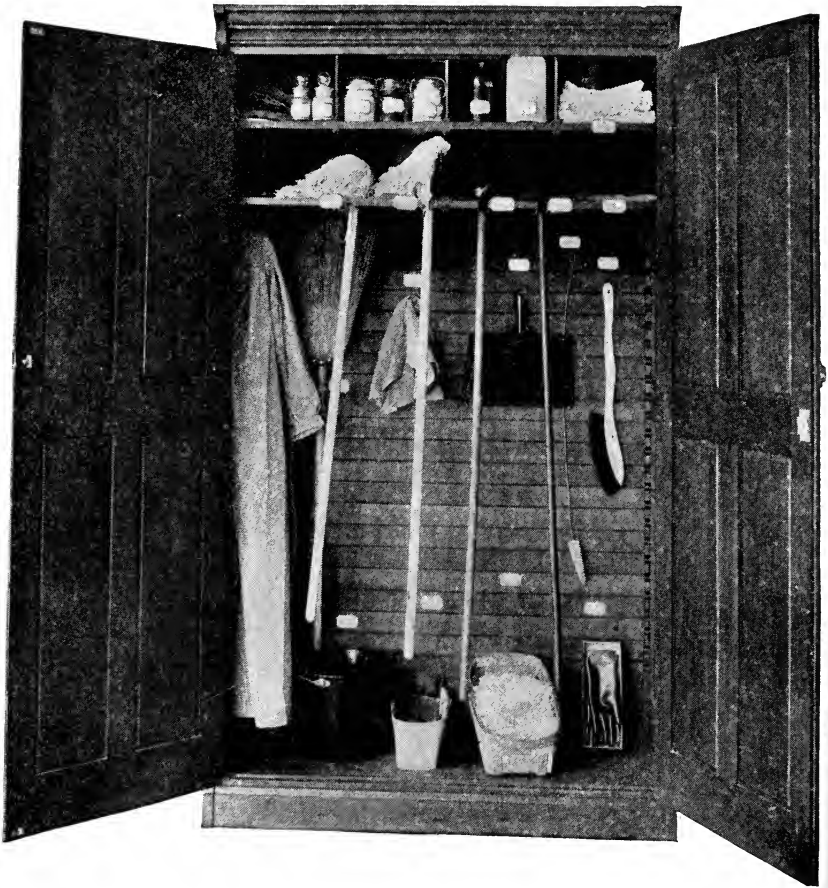

FIG. 137.—An old wardrobe converted into a housekeeping closet. Courtesy of Cornell University.

building, old wardrobes may be used, painting them inside with white enamel paint to make them easily cleaned. White enamel sectional closets may be purchased for broom and brush closets. Such storage facilities may be purchased from kitchen cabinet makers.

Linen Closets.—Linen closets should be planned with the

general idea of being able to classify and to organize the different sizes of sheets and pillow slips, and to have a place for towels and spreads, in fact, a compartment for every class of household linen. It will be a help to list the various things, and then divide and space the shelves to hold each kind of linen.

In some houses, the housewife sees fit to combine linen storage with a sewing and mending room. This is especially desirable when the family is large. A bin or drawer, or better, several drawers permitting classification of the material waiting to be mended, is a help.

As the linen closet needs to be especially free from dust, it should have either a tight-fitting door of its own, or better still, should have some cover provided for the shelves. As piles of the linen material are heavy to lift, the shelves may have drop fronts (Figs. 138 and 139), that is, fronts hinged so that they drop down when opened, which will give the cleanliness of drawers with the convenience of shelves. These shelves make it easier for the housekeeper to take account of stock.

There is quite a difference of opinion among housekeepers as to whether the stock of supplies be used in rotation, by always drawing from the bottom and putting the clean on top, or whether a set of three or four of each type of linen be in constant use until worn out. On the whole, the former seems more desirable, as some fabrics deteriorate with age.

Medicine Closets.—It would seem wiser if the housekeeper could plan her medicine closet for some part of the house other

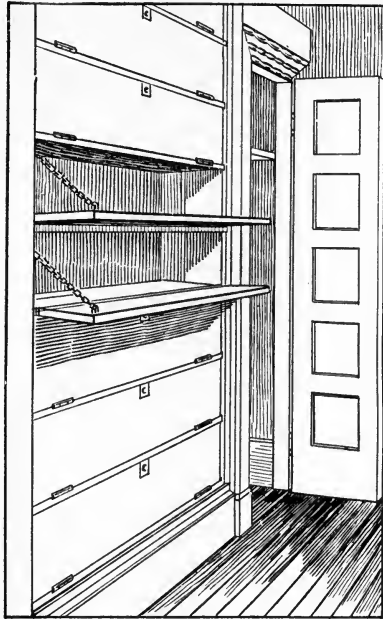

FIG. 138.—Linen closet. Drop fronts acting as shelves—more efficient than drawers, as they keep the linen equally clean, and it is more easily sorted and counted.

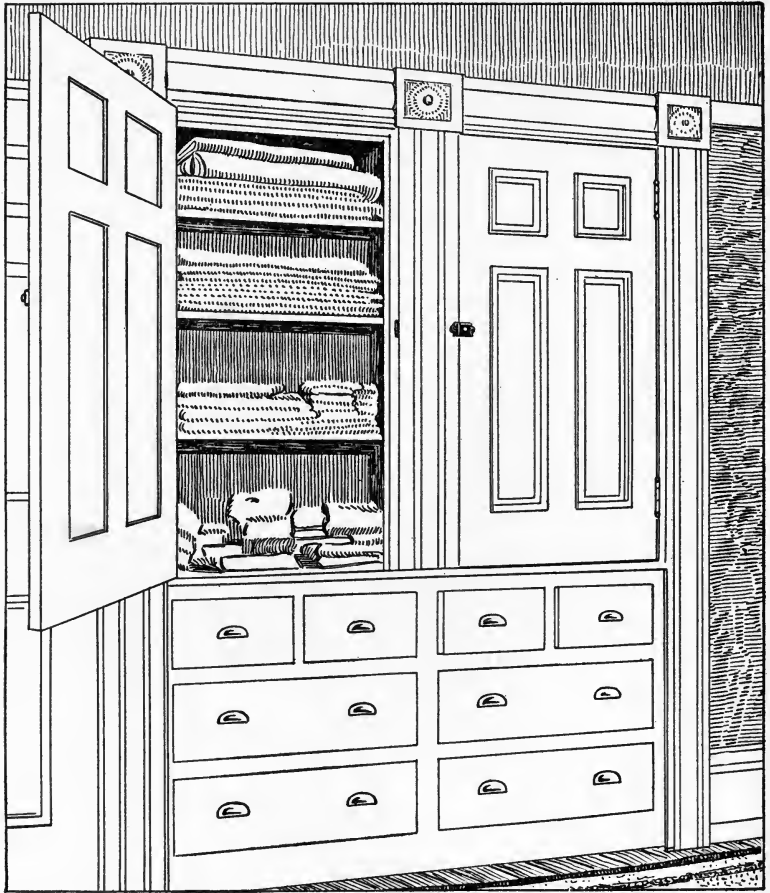

FIG. 139.—Linen closet with good arrangement of drawers and shelves—very suitable for a hall.

than the bathroom. A good place is a shallow closet off the hall near the housekeeper's room. Here it is of service to all, without the disadvantage of being in the bathroom. It helps also to put medicines in a special place, so that there is less likelihood of running the risk of using lotions for medicines and *vice versa*.

For the medicine case, a shallow closet with narrow shelves is desirable, so that the medicine case can be like the apothecary's

shop with single rows of bottles (Fig. 140), each with its label in sight. As many medicines keep best in the dark, the door of this closet should have a mirror or wood panel rather than plain glass.

Some housekeepers think it wise to get a set of standard druggists' display bottles, small and larger sizes, with glass stoppers and permanent etched labels, and keep medicines in them. They give a very attractive appearance to the closet. It is wise to keep poisons like carbolic acid on a shelf by themselves in bottles of an unusual shape, or with a rough outside finish, so that if one went to the closet in the dark, attention would be instantly attracted. Also have a shelf for prescription bottles which may accumulate in large families; they should not be kept indefinitely.

In houses where no provision was made for a medicine closet, either wooden or metal closets may be purchased. These can be screwed to the wall, and will give good service.

Emergency cases or kits are prepared by being fitted out with bandages, gauze, scissors, tweezers, and the various needs for emergencies. They range in size and corresponding cost from small pocket cases to wall closets of the medicine closet size and efficiency.

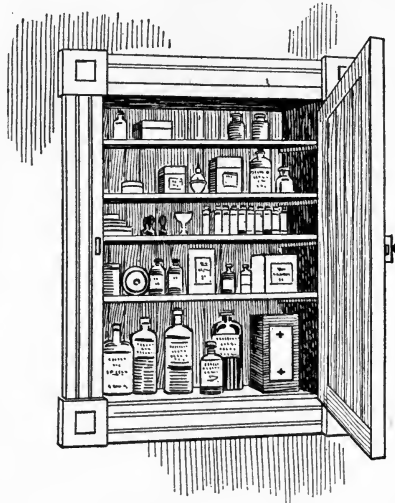

FIG. 140.—A medicine closet.

LIST OF MEDICAL EQUIPMENT AND SUPPLIES

Equipment:

Absorbent cotton
 Atomizer
 Bandages—2 sizes
 1-inch
 3-inch
 Clinical thermometer
 Corks—new; different sizes
 Eye cup
 Empty clean bottle
 Gauge
 Hot-water bag
 Icebag

Graduated glass
 teaspoons
 ounces
 Medicine dropper
 Medicine glass
 Nasal douche
 Old linen
 Piece of clean flannel
 Safety pins—2 sizes
 Surgeon's plaster
 Syringe
 Tweezers

Supplies:

Arnica
 Aromatic spirit of ammonia
 Bicarbonate of soda
 Boracic acid
 Camphor
 Carbolic acid
 Cold cream
 Collodion
 Glycerine
 Hydrogen peroxide
 Iodine

Laxative tablets
 Listerine
 Menthol tube
 Oil of peppermint
 Preparation for burns
 Quinine
 Salt—Epsom or Rochelle
 Smelling salts
 Turpentine
 Vaseline
 Witch hazel
 Zinc ointment

Bathroom, Closet and Equipment.—The bathroom should be complete in its furnishings, and to make it so, there should be plenty of racks for towels; hooks for clothing; holders for glasses, sponge, tooth brushes and soap; a glass shelf; and a mirror. Besides these, a tub seat for a foot bath; a stool low enough to be used as a slipper chair; and a rug which is easily cleaned, not injured by water, and comfortable for the bare feet, add comfort and convenience. A crash bath mat or a cork mat to be used just when stepping from the bath will keep the rug in better condition.

Bathroom Closet.—If the medicine closet is placed in some other part of the house, the bathroom closet may then be shelved and divided more as a toilet closet ready to hold such toilet articles as soaps, tooth pastes, extra toilet paper, towels and wash cloths. There could be a small compartment for nasal and eye douches, and perhaps a shelf for various washes such as listerine, peroxide, and the usual home remedies which all the family use. Tooth brushes are better in the air, so put the holders outside of the closed closet.

Equipment:

Bath brush
 Bath mat
 Bathtub brush
 Clothes brush
 Dental floss.
 Drinking glasses
 Flush-closet cleaner
 Hand brush
 Matches
 Nail brush
 Scissors
 Scrubbing brush
 Shaving outfit
 razor
 strop

Shoe dressing
 Shoe polish pad
 Soap rack
 Sponge
 Sponge rack
 Surgeon's plaster
 Toilet paper
 Tooth brushes
 Towels
 bath
 hand
 Wash cloths

Supplies:

Alcohol
 Bay rum
 Bicarbonate of soda
 Cold cream
 Hair tonic
 Hand lotion
 Hydrogen peroxide
 Iodine
 Listerine
 Porcella or whiting

Pumice
 Scouring powder
 Shaving cream or soap
 Soap
 Soap powder
 Toilet ammonia
 Toilet water
 Talcum powder
 Tooth wash
 Witch hazel

Shoe-cleaning Outfit.—Cleaning of shoes is often done out of the house; but if they are to be cleaned and polished at home, one needs an outfit of a cleaning brush, a daubing brush, and a polishing brush. These are bulky enough to require a box, which takes up considerable room. There may be a difference of opinion as to where this cleaning work should be done. If the bathroom is large enough, there is no reason why the cleaning should not be done there. If the box is the usual blackening box, it has a carpeted top, and may serve as a seat.

In houses where back hallways are commodious, that may seem a better choice, because the time required to clean shoes may mean that the bathroom is in use too long for the comfort of other members of the family.

Tool Closet.—A closet or chest of tools should be provided with a work bench. A list of desirable items follows: Awl; brass hooks; brass rings; chisel—cold, wood; emery paper; gimlet; glue; hammer; hatchet; nails, several sizes; oil can; paint brushes; picture hooks; picture wire; pliers; punch for leather; sandpaper; saw; screw eyes; screws, several sizes; screw driver; shears, heavy; steel wool; tacks, several sizes and kinds; tack puller; upholstery tacks; wire; wire cutter; wrench.

CLOTHING STORAGE

Hangers.—Those garments which are in frequent use will keep their shape better if hung on coat and skirt hangers. The coats should be buttoned to keep the fronts from sagging. Skirts will hang much better if clamped by the band in a skirt hanger. If one is travelling, or is without sufficient hangers for coats, some may be made for coats and dresses by rolling newspapers tightly and tying in the middle of the roll with a string or tape, or in an emergency

with a handkerchief. Make a loop to go over the hook. Half of a wooden barrel hoop, wound with strips of cloth and suspended with a tape in the middle, is an excellent hanger. Two safety pins fastened in each end of a folded skirt band will hold the skirt in good shape.

Dress garments for both men and women, as well as other special clothing, will have suitable protection if slipped into an old night-dress, or a cambric or percale slip, or cover bag made for the purpose. The material should be light so that its weight will not crush soft laces and dress fabrics. The sleeves may be stuffed with tissue paper.

To Put Away Clothing.—The first essential in storing clothing is cleanliness; therefore all spots should be removed, especially from woolens. Muslins and linens should be washed, not starched, and left rough dry. Silks when possible should be rolled. The thoroughly clean garment should be packed in moth-proof containers, which range all the way from tight newspaper wrappings, and sheets of tar paper, to tar-paper bags and cedar chests. Pepper, tar balls, camphor, cedar chips, or a combination of cedar, camphor, and tar, such as is sold in packages, are usually enclosed with garments as an extra precaution. The object of these materials is to keep out moths and other insects, as they are pungent and irritating to the air passages of the insect.

In wrapping clothing, the essential point is to overlap the wrappings to avoid having cracks. This may be done by interweaving sheets of newspaper so that the journey of the moth would be decidedly roundabout. Newspaper caps can be fitted over the ends, and then when tied tightly one has a bundle which may be considered safe. Packages, boxes, and even closets, can be sealed with strips of paper. This is advisable in houses where, for some unknown reason, there is much trouble with moths. In city homes where one is especially limited for room, it may seem advisable to send large pieces such as furs and rugs away to be put in cold storage. The cold storage of clothing is like the cold storage of food—the temperature so low (34 degrees) that bacterial life is inactive.

Shoes, when not in use, should be stored where there is a circulation of air, and should be put away clean and dry (Fig. 141). Leather will resist a certain amount of water, but needs to be dried

carefully in order to maintain its pliability. If it is dried too close to heat, as is so often done with shoes, the leather becomes hardened and parched beyond repair. Leather dries in the air,

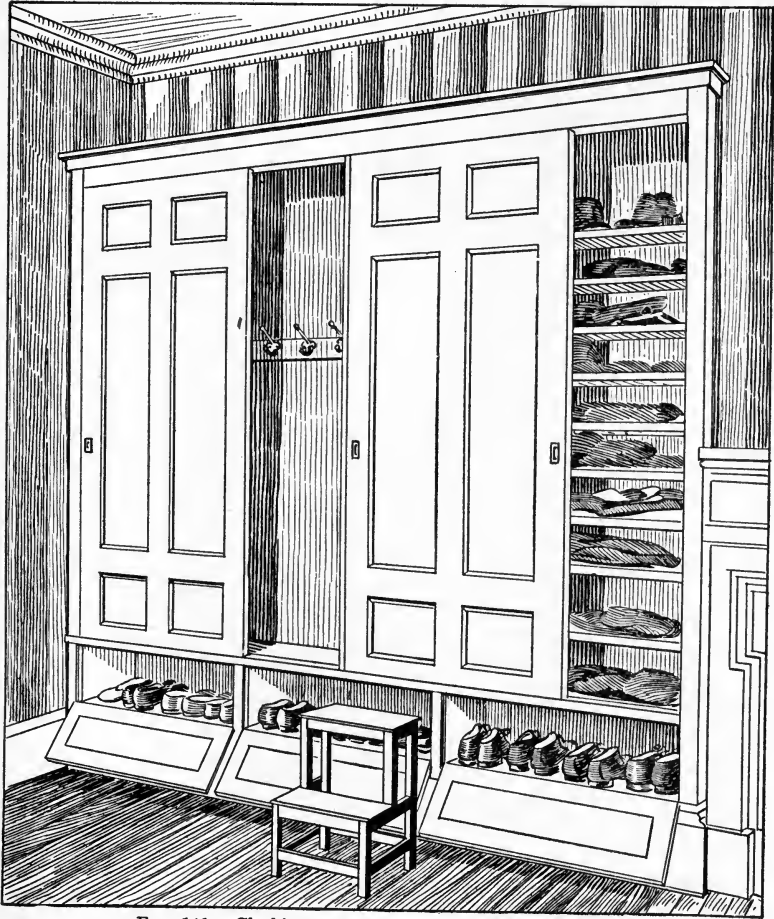

FIG. 141.—Clothing storage, with special place for shoes.

and needs redressing with some oil mixture. This is especially so with shoes that have hard wear.

Keep shoes in shape by stuffing with paper, or by using a shoe

tree; a corset steel will make a good shoe-tree substitute. Two pairs of shoes worn alternately will wear longer than if they are worn consecutively.

Clothing Storage Closet or Boxes.—Moths and other small pests, such as silver fish and buffalo bugs, may do great damage to clothing, blankets, etc., when in storage. Often the housekeeper stores these articles in old trunks that perhaps have served their first use for travelling. This kind of storage seems satisfactory because the trunk affords a means of locking up the extra material; but the disadvantage of such an old trunk is that it may not be tight enough to be vermin-proof. Special chests, either cedar lined or all cedar, furnish a much better means of storage. They are usually tongued and grooved, so the cracks are virtually sealed. The cover has a heavy molding and when in place puts the contents into a closed and sealed box.

Closets in the attic or top floor are often planned on a large scale especially for summer storage of woolens. These are sometimes cedar lined, have sealed floors, and the door closes against a molding, so that when entirely packed it is possible to seal the door and thus make an air-tight room. None of these closets can insure proper care of the clothing unless the clothing is first thoroughly cleaned, and the closet cleaned and properly sealed. Under these conditions any well-made closet, even if without cedar, may be a good storage closet. Closets have an advantage over trunks, for they can take large garments, even rugs, robes and heavy coats, and suits without folding. It is far better, for example, to hang furs, than to fold them and pack tightly in a box.

Sewing materials, such as extra pieces of goods, odd bits of trimming, hooks and eyes, buttons, tapes, and many other things needed for mending and marking are best stored near the sewing machine and its working center. This place may be in the housewife's bedroom, or the nursery, but best of all in a room set aside as a sewing-room. This room may, if necessary, be so planned that it makes an excellent extra guest room; but sewing work really demands its own accommodations.

Every housewife has her own ideas about storing patterns and left-over bits of material, but it would seem that had she ever tried shelves with hinged drop-fronts (like a linen closet) or drawers, she would not consider bags. With bags, too often the whole contents

must be emptied to find the thing desired. If a case of small and shallow drawers were built on one side of the room, they would furnish excellent storage for all sewing materials that are small but can be so easily classified. In a chest of larger drawers can be kept pieces of materials, trimmings, bolts of belting and braid. Besides these, there is needed at least one drawer for collecting garments for mending, and another for stockings for mending.

Sewing cabinets (Fig. 142), tables, and baskets are good in a small way, but if a housekeeper is to do much sewing, altering and mending, she will need more storage room. An old chiffonier will serve the purpose well for the larger things, one drawer being partitioned off to make bins for the small necessities. Boxes of different sizes will serve as bins, or there may be made many small partitioned spaces (perhaps by the man of the house), which will give additional chance for dividing and classifying sewing supplies. Wire nails one inch long, driven at regular intervals in the bottom of a drawer, will keep

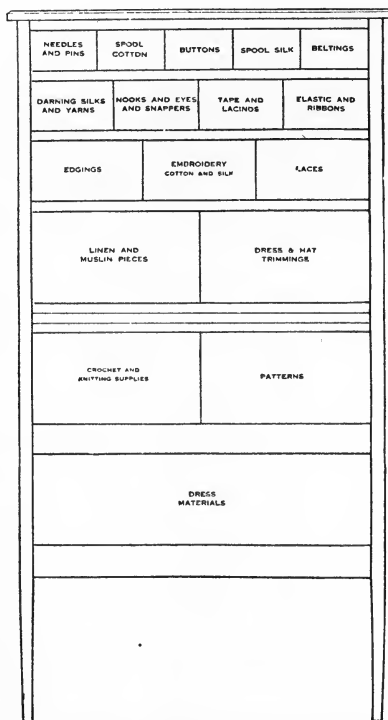

FIG. 142.—Caroline sewing case. Designed by Mrs. W. H. Wadhams, New York City.

spools in order ready for instant use, because the size of thread is shown. (For Sewing Supplies, see chapter on Supplies, page 143.)

STORAGE OF ARTICLES OF PERSONAL USE

There are many personal articles of more or less daily use about the house, the convenient care of which is a problem. Such articles as books, magazines, music records, athletic goods illustrate this

problem. Much of the daily work of the home consists of putting these things in order. There are two parts to the solution of this problem: one part is to provide a regular place for keeping such things; the other is training children and older persons, as far as that is practicable, to put things back after using them. Two storage problems in this field are presented: music and athletic goods.

Music cabinets can be bought or made for storing sheet music, phonograph records, and player piano rolls. So much music is bound with only a paper back that shelves seem more suitable than racks on which the music must stand book fashion. Have many shelves close together rather than two or three far apart, for then fewer sheets may be stored in each section. The music is easier to find, and can be classified according to kind, or to author. Many find it wise to bind up sheet music with twenty-five or more sheets in a cloth book-binding, with an index page. Phonograph records are conveniently kept in albums.

Sport or athletic goods are usually to be used out of doors, so it is better to plan a good closet for such things on the first floor or in the basement, or perhaps off the vestibule. They need to be kept dry and clean, and the space should be provided with hooks to hang tennis rackets and special clothing, shelves to lay gloves and nets, and small drawers or boxes to hold balls and other small articles.

TO CLOSE THE HOUSE

The house itself should be thoroughly clean, so clean that there is no chance for particles of dirt and dust to attract vermin. All portieres should be taken down, brushed and put away from dust and moths. The lace or net curtains should be washed and left rough dry ready to be starched, stretched and finished. Bureau drawers should be gone over, woollens aired and put away from moths, and left in order.

To Store Silver.—When storage of silver is spoken of, one usually pictures a safe deposit vault; but whether stored there or in the house, the housewife should take some special precaution to avoid scratching. Of recent years the silversmith has delivered silver in cases or in cotton flannel bags. It behooves the housekeeper to keep these cases and bags, because of the great protection they offer in the storing of silver, whether it is placed in the side-

board from one special function to another, or stored away in a chest or vault.

If the housewife has no such cases, there can easily be made or purchased special bags (Fig. 143), to fit the different pieces of silver; or one may cut squares which may be used for wrapping each piece. The jewelers use red, gray, or green canton flannel,

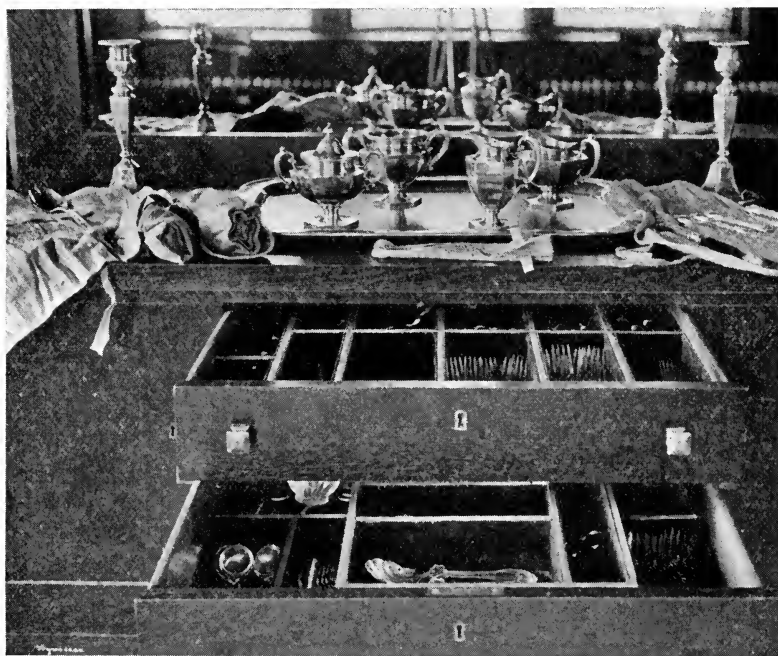

FIG. 143.—Storage of silver. The storage bags are of canton flannel. The drawers are lined with canton flannel or velvet.

not white, because the chemical that has bleached the white canton flannel often causes the silver to darken. Cases should be made for flat silver with separate pocket sections for each piece, so that when the small pieces are rolled there is a layer of canton flannel between pieces; with tape sewed to the case, it makes possible a neat, compact roll. If the drawer, chest, or bag has in it a few pieces of gum camphor, the tarnish will not form so soon.

Rugs should be cleaned, and if they are not to be in use for some time, they should be rolled, and put away as woolens. Rolling rather than folding will prevent creases. In homes where there are many fine rugs, they may conveniently be wrapped and left on the floor in one of the rooms, without carrying up or downstairs. This does not afford any special safety against fire, so it is often considered an economy to have valuable rugs cleaned by the expert cleaner and placed in cold storage, in a fireproof storage warehouse.

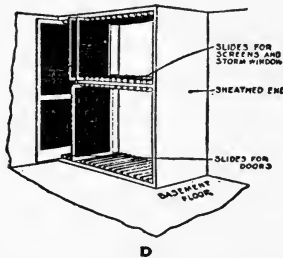

FIG. 144.—Racks for window screen storage. Courtesy of Charles E. White and *Ladies Home Journal*.

Upholstered furniture should have a thorough brushing and beating with a soft beater, or should be cleaned with a vacuum cleaner—a more thorough method. The furniture should be covered with dust sheets and paper, too, as a special precaution against moths.

Beds should be left well aired, unmade, and with the pillows covered with a clean sheet.

Pictures and Chandeliers.—Place fine nets or muslin over the pictures that have no glass, as is usual with oil paintings, and over those that have gilt frames. Lemon oil, or any very thin oil, may be wiped over the gilt chandeliers and brass bedsteads, as it prevents the shellac from hardening and cracking, or perhaps peeling off, and rust spots from forming on the unprotected metal.

Cereals and Food Containers.—If the house is to be closed for a long period, it is wise to empty out such foods, and leave the containers empty after a thorough scalding and airing. Should cereals be kept for a short time when the house is closed, be sure that the containers are tightly closed. Put candles and matches in tight tin boxes.

Stoves may be treated with oil, or may be well blackened; the latter should be done so well that the blacking becomes really an enamel coating. Gas stoves should be left with a coat of black enamel stove paint, a fireproof kind which is made especially for stoves.

Windows.—Papers placed in the windows before closing will tighten the cracks and prevent the sifting in of dust. A little light is good; but a window with no shutter or shade exposes wallpaper,

rugs, and all furnishings to an unnecessary fading from the effect of the sunlight.

Window screens should be taken out, cleaned, wiped with oil or kerosene and stored in a dry place (Fig. 144).

Rubber goods deteriorate very rapidly in heat and sunlight, therefore they should be kept in a cool, dark place. Where two thicknesses of rubber are likely to stick together, they should be wiped as dry as possible, or hung to dry, and dusted with talcum powder. If oil has been used with rubber, whether a syringe bag or automobile tire, it must be entirely removed, or a soft spot will form in the rubber. Kerosene dissolves rubber; if used to clean it, as in the case of a wringer, the kerosene should be washed off immediately.

Iron and steel should be wiped over with kerosene or sweet oil, using always a liquid oil rather than lard or heavy grease. A salty grease like kitchen fat will produce rust and should not be used.

Flat-irons are best cleaned and waxed, even to their handles, and then wrapped tightly in newspaper.

Electric Motors.—All motors such as may be found on the washing machines, ironers, vacuum sweepers, should be stored where it is very dry; it is wise to take them out of a cellar or basement and put them in the upper part of the house. Motors that have absorbed moisture will spark and cross circuit, and to overcome the difficulty will have to be sent to be rewound, a renewal that may cost ten dollars or more.

Plumbing.—All flush closets and traps under wash basins and other fixtures should be thoroughly flooded with strong soap suds, carbolic acid water, or hot washing soda solution. Soda is most generally used because the housekeeper is familiar with it. It is to be used in the proportion of one to two pounds of soda to a gallon of water. If this is done at the last, before leaving the house, it will mean that this soda water has not only gone down the pipes, but that some of it has remained in the traps. In order that this water in the trap under basins may not evaporate during the absence from the house, the stoppers may be put into the waste openings in the basins; but never do this unless the water is shut off at the main inlet pipe. This will prevent any chance of a flood by a sudden forcing of the faucet. Another way to prevent evaporation is to paste a heavy paper cover over the tops of the basins; but the best way is to pour about one-half cup of sweet oil into each trap.

Oil should also be put into flush closet traps. This will float on the water that is in the trap, act as a seal, and prevent evaporation. Be sure that the house inlet pipe is turned off and the house pipes drained, so that no one can draw water, or no faucet be forced open by pressure from the main, and so that a broken pipe, as might occur in the winter, could not flood the house.

TO ORGANIZE STORAGE

Tags and Labels.—Food containers, all packages whose contents are not self-evident, and especially every medicine bottle, should be carefully labelled. It saves time and insures proper use; lack of labels with medicine may lead to serious consequences.

The housekeeper will find in various stationers' stores labels and tags of appropriate shape and size, and often specially designed for various household uses (Fig. 145). Books of household labels are a convenience because they are printed, and save writing the names. Key tags for closets, larger tags for jugs and boxes, and even little metal holders which can be attached to the drawers, are obtainable in the market. It will be found the greatest saving to purchase the best kind of tags, write names

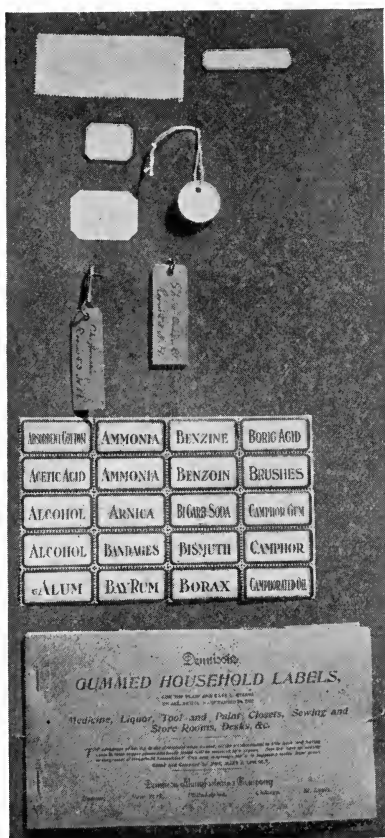

FIG. 145.—Various kinds of labels for different needs.

plainly, cover the names with shellac to preserve them; and then to take time to organize and label all containers, shelves, closets, and drawers, whose contents can be better controlled thereby.

Filing Boxes.—Filing, pamphlet, and storage boxes may be purchased in various sizes and shapes, and are without doubt the best way to classify and tabulate all such things as business papers, receipted bills, photographs, clippings, and special copies of magazines and newspapers.



FIG. 146.—Housekeeper's desk.

Card Catalogs.—The card catalog method of filing information is most convenient. The cards are quite inexpensive if bought in hundred lots, and by means of several boxes with thumb index tabs, one may have an effectively organized set of helpful references. Addresses are best kept this way; recipes are well arranged by divid-

ing into various sections such as soups, meat, salad, etc. Housewives who have used the card catalog method often arrange their budget and expense records on cards; some even list the winter and summer storage together with the type of article, and keep account of supplies and materials, together with the cost, purchased in a year; cards also serve to take account of stock in large supply closets. The small 3 x 5-inch cards and the larger 5 x 8-inch cards are both desirable.

Slips of paper about 3 x 5 inches in size, arranged in alphabetical order and kept either in a box, or in groups in envelopes with a group label on the envelope, make a very inexpensive way of using the card record system.

Business Desk.—The housewife should have a business-like desk for her business books, records, papers, and perhaps a typewriting machine, as well as a place to sit and write. The desk drawers will furnish most convenient storage (Fig. 146).

Small closets, perhaps in a panel in the woodwork of the library, den, or hall, will make excellent storage space for writing paper, pencils, ink, glue, blotters, etc.

Wrapping paper and string are wanted in so many places that it seems wise to plan several small storage places in different parts of the house. Drawers have been used successfully, but because it is a compact way, suitable for the needs of doing up bundles, a paper and string bag has proved very satisfactory. Instead of making the usual bag drawn up with a drawstring, a shaped bag is more convenient. One and one-half yards of cretonne will not only make such a bag, but will allow for a pretty matching of the pattern, even if the pattern is large. Any plain material will cut to better advantage but may not be so decorative. A roll of wrapping paper and a ball of string, arranged as in stores, may be placed at some convenient point in the house, as in the mending or sewing room, or in a large kitchen.

SUGGESTIVE QUESTIONS

1. Draw a diagram to show how your kitchen table may be made into a kitchen cabinet for your home kitchen.
2. Plan a linen closet.
3. How may labels be attached to glass and tin containers?
4. Make a list of contents to be put on door of the closet containing tools.

5. Make a diagram of a cellar showing best places for fruit and vegetable storage.
6. What rules should be observed in putting away clothing?
7. How would you store curtains through the summer?

REFERENCES

- CHILDS, GEORGIA B., THE EFFICIENT KITCHEN. McBride, Nast & Co.
FREDERICK, CHRISTINE, THE NEW HOUSEKEEPING. Doubleday, Page & Co.
MACLEOD, SARAH, HANDBOOK OF CLEANING. Harper & Bros., New York.
TABER, C. W., THE BUSINESS OF THE HOUSEHOLD. J. B. Lippincott Company.
WHITE, CHARLES SUCCESSFUL HOMES AND HOW TO BUILD THEM. Macmillan Co.

CHAPTER IX

CLEANING AND CARE OF ROOMS, BEDS, BATH-ROOM, KITCHEN, METALS

A CLEAN house is a great joy, is a sanitary necessity, and reflects credit on the housekeeper, provided she has her work so organized that she does not spend her entire time and strength doing it. Time and effort are the real test. When the housekeeper makes a study of this department of her business, she finds labor-saving tools and many short cuts in method possible, which give as good results, sometimes better than the old way, and accomplish the work in half the time. Labor-saving tools are not necessarily tools with much mechanism, or a motor to do the work, while the housekeeper reads or visits; they are often hand tools which are fitted to the task they are to perform. A soft, spongy, rough-weave dish cloth is no more costly than a piece of smooth towelling, but is a great deal better dish cloth. The rougher material washes and wipes better. It is only a question of getting the round peg in the round hole. Cost in money is really little, but the real cost is in mental exercise. Let the housewife read, investigate, and be willing to try a new method until she proves that it is better or worse than her own.

Under Equipment and Labor-saving Appliances, page 84, has been discussed the requirements of good tools, suitability for their work by their shape, size, and ease with which they may be handled and cleaned. But what saving is the tool if the method is poor? The "head will save the heels" by studying methods of work; and that is the problem of this chapter on Cleaning.

Cleaning involves a mechanical rubbing, often combined with the chemical dissolving of dirt, grease, or oxides of metals as is seen in the tarnish of metals. It means gathering dust into a cloth without spreading it; washing with soap and water to cut the grease which holds the dirt; rubbing with oils and polishes and abrasive materials to produce a bright, shiny surface.

Everything in the house must be cleaned, and many things have finally to be renovated (see chapter on Cleaning and Renovat-

ing, page 273. The cleaning of one room is not particularly different from another; it is therefore best to consider how to clean the different groups or types of furniture or furnishings. In that way the cleaning of the whole house may be studied. The short cuts of experience are often the greatest time and labor savers, and are not evidences of slackness, but of efficiency. Often the shortest way is the best.

CLEANING OF ROOMS

General Rules for Cleaning a Room.—Dust and remove or put under cover small articles and bric-a-brac.

Dust or brush furniture; if small, remove from the room, if large, cover with a dust sheet.

Shake and brush curtains and hangings; remove from the room, or pin in dust bags.

Roll up small rugs and remove from the room to clean; if large, sweep and fold back the edges towards the center.

Dust ceiling and walls.

Dust window shades.

Clean radiators.

Dust closet floor.

Dust floors.

Dust doors, baseboard, and other woodwork to the floor and baseboard.

Clean windows.

Clean chandelier.

Wash globes.

Wash mirrors.

Wipe pictures.

Polish floor.

Return rugs, furniture and bric-a-brac.

Polish brass and silver unless all are done on a special day.

The question arises, Shall all things that can be moved, be taken from the room, or shall the dusted bric-a-brac stay on some cleaned table or bed, covered, and only the small pieces of furniture that stand on the floor, in the way, be removed? Time allowance will perhaps answer the question. If a maid has many rooms to clean in a specified time, she cannot take everything out. A tray for small articles will help a great deal; and to cover after dusting will also save time, because less dust gets on the furniture or fur-

nishings. For a thorough cleaning (Fig. 147) remove as much from the room as possible, because in the end much handling is avoided, and besides there is the handicap of having to work around things. On cleaning the things that are left in the room, various routines of work may be employed, but a good general rule is to dust high things first, then lower ones, taking everything in order. In a bedroom, the bed brings in a different problem; but if the mattress and springs are brushed, and the bed made up before the



FIG. 147.—Room ready for sweeping.

really dusty work is started, it can be used to hold small ornaments, and then kept thoroughly covered during the cleaning process.

Dust covers should be freely used during the cleaning process. (See *Cleaning Equipment*, page 120.)

Dustless Sweeping.—In sweeping try to keep from flirting the broom, as this throws the dust about unnecessarily. There are several “dustless” ways of sweeping, by moistening the broom and shaking out *all* the water before sweeping; by sprinkling damp, left-over tea leaves or bits of moistened paper on the carpet, because these toss ahead of the broom and moisten and gather up the dust; by spreading moist sawdust on tile or linoleum floors; and by

using a broom bag over the broom, or some prepared dustless sweeper on wood floors. The moistened broom is the least work, but unless one is very careful the broom is used too wet, and soon the dust is made into mud which when spread by the broom dulls the carpet or wood floor. The dampened paper is a cheap, satisfactory method and does no harm to the rug or carpet. Sprinkle a newspaper as clothes are sprinkled, and then tear into bits and scatter over the floor; it need not be over the whole floor, but here and there in small quantities. In homes where the vacuum cleaner is used daily or weekly, much dust and dusting have been eliminated. There is less shaking of rugs and almost no whipping of upholstery and drapery. Vacuum cleaners will not, however, remove dust films from wood-work, or haze from windows and mirrors, or dust from ornaments, so some cleaning still remains to be done by hand. (For vacuum cleaners see *Cleaning Equipment*, page 122.)

Dustless Sweepers.—(See *Cleaning Equipment*, page 121.)

Dusting.—A good duster is any soft, clean, non-scratching and non-linting cloth. A good dusting stroke is one that wipes and at the same time gathers the dust into the cloth. Cheesecloth is a good material for all kinds of dusting; old silk makes a soft duster, but cheesecloth, if clean, will do as well. (For cleaning cloths, see *Cleaning Equipment*, page 118.)

Dustless dusting is quite like dustless sweeping. A soft cloth, one that wrings dry easily, may be wrung out of very hot water, shaken to let out the steam, and it will make an excellent dustless duster. A tablespoon of kerosene added to a quart of hot water, from which the duster is wrung, will make a duster as satisfactory as the more expensive ones for dusting all wood surfaces. Of course, no oily duster should be used on wallpaper or wherever the oil may make a mark.

To Wipe Walls.—Either painted or papered walls need wiping, and because a soft duster gathers dirt without scratching, plan to use a long-handled, soft hair brush or outing flannel bag on a broom. Wool brushes are sold for the purpose, but they are expensive, need a great deal of care to wash and keep clean, and their efficiency does not warrant the time and effort cost.

Wallpaper may be easily marred by hard rubbing. Use a soft, perfectly clean cloth, like outing flannel, and rub with a very even stroke and very little pressure. Rubbing hard blurs the pattern,

wipes off gilt, and often roughs the paper so that a spot results. One method for spotted or sooty paper is that used with soft stale bread by cutting away the hard scratchy crust, and using a fresh part of the inside of the loaf as fast as it soils. Putty erasers and prepared starch or dough cleaners can be used, but unless one has much time and more patience to do it evenly, one ought not to begin. The results are not very satisfactory, and, too, all the cleaner must be removed. The starch and dough cleaners may draw ants, flies, silver fish, and small insects that feed on flour or wheat. Putty wallpaper cleaners may be bought in cans.

Grease spots are hard to remove from wallpaper. A warm iron and blotting paper is one way to absorb grease; but one that is better, in that it will not change the color of the paper, is to put on as thick a layer of fullers' earth or magnesium, or even talcum powder, as will stay on the upright surface. After twenty-four hours lightly brush off the powder. Heavy rubbing will spread the grease that the powder has absorbed. Several applications will do much toward cleaning the paper if it does not succeed entirely.

Other Wall Coverings.—Heavy, embossed paper, burlap, tapestries, and brocades, will hold dust, so the main care is a frequent brushing with a hair brush, or going over them with the vacuum cleaner. Any very special cleaning with gasolene, or detergents, will end in very irregular results, and had better not be undertaken.

Painted Walls.—Painted walls are very likely to be found, at least in the laundry, kitchen, bathroom, and vestibules; besides, many bedroom and living room walls are often painted. Any painted wall in a room where there are grease fumes or moisture will soil quickly and needs to be wiped frequently. Dull finished paint, especially white painted woodwork, may be cleaned with whiting applied with a cloth moistened with very hot water. Clean only a small space at one time, and in straight lines. Yellow soaps, and soda or washing powders, will do rapid work on cutting grease on painted walls, but they will yellow white paints and may change the color of colored paints. Washing powders may be used in cleaning painted walls when the walls are very dirty and greasy, and the one thought is to get them clean, regardless of the effect on the color. Use three to five tablespoons of powder to a pail of warm water. Wash with one cloth and wipe with another, changing for clean water and clean cloths often enough to prevent streaks. Use an up and

down motion and be sure each stroke overlaps the last and leaves no streaks. Enamel painted walls may be washed like a dish, only they require many changes of water and cloths, much perseverance, and a standard for good work. If the wall is to be renewed by painting, the painter's estimate should include a preliminary washing, and then it should be done under the supervision of the housekeeper. No one wants to paint on top of dirt; and on top of grease, paint will not stick.

Calcimine walls are often used, as their first cost is much less than that of enamel paint. This may not in the end represent economy, because calcimine spots easily, streaks with moisture, as steam condenses on the walls, and it cannot be washed or even wiped with a stroke heavy enough to clean.

Tiles.—Wall tile is usually glazed tile, and therefore is easy to clean by washing with warm soapy water. The floor tile is of the same material, but usually it has less glaze and is more difficult to clean on that account, and also because the wear of the foot action and the grit from the soil on shoes leaves a grimy mark. For tile floors, use strong soap suds applied with a long-handled scrub brush or a cloth mop; either tool allows pressure which a string mop does not give. A strong suds for the work may be made by combining 1 lb. washing soda with 1 lb. soap and 4 gallons of water. In houses or institutions where there is much tile to clean, this mixture may well be kept on hand ready for use.

If there is paint on the tile, as is often the case after repainting walls, it may be removed by rubbing with a cloth moistened with turpentine, or if very fresh, by yellow laundry soap and water. If any of the paint has dried and is hard to remove, moisten the cloth in turpentine and then use some abrasive cleaner; the turpentine softens the paint, and the scratchy material loosens it. Stains on floor tile are likely to happen because of the lack of glaze. Should the soda and water solution not remove such a stain, apply to the spot a dilute acid, either oxalic or hydrochloric, using two parts water to one part acid. The acid dissolves a little of the lime in the tile and produces a new clean surface. As soon as the acid touches the tile there will be an effervescing, which shows the dissolving power of the acid. Use only a little at one time and in definite places, then wash quickly with soapy water. Soap will stop the action of the acid.

Painted floors should be wiped up with clear water, without soap if possible. Any soap used must be free from excess soda, and no washing powders should be used.

Hard Wood.—Any hard-wood floor, whether oiled or waxed or varnished, must be kept free from dust and grit if it is to be kept bright and shining, as grit scratches and clouds the floor. Moisture changes the color, oil darkens; so it is wise to keep the floor clean by the use of a clean soft dusting cloth. When a more thorough cleaning is desired, the woodwork may be wiped up with the following mixture, using it much as one would use water to wash up a floor. Use two pieces of cheesecloth, one for washing and one for wiping, and as fast as the mixture soils mix a new quantity. Mix

- 1 quart boiling water
- 3 tablespoons boiled linseed oil
- 1 tablespoon turpentine

For other suggestions for Woods, see chapter on Cleaning and Renovation, page 289.

White Enamel Wood or Metal.—Use clear lukewarm water and with a soft cheesecloth wipe the enamel paint. Two or three drops of ammonia in a pail of water will cut the grease better than soap which yellows the paint. Whiting or Bon Ami may be used on a moistened cloth. Both of these cleaners will leave a dust, but the washing of the woodwork may be done between the sweeping and the dusting of a room.

Care of Floor Coverings.—The floors of a room require daily care, which is the brushing up of lint, dust fluff, thread, or perhaps crumbs as in the dining room. A carpet sweeper may be used for this, or a long-handled dustpan and a small broom. The expense of the last two articles is a trifle more than for the short-handled dustpan which we have been accustomed to use, but there is a great saving to the worker.

For the weekly care of rugs, it is well to take those easily handled out of doors to clean. It means less dust for the worker and less dirt stays in the house. Rugs should be laid face down on the grass or on a platform, or if space does not permit, be hung on a clothesline. Beat with a flat rattan beater, rather than a wire or stick beater, which will cut fine rugs; and then brush both sides. To keep from marring the rug, hang it wrong side down over the clothes line. This

method will give the rug less wear than to shake it, which tears and frays the ends.

Carpets, fortunately, are not so much used as they once were. They represented so much work, that, as has been said in the chapter on Furnishings, most carpets have been cut into strips or rugs. Any carpet, when taken up, can be cleaned like a small rug, and if too large to remove often, may be swept and rolled towards the center of the room from each side, so that as large a space as possible is left on all sides to clean. Any carpet or rug tacked to the floor needs very special care around its edges as too often that part of the rug may get moth-eaten. Of course, a vacuum cleaner may be used so frequently and easily that few rugs or carpets, large or small, need to be taken up. The vacuum does not harm rugs, even the fine ones, as much as the sand and grit are likely to do if left in the rug, as they gradually cut the fibers with their sharp particles.

Matting or any jute or straw covering may be swept, but because of its weave it is very likely to sift dirt to the floor underneath. To sweep matting well and then wipe it with cloths wrung out of hot water to which a few drops of ammonia have been added, should keep this floor covering in good condition; the dirt beneath should be regularly removed, of course.

Linoleums are made of cork, packed tile fashion on a cloth foundation, and the whole is waxed or varnished over as a top finish. Linoleum may be kept in good condition by washing with a soft cloth or brush, and by avoiding as far as possible the scratching of the surface. For a washing solution, use the best white household soap, or better still castile, as too much strong soda will not only fade the colors, but will more or less dry out the surface finish. Linoleums have so much wear and tear from the friction of walking, and from the moving of tables or chairs, that they need care by oiling or waxing. Waxing with the wax described on page 294, under Table Tops, is an excellent way to keep floor linoleum in good condition. Linoleum is a cork composition material and quite porous, so the wax may be rubbed on until it sinks into the pores of the linoleum. This fills all the interstices between the particles of cork, and makes the linoleum surface a solid mass with much greater durability than without it. Milk, which has sometimes been recommended as a cleaner, gives a sticky finish and leaves a sugary covering on the linoleum to attract flies and insects, perhaps vermin.

If the linoleum is varnished or shellaced, wipe it with the linseed oil and turpentine mixture recommended for cleaning hard woods (page 246).

Radiators.—Radiators and registers are dust catchers because of their situation and construction. A small flat brush comes for this purpose, or a cloth may be folded on a flat stick and used as a substitute (Fig. 148). When cleaning, put a moistened paper



FIG. 148.—Cleaning the radiator.

under the radiator, to catch the dust as it falls down. Registers are often screwed in the floors but these screws are easily removed and the register lifted out; then open the shutter and wipe the fans of the register with a moistened cloth.

Window cleaning may be well done by using paper instead of a cloth. This is economy to the worker, as various pieces of soft paper come into the house and can be easily saved for this work;

choose paper that does not lint. Should one prefer a cloth, choose one clean and free from lint. Chamois is a good cleaner but expensive at first cost, and requires care to be kept very soft and ready to do good work (Fig. 149).

Various cleaning mixtures may be used with either the paper or the cloth; clear water, or clear water with a few drops of ammonia, or with a little dissolved washing soda, about 1 tablespoon to a pail of water; and on very cold days, the cloth may be moistened with wood alcohol. This last makes a most efficient cleaner, but is expensive. Soap is less satisfactory because it leaves a film over the surface of the glass. Whiting or some prepared cleaning paste may be used on windows. The idea is to let these dry and then wipe off the powder, which takes off the grease film, leaving the windows bright and clear. If the windows are cleaned by this method it should be before the room



FIG. 149.—Washing a window.

is all cleaned, as there will be a great deal of dust about, especially close to the window on window sills and floors. Try to clean windows when the sun is not shining on them directly, as it causes uneven evaporation of moisture and gives a streaked surface.

Mirrors.—In cleaning mirrors, care should be given to keep the water from the backs. This is especially true with the small hand mirrors, mounted either in silver or celluloid, because in the cleaning there is a chance for water to get in behind the glass. Whiting applied with a cloth which has been moistened with a few drops of wood alcohol or water will make an excellent cleaner and will not need an abundance of water. The whiting method of

cleaning mirrors and windows should be done before the room is dusted; see cleaning of windows, above.

Paint on Glass—Window or Mirror.—Remove by washing with washing soda and boiling water, or with turpentine, in the same way as for paint on tile.

Piano keys are best cleaned with wood alcohol. If alcohol can not be used, it is best to use clear warm water, not hot, and no soap. Should soap be used, choose only a good white soap, as the soda in many household soaps will be enough to yellow the keys.

Marble.—Marble is best washed in soap and water, and wiped dry so as to leave no water stains. To polish marble, rub with a smooth piece of marble and water. Acids of any kind take off all polish, so one should be careful of lemon juice or any acid medicines and acid drinks. Even the spoon that has stirred them, unless rinsed, if laid on marble will be likely to destroy the polish.

Kerosene Lamps.—Fill kerosene lamps about three-quarters full of oil; if entirely full it will leave no room for the expansion of gases, and the oil will ooze out of the screw top. With a soft paper wipe the wick, being careful to remove all the charred particles. This will give a straighter wick than to cut with the scissors. Wash and wipe the chimney like any piece of glass (see page 248), and with soap and water wash the lamp itself. By keeping the wick turned down in the burner when not in use, and by boiling the wick and burner in strong soap suds or soda and water at least once in two weeks, the strong odor so common to kerosene lamps is rarely present. Attend to the lamps in the morning, and then they are ready, for it is a bad plan to do such work after dark.

BED ROOM—CLEANING AND CARE

To Clean a Bed.—The care of the bed is one of the special problems which must be considered in addition to the general methods of cleaning rooms.

The *bed frame* should be kept dusted; if of enamel or wood, it may be cleaned as such; if brass, the use of a little lemon or linseed oil on the cloth will do much to keep the shellac soft and prevent its cracking because too dry.

Springs.—Wipe the springs with a soft cloth and two or three drops of lemon oil. To say use oil, need in no way mean to use enough to grease the mattress. If the springs are box springs,

brush thoroughly to keep free from dust; if one has a vacuum cleaner it will give most satisfactory results. The springs should be dusted often enough to keep free from dust.

The *mattress* should be brushed and beaten with a flat rattan beater at least once a month. The mattress should be aired every day and turned (Fig. 150). Turning a mattress keeps it in good shape and makes it wear more evenly. Each day the bedroom should be thoroughly aired, and at the same time the bed can be aired. Put a chair at the foot of the bed and throw the bedding back off the bed on to the chair—one layer at a time. This will air the bedding and allow the mattress to air when the bedroom is aired



FIG. 150.—Airing the bed.

each day. Two or three times a week take all bedding off the bed, spread it over two chairs so as to keep it from getting on the floor and soiling. There is no need to dangle bedding out of the window, for then it is likely to wipe the side of the house and get soiled. A good way to air the mattress is to stand it up against the wall or draw it over the foot-board.

To Make the Bed.—*Mattress Cover.*—If one keeps a mattress cover on the mattress, as was suggested on page 192, it is not taken off except as the mattress is cleaned.

Mattress Pad.—Sometimes this is large enough to tuck in; if so, it should be stretched very tight so as to be free from wrinkles. More often it just fits the top of the mattress, and in that case the sheet holds it in place (Fig. 151).

The *lower sheet* is put on with the wide hem at the top and with the right side up. To make the bed more comfortable and also to have the sheets wear better, be sure to tuck the sheet in well at the top and to put the sheet on very straight. If the suggestion that is given in the chapter on Furnishings is followed, the housewife will buy her sheets enough larger than the mattress to have at least a half-yard to tuck in on all sides of the bed. If a lower sheet is short, tuck it in well at the top, and there will be enough below to cover the



FIG. 151.—Enamel bed with woven wire spring, imperial edge mattress and quilted bed pad.

mattress even if it does not tuck in. The hospital tuck-in of sheets can easily be used in the home, and after one becomes accustomed to turning in the corners of the sheets it is so easy and makes the bed so much better looking, that one wonders why it has not always been done.

To make the bed hospital fashion, tuck in the sheet at the bottom and the top, drawing it in both directions until very tight; then mitre the corners by bringing the corner of the sheet around the corner of the mattress to the sides of the bed, box fashion (Fig. 152); meantime have the side part of the sheet up on the mattress out of the way, to drop down only after the corner is mitred. Turn



FIG. 152.—First step in making a square corner.

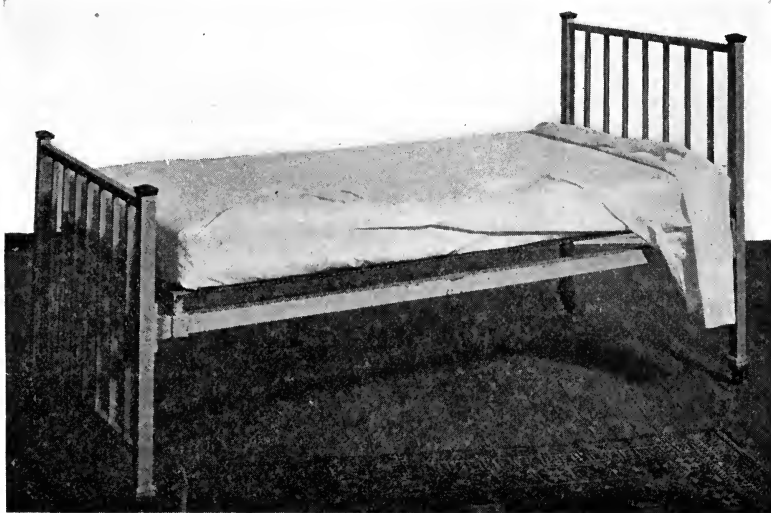

FIG. 153.—Second step in making a square corner.

the tuck-in part of the corner under the side of the mattress (Fig. 153), finishing the mitred corner; then bring down the side of the sheet under the mattress. The lower sheet is mitred at all four corners, while the upper sheet and blanket are done at the foot. Sometimes the border on the blanket helps one to see how the fold is placed because the border as a guiding line goes around the foot of the mattress just as far as it lasts.

The Upper Sheet.—Put this on with the right side down and the wide hem at the top, which brings the turn-back of the sheet right side up (Fig. 154). A sheet that fits the bed well will have a good wide turn-back which protects the blanket.

Blankets.—The blanket comes next to the sheet, and economy teaches that it is better to cut the pair of blankets apart, bind them and use separately. Put the blanket on like the sheet, and when it fits the bed it will come up to the fold of the sheet as it is turned back over the blanket, about ten inches from the head of the bed (Fig. 155).

The *spread* or *counterpane* is arranged differently on different types of beds. The wooden beds give a place to tuck in the counterpane, while the cots and brass beds look better when made up so that less of the bed frame shows. A valance makes a pretty finish and usually the spread meets it in such a way that the bed looks quaint and attractive.

The bed for a sick person is made up like any other bed that has the mitred corners, except that in cases of severe illness, when the patient is quite helpless, a draw-sheet is put on top of the lower sheet. This draw-sheet is a strong sheet folded in half with hems together. These hems are strong enough to resist tearing and sloughing down in the bed as the patient slides down (Fig. 156). Place this draw-sheet so it will come under the heavy part of the body as the patient lies in bed. Stretch it tight and tuck it well under the mattress. In severe cases this draw-sheet takes the place of the lower sheet and the lower sheet becomes more a cover to the mattress, not often changed, even pinned with safety pins to the corners of the mattress. The draw-sheet is easily changed, with less discomfort to the patient; the necessary lifting of the patient can be done by two people, one at each side of the bed, making the sheet like a hammock. It can also be changed without lifting the patient, by rolling the patient first to one side of the bed, while the sheet is



FIG. 154.—The corner finished.

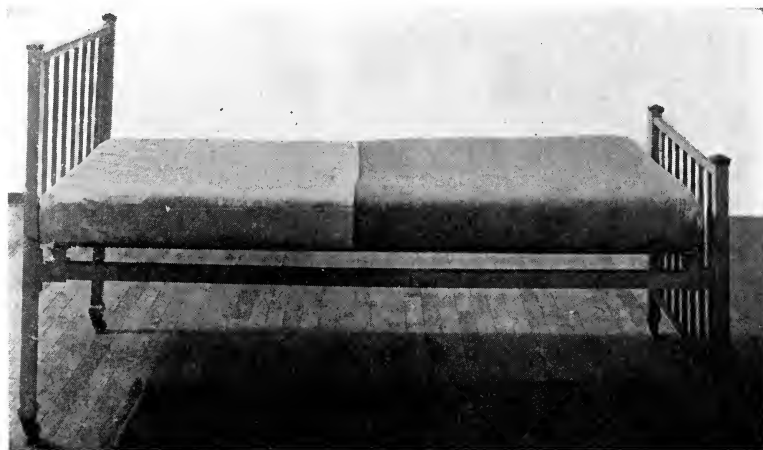

FIG. 155.—Blanket in place showing square corner and sheet protection.

spread over one-half of the bed, then to the other side of the bed upon the fresh sheet, which can then be stretched over the whole mattress. For a long sickness the bed frame may be raised on heavy



FIG. 156.—Bed made with draw sheet.

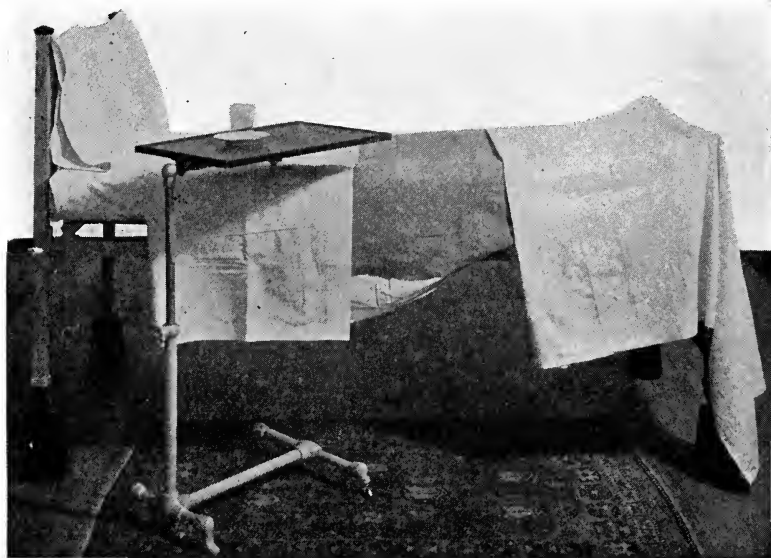

FIG. 157.—A home bed raised on blocks. Also, invalid's bed stand.

blocks, making it much easier for the nurse; blocks of wood with a place hollowed out for the casters so that the bed will be steady are satisfactory (Fig. 157). If blocks are used without a hollow in them, take out the casters so that the bed cannot possibly roll when upon the blocks.

To Prepare Bed for Night.—To save the good day-spread, take it off and fold carefully so it will be ready to go back on the



FIG. 158.—Preparing bed for night.

bed in the morning looking fresh. A sheet or light Marseilles spread for night use may be made up under the day-spread, or a sheet may be spread over the blanket at night to keep it clean. It quite pays to do this as the blanket keeps clean much longer. Turn down the sheet and the blanket by turning back the corner far enough so that the occupant need not feel it necessary to pull the bed to pieces to get into it (Fig. 158).

CLEANING OF BATHROOM FURNISHINGS

Care of Porcelain and Enamelled Iron.—Whether in a bathtub, wash basin, or washtub, porcelain needs the same kind of care. If each time it is used, it is washed with soap suds, rinsed, and

wiped dry, it can be kept in good condition. Water leaves it stained by making water marks, and if the water has iron in it, as it dries it leaves a yellow tint which slowly discolors porcelain. Leaky faucets produce iron rust stains. These stains may be rubbed off with lemon juice or vinegar, provided the stain is not of too long standing. For what seems to be a more permanent stain, moisten a small wad of toilet paper with a few drops of dilute oxalic acid or hydrochloric acid (both poisons) and wipe the stain; then when it is dissolved, wash the porcelain with soapy water. The paper that

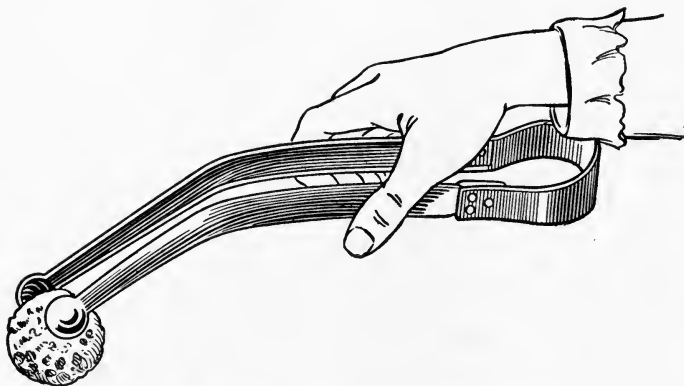

FIG. 159.—Metal forceps for cleaning flush closet.

has been used can be burned, or put into the toilet. To dilute acids, use equal amounts of acid and water; *pour the acid into the water*. The stains from soiled soapy water will clean off with kerosene. No scratchy cleaner should be used with porcelain or enamelled plumbing fixtures. The use of a gritty or scratchy cleaner produces a multitude of tiny scratches which soon look like dirt and wear. Scratches cannot be taken off porcelain. As cleaners, whiting or porcella, applied with a damp cloth, will give the best results.

Flush Closets.—A daily washing of flush closets can be done by a ten-cent string mop, or by soapy water in the metal forceps which have been made for the purpose (Fig. 159). Soap and water is a good sterilizer for every-day work; but for occasional special cleanings, washing powders may be used, or dissolved soda, chloride

of lime, or potassium permanganate. Put any of them down the flush closet, let stand fifteen or twenty minutes, and then flush thoroughly. The washing powders introduce soap and soda together; the chloride of lime may be used directly from the can, or the sediment left from making Javelle water (see page 138) may be used as a disinfectant.

In using potassium permanganate to sterilize flush closets, make up a solution in the proportion of one teaspoon of the crystals to one quart of water. The solution will be a rich purple color, and if it is to be kept, it should be carefully labelled. Potassium permanganate used in the same proportion makes an excellent floor stain; as it dries, it oxidizes and turns a rich brown.

Handles.—All handles in the bathroom—the pull of the flush closet, the faucet handles, the door knobs—should have special and frequent cleaning. The scientist tells us that the hand is a most important link in the transfer of disease germs.

To Clean Combs.—Combs should be regularly cleaned in a sanitary way by soaking the comb in cool water to which a few drops of ammonia have been added. This will loosen the dirt and will not discolor the comb. After soaking about one-half hour, an ordinary brush like a nail brush, will clean the comb finally. Rinse and wipe dry. In a less sanitary way a comb may be dry cleaned by a stiff brush or by one of the little cleaners that may be found on the market. One is made of horse hair, another of white cord, which may be worked back and forth between the teeth of the comb; a third is a little fine steel brush which brushes the comb clean. If any of these cleaners are used, be careful to see that they are kept clean.

CLEANING OF BRUSHES

As hot water and strong soda soaps yellow the bristles of brushes, and soften them, wash brushes by shaking them up and down in cool water to which a few drops of ammonia have been added. Rinse in cool water and shake out all the water possible. Stand in the air to dry with bristles down in such a way that the water will run out of the bristles away from the back. Very soft-fibred brushes had better be hung with bristles down to dry, as the bristles would spread under the weight of the back if stood to dry. This method of cleaning applies to every kind of brush which is used in the house.

METALS

Metals are discolored by water spots, grease films from the air, or from food, soot, and charred food, or by the oxygen of the air and sulphur fumes combining with the metal, producing oxides and sulphides of the metal. Metals are also discolored by other chemicals; as salt discolors aluminum.

Saponifying the grease film is an easy way to remove that kind of soil. Soap and water, or dissolved washing soda and water, are the two agents commonly used.

Friction, such as rubbing with a soft cloth or a chamois, will remove light discolorations and will assist the soap and water just as in any dish washing. Heavier friction, such as is secured by a paste of whiting with alcohol or water, rottenstone, pumice, buffing wheel, ashes, or sand, is needed for deeper discolorations of the sturdy metals, and to remove dirt and grime which have adhered to the metal.

The solvent action of chemicals is quite an everyday way of dissolving oxides and sulphides of the metal. The method is quicker than the friction or saponifying method alone. Some acid foods, such as tomato, rhubarb, lemon, vinegar, or cream of tartar, often furnish enough acid and are safe to use as cleaners. Oxalic acid is a stronger acid, but because it is a poison it should be used with great care. One hesitates to have such things about in any cleaning, and cleaning a cooking and a serving dish with a poison should mean most careful work in order to be assured that no acid remains. The dish should be thoroughly washed with soap and water, followed by a hot rinse, to remove the last trace of the acid.

Concentrated oxalic acid may be bought at the drug store, or if the housewife prefers to buy the acid in crystal form, it is easy to make a concentrated solution by a little more than enough water to cover the crystals. Allow to stand long enough for the crystals to dissolve; use the liquid from this mixture. It is always a concentrated solution as long as undissolved crystals remain in the bottom of the jar. Dilute for use by adding a given quantity of acid to an equal quantity of water. (The acid and Housewife's Metal Polish recipe given below are *poisons*.)

The housewife should consider a number of things in cleaning metals. All metals should be cleaned by the method which means the least loss, the least roughening, and the least expense both as

to time and effort, and the best color as a finish. This is especially true for expensive metals like gold and silver. Chemicals are inclined to leave a very bright glaring metal surface, to which one may apply the term flat, not a rich lustre as the metal at its best should have. Such cleaning often means that the surface does not last so long. Metals, especially silver, are roughened by cleaning as the microscope will show; the aluminum pan method of cleaning silver gives less roughening and shows the flat color tone. Weighing the metal before cleaning and after would be the only way to tell which method is the most destructive to the metal.

With the suggestions given concerning the cleaning of all metals, the following directions may be used for the cleaning of special metals.

Agate.—Boil in soda water to remove grease. Rub with fine abrasive. Wash in hot soapsuds. Wipe dry.

Aluminum.—Wash in hot soap and water. Polish with steel wool, or whiting moistened with alcohol. Dilute acid may be used (page 94). Alkalies darken aluminum. Rinse in hot water. Wipe dry.

Brass.—If badly tarnished, wash in soda solution to remove grease. Clean with housewife's solution:

Housewife's Metal Polish for Brass and Copper.

2 oz. dilute oxalic acid, $\frac{1}{4}$ cup
 1 box electro-silicon
 4 oz. wood alcohol, $\frac{1}{2}$ cup
 1 pt. kerosene (1 pt. = 16 liquid oz.)

Add the acid to the water, instead of water to acid, to avoid its sputtering. Mix the recipe by putting the silicon in a bottle; add the alcohol, oxalic acid, and kerosene. Shake well each time before using.

Clean with dilute oxalic acid, or strong lemon juice or vinegar, and fine abrasive; wash in plenty of water. Polish with rottenstone or with metal polish. Wipe dry with clean soft cloth.

Copper.—Same as brass.

Iron.—Boil in strong solution of soda and water to remove grease. Rub with any good abrasive (use newspaper instead of cloth). Wash in hot soapsuds. Rinse in hot water. Dry while hot.

Wrought Iron.—Rub with a soft cloth devoid of lint; use a thin oil as kerosene, lemon oil, or a prepared mixture, and rub thoroughly.

Nickel.—Wash with soap and water. Polish with whiting moist-

ened with alcohol, ammonia, or water. (Do not use any chemicals or coarse abrasive on nickel.) Wipe dry.

Pewter or Britannia Ware.—Use any *fine* abrasive, as metal is very soft and scratches easily; whiting and oil, rottenstone and oil, fine steel wool and oil. Wash with hot soapsuds. Wipe dry.

Porcelain.—For general cleaning, wash with soap and water. Polish with fine powder (porcella or whiting). Wipe dry.

For Stains.—Iron rust: dilute hydrochloric acid; apply with soft cloth or tissue paper; wash off acid with soap and water.

Other stains: kerosene—apply with soft cloth or tissue paper; wash with soap and water; wipe dry.

Steel.—If greasy, clean as iron. Rub with any fine abrasive (bath brick best); if knives, apply with cork or wad of paper (avoid soaking handles). Wash in warm soapsuds. Wipe dry. If rusty, rub with oil and fine abrasive like rottenstone.

Tin.—Place in hot soda solution for a few (3–5) minutes to remove grease (longer will tend to dissolve the tin, leaving iron surface). Rub with any fine abrasive, as whiting. Wash in hot soapsuds. Rinse in hot water. Wipe dry while hot to prevent rust.

Zinc.—Rub hard with whiting moistened with water or kerosene. Hot vinegar may be used. Wash with hot soapsuds. Wipe dry.

Cleaning Silver.—*Washing.*—The careless gathering of dishes for dishwashing brings kitchen knives and forks into contact with the silver, and subjects it three times daily to the wear and tear of scratches and dents. This is most quickly discovered on silver which is of the severely plain pattern. The first point, then, in the care of silver is in careful sorting and washing.

The best plan is to sort the silver and put it in a papier maché holder. In the absence of such a special holder any deep pitcher or bowl, deep enough to allow water to come over the soiled part of the silver, may be used. The best utensils of this kind are purchasable with two compartments, one for the knives, which are always heavy and scratch the spoons and forks; and an adjoining compartment for the lighter silver. The larger pieces should be kept separate from one another, because stacking will give opportunity for them to rub and scratch.

Wash the silver in clean, hot, soapy water, give it a hot rinse, and wipe very dry with a clean towel. If this is done carefully with

every piece of silver used on the table, that silver will need less of the so-called weekly or semi-monthly cleaning. Washing of silver does much less harm than scouring. Be careful in taking the silver from the wash water not to mix the knives with the forks, and do not throw them upon tables or trays. They are drained more satisfactorily on a towel. This is especially true of silver vegetable dishes, creamers, and sugar bowls; it is not so easy to keep the small silver from scratching. Even silver that is not often used should have a frequent washing in hot soapy water, to prevent tarnish. This will save cleaning.

Cleaning.—All silver will need cleaning at some time, whether used frequently or not. Some housewives do this cleaning regularly once a week. This involves unnecessary wear on the silver, as well as unnecessary tax on the worker, and can be done quite as well only once in two weeks, if the dining-room silverware is promptly and thoroughly washed after each use, and if the silver ornaments, door knobs, bureau silver, etc., are rubbed with a soft cloth when the dusting is done.

Soft cloths should be on hand for the rubbing of the silver. White outing flannel gives perhaps the best all-around satisfaction, because it is very soft and can be washed out easily by means of warm soapy water.

Assemble all silver tools and supplies. Apply the polish with a clean soft cloth and rub thoroughly, then polish with another clean soft cloth. If silver is much ornamented, soft brushes will have to be used. (See Cleaning Equipment, page 119.)

If the silver cleaning pan (see chapter on Supplies, page 134), is used, one tablespoonful each of baking soda and salt are used to every quart of water; this mixture is right for quick cleaning action. If the housewife does not have a regular cleaning pan, she may substitute a clean bright aluminum saucepan, with one tablespoonful each of salt and baking soda, or one teaspoonful of soap powder, to each quart of water. Have the water hot, the salt and soda measured, and the silver ready to put into the pan as soon as the salt and soda have been added to the water. There will be a strong effervescence for the first few seconds, for which reason the pan must not be too full of water.

After cleaning silver, have ready a pan of hot soapy water, with a drop or two of ammonia, and clean towels for drying. Wash the

polished silver, rinse, and dry, according to the directions given above for washing. In washing hand mirrors, care should be taken that no water gets in behind the glass, as the mirror may be spoiled. No silver should be used after cleaning without being washed. It not only does not look so well, but is not in a suitable condition to use.

WASHING DISHES

Preparation.—A little time spent in preparing dishes for washing will in the end be much time gained. To prepare dishes for washing, all scraps of food should be removed. This is usually called scraping the dishes, but it is better if wiping is the process actually employed, because the sharp edges of knives used in scraping harm fine dishes. A little wad of paper or the skin of a baked potato makes an excellent wiper. A rubber scraper is made for the purpose, but it costs ten cents, and is only one thing more to keep clean.

As the dishes are cleaned of all particles of food, they may be stacked in piles of plates, saucers, etc.; silverware put in a pitcher or pan with water; glasses or cups gathered together, and heavier platters and vegetable dishes placed together. Cooking utensils are better kept by themselves because they are too heavy to be washed with the better dishes.

Kitchen Utensils.—Most people dislike to wash the pots and pans; but if they are put to soak the minute they are emptied, with a little soap powder or dissolved soda to cut the grease, with cold water for the egg and milk dishes, and hot water for the greasy and sugary dishes, it will be found that they have cleaned themselves to such an extent that their washing is no harder than that of china. The small quantity of grease that adheres to frying pans may be wiped out with paper before putting them to soak. It will be found that they will wash with hot soapy water like any dish. Use a wooden skewer to reach corners.

Washing.—Now that the dishes are ready to be washed, have a clean dishpan full of hot soapy water. The dishes can stand any heat that is comfortable to the hands.

With a clean dish cloth, wash the *glassware* first. Rinse in a second pan of water hotter than the wash water, and stand to drain on a drainboard at the side of the sink, in a wire dish drainer (Fig. 27), or on a large tray, using a towel on which to stand the

glasses to prevent chipping the edges of them. While still warm the glasses should be wiped with a perfectly clean glass towel, one that is free from lint.

The *silver* should be the next pile washed. The hot water which has washed the glasses may be used for the silver. Have plenty of soap in this water, and take time to give the silver a good rubbing with soap, for this rubbing, followed with a very hot rinse, will keep the silver bright. Silver washed thoroughly every day will lessen the work of the special cleaning (page 133). While still hot, wipe the silver very dry.

China.—A second clear wash water should be prepared and the rest of the dishes washed; take thought to wash the cleanest ones first. If a very hot rinse is used for these dishes and they are placed on a wire dish drainer (which may be purchased for a few cents), the dishes will need little wiping. Fine gold decorated dishes and cut glass must not have as hot a rinse as other dishes. The reason that the dish drainer is worth many times its cost is that it eliminates much of the work of wiping, and the consequent use of many towels, and the wiping with towels that have been used too long and are no longer fresh; if the rinse is very hot, and the dishes are placed in the rack, they will dry while the heavier dishes are being washed. Grouping the dishes at the beginning means that the same group or pile is now ready to be put away without further sorting.

Knives.—The knives are usually separated and washed by themselves for three reasons: first, because they are heavy and are likely to scratch the silver forks and spoons; second, if they have pearl, bone or wooden handles, the handles should be kept out of water, as soaking takes the lustre out of the pearl or bone and yellows it, while wooden handles swell in water so that they gradually loosen and come off; a third possible reason for washing them by themselves is that the blades, if of steel, need to be scoured. Pulverized bath brick, which may be bought in packages at ten cents each, with a good sized flat cork will make the cleaning of the steel easy and quick work. If a cork is not at hand, use a little wad of paper, as there is no need of staining or wearing a hole in a good dish cloth. Wipe all knives dry before putting away.

Dish Towels and Cloths.—It is essential to have clean dishes, not only for the looks of the dishes, but especially because the dish comes in such close contact with the food that it must be absolutely

clean. If the dishes have been properly prepared for washing, and have been well washed, and the towels used only for wiping dishes, once a day would be sufficient for a washing out of the dish towels themselves. The dish-cloths, however, should be washed after each dishwashing. At the times when the towels are not washed, they should be hung out, singly, to dry, always in the air, and with as much sun as possible. Warm soapy water is best for washing towels, and two or three times a week they may have, besides the washing, a few minutes boil. After washing, boil the clean towels; rub them thoroughly with soap, put in a pan of cold water, and heat to the boiling point. Boil five minutes, follow with a hot rinse, then a cold, and hang to dry.

To Clean the Sink.—The sink should have care three times daily. The first thing that has been done toward its care is scraping or wiping the dishes before washing, so that the dish water is clean and without particles of food in it. This is necessary, because the grease and the particles of food clog the drain. A sink strainer, which is preferably of the type of a wire purée sieve rather than the kind often sold under the name of sink strainer, should be kept in the bottom of the sink over the drain outlet, so that all water may be poured through it. Never pour grease into the sink, for first of all, it is wasteful; and secondly, when it cools it forms a coating on the inside of the drain, which, if through carelessness, it is allowed to continue to form, will in time close the pipe. The little grease which is bound to come in any dishwater will not stop the sink drain if after each dishwashing the pipe is flooded with hot water. This hot water liquefies the grease, and carries it down and out of the pipe. If washing soda is used to cut the grease, as is so often done, it should be followed with an abundance of very hot water, otherwise the soda which is used to clean the sink, and the grease in the pipe, make soft soap which congeals on cooling and may close the drain. The hot water flushing of a sink three times a day, where particles of food and grease have been carefully kept out of the drain, will almost entirely do away with the use of soda. Finally, wash the sink as porcelain, soapstone or iron (see pages 261 and 262). Clean the faucets as brass or nickel (see pages 260 and 261).

Outline for Washing Dishes.—Put cooking utensils to soak as soon as emptied. Egg, milk, and flour dishes should soak in cold water. Sugar and fat dishes should soak in hot water. Wipe frying

pans with paper; soak in hot water and dissolved soda. Scrape and pile dishes according to size and shape. Keep handles of knives and eggbeater out of water.

In General.—Wash everything in hot soapy water. Rinse in clear hot water; drain, and if necessary, dry while hot. Use dishcloth or brush for washing. Use wooden skewer for corners.

Glasses.—Wash in warm soapy water. Rinse in clear hot water. Wipe with towel free from lint.

Silver.—Wash in hot soapy water. Rub silver well. Rinse in very hot water. Wipe dry with very clean towel.

China.—Wash in hot soapy water. Rinse in hot water. Drain or dry.

Steel Knives.—Scour with bath brick applied with a cork.

Wood (Spoons, Table Top).—Wash with cold water. Scrub with an abrasive material and scrub brush. Rinse well.

Dough Boards.—Soak with cold water to soften dough. Wash as above, using cold water and an abrasive cleaner rather than soap.

Utensils.—Wash inside and outside.

Supplies:

Ammonia	Scouring powder or soap
Bath brick for knives	Soap
Dissolved soda	Washing soda
Metal cleaner:	
silver	
coarser material	

Equipment:

Bottle brush	Sink strainer
Cork	Soap dish
Dish cloth	Soap shaker with soap scraps
Dish pan	Towels for
Dish drainer	china and glass
Dish mop	kitchen
Metal mesh pot cleaner	hand
Scrub brush	Vegetable brush
Sink brush	Dishwashing machine

CLEANING STOVES

As we clean up the sink after each meal, so should we care for our stoves. They will not only be much less of a care, but they will look better and be always ready for service. All stoves may be kept in good condition by wiping off, while still warm, any grease splatterings or spilled food, with a crushed newspaper. Rub the stove

briskly with a second piece of paper, and the stove will be smooth and black enough to make constant blacking unnecessary. Any sticky food can be easily washed off with hot soapsuds again using the paper in preference to the cloth, so that there will be no dirty cloth, either lying about constantly dirty, or having to be washed. Once or twice a week, the stoves (*when cold*), may be gone over



FIG. 160.—Cleaning a gas stove.

with a cloth moistened with kerosene, rubbing them thoroughly until they are clean and bright.

If blacking is preferred to oil, one may protect the hand during the process by using paper bags which are usually plentiful in the home. The stove must be clean, that is, free from particles of food, bits of coal, wood or ashes, before applying the blacking. Moisten the blacking with a little warm water, and with a dauber, apply to the stove either before lighting the fire, or when the fire in the coal

or wood stove is so low that the blacking does not sputter or boil on the surface. Polish with the polishing brush as soon as the blacking is dry. Blacking should be put on a cool stove for two reasons: The hot stove wastes blacking, and some blackings contain inflammable liquids which would cause fire. It takes a great deal of time to blacken stoves, to say nothing of the dirt involved, and the oil will give a much better looking stove with less effort.

Gas stoves and kerosene stoves may be kept in good condition by washing with soap and water, or soda and water when very greasy, and then when cold, wiping over with kerosene or a mixture of two parts kerosene and one part turpentine. These stoves with enamel finish need only washing. The tray under the gas top burners should be taken out regularly and cleaned.

Burners from oil and gas stoves may be cleaned by detaching them from the stove, placing in a pan large enough to hold them, and covering with washing soda and water (Fig. 160). One-half to one pound of soda may be used to a gallon of water. Bring to boiling point and let boil until the grease, soot and charred food sloughs off. Wipe off with paper or an old brush, rinse with hot water, and put back on the stove to dry by lighting the fire. The nickel on the stoves should be kept free from rust with a little kerosene, lemon or linseed oil, and can be washed frequently. Any of the metal polishes will keep it bright. (See *Cleaning of Nickel*, page 261.)

REFRIGERATOR.—CLEANING AND CARE

Daily.—Wash the ice before putting it into the refrigerator.

Do not wrap the ice; it must melt in order to keep the box cold.

Remove discolorations on porcelain lining with whiting or porcella (see page 262).

Look over the contents and plan to use all left-overs while perfectly fresh.

All food must be in clean utensils.

Do not put food into the refrigerator on dining-room china.

Keep food in the section of the refrigerator intended for it.

Do not allow food of strong odor to remain uncovered in the refrigerator. Covers may be made of waxed paper.

Keep food such as broken eggs, mayonnaise dressing, etc., covered; lettuce and parsley should be washed and then stored in

clean cloths or glass jars, without water. Unbroken egg yolks may be covered with water; this will keep them from drying; change water every day.



FIG. 161.—Cleaning a refrigerator.

Charcoal, unless fresh, has no power to absorb odors. To freshen, boil in water and cool.

Twice a Week.—Wash thoroughly the outside of the refrigerator with a damp cloth, and dry.

Wash all parts of the inside except the ice section, using cold

water to which a few drops of ammonia have been added. Soda water may be used.

Weekly.—Remove ice rack and scrub it, wash in soda solution and in clear cool water. Rinse in cold water. Boil with hot soda water once in two weeks (Fig. 161).

Wash shelves and walls, using hot water to which a few drops of ammonia have been added.

Use a wooden skewer to clean grooves.

Rinse in clear hot water.

Dry thoroughly.

Wash outside of refrigerator with a damp cloth, then dry thoroughly.

General Suggestions.—Keep doors of refrigerator closed.

Do not use cleaning materials like soap which leave a strong odor; ammonia or soda and warm water are the best.

Washing a refrigerator with hot water of course raises its temperature; so use cold water ordinarily. Hot water is necessary occasionally because it cleans better, and sterilizes when the parts are boiled in it.

TO CLEAN FILTERS

The very small filters, which are filled with cotton, asbestos, or pebbles and charcoal, filter very rapidly. Because the filtering substance is in small amounts and of very porous material, such a filter cannot be considered dependable. To increase their efficiency, some small filters may be reversed daily by turning end for end and flooding the filtering medium; then by boiling the whole filter daily, it may be made temporarily sterile. Filters with pads should have the pads changed regularly each day.

Another type of filter is made of stone crocks, set one upon the other, and through the porous material of the bottom of the upper crock the water passes by gravity to the lower crock. This filter is slow in its action, and must be cleaned regularly. None of these can be safely relied upon in water carrying disease germs.

The Pasteur "germ-proof" type of filter with proper care is more to be depended upon; in this, the water is forced through a porcelain cylinder from the outside. It can be cleaned by the housewife, by shutting off the inflow of water, loosening the metal band and lifting the porcelain tubes carefully from the outer metal or

glass cylinder; with a brush wash the outside of the tubes to remove deposit, rinse and replace; then fasten the clamp and turn on the water. This does not give a sanitary cleaning, however, and dependence must be put upon replacing the filtering cylinder regularly with a sterile one and sending the used one to the factory to be rebaked. Do not attempt to rebake the tubes at home, as the housewife's oven is no more suited to that work than it is to firing china. The supply house will exchange fresh tubes for those needing to be baked. (See chapter on Plumbing, page 42.)

The filtering problem is a double one, to remove visible sediment from water, and various filters will do this; and to remove invisible disease and other germs, which cannot be certainly accomplished by the household filter. The only reliance to be placed in the latter case is upon having the water boiled before using it. A household filter not properly cared for may even increase the bacteria in the water, because it affords a place in the uncared-for filter medium for bacteria to multiply.

SUGGESTIVE QUESTIONS

1. How would you proceed to clean a brass bed?
2. How can one take finger marks off mahogany?
3. If a machine is very greasy, how may it be cleaned?
4. How may one remove a rusty deposit in the bottom of a water bottle?
5. Make a set of rules to be given to a maid for cleaning metals.
6. How do you remove burned food from an enamel saucepan?
7. List a number of economies possible today in cleaning.

REFERENCES

- BROADHURST, JEAN, HOME AND COMMUNITY HYGIENE. J. B. Lippincott Company.
- BUCHANAN, ESTELLE D., and ROBERT E., HOUSEHOLD BACTERIOLOGY. Macmillan Co.
- CONN H. W., BACTERIA, YEASTS AND MOLDS. Ginn & Co.
- MACLEOD, SARAH, HANDBOOK OF CLEANING. Harper & Bros.
- DONHAM, AGNES, MARKETING AND HOUSEWORK. Little, Brown & Co.
- RICHARDS, E. H., COST OF CLEANING. Whitcomb & Barrows.
- TALBOT, MARION, HOUSE SANITATION. Whitcomb & Barrows.

CHAPTER X

CLEANING AND RENOVATION

RENOVATION is renewal, and means the cost in time and money to make like new. It is economy in so far as the renovation cost of an article does not exceed the original cost. In fact, the cost of renovation should be considered well by the housewife when she purchases the various types of household furnishings. Beds, bedding, carpets, furniture, kitchen equipment—in fact, every tool or utensil, all furniture and furnishings, should be purchased only after the consideration of first cost, depreciation, such as fading, cracking, and roughing, and renewal cost. Fabrics may justify a large first cost if they are of material that can be cleaned, or dyed, or which is worthy of re-cutting. To pay for quality under such conditions justifies the purchase.

FABRICS

The first and most common type of renovation is laundering with soap and water. The housewife is so accustomed to this process in connection with her clothing that she rarely stops to consider it as renovation. However, when her attention is directed to the fact that such things as blankets, curtains, portieres, etc., which are usually sent to the dry cleaning establishment, can be renovated by an intelligent use of soap and water, the process acquires a new significance. When these furnishings are sent to the cleaner, the cost of renewal adds materially to their original cost, and so may not represent economy. Careful laundering by the housewife will eliminate this extra cost, with no harm to the fabrics. And the chances are that, if so cleaned, they will be cleaned as frequently as is necessary to keep them fresh, whereas the cost of dry cleaning makes its use infrequent.

Fabric stains are unsightly and make a garment look either old or untidy if not removed. The stains that are found on household fabrics are in most cases possible to remove; they will always come out better when fresh. For that reason, let the housewife try to

remove them first with clear cold water, as half the stains may be washed out in cold water without further work and with no harm done to the fabric.

Stain work outfit:

1 dropper for each chemical
1 cup
1 bowl
Blotting paper and cloth the
color of the fabric, or
white and non-linting

Soft cloth
Soft brush

Stain Re-Agents:

Alcohol
Ammonia

Borax

Chloroform or ether
Cream of tartar or salts of
lemon
Detergent
Gasoline
Hydrochloric acid
Javelle water
Lard or tallow
Oxalic acid
Potassium permanganate
Soap

Recipe for Detergent.—1½ oz. white castile soap, 1 oz. ether, 1 oz. alcohol, 4 oz. ammonia.

Cut soap fine and heat in one pint of soft water until dissolved. Then add three quarts of cold water and the other ingredients. For cleaning black goods, use one quarter cup of this liquid in one pint of warm water. If this makes the article too stiff, add more water. For removing spots from woolen goods such as men's clothing, apply the detergent, only slightly diluted, with a sponge. It is always safer to test this detergent or any other cleansing solution with a piece of the material (*e.g., an underseam*) before attempting to remove stain, as the ether may affect the color.

Stains and Their Removal.—(For detailed directions, see page 276.)

To remove all unknown stains, grass and mildew, wash the stain in cold water.

To remove chocolate with cream, cocoa with cream, cream, gravies, scorch, sewing machine grease, and tea with cream, wash with cold water and soap; any trace of stain may be removed with warm water and soap.

To remove blood and mucus, mucus, and pus, soak in cold water to which salt has been added, 1 cup of salt to 8 quarts of water, then wash in warm water and soap.

To remove blood, punch, sugars, and syrups, wash in warm water until the stain disappears.

To remove grease, meat juice, and perspiration, wash in warm water and soap, or use magnesium, chalk, starch or meals—not flours.

To remove indelible pencil, stove blacking, tan shoe polish, tar, and wagon grease, put lard on stain, rub well into the grease spot; wash with soap and warm water. Repeat until removed.

To remove bluing, clear coffee, clear tea, and fruit, spread stain over bowl; pour boiling water through the stain from a height.

To remove old stains of chocolate, cocoa, coffee, and tea, moisten with cold water; cover with borax, and let stand a few minutes; rinse with boiling water.

To remove wine, put thick layer of salt on stain as soon as made; pour boiling water from a height through the stain as soon as convenient.

To remove ink and iron rust, use dilute acids (lemon juice, sour milk, cream of tartar, rhubarb, pineapple, hydrochloric and oxalic acids. Use food acids direct without dilution; dilute hydrochloric and oxalic acid, with equal quantities of water.). Apply the acid, let stand a few seconds, rinse with warm water; continue until stain disappears, then wash with soap and water.

To remove ink and stubborn stains, use dilute acids (see paragraph above) and Javelle water. Apply the acid, then follow with Javelle, finally rinse with hot water and soap.

To remove old stains and stubborn stains, use dilute oxalic acid (as above) and potassium permanganate. Apply a few drops of potassium permanganate; rinse with warm water, then apply oxalic acid. Repeat until stain disappears and finally wash with soap and water.

Before beginning to work on the stain find out if possible: What kind of fabric is stained, and what is the stain. If the fabric is colored, one must decide which is least objectionable, the stain, or the resulting color or lack of color which may come from the action of the chemical used to remove the stain. Try the stain remover on a sample of the fabric or on some under-seam, to see the effect.

In using chemicals one should know that alkalis, like soda, potash, ammonia, and strong soaps, yellow and destroy wools and silks. Dilute acids, such as half-strength oxalic, citric, and hydrochloric, may be used on wools and silks. Dilute acids and alkalis may be used on cottons and linens.

Cold water will remove many stains and is, therefore, the first thing to try, especially if the stain is unknown. The worker must realize that it takes time, and that several short applications are

better than one continuous one. If any reagent has been used, except chloroform or gasoline, which always quickly evaporates, wash out with soap and water or a very abundant use of water. This will stop further work of the chemical and the possible formation of holes.

Method of Procedure.—The method of removing stains is as follows: Spread the stained portion over a bowl. With dropper apply the proper chemical. Follow quickly with warm water. (Test by holding the whole finger in the water; it should not burn.) Many short applications are surer and safer than the one long-continued use of a chemical before rinsing. When the stain has disappeared, wash the spot well until the chemical is entirely removed, then wash in soap and water, and rinse.

Rules that a good worker on stains follows:

1. Know material.
2. Know stain.
3. Use dilute chemical.
4. Use a dropper.
5. Always use simple reagents first.
6. Wash thoroughly.

Each stain presents its own peculiar problem, because the dye and the fabric play an important part, and even with these two conditions understood, the stain itself presents difficulties. For example, coffee with cream, and coffee without it are two distinct problems. A good general rule to follow when there are combined problems is to work as if the stain were all due to the material that is most difficult to treat. In case of a stain of coffee with cream, work as if it were entirely cream. Cream being a fat, use cold water, and then cold water and soap. Coffee without cream is instantly removed with boiling water. Fruit under the same condition responds similarly. In the same way, when a combined fabric is to be cleaned, proceed always as if the whole material were entirely the most delicate one. For example, wool and cotton, wash as wool.

Good general rules to follow are:

Clear sugar stains, like punch, use hot water.

Clear fat stains, like olive oil, use cold water and soap.

Clear albumen stains, like blood or egg, use cold or tepid water.

Use magnesia or chalk for grease stains only.

Any combination of material like blood and grease as in gravy, use cold water; like fat, sugar and albumen, as chocolate ice-cream, cold water.

Precautions in Spotting.—Stain removal or “spotting” means that a water ring will often follow, and that the fading or running of colors may result. When the whole garment is to be washed after the stain is removed, the problem of stain removal is much less difficult than if only the spot is to be removed. If the garment is to be washed, take out the spot first, and then proceed to wash the whole. If the garment is to have a stain removed, place the garment on a clean work-table and isolate the spot as much as possible for two reasons—first, to keep from spotting the rest of the material by any accidental dropping of water or chemicals; and, second, so that the chemical or water used will have the least chance to spread. Put a cloth over the larger part of the garment as protection. Place the stain on a folded cloth, or white blotting paper, or over a bowl. Use the cloth method for silks or fabrics not to be washed later, and use the bowl method for white goods to be washed or where water does not harm. Moisten the stain with cold water, then apply the chemical by dropping from the dropper; the chemical does better work if the way is prepared by moistening the stain. As fast as the stain loosens and is absorbed by the cloth and blotting paper, use a new pad. If colors are very delicate, use cold water instead of warm, and use dilute chemical, even though it takes a longer time. Warm water often loosens a dye. A water ring may be left after a spot has been removed. (See below.)

Saving Colors.—Stripes are saved by streaking the adjoining stripes with soap or borax, especially if acid is to be used; for example, in taking ink out of a white stripe among colors. Where colors are very uncertain, it is helpful to use pieces of material of the same color for the pad under the stain and for the rubbing cloth. A white cloth often leaves a fine lint stain which is very difficult to remove.

To remove a water ring, hold the stain over steam and shake until thoroughly moist, not wet, then shake dry. Often the whole breadth of material will have to be steamed. Steam is easily obtained by boiling a small amount of water in the teakettle, fitting the top tightly and tying a piece of cheesecloth over the spout.

This cheesecloth prevents sputterings of water from spotting the fabric.

Laundering.—Laundry work is a weekly renovation, requiring much consideration, too much for a small part of a chapter; but as laundering is renovation and renewal, a few brief directions will be given. (For Laundry Equipment, see page 103; for Supplies, see page 136.)

Sort the clothes into piles of white and color, and separate these piles of fabrics into wool, silk, cotton, and linen. Mend wherever possible, before washing. A stitch in time saves nine.

Remove stains from white clothes if these stains are of such a nature as to need special attention. Many ordinary stains come out in the process of washing.

Soaking clothes in cold water helps to clean them, because it softens and dissolves so much of soil, and it certainly makes washing easier. On account of the possible stains, use cold water, not hot. Soak only cottons and linens.

Wash in warm water and soap suds. There has been enough soap used when the suds holds and does not settle on the water as a scum.

Boil only white linens and cottons; should one wish to economize on time, fuel or work, scald the clothes by covering with hot water, not waiting to boil. Boiling helps to clean very soiled clothing and is good to sterilize the clothes. To boil, rub the clothes, especially soiled spots, with soap, fill boiler with cold water, and put on to boil. There must be good suds. Boil five minutes after boiling point is reached, then rinse in hot water. Boiling, when done, should follow the washing and two hot rinses should follow that. Do not boil dirty clothes, and do not boil with naphtha soaps.

Rinse in two hot rinses so as to flood off all greasy dirty soap suds, which would form a sticky scum if cooled.

Rinse in cold water, because the cold water opens the fabric and chills the clothes, preparing them for the blue.

Blue in well-stirred, clean blue water. If solid blues are used, tie them in several thicknesses of cheesecloth or a heavy piece of flannel or muslin. Use about one teaspoonful of liquid blue to a tub, and about one-third of a ball to a tub.

Starching is a process which, when used, follows the bluing. When the garment is to be starched, use the following proportions:

1-3 tablespoons starch
1 teaspoon paraffin
1 teaspoon borax
1 quart hot water

Mix all dry ingredients, moisten with cold water, and then add boiling water, stirring well. Cook until paste is clear, about ten minutes, stirring to prevent burning. Use starch only after being well cooked and strained. Use hot starch for all things except colors. Starch with garments wrong side out, wring out all the starch that can be wrung out, and rub in the remainder. A good worker never leaves a glaze of starch on the garment, but works it well into the fabric. Avoid using a starch too thick and pasty.

Dry by hanging with the wind, by pinning straight, and by hanging enough of the garment over the line to prevent the corners from tearing. A double garment like a petticoat is less likely to tear if it is hung so that the opening is with the wind.

Take down from the line, fold in even folds without crushing, and much will be saved in the ironing.

Sprinkling should be done evenly and thoroughly, but not too heavily. A good rule is that thin and thick goods require the most care, like lace and tucks. Roll tightly so that the moisture penetrates, and place the rolls close together in the basket. Clothes should be moistened at least one-half hour before the ironing is to be done; and when the weather is not too warm, over night is better; too long a delay after moistening for ironing may result in mildew.

Iron with clean, hot irons, and always iron as large a space as possible at one time. Always iron each section dry as it is ironed, for this prevents the rough-dry appearance which follows if the clothes are not sprinkled enough or are not ironed dry as they are ironed. Iron the garment by first ironing those parts that when finished may hang off the board out of the way while the rest is ironed. Iron table linen half dry on the wrong side, and entirely dry on the right. Iron embroidery on the wrong side on a pad heavy enough to allow the embroidery to sink well into the pad. Thick embroidery requires a thick pad. Silks should be pressed on the wrong side, and heavy silks are best pressed with a cheesecloth under the iron; this is especially true for heavy seams or folds. Too hot an iron will not only glaze but crack the silk. Silks often finish better if the cheesecloth or the silk itself is slightly damp

when ironed. Woolens should be ironed on the wrong side or should be pressed on the right side with dampened cheesecloth over the wool. Pull up the cheesecloth against the nap of the wool, and in that way lift and fluff it. Woolen blankets are much improved by brushing with a stiff whisk broom.

Washing Colored Goods.—For these, it may not be possible to use soap, in which case starch water, such as might be made by using grated potato, bran, soap bark, or in fact, ordinary laundry starch paste, may be substituted. With these agents the only thing that could affect the color would be the water softening the dye; avoid this by using cold water instead of warm. To use any of these, add them directly to the wash water, using about 2 cups to a half-gallon of water. Small quantities of bran or soap bark will go farther if heated in the water for 10 to 15 minutes, and then strained out. Use the grated potato raw, but without paring.

Colors may be preserved to a great extent by the use of cool water, soap in solution, and the use of soap substitutes. If the water causes the color to "run" or "bleed," use salt as quickly as possible—so quickly that the salt must be at hand ready for instant use; but do not use "for fear"; salt hardens the water, so better results will follow washing first. Use 1 to 2 cups salt to enough water to cover garment.

Bleaching—*To Bleach Cottons and Linens.*—In bleaching, always have the fabrics clean. So the first step is to wash out the dirt. There are three household methods of bleaching.

The first method is to spread the wet garment on the grass or on a towel in the sun. As it dries, remoisten, because water supplies one of the best bleaching agents—oxygen.

The second method is by using *Javelle*. *Javelle* is a solution which may be purchased at the drug store, or may be made with little effort and expense by the housewife.

Recipe for Javelle Water:

1 lb. washing soda
1 qt. boiling water
½ lb. chloride of lime
2 qts. cold water

Put the soda into an agate pan and add boiling water. Mix the lime in the cold water. Pour this mixture into the dissolved soda. When settled, pour the clear liquid into a bottle and use as *Javelle* water. Keep in a dark place. The sediment will disinfect sinks and flush closets.

This Javelle mixture should be allowed to settle and only the liquid bottled and used. It is cloudy Javelle which is harmful to clothes. To every pail of water use one to two cups of Javelle liquid. Hot water will facilitate the work, but do not boil. Plunge the clean wet garment into the water to which Javelle has been added. After three or four minutes wash in hot soapy water. Repeat if necessary.

The third method of bleaching is by *potassium permanganate* and *oxalic acid*. They may be used in large quantities for the whole garment, or with a dropper to remove spots. Make the permanganate solution by using one teaspoon of crystals to one quart of water, and use half-strength oxalic acid, which is made from a concentrated solution by adding to an equal amount of water. Add acid to water instead of water to acid, to avoid its sputtering. Apply the permanganate to the clean, moistened garment, then rinse with warm water; the garment will turn a good brown; follow with dilute oxalic acid, which will whiten. Rinse with several washings of water, and finally wash either the spot or the whole garment with soapy water. This last step is always necessary, so as to be sure that no chemical has been left in the garment. Oxalic acid is a poison.

To Bleach Wools and Silks.—Neither Javelle nor potassium permanganate can be used to remove stains from silks or wools, unless a stain is so bad that the slight yellowing from Javelle or permanganate is nothing as compared to the stain.

For both silks and wools, borax can be used, as it is a mild bleach for either fabric. Hyposulphite of soda, which is the "hypo" used in photography, can also be used for woolens or silks. A tablespoonful of crystals dissolved in a quart of water will make a good rinse to whiten silks; follow with clear water. Silk or wool, once yellowed, is hard to bleach because of its delicateness.

For wools, sulphur fumes allowed to pass through the clean, wet garment is the best bleach. Care should be used in doing this work to avoid fire and not to subject the worker to the danger of inhaling the fumes. Unless one has facilities for working out of doors it is rather inadvisable to attempt it. A barrel and a sulphur candle make a good bleaching outfit. Place the pan of water, in which stands the candle, down in the bottom of the barrel, so that the fumes from the lighted candle are forced to rise and circulate through the garment, which is suspended in the barrel on clean

white strings or strips of muslin. Be careful of two things: do not inhale the fumes, and arrange the candle so as to prevent fire.

Pale bluing in the rinse water of either white silks or wools will do considerable towards keeping the white clear and preventing its yellowing. Photographers' "Hypo" (hyposulphite of soda) can be used to restore the whiteness to silks or wools, but any stronger chemical bleach will yellow both wools and silks.

Velvets.—All materials of this nature, often found in portieres, table runners, and cushions, may be renovated by brushing thoroughly with a soft brush. If any whipping is to be done, it should always be done from the back so as not to mar or print the velvet with the beater. Water spots on velvet may be steamed out. This may be done by either of two methods: Put about one-half inch of water in the teakettle, tie a piece of cheesecloth over the spout, and let the water boil hard. In this way a jet of steam will be produced in which the velvet can be shaken. This process may have to be repeated several times, but in almost all cases the worker will be rewarded. If one prefers to use a wet cloth on a hot iron, steam can be produced this way; but for large, heavy pieces the teakettle method is best. Cleaning may be done satisfactorily with magnesium or chalk by spreading a thick layer of powder; let it remain for several hours, even a day or so, and then shake and brush off the powder. This method is not applicable when the garment is badly soiled.

Eiderdown Quilts.—Prepare a suds of warm water and white soap. Souse or knead the quilt in the suds. Use a second suds, two waters for rinsing, and then hang to dry by spreading out between two lines. As often as possible while drying shake from all four sides to re-liven the down, and to help to re-spread it. It will be found that any wringing must be done by squeezing. The pressing of the silk or sateen cover may be done with a warm iron. A little time will be required after the down is dry to spread it about with the fingers. The quilts may be most satisfactorily cleaned in this way, and will lack only a little of the original puffiness, which came from the down being blown into the various section patterns as the quilt was being made.

Pillows.—Pillows may be washed, without removing the feathers from the case, in a tub or washing machine. Wash by sousing up and down in the water, and then after rinsing, hang to dry in

the sun and wind. Choose a windy day for this work if possible, as wind dries and livens the feathers well. It will be easier to clean the tick if the feathers are removed, as the tick often needs rubbing which will break the feathers. For this, transfer the feathers to a cheesecloth bag, and wash feathers in the bag, and wash the ticking separately.

Gold and Silver Lace and Embroidery.—These may be cleaned by brushing with alcohol or gasoline. If this lace is in a dress, carry out the same precautions as given above (page 277) for “spotting.” This metal lace may also be cleaned by boiling in salt and water, using two tablespoonsful of salt to each pint of water.

Corduroy.—Corduroy, which is often used for hangings as well as clothing, can be washed successfully. To wash, prepare a suds of luke-warm water and soap. Wash or souse the material up and down in the soapsuds, rinse in several waters, and hang dripping on the line. There can be no wringing, because that would mar the velvet. When dry brush with a soft brush and do not iron.

To Dry Clean.—Dry cleaning is a problem for the expert worker, and because there is so much of a fire risk involved, it should never be done by the careless worker and never by anyone except under excellent conditions, such as plenty of air, suitable containers, a possible way of disposing of the gasoline after use, and no opportunity for fire, such as cigars, matches, candles, gas light or lamps, or even a cook stove. An open flame of any sort will ignite the gasoline fumes at a distance of several feet—real contact of the fire and the liquid is not necessary.

For the best gasoline work a person should have on hand as much gasoline as she would have water for washing, and it should be used in as generous quantities as water, otherwise streaky, grimy clothes will result. Soap may be used in conjunction with the gasoline by taking the cleansing brush and rubbing the spot directly with the gasoline and soap, as if it were soap and water. There should be much rinsing to insure good color. Finally, however, things which have been continuously gasolined are likely to turn yellow and are almost impossible to bleach white. Saving used gasoline for the next cleaning is not in the long run a saving, because the exposure causes the gasoline to become less volatile and more oily, and consequently a grimy cleaner. To dispose of used

gasoline, pour on a gravel or sandy soil, or let it evaporate in the shade. Gasoline must not be put down drains.

Other ways of dry cleaning are by the use of fullers' earth, dry starch, magnesia, and meals, *e.g.*, bran and cornmeal. The principle of this cleaning is that these dry materials absorb the grease which binds soil to the fabrics, and then the soil is set free to be brushed off with the dry powder. Before doing much brushing always shake off the powder. This will help to prevent the griminess that otherwise will follow.

Dyeing.—Dyeing is rather a last alternative toward renovation of a fabric which cannot be washed or dry cleaned with satisfactory results, or which has spots. To dye the garment, wash it clean, rinse well, and it is ready to dye; no one would dye a soiled garment. Many housewives attempt to dye goods at home. It is suggested that some small, inexpensive thing be attempted first, as much can be learned in this way about the best way to proceed. In all cases the garment should be cleaned from grease, the dye should be mixed according to the prescribed methods which come with almost every package of dye, and there should be sufficient quantity, so that the garment may completely float in the dye solution and in that way avoid streaking. If, in its original state the garment is uneven in color, for example, if a person has tried to "spot" it, and some of the color has been withdrawn, the dye should be put on these lighter spots with a cloth or brush before the rest of the garment is dipped. Otherwise, when the garment is dyed for the purpose of covering up spots, the spots will in all probability appear a shade lighter. This is the reason for the expert's advice that the color chosen for an old garment should be a very dark one, either blue or black, for then it will be so dark that it will probably cover up many imperfections. As dyeing requires soaking in water, the fabric is very likely to shrink. All of this must be taken into consideration before attempting to do any work. It is one thing to have a garment renovated and have it turn out so well that it may be called an economy; but it is decidedly a waste to pay for renewal, and have a garment which cannot be used.

Rugs and Carpets.—The first thought in renovating rugs and carpets is to get them clean. To remove the soil they are usually sent away to be scoured, and this is advisable, especially if the rug or carpet is very large and weighty to handle. A rug can be freed

from dust by whipping with a flat rattan beater. A wire or a stick beater is hard on the rug because either may cut the fiber. Shaking a rug often frays the ends.

Any rug, if one has the endurance, may be thoroughly freshened at home by first getting it entirely free from dust, and then preparing a heavy lather (as heavy as a shaving lather), of any white soap and water (Fig. 162). With a soft brush this suds may be spread on the rug, always with the thought of keeping up a strong



FIG. 162.—Washing rug or carpet. Any rug may be washed, if the colors are fast. Test with a little water first.

frothy lather. Apply the suds with the brush and rinse it off with soft cloths or sponges which have been wrung out of warm water. Do only a small part at a time. Rinse each part as you work rather than spread over too large a surface at one time. The rinsing is an essential part, so be careful to change the water very frequently, and as fast as it darkens in color. The washing method may be applied to practically all rugs, except those that would fade even with water.

Many rugs may be actually washed in the washtub or in a washing machine. First brush or beat to remove all possible dust; then

give it a clear wash first to remove the dirt it is not possible to brush out. Then add soapsuds and wash until clean. Several rinses will clear up the coloring and remove any soap which if allowed to remain would make the rug sticky. In order that the rug be not marked, do not attempt to wring, but hang dripping on the line wrong side down, and let drip until dry. The washing of rag rugs should be planned for when they are made by having the rags of permanent color so as to allow for washing. Many rag rugs do not appear to wash well because they have been washed in too small an amount of water, and not rinsed well. This is often the case when done in the washtub and is especially so if the person is not strong enough to handle the rug easily and rinse it well. In such a case the rug had better be laid on a floor, like that of the porch, scrubbed with a broom and suds, and rinsed by pails of water or by means of the hose. Poor rinsing leaves a grimy rug.

Matting.—To clean matting, use ammonia and cold water, trying to avoid using much soap; never use very hot water, or a soap that contains a good deal of soda. Cold water will give the best results. To remove grease spots, spread either fullers' earth, dry starch, or whiting on the stain. This dry absorbent should take up the grease. A second application may be necessary, each time letting the absorbent remain for a few days. Detergent (page 274) can be used to remove grease, or ether or chloroform will dissolve grease. Be careful to absorb the grease by a pad under the stain, changing it as fast as soiled. (Avoid a fire with ether.)

Linoleum.—A much worn linoleum can be freshened and saved by using varnish. This varnish, like that for the floor, must be of a very good quality and put on as a thin covering, because varnish that is either of poor quality or is put on too thick, is likely to prove worse than none.

Tapestries.—Tapestries, either wools or silks, should be kept thoroughly brushed or cleaned with the vacuum cleaner to keep out the dust, and also to ward off moths. To wash, lukewarm or cold water should be used, and in this dissolve enough white soap to make a good suds. With a soft brush apply the suds, and rinse with clear water until all soap is removed. It is advisable to keep the tapestries flat. They may be tacked on a table top, or they may be hung to be cleaned. With careful workmanship they could be cleaned in their frames provided they were not fastened on a back mounting

so that there would be no chance for soap and water to get in underneath where it would not dry out easily. Warm cornmeal or fullers' earth will give a dry cleaning, but every particle must be brushed off when finished.

Window Shades.—Window shades can be first cleaned by leaving them on the roll and gradually unwinding, as one wipes carefully on both sides. If this were done often there would be less need for special cleansing. Any good white window shade can be cleaned by making a very thick soapsuds of white soap and warm water, and applying with a soft sponge. The sponge should be wrung almost dry so as not to water-soak the shade. To do this work one should spread the shade on a table or some large flat surface. Cornmeal or fullers' earth may be used with a stiff brush in cases where the shade is not to be washed. Shades that are too old to be washed can sometimes be painted with a good quality of white paint, being careful to put it on in a thin layer, and getting it thoroughly dry before putting the shade up. To wash colored shades may be a risk, because the color is likely to fade and become streaky.

LEATHER

Fur Rugs.—Fur rugs are like any other skin material, very likely to dry in the heat of the room. For that reason a rug will deteriorate faster than one would imagine. A white fur rug can be washed with soap in somewhat the same way as one would wash a small dog, rinsing in lukewarm water, and then letting it lie on the floor to dry. Blue rinse water will whiten the white hair. Because, unlike the live animal, there is no supply of natural oil, the housekeeper may make up this deficit by putting a little neatsfoot oil, lemon oil, or linseed oil on the back of the skin. A mounted fur rug, if very soiled, can be cleaned with heavy lather and rinsed by wiping with wet sponges, as was suggested for rugs (page 285).

It is not possible to wash the rug, of course, if the skin is mounted with a heavy flannel or wool back. In such a case, clean the skin with warm cornmeal. Put the cornmeal in the oven until thoroughly warm; then, in handfuls, rub it over the rug. As fast as it soils, use fresh meal. Then cover the rug with fresh meal and let stand over night on several days; shake and brush. Be sure the cornmeal is out of the rug so as not to attract any insects.

Chamois.—Chamois as a window cleaner requires so much care to keep it in good condition that it is used much less than it once was. The first cost also is high. Whether it be chamois window cloth or chamois gloves, wash in lukewarm water, rinse well and then pull to shape before drying. As the skin dries it should be pulled, shaped, and rubbed to keep it from drying stiff. Should the skin become very hard, a warm water rinse with a teaspoon of olive oil to two quarts of water will do much to soften it. The chamois such as are used for table covers may be washed by taking a brush and lukewarm soapsuds. With a dry lather go all over the chamois, then rinse with lukewarm water, wiping with a soft sponge or cloth; when the chamois is dry, brush up the fibre with a soft brush. Many water spots and grease spots can be removed in this way. Often it is better to do the whole piece rather than to try to remove certain spots. Certain colors will be affected by this method, but if the whole skin is done, the tone of color will be quite even and look better than if the skin is "spotted."

Leather Upholstery.—Leather used as upholstery is very likely to become dried from indoor heat; as it dries it parches and cracks. To keep it in good condition and hence to help it to resist wear, it should be rubbed over with oil, with the same idea as one often puts oil on the hands to keep them from chapping. Remembering that any oil dressing will darken the leather, use as light an oil as possible, such as paraffin oil, lemon oil, neatsfoot or linseed oil.

If the leather is soiled it can be cleaned with some of the cleansers which the housekeeper will obtain most easily by purchasing in bottles prepared for shoe cleaning. A solution of white soap and water to which oil and alcohol have been added, will give a good cleaner. To prepare, use one bar of white soap dissolved in one cup of water; then add one cup of alcohol and two cups of light oil. This will not only clean the leather but will help to supply some of the oil it naturally requires. If one is to oil leather, be careful to rub off all excess oil as it will catch dirt, and very quickly darken the leather.

Imitation leathers, which are really enamelled cloth, will be somewhat renewed by the oil, in the same way as linoleum would be, but the housekeeper must remember that this is only a cloth with an enamelled finish and has no power of absorption. It is bound to scale off in time with wear.

METALS

Stoves.—Stoves may be painted by using black enamel stove paint, and if allowed to dry thoroughly, the paint will remain for several months, making the cleaning of the stove only a matter of washing with a cloth or paper and soapy water.

Steel or rusty iron is probably most easily cleaned with pumice or emery powder. This is cleaning by abrasion, or the scratch method, and care will have to be taken to avoid scratching too deeply into the metal. The pumice alone will not only remove the rust, which may have penetrated below the outer coating, but will tend to leave a rough uneven surface. Oil used with the pumice will lubricate the pumice, and keep it from attacking the metal too directly, thus producing a smooth cleaned surface.

Tin or zinc bathtubs can be painted with white enamel paint. One should be very sure that the tub is thoroughly dry before beginning, and that after each layer of paint there has been ample time for the paint to dry. Two layers of house paint followed by two of enamel paint will give a good finish for a bathtub that will probably last one season. To harden the paint before putting the tub to use, fill the tub with cold water and let stand for several hours. Do this before attempting to use it at all. Do not begin to paint a tub unless it is the last resource for renovation, as once painted it will require frequent renewal.

WOODS

The care and renewal of woods is one of the complex problems of the housewife. The problem is made complex by the many kinds of woods, and the varied ways of finishing them. It would require an expert to meet these complexities, but there are a number of simple suggestions that may be followed with much success.

The everyday woods are pine, which is the soft wood most commonly used, and oak, ash, maple, walnut, mahogany, and cherry, which are the common hard woods. Any of the woods may be found in house finish, or used for furniture. They are finished with either wax, oil, or varnish. The wax or oil dressing sinks into the wood, while the varnish produces a shell-like glaze which prevents the wood from absorbing oil or wax. The best care for all wood finish is to keep it free from dust and grit by using a clean dry cloth, and when the wood is to be polished or "done over," give special attention to

it. Poor results often follow wiping wood with an oiled or dampened cloth.

To *refinish* means to recoil or rewax or repolish, besides covering up scratches, dents, heat or water marks. The work involved is more or less limited, and so is within the strength of the housewife. However, no one ought to undertake the more extensive work of "doing over" a piece of furniture unless thoroughly familiar with the amount of time and labor required.

To compare the expense of doing over at home and of hiring it done, one needs to think of the cost of the many kinds of material necessary in order to have a little of this or a little of that which will be necessary for a small job, yet sufficient to do many pieces of work; and if the materials are not entirely used, this means an expense about equal to the price charged by the professional; while with him there is a much greater likelihood of success than if the work is done at home. The work, to be successful, cannot be dropped at many stages, and the housewife's results often suffer on this account. The materials dry quickly if not used, and as most of them are inflammable, they should be carefully put away. Care should be given, too, to the cloths and brushes; wash the cloths and brushes, or else put them in a stone crock or tin can where they could not cause a fire if spontaneous combustion results.

These difficulties are not mentioned to discourage the housewife, but to present the problem as one for which a person of some experience is needed, and which involves considerable expense and much time for successful work. If the man of the family enjoys this kind of shop work in the evenings, then it is good home work for him, giving exercise and providing a means of saving money, as well as securing pleasurable results in the good finish to which many woods readily respond.

To Remove Paint or Varnish.—Prepared removers may be bought, but a less expensive remover is either potash or soda or ammonia. The worker should be careful, as all these materials are very caustic, burning hands or fabrics, and any splatterings would ruin wall or woodwork. To work with any one of them, have all the air possible, and leave the room while the paint or varnish is softening, as one should not inhale their fumes more than is necessary. A folded, moistened handkerchief over the nose and mouth will add to the comfort of the worker. The softened varnish on

floors may be removed by hot water put on and taken off by a mop and a mop wringer. The hands cannot be used, as no glove would resist the caustic. For proportions use—

Either, 1 lb. soda—5-6 qts. boiling water
or, 1 lb. potash—6 qts. cold water

To Bleach Wood.—Add to either soda or potash solution 1 lb. quicklime, using cold water to mix, and apply to bleach wood. Oxalic acid will also whiten wood if applied long enough; it is especially good to remove spots like ink or stains of wear from floors. Use the acid about concentrated and to a room 15 x 20 ft. about four pounds will be needed. The acid is a POISON.

To Use a Filler.—“Fillers” are used for wood before finishing. A filler is made of boiled linseed oil (1 pint), turpentine ($1\frac{1}{2}$ qts.), and whiting or cornstarch (1 pint of either, or both mixed half and half). This makes a white filler which must be darkened for dark wood, as follows:

For oak, use about 1 teaspoon raw umber.

For mahogany use $\left\{ \begin{array}{l} 1 \text{ tsp. burnt sienna} \\ \frac{1}{4} \text{ tsp. yellow ochre} \\ \frac{1}{2} \text{ tsp. Bismarck brown} \end{array} \right.$

For walnut use $\left\{ \begin{array}{l} 1 \text{ tsp. burnt umber} \\ \frac{1}{2} \text{ tsp. Venetian red} \\ \frac{1}{2} \text{ tsp. yellow ochre} \end{array} \right.$

Test all colors on a board and if too light add more coloring; if too dark, add more oil and turpentine.

To Stain.—Various stains may be bought, and as there are so many good ones, it seems unwise to try to make them, and so spend time uselessly, unless one knows definitely that good results may be obtained. One homemade stain is very satisfactory and easily made by using $\frac{1}{4}$ lb. potassium permanganate crystals and 4 quarts of water. This stain turns brown soon after mixing and may be tested on a board or folded newspaper. Let the stain dry thoroughly, and then rub the wood with oil or wax, or varnish. Do not use for two or three days, and then polish the oiled or waxed wood again, and the results will be most satisfactory. The varnished floor needs only to set and harden to resist wear before being used.

To Oil.—Oil should be used to renew an oiled surface. Apply

the lemon oil, paraffin oil, or boiled linseed oil by rubbing in circles and polish by rubbing in straight lines with the grain of the wood.

To Wax.—Remove every particle of dirt, which must be done before anything is put on any wood. Wax an oiled or waxed surface. Any spots may be removed with a soft woolen cloth and turpentine, and if the spots are very persistent, use a little rottenstone well mixed with the turpentine. Wax by applying a very thin coating of prepared wax (p. 295) and then rub. Use a piece of domet flannel or a weighted brush. For table tops the worker's hand is best. When the worker is sure she has rubbed enough, rub some more.

To Shellac or Varnish.—Use good quality materials and be careful to have both shellac and varnish very thin, in no way thick enough to be sticky. Apply with a clean brush in straight lines, and just as far as possible in continuous, non-lifting strokes. Good shellac work is quite dependent upon the stroke* of the worker, for if a short, irregular, lifting stroke is used, shellac will stick and turn white. In other words, keep the stroke so even and continuous that air does not get under the brush. Waterproof varnish may be used on wooden floors in rooms where water plays an important part, such as the kitchen, bathroom, or laundry; and also in halls and vestibules.

To Remove Scratches.—Often a good furniture polish will cover up the scratches, because it contains dye or stain enough to darken the wood which has been bared by a scratch. If one has no prepared furniture polish, rub with lemon oil or boiled linseed oil. Scratches on mahogany may be retouched with a little permanganate of potash. Its use as a wood dye has just been stated. If the scratch is to be polished, rub the spot carefully with fine grade sandpaper or steel wool, and then brush away every particle of dust formed by sandpapering. Make a pad by folding a small wad of cotton in a soft cloth free from lint. Wet the pad with paraffin oil and then shellac. Touch the surface with the pad, using no pressure but a sliding stroke. Do not lift the pad when rubbing as air will cloud the shellac. Several repetitions may be necessary for the color desired.

To Remove Dents or Bruises.—This kind of a bruise is deeper than skin deep. It means that the layers of wood have been packed down by the force of a knock or fall. If not too deep a bruise, it is possible to oil and rub, and darken the bruise so that it

is little noticed. If the dent is deeper than this, moisten soft thin blotting paper in hot water and gently apply heat by means of a hot iron. The moisture and heat swells the wood and the dented part rises. This would not be possible with veneer, which is only a thin wood surface finish, glued to a wood backing.

To Remove Water Spots.—Often the radiator leaks, or in some other way water has been spilled on wood; the water mark left is a filmy gray spot. It is easily removed with a few drops of household ammonia on a cloth. Moisten the cloth, add two or three drops of ammonia, and rub the spot with a clean cloth. Polish afterwards with oil and a soft cloth.

To Remove Alcohol Spots.—Fortunately an alcohol spot is not deep, and often a quick rubbing at once with a cloth or even with the fingers, rather than lose time looking for the cloth, will return the finish. Lemon, linseed or prepared oil on a cloth and good rubbing will help to restore an old spot. Rottenstone and linseed oil, rubbing in circles, keeping plenty of oil to lubricate the rottenstone, will bring up a polish. The rottenstone must float in the oil, or it will scratch.

To Clean Water Spots on Waxed Floors.—Rub in circles with turpentine and flannel cloth. The turpentine cleans, and will partially soften the wax so that it gives up its dirt.

To Clean Painted, Varnished, and Oiled Wood.—Use linseed oil and petroleum, and rub with a soft cloth, following with a clean polishing cloth.

To Polish Wood.—Rub with turpentine and linseed oil in equal proportions. It will polish like wax and not be so slippery. If this mixture is used to rub unpolished wood and the rubbing is continued long enough, the polish will be beautiful, with soft satiny lustre, much prettier than any shellac or varnish could produce.

Painting.—Paint can be renovated by cleaning either with clear water, with whiting, or whiting and water, but actually to renovate it will require repainting. To do this, either scrape off, burn off, or with washing soda or some patent remover wash off, all the old paint. If this is not to be done, as in the case of repainting bread boxes, enamelled shelves, etc., the loose paint should be scratched off with fine sandpaper. This should bring the spots where the paint is off to a smooth level with the paint surrounding them. Touch these uncovered spots with the paint first, going all over the

article to be painted. When this coat is dry, paint the whole surface with one coat; when thoroughly dry, put on the second coat. If it is white enamel paint that is to be used, a better finish and a more economical piece of work will be accomplished by using two coats of house paint, and then one or two of enamel paint. Enamel paint will go on very irregularly if put directly on the unpainted surface.

To Glue Furniture.—Buy a standard glue, and if it seems thick and stringy, stand in hot water until it has thinned with the heat. Clean the two pieces to be glued, as glue will not adhere to old glue. Vinegar will remove old glue. Apply glue to both pieces and fit perfectly. There is no need to use so much glue as to have it protrude beyond the mend. A little warm water will remove the surplus, only do not let it mix with the glue and thin it. When the mend has been made, some press or support must be used to hold the pieces tightly together. As cord often marks, tapes or pieces of torn cloth with sometimes a straight “splint” makes a good bandage for a break until the glue sets. Iron clamps, for holding furniture together while glueing, may be purchased at small cost.

Wickerware.—Wickerware can be stained or painted just like wood, the main precaution being to put the stain on in two light coats, instead of one dark one, so that where the wicker overlaps in the pattern, the dye will not be too dark. It will be found troublesome to paint the wicker unless the paint is used rather thin. Use turpentine to thin the oil stain, and test the color on an under side where, if the color is over dark, it will not be noticed. Stain or paint on newspaper gives one a very good idea of the degree of color tone. Do not use water stain.

Table Tops.—Table tops will have to be sandpapered to produce a new finish. Before this is done a certain amount of bleaching can be done by using soda to extract grease; and follow this with several scrubblings to overcome the yellowness from the soda. To sandpaper, use fine-grained sandpaper; by folding it on a block of wood, it can be used more easily as well as more economically. To stain an old table: Sandpaper it down to as near one tone of color as possible. Apply the stain, as an oil stain, making two applications of a thinner stain rather than one of a thicker dye. This oil stain should sink into the table and when dry, it may be rubbed with wax.

Old tables can be covered with a thin oilcloth which will last for a considerable time. A heavy piece of linoleum will give longer service.

Receipt for Prepared Wax.—Use any prepared wax; or melt $\frac{1}{4}$ lb. beeswax over water, and when melted remove from the fire and stir in one pint of turpentine. Stir until the mixture is like a thick batter, when it is ready to put into a jar and be used as needed. The hand is the best wax rubber, as its warmth softens the wax. The soft outing flannel may be used, and in either case put on a thin layer and rub. The finish is all in the rubbing; there cannot be too much.

RENOVATING SUNDRY MATERIALS

Lacquered Ware.—Lacquered ware may be washed by using a soft cloth or a sponge which has been wrung nearly dry out of warm soapsuds. Rinse with clear cold water, wipe off all the soap, and then polish with a dry soft cloth. Do not put into the water. Wiping a lacquered bed or desk set with thin oil will do much to keep it from scratching and it also prevents the lacquer from drying and cracking.

Brass mountings are usually covered over with a fine lacquer finish. This lacquer in some measure protects the brass, although tarnish is gradually produced by the air. Perspiration of the hands and cleaning will finally remove the lacquer; then the surface must be either refinished or polished. To rebrnish and refinish is often quite expensive, as in the case of knobs and handles and brass beds. The housewife may polish by using fine rottenstone and sweet oil. Mix these two together as a paste; rub with a light, even stroke, being sure to use plenty of oil so as to prevent the rottenstone from scratching. The success of the work depends entirely upon the gentleness and evenness of the stroke. The housewife may find that it is advisable to try first the oil finish or one of the metal polishers for fear that the untrained worker will rub too hard with the rottenstone.

Plaster Casts.—Plaster casts that have a dull finish are often seriously harmed by water, so that frequent dry dusting and never handling the cast with soiled hands, is the first and best care. To renew a plaster cast, cover with fine whiting and magnesia, or fullers' earth. This may be applied without rubbing, but in order

that all of the surface be covered it may be patted on with a soft cloth or soft cotton. Roll the cast in a cloth, and let it remain for several days; brush off with a soft brush, being careful not to rub hard. This will do much towards cleaning, but there is no special way to remove stains without changing the color of the cast.

Oil Paintings.—With a soft sponge or cloth wrung out of warm soapsuds (not hot), wash the painting by washing a small strip each time and then wiping it. After the painting is clean, apply a thin coating of linseed oil with a soft cloth, either cheesecloth or outing flannel, or even a bit of gauze into which a little cotton has been folded. Put this on evenly, and the oil will sink in, doing somewhat as it does with leather, keeping the paintings free from cracking. If the painting is to be varnished later, it should be varnished two or three days after it has been oiled. The best oil and the best varnish should be used.

SUGGESTIVE QUESTIONS

1. If a mattress is spotted, what simple methods may be used to clean it without washing it?
2. How may lacquered bread boxes be freshened and made like new?
3. How may grease spots be removed from carpets?
4. If a hot water faucet leaks and steams the bathroom so that the walls are darkened and the wood work whitened, how may both be renewed to original condition?
5. How may brass handles on an old bureau be refinished by the housewife?
6. How may a window sill be refinished after having had paper stuck to it?
7. Given cretonne draperies, how may they be cleansed in the home?

REFERENCES

- BALDERSTON, L. RAY, LAUNDERING. L. Ray Balderston.
 BRANN, WILLIAM T., DRY CLEANER, SCOURER AND GARMENT DYER. H. C. Baird & Co.
 CLARK, T. M., CARE OF THE HOUSE. Macmillan Co.
 FARMERS' BULLETIN 1099, HOME LAUNDERING. U. S. Department of Agriculture.
 FARMERS' BULLETIN 861, REMOVAL OF STAINS FROM CLOTHING AND OTHER TEXTILES. U. S. Department of Agriculture.
 PARLOA, MARIA, HOME ECONOMICS. Century Co.
 RANKIN, MARGARET, SCIENCE OF LAUNDRY WORK. Blackie & Son, London.

CHAPTER XI

DISINFECTANTS AND FUMIGANTS

IN THIS day of preventive treatment rather than cures, why not apply the idea to the home? Why not try to ward off the need of disinfectants and fumigants as cures, by adopting effective preventive measures? The housewife should attack the sanitation problems of the home daily as a housekeeper, rather than prepare for special emergencies which must be met with heroic measures. Various points which concern disinfection and fumigation have been suggested in the chapters on Plumbing, Household Pests, and Cleaning. The following outline states some of the practical preventive measures to be taken by the housewife in her daily work.

PREVENTIVE MEASURES IN HOUSEHOLD SANITATION

A. The Grounds about the House.—Cover all rain barrels and cisterns to prevent breeding of mosquitoes; put a film of kerosene on pools of water during the summer.

Screen all privies to prevent flies from carrying disease.

Test all water for purity.

Carry all waste water far enough from the house and from cisterns and wells to prevent contamination.

Clean and sterilize by whitewashing all outhouses—cow stalls, pig pens, chicken coops, etc.

B. The Cellar.—Ventilate the cellar by providing two or more open windows, to keep it dry and hence sanitary as a storage room, and as a foundation to the house; if there is but one window, open half of it and run an air flue from the other half to a point near the cellar floor.

Whitewash the walls and ceiling of the cellar; this cleans and sterilizes.

Place a concrete floor in the cellar to promote dryness.

C. The Kitchen.—Keep the kitchen well aired, because this will keep it cooler.

Keep the sink clean, as soiled pipes not only produce odors, but may draw vermin.

Scald all milk bottles and pans, air well, and keep clean.

Keep the refrigerator free from old food, lest the food decay and become a breeding place for bacteria.

Wash the ice before putting it into the refrigerator, lest it carry in unnecessary dirt.

Empty the garbage can each day, wash, and air it.

If garbage is not used as food for animals, or removed by the community, it should be buried to be used as fertilizer, or burned to avoid its attracting vermin or putrefying.

D. The Laundry.—Keep soiled clothes dry and well aired until washed. Wash often enough to prevent any chance of odors from soiled clothes. Clean clothes, fresh from the laundry, are safe, whereas soiled clothes may carry the risk of disease, and may attract vermin.

Isolate and wash separately all clothing that has been used in connection with colds or any other sickness. As a precaution wash laundry bags and clean clothes baskets.

E. The Bedroom.—Air beds at the same time that the rooms are being aired, half an hour to an hour.

Keep beds free from dust, as dust invites vermin.

F. The House in General.—Prevent the collecting of dust, which not only makes the house untidy, but draws many kinds of small household pests.

Do all dusting with dampened or oiled dusters or sweepers, so as not to spread the dust.

G. Personal Cleanliness is for Each.—When one has plenty of soap and water it is easy; without, everyone must exercise great perseverance.

Mothers in home, teachers in school can promote health by urging a few rules used by Dr. Theobald Smith in his School Health Work.

Do not spit if you can help it.

Do not put fingers in mouth.

Do not wet pencils in the mouth or fingers when turning leaves of books.

Do not put money or pins in the mouth.

Keep hands, nose and mouth, clean.

DISINFECTANTS AND FUMIGANTS

Every housewife should be acquainted with disinfectants and fumigants, because drains, garbage cans, and ice boxes need them; and cellars must be kept free from chance causes of odors or sickness. One must be ready for the unexpected need of an exter-

minator for vermin, or the need of a disinfectant or fumigant during and after the appearance of disease.

The terms disinfectants, germicides, fumigants, and the like are often used without an understanding of the terms; indeed, they seem often to be used interchangeably.

Disinfectants and germicides are substances which destroy disease germs. Antiseptics retard the growth of germs, but do not necessarily destroy germ life. Salt and sugar may preserve food by retarding germ action but they do not destroy the germ. Bichloride of mercury (corrosive sublimate) is an antiseptic if used in a solution of 1 part to 300,000 parts of water, and is a disinfectant in a solution of 1 part to 1000 parts of water (1 tablet to 1 pint of water); the latter destroys germ life. Both solutions are poisons. Fumigants and deodorants destroy or cover up odors, and may disinfect.

In nature there are many powerful and safe disinfectants: sunlight, dryness, cleanliness, and heat—so-called physical means of disinfection. Dry air and sunlight are foes to germs; moisture and filth are their best friends. With sunlight, cleanliness, and dry air, decaying vegetation and filth diminish, and in the same measure the chance for health increases. Heat like oven heat up to 300° Fahrenheit, or boiling temperature of 212° Fahrenheit for one hour, will thoroughly disinfect. To test oven heat without a thermometer, lay a small wad of cotton in the oven; at 300° Fahrenheit, the cotton will scorch as if ironed with too hot an iron. Boiling for ten minutes in a closed vessel destroys all disease germs except the spores, which may later develop into germs, and makes disinfecting of clothing possible. In the laundering of clothing various alkaline reagents are used which increase the disinfecting power of the water, and decrease the length of time required for disinfecting ordinary soiled clothing. Many of our household cleaning methods fortunately are disinfecting methods.

Let the study begin with these simple everyday methods. They are effective and inexpensive; besides, the substances are so familiar as to cause no hesitancy in their use.

Soap, borax, ammonia, and washing soda are sufficient in the cleaning of ice-boxes, window boxes, basins, and flush closets which are to be cleaned daily.

Soapsuds Solution.—One cake of soap dissolved in 3 quarts of water.

Soda Solution.—One-half pound of washing soda dissolved in 3 gallons of water. Either solution may be used for wall or floor washes, when a room is to be disinfected. Such a solution is easily applied with a pail of hot water and a broom or mop.

It has been proved that the usual methods employed in washing clothes disinfect the clothing for general use. A good laundering with soap and water, five to ten minutes boil or hot scald, the sun and air in drying, and finally, the heat of the iron in ironing, are sufficient for disinfecting clothing.

Lime in its various forms is especially good as a disinfectant or germicide. It is cheap and harmless.

Quick-lime is lime oxide, and has great power of absorbing water. On exposure to the air it absorbs so much water that it breaks up into a powdered form called air-slaked lime. Quick-lime is often put about damp cellars and out houses because of this power to absorb moisture. When it breaks down into a powder, it has no more power to absorb water from the air, and no more power as a germicide.

Slaked lime (hydrated lime) and *milk of lime* are used to disinfect excreta. A 5 per cent. solution of slaked lime will require one hour to do its work thoroughly.

Whitewash is slaked lime thinned with water until it is of the consistency to spread with a brush. Adding glue helps to make the whitewash stick to the surface. Whitewash is much used on fences, outhouses, cellars, and chicken coops, to kill bacteria and vermin, to deodorize, and to improve appearance.

*Recipe for Whitewash **

½ bu. lime slaked with boiling water
 ½ peck of salt dissolved in warm water
 3 lbs. ground rice boiled to a thin paste
 ½ lb. powdered Spanish whiting
 1 lb. clear glue, dissolved in warm water

Mix and let stand for several days. Use hot as possible.

Lime water may be used to rinse milk pans and bottles, and chambers. A 3 per cent. solution is known to kill typhoid bacteria, and a 20 per cent. solution will disinfect excreta. This requires from one-half to one hour.

Chlorinated lime, commonly called chloride of lime, and sold as a bleaching powder, is a disinfectant when used dry, as when

* U. S. Bureau of Standards, Dept. of Commerce. Circular No. 70.

put down basins and toilets. As a bleaching solution, when used in washing, it not only bleaches but disinfects. It deteriorates rapidly on exposure to the air.

Hydrogen peroxide is an unstable compound, which is readily affected by light and heat. Therefore it should be kept in dark-colored glass bottles, and tightly corked. It is especially good for use in connection with discharging wounds to disinfect the suppuration products. It is not used so much as formerly as a general disinfectant for wounds, or as a gargle, on account of its irritating effect on the membranes. Its action is over in about five minutes.

Alcohol.—Alcohol above 50 per cent. strength is a good disinfectant for the hands, or for a needle that is to be used to remove a splinter.

The preceding disinfectants have been those used in regular home methods. The ones given below are stronger in action and poisonous. Great care should be exercised in their use, and it is quite necessary that the one doing the work should be thoroughly trained for her task. For two reasons is this necessary—the chance for a fatal mistake, and the risk of having an essential point omitted so that doubt enters into the point as to whether the work is thoroughly done.

Tincture of iodine is very good to apply to any fresh wound which may later be infected, such as an open bruise, a cat scratch, or a cut from a rusty nail. It is bought in a 7 per cent. solution, and may be used in this strength or in half-strength.

Bichloride of mercury, or corrosive sublimate, is purchased in tablet form. It is a poison and should be handled as such, with the greatest care, and when not in use should be so stored or bottled that no one can possibly mistake it for medicine. To tie a small toy bell around the neck of the bottle is a good safeguard, especially for dark places. (White of egg is the antidote.) It is a powerful disinfectant, but limited as to its use because soaps, proteins, and sulphur precipitate it. It will not stain fabrics, except after constant and long-continued soaking. But it does corrode metal, and so cannot be used for disinfecting any metal utensil. Its best use is for the disinfection of smooth surfaces such as rubber, enamel and glassware, and for clean hands. For the hands a solution of 1 tablet ($7\frac{1}{2}$ grains) to 2 pints of water should be used. Do not mix in a metal dish. For other disinfection use 1 tablet to 1 pint

of water. Allow from one-half to one hour for disinfection of things placed in the solution.

Formalin is a water solution of formaldehyde gas, valuable as a disinfectant. It is second to bichloride of mercury as a disinfectant of rubber, and is good for clothing and utensils. It may be purchased at the drug store as a 40 per cent. solution and reduced to a 4 per cent. solution, by adding some of it to ten times its bulk of water), which is the strength used for disinfection. Soak the articles in this 4 per cent. solution for one hour.

Carbolic Acid Solution (Antidote—Alcohol).—The usual strength in which this is used is 5 per cent.—in the proportion of 1 lb. of carbolic crystals to $2\frac{1}{2}$ gals. of hot water. Stir or shake in a corked bottle until the mixture is free from the small drop for-

Table of Disinfectants

	Strength	Time	Used for
Boiling water.....	$\frac{1}{2}$ -1 hr..	All articles that are not harmed by water.
Slaked lime.....	2 lb. lime to 1 pt. water	1 hr.....	Excreta.
Milk of lime.....	2 lbs. slaked lime to 4 qt. water	Excreta.
Lime water.....	$\frac{1}{2}$ cup lime to 4 qt. water	$\frac{1}{2}$ -1 hr..	Rinsing milk vessels and chambers; typhoid bacteria.
Chlorinated lime (chloride of lime)	$\frac{1}{2}$ lb. chloride of lime to 1 gal. water	Flush closets, basins, bleaching.
Hydrogen peroxide..	Undiluted.....	5 min...	Discharging wounds.
Alcohol.....	50 per cent.-70 per cent.	1 min...	Hands, instruments.
Tincture of iodine...	7 per cent., or 1 part 7 per cent. solution 1 part water	1 min...	Fresh wound where danger of infection.
Bichloride of mercury	(a) 1 tablet ($7\frac{1}{2}$ gr.) 2 pt. water	Hands.
	(b) 1 tablet to 1 pt. water	$\frac{1}{2}$ -1 hr..	Clothing, rubber, enamel, glassware.
Formalin, 4 per cent.	1 cup 40 per cent. solution to 5 pt. water	1 hr.....	Rubber, clothing, utensils.
Carbolic acid.....	5 per cent.....	1 hr.....	Clothing that cannot be boiled.
Creolin.....	} 1-2 per cent.....	$\frac{1}{2}$ -1 hr..	Same as carbolic.
Lysol or cresol.....			
Trieresol.....			

mation on the bottom of the vessel. Exposure for one hour to a 5 per cent. solution is usually effective for bacteria, not for spores. In cleaning slop-jars and chambers use a string mop, as carbolic is very irritating to the skin. It is generally used to disinfect articles that cannot be boiled; articles, like clothing and bedding, which can be boiled, can be completely sterilized by boiling in water without the use of carbolic acid.

Creolin, lysol or cresol, and **tricresol** are coal-tar products used in place of carbolic acid. Creolin has about the same value as pure carbolic, and lysol and tricresol are about three times as powerful. They are less irritating to the skin, but are more expensive than carbolic. Use a 1 per cent. or 2 per cent. solution dissolved in tepid water.

MILD ANTISEPTIC

Boric acid or boracic acid is a mild non-irritating antiseptic. Because of its mildness it is a very general home treatment for eye, ear, nose and mouth. Boric acid dissolves easily in hot water, and a saturated solution, diluted by equal quantity of water, gives the usual strength solution.

FUMIGANTS

Fumigants are agents which give off a gas which is destructive to bacteria or to vermin. They are not used as much as formerly after contagious diseases like measles. In ordinary contagious diseases the main reliance now is placed upon thorough soap and water cleaning. If of real value, fumigants must be strong in the gas they give off; this makes it dangerous for an untrained person to carry on the work, and under ordinary conditions the results will scarcely pay her for her labor and attendant risk. However, it is well for the housewife to know about these agents, for they are useful in their ability to destroy vermin; and she may, in the absence of a trained nurse or a Board of Health representative, be called upon to fumigate a room after sickness. It is important for her to be thoroughly informed as to the method before she undertakes to do the work.

Formaldehyde gas and **sulphur fumes** are the usual fumigants. The sulphur is most often used to exterminate household pests, while formaldehyde is a valuable disinfectant, but does not kill vermin.

Formaldehyde gas may be produced in several ways. One especially effective way is to combine potassium permanganate with formalin. Allow one-half pound of potassium permanganate to each 1000 cu. ft. of air space. To every half-pound of permanganate allow 1 pint of formalin. Prepare the room as for any fumigation (see page 304), and when all is ready, put the permanganate in a galvanized iron kettle or pan, which is set upon bricks or in water to protect the floor from heat; pour on the formalin and immediately leave the room. The formaldehyde gas is given off, which is most irritating to the mucous membrane and is poisonous. Its penetrative power is not very great, so that it is necessary for everything in the room to be entirely exposed to its action.

Park and Williams * give the formulæ for formaldehyde generation found on page 304.

Sulphur Fumes.—Sulphur is not very effective in destroying germs, but it is very valuable in the extermination of pests. Sulphur fumigation involves the danger of fire as well as of inhaling the poisonous fumes. A sulphur candle or flowers of sulphur may be used; the candle is easily obtained and the wick helps to keep it burning. For flowers of sulphur pour on a tablespoon or more of alcohol to insure its burning; the worker will not then need to go into the room to relight the sulphur, and expose herself to the fumes. Allow 4 lbs. of sulphur to every 1000 cu. ft. of air space. Expose eight to twelve hours.

Two Formulæ for Formaldehyde Generation

Either will disinfect 1000 cu. ft. in 5 hours.

I. Potassium permanganate	10 oz.
Formaldehyde solution, 40 per cent.....	9 oz.
Water	4.5 oz.
II. Quicklime	2 oz.
Potassium permanganate	5 oz.
Oxalic acid	½ gram
Formalin	5 oz.
Water	2½ oz.

Mix lime and potassium permanganate in pan. Pour over this the remaining substances in solution.

Hydrocyanic acid gas is effective in destroying household pests, but is one of the most poisonous gases known, and for that reason work with it should be done only by an experienced person.

* Park and Williams, *Pathogenic Microorganisms*.

To Prepare a Room for Fumigation.—Knowledge on the part of the worker is necessary, and when she is thoroughly trained to do the work she will not need to be cautioned against either fire danger or the risk of inhaling the fumes. Get all the things in the room ready. Arrange the contents of the room so that everything will be exposed to the gas. Bedding should be hung over a line. Do not remove from the room anything that was there during the illness. If sulphur is used, the metal door knobs and bed should have a thin coating of fresh (non-salty) fat. Sulphur will corrode metal and will fade color; but colored fabrics may have to be left in, subject to fading, in order to run no risk of leaving germs or vermin in draperies, etc.

Seal the room by closing the window and door cracks with paper or cotton, and stopping the key-holes. Put the potassium permanganate, the potassium cyanide, or the sulphur candle, in a galvanized pail or stone crock. Stand the pail or crock on two bricks or in a larger pan of water, so that the heat created by the chemical action or from the burning sulphur may have no chance to burn the floor or other surrounding material. Pour the formalin on the permanganate, or the sulphuric acid and water on the cyanide, or light the sulphur, and go quickly from the room. The door may be additionally sealed on the outside after closing it. Be sure to have everything so planned and ready that there will be no need to hesitate or to try to go back. For a person who may be slow from inexperience, it is a good safeguard to tie a moist handkerchief over the nose and mouth. The room should be kept closed for eight to twelve hours; then it must be thoroughly aired and cleaned, so that no fumes remain.

To Clean Rubber Gloves.—Wash them in cold water and then boil 2–5 minutes. Overboiling will weaken the rubber. As soap is a good disinfectant, wash both sides of the gloves in warm water and soap, then dry. Gloves that are to be worn to prevent infection should be tested for small holes. When the gloves are in water air bubbles will mark any hole. Such a glove is not safe.

SUGGESTIVE LIST OF HOUSEHOLD DISINFECTANTS

The above suggestions include established solutions and methods of fumigating and disinfecting. Through advertising, various new disinfectants and fumigants may reach the housewife; but the simplest and most active have been suggested. Additional problems

regarding household pests are given in Chapter XII (page 307) and that chapter and this may well be considered together.

Salt and water	}	are standard mouth washes, and they may be used in a dilute form as a gargle.
Listerine		
Potassium permanganate		
Boiling water	}	are standard solutions for washing, cleaning and disinfecting cuspidors, chambers, flush closets, clothing.
Soap and water		
Soda and water		
Lime		
Carbolic acid		
Creolin		
Lysol or cresol		
Tricresol		
Alcohol	}	are standard killers of germs such as may produce disease.
Tincture of iodine		
Carbolic acid		
Lysol and tricresol		
Formalin		
Bichloride of mercury		
Sulphur	}	are standard fumigants.
Hydrocyanic acid gas		
Formaldehyde gas		

SUGGESTIVE QUESTIONS

1. What precautions can every housewife take in caring for soiled clothing?
2. Suppose one member of a family must nurse another who has a severe nose and throat cold. What care should the well member take for her own safety? List all suggestions.
3. What are the usual ways and means whereby contagion may be spread? List.
4. How may a bed be treated after a severe sickness?

REFERENCES

- BROADHURST, JEAN, HOME AND COMMUNITY HYGIENE. J. B. Lippincott Company.
- BUCHANAN, ESTELLE D., AND ROBERT E., HOUSEHOLD BACTERIOLOGY. Macmillan Co.
- CONN, H. W., BACTERIA, YEASTS AND MOLDS. Ginn & Co.
- DAKIN AND DUNHAM, HANDBOOK OF ANTISEPTICS. Macmillan Co.
- ELLIOT, S. MARIA, HOUSEHOLD HYGIENE. American School of Home Economics.
- LIPMAN, J. G., BACTERIA IN RELATION TO COUNTRY LIFE. Macmillan Co.
- MAXWELL AND POPE, PRACTICAL NURSING. G. P. Putnam & Co.
- POPE, ANN E., POPE'S MANUAL OF NURSING PROCEDURE. G. P. Putnam & Sons.
- RICHARDS, E. H., SANITATION AND DAILY LIFE. Whitecomb & Barrows.
- SAUNDERS, GEORIANA J., MODERN METHODS OF NURSING. W. B. Saunders Co., Philadelphia.
- TALBOT, MARION, HOUSE SANITATION. Whitecomb & Barrows.

CHAPTER XII

HOUSEHOLD PESTS

Prevention.—Household pests are troublesome, dangerous, and destructive; therefore they call for constant vigilance. They crawl or fly, hide in dark unexpected nooks, and often come from filthy places. They reproduce so rapidly that they are much easier to keep out than to exterminate after they have gained a foothold. Eternal vigilance is the price of preventing pests.

Prevention means to fill up cracks and holes, allow no dust to collect or spilled food to remain, keep food tightly covered, use screens or traps, fill up stagnant pools, cover rain barrels, keep house leaders free from stagnant water, screen or fumigate manure piles, and use insecticide in garbage containers, privies, and manure piles. The cleanest house, however, may gain the unexpected visitor in the grocery basket, laundry bundle, or even in the valise when travelling. Cleanliness is the one great preventive measure, but not the absolute cure, because of the possibility of this unexpected entrance of vermin.

Extermination becomes a cure of a more heroic nature and involves much work, and often the use of some powerful agent. Methods of extermination include closing runways and cracks; use of powders, fumes, poisons, and traps.

Closing runways is accomplished by using putty, plaster-of-Paris, wooden strips, etc.

Putty is the best agent to use with wood. It may be bought at the paint shop, and colored to match the wood. If the cracks are not too large, putty will make a good filling; but very wide cracks had better have a strip of wood put in, with putty on each side of the strip. Molding may often be used to advantage.

Plaster-of-Paris is also used to fill cracks; it is bought as a powder, and is mixed with water when and as it is needed. It hardens almost immediately. It can be mixed in an old cup or tin cover, or even in a cardboard box, just as it is to be used and in such small quantities as can be handled quickly. It is very white, and may be colored to match the rest of the wall or floor; any coloring

desired may be put into the water before mixing it with the plaster-of-Paris.

Powders.—The second step, which calls for the use of non-poisonous and non-inflammable methods, is by spreading powder such as borax, alum, soap powder, or even pepper. Next to these in strength are pyrethrum, Persian insect powder, and bulach—a California product. The next in strength and last of the powders to use are strychnine and arsenic. These should be used with the greatest care and only as the last resort, as they are dangerous poisons.

Powder can be sprinkled in cracks and about shelves or drawers; on shelves try to keep it on the back edge so that it will not mix with the contents of the shelf. It is wise to blow the powder far back into cracks, and for that work, one may buy a blower which by means of its bellows blows the powder deep into crevices.

Strychnine and arsenic may be used as powders, or in a solution with a paint brush or feather. To be sure of better control of these poisons, either may be mixed with a paste made of flour and water and spread on strips of paper, which in turn are laid in drawers or closets or on tables and drain boards, especially at night. The great danger of using these powerful poisons in the kitchen is obvious, and should be carefully considered beforehand.

Fumes.—In the place of powders, remedies with strong pungent odor may be used, such as kerosene or ammonia, and also those that are not only pungent but also highly inflammable, such as gasoline or benzine. The danger of these last two is the risk of fire, and both should be used out of doors as much as possible; or if indoors, with all windows open and absolutely no fire or open flame of any kind about. Poisonous gas fumes such as sulphur, formalin, or hydrocyanic acid gas may be used, but it is best always to try thoroughly the simplest and safest methods first, using the inflammable or poisonous only as a last resort.

Kerosene, ammonia, or carbolic acid may be used in wash water, or by themselves as washes on the floors and in the closets. They should be applied with a paint brush in order to save the hand.

Inflammables.—The usual method of using gasoline or benzine is to saturate the articles of clothing or upholstery by spraying it in with a sprinkler, or a brush, or by pouring it on to soak the place where the vermin have deposited their eggs. To do this work, the greatest care must be exercised; a careless worker should never be

allowed to do it. The work is best done out of doors and usually mattresses, pillows, clothing, etc., can be carried outside. To do the work on the lawn will kill the grass, so work on a walk or gravel path. Be sure to let the gasoline all evaporate before using the article; about twenty-four hours should be allowed for this. *Don't light matches or bring any light to see whether the gasoline is destroying the pest. It may destroy you.*

Sulphur, Formalin.—These fumes are very pungent and irritating to the nasal passage, besides being poisonous, if inhaled. Sulphur fumes will bleach out color, so that carpets and any color in the room may be effected. Metal beds and all door knobs will have to be covered with a thin coating of lard or fresh fat to keep the sulphur from corroding the metal. Formalin is used for fumigating, and is a germicide. (See chapter on Fumigation, page 303.)

Traps and Screens.—These exterminators are in a class by themselves. They may or may not kill; often they simply prohibit action, as do many traps, mosquito nets, etc. With some traps there is a sweet attractive mixture which may contain a poison. Some traps operate by killing. Any trap should be kept clean because, as in mouse and rat traps, the odor may be a warning to the otherwise next victim; scalding is helpful in removing odors.

INDIVIDUAL PESTS

House Fly.—A carrier of disease, hence a menace to health (Fig. 163).

Prevention.—1. Do away with breeding places of maggots in manure piles, chicken yards, privy vaults. Build fly-proof. Destroy maggots with kerosene, borax, chloride of lime, hellebore, iron sulphate.

2. Screen all windows and doors, especially kitchen and dining-room.

3. Absolute cleanliness in house.

4. Keep food and garbage containers tightly covered.

5. Store no soiled papers and cloths.

Extermination.—1. "Swat the fly."

2. Sticky flypaper.

3. Fly traps—various good types. A good home-made trap consists of a cup or can on the end of a stick with hot soapy water in cup; hold under flies on ceiling.

4. Natural enemy is the centipede.

5. Poisons: to get best results from these remedies, darken the room except one window; place poison in light near this window.

Pyrethrum.—Persian insect powder and bulach. Sprinkle liberally at night in unused rooms. Sweep up in morning.

Formaldehyde.—1 part formaldehyde to 10 parts water. Place in saucers.

Bichromate of Potash.—1 part bichromate to 2 parts water. Place in saucers.

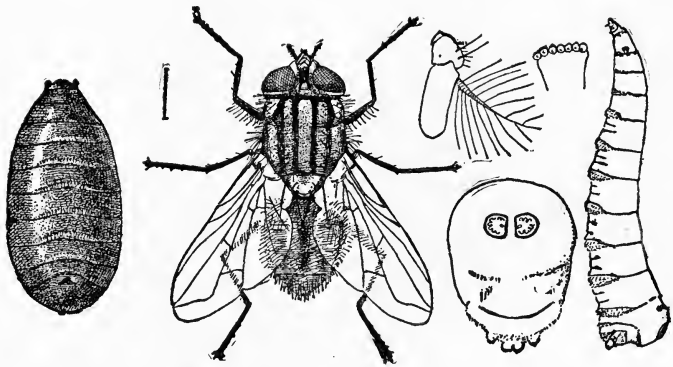

FIG. 163.—The house fly, *Musca domestica*: larva with details at right, puparium at left

Mosquitoes.—Carriers of malaria, yellow fever, and several other fevers.

Prevention.—By treatment of breeding places.

1. Drain or fill up ponds, pools, etc., or if this is not possible—Spread kerosene oil over surface every two weeks during summer. Introduce natural enemies into ponds, such as gold fish, silver fish, and minnows.

2. Remove old tin cans, pails, bottles, and other possible containers of water.

3. Cover rain barrels and tanks with fine wire netting.

4. Screens at all windows and doors.

Extermination.—1. Bed nets at night (have net large enough to allow free circulation of air; be sure no mosquito is inside the net, and net is free from holes and tears).

2. Mosquito traps—home-made, same as for flies.

3. Repellent oil: (a) Oil of citronella (apply to screens if badly infested). (b) Repellent mixture: Oil of citronella, 1 oz.; spirit of camphor, 1 oz.; oil of cedar, $\frac{1}{2}$ oz. A few drops of this mixture on a cloth hung on the bed at night is effective.

4. Smudges: Anything that will make a dense smoke will drive away mosquitoes. Pyrethrum powder made into paste and burned is effective.

5. Fumigants: Sulphur is burned in case of disease-causing mosquitoes.

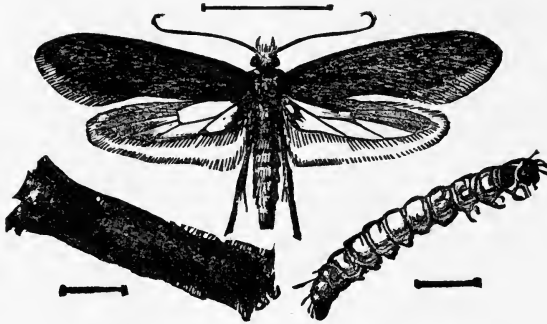

FIG. 164.—Clothes moth—with puparium and larva below.

The latter two must not be burned where people can inhale the fumes too closely.

Clothes Moths.—Destructive to woolen textiles, fur, feathers, and carpets or upholstery. The destruction is done by the larva or worm which develops from the moth egg (Fig. 164).

Prevention.—Keep moths from depositing eggs.

1. Hang textiles in sun and air, and
2. Carefully beat and brush so as to remove any eggs that may be present, and
3. Pack tightly in clean boxes, bags of cotton, linen or strong paper, and include
4. Repellents such as tobacco, pepper, camphor, naphthaline balls, and cedar chips, which are effective in keeping moths out, as long as odor is strong; then
5. Seal edges of boxes with wrapping paper.
6. Keep closets clean.

7. Or use cold storage method (adopted by dealers in furs, etc.). Temperature is so low as to produce inactivity.

Extermination.—If the moth worm has developed, the house-keeper must give her attention to the closet or storage place.

1. Take clothing to sunlight and brush thoroughly.
2. Wash the closet with strong soapsuds.
3. Burn a sulphur candle.
4. Spray walls, shelves, and boxes with oil of cedar, gasoline, or benzene. (Avoid fire.)

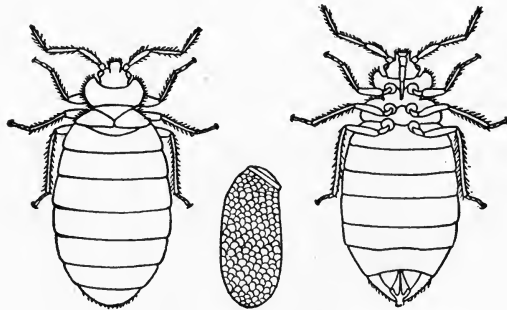

FIG. 165.—The bed-bug from above and below and egg.

Bed Bugs.—Possible carriers of disease (Fig. 165). Found in dusty, undisturbed places first; easily carried in clothing.

Prevention.—1. Inspection of beds and bedding, especially seams and tuftings of mattresses.

2. Careful inspection of all baggage and clothing coming into house.

Extermination.—1. Hot water.

2. Benzine or kerosene injected into all crevices of beds and walls.

3. Corrosive sublimate.

4. Oil of turpentine.

5. Fumigants: sulphur—to be burned—most efficient remedy, but to be handled with great care (see page 303).

Roaches.—Cock roaches, croton-bugs, water bugs (Fig. 166). More abundant in pantries and kitchens, near garbage pails, sinks, and warm places such as hot water boilers. They feed on dead ani-

mal matter and food of all kinds. Wet scrubbing brushes, refrigerator drip pans, and dish cloths seem especially to draw them.

Prevention.—1. Keep kitchen and pantry clean from crumbs.

2. Cover all food.

3. Keep sink dry; no wet mops or dish cloths.

4. Place alum or borax in water pan under refrigerator.

5. Sprinkle roach powders under refrigerator.

Extermination.—1. Dust: Powdered borax, pyrethrum powder, sodium fluoride, sulphur flowers.

2. Poison paste: Spread on bits of cardboard placed in runways.

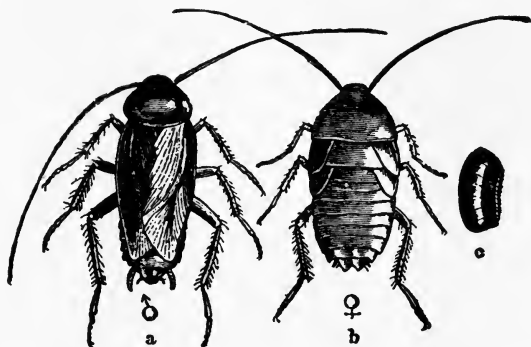

FIG. 166.—The Oriental roach, *Periplaneta orientalis*.—a, the male; b, the female; c, egg-case.

3. Trapping.—Roaches like rancid grease, and can often be caught in a pan well lined with grease, as they cannot crawl through it. A bread pan with sides about three inches deep makes a good trap. To kill trapped roaches, plunge trap into very hot water.

Ants.—Especially hard to fight because they are so small and usually come in such myriads.

Prevention.—1. Keep all food covered.

2. Place legs of tables and refrigerators in cups of water covered with a coating of oil.

Extermination.—1. Find the ant-hill, and inject kerosene into it and close tightly with cotton soaked in kerosene.

2. Soak sponges in sweetened water; after ants have crawled into it, plunge the sponge into boiling water.

3. Spread borax on shelves.

4. Poison. Soak sponges in syrup poisoned with arsenate of soda, and the ants will carry the poison to larvæ in nest. (Use arsenate with great care, as it is a poison.)

5. Strong soapsuds—harmless and very effective.

Carpet Beetles (Buffalo Bugs).—Feed upon carpets and woolens and silk. Are most destructive because they eat so many types of things (Fig. 167).

Prevention.—1. Replace carpets by rugs.

2. Take up carpets at least twice a year, and thoroughly clean carpets and floors.

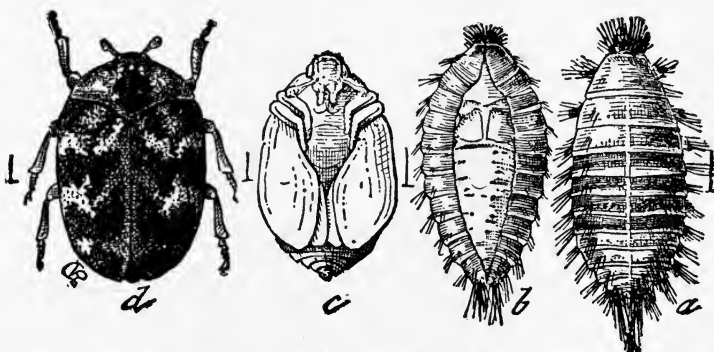

FIG. 167.—The carpet-beetle, *Anthrenus scrophularia*.—a, larva; b, larval skin split to expose the pupa within it; c, pupa; d, beetle.

Extermination.—1. Thorough house cleaning: Thoroughly clean carpet. Spray with benzine. Wash floors with hot water. Clean out cracks—pour kerosene or benzine into cracks and under baseboards. (Benzine very inflammable.) Fill cracks with plaster-of-Paris. Lay tarred paper under carpets. Every little while take up edges of carpet and look for insects.

2. Steam.—Place damp cloth over carpet; iron with hot iron. Steam will pass through carpet and will kill insects directly under the ironed part.

3. Poison.—Corrosive sublimate and alcohol—60 gr. corrosive sublimate dissolved in 1 pint of alcohol. Apply to edges and under-sides of carpet; will destroy larvæ. (Great care must be used because corrosive sublimate is a violent poison.)

Fleas.—Parasites and carriers of disease. Two species in dwelling houses: human, and cat or dog flea (Fig. 168).

Prevention.—1. Destroy adult flea; the eggs are like small black powder, called nits.

2. Keep cats and dogs clean and free from fleas. Bathe frequently in solution of creolin. For dogs—4 tablespoons creoline to 1 quart water. For cats—2 tablespoons creoline to 1 quart water.

3. Animals' sleeping rug or pillow should be often beaten and hung in sun.

Extermination.—1. Care of carpet, rugs, or floors—(a) Sweep carpets and take up often; (b) wash floors with strong soapsuds;

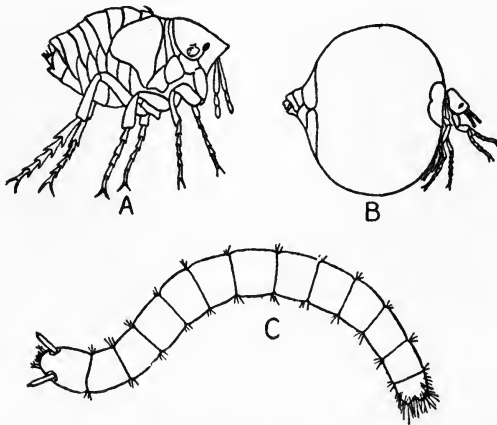

FIG. 168.—The jigger flea: a, normal female; b, distended with eggs; c, larva.

(c) fill up cracks of floors; (d) sprinkle carpets with benzine or gasoline; naphthaline, or alum (powdered or in solution).

2. Repellents—(a) Oil of pennyroyal; (b) boughs and chips of pine; (c) naphthaline crystals; (d) pyrethrum.

The oil of pennyroyal can be applied to the human skin; or can be used in the household by rubbing around window or on floor.

Rats and Mice; Squirrels; Chipmunks.—All are very destructive of food, clothing and leather, and are very dirty.

Prevention.—1. Close all holes or openings by which they enter. Tin makes a good cover.

2. Keep all food covered.

3. Leave no crumbs about.

Extermination.—1. Traps set near possible entrance. Scald traps before setting to remove suspicious odors.

2. Poisons—various preparations on the market. Cannot be used with pet animals about.

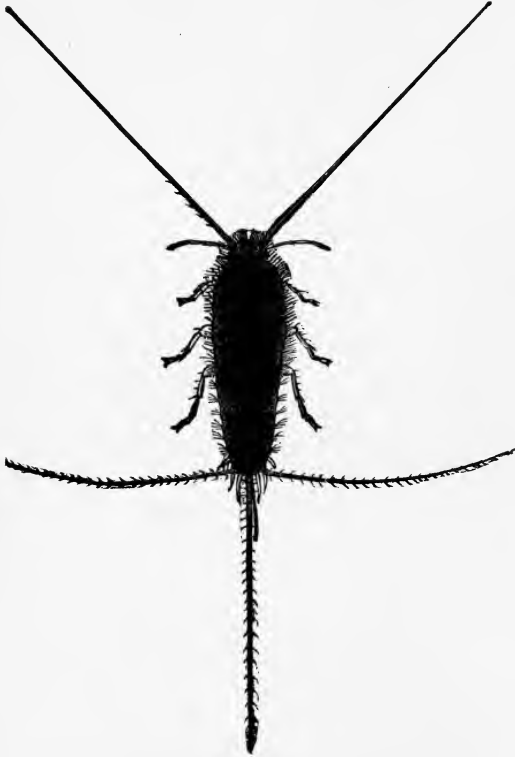

FIG. 169.—The silver-fish, *Lepisma domestica*.

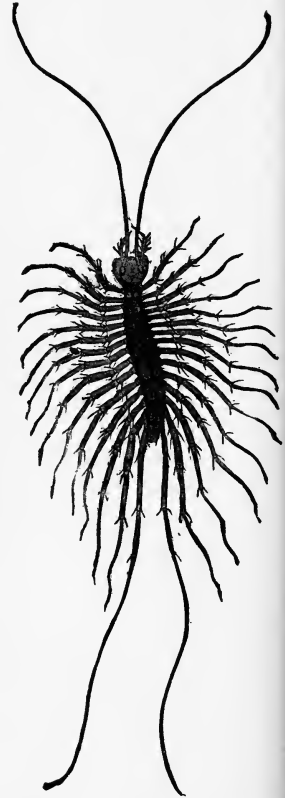

FIG. 170.—A house centipede. *Scutigera forceps*.

3. Cats as catchers.

4. Weasels—professional vermin exterminator brings his own weasels.

Silver Fish (fish moth, bristle tail) (Fig. 169).—Injurious to bookbindings, glazed paper, starched clothing, linen, curtains, stiff silks, wallpaper paste.

Prevention.—1. Keep the place dry and well aired.

Extermination.—1. Pyrethrum powder sprayed on book shelves, in drawers, etc.

2. Sodium fluoride sprayed wherever pests occur.

3. Arsenic (deadly poison). Add to starch paste. Place on small pieces of cardboard where pests occur.

Centipedes.—Abundant in bathrooms, moist closets, cellars, conservatories, and around heating pipes and registers (Fig. 170).

Prevention.—1. Constant inspection of moist places.

2. Keep places dry and aired.

Extermination.—1. Destroy centipedes whenever seen.

2. Apply fresh pyrethrum powder.

SUGGESTIVE QUESTIONS

1. What safe ways can be suggested for ridding a bed of vermin?
2. How can you clean a sugar box of ants?
3. A housewife once thought she had a cricket and hated to kill it because of an old-fashioned superstition. Later she found she had been harboring a household pest. What was it?
4. If a kitchen is infested with roaches what means may be employed to exterminate?

REFERENCES

- BISHOPP, F. C., FLEAS AS PESTS TO MAN AND ANIMALS, WITH SUGGESTIONS FOR THEIR CONTROL. U. S. Dept. of Agric., Farmers' Bulletin No. 683.
- BISHOPP, F. C., FLY TRAPS AND THEIR OPERATION. U. S. Dept. of Agriculture, Farmers' Bulletin No. 734.
- HERRICK, GLEN W., HOUSEHOLD INSECTS AND METHODS OF CONTROL. Cornell University Bulletin No. 49.
- HOWARD, L. O., THE CARPET BEETLE, OR BUFFALO MOTH. U. S. Dept. of Agriculture, Farmers' Bulletin No. 626.
- HOWARD, L. O., HOUSE FLIES. U. S. Dept. of Agriculture, Farmers' Bulletins Nos. 459 and 679.
- HOWARD, L. O., HYDROCYANIC ACID GAS AGAINST HOUSEHOLD PESTS. U. S. Dept. of Agriculture, Farmers' Bulletin No. 699.
- HOWARD, L. O., MOSQUITOES, HOW THEY LIVE, CARRY DISEASE, ETC. McClure, Phillips & Co.
- HOWARD, L. O., REMEDIES AND PREVENTIVES AGAINST MOSQUITOES. U. S. Dept. of Agriculture, Farmers' Bulletin No. 444.
- MACLEOD, SARAH, THE HOUSEKEEPER'S HANDBOOK OF CLEANING. Harper & Bros.
- MARLATT, C. L., THE BEDBUG. U. S. Dept. of Agriculture, Farmers' Bulletin No. 754.
- MARLATT, C. L., COCKROACHES. U. S. Dept. of Agriculture, Farmers' Bulletin No. 658.
- MARLATT, C. L., HOUSE ANTS, KINDS AND METHODS OF CONTROL. U. S. Dept. of Agriculture, Farmers' Bulletin No. 740.
- MARLATT, C. L., THE HOUSE CENTIPEDE. U. S. Dept. of Agriculture, Farmers' Bulletin No. 627.
- MARLATT, C. L., THE SILVER FISH, AN INJURIOUS HOUSEHOLD INSECT. U. S. Dept. of Agriculture, Farmers' Bulletin No. 681.
- MARLATT, C. L., TRUE CLOTHES MOTHS. U. S. Dept. of Agriculture, Farmers' Bulletin No. 659.
- PARLOA, MARIA, HOME ECONOMICS. Century Co.

CHAPTER XIII

SUGGESTIONS FOR TEACHERS

HOUSEWIFERY, as presented in this book, represents technique of housekeeping. As a subject of study, it may form either a course by itself which is to give special attention to the practical processes of housekeeping with appropriate laboratory exercises; or, where the curriculum has not yet developed so that housework is taught in a course by itself, housewifery may be made a part of the course in household management; or together with other management topics, selected lessons in housewifery may be introduced into other courses in the home economics curriculum, as in cooking courses.

If provision is made for a separate housewifery course, it should have its specially prepared teacher and its special equipment and laboratory, just as is provided for any other subject of instruction. At the same time this subject is of such a nature that simple lessons in housewifery may be given by teachers of the home economics courses, and indeed by regular classroom teachers provided they have had proper training. Moreover, the importance of the subject is such, dealing as it does with the fundamental sanitary problems of household living, that it is desirable that it should be taught most widely to older as well as to younger students everywhere.

The problems to be met both by the teacher of housewifery who gives a special course in this subject, and by teachers of other subjects who introduce a number of housewifery lessons into other courses, will be considered in this chapter.

Methods of Teaching.—Housewifery is a subject which can be presented theoretically by lectures or talks, but since it concerns practical processes it is very important that the teaching of theory be constantly accompanied by practice in order to try out ideas, to make mental impressions more vivid, and to equip the learner to do successfully the particular task concerned. A textbook in the hands of students will help present theory in well-organized form, though of course there must be oral instruction by the teacher who describes processes and leads the group in discussion; a textbook becomes later a reference book. Students will usually keep note-

books. Illustrative material (Fig. 171) and excursions to places of business, to homes and to institutional households, will help make clear the problems involved.

Laboratory Work.—Practical work must be provided, whether it be in the student's own home, in and about the school building, or in a special housewifery laboratory suitably equipped, or in a practice house or apartment. The special housekeeping laboratory ought to be provided in all higher institutions, and even in high



FIG. 171.—Storage of illustrative material.

schools there is a great advantage in the special room set aside with its proper equipment and teaching materials. For one thing it gives an importance in the minds of the students to the prosaic work problems of the home to find them the subject of instruction appropriately housed in a housewifery laboratory. And such a special room makes it also possible to do better teaching, since equipment and teaching material of all kinds can be gradually collected in such a room where it is at hand to illustrate points arising in the teaching.

Housewifery Laboratory.—A room 30 x 30 or thereabouts will make an adequate housewifery laboratory (Fig. 171). The equipment actually required for a beginning may be very simple—a few tables, a sink with water supply, a gas stove or better several gas

burners, and storage facilities for teaching materials. This of course is an inexpensive furnishing which will place much additional labor on the teacher, but it does make the work possible if there is only a small amount at first available for the equipment of a housewifery laboratory (Fig. 172). With such a meagre equipment, the illustrative material must be furnished by borrowing



FIG. 172.—Laboratory equipment.

from other departments, and by teacher or students bringing in special problems for the day, and the class may have to be satisfied with such help as is furnished by demonstrations given by the teacher. Like all demonstration work it has only a small part of the value of the actual work done by the students themselves.

The supplying of pieces of silver and of various metals to be cleaned, a few pieces of linen that might be used for teaching hemming of nappery, or cretonnes to be made up into various bags and holders or upholstered into pillows—this and similar

material might easily be brought in by students. But when beds, refrigerators, stoves, etc., are part of a lesson, it will be seen at once that it would be more practical to have them in the laboratory, if possible; at any rate somewhere in the school where a class can assemble and study them. Teachers sometimes take their classes to their own apartments or homes for special lessons, but this is unsatisfactory, because of the time lost in the students' going and coming, and because often the class is too large to work without confusion.

As soon as conditions permit, therefore, the requisites for instruction in this subject should be provided as adequately as for any other subject. This requires a good-sized laboratory room with one or more large store-rooms, for there is a large amount of teaching material which can wisely be used. The room should have work table space for 30 students; the tables should be moveable, with soft wood tops, so that they will not be injured by rough work and can be refinished readily; they should be of standing height (34"-38"), with high chairs provided. The tables may well be arranged in a horse-shoe form with the teacher's desk raised at the opening of the horse-shoe. In addition to running water, and gas outlets including a range, there should be storage cupboards and glass display cases in the room, and ample space for bringing in from the store-room, a bed, refrigerator, furniture, utensils of all kinds, and exhibits. Ample blackboard space should be provided and also cork board for pinning up exhibit material.

The store-rooms should have shelving and cupboards, and considerable floor space for storing materials, labor-saving equipment, etc., when not in use in the laboratory. One or two rooms 12 x 15 will not be too large for storage space.

Laboratory Equipment.—To equip the laboratory, one would have to set aside about \$500, if the ideal work-room is to be established, but, given a room, teaching materials can if necessary be gradually accumulated. In general there should be present samples of the materials, tools, working equipment, and supplies, and of the furnishings which enter into the ordinary household. The various items listed in the chapters of this book so far as they can conveniently be brought into a school workroom suggest what equipment the laboratory should have. If one has to equip from the first, one should inquire as to materials which can be had on loan so

as to make one's funds reach as far as possible. Gradually, however, get into the laboratory the things used regularly.

Some idea of desirable equipment may be had from the following concrete suggestions:

Plumbing fittings as trap, faucet, etc.; charts of plumbing and heating systems; sample lighting equipment; working equipment of kitchen, laundry, and cleaning processes; larger labor-savers as washing-machines, dish-washers, vacuums; supplies of all kinds, as soaps, dustless sweeper materials; samples of the materials with which the housewife deals—wood samples in various finishes, types of flooring, etc.; metals of all kinds in forms suitable for experimental cleaning; household linens, floor coverings, wallpapers, hangings, curtain and curtain fixtures, etc.

The teacher may bring out both the art and economic side of furnishing by having the students mount their illustrations of furniture and their samples of materials so as to represent the furnishings of one room, which they present with an estimate of the cost. By comparison and classroom discussion, students are led to see better combinations as to both line and color. At all times, comparative cost must be part of the study, and at no time should expensive things alone be considered. The type of student controls the desirable range of costs in such a problem, but the teacher of housewifery must always teach economy.

One handicap to the above method is the viewpoint of the merchants. Many catalogs are put out at great expense, so great that the merchants feel that it is impossible for them to furnish these expensive catalogs without there being some anticipated purchase of the article. The author has found that many firms gladly cooperate in this type of educational work if they are consulted and given time to prepare some sheets of special value to students, rather than have them use or cut up catalogs.

Loans from Firms.—Teachers may have help through the loaning of equipment by manufacturers or local dealers. This is especially important with expensive equipment such as vacuum cleaners and washing machines. It is a disadvantage to own too many of these, because the laboratory soon becomes a museum of machines which finally become too old to serve as up-to-date equipment. An exhibit of large labor-savers is valuable for comparative purposes. Manufacturers will often extend the courtesy of

a visit to the plant to the class, and such excursions to both factories and stores are of great service. Lantern slides will often be furnished by firms, they being given the privilege of putting their names in the corner of the slides.

Helps in Classroom.—Catalog and advertising material, together with newspaper articles may be made available for the students through the use of folio boxes; catalogs may also be filed on edge in a deep drawer. This material to be of service must be well indexed. Folio or filing boxes may be obtained from any book dealer. A catalog of larger sized index cards is useful for information taken from catalogs and other sources. The bulletin board should be used for interesting items. A shelf of reference books should be provided in the laboratory.

Whether or not a text-book is used, it may be found helpful to outline the lesson and give such an outline on a typewritten sheet preceding a lesson. On this outline may also be added a set of problems and a list of reference readings; this sheet helps the student to prepare her lesson. Any recipes, *e.g.*, of cleaning solutions, or directions for work, should be given to each student on mimeograph sheets, cut to fit the notebook. These sheets will save time of dictation by the teacher in class, and also eliminate mistakes in copying.

Practice Work, Practice Houses (Figs. 173, 174).—The laboratory method is extended to a more real and definite working out of the problem by the use of practice houses or practice apartments. Practice houses have proved to be an advantage for different types and ages, from the girls of grammar school to those of college age, and even in teaching housekeepers in extension classes. To make the practice house very real and of the desired help to the individual, the class should be of a family size, otherwise there is too much division of labor, as well as too small a share of responsibility. The public school practice house lacks a large part of the value that a regular practice house may have, because students do not make it their real home, being there only through school hours. Some have suggested that in time eighth-grade and high school girls will be asked as part of their practical study of housekeeping to live for a week or more in a model house or apartment.

In a practice apartment or a practice house, the student should ideally be given the individual tasks of a member of the "family" living in the house. Her work should finally extend through all

branches of housekeeping and homemaking—mistress, maid, laundress, buyer, guest etc. A good way is to change the working schedule once a week, then to bring in a new group, 'because this gives time to perfect methods reasonably and, too, the home schedule is usually operated on a weekly basis. This is also of service to the one who has charge of the food and the budget. A senior student or



FIG. 173.—Practice house, Oregon Agricultural College, Corvallis, Oregon.

an assistant teacher in the department may act as a leader of the group, but the work must be closely supervised; a good standard of work gives sufficient basis for credits for this practice work. The number of points allowed a student for this practical work varies with different standards of training, but when properly supervised it should be counted as equivalent to laboratory hours within the institution, and given credit accordingly.

Model housekeeping centers are established in some cities as a basis of teaching better housekeeping standards, especially to the

foreign women who live in the community. These are apartments furnished economically but with all necessities for good housekeeping and homemaking; often each item is marked with the cost for the information of visitors. Such centers are also used by the public school children, who come for certain periods a week to have work in an apartment which is a standard for the kind of an apartment in



FIG. 174.—Living-room of practice house, Oregon Agricultural College, Corvallis, Oregon.

which they live. The center is usually in charge of a special teacher who conducts all the work of the center.

Practice Work in Homes.—Some teachers of housewifery have encouraged definite work being done by students in their own or others' homes, credit being given for stated hours of work. The main difficulty has been to find some way to supervise and check up the work and to rate students. Such work, particularly when done for compensation in the homes of others, may prove an important step toward the training of young women in wage-earning occu-

pations related to the home. The disadvantage in having the student take her training in homes of others results from lack of standardized housekeeping methods. Each housewife may be a good teacher and a good housekeeper but the methods of any two will vary widely. This in fact, is one reason that housekeeping schools have made such slow progress.

School Courses in Housewifery.—In high schools, both junior high schools and regular high schools, and in technical and vocational schools for girls, a definite course of lessons in housewifery should be taught. This will be either a unit course in the home economics department, or perhaps a half unit with some other course.

There are given below two outlines of courses: the first a nine-lesson course given in the Washington Irving High School, New York City, where a practice apartment is available; and the second a more detailed outline of eight lessons which may be used in schools, in settlements or other special classes, or in rural extension work.

LESSON OUTLINES NO. I.

Housekeeping Lessons Given at Washington Irving High School, New York City

LESSON I

1. Discussion of previous work under other subjects related to the home.
2. Habits, their value and formation
3. Practice Apartment shown and explained
 - a. Rooms discussed—number and size
 - b. New Law for Tenements—average size and rent
 - c. Necessary points in any apartment
4. Home work. Each girl examines her cellar and the door leading to the roof.

LESSON II

1. Plumbing,—construction and care
 - a. Importance of good plumbing
 - b. Open plumbing
 - c. Traps—construction and use
 - d. Care of sink, pipe, and tray. Use of alkalies
 - e. Care of bathroom fixtures. Use of disinfectants
2. Practical work—Opening of trap, cleaning of sink, tub, basin and flush closet

LESSON III

Care of Floors and Woodwork

1. Natural wood
2. Stained or painted floor
3. Oiled and waxed floors
4. Linoleum and oilcloth
5. Matting
6. Carpets and rugs.

LESSON IV

Care of Closets and Windows

1. Kitchen closets
 - a. Treatment and arrangement
 - b. Care and cleaning
2. Clothing closets
 - a. Economical use of space
 - b. Care
3. Windows and mirrors
 - a. Care and cleaning

LESSON V

Cleaning of Metals

1. Purpose
2. Danger of cheap, unknown polishes
3. Making of simple, inexpensive ones at home
4. Method of cleaning steel, iron, tin, zinc, copper, brass, gold, silver, and nickel

LESSON VI

Daily Care of Rooms

1. Kitchen
 - a. Sweep floor with hair broom
 - b. Dust if necessary
 - c. Clean sink
 - d. Clean stove
 - (1) If it is a gas range, wipe burners and top of stove with a damp cloth. Clean the pan underneath the burners
 - (2) If it is a coal range, remove ashes, brush hearth, and wipe stove. Rub with oily cloth if necessary
 - e. Wash tables and shelves if necessary
2. Bathroom
 - a. Wipe floor if necessary
 - b. Clean inside of flush closet if necessary. Bathtub and wash basin should be left clean by each person who uses them
3. Other rooms, such as living room or bedroom
 - a. Brush rug or carpet with carpet sweeper
 - b. Dust bare floor with dustless mop or bag on the broom
 - c. Dust window sills, furniture and ornaments. Do not wrinkle bureau covers or table covers when removing them. Empty and dust sweeper, brush dust from dustless mop and wash duster

HOUSEWIFERY

LESSON VII

Cleaning a Room

1. Difference between Daily Care and Cleaning of a room
2. Preparation of room
 - a. For cleaning with a vacuum cleaner
 - b. For cleaning with broom
 - (1) Furniture
 - (2) Hangings
 - (3) Pictures
 - (4) Ornaments
 - (5) Carpet or rugs
3. Cleaning. Methods as dustless as possible—use dustless mop and duster and dampened paper for the floor, if necessary

LESSON VIII

Cleaning and Polishing of Furniture

1. Substances to be avoided, and why
2. Substances to be used, and why
3. Cleaning:
 - a. Water
 - b. Neutral soap
 - c. Whiting
 - d. Oil
4. Polishing:
 - a. Polishes to be avoided. Reasons
 - b. Simple home-made polishes. Advantages
 - c. Method of work
 - d. Care of oily cloths

LESSON IX

Furnishing and Care of the Sleeping Room

1. Furnishing:
 - a. All furnishings should be easy to clean or wash
 - (1) Floor covering. Bare floor with a rug is best. Carpet is undesirable
 - (2) All hangings and covers should be made of washable material
 - (3) Furniture should be plain. An iron bed is best
2. Care
 - a. Of room
 - (1) Keep free from dust
 - (2) Keep well ventilated
 - (3) Keep neat
 - b. Of bed
 - (1) Air bedding and room in the morning, if possible. Open closet door while airing room
 - (2) Examine bed occasionally to keep it free from vermin
 - (3) Turn mattress often

LESSON OUTLINES NO. II

For Schools, Settlement and Other Special Classes; or Rural Extension Work

*Introduction to the Course—An Appeal for Scientific Homemaking.
Present-day Methods—Results Possible*

Establish concept of:

A house—a building

A home—what the family life makes it

Housewifery—a study of the problems daily confronting the housewife

Homemaker—the one upon whom the success or failure of the home primarily depends

LESSON I

Choosing the Home. Analysis of the House

1. Considerations in choosing the home
 - a. Surrounding conditions
 - (1) Physical
 - (a) Character of buildings in vicinity
 - (b) The water supply
 - (2) Social
 - (a) Character of neighborhood
 - (b) Proximity to business and school
 - b. The house or apartment itself
 - (1) Condition of building
 - (2) Plumbing
 - (3) Ventilation
 - (a) what it is
 - (b) how secured
 - (c) influence on health
 - (4) Sunlight
 - (5) Heating
 - (6) Lighting
 - (7) Arrangement of rooms
2. Analysis of the House
 - a. Divisions into
 - (1) the work part
 - the rest part
 - the pleasure part
 - (2) the communications between parts
 - b. The law that parts should relate as well as connect

LESSON II

The Cleaning Process

In the cleaning process, we consider:

1. The cleaning tool
 - a. What constitutes a tool to-day
 - b. How to choose a tool
 - (1) Analysis of tool as to
 - (a) need
 - (b) quality, and suitability to purpose
 - (c) cost
 - (d) cost of repair

NOTE.—Demonstration with tools.

2. The Cleaning Material
 - a. Talk over cleaning solutions the women use
 - b. Make solutions to be used in the class work *
 - (1) Soap solution
 - (2) Javelle
 - (3) Washing soda
 - (4) Oxalic acid solution
 - (5) Detergent

LESSON III

The Kitchen

Correlate the analysis of the house with the principles or organization as applied in the remaining lessons: even if the home consists of one room and all the processes and divisions be included in it, the analysis and principle remain the same; therefore these processes and divisions will be taken up as such, the class to make application to individual home conditions.

1. Analysis of work performed in the kitchen, viz.: The preparing of food, the cooking of food, washing dishes, putting away dishes
 - a. As determining
 - (1) The essentials in the structure and finish of the floor, walls, and ceiling
 - (2) Ventilation
 - (3) Light
 - b. With regard to efficient routing of work †
2. Practical work: Measure working heights. Show a room:
 - a. Inefficiently arranged
 - b. Efficiently arranged without extra cost

Problem for next lesson: To bring in list of, or have in mind, the necessary kitchen equipment.

LESSON IV

Permanent Equipment

1. The kitchen cabinet ‡
 - a. Construction
 - b. Organization and contents §
 - c. Care
2. The stove
 - a. Kinds
 - (1) Coal
 - (2) Gas
 - (3) Fireless cooker
 - b. Working principles
 - c. Care

* The teacher to make these solutions as a demonstration.

† Emphasize and enlarge upon routing of all housework from this text.

‡ Emphasize correct height of working surfaces.

§ Correlate with last lesson.

3. The sink
 - a. Principles of construction
 - b. Kinds
 - (1) Porcelain
 - (2) Enamel on iron
 - (3) Iron, etc.
 - c. Care

Practical work, combined with teaching. Utensil cleaning, dish washing, care of sink, disposal of kitchen waste.

LESSON V

The Kitchen. Permanent Equipment (continued)

1. The refrigerator
 - a. Principles of construction
 - b. Care
2. The window box
 - a. Principles of construction
 - b. Use
 - c. How made
3. The cupboard for dining room dishes
 - a. Organization
 - b. Equipment of dishes
 - c. Care

Discussion of cheaper devices or make-shifts.
 Practical work: Cleaning refrigerator, constructing a window box or refrigerator, according to the season of the year.

LESSON VI

The Laundry

1. Analysis of its use as determining
 - a. Essentials in structure and finish of floor, walls, and ceiling
 - b. Light
 - c. Heat
 - d. Ventilation
2. The equipment *
 - a. Tubs
 - b. Ironing board
 - c. Equipment for making starch
 - d. Table

Practical work, combined with teaching: Stain removing, emphasizing danger and necessity for care, in using stain-removing materials; lesson in laundering; care and cleaning of laundry.

NOTE.—As laundry work is only a small part in the whole scheme of the course, let the practical work be along the line of bleaching, removing stains, making starch, sponging and pressing.

* Emphasize correct height of working surfaces.

LESSON VII.

The Dining Room. The Living Room.

1. The Dining Room
 - a. Analysis of its use as determining
 - (1) The essentials in structure and finish of floor, walls, and ceiling
 - (2) Light
 - (3) Heat
 - (4) Ventilation
 - (5) The essential characteristics of the furnishings
 - (a) Furniture
 - (b) Floor coverings
 - (c) Curtains
 - (d) Pictures and ornaments
2. The Living Room *
In connection with living and dining rooms, discuss
3. The cleaning closet
 - a. Need of, whether it be a real closet or space in the corner
 - b. Equipment
 - c. Organization

Practical work, combined with teaching: Cleaning the living room and the dining room; renewal and renovation of furniture, floors, walls, and ceiling, emphasizing danger and necessity for care, in handling materials. Rug cleaning.

NOTE.—This practical lesson should teach correct methods of scrubbing, sweeping, dusting, disposal of dust, window cleaning, etc.

LESSON VIII.

The Bedroom. Vermin. The Bathroom.

1. The Bedroom.
 - a. Analysis of its use as determining
 - (1) The essentials in structure and finish of floor, walls and ceiling
 - (2) Light
 - (3) Heat †
 - (4) Ventilation
 - (5) Furnishings
 - b. The bed
 - (1) Parts
 - (a) Bedstead
 - (b) Spring
 - (c) Mattress
 - (d) Pillows
 - (e) Covering
 - (2) How made
 - (3) Cleaning and sanitation

* Emphasize importance of "homey" quality in living room. Show that the laws of good taste are the same for elaborate and for simple interiors.

† Try to offer some solution for the heatless bedroom.

2. Vermin
 - a. Habits
 - b. Kinds
 - c. Prevention
 - d. Eradication
3. The linen closet
 - a. Need of, whether it be a real closet or a space set aside for it
 - b. Organization
 - c. Equipment
4. The bathroom
 - a. Analysis of its use as determining
 - (1) The essentials in structure and finish of floor, walls and ceiling
 - (2) Light
 - (3) Heat
 - (4) Ventilation
 - b. Equipment
 - (1) How to tell bad from good
 - c. Plumbing
 - (1) Water supply
 - (a) Filtration
 - (2) Sewage
 - (a) Principles of drainage
 - (b) Traps, safe and unsafe

NOTE.—Emphasize importance of using bathtub for bathing, and importance of extreme cleanliness if laundry tubs are used for bathing. This lesson should not only teach sanitation and hygiene, but convince the class of their vital connection with health. If this group is to have a course in laundry work, omit Lesson VI, use VII as VI; and divide this lesson into two lessons for VII and VIII.

Reviews.—It is important by constant reviewing to get a broad survey, and to bring together general explanations and procedures. The review may be in terms of principles; for example, to explain the applications of bacteriology in securing sanitary standards of housekeeping, or to justify the various cleaning processes on this basis; to explain the management of a furnace, fireless cooker, etc., in terms of the physical principles of heat. Reviews may also be of a practical nature, and concern the technique of the household. This is particularly important so that the person trained in housewifery may become a capable manager and wise economizer of time, labor, money, and materials. Such reviews should be given not only at the end of a course, in order to test knowledge, but as brief exercises in connection with regular class meetings to enliven interest and to give that practical knowledge and skill which make the housewife ready to meet any emergency in her domain, and also help her serve as a real economizer for the nation.

As a sample review project, there are listed below typical "economies and short cuts." Such a list may be used as a check on personal practices: how many of these do I practice? How many could I adopt? Let the student, housewife, or reader extend the list to a dozen practical points under each heading.

Housewifery as a Business:

Have a plan for housework—saves time and keeps order.

Make a budget of expenditures—helps to save income.

Study your house plan—may suggest improvements.

Plumbing:

Keep small strainer in sink—will catch small particles of food which may block the drain.

Keep washers on faucets—saves water bills.

Pipe running water wherever used—saves steps.

Heating and Lighting:

Put covers on saucepans—saves heat and hence fire.

Give care to dampers of stove—saves stove and fuel.

Put mantles on lights—give more light, save fuel, hence cost less money.

Equipment and Labor Saving Appliances:

Use paper on table in cleaning vegetables—saves scrubbing table.

Use paper to line garbage can—makes cleaning easy and less distasteful.

Place pans and utensils near stove, sink, or table, where they are to be used—saves steps, work, time.

Get a power washing machine—do other work while it works.

Raise the table, ironing board, washtub—saves the worker's back.

Use electric or gas iron—saves time and work for the ironer.

Supplies:

Save scraps of soap—use for wash boiler or machine.

Save and clarify fat—it cooks food, and makes soap.

Use blue that dissolves—saves money and will not streak on clothing.

Furnishings:

Choose small figures—saves material in matching, hence money.

Money spent in fast colors good economy—saves time and work of making new.

Keep leather cool, aired, and oiled—saves it from cracking.

Cleaning and Care:

Put dust sheets over furniture when sweeping—saves work.

Use moistened paper to take up dust—saves worker.

Scrape, stack dishes, and wash in regular order—saves time in washing, wiping, and putting away.

Cleaning and Renovation:

Mend clothes before washing—a stitch in time saves nine.

Put clothes to soak—makes washing easy, saves clothes.

Try cold water first on stains—removes many and saves clothing and work.

Use kerosene to remove discolorations on porcelain—will save scratching.

Disinfectants and Fumigants:

Put cheap wallpaper on children's room—may often need to be taken off after children's diseases.

Use soap and water freely—kills germs and saves doctors' bills.

The College Course in Housewifery.—A college teacher of housewifery has the interesting task of teaching a practical subject and placing it upon a scientific basis. Obviously there is need of making the instruction entirely sound as regards scientific facts, and the college teacher will need to draw upon the resources of her own scientific training and also have close working coöperation with the scientific departments. At the same time, the housewifery course is not intended to be a course in applied science but a course in technique or the various practical processes which are carried on in the home. If the practical note is not dominant, the instruction will fail as did to a certain extent agricultural education for so long a time through its efforts to be "scientific."

How may the college instructor best use this text? She may either follow it rather closely as an outline of subject matter, breaking up the chapters so as to form the appropriate number of units; or on the other hand, she may wish to follow a different sequence of topics, suggestions of which may be drawn from the two courses outlined in detail in this chapter. In such a sequence an important element may be a discussion in turn of the various rooms of the house from cellar to attic, under each room bringing in the problems of equipment, supplies, storage, and cleaning appropriate to it. Whatever be the sequence of topics, this text is intended to be an outline of subject matter which will be serviceable in the hands of the individual student. The text is, however, only the verbal aspect of the instruction, a very important part of which must be acquaintance with, and skill in, the actual processes of housekeeping to be secured through laboratory and other practice.

Laboratory exercises in college teaching while primarily arranged to illustrate different household processes may well be chosen because of their relation to the various fields of scientific study with which the students are familiar. For example, tests of various household supplies, such as metal polishes, may be undertaken by the student and carried out in terms of chemical science. Concrete items of household equipment such as the dish washer, vacuum cleaner, washing machine, may be examined and tested in terms of physical principles as well as used practically to acquire a desirable technique. Sanitary problems such as the care of dish cloths, the washing and drying of dishes, the removal of dust, may be tested by the methods of bacteriology. Studies economic in nature may be made of the work problem; household equipment, depreciation and upkeep. Social studies may be made, for example, of the household employee, or the housewife as a worker. Also, architectural studies of house plans, particularly of the service portion of the house, will be appropriate. These suggestions are given to indicate the fact that the subject matter of housewifery really involves the problems that lie in a dozen sciences, so that it merits an important and dignified place in the college curriculum.

The **class period** in housewifery for college instruction may well be a three-hour period, providing time both for instruction and laboratory practice, or a separate lecture period may be provided with a two-hour laboratory period at another time. The instruction may be made interesting by relating it very closely to the real life of the home and the community. The class hour may well begin by five-minute reports from students on assigned topics, such as housewifery articles in the current newspapers, magazines and other literature, observations on household practice in homes visited during the vacation; suggestions from manufacturers' demonstrations, and visits to stores and institutions. Student participation in developing the subject matter in a practical field like this is directly effective in making them interested to apply the subject matter presented by the instructor. Following such brief reports, the instructor presents the topic for the period on which the students have already examined reference material; discussion follows to clear up points in theory before the practical work begins.

Half to two-thirds of the three-hour period may then be devoted to practice work. The general topic is assigned for the consideration of the class—for example, the cleaning of metals. Then the students

are organized into working groups and to each a special topic, for example, brass, silver, or nickel is assigned. The students test various reagents and tools for the problem in hand and make notes on results. Each group is organized with a student leader who is responsible for progress and results, and this is in itself a training of value. At the close of the hour the students clean up the room and put away materials and supplies, which is a valuable house-keeping lesson.

The part-time service of a maid is necessary for such a laboratory, with duties of caring for materials, getting materials out for laboratory use before the class hour begins, emergency cleaning, caring for bulletin boards, etc. The instruction to be successful should have a wealth of illustrative material as well as other adequate provision of materials, tools, and supplies, and their organization and care is in itself a piece of work requiring part of a worker's time. A laboratory fee may well be charged for the work; \$2 seems sufficient for a half-year course.

In the college curriculum, housewifery will probably be closely related to the household management courses as explained below.

Demonstration Teaching.—For the teacher who is working with the college student or with the housekeeper, much may be done by demonstration lectures in which one carries through a process, or shows a tool or piece of equipment and illustrates its use. Such drawings as those shown to illustrate height of working surfaces and posture during work may be easily drawn by the teacher (Fig. 175, *a, b, c, d, e, f*). Demonstrations may be given in the school by the teacher, by the lecturer in extension work, and by "demonstrators" employed in the educational departments of manufacturing companies, including gas and electric companies interested in introducing their products. With this type of work, moving pictures begin to play an important part, and the teacher of housewifery will find that it is possible to rent reels on different subjects, showing both the mechanical methods of equipment and devices, and the efficiency aspects of housekeeping. This is a new field that we are just entering, for which the possibilities seem without limit. Much has been made of demonstration lecture methods in teaching foods and cooking to adult audiences, and housewifery is a subject in which demonstrations are equally applicable.

With the emphasis now on the teaching of vocational home-

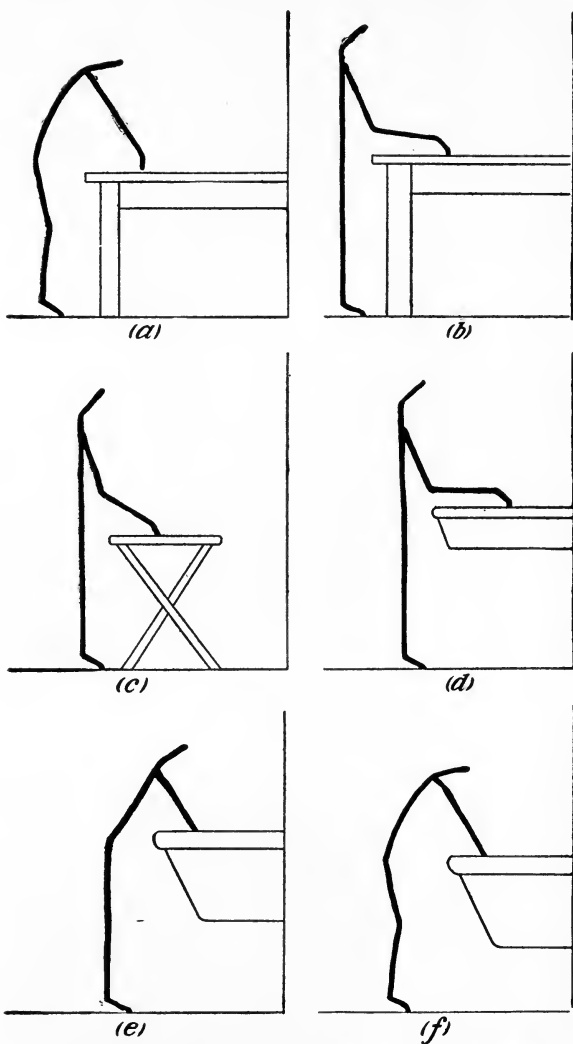

FIG. 175.—*a*, table too low. Note worker's back. *b*, table height good. No strain anywhere. *c*, ironing board height good; is lower to allow for pressure with iron. *d*, sink, position good. *e*, correct position at washtub; *f*, incorrect position at washtub.

making in many states, a large problem will be the teaching of actual housekeepers, and more consideration will be given to demonstration teaching. In rural communities, a private kitchen in one home when equipped with running water or with new devices, may be used as a "demonstration" for the housewives in that section. Concrete working "demonstrations" of this kind have been used in rural extension teaching both of home economics and of agriculture in many states. The home or farm thus "demonstrates" some concrete items of good housekeeping or good farming to the neighbors.

Housewifery Topics in a Cooking Course.—The following housewifery topics among many others may be readily brought into a cookery course: dish-washing, laundry equipment, laundering process (towels), stain removal, care of range, silver polishing, care of woods, metals, etc., cleaning a room, care of sink, economy of fuel, care of refrigerator, and kitchen equipment. Some of these topics may be used as separate lessons in the foods course; or they may be brought in incidentally in a cooking lesson. Teachers of cookery will find it helpful to consider the topics presented in this book from the point of view of adapting parts of them to their courses. The book may also be assigned their students as reference reading on many problems related to food preparation.

Special Classes in Housewifery.—Teachers will find it possible to organize special classes in housewifery for housekeepers, and for household employees, who may come at hours when laboratories are not otherwise used. Classes for wage-earning young women will be popular in the evening, especially if a model house or an apartment is available, so that the teaching is real and there is opportunity for home-like gatherings. In such classes, a small unit of four to eight lessons on definite practical topics is desirable. (See Lesson Outlines I and II, pages 326, 329.)

Housewifery and Household Management.—Instruction in household management, whether in high schools or in higher institutions, presents the theory of organizing and administering the household. The problems of housework, or the technique of housekeeping which forms the subject matter of housewifery, are evidently closely related to household management. Accordingly, many courses in household management already provide laboratory and other practice work in what is really housewifery, and to such teachers this book may prove useful as a text.

Advanced Study of Housewifery.—The problems of house-

wifery are worthy of advanced study and research, and in higher institutions the instructor will do well to secure for such studies the coöperation of such scientific departments as chemistry, physics, and bacteriology. The problems can often be guided coöperatively, the housewifery teacher checking up the practical aspects of a problem such for example as dish-washing methods, and the scientific department conducting as its part, the study of the mechanism of machines. In such institutions, the housewifery work merits an advanced research laboratory of its own for advanced students.

The Teacher of Housewifery.—The teacher of this subject should, if possible, be trained in chemistry, physics, and bacteriology in order to understand the background of the subject. But, even more, she needs to be an experienced housekeeper. Those preparing to teach it should do the actual work of a household for a period of several months, meeting responsibilities of the tasks, money, time, materials, equipment, etc., personally. So only can they successfully adjust theory and practice in their own minds and help students to do the same.

The teacher is to set standards, but because students represent so many types of homes, she must be prepared to teach ways and means of housework as carried out under varying conditions. She must be able to present standards as ideals, rather than practices which every one must adopt. She must not only present her ideal and hold to it, but must at the same time readjust the standards of the students and carry them as far forward as is practicable.

It is a poor policy to over-train by presenting a standard that is economically impossible for certain students. For example, a good duster is any cloth that is non-scratching, soft, and non-linting; but it is better for the students to suggest types of material that might be of service in the homes, even if worn-out clothing is to be used as a duster, rather than for the teacher to present one or two types of purchased dusters which she suggests because used in her own training school. The teacher must know and teach economy. For example, many points regarding renovation must be taught, so that the student will be able to help reduce family expenditures. The teacher must not only know facts from books, but should have had the greatest experience possible, that experience which helps her to meet an emergency and readjust herself and her work to actual conditions.

INDEX

- Acetylene as a fuel, 55
 - danger from, 57
 - lights, 81
- Acids, 135
- Advanced study in housewifery, 339
- Agate utensils, 96
 - to clean, 261
- Air pressure tank system, 29
- Alcohol as disinfectant, 300
 - as fuel, 55
 - for cleaning, 249, 250
- Alkalies in soap, 136
- Alternating electric current, 59
- Aluminum cleaning pan for silver, 97
 - to clean, 261
 - utensils, 94
- Ammonia, 135
 - as a germicide, 299
 - in soap, 136
- Antiseptics, 298
- Ants, 313
- Arsenic for pests, 308
- Ash chutes, 74
- Axminster carpeting, 161

- Basement storage, 205
- Baskets and hampers, 110
- Bath brick, 135
- Bathroom, equipment, closets, 226
- Bath tubs, 50
 - to clean, 257
- Bed bugs, 312
- Beds, 186
 - box springs, 188
 - care of, 250
 - cleaning of, 250
 - cost, 189
 - disinfecting, 304
 - for the sick, 254
 - frame, to clean, 250
 - relative costs of, 189
 - removing pests, 312
 - sheets, 193
 - sizes of, 189, 196
 - spreads, 193
 - springs, 193
 - to make, 251
 - to prepare bed for night, 257
- Bedsteads, 186
 - to clean, 250
- Beeswax, 130
- Benzine, 131, 308
- Bichloride of mercury as a disinfectant, 301
- Binding of blankets, 196
- Blankets, 193, 254
- Bleaching cotton and linens, 280
 - wools and silks, 281
- Bleach wood, 291
- Blended starch, 140
- Bluing, 141
 - clothes, 278
- Boiling clothes, 278
- Borax, 136
 - as a disinfectant, 299
 - as a starch substitute, 140
 - in soap, 136
- Boxes as filing cases, 237
- Box springs, 188
- Bran as a soap, 147
 - as a starch substitute, 141
- Brass, lacquered, 295
 - mountings, 295
 - to clean, 261
- Bread and cake mixer, 98
- Britannia ware, to clean, 262
- Brooms, closets, 119, 221
- Brushes, 119, 259
- Brussels carpet, 160
- Bucket pumps, 26
- Burners, 58, 61, 74
 - of stoves, to clean, 269
- Business desk, 238
- Buying, general rules, 129

- Cabinet, kitchen, 92
- Cake mixers, 98
- Calcimine walls, 245
- Candle, paraffin, 80
- Canned heat and light, 55
- Canning outfit, 128
- Canning and preserving containers, 217
- Carbolic acid solution, disinfectant, 301
 - for pests, 308

- Carbon filaments in electric lights, 82
- Card catalogues, 237
- Care of beds, 250
 - floor covering, 246
 - porcelain, 257
 - refrigerator, 267
 - rooms, 241
 - shoes, 288
- Carpet beetle, 314
- Carpet sweepers, 122
- Carpeting, brussels, 160
 - chenille, 161
 - hemp and grass, 161
 - ingrain, 160
- Carpets and rugs, 158
 - to clean, 147
- Cast iron utensils, 93
 - to clean, 261
- Caves or dug-outs for food, 211, 216
- Cellar, ventilation of, 297
 - stairs, 4
 - storage, 205
- Centipedes, 317
- Cereals and food containers, 216
 - to store, 234
- Cesspools, 37
- Chamois, to clean, 288
- Chain bucket pumps, 26
- Charcoal, 54
- Chart, for service, 16
- Cheesecloth, 125
- Chenille, carpet, 161
- China, 198
 - service for six, 201
 - to wash, 265
- Class period, 336
- Cleaners and polishers, 130
- Cleaning and care of rooms, 240
 - cloths, 125
 - equipment, 118
 - tools, 118
 - stores, 267
 - refrigerator, 269
- Cleaning and renovation, 273
 - bathroom furnishings, 257
 - of fabrics, 273
 - of furniture, 132
 - of metals, 260
 - of room, 241
- Clinkers, to remove, 74
- Closing runways of pests, 307
- Closets for bathroom, 226
 - brooms and cleaners, 221
 - clothes, 227
 - kitchen, 209
 - laundry, 208
 - linen, 222
 - medicine, 223
 - pantry, 209
 - preserves, 206
 - shoes, 228
 - tools, 227
- Clothes chute, 207
- Clothes-pin bag, 111
- Clothes, washing, 278
- Clothing storage closet, 230
- Coal, 53
 - storage, 206
- Coal-bin, 206
 - dust, 54
- Coke, 54
- College course in housewifery, 335
- Color tints, 140
- Colored goods, to wash, 280
- Coloring matter in soap, 137
- Combs, to clean, 259
- Comfortables, to clean, 282
 - to make, 196
- Commercial storage, 204
- Comparative value of rugs, 162
- Conservation of heat, 74
- Containers, earthen, 217
 - food, 216
 - garbage, 218
 - glass, 217
 - preserving and canning, 217
 - soiled clothes, 110
 - tin, 217
- Cook stoves, 61
 - coal, 62
 - electric, 63
 - gas, 62
 - kerosene, 63
- Copper, to clean, 261
- Corduroy, to clean, 283
- Cork for knives, 98
- Cornstarch, 140
- Cost of rugs, 162
- Cotton mattresses, 191
- Cotton, to bleach, 280
- Counterpanes, 193, 254
- Covering of heating pipes, 76
- Creoline, as a disinfectant, 302
- Cresol, as a disinfectant, 302

- Cretonnes, 176
Crockery containers, 94
Curtains, 169
- Dampers, conservation, 74
 of furnaces, 73, 76
 of stoves, 73, 76
- Danger from acetylene, 59
 gas, 59
 gasoline, 59
 kerosene, 59
- Demonstration teaching, 337
- Denim, 176
- Detergent, 274
- Dextrine, as a starch substitute, 141
- Direct electric current, 59
- Dish cloths, 184
 paper, 98
 to clean, 265
- Dishes for the refrigerator, 205
- Dish mops, 98
 towels, 183
- Dishwashing, 264
 machine, 100
- Dishwater, disposal of, 31
- Disinfectants and fumigants, 297,
 298
 alcohol, 300
 bichloride, 301
 carbolic acid, 301
 creoline, 302
 cresol, 302
 formalin, 301
 lysol, 302
 hydrogen peroxide, 300
 table of, 302
 tincture of iodine, 301
 tricrosol, 302
- Division of space in the home, 1
- Dolly clothes washing machine, 107
- Domet flannel, 125
- Drain boards, 45
 outlet, 45
- Drains of sinks, 45
- Draperies and curtains, material,
 165
 relative value of, 169
- Dry cleaning, 283
- Dryers, 111
- Drying clothes, 279
- Dug-outs or caves, 216
- Dumb waiters, 101
- Dust covers, 120, 242
 for mattresses, 192
- Dusting, 243
- Dustless dusters, 243
 dusting, 243
 sweepers, 121
 sweeping, 242
- Dust pans, 121
- Dyeing, 284
- Earthen containers, 217
 dishes, 94
- Earth water closets, 33, 34
- Economical utensils, 75
- Economy of light, color of walls, 149
 inverted lights, 81
 types of shades, 80
- Egg storage, 218
- Eiderdown quilts, to clean, 282
- Electric cook stove, 63
 current types, 59
 fans, 128
 irons, 116
 lamps, 82
 lighting, 59, 82
 of gas, 59
 meter, to read, 60
 motor, 127
 to stove, 235
 pumps, 28
- Electricity as a fuel, 59
 as a light, 82
 to read a meter, 60
- Embroidery pads, 114
- Enamel cloth, 152, 173
 ware, 96
 painting of woodwork, 293
- Equipment, bathroom, 226
 cleaning, 118
 construction of, 85
 dishwashing, 264
 economy of, 85
 efficiency of, 85
 general, 84
 height of, 87
 kitchen, 90
 labor-saving appliances, 85, 103
 laundry, 103
 placing of, 86
 selection of, 84
 utility of, 85
- Essentials of table linen, 177
- Extermination of pests, 307
- Fabrics, to clean, 273
 to dye, 284

- Faucets, foot pressure, 41
 goose-neck, 41
 leaky, to mend, 41
 material, 40
 Feathers, mattress, 191
 pillows, 192
 Filing boxes, 237
 Filters, 42
 kinds, 43
 to clean, 271
 Fireless cooker, 76, 98
 gas stove, 78
 Fixtures, plumbing, 40
 Flat-work ironers, 117
 Flax-jute, 162
 Fleas, to exterminate, 314
 Flies, to exterminate, 309
 Floor, 153
 cloths, 125
 coverings, to clean, 246
 finished, 155
 kinds of woods, 153
 Flush closet, 35
 to clean, 258
 Food containers, 216
 pits or caves, 216
 storage, 211
 Foot-pressure faucets, 41
 Force pumps, 26
 Formaldehyde gas, 303
 formula, 304
 Formalin, 301, 309
 Formula, formaldehyde gas, 304
 Fuels, 53
 Fumes, 308
 formaldehyde, 303
 formalin, 309
 sulphur, 303, 309
 Fumigants, 297, 298, 303
 for extermination of pests, 308
 Furnaces, hot-air, 65
 hot-water, 66
 one-pipe, 67
 steam, 68
 Furnishings, household, 148
 Furniture, 170
 cleaners, 132
 coverings, 173
 light, 172
 polishes, 132
 to glue, 294
 wooden, 172
 Fur rugs, 287
 Galvanized sinks, 44
 washtubs, 47
 Garbage containers, 218
 incinerator, 220
 utilization, 221
 waste, 31
 Gas, 57
 burners, 58, 61
 cook stove, 62
 danger from, 59
 lights, 81
 meters, to read, 57
 pilot lights, 58
 tops, 74
 water heater, 69, 70
 Gasoline, as exterminator, 308
 as cleaner, 131
 as fuel, 55
 danger from, 131
 engine, 28
 General equipment, 84
 construction, 85
 labor-saving, 85
 selecting, 84
 utility and efficiency, 85
 General rules for cleaning room, 241
 for laundering, 278
 General standard of utensils, 97
 Germicides, 298
 Glass table tops, 92
 utensils, 94
 Glassware, 202
 Globes, effect of, 80
 Gold and silver lace, to clean, 283
 Goose-neck faucets, 41
 Grate fires, 65, 72
 Gravity water system, 27
 Grease stains, to remove, 274
 traps, 37
 Grouping tools, 8
 Gum arabic, as starch substitute,
 141
 Hair mattress, 191
 pillow, 192
 Half-teaspoon measure, 98
 Halls, 4
 Hampers, clothes, 110
 Handles for bathroom fixtures, 259
 Handles for curtains, 171
 Hanging clothes, 227
 Hard plaster or cement walls, 152
 Hard water, 22

- Hard water, permanently, 23
 temporarily, 22
 Hard wood, 153
 to clean, 246
 Heating, 61
 grate fires, 65
 Heating and lighting, 52
 by stoves, 65
 Height of sinks and washtubs, 47
 working surfaces, 87
 Helps in classroom, 323
 Hemp and grass carpeting, 161
 furniture, 172
 Home laundry equipment, 103
 Hot-air furnace, 65-67
 Hot-water heaters, 68
 heating system, 66
 Hour service, 19
 chart, 18
 House, to close, 232
 Houseflies, 309
 Household equipment, 84
 furnishing, 148
 labels, 236
 linen, 176
 measures, 146
 paper supplies, 144
 pests, 307
 to exterminate, 307
 to prevent, 307
 pottery, 198
 supplies, 129
 waste, 31
 water waste, 31
 Housekeeper's desk, 238
 House plans, 10-12
 Housewifery and management
 courses, 339
 as a business, 1
 laboratory, 319
 special classes, 339
 topics in cooking courses, 339
 Housewife's suggestions to the
 architect, 4-8
 Human waste, 32
 Humidity and heating, 52
 Hydraulic ram, 28
 Hydrochloric acid, 135
 used for stains, 276
 Hydrocyanic acid gas, 304
 Hydrogen peroxide, 300
 Iceless refrigerators, to make, 214
 Importance of storage problems, 204
 Incinerators, 220
 Ingrain carpets, 160
 Indirect lighting, 80
 Inflammables, to use for pests, 303
 Ink, to remove, 275
 Inorganic waste, 31
 Insoluble bluing, 141
 Installation and care of water sys-
 tem, 29
 Instantaneous water heater, 70
 Insulation, 76
 Inverted lights, 80
 Iron and steel, 235
 care of, 262
 storage, 235
 to clean, 261, 262
 Iron holders, 116
 Ironing, 279
 Ironing boards, 112
 covers, 115
 for sleeves, 113
 pads, 144
 Iron rests, 116
 Iron rust, to remove, 275
 Irons, 115
 alcohol, 116
 care of, 261
 electric, 116
 gas, 116
 gasoline, 116
 kerosene, 116
 to clean, 235
 Javelle water, 280
 Kerosene, 54
 as a cleaner, 131
 as a fuel, 54
 cookstove, 63
 danger from, 59
 for pests, 312
 lamps, 80
 to clean, 250
 hot-water heater, 70
 Key tags, 236
 Kinds of fuels, 53
 irons, 116
 rugs, 158
 storage, 204
 water, 22
 wood, 153
 Kitchen cabinet, 92
 closets, 209
 cooking ware, 198

- Kitchen equipment, 90
 sanitation, 297
 storage, 92, 209
 supplies, suggested list, 103
 tables, enamel, 92
 glass, 92
 wood, 92
 towels, 183
 utensils, 93
 aluminum, 94
 crockery and glass, 94
 enamel or agate, 96
 standards of, 97
 steel, 96
 tin, 97
 to wash, 264, 265
 wire, 97
 wooden, 97
 workshop, 2
 Knives, to wash, 265

 Labels, household, 236
 Laboratory, classroom, 319
 equipment, 321
 exercises, 326
 work, 319
 Labor-saving appliances, 84
 Lacquer, to renovate, 295
 Lamps, electric, 82
 kerosene, 80
 to clean, 250
 Laundering, general directions, 278
 Laundry, closets, 208
 equipment, 103, 105
 suggestive list, 118
 storage, 207
 stoves, 64
 work unit, 2
 Leaky faucets, 41
 Leather, care of, 288
 furniture, 173
 Lemon oil, 131
 Lesson outlines, 326, 333
 Light furniture, 172
 Lighting, 79
 acetylene and presto, 81
 candles, 80
 electric, 82
 gas, 81
 hints on, 83
 kerosene, 80
 Lights, pilot, 58
 Lime, 299
 chlorinated, 300

 Lime, quicklime, 299
 slacked, 300
 water, 300
 Linen, 176
 closets, 222
 essentials of table linen, 177
 sizes of table linen, 179
 tests for purity of, 176
 to buy, 184
 Linoleum, 157
 to clean, 247, 286
 to lay, 157
 Linseed oil, 130
 Liquid glass, for egg storage, 218
 Lower sheet for bed, 251
 Loans from firms, 322
 Long-handled dustpan, 121
 Lysol, 302

 Machine oil, 132
 Making fire, 70
 grate, 70
 stove and furnace, 70
 Mangle, 117
 Marble, to clean, 250
 Marking linen, 185
 handkerchiefs, 186
 napkins, 186
 pillow case, 186
 sheets, 186
 table cloth, 185
 towels, 186
 Materials for cleaning, 118
 Matting, to clean, 286
 to sweep, 247
 Mattresses, 189
 covers, 192, 251
 pads, 192, 251
 fillings, 190
 to clean, 251
 tufting, 190
 Measures, 145
 Meat grinders, 98
 stain, to remove, 274
 Medical equipment and supplies, 225
 Medicine closet, 223
 Metal lace and embroidery, 283
 Metal polishes, 133
 mesh pot washer, 98
 Metals for utensils, 94, 96, 97
 to clean, 260
 Metal table tops, 92
 Meter for electricity, 60
 for gas, 57

- Method of removing stains, 276
Methods for teaching housewifery, 318
Mice and rats, to exterminate, 315
Milk separators, 128
Mirrors, 249
Miscellaneous equipment, 126
Model housekeeping centers, 324
Mohair for furnishing, 175
Mops, 124
 duster, 125
 wringer, 125
Mosquitoes, to exterminate, 310
Moths, to exterminate, 311
Motors, small, 127
 to stove, 235
Mourning starch, 140
Music cabinets, as storage, 232

Napkins, 179
Naphtha, 131
 as a cleaner, 131
National springs, 188
Nickel cleaning, 261
Notions, suggestive list of, 142

Oilecloth for walls, 152
Oil dust mop, 125
Oiled wood, 155
Oil painting, to clean, 296
Oil stove burners, to clean, 63, 250
One-pipe heater, 67
Open plumbing, 46
Order of work for cleaning, 241
Organic waste, 31
Organization of household, 15
Oriental rugs, 161
Oscillating washing machine, 109
Other fuels, 54
Outline for washing dishes, 266
Oxalic acid, 135
 used for stains, 275

Pads for mattresses, 192
Paint and calcimine walls, 152
 to clean, 244
Painted floors, to clean, 246
Painting, bath tub, 244
 wood, 293
 to clean, 296
Painting oil, 209
Paint on glass, to remove, 250
Palette knife, 98
Pantry, work unit, 2

Paper dish cloths, 98
 paraffin, 144
 tissue, 144
 toilet, 144
 towelling, 145
 wall, 149
 wrapping, 145, 238
 writing, 145
Paraffin candles, 80
 oil, 130
 wax, 130
Pastes for metal cleaning, 133
Personal cleanliness, 298
Pests, ants, 313
 bed bug, 312
 carpet beetle, 314
 centipedes, 317
 fleas, 314
 flies, 309
 mosquitoes, 310
 moths, 311
 rats and mice, 315
 roaches, 312
 silverfish, 316
 squirrels and chipmunks, 315
 to exterminate, 307
Pewter and britannia, to clean, 262
Piano keys, to clean, 250
Pictures, to clean, 296
 to store, 234
Pile carpets, 160
Pillows, to clean, 282
 feathers, 192
Pilot lights, 58
Pipeless heater, 67
Pipes, to thaw, 30
Piston pumps, 25
Placing equipment, 6, 86
Plaster casts, to clean, 295
Plaster of paris, to use, 307
Plumbing, 21
 fixtures, 40
 open plumbing, 46
 to close the house, 235
Poisons to exterminate vermin, 308
Polishes, furniture, 132
 metals, 133
 wood, 155
Porcelain, sinks, 44
 to clean, 257, 262
 tubs, 47
Potassium permanganate, 275
Pottery, 198
Powders for pests, 308

- Preserve closet, 206
 Pressure and suction washer, 108
 Practice work, 323
 in homes, 325
 Preparation for dishwashing, 264
 Presto lights, 81
 Preventive measures in household
 sanitation, 297
 bedroom, 298
 cellar, 297
 grounds, 297
 house in general, 297
 kitchen, 297
 laundry, 297
 Privies, 33
 Pumping by power, 28
 electric pumps, 28
 gasoline engines, 28
 hydraulic ram, 28
 windmill, 28
 Pumps, 25
 chain, 26
 bucket, 26
 electric, 28
 force, 26
 piston, 25

 Quality of blankets, 193
 Quicklime, 299
 Quilts, 196

 Radiators, to clean, 248
 Rag rugs, 162
 Rain water, 23
 Ram, hydraulic, 28
 Rats and mice, extermination of,
 315
 Recipe, detergent, 274
 javelle, 280
 filler for woods, 291
 formaldehyde gas, 304
 furniture polish, 132
 metal polish, 261
 oxalic acid, 275
 paint remover, 290
 paste for wallpaper, 152
 prepared wax, 132, 295
 soap, 137
 starch, 279
 wood cleaner, 246
 whitewash, 300
 Recreation unit of house, 3
 Refrigeration, 211

 Refrigerator, arrangement of, 214
 care of, 269
 cleaning, 269
 construction, 214
 dishes, 215
 iceless, 214
 temperature of, 212
 Regulating dampers, 72
 Removing stains, 277
 water rings, 277
 Renovation of brass mountings, 295
 of lacquered ware, 295
 of oil paintings, 296
 of plaster casts, 295
 of woods, 289
 Repp for drapery and upholstery,
 176
 Rest unit of house, 3
 Reviews in housewifery, 333
 Rice starch, 140
 Rinsing clothes, 278
 Roaches, to exterminate, 312
 Rooms, cleaning of, 241
 fumigating of, 305
 lighting of, 79
 Rosin, 136
 Rotary washer, 108
 Rotten stone, 133
 Rouge cloths for silver, 134
 Rubber goods, to clean, 235, 305
 to store, 235
 Rugs and carpets, 158
 to clean, 247, 284
 to store, 234
 types of, 158
 value of, 162
 weave of, 160, 162
 Rules for buying supplies, 129
 Rural home storage, 204
 Russia iron, 93

 Sanitation of bedroom, 298
 cellar, 297
 grounds about house, 297
 house in general, 298
 kitchen, 297
 laundry, 298
 Saving colors, 277, 280
 Schedule for housewife without
 help, 15
 with help, 16, 17
 School courses in housewifery, 326,
 333
 Score cards, 13, 14

- Scourers and cleaners, 139
 Screen for pests, 309
 cleaning of, 235
 storage of, 234
 Selecting equipment, 84
 Septic tank, 38
 Service chart, 16, 17
 Setting colors, 277
 Sewage disposal, 37
 Sewing machine, 126
 Sewing supplies, 142
 storage of, 231
 Sheets, for bed, 193
 Shellacked floors, 155
 Shoes, to clean, 288
 cleaning outfit, 227
 storage, 228
 Silks, to bleach, 231
 Silver, care of, 233
 cleaners, 133
 cleaning of, 262
 cleaning pans, 134, 263
 cloths, 134
 pastes, 134
 powders, 134
 soaps, 134
 storage, 232
 Silverfish, 316
 Silverware, 196
 Simmering burners, 74
 Sink, 43
 drain boards, 45
 drains, 45
 faucets, 41
 heights of, 47, 87
 materials, 44
 open plumbing for, 46
 size of, 44
 slop, 47
 space savings, 46
 strainer, 98
 to clean, 266
 Slacked lime, 300
 Slate sinks, 44
 Sleeve boards, 113
 Small electric motor, 127
 Soaking clothes, 278
 Soap, 136
 as a disinfectant, 299
 bark, 139
 chips, 138
 for silver, 262
 making of, 137, 138
 powders, 138
 Soap solution, 137
 substitute, 139
 Soda, 138
 solution, 138, 299
 Soft water, 22
 Softening water, 23
 Sorting clothes, 278
 Space for furniture, 6
 Space-saving sinks, 46
 Special classes in housewifery, 339
 Special storage closets, 221
 Spiral springs, 188
 Sport and athletic goods, storage
 of, 232
 Spotting precautions, 277
 Springs for beds, 187
 Sprinklers, 112
 Sprinkling clothes, 278
 Squirrels and chipmunks, as pests,
 315
 Staining woods, 291
 Stains, outfit, 274
 precautions, 277
 to remove, 274
 Standardization, 9
 Standardizing, tools and tasks, 9
 Starch, 139
 blended, 140
 kinds, 140
 mourning, 140
 prepared, 140
 recipe for, 279
 substitutes, borax, 140
 bran, 141
 dextrine, 141
 gum arabic, 141
 tints for, 140
 Starching clothes, 278
 Starting fires, furnaces, 70
 grates, 65
 stoves, 70
 Stationary tubs, 104
 Steam heating, 68
 Steel, 96
 to clean, 262, 289
 wool, 133
 Storage, 204
 closets, 221
 of articles for personal use, 231
 of carpets and rugs, 234
 of clothing, 227
 cellar, 205
 commercial, 204
 eggs, 218

- Storage, electric motors, 235
 iron and steel, 235
 laundry, 207
 linen, 223
 medicine, 223
 music, 232
 personal articles, 231
 preserves, 206
 rural, 204
 rubber goods, 235
 shoes, 228
 sewing materials, 230
 silver, 232
 sport or athletic goods, 232
 tools, 227
 trunks, 207
 vegetables, 206
 wrapping paper, 238
- Stove boiler, 68
 burner, 58
 care of, 73
 cleaning, 289
- Stoves, 234
 cook, 61
 coal, 62
 gas, 62
 electricity, 63
 kerosene, 63
 heating by, 65
 laundry, 64
 to clean, 289
- Strychnine for pests, 308
- Subsoil drainage, 39
- Suggestions for buying china, 200
 for buying linen, 184
 for review, 334
 for teachers, 318
 for ventilation, 52
- Suggestive lists of bathroom equip-
 ment, 226
 of china, 201
 of cleaning, 118
 of glass, 201
 of household disinfectants,
 305
 of household supplies, 104
 of kitchen, 90
 of laundry, 103, 104
 of linen, 184
 of medical equipment and
 supplies, 225
 of sewing, 143
 of silver 201
 of paper, 145
- Sulphur fumes, 303, 309
- Sunlight as a bleach, 280
 as a disinfectant, 299
- Supervision of water supply, 22
- Supplies, buying of, 129
 cleaning, 118
 kitchen, 90
 laundry, 103
 medicine, 225
 paper, 144
 sewing, 143
 writing desk, 145
- Sweepers, 221, 222
- Sweeping, dustless, 242
- Swinging shelves, 207
- Table linen, essentials of, 177
 sizes, 179
- Table tops, 294
- Table, kinds, 294
 enamel top, 92
 glass top, 92
 wooden top, 92
 height of, 90
 of disinfectants, 302
 of weights and measures, 145
 to choose, 92
- Tableware, 198
- Tags and labels, 236
- Tank system, air pressure, 29
- Tanks, water, 29
- Tapes for marking, 185
- Tapestries, 173
 to clean, 286
- Teacher of housewifery, 340
- Tea leaves for cleaning, 242
- Test for purity of linen, 176
- Tile walls, 152
 floors, 156
 to clean, 245
- Tincture of iodine, as a disinfectant,
 301
- Tinware, 97
 to clean, 262, 289
- Tissue paper, 144
- To bleach cottons and linens, 280
 silks and wools, 281
 wood, 291
- To buy, general rules, 129
- To clean agate, 261
 aluminum, 261
 a room, 241
 bathroom furnishings, 257
 bed, 250

- To clean a frame, 250
 springs, 250
 brass, 261
 lacquered, 295
 mountings, 295
 britannia, 262
 brushes, 259
 burners on oil stoves, 269
 gas stoves, 269
 calcimined walls, 245
 carpets, 247
 chamois, 288
 combs, 259
 copper, 261
 corduroy, 283
 dry clean, 283
 eiderdown quilts, 822
 enamel paint, 246
 filters, 271
 flush closets, 258
 furniture, 246, 289
 furs, 287
 gold and silver lace, 283
 handles, 259
 hardwood, 246
 iron, 261
 lacquered ware, 295
 lamps, kerosene, 250
 leather, 288
 linoleum, 247, 286
 marble, 250
 matting, 247, 286
 mattress, 251
 metals, 260
 mirrors, 249
 nickel, 261
 oiled wood, 263, 291
 oil painting, 296
 paint from glass and mirrors,
 250
 painted floors, 246, 293
 walls, 244, 293
 pewter, 262
 piano keys, 250
 pillows, 282
 plaster casts, 295
 porcelain, 257, 262
 radiators, 248
 refrigerator, 269
 rubber, 235, 305
 rugs and carpets, 247, 284
 silver, 262
 sinks, 266
 springs, 250
- To clean steel, 262, 289
 stoves, 267, 289
 table tops, 294
 tapestries, 286
 tiles, 245
 tin, 262, 289
 varnished wood, 291, 293
 velvets, 282
 wall coverings, 243, 244
 wallpaper, 243
 walls, 243
 white enamel wood, 246
 wicker ware, 294
 windows, 248
 window shades, 282
 wooden floors, 155
 woods, 289
 zinc, 262, 289
- To close the house, 232
 To dry clean, 283
 To glue furniture, 294
 Toilet paper, 244
 To make a bed, 251
 a fire, 70
 a sick bed, 254
 To oil wood, 291
 To organize storage, 236
 Tools for cleaning, 118
 housewife, 227
 To paint, 293
 To polish wood, 293
 To prepare bed at night, 257
 To prepare room for fumigation, 304
 To put away clothing, 228
 To put on upper sheet, 254
 lower sheet, 251
 To read gas meter, 57
 electric meter, 60
 To refinish table tops, 294
 woods, 290
 To remove alcohol spots, 293
 clinkers from fire pot, 74
 dents and bruises, 292
 paint and varnish, 290
 scratches from woodwork, 292
 stains from clothing, 274
 water from woodwork, 292
 water spots from fabrics, 277
 from wood, 293
 from waxed floors, 293
 To restore color, 280
 To stain wood, 291
 To store beds, 234
 clothing, 227

- To store eggs, 218
 - linen, 222
 - medicine, 223
 - personal articles, 231
 - rugs and carpets, 234
 - shoes, 228
 - silver, 232
 - tools, 227
 - trunks, 207
 - window screens, 235
- To thaw water pipes, 30
- To use a filler, 291
 - a filter, 292
- To varnish, 142
- To wax wood, 292
- Towels, 179
 - size of, 183
 - kinds, 179, 183
- To wipe walls, 243
- Traps, grease, 36, 37
 - for pests, 309
 - water, 36
- Tray, 145
- Tricresol, 302
- Trunk storage, 207
- Tubs, bath, 50
 - wash, 47
- Tufted carpets, 161
- Tungsten lamps, 52
- Turpentine, 131
 - on waxed floors, 293
- Upholstered furniture, 173
 - materials for, 173
 - to store, 234
- Upper sheet, to put on, 254
- Utensils, comparative value of materials, 93, 97
- Vacuum bottles, 79
 - cleaners, 122
 - sweepers, 122
- Various washing devices, 110
- Varnished wood, 289
 - care of, 289, 291, 293
- Vegetable bins, 206
- Velvets, to clean, 282
- Ventilation, 52
 - suggestion for, 53
- Voltage, 59
- Wallpaper, 149
 - to clean, 243
 - coverings, to clean, 243, 244
- Wallpaper, kinds, 150
- Walls, 149
 - finish of, 152
- Wash basins, 51
 - benches, 104
 - boards, 104
- Washing china, 265
 - clothes, 278
 - devices, 110
 - dish towels, 265
 - dishes, 264
 - glass, 264
 - kitchen utensils, 264
 - knives, 265
- Washing machines, 107, 110
 - rugs and carpets, 286
 - silver, 265
 - soda, 138
 - windows, 243
- Washing soda as a disinfectant, 299
- Wash tubs, 47, 104
 - height of, 47
 - material of, 44
- Water, heating by gas, 69
 - heating by kerosene, 71
 - installation and care, 29
 - kinds of, 22
 - pumps, 25
 - shut off, 30
 - stains, to remove, 277
 - stopcock, 30
 - storage, 24
 - supply, 22
 - tanks, 29
 - traps, 36
- Waste, household water, 31
 - human, 32
 - inorganic, 31
 - organic, 31
- Waxed, oiled or varnished wood, 155
 - to clean, 132
- Wax, for polished furniture, 132
 - recipe for, 295
- Weights and measures, 145
- Wells, 24
- Wheel egg beater, 99
- Wheel table, 101
- White enamel paint, 294
 - to clean, 246
- Whitewash, 300
- Whiting, 134, 135
- Wicker furniture, 172
 - to clean, 294

- Wilton carpets, 161
- Window food storage box, 99, 216
- Windows, to clean, 248
 - to close the house, 234
- Window shades, 171, 287
 - screens, 171, 235
 - ventilators, 171
- Wire dish drainer, 100
- Wire ware, 97
- Wood as fuel, 53
 - bins, 206
 - care and renewal, 298
 - to bleach, 291
 - to clean water spots from, 293
 - to clean painted and varnished, 293
 - to oil, 155, 291
 - to paint, 293
 - to polish, 293
 - to refinish, 155, 293
 - to remove alcohol from, 293
 - to remove dents and bruises from, 292
- Wood, to remove paint and varnish from, 290
 - to remove scratches from, 292
 - to remove water spots from, 293
 - to shellac, 292
 - to stain, 291
 - to use a filler on, 291
 - to wax, 155, 292
- Wooden furniture, 172
 - sinks, 44
 - spoons, 100
 - table tops, 92, 294
 - ware, 97
 - wash tubs, 47
- Work of removing stains, 276
- Work unit, 1
- Wrapping paper and string, 238
- Wringers, 106
 - for mops, 125
 - to clean, 235
- Wrought iron, to clean, 261
- Zinc, to clean, 262, 289





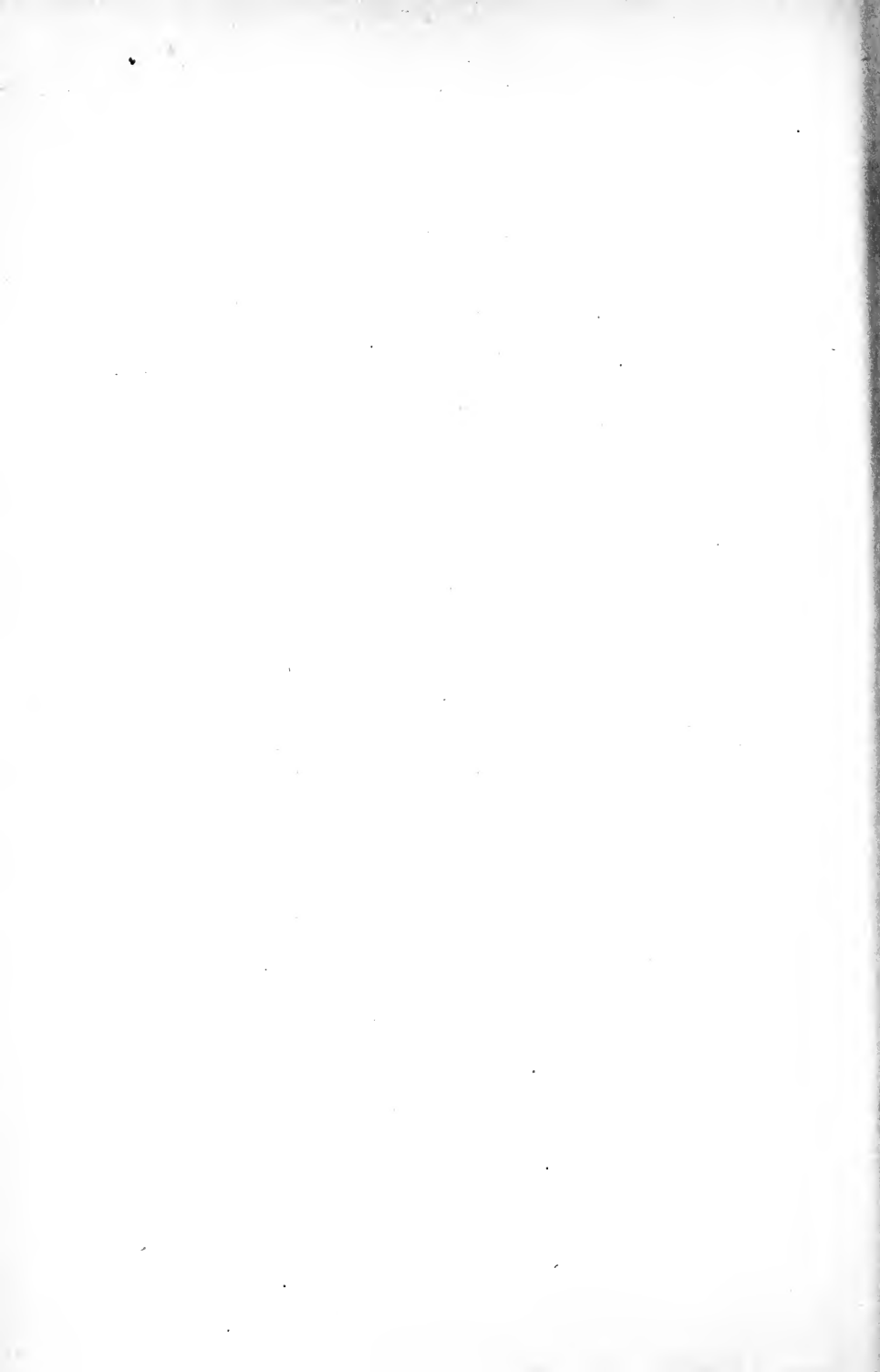

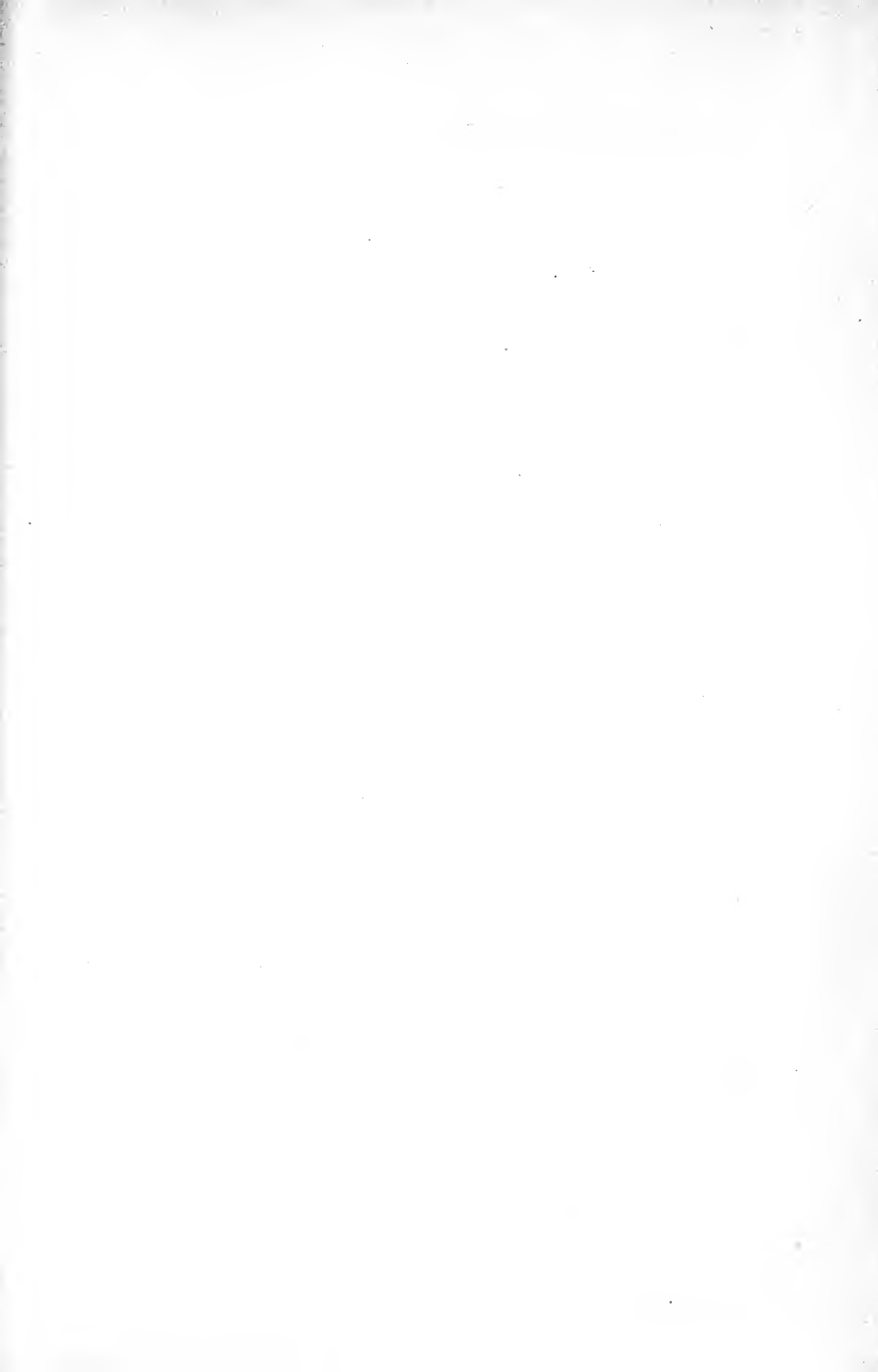

RETURN TO → CIRCULATION DEPARTMENT
202 Main Library

LOAN PERIOD 1	2	3
HOME USE		
4	5	6

ALL BOOKS MAY BE RECALLED AFTER 7 DAYS
RENEWALS AND RECHARGES MAY BE MADE 4 DAYS PRIOR TO DUE DATE.
LOAN PERIODS ARE 1-MONTH, 3-MONTHS, AND 1-YEAR.
RENEWALS: CALL (415) 642-3405

DUE AS STAMPED BELOW

DEC 05 1991		
AUTO DISC DEC 10 '90		
NOV 10 2001		



250
YC 93867

U.C. BERKELEY LIBRARIES



C007008928

539976

TX145

B3

1921

UNIVERSITY OF CALIFORNIA LIBRARY

